

RADIO-CRAFT

HUGO GERNSBACK, Editor



WAR!
— By RADIO
REMOTE CONTROL
See Page 328



"MY TIME IS . . ."

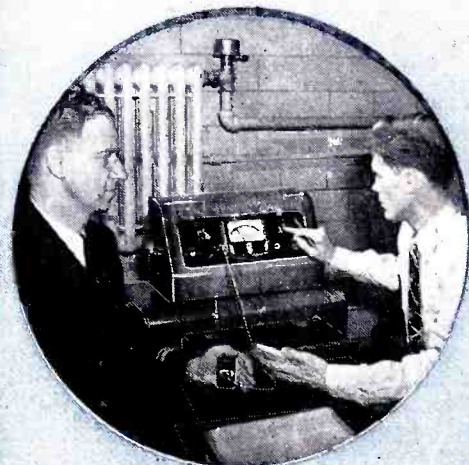

"AFFECTOMETER"



SEXTUPLEX



CONE ANTENNA

RADIO'S GREATEST MAGAZINE

25c

CANADA 30c

AMPERITE Announces the **BIGGEST ADVANCE**
in the Dynamic since its Inception!

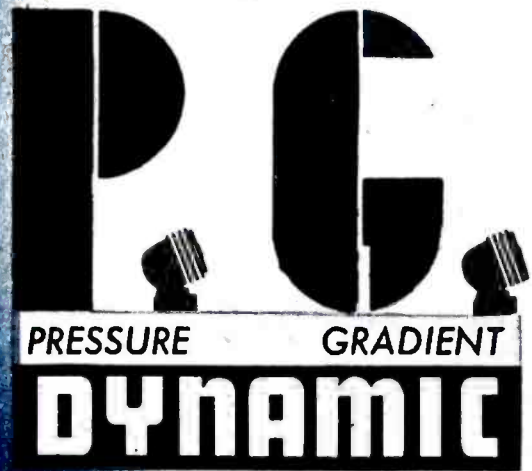

UNI-DIRECTIONAL. NEW
REFLECTOR, ELIPSOID PICKUP PATTERN

ELIMINATES FEEDBACK

FLAT RESPONSE



**COMBINATION VELOCITY-DYNAMIC
ACHIEVED WITH
ACOUSTIC COMPENSATOR**

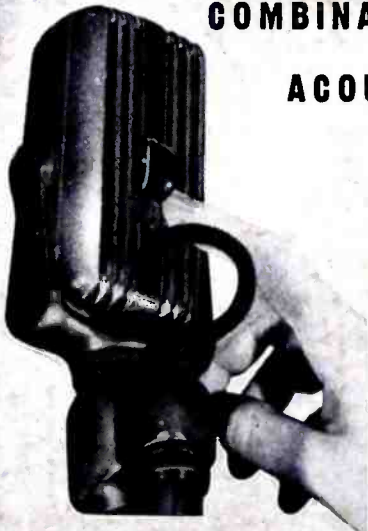

An exclusive Amperite feature: By moving up the Acoustic Compensator you change the AMPERITE VELOCITY to a DYNAMIC microphone without peaks. At the same time you reduce the back pick-up, making the microphone practically UNI-DIRECTIONAL.

WITH ACOUSTIC COMPENSATOR:
MODEL RBHk; RBMk (200 ohms) with switch, cable connector.

Chrome. LIST \$42.00

RSHk; RBSk (200 ohms). Switch, cable connector, Acoustic Compensator.

Chrome or Gunmetal. LIST \$32.00

AMPERITE KONTAK MIKE
Puts Musical Instruments Across



So beautiful is the tone produced with the Kontak Mike, that it was used in the Philadelphia Symphony to amplify a mandolin solo. Gives excellent results with any amplifier, radio sets, and record players.

MODEL SKH (hi-imp) LIST \$12.00

MODEL KKH, with hand volume control. LIST 18.00

Plug extra List 1.50

FOOT PEDAL, for making beautiful crescendos LIST 12.00

WRITE FOR FREE SALES AIDS

AMPERITE ©.

561 BROADWAY, N. Y. U. S. A.

**Men NOW in Radio
who Don't Think
they know it ALL
Read This**

You don't want to see younger, better-trained men push ahead of you, I know. You don't want Radio's new technical developments to baffle you either, I am sure. You want to get ready to "cash in" on Television. Frequency Modulation, too. I have helped many already in Radio to win promotions, to make more money. Read my message below.

**J. E. SMITH, President
NATIONAL RADIO INSTITUTE
Established 25 years**

He has directed the training of more men for Radio than anyone else—has helped men already in Radio to get ahead, and men not in Radio to get into Radio and win success.



**If You're NOT
Working in Radio Now
Read This**

Do you want to make more money? Do you want to cash in on your present interest in Radio, Television, Frequency Modulation? Do you want a full-time job with good pay in one of Radio's many fascinating branches? Or do you want to make extra money in your spare time to boost your present income? If you want to do either of these things—you owe it to yourself to find out how I have trained hundreds of men for jobs in Radio. MAIL THE COUPON BELOW—TODAY.

Make Me Prove I Can Train You at Home for RADIO and TELEVISION

Clip the coupon and mail it. I'm certain I can train you at home in your spare time to be a Radio Technician. I want to send you a sample lesson free; to examine, read. See how clear and easy it is to understand. See how my Course is planned to help you get a good job in Radio, a young, growing field with a future. You don't have to give up your present job, or spend a lot of money to become a Radio Technician. I train you at home nights in your spare time.

**Many Radio Technicians Make
\$30, \$40, \$50 a week**

Radio broadcasting stations employ operators, technicians, and pay well for trained men. Radio manufacturers employ testers, inspectors, servicemen in good-pay jobs with opportunities for advancement. Radio jobbers and dealers employ installation and servicemen. Many Radio Technicians open their own Radio sales and repair businesses and make \$30, \$40, \$50 a week. Others hold their regular jobs and make \$5 to \$10 a week fixing Radios in spare time. Automobile, police, aviation, commercial Radio; loudspeaker systems, electronic devices, are newer fields offering opportunities to qualified men. My Course includes

Television and Frequency Modulation which promise to open good jobs soon.

Charles F. Helmuth, 419 N. Mass. Ave., Atlantic City, N. J., writes: "I started Radio in the Marines. Later I took the N. R. I. Course. Now I am my own boss, and get jobs over others who were sure they had them. I owe plenty to N. R. I. Training." James E. Ryan, 119 Pebble St., Fall River, Mass., writes: "I was working in a garage when I enrolled with N. R. I. I am now Radio service manager for the M— Furniture Co. for their four stores."

**Many Make \$5 to \$10 a Week Extra
in Spare Time While Learning**

The day you enroll, in addition to my regular Course, I start sending you Extra Money Job Sheets—start showing you how to do actual Radio repair jobs. Throughout your Course I send plans and directions which have helped many make \$5 to \$10 a week extra in spare time while learning. I send special Radio equipment; show you how to conduct experiments, build circuits. My 50-50 training method makes learning at home interesting, fascinating, practical. I devote more than 10 Lesson Texts exclusively to Television, and in addition Television fundamentals are covered by my regular Course.

You Get This Professional Servicing Instrument

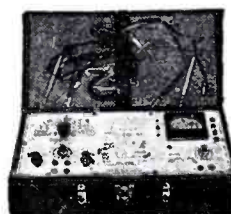

This instrument makes practically any test you will be called upon to make in Radio service work on both spare time and full time jobs. It can be used on the test bench, or carried along when out on calls. It measures A.C. and D.C. voltages and currents; tests resistances; has a multi-band oscillator for aligning any set, old or new. You get this instrument to keep as part of your N. R. I. Course.

**Get Sample Lesson and 64-Page Book
Free — Mail Coupon**

Act today. Mail coupon now for Sample Lesson and 61-page Book. They're FREE. They point out Radio's spare-time and full-time opportunities and those coming in Television; tell about my Course in Radio and Television; show more than 100 letters from men I trained, telling what they are doing and earning. Read my money back agreement. Find out what Radio offers you. Mail the coupon in envelope or paste on penny postcard—NOW!

**J. E. SMITH, President
Dept. ONX, National Radio Institute
Washington, D. C.**

SAMPLE LESSON FREE

I want to prove that my Course gives practical, money-making information; is easy to understand—is what you need to master Radio. My sample lesson text, "Radio Receiver Troubles—Their Cause and Remedy," covers a long list of Radio receiver troubles in A.C., D.C., battery, universal, auto, T.R.F., super-heterodyne, all-wave, and other types of sets. And a cross reference system gives you the probable cause and a quick way to locate and remedy these set troubles. A special section is devoted to receiver checkup, alignment, balancing, neutralizing and testing. Get this lesson FREE. No obligation. Just mail coupon.

GOOD FOR BOTH 64 PAGE BOOK FREE SAMPLE LESSON FREE

**J. E. SMITH, President, Dept. ONX
National Radio Institute
Washington, D. C.**

Dear Mr. Smith: Mail me FREE, without obligation, your Sample Lesson and 64-page book, "Rich Rewards in Radio," which tells about Radio's spare-time and full-time opportunities and explains your 50-50 method of training men at home to be Radio Technicians. (No salesman will call. Write plainly.)

(Please Check)

I AM doing Radio work. I am NOT doing Radio work.

Name Age

Address

City State **14X1**

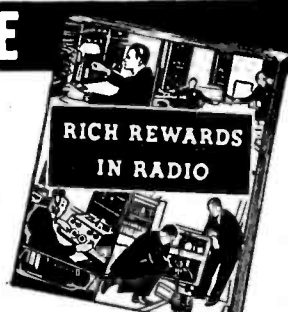

RADIO-CRAFT

HUGO GERNSBACK, *Editor-in-Chief*

N. H. LESSEM
Associate Editor

THOS. D. PENTZ
Art Director

R. D. WASHBURNE, *Managing Editor*

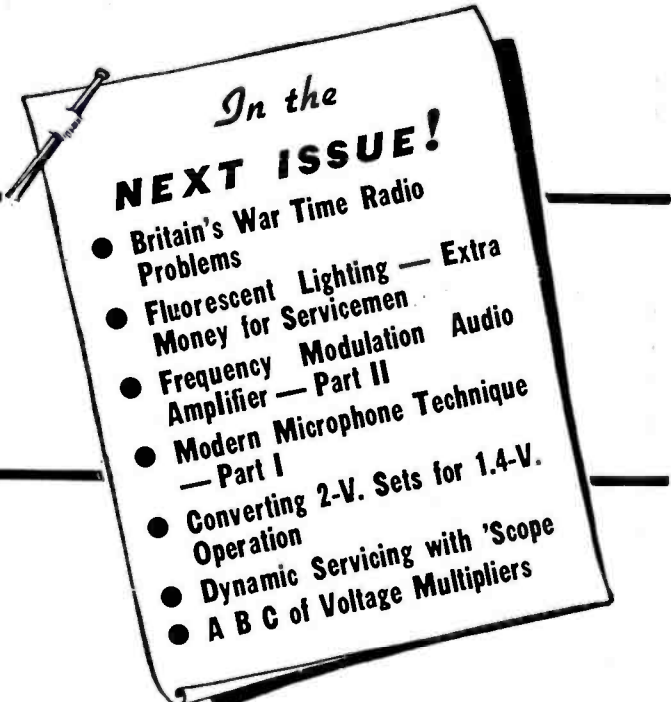

Contents DECEMBER, 1940 Issue

VOLUME XII -- NUMBER 6

Mailbag	323
Editorial: Unique Radio Uses	Hugo Gernsback 327
The Radio Month in Review	328

SERVICING

New Circuits in Modern Radio Receivers—No. 39	F. L. Sprayberry 330
Operating Notes	331
Lucrative Sideline for Servicemen—in Electroplating	Harry Dodge 332
RADIO SERVICE DATA SHEETS:	
No. 296—Galvin "Motorola" Model B-150 Bicycle Radio ..	334
No. 297—Stromberg-Carlson Model 500 Series (Models 500-H, 500-J and 500-S)	336
Servicing Troubles	L. C. Juergens 335

F.M.

The ABC of Frequency Modulation	G. H. Browning and F. J. Gaffney 337
A New A.F.-Drift Correcting, Signal-Balancing Direct-Coupled F.M. Audio Amplifier—Part I	A. C. Shaney 350

TEST INSTRUMENTS

Build This Practical Vibrator Tester	Roger Dickey 340
Manufacturers' Tube Replacement Codes and Policies	344
25-Range Test Meter	Milton Reiner 346

SOUND

Sound Engineering—No. 12	Conducted by A. C. Shaney 348
A New A.F.-Drift Correcting, Signal-Balancing Direct-Coupled F.M. Audio Amplifier—Part I	A. C. Shaney 350
Case Histories of P.A. Sales—No. 12—Funeral Parlor Sound System	Ray W. Winter 355

ENGINEERING

Sound Engineering—No. 12	Conducted by A. C. Shaney 348
Circuit Applications for the Miniature Tubes	358

EXPERIMENTERS

Building a Modern Miniature-Tube Metal-Treasure Locator	G. M. Bettis 364
---	------------------

RADIO DEVELOPMENTS

Station WOR Gets F.M. Voice	367
Present Status of F.M. Broadcasting	Dick Dorrance 367
Latest Radio Apparatus	369

DEPARTMENTS, ETC.

Mailbag	323
The Radio Month in Review	328
New Circuits in Modern Radio Receivers—No. 39	F. L. Sprayberry 330
Operating Notes	331
RADIO SERVICE DATA SHEETS (See Servicing)	334, 336
Book Reviews	343, 345, 357, 384
Sound Engineering—No. 12	Conducted by A. C. Shaney 348
Case Histories (See Sound)	355
Latest Radio Apparatus	369
Classified Radio Directory—Section III	375
Shop Notes—Kinks—Circuits	363, 382



Published by Radcraft Publications, Inc. Publication office: 29 Worthington Street, Springfield, Mass. Editorial and Advertising Offices: 20 Vesey Street, New York City, Chicago Advertising Office: RADIO-CRAFT, 520 North Michigan Avenue, Chicago, Ill.

RADIO-CRAFT is published monthly, on the first of the month preceding that of date; subscription price is \$2.50 per year in U. S. (In foreign countries, 75c additional per year to cover postage; Canada, 50c additional.) Entered at the post office at Springfield as second-class matter under the act of March 3, 1879.



Foreign Agents:

London—Gorrings's American News Agency, 9A Green St., Leicester Square, W. C. 2, England.
Paris—Messageries Dawson, 4 Rue Faubourg, Poissonniere, France.
Melbourne—McGill's Agency, 179 Elizabeth St., Australia.
Dunedin—James Johnston, Ltd., New Zealand.



Text and illustrations of this magazine are copyright and must not be reproduced without permission of the copyright owners.



Copyright 1940 Radcraft Publications, Inc.

AN OL' TIMER TALKS

Dear Editor:

As a precedent, by virtue of which, I'm not exactly a stranger in your columns, I refer you to my article in your *Radio-Craft* of October 1933—page 223.

Well, that was way back in the "Dizzy '30s"—and now as we are getting a good start into the "Roaring '40s", I feel the urge again. Unlike the last crack which was more on the technical side, I'm going to stick my neck out this time way over on the economic side.

It has been my good fortune to become personally acquainted with more radio Servicemen than the average. For example, in 1939 I barnstormed through 43 states, Canada and Mexico (of course such a swing included the Frisco and New York Fairs)—so my story need not be confined to the rather limited horizon of Vinegar Bend, Loadyville, Chitling Switch or even Main Street—nor need it be excluded from Miami, Los Angeles, Denver or even The Cross Roads of the World at 42nd and Broadway!

The schedule, herewith, of costs, entitled "Why It Costs the Average Serviceman \$4.33 to Repair the Average 'Radio'" is self-explanatory, and we all know that we don't average that \$4.33 receipts for the average job and we don't need any auditor to tell us how "unrich" we are getting very fast at that speed!

Somewhere along Main Street between Vinegar Bend and The Crossroads of the World, I must have skipped "That Man Who Knows"—so won't somebody please speak a piece for "That Little Man Who Wasn't There?"

QUINCY GIBBON,
Rolling Fork, Miss.

See illustration, on page 324, of Mr. Gibbon's business-getting sales slip.

2-BIT NEWSSTAND CUSTOMER

Dear Editor:

Can a 2-bit newsstand customer have your ear? Keep *Radio-Craft* for the Serviceman. *QST*, *Radio News*, and *Radio* cover the Amateur field to a satisfying fullness. Constructional articles for beginners likewise are covered well by *RADIO & TELEVISION*. Keep, yes even expand, articles such as those by Sprayberry and Shaney. As for Operating Notes, each month's crop I enter in my Rider's index. Re: Philco Warranty Station Plan placing more money in hands of Servicemen, well, maybe. At least they don't say yes nor do they say no. Philco always produced money for Servicemen but OH those headaches.

JOHN E. HUSSEY,
Salem, Mass.

DOESN'T AGREE WITH OUR BOSS

Dear Editor:

I have been in the Servicing business for the past 2 years. During the same period I have subscribed to *Radio-Craft*.

I have always enjoyed your Editorials. In fact I practically always agreed with you. However, I cannot absolutely agree with the Editorial in the August number. Not that I would say (as you were afraid some Servicemen would) that you know nothing about the subject. Probably you know much more than I'll ever know about the business conditions of the average Servicemen all over our great country. However, I believe you will agree with me when I say that there are exceptions which prove the Rule. ; Let me tell you about the conditions in this farming district in southwestern Iowa.

In the first place Mr. Farmer just loves to save money. He will pay 25c for a tool

MEISSNER—and F-M

the only COMPLETE line
for Listeners and Experimenters

CONSOLE F-M RECEIVER

For highest quality, noiseless, static-free reproduction of Frequency Modulated Broadcasts, this big console receiver is the finest obtainable!

Its powerful, 13-tube chassis, with built-in super-sensitivity, together with a special high-fidelity P-M Dynamic speaker in the large bass-reflex tone chamber assure the discriminating listener of maximum satisfaction. Covers the complete F-M frequency range (42 to 50 MC) and is provided with a very flexible five-position "tone" control—exactly the right quality at your fingertips!

The large, walnut-finished cabinet is a work of art in itself—41 inches high, 30 1/4 inches wide and 15 1/2 inches deep—massive, but well proportioned. The special bass-reflex tone chamber is completely enclosed at the rear for most effective baffling. Rich, two-toned veneers provide a beauty seldom seen except in the highest-priced receivers.

Model 9-1037 List \$135.00

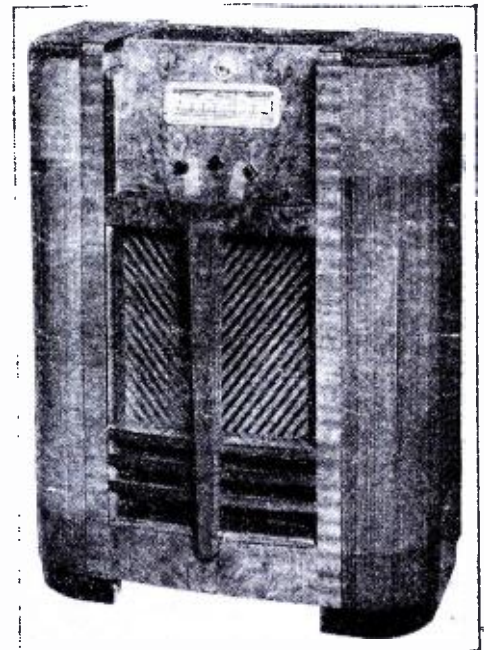

TABLE MODEL F-M RECEIVER

This model is identical in all respects to the Console Model described above except for the size and shape of the cabinet. Uses the same 13-tube chassis and same high-quality P-M speaker. Housed in a beautiful two-tone walnut cabinet, 12 1/4" high, 22 3/4" wide and 11" deep it provides a convenient economy of space but at the same time, permits a quality of reproduction impossible with an ordinary type receiver.

Model 9-1023 List \$99.25



R-F TUNING ASSEMBLY

For the experimenter who wants to build his own! Complete "front end" of the F-M receiver, wired and tested, ready to install in chassis as single unit.

01340 List \$17.50



4.3 MC I-F TRANSFORMER

Special, wide-acceptance band I-F transformers designed for all stages between the mixer and limiter tubes. Double-tuned, set at 4.3 MC.

01348 List \$1.75



DISCRIMINATOR TRANSFORMER

The "heart" of the F-M receiver, this wide-band transformer is specially designed for its important position between the limiter and detector. Air-tuned.

01350 List \$6.00

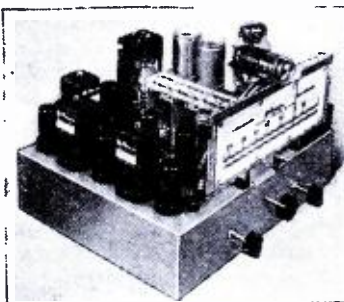

F-M CHASSIS ONLY

The same chassis used in both the above receivers—separately available for installation in your own cabinet! Complete and ready to operate, less tubes and speaker. See it at your Jobbers!

9-1041 List \$68.30

Ask About the New Meissner Recorders!

ORDER THIS INSTRUCTION BOOK

See your Jobber at once or send 50c direct for your copy of the big 168-page Meissner Instruction Manual. Contains latest data on Frequency Modulation, complete circuit and pictorial diagrams on Meissner kits.

ASK FOR FREE CATALOG

Get your name in early! Brand new Meissner General Catalog will be ready soon. Lists hundreds of items of interest to the serviceman and experimenter. You can't afford to be without it. Order yours today!

ADDRESS DEPT. C-12





Learn RADIO SERVICE WORK with these 2 BIG Ghirardi BOOKS

MODERN Radio SERVICING

Learn How with this!

Here's the world's most highly praised course in practical radio service work—all for you in this one handsome 1300-page home-study book. First, a big 420-page section explains all types of servicing test instruments—how they work, how constructed, how to build, how to use them. Then, 900 more pages give you a thorough, step-by-step procedure course in trouble-shooting, testing, aligning and repairing all makes of radio sets and other electronic devices by latest scientific "factory methods." Learn radio servicing this quick, easy, economical way. Learn **WHAT** to do and **HOW** to do it. Get your copy today. **\$4**

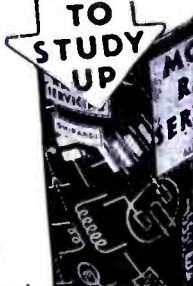

RADIO Trouble-Shooters HANDBOOK

Save Time with this!

Here's real help for servicemen—518 big manual-size pages of valuable, time-saving, factory-checked servicing data right at your finger tips to help you do every servicing job quickly and accurately. Its **52 BIG SECTIONS** contain 275 large pages of time-saving "Case Histories" on over 3,300 receivers. Alignment data for over 15,000 sunchets. Servicing and installation data for all Auto Radios. Trouble-Shooting Charts. Tube, Resistor and Capacitor Charts. **EVERYTHING!** Speed up your service work with all the vital servicing data NOW in this one big book. **\$3**



MAIL COUPON TODAY!

Radio & Tech. Publ. Co.
45 Astor Pl. New York
Dept. RC-120

Enclosed find payment for:
 MODERN RADIO SERVICING RADIO TROUBLE-SHOOTER'S HANDBOOK BOTH books at \$8.30 Money-Saving Combination Price

Check here for FREE Circulars.

NAME

ADDRESS

CITY STATE

MONEY-BACK IF NOT SATISFIED!

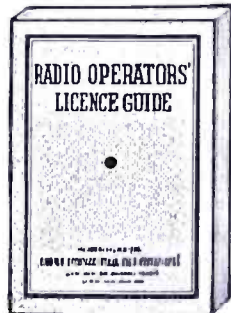

RADIO OPERATORS' LICENSE GUIDE

SECOND EDITION

Containing over twelve hundred and fifty acceptable answers to the new "Six Element" radio operator license examination questions as embodied in the Federal Communications Commission Study Guide.

YOU NEED THIS GUIDE TO PASS YOUR EXAMINATION

\$3.00 Postpaid, refunded if not satisfactory.

Wayne Miller, Suite 200
Engineering Building
Chicago, Illinois



Be a RADIO SERVICE EXPERT LEARN AT HOME IN SPARE TIME

Clear, simple, fascinating lessons—practical work with experimental kits—make training easy and fast. Up to date R.T.A. methods, under personal guidance of prominent engineer and educator, highly endorsed by leaders in radio industry. Spare-time profits soon pay for training.

START NOW — have your own business or fit yourself for well paid work with radio dealers, in factories, police, marine or television fields. **DON'T DELAY!** Send **AT ONCE** for complete information and Big Opportunity. **BOOK FREE!**

RADIO TRAINING ASS'N. OF AMERICA
1559 Devon Ave. Dept. RC-120 Chicago, Ill.



Correspondence Courses in RADIO and ELECTRICAL ENGINEERING

ELECTRICAL ENGINEERING Get good grasp of wide electrical field. Prepare yourself, at Low Cost, for secure future. Modern, simplified, you can understand quickly.

RADIO ENGINEERING Extra fine course in radio, public address, photo-electric work. Trains you to be super-service man, real vacuum tube technician. Exper. kits furnished. Diploma on completion. Tuition, \$25. either course. Deferred payment plan. **FREE** Get copies of school catalogs, student magazines, complete details. **SEND NOW!**

LINCOLN ENGINEERING SCHOOL, Box 931-C24, LINCOLN, NEBR.

Mr. Quincy Gibbon of Rolling Fork, Miss., has developed the business-getting sales ticket shown in the illustration at right. The obverse and reverse sides of this sales slip are shown. Mr. Gibbon's description of his service experience is given on pg. 323.

Mr. _____
Residence _____ Phone _____
Business _____ Phone _____
Radio _____ Model _____

RADIO CITY
Where Your Music Begins
258 DELTA ST. QUINCY GIBBON PHONE 1145

Service Call	6	\$1.50
Shop Labor	6	\$1.50
Trips	6	\$.25
Resistors	6	\$.25
Bypass Condensers	6	\$.25
Filter Condensers	6	\$1.15
Audio Transformers	6	\$1.25
I. F. Transformers	6	\$2.25
Volume Controls	6	\$1.25
Pilot Lights	6	\$.25
Knobs	6	\$.10
Tubes		
Batteries		
Other Material		
Complete Overhaul	TOTAL	
On Contract Price	C. O. D.	
	17	By Cash
Balance Due - Please Remit		

Dealer's Flat Rate:
\$2.00 per Job Plus Material at Wholesale Cost.

Why It Costs The Average Service Man \$4.33 To Repair The Average Radio

Monthly Overhead:

1 Salary (300 hours @ 50c)	\$ 150.00
2 Automobile	60.00
3 Rent	20.00
4 Lights	10.00
5 Telephone	10.00
6 Heat and Ice	10.00
7 Stationery and Postage	10.00
8 Advertising	10.00
9. Instruments, Tools & Service Manuals	10.00
10 Interest, Insurance and Taxes	10.00
Sub Total	\$ 300.00
Tubes, Batteries and Parts	1 Month
Grand Total	Est. Month
PROFIT	NONE

SO WHAT?

Here's What!

His cost per job, assuming 30 working days per month and material costing \$1.00 per job and an average of 3 jobs per day will be: \$390.00 ÷ 90 = \$4.33 actual cost per job.

Print Limit From 13000

which would last a year much easier than he would pay 50c for a better tool which would last 5 years. All he can see is his immediate saving.

I grew up in this district and right here in Glenwood, I saw Servicemen working for only 50% of what they ought to get. I was of the opinion that if a man had the nerve to ask good prices he could get it. Provided of course that he had all the instruments necessary to do good work with and that he put in good quality parts.

When I became sufficiently interested in servicing to make it my career, I still held to this viewpoint. I prepared myself for servicing with a National Radio Institute course. I bought the best instruments and stocked high-quality parts.

I started out with an estimate charge of \$1.00 and an hour charge of \$1.50. None of my competitors charged for an estimate. I got very few sets. Lots of people inquired, but my! how their eyebrows lifted at the dollar estimate charge. I dropped this charge to 50c and got more business. Finally I dropped it altogether. Again I got more business. However I still wasn't doing very well. Where my competitors would get \$3. for a job I'd get \$6. Mr. Farmer found that out soon enough. Neither of my competitors had as complete a line of instruments; neither had as good a stock. But they got the business. I advertised 3 times as much as they. And what is more important I gave the advertising a chance by running it for more than a year. The direct results from the ads was so small as to cause me to finally cancel all my advertising.

Now I am charging not by the hour, but by the set, and trying not to let any set that comes into the shop for an estimate go out without my fixing it up. Since the best prices I get are only 50% of what I should be getting, the prices I sometimes get are downright pitiful.

However I am still in business and am

getting more business all the time. I am working for the same prices as my competitors but since I have a better equipped shop I do better work and the work stands up longer.

What I am now wondering though is how will I keep my equipment at the standards I desire at the prices I am forced to work at?

The answer to this must lie in a union of Servicemen to set prices for all servicing at a fair level so that the Serviceman gives good value and also gets good wages for his work.

No, Mr. Gernsback, not all of us Servicemen are heading toward the poorhouse because of lazy, halfhearted methods. Some of us are forced to it by ignorant people who will not recognize good work, good equipment, good training, and good parts.

I think that the servicing situation is different in cities. Of course servicing costs are higher in a city, but their prices even then leave a bigger profit than in towns like Glenwood, where the chief source of revenue is the farmers. People in cities seem to have more ideas of the necessity of equipment. The farmer must be educated to this thought also. It will take a million years to do this however. Mr. Farmer is a very hard-headed individual.

ARTHUR BARNES,
Glenwood, Iowa.

... Re: Sept. "R.-C."

Dear Editor:

Your article on F/M Rcvrs. on page 148 is very interesting, and I suppose you fellows will give us some more articles as we go along, which is FB for us fellows.

Here is a diagram using type 30 tubes that a local Ham has had some trouble with, due to microphonics, etc., in the set. Can you publish some data on this? He has tried all kinds of "rigs" without getting results

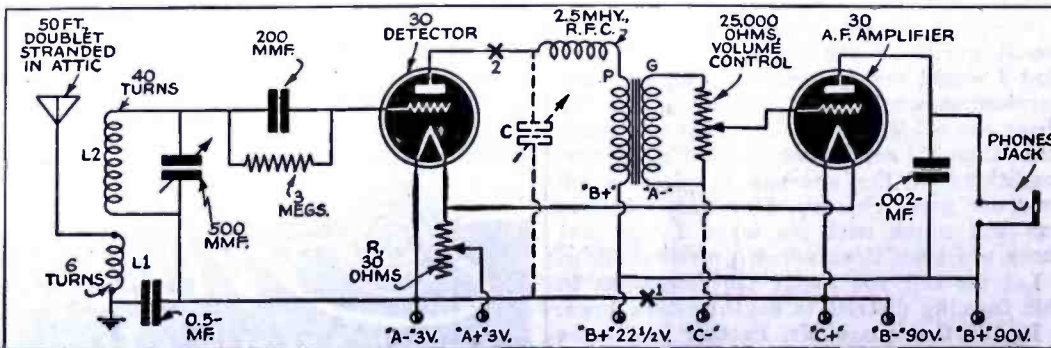

The circuit which troubled Mr. Sherwood and his friend.

that are anywhere near expectations. Perhaps an article on some such, would be of general interest to others, who have had "jumbles"?

The loop adapter write-up on page 169, by Leutz, is very FB & will meet with much interest, particularly when the days are with humidity around 95%!

Well that's about all from here, and I hope to be able to send some \$ your way, a little later for that 1941 year!

Thank you, & 73 for now. Your 1/4x8 (?—Ed.) &— . —

HENRY SHERWOOD,
Bridgeport, Conn.

The circuit mentioned by Mr. Sherwood is reproduced here. The original diagram shows the use of a Hammarlund R.F. choke and Baldwin type C magnetic headphones.

It is unfortunate that Mr. Sherwood did not supply sufficient details as to just what expectations the owner of this set had, and to what extent this receiver failed to meet these expectations.

Perhaps the complaint of microphonics was due to a lack of a grid-return in the A.F. amplifier. We have returned this grid to a negative "C" voltage as indicated in dotted lines. If a condition of excessive microphonics is still experienced it is possible that one or both of the tubes should be replaced with more sturdy ones of the same type number; transposing the present tubes may eliminate the trouble. It is also possible that the detector gridleak of 3 megs. may be open or at much higher than the rated value.

By proper adjustment of the gridleak value reproduction of fair quality may be obtained with 90 V. on the plate of the detector. However greater sensitivity will result if the plate-return lead is broken at X1 and the plate voltage reduced to about 22 1/2 V. The best value may be determined by experiment.

A third or tickler coil may be connected into the plate circuit by breaking the plate lead at X2. If this coil is brought into inductive relation with coil L2, regeneration may be obtained if the polarity of this coil is correct. Regeneration greatly increases the selectivity and sensitivity of a set of this type. Regeneration may be controlled by connecting a variable condenser, C, as shown dotted; if a commercial 3-coil assembly is used the correct capacity for this position ordinarily is specified in wiring instructions which accompany the coil kit.

THAT "READY FOR TELEVISION" BUSINESS

Dear Editor:

Maybe your readers will get a kick out of the *enclosed marked news clipping if they have not already seen it. It was taken from the Feb. 14, 1940, edition of *The News-Sentinel*, Ft. Wayne, Ind.

E. W. MILLER,
Ft. Wayne, Ind.

*Reproduced below.

Trying to get ahead in the radio business is a virtue. The question is, are you trying to get ahead of want, your

Every radio you see now has a push button for television, but darned if we can find the place where the picture would be if there was any.

LEARN RADIO

at HOME in SPARE TIME

More Jobs FOR MEN WITH RADIO TRAINING!



972-Page Course in RADIO, SOUND, ELECTRICITY, TELEVISION, CATHODE-RAY TUBES, ETC.

36 Volumes in 1

Brand-new opportunities are opening up everywhere for men with basic radio training! Thousands of radio jobs are being created by the new National Defense activities—more radio jobs in Radio Manufacturing—more work for Service Men—and best of all, thousands of new radio jobs are being provided by the Army expansion plans. There's actually a shortage of trained radio men now!

ARMY PAYS PREMIUM TO RADIO MEN!

Every branch of the military service needs men with radio and electrical knowledge so urgently, that they command a premium in pay and in rank. In fact, those who reach top rank as non-commissioned officers get 6 times more than a private's base pay! Think that over—a knowledge of radio fundamentals will mean MORE MONEY and RANK to you, whether you are planning to enlist now or wait for conscription.

Ghirardi's

COMPLETE 1-Vol.

COURSE WILL TRAIN YOU Quickly!

Grab This Big

OPPORTUNITY



TO LEARN RADIO NOW—AT HOME!

How can you cash in on this situation? You don't need to be held back because you lack the necessary radio knowledge. Learn Radio Now—at Home! You can get exactly the training you need in short order—all from this world-famous big 972-page Ghirardi book. Read it at home in your spare time. No long, tedious course. No expensive "lessons." You get everything complete in one handy, bound volume—and you learn it quickly! Thousands of successful radio men started their careers this way.

Ghirardi's Clear Explanations Make Course AS EASY AS A.B.C.

RADIO PHYSICS COURSE is as easy to read as your daily newspaper. It's absolutely amazing the way Ghirardi explains every phase of Radio so simply and so clearly that you understand it immediately. It's as easy as a primer. That's why leading radio schools use it the world over. No previous study is necessary—no "math." And the beauty of it is, you teach yourself—checking with 856 Review Questions!

COMPLETE COURSE IN 1 BIG BOOK

RADIO PHYSICS COURSE is a miracle of condensation. It's really thirty-six different instruction courses covering the entire vast field of radio all packed into one easy-reading home-training book of nearly a thousand illustrated pages. Your training is planned logically, thoroughly and comprehensively. Step by step, Ghirardi takes you rapidly from the very first principles of Sound and Electricity right on up through the very newest things in Radio and Television. He explains all the essentials you need for a complete knowledge of all modern radio fundamentals.

YOU SAVE MONEY!

Never before has it been possible to master the study of radio so easily, so quickly and so economically! You'd pay at least Fifty Dollars for radio instruction like this elsewhere . . . but you get it all in this 1 book for only \$4. Check over the list of 36 Chapter Sections in the next column—see what the RADIO PHYSICS COURSE will teach you!

RADIO, ELECTRICITY and SOUND Complete Plus Many Other Valuable Special Features Are Covered in These 36 Big Chapter-Sections. 972 Pages. 508 Diagrams, Charts and Photos. 856 Review Questions.

- | | |
|--|---|
| 1. Radio Broadcasting System. | 19. Construction Features of Vacuum Tubes. |
| 2. Sound, Speech and Music as Related to Broadcasting. | 20. Vacuum Tube Detector and Amplifier Action. |
| 3. Electron Theory. Electric Current. | 21. Radio Frequency Amplification. |
| 4. Electrical Units. Ohm's Law. Resistance. | 22. Superheterodyne Receivers. |
| 5. Electrical Circuits. Batteries. | 23. Design of R.F. Amplifiers and Tuning Coils. |
| 6. Magnetism. | 24. Audio Amplification. |
| 7. Electromagnetism. | 25. Loud Speakers. |
| 8. Electromagnetic Induction. | 26. Battery Operated Receivers. |
| 9. Inductance and Inductors. | 27. Power Supply Units. |
| 10. Capacitance and Condensers. | 28. Electric Receivers. |
| 11. Alternating Current Circuits. | 29. Automobile and Aircraft Receivers. |
| 12. Electric Filters. | 30. Phonograph Pickups and Sound Amplifier Systems. |
| 13. Electrical Measuring Instruments. | 31. Short Wave Reception. |
| 14. Electromagnetic Radiations. | 32. Vacuum Tube Applications and Photoelectric Cells. |
| 15. Radio Transmission, the Broadcasting System. | 33. Television. |
| 16. The Receiving Station, Detection with Crystals. | 34. Antennas and Grounds. |
| 17. Elementary Study of the Vacuum Tube. | 35. Testing and Servicing. |
| 18. Vacuum Tube Characteristics. | 36. Sound Motion Pictures. Appendixes (Charts, Tables). |

USE IT 5 DAYS —OUR RISK

You can't possibly lose—for our Money-Back Guarantee protects you 100%. Send for the book. Read it for 5 days. If you're not fully satisfied, return it in good condition. We will refund your money at once—no fuss—no trouble. Take us up on this offer—fill out and mail this coupon—AT ONCE!

\$4
Only

RUSH COUPON TODAY

RADIO & TECHNICAL PUBL. CO. Books Shipped
45 Astor Place, New York Dept. RC-120 Postpaid Anywhere

Enclosed find \$4 (\$4.50 foreign) for my copy of Ghirardi's "RADIO PHYSICS COURSE" (2nd Edition) with your 5-day Money-Back Guarantee.

NAME
ADDRESS
CITY STATE

Please send me free descriptive literature about "RADIO PHYSICS COURSE."

Get Started - RUSH COUPON NOW!

RADIO TECHNOLOGY

RCA Institutes offer an intensive course of high standard embracing all phases of Radio and Television. Practical training with modern equipment at New York and Chicago schools. Also specialized courses in Aviation Communications, Radio Servicing and Commercial Operating. Catalog Dept. RC-40.

RCA INSTITUTES, Inc.
A Radio Corporation of America Service
75 Varick St., New York, 1154 Merchandise Mart, Chicago

RADIO-TELEVISION

Oldest, largest Radio-Television school in West trains you for good pay job. Complete instruction including Radio Construction and Service, Broadcast Operating, Sound, Talking Pictures, Television, Public Address, etc. Flexible plan to meet specific needs of those with or without jobs. Transportation allowed to L.A. Earn room and board while learning. Request Free Catalog.

NATIONAL SCHOOLS Dept. RC-12
Los Angeles



**THIS
BEAUTIFUL DESK
for only \$1.00 EXTRA**

**WITH ANY
REMINGTON
PORTABLE TYPEWRITER**

The
COMBINATION
FOR AS LITTLE AS
10¢ A DAY

How easy it is to pay for this combination of desk and Remington Deluxe Noiseless Portable Typewriter! Just imagine, a small good will deposit with terms as low as 10c a day to get this combination at once! You will never miss 10c a day. Yet this small sum can actually make you immediately the possessor of this amazing office at home combination. You assume no obligations by sending the coupon.

A beautiful desk in a neutral blue-green which will fit into the decorations of any home—trimmed in black and silver—and made of sturdy fibre board—is now available for only one dollar (\$1.00 extra) to purchasers of a Remington Noiseless Portable Typewriter. The desk is so light that it can be moved anywhere without trouble—it is so strong that it will hold six hundred (600) pounds. With this combination of desk and Noiseless Deluxe Portable Typewriter, you will have a miniature office at home. Learn the complete details of this offer. Mail the coupon today.

THESE TWO EXTRA FOR YOU

LEARN TYPING FREE

To help you even further, you get free with this special offer a 32-page booklet, prepared by experts, to teach you quickly how to typewrite by the touch method. When you buy a Noiseless you get this free Remington Rand gift that increases the pleasure of using your Remington Noiseless Deluxe Portable. Remember, the touch typing book is sent free while this offer holds.

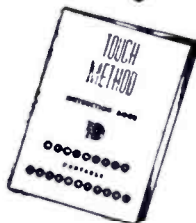

SPECIAL CARRYING CASE

The Remington Deluxe Noiseless Portable is light in weight, easily carried about. With this offer Remington supplies a sturdy, beautiful carrying case which rivals in beauty and utility the most attractive luggage you can buy.



SPECIFICATIONS

ALL ESSENTIAL FEATURES of large standard office machines appear in the Noiseless Portable—standard 4-row keyboard; back spacer; margin stops and margin release; double shift key and shift lock; two color ribbon and automatic ribbon reverse; variable line spacer; paper fingers; makes as many as seven carbons; takes paper 9.5" wide; writes lines 8.2" wide. There are also extra features like the card writing attachment, black key cards and white letters, touch regulator, rubber cushioned feet. These make typing on a Remington Deluxe Noiseless Portable a distinct pleasure. Thousands of families now using the Remington Deluxe Noiseless Portable know from experience how wonderful it is!



**MAIL
COUPON
NOW!**

Remington Rand Inc., Dept. 189-12
465 Washington St., Buffalo, N. Y.

Tell me, without obligation, how to get a Free Trial of a new Remington Deluxe Noiseless Portable, including Carrying Case and Free 32-page Typing Instruction Booklet on terms as low as 10c a day. Send Catalogue.

Name.....

Address.....

City.....State:.....

RADIO-CRAFT

"RADIO'S GREATEST MAGAZINE"

. . . random examples of
radio's unusual applications
suggest rich rewards

UNIQUE RADIO USES

By the Editor — HUGO GERNSBACK

WE have become so accustomed to the wonders of Radio, and are taking it so much for granted, that we do not give it much attention these days. Even the technical radio man, after a while, begins to think that the word "radio" stands only for broadcasting in one way or another.

There are, however, hundreds of different uses for radio and the list is constantly growing, so much so, that it becomes difficult, even for the research man to keep track of its widening scope.

When I speak of odd and unique radio applications, I wish to keep almost exclusively to *radio transmitters*, or *receivers*, or both, as we know them today. I purposely stay away from the field of electronics and other allied fields of radio where the applications are extremely large.

Most people probably know of some of the unusual uses of radio, such as for instance, the following:

Shortwave fever apparatus used in fighting various diseases. Then there are the many industrial uses, some of which are fairly well known, as for example cooking by radio, whereby shortwave radio apparatus causes food to be cooked *from the inside out*; in the case of frankfurters cooked in this manner the heat originates in the center and then spreads out to the skin. A parallel application is the high-frequency radio furnace, used in the preparation of chemicals, mixtures, alloys, etc. Experiments have been conducted for some time in an electric horticulture plant where a special, heat-producing radio transmitter is used to speed-up plant growth by ultra-shortwave radiation. This art is as yet in its infancy but shows promise for the future.

Not so well-known are the following, many of them made relatively recently:

The Chicago police are reported to be using a sort of *radio detectivephone* system. In this rather unique application of radio a miniature shortwave transmitter and a microphone are concealed on the body of a detective who thus can walk on the street, or indoors, without anyone knowing that he is a "walking radio station." Cruising along perhaps a few hundred feet away is a police automobile equipped with a radio receiver and sound recorder. Thus should the detective visit a dangerous dive, or abode tenanted by criminals, the operators in the police automobile are enabled to listen-in to anything that goes on in the immediate vicinity of the detective, and should he be attacked, he can summon help instantly. The important point of this use of radio is that no one knows that the detective is carrying a radio station around with him.

There is a radio-equipped, self-contained weather observation station which recently underwent tests at the United States Naval Air Station at Anacostia, D. C. This new *radio weather robot* automatically transmits signals to a remote point. Installed on top of a mountain, it automatically transmits to a distant receiving set, whenever desired, barometric pressure, air temperature, relative humidity, wind direction and velocity, rainfall and other meteorological factors.

Not so long ago there was a 16-year-old girl in Iowa confined to her home during a long illness. Again radio came to the rescue and enabled her to keep up her class work without going to school. A 2-way sound system comprising loudspeakers, linked by telephone wires between her room at home and the class-room in the local school, enabled her to get her education without interruption.

For half-a-century geologists were unable to determine the path followed by a subterranean river, running for 3 miles underground, at Bellview, Ohio. Radio technicians solved the mystery by placing a shortwave transmitter inside an 8-in. rubber ball. This was floated down the river and during its underground journey the technicians, by means of direction-finding radio receivers, were enabled to accurately follow the course of the rubber ball and trace the twisting river.

Enemy airplanes, bombing planes, etc., can be detected when quite a distance away by the reflected radio waves—a radio echo, in other words. The British have great hopes that this system will enable them in due time to locate enemy planes when still a considerable distance off—that is, 25 to 50 miles and perhaps further. There is also in use a special submarine detector, somewhat similar to the airplane detector, which also works by ultra-short waves. The waves are reflected from the submarine and returned to a special receiver which accurately locates the submarine.

Aviation has been greatly benefited by the use of the *radio altitude indicator*, which is a device roughly similar to the echo devices. This is a special radio transmitter which sends an ultra-shortwave signal to the terrain below; the reflected wave is indicated on a panel meter calibrated in feet so that the aviator can read directly how high up he is at any given moment. The radio altitude indicator—an extremely accurate instrument—is of great value, particularly during fogs, heavy rains, nights, etc., when it is impossible to see the ground or water body over which the airplane is flying. Another radio facility operating on the echo principle is the so-called metal or treasure locators whereby 2 special radio sets are used in a certain manner in order to locate underground pipes, buried treasures and the like.

In the exploration of the upper stratosphere and beyond, where it has been impossible so far for human beings to ascend, radio again has come to the rescue. We now have special sounding balloons which carry tiny ultra-shortwave transmitters and which give our meteorologists accurate information as to temperature, wind velocity, special radiations such as cosmic rays, and many other factors that we would not know of otherwise.

Where it is difficult to install wires, due to terrain difficulties or for other reasons, there is now a system whereby the height of water in a reservoir can be accurately relayed back to the power house by shortwave radio. A machine connected with a radio transmitter at the reservoir automatically registers the height of the prevailing water level and the engineer at the distant power station knows at all times exactly the amount of water contained in the reservoir.

• THE RADIO MONTH IN REVIEW •

The "radio news" paper for busy radio men. An illustrated digest of the important happenings of the month in every branch of the radio field.

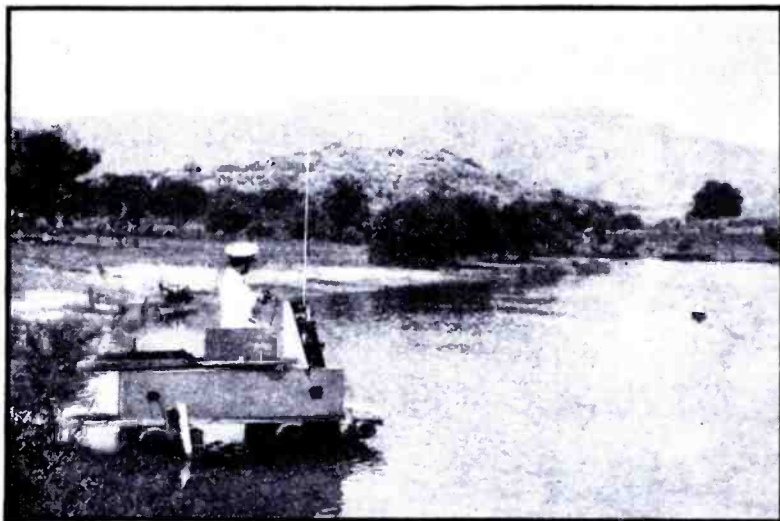

WAR—BY RADIO REMOTE CONTROL (Cover Feature)

"Stills," from the Paramount Pictures, Inc., movie reel, "Popular Science," are shown here and on the cover. A radio transmitter sends shortwave impulses, under telephone-type dial control, which cause the \$10,000 miniature model fleet of Howard E. Bixby, retired mechanical engineer of Glendale, Calif., to automatically turn, aim and fire guns, etc. His 10-ft., 350-lb. vest-pocket battleship *California* is queen of the fleet; his smaller *Kentucky* responds to whistled commands.



SEXTUPLEX

"For the first time in history," says G.E., a voice was carried over every known scientific means of voice communication when George A. Mead, State Commander, broadcast during the American Legion Convention in Schenectady, N. Y., last month.

PREPAREDNESS

UNCLE SAM'S Defense program is now advancing on the double-quick on all fronts. Radio came well forward in the vanguard, last month, when President Roosevelt issued an executive order that established a Defense Communications Board to coordinate all branches of communication—radio, wire and cable—with the national defense, and to prepare plans for operation "during any national emergency."

Air programs dedicated to the purpose of preparedness "just in case," reached a new high in number, last month. The National Association of Broadcasters not only aired the address, "Broadcasters Defend America," but also made it available in a pamphlet. . . . N.B.C. completed plans to send a crew of announcers, engineers and production men on a grand tour of the nation's 13 training centers, to bring to the folks back home, in some measure, news of the young men called-up for training from, mainly, the "21 to 35" group.

The American Radio Relay League announced exceptional progress of its plan to boost the code receiving speed of a first contingent of 5,000 amateur radio operators to 20 words-per-minute. Listen-in nightly,

except Fridays, to W1AW's tape transmissions at 10:15 P.M. on 1,761, 3,825, 7,280, 14,254, and 28,510 kc. . . . Employees called to the colors from RCA, General Electric and other radio companies have been given official guarantees that their insurance and other benefits, the difference in salary, and their jobs, will be continued. . . . Westinghouse Elec. & Mfg. Co.'s Radio Division in Baltimore has completed the first of 3 new buildings designed to help double production of special Army and Navy radio equipment.

The American Tel. & Tel. Co., Long Lines dept., plans to extend its wired-radio (carrier telephony, telegraph and facsimile) system, as an element in the national defense plans, along lines dictated by 1st World War experience, but on a far larger scale. Coaxial lines will be installed between Boston-New York, New York-Florida, Oklahoma City-Los Angeles, Stevens Point (Wis.)-Minneapolis, and Baltimore-Washington. . . . Clifford E. Denton, Chairman, Radio Committee of the Advisory Board on Vocational Education, Board of Education, New York, last month announced that plans are being executed which will make available facilities for a training, in radio, that meets the requirements of the National Board of Education, the National Defense Committee, and the Army, Navy and Air Corps. At present, this Defense Program will

take men out of industry and further their training to improve their usefulness both to industry and to the nation.

SOUND

WENDELL WILLKIE, No. 1 presidential hope of the G.O.P., and the man who turned thumbs down on expenditures for sound trucks, last month addressed his supporters over a public address network in Elwood, Ind. This Western Electric P.A. system, perhaps the largest ever used for only a day, was set up and interlinked to address huge groups in 3 different sections of the town.

Vivid evidence of the dramatic revival of the musical reproduction business is seen by The Index, houseorgan of The New York Trust Co., in sales last year, of 370,000 radio-phonograph combinations, and 60,000-000 phono records; and points to recent technical improvements which will further stimulate business in this branch of the Sound business.

A Sunday edition of *PM* newspaper last month cooked-up the trick title "Wire Sex for Sound" in description of a new idea in wired music. It seems that a Hollywood operator has set up an "interphone" be-

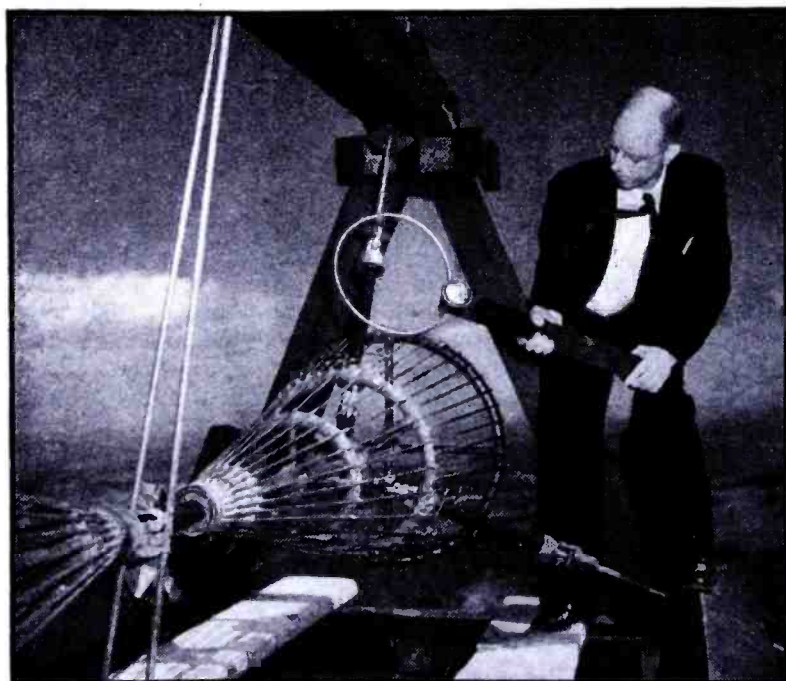

TELEVISION CONE ANTENNA

Shown here (and on *Radio-Craft's* cover) exploring the field of distribution of the new conical television antenna erected at General Electric's Helderberg television station W2XB, near Schenectady, is L. M. Leeds in charge of television development for G.E. This antenna carries the image transmission.



"STEP ON THE RADIO!"

Zenith's new Safety Foot Control is shown in use (arrow) in a 1941 Nash. A different station is tuned-in each time the foot-operated plunger is fully depressed; a solenoid does the trick. A slight pressure on the foot-plunger mutes the program as an aid to conversation, listening for traffic sounds, etc. Back-seat drivers require a second foot-control. A simple idea, yet it represents an important contribution by radio to driving safety.

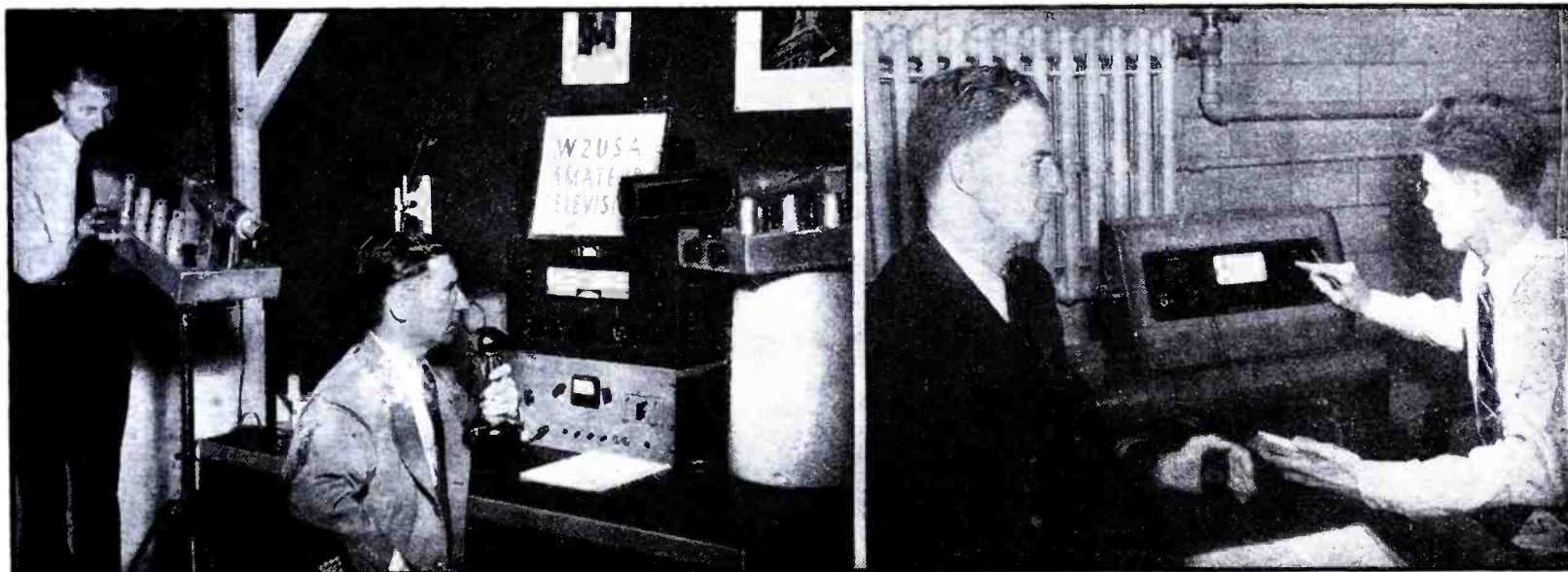

"FAIR" 2-WAY HAM TELEVISION

AFFECTOMETER

Ham-radio simultaneous 2-way, 120-line-definition television was publicly demonstrated for the first time, last month, between W2USA's glass-enclosed studio (see photo) in the Maritime, Transportation and Communication Building at the N. Y. World's Fair, and Fred Cusick's amateur station W2HJD in the N. Y. Daily News Building, 8 miles away, at 220 E. 42 St., N.Y.C. The equipment, described in detail in past issues of *QST* magazine, included the image receiver genial "Art" Lynch, W2DKJ, is facing and the image transmitter shown manned by Bill Meissner, W2HYJ, both units operating on channels in the 112-116 mc. or 2.5-meter band; and the 2-way sound equipment, center, on channels in the 56-60 or 5-meter band.

The Affectometer, as the instrument shown above and on *Radio-Craft's* cover is called, is being developed in the American Airlines pilot training school by Capt. Bill Lester, chief of the school, to determine the length of time required by prospective pilots to return to normal after being upset mentally or emotionally. Operating on the principle of the simple "lie detector" described in a past issue of *Radio-Craft*, it electrically records the effect of secretions of the sweat glands (active during all stimulations of the emotions) upon electrodes strapped to the palm of the hand. Above, left, First Officer John Price.

tween a studio and 20 bars. Procedure: customer drops nickel in slot, swaps banter with girls with phonogenic voices who urge the purchase of a beer and request a music title, and then listens to the musical selection via wired sound.

Chinatown in New York City last month was treated to a visitation of sound trucks spouting warnings in the Chinese tongue, that all Chinese aliens must register before Dec. 26.

be transplanted from Wayne, N.J., to 1,200 acres at Brentwood, Long Island, N.Y.

KDKA's new "Hear Yourself" air program holds the mirror to vocal Pittsburghers. This commercial by the makers of Breakfast Cheer coffee involves the use of a mobile recording van, and a master of ceremonies whose job it is to interview purchasers inside some grocery store. Recordings go on the air a few days later.

forating. This construction is essential in certain types of radio tubes.

The Time Capsule, 800-lb. "letter" to the people of A.D. 6939 last month was sealed in its 50-ft. well in the grounds of the Westinghouse Exhibit at the New York World's Fair. The Time Capsule contains objects, illustrations and descriptions of not only radio items but also many others representative of the civilization of the 20th Century. Rods of Cupaloy have been imbedded in the plastic above the Capsule to aid "treasure"-finding devices to locate it, 5,000 years hence.

Dr. W. D. Coolidge, director of the G.E. Research Laboratory, has been named to the newly-organized National Inventors' Council, composed of 12 scientists and industrial leaders, a body created by Sec'y of Commerce Harry Hopkins to encourage civilian inventions as part of the program of the National Defense Research Committee.

The Writers' School, New York City, now has a seminar for radio script writers.

BROADCASTING

"CALLING car 47 . . . proceed at once to Avon Street . . . investigate," and similar phrases foreign to its program interrupted studio rehearsals of a "Topics and Tunes" program by a WOR orchestra, last month. Engineer Dick Davis finally discovered that musician Ross Amelia's electric guitar was functioning as a crude detector, its magnetic pick-ups over the guitar strings acting, in conjunction with its associated amplifier, to pick up and amplify broadcasts from the Newark Police radio transmitter a block away.

Last month station WGY was shifted from N.B.C. to the General Electric Co. . . . WEAJ's field strength in Manhattan was boosted about 10 times through its move from Bellmore, L.I., to Port Washington, L.I., says N.B.C.'s radio facilities engineer Raymond F. Guy. . . . Little Pea Island in L.I. Sound off New Rochelle, N.Y., will soon be the home of station WABC, 50-kw. key of C.B.S.'s net, and now at Wayne, N.J. . . . C.B.S.'s shortwave station WCBX will

ENGINEERING

JAPAN is scheduled to get its first taste of wired radio, come '41, reports *Variety*. Master receivers in the plant of the telephone or power company will feed remote loudspeakers via the respective system of supply wires. A "recorded service" (facsimile?) also is due to be worked into the scheme, with the equipment being an add-on attachment to the regular receivers.

To demonstrate how its new line of "Teledot Koolohm" resistors operate, Sprague Products Co. has prepared an ingenious mailing piece. If you follow instructions, which are to hold a match underneath the colored dots on printed resistors, heat from the match too slight to burn the card turns the red dots to brown—just as would an overload of an actual "Teledot" resistor.

Add new radio term: "pertruded nickel"—a term coined by Baker & Co. to describe a metal mesh formed by pushing holes through sheeting, thus retaining all the metal, instead of cutting out the metal as in per-

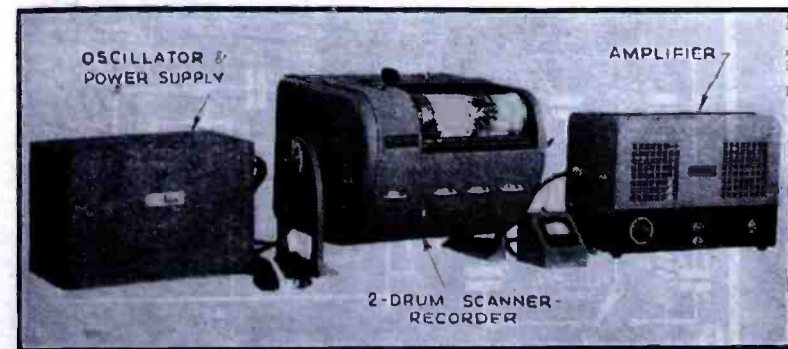

DUPLEX FACSIMILE
Last month this new streamlined machine handled 8 sq. ins. of copy per minute, at 100-line fidelity — by radio and line-telephone — between a plane, a mobile field-lab. trailer at Bendix Airport, N. J., and the Finch Telecommunications, Inc., plant at Passaic, N. J. It's self-synchronizing, and simultaneous 2-way.

"MY TIME IS YOUR TIME . . ." Here we see Rudy Vallee double-checking on the most exacting sound-disc "mirror" of his voice, an electrical transcription, preparatory to airing it over an N.B.C. network.

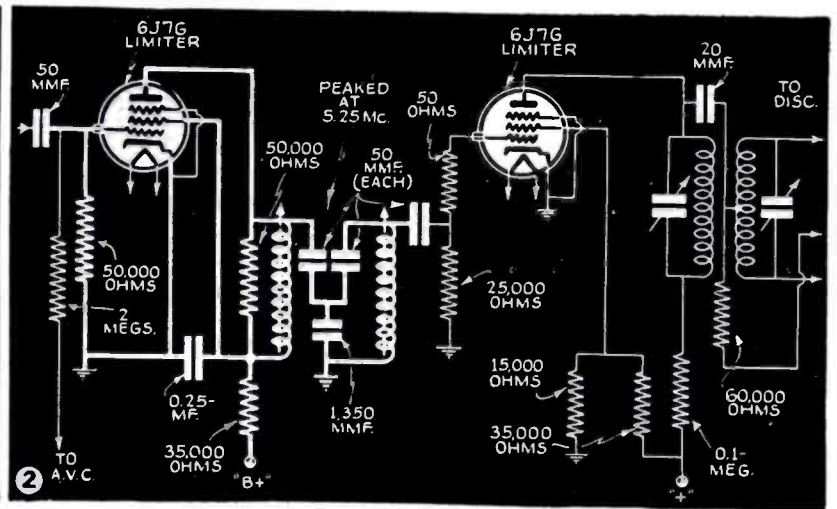
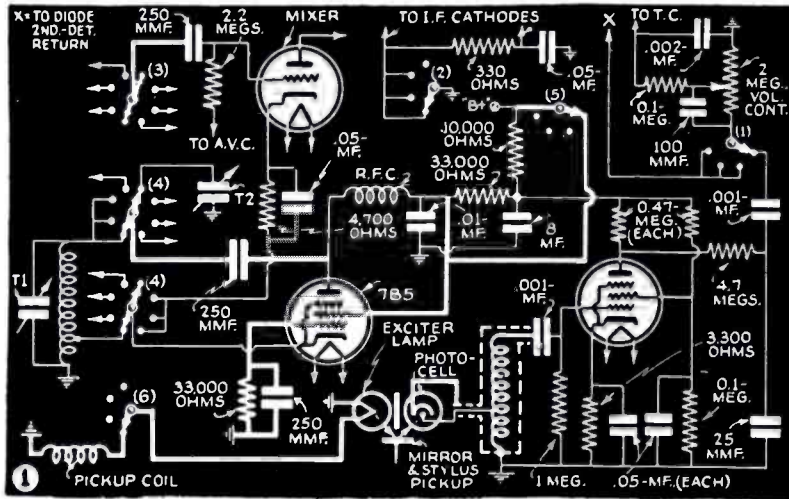

NEW CIRCUITS IN MODERN RADIO RECEIVERS



In this series, a well-known technician analyzes each new improvement in radio receiver circuits. A veritable compendium of modern radio engineering developments.

F. L. SPRAYBERRY

No. 39

(Fig. 1) CIRCUIT PROVISIONS FOR PHOTOELECTRIC PICKUP

PHILCO MODELS 41-608, AND 41-609.—In this circuit the phono-radio changeover switch is in mechanical combination with the wave-band switch so that the pickup exciter lamp may be supplied with high-frequency voltage. Other circuit changes are made for phonograph operation.

From inspection of Fig. 1, the following circuit changes permit photoelectric phono-graph reproduction: (1) The audio input at the volume control is shifted from the usual diode-return circuit to the output of a pickup preamplifier; (2) the cathode circuits of the 2 I.F. amplifiers are opened to prevent radio reception; (3) the mixer grid input circuit is opened to further prevent signal interference; (4) the oscillator plate and cathode circuits are switched for producing a fixed frequency of 1.8 mc.; (5) the oscillator, screen-grid and plate voltages are increased to raise the power output of the oscillator; and, (6) a pickup coil coupled to the oscillator tank circuit is connected to the pickup exciter lamp. Note that the photovoltaic cell is permanently coupled to the preamplifier input by means of an autotransformer for impedance transformation.

Note that the oscillator is a power amplifier tube (7B5) and uses a very unusual

circuit having the control-grid at constant potential while the cathode and shunt-coupled plate are at R.F. The power output of the oscillator is thus increased to supply the pickup exciter lamp.

(Fig. 2) FREQUENCY MODULATION RECEIVER USES 2 LIMITERS IN CASCADE

SCOTT MODEL CUSTOM-BUILT F.M.—To greatly expand the field strength range in which this receiver may satisfactorily operate and to eliminate any amplitude modulation arising from the selectivity characteristics of the I.F. amplifier, 2 limiter stages are used.

As Fig. 2 illustrates, the 2 limiters are in cascade arrangement followed by the discriminator detector. The limiter input is sensitive down to a few microvolts and from the coupling condenser and grid resistor values it may be observed that the limiter action is quite rapid. This serves to reduce the effects of impulse noise which might be great enough to affect the 2nd-detector adversely.

(Fig. 3) NEW METHOD OF AUDIO BIAS DERIVED FROM THE SIGNAL

EMERSON MODEL EQ-368.—A small I.F. signal is fed to the 1st audio grid causing rectification and thus builds up a bias on

the grid very much like the action of a gridleak-condenser detector.

As shown in Fig. 3, the slider of the volume control is joined to the top of the volume control with a resistance-capacity circuit, R11-C30. This circuit will pass no appreciable A.F. but about 90% of the I.F. supplied to it. Impressed on the 6SQ7GT grid, this produces a small rectified voltage which is applied as a bias. This action is carried well down into the low volume settings of the volume control. With this method of bias a lower value of grid resistance may be used tending to give the amplifier more stability. Also we need not depend on the bias created by the cathode "work function" which rarely exceeds 1/2-volt.

(Fig. 4) WAVE-BAND SWITCH CONTROLS BASS COMPENSATOR

RCA MODEL V-170.—Since bass compensation is undesirable for intelligible short-wave reception and to avoid the necessity for 2 adjustments of the receiver controls, the bass compensator condenser is shorted by one section of the wave-band switch.

The circuit is shown in Fig. 4. It is conventional except for the mechanical grouping of the waveband and bass compensator switches. No further explanation is therefore needed.

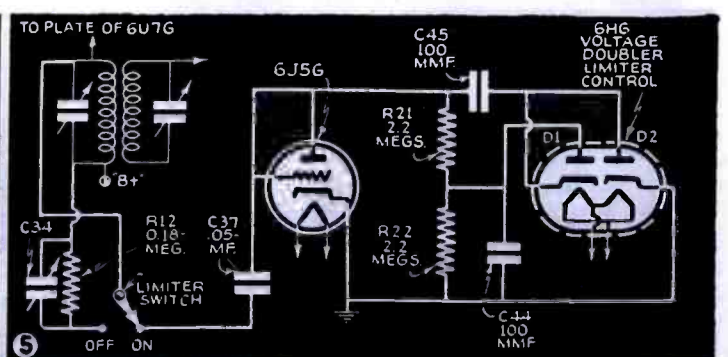
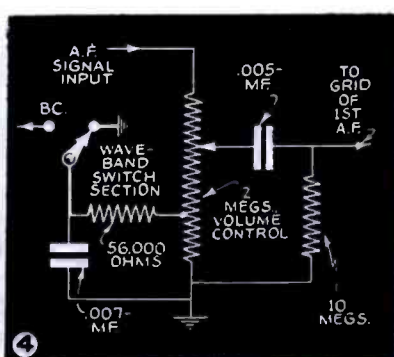
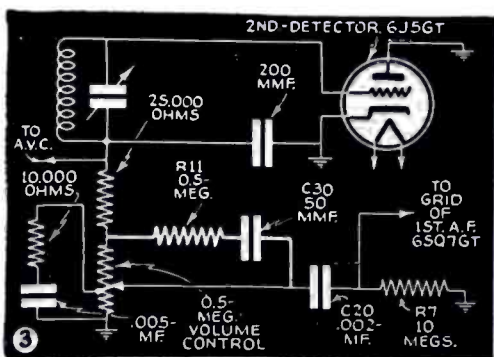

(Fig. 5) NEW LIMITER CIRCUIT FOR AMPLITUDE MODULATION UTILIZES VOLTAGE-DOUBLING RECTIFIER

SEARS, ROEBUCK & Co., (SILVERTONE) MODELS R-121 AND 721.—*The conductivity of a peak limiter tube is normally maintained at zero by a voltage-doubling rectifier even though a normal signal is traversing the circuit. A large noise impulse will produce conductivity of the limiter rectifier be-*

fore it has time to operate the doubling circuit.

The circuit is shown in Fig. 5. The modulated I.F. signal at the I.F. plate is fed to the entire limiter circuit through C37 (0.05 mf.). The I.F. continues through C45 making the plate of diode D2 of the 6116 approach the negative signal peak in value. To this voltage is added the negative signal peak which through application to the cathode of D, produces a negative peak on the

plate of diode D1, of about twice the signal peak. This negative voltage is impressed on the plate and grid of the 6J5G limiter through R21 thus preventing conduction for normal signals. A large positive noise peak, however, will cause conduction of the 6J5G, which with C37 will so load the I.F. amplifier that it will have practically no output for a very brief period. The next few following I.F. cycles will restore the circuit to normal.

OPERATING NOTES

... REPLACING OCTAL TUBES

In servicing sets using the octal base tubes, I occasionally find one that is dead or that will "motorboat." The cause is often traced to some of the tubes being in the wrong sockets. The owner often takes the tubes out for inspection or to be tested and gets them in the wrong sockets.

Always check the tubes with the service diagram to make sure the correct sockets are being used.

... PZH TUBE

This tube is not directly interchangeable with type 2AS as specified in several charts. The 2A5 is a 6-prong tube and the PZH has 7 prongs. In the PZH, the suppressor is brought out to a separate pin. This necessitates a change in the socket.

... WELLS-GARDNER 5E SERIES

If this set is noisy, replace the 50-mmf. condenser between the plate of the type 34 I.F. tube and the grid of the 2nd-detector. This is not a regular condenser but is a special capacity wire type that can be replaced with a 0.001-mf. mica condenser.

... TRAV-LER 51

Noisy operation frequently shows up, especially if the set is jarred. The shield on the control-grid lead of the type 75 tube may be shorting to the can of the electrolytic condenser. The can of the condenser is at negative potential with respect to chassis.

... PHILCO 57

This is a small 4-tube A.C. model. If this set becomes noisy, especially when the tuning condenser is rotated, look for some wax or tar between the plates of the variables. The power transformer in this model sets over the condensers and when hot will often cause some wax or tar to run out of it down between the condenser plates.

... GRUNOW 1937

A peculiar hum which develops on some of the Grunow 15-tube models, after the set has played a few minutes, can be eliminated by connecting the shell of the large speaker to ground.

... PUSHBUTTON TUNING

If you have trouble with the pushbuttons sticking in a pushbutton model, it's because the radio set is kept where there is too much sun or heat. The heat swells the buttons so that they stick on the sides. Often the springs will also lose their tension. Remove the buttons that stick and sand the high spots down. Either stretch the springs for better tension or replace.

If the buttons are replaced they should be of some material other than bone or rubber so they will not warp.

MARION L. RHODES,
Knightstown, Indiana.

... PHILCO 40-125

Speaker rattle when the voice coil of this set is not off-center may be due to a loose

cone rim, a fact not readily apparent because the felt around the rim conceals the defect. Remove the felt for inspection. If the rim mounting is loose, or pries up easily in sections or entirely, cement the rim and replace the felt around the covering.

... GENERAL ELECTRIC G-106

Trouble in Electric tuning: if dial pointer moves toward 550 kc. at normal speed, but moves very slowly or not at all towards 1,500 kc. at the right-hand side of the dial, first check the pushbutton contacts at the rear of the tuning condenser. Clean the selector rim and contacts with a brush dipped in carbon tetrachloride. Clean the rim with the solution by saturating a cloth, holding the cloth against the rim and turning the bakelite wheel on which the selector is mounted.

If the above fails, check the rubber drive bushing on the electric tuning motor's shaft. Loosen the set-screws of the rubber bushing and ship it forward so that it exerts pressure on the drive wheel associated with the tuning condenser. If the action is squeaky, oil the condenser bearings and use a light grease on the horizontal members supporting the dial pointer runner.

If no motor response is had, check the high-capacity electrolytic condenser across the windings of the motor.

... WESTINGHOUSE 166-L

Trouble: speaker rattle due to loose rim mounting. Cement the cone with Duco. Also, if the dustproof voice coil cover is loose, rattle will be present. Usually, ordinary nail polish from the drugstore will permit an easier application of adhesive since an applicator comes with the polish and it flows on without trouble. The dustproof cover becomes loose where the 35Z5 tube's radiated heat reaches it.

WILLARD MOODY,
New York, N. Y.

... WELLS-GARDNER, AND WARD "AIR-LINE" OEL (11-Tube)

If complaint is "distortion" check the 25,000-ohm bleeder resistor connected from the 6F6 screen-grid to cathode of the 6C5 1st A.F. tube (R14 on factory diagram). This is a 3-watt carbon resistor which changes in value. Used a 10-watt wire-wound resistor to eliminate this trouble.

... WELLS-GARDNER, AND WARD "AIR-LINE" 2DL (13-Tube)

Complaint was a slight change in volume accompanied with a popping noise; also, a slight change in the slot of the 6G5 tuning eye would occur. This trouble was traced to a defective high-fidelity switch which is located on the tone control. Replacing the switch was the only remedy.

... CROSLLEY 629 PHONO-RADIO COMBINATION

Set faded on Radio and Phono position. This complaint was caused by the 0.006-mf.

condenser connected from the center lug of the volume control to the 6Q7G tube socket.

... SENTINEL-ERLA MODEL 14A

This set had fair volume but could not be peaked at 600 kc. A 50,000-ohm resistor, connected from the 540-1,730 kc. oscillator coil to ground, changed in value and caused the trouble.

... CROSLLEY 726

Set "dead" and no screen-grid voltage on 6A8 and 6K7 I.F. tube. In this case, check the 16,500-ohm section of the candohm resistor. This resistor is marked 57-Z on the factory diagram.

... CROSLLEY 955

Set inoperative at times also gets very noisy. Check the 1,100-ohm bias resistor connected from the cathode of the 6C5 driver tube to ground. This is a flexible resistor and marked No. 46 on factory diagrams.

... ZENITH 9S-262

If the complaint is "inoperative," and a check shows no plate voltage on the 6L7G 1st-detector and 6K7G I.F. tube, check for a shorted 0.05-mf. condenser (marked C8 in factory diagram).

... S.M. S8 HALLICRAFTERS

In complaint of poor tone, check for a leaky 0.1-mf. condenser from plate supply of the type 75 tube to ground.

... G.E. E72

Set "dead" and smoke comes out of the I.F. coil can, next to the dial. A shorted 0.02-mf. condenser connected to the primary of this I.F. coil causes to burn up the 25,000-ohm resistor which is located inside of the I.F. coil can.

THOS. R. DISSINGER,
Chicago, Ill.

... PHILCO 71-91

Shadow-meter does not work properly. If shadow-meter gradually widens out after set has been in use for a few minutes, install 2 No. 44 tubes in R.F. and I.F. sockets. Condition is caused by gassy tubes. Try several tubes, choosing the ones which give best results.

... PHILCO 39-17

These sets are frequent offenders, the usual complaint being "dead", due to the type of wiring used in nearly all '39 Philco models.

Examine output transformer leads. Wires will be found shorted to chassis due to the fact that the rubber insulation has become very soft causing voltage breakdown. The power transformer uses the same type of wire, and the writer suggests replacement of this unit, although repair can sometimes be made by using spaghetti on all leads.

ISADORE HYMAN,
Norfolk, Va.

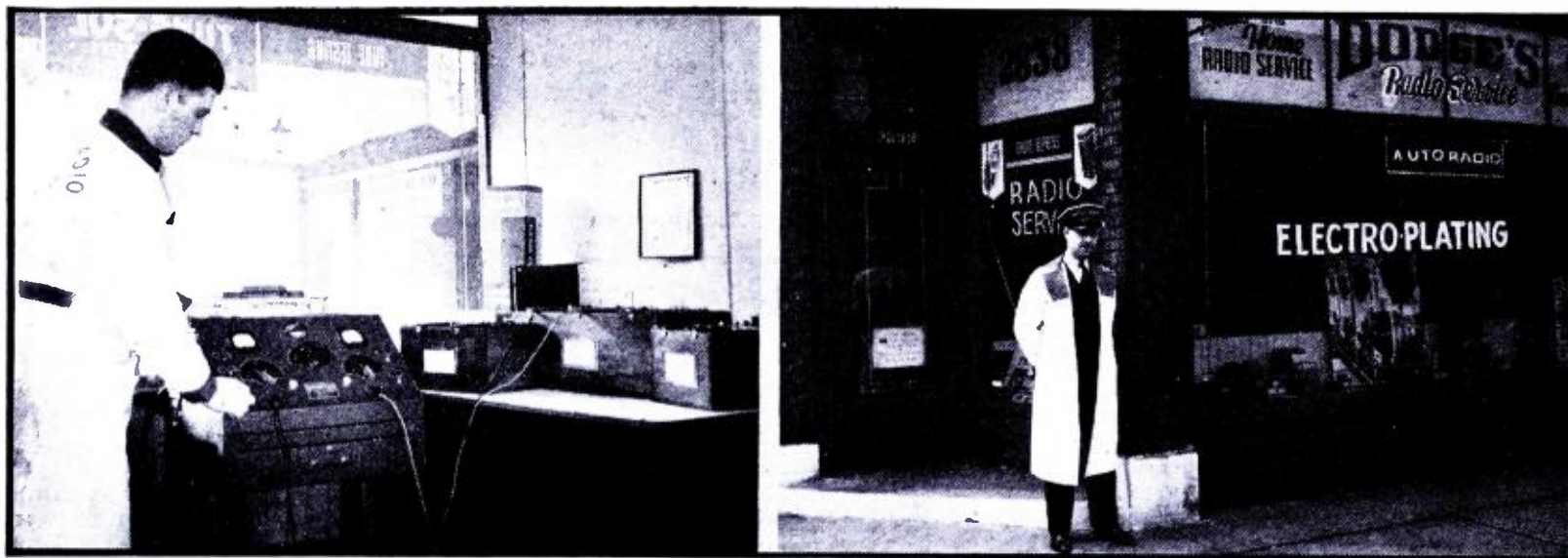

Signs help a lot (see photo at right) to get electroplating business for Harry Dodge, shown busy on the job in photo at left.

LUCRATIVE SIDELINE FOR SERVICEMEN — in *Electroplating*

The author tells how a successful Chicago service shop, by installing an electroplating outfit, frequently gets new customers who also want their radio sets repaired.

HARRY DODGE

WHERE can one go to have spoons, a doorknob, or a faucet replated? Answering this question opened for me an unexpected sideline to my radio business and a surprisingly remunerative source of income.

I had tried to get a little plating work done and the difficulty I encountered set me thinking. The big plating shops wouldn't be bothered; the small shops did not always have the metal necessary—and if they did I was lucky to get the pieces in a week.

I POSE A QUESTION

I'm always on the lookout for "dodges" to better my income and my services to my customers. There isn't much to electroplating. Why couldn't I do it?, I wondered. Why not offer it as an extra service that would draw customers to my shop?

Who would the customers be? I called on a few prospects to test my idea. The first was an antique dealer. Could I do silver and gold? I reckoned I could, though not yet having the haziest idea how it was actually done. He showed me more work than I could expect to do in a week! Next, I tried a real estate office that manages several apartments. Could I nickel-plate faucets and door knobs? How quickly could I get the work out? They didn't ask me how much it cost, but how quickly it could be done.

An auto repair shop wanted to know if I could resilver headlight reflectors. My dentist had a handful of instruments that needed a fresh surface of nickel. A restaurant wanted its soup spoons, ladles, and pickle forks tin plated. Some of my regular radio service customers had 26-piece sets of silver that needed replating—only they had never thought of having it done.

There wasn't any question about customers.

THE START

In making inquiries I learned of a chap who had a complete electroplating outfit in

his basement and was doing part-time work with it. It was so profitable he was about to give up his job driving a truck and devote all his time to electroplating. I got him to install his whole outfit in my shop.

It didn't take up much space. The main part of it was an automatic mobile unit about the size of a small console radio receiver with a sloping panel. It contained a rectifier, automatic timing mechanism, voltmeter, and ammeter, and a time-delay reversing switch.

Also there were motor and buffing wheels mounted on a wood base, an electrically-heated cleaning tank and some smaller tanks for plating. A set of electrolytic anode brushes accompanied the outfit for brush-plating objects which couldn't conveniently be dipped in the regular plating tank. The chemicals came in powder form, and my new partner mixed these with distilled water for his cleaning and plating solutions.

Cleaning.—I learned that the process was simple. First, he cleaned the object to be plated with the wire buffer, then polished it with the cotton buffer. Next he hung the object in the heated cleaning solution and connected his machine. It passed current through in one direction for about 5 minutes, "making," he said, "bubbles of hydrogen around the steel and cleaning it thoroughly." Then the machine automatically reversed the current for 2 seconds, causing oxygen bubbles (around the piece) which removed the film of hydrogen. Then a bell rang in the plating machine to notify him that the job was clean.

1st Rinse.—From here on he handled the clean metal with rubber gloves to avoid getting any grease on it from his fingers. He washed it thoroughly in running water to remove traces of the caustic cleaning solution, then attached wires which connected with an insulated strip over the plating bath.

Plating.—Making the proper connections to the plating machine, he set the timer and the current control according to a set of instructions. The plating bath required

about 20 minutes, during which he examined the metal at intervals to see that it was taking a smooth plating.

2nd Rinse.—When the bell in the machine rang, indicating the prescribed time had elapsed, he removed the beautifully plated metal and washed it again to rid it of any of the plating solution.

Polishing.—After drying it with a cloth he went over it with a cloth buffer, and if I hadn't seen it done I would have sworn the piece had just come from a factory.

That is just the mechanical part. Simple, isn't it?

I'm getting 33 1/3% cut on the work; and from 5 to 10 new customers a day are bringing work into the shop. Some of them, of course, have radio sets to fix, too. Thus I've enlarged my income and my clientele, and I'm giving more service to my customers.

GENERALITIES

Although formulas and operating procedures for electroplating are generally available from the plating supply houses and in textbooks, the following additional comments may be of interest as some of them can be learned only as a result of considerable experience.

Speaking in general, the electroplating of iron or steel requires a current reversal for 3 seconds to remove the deposit of caustic soda that replaces the dirt and oxides on the surface of the work. The object must then be thoroughly cleansed of any trace of soda to prevent reaction of the soda with the acid and thus weaken the plating solution.

In plating copper in a sodium cyanide solution a 4-V. D.C. supply is ample but the current must be reduced through a heavy-duty rheostat to obtain the requisite degree of lightness and brightness of the copper deposit.

For copper plating in a blue vitriol (copper sulphate) solution 2 V. D.C. supply is ample.

Nickel plating requires the use of pure



Scores Again!

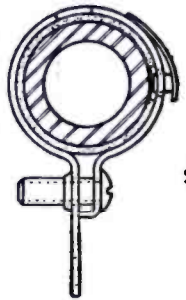

CROSS SECTION VIEW

Heat-resistant, constant-pressure stainless steel spring spot-welded to band

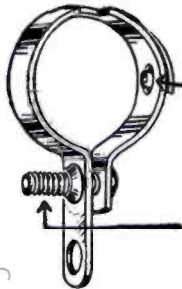
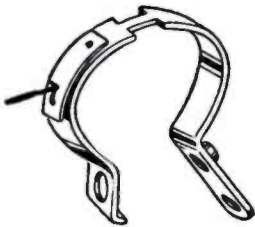

Silver contact button spot-welded to spring extends through hole in band

Thread on band — no nut required

...A NEW *Positive Pressure* BAND FOR ADJUSTABLE RESISTORS

No more broken or damaged resistance windings when you move the slider band on adjustable wire-wound resistors! No more oxidation or corrosion at point of contact.

No matter how much you tighten the new IRC Positive Pressure Contact Band itself, the pressure of the silver contact button on the windings remains safe, constant and positive. No matter how often the bands are readjusted, there is no danger to the windings. Moreover, the bands will not deteriorate under high operating temperatures or under constant use.

These new bands are available in 9/16", 3/4" and 1 1/8" diameters and are now supplied with all IRC Adjustable Wire-Wound Resistors from 25 to 200 watts, inclusive. Sold separately for use on your old resistors, too. Ask your jobber. Stop throwing adjustable resistors away because of broken wires and corroded contacts!

INTERNATIONAL RESISTANCE COMPANY
401 North Broad Street, Philadelphia, Pa.

sheet or cast nickel. Good work requires a base of copper; except in plating tableware in which case, to avoid the danger of taking too much copper into the system when using the tableware, the copper undercoating should be avoided.

In plating silver a pure silver anode must be used. Silver coins used as anodes will quickly ruin the plating solution because of the alloy in the coins.

Black iron plating for rust-proofing tools is really not a plating but an oxidizing process. The "solution" is pure distilled water—the drugstore variety rather than that obtained at filling stations—in a copper tank. The iron tool to be coated is made the negative terminal and is immersed in the water, brought almost to the boiling point, in the positive-terminal copper tank. Use 60 to 100 V. for 30 to 50 minutes. Higher voltage and longer periods of time are necessary if the temperature of the solution is less than 180° F., or if the area of the work is increased. An old "B" eliminator is a good source of voltage for small objects such as pliers.

A process for chromium plating is not given as the only good solutions are patented and restricted to licensed users. Besides the fumes thrown off in this process are very injurious when inhaled. Objects to be chromium plated should first be copper plated, then nickel plated, and then taken to a commercial plater for the final flash of chromium.

In all plating processes, the most important item in the procedure is to clean the surface to be plated and then avoid handling, unless rubber gloves are used, for fear of leaving finger marks of sweat or grease which will not take the plating. As the plating is usually very thin, do not

expect it to fill up dents or scratches. The plated job will only be as smooth as the metal under it.

It is best to purchase plating compounds already prepared in dry form, ready to mix with water. Thus, there is less danger of poisoning or developing poisonous gases by mixing the wrong chemicals. Handle all cyanide compounds with rubber gloves and never mix an acid of any kind with cyanide

compounds as a colorless and odorless gas is given off which is very toxic—one form of this cyanogen gas is used in Utah for the execution of criminals in a gas chamber.

"MICROPHONE TECHNIQUE"

Be sure to order your January issue of *Radio-Craft* today so as not to miss the first chapter of this up-to-date article on the proper use of modern microphones.

Newest use of radio to come to the attention of *Radio-Craft* is that of a newsboy who has found it profitable to build a battery-portable into his shoe-blackening case.



Radio Service Data Sheet

GALVIN "MOTOROLA" MODEL B-150 BICYCLE RADIO

3-Tube Superhet. (2 triple-purpose tubes and 1 power tube); A.V.C.; Permeability Tuning of Antenna and Oscillator Circuits; 4-In. P.M. Dynamic Speaker. 1.4 V. Tubes; Lower Battery Drain.

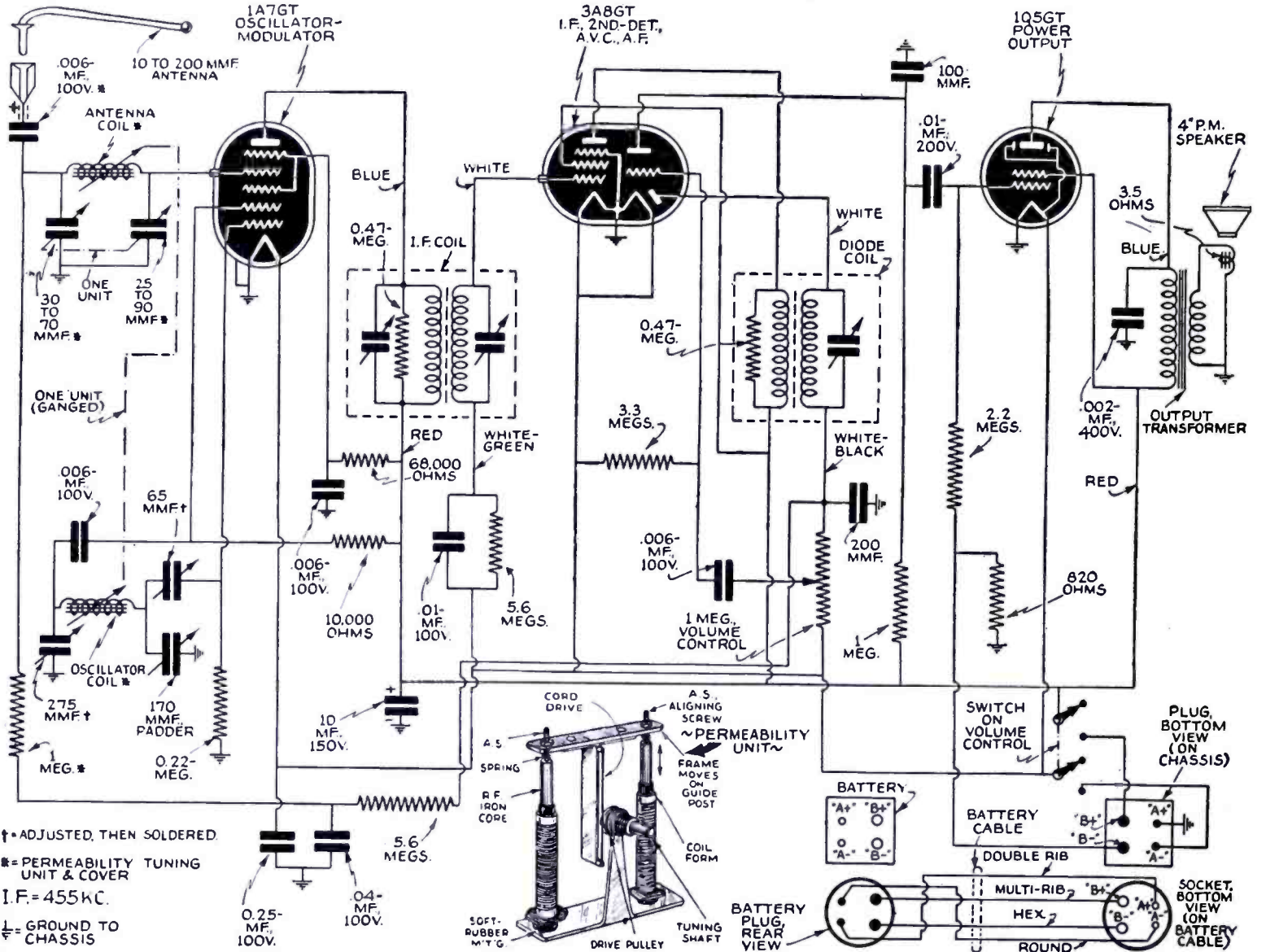
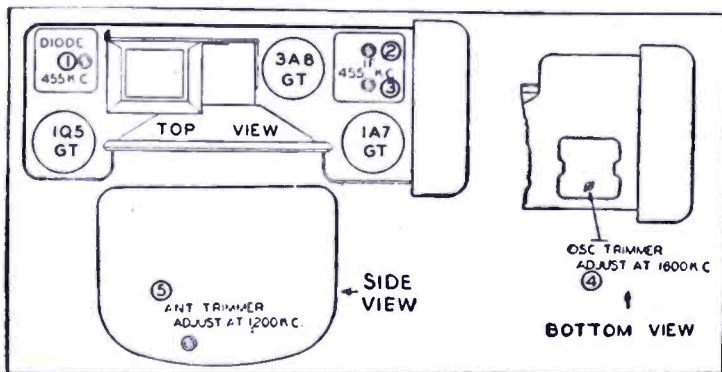
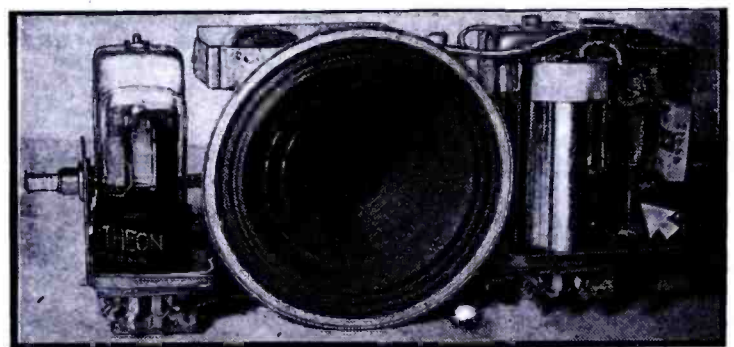

Diagram of Motorola B-150 Bicycle Radio Set. Note permeability tuning unit. The market: 6,000,000 bike owners.



Sketches showing locations of alignment trimmers.



Chassis view. Note compactness; and tuner (arrow).

Operations In Order	Tuning Dial Set At	ALIGNMENT CHART	Adjust. Trimmers No.	Generator Set At
1	Minimum	Dummy Antenna	1-2-3	455 kc.
2	1,600 kc.	0.1-mf. Grid	4	1,600 kc.
3	Minimum	50 mmf. Antenna Terminal	5	1,200 kc.
	1,600 kc.	50 mmf. Antenna Terminal		
	1,200 kc.			
SENSITIVITY AND STAGE GAIN MEASUREMENTS				
Average Microvolts Input	Generator Set At	Dummy Feeder Connected to	Leak Resistance	Output Meter Reading
4500	455	I.F. Grid	0.5-meg.	0.32-V.
85	455	Mod. Grid	0.5-meg.	0.32-V.
100	600	Mod. Grid	0.5-meg.	0.32-V.
15	600	Ant. Terminal	None	0.32-V.
Volume control set at max. * 0.05-W. = 0.32-V.				
VOLTAGE CHART				
Tube	Plate	Screen	"A" Supply Voltage—1½-V. "B" Battery Voltage—90-V. Measurements from socket terminal to chassis ground using 1,000 ohms/volt meter.	
Osc. Mod.	85-V.	35-V.		
I.F. Det.	85-V.	85-V.		
AVC A.F.	80-V.	85-V.		
Pwr.				

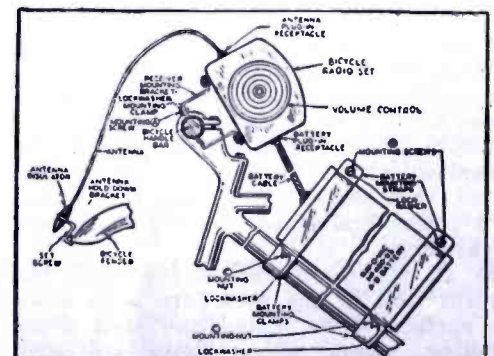

Placement of set and power unit on bicycle frame.

SERVICING TROUBLES

AM submitting a few of the troubles I have encountered and what I have done to remedy them.

(1) A resistor that will get hot enough to melt stick shellac when held against it, is either too small or not getting the proper ventilation.

(2) I have traced 3 cases of noisy reception when a person walks across the floor. The trouble was located in the basement where the gas and water pipes crossed each other, they were just close enough together that a slight jarring of the floor, caused them to make a minute connection. This was remedied by properly bonding with ground clamps and heavy wire. Another case was an ungrounded BX light cable lying across a water pipe. This was remedied by the same method as above. Another case where the door-bell wires had sagged and were lying across a hot-water pipe, the heat had melted the wax coating and general vibration wore the thread covering away, causing a disturbance each time the unprotected wire touched the pipe. This was remedied by placing that section of the door-bell wire in a length of loom.

(3) I have traced a very severe and troublesome case of intermittent reception, to a very poor soldering job on the top of the control-grid cap where the control-grid wire connects to the cap. Although the cap may have plenty of solder on it, there is always the chance that the wire was not properly tinned in manufacturing. Therefore reception is good when the tube is cool, and out of operation when heated. A hot soldering iron with a little flux will suffice in most cases. It is also well to resolder the tube prongs.

(4) Another case of intermittent reception was found in an inferior make of wax tubular condensers. Some of the condensers do not have a very solid weld between the lead wire and foil. These can be located at once by placing set in operation and slightly rotating the condenser with your finger. To avoid getting a severe, unexpected shock, I always wear a pair of rubber gloves. It is a very good idea when replacing these condensers, especially where there is heat, to use a good, reliable make of mica-molded condensers. This will avoid future troubles of this nature.

(5) I have found at least 3 cases of noisy or intermittent reception in car-radio sets where the male socket of the battery or antenna connectors have been sprung so far apart that the female plug would make and break contact at intervals. In all cases this was remedied by squeezing the male socket back in shape. These sockets should fit so snug, that it takes a little effort to insert them. Also see that each plug has a small mound of solder, for connection, on the tip of each plug.

(6) Another case of noisy and intermittent reception, when the radio receiver was found to be OK and set still gave trouble, was due to the lightning arrestor. It was found to have filled with dust and minute particles of metal which had seeped in or were blown-in between the contacts. A trouble of this kind can be readily located by placing the radio set in operation and tapping the arrestor with the butt end of a screwdriver. The receiver will readily act-up if this should be the trouble.

(7) I have had many tubes in the shop that tested up OK, but in one case of intermittent reception, the set always played swell when in the shop but when taken to the customer's home the intermittent reception would start. I tested the tubes in my tester at the customer's house, and again at the shop, they always came up to standard. The set had me puzzled so I decided to get at the bottom of the trouble at any cost.

I put a complete new set of tubes in the customer's radio set and took the old tubes back to the shop. I tested them about 5 times each, with no result except a batch of tubes that tested OK, so I decided to try just once more. In changing the filament selector switch I accidentally left it on the 7.5-volt tap. Not knowing this, I proceeded to test the tubes. The third one I tested showed a short, and all the rest tested OK. It was then I noticed that I had the filament selector on the 7.5-volt tap.

Suddenly it dawned on me, why couldn't the customer's line voltage be abnormally higher than standard for his radio set? I went directly to the customer's house, checked his line voltage, and found it to be 5 volts over the regular, specified line voltage. This increase in line voltage was 10 volts over the value recommended by the set manufacturer. Therefore the increase in voltage was just high enough to cause a cathode short by the increase of heater temperature, causing the cathode to expand further than normal. This was remedied by installing an autotransformer to regulate the voltage to the requisite amount.

(8) Intermittent reception was located in several multi-band receivers at the band changeover switch assembly. The small particles of metal that had worn away from contacts had settled loosely between the stationary contacts, and each time, the radio set would become noisy when the volume was raised; sometimes the set discontinued playing altogether. This was remedied by taking a toothbrush and benzine, and cleaning-away the accumulated particles; and then, by applying a small amount of vaseline to the wiper contacts, future trouble of this kind was eliminated.

L. C. JUERGENS,

Highland Radio Service, Mankato, Minn.



N. U. SPECIAL

GET THIS

NEW WALSCO STAPLER

\$ 7.00

\$5.00 For Condensers
\$2.00 as Deposit

EVERY RADIO SERVICE MAN NEEDS IT . . .

New automatic stapler for quick and easy installation of lead-ins—indoor antennas — running leads and power cards, P.A. installations and other shop use. Usual dealer price, \$3.30.

CONTENTS —

1 WALSCO STAPLER

TYPE	QUANTITY
JB 8450	1
SC 8450	1
AT 8150	1
1615	1
8250	1
4450	1
8450	2
1645	1
AT 1125	1
8845	1
T 601	2
602	2
605	2
610	3
625	1

List Value of N. U. Condensers in Kit, \$10.00. Dealer Price Walsco Stapler, \$3.30 (Packed Together)

YOURS FOR ONLY \$7.00

YOURS FREE ON THIS N. U. CONDENSER DEAL

DEALER PAYS \$5.00 FOR CONDENSERS, THE ADDITIONAL \$2.00 IS REBATED WHEN DEAL REQUIREMENT IS COMPLETED

How You Get It

Just order from your N. U. distributor. Your total payment is \$7.00. You sign an agreement for 75 points and deposit is refunded when the 75 purchase points are completed. Points can be used on N. U. Tubes, Sound X/Tra Tubes, N. U. Radio Batteries or N. U. Condensers. The National Union Program on free equipment has helped thousands of dealers to own the "finest radio shop in town."

Points Are Counted as Follows:

1 Tube = 1 Point, 1 Electro Condenser = 1 Point, 10 Paper condensers = 1 Point, 2 Numite Condensers = 1 Point, 1 Radio Battery = 1 Point.

See Your N. U. Jobber or Write

NATIONAL UNION Radio Corp.
57 STATE ST., NEWARK, N. J.

COPYRIGHT

Radio Service Data Sheet

STROMBERG-CARLSON MODEL 500 SERIES (Models 500-H, 500-J and 500-S)

6-Tube A.C.-D.C. Superhet.; Built-In Loop Antenna; Automatic Volume Control; Step Tone Control; Tuning Range, 0.54-1.54 Megacycles; Power Consumption, 30 W.; P.M. Dynamic Speaker; Headphone Attachment; Phono Terminals.

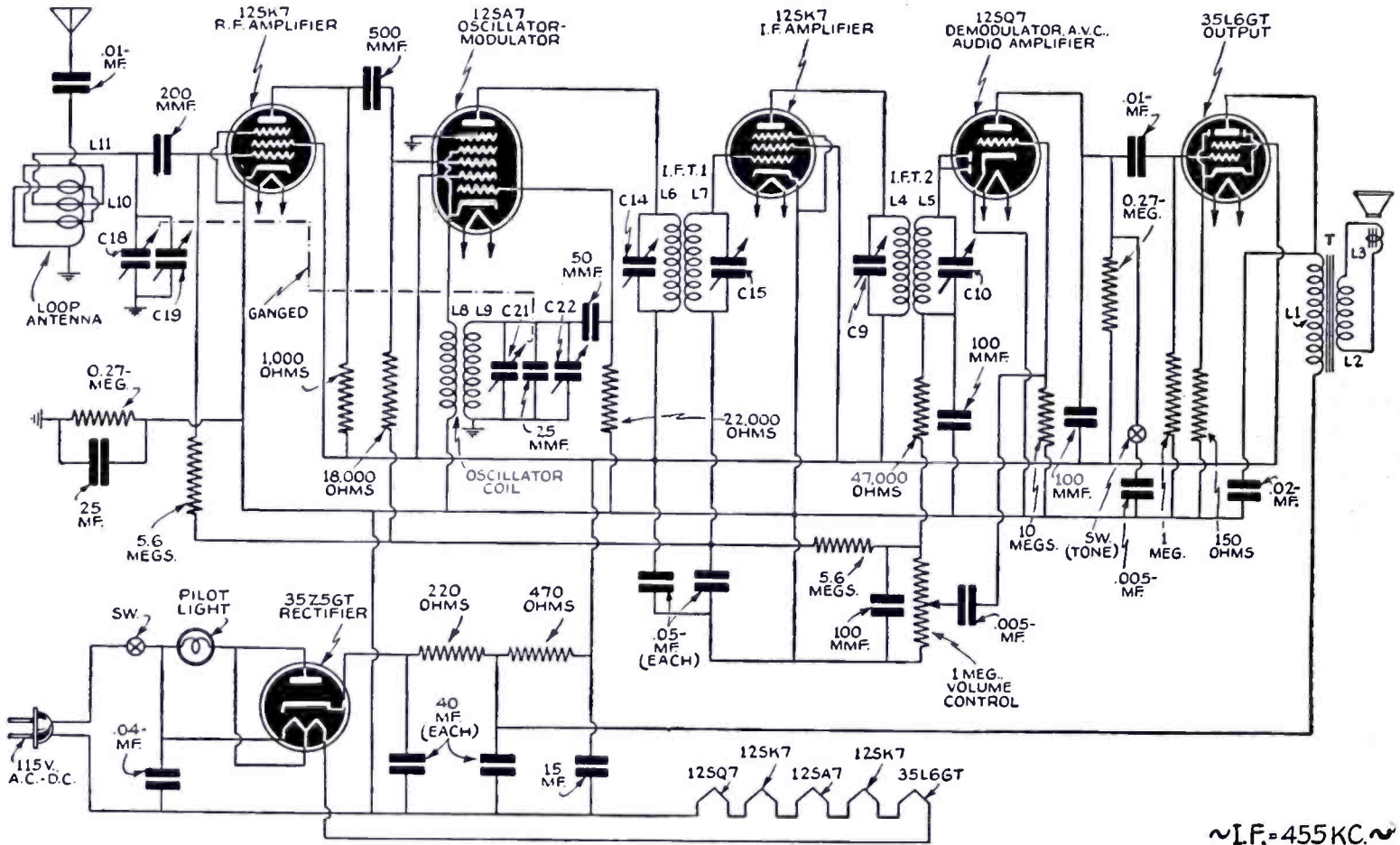

Complete schematic diagram of the Stromberg-Carlson No. 500 series, A.C.-D.C. receivers.

~I.F.=455 KC~

ALIGNING INFORMATION

Use a modulated signal generator with variable output voltage and a sensitive output meter across the voice coil. Align using the smallest possible input from the signal generator; volume control "full on".

Important: Be sure metal plate is fastened in place on the bottom of the chassis before alignment is attempted.

ALIGNING PROCEDURE (follow this order exactly).

I. Dial Pointer Adjustment.

With the plates of the gang tuning condenser fully engaged set the dial pointer in a vertical position directly on the calibration marks located at the top and bottom of the dial scale.

II. Intermediate Frequency Adjustments.

1. Tune the set to the extreme-low-frequency position. (Variable condenser plates all the way in.)
2. Connect ground terminal of signal generator to chassis.
3. Introduce a modulated signal of 455 kc, using a 0.01-mf. condenser in series with the lead from the signal generator to the oscillator aligning condenser located on the front section of the variable condenser.
4. Adjust the I.F. aligners for maximum output in the following order:
 - A. Sec. of 2nd I.F. trans.
 - B. Pri. of 2nd I.F. trans.
 - C. Sec. of 1st I.F. trans.
 - D. Pri. of 1st I.F. trans.

III. Radio Frequency Adjustments.

1. Replace the 0.01-mf. condenser in series with the output lead of the signal generator with a 200 mmf. condenser and connect them to the antenna terminal located on the back of the loop assembly.
2. Set the signal generator's frequency and the receiver's tuning dial to 1.4 mc.
3. Adjust the oscillator and antenna aligning condensers for maximum signal.
4. Set both the signal generator's frequency and the receiver's tuning dial to 0.6-mc. and check calibration.

NOTE: If the calibration is too far off at 0.6-mc., operations 2 and 3 may be repeated until the best results are obtained.

NORMAL VOLTAGE READINGS

Use a good, high-resistance voltmeter having a resistance of at least 1,000 ohms/volt. Take all D.C. voltage readings on the 500-v. scale except where an asterisk (*) appears. Take all readings with chassis operating and tuned to 1,000 kc.—no signal. Use a line voltage of 120 V. or make allowance for the variation.

Read from indicated socket terminals to terminal No. 3 of the 12SK7 I.F. Amp. Socket ("B-").

See Location Chart for position of terminals.

A.C. Voltages are indicated by boldface; when the receiver is operated from a D.C. power supply, D.C. voltages will be obtained in place of A.C. voltages shown.

Tube	VOLTAGE—TERMINALS OF SOCKETS							
	1	2	3	4	5	6	7	8
12SK7	—	52	0	0	0	+91	37	+86
12SA7	—	37	+86	+91	+7.5*	0	24.8	0
12SK7	0	24.8	0	0	0	+91	12.5	+86
12SQ7	0	0	0	0	0	+23	12.5	0
35L6GT	0	86	+98	+91	0	—	52	+4.8
35Z5GT	—	120	114	—	114	—	86	+115

*Read on 100-V. scale of 1000/volt meter.

CONTINUITY TEST

CAUTION: Remove all tubes. Disconnect the receiver from the power supply and short terminal No. 8 of the 35Z5GT rectifier tube to the chassis base before making continuity test. Use a good meter capable of measuring accurately up to several megohms.

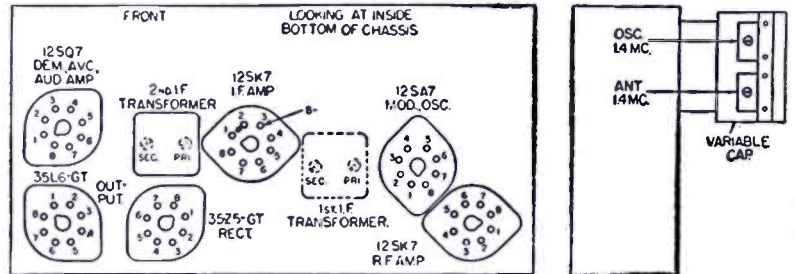

Locations of main components and alignment trimmers.

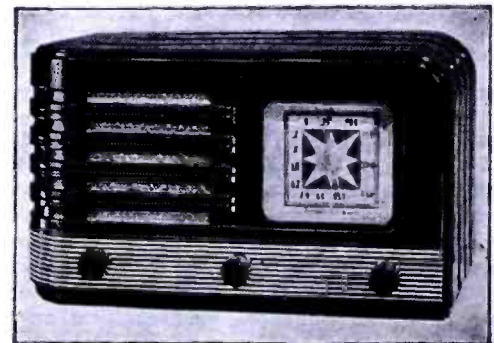

Stromberg-Carlson model 500-H table model receiver.

The resistances given are often approximate, owing to electrolytic condensers in the circuit. When this is the case, be sure to reverse the test leads and read the highest resistance. Read from indicated terminals to chassis base except when an asterisk (*) appears. See Location Chart for position and numbering of socket terminals.

Tube	TERMINALS OF SOCKETS							
	1	2	3	4	5	6	7	8
12SK7	S	0	270000Ω	8M	270000Ω	700Ω	0	1700Ω
12SA7	S	0	750Ω	700Ω	300000Ω	270000Ω	0	12M
12SK7	S	0	270000Ω	6.8M	270000Ω	700Ω	0	750Ω
12SQ7	S	10M	270000Ω	1.5M	1.5M	270000Ω	0	270000Ω
35L6GT	S	0	450Ω	700Ω	1.3M	0	0	270000Ω
35Z5GT	S	0	0	0	0	0	0	0

Symbols used are as follows: Ω—ohms; M—megohms; S—Short; O—open.

THE ABC OF FREQUENCY MODULATION

The following article supplements with a detailed analysis and performance information the sketchy description of Frequency Modulation fundamentals by the authors in their preceding, 2-part article, "Frequency-Modulated Programs on Your Present Receiver!" in the December 1939 and January 1940 issues of Radio-Craft.

G. H. BROWNING and F. J. GAFFNEY

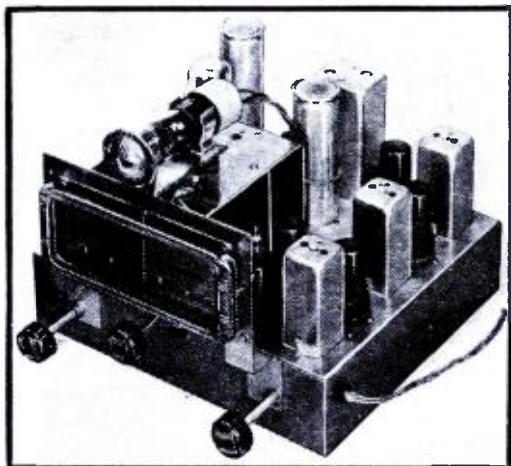

Mr. Serviceman: Here's a chassis view of the sort of radio receiver you soon will be called upon to install, align, etc. Will you know how?

DURING the last year Frequency Modulation has received such a marked impetus that the Serviceman is beginning to recognize a real need for a detailed, fundamental knowledge of the new system particularly as it pertains to service and alignment of the new "F.M." receivers.

Perhaps a good starting place for an article to explain the details of F.M. receivers is a debunking of much of the mystery with which this new system has been clothed in the eyes of the Serviceman. Exactly the same principles of amplification, frequency conversion, etc., are employed in a frequency modulation superhet. receiver as with the more common or amplitude modulation receiver. Characteristics of the amplifiers themselves are, to be true, different. But the Serviceman has already dealt with many types of amplifying systems during the progress of the radio art to its present state and the new system should present no problems more complicated than those already present.

PROBLEMS IN BAND COVERAGE

One fact which appears to alarm the average Serviceman is the high-frequency band employed for the transmission of F.M. signals. The band of frequencies between 42 and 50 mc. has been assigned by the F.C.C. for this purpose. This means that

(a) the tuned antenna circuit, (b) the R.F. amplifier, and (c) the oscillator sections of the superhet. F.M. receiver must operate at these high frequencies. This of course results in certain design and stability problems which are not present to such a marked degree in allwave receivers. These problems, however, are ones which are of importance primarily to the manufacturer rather than to the Serviceman.

Once the design for a high-frequency R.F. tuner has been correctly worked out, it can be expected to perform satisfactorily with little attention. Due to the fact that only a few turns of heavy wire are used for winding the coils, there is little if any possibility of shorted or open turns in the R.F. system. One precaution might be pointed out, however. If it becomes necessary to replace an open or shorted resistor or condenser located in the high-frequency tuner, the exact position of the component to be replaced should be carefully noted by the Serviceman and the replacement made so that the new component occupies exactly the same position as did the original. This precaution is necessary at these high frequencies because of the regeneration difficulties which can be caused by even a very short lead incorrectly located. Even more care would have to be exercised were it necessary to replace a coil, but as previously pointed out, this is seldom if ever required.

In the design of a high-frequency tuner for the F.M. band, stability is the most important consideration. This is particularly true as regards the frequency stability of the high-frequency oscillator since a change in its frequency will result in a marked detuning of the receiver with consequent increase in noise level. If the detuning is severe enough, marked distortion will also occur.

Even after all of the precautions as regards component stability have been considered, a certain amount of drift is still present due to the oscillator or mixer tube itself. This can be minimized by using an oscillator circuit of high capacity; and, if required, by using a certain amount of compensation in the form of a negative temperature coefficient condenser suitably located in the oscillator circuit. The detuning effect due to the tube is, of course, present

only during the warm-up period which is ordinarily for about the 1st half-hour during which the set is in operation. It might be pointed out here that any FM receiver should be retuned after about 10 minutes to insure best quality reception.

THE F.M. INTERMEDIATE FREQUENCY STAGES

The requirements of the I.F. amplifier are perhaps the next logical subject of discussion. Under present standards of transmission, the frequency swing of the carrier for 100% modulation is 75 kc. either side of the center frequency. In order to transmit the signal faithfully, a transmission system which is capable of passing a band of frequencies 150 kc. wide is required. As will be pointed out in connection with limiter action, however, it is not necessary for the I.F. amplifier itself to have this extreme bandwidth in order to faithfully reproduce F.M. signals. It has, in fact, been found that for the usual signal strengths available at the input to the receiver, the response of the I.F. amplifier may be "down 10 times" 100 kc. away from the center frequency without impairment of the recovered audio signal.

A certain amount of selectivity is required in the I.F. amplifier to achieve good adjacent-channel separation. This is particularly important when it is desired to receive a weak signal in the presence of a very strong signal on an adjacent channel. The design of the I.F. system is somewhat of a compromise, then, between the bandwidth required for faithful reproduction and the selectivity required for adjacent-channel separation.

During the past year, stations have been operating on an experimental basis on carriers spaced only 200 kc. apart. This has resulted in a rather severe selectivity requirement. Starting in 1941, however, the new channel assignments will go into effect and these are made in such a manner that no 2 stations serving the same locality will be separated by less than 400 kc. With this channel spacing the design problem is not particularly severe. The curve of Fig. 1 illustrates a satisfactory characteristic.

I.F. SELECTIVITY

One erroneous idea in the minds of many Servicemen is that too-sharp an I.F. channel will result in a loss of the higher audio frequencies as is the case with present amplitude modulation receivers. With F.M. receivers this is definitely not the case, since the required bandwidth is a function of frequency swing and is largely independent of the audio frequencies with which the transmitter is modulated. As will be pointed out in the discussion of the detection (demodulator) circuit, the actual result of too-sharp an I.F. system is to produce distortion on the loud signal passages.

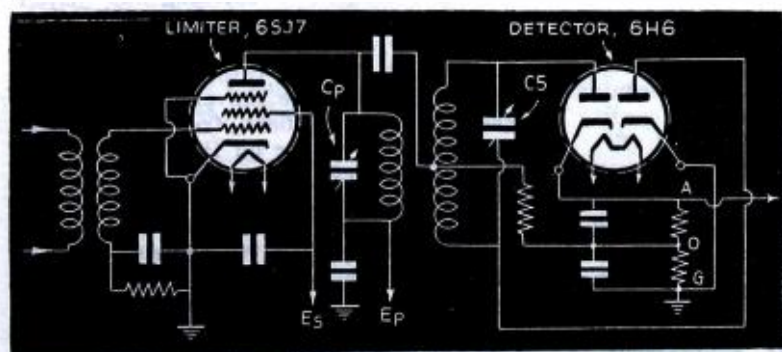
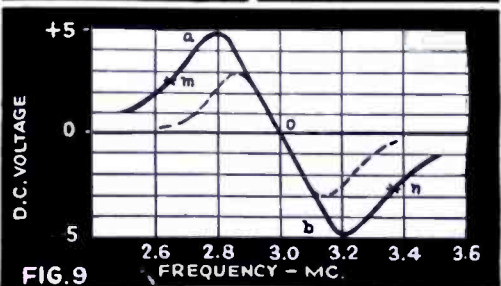
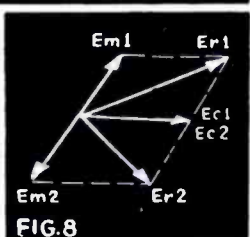
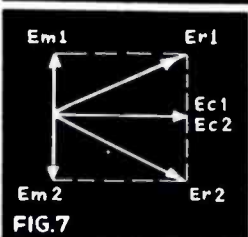
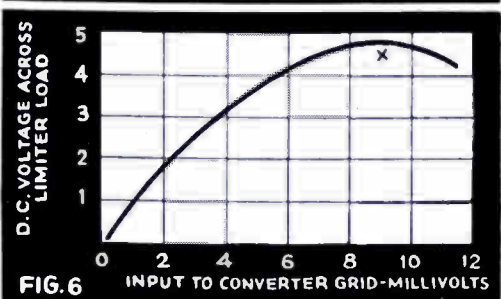
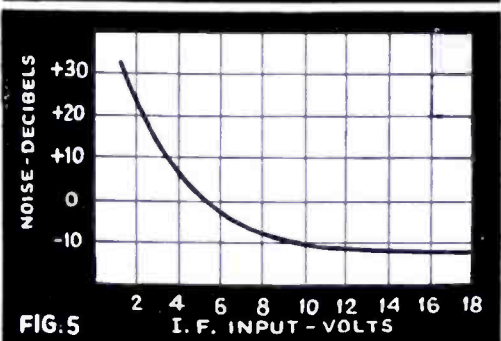
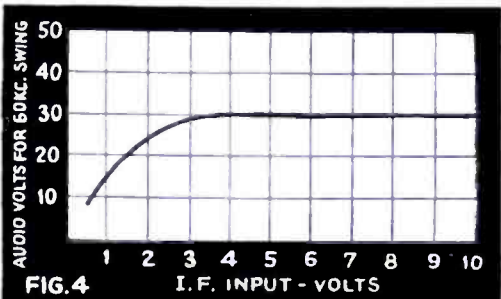
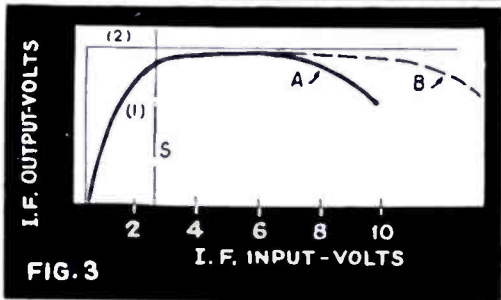
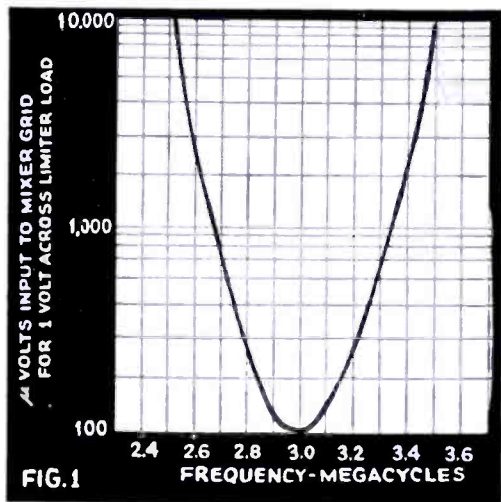

Fig. 2. The ins and outs of Frequency Modulation will be easier to learn during its developmental stage. Diagrammed at left is the "heart" of F.M. circuits.



The broad band characteristic required in the I.F. amplifier is obtained by over-coupling the coils of the I.F. transformers and by resistance loading. The effect of resistance loading, which is accomplished by placing proper value resistors across one or both of the transformer windings, is to effectively lower the Q of the I.F. coils. In addition to broadening the response characteristic, resistance loading also results in the elimination of fuzz frequencies in the recovered audio signal which would otherwise be present due to transients in the system as the frequency is varied.

To obtain the required reception characteristic, it is necessary to employ a reasonably-high-frequency I.F. system. A frequency of about 3 mc. has been found optimum for this use. Higher frequencies than this result in decreased gain and increased stability problems while with lower frequency systems it is difficult to obtain the required bandwidth. There has been no attempt at standardization as yet, however, and receivers at present on the market may be found to employ intermediate frequencies anywhere in the range from 2 to 5 mc.

THE LIMITER

One device present in an F.M. receiver which is somewhat new to the service man is the *limiter*. This device is nothing more than a tube employing a resistor-and-condenser bias whose plate and screen-grid voltages are sufficiently low so that the tube saturates. A typical limiter circuit is shown in Fig. 2.

The device depends for its operation on the fact that the output I.F. voltage can not exceed some fraction of the applied D.C. plate voltage. Consequently if a curve of I.F. output voltage vs. an I.F. input voltage is plotted, it has the form shown in Fig. 3, curve 1. The ideal response curve for a limiter would of course be a characteristic as shown in curve 2.

For such a characteristic, a very weak signal would result in full output from the limiter and further increase in signal would result in no change in output voltage. This curve is not capable of practical accomplishment, however, but curve 1 can be actually obtained. From curve 1 it can be seen that a certain input voltage is required to produce saturation. The value required is that indicated by the dotted line S in the diagram. For values of input greater than this, the output voltage is constant until a second point on the curve is reached, after which greater values of input may result in an actual decrease in output. To prevent this, a form of bias whose value depends on the I.F. voltage feed to the input of the tube is employed. Such bias is most conveniently obtained by means of a resistor and condenser, and when suitable values are used the curve may be made to have a flat characteristic out to point B, a point of sufficiently high input to result in adequate operation for all practical values of signal.

Figure 4 shows a curve of audio voltage developed at the detection transformer plotted against volts input to the limiter grid. It can be seen from this curve that input voltages of greater than about 3 volts result in no further increase in audio output when the frequency swing is maintained at some constant value.

NOISELESS OPERATION

In order to accomplish noise-free operation, however, a value of input signal somewhat greater than this is required. The curve of noise reduction is shown in Fig. 5. From this it can be seen that about 10 volts of I.F. are required at the grid of the limiter for most complete noise suppression. A

material amount of noise reduction however, occurs for signal levels of 7 or 8 volts, as indicated in Fig. 5.

These high values of signal required at the limiter grid for noise-free reception explain the requirement of a high-gain I.F. system. It is for this reason that 3 intermediate frequency stages are usually employed. The gain of a 3-stage I.F. amplifier at 3 mc. is about 10,000 if one 1852 and one 6SK7 tube are used as the I.F. amplifiers. If two 1852 tubes are employed the gain is about 15,000. The total gain of the system to produce 3 V. at the limiter grid with an input signal of 10 microvolts is 300,000. It can thus be seen that the R.F. system should have a gain of at least 30 not counting the conversion gain in the mixer tube. For noise-free operation with such weak signals, the R.F. system should have a gain of about 20 if two 1852 tubes are used in the I.F. system.

The voltage developed across the limiter load serves as an excellent indication of signal strength. This voltage is nearly directly proportional to signal strength for values up to several hundred microvolts. The curve of limiter voltage vs. signal strength is shown in Fig. 6. Bending of the curve which begins at point X is due to overloading of the I.F. amplifier tubes. Strangely enough, overloading the I.F. amplifiers does not result in distortion in the case of a frequency modulation receiver but merely serves as a *prelimiter* device to keep the output more nearly constant. The voltage across the limiter load is an excellent alignment indicator as will presently be explained.

CHECKING THE LIMITER

From the above curves and explanation, it can be appreciated that the *limiter* in an F.M. receiver acts not only as a means of "ironing out" amplitude variations in the carrier but also as an automatic volume control. It has been pointed out that a certain minimum signal strength is required to saturate the limiter so that noise-free reception will be obtained. For this reason it is not desirable to incorporate in an F.M. receiver any A.V.C. of the conventional sort, for it is desirable to maintain the signal strength at the limiter grid as high as possible. Provided that the limiter grid voltage does not drop below 3 volts in the system being discussed, extremely wide variations in field strength at the antenna may occur with absolutely no change in recovered audio level.

The operation of the limiter may be checked in several ways. Perhaps the most convenient method is to connect a vacuum-tube voltmeter between the plate of the limiter tube and ground. A signal from a single generator is then fed to the control-grid of the converter tube at the intermediate frequency and the level of this signal is increased gradually starting from about 100 microvolts. The output voltage should begin to flatten off somewhere between 200 and 400 microvolts input and should be constant for all higher values of input level.

Another method of checking the limiter action is to connect a high-impedance D.C. voltmeter or vacuum-tube voltmeter between the ungrounded 6H6 cathode and ground. A signal put into the converter grid at the exact I.F. intermediate frequency should result in zero voltage on the meter. If the signal frequency is now changed by approximately 50 kc. a reading should be obtained. The level of the input signal may now be varied from 100 microvolts up, whereupon the meter reading should increase to the point where the signal level is somewhere between 200 and 400 microvolts and should thereafter remain constant.

THE DEMODULATOR (2nd-Detector)

The final point of difference between an F.M. and A.M. receiver is in the detection system. An F.M. detection system is entirely different both in its construction and theory of operation from the conventional diode detector used with A.M. receivers.

Referring to Fig. 2 it will be seen that the "detection transformer" which feeds the demodulator or 2nd-detector has, in addition to the magnetic coupling between its coils, a capacity coupling between the top of the primary and the center-tap of the secondary. This results in 2 voltages being developed between the plate of each diode and the center-tap of the transformer. If the frequency of the impressed signal is exactly that to which both primary and secondary are tuned, the voltage developed by magnetic induction will be almost exactly 90° out-of-phase with the voltage developed by means of the capacity coupling.

These voltages are shown in Fig. 7. The subscripts *m*, *c*, and *r*, refer respectively to the magnetic component, the capacity component, and the resultant voltage. The subscripts 1 and 2 refer to the upper and lower diodes respectively. It can be seen from the figure that E_{r1} and E_{r2} are equal in magnitude under these conditions. These voltages are rectified in the diodes and produce equal and opposite voltages between the 2 cathodes and point 0. The voltage AG is thus zero.

If, now, the frequency is made to depart from that to which the system is tuned, the capacity voltage fed to each plate will be the same, but that due to the magnetic induction will shift in phase as shown in Fig. 8. The resulting voltages E_{r1} and E_{r2} are now no longer equal so that the difference between their rectified values appears between A and ground. An increase in frequency results in point A becoming negative with respect to ground, while a decrease in frequency results in point A becoming positive with respect to ground.

A plot of the D.C. voltage is shown in Fig. 9 for plus and minus departures from the center frequency. If the input frequency is varied at an audio rate, an audio voltage will be developed across this output network. (NOTE: In Fig. 9, D.C. voltages +5 and -5 should be +50 and -50, an error caught too late for correction in the drawing.—Ed.) To insure faithful reproduction, it is essential that the portion of this curve being used (between plus and minus 75 kc. deviation) be linear. In the case of very strong signals being fed to the detection transformer, the point at which the curve bends over, points A and B in Fig. 9, is determined by the design of the transformer itself. If the incoming signal is too weak, however, the overall detection characteristic may appear as shown in the dotted curve, the point of bending occurring for smaller frequency departures due to lack of voltage at frequencies closer to the center frequency than was previously the case. This can result in distortion on loud passages since the frequency swing is greater with greater amplitudes of audio voltage fed to the microphone at the transmitter. Note that this effect can occur only on weak signals where the operation of the limiter is not sufficient to maintain the output voltage constant over the range of frequency excursions encountered. Again it must be emphasized that the sharp I.F. system does not result in loss of high audio frequencies but rather in distortion with large volumes.

An interesting point in connection with the detection transformer is that rectification may occur with resultant audio signals at 3 points on the curve. These are point 0, the correct one, and points *m* and *n* on the tails of the characteristic. Point 0 is, of course, the only one at which good noise

OHMITE Ohm's Law Calculator

Solves any Ohm's Law problem with one setting of the slide

Here's the handiest Ohm's Law Calculator you've ever seen! Specially designed for you by Ohmite Engineers. Gives the answer to any Ohm's Law problem in a jiffy, with one setting of the slide. No decimal points to worry about because all values are direct reading. Simple as can be. Does not require any knowledge of a slide rule to operate. Nothing else like it. Smaller

than any such calculator ever available. Size 4 1/8" x 9". Covers the range from .1 ohm to 10 megohms, also the range of currents, wattages and voltages commonly used in radio and commercial work. A setting of the slide also tells the stock number of resistor or rheostat you may need. Available to you for only 10c to cover handling cost. At your Jobber, or send 10c in coin now.

It's NEW

It's Complete

OHMITE MANUFACTURING COMPANY
CHICAGO, ILLINOIS U.S.A.

OHMITE MANUFACTURING CO
4896 FLOURNOY ST., Chicago, Illinois
10c in Coin enclosed. Send Ohm's Law Calculator.

Name

Address

City State
Res. Craft—Dec.

Be Right with OHMITE
RHEOSTATS • RESISTORS • TAP SWITCHES

reduction and high fidelity will be obtained. At this point also the greatest audio signal is obtained.

ALIGNMENT

The alignment of an F.M. receiver is similar in many respects to that of a high-frequency amplitude receiver. The intermediate frequency system may be aligned by simply adjusting primaries and secondaries of the I.F. transformers for maximum response at the correct I.F. if the design of the transformers is such as to give a single peak response. If the transformers are designed for double peaks, the alignment is considerably more difficult and the use of a frequency wobbler is indicated. The alignment of the R.F. and antenna systems is identical with that of an A.M. receiver. The antenna circuit should be aligned whenever possible with the antenna which is to be used with the receiver.

The alignment of the detection transformer which is the only real point of difference is made as follows:

- (1) Connect a high-impedance voltmeter or vacuum-tube voltmeter between point A of Fig. 2 and ground.
- (2) Put in an I.F. signal to the grid of the converter tube and, making sure that the frequency is exactly the correct I.F., adjust the primary trimmer, C_p , of the detection transformer to give exactly zero voltage.
- (3) Change the input frequency to 75 kc. lower than the I.F. Note the reading of the meter.
- (4) Change the input frequency to a frequency 75 kc. higher than the I.F. To observe the reading of the meter it will now be necessary to reverse the terminals unless a center-scale meter is employed. Note the

second reading of the meter. If the system is correctly aligned, the readings for plus and minus 75 kc. deviation will be exactly equal in value and opposite in polarity. If this is not the case, adjust the secondary trimmer, C_s , of the detection transformer slightly and repeat the procedure until exactly equal voltages are obtained.

(5) Adjust the input frequency to the exact I.F. and readjust, if necessary, the primary to give exactly zero voltage. The alignment is now complete.

In replacing components in the I.F. amplifier the same precautions should be taken as with the R.F. system. All replacements should be connected as nearly as possible in the same location and in the case of condensers the lengths of leads should be as near as possible like those of the removed condenser.

This article has been prepared from data supplied by courtesy of Browning Laboratories, Inc.

ENGINEERING

The Delaware River Joint Commission has asked the F.C.C. for permission to set-up a 2-way radio system to facilitate bridge traffic control.

A large glass jar, in G.E.'s plastic research lab, at Pittsfield, Mass., for keeping a constant-temperature bath for measuring viscosity in plastic materials, had a tendency to collect scum, making the glass opaque. Cleaning the jar twice a week being a tedious job for chemist Samuel Johnson, he finally hit upon the use of 3 goldfish to eat the scum, upon which they seem to thrive.



In this article the author describes the practical Vibrator Tester which he built after analyzing currently-available models. No new services are claimed for this apparatus; simplicity is the feature of this device—"which will test all types of vibrators."

← The completed Practical Vibrator Tester presents a commercial appearance.

Build this Practical

VIBRATOR TESTER

ROGER DICKEY

THE past 2 years I have been using an oscilloscope to test vibrators. This method, although quite accurate, is very slow. Also, since the vibrator must be in the set to make the test, it has become a real problem what with the customers bringing in just the vibrator to be tested (as they are accustomed to do with tubes).

Many good vibrator testers are available, but due to their complicated circuits, cost a little too much money for the average Serviceman to own.

After carefully studying the different types, styles and circuits used on all vibrators I worked out the circuit for the Practical Vibrator Tester here described. It has proved very successful. I do not claim it to be better than other testers, but it will do anything any other vibrator tester will do and is much less complicated.

The main features are:

- (1) Sockets for all "plug-in" type vibrators.
- (2) Tip-jacks to allow for special types—not "plug-in."
- (3) Tests vibrator for its ability to start on low voltage.
- (4) Meter indication of voltage at which vibrator starts.
- (5) Tests vibrator for steadiness of output.
- (6) Tests all vibrators under actual operating conditions.
- (7) English reading Red (bad) and Green (good) scale for test.
- (8) Tester has a single circuit-selector switch that makes proper circuit changes for various vibrators.
- (9) A type switch changes circuit for interrupter- or synchronous-type vibrators.

- (10) A minimum number of controls for making a quick and accurate test.
- (11) Easy to construct.
- (12) Inexpensive to build.

CIRCUIT

The unusual feature is the wiring of the sockets and the manner in which they connect to the rotating contacts of the 6-gang, 11-position switch. About 75% of all vibrators can be tested without even moving the circuit selector switch from the No. 1 position. This simplifies the switching necessary for making most tests.

In order to conserve space on my service bench the tester was combined with an A.C. power control panel which I remodeled at the time of building the vibrator tester. It would be a simple matter to build it to fit in a portable case.

The diagram and parts list are self explanatory. The 1½-ohm rheostat was placed in the "A-" lead to avoid insulating the shaft. Switch Sw.4 is a single-pole double-throw spring switch that remains in Position No. 1 until the button is pressed to make the test and then connections are as in Position No. 2.

The meter used was a 0-10 ma. instrument taken from an old tube tester. A 0-1 ma. meter may be used by changing the values of resistors R3, R4 and R5. Resistor R2 (5,000 ohms) places a load of 40 ma. on the vibrator at 200 volts which is approx. the same as when the vibrator is in actual operation in a receiver.

The only adjustment necessary on the tester is to use a new vibrator and adjust R1 until the meter reads 6V. Then press down test button Sw.4 and adjust R4 until meter reads exactly to the center of the green scale. The tester needs no further adjusting.

The proper test procedure is quite simple:

- (1) Set selector switch and type switch to positions as given on chart.
- (2) Place vibrator in socket shown on chart.
- (3) Turn tester on and wait about ½-minute for the type 84 tube to heat up.
- (4) Turn R1 gradually increasing voltage

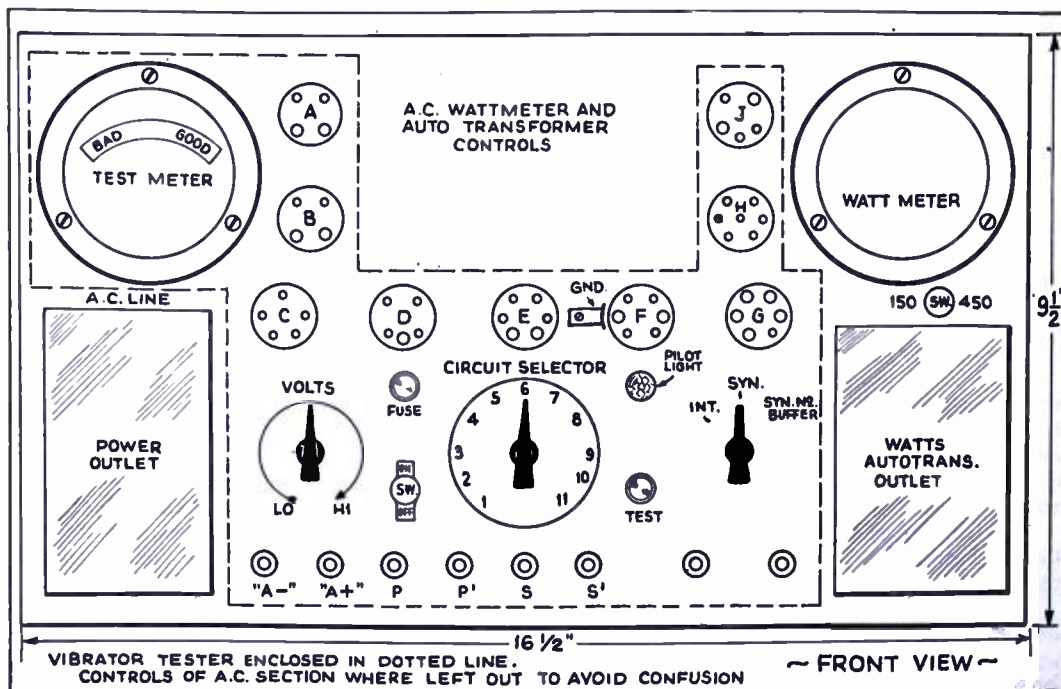

This panel layout if reproduced as a photostat to any desired size may be used as a general layout for the locations of components, etc. This layout also supplies most of the panel markings.

— BUY DIRECT FROM THE MANUFACTURER AND SAVE —

WE KNOW OUR PRICES ARE VERY LOW and expect a certain amount of skepticism from servicemen who have never purchased the SUPERIOR way, but five years of sticking to our way of doing business has convinced us and many thousands of servicemen who have purchased from us that it is a practical and mutually profitable way of doing business. We know that the average income of the Radio Serviceman prohibits his purchasing high-priced equipment, and yet the very nature of his work makes it necessary for him to use accurate, dependable and up-to-date equipment. We know we have solved the problem for him and our continually expanding business proves that servicemen recognize this claim to be true.

BESIDES THE THOUSANDS OF SERVICEMEN AND TECHNICIANS, THE FOLLOWING WELL-KNOWN NAMES ARE LISTED AMONG SUPERIOR INSTRUMENT PURCHASERS: Standard Oil Company of New Jersey; U. S. Dept. of Agriculture; U. S. Dept. of Commerce; U. S. War Department; C.C.C. Camps; National Youth Administration; Goodyear Tire and Rubber Co.; E. I. duPont de Nemours & Co.; University of Nebraska; Leland Stanford Junior University; Westminster College; Oberlin College; University of Michigan; Boston College; Pomona College; Board of Education, Remus, Michigan; Board of Education, City of New York; Board of Vocational Education, State of Illinois; City of Bartow, Florida; Florida State Dept. of Education; Educational Dept., Custer, North Dakota.



The New Model 1220 POCKET LABORATORY

- ★ WEIGHS ONLY 28 OUNCES!!
 - ★ USES A 2% ACCURATE 0-200 MICROAMMETER—ENABLING MEASUREMENTS AT 5000 OHMS PER VOLT
- SPECIFICATIONS**

- ★ 6 D.C. Voltage Ranges: 0-3-10-50-250-500-5,000 volts.
- ★ 3 A.C. Voltage Ranges: 0-15-150-1500 volts.
- ★ 4 Resistance Ranges: 0-3000 ohms, with 15 ohm center, direct reading to 0.2 ohm; foregoing base range multiplied by 10, by 100 and by 1,000, to read up to 3 Meg. with self-contained 3 V. flashlight battery.
- ★ D.C. Current Ranges: 0-200 microamperes; 0-2-20-200 Milliampères, using wire-wound shunts.
- ★ 3 Output Meter Ranges: Same as A.C. Voltage Ranges.
- ★ 3 Decibel Ranges: From -2 to +58 D.B., based on .006 watt in 500 ohms.

Model 1220 comes complete with cover, self-contained battery, test leads and instructions. ONLY **\$10⁴⁵**

THE NEW CHANNEL-ANALYZER

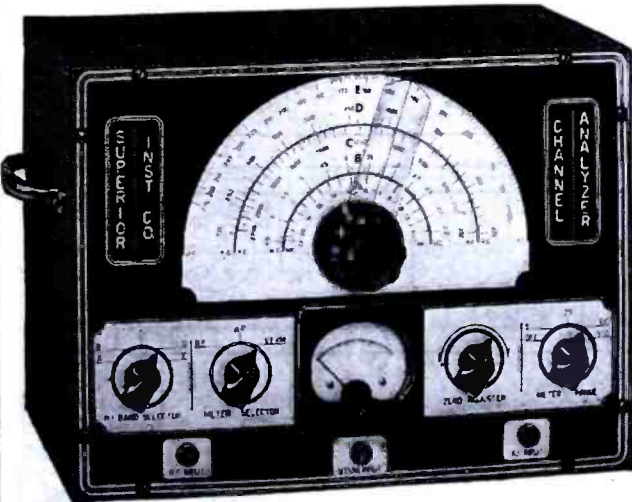

FOLLOWS THE SIGNAL FROM ANTENNA TO SPEAKER OF ANY SET

The well-established and authentic SIGNAL TRACING METHOD of locating the very circuit in which there is trouble, and the very component that causes the trouble, is now for the first time available at a price any radio serviceman can afford.

THE CHANNEL-ANALYZER WILL

- ★ Follow the signal from antenna to speaker through all stages of any receiver ever made.
- ★ Instantly track down exact cause of Intermittent operation.
- ★ Measure both Automatic-Volume-Control and Automatic-Frequency-Control, voltages and circuits without appreciably loading the circuit, using built-in highly sensitive Vacuum-Tube Voltmeter.
- ★ Check exact gain of every individual stage in receiver.
- ★ Track down and locate cause of distortion in R.F., I.F., and A.F. amplifier.
- ★ Check exact operating voltage of each tube.
- ★ Locate leaky condensers and all high-resistance shorts, also show opens.
- ★ Measure exact frequencies, amount of drift and comparative output of oscillators in superhets.
- ★ Track down exact cause of noise.

The Superior Channel-Analyzer comes housed in shielded cabinet and features an attractive etched aluminum panel. Supplied complete with tubes, three specially engineered shielded input cables, each identified as to its purpose. Also full operating instructions. Size 13" x 10" x 6". Shipping weight 19 pounds. Only **\$19⁷⁵**

The New Model 1240 TUBE TESTER

Instantaneous snap switches reduce actual testing time to absolute minimum. Tests all tubes 1.4 to 117 volts.

Sockets for all tubes — No adapters.

SPECIFICATIONS:

- ★ Tests all tubes, 1.4 to 117 volts, including 4, 5, 6, 7, 7L, octals, octals, Bantam, Jr., Peanut, single ended, floating filament, Mercury Vapor Rectifiers, the new S series, in fact every tube designed to date.
- ★ Spare socket included on front panel for any future tubes.
- ★ Tests by the well-established emission method for tube quality, directly read on the GOOD ? BAD scale of the meter.
- ★ Jewel protected neon.
- ★ Tests shorts and leakages up to 2 megohms in all tubes.
- ★ Tests leakages and shorts in all elements AGAINST all elements in all tubes.
- ★ Tests BOTH plates in rectifiers.
- ★ Tests individual sections such as diodes, triodes, pentodes, etc., in multi-purpose tubes.
- ★ Latest type voltage regulator.
- ★ Features an attractive etched aluminum panel.
- ★ Works on 90 to 125 volts 60 cycles A.C.

Model 1240 comes complete with instructions and tabular data for every known type of receiving tube. Shipping weight 12 pounds. Size 6" x 7 1/2" x 10 3/4". Our Net Price **\$11⁸⁵**
Portable cover \$1.00 additional

MODEL 1230 SIGNAL GENERATOR



WITH FIVE STEPS OF SINE-WAVE AUDIO

SPECIFICATIONS:

1. Combination R.F. and A.F. Signal Generator. R.F.—100 K.C. to 90 Megacycles, A.F.—200 to 7500 cycles; Sine-Wave.—WITH OUTPUT OF OVER 1 VOLT. All direct reading, all by front panel switch manipulation.
 2. R.F. and A.F. output independently obtainable, alone or with A.F. (any frequency) modulating R.F.
 3. Latest design full-range attenuator used for controlling either the pure or modulated R.F.
 4. Accuracy is within 1% on I.F. and broadcast bands; 2% on higher frequencies.
 5. Giant dial etched directly on front panel, using a new mechanically perfected drive for perfect vernier control.
 6. Operates on 90 to 130 V. A.C. or D.C. (any frequency).
- The Model 1230 comes complete with tubes, shielded cables, molded carrying handle and instructions. Size 14" x 6" x 11". Shipping weight 15 pounds. Only **\$12⁸⁵**

SUPERIOR INSTRUMENTS CO.

136 Liberty St., Dept RC-12
New York, N.Y.

•TEST INSTRUMENTS•

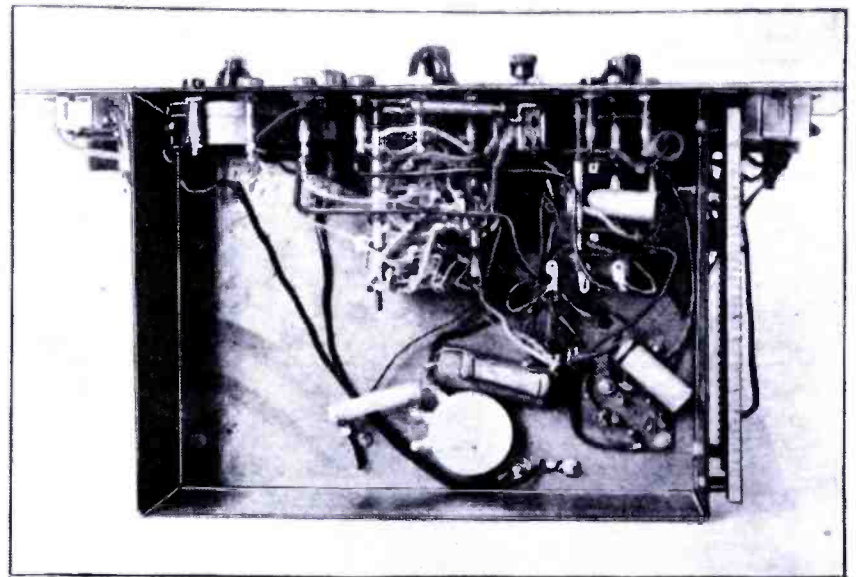
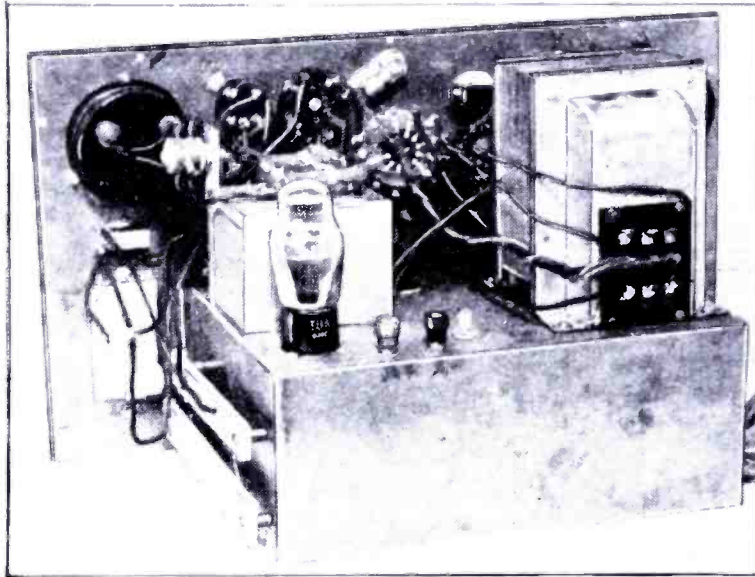

The above photos, rear and underside views, of the Practical Vibrator Tester show how the parts used by the author are placed in the actual instrument.

until vibrator starts. A good vibrator will start at 5.2 volts or less.

(5) Set R1 until voltage is 6 volts, then push test button.

A good vibrator will read to center of green scale and the meter hand will remain perfectly still. If the meter hand fluctuates or reads in the red sector the vibrator is "no good."

In compiling a test chart for the Practical Vibrator Tester it was found that there are 265 different part or type numbers used by 5 manufacturers. Each one has a different number for the same type of vibrator.

There is no reason why the manufacturers could not agree on a standard numbering system. This list is presented here.

VIBRATOR TEST CHART

DELCO

1209282	D 1 SYN	5050498	J 1 SNB
1211375	C 1 SNB	5050651	C 1 SNB
5037400	D 1 SYN	5050673	B 1 INT
5038055	D 1 SYN	5052374	E 4 INT
5039661	D 1 SYN	5052378	A 1 INT
5039757	D 1 SYN	5052525	E 6 SNB
5040000	A 1 INT	5052538	A 1 INT
5040700	D 1 SYN	5052869	F 1 SNB
5041125	C 1 SNB	5053141	C 1 SYN
5041245	D 1 SYN	5053179	G 1 SNB
5041376	J 1 SYN	5053181	D 1 SNB
5042240	A 10 INT	5053183	H 1 SYN
5042703	A 1 INT	5053185	C 1 SNB
5043853	J 1 SYN	5053501	F 1 SNB

MALLORY

245	C 1 SNB	285	C 1 SNB
245A	C 1 SNB	285XS	E 3 SNB
245C	D 1 SNB	P285Y	E 3 SNB
W245	C 1 SNB	W285	C 1 SNB
W245A	C 1 SNB	286S	F 1 SNB
246	E 6 SNB	287M	F 1 SNB
246P	E 6 SNB	289Y	H 1 SNB
W246	E 6 SNB	294	A 1 INT
247	G 1 SNB	294C	B 1 INT
248	F 1 SNB	294SW	A 2 INT
249	H 1 SYN	296	E 4 INT
253	A 1 INT	297	E 4 INT
253T	A 1 INT	299	E 2 INT
253Y	A 1 INT	500P	A 1 INT
270B	C 1 SYN	501P	A 1 INT
271	C 1 SYN	504	E 5 INT
271HD	C 1 SYN	505P	A 1 INT
273	C 1 SYN	507P	A 1 INT
273C	D 1 SYN	508P	B 1 INT
273D	J 1 SYN	510P	A 1 INT
275	C 1 SYN	514	J 1 SNB
275XS	E 3 SYN	715	J 1 SNB
277S	F 1 SYN	716	J 1 SNB
281	C 1 SNB	722A	E 1 SNB

725	H 1 SYN	850
728A	E 1 SNB	851
825	A 1 INT	852

MEISSNER

405	A 1 INT	712
435	B 1 INT	713
438	A 1 INT	714
440	A 2 INT	715
441	E 5 INT	717
442	E 2 INT	718
449	E 4 INT	719
P450	A 1 INT	720
452	E 4 INT	723
454	A 1 INT	726
P454	A 1 INT	727
459	C 8 INT	728
461	C 7 INT	731
469	E 4 INT	800
705	C 1 SYN	801
706	F 1 SYN	EU1
708	G 1 SNB	

RADIART

3223	E 4 INT	3263
3260	A 1 INT	3264
3261	E 4 INT	3283
3262	A 1 INT	3299

B 1 INT	3302	E 4 INT	4414	H 1 SNB
B 1 INT	3220	A 10 INT	4416	E 6 SNB
B 1 INT	3356	E 4 INT	4417	C 1 SNB
	3399	A 1 INT	4501	F 1 SYN
	3417	A 1 INT	4502	C 1 SYN
E 6 SNB	3461	D 1 SYN	4504	J 1 SYN
D 1 SYN	3679	D 1 SYN	4505	C 1 SYN
D 1 SNB	3741	A 1 INT	4608	E 3 SYN
C 1 SNB	3782	A 1 INT	4611	J 1 SYN
E 3 SNB	3786	C 8 INT	4612	E 6 SNB
J 1 SYN	3806	A 1 INT	4613	D 1 SYN
H 1 SNB	3815	A 1 INT	4614	D 1 SYN
E 3 SNB	3842	A 1 INT	5300	A 1 INT
F 1 SNB	3850	F 1 SYN	5301	A 1 INT
J 1 SNB	3865	A 1 INT	5303	B 1 INT
F 3 SYN	3883	F 1 SNB	5304	C 7 INT
F 1 SNB	3888	A 1 INT	5305	A 1 INT
E 1 SNB	3989	G 1 SNB	5306	E 4 INT
C 1 SNB	4253	A 1 INT	5310	A 1 INT
C 1 SNB	4255	H 1 SYN	5312	E 4 INT
A 1 INT	4257	H 1 SNB	5313	A 1 INT
	4260	A 1 INT	5320	A 1 INT
	4301	A 1 INT	5321	A 1 INT
	4313	A 1 INT	5322	A 10 INT
E 4 INT	4318	E 5 INT	5323	A 1 INT
A 1 INT	4320	E 2 INT	5325P	B 1 INT
C 1 SYN	4402	C 1 SNB	5326P	A 1 INT
E 4 INT	4403	C 1 SNB	5327P	A 1 INT

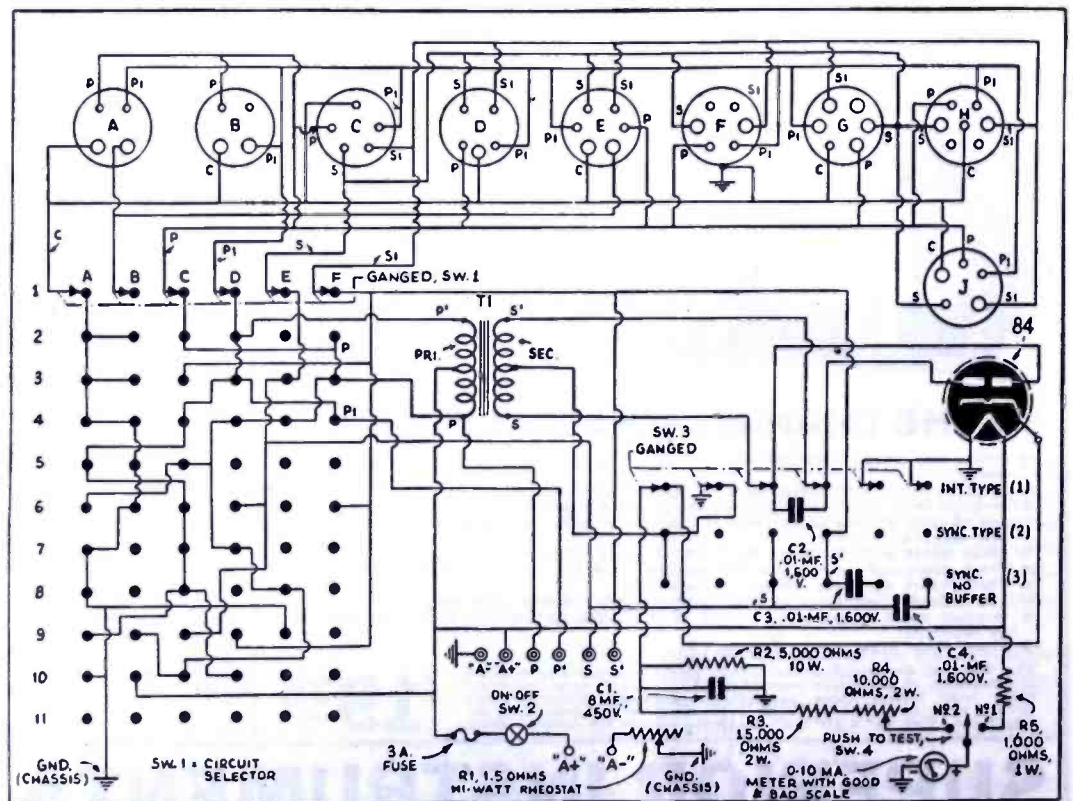

Schematic circuit of the Practical Vibrator Tester which Servicemen and experimenters may wish to duplicate.

5330	A 1 INT	5409-4	C 1 SNB
5331	A 2 INT	5411	E 6 SNB
5333	B 1 INT	5413	C 1 SNB
5334	B 1 INT	5415	C 1 SNB
5335	B 1 INT	5420P	E 6 SNB
5339	B 1 INT	5421	E 6 SNB
5340M	B 1 INT	5426	J 1 SNB
5341M	B 1 INT	5427	E 6 SNB
5342M	A 1 INT	5428	E 3 SNB
5365	E 4 INT	5430	E 1 SNB
5400	F 1 SNB	5431	C 1 SNB
5405	D 1 SNB	5434	E 1 SNB
5406	H 1 SYN	5435	E 6 SNB
5407	F 1 SNB	5437	F 1 SNB
5409	C 1 SNB	5438	F 1 SNB
5410	D 1 SNB	5439	E 6 SNB

UTAH

NB4	A 1 INT	NP64	E 5 INT
NP40	A 1 INT	SP5	C 1 SNB
NP41	A 10 INT	SP50	C 1 SYN
NP42	A 1 INT	SP51	D 1 SYN
NP43	A 2 INT	SP52	J 1 SYN
NP44	A 1 INT	SP53	C 1 SYN
NP45	B 1 INT	SP54	J 1 SNB
NP46	A 1 INT	SP55	D 1 SNB
NP47	A 1 INT	SP56	C 1 SNB
NP48	A 1 INT	SP57	C 1 SNB
NP49	A 1 INT	SP6	G 1 SNB
NP480	B 1 INT	SP60	E 3 SNB
NP481	A 1 INT	SP62	F 1 SNB
NP482	A 1 INT	SP63	F 1 SYN
NP483	A 1 INT	SP64	E 1 SNB
NP484	B 1 INT	SP66	E 6 SNB
NP485	A 1 INT	SP67	E 3 SNB
NP487	B 1 INT	SP68	E 3 SYN
NP489	A 1 INT	SP69	F 1 SNB
NP491	A 1 INT	SP640	F 1 SNB
NP65	E 4 INT	SP641	F 1 SNB
NP50	C 7 INT	SP645	F 1 SNB
NP51	C 8 INT	SP71	H 1 SYN
NP6	E 4 INT	SP72	H 1 SNB
NP61	E 4 INT	4SP5	C 1 SNB
NP62	E 5 INT	4SP56	C 1 SNB
NP63	E 2 INT	4SP66	E 6 SNB

SYN—Synchronous Vibrator with Buffer Condensers.

SNB—Synchronous Vibrator without Buffer Condensers.

INT—Interrupter Type.

List of Parts

- One Yaxley 6-gang, 11-position non-short-ing switch, No. 1361-L, Sw.1;
- One H.&H.S.P.S.T. toggle switch, Sw.2;
- One Yaxley 6-gang 3-position non-short-ing switch, No. 1323-L, Sw.3;
- One S.P.D.T. jack-type push switch. Re-mains closed in position No. 1 when not pressed, Sw.4;
- One Carter Hi-watt rheostat, 1.5 ohms, R1;
- One I.R.C. wire-wound resistor, 5,000 ohms, 10 W., R2;
- One I.R.C. resistor, 15,000 ohms, 2 W., R3;
- One Yaxley wire-wound rheostat, 10,000 ohms, 2 W., R4;
- One I.R.C. resistor, 1,000 ohms, 1 W., R5;
- One electrolytic condenser, 8 mf., 450 V., C1;
- Three tubular vibrator condensers, 0.01-mf., 1,600 V., C2, C3, C4;
- One any standard vibrator transformer, T1;
- One 5-prong wafer socket;
- One type 84 tube;
- Six insulated tip-jacks;
- One Yaxley circuit-selector dial plate, No. 381, 1 to 11 positions;
- Nine Amphenol vibrator sockets, one of each type used;
- One Triplett 0-10 ma. milliammeter with Good-?-Bad scale;
- One panel-mounting fuse holder.

"4 DATA SHEETS"

Due to unforeseen circumstances it was necessary to present only 2 Data Sheets this month instead of the 4 mentioned last month.

BUY DIRECT FROM THE MANUFACTURER AND SAVE

THE NEW MODEL 1280 SET-TESTER

A complete testing laboratory all in one unit. Tests all tubes, reads A.C. volts, D.C. volts, A.C. current, D.C. current, High Resistance, Low Resistance, High Capacity, Low Capacity, Decibels, Inductance, and Watts.



- * Instantaneous snap switches reduce actual testing time to absolute minimum.
- * Spare socket, and filament voltages up to 117 volts make the Model 1280 proof against obsolescence.
- * Latest design 4½" D'Arsonval type meter.
- * Comes housed in attractive, leatherette covered carrying case.
- * Sloping panel for rapid, precise servicing.
- * Works on 90-125 volts 60 cycles A.C.

The primary function of an instrument is, of course, to make measurements accurately and when designing test equipment this is our first thought. However, we also appreciate the important part the appearance of an instrument plays in the impression a serviceman makes on his customers, especially on home calls. We have, therefore, paid special attention to the outward design of all of our new instruments. For instance the panel of this Model 1280 is made of aluminum and etched by a radically new process, which results in a beautiful, confidence-inspiring appearance.

SPECIFICATIONS

- * Tests all tubes, 1.4 to 117 volts, including 4, 5, 6, 7, 7L, octals, loctals, Bantam Jr., Peanut, single ended, floating filament, Mercury Vapor Rectifiers, the new S series, in fact every tube designed to date.
- * Spare socket included on front panel for any future tubes.
- * Tests by the well-established emission method for tube quality, directly read on the GOOD ? BAD scale of the meter.
- * Jewel protected neon.
- * Tests shorts and leakages up to 2 meg-ohms in all tubes.
- * Tests leakages and shorts in all elements AGAINST all elements in all tubes.
- * Tests BOTH plates in rectifiers.
- * Tests individual sections such as diodes, triodes, pentodes, etc., in multi-purpose tubes.
- * Latest type voltage regulator.
- * Features an attractive etched aluminum panel.

- Complete A.C. and D.C. Voltage and Current Ranges.
- D.C. Voltage: 0-15, 0-150, 0-750 Volts.
- A.C. Voltage: 0-15, 0-150, 0-750 Volts.
- D.C. Current: 0-1, 0-15, 0-150, 0-750 ma.
- A.C. Current: 0-15, 0-150, 0-750 ma.
- 2 Resistance Ranges: 0-500 ohms, 500-5 megohms.
- High and Low Capacity Scales: .0005 to 1 mfd. and .05 to 50 mfd.
- 3 Decibel Ranges.
- 10 to +19.
- 10 to +38, -10 to +53.
- Inductance: 1 to 700 Henries.
- Watts: Based on 6 MW. at 0 D.B. in 500 ohms .006000 MW. to 600 watts.

Model 1280 comes complete with test leads, tabular charts, instructions, and tabular data for every known type of receiving tube and many transmitting tubes. Shipping weight 18 lbs.

ONLY \$19.95

PORTABLE COVER \$1.00 ADDITIONAL

SUPERIOR INSTRUMENTS CO. 136 Liberty St., Dept. RC-12 NEW YORK, N. Y.

BOOK REVIEW

TELEVISION BROADCASTING, by Lenox R. Lohr, President of the National Broadcasting Co., with a foreword by David Sarnoff (President of RCA.), size 6¼x9¼", 274 pages; illustrated with diagrams and photos of actual television broadcasting, published by McGraw Hill Book Co., Inc., New York, 1940.

This is a very valuable book to the general student of television and it covers such interesting and vital subjects as the legal aspects of television service, the rôle of the sponsor in television, basic economic factors, the problem of network broadcasting for television, general aspects of outdoor television pickups, etc. Other topics discussed at length, in an authoritative manner, are motion picture film television, with diagrams showing how the images from the films are picked up by the iconoscope, etc., and a valuable section covers the production of studio programs, while an appendix contains a typical television script, with production directions. To round out the book the author has included a chapter on the technical elements of television systems, with diagrams and photos.

A NEW SUBSCRIPTION OFFER! See Page 362



FREE!

HAMMARLUND NEW "40" RADIO CATALOG

The latest Hammarlund catalog with complete data, illustrations, drawings and curves on the entire Hammarlund line. Address Department RC-124 for your free copy.

HAMMARLUND MFG. CO., INC. 424-438 West 33rd Street, New York City

NEW Combination Tester

TRIPLET
MODEL 1183

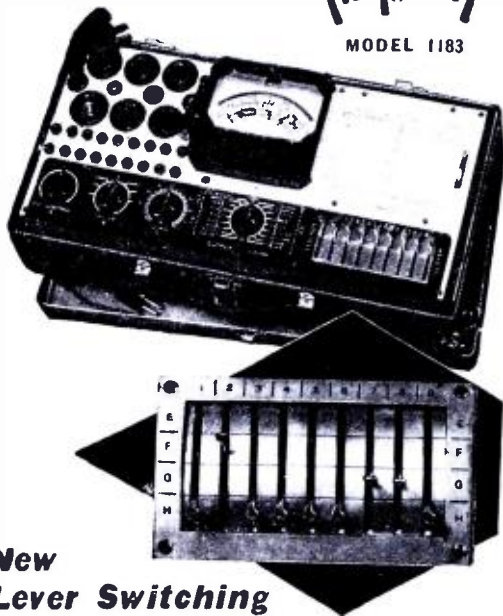

New Lever Switching

Combining simplicity of operation with absolute flexibility, Triplet's new lever switching permits individual control for each tube element—yet test procedure is simple and quick. The switch setting shown above will permit tests of 45 commonly used different type tubes without change of position of the levers. Many tubes require only two lever switch settings—more than half, only three settings. Model 1183 is truly a Non-Obsolescent Tube Tester, combined with a Volt-Ohm-Milliammeter and Free Point Tester . . . three fundamental testers that you can use for many years. Volt-Ohm-Milliammeter Ranges: 0-10-50-250-500-1000 AC and DC Volts; DC at 10,000 Ohms per volt; AC at 2,000 Ohms per volt. DC Milliamperes 0-1-10-50-25.; Resistance 0-500 low ohms; 0-15,000 Ohms; 0-1.5 and 0-15 Megohms. Complete Free Point Tester with sockets for all tubes, including new Midgets. Tube Tester has new lever type switch. Speedex Roll Chart, removable from panel as separate unit . . . Dealer Net Price . . . \$49.84

MODEL 1621

MODEL 1621 . . . Portable tube tester, lever-switch operated. Four "quick change" non-obsolescent features:

RED DOT Lifetime Guaranteed Instrument, Speed Roll Chart, New socket panel and Switching Section, which can be replaced in case of unanticipated changes. Dealer Net . . . \$39.84.



MODEL 1270

MODEL 1270 . . . An advanced electrical circuit analyzer that shows the wattage consumption, amperes and line voltage of ALL household appliances including electric ranges under actual operating conditions. Dealer Net . . . \$29.83



Write for Catalog — Section 1612 Harmon Drive

THE TRIPLET ELECTRICAL INSTRUMENT CO.
Bluffton, Ohio

MANUFACTURERS' TUBE REPLACEMENT CODES AND POLICIES

When servicing radio sets requiring tube replacements Service-men should be conversant with manufacturers' guarantees.

All radio tubes used in Stewart-Warner (and other manufacturers') receivers are guaranteed by their respective manufacturers and all adjustments are made through the manufacturers on the basis of each maker's replacement policy. *Therefore, all returns of defective tubes must be made directly to the tube factories in accordance with their routines.*

When returning defective tubes to the manufacturer, be sure to attach a tag or label describing the defect and stating the length of time the tube was in service.

The tube manufacturers code-mark the tubes to indicate the date of shipment and their warranty extends for a definite length of time after the code date. All tubes used in current model Stewart-Warner (and some other manufacturers') receivers are guaranteed for 12 months after the code date. In addition, tubes sold to set manufacturers usually are coded ahead so that the warranty period actually begins several months after the date of manufacture, thus normally allowing sufficient time for the set to go from factory to distributor to dealer to customer. For example, a tube shipped to us in July might be code marked August or September, and the warranty would then extend 12 months after the code marking. Thus, there is ample time for the set to move from the factory to consumer and still be in the code date warranty during the 90-day guarantee on the receiver.

Details of the Ken-Rad, Sylvania and Raytheon tube adjustment policies are explained below. Tubes beyond the time limit as shown in these policies are considered obsolete and free replacement will ordinarily be refused.

STEWART-WARNER CORP.,
Service Department.

KEN-RAD TUBE ADJUSTMENT POLICY

Ken-Rad Radio Tubes are guaranteed to be free from mechanical and electrical defects due to either workmanship or materials. All tubes not coming within this guarantee will be replaced provided return is made to the factory within replacement period. (See below.)

If adjustment is claimed on tubes out of replacement period they should be submitted to the factory for decision and must be accompanied by stickers (supplied on request), showing the user's name and address, length of service and reason for claiming adjustment. Broken tubes or physically abused tubes (example, elements distorted due to rough handling, tubes with broken or missing base pins, etc.) are not subject to adjustment.

All Ken-Rad Tubes are code marked to indicate date of shipment from the factory. Tubes not coded, tubes coded with a single letter, and tubes coded A7 to L7, M8 to Z8 and A9 to G9, are obsolete and are not subject to adjustment. Tubes which will operate but have given average life in service and tubes which test within reasonable limits should not be returned.

Description of Code Marking and Replacement Periods.—Tubes claimed defective in accordance with the above policy will be replaced if returned during or prior to the months shown below.

Will be replaced if returned during or prior to

Tubes Coded	If in Group I	If in Group II
H9	Obsolete	July 1940
I9	Obsolete	Aug. 1940

Tubes Coded	Obsolete	Sept. 1940
J9	July 1940	Oct. 1940
K9	Aug. 1940	Nov. 1940
L9	Sept. 1940	Dec. 1940
MO	Oct. 1940	Jan. 1941
NO	Nov. 1940	Feb. 1941
PO	Dec. 1940	Mar. 1941
RO	Jan. 1941	April 1941
SO	Feb. 1941	May 1941
TO	Mar. 1941	June 1941
UO	April 1941	July 1941
VO	May 1941	Aug. 1941
WG	June 1941	Sept. 1941
XO	July 1941	Oct. 1941
YO	Aug. 1941	Nov. 1941
ZO	Sept. 1941	Dec. 1941

Tube Classifications

Group I—1A5G or GT, 1A7G or GT, 1B7G or GT, 1C5G or GT, 1D8GT, 1G4G or GT, 1G6G or T, 1H5G or GT, 1N5G or GT, 1N6G, 1P5G or GT, 1Q5G or GT, T5GT, 3A8GT, 3Q5GT, 1LA4, 1LA6, 1LB4, 1LH4, 1LN5.

Group II—All other types.

SYLVANIA TUBE ADJUSTMENT GUIDE

Guarantee.—Sylvania radio tubes are guaranteed to the consumer for 6 months from date of purchase, which is accomplished by a guarantee enclosed in every Sylvania sealed carton, and which, to be effective, must be properly filled out by the retailer at the time of sale.

Sylvania retailers are authorized to accept for adjustment any alleged defective Sylvania tube presented by a consumer, if it is accompanied by the identical guarantee form indicating purchase less than six months prior. Tubes not accompanied by proper guarantee are subject to adjustment as provided for by the code date etching as described under "Obsolescence Schedule."

Instructions.—Sylvania tubes may be submitted for adjustment only by authorized Sylvania jobbers. Jobbers may return defective tubes for adjustment once each month. All return shipments must bear Sylvania return authorization labels, available on request. Tubes received from retailers will be returned without inspection to the retailer, transportation charges collect. Transportation charges on all return shipments must be prepaid. We in turn will prepay the replacement transportation charges.

All tubes proven subject to adjustment, in accordance with our guarantee and this guide, will be replaced type for type. The option to issue a merchandise credit memorandum to cover the value of the tubes found subject to adjustment, computed at current prices, is reserved.

It is suggested that full details regarding unusual defects be supplied when tubes are returned for adjustment, to avoid improper handling and delay.

Obsolescence Schedule—Sylvania radio tubes automatically become obsolete and not subject to adjustment, depending on code dates, as outlined in the following schedule:

Tubes Coded	Designating Shipment Between	Become Obsolete
Z-9	May 1, '39-Aug. 1, '39	July 1, '40
V-9	Aug. 1, '39-Nov. 1, '39	Oct. 1, '40
T-0	Nov. 1, '39-Feb. 1, '40	Jan. 1, '41
N-0	Feb. 1, '40-May 1, '40	Apr. 1, '41
Z-0	May 1, '40-Aug. 1, '40	July 1, '41
V-0	Aug. 1, '40-Nov. 1, '40	Oct. 1, '41
T-1	Nov. 1, '40-Feb. 1, '41	Jan. 1, '42
N-1	Feb. 1, '41-May 1, '41	Apr. 1, '42

Tubes Not Subject to Adjustment

Broken Tubes.—Broken tubes are considered evidence of rough handling.

Abused Tubes.—Tubes on which improper voltage has been imposed or tubes which have been electrically, mechanically, or physically abused. Burned out filament is presumed to indicate electrical abuse. (Most prevalent types—26, 99, battery types, ballast types, rectifier types, etc.)

Sufficient Service Tubes.—Tubes which show evidence of having rendered reasonable and sufficient service.

Serviceable Tubes.—Tubes which prove by test to be within serviceable limits and in satisfactory operating conditions.

Defaced Etching.—Tubes with brand or code dates removed or obliterated are not subject to adjustment.

Obsolete Tubes.—Any Sylvania tube presented for adjustment which is beyond code date limit and/or not accompanied by the properly executed guarantee form.

Sylvania radio tubes having code dates other than those shown above are obsolete, and not subject to adjustment.

RAYTHEON TUBE ADJUSTMENT POLICY

All Raytheon radio tubes are guaranteed for a period of 1 year as determined from the code. The code consists of a letter indicating the quarter of the year and a digit indicating the year. It is painted on the left-hand side of the Raytheon trade-mark on the tube, or printed on a label on the bulb. This system provides a maximum guarantee of 15 months and a minimum guarantee of 12 months. The following chart will be found convenient in determining the expiration of the guarantee period of a tube:

Code	Indicates Shipment Prior to	Guarantee Expires
C9 or C9	March 31, 1939	March 31, 1940
F9 or F9	June 30, 1939	June 30, 1940
I9 or I9	Sept. 30, 1939	Sept. 30, 1940
L9 or L9	Dec. 31, 1939	Dec. 31, 1940
CO or CO	March 31, 1940	March 31, 1941
FO or FO	June 30, 1940	June 30, 1941
IO or IO	Sept. 30, 1940	Sept. 30, 1941
LO or LO	Dec. 31, 1940	Dec. 31, 1941
C1 or C1	March 31, 1941	March 31, 1942

Example: A type 6A7 tube coded C9 indicates shipment during months of Jan., Feb. or March, 1939, and is guaranteed until March 31, 1940.

Tubes with codes other than listed above are considered to have given ample service and are not subject to adjustment.

Returned tubes which are beyond the guarantee, in accordance with this guide, will be scrapped at the Raytheon Service Stations unless specific request is made otherwise.

This supersedes Tube Adjustment Guide of Feb. 1939.

Return Postage Paid.—Raytheon pays return postage on all adjustments received prepaid. Transportation charges are paid one way and tubes should be returned transportation charges prepaid and packed carefully to avoid breakage.

Type for Type.—Replacement is made after inspection for any tube subject to adjustment type for type. The option to issue a merchandise credit memorandum to cover the value of tubes subject to adjustment computed at current prices, is reserved by the manufacturer.

Precautions.—Only tubes which are defective through fault of the manufacturer and which are within the guarantee period are covered by the guarantee. (Note other side.) Tubes which will give good service and broken, defaced, electrically abused, or internally damaged tubes, of course, are not to be returned for adjustment.

BUY DIRECT FROM THE MANUFACTURER AND SAVE

THE NEW DYNAROMETER

Features New Giant 8½" Double Jewelled Meter

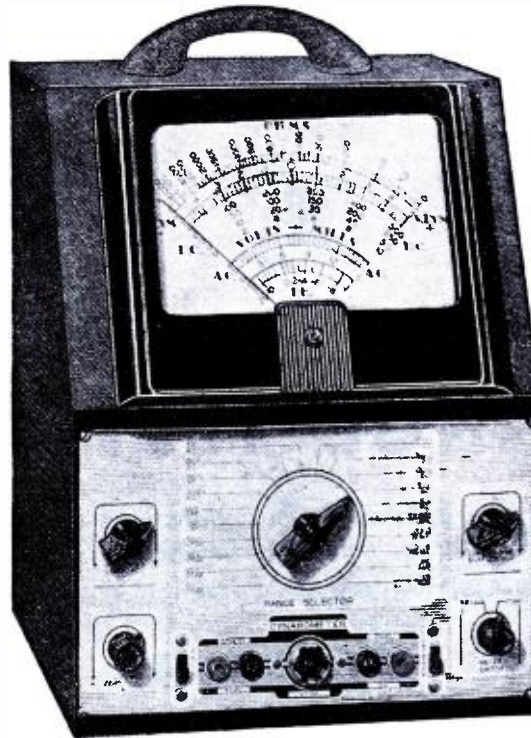

This amazing versatile instrument is our answer to the demands of radiotriicians for a combination instrument which, in addition to making the usual V.O.M. measurements, will also permit DYNAMIC D.C. VOLTAGE MEASUREMENTS without interfering with or upsetting delicately balanced circuits, such as tuned circuits, electronic apparatus, control voltages, etc. Actually, as you will note from the specifications listed below, the DYNAROMETER is a combination Vacuum-Tube Voltmeter and V.O.M. besides permitting additional measurements such as Capacity, Decibels, Inductance, etc. All calibrations printed in large, easy reading type on the giant 8½" double jewelled meter. The Input Impedance for the V.T.V.M. is 11,000,000 ohms with 2,000,000 ohms per volt on the lowest range. The 4 V.T.V.M. ranges are 5, 25, 100 and 500 Volts, and because of the zero center no attention need be paid to polarity since the meter will read either in the plus or minus direction, depending on the position of the probes.

HAVE YOU EVER—

Tried to measure Control Voltages such as A.V.C., A.F.C., oscillator, etc.?
Impossible with the ordinary V.O.M. due to loading of the circuit BUT the 11 megohm input impedance of the DYNAROMETER enables measurements without molestation at any point in the receiver.

Tried to locate distortion in the audio section of a receiver?
A long tedious job with the ordinary V.O.M. but almost instantaneous with this new DYNAMIC method of testing.

Tried to isolate the cause of trouble in an intermittent job?
A cinch with the DYNAROMETER. Extreme sensitivity and flexibility enable speedy measurements at points usually impractical when using a standard MULTIMETER.

SPECIFICATIONS:

- 4 D.C. VOLT RANGES AT 11 MEGOHMS INPUT:
0-5/25/100/500 Volts
- D.C. VOLTAGE MEASUREMENTS IN 5 RANGES:
(at 1000 ohms per volt)
0-10/50/250/500/5000 Volts
- A.C. VOLTAGE MEASUREMENTS IN 4 RANGES:
(at approximately 800 ohms per volt)
0-15/150/1500/3000 volts
- RESISTANCE MEASUREMENTS IN 3 RANGES:
0-1,000 Ohms, 0-10,000 Ohms, 0-30 Megohms.
- D.C. CURRENT MEASUREMENTS IN 4 RANGES:
0-1, 0-10/100/1 Amp./10 Amp.
- 4 OUTPUT RANGES:
0-15/150/1500/3000 Volts
- 2 CAPACITY RANGES:
.0005—1 Mfd.
.05—100 Mfd.
- INDUCTANCE:
1 H.—70 H.
7 H.—10,000 H.

The Dynarometer operates on 90-120 Volts 60 cycles A.C. Comes complete with test leads and all necessary instructions. Shipping weight 20 lbs. Size 13½"x10"x8¼". Our net price **\$18⁷⁵**

SUPERIOR INSTRUMENTS CO. 136 Liberty St., Dept. RC-12
NEW YORK, N. Y.

BOOK REVIEW

AUTOMOBILE RADIO PRINCIPLES AND PRACTICE, by B. Baker Bryant (1940). Published by Radcraft Publications, Inc. Size, 6 x 9 ins., stiff cover, 55 illustrations, 64 pgs. Price, 50c.

Latest addition to the *Radio-Craft* Library is book No. 24 which is a complete treatise on the subject of auto-radio covering all phases from installing and servicing to maintenance. We quote from the author's preface: "... this is a practical treatise based on practical experience by practical radio people for the practical radio-technician, he who is already conversant with the engineering but is primarily interested in the practical end of the art."

Chapter headings: Introduction—The Auto-Radio Art; Features of the Modern Automobile Receiver; Installations of Automobile Radios and Antenna; The Automobile High- and Low-Tension Electrical Systems; Automobile Electrical Disturbances; Vibrator Converters and Motor Generators; Service Hints, Classified Automobile Installation Notes, and Conclusion.

The Best Book on Sound!
See Page 356

RADIO EVERYTHING IN RADIO

This one big book serves your entire radio needs. It includes sets, parts and supplies, public address systems, amateur equipment, testers, kits and fluorescent lighting. You'll find the nationally known favorites at the lowest possible prices. Get your copy of this big FREE CATALOG today.

BIG FREE CATALOG HAS IT!

BURSTEIN-APPLEBEE COMPANY
1012-14 MCGEE STREET, KANSAS CITY, MISSOURI

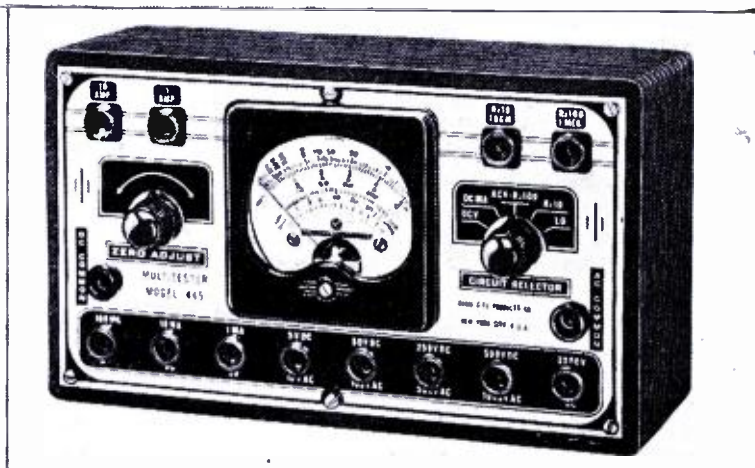
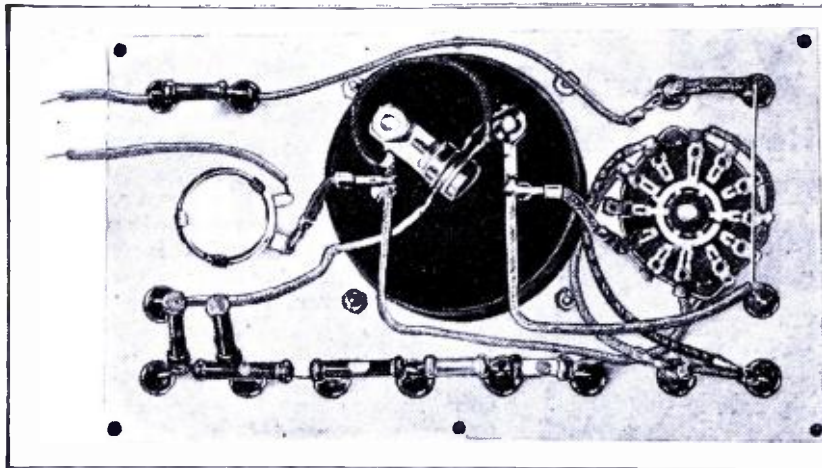

Inside and outside views (left to right) of the 25-Range A.C.-D.C. Test Meter.

25-RANGE TEST METER

This article tells Servicemen and experimenters how to make an efficient multi-range meter. The design is so simple the average beginner will have little difficulty duplicating this comparatively inexpensive A.C.-D.C. instrument.

MILTON REINER

THE meter unit described here is one which combines wide utility with good engineering design, economy and simplicity of construction. It is an instrument which will prove decidedly useful to the most experienced Serviceman or experimenter, and yet is so simple to build that it is well within the ability of even the beginner.

The design is not a makeshift with compromises to permit the use of standard resistors, etc. Instead it is a straight commercial design but with the resulting odd resistor values made available on the market so that they need not constitute a stumbling block for anyone desiring to construct this unit.

Because there has been an insistent demand for such an instrument in kit form, especially from beginners who are after the utmost economy, and the experience of "rolling their own," this model has been made available either as a complete kit, or in the form of a foundation D.C. kit to which the necessary parts to convert it to A.C. measurements can later be added.

The completed unit provides a wide variety of measurements as follows:

- D.C. voltage: 0-5/50/250/500/2,500
- D.C. milliamperes: 0-1/10/100/1,000
- D.C. amperes: 0-10
- A.C. voltage: 0-10/100/500/1,000
- Resistance: 0-500 ohms/0.1-1. meg.
- Decibels: -8 to +15, +12 to +35, +26 to +49, +32 to +55.
- Output ranges: Same as A.C. voltage ranges.

UNIVERSAL MULTIPLIERS

Where A.C. and D.C. measurements are to be made with the same meter, complications are introduced by the fact that when an instrument rectifier is inserted in the meter circuit for A.C. measurements it has the effect of changing the inherent sensitivity and resistance value of the meter. It is therefore necessary either to use different sets of multiplier resistors for the A.C. and D.C. voltage ranges, or to provide some form of correction.

With the copper-oxide type of rectifier, meter sensitivity is reduced nearly 60% and actually becomes about 420 ohms-per-volt for A.C. measurements, as compared with 1,000 ohms/volt for D.C. In spite of this, the same multipliers can be used for both.

This is accomplished by reducing the effective sensitivity of the meter circuit during D.C. voltage measurements by shunting it with the proper resistance value. It need not be brought down to a sensitivity of 420 ohms/volt, but only to twice this value, or 840 ohms/volt. Obviously this reduction from 1,000 to 840 results in somewhat greater loading of circuits under measurement but the slight difference is of no great importance. If a circuit under measurement has a resistance value of 10,000 ohms, for instance, and its voltage is to be measured on the 100-volt range of the meter, the loading effect of the meter will be only 1.6% greater if its resistance is 84,000 ohms than would be the case were its resistance 100,000 ohms (0.1-meg.)

With a shunt value selected to reduce

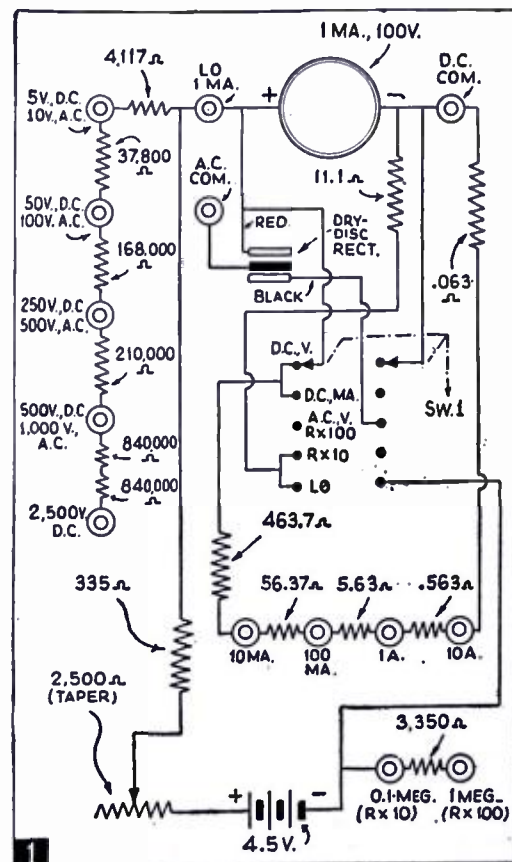

meter sensitivity to 840 ohms/volt, and using the same multipliers for both A.C. and D.C. measurements, the A.C. range of a given multiplier will be double that of the

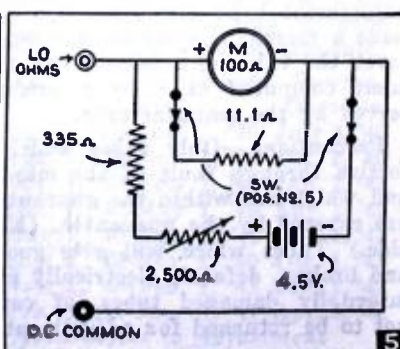
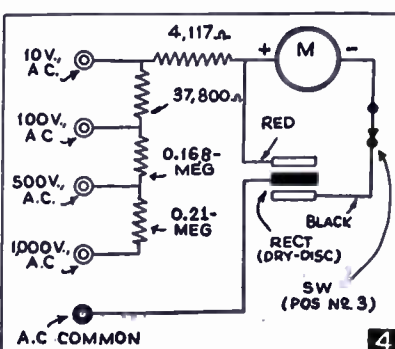
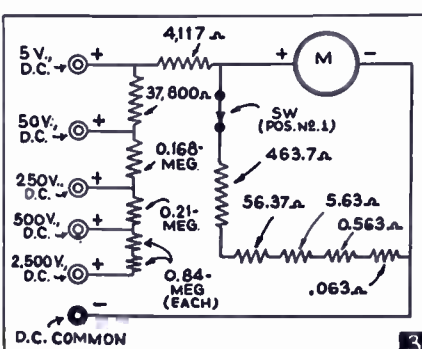
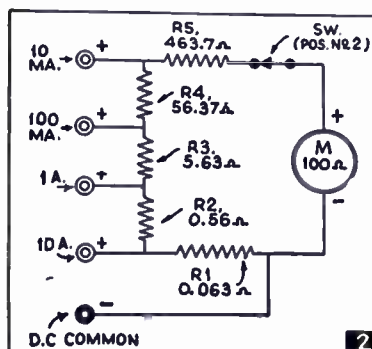

D.C. range. Thus the multiplier in the 5-volt D.C. range will provide a 10-volt A.C. range, etc. The same multipliers, terminals and even meter scale therefore serve for both A.C. and D.C. voltage measurements. The only required change when going from one to the other is to insert (by switching) the rectifier for A.C., and the shunt for D.C.

D.C. CIRCUIT

An interesting arrangement is that employed for direct current measurements. In analyzing this, the circuit of Fig. 2 is helpful. This is the circuit of Fig. 1 with all parts eliminated which do not pertain to this type of measurement.

Here we have all the current shunts joined together to form, with the 100-ohm meter, a closed circuit with resistance of 626.3+ ohms. From this any desired current range can be obtained by simply inserting one test probe in the "Common" jack and the other in the jack representing the desired range. No switching is required in changing ranges. Thus, when the probe is inserted in the "10 Amp." position, the current under measurement will divide between 2 paths, one including only R1, the other including all other resistors and the meter. The meter path will have a resistance of 626.26 ohms while the shunt path (R1) is only 0.063-ohm. This is a ratio of very close to 10,000 to 1, therefore the original meter range of 1 ma. is multiplied 10,000 times, giving readings up to 10 amperes. (Actually a shunt multiplies the original meter range by the ratio of the resistances plus.)

When the probe is inserted in other ranges, the shunt branch increases in value while the meter branch decreases, thus reducing the ratio and decreasing the current range.

The total value of resistance in Fig. 2 is not important so long as the proper ratios are maintained. A figure of 626.3+ was selected in this case because this is the correct shunt value to provide the 840-ohms/volt sensitivity discussed earlier. This shunt network is therefore left in the circuit not only for all current measurements but also for D.C. voltage measurements, and switching operations are therefore greatly simplified. In addition, construction is considerably simplified by avoiding separate shunts for each current range, and separate multipliers for A.C. and D.C.

Because many beginners are likely to be interested in this instrument it is felt that a study of the foregoing discussion will help to provide a better basic understanding of meter circuits, etc.

Figure 3 shows the arrangement employed for D.C. voltages. The 5 tip-jacks provide 5 ranges. Multiplier values are de-

termined on the basis of 840 ohms/volt sensitivity as discussed earlier. Thus at the 5-volt jack the resistance is 4,117 ohms, plus that of the meter (and its shunt which reduces the meter resistance from 100 to 83 ohms), or a total of 4,200 ohms. At the 50-volt jack the resistance is 42,000 ohms, etc.

A.C. CIRCUIT

In Fig. 4 is shown the A.C. voltage circuit. This is similar to Fig. 3 except that the shunt network is switched-out automatically and the rectifier cut-in when the selector switch is set for A.C. measurements. The rectifier is of the copper-oxide half-wave type with provision for bypassing the reverse peaks to avoid the development of unsafe inverse voltages across the rectifier during use of the higher voltage ranges.

Figure 5 is the circuit arrangement when the selector switch is set for "Lo" ohms measurements. The meter is shunted to provide a 10-ma. range and the variable resistor adjusted until the meter reads full-scale. Any resistance connected between the "Common" and "Lo" terminals will act as a meter shunt and reduce its reading accordingly. Readings down to 0.2-ohm are obtainable with this arrangement and are read directly on the special "Lo" ohms scale on the meter.

The circuits employed for the 0.1-meg. and 1 megohm ranges are shown in Figs. 6 and 7. These are the conventional series circuits and are similar except that in the lower one the 10-ma. shunt is used and the limiting resistors are lower in value.

The kit's engraved and punched panel greatly facilitates the correct assembly of the parts. Because the 14 tip-jacks are supplied with self-locking mounts, the entire assembly of panel parts can be completed in perhaps 15 minutes. All resistors are mounted directly on the terminals to which they connect. The meter rectifier is supplied with a bracket which is mounted on one of the meter terminals.

List of Parts

- One Radio City milliammeter, model 446, 0-1 ma., 100 ohms, 3-in.-sq. bakelite case;
- One Radio City panel, 8 x 4 1/2 ins., etched, engraved and punched;
- One Radio City 2-gang, 10-point rotary switch;
- One Radio City instrument rectifier for No. 446 meter;
- One Radio City special-taper rheostat, small type, 2,500 ohms;
- Twelve Amphenol insulated tip-jacks with self-locking mounts, red;
- Two Amphenol insulated tip-jacks with self-locking mounts, black;
- One Radio City wood instrument case, polished hardwood, to take above panel; has built-in compartment for 3 flashlight cells;
- Three 1 1/2 V. large-unit flashlight cells;
- One pair test probes, insulated handles (not supplied nor essential to kit).

RESISTORS

- One RCP shunt, 0.063-ohm (bare Manganin wire);
- One Radio City, 0.563-ohm, flexible;
- One Radio City, 5.63 ohms, flexible;
- One Radio City, 56.37 ohms, flexible;
- One Radio City, 335 ohms, flexible;
- One Radio City, 463.7 ohms, flexible;
- One Radio City, 11.1 ohms, flexible;
- One Radio City, 4,117 ohms, carbon;
- One Radio City, 3,350 ohms, carbon;
- One Radio City, 37,800 ohms, carbon;
- One Radio City, 0.168-meg., carbon;
- One Radio City, 0.21-meg., carbon;
- Two Radio City, 0.84-meg., carbon.

This article has been prepared from data supplied by courtesy of Radio City Products Co.

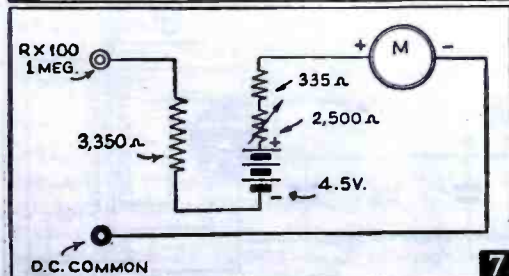
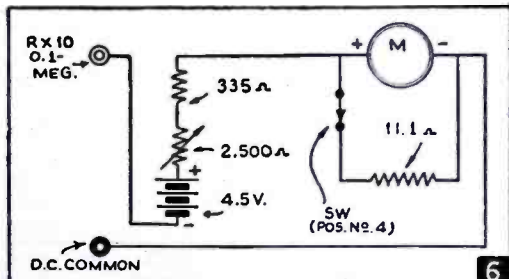

if it's an

RCP
dependable
TEST
instruments

its the
lowest priced
quality tester

**MODEL 310
TUBE
TESTER**

with Rotary
Selector
Switch



An all-quality instrument from its rotary selector switches which speed operation to the heavily silverplated contacts for low loss. Completely modern in circuit design, operation and efficiency. Has newest "Rolindex" brass-geared, mechanically operated roll-type tube test charts. Insures smooth, positive, speedy operation. Tests every type tube. Tests pilot lights, headlights, etc. Separate test for noise, hum, intermittents and bad connections. Spare socket for future tube developments. Hot interelement short and leakage test between all individual elements. Hot cathode leakage test. Test ballast tubes. Continuously variable adjustment for operation at any line voltage from 105 to 135 volts. Line voltage directly indicated on D'Arsonval meter—far more accurate and reliable.
Dealer Net Price **\$21.95**

**MODEL 803
COMBINATION
TUBE AND
SET TESTER**



This portable "service shop" tests (at standard R.M.A. specifications) all latest tubes, miniature and bantam, Jr., all filament voltages. Hot interelement short and leakage tests for individual elements. Individual section tests of multi-purpose tubes. Line voltage regulation 103 to 135 volt-meter indication. Noise test for tubes which otherwise test good. Exclusive measurement method eliminates large errors. Latest mechanical roller type tube chart.

DC voltmeter 0/10/50/500/1000 at 1000 ohms per volt
Four range AC voltmeter 0/10/50/500/1000
DC milliammeter 0/1/10/100/1000 DC Ammeter 0/10
Ohmmeter 0/500/5000/1,000,000/10,000,000
D.B. Meter—8 15/15 to 29/29 to 49/32 to 55 decibels
Four range Output Meter same as AC volts

Complete, ready to use with test leads. Dealer Net Price **\$32.95**

Send for new Catalog 12¢ describing the complete RCP line of 1940 Dependable Test Equipment. Write today.

RADIO CITY PRODUCTS CO., INC.
88 PARK PLACE • NEW YORK CITY



SOUND ENGINEERING

*Free Design and Advisory Service
For Radio-Craft Subscribers*

Conducted by A. C. SHANEY

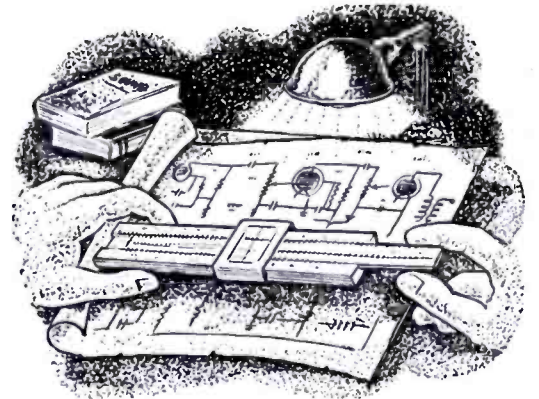

This department is being conducted for the benefit of RADIO-CRAFT subscribers. All design, engineering, or theoretical questions relative to P.A. installations, sound equipment, audio amplifier design, etc., will be answered in this section. (Note: when questions refer to circuit diagrams published in past issues of technical literature, the original, or a copy of the circuit should be supplied in order to facilitate reply.)

No. 12

A 6V6G INVERSE-FEEDBACK AMPLIFIER

The Question . . .

I have use for several amplifiers having the following qualities: high fidelity, inverse feedback, adaptability to phonograph and radio tuner, no tone control, and a single 6V6 in the output stage, for 115 Volts A.C. operation.

I would greatly appreciate a diagram on the construction of such amplifiers.

ARNOLD KLEIN,
Bronx, New York

The Answer . . .

A circuit diagram of the type amplifier you desire, is indicated in Fig. 1. This circuit follows conventional design throughout the amplifier proper. A resistance-isolated

mixing circuit is employed for extreme simplicity. Independent controls are provided for both your radio and phono input.

The inverse feedback is looped from the voice coil winding of the output transformer to the cathode of the 1st stage. This particular arrangement is most effective when properly employed. It may be necessary for you to reverse the primary or the secondary of the output transformer in order to obtain correct phase relationship for inverse feedback. The value of Rx will be dependent upon the amount of feedback you desire, as well as the impedance of the voice coil winding. You could start with a value of approximately 10,000 ohms. The amount of feedback will be controlled in the series cathode circuit of the first 6C5 stage. The exact amount of feedback incorporated into

the circuit can easily be measured by connecting a high-resistance output meter across the voice coil winding, and feeding 1,000 cycles into either the phono or radio input. As the 1,000-ohm control is turned up, the output level should drop. The amount of drop in db. is equal to the feedback in db. incorporated into the circuit. At least 8 or 10 db. of feedback should be incorporated in order to provide any degree of compensation for frequency discrimination of the output transformer, speaker, and output stage.

All resistors, excepting those otherwise marked, are of the 1/2-watt type. Chokes Ch.1 and Ch.2 could be identical units capable of handling 75 ma., each having an inductance of approximately 10 henries. The output transformer should be of a reasonably good quality in order to handle the desired power without introducing excessive distortion.

No particular precautions are necessary in the construction of this amplifier. Reasonable care should be exercised in the placement of the 1st stage and its associated input controls and components, so as to avoid hum pick-up.

3-CHANNEL PREAMPLIFIER—CRYSTAL MICROPHONES IN PARALLEL

The Question . . .

I would appreciate it very much if you could supply me with a crystal microphone preamplifier circuit having 3 microphone inputs. Each input should have a separate volume and tone control. Also please include a method of connecting this preamplifier to the phonograph input of an 85 to 150 watt amplifier. The unit should be self-powered from a 110-volt 60-cycle line. Hum should be kept as low as possible.

What loss, besides decreasing the volume in half, occurs when 2 crystal microphones are connected in parallel?

ROBERT MITCHELL,
Chicago, Ill.

The Answer . . .

A schematic circuit of a 3-channel crystal microphone preamplifier with independent volume and tone controls for each channel is indicated in Fig. 2.

As you did not mention the exact type of tone control you desire, I have taken

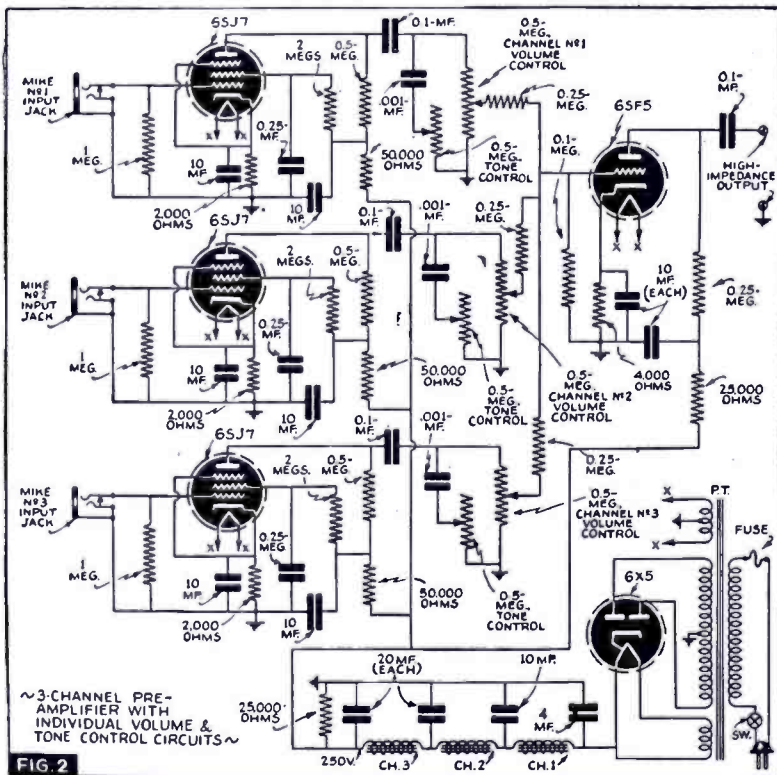

Each channel in this triple stage preamplifier has its own tone and volume controls. This diagram was prepared in answer to questions by Mr. Mitchell.

Complete diagram of a universal amplifier, incorporating controlled inverse feedback, requested by Mr. Klein.

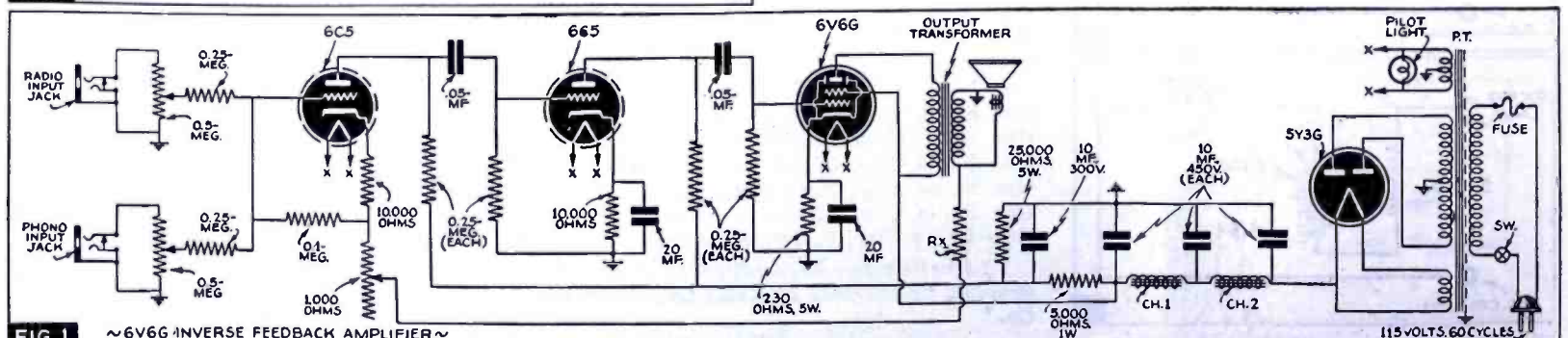

it for granted the popular high-frequency attenuator type is desired. If additional high-frequency attenuation is desired, the 0.001-mf. condenser in the tone control circuits may be increased to 0.01-mf. On the other hand, if excessive H.F. attenuation is prevalent, these condensers may be reduced to 100 mmf. The isolating ¼-meg. resistor, in series with the center arm of each volume control, provides 2 desirable functions: (1) it prevents interaction of tone control, so that should one channel be set for maximum high-frequency attenuation, the other channels will not be affected; (2) it prevents appreciable interaction of volume control circuits. Adjusting one control from maximum to minimum attenuation will change the input signal at the 6SF5 tube by less than 2 db.

As you did not include a circuit diagram of your 85-150 watt amplifier, it is impossible to give you a specific output circuit adapted to your phono input. It is assumed however, that your amplifier input is of the high-impedance type. If such is the case you can couple the high-impedance output of the preamplifier directly into the high-impedance amplifier input.

Chokes Ch.1, Ch.2 and Ch.3 should be capable of carrying 10 milliamperes and be capable of developing an inductance of approx. 30 henries. All resistors are of the ½-watt carbon type unless otherwise marked. The power supply should be capable of delivering 250 volts at approximately 5 ma. In constructing this unit, care should be exercised in keeping the chokes away from any of the preamplifier tubes so as to avoid inductive hum pick-up. It will also be necessary to carefully place all components of the 1st stage circuit away from any hum-producing source. All leads should be kept as short as possible. Shielding should be employed at the input grid circuits.

When 2 microphones are connected in parallel, a number of unusual conditions, other than a decrease in volume, may become apparent under actual working conditions. If both microphones are not in-phase, the outputs of the microphones will cancel each other. This is particularly noticeable when the sound wave is equidistant from each microphone. If the microphones are in-phase, but at unequal distances from the sound sources, a peculiar type of frequency discrimination may become apparent. Assuming that the speed of sound is 1140 feet per second, it is apparent that a 1,000-cycle tone will have a wavelength of 1.14 feet. This means that the distance between the maximum possible sound pressure and the minimum sound pressure would be separated by a distance of 1.14 feet. If a microphone is placed, let us say, 3 feet from a sound source, and another one (in-phase) 4.14 feet from the same sound source, it is obvious that one microphone would be producing its maximum positive voltage, while the other would be producing its maximum negative voltage, the combined output of which may approach 0. This condition would be prevalent at discrete frequencies only, and can easily be detected when sound measurements are made in an open area where reflections do not tend to balance this out-of-phase condition.

There are a number of other undesirable conditions, brought about by paralleling crystal microphones, which are too involved for adequate discussion in this department.

NEWS SHORT

U.S. Patent No. 2,209,971 describes the use of a variable-area sound pattern of opaque metal (an electroplating?), on a transparent material, for grainless sound reproduction by means of a photocell and amplifier.

IT'S RCA FOR UNMATCHED QUALITY..UNBEATABLE LOW PRICES!

Your BEST Bridge Between Amplifier and SOUND! RCA QUALITY SPEAKERS



Power Sound Projector.
Handles 100 Watts—
projects to 4,000 feet.
MI-6256.



12" P.M. Dynamic—
Handles 10 Full Watts
with high quality.
MI-6247A.



Directional Sound Baffle.
Efficient. Wide Angle.
MI-4428 for 12" Speaker.

YOU KNOW . . . and we know . . . that sound reproduction quality is more often marred by the *speaker* than by any other element in the system! That's why good speakers are your *best* Sound Investment!

Who makes the best speakers—? RCA. Why—? Because the extensive research of the greatest name in radio has found the best answers to problems of speaker design and manufacture. When you buy a modern RCA Speaker, you buy *low distortion*—for extra clarity in speech and music. You buy uniform, extended *frequency-response*—for higher-fidelity. You buy higher audio-to-sound *conversion efficiency*—for greater coverage with smaller amplifiers . . . for more actual Decibels from your Watts!

And because of the tremendous mass-production facilities of RCA, prices are pleasingly *low*! Believe your ears—*hear* RCA Speakers at your RCA Distributor's this week!



High Output—High Quality! 15" Permanent Field Dynamic. MI-6237.

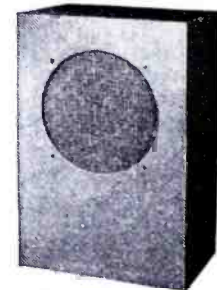

Auditorium Wall Speaker Cabinet—for MI-6237, or other 15" P.M. Dynamic. MI-6223.



Revolutionary! New RCA Accordion Edge Speaker. "Bellows Action." MI-6234.

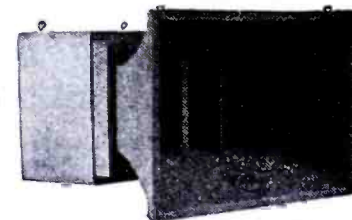

Wide Angle Baffle. Efficient. Wide Angle. MI-4420 for 12" Speaker.



Commercial Sound

RCA Mfg. Co., Inc., Camden, N. J. • A Service of Radio Corporation of America

Any Sound System Sounds Better Equipped with RCA Radio Tubes

SLIPS THAT PASS IN THE MIKE

BROADCASTING is a tense business, and when man meets mike, it's only human that once in a while there are slip-ups. WOR announcer Jerry Lawrence, and conductor of the poetry program "The Vagabonds' Trail," heard Tuesdays from 10:30 to 11:00 P.M., makes a hobby of collecting radio boners. Here are a few choice samples, from the Lawrence archives—*fluffs* made by well-known announcers:

David Ross: "We present Tito Guitar and his romantic Guizar."

Andre Baruch: "Good Ladies Evening and Gentlemen," and (introducing a noted journalist) "Mr. —, Acidity Editor of . . ."

Frank Knight: "The weather report: tomorrow rowdy, followed by clain."

Mel Allen: "It's Smipe Poking Time, Gentlemen!"

Floyd Neale—(signing off): "This is the Musical Broadcasting System." (Neale announces all of WOR-Mutual's many important concert programs.)

An unidentified N.B.C. Chicago mikeman: "This is the National Biscuit Company."

Art Whiteside (presenting the Crown Prince of Norway): "Today it is our extreme pleasure to introduce the Brown Quince of Norway."

And then there's the story they tell about a veteran radio editor and crackerjack radio interviewer, who began one of his interview programs with the question: "Tell me, Miss So-and-So, what was the dirt of your birth?"

A New A.F.-Drift Correcting, Signal-Balancing, Direct-Coupled

F.M. AUDIO AMPLIFIER



This circuit achieves remarkable results (Frequency Response—13 to 30,000 cycles \pm 1db.; Noise Level—at least 75 db. below rated power output; Distortion—1% total harmonics at average working level). It includes a novel D.C. balancing arrangement, A.C. balancing circuit and push-pull balanced feedback, all of which provide marked reduction in tube noise and hiss, and a wide range response, as well as sufficient clean power output to provide distortionless high- and low-frequency amplification beyond requirements set for F.M. transmitters.

A. C. SHANEY

PART I

FOREMOST among problems presented by Frequency Modulation is the design of an amplifier which will not prove to be the "bottle neck" of the entire system. The new standards set by the Federal Communications Commission for designing F.M. transmitters, that should be taken into consideration when designing an audio amplifier for F.M. receivers, briefly follow:

- (1) The transmitter and associated studio equipment shall be capable of transmitting a band of frequencies from 50 to 15,000 cycles within 2 decibels of the level of 1,000 cycles. In addition, provision shall be made for pre-emphasis of the higher frequencies in accordance with impedance frequency characteristics of a series inductance-resistance network, having a time constant of 100 micro-seconds.
- (2) The noise in the output of the transmitter in the band 50 to 15,000 cycles shall be at least 60 decibels below the audio frequency level represented by a frequency swing of 75 kilocycles (100% modulation).
- (3) At any frequency between 50 and 15,000 cycles at a swing of 75 kilocycles the combined audio frequency harmonics generated by the transmitting system shall not be in excess of 2% (root mean square value). This means, simply, that the transmitter should be capable of passing a band of 50 to 15,000 cycles \pm 2 db. of the 1,000-cycle reference; it shall have a combined hum and noise level at least 60 db. below full power output; and, it should not generate more than 2% total

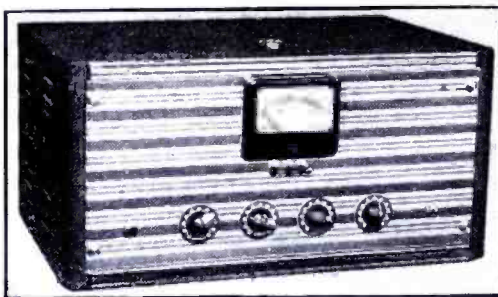

The completed Frequency Modulation Audio Amplifier. Controls, left to right: Radio Volume, Phono Volume, H.F. Equalizer, L.F. Equalizer. On the right side of the controls is the On-Off switch; on the left side, the pilot light. The 3 pushbuttons underneath the VU Meter are for the Meter for Attenuator Ranges.

harmonics at any frequency within its transmitted band.

F.M. A.F. AMPLIFIER STANDARDS

In setting up standards for an F.M.-receiver audio amplifier the natural reaction would be to use the standards set for the F.M. transmitter. Careful consideration, however, will reveal specific disadvantages for such an arrangement.

It is obvious that for ideal performance, the amplifier at the receiving end should have an effectively flat frequency response, introduce no distortion and have no inherent noise. With such an ideal amplifier, the full benefits of frequency modulation will be obtained.

Any discriminating characteristics inherent within the receiving amplifier will, of necessity, introduce additional detrimental conditions, which are added to existing de-

ficiencies within the transmitter to provide an overall result far below a desirable ideal. For example, let us assume that the transmitter is down 2 db. at 50 cycles. The receiving amplifier (which was built in accordance with the standards set for F.M. transmitters) is also down 2 db. at 50 cycles. The overall result will be a 4 db. loss at this low frequency, which is sufficient to change the character of many types of music. Similarly, an amplifier which introduces 2% distortion (say at an average level of 1 watt) will provide an ultimate program having a combined distortion of more than 2% (which we can assume was produced by the transmitter). It therefore follows that the amplifier should be definitely better than the transmitter.

In addition to this, it is also feasible to assume that additional improvements will be made in F.M. transmitters, and F.C.C. regulations may tighten their specifications. If this occurs, an amplifier which has been built to existing standards may not pass on to the listener all the benefits of future improvements in F.M. transmission. *The present specification covering the width of the audio band is unbalanced,** and it is reasonable to assume that, in time, the lower portion of the band will ultimately be extended to at least 26 cycles to produce a balanced spectrum.

Proof of this line of reasoning can be found in new F.M. transmitters, which are being constructed to exceed the F.C.C.'s F.M. requirements. For example, one of

*See "Balanced Audio Spectrums," *Radio-Craft*, Sept., 1940, pg. 164.

A Letter from the Author

Dear Editor:

The development of this stabilized push-pull Direct-Coupled Frequency Modulation Amplifier has convinced all technicians who have studied, and checked the performance of the circuit, that we have finally removed the last obstacle for universal application of Direct-Coupled Amplifiers. In fact, our development (patent applied for) has over-shot our desire to make the stability of this model at least equal to standard resistance-coupled circuits.

In a conventional push-pull resistance-coupled amplifier, signal unbalance between each side of the circuit is carried through and finally cancelled in the output transformer. This condition introduces an unbalanced push-pull action and is usually encountered to a varying degree, in all standard resistance-coupled amplifiers. In our attempt to balance the amplifier for variations of plate current in push-pull tubes, we found that we had also developed a circuit which would stabilize for variations in tube gain. The revolutionary circuit arrangement provides for balancing of the signal circuit in the preamplifier stages long before it reaches the output transformer.

Aside from the advantages gained by an extended frequency response range, and very low noise and hum levels, this A.C. balancing circuit makes this general type of amplifier far superior to any standard resistance-coupled unit.

A. C. SHANEY

P.S.—Although this particular amplifier was designed for F.M. applications, your readers should not construe this as limiting the application of the unit for this purpose only. Its exceptionally fine response, low noise level, and no effective distortion, makes it admirably adapted for any other application which would normally require a high-quality laboratory amplifier.

P.P.S.—My associates have named this unusual balancing circuit "The A. C. Shaney Balancer."

A. C. S.

Performance IS THE WORD!

HOWARD COMMUNICATION RECEIVERS

—Acclaimed By Short Wave Listeners and Amateur Operators Alike!

MODEL "436"

7 tubes. Contains all features of Model 435 but adds noise limiter, flywheel inertia tuning controls and micrometer band spread **\$39⁹⁵**



MODEL "435"

An outstanding performer on all bands. 6 tubes, electrical band spread, ceramic coil forms, BFO, AVC, built-in 6½ inch speaker and iron core IF's. Tunes 540 KC to 43 MC in four bands. The finest low priced receiver available. **\$29⁹⁵**



MODEL "437"

9 tubes. Provides RF preselection, 2 IF stages, crystal filter, noise limiter, electrical band spread, built-in speaker and other important features. A top performer. **\$54⁵⁰**
(With Crystal \$62.00)



MODEL "490"

The world's finest communication receiver. 14 tubes, 2 RF stages, calibrated band spread, 9 position variable IF selectivity, air-tuned IF transformers, temperature compensated oscillator, automatic noise limiter, crystal filter, variable audio fidelity, 8 watt push-pull output.

Model 490 has many exclusive and desirable features. Complete with crystal filter and 10" speaker to **\$149⁵⁰**

(Export Prices Slightly Higher)

Four Great Receivers! . . . from the Beginner's Favorite to the WORLD'S FINEST

Quality at a price that isn't "loaded" will always command a buyer's attention. That's why HOWARD Communication Receivers sell in steadily growing volume. Every HOWARD Receiver is truly a triumph of design, performance, beauty and engineering craftsmanship—each developed to meet the exacting demands of today and tomorrow.

Owners everywhere have been literally amazed by the abundance of exclusive features found in the 1941 HOWARD Communication Receivers. Dollar for dollar, the outstanding performance of these great receivers is unsurpassed—they represent America's finest values. Be sure to see the brilliant new HOWARD Models before you buy any receiver.

See these HOWARD Receivers at Your Dealer Today!

PROGRESSIVE SERIES PLAN

Howard's revolutionary direct factory conversion set-up enables you to own at all times the finest receiving equipment—without loss or unfavorable trade-in deals. It is the most flexible and all-in-your-favor purchase plan in existence. Inquire today!

HOWARD RADIO CO.

1731-35 Belmont Ave., Chicago, Ill. Cable Address: HOWARDCO., U.S.A.

America's Oldest Radio Manufacturer

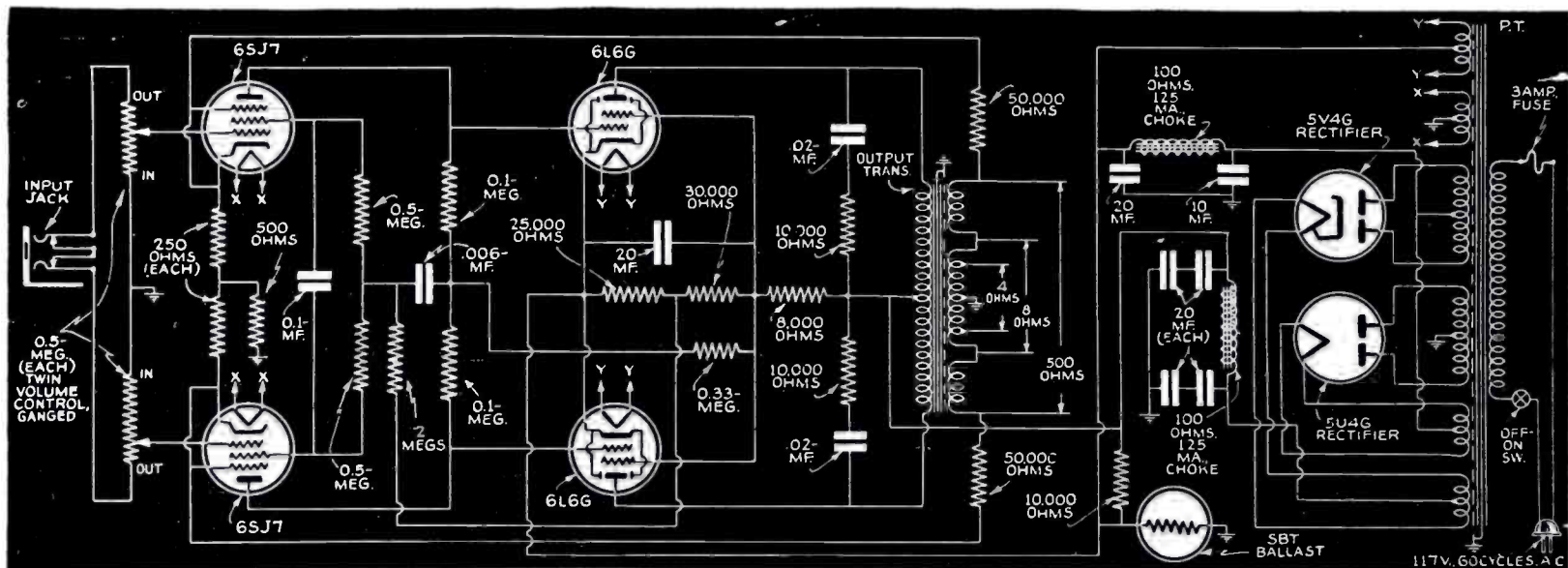

Schematic circuit of the Push-Pull Direct-Coupled Frequency Modulation A.F. Amplifier. It incorporates balanced negative-feedback and novel A.C. and D.C. balancing circuits.

the largest manufacturers of transmitters guarantees the following audio characteristics:

- (1) Frequency Response—Flat ± 1 db. from 30 to 15,000 cycles.
- (2) Noise Level—70 db. below full modulation.
- (3) Distortion—Less than 2%, total harmonics.

It was therefore decided to anticipate a reasonable amount of improvement and design this F.M. amplifier so as to prevent obsolescence. The following tentative specifications were set:

- (1) Frequency Response— ± 1 db. from 13 to 30,000 cycles.
- (2) Noise Level—At least 75 db. below rated power output.
- (3) Distortion—1% (at average working level), total harmonics.

With an amplifier of this type, it was felt no ultimate consumer would ever have to worry about having the "bottle neck" of an F.M. program in his audio amplifier equipment.

Furthermore, reasonable improvements in F.M. transmitters (based on similar improvements which have taken place in A.M. work) will provide direct benefits to the listener.

SELECTING THE FEATURES

The Equalizer

Offhand, it would appear that an F.M. Amplifier should be built to meet ideal requirements and have unvarying characteristics. In other words, the amplifier should be devoid of high-frequency or low-frequency controls. Referring to the requirements set by the F.C.C., it will be noted that provision *must* be made in every F.M. transmitter to pre-emphasize high frequencies. This means that high frequencies will be accentuated during transmission. The purpose of this pre-emphasis is to attenuate residual atmospherics.

As disturbing effects of atmospherics are predominant in the higher audio frequencies, it is logically assumed that accentuation at the transmitter and attenuation at the receiver will ultimately result in a flat overall response and at the same time, materially attenuate atmospherics. This is graphically illustrated in Fig. 1.

If we assume that a high-frequency program signal has a level of +20 VU and it is pre-emphasized to a level of +23, this signal will be received along with an atmospheric disturbance of say +20. Hence, without pre-emphasis, the original program signal and the atmospheric will be of equal

intensity. On the other hand, pre-emphasis has already made the program signal appreciably higher than the atmospheric. By attenuation in the receiver, the program signal is brought back to its original level of +20 VU, and the atmospheric is reduced 3 VU. The degree of attenuation of dis-

turbances is a function of the pre-emphasis at the transmitter.

From a casual study of this operating procedure, it would appear that a high-frequency attenuator is the only required control of the receiver. A study of existing deficiencies in present records, however, will

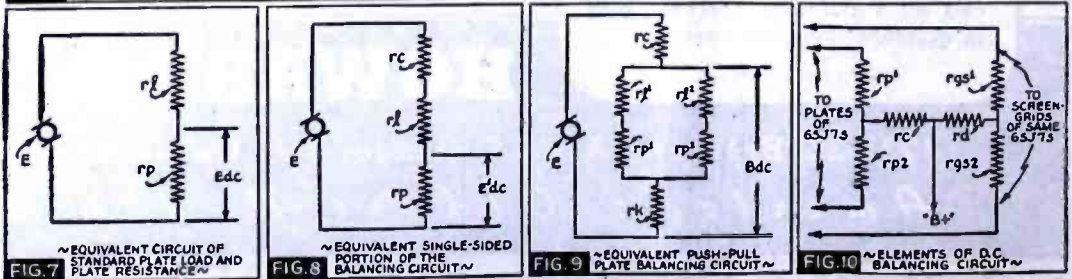
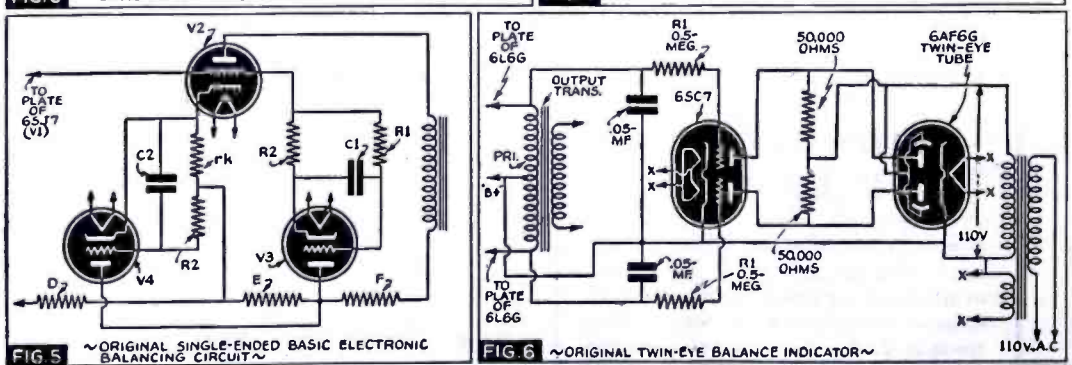
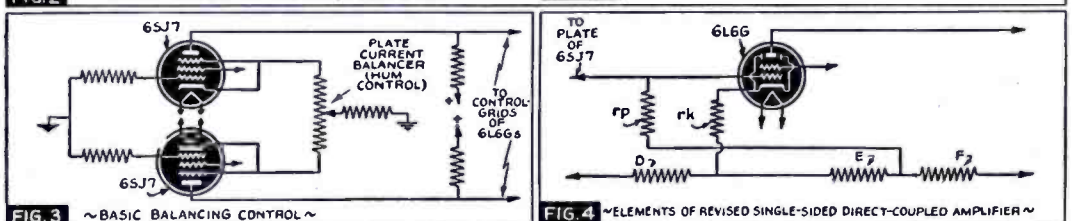
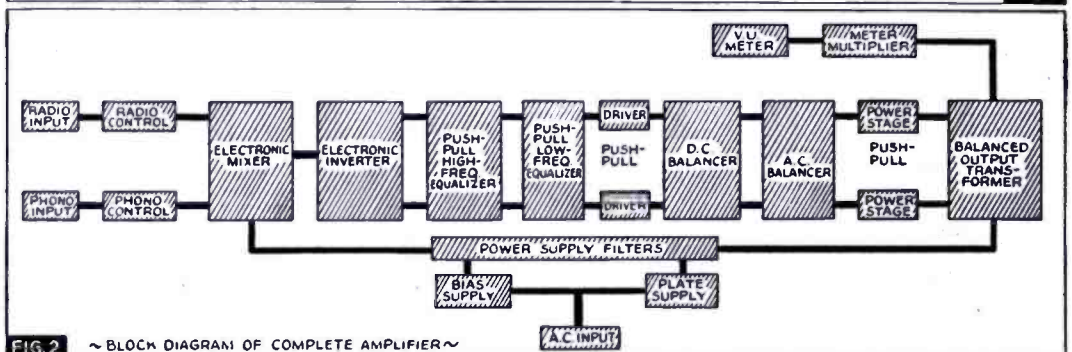
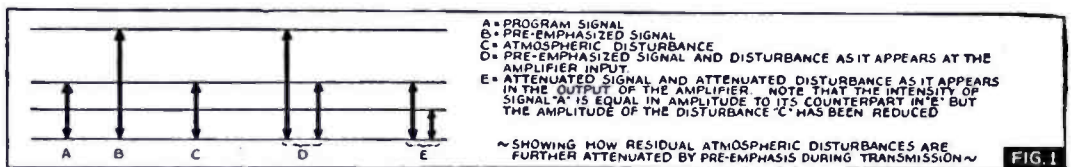

clearly indicate that both the high and low frequencies should be independently controlled, and the control range should provide for both attenuation and accentuation. Another very desirable characteristic in the equalizer circuit is to have it exactly complement the equalizer used at the transmitter or in the recording studio (for recorded programs). The equalizer should not introduce harmonics, hum, or resonant peaks in any portion of the spectrum.

The VU Meter

It was also considered desirable to have a visual monitoring arrangement so as to indicate normal, average, and peak levels of the program. This auxiliary feature is highly desirable when it is required to avoid overload of either the amplifier or the loudspeaker. Low-frequency speaker overload is usually judged from a distortion viewpoint, because the intensity of the signal cannot be accurately judged in view of the fact that the ear is comparatively insensitive to low frequencies. Only critical listeners, therefore, will detect overload at low frequencies. The use of the meter, however, makes it possible for any average individual to adjust the intensity of the program level so as to definitely prevent overload at any frequency. Furthermore, it becomes relatively simple to detect just what actual effect the various settings of the equalizer controls have upon the overall program level.

Dual-Channel Input and Electronic Mixer

In order to extend the usefulness of this Direct-Coupled F.M. Amplifier, it was considered desirable to incorporate an additional input circuit so that phonograph records, in addition to F.M. transmissions, may also be enjoyed.

A dual circuit input could most economically be employed by the use of a change-over switch, but inasmuch as the average volume level of the radio program and the recorded program may be different (and therefore necessitate a continual change), it was thought more desirable to incorporate an electronic mixer. This provides 2 entirely independent input channels with independent controls so that each level may be set for ideal results. Furthermore, the use of the electronic mixer insures complete isolation of both controls, so that they do not affect either the volume or the frequency response characteristics of its associated channel.

Details covering the design of these 3 features will be described in Part II of this article. A block diagram which shows the relative position of the various features is given in Fig. 2.

THE AMPLIFIER

In order to more fully understand the advanced design principles incorporated in this unusual Direct-Coupled F.M. Amplifier, it is suggested that the reader refer to the previously-published data.*

As all of the several 10-, 20- and 30-Watt Direct-Coupled Amplifiers previously described in this magazine have been designed around an effective drift-correcting circuit, no immediate improvement in stability seemed apparent. Subsequent investigation, disclosed that unusual difference in plate resistances of the input tubes affected the performance of direct-coupled amplifiers more than resistance-coupled units. This difference in effect was

*See the July, 1939, issue of *Radio-Craft*, pg. 16, for the elementary principles involved in the design of direct-coupled amplifiers.

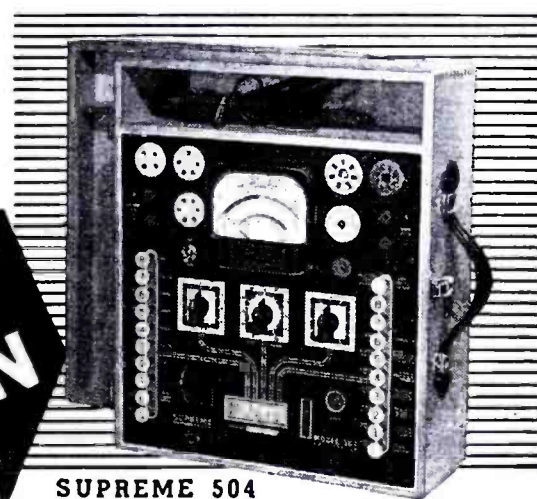
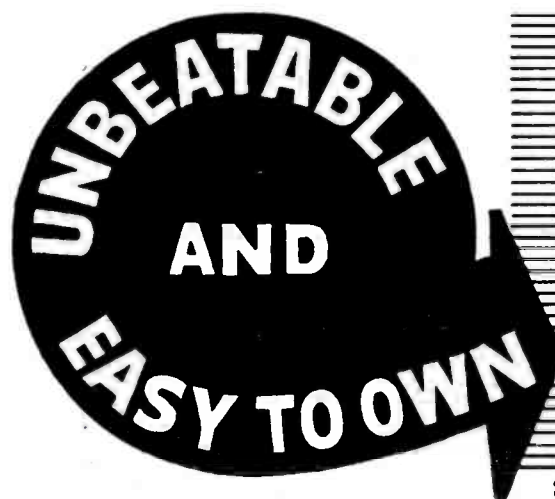

SUPREME 504

More than 3,000 SUPREME Model 504 Tube & Set Testers in constant and profitable service prove it to be the unbeatable value in the test equipment field. There are many combination tube and set testers but only SUPREME offers those necessary and desirable advantages found in the Model 504.

Take SPEED, for instance. As a multimeter, 31 ranges and functions are at your finger tips. Only two pin jacks and two rows of quick acting push buttons are necessary to give you complete control. Functional switches are on one side of the panel and range switches on the other side of the panel. All that is necessary is to press one button on the left hand row for the function desired and one button on the right hand row for the range desired.

As a tube tester, merely rotate the smooth acting roller chart to the type desired and "follow the arrows." Leakage tests are equally simple. With the same set-up just press one button after another on the right hand side of the panel.

Speed in testing electrolytic condensers too. All electrolytic capacitors, including high voltage filter capacitors and low voltage—high capacity by-pass condensers are checked at their CORRECT WORKING VOLTAGE on an English reading scale.

For ACCURACY the Model 504 is unsurpassed—a guaranteed over-all accuracy of 2% on D.C. and 3% on A.C. Contrast this with other instruments in which only the meter is guaranteed 2% or only the resistors to some percentage. SUPREME guarantees the OVER-ALL ACCURACY—not just one component part.

And, when we say 3% accuracy on A.C. functions we do not mean just at room temperature. The 504 incorporates an entirely

new "Perma-grad" temperature compensated circuit. Each rectifier is individually matched with a specially wound spool of Hytemco wire which nullifies the result of temperature change on the rectifier by re-acting in the opposite direction. Thus, accuracy is not guaranteed at just one temperature but is guaranteed to be within 3% over a wide range of from 40 to 95 degrees. You may be sure that your Model 504 is always accurate—summer or winter.

Protection against OBSOLESCENCE is important. The Model 504 is built to be modern today and to stay modern tomorrow. It provides for all filament voltages from 1.4 volts to the full line voltage, of course, but much more than that—it is the only instrument having the PATENTED DOUBLE FLOATING FILAMENT RETURN SELECTOR SYSTEM which automatically re-connects every tube socket to the proper arrangement while the instrument is being set up from the roller tube chart. Tube base connections on future tubes may change to any of the many hundreds of POSSIBLE arrangements and the 504 will take care of it—automatically—even unknown to the operator. That's why the 504 has only one socket for each type of tube—it is impossible to put a tube in the wrong socket.

These are just a few of the many PLUS advantages you have when you own a Model 504 Tube & Set Tester. It is beautiful in appearance, sturdily built, carries a year's free tube setting service and best of all, it is EASY TO OWN. If you can afford a telephone or if you can afford your cigarettes, you can afford the Model 504. This complete laboratory, combining a 7-way tube tester, a 31-range set tester and a complete condenser analyzer, costs you no more than 18c a day on the world's easiest installment terms.

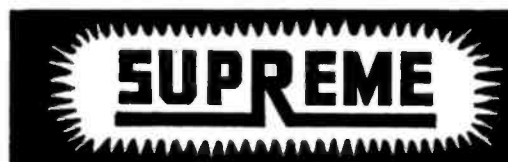

For full information on Model 504 and complete Catalog of new, 1941 SUPREME test equipment, write
SUPREME INSTRUMENTS CORP.
 DEPT. RC-10
 GREENWOOD, MISSISSIPPI

to be expected to be noticeable because of the increased efficiency, improved response, and lower noise level characteristic of direct-coupled amplifiers. Upon further investigation, it was found that manufacturers of tubes had not set close standards for plate resistance of preamplifier and voltage amplifier tubes.

Although normal variations in tubes produce a measurable difference in the performance of the resistance- and transformer-coupled amplifiers, they have been found to produce another effect in direct-coupled amplifiers. For example, an unbalanced pair of input tubes would unbalance the plate current or the output tubes sufficiently to increase residual hum and require readjustment of the hum-balancing adjustment. It was therefore decided

TURNER
Microphones

Write for free new literature to
The TURNER CO., Cedar Rapids, Iowa
Crystals licensed under patents Bush Development Co.

UNIVERSITY
LABORATORIES

GUARANTEE
 Your election sound sales. All University Loudspeakers are fully guaranteed for a period of one year. See your distributor or write us.
UNIVERSITY LABORATORIES
 195 Chrystie St.
 New York City

Service Men Make Money With Airline SOUND SYSTEMS

Here are expressions culled from hundreds of letters they wrote us about the Ward Airline: "Increased my P.A. business 50%!" "Made a good living . . . paid for it many times over!" "Assured of weekly rentals!" "Paid for itself twice over!" "Definitely increased my business!" There's a reason for all this, of course! It's because of Airline's clear tone, its volume without hum or distortion, its assured, dependable performance under all conditions. They make money, furthermore, because of Airline's low

upkeep . . . often a year or more of service without a penny for repairs or replacements.

Send for Catalog

More of the reasons are given in the Airline Sound Systems Catalog. It tells you how to select the sound system for your particular purpose . . . what amplifiers, what type of mikes, what kind of speakers and how to place them. And see how Ward's direct selling plan saves you money. Send for this catalog at once! It's FREE!

**TIME PAYMENTS—15-DAY TRIAL
MONEY-BACK GUARANTEE**

Montgomery Ward CHICAGO

9 GREAT MAIL ORDER HOUSES
MORE THAN 600 RETAIL STORES

MONTGOMERY WARD & CO.

Dept. RZ-41, Chicago, Ill.

Please mail at once Free Catalog on Airline Sound Systems.

Name

Address

City State



RADIO DIAGRAMS

MOST - OFTEN - NEEDED

**MOST
OFTEN-
NEEDED
RADIO
DIAGRAMS**

ALL MAKES 1926-1938

In this one low-priced manual you have all the circuits you really need. 427 diagrams of most-often serviced radios is the help you want for easier, faster, and better repairs. You will find 4 out of 5 diagrams needed in this manual. 244 pages, large 8½x11 in. size. Special price **\$1.95**

HOW TO SAVE TIME

Service hints, diagrams, alignment data, test charts, and parts lists included will prove time-savers and money-makers for you. Get these handy "on-the-job" handbooks. No need to work blind-folded. The time saved in two days will more than pay for these manuals.

1939-1940 DIAGRAMS

This single manual will give you over 80% of all 1939-40 circuits ever needed, acquaint you with recent radio developments, and teach you how to service quickly millions of sets sold last year. Models of 43 manufacturers. 212 large pages, 8½x11 inches. Limited quantity at **\$1.50**

**4 OUT OF
5
CIRCUITS
YOU
NEED**

**MOST POPULAR
1940
RADIO
DIAGRAMS**

FREE EXAMINATION

SUPREME PUBLICATIONS, Room 345
3727 W. 13th St., Chicago, Illinois

Ship the manuals checked. I must be satisfied or you will refund my money in full.

Most Often-Needed Diagrams, 1926-1938, @ \$1.95

Most Popular 1940 Radio Diagrams, @ \$1.50

I am enclosing \$....., send postpaid

Send C.O.D. I will pay the mailman.

NAME (Write address below and send this corner)

that 2 self-correcting networks would be incorporated in this new amplifier; one to automatically balance for difference in the plate resistance of the driver tubes and the other to automatically balance for difference in gain of the driver tubes. As a further requisite, it was decided that these circuits should provide for superior results in the direct-coupled amplifier as compared to a standard resistance-coupled amplifier with a given set of greatly unbalanced (or even defective) tubes.

THE D.C. BALANCING CIRCUIT

During the development of the 30-Watt Direct-Coupled Amplifier,* it was found that a normal variation between tubes could be compensated-for by correcting the bias on the input tubes. The basic portion of this manual balancing circuit is illustrated in Fig. 3.

Fortunately, when an unbalance of more than 10 milliamperes occurred in the output stage, the hum level came up. It therefore became a relatively simple matter to balance the input tubes by adjusting for minimum hum. With a change of input tubes, it was sometimes necessary to re-adjust the initial setting. It was found, however, that some of the ultimate users of these amplifiers would insert greatly-unbalanced tubes, without attempting to re-adjust for balance. It was therefore believed highly desirable to provide some automatic means for balancing. The first method of attack which presented itself was to use a tube in place of the load resistance of the voltage amplifier and arrange for automatic compensation for variations in plate resistance of the voltage amplifier. Another tube was to be used to

*See the October, 1939, issue of *Radio-Craft*.

augment the bias of the output tubes, so as to compensate for variations in output plate current.

In Fig. 4, which shows the elements of a revised single-sided direct-coupled amplifier, R_p is the plate resistance of the voltage amplifier and R_k is the partial cathode resistor of the power amplifier.

Figure 5 shows the basic balancing circuit originally conceived to automatically compensate for both variations in plate resistance of the input tube V1 and the output tube V2. It will be noted that V3 is used as a plate load resistor for V1. The bias applied to V3 through R1 depends upon the plate current flowing through its cathode resistor R2. The time-delay constant of R1, C1, prevents signal frequencies from affecting a change in the plate resistance of V3, and limits automatic adjustments only for "steady state" or average conditions; V4 was to be used as a shunt across R_k , so as to keep the bias across R_k constant. This circuit is likewise made responsive only to steady state or average unbalance, by inserting a time lag through the resistor-condenser network R2-C2.

Inasmuch as the final amplifier was to be push-pull throughout, 4 additional tubes would be required for this balancing action. The added expense and complexity of this circuit inspired additional research to produce a simpler and more economical circuit to achieve the desired results.

A side project was started to adapt the use of the twin indicator (6AF6G) through a twin-triode amplifier (6SC7), so arranged as to measure the voltage drop across the balanced primary winding of the output transformer. A special transformer was wound so that both sides of the primary were of equal D.C. resistance (and equal A.C. impedance). The idea behind this development was to provide a partially visual check on the plate current of the output tubes so that should greatly unbalanced tubes be used, it would become immediately visible, and the tube would provide for readjustment. It was found, however, that the indicator with its associated amplifier was too insensitive for the average user to adjust within a 10-ma. balance. This circuit was therefore abandoned, but it is given in Fig. 6 for the benefit of some readers who may have other applications for this particular type of indicator. The condenser-resistor network R1-C1 provides a time delay to prevent A.C. potentials from having any effect upon the twin-eye indicator. A novel portion of the circuit is that raw A.C. is applied to the plates of the indicator. The flicker is not observed because of the persistence of vision of the eye which will tolerate interrupted images down to about 16 cycles before flicker becomes visible.

The easiest way to understand the action of the final D.C. balancer is to substitute a resistor (r_l) for the plate load and another (r_p) for the plate resistance of the tube. If a D.C. voltage E (as indicated in Fig. 7) is applied across this network, the voltage E_{dc} is the effective voltage applied to the plate of the tube and is dependent upon the voltage drop across r_l . Thus, if r_p is varied from zero to infinity, the voltage will vary proportionately. The ratio of voltage change will depend upon the ratio

$$\text{of } \frac{r_p}{r_l + r_p}$$

If r_l is made large in comparison to r_p , the ratio of change will be small. If an additional resistor (r_c) is inserted in series with both r_l and r_p , as indicated in Fig. 8, then the effective voltage E'_{dc}

would be equal to $\frac{r_p}{r_c + r_l + r_p}$. The push-pull version of this circuit is indicated in

Fig. 9. If we neglect r_k (which is very small) the voltage which appears across $r_l' + r_p'$, is equal to B_{dc} which can be calculated from

$$B_{dc} = \frac{(r_l^1 + r_p^1)(r_l^2 + r_p^2)}{r_p^1 + r_l^1 + r_p^2 + r_l^2} + \frac{(r_l^1 + r_p^1)(r_l^2 + r_p^2)}{r_p^1 + r_p^2 + r_l^1}$$

If r_l^1 is 100,000, r_c is 500,000, and r_p^1 varies from 800,000 to 120,000 (which represents a \pm variation of approx. 20%), it will be found that the percentage of change at B_{dc} is 1.9% as compared to a 4% change which would take place under conditions of Fig. 7. In other words, a 50% correction is affected. If the same type of network is applied to the screen-grids of the driver tubes, as indicated in Fig. 10, still more correction is affected.

The practical value of this self-balancing circuit can best be indicated by referring to laboratory data compiled during its development. A total of 100 average 6SJ7 tubes were checked for the maximum deviation they produced in the output plate circuit of the 6L6G's. Two sets of the worst combination produced the following results:

Unbalanced Tube Numbers	Output Unbalance
1 and 2	61 ma.
1 and 3	68 ma.

A NEW FM AUDIO AMPLIFIER

"The Ultimate in Design"

FREQUENCY RANGE: 13-30,000 c.p.s. \pm 1 db
MUSICAL RANGE: 11 Octaves
DYNAMIC RANGE: 80 db
POWER RANGE: 0.003 to 30,000 Milliwatts

Outstanding in its design, performance, construction, and appearance. This amplifier was specifically designed for use with frequency modulation tuners, standard amplitude modulation receivers, and absolute fidelity phono reproducers. Leads, by a wide margin, the very finest resistance, impedance or transformer-coupled amplifiers. Incorporates two basic AC and DC balancing circuits (Pat. app. for) which provides greater circuit stability than conventional amplifiers.

Guaranteed for FIVE YEARS.

Write for literature describing this FM Amplifier

AMPLIFIER CO. of AMERICA

17 WEST 20th STREET NEW YORK, N. Y.

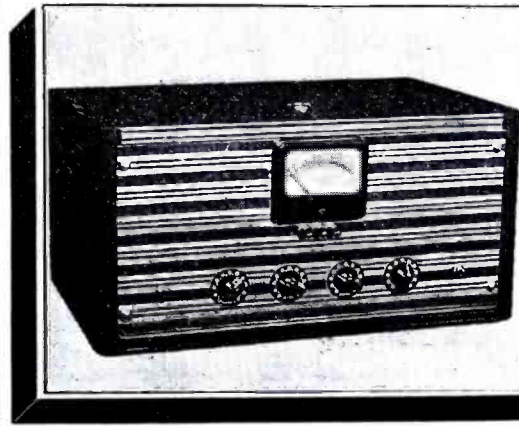

When these same tubes were inserted into the balancing circuit, the following results were noted:

Unbalanced Tube Numbers	Output Unbalance
1 and 2	8 ma.
1 and 3	8 ma.

As the D.C. balancer becomes an integral part of the A.C. balancer circuit as well, it was necessary to select optimum resistor values which would provide a minimum D.C. unbalance and minimum A.C. unbalance. The design of the A.C. balancer circuit will not be covered here because of lack of space but will be discussed in Part II.

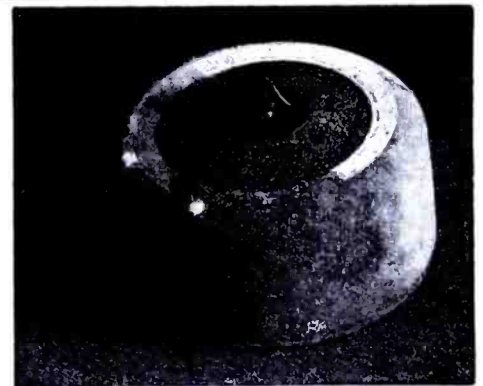

Model TBUA

CASE HISTORIES OF P.A. SALES

No. 12—Funeral Parlor Sound System

FEW sound Servicemen, I believe, have taken advantage of a very profitable outlet for their sound systems. This use—rental to funeral directors to accommodate overflow crowds—has brought in several extra dollars and much valuable advertising in the way of satisfied customers and interested attendants; often a worthwhile sale may be made. I have had 2 of this type of rental in the last 2 months. Of course every funeral has not an overflow attendance. I will refer to an installation I made some time ago.

A very prominent physician in my town was killed in an auto accident. On the evening before the funeral, the minister and undertaker came to me and asked to have the outside lawn and sidewalk covered with a public address system. I set up at 10:00 A.M. in order to be out of the way of the early visitors. The church is small and holds 250; a conservative estimate of the number outside the church was about 200. Everyone outside heard perfectly and persons stand-

ing in the vestibule told me they noticed no cut-off or dead spots between the minister and loudspeakers. An outside listener remarked that a soprano soloist sounded as beautiful outside as she ordinarily did inside. The family, minister, friends and undertaker are thoroughly pleased; the undertaker has promised me his future business in this line.

A very vital technical problem on an installation of this type is the monitoring and placement of the microphones. A loud blast of a loud-voiced minister or singer would immediately ruin the service and also the sound man's reputation.

To solve this problem, only 1 dynamic microphone was used. This mike was placed about 5 ft. from the pulpit and 8 ft. from the choir and singers. Thus I eliminated the possibility of blasts into the microphone and also enabled the use of but 1 microphone and 1 long line.

It was decided that the best place to monitor was at the loudspeakers. A table was set up on the lawn, next to the building and at a moderate distance from the speakers, and the amplifier placed on it.

As the end of each solo or talk, I lowered the decibel gain to a low value for a moment in order to obtain the new volume level and avoid a disagreeable blast.

Very little adjustment of the controls was found necessary. In tests, no feedback was encountered with gain on full. The church is located on a corner; I set the loudspeakers at right angles (see illustration), and secured perfect coverage at a very moderate level—about 4 watts on each speaker. The speaker cables were suspended 10 feet above the walk and laid along the curb in the street in order to eliminate hazards of tripping. Large, infinite-baffle speakers were used for the sake of portability, appearance and high-fidelity reproduction.

Usually no music is desired outside the

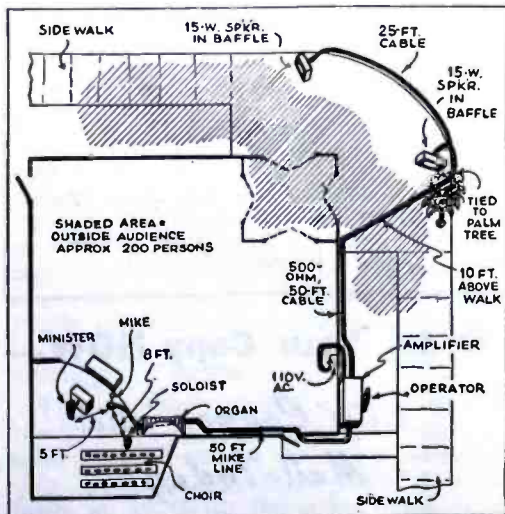

TALK-BAK*

Talk-Bak* intercommunication units provide complete versatility of operation.

- neat appearance
- rugged construction
- low initial cost
- low upkeep cost
- natural tone quality

Write for free bulletin

WRIGHT-DECOSTER, Inc.

2251 University Ave., St. Paul, Minn.
Export Dept.: M. Simons & Son Co., New York
Cable Address: "Simontrice"

Canadian Representatives:
Wm. F. Kelly Co., 1207 Bay St., Toronto, Ontario
Taylor & Pearson, Ltd., Edmonton, Alberta

*Copyrighted.

A Complete Book on Sound—
AMPLIFIER HANDBOOK & P.A. GUIDE
Turn Page

NEW AUDIOGRAPH Sound Catalog

AUDIOGRAPH Sound Systems represent the latest in Sound Engineering and Design—a complete line plus pre-tested accessories.

NEW LOWER PRICES

Outstanding quality and performance at prices that help you meet any competition.

WRITE FOR FREE COPY

JOHN MECK INDUSTRIES
1313 W. Randolph St., Chicago, Ill.

Order your copy NOW—the only

P. A. HANDBOOK

**1st Edition
Almost Gone!
ORDER TODAY**

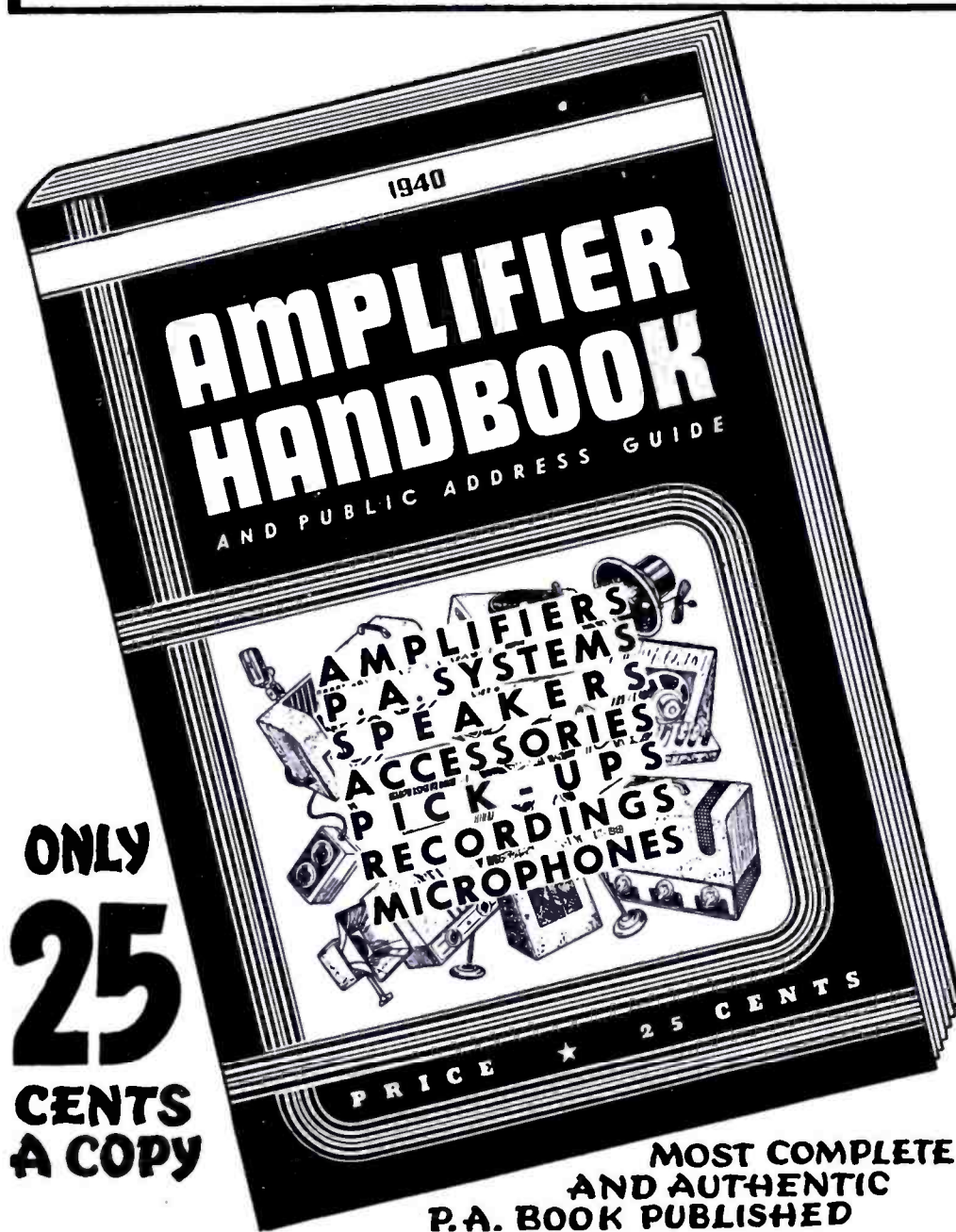

**ONLY
25
CENTS
A COPY**

A Resume of the Contents of the AMPLIFIER HANDBOOK AND PUBLIC ADDRESS GUIDE

FOREWORD

INTRODUCTION

Definitions—decibels, frequency, input, output, impedance, etc.

SECTION I—SOURCE

Carbon microphones (single-button and double-button)

Condenser microphones

Velocity (ribbon) microphones

Dynamic microphones

Crystal microphones (sound-cell types, crystal diaphragm types)

Cardioid microphones

Contact microphones

Phonograph pickups (magnetic types, crystal types)

SECTION II—AMPLIFIERS

Voltage Amplification

Design of resistance-coupled voltage amplifiers

Commercial voltage amplifier

The Power Stage

Class A amplifiers

Class AB amplifiers

Class AB₁ amplifiers

Class AB₂ amplifiers

Class B amplifiers

When to apply class A, AB, and B amplification

Power Supplies

Half-wave rectification

Full-wave rectification

Voltage doublers

Filter Circuits

Power supply regulation, etc.

Practical Hints on Amplifier Construction

Microphonism

Placement of components

Tone compensation

Inverse feedback

Remote control methods

SECTION III—DISTRIBUTION

The Loudspeaker

Dynamic speakers

Speaker performance (frequency response, efficiency)

High-fidelity speakers

Speaker Baffles and Housings

Outdoor speaker installations

Power cone speakers

Radial (360° distribution) speaker baffles

SECTION IV—COORDINATION

Input impedance matching

Matching speakers to P.A. installations

Phasing speakers

Effect of mismatching speakers to amplifier output

A typical P.A. installation (in a skating rink)

SECTION V—USEFUL PUBLIC ADDRESS DATA AND INFORMATION

Speaker matching technique

The ABC of Db., VU, Mu, Gm and Sm

Charts and formulas useful to the practical P.A. sound man

Handy index to important articles on public address and sound

THAT no book has yet been published which covers amplifiers and sound systems (also kindred systems), in one complete, authentic volume is almost unbelievable. Yet, it is a fact, there is no book in print which covers Public Address from A to Z. To bridge this wide-spread gap, RADIO-CRAFT will publish a complete, magnificent volume on Public Address of such magnitude—so complete and authoritative—that every man engaged in radio can have both a theoretical and practical knowledge of the function and operation of sound systems. The editorial pages are so filled with instruction and replete with illustrations that the volume fully justifies its title of 1940 AMPLIFIER HANDBOOK AND PUBLIC ADDRESS GUIDE. This great HANDBOOK on Public Address should be read and studied by those who consistently build, service and sell sound equipment.

A MATCHLESS VOLUME

As complete as you would expect to find any engineering handbook—this is how the radio or P. A. man finds the AMPLIFIER HANDBOOK AND PUBLIC ADDRESS GUIDE. With essential technical data compiled from an exceptionally large number of sources, the volume covers nearly a hundred different subjects coordinating every conceivable branch or sub-division of Public Address.

THE CONTENTS

To actually show the scope and magnitude of the AMPLIFIER HANDBOOK AND PUBLIC ADDRESS GUIDE, an analysis of the contents is found at the right, showing the breakdown of the material featured within each particular section. A thorough reading of the contents shows the completeness of this book.

RADCRAFT PUBLICATIONS ■ 20 VESEY STREET ■ NEW YORK, N. Y.

RADCRAFT PUBLICATIONS, INC. ★ 20 VESEY STREET ★ NEW YORK, N. Y.

RC-1240

Gentlemen: Enclosed find my remittance of 25c for which send me POSTPAID, one copy of your NEW—1940 AMPLIFIER HANDBOOK AND PUBLIC ADDRESS GUIDE.

Send me others, for friends, also POSTPAID @ 25c each.

Name Address

City State

Remit by check or money order; register letter if you send cash or unused U.S. Postage Stamps.

Order Your Copy NOW—

*Clip Coupon and
Mail Today!*



Radio Service Men! Hams! GET THIS FREE CATALOG

For Quick Service . . Complete Selections . . Right Prices

WRITE FOR CATALOG F717RC

NOW—Service Men as well as Hams can get everything they want from Sears—and pay for it on Sears Easy Payment Plan!

And Remember—when you buy from Sears, you pay shipping charges *only from your nearest Sears Mail Order House!* You'll Save Time—You'll Save Money—and you'll be Satisfied! Sears famous Money-Back Guarantee assures your complete satisfaction.

Sears, Roebuck and Co. carry *in stock* the most up-to-date and complete assortments anyone could ask for—in Radio, Public Address and Recording equipment. Get this big FREE catalog *today*. Write for F717RC!

Attention, Public Address Users! THIS CATALOG'S FREE, TOO!

Prominent Public Address users and Rental outfits have found it pays big dividends to get their equipment from Sears. Latest equipment at amazingly low prices—and you save Real Money on shipping charges! Order this big book *today*—write for F732RC.



SEARS, ROEBUCK and CO.

Chicago, Philadelphia, Boston, Kansas City, Minneapolis, Atlanta
Memphis, Dallas, Seattle, Los Angeles

church or mortuary before and after the service, but if music is desired, an extra mike may be used to pick-up soft organ music; or recordings may be played. It is important to have a correct, not-too-loud volume level.

If organ, singer or minister is located too far from the microphones, severe audience noise may result. If these 3 sound sources are not in a radius of 8 or 9 feet, several microphones should be used; semi-directional mikes work best.

Here's hoping that other sound men will find this unusual use for their equipment as worthwhile as I. I charge \$6 to \$12 for this service, depending upon the equipment used, the size of the funeral and the time spent. Of course, contacts must be made through the funeral directors.

The parts list and the specifications of the public address system, and a rough sketch of the set-up, are given here.

I have found that a supply of several dozen screw-hooks and eyes are very handy to use to hang power and speaker cables to keep them in a neat position when on a portable job.

My amplifier I consider quite unique as well as original. It has 2 mike channels, a phono input and a combination phono or all-wave Tobe Tuner. The radio receiver may be tuned-in with earphones and electron eye independently of the amplifier, i.e., with the amplifier public address system in operation. I use this feature to tune-in favorite dance bands while playing recordings for dances.

The amplifier consists of 10 tubes; the receiver has 6. Two separate power supplies are used, one for the output tube plates only. The hum cannot be heard at a distance of 10 ft. in the living room of my

home. It has 5 inputs, adjustable line and voice coil outputs and adjustable 500-ohm line permanent-magnet speakers. The output uses two 6B5s at 425 V. for 20 W. high-fidelity output. Provisions are made for decibel meter and headphone monitoring. The mixer is a 4-channel electronic circuit. High- and low-pass filters are to be added very soon.

Approximate net cost of equipment less labor, \$220; retail value, not less than \$380.

All parts are the highest quality of standard grade.

A complete set of extra tubes for the amplifier is carried at all times as a safety factor.

Parts List

	list price
American Dynamic mike, model D-5-T	\$32.50
Astatic Tru-Tan phono pickup, model B-10	17.50
Green Flyer motor, model A	13.25
Shure mike stand, model S-51	12.50
Two Wright-DeCoster P.M. speakers, 15-watts, @ \$22.50	45.00
One Jensen 12 inch Electro-dynamic	15.00
Two infinite-baffle enclosures, similar to Cinaudagraph units, 36 x 36 x 13 ins. deep (home built), value ..	30.00
Lenz and Belden cables, total 375 ft.	15.00
Amplifier (approx.)	160.00
Inca transformers and chokes	
RCA and Sylvania Tubes	
IRC and CRL resistors and controls	
Sprague and Aerovox condensers	
Tobe All-Wave Tuner	
Miller I.F. coils and tie points	
Amphenol connectors and sockets	

Gray metal crackle cabinet 18 x 13 x 12 ins. deep
Radio-Television Supply Co., Los Angeles

\$340.75

plus many hours' labor

RAY W. WINTER,
Serviceman for Jenk's Electric,
La Habra, Calif.

The 4th prize in the 2nd Section of "R.-C.'s" \$4,000 P.A. contest, last year went to Mr. Winter for his contribution.

BOOK REVIEW

MOST POPULAR 1940 RADIO DIAGRAMS with "alignment" data. Service Hints and Parts List. Size 8½"x10¼". 208 pages, stiff paper covers, published by Supreme Publications, Chicago, Illinois.

This book will be found very useful to the student, the Serviceman and electricians who now and then service radio sets. All necessary checking data, such as intermediate frequencies, etc., are given in the diagrams, together with the values of the various condensers, resistors, etc. The diagrams are printed in excellent, legible form, practically a diagram to a page, and the selection of the diagrams covers all of the more popular receivers now in use by the public. Even the student Serviceman will have no trouble in checking up a receiver circuit from these clear diagrams, and instead of having to hunt through hundreds of circuits the selection of the most popular ones has all been done by the editor of this book.

SERVICEMEN

Keep posted on F.M. Read the feature articles on this subject in the January, 1941, issue of *Radio-Craft*.

CIRCUIT APPLICATIONS FOR THE MINIATURE TUBES

This Article presents applicational information on the miniature tubes 1R5, 1S4, 1S5, and 1T4, which operate from a 45-volt "B" battery and a 1½-volt "A" cell. Only one-fifth the cubic size of the 1.4-volt GT tubes, these new tubes are well suited for use in wearable hearing-aids, meteorological balloons, pocket-size receivers, other portable receivers, or any radio equipment where small size and light weight are important.

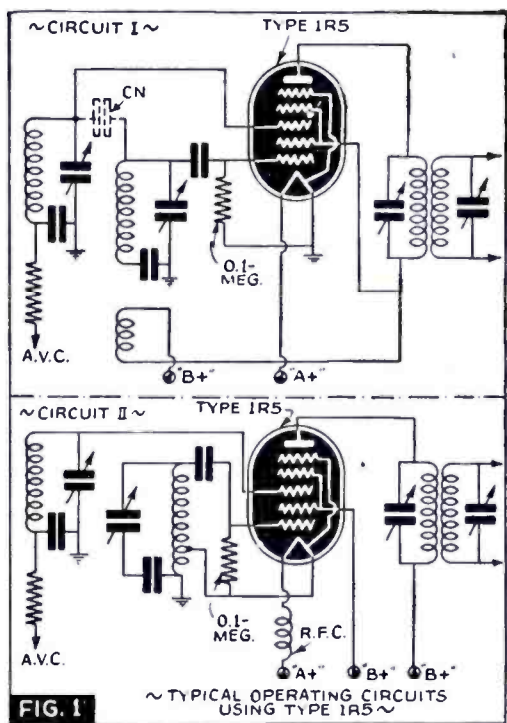

FIG. 1 ~ TYPICAL OPERATING CIRCUITS USING TYPE 1R5 ~

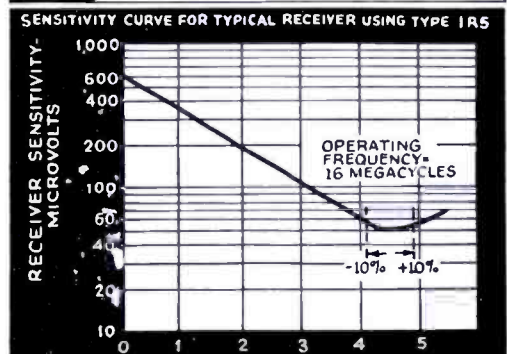

FIG. 2

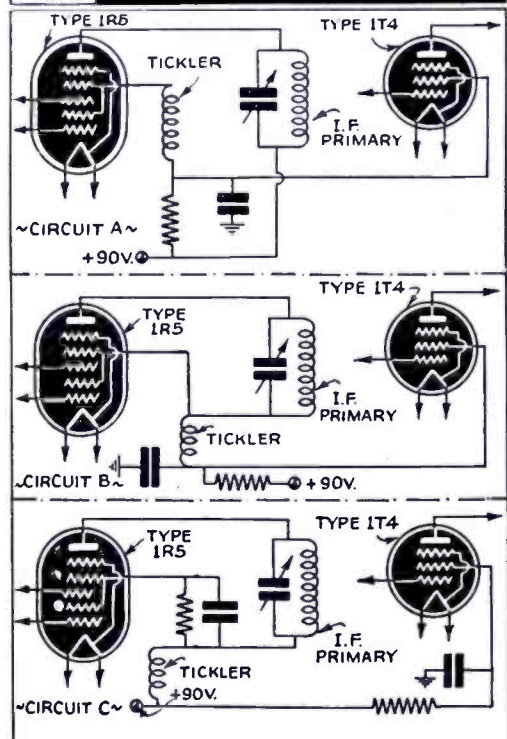

FIG. 5 ~ MODIFICATIONS OF CIRCUIT I FOR RECEIVERS WITH 90-VOLT "B" SUPPLY ~

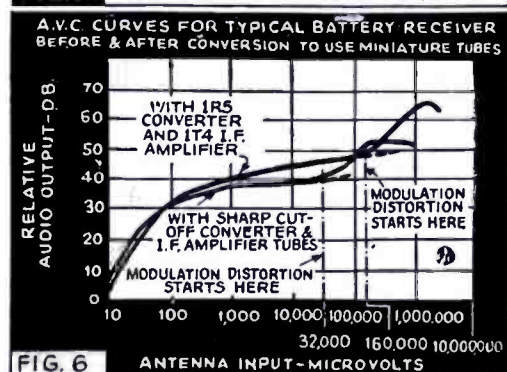

FIG. 6

THIS article is concerned principally with the use of the types 1R5, 1S4, 1S5 and 1T4 miniature tubes in receivers and especially with the operation of the 1R5 pentagrid converter.

In addition to their small size—compact structure makes it possible to mount a full-size 1.4-V. filament in a tube only 2 1/8 ins. long—and low "B" voltage requirement, the miniature tubes have other important advantages. The 1R5 pentagrid converter employs an oscillator circuit which inherently gives high oscillator transconductance. Both the 1R5 converter and 1T4 I.F. amplifier have a remote cut-off characteristic which enables them to handle a wide range of signal strengths without modulation distortion. The 1S5 diode-detector and A.F. amplifier tube has a pentode amplifier section which can provide an audio gain of 30 when "B" supply is 45 volts, and adequate signal output when the "B" battery is at the end of its life. The 1S4 output tube has a maximum-signal power output of 65 milliwatts when plate and screen-grid voltage are 45 volts, and 190 milliwatts when plate and S.-G. voltage are 67.5 volts. All the miniature types have a single-ended construction which eliminates flexible grid leads and top-cap connectors.

CIRCUITS—1R5 PENTAGRID CONVERTER

The 1R5 is a pentagrid converter similar to the 6SA7 in that the 1R5 has no separate oscillator anode. Typical circuits for the 1R5 are shown in Fig. 1. In Circuit I, oscillator feedback is provided by making plate and screen-grid current flow through a tickler coil. In Circuit II, oscillator feedback is provided by connecting the filament to a tap on the oscillator tank coil. This 2nd circuit is similar to the cathode feedback circuit used with the 6SA7.

In both circuits, the 1R5 has 2 important advantages in addition to the fact that the "B" supply can be as low as 45 volts. One advantage is that, in both circuits, almost all the electron current emitted by the filament is effective in providing feedback. As a result, the oscillator transconductance of the 1R5 in the circuits of Fig. 1 is higher than that of other battery-operated converter types in the conventional circuit where the feedback current (the oscillator-anode current) is only about 50% of the total emission current. The high oscillator transconductance of the 1R5 makes it possible to obtain wider tuning ranges with this tube.

A 2nd advantage of the 1R5 is due to the fact that the arrangement of grid side-rods in the 1R5 is similar to that in the 6SA7. Because of this arrangement, most of the electrons turned back toward the filament

by the negative signal grid are prevented from reaching the space charge near the filament. This action of the side-rods, together with the electrostatic shielding of the screen-grid, practically isolates the filament space charge from the signal-grid. As a result, changes in signal-grid bias produce very little change in oscillator transconductance. Changes in A.V.C. bias, therefore, produce very little change in oscillator frequency. This feature of the 1R5 is important in shortwave operation.

COMPARING CIRCUITS I AND II

In a receiver which is to use the 1R5, the choice between Circuits I and II depends on the frequency range of the receiver. In a set tuning not higher than about 6 megacycles, Circuit I is generally preferable. In a set which is to tune higher than this frequency, Circuit II may be preferable. At the high frequencies, the choice between the 2 circuits depends on the following considerations.

Circuit I has the advantage that it is somewhat easier to provide adequate grid excitation in a tickler-feedback oscillator than in a cathode feedback oscillator. When Circuit I is operated at frequencies higher than about 6 megacycles, a neutralizing condenser C_N should be connected in the circuit, as discussed in the next paragraph. Circuit II has the advantage that it does not require this neutralization. Also, band-switching in Circuit II may be simpler than in Circuit I. The relative importance of these advantages will determine the choice between the 2 circuits for use in a particular receiver operating at high frequencies.

NEUTRALIZATION OF CIRCUIT I

In operation of Circuit I at frequencies above 6 megacycles, the oscillator voltage on the screen-grid may cause considerable oscillator voltage to appear on the signal-grid. The reason is that, at these frequencies, there is only a small percentage difference between the signal and oscillator frequencies. The impedance of the signal-grid circuit at oscillator frequency is therefore appreciable compared with that of the screen-grid-to-signal-grid capacity. To minimize the oscillator voltage on the signal-grid, a small condenser should be connected between the signal-grid and the No. 1 grid, as indicated in dotted lines in Fig. 1, when Circuit I is to be tuned higher than 6 megacycles. Because the oscillator voltage on the No. 1 grid is in phase opposition to that on the screen-grid, the oscillator voltage on the signal-grid can be practically cancelled by use of the proper capacity for C_N .

The effect on receiver sensitivity of varia-

tion in the capacity of C_N is indicated by Fig. 2. This curve was plotted for a typical receiver operating at 16 megacycles. The values on this curve are not necessarily correct for other receivers, but the curve shape is approximately correct for other receivers.

The explanation of this curve shape is briefly as follows: There are 2 components of oscillator voltage on the signal-grid, one applied from the No. 1 grid, the other applied from the screen-grid. The 2 components are in phase opposition. In the receiver for which the curve of Fig. 2 was plotted, when C_N is approximately equal to 4.5 mmf., the 2 components are equal, and cancel each other. When C_N is smaller than 4.5 mmf. the net resultant oscillator voltage on the signal-grid is in-phase with the screen-grid voltage and out-of-phase with the No. 1-grid voltage. As a result, the oscillator voltage on the signal-grid reduces the modulation of the electron stream by the No. 1 grid and, therefore, reduces conversion transconductance. When C_N is larger than 4.5 mmf. the net resultant oscillator voltage on the signal-grid is in phase with the No. 1-grid voltage. This in-phase voltage on the signal-grid increases plate current above the value giving maximum conversion transconductance, and causes the D.C. to the signal-grid to become comparatively large. This grid current loads the signal-grid tuned circuit and increases the A.V.C. bias voltage on the I.F. tube. From this explanation it can be understood why there is a value of C_N giving maximum sensitivity. However, the value of C_N is not critical; it can be seen from Fig. 2 that variations of $\pm 10\%$ in C_N do not cause excessive variation in the sensitivity of the receiver measured. In other receivers, it has been found that capacity variations of $\pm 20\%$, or even more, can be tolerated.

Consideration of Circuit I shows that the value of C_N providing best neutralization depends on the ratio of the amplitude of oscillator voltage on the screen to that on the No. 1 grid. This ratio is determined by the turns ratio between the tickler coil and the No. 1-grid coil. The optimum value of C_N , therefore, depends on the number of tickler turns. A good method for adjusting C_N and the number of tickler turns for the frequency band between approximately 6 and 18 megacycles is as follows.

First, tune to the low-frequency end of the band and adjust the tickler turns to give 20 microamperes No. 1-grid current. Then, tune to the high-frequency end of the band and adjust the capacity of C_N to give maximum receiver sensitivity. In receiver production, it may be desirable to use a value of C_N somewhat smaller than the value giving maximum sensitivity so that manufacturing variations will not make C_N much larger than the optimum-sensitivity value. If C_N becomes much larger than this value, circuit instability is likely to result because of interaction between the oscillator and signal-grid circuits. In the receiver for which the curve of Fig. 2 was plotted, a value of 4 mmf. for C_N gave prac-

tically no interaction, 5 mmf. caused some interaction, and 7 mmf. made the circuit inoperative. The value of C_N selected for use in the 6-18 megacycle band can also be used in the middle- and low-frequency bands. In the middle-frequency band, the optimum value of C_N is not at all critical, while in the low-frequency bands, the presence of C_N in the circuit has very little effect on circuit performance.

In the high-frequency band, the effect of variation in C_N on receiver sensitivity and stability depends on the amplitude of oscillation. When this amplitude increases, the value of C_N becomes more critical. Hence, this capacity is generally most critical at the high-frequency end of the band. When it is desired to reduce the effect of variation in C_N on receiver sensitivity, this reduction can be made by limiting the amplitude of oscillation at the high-frequency end of the band. A simple method for limiting this amplitude is to connect a resistor in series with the oscillator trimmer condenser.

The method used to vary C_N in our laboratory tests consisted of connecting in the circuit different fixed condensers. Each fixed condenser was made by winding a length of bare copper wire tightly on a length of rubber-covered wire. The capacities of these condensers were measured on a Q-meter.

R.F. CHOKE FOR CIRCUIT II

An R.F. choke for Circuit II should meet the following requirements which are not difficult to satisfy. The resistance of the choke should not be so large as to cause excessive drop in the filament voltage supplied to the 1R5. A resistance of 1 ohm, or less, is satisfactory. The inductance of the choke should be large enough to provide effective choking at the lowest frequency to which the oscillator tunes. For operation in the domestic broadcast band, an inductance of 30 to 40 microh. is generally satisfactory. The distributed capacity of the choke should be small enough so that the resonant frequency of the choke is higher than the highest frequency to which the oscillator tunes.

FEEDBACK—CIRCUITS I AND II

In Circuit I, the number of tickler turns should be large enough so that strong oscillation is maintained throughout the tuning range and throughout battery life. However, the number of tickler turns should not be much larger than necessary because an excessive number of tickler turns causes a reduction in conversion transconductance. The reason is that an increase in tickler turns causes an increase in the amplitude of oscillator voltage on the screen-grid. When Circuit I is in normal operation, cathode current flows only during the positive half-cycles of No. 1-grid voltage. During these half-cycles, the oscillator voltage on the screen-grid is negative. Hence, an increase in the amplitude of oscillator voltage on the screen decreases the effective D.C. screen voltage. As a result, an increase

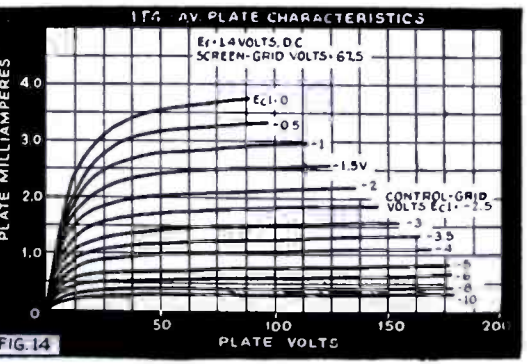
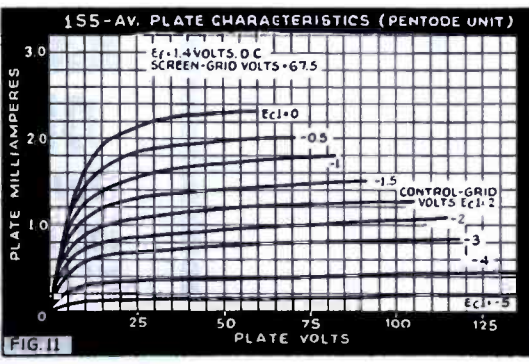
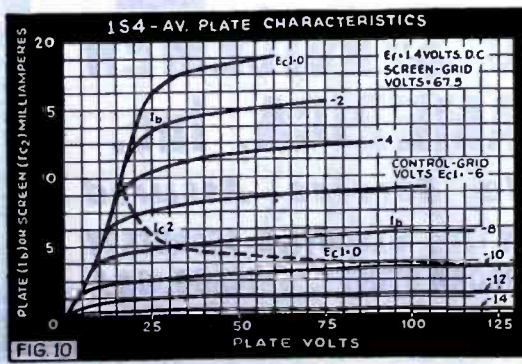
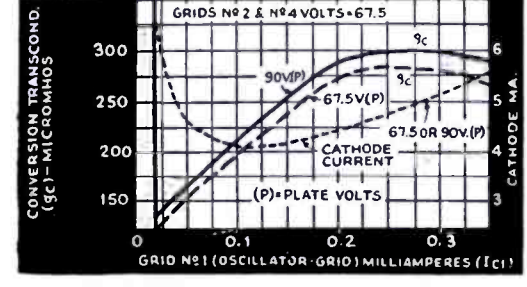
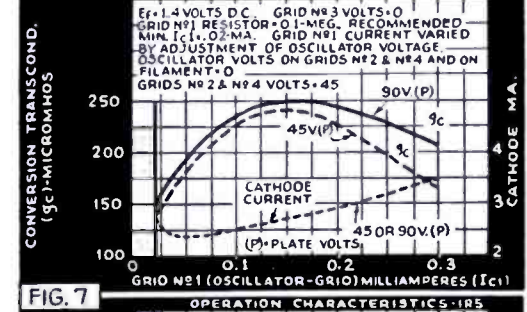
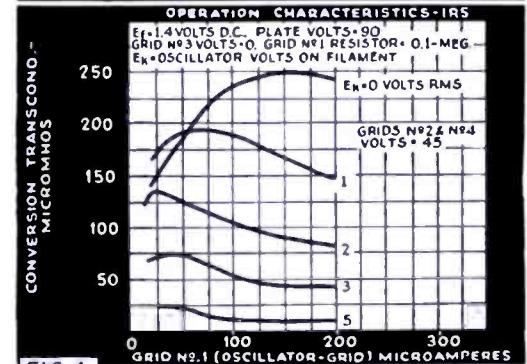
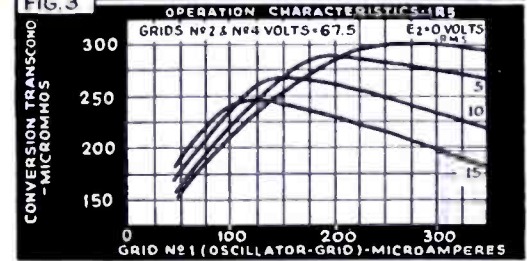
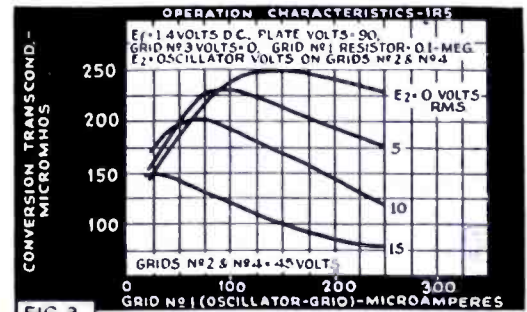

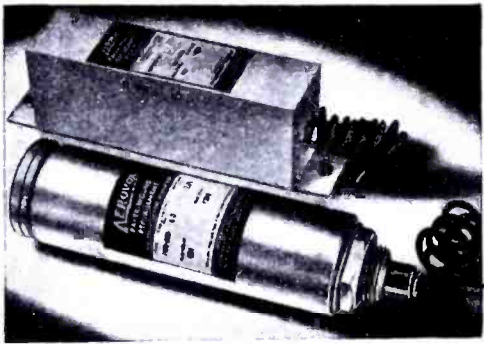

**Doubles
IN PAPER . . .**

- They look like electrolytics. Actually they are paper condenser substitutes for electrolytics where excessive surges or peaks cause trouble. Series PWC matches cardboard-case electrolytics. Rated at 800 v. surge or 600 v. D.C.W. Units replace 4 mfd. (actual 2), 8 mfd. (2.75) and 8-8 mfd. (1.75-1.75) electrolytics. Series PWC of same voltage rating, replacing 4 mfd. (actual 2) and 8 mfd. (3 mfd.) electrolytics. Use them to avoid costly comebacks!

Ask for CATALOG . . .

These handy servicing and set-building aids are listed in the latest Aerovox Catalog. Ask jobber for copy—or write us direct.



in tickler turns above a certain number reduces conversion transconductance.

Similar statements are true of Circuit II. The filament tap on the oscillator tank coil should be far enough up the coil for strong oscillation. However, the tap should not be too far up the coil because the oscillator voltage on the filament makes the filament positive with respect to the signal-grid during positive half-cycles of No. 1-grid voltage. Hence, the oscillator voltage on the filament has the effect of increasing the negative bias on the signal-grid and thus reduces transconductance.

These statements are illustrated by the curves of Figs. 3 and 4 which show the effect on conversion transconductance of the oscillator on the screen-grid in Circuit I, and of the oscillator voltage on the filament in Circuit II. These curves can be used as a guide when a 1R5 oscillator coil is to be adjusted to give best sensitivity over a tuning band. The curves are convenient to use.

A simple vacuum-tube voltmeter adequate for measuring oscillator voltage on the 1R5 screen-grid or filament consists of a diode in series with a 0.1-meg. resistor and a microammeter. In the domestic broadcast band, best sensitivity is usually obtained when oscillator-grid current ranges between 50 and 150 microamperes.

MODIFYING CIRCUIT I FOR 90-V.

Modification of Circuit I may be desirable when the "B" supply is 90 volts. This supply voltage may be used in a receiver where it is desired to obtain more power output than can be provided by a 1S4. For such a receiver, a good tube line-up is a 3Q5-GT operated at 90 volts plate and screen-grid voltage, a 1S5 operated at the 90-volt conditions given below under "Resistance-

Coupled Operating Conditions for 1S5 Pentode," a 1T4, and a 1R5. Because the maximum rated screen-grid voltage of the 1R5 and 1T4 is 67.5 volts, a series screen-grid resistor is necessary for these tubes unless a 67.5-volt battery tap is employed.

Figure 5 shows 3 methods of supplying screen-grid voltage to a 1R5 and 1T4 from a 90-volt battery in a receiver where the 1R5 stage employs tickler feedback.

Circuit A.—In circuit A, the 1R5 plate current does not flow through the tickler coil; the tickler feedback current is the screen-grid current alone. With this arrangement, the feedback current, and hence the oscillator transconductance, changes with A.V.C. bias. This change may be objectionable in the shortwave bands but is unimportant in the domestic-broadcast and longwave bands.

Circuit B.—In circuit B, the voltage on the 1R5 plate is lower than in circuit A. As a result, the conversion gain obtainable from circuit B is somewhat less than that from circuit A. However, in circuit B, both the plate current and screen-grid current of the 1R5 contribute to the tickler-feedback current. Because the sum of plate current and screen-grid current changes very little with A.V.C. bias, oscillator transconductance in circuit B is less affected by A.V.C. bias than in circuit A. As a result, circuit B gives better oscillator performance in the shortwave bands than circuit A.

Circuit C.—The diagram of circuit C gives somewhat more conversion gain than circuit B because the 1R5 plate voltage is higher in circuit C. Also, the oscillator performance of circuit C is good in all bands because the tickler coil carries both the plate current and the screen-grid current of the 1R5. However, circuit C employs an additional screen-grid resistor for the 1T4.

Mr. Radio Serviceman:

RSA MEANS BUSINESS!

New business promotion plans and new member-helps spell increased profits for RSA members at the start of the new season. Watch for the RSA Replacement Parts Guide—New Broadcast Promotions—New Member Helps! Don't be the last man in your neighborhood to join RSA. Send the coupon Today!

MAIL THIS COUPON NOW!

RADIO SERVICEMEN OF AMERICA, INC.
304 S. Dearborn St., Chicago, Ill.

I am interested in RSA Membership. Tell me about it.

Name

Address

City State

RC-1240

**Let's Grow Together
in 1940!**



**RADIO SERVICEMEN
OF AMERICA, Inc.**

Reliable Service Assured

**JOE MARTY, JR., EXECUTIVE SECRETARY
304 S. DEARBORN STREET, CHICAGO, U.S.A.**

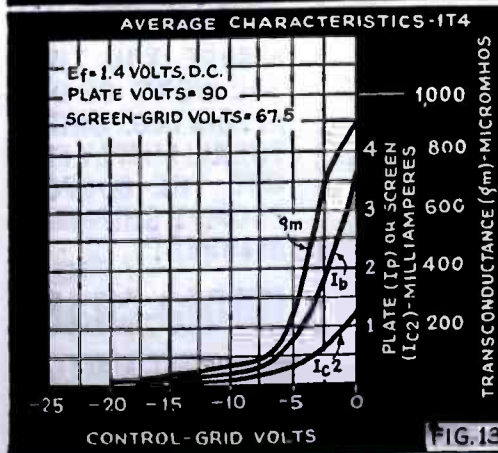
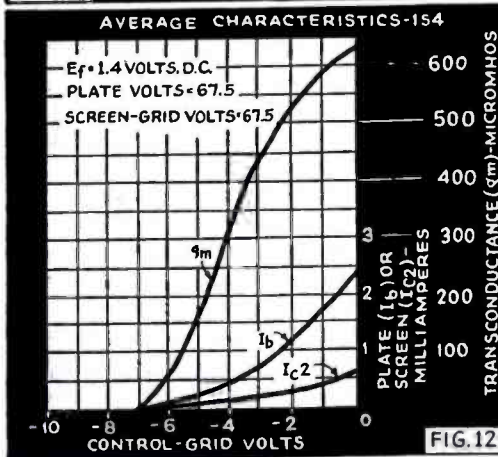
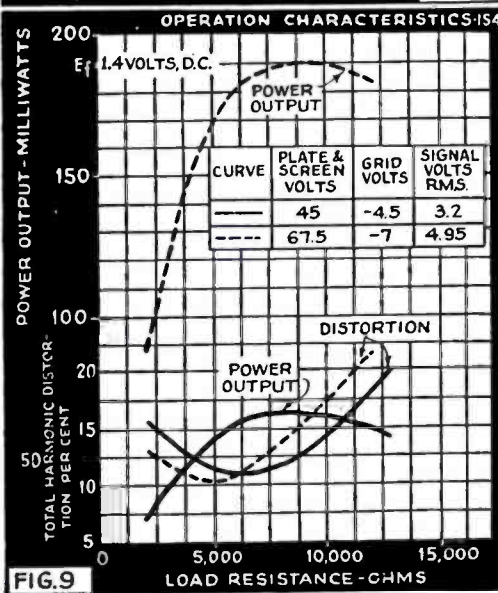
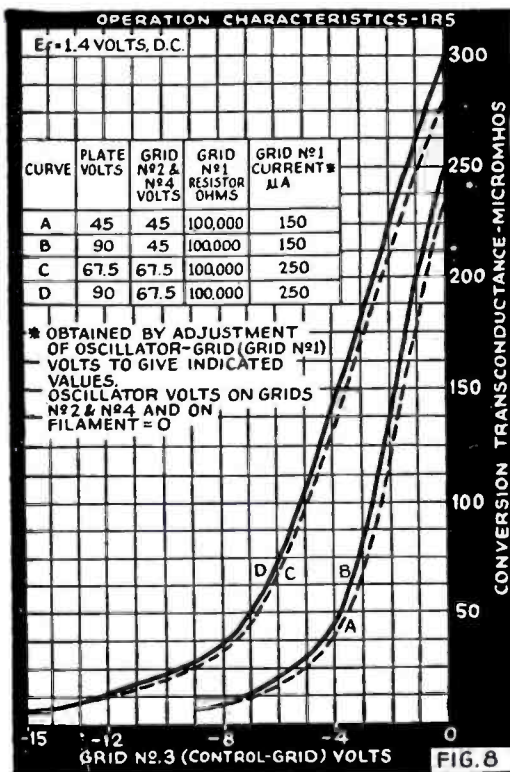

REMOTE CUT-OFF—1R5 AND 1T4

Both the 1R5 converter and 1T4 I.F. amplifier have remote cut-off. As a result, a receiver using these tubes can have a better A.V.C. characteristic than a receiver using sharp cut-off types. This statement is illustrated by Fig. 6 which shows A.V.C. curves for a typical battery-operated receiver before and after conversion to the miniature tubes.

In this figure the curve for the sharp cut-off tubes bends upward at an antenna input of about 30,000 microvolts. At this value of input, the A.V.C. bias on the converter and I.F. tubes is a large percentage of their cut-off bias. As a result, there is some clipping of negative signal peaks on the I.F. amplifier grid. This clipping produces an increase in the percentage modulation of the I.F. amplifier output, and thus causes the upward bend in the curve for measured audio output. In other words, the upward bend in the curve indicates the signal strength at which modulation distortion starts. The curves show that the range of signal strengths amplified without appreciable modulation distortion is about 5 times larger for the miniature tubes than for the sharp cut-off types.

CURVES FOR MINIATURE TYPES (67.5 V. ON S.-G.)

The maximum rated screen-grid voltage of the 1R5, 1T4, and 1S4 has recently been raised from 45 to 67.5 volts. The maximum rated plate and S.-G. voltages of the 1S5 had been previously set at 90 volts. Curves for all 4 types at a screen-grid voltage of 67.5 volts are given in Figs. 7-14. Figure 9 also shows power output and distortion curves for the 1S4 operated at 45 volts plate and screen-grid voltage. It should be noted that, in a receiver where part of the "B" supply voltage is used to bias the output tube, the values of transconductance and power output will be somewhat less than those shown in the curves.

RESISTANCE-COUPLED OPERATING CONDITIONS—1S5 PENTODE

Plate supply voltage	45	67.5	90 volts
Screen-grid supply voltage	45	67.5	90 volts
Control-grid voltage	0	0	0 volts
Load resistor	1	1	1 megohm
Series screen-grid resistor	3	3	3 megohms
Control-grid resistor	10	10	10 megohms
Control-grid resistor for following stage	2	2	2 megohms
Voltage gain* (approx.)	30	40	50

* Obtained when the grid of the pentode unit is fed from a source having an impedance of 1.0 megohm.

SHIELDING AND SOCKETS

Shielding cans are not usually required for the miniature tubes. The 1T4 I.F. amplifier tube has a shielding electrode which surrounds the plate and is internally connected to the filament. The socket for a 1T4 should have a central metal insert shielding the grid base pin from the plate base pin, which is opposite the grid pin. The socket for a 1R5 should be cushioned as a precaution against microphonics. Suitable cushioning can be provided by soft rubber grommets between the socket and chassis. Similar cushioning for the 1T4 may be desirable. It may be necessary to mount a baffle plate or other shielding between the 1S5 and output tube to prevent audio feedback. Also, in a receiver tuning to the longwave band where signal frequencies are close to the intermediate frequency, it may be necessary to shield the 1S5 and 1T4 from the loop and the R.F. input leads.

When a miniature tube is removed from



Readrite
"RANGER"

MODEL 739

HANDY POCKET "LAB"

\$9.90

DEALER NET PRICE

• Model 739 Pocket Volt - Ohm - Milliammeter stands alone in the quality class. Selector Switch . . . Molded Case . . . Precision 3-Inch Meter has 2 Genuine Sapphire Jewel Bearings. AC and DC Volts 0-15-150-750-1500; (DC at 1000 ohms per volt); DC MA. 0-1.5-15-150; High and Low Ohms scales. Resistance, Low ohms, 0-500, backup circuit with 25 ohms at center scale; 0-500,000 ohms. External batteries may be used for higher resistance measurements. Size—3 1/16" x 5 7/8" x 2 1/4". \$9.90 Attractive modernistic silver and black panel. Dealer Net Price



★ ★ ★
MODEL 510

A Handy Pocket-Size All-Purpose Volt - Ohmmeter . . . Ranges 0-300 DC Volts; 0-10,000 ohms. Complete with Battery Dealer Net Price **\$2.25**

★ ★ ★
MODEL 432-A
TUBE TESTER

The Outstanding Tube Tester Value . . . Checks all types including Loctals, Single Ends, Bantam Jr., and the new Midgets, Gaseous Rectifier, Ballast, High Voltage Series, etc. Filament Voltages from 1.1 to 110 volts. Direct Reading GOOD-BAD Meter Scale. Counter or Portable Leatherette Case with roomy compartment for tools. **\$18.85**

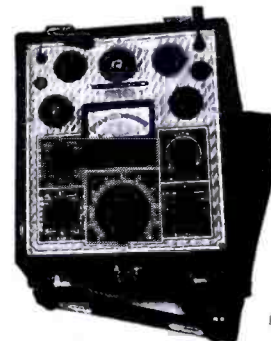

Section 1216 College Ave.

READRITE METER WORKS, Bluffton, Ohio

FREE TO YOU!

RADIO PARTS AND ACCESSORIES

HERE is some real BIG NEWS for you! Through a fortunate arrangement which we have been able to make, we can now offer you FREE premiums of such extraordinary value that they overshadow anything we have ever offered in the past with subscriptions to RADIO-CRAFT Magazine.

NEVER BEFORE, in the 11 years' history of the magazine, have we offered such worthwhile premiums. All of these radio parts and accessories can be used to good advantage by the "ham" or constructor in his daily experiments.

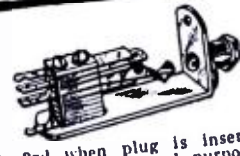

TELEPHONE JACK
Substantial long frame phone jack. 2-circuit filament control type. Opens 2 circuits, closes 2. Can be used for variety of control purposes in radio and telephone work. 2 3/8" long, 1" high. Ship. weight 4 oz.
Premium No. 1 (3 Pts.) Val. 35c.



PUNCHED CHASSIS
Heavy plated steel chassis with holes punched for 11 tubes, power transformer, speaker plug and tuning dial. Great for large experimental sets, transmitters, etc. Reinforced construction. 13"x7 1/2"x2 1/2". Ship weight 3 lbs.
Premium No. 2 (5 Pts.) Val. 25c.



TWO GANG POTENTIOMETER
Well-made Yaxley 2 gang wire wound potentiometer. 2 units are insulated from each other. One is 5000, the other 15,000 ohms. Used as control antenna and bias in broadcast receiver. Also useful in experimental circuits. Ship. weight 1 lb.
Premium No. 3 (5 Pts.) Val. 25c.



ALLOY CHASSIS
Medium weight alloy metal chassis punched for power transformer and 8 tubes as well as numerous mounting holes. Easily drilled metal. Open ends. Well made. 10 3/8"x6 5/8"x2 1/2". Ship. weight 2 lbs.
Premium No. 4 (5 Pts.) Val. 25c.

These parts are given to you IN ADDITION to the cut-rate subscription prices we list below:
7 mos. for \$1 (saving you 75c over the single-copy price)
16 mos. for \$2 (saving you \$2 over the single-copy price)
24 mos. for \$3 (saving you \$3 over the single-copy price)

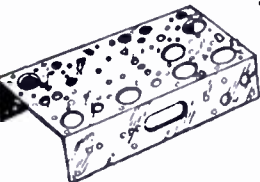

7 TUBE CHASSIS
Alloy metal chassis punched for 7 tubes, condensers, etc. Ideal for building small sets or simple apparatus. Metal is easy to drill. Size 10 1/2"x5 3/8"x2". Ship. wt. 2 lbs.
Premium No. 5 (5 Pts.) Val. 25c.



CONNECTING CABLE & TERMINAL
Unusually well made Philco 8 foot, 5 wire cable with spade terminals at one end and terminal block with 8 positions at other end. Wires color coded. Well insulated. May be used for remote control or battery connections, etc. Terminal block 3"x3"x3/4". Ship. weight 1 lb.
Premium No. 6 (6 Pts.) Val. 35c.

And, of course, the longer your subscription runs, the more merchandise you obtain FREE. As we expect a tremendous response to this offer, we would suggest that you send your remittance without delay, as our supply of parts is limited and we won't be able to duplicate this offer again.



LOUDSPEAKER UNIT
Kellogg magnetic loudspeaker unit for use with horn speaker. Has adjustable diaphragm. May be used as pillow speaker or attached to acoustic phonograph. Also useful as sensitive microphone for voice reproduction. Threaded (1/8" diam.) phone for throat. Size 2 1/2" diam., 1 3/8" deep. Ship. wt., 2 lbs.
Premium No. 7 (10 Pts.) Val. 75c.

A SHORT while ago we were informed that one of the largest surplus houses in the East was ready to sacrifice a huge quantity of radio parts and accessories which cost the original manufacturers thousands of dollars. We entered into an agreement with this house whereby we suggested to them to allow us to offer these parts to our readers in connection with subscription offers. The surplus house enthusiastically endorsed our plan. We—the publishers—pay the surplus house cash for each of these parts, and you—the reaper of this fortunate arrangement—will get these valuable radio parts and accessories **ABSOLUTELY FREE**. This is positively the first time that we have been enabled to make such an unprecedented offer which in many ways sounds too good to be true. Nevertheless, we vouch for it in every way and we know you will not be disappointed. This special arrangement enables us to offer you this valuable merchandise **FREE** with your subscription to RADIO-CRAFT magazine, at a price which is already a tremendous saving over the newsstand cost. This is how the plan works:— Next to the premium number of each item, we show its point value.

- For each 7 months' subscription (\$1.00) you receive 15 points' worth of merchandise free.
- For each 16 months' subscription (\$2.00) you receive 30 points' worth of merchandise free.
- For each 24 months' subscription (\$3.00) you receive 45 points' worth of merchandise free.

For instance, if you send us a seven months' subscription at \$1.00, you are entitled to 15 points' worth of free merchandise. You may order one No. 4 (5 points) and one No. 7 (10 points). Or if you wish, one each of numbers 2, 3 and 4 (each 5 points), or any other combination which totals 15 points. Similarly, if you send us a 16 months' subscription (\$2.00) you may order any combination of merchandise which totals 30 points. On a 24 months' subscription (\$3.00), any combination totalling 45 points. Due to the high cost of the merchandise, we cannot ship the articles

prepaid, therefore we show the weight of each piece, packed. If you wish your free parts sent by parcel post, please add to your remittance a sufficient amount to cover postage. Or, if you would rather have us send the parcel express charges collect, we will be glad to do so. Please remember that we do not sell these articles. You cannot buy them from us at any price. In order to make sure that you receive your parts promptly, **ORDER TODAY**. Fill out the coupon, clip and mail to us together with the proper remittance.

ALL RADIO PARTS ARE NEW AND UNUSED
Many are in their Original Packing

IMPORTANT TO PRESENT SUBSCRIBERS

If you are already a subscriber or have recently subscribed to the magazine, this offer still holds good for you, too. We merely will lengthen your subscription for either 7 months, 16 months or 24 months, as the case may be. There is a place on the coupon which provides for this.

RADIO-CRAFT, 20 Vesey Street, New York, N. Y. RC-1240

Please enter my subscription to RADIO-CRAFT for

7 months—\$1.00. Plus 15 points' worth of FREE radio parts.

16 months—\$2.00. Plus 30 points' worth of FREE radio parts.

24 months—\$3.00. Plus 45 points' worth of FREE radio parts.

I enclose my remittance for \$....., which includes parcel post charges on the FREE parts I am ordering.

Please send the merchandise to me express charges collect.

I am a subscriber now. Lengthen my subscription for months:

I am circling the numbers of the parts I wish to have you send me Free.
Nos. 1 2 3 4 5 6 7

Name Address

City State

(Send remittance in form of check or money order. If you send cash or unused U. S. postage stamps, be sure to register your letter.)

DON'T MISS THIS OPPORTUNITY! WE ASSURE YOU THAT YOU WON'T BE DISAPPOINTED. ORDER TODAY! SIMPLY FILL OUT THE COUPON. PROMPT SHIPMENT ASSURED!

RADIO-CRAFT
20 VESEY STREET
NEW YORK, N. Y.

its socket, the tube should be pulled straight away from the socket without a rocking motion. *Rocking the tube in its socket produces a transverse pressure on the base pins which may crack the glass base.*

Likewise, *wiring to the sockets should not pull socket terminals out of position because this pull applies transverse pressure to the base pins.* Socket contacts should grip the base pins not less than 1/8-inch below the base so that the base pins can bend slightly to make up for misalignment of socket holes or contacts.

This article has been prepared from data supplied by courtesy of RCA Manufacturing Co., Inc.

BOOSTER TYPE TONE CONTROL

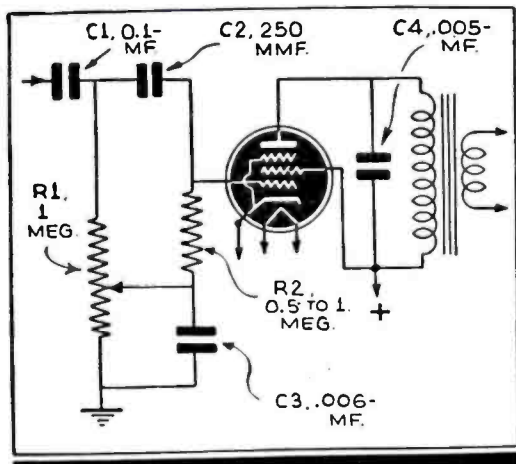

Here is a diagram of an unusual tone control circuit. In the "Treble" position, the low frequencies are completely cut off, resulting in exceptional clarity for speech and C.W. In the "Bass" position, the high frequencies are attenuated, decreasing atmospheric noises, yet maintaining clarity. At a point midway on the control, a balance may be found that gives excellent tone quality due to the boosting effect on both high and low frequencies. This control, because of its wide range, should be useful for short waves.

Condenser and resistor sizes are not critical but different values may be tried for C3.

CECIL GUDMUNDSON,
Berens River,
Man., Canada

COLOR-CODED WRENCHES

● TO put a stop to picking up 5 wrong out of a possible 6 socket wrenches I hit upon the scheme I recommend to Servicemen of marking them according to the R.M.A. color code; smallest, black, etc.

MORSE RADIO SERVICE,
Moline, Ill.

STATEMENT OF THE OWNERSHIP, MANAGEMENT, CIRCULATION, ETC., REQUIRED BY THE ACTS OF CONGRESS OF AUGUST 24, 1912, AND MARCH 3, 1933.

Of RADIO-CRAFT, published monthly at Springfield, Mass., for October 1, 1940.

State of New York }
County of New York } ss.

Before me, a Notary Public in and for the State and county aforesaid, personally appeared H. Gernsback, who, having been duly sworn according to law, deposes and says that he is the editor of *Radio-Craft* and that the following is, to the best of his knowledge and belief, a true statement of the ownership, management (and if a daily paper, the circulation), etc., of the aforesaid publication for the date shown in the above caption, required by the Act of August 24, 1912 and as amended by the Act of March 3, 1933, embodied in section 537, Postal Laws and Regulations, printed on the reverse of this form, to wit:

1. That the names and addresses of the pub-

Get Your Copy of the Big
SYLVANIA

Tube Fact Book

272 Pages of Vital
Tube Information
Including
Operating Conditions
Tube Characteristics and
Circuit Applications on
374 Tube Types

USE THIS COUPON TODAY

SYLVANIA

Set-Tested Radio Tubes

Actual Size 4 1/2" by 9 1/4"
—272 fact-filled pages



HYGRADE SYLVANIA CORP.
Emporium, Pa. RC120

Enclosed is 35c. Please send me a copy of the latest edition of the Sylvania Technical Manual.

Name

Address

City State

Serviceman Experimenter
 Dealer Amateur

lisher, editor, managing editor, and business managers are: Publisher, Radcraft Publications, Inc., 20 Vesey St., New York, N. Y.; Editor, H. Gernsback, 20 Vesey St., New York, N. Y.; Managing Editor, R. D. Washburne, 20 Vesey St., New York, N. Y.; Business Managers, none.

2. That the owner is: (If owned by a corporation, its name and address must be stated and also immediately thereunder the names and addresses of stockholders owning or holding one per cent or more of total amount of stock. If not owned by a corporation, the names and addresses of the individual owners must be given. If owned by a firm, company, or other unincorporated concern, its name and address, as well as those of each individual member, must be given.) Radcraft Publications, Inc., 20 Vesey St., New York, N. Y.; H. Gernsback, 20 Vesey St., New York, N. Y.

3. That the known bondholders, mortgagees, and other security holders owning or holding 1 per cent or more of total amount of bonds, mortgages, or other securities are: (if there are none, so state.) None.

4. That the two paragraphs next above, giving the names of the owners, stockholders, and security holders, if any, contain not only the list of stockholders and security holders as they appear upon the books of the company but also, in cases where the stockholder or security holder appears upon the books of the company as trustee or in any other fiduciary relation, the name of the person or corporation for whom such trustee is acting, is given; also that the said two paragraphs contain statements embracing affiant's full knowledge and belief as to the circumstances and conditions under which stockholders and security holders who do not appear upon the books of the company as trustees, hold stock and securities in a capacity other than that of a bona fide owner; and this affiant has no reason to believe that any other person, association, or corporation has any interest direct or indirect in the said stock, bonds, or other securities than as so stated by him.

5. That the average number of copies of each issue of this publication sold or distributed, through the mails or otherwise, to paid subscribers during the twelve months preceding the date shown above is..... (This information is required from daily publications only.)

H. GERNSBACK, Publisher.

Sworn to and subscribed before me this 26th day of Sept., 1940.

MAURICE COYNE, Notary Public.
Notary Public, N. Y. Co. No. 104

(My commission expires March 30, 1942.)

TELEVISION & SHORT WAVE HAND BOOK

Just Out! Tells you all you need to know about these important subjects. Up-to-the-minute, hundreds of illustrations—diagrams. Over 35 chapters. 300 pages. Gives many Hints and Helps on Television and Short-Wave. Needed by every amateur or professional radioman. Useful to Army or Navy men. **SEND NO MONEY!** Just mail coupon, pay postman \$1 plus few cents postage, pay balance \$1.50 in 30 days or pay postman in full and receive an American Pocket Lighter (Value \$1) absolutely free. Money back within 5 days if not okay.



FORTUNY'S PUBLISHERS, INC.
87 Fifth Ave., N. Y.

Mail "Television & Short-Wave Handbook." Price \$2.50 plus few cents postage. I will pay postman in full \$1 plus postage. Balance within 30 days.

Name

Address R.C.

FILMGRAPH
VOICE AND MUSIC RECORDINGS

Lengthy or continuous recordings now possible with newly patented "FILMGRAPH". Over 13 hours of indexed voice, radio, code, telephone recording on a single 500 ft. reel of film costing \$3.00 and up. No other expense. INSTANTANEOUS and PERMANENT play-back. Can easily be synchronized with Motion pictures. Bulletins free.

MILES REPRODUCER CO., INC. Dept. RGB,
812 Broadway, New York City

SOLAR RED-CAPS

Smaller Diameter Dry Electrolytics

SPEED Servicing
Write for Catalog



SOLAR MFG. CORP. Bayonne, New Jersey

BUILDING A MODERN MINIATURE-TUBE METAL-TREASURE LOCATOR

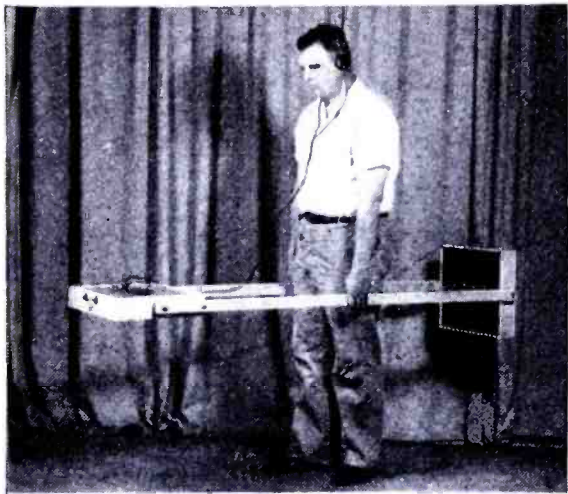

The author of this article tells how economy in operation, weight and bulk may be achieved in a sensitive metal locator by utilizing the new miniature-type battery tubes. Complete construction details are included.

G. M. BETTIS

In the group of photos the view at top shows the completed "Treasure" (Metal) Finder in use. Immediately underneath are the interior and exterior views, left to right, respectively, of the Transmitter unit. The 2 remaining photos show the exterior and interior, left to right, respectively, of the "Treasure" Locator.

Use of standard, reliable radio parts that can be purchased from most jobbers.

OPERATION

The *Transmitter* is attached to the 2 handles in the vertical position and the *Receiver* in the horizontal position with the operator wearing the phones and watching the meter.

The *Receiver* is tuned to the neutral part of the transmitter field, which is approximately at right-angles, by adjustment of the *Transmitter* by means of the turn-buckle. This is easy to do when the instrument has been properly built. The presence of metal in the *Transmitter* field will cause the receiver to be out-of-balance and a loud signal will be heard in the phones; at the same time a deflection will be noticed in the meter.

When making tests it should be well to know that pipe lines buried for some time will give a better indication than new lines on top of the ground. *The actual surface area of an object, and not the weight, is what governs the sensitivity.*

The closer together are the *Transmitter* and *Receiver*, the less power can be used in the *Transmitter* because no balance can be obtained, but the instrument then will detect smaller objects at a shallow depth; on the other hand increasing the power, and the distance between *Receiver* and *Transmitter*, will make it possible to locate larger objects at greater depths.

Increasing the frequency at which the instrument operates, beyond that specified in the following description, increases the sensitivity of the unit but at the same time reduces its depth of penetration; also the harder and more critical is the instrument to construct and operate satisfactorily.

CONSTRUCTION

You cannot take a pair of pliers, screw-driver, soldering iron, and pocket knife, to build an instrument of this sort, and expect it to work when you turn the switch on. The following detailed steps may seem amateurish but it will be well worth your time to follow most of them.

First consideration is the construction of the *Transmitter* and *Receiver* chassis and loops the details of which are shown in Figs. 1 to 7. The loop frame is made of white pine and glued together with blocks A and B (also glued in place). Two coats of orange shellac are applied and allowed to thoroughly dry between coats. The chassis shown in Figs. 5, 6, and 7 are made of tempered Masonite and held in place with small brass screws.

The detail drawings of Figs. 8 and 9 show the *Transmitter* and *Receiver* cases which are made of white pine with front panels and sliding doors of tempered Masonite. The inside of the *Receiver's* front panel is covered with a piece of aluminum foil glued-on for shielding purposes and grounded to "A—."

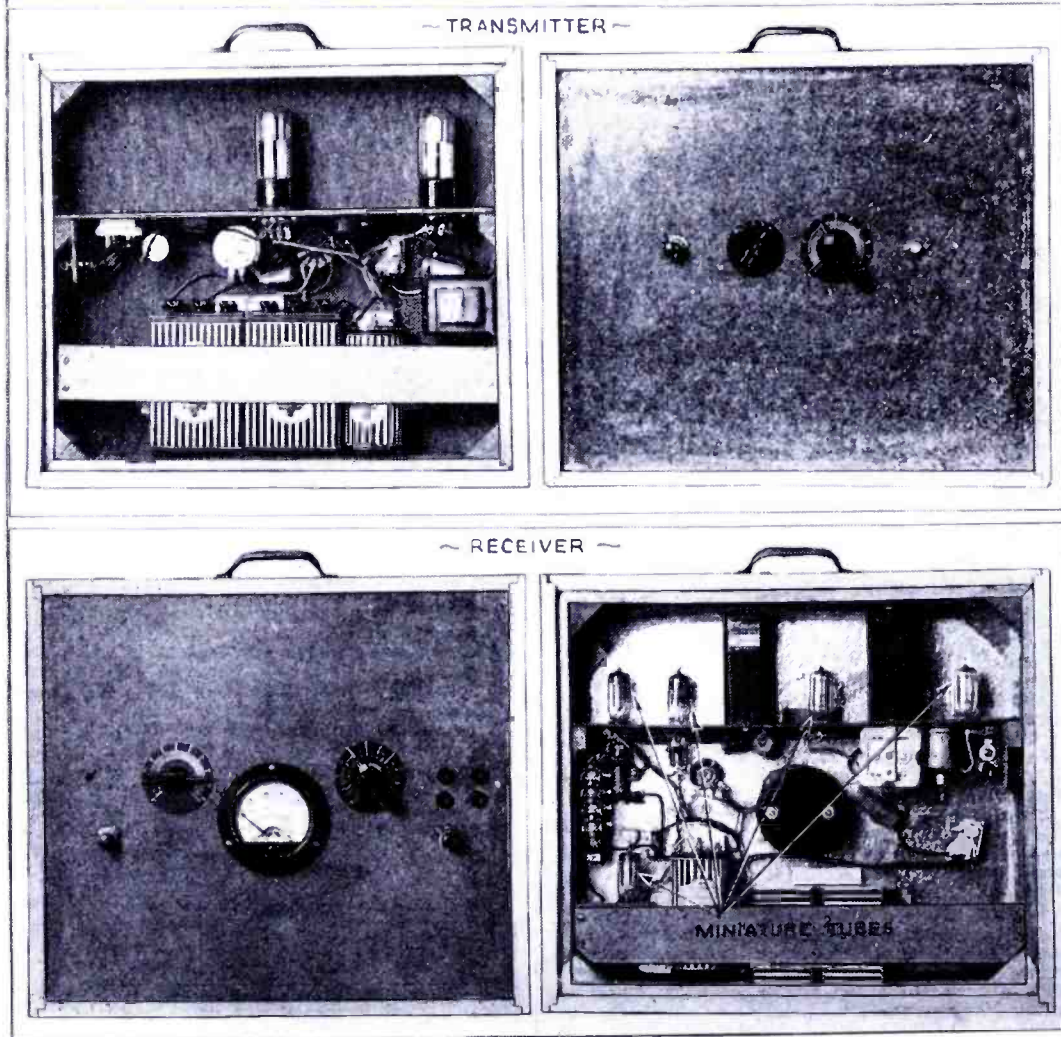

METAL locators—so-called "treasure" finders—have been built and experimented with often but the one described here is of the *radio balance* type and is extremely flexible as there are several variable controls that make it possible for one to get the most from the instrument without rebuilding for a few small changes. These variable controls are not gadgets but are useful for proper and precise adjustment which is necessary for successful operation.

FEATURES

The features of this locator are:

Use of the well-proven radio balance;
Practical use of the RCA Miniature tubes that are designed to operate on a 1.5 volt "A" cell and maximum of 45 volts "B" bat-

tery, and thereby achieving greater efficiency in a portable instrument;

Use, in the *Receiver*, of a 1T4 tuned-radio-frequency stage, 1S5 diode detector and pentode A.F. voltage amplifier, 1S4 pentode power amplifier, and 1T4 vacuum-tube meter indicator;

Use of a sensitive 100-microampere meter in the visual indicator;

Amplitude modulation of the transmitter inasmuch as the more common self-modulated oscillator cuts down the output of the transmitted radio-frequency signal;

Use of a 1G6G push-pull R.F. oscillator modulated with another 1G6G A.F. oscillator;

Use of portable lightweight batteries that give good results and reasonable length of service;

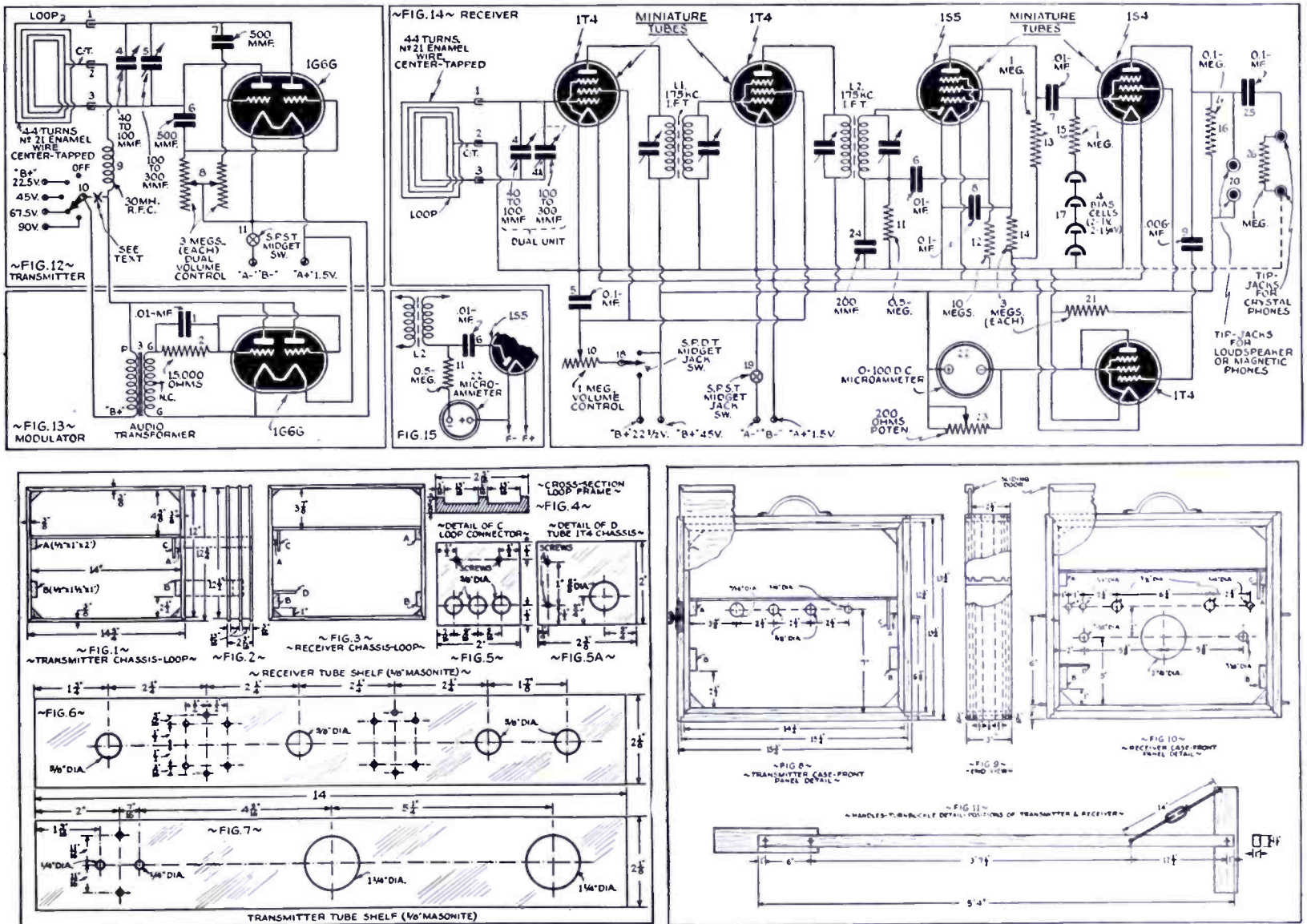

Two strips of Masonite 1½ x 14 ins. are also made to fasten to blocks B to hold the batteries in place. A few white pine blocks are glued to the front panels at top and sides of the batteries to keep the batteries firmly in place.

The Transmitter and Receiver chassis loops, fit snugly inside the cases as shown, and are held there by brass screws which extend through the center portion of the loop frame. The holes shown are for the standard parts specified in the accompanying List of Parts.

The handles and positions of the Transmitter and Receiver are shown in Fig. 11, as well as the small turnbuckle that will be used to tune to a perfect balance, and to keep the apparatus anchored firmly when in use. The detail of the 3/16- x 2-in. bolts held in place with nuts for attaching to handles is shown in Fig. 8. The hole centers are shown in Figs. 8 and 10 for other bolts. Additional holes every 6 ins. can be made in handles for bringing the Receiver closer to the Transmitter for operation on lower power. The Locator will operate much more efficiently when held as close to the ground as possible. Therefore it is suggested that in some cases it may be desirable to sling the Locator from the shoulders by straps, or cords with shoulder pads or hand grips.

The woodwork can be done in a home workshop or by a local cabinet shop. The work shown was built in the writer's workshop while waiting for the components he had to get by mail order.

The loops are wound with 22 turns of No. 21 enamel wire in each groove, on the outside of the loop frame, making a total of 44 turns per loop. The loop frame was

first covered with a layer of No. 912B ribbon. The loops are all wound in the same direction and soldered to the sockets that are mounted in C as shown in Fig. 5.

TRANSMITTER

Now start construction of the Transmitter by mounting switch 11 in a 7/16-in. hole in the panel; switch 10 in its 3/8-in. hole; next, control 8; then, condenser 4 so it can be adjusted through the 1/4-in. hole; and finally, the sockets and condenser 5.

The Transmitter is wired, as shown in Fig. 12, by connecting the dotted line at X and omitting the connections to the modulator. The batteries are then wired-up and the unit turned on with control 8 advanced most of the way. Place the Transmitter close to a broadcast receiver set on 700 kc., then adjust condensers 4 and 5 as well as control 8 so a signal will be heard over the radio set.

Remove the tube from the Transmitter and wire-up the modulator, as in Fig. 13, and disconnect the wire at X. Put a pair of headphones in series with the "B+" lead to the A.F. transformer and, with tube and batteries in place, a good signal should be heard in the phones. It may be necessary to reverse the grid and grid-return leads of the A.F. transformer to obtain a signal in the phones. Now remove the phones from the "B+" lead and substitute for the phones a 0-15 ma. D.C. milliammeter, and with the tube replaced in the transmitter and modulator control 8 properly adjusted, that should be from 2.5 to 4 ma. drain, using a 90-V. "B" supply, a good signal on about 700 kc. is fed to the broadcast receiver. With all the bugs out of the Transmitter proceed to the Receiver.

RECEIVER

Mount the phone-tips (being careful to see they do not short to the aluminum foil inside the panel), control 10, control 23, condenser 4 (so it can be adjusted through the 1/4-in. hole), switch 18, and switch 19 (on front panel of Receiver case). Then mount the sockets and transformers, and wire-up all but the meter and control 23 as shown in Fig. 14. In place of resistor 11 put a 100,000-ohm resistor with the positive meter connection to "F—" and the negative meter connection to a 100,000-ohm resistor as shown in Fig. 15.

With the 1T4 tube removed, that connects to the meter shown in Fig. 14, turn-on the Receiver after all connections to the Miniature tubes have been carefully checked as the connections vary and serious damage will result to tubes not properly connected or in their right sockets. There should be no reading on the meter until the Transmitter is brought close to the Receiver. When the Receiver is properly lined up with Transmitter readings should be obtained as given in Table I. Condensers 4 and 4A, and transformers 16-5981 and 16-5730, are to be adjusted for maximum meter reading. In Table I are shown not only 4 series of tests, but also several others that may be made, and it is well worth while to make them and record the results for future reference while the Receiver is connected in this manner.

TABLE I

Transmitter		Receiver	
"B"		Cont. Meter	
Sw. 10	Cont. 8 Ma.	Sw. 18	10 22
Series 1	22.5 3.8 .5	22.5	10 10
	45 3.8 1.5	22.5	10 34

STEP UP YOUR SHOP PROFITS with Atlas EQUIPMENT



EASY TO OPERATE

It's easy to turn out your own machine work on an Atlas Lathe—and make for yourself the profits you now have to pay others.

Radio Servicemen in all sections find that the Atlas Lathe makes quick work of dial shafts and drums, knobs, special screws and studs; service tools, microphones, special dies and molds. Operating instructions show correct gear set-ups for winding R.F., choke, and short wave coils, transformers.

Send Coupon for FREE 1941 Catalog

See the many operations you can do in your own shop with Atlas Equipment. Send the coupon below today for full details.

Atlas

LATHES • DRILL PRESSES • ARBOR PRESSES
METAL SHAPERS • VISES • CIRCULAR SAWS

ATLAS PRESS CO.
1245 N. Pitcher St., Kalamazoo, Mich.

Please send me your 1941 Catalog on 6" Metal Lathes 10" Metal Lathes New Milling Machine 7" Metal Shaper Drill Presses Arbor Presses.

Name

Address

City and State

GOLDENTONE .. 50% OFF

DEAL DIRECT FACTORY PRICES — Over 60 models to choose from—4 to 12 tubes. Portables \$8.08 up. Farm sets \$8.08 up. Car sets \$8.08 up. Foreign band sets \$8.08 up. Samples 50% off. Quantity discounts. Free 1941 Bar-kain catalog gives details of 10-day FREE trial, agent's proposition and discounts. Mail postcard. GOLDENTONE RADIO CO., DEPT. RC, OEARBORN, MICH.

Free Catalog

NO DRY TRIAL **4.95** **READY TO PLAY**

YEAR GUARANTEE

CANADIAN SERVICEMEN

can now purchase SUPERIOR Test Equipment direct from Radio Parts Supply Co., 962 Bleury St., Montreal Canada. They stock our complete line. See pages 341, 343, 345 in this issue.

SUPERIOR INSTRUMENTS CO.

	67.5	3.8	2.7	22.5	10	36
	90	3.8	4.0	22.5	10	38
Series 2	22.5	3.8	.5	22.5	8	2
	45	3.8	1.5	22.5	8	23
	67.5	3.8	2.7	22.5	8	24
	90	3.8	4.0	22.5	8	25
Series 3	22.5	4.8	.5	45	9	7
	45	4.8	1.2	45	7	20
	67.5	4.8	1.6	45	5.2	20
	90	4.8	2.5	45	5	20
Series 4	22.5	4.8	.5	45	10	12
	45	4.8	1.2	45	10	35
	67.5	4.8	1.6	45	10	36
	90	4.8	2.5	45	10	38

After obtaining proper results in these tests disconnect the 100,000-ohm resistor and complete the Receiver and meter wiring exactly as shown in Fig. 14. Be sure that meter shunt 23 in the Receiver is adjusted so that there will be no reading when the Receiver is turned on, then you can adjust control 23 so there will be practically full-scale reading.

The Transmitter will cause a strong deflection in the meter reading when brought close to the Receiver but when balanced at approximately right-angles the reading will rise to full-scale.

The Receiver and Transmitter are now ready for attachment to the handles and careful adjustment of the turnbuckle will cause the meter to read full-scale; at the same time there will be no signal in the phones. Now, when passing over metal, a strong signal in the phones and a deflection in the meter reading will be produced.

SENSITIVITY

The Locator when assembled and tuned should be adjusted so that there will be a slight deflection, in the meter reading, from the peak that it is possible to tune to. In other words, slightly to one side of the maximum null spot heard in phones, and slightly below the peak reading on the meter. One of the 2 positions in which these indications can be obtained is much better than the other.

The writer has tested the Locator on a ½-in. water line that was known to be buried 21 ft. A deflection from 95 to 10 on the meter scale (which is from 0 to 100) was obtained. On a 4-in. water line buried 4½ feet the meter deflection was from 95 to 15; and, when tested over a 12-in. line buried 11 ft. and which did not carry anything, a deflection from 95 to 50 on the meter was secured. A loud signal also was produced in the phones on all these tests.

These results were obtained with the Transmitter and Receiver at the outside holes in the handles as shown in Fig. 11. When the Receiver was brought closer to the Transmitter (by assembling in one of 3 holes made 6 ins. apart in each handle, in addition to the ones shown in Fig. 11) the instrument was made more sensitive to smaller objects. The assembly and operation of the Locator therefore will be governed by the object that is to be searched-for in regard to its distance and dimensions.

List of Parts

TRANSMITTER

- One Amphenol No. 78-1M socket 70-1M plug black, 1;
- One Amphenol No. 78-1M socket 70-1M plug red, 2;
- One Amphenol No. 78-1M socket, 70-1M plug green, 3;

CONDENSERS

- One Meissner "Alignaire" No. 22-5200, 40-100 mmf., 4;

- One Meissner dual No. 22-5293, 100-300 mmf., 5;
- Two Mallory type TP 403, 500 mmf., 6, 7;

MISCELLANEOUS

- One Mallory dual control, type DRP 232, 3 megs., 8;
- One Mallory dial plate, No. 397;
- One Mallory knob, No. 365;
- One Mallory S.P.S.T. midget switch, No. 10, 11;
- One RCA type 1G6G tube;
- One Amphenol "Super-Mip" socket, No. 54-8;
- Two Burgess portable batteries, No. Z30NX, 45 V.;
- One Burgess portable drycell, No. 44, 1.5 V.;

MODULATOR

- One Mallory condenser, type TP 410, 0.01-mf., 1;
- One I.R.C. resistor, type BT½, 15,000 ohms 2;
- One audio-frequency transformer for type 30 to 19 tube (class-B driver);
- One RCA type 1G6G tube;
- One Amphenol type RS8 socket;

RECEIVER

- One Amphenol No. 78-1M socket 70-1M plug, red, 2;
- One Amphenol No. 78-1M socket 70-1M plug, green, 3;

CONDENSERS

- One Meissner "Alignaire" No. 22-5200, 40-100 mmf., 4;
- One Meissner dual No. 22-5293, 100-300 mmf., 4A;
- Two Mallory type TP 418, 0.1-mf., 5, 8;
- Two Mallory type TP 410, 0.01-mf., 6, 7;
- One Mallory type TP409, 0.006-mf., 9;
- One Mallory mica, 200 mmf., 24;

RESISTORS

- One I.R.C., type BT½, 0.5-meg., 11;
- One I.R.C., type BT½, 10 megs., 12;
- Two I.R.C., type BT½, 1 meg., 13, 15;
- Two I.R.C., type BT½, 3 megs., 14, 21;
- One I.R.C., type BT½, 0.1-meg., 16;

MISCELLANEOUS

- One Mallory-Yaxley control, No. Y-1000M-P, 1 meg., 10;
- One Mallory dial plate, No. 397;
- One Mallory knob, No. 365;
- One Mallory type GB14 holder, 4 bias cells, 17;
- Two Mallory cells, 1 V.;
- Two Mallory cells, 1½ V.;
- One Mallory S.P.D.T. midget jack switch, No. 11, 18;
- One Mallory S.P.S.T. midget jack switch, No. 10, 19;
- Two Mallory tip-jacks, No. 521, 20;
- One Hickok 0-100 microampere D.C., meter, No. 46, 22;
- One Mallory-Yaxley 200-ohm control, No. C200P, 23;
- One Mallory dial plate, No. 393;
- One Mallory knob, No. 365;
- Three RCA type 1T4 miniature tubes;
- One RCA type 1S5 miniature tube;
- One RCA type 1S4 miniature tube;
- Three Amphenol sockets, No. 54-7P;
- Two Amphenol sockets, No. 78-7P;
- One Amphenol ribbon, No. 65-001 912B;
- One Amphenol bottle liquid, No. 912, 53-4;
- One lb. No. 21 enameled copper wire;
- One Meissner ferrocort I.F., interstage, No. 16-5981, 175 kc.;
- One Meissner ferrocort I.F., output, No. 16-5730, 175 kc.;
- One Burgess portable battery, type Z30NX, 45 V.;
- One Burgess portable drycell, No. 44, 1.5 V.

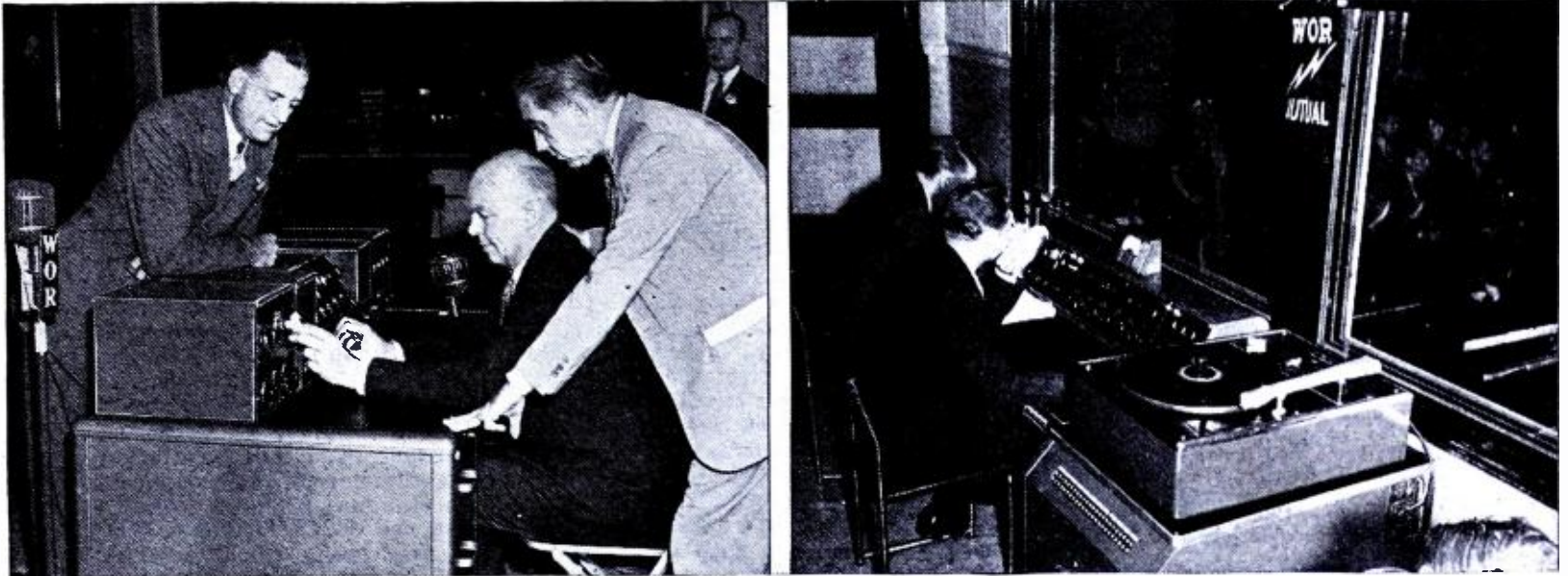

Above, Major Edwin H. Armstrong at the control panel of W2XOR, atop 444 Madison Ave., during the 1/2-hour dedicatory air-premiere program of this wide-band Frequency Modulation station. At left, J. R. Popple, WOR's chief

engineer; and right, Alfred J. McCosker, WOR's president. The photo at right shows engineers monitoring an F.M. broadcast in WOR's "Studio One" at 1440 Broadway.

STATION WOR GETS F.M. VOICE

NEW YORK CITY got its first full-time wide-band Frequency Modulation radio transmitting station last month when WOR started regular daily program service over W2XOR from the 42nd floor of 444 Madison Ave. At this elevation (about 630 ft. above sea level) the radius-range is about 48 miles.

The new super-fidelity, staticless transmitting station, the first of its kind in the city, was officially dedicated when Major Edwin H. Armstrong, inventor of the wide-band system of F.M. broadcasting employed in this station, threw the key that put the station on the air.

W2XOR will operate on a daily schedule from 9 A.M. to midnight with programs originating from WOR's New York studios at 1440 Broadway, from Newark (N.J.), and

from the Mutual Playhouse in N.Y.C. Operating on a frequency of 43.4 megacycles (43,400 kc.) the station will originate 2 hours of programs of its own apart from those of its mother station, WOR.

The 1,000-watt synchronized transmitter of the station is the latest product of Western Electric laboratories and incorporates several innovations in frequency modulation design that result in less distortion, less dial drift and easier tuning for F.M. listeners; a new type of circuit and temperature-controlled crystals give it the unusually efficient frequency stability of 0.0025%. The transmitter and studio equipment is designed for a fidelity range of 30 to 15,000 cycles.

A unique feature of the new F.M. station, is that it is equipped for frequency modulation *all the way*, with special equipment

including a new "egg" microphone in the studio (see photo at upper-left); also, high-fidelity broadcast lines that connect studio and transmitter are corrected for a frequency range of 20 to 20,000 cycles.

The vertical coaxial antenna on the roof stands 75 ft. above the roof. Two auxiliary 40-ft. antennas on the roof are for emergency use with the F.M. transmitter, for facsimile, and high-frequency shortwave relay broadcasting.

The transmitter room at 444 Madison Avenue is also a research laboratory and will be equipped with a workshop and measuring apparatus, so that research and experimentation can be carried on at all times.

Application is pending for permission to operate a 100-watt RCA auxiliary F.M. transmitter.

Present Status of

F. M.

Broadcasting

DICK DORRANCE

THE progress of Frequency Modulation ("F.M.") as with anything that is new and not fully understood—has given rise to a number of common fallacies, widely spread by omnipresent pseudo-experts who do not grasp the picture quite so fully as they believe they do.

Many of these fallacies deal with the capabilities and limitations of F.M.; others seek to anticipate public reaction. Most of them are sheer conversation pieces. All of them bear refutation, in light of the remarkable growth that has attended the new noise-free, full-fidelity method of radio broadcasting during recent months.

Here, for example, are a few representative misconceptions about F.M. that have gained erratic circulation.

(1) *F.M. stations can't be heard more than 50 miles from the trans-*

mitter. Therefore they can't begin to service as great an area as the regular amplitude stations. It will take many, many more stations to cover as great a territory as that reached by the major standard stations today.

This is a common example of misinformation. The coverage area of an F.M. station is based on a combination of 3 factors:

- (a) The height of the antenna above the surrounding countryside;
- (b) The power used at the transmitter; and,
- (c) The type of antenna employed.

Service ranges of 100 to 125 miles from the transmitter are quite possible, and many of the applications now pending before the Federal Communications Commission will be for such service areas. The range of an F.M. station is the same by day and night—an unvarying, unfading signal of remarkable clarity. Very few 50,000-watt stations of the ordinary type reach a greater area with consistency during daytime hours. The night-time coverage is greater, of course, but marred by fading, static and cross-interference beyond the primary coverage area.

(2) *F.M. networks are impossible with the use of telephone wires because these wires won't carry the high-fidelity*

notes that F.M. demands for full-natural quality. Therefore the use of radio-relay—small transmitters placed at intervals across the country to carry programs from network station to network station—is the only answer. This would be very expensive and there is no proof that it might be satisfactory for a coast-to-coast hook-up.

Wrong again. Telephone wires can carry the 30-to-15,000 cycle range of tone demanded by F.M. stations. They can carry even much higher ranges. Such telephone lines do not exist widely at present because there is no great demand for them. But the phone companies stand ready to supply this superior service when the demand is strong enough to warrant the installation of such new facilities.

The development of F.M. networks on a nationwide scale, co-operatively run, is expected to start within another year or two. By that time the telephone companies will probably have the new, full-range wires ready for use.

(3) *The public has a "tin ear." The public can't tell a high note from a medium one. Furthermore, the average hearing doesn't register above 10,000 cycles, so why bother with a lot of fancy equipment to bring in notes as high as*

RADIO DEVELOPMENTS.



Are you "pinned down" into a routine radio job? The lack of technical training is the stumbling block that keeps the average radioman from getting a better job or even holding his present job. But you CAN do something about it—if you will! Your radio experience backed by technical training will equip you for the good-paying jobs that await trained men. CREI home study courses in Practical Radio and Television Engineering are prepared for experienced radiomen who realize not only the value—but the necessity of CREI training if they are to make good in the important jobs where trained men are always in demand.

Write for FREE Book — "A Tested Plan"

To enable us to send you complete information, please state briefly your background, education and present position—and whether you are interested in home-study or residence training.



CAPITOL RADIO Engineering Institute

Dept. RC-12, 3224 16th Street, N. W., Washington, D. C.



ELEMENTARY MATHEMATICS

EASY — SIMPLIFIED — PRACTICAL

HERE is a book for the business man, the technician and craftsman explaining and answering every operation and meaning with interpreting illustrations and examples. It is the key to a simple understanding of many perplexing problems in daily life. In clear, positive and definite language, the author popularizes and clarifies every subject and helps the reader to overcome any apparent difficulty in the study of mathematics. A real home study-course in mathematics for the student or the man who wants to achieve proficiency or desires to brush-up on his knowledge. Entire Chapter on Special Mathematics for the Radio Technician

CONTENTS OF BOOK

- CHAPTER I. Arithmetic—Addition—Subtraction—Multiplication—Division
- CHAPTER II. Factoring and Cancellation—Fractions—Decimals—Percentage—Ratio—and Proportion.
- CHAPTER III. The Metric System.
- CHAPTER IV. How to Measure Surfaces and Capacity (Geometry).
- CHAPTER V. Powers and Involution—Roots and Evolution.
- CHAPTER VI. Mathematics for the Manual and Technical Craftsman—Thermometer conversions—Graphs or Curve Plotting—Logarithms—Use of the Slide Rule.
- CHAPTER VII. Special Mathematics for the Radio Technician.
- CHAPTER VIII. Commercial Calculations—Interests—Discounts—Short Cut Arithmetic.
- CHAPTER IX. Weights and Measures—Useful Tables.

ONLY 50c POSTPAID

"Elementary Mathematics" can be carried readily in your pocket. Send Stamps, Cash or Money Order.

TECHNIFAX

1917 S. State St. RC-1240 Chicago, Ill.

WILL BUY FOR CASH

OLD POSTAGE STAMPS AND COMPLETE COLLECTIONS

Thousands of dollars lying idle in old postage stamps and collections! Dig yours out and sell at today's top prices. Especially interested in old United States stamps (used or unused) and later issues up to 1930. Write for references, or send stamps for prompt appraisal and offer.

HARRY P. BRIDGE

1324 Walnut St. Philadelphia, Pa.

Get An Electric Dry Shaver ABSOLUTELY FREE!

See Page 382

15,000 cycles? "High fidelity" doesn't mean anything, because the average A.M. set today can't reproduce notes above 5,000 cycles anyway.

This let-well-enough-alone attitude is a poor argument. The public has a so-called "tin ear" only in that it has never known what natural, full-fidelity radio can sound like. Experience shows that average listeners, after hearing F.M. for a period of a few days, are acutely aware of a flatness in standard broadcast reception when they return from F.M. to A.M.

The fact that the average hearing does not go above 10,000 cycles is no indication that the ear does not catch and appreciate the many overtones created in this airy region of the sound spectrum. It is here that the illusion of color, depth, extreme naturalness is created. It is further heightened by the fact that F.M. has no "carrier noise." There is no rushing sound when voices or music are not present on the wave, as in standard broadcasting. F.M. is completely silent. The faintest innuendoes of tone are not muffled in this everpresent background rush.

(4) It's proof, say the F.M. scoffers, that the public doesn't want or appreciate high-fidelity, since surveys show so many listeners leave their tone controls on the "bass" position. This cuts out the treble notes that occur up around 8,000 cycles and above.

Actually it proves nothing of the kind. It merely shows that the average listener is instinctively aware of the background rush in amplitude or "A.M." broadcasting which becomes definitely prominent with the tone control at "treble." By reducing the tone control to "bass" all the highs, badly distorted through the rushing background, are eliminated and the listener has a nearer (albeit lopsided) approximation of the real, natural thing. True "high-fidelity" does not place any emphasis on either bass or treble. High-fidelity reproduces precisely what the microphone hears, with the same proportion of highs and lows.

(5) Why buy a new F.M. receiver when all the best programs are still on the regular stations? How can anyone expect the average radio listener to have 2 complete receivers in his living room? There are 45,000,000 receivers in this country. Why should they become obsolete overnight?

Nobody wants them to. There are now 14 companies manufacturing the new F.M. receivers for marketing during the next few months. But—in almost every case—the new F.M. sets also have a band-switch that can turn instantly to standard broadcasts, thus giving you a choice of the old or the new.

In addition, a number of manufacturers are making "adaptors" or "translators" that may be used in conjunction with a standard set to receive F.M. programs. Their use, however, is only recommended with sets that have superior tone—since the F.M. full-fidelity qualities may be easily destroyed by a poor loudspeaker.

America's 45,000,000 radio sets will not be obsolesced overnight. As the public buys new sets, it will be urged to purchase combination A.M.-F.M. receivers. The process therefore will be one of normal absorption over a period of years.

(6) F.M. is quite beyond the range of the average pocketbook. F.M. sets will always be much more expensive than the regular type of receiver.

F.M. sets today are not produced in mass quantities. Consequently their "per unit" cost is greater. Basically there is no important difference between the components used in an F.M. receiver and those of a standard receiver, except that F.M. de-

mands a better loudspeaker and better-quality parts in the audio-frequency section of the set.

F.M. receivers today start at \$70, run up as high as you care to pay for a fancy cabinet and allied gadgets (such as phonograph, automatic record-changer, short-wave bands, etc.). The new adaptors will sell for less than \$50. As the public purchases larger numbers of F.M. sets, the price will naturally tend to decrease.

(7) Even if you do purchase an F.M. receiver, there are no programs of interest on the air. Most of the F.M. stations will just relay programs of regular stations so that, from an entertainment angle, there's not much sense in getting an F.M. receiver.

On January 1, 1941 the new F.M. broadcast band will be opened to full F.M. commercial operation on a par with standard broadcasting.

The new F.M. stations realize strongly that they must provide a different program schedule, to a good degree, from that heard over the regular stations. Many of them are already offering a daily schedule that duplicates only the most popular and important broadcasts. The new regulations issued by the Federal Communications Commission require a minimum of 6 hours' operation daily—3 in daylight hours, 3 at night—with at least 1 hour in each period devoted to special F.M. programming. Almost all of the new stations, however, will operate much longer than 6 hours daily, originate far more than merely 2 hours of F.M. shows a day.

Many of the new stations will have no connection with existing broadcasters; their programs, therefore, will naturally have to be special originations. Purchase of a combination F.M.-A.M. receiver is tantamount to opening up a whole new world of radio listening enjoyment . . . clearer, more natural, quieter than radio has ever been before.

This is the Frequency Modulation side of the story as presented by F.M. Broadcasters, Inc., the official "voice" of all F.M. broadcasters, or at least, those which operate on the Armstrong "wide-band" F.M. system. What do the A.M. boys have to say in defense of present and future amplitude modulation broadcasting?—Editor

TEST INSTRUMENTS ON TUBE DEALS

National Union announces that during the months of October and November they have special arrangements where dealers can secure Triplett instruments for a very small deposit. Jobbers have complete details.

SAYS "W.W.":

"We don't know why the Axis thinks it can scare Americans . . . Who do they think they are—Orson Welles?"—(From Walter Winchell's "On Broadway" in a recent issue of the N. Y. Mirror.)

"SOUND ENGINEERING—No. 11"

The diagram at right shows the proper circuit for the grid-return of the type 56 tube in diagram Fig. 2, pg. 278, of the Nov., 1940, issue of Radio-Craft. This circuit appears in the department, "Sound Engineering—No. 11." Note also that the input jack reading "carbon" microphone, in this figure, should read "crystal."

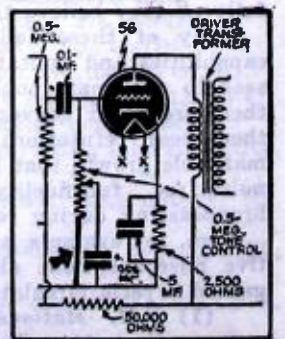

FUSE HOLDER

Alden Products Co.
Brockton, Mass.

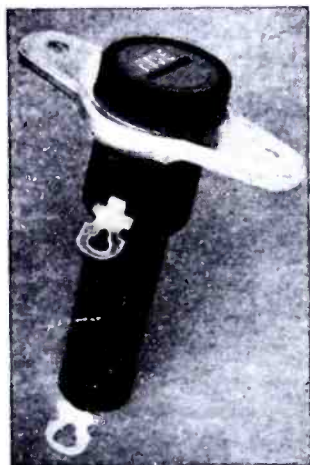

MOUNTS by means of rivets or screws to the panel and therefore cannot work loose. The contacts at the far end of the holder have an internal spring which ejects the fuse even though the glass may have been broken. Slotted-top type (illustrated) is removable with screwdriver; knurled-top, with fingers.—Radio-Craft

POWER LINE FILTER

Belden Mfg. Co.
4689 W. Van Buren St., Chicago, Ill.

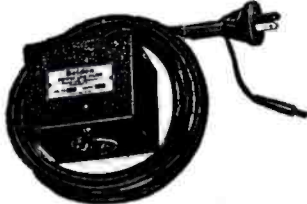

KNOWN as No. 8100 this new unit is designed to eliminate power line interference. Contains 2 dual condenser sections and 2 dual high-Q choke coils, which it is claimed eliminates man-made static in the power lines for both broadcast and shortwave bands.—Radio-Craft

BLOWER SYSTEM FOR RECORDINGS

Presto Recording Corp.
242 West 55 St., New York, N. Y.

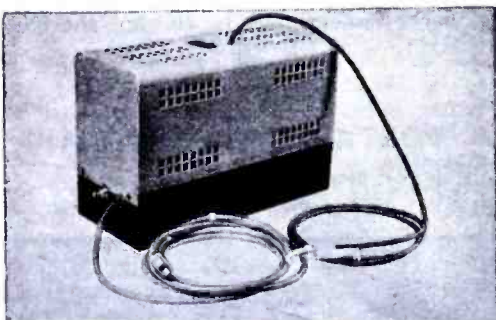

MODEL 400-A blower system eliminates 1 of the commonest hazards of instantaneous recording. It directs a tiny blast of air across the surface of the disc just behind the cutting head, throwing the waste thread to the center of the disc. The intense airstream removes lint or grit from

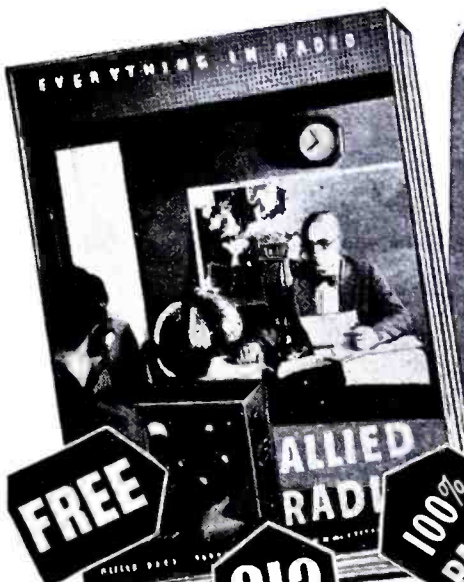

FREE **212 PAGES** **100% RADIO**

RADIO'S GREATEST CATALOG
FOR SERVICEMEN, DEALERS, SOUNDMEN, AMATEURS

If you're in Radio, you can't afford to be without the new 1941 ALLIED Radio Catalog! It's the biggest ever—212 value-packed pages—and the best ever. Shows everything in Radio. Send for your copy now.



New! Radio Dictionary! Just out—compiled by leading authorities. Gives easy-to-understand definitions of all commonly-used radio terms. **Biggest dime's worth in Radio.** Order by **10c** coupon below

15,000 PARTS



• Radio's most complete Catalog—with everything for everyone in Radio. Don't miss the special Builders' and Experimenters' section and the complete Amateur selection of communications sets, etc.

ALLIED RADIO
CHICAGO, ILLINOIS

the surface of the disc just before it passes under the cutting needle. Blower operates quietly and can be used in the same room as the microphone if necessary.—Radio-Craft

6 - 110 V. MOBILE AMPLIFIER

Erwood Sound Equipment Co.
224 W. Huron St., Chicago, Ill.

CHANGING power cables is all that is necessary to change from 6-V. battery operation to 110 V., A.C. The amplifier is a completely self-contained unit of portable construction with facilities for use with 2 microphones. Has a built-in playing mechanism. Its variable output impedance accommodates a variety of speaker installations.—Radio-Craft

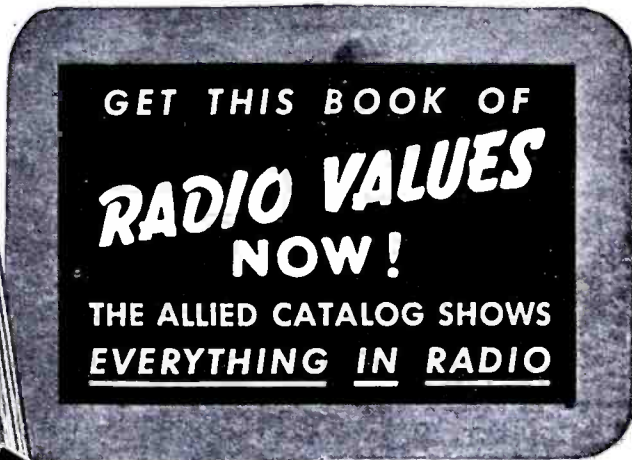

GET THIS BOOK OF
RADIO VALUES NOW!
THE ALLIED CATALOG SHOWS
EVERYTHING IN RADIO



83 NEW MODELS

• 1941 Radio Hits! New style plastic and wood table models; world-wide sets; "Camera" and 3-way Portables; Phono-Radio-Recorders, Combinations, Auto Sets, etc.—all at amazingly low prices—in a big special 40-page radio set section!



NEW P.A. SYSTEMS

• 1941 P.A. design—for every Sound application. 24 new Systems—7 to 75 watts—new features throughout! Lowest prices! Attractive Time Payment Plan and 15 Day Trial Offer. Complete P.A. accessory line—big special 35-page section!

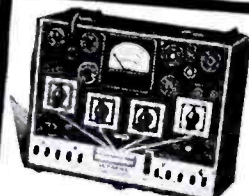

BIG SERVICE SECTION

• More than 120 pages, all value-packed—devoted to new Test Equipment, tools, Service books, etc. More than 15,000 quality parts for every radio purpose—all at prices that save you money!

FREE SEND COUPON

Depend on ALLIED—the World's Largest Exclusive Radio House!

ALLIED RADIO CORP.
833 Jackson Blvd., Dept. 2-M-1, Chicago, Ill.

Send me your FREE 1941 Fall Radio Catalog.

I enclose 10c for New Radio Dictionary.

Name

Address

City State

COOL-HANDLE SOLDERING IRONS

Belden Mfg. Co.
4689 W. Van Buren St., Chicago, Ill.



THE handles of these irons are separated from the elements and tips by a series of baffle plates designed to keep the handles

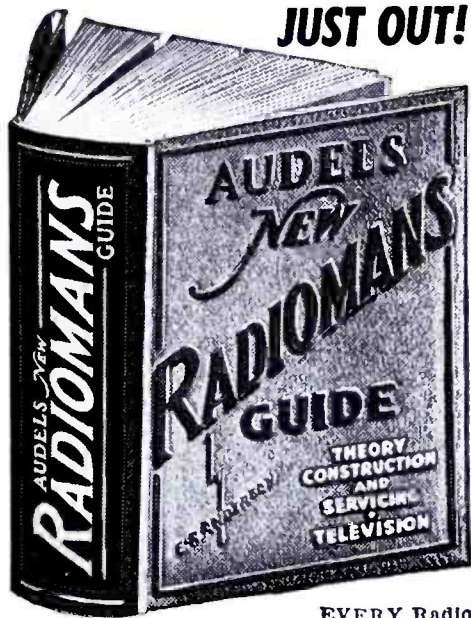

JUST OUT!

RADIO

EVERY Radio Mechanic—Service Man & Student Needs "Audels Radiomans Guide"—Just Out!

The whole subject of Modern Radio—covering the Basic Principles—Construction & Operation—Service—Repairs—Troubles—All Easily Understood. Over 750 Pages, 400 Illustrations, Parts & Diagrams—LATE TELEVISION DATA—Valuable for REFERENCE AND HOME STUDY.

4 To get this practical information in handy form for yourself fill in and mail coupon today. **COMPLETE • PAY ONLY \$1 A MO.**

AUDEL, Publishers, 49 W. 23rd St., N. Y.

Mail AUDELS NEW RADIOMANS GUIDE for free examination. If O. K. I will send you \$1 in 7 days; then remit \$1 monthly until price of \$4 is paid. Otherwise, I will return it.

Name _____
 Address _____
 Occupation _____
 Reference _____ RCF

T WIRELESS TRANS-CASTER

This wonderful new device has hundreds of practical applications. Broadcasts voice or music from any room or floor in home, office or store to any radio in same building WITHOUT CONNECTING WIRES! Works from any lighting socket, a.c. or d.c. Transmits your favorite recordings from electric phonograph through any radio WITHOUT CONNECTIONS between radio and phonograph. Transforms your radio into an efficient public address system. Acts as an interoffice communication system. Simplifies home broadcasting. Great fun for parties, entertainments, etc. Ideal for auditions. If your neighbor's radio in same building annoys you, you can tell him so THRU HIS RADIO. Can be used as a radio nursemaid to warn of trouble in nursery. No need to go upstairs. Merely tune your radio to a predetermined point on dial and listen in. If baby is crying, you'll hear him clearly through the radio. Also permits use of radio as a detectaphone. Listen to secret conversations. Impossible to enumerate many other uses in this limited space.

DE LUXE MODEL TRANSCASTER-TRANSMITTER

Powerful, high-gain device engineered so that it will transmit high-fidelity music without connection wires to remote radio set. No sacrifice of quality or power. Uses separate rectifier tube, 6J7 screen grid mike amplifier, and dual purpose 6A7 modulator and oscillator. (165 tubes)

Price, complete, ready to operate... and mike) **\$4.95**

Set of 3 Matched Tubes \$1.95
H. G. CISIN, Chief Eng.
 ALLIED ENGINEERING INSTITUTE
 DEPT. R.C.
 85 WARREN ST., NEW YORK, N. Y.

PATENTS—TRADE MARKS

Booklet concerning Inventions & Patents Form "Evidence of Conception" with instructions for use and "Schedule of Government and Attorneys Fees"—Free

LANCASTER, ALLWINE & ROMMEL
 Registered Patent Attorneys
 436 Bowen Bldg. Washington, D. C.

Attention Dealers

Wholesale prices on Arcturus Radio Tubes, Supreme Instruments, Wright Speakers, J.F.D. Ballast and dial Belt Kits, Ward Leonard Relays, Resistors, Catalog 10c.

ANCHOR RADIO DISTRIBUTING SERVICE
 213½ Dryden Road, Dept. RC, Ithaca, New York

cool. The iron will not roll on a flat surface since the baffle plates are hexagonal in shape. Available in 80, 100 and 150 W. sizes.—Radio-Craft

TUBULAR NEUTRALIZING CONDENSERS

Bud Radio, Inc.
 5205 Cedar Ave., Cleveland, Ohio

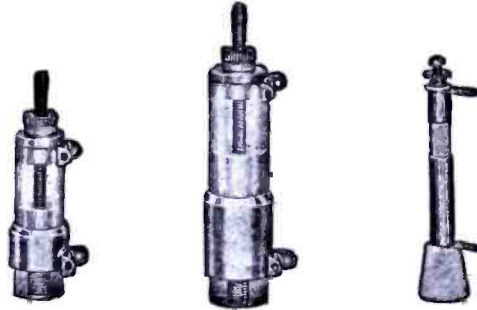

THESE small, compact neutralizing condensers are tubular in design and have a single hole for mounting. Capacities are adjusted by means of a screwdriver and may be locked at any desired setting. Available in capacities of 0.25-mmf. to 4 mmf. at 1,000 V.; 0.25-mmf. to 5 mmf. at 2,000 V.; and 1 mmf. to 9.5 mmf. at 3,000 V.—Radio-Craft

PREAMPLIFIER

Montgomery Ward & Co.
 Chicago, Ill.

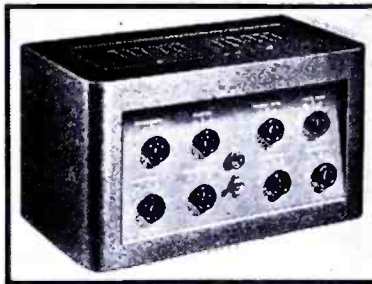

THE 6 channels of this exceptionally quiet, "Professional Airline" preamplifier permit the use of 4 additional microphones at one time with 2 extra phonos. The unit can be operated up to a mile distant from the amplifier itself. The controls include 2 tone boosters, to emphasize either the low bass or high treble notes, or both; and 4 microphone input controls for regulating volume in each individual mike. There are also 1 master phono volume control and 1 master gain control. The unit consumes 60 W. of power and operates on 105-125 V., 50-60 cycles A.C.—Radio-Craft

"A - B" BATTERY ELIMINATOR

Electro Products Labs.
 549 W. Randolph St., Chicago, Ill.



THIS model AD unit operates from 110-V. line, either A.C. or D.C., and furnishes "A" and "B" voltages for the 1.4-V. bat-

tery portables. Provides 90 V. of "B" at 18 milliamperes and 1.4 V. of "A" for up to 6 tubes. Unit measures only 6¼ x 5¼ x 2½ ins.; battery plugs of standard portables plug into unit; available harness fits unit to non-standard receivers.—Radio-Craft

MOBILE AMPLIFIER

John Meck Industries
 1313 W. Randolph St., Chicago, Ill.



MODEL AMR-15C is a 15-W. mobile amplifier timed for election sales. Has built-on phono top which operates from both 6 V. battery and 110 V. A.C. Optional equipment includes 2-piece leatherette carrying case, housing 2 P.M.-type speakers and all accessories.—Radio-Craft

NEW CONTACT BAND FOR ADJUSTABLE RESISTORS

International Resistance Co.
 401 N. Broad St., Philadelphia, Pa.

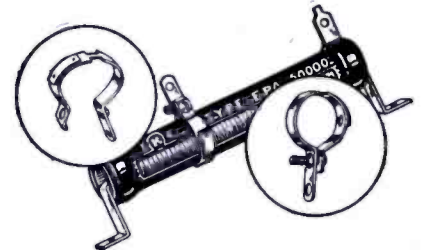

THE new band for adjustable resistors, designed so it cannot be adjusted too tightly, can be used at temperatures above those ordinarily met in resistor operation. This eliminates the danger of wire breakage and other damage due to making the band too tight.—Radio-Craft

PORTABLE P.A. SYSTEM

Commercial Sound Division
 RCA Mfg. Co., Inc., Camden, N. J.

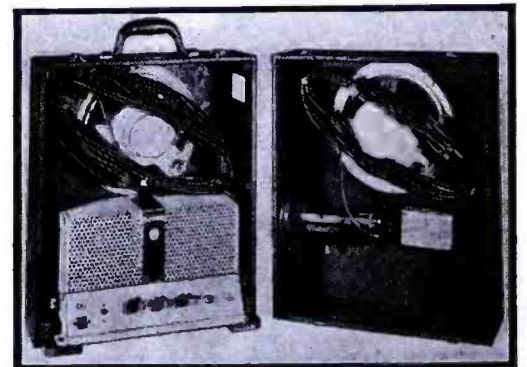

TYPE PG-180 is a compact 15-W. portable P.A. unit in a single carrying case. Its basic unit is the RCA amplifier type MI-12202. The 2 loudspeakers are 10¼-in. P.M. types while the microphone is a Junior Velocity type mounted on a table stand. Provisions are made for 2 separate high-impedance input circuits with individual volume controls. Suitable for indoor audi-

ences up to 2,000 persons. Carrying case measures 21 x 16 $\frac{3}{4}$ x 11 ins. deep. Weight, 43 lbs.—*Radio-Craft*

VANE-TYPE CERAMIC TRIMMER CONDENSER

Centralab
900 E. Keefe Ave., Milwaukee, Wis.

FIXED plate bonded to the ceramic base, eliminating the usual variable air film. Variable plate rotates on a ground ceramic surface. Equally stable at all capacity adjustments. Provides negative temperature compensation of 0.0006-mmf./mmf./°C. Power factor less than 0.1-%. Capacity change with humidity or temperature cycling less than 0.5-%. Available capacity ranges: 2 to 6 mmf., 3 to 12 mmf., 7 to 30 mmf., and 60 to 75 mmf. Unit measures about $\frac{1}{2}$ x $\frac{3}{8}$ $\frac{1}{8}$ -in. thick.—*Radio-Craft*

SOCKET SHIELD

James Millen Mfg. Co., Inc.
Malden, Mass.

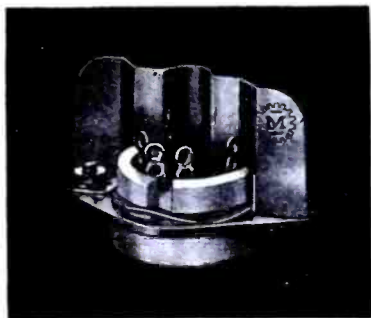

AS illustrated this aluminum socket shield electrostatically isolates the grid and plate terminals of single-ended metal tubes, thus permitting their use in high-gain circuits. Shield is made of aluminum.—*Radio-Craft*

COMPLETE HOME RECORDER—PLAYBACK—P.A. SYSTEM

Talk-A-Phone Mfg. Co.
1219 W. Van Buren, Chicago, Ill.

THREE units in one, viz., (1) easily-operated recorder, (2) record player, and (3) complete P.A. system, including amplifier, crystal microphone and 6 $\frac{1}{2}$ -in. dynamic speaker. Plays-back the recordings it makes, or plays any standard 10- and 12-in. records with cabinet lid closed. Develops 3 W. of power output as P.A. system. Amplifier is a 5-tube job, including rectifier and visual tuning indicator. The entire unit is housed in a single carrying case measuring 16 x 16 x 14 ins. high. Weight, approx. 45 lbs.—*Radio-Craft*

"ROLINDEX" CHART

Radio City Products Corp.
88 Park Pl., New York, N. Y.



THE "Rolindex" tube chart when mounted on old tube testers greatly increases their business-like appearance in addition to speeding tube testing and avoiding the use of separate charts. "Rolindex", which measures 11 x 3 $\frac{3}{4}$ x 3 ins., is mounted behind a transparent plastic window with a hairline engraved across its center for easy

reading of the control settings. It is supplied in 2 models, viz., one with internal illumination (model 102) and one without (model 101).—*Radio-Craft*

POWER LEVEL RECORDER

Sound Apparatus Co.
150 W. 46 St., New York, N. Y.

AUTOMATICALLY makes a continuous and permanent record of the transmission characteristics of any electroacoustic apparatus. The instrument can be equipped with input potentiometer of different kinds, as for instance, db. potentiometer in steps of $\frac{1}{4}$, $\frac{1}{2}$, $\frac{3}{4}$ and 1 db., linear potentiometer and also phon potentiometer for making any loudness measurement. Unit is popularly priced. The instrument is designed for 110 V., 60 cycles. Size, 10 $\frac{1}{2}$ x 12 x 8 ins. wide; weight, 22 lbs.—*Radio-Craft*

RECORDING-PLAYBACK UNIT

Mellaphone Corp., Rochester, N. Y.

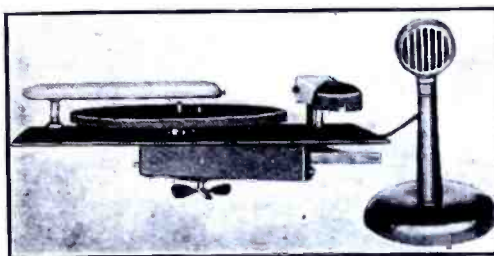

THE model TT recording-playback unit here illustrated is interchangeable with present recording mechanisms already on the market. Powered by heavy-duty recording motor with weighted turntable. Magnetic-type cutting head. Playback pickup optional in either crystal or magnetic type. Top plate measures 10 x 15 ins. and is made of 1/16-in. steel.—*Radio-Craft*

"HI-CLEARANCE" CUTTING STYLUS

Wilcox-Gay Corp.
Charlotte, Mich.

THIS new cutting stylus has been designed to eliminate the tendency to chip rather than make a smooth cut when recording at 33-1/3 r.p.m. The "Hi-Clearance" cutting stylus now makes possible dual speed (78 and 33 r.p.m.) home recording.—*Radio-Craft*

MODERNIZER KIT FOR TUBE TESTERS

Allied Radio Corp.
833 W. Jackson Blvd., Chicago, Ill.



THIS kit, known as model B11680, permits testing new tubes in old tube-testers. It provides filament voltages of 25-30-35-50-70-85 and 117 V. for the new high-voltage filament tubes. Voltages are selected by a rotary tapped switch mounted on its panel or in a spare socket hole of the tube tester. Installation is very simple, requiring only 2 connections with the tube checker.—*Radio-Craft*

RADIO-RECORDER-PHONO ATTACHMENT

Rock-Ola Mfg. Corp.
800 N. Kedzie Ave., Chicago, Ill.

THIS company, best known for its coin phonographs, has entered a new field with the announcement of a line of com-



196 PAGE
Lafayette
**BOOK OF
BUYS!**



What a book to have! Just open it to the section you are interested in—there's your radio, sound system, your choice of nationally advertised parts. Everything's here—everything that's new in radio and a lot of needed equipment no longer made. But that's only the start of the story! Lafayette prices are the lowest—saving you money on everything you buy, while you save time by ordering at home. Send for FREE copy of the Lafayette Radio Catalog today.

LOOK what's in it!

<p>RADIOS</p> <p>64 brilliant new models for home, farm, camp and car. Voted "Best Buy" consistently by Consumer Test laboratories. 30 day home trial. Portables, mantels, consoles, phono-radios.</p>	<p>TEST EQUIPMENT</p> <p>The leading lines, the newest "wrinkles", the biggest values. Pocket and portable testers, combinations, all-purpose models—easy to own on Lafayette's pay-as-you-earn plan.</p>
<p>RADIO PARTS</p> <p>All the famous names at rock-bottom low prices. Complete stocks include latest type tubes. Special section of super values.</p>	<p>SOUND SYSTEMS</p> <p>Three complete ranges. Years ahead in engineering, and styling—here's P.A. for every purpose, priced for every purse.</p>
<p>HAM EQUIPMENT</p> <p>The latest developments in your favorite line. Big savings. New Easy Pay Plan. Now you can enjoy the rig you've always wanted.</p>	<p>HOME BUILDERS KITS</p> <p>See these Kits for experiment and thrifty fun at home, building radio and television receivers. New! Build-it-yourself kit for FM.</p>

THIS BOOK SAVES YOU — TIME. If it isn't in the catalog, Lafayette can get it for you. Famed fast service. **MONEY.** Famed fast service. **MONEY.** Famed fast service. Lafayette will NOT be undersold. Mail coupon at once for FREE copy of Radio's latest, greatest buying guide!

FREE FOR CHRISTMAS! Lafayette's special gift catalog. Packed with suggestions for family and friends. Ready now—get your FREE copy at once.

Lafayette Radio

NEW YORK, N. Y.
100 Sixth Ave.
CHICAGO, ILL.
101 W. Jackson Blvd.
ATLANTA, GA.
265 Peachtree Street
BOSTON, MASS.
BRONX, N. Y.
NEWARK, N. J.
JAMAICA, L. I.

LAFAYETTE RADIO CORP.
Dept. 3M—901 W. Jackson Blvd., Chicago, Ill.
or 100 Sixth Ave., New York, N. Y.

Rush FREE Catalog No. 82.
 Rush FREE Gift Catalog No. 83.

NAME.....

ADDRESS.....

CITY..... STATE.....

LATEST RADIO APPARATUS

ONLY \$4.96 U. S. NAVY AIRPLANE-TYPE Microphone and Receiver

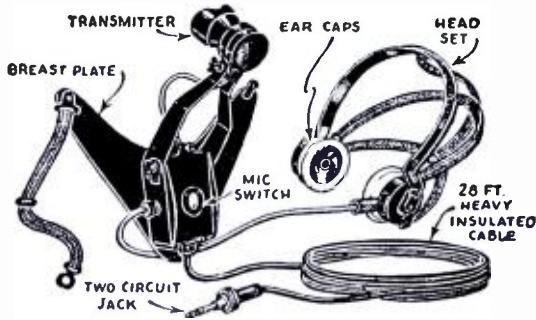

THIS Microphone and telephone headset outfit was built especially for the U.S. Navy Aviation Corps for Plane-to-Plane and Plane-to-Ground communication.

The Holtzer-Cabot Electric Company constructed the outfit to Government specifications and under rigid Navy Department supervision.

The outfit consists of a low-impedance carbon microphone (transmitter), securely fastened to a metal breast-plate, and a set of heavy-duty, low-impedance earphones. A specially constructed switch on the back of the breast-plate controls the microphone circuit. The earphones are U.S.N. Utah type, attached to adjustable headband. Twenty-eight feet of very heavy weather and water-proof conductor cable, terminating in a special brass plug, is furnished with this complete outfit. Current of not more than 10 volts should be used. A storage battery is the most satisfactory current supply. Talk in a natural tone of voice, when using the outfit, with the lips close to the mouthpiece. Shouting and loud talking should be avoided.

We understand that the U.S. Government paid more than \$40.00 for each of these outfits. We have bought the whole lot at a low price and are offering them, as long as the supply lasts, at \$4.96 each, complete as shown in illustration. The shipping weight is 9 lbs.

All merchandise in original packages—never used. Money-back guarantee.

All Shipments will be forwarded by Express Collect if not sufficient postage included.

WELLWORTH TRADING CO.
1915 So. State St., Dept. RC-1240, Chicago, Ill.

A NEW BOOK ON
AUTO RADIO: See Page 383



JUST OUT!

THE FIRST
ISSUE OF

FLIGHT

THE PICTORIAL
FLYING REVIEW

Contains: Editorial by Hugo Gernsback, descriptions of the latest American and foreign bombing and fighter planes; night-flying; parachute troops; bombs, technique of bombing and results; anti-aircraft guns and search-lights; aeroplane cannon and machine guns; torpedo planes; flight rays; aerial blockade; and other subjects.

FLIGHT MAGAZINE
20-R Vesey St., New York, N. Y.

Brings you news from the entire world of all important phases of aviation and aeronautics in a non-technical, yet educational manner. Keeps you abreast of all the major developments as fast as they develop anywhere.

Attractive three-color cover, numerous illustrations.

15¢ a copy

Subscription price \$1.50 a year, Canada and foreign \$2.00.

bination home recorders with radio and phonograph attachments. The units have 5 to 11 tubes and are said to be the only ones on the market which in addition to the radio and phonograph are capable of automatically playing 20 records.—Radio-Craft

DISPLAY-SIZE TUBE CHECKER

The Hickok Electrical Instrument Co.
10302 Dupont Ave., Cleveland, Ohio



THIS instrument is designed primarily to assist dealers in making more tube sales since it has a large 9-in.-square meter with an illuminated dial which clearly indicates "good-bad-doubtful"—eliminating from the customer's mind all doubt of the tube's quality. Known as model 530-M, this instrument tests tubes by measuring their dynamic mutual conductance in micromhos. It checks ballast tubes, visual indicating tubes, miniature tubes, etc. In addition it tests for shorts (hot or cold), tube noise and gas.—Radio-Craft

F.M.-A.M. PHONO COMBINATION

Radio Wire Television, Inc.
100 Sixth Ave., New York, N. Y.

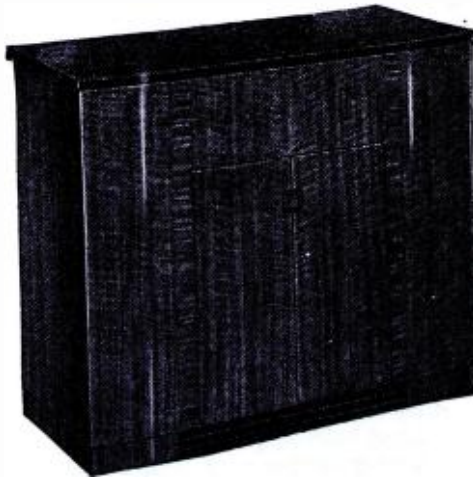

MODEL FM-13 is a 3-way instrument incorporating F.M. and A.M. radio reception, and phono record reproduction. A 9-tube dual tuner provides a tuning range of 550 to 1,600 kc. for standard A.M. broadcasts and 40 to 50 mc. for F.M. broadcasts. The audio system, rated at 20 W. output, is claimed to be substantially flat from 30 to 15 c.p.s. Other features include balanced dual speakers, automatic bass com-

OPPORTUNITY AD-LETS

Advertisements in this section cost 15 cents a word for each insertion. Name, address and initials must be included at the above rate. Cash should accompany all classified advertisements unless placed by an accredited advertising agency. No advertisement for less than ten words accepted. Ten percent discount six issues, twenty percent for twelve issues. Objectionable or misleading advertisements not accepted. Advertisements for January, 1941, issue must reach us not later than November 7th.

Radio-Craft • 20 Vesey St. • New York, N. Y.

BOOKS AND MAGAZINES

ASSURE YOURSELF OF GREATER PROFITS BY doing radio service jobs more quickly. Authentic service guides show you the way to locate and correct troubles in any radio receiver. Gernsback Official Radio Service Manuals show you how to complete more repair jobs in less time—how to earn more money by faster servicing. Radcraft Publications, 20 Vesey St., New York City.

WE HAVE A FEW HUNDRED RADIO ENCYCLOPEDIAS, by S. Gernsback, second edition, originally sold at \$3.98. Book has 352 pages, weight 3 lbs., size 9 x 12 inches. Red morocco—keratol flexible binding. Send \$2.49 in stamps, cash or money order and book will be forwarded express collect. Technifax, 1915 So. State Street, Chicago, Illinois.

WHAT DO YOU KNOW ABOUT AMPLIFIERS AND Sound Systems? The Amplifier Handbook and Public Address Guide covers P.A. from A to Z. Most complete and authentic book published on the subject. Contains 80 pages of vital information on Amplifiers, P.A. Systems, Speakers, Accessories, Pickups, Microphones, etc. Printed on fine coated stock, with numerous photographic illustrations and explanatory diagrams, and only 25c. See page 236.

DIATHERMY MACHINES

DIATHERMY, SHORT-WAVE THERAPY, AND ULTRA short-wave therapy machines custom-built by radio engineer at considerable saving over commercial machines; 6 meters, 16 meters or any other frequency specified can be furnished. Machines substantially built with high patient safety factor. 250-300 watts output. Neat professional appearance. Automatic safety time switches. All necessary pads and electrodes. For sale only to physicians, hospitals, and sanatoriums. Prices from \$165.00 to \$300.00. Not for sale to the general public. Write, giving your own specifications and requirements. No literature available; custom construction only. Allan Stuart, P. O. Box 56, Teaneck, N. J.

EDUCATIONAL COURSES

USED CORRESPONDENCE COURSES AND EDUCATIONAL Books Bought, Sold or Rented. Catalog Free. Vernon Exchange, Hlenagar, Ala.

CORRESPONDENCE COURSES AND EDUCATIONAL books, slightly used. Sold, Rented, Exchanged. All subjects. Satisfaction guaranteed. Cash paid for used courses. Complete details and bargain catalog FREE. Write Nelson Company, 500 Sherman, Dept. M-242, Chicago.

MANUSCRIPTS WANTED

WANTED—MANUSCRIPTS, POEMS, SONGS FOR publication. Fortuny's, 87 Fifth Ave., New York.

PHOTOGRAPHY

1/100,000 OF A SECOND SPEED FLASH UNIT FOR Stroboscopic Photography, \$200.00. Apt. 63, 782 West End Ave., New York City.

RADIO

WE BUY AND SELL USED RADIO TESTING EQUIP-ment. Time payments if desired. Harold Davis, Inc., Jackson, Miss.

WILL SWAP ARVIN AUTOMOBILE RADIO RECEIVER, for magnetic detector. Set has excellent sensitivity and fine tone-quality. Also want airplane-cloth speaker, Adams-Morgan wood-case variable condenser, navy-type loosecoupler, deForest Audion control box, or what old apparatus have you? B. Bernard, 40 Manning Ave., N. Plainfield, N. J.

HARD-TO-GET RADIO DIAGRAMS. TRY USUAL sources first. If you can't get them, try us. Price, 75c to \$1.50 if we succeed; no charge if we don't. You lose nothing! Send no money—write first giving fullest information. Enclose return-addressed, stamped envelope. We have helped many Servicemen, experimenters and radio fans. We may help you. Allan Stuart, P.O. Box 56, Teaneck, N. J.

RADIO KITS

RADIO KITS—\$3.95 UP. SINGLE BAND; ALL WAVE. 5-10 tubes. Fluorescent lighting. Save 50%. McGee Radio, P-2055, K.C., Mo.

STAMPS

THREE SCARCE SETS, NOW OBSOLETE, 25c, WITH new customer, gift: Box 211, Malden, Mass.

TECHNICAL ART SERVICE

DRAFTING AND ART SERVICE—A COMPLETE Service for the Industrial and Commercial Marketers. If your business or plant can't afford a designing or drafting staff, don't let this stop you from going ahead with that new product you intend marketing, or that catalog of mechanical or electrical items which needs fine detailed drawings and highly retouched photographs. Any mechanical, electrical or radio problem can be solved for you by our associated staff of designers, draftsmen and artists, and technical copywriters. Write for any additional information as to methods and price for this service. Tec-Art Drafting Service, 228 Charlotte Terrace, Roselle Park, N. J.

DRAFTING SCHEMATIC DIAGRAMS SEND US A rough sketch of your circuit. Estimates by return mail. Our prices are moderate; our work guaranteed. No jobs too big or small. Wm. Kadlecck, Jr., 440 East 85th St., New York, N. Y.

pensation and separate manual controls for bass and treble equalization. The phonograph is of the automatic record changing type. Handles up to ten 10- and 12-in. records, mixed. Pickup, of tangent-arm type, reduces record wear.—*Radio-Craft*

REMOTE CONTROL RADIO TELEPHONE

Jefferson-Travis Radio Mfg. Corp.
136 W. 52 St., New York, N. Y.

A 50-W. completely remote-controlled radio telephone instrument. It is possible with this instrument to place the main unit in some inconspicuous spot below deck while up to 3 remote control units may be placed at convenient locations in various parts of the vessel. These control units consist of telephones, speakers and operating controls. An automatic voice control feature eliminates the need for a press-to-talk button arrangement. Further, a remotely-controlled "gate" is designed to suppress static. All components of the instrument are completely corrosion-proofed to stand up against moist salt atmospheric conditions.—*Radio-Craft*

360° TRUMPET

University Laboratories
195 Chrystie St., New York, N. Y.

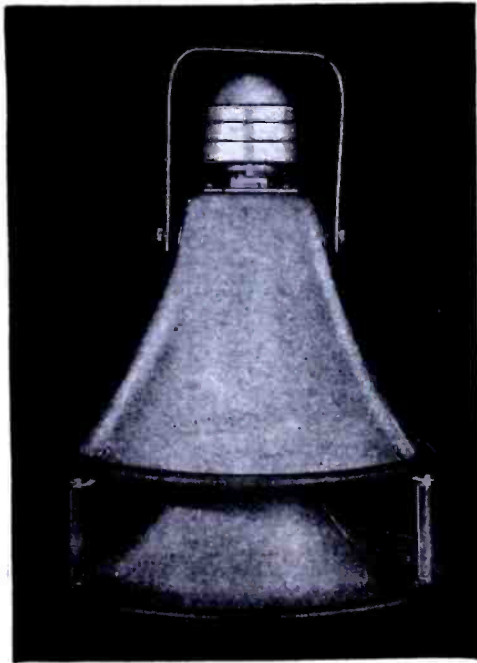

MODEL RSH Radial is not a cone speaker but an exponential driver unit speaker of the high-power public address type. Acoustically it is claimed to be equivalent to a 3-ft. exponential horn. Provides 360° radiation. Overall height, 20 ins.; bell dia., 15 ins. It is claimed to give uniform distribution without "hot" spots and is especially useful where one speaker must cover large areas and still overcome high background noise.—*Radio-Craft*

75-CHANNEL ULTRA-H.F. XMITTER-RECEIVER

Westinghouse Electric & Mfg. Co.
Radio Division, Baltimore, Md.

THE type HR ultra-H.F. transmitter-receiver battery-portable has 75 calibrated frequency channels in the band from 28 to 65 mc. Ideal for communication between scattered field groups as in traffic, fire, large-scale construction, or rescue control work. Weight, complete with batteries, antenna, microphone, headphones and key, is 30 lbs. Receives on one channel, sends on another, crystal controlled. Tube complement: 3-958 triodes, 1-959 pentode, 2-30 triodes, 1-1E7G twin-pentode. Output, 0.5-W. min. Av. receiver sensitivity, 5 microvolts.—*Radio-Craft*

COMPLETE RADIO COURSE \$1.95

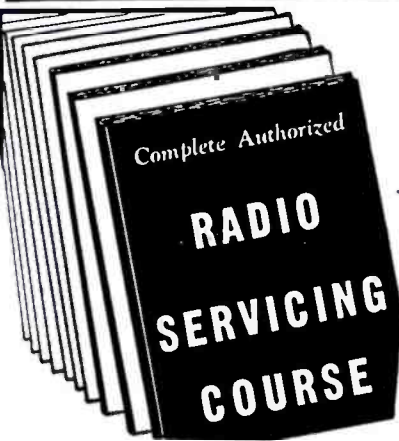

AMAZING OFFER

Your chance to get exact reprint of regular \$39.00 Radio Technical Institute course for only \$1.95, the full price. This is the latest Radio and Television Course, complete in every way, and exactly the same as the much higher priced original lessons. Complete with supplementary material.

\$1.95
POSTPAID

EVERYTHING ABOUT RADIO

The training is remarkably complete. You quickly learn radio servicing from simple circuits to signal tracing. From the very start you are introduced to real radio methods and equipment. After finishing this course you will be able to expertly service every radio set. Take advantage of this unusual bargain in radio education.

Guarantee

You must be satisfied or your money will be refunded immediately.

TELLS HOW TO USE INSTRUMENTS

Many active servicemen have found this reduced-price course excellent for brush up and study of new servicing methods. Reprinted in 1940, with added information on signal tracing, television, visual alignment, P.A. application, photo-cells, etc. All about A.V.C., how to use an oscilloscope, what is feedback, resonance action, and every other fact you must know to be the best serviceman. 43 radio manufacturers helped to prepare this course.

PREPARED FOR HOME-STUDY

This complete, low-priced course will give you all the training needed to get ahead in the growing field of Radio. No special education or previous experience required. The lessons are clear, interesting, easy to master and use. A final examination and diploma available after course is finished. Special \$1.95 price for the entire course can be earned the first hour of radio work.

PARTIAL LIST OF LESSONS

Elementary Electricity, Radio Parts, Batteries, Circuits, Magnetism, Electromagnets, Ohm's Law, Radio Mathematics, Wattage Calculation, Induction, R.F. Coils, I.F. Transformers, Condensers, A.C. Filters, Reactance, Mixed Circuits, Vacuum Tubes, Stage Gain, Detectors, R.F. Amplifiers, Superhet Principle, A.V.C. Ballast Tubes, Meters, Testing Methods, Instruments, Service Fundamentals, V.T. Voltmeter, Using the Oscilloscope, Alignment, Sound and Hearing, Public Address, Amplifiers, Loudspeaker Placement, Microphones, Inverse Feedback Methods, Recording, Power Supplies, Auto Sets, Servicing Short-Cuts, Case Histories, Radio Transmission, Modulation, Crystal Oscillators, Photocells, Sound Movies, Television Principles, Setting Up a Radio Business, Extra Profit Ideas, And many others.

GOOD REVIEW COURSE

Learn new speed-tricks of radio fault finding, servicing short-cuts, case histories of common troubles, extra profit ideas. Many large lessons on use of regular test equipment, explanation of signal tracing test methods, television to the minute, recording dope. With this information you will save enough time on one radio job to pay the special \$1.95 price for the complete course.

NEW LIMITED EDITION

Rush your order to us today. You may not have another opportunity like this. Only a small number of courses reprinted to sell at the reduced price. You are protected with our money-back guarantee. Catch up with your radio education. Begin studying this course this very week.

FREE EXAMINATION COUPON

SUPREME PUBLICATIONS, Room 335
3727 W. 13th St., Chicago, Illinois
Ship the complete Radio Course at the special reduced price. I must be pleased, or will get my money back.
 I am enclosing \$1.95, the full price, sent postpaid.
 Ship C.O.D. I will pay postman \$1.95 and a few cents for postage.

Name
Address
City State

SOFT-FACE HAMMERS

Stanley Tools New Britain, Conn.

SERVICEMEN will be interested to learn that this tool company has introduced a line of soft-face hammers that permit work on sheet metals or machine parts without nicking or marring. Stanloid, a tough, resilient non-metallic substance (celluloid composition) tips each hammer-head.—*Radio-Craft*

AUTO-RADIO DEMONSTRATION POWER PACK

Standard Transformer Corp.
1500 N. Halsted St., Chicago, Ill.



DESIGNED specifically to aid Servicemen and dealers to demonstrate auto-radio receivers in their stores, directly

from the lightline. Known as model 132, this power pack unit delivers 12.5 amperes at 3 to 6 V. Will handle all types and sizes of audio-radio sets. In addition it is useful for operating and demonstrating 6-V. automobile accessories as well as many applications in the electroplating field. Tap-switch on transformer primary provides required output voltage (indicated on a meter). A fuse protects the transformer; an overload relay protects the remaining components.—*Radio-Craft*

PLUG-IN AERIALS FOR PORTABLES

Philco Corp.
Tioga and C Sts., Philadelphia, Pa.

A N auxiliary aerial, equipped with suction cups, has been developed which

DATAPRINTS



TESLA-LOUDIN COILS

- 20c Ea. in order for 10 (Data and Drawings only.)
- 36" Sp'k Tesla-Oudin Coil 40c
- (1 K.W. Exc. Trf. Data incl.)
- 8" Sp'k Tesla-Oudin Coil 40c
- (1/4 K.W. Exc. Trf. Data incl.)
- 3" Sp'k Oudin; 110 Vt.
- "Kick Coil" type.....40c
- 3" Tesla Works on Ford Coil40c
- 1" Sp'k Vibrator Hi-Freq. Coil 40c

NEW! 5 ft. Sp'k. Oudin Coil & Exciter
Data75c



Induction PIPE & ORE LOCATOR

Induction Type, Data40c
Radio Type40c

More DATAPRINTS 40c each!

- 5 Meter Superhet.
- 1/4 Meter Tr. & Rec.
- 20 A.C. Probs. & Ans.
- 20 Telephone Hook-ups
- 100 Mech. Movements
- 20 Motor Hook-ups
- Television Hook-up
- 20 Elec. Party Tricks
- Solenoids and Magnets —get list.
- Fry Eggs on Ice!
- Experimental Telephone
- Radio Control for Models
- Diathermy Apparatus
- Inductor Organ
- Electric Refrigerator
- Wheatstone Bridge
- Weld. Transf. 2 K.W.
- Rewinding Armatures
- String Galvanometer
- 20 Simple Bell Circuits
- Steel Wire Recorder!
- Water Wheels or Turbines
- Photo Cell and Relay
- Ring 4 bells: 2 Wires
- 20 Tesla Tricks
- Polarized Relay
- Induction Balance
- Electric Pipe Thawer

Special Prices: 4 prints \$1.00; 10 for \$2.00; Single, 40c each. Get New Catalog 100 A.

The DATAPRINT Co.

Lock Box 322C, Ramsey, N. J.

SUPER BARGAINS

Practically all of the attractive items listed here are brand new, others are reconditioned like new; but ALL are in PERFECT WORKING ORDER. In many cases, the parts alone total more than the price we are asking. 100% satisfaction guaranteed or your money refunded. ORDER FROM THIS PAGE. Use the convenient coupon below. Include sufficient extra remittance for parcel post charges, else order shipped express, collect. Any excess will be refunded. C.O.D. shipments require 20% deposit. If full remittance accompanies order, deduct 2% discount. Send money order, certified check, new U. S. stamps. No C.O.D. to foreign countries.

ORDER TODAY LIMITED QUANTITIES PROMPT SHIPMENTS ASSURED

2-SPEED PHONOGRAPH TURNTABLE



Adapts any phonograph for both 33-1/3 and 78 R.P.M. This ingenious device, by simply replacing your present turntable, automatically modernizes your machine to play 23 1/3 R.P.M. high-fidelity transcription records as well as the standard 78 R.P.M. records. Quickly installed by anyone. Complete instructions furnished. Felt-covered turntable measures 12" in diameter and fits all standard phonographs. Packed in original box. Shp. Wt. 3 lbs.
ITEM NO. 89
YOUR PRICE \$.95

PACENT RADIOFORMER KIT NOISE-FREE ANTENNA TRANSFORMER

Now you can have an expensive noise-free antenna system for a song. Kit consists of two matched R.F. transformers; one which is attached to the antenna and the other to the input of the receiver to enjoy noise-free radio reception. Only additional requirement is a shielded lead-in wire. Installation simple as ABC. Anyone can do it. For use with broadcast receivers only. Both transformers thoroughly shielded in aluminum cans. Weather resistant; can't corrode or rust. Complete instructions included. Packed in original box. Shp. Wt. 1 1/2 lbs.
ITEM NO. 92
YOUR PRICE \$.95



DELCO 6-VOLT D.C. MOTORS

A sturdily-built motor with brushes completely enclosed in dirt-proof iron case. Excellent for car fans, window displays, model electric trains, erector sets, etc. Small, light, compact. 2 1/2" diam. by 3 1/2" overall. Shaft 3/16" diam. Operates from 6-volt storage battery or "hot shot." Long-life bearings. Ideal motor for experimenters. Shp. Wt. 3 lbs.
ITEM NO. 86
YOUR PRICE \$ 1.50

G.E. INDUCTION DISC MOTOR FOR RECORDING PLAYBACK AND DISPLAY PURPOSES



Substantially constructed by General Electric, this ball-bearing motor is a high-quality phonograph unit. Its power and smooth-running make excellent home recording work. Its speed, governor-controlled, is variable both below and above 78 r.p.m. For 110 volts, 60 cycles. A.C. Sold less turntable and shaft. 7 1/2" diameter x 5 1/2" high. Shp. Wt. 14 lbs. Packed in Original Box.
ITEM NO. 81
YOUR PRICE \$ 3.95

SUPER SPECIAL 3 1/2 R.P.M. SYNCHRONOUS MOTOR

There are 101 uses for a synchronous motor making only 3 1/2 revolutions per minute. Ideal for crowd-catching store-window displays, agitating film-developing tanks, as an electric winch on model motor boats, as derrick motor in erector sets, etc. Built-in high-ratio step-down gears provide amazing amount of power. Made by Haydon Mfg. Co. of Waterbury, 2" in diameter x 2 1/2" x 1" thick overall. Shp. Wt. 2 lbs.
ITEM NO. 76
YOUR PRICE \$ 1.95



MECHANICAL FLASHLIGHT

This battery-less flashlight generates its own power merely by pressing handle. Gives strong light whenever needed. Costs nothing to maintain. Amazing new miniature dynamo operates flashlight. Pocket size, 4 3/4" x 2" x 1". Shp. Wt. 2 lbs.
ITEM NO. 88
YOUR PRICE \$ 1.70



AMAZING BLACK LIGHT!!

Powerful 300-Watt Ultra-Violet Bulb



The best and most practical source of ultra-violet light for general experimental and entertainment use. Makes all fluorescent substances brilliantly luminescent. No transformers of any kind needed. Fits any standard lamp socket. Made with special filter glass permitting only ultra-violet rays to come through. Brings out beautiful opalescent hues in various types of materials. Swell for amateur parties, plays, etc., to obtain unique lighting effects. Bulb only. Size of bulb. Shp. Wt. 1 lb.
ITEM NO. 87
YOUR PRICE \$ 2.00

ULTRA MAGNET

LIFTS MORE THAN 20 TIMES ITS OWN WEIGHT

LITTLE GIANT MAGNET. Lifts 5 lbs. easily. Weighs 4 oz. Made of ALNICO new high-magnetic steel. Complete with keeper. World's most powerful magnet ever made. The experimenter and hobbyist will find hundreds of excellent uses for this high quality permanent magnet. Measures 1 3/4" x 1 1/2". Shp. Wt. 3/4 lbs.
ITEM NO. 86
YOUR PRICE \$ 1.00



AUTO-RADIO REMOTE CONTROL

Designed for Ford cars, this fine remote control head may be adapted for use with most auto-radio receivers and in other type cars. Control furnished complete with two flexible cables (one for tuning and one for volume) and built-in pilot light. Flexible cables each 20 inches long. Tuning ratio is approximately 7 1/2 to 2. The on-off switch is built directly into the remote control. Over-all dimensions 3 1/2 inches wide, 3 1/4 inches high. Complete with matched knobs. Packed in original box. Shp. Wt. 4 lbs.
ITEM NO. 93
YOUR PRICE \$ 1.95



NEW ELECTRIC MOTOR-SAW

Now you can have all the fun of fine, fast jigsaw work without any of its difficulty. Simply steer the lightning-fast blade and see it seemingly melt its magic way through wood, plastics and building board. 7200 STROKES per MINUTE! Average cutting speed 1 foot per minute through 3/4" medium hard wood. Works 3 times faster than any free-hand saw. Operates on 50-60 cycle 110 v. Alternating Current. Screw adjusts blade stroke from 1/8" to 5/16". Off-On Switch built in handle. Complete with 6 ft. power cord and 3 saw blades.
ITEM NO. 87
YOUR PRICE \$ 4.85



KELLOGG LOUD-SPEAKER UNIT

This speaker unit sold originally for \$3.50, for use with speaker horns. It is an excellent unit and may still be used for the same purpose. Magnetic type, uses a powerful double-pole magnet. Volume is controlled by adjusting knob on back of metal case. Remarkably clear in tone. Excellent as an extra "personal" speaker. Easily attached to any radio. Can also be used as a sensitive high-impedance microphone. Gives excellent quality for speech. Cap is made of thick bakelite provided with threaded throat. Packed in original box. Shp. Wt. 2 lbs.
ITEM NO. 95
YOUR PRICE \$.75



CONTACT SERVICE KIT

General Cement Mfg. Co.
919 Taylor Ave., Rockford, Ill.

MODEL 777 service kit is designed for cleaning noisy attenuators, tuners, all-wave switches, variable contacts, etc. Consists of special contact cleaner and corrosion-resistant lubricant.—Radio-Craft

NEW GLASS FUSES

Littelfuse, Inc.
4757 Ravenswood Ave., Chicago, Ill.

UNDERWRITERS-approved 3-AG glass-enclosed plug-in fuses in ratings up to 8A. for 250 V. A.C. or D.C. service or less, are available for the first time from any manufacturer. A large saving in space is effected.—Radio-Craft

"DETERMOMH" DECADE RESISTANCE BOX

Ohmite Mfg. Co.
4835 Flournoy St., Chicago, Ill.



THIS instrument makes it simple as A-B-C to determine the proper replacement resistors for burned-out units. It is available in 2 ranges, viz., 1 to 9,999, and the other 10 to 99,990 ohms. These sizes are in addition to the 100 to 999,900 range instrument already available. The resistance element is made up of wire-wound resistors connected to tap-switches. May be connected directly in any radio or electrical circuit which does not cause the instrument to dissipate more than 1 W. for each tap in the circuit. Measures 6-3/16 x 8 1/2 x 3 3/4 ins. deep.—Radio-Craft

MINIATURE RADIO

DeWald Radio Mfg. Corp.
436 Lafayette St., New York, N. Y.

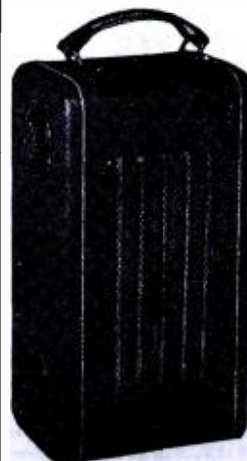

WEIGHING only 4 lbs., this model 410 receiver is a miniature personal radio set. Features of its circuit include automatic volume control, built-in loop antenna, tuning range of 1,700 to 540 kc. and a dynamic speaker. The receiver is housed in a compact saddle-stitched simulated-cowhide case which measures but 9 x 4 1/4 x 3 3/4 ins. deep.—Radio-Craft

HUDSON SPECIALTIES CO., 40 West Broadway, N. Y. C.

WE HAVE NO CATALOG. IT'S EASY TO ORDER—CLIP COUPON—MAIL NOW ORDER FROM THIS PAGE

HUDSON SPECIALTIES CO., 40 West Broadway, Dept. RC-1240, New York, N. Y.
I have circled below the numbers of the items I'm ordering. My full remittance of \$..... (include shipping charges) is enclosed.
OR my deposit of \$..... is enclosed (20% required), ship order C.O.D. for balance. No C.O.D. order for less than \$2.00. (New U. S. stamps, check or money order accepted.)
Circle Item No. wanted: 76, 81, 86, 87, 88, 89, 92, 93, 95, 96, 97
Name Address
City State
Send remittance by check, stamps or money order; register letter if you send cash or stamps.

Where to Buy It! —

CLASSIFIED RADIO DIRECTORY

Handy Buying Guide, by Products and Manufacturers' Names and Addresses, for the Entire Radio Industry

This DIRECTORY is published in sections—1 section per month. This method of publication permits the DIRECTORY to be constantly up-to-date since necessary revisions and corrections can be made monthly. All names preceded by an asterisk (*) indicate that they are trade names.

If you cannot find any item or manufacturer in this section or in previously-published sections, just drop us a line for the information.

Section I of this DIRECTORY was published in the October, 1940 issue. Presented here is Section III.

While every precaution is taken to insure accuracy, Radio-Craft cannot guarantee against the possibility of occasional errors and omissions in the preparation of this Classified Directory. Manufacturers and readers are urged to report all errors and omissions at the earliest moment to insure corrections in the very next issue.

MAGNETS



Permanent P

- BELDEN MFG. CO., 4647 W. Van Buren St., Chicago, Ill.—P
- CRUCIBLE STEEL CO. OF AMERICA, 405 Lexington Ave., New York, N. Y.—P
- GENERAL ELECTRIC CO., Schenectady, N. Y.—P
- PITTMAN ELECTRICAL DEVELOPMENTS CO., 127 Nippon St., Phila., Pa.—P
- RACON ELECTRIC CO., INC., 52 E. 19th St., New York, N. Y.—P
- RADIO ELECTRIC SERVICE CO., INC., N. W. Cor. 7th & Arch Sts., Phila., Pa.—P

METAL FOR RADIO



- Aluminum A
- Brass B
- Chassis C
- Core materials CM
- Die castings DC
- Foils F
- Laminations L
- Molybdenum M
- Nickel N
- Panels P
- Permanent magnets PM
- Racks R
- Speaker housings SH
- Stampings S
- Tantalum TA
- Transformer housings TH
- Tungsten T
- Special chemicals and metals SCM
- Spring contact metals SM
- Graphite G
- Tube parts TP
- Copper wire CW
- Electrical sheet steel ESS
- Cold-rolled steel CSS
- Stainless steel SS
- Zinc Z
- Pulleys PS
- Brackets B
- Pertruded nickel PN

- AEROVOX CORPORATION, 740 Belleville Ave., New Bedford, Mass.—B
- AIRPLANE & MARINE DIRECTION FINDER CORP., Clearfield, Pa.—FM, FS
- ALLIED RADIO CORP., 833 W. Jackson Blvd., Chicago, Ill.—A, B, C, CM, F, L, M, N, P, PN, R, SH, S, TA, TH, T, TP, G
- AMERICAN RADIO HARDWARE CO., 476 Broadway, New York, N. Y., *'Arhco'—A, B, C, S

- THE AMERICAN ROLLING MILL CO., Middletown, Ohio—ESS, CSS, SS, CM
- VICTOR J. ANDREW, 6429 S. Laverne Ave., Chicago, Ill.—C, FM, FS, R, SA, SR, L
- APPROVED TECHNICAL APPARATUS CO., 123 Liberty St., New York, N. Y.—C, SR
- ACRO TOOL & DIE WORKS, 2815 Montrose Ave., Chicago, Ill.—S
- *ARLAB, Arlavox Mfg. Co.
- ARLAVOX MFG. CO., 430 S. Green St., Chicago, Ill.—C, PM, SH, S
- *ARMCO, The American Rolling Mill Co.
- ASSOCIATED RESEARCH, INC., 16 N. May St., Chicago, Ill., *'Vibrotest'—B, IT, M
- BAKER & CO., INC., 113 Astor St., Newark, N. J.—N, PN
- THE BALTIMORE BRASS CO., 1201 Wisconico St., Baltimore, Maryland—B
- BUD RADIO, INC., 5205 Cedar Ave., Cleveland, Ohio, *'Bud'—A, C, P, R, SH
- CALLITE PRODUCTS CO., 534 39th St., Union City, N. J.—M, T
- CAMBRIDGE INSTRUMENT CO., INC., 3732 Grand Central Terminal, New York, N. Y.—G
- CINEMA ENGINEERING CO., 1508 S. Verdugo Ave., Burbank, Calif., *'Cinema'—P, R
- CRESCENT TOOL & DIE CO., 4140 Belmont Ave., Chicago, Ill., *'Crescent'—C, SH, S, TH, P, PS, PS, B
- CROWE NAME PLATE & MFG. CO., 3701 Ravenswood Ave., Chicago, Ill., *'Crowe'—P, S
- CRUCIBLE STEEL CO. OF AMERICA, 405 Lexington Ave., New York, N. Y.—PM
- WILBUR B. DRIVER CO., 150 Riverside Ave., Newark, N. J.—N
- DRIVER-HARRIS CO., Harrison, N. J.—N, TP
- DUAL REMOTE CONTROL CO., 31776 W. Warren St., Wayne, Mich., *'Ducon'—S
- *DUCON, Dual Remote Control Co.
- D-X RADIO PRODUCTS CO., 1575-1579 Milwaukee Ave., Chicago, Ill.—C
- HUGH H. EBY, INC., 4700 Stenton Ave., Phila., Pa.—S
- ELECTRO-VOICE MFG. CO., 1239 South Bend Ave., South Bend, Ind.—DC
- GEORGE D. ELLIS & SONS, INC., 309 N. 3rd St., Phila., Pa.—S, TH
- EMPIRE NOTION CO., 105 E. 29th St., New York, N. Y.—S
- ERIE CAN CO., 816 Erie St., Chicago, Ill.—C, S, TH
- ESSEX WIRE CORP., 14310 Woodward Ave., Detroit, Mich.—CW
- FANSTEEL METALLURGICAL CORP., 46 W. 22nd St., N. Chicago, Ill.—M, T, TA
- FISCHER DISTRIBUTING CORP., 222 Fulton St., New York, N. Y.—A, B, C, CM, F, G, L, M, N, P, PM, R, SH, S, T, TH, TP, TA
- GENERAL CEMENT MFG. CO., 919 Taylor Ave., Rockford, Ill.—A, F, P, G
- GENERAL ELECTRIC CO., Schenectady, N. Y.—PM
- GENERAL EXTRUSION CORP., 181 Long Ave., Hillside, N. J.—A, Z
- GENERAL RADIO CO., 30 State St., Cambridge, Mass., *'G-R'—C, P, R
- *G-R, General Radio Co.
- GOAT RADIO TUBE PARTS, INC., 314 Dean St., Brooklyn, N. Y.—S, TP
- L. F. GRAMMES & SONS, INC., 366 Union St., Allentown, Pa.—S
- ROBERT M. HADLEY CO., 709 E. 61st St., Los Angeles, Calif.; P.O. Box 456, Newark, Del., *'Hadley'—C, L, P, R, SH, TH
- HARRISON RADIO CO., 12 W. Broadway, New York, N. Y.—A, C, P, R
- HOSKINS MFG. CO., 4445 Lawton Ave., Detroit, Mich.—N
- HUNTER PRESSED STEEL CO., Lansdale, Pa.—S
- *ICA, Insuline Corp. of America
- INSULINE CORP. OF AMERICA, 30-30 Northern Blvd., Long Island City, N. Y.—A, B, C, P, R, SH, S, CM
- INTERNATIONAL NICKEL CO., INC., 67 Wall St., New York, N. Y.—N
- CHARLES JACK MFG. CORP., 27 E. Philadelphia St., York, Pa.—P, R

- E. F. JOHNSON CO., Waseca, Minn.—A
- JOHNSTON TIN FOIL & METAL CO., 6106 S. Broadway, St. Louis, Mo.—F
- KARP METAL PRODUCTS CO., 129 30th St., Brooklyn, N. Y.—C, P, R, SH, S, TH
- KING LABORATORIES, INC., 205 Oneida St., Syracuse, N. Y.—SCM, TB
- LAFAYETTE RADIO CORP., 100 6th Ave., New York, N. Y.—A, C, P, R, SH
- LE FEBURE CORPORATION, 716 Oakland Blvd., Cedar Rapids, Iowa—C, P, R
- P. R. MALLORY & CO., INC., 3029 E. Washington St., Indianapolis, Ind.—M, T
- J. W. MILLER CO., 5917 S. Main St., Los Angeles, Calif., *'Miller'—C, S
- MONTGOMERY WARD & CO., 619 W. Chicago Ave., Chicago, Ill.—C, P, R, SH
- NATIONAL COMPANY, 61 Sherman St., Malden, Mass., *'National'—C, P, R
- NEW ART SPECIALTIES, INC., 816 W. Erie St., Chicago, Ill.—S
- NORWALK TRANSFORMER CORP., South Norwalk, Conn., *'Norwalk'—CM, L, PM, TH
- PAR METAL PRODUCTS CORP., 32-62 49th St., Long Island City, N. Y., *'Par Metal'—P, SH
- PAUL & BEEKMAN, 4250 Wissahickon Ave., Phila., Pa.—C, SH, S, TH
- GEORGE F. PETTINOS, INC., 1206 Locust St., Phila., Pa.—G
- RACON ELECTRIC CO., INC., 52 E. 19th St., New York, N. Y.—PM, SH
- RADIO ELECTRIC SERVICE CO., INC., N. W. Cor. 7th & Arch Sts., Phila., Pa.—A, C, P, R, SH, S
- RADOLEK COMPANY, 601 W. Randolph St., Chicago, Ill.—A, B, C, P, R, SH
- THE RIVERSIDE METAL CO., Pavilion Ave., Riverside, N. J.—N, PB, BC, SMX
- MAXWELL SMITH CO., 1027 N. Highland Ave., Hollywood, Calif.—P, R, S
- STANLEY TOOLS, New Britain, Conn.—S
- STEWART STAMPING CORP., 621 E. 216th St., New York, N. Y.—S
- SORENG-MANEGOLD CO., 1901 Clybourn Ave., Chicago, Ill.—S
- STROMBERG-CARLSON TELEPHONE MFG. CO., 100 Carlson Rd., Rochester, N. Y.—R
- SUN RADIO CO., 212 Fulton St., New York, N. Y.—A, C, P, R, SH, S
- THOMAS & SKINNER STEEL PRODS. CO., 1107 E. 23rd St., Indianapolis, Ind.—L, PM, S, TH
- THORDARSON ELECTRIC MFG. CO., 500 W. Huron St., Chicago, Ill.—TH
- UNITED RADIO MFG. CO., 191 Greenwich St., New York, N. Y.—A
- WILCOX ELECTRIC CO., INC., 4014 State Line, Kansas City, Kans.—P, R
- X-L RADIO LABORATORIES, 420 W. Chicago Ave., Chicago, Ill.—A, B, S, S

METAL, ORE & OIL LOCATORS



- Geophysical prospecting instruments (ore & oil) G
- Pipe locators P
- 'Treasure' locators T

- ALLIED RADIO CORP., 833 W. Jackson Blvd., Chicago, Ill.—G, P, T
- BARKER & WILLIAMSON, Ardmore, Pa.—G, P, T
- ENGINEERING RESEARCH CORP., 909 Giddens Lane Bldg., Shreveport, La.—P, T
- FISHER RESEARCH LABS., Palo Alto, Calif.—G, P, T

• CLASSIFIED RADIO DIRECTORY •

RADOLEK COMPANY, 601 W. Randolph St., Chicago, Ill.—T
RCA MFG. CO., INC., Camden, N. J.—G
SPRAGUE PRODUCTS CO., North Adams, Mass.—P, T

MICROPHONES



Cable (see Wire)
 Carbon CAR
 Condenser CON
 Contact CT
 Crystal CRY
 Dynamic DYN
 Home broadcasting HB
 Velocity VEL
 Accessories ACC
 Connectors CTR
 Stands STD
 Springs SPR
 Home broadcasting (wireless) HBW
 P. M. dynamic microphones PM
 Felt feet FF

AIRPLANE & MARINE DIRECTION FINDER CORP., Clearfield, Pa.—CAR
ALDEN PRODUCTS CO., 715 Center St., Brockton, Mass.—CTR
ALLIED BURNS CO., 1008 Madison Ave., Toledo, Ohio—CAR, DYN, VEL, ACC
ALLIED ENGINEERING INSTITUTE, 85 Warren St., New York, N.Y.—HBW
ALLIED RADIO CORP., 833 W. Jackson Blvd., Chicago, Ill.—CAR, CON, CT, CRY, DYN, HB, VEL, ACC, CTR, STD, SPR
AMERICAN CONDENSER CORP., 2508 S. Michigan Ave., Chicago, Ill.—CON
AMERICAN MICROPHONE CO., INC., 1915 Western Ave., Los Angeles, Calif.—*American—CAR, CON, CRY, DYN, HB, VEL, ACC, CTR, STD, SPR
AMERICAN PHENOLIC CORP., 1250 Van Buren St., Chicago, Ill.—*Amphenol—ACC, CTR
AMPERITE COMPANY, 561 Broadway, New York, N. Y.—*Amperite—CT, VEL, STD, DYN
 *AMPHENOL, American Phenolic Corp.
ART SPECIALTY CO., 1115 N. Franklin St., Chicago, Ill.—ACC, STD
ASTATIC MICROPHONE LABORATORY, INC., 830 Market St., Youngstown, Ohio—*Astatic—CRY, STD, DYN
ATLAS SOUND CORP., 1451 39th St., Brooklyn, N. Y.—*Atlas Velvet Action—ACC, CTR, STD, SPR
AUDIOGRAPH SOUND SYSTEMS, 1313 W. Randolph St., Chicago, Ill.—CON, CRY, DYN, CT, STD
BANK'S MFG. CO., 5019 N. Winthrop Ave., Chicago, Ill.—DYN, HB
BARKER & WILLIAMSON, Ardmore, Pa.—CON
BELFONE, Bell Sound Systems, Inc.
BELL SOUND SYSTEMS, INC., 1183 Essex Ave., Columbus, Ohio—*Belfone—CRY, DYN, VEL, STD
BIRNBACH RADIO CO., INC., 145 Hudson St., New York, N. Y.—ACC, CTR
W. C. BRAUN, INC., 601 W. Randolph St., Chicago, Ill.—STD
I. R. BRAWLEY FELT CO., INC., 275-20th St., Brooklyn, N. Y.—FF
BRUNO LABORATORIES, INC., 30 W. 15th St., New York, N. Y.—*Bruno, *Velotron—VEL, ACC, CTR, STD, SPR
BRUSH DEVELOPMENT CO., 3311 Perkins Ave., Cleveland, Ohio—CRY, ACC, CTR, STD, CT
BUD RADIO, INC., 5205 Cedar Ave., Cleveland, Ohio—STD
 *BULLET, Transducer Laboratories
CANNON ELECTRIC DEVELOPMENT CO., 420 West Ave., 33 Los Angeles, Calif.—ACC, CTR
CARRIER MICROPHONE CO., 439 So. La Brea Ave., Inglewood, Calif.—CON, DYN, VEL
CINEMA ENGINEERING CO., 1508 S. Verdugo Ave., Burbank, Calif.—*Cinema—CON, STD
CRUMPACKER DISTRIBUTING CORP., 1801 Fannin St., Houston, Tex.—CAR, CON, CT, CRY, DYN, HB, VEL, ACC, CTR, STD, SPR
DE VRY CORPORATION, 1111 Armitage Ave., Chicago, Ill.—CRY, DYN, VEL
EASTERN MIKE-STAND CO., 56 Christopher St., Brooklyn, N. Y.—*Eastern—ACC, CTR, STD
ELECTRICAL INDUSTRIES MFG. CO., Red Bank, N. J.—CAR
ELECTRO-VOICE MFG. CO., 1239 South Bend Ave., South Bend, Ind.—*Electro-Voice—CAR, DYN, VEL, ACC, CTR, STD, SPR

ERWOOD SOUND EQUIPMENT CO., 224 W. Huron St., Chicago, Ill.—CON, CRY, DYN, ACC, STD, CTR
FISCHER DISTRIBUTING CORP., 222 Fulton St., New York, N. Y.—CAR, CON, CT, CRY, DYN, HB, VEL, ACC, CTR, STD, SPR
GALVIN MFG. CORP., 4545 Augusta Blvd., Chicago, Ill.—*Motorola—CAR
GENERAL CEMENT MFG. CO., 919 Taylor Ave., Rockford, Ill.—CAR, ACC, SPR
GENERAL ELECTRIC CO., Schenectady, N. Y.—CON, HB
GLOBE PHONE MFG. CORP., Reading, Mass.—CAR, DT, CRY, DYN, VEL
THE HALLDORSON CO., 4500 Ravenswood Ave., Chicago, Ill.—STD
HARRISON RADIO CO., 12 W. Broadway, New York, N. Y.—CAR, CON, CT, CRY, DYN, VEL, ACC, CTR, STD, SPR
HUNTER PRESSED STEEL CO., 8th St. & Maple Ave., Lansdale, Pa.—SPR
 *ICA, Insuline Corp. of America
INSULINE CORP. OF AMERICA, 30-30 Northern Blvd., Long Island City, N. Y.—*ICA—CAR
HOWARD B. JONES, 2300 Wabansia Ave., Chicago, Ill.—CT
KELLOGG SWITCHBOARD & SUPPLY CO., 6650 S. Cicero Ave., Chicago, Ill.—CAR
KAAR ENGINEERING CO., 619 Emerson St., Palo Alto, Calif.—*Kaar—CAR
LAFAYETTE RADIO CORP., 100 6th Ave., New York, N. Y.—CAR, CT, CRY, DYN, HB, VEL, ACC, CTR, STD, SPR
THE LIFETIME CORP., 1825 Adams St., Toledo, Ohio—CAR, CON, DYN, VEL, ACC, STD, SPR
THE LINCROPHONE CO., INC., 1661 Howard Ave., Utica, N. Y.—CRY, DYN, VEL
M & H SPORTING GOODS CO., 512 Market St., Phila., Pa.—CAR, CT, CRY, DYN, VEL, ACC, CTR, STD, SPR
JOHN MECK INDUSTRIES, 1313 W. Randolph St., Chicago, Ill.—*Audiograph—CRY, DYN, VEL, ACC, CTR, STD
MILES REPRODUCER CO., INC., 812 Broadway, New York, N. Y.—CAR, CON, CT, CRY, D, HB, ACC, STD, SPR
MONTGOMERY WARD & CO., 619 W. Chicago Ave., Chicago, Ill.—CAR, CRY, VEL, CT, DYN, ACC, CTR, STD
 *MOTOROLA, Galvin Mfg. Corp.
 *MYSTIC MIKE, Olson Mfg. Co.
NATIONAL DOBRO CORP., 400 S. Peoria St., Chicago, Ill.—CRY, STD
OLSON MFG. CO., 362 Wooster Ave., Akron, Ohio—*Mystic Mike—CAR, HB
OPERADIO MFG. CO., St. Charles, Ill.—CRY, DYN, VEL, STD
PARAPHONE HEARING AID, INC., 4300 Euclid Ave., Cleveland, Ohio—CAR
 *PERMANIC, Quam-Nichols Co.
PHILMORE MFG. CO., 113 University Place, New York, N. Y.—*Philmore—CAR, DYN
PHONOTONE LABORATORIES, INC., S. E. 15th St., Washington, Ind.—CRY, DYN, VEL, ACC, CTR, STD
QUAM-NICHOLS CO., 33rd Pl. & Cottage Grove Ave., Chicago, Ill.—*Permanic—DYN
RACON ELEC. CO., INC., 52 E. 19th St., New York, N. Y.—DYN
RADIO ELECTRIC SERVICE CO., INC., N. W. Cor. 7th & Arch Sts., Phila., Pa.—CAR, CON, CT, CRY, DYN, HB, VEL, ACC, CTR, STD, SPR
RADIO RECEPTOR CO., INC., 251 W. 19th St., New York, N. Y.—*Radio Receptor—DYN
RADIOTONE, INCORPORATED, 7356 Melrose Ave., Hollywood, Calif.—CRY, DYN, STD
RADOLEK COMPANY, 601 W. Randolph St., Chicago, Ill.—CAR, CT, CRY, DYN, HB, VEL, ACC, CTR, STD, SPR, CON
RCA MFG. CO., INC., Front & Cooper Sts., Camden, N. J.—*RCA—DYN, HB, VEL, ACC, CTR, STD, CRY
REMLER CO., LTD., 2101 Bryant St., San Francisco, Calif.—*Remler—CRY, ACC, CTR, STD
ROWE INDUSTRIES, INC., 3120 Monroe Street, Toledo, Ohio—CT
MAURICE SCHWARTZ & SON, 710-712 Broadway, Schenectady, N. Y.—CAR, CON, CT, CRY, DYN, HB, VEL, ACC, CTR, STD, SPR
SELECTAR MFG. CORP., 30 W. 15th St., New York, N. Y.—HB, VEL, ACC, CT
SETCHELL CARLSON, INC., 2233 University Ave., St. Paul, Minn.—CTR
SHURE BROTHERS, 225 W. Huron St., Chicago, Ill.—CAR, CON, CRY, DYN, ACC, CT, STD, SPR
MARK SIMPSON DIST. CO., INC., 16 Hudson St., New York, N. Y.—STD
SOUND APPARATUS CO., 150 W. 46th St., New York, N. Y.—CAR, CON, CRY, DYN, STD
SPEAK-O-PHONE RECORDING & EQUIPMENT CO., 23 W. 60th St., New York, N. Y.—*Speakophone—CRY, STD, DYN, CT, CAR
STROMBERG-CARLSON TELEPHONE MFG. CO., 100 Carlson Rd., Rochester, N. Y.—CAR
SUN RADIO CO., 212 Fulton St., New York, N. Y.—CAR, CON, CT, CRY, DYN, HB, VEL, ACC, CTR, STD, SPR
SUNDT ENGINEERING COMPANY, 4757 Ravenswood Ave., Chicago, Ill.—CRY
TIBBETTS LABORATORIES, Camden, Me.—CRY

TRANSDUCER LABORATORIES, 42 W. 48th St., New York, N. Y.—DYN
THE TURNER CO., 909 17th Ave., Cedar Rapids, Iowa—CRY, DYN, HB, ACC, STD
UNIVERSAL MICROPHONE CO., Inglewood, Calif.—CAR, CON, CRY, DYN, VEL, ACC, STD, SPR
 *VELOTRON, Bruno Laboratories, Inc.
VIBRALOC MFG. CO., 1273 Mission St., San Francisco, Calif.—DYN, VEL
THE WEBSTER-CHICAGO CORP., 5622 W. Bloomingdale Ave., Chicago, Ill.—*Webster-Chicago—CRY, DYN, VEL, ACC, STD
 *WEBSTER-CHICAGO—The Webster-Chicago Corp.
WESTERN ELECTRIC CO., 300 Central Ave., Kearny, N. J.—CAR, CON, DYN, ACC, CTR, STD

NOISE ELIMINATION EQUIPMENT



Interference analyzers . . . IA
 Interference locators . . . I
 Power filters P
 Radio set filters S
 Industrial noise analyzers . . INA

AEROVOX CORPORATION, 740 Belleville Ave., New Bedford, Mass.—IA, I, P, S
AMERICAN COMMUNICATIONS CORP., 123 Liberty St., New York, N. Y.—IA, I, P, S
AUTOMATIC ELECTRIC MFG. CO., 729 S. Front St., Mankato, Minn.—P
BELDEN MFG. CO., 4647 W. Van Buren St., Chicago, Ill.—S
BENDIX RADIO CORP., 920 E. Fort Ave., Baltimore, Md.—I
L. S. BRACH MFG. CORP., 55 Dickerson St., Newark, N. J.—S
BUD RADIO, INC., 5205 Cedar Ave., Cleveland, Ohio—*Bud—P
CONSOLIDATED WIRE & ASSOC. CORPS., Peoria & Harrison Sts., Chicago, Ill.—S
CONTINENTAL CARBON, INC., 13900 Lorain Ave., Cleveland, Ohio—*Continental, *Filternoys—P, S
CORNELL-DUBILIER ELEC. CORP., South Plainfield, N. J.—*Quietone—P, S
ELECTRO PRODUCTS LABORATORIES, 549 W. Randolph St., Chicago, Ill.—P, S
***ELIM-O-STAT**, Solar Mfg. Co.
FERRIS INSTRUMENT CORP., Boonton Ave., Boonton, N. J.—*Ferris—IA, I
 *FILTERNOYS, Continental Carbon, Inc.
GENERAL ELECTRIC CO., Pittsfield, Mass.—P
GENERAL WINDING CO., 254 W. 31st St., New York, N. Y.—*Gen-Win—P, S
 *GEN-WIN, General Winding Co.
GIRARD-HOPKINS, 1437 23rd Ave., Oakland, Calif.—S
THE HALLDORSON CO., 4500 Ravenswood Ave., Chicago, Ill.—S
 *ICA, Insuline Corp. of America
INSULINE CORP. OF AMERICA, 30-30 Northern Blvd., Long Island City, N. Y.—*ICA—P, S
INTERNATIONAL TRANSFORMER CO., 17 W. 20th St., New York, N. Y.—P
MEISSNER MFG. CO., 7th & Belmont, Mt. Carmel, Ill.—S
J. W. MILLER CO., 5917 S. Main St., Los Angeles, Calif.—*Miller—IA, I, P, S
OHMITE MFG. CO., 4835 W. Flournoy St., Chicago, Ill.—P
PHILCO RADIO & TELEVISION CORP., Tioga & C Sts., Phila., Pa.—P, S
PHILMORE MFG. CO., 113 University Place, New York, N. Y.—*Philmore—P, S
POTTER COMPANY, 1950 Sheridan Rd., North Chicago, Ill.—P, S
 *QUIETONE, Cornell-Dubilier Elec. Corp.
RCA MFG. CO., INC., Front & Cooper Sts., Camden, N. J.—IA, I, S
SNYDER, INCORPORATED, 813-23 Noble St., Phila., Pa.—P
SOLAR MFG. CORP., Bayonne, N. J.—*Elim-O-Stat—P, S
SPRAGUE PRODUCTS CO., No. Adams, Mass. IA, I, P
 *TACO, Technical Appliance Corp.
TECHNICAL APPLIANCE CORP., 17 E. 16th St., New York, N. Y.—*Taco—S
TEFFT RADIO CO., Plymouth, Mich.—I
TELEVISO COMPANY, 341 N. Pulaski Rd., Chicago, Ill.—IA, INA
TOBE DEUTSCHMANN CORP., Canton, Mass.—IA, I, P, S
 *UTC—United Teletone Corp.
UNITED TELEPHONE CORP., 150 Varick St., New York, N. Y.—*UTC—P
EARL WEBBER CO., 1313 W. Randolph St., Chicago, Ill.—*Webber—I

NOW READY FOR DELIVERY!

You receive Valuable subscription to **RADIO-CRAFT**
 PLUS A FREE COPY of 1940 Radio-Television Reference Annual

WITH our compliments, we want to send a copy of the 1940 RADIO-TELEVISION REFERENCE ANNUAL to you FREE, if you will simply take advantage of RADIO-CRAFT magazine's special subscription offer NOW. This offer is being made for a limited time only.

The 1940 RADIO-TELEVISION REFERENCE ANNUAL has 68 pages, large size 8½ x 11½, with over 170 illustrations. The contents of this book has never appeared before in handy book form. Its pages cover practically every branch of radio sound, public address, servicing, television, construction articles for advanced radio men and technicians, time and money-saving kinks, wrinkles, useful circuit information, "ham" transmitters and receivers, and a host of other data.

The Annuals have always been regarded as a standard reference work for every practical branch of radio operation and service. This 1940 edition ably sustains this reputation. Every radio man wants a copy of this valuable book. Just as this book will be of unquestionable value to you, so, too, will every monthly issue of RADIO-CRAFT. This magazine brings you big value every month. It keeps you intelligently informed about new developments in radio and television. You want the news, want it fully but concisely, want it first—that is why you should read RADIO-CRAFT regularly.

This very special offer is made for just one purpose—we want you as a regular subscriber. The Annual, whose contents appears at the right, is not sold, but a copy is FREE to you if you subscribe now.

**SAME SIZE AS
 RADIO-CRAFT**



THIS COUPON BRINGS YOU THE ANNUAL

RADIO-CRAFT • 20 VESEY STREET • NEW YORK, N. Y.

Gentlemen: Enclosed you will find One Dollar for which enter my subscription to RADIO-CRAFT Magazine for Eight Months. Send me **ABSOLUTELY FREE** and **POSTPAID**, my copy of 1940 RADIO-TELEVISION REFERENCE ANNUAL.

This is a new order Extend My Present Subscription

NAME ADDRESS

CITY STATE

DON'T DELAY — MAIL TODAY! RC-1240

Read the summary of contents in this FREE BOOK!

THE 1940 RADIO-TELEVISION REFERENCE ANNUAL contains a collection of the best and most important articles. Covering as they do nearly every branch of radio, they form a handy reference works. In addition, many time and labor-saving kinks, circuits and wrinkles, tried and tested by practicing Servicemen, experimenters and radio fans have been included. This book cannot be bought anywhere at any price. Yet it is yours by merely subscribing. Use the convenient coupon below.

BEGINNER'S SIMPLE INEXPENSIVE CONSTRUCTION ARTICLES

Beginner's Breadboard Special - a 1-Tube High-Gain All-Wave Receiver—Wiring Pointers for Radio Beginners—A Watch Charm Size 1-Tube Set—Beginner's Simple Volt-Milliammeter—Making a 1-Tube Broadcast Loop Receiver—A.C.-D.C. Power Supply for Battery Portables—A 1-Tube Short-Waver with Band Coil Switching.

MORE ADVANCED SET CONSTRUCTION

The "High-Seas 4" Broadcast Lamp Radio—How to Build a 6-Tube 1.4-Volt Short-Wave Superhet for the "Ham" or Short-Wave Fan—Build the "Lunch Box 5" Super Set - a Broadcast Battery Portable—How to Build a Plug-Together 8 Tube Broadcast Set—The "5-in-4" All-Wave Radio for A.C. Operation—An Easily-Built 3-Tube Midget Broadcast Superheterodyne Receiver.

THE SERVICEMEN'S SECTION

Bass Tone Control—Simplified Variable Selectivity—Practical Servicing Pointers—Servicing Universal A.C.-D.C. Receivers—Killing the "Intermittent" Bug—A Service Shop A.C. to D.C. Power Supply—Sideline Money for Servicemen—Adding A.V.C. to any Screen-Grid T.R.F. Receiver—Iron Particles in Speaker Air Gap.

TEST INSTRUMENTS

A Useful Neon Lamp Tester—An Inexpensive Output Meter—Making Milliammeter Multipliers—Home-Made Frequency Modulator—The Busy Servicemen's V.T. Volt-Meter.

PUBLIC ADDRESS AND AMPLIFIERS

Build this Combination A.C.-D.C. Radio and Inter-Communicator—Speaker Placement in P.A. Work—The Design and Construction of an Inexpensive All-Push-Pull 10-Watt Amplifier—Obscure Sources of Hum in High-Gain Amplifiers—How to Build a High-Fidelity 5-Watt Versatile Amplifier.

"HAM" SECTION

Ultra-High Frequency Antennas—The Beginner's Low-Cost Xmitter—Modulator Meter—Phone Monitor—The Beginner's "Ham" Receiver—2½ Meter Acorn Transceiver.

TELEVISION

How to Build a 441 Line T.R.F. Television Receiver—Useful Notes on Television Antennas.

MISCELLANEOUS

Simple Photo-Cell Relay Set Up—Making a Burglar Alarm—How to Build A.C.-D.C. Capacity Relay—How to Make a Modern Radio Treasure Locator.

USEFUL KINKS, CIRCUITS AND WRINKLES

Making a Flexible Coupler—Two-Timing Chime—A Simple Portable Aerial—An Improvised Non-Slip Screw-Driver. NOTE: The book contains numerous other useful Kinks, Circuits and Wrinkles, not listed here.

(approximately)

45 ARTICLES

(approximately)

170 ILLUSTRATIONS

68 BIG PAGES

**RADIO-CRAFT
 20 VESEY STREET
 NEW YORK, N. Y.**

CLASSIFIED RADIO DIRECTORY

PAINT, CEMENT & WAX PRODUCTS



Cement	C
Coil dopes	CD
Enamels	E
Insulating compounds	I
Lacquers	L
Paint	P
Resins	R
Rubber (liquid & plastic)	RU
Self-designing paints & enamels	SPE
Solvents	S
Varnish	V
Wax	W

ALDEN PRODUCTS CO., 715 Center St., Brockton, Mass.—C, E, L, I
ALLIED RADIO CORP., 833 W. Jackson Blvd., Chicago, Ill.—C, E, I, L, P, V, W
 AMERICAN PHENOLIC CORP., 1250 Van Buren St., Chicago, Ill.—*Amphenol"—C, I
 *AMPHENOL, American Phenolic Corp.
 BUD RADIO, INC., 5205 Cedar Ave., Cleveland, Ohio—L
 CARRON MFG. CO., 415 S. Aberdeen St., Chicago, Ill.—C
 CELLULOID CORPORATION, 10 E. 40th St., New York, N. Y.—C
 CONSOLIDATED WIRE & ASSOCIATED CORPS., 512 S. Peoria St., Chicago, Ill.—C, E, I, L, P, V, W
 *CROLITE, Henry L. Crowley & Co.
 HENRY L. CROWLEY & CO., 1 Central Ave., West Orange, N. J., *Crolite"—C
 CRUMPACKER DISTRIBUTING CORP., 1801 Fannin St., Houston, Tex.—C, I
 D-X RADIO PRODUCTS CO., 1575 Milwaukee Ave., Chicago, Ill.—C
 FISCHER DISTRIBUTING CORP., 222 Fulton St., New York, N. Y.—C, E, I, L, P, V, W
 *G-C, General Cement Mfg. Co.
 GENERAL CEMENT MFG. CO., 919 Taylor Ave., Rockford, Ill., *G.C.—P, E, I, L, C, V, W
 GENERAL ELECTRIC CO., Schenectady, N. Y.—C, I, P, W, E, L, V
 GENERAL ELECTRIC CO., 1285 Boston Ave., Bridgeport, Conn. *GE"—C
 HARRISON RADIO CO., 12 W. Broadway, New York, N. Y.—C, E, I, L
 *HARVEL, Irvington Varnish & Insulator Co.
 *ICA, Insuline Corp. of America
 INSULINE CORP. OF AMERICA, 30-30 Northern Blvd., Long Island City, N. Y., *ICA"—C, L
 INSULATION MANUFACTURERS CORP., 565 W. Washington Blvd., Chicago, Ill.—C, E, I, L, V, W
 IRVINGTON VARNISH & INSULATOR CO., 18 Argyle Terrace, Irvington, N. J., *Irvington," *Harvel"—E, P, R, V
 J. F. D. MFG. CO., 4111 Ft. Hamilton Pkwy., Brooklyn, N. Y., *JFD"—C
LAFAYETTE RADIO CORP., 100 6th Ave., New York, N. Y.—C, E, I, L, P, V, W
 M & H SPORTING GOODS CO., 512 Market St., Phila., Pa.—C
 MAAS & WALDSTEIN CO., 438 Riverside Ave., Newark, N. J.—C, E, I, L, P, V, W
 MAGIC ART PAINT CO., Box 23, Hasbrouck Heights, N. J.—P, SPE
MEISSNER MFG. CO., 7th & Belmont, Mt. Carmel, Ill.—C
 MICA INSULATOR CO., 200 Varick St., New York, N. Y., *Mico"—V
 *MICO, Mica Insulator Co.
 NASH RADIO PRODUCTS CO., 6267 Gravois Ave., St. Louis, Mo.—C, E, L, P, V, W
 GEORGE F. PETTINOS, INC., 1206 Locust St., Phila., Pa.—C
 POINSETTIA, INC., Pitman, N. J.—W
RADOLEK COMPANY, 601 W. Randolph St., Chicago, Ill.—C, E, I, L, P, V, W
 ROXALIN FLEXIBLE LACQUER CO., Elizabeth, N. J.—E, L, P
 MAURICE SCHWARTZ & SON, 710-712 Broadway, Schenectady, N. Y.—C, E, I, L, P, V, W
 WALTER L. SCHOTT CO., 5264 W. Pico Blvd., Los Angeles, Calif.—*Walsco"—C, E, L, S, W
 SELF-VULCANIZING RUBBER CO., INC., 605 W. Washington Blvd., Chicago, Ill.—C, I, RU
 SMOOTH-ON MFG. CO., 572 Communipaw Ave., Jersey City, N. Y.—C
 SUN RADIO CO., 212 Fulton St., New York, N. Y.—C, I
 TELERADIO ENGINEERING CORP., 484-90 Broome St., New York, N. Y.—L, W
 VULCAN ELECTRIC CO., 600 Broad St., Lynn, Mass.—W
 *WALSCO, Walter L. Schott Co.
 THE WEBSTER-CHICAGO CORP., 5622 Bloomingdale Ave., Chicago, Ill., *Webster-Chicago"—CRY, DYN, ACC, STD
 *WEBSTER-CHICAGO—The Webster-Chicago Corp.
 ZOPHAR MILLS, INC., 112 26th St., Brooklyn, N. Y.—C, I, W

PLASTICS



Cellulose acetate	C
Phenols	PH
Polystyrene	P
Lucite	L

BAKELITE CORPORATION, 247 Park Ave., New York, N. Y., *Bakelite"—C, PH, P
 BUD RADIO, INC., 5205 Cedar Ave., Cleveland, Ohio, *Bud"—L
 CELLULOID CORPORATION, 10 E. 40th St., New York, N. Y.—C
 E. I. DUPONT DE NEMOURS & CO., INC., Plastics Dept., 626 Schuyler Ave., Arlington, N. J.—L
 DUREZ PLASTICS & CHEMICALS, INC., North Tonawanda, N. Y., *Durez"—PH
 GENERAL ELECTRIC CO., Schenectady, N. Y., *Textolite"
 *INSUROK, Richardson Co.
 NATIONAL VULCANIZED FIBRE CO., Wilmington, Del., *Phenolite"—PH
 *PHENOLITE, National Vulcanized Fibre Co.
 RICHARDSON COMPANY, 27th & Lake Sts., Melrose Park, Ill., *Insurok"
 *TEXTOLITE, General Electric Co.

PLASTIC MOLDERS



Cabinet molders	C
Small parts molders	P

ALDEN PRODUCTS CO., 715 Center St., Brockton, Mass.—P
ALLIED RADIO CORP., 833 W. Jackson Blvd., Chicago, Ill.—C, P
 AMERICAN INSULATOR CORP., New Freedom, Pa.—C, P
 AMERICAN PHENOLIC CORP., 1250 Van Buren St., Chicago, Ill., *Amphenol"—P
 AMERICAN RADIO HARDWARE CO., 476 Broadway, New York, N. Y., *Arhco"—P
 *AMPHENOL, American Phenolic Corp.
 *ARHCO, *American Radio Hardware Co.
 ASSOCIATED ATTLEBORO MFG., INC., Attleboro, Mass.—C, P
 AUBURN BUTTON WORKS, Auburn, N. J.—C, P
 BARBER-COLMAN CO., Rockford, Ill.—P
 BOONTON MOLDING CO., 326 Myrtle Ave., Boonton, N. J.—C, P
 *CELORON, Continental-Diamond Fibre Co.
 CHICAGO MOLDED PRODUCTS CO., 1030 Kolmar Ave., Chicago, Ill.—C, P
 CONTINENTAL-DIAMOND FIBRE CO., Newark, Del., *Celoron"—P
 HARRY DAVIES MOLDING CO., 1428 N. Wells St., Chicago, Ill.—C, P
 DUREZ PLASTICS & CHEMICALS, INC., North Tonawanda, N. Y., *Durez"—C, P
 HUGH H. EBY, INC., 4700 Stenton Ave., Philadelphia, Pa.—P
 ELECTRICAL INDUSTRIES MFG. CO., Red Bank, N. J.—P
 EMPIRE NOTION CO., 105 E. 29th St., New York, N. Y.—P
 ERIE RESISTOR CORP., Erie, Pa.—P
 GEMLOID CORPORATION, 79-10 Albion Ave., Elmhurst, L. I., *Gemute"—P
 *GEMUTE, Gemloid Corp.
 GENERAL ELECTRIC CO., Schenectady, N. Y.—C, P
 INSULATION PRODUCTS CO., Richland St. & Annon Way, Pittsburgh, Pa.—P
 *INSUROK, Richardson Co.
 JONES-ORME CO., 2233 University Ave., St. Paul, Minn.—P
 KURZ-KASCH, INC., 1421 S. Broadway, Dayton, Ohio—C, P
MEISSNER MFG. CO., 7th & Belmont, Mt. Carmel, Ill.—P
 MICAMOLD RADIO CORP., 1087 Flushing Ave., Brooklyn, N. Y.—P
 JAMES MILLEN MFG. CO., 150 Exchange St., Malden, Mass.—P
 ELMER E. MILLS CORP., 812 W. Van Buren St., Chicago, Ill.—P
 PARISIAN NOVELTY CO., 3510 S. Western Ave., Chicago, Ill.—P
 POINSETTIA, INCORPORATED, Pitman, N. J.—P
 RADIO KNOB COMPANY, 43 E. Ohio St., Chicago, Ill.—P
 REMLER CO., LTD., 2101 Bryant St., San Francisco, Calif., *Remler"—C, P
 RESINOX CORPORATION, 230 Park Ave., New York, N. Y.—C, P
 RICHARDSON COMPANY, 27th & Lake Sts., Melrose Park, Ill.—*Insurok"—C, P
 MAXWELL SMITH CO., 1027 N. Highland Ave., Hollywood, Calif.—P

SYRACUSE ORNAMENTAL COMPANY, Syracuse, N. Y.—C, P
 S. S. WHITE DENTAL MFG. CO., 10 E. 40th St., New York, N. Y.—P
 TELEX PRODUCTS CO., Minneapolis, Minn.—P

RADIO LOGS, MAPS & GLOBES



Amateur station logs	ASL
Geographical globes	GG
OSL & SWL card album	OSCA
Radio logs	RL
Radio globes	RG
Shortwave charts	SWC
World time clocks	WC
World's tour maps	WTM

GEORGE F. CRAM CO., 730 E. Washington St., Indianapolis, Ind.—GG, RL, M
 GORDON SPECIALTIES CO., 1104 S. Wabash Ave., Chicago, Ill.—OSCA, WC
 CARL GOOR PRINTING CO., INC., 2615 N. Ashland Ave., Chicago, Ill.—SWC
 HAYNES & RADIO LOG, P. O. Box 444, Park Ridge, Ill.—RL
LAFAYETTE RADIO CORP., 100 6th Ave., New York, N. Y.—WC, RL, ASL, RG
 RADIO INSTRUMENTS MFG. CO., 1131 Terry Rd., Jackson, Miss.—RL, RG
RCA MFG. CO., INC., Camden, N. J.—ASL, STM
 WEBER-COSTELLO CO., Chicago Heights, Ill.—RG, M, G

RECEIVING SETS (INCLUDING ADAPTERS & CONVERTERS)



All-wave	AW
Amateur	AM
Auto	A
Aviation	AV
Battery (home)	BH
Battery portable	BP
Commercial	COM
Direction finders	DF
Facsimile	FAC
Farm	F
Frequency Modulation (sets and/or adapters)	FM
Home	H
Home furniture	HF
Kits	K
Loop adapters	LA
Loop converters	LC
Loop receivers	LR
Marine	M
Phonograph—Radio	PR
Police	P
Police auto	PA
Radio—Recorder comb.	RR
Shortwave adapters	SWA
Shortwave auto converters	SWAC
Television	T
Shortwave	S
Shortwave auto converters	SWAS
Ultra-high frequency	UH

ABC RADIO LABORATORIES, 3334 N. New Jersey St., Indianapolis, Ind., *ABC"—SWAC
 *ADMIRAL—Continental Radio & Television Corp.
 AIR KING PRODUCTS CO., INC., 1523 63rd St., Brooklyn, N. Y., *Air King"—BP, F, FM, H, PR, T
 *AIRLINE, Montgomery Ward & Co.
 AIRPLANE & MARINE DIRECTION FINDER CORP., Clearfield, Pa.—AV, COM, DF, M, P, PA
 *AIR SCOUT—Allied Engineering Institute.
ALLIED ENGINEERING INSTITUTE, 85 Warren St., New York, N. Y., *Air Scout"—AM, M, P
ALLIED RADIO CORP., 833 W. Jackson Blvd., Chicago, Ill., *Knight"—A, BP, F, PR, T, AM, AV, BH, COM, FAC, FM, H, K, LA, LC, LR, M, P, PA, UH, AW, S, SA, SC
 AMERICAN COMMUNICATIONS CORP., 123 Liberty St., New York, N. Y.—COM, M, PR, P, PA

• CLASSIFIED RADIO DIRECTORY •

AMERICAN TELEVISION CORP., 130 W. 56th St., New York, N. Y.—T
 ANDREA RADIO CORP., 4820 48th Ave., Woodside, L. I., N. Y.—BP, H, PR, T, TK
 ANSLEY RADIO CORP., 4377 Bronx Blvd., New York, N. Y.—"Dynaphone"—COM, H, FM, LR, M, PR, AW, S
 *ARVIN—Noblitt-Sparks Industries, Inc.
 AUTOCRAT RADIO CO., 3855 N. Hamilton Ave., Chicago, Ill.—"Autocrat"—A, BP, F, H, PR
 AUTOMATIC RADIO MFG. CO., INC., 122 Brookline Ave., Boston, Mass.—A, BP, H, PR
 *AUTOPHONE—CAVALIER MOTORS ASSOCIATES, INC.
 BANK'S MFG. CO., 5091 N. Winthrop Ave., Chicago, Ill.—BP, M, PR, P, PA
 BARKER & WILLIAMSON, Ardmore, Pa.—AV, LR, M, P, PA, SWAC
 BASSETT RADIO MFG. CORP., Niles, Mich.—AV, COM, P, PA
 BEE ENGINEERING CO., 7665 Grand River Ave., Detroit, Mich.—P, PA
 BELL RADIO & TELEVISION, 125 E. 46th St., New York, N. Y.—"Bell"—A, F, H, T, PR
 BELMONT RADIO CORP., 1257 Fullerton Ave., Chicago, Ill.—"Belmont"—A, BP, F, H, PR, T, BH
 BENDIX RADIO CORP., 920 E. Fort. Ave., Baltimore, Md.—AV, LR
 BLILEY ELECTRIC CO., 200 Union Station Building, Erie, Pa.—C
 BOND PRODUCTS CO., 13139 Hamilton Ave., Detroit, Mich.—BP, H, PR, AW
 BROWNING LABORATORIES, INC., 750 Main St., Winchester, Mass.—"Browning"—AM, FM, K, PA, UH, AW, SWA, SWC
 BRUNSWICK RADIO DIV., Mersman Bros. Corp., 206 Lexington Ave., New York, N. Y.—HF
 CALVERT MOTORS ASSOCIATES, LTD., 1028 Linden Ave., Baltimore, Md.—A, H
 CANTON TRADING CO., 135 Liberty St., New York, N. Y.—"Kantola"—BP, H, PR
 CAVALIER MOTORS ASSOCIATES, LTD., 2028 Linden Ave., Baltimore, Md.—"Autophone," "Mobelette"—A, BP
 CHAMPION RADIO LABORATORIES, 14553 Madison Ave., Lakewood, Ohio—"Champion" "Victory," "Monarch" "LaSalle"—A, F, H, PR
 CINEMA ENGINEERING CO., 1508 W. Verdugo Ave., Burbank, Calif.—"Cinema"—COM
 COLONIAL RADIO CORP., 254 Rano St., Buffalo, N. Y.—A, BP, F, H, PR
 CONTINENTAL RADIO & TELEVISION CORP., 3800 W. Cortland St., Chicago, Ill.—"Admiral"—BP, F, H, PR, BH, AW, S, RRC
 THE CROSLLEY CORP., 1329 Arlington St., Cincinnati, Ohio—"Crosley"—A, BP, F, FAC, H, PR
 CRUMPACKER DIST. CORP., 1801 Fannin St., Houston, Tex.—A, AV, BH, BP, F, PR, P, PA
 DELCO RADIO DIVISION, General Motors Service, Kokomo, Ind.—A, F, H
 DETROLA CORPORATION, 1501 Beard Ave., Detroit, Mich.—"Detrola"—A, F, H, PR, P
 DE WALD RADIO MFG. CORP., 436 Lafayette St., New York, N. Y.—BP, H, COM, BH
 DOOLITTLE & FALKNER, INC., 7421 S. Loomis Blvd., Chicago, Ill.—P, PA, COM
 ALLEN B. DUMONT, 2 Maine Ave., Passaic, N. J.—"DuMont"—T
 *DYNAPHONE—Ansley Radio Corp.
 ELECTRICAL RESEARCH LAB., INC., 2020 Ridge Ave., Evanston, Ill.—"Erla," "Sentinel"—BP, F, H, PR
 *ELECTROTONE—Harris Mfg. Co.
 EMERSON RADIO & PHONOGRAPH CORP., 111 8th Ave., New York, N. Y.—BP, F, H, PT, T
 *ERLA—Electrical Research Lab., Inc.
 ESPEY MFG. CO., INC., 305 E. 63rd St., New York, N. Y.—BP, H, M, FM, LR, PR, T, AW
 FADA RADIO & ELECTRIC CO., 30-20 Thomson Ave., Long Island City, N. Y.—"Fada"—A, BP, F, FM, H, PR, T
 FARNSWORTH TELEVISION & RADIO CORP., 3700 Pontiac St. (Extended), Fort Wayne, Ind.—A, BP, COM, F, FM, H, PR, T, AM, AV, BH, M, P, PA, AW
 FEDERAL TELEGRAPH CO., 200 Mt. Pleasant Ave., Newark, N. J.—M
 FINCH TELECOMMUNICATIONS, INC., 1819 Broadway, New York, N. Y.—FAC
 GALVIN MFG. CORP., 4545 Augusta Blvd., Chicago, Ill.—"Motorola"—AM, A, AV, BT, COM, F, H, M, PR, P, PA, T
 GAROD RADIO CORP., 70 Washington St., Brooklyn, N. Y.—"Garod"—F, H, PR, TK
 GE—General Electric Co.
 GENERAL ELECTRIC CO., Schenectady, N. Y., & Bridgeport, Conn.—BP, F, FM, H, PR, A, BH, LR, P, PA, T, UH, AW, AV, S
 GENERAL TELEVISION & RADIO CORP., 511 S. Sangamon St., Chicago, Ill.—BP, F, H, PR
 GILFILLAN BROS., INC., 1815 Venice Blvd., Los Angeles, Calif.—"Gilfillan"—BP, F, H, PR, T
 GOLDENTONE RADIO CO., 15123 Warren Ave., Dearborn, Mich.—BH, BP, F, H, PR, AW
 GREBE MFG. CO., INC., 70 W. Washington St., Brooklyn, N. Y.—"Grebe"—BP, F, H, PR
 THE HALLICRAFTERS, 2611 Indiana Ave., Chicago, Ill.—AM, BP, COM, FM, H, M, UH, AW, S
 HAMMARLUND MFG. CO., INC., 424 W. 33rd St., New York, N. Y.—"Super-Pro"—AM, AV, COM, AW, S
 HARRIS MFG. CO., 2422 W. 7th St., Los Angeles, Calif.—"Electrotone"—PR

HARRISON RADIO CO., 12 W. Broadway, New York, N. Y.—AM, AV, BH, BP, CON, FAC, FM, K, LR, M, T, UH, AW, S, SA, SWAC
 HARVEY-WELLS COMMUNICATIONS, INC., Southbridge, Mass.—AV, COM, M, P, UH, PA
 HEINTZ & KAUFMAN, LTD., South San Francisco, Calif.—COM
 *HK—Heintz & Kaufman, Ltd.
 HOWARD RADIO CO., 1735 Belmont Ave., Chicago, Ill.—AM, BH, BP, COM, F, FM, H, LR, PR, AW
 JEFFERSON-TRAVIS RADIO MFG. CORP., 198 Milburn Ave., Baldwin, L. I., N. Y.—M, P, PA
 KAAR ENGINEERING CO., 619 Emerson St., Palo Alto, Calif.—"Kaar"—M, P, PA, UH
 KADETTE RADIO CORP., 200 Hill St., Ann Arbor, Mich.—BP, H, PR
 *KANTOLA—Canton Trading Co.
 KARADIO CORPORATION, 2233 University Ave., St. Paul, Minn.—"Karadio"—A, AV, BP, COM, M, P, PA
 KARNIS-WHITE CORP., 1775 Broadway, New York, N. Y.—BH, BP, COM, F, LR, M, P
 KINGSTON RADIO CO., INC., Kokomo, Ind.—"Kingston"—H, BH, F, LR, PR, S
 *KNIGHT, Allied Radio Corp.
 *LAFAYETTE, Radio Wire Television, Inc.
 LAFAYETTE RADIO CORP., 100 6th Ave., New York, N. Y.—AM, A, AV, BH, BP, COM, F, FM, H, K, LR, M, PR, UH, AW, S, SA, SC
 *LASALLE—Champion Radio Laboratories
 LAUREHK RADIO MFG. CO., 3918 Monroe Ave., Wayne, Mich.—"Laurehk," "Musique"—BP
 LEAR AVIATION, INC., Dayton Municipal Airport, Dayton, Ohio—AV
 FRED M. LINK, 125 W. 17th St., New York, N. Y.—P, PA, UH
 L'TATRO MFG. CO., 417 W. Water St., Decorah, Iowa—BP, F, H
 MAJESTIC RADIO & TELEVISION CO., 2600 W. 50th St., Chicago, Ill.—"Majestic"—BP, F, H, PR, BH, FM, LR, P, PA, AW, S
 MANSLEY RADIO CORP., 182 Milburn Ave., Baldwin, N. Y.—AV, M, P, PA
 MARCONIPHONE, INC., 679 Madison Ave., New York, N. Y.—"Marconiphone"—H, PR
 MARINEPHONE INC., 123 Liberty St., New York, N. Y.—M
 MARINE RADIO CORP., 117-19 168th St., Jamaica, N. Y.—"Marine"—AM, AV, COM, A, FM, M, P, PA, AW, S
 MEISSNER MFG. CO., Mt. Carmel, Ill.—AM, BP, FM, T, K, SA
 MIDWEST RADIO CORP., 909 Broadway, Cincinnati, Ohio—"Midwest"—H, AM, AW
 JAMES MILLEN MFG. CO., INC., 150 Exchange St., Malden, Mass.—AM, AV, COM, FM, UH
 *MOBILETTE—Cavalier Motors Associates, Inc.
 *MONARCH—Champion Radio Laboratories
 MONTGOMERY WARD & CO., 619 W. Chicago Ave., Chicago, Ill.—"Airline"—AM, A, BP, F, H, BH, FM, LR, PR, AW, S, K
 *MOTOROLA—Galvin Mfg. Corp.
 NATIONAL COMPANY, 61 Sherman St., Malden, Mass.—"National"—AM, COM, AV, BH, BP, FM, K, M, P, PA, UH, AW, S
 NOBLITT-SPARKS INDUSTRIES, INC., Columbus, Ind.—"Arvin"—A, BP, H, PR, LR
 PACKARD BELL CO., 1320 S. Grand Ave., Los Angeles, Calif.—"Bell"—BP, H, PR, T
 PACENT ENGINEERING CORP., 79 Madison Ave., New York, N. Y.—"Pacent"—FM, H, PR, K
 PHILCO RADIO & TELEVISION CORP., Tioga & C Sts., Philadelphia, Pa.—BP, F, H, P, PA, A, BH, LA, LR, PR, AW, S
 PHILMORE MFG. CO., 113 University Pl., New York, N. Y.—"Philmore"—BP, H, K, BH, LA, S
 *PIERCE AIRO—De Wald Radio Mfg. Corp.
 PIERSON-DELANE, INC., 2345-47 W. Washington Blvd., Los Angeles, Calif.—AM, AV, BP, COM, P, PA, UH, AW, S
 PILOT RADIO CORP., 37-06 36th St., Long Island City, N. Y.—"Pilot"—BP, F, H, PR, M, BH, FM, AW, S
 PORTOMATIC CORPORATION, 985 Madison Ave., New York, N. Y.—"Portomatic"—PR
 PRESTO RECORDING CORP., 242 W. 55th St., New York, N. Y.—"Presto"—COM
 RADEX CORPORATION, 1733 Milwaukee Ave., Chicago, Ill.—LA, LR
 RADIOBAR CO. OF AMERICA, 269 Broadway, New York, N. Y.—PR
 RADIO ELECTRIC SERVICE CO., INC., N. W. Cor. 7th & Arch Sts., Phila., Pa.—AM, A, BH, BP, F, FM, H, K, M, PR, P, T, UH, AW, S
 RADIO ENGINEERING LABS, INC., 35-54 36th St., Long Island City, N. Y.—FM, P, PA, UH, M
 RADIO MFG. ENGINEERS, INC., 111 Harrison St., Peoria, Ill.—AM, AV, BP, COM, M, P, UH, AW, S, SA, SC
 RADIOMARINE CORP. OF AMERICA, 75 Varick St., New York, N. Y.—COM, M
 RADIO NAVIGATIONAL INSTRUMENT CORP., 500 5th Ave., New York, N. Y.—AV, LR, M
 *RADIO NURSE—Zenith Radio Corp.
 RADIO PRODUCTS CORP., 3800 W. Cortland St., Chicago, Ill.—A, BP, H, PR
 RADIO RECEPTOR CO., INC., 251 W. 19th St., New York, N. Y.—AV, COM, FM
 RADIO TRANSCEIVER LABS., 86-27 115th St., Richmond Hill, N. Y.—"Radio Transceiver Labs"—AM, BP

RADIO WIRE TELEVISION, INC., 100 6th Ave., New York, N. Y.—"Lafayette"—AM, A, BP, F, H, PR
 RADOLEK COMPANY, 601 W. Randolph St., Chicago, Ill.—"Radolek"—AM, A, BP, F, H, PR, AV, BH, COM, FAC, FM, M, P, PA, T, UH, AW, S, SA, SC, K
 RAY JEFFERSON, INC., 182 Milburn Ave., Baldwin, N. Y.—LR, M, P, PA
 REMLER CO., LTD., 2101 Bryant St., San Francisco, Calif.—"Remler"—BP, F, H, PR
 RCA MFG. CO., Front & Cooper Sts., Camden, N. J.—"RCA," "RCA Victor"—AM, A, AV, BP, COM, F, H, PR, P, PA, T, FAC, BH, S, AW, UH, M
 *RCA VICTOR, RCA Mfg. Co.
 *RME—Radio Mfg. Engineers, Inc.
 ROWE INDUSTRIES, INC., 3120 Monroe St., Toledo, Ohio—AV
 E. M. SARGENT CO., 212 9th St., Oakland, Calif.—"Sargent"—AM, COM, DF, M
 MAURICE SCHWARTZ & SON, 710-712 Broadway, Schenectady, N. Y.—AM, A, AV, BH, BP, COM, F, FAC, FM, H, K, LA, LC, LR, M, PR, P, PA, T, UH, AW, S, SA, SC
 E. H. SCOTT RADIO LABS., INC., 4450 Ravenswood Ave., Chicago, Ill.—AM, FM, H, PR, AW
 SENTINEL RADIO CORP., 2020 Ridge Ave., Evanston, Ill.—BH, BP, F, FM, H, PR, T, AW, S
 *SENTINEL—Electrical Research Lab., Inc.
 SETCHELL CARLSON, INC., 2233 University Ave., St. Paul, Minn.—A, BH, BP, F, LR, M, PA, AW, S
 SILLCOX RADIO & TELEVISION CORP., 60 Wall Tower, New York, N. Y.—A, BP, F, H, PR, T
 SKY CHIEF RADIO SALES CORP., 335-345 E. 27th St., New York, N. Y.—BH, BP, COM, F, H, PR
 *SKYRIDER—Hallcrafters, Inc.
 MAXWELL SMITH CO., 1027 N. Highland Ave., Hollywood, Calif.—AM, AV, COM, FM, M, P, PA
 SONORA RADIO & TELEVISION CORP., 2626 W. Washington Blvd., Chicago, Ill.—A, BP, F, H, PR, T
 SPARKS-WITHINGTON CO., E. Ganson Ave., Jackson, Mich.—"Sparton"—BP, F, H, PR, T
 *SPARTON—Sparks-Withington Co.
 STEWART-WARNER CORP., 1826 Diversey Pkwy., Chicago, Ill.—"Stewart-Warner"—A, BP, F, FM, H, PR, T
 STROMBERG-CARLSON TELEPHONE MFG. CO., 100 Carlson Rd., Rochester, N. Y.—"Stromberg-Carlson"—F, FM, H, PR, T
 SUN RADIO COMPANY, 212 Fulton St., New York, N. Y.—AM, A, BH, BP, COM, F, FAC, FM, H, K, LA, LR, M, PR, T, UH, AW, S, SWAC, SA, LC
 *SUPER-PRO, Hammarlund Mfg. Co.
 TAY BERN EQUIPMENT CORP., 135 Liberty St., New York, N. Y.—AV, COM, M, P, PA, UH
 *TEFFT RADIO CO., Plymouth, Mich.—AM
 TELEVISION COMPANY, 341 N. Pulaski Rd., Chicago, Ill.—M
 THORDARSON ELECTRIC MFG. CO., 500 W. Huron St., Chicago, Ill.—K
 TRAVLER RADIO & TELEVISION CORP., 1036 Van Buren, Chicago, Ill.—A, BH, BP, F, H, PR, AW, S
 TREBOR RADIO CO., Pasadena, Calif.—"Trebor"—A, H
 TROY RADIO & TELEVISION CO., 1144 S. Olive St., Los Angeles, Calif.—AV, BH, BP, R, H, PR, T, AW, S
 *TRUETONE—Western Auto Supply Co.
 UNITED CINEPHONE CORP., 43-37 33rd St., Long Island City, N. Y.—AV
 UNITED STATES TELEVISION MFG. CORP., 220 E. 51st St., New York, N. Y.—T
 UNIVERSITY BATTERY CO., 3410 S. La Salle St., Chicago, Ill.—"Universal"—A, F, H
 *VICTORY—Champion Radio Laboratories
 WARWICK MFG. CO., 1700 W. Washington Blvd., Chicago, Ill.—"Warwick"—A, BP, F, H, BH, PR, S
 WATTERSON RADIO MFG. CO., Dallas, Texas—F, H
 WELLS-GARDNER & CO., 2701 N. Kildare Ave., Chicago, Ill.—AM, A, BP, F, PR, BH, S
 WESTERN AUTO SUPPLY CO., 2107 Grand Ave., Kansas City, Mo.—"Truetone"—A, BP, F, H, PR
 WESTERN ELECTRIC CO., 300 Central Ave., Kearny, N. J.—AV, M, P, PA
 WESTINGHOUSE ELECTRIC SUPPLY CO., 150 Varick St., N. Y.—"Westinghouse"—BP, F, H, PR, T
 WILCOX ELECTRIC CO., INC., 4014 State Line, Kansas City, Kans.—AV, COM, M, P
 WILCOX-GAY CORP., Charlotte, Mich.—"Wilcox-Gay"—BP, H, PR, P, RRC
 ZENITH RADIO CORP., 6001 Dickens Ave., Chicago, Ill.—"Radio Nurse"—AM, A, BP, COM, F, FM, H, M, PR, P, PA, T
 ZEPHYR RADIO CO., 13139 Hamilton Ave., Detroit, Mich.—"Zephyr"—A, F, H, PR

RECORDS & RECORD-PLAYING EQUIPMENT

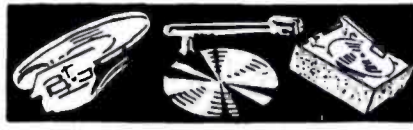

Automatic record changers ARC
Coin phonographs . . . CP

• CLASSIFIED RADIO DIRECTORY •

Coin record players . . . CM
 Electric phonographs . . . EL
 Home recorders . . . HR
 Home-recording blanks . . . HRB
 Magnetic tape records . . . MTR
 Motors . . . M
 Musical tower . . . MT
 Needles . . . N
 Phono oscillators . . . PO
 Pickups (crystal) . . . PC
 Pickups (dynamic) . . . PD
 Pickups (magnetic) . . . PM
 Records . . . R
 Recorders . . . RS
 Record albums . . . RA
 Record cabinets . . . RC
 Record carrying cases . . . RCC
 Record compounds . . . RO
 Record index system . . . RIS
 Record player attachments . . . RP
 Record racks . . . RR
 Store equipment . . . SE
 Turntables . . . TT
 Turntables flocked . . . TF
 Transcription record players . . . TR
 Wireless players . . . WP
 Wireless player adapter . . . WPA

H. W. ACTON CO., INC., 370 7th Ave., New York, N. Y., *Actone"—N
 *ACTONE—H. W. Acton Co., Inc.
 ADLER MFG. CO., 2901 W. Chestnut St., Louisville, Ky.—RC
 ALLIANCE MFG. CO., Alliance, Ohio—M, TT
 ALLIED ENGINEERING INSTITUTE, 85 Warren St., New York, N. Y.—PO
 ALLIED RADIO CORP., 833 W. Jackson Blvd., Chicago, Ill., *Knight"—EL, RP, TR, WP, ARC, M, N, CM, PC, PM, PD, R, PA, PC, TT
 AMERICAN COMMUNICATIONS CORP., 123 Liberty St., New York, N. Y.—EL
 AMPLIFIER CO. OF AMERICA, 17 W. 20th St., New York, N. Y., *ACA"—TR, TT, PC, PM, PD
 AMPLITONE PRODUCTS CO., 135 Liberty St., New York, N. Y.—ARC, EL, M, N, PC, PM, RA, RC, RP, SE, TR, TT, WP
 ANDREA RADIO CORP., 4820 48th Ave., Woodside, L. I., N. Y.—EL
 ANSLEY RADIO CORP., 4377 Bronx Blvd., New York, N. Y.—PC, RC, RP, TR
 ASTATIC MICROPHONE LABORATORY, 830 Market St., Youngstown, Ohio, *Astatic"—PC
 AUDAK COMPANY, 500 5th Ave., New York, N. Y., *Audax"—PM
 *AUDAX—Audak Co.
 AUDIO DEVICES, INC., 1600 Broadway, New York, N. Y., *Audiopoint"—N
 AUDIOGRAPH SOUND SYSTEMS, 1313 W. Randolph St., Chicago, Ill.—ARC, EL, PC, PD, RP, TR, TT, PM
 AUTOCRAT RADIO CO., 3855 N. Hamilton Ave., Chicago, Ill., *Autocrat"—EL, M, PC, ARC, WP
 BANK'S MFG. CO., 5019 N. Winthrop Ave., Chicago, Ill.—EL, ARC
 *BELFONE—Bell Sound Systems, Inc.
 A. BITTER CONSTRUCTION CORP., 27-01 Bridge Plaza N., Long Island City, N. Y.—RC, RP
 *BLUEBIRD—RCA Mfg. Co.
 DAVID BOGEN CO., INC., 663 Broadway, New York, N. Y.—ARC, EL, M, RC, PM, TT
 BROWN ELECTRIC CO., 65 Atlantic Ave., Rochester, N. Y.—EL, PM, TT
 *BRUNSWICK—Columbia Recording Co.
 BRUSH DEVELOPMENT CO., 3311 Perkins Ave., Cleveland, Ohio—PC, MTR
 BUD RADIO, INC., 5205 Cedar Ave., Cleveland, O.—WP
 CALVERT MOTORS ASSOCIATES, LTD., 1028 Linden Ave., Baltimore, Md., *Calvert"—EL, WP
 CANTON TRADING CO., 135 Liberty St., New York, N. Y., *Kantola"—ARC, EL, RA, PR, WP
 CARRON MFG. CO., 415 So. Aberdeen St., Chicago, Ill.—EL, M, N, PM, R, TR, TT
 *CHAMPION—Decca Records, Inc.
 CHAMPION RADIO LABORATORIES, 14553 Madison Ave., Lakewood, Ohio—RP, WP
 CHICAGO NOVELTY FURNITURE CO., 1750-60 N. Campbell Ave., Chicago, Ill.—RC
 CHICAGO SOUND SYSTEMS CO., 200 E. Illinois St., Chicago, Ill.—EL, RC, RP, TR, WP, RCC
 CINEMATONE CORPORATION, 1107 N. Highland Ave., Hollywood, Calif.—CM
 *CLARION—Transformer Corp. of America
 CLARK PHONOGRAPH RECORD CO., INC., 216 High St., Newark, N. J.—R
 COLUMBIA RECORDING CORP., 1473 Barnum Ave., Bridgeport, Conn.—N, R, RA
 CONTINENTAL RADIO & TELEVISION CORP., 3800 W. Cortlandt St., Chicago, Ill.—WP
 CRACRAFT, INC., 28 Grove St., New York, N. Y.—R
 CRUMPACKER DIST. CORP., 1801 Fannin St., Houston, Texas—N, PC, PM, R, RP, TR, TT, WP, PD

DECCA RECORDS, INC., 50 W. 57th St., New York, N. Y., *Decca"—EL, M, N, PC, R, RA, RC, RP, WP
 DEVRY CORPORATION, 1111 Armitage Ave., Chicago, Ill.—EL
 DE WILD RADIO MFG. CORP., 436 Lafayette St., New York, N. Y.—EL, WP, ARC
 *DO RE MI—Mills Novelty Co.
 DUPLEX RECORDING DEVICES CO., 514 W. 36th St., New York, N. Y.—TR
 *DURALITE—Musicraft Records, Inc.
 *DYNAPHONE—Ansley Radio Corp.
 D-X RADIO PRODUCTS CO., 1575 Milwaukee Ave., Chicago, Ill.—EL
 ELECTRICAL INDUSTRIES MFG. CO., Red Bank, N. J.—PC, TR, TT
 ELECTRO ACOUSTIC CO., 2131 Bueter Rd., Ft. Wayne, Ind.—EL, RC, RP, TR, TT
 ELECTRONIC SOUND & MUSIC CO., 10 Stuyvesant St., New York, N. Y.—EL, RS
 *ELECTROTONE—Harris Mfg. Co.
 ERWOOD SOUND EQUIPMENT CO., 224 W. Huron St., Chicago, Ill.—ARC
 ESPEY MFG. CO., INC., 305 E. 63rd St., New York, N. Y.—EL, RP, WP, TT
 FAIRCHILD AERIAL CAMERA CORP., 8806 Van Wyck Blvd., Jamaica, L. I., N. Y., *Fairchild"—PC
 FARNSWORTH TELEVISION & RADIO CORP., 3700 Pontiac St. (Extended), Fort Wayne, Ind.—ARC, EL
 FISCHER DISTRIBUTING CORP., 222 Fulton St., New York, N. Y.—ARC, EL, M, N, PC, PD, PM, R, RP, TR, TT, WP
 FLEX RECORD CO., 9 Rockefeller Plaza, New York, N. Y.—R
 FLOCK PROCESS CORP., 17 W. 31st St., New York, N. Y.—TF
 THE JOHN GABEL MFG. CO., 1200 W. Lake St., Chicago, Ill.—ARC, EL, PM, CM
 GALVIN MFG. CORP., 4545 Augusta Blvd., Chicago, Ill., *Motorola"—ARC, EL, WP
 GARRARD SALES CORP., 296 Broadway, New York, N. Y.—ARC, EL, M, N, PC, PM
 GENERAL CEMENT MFG. CO., 919 Taylor Ave., Rockford, Ill.—N
 GENERAL COMMUNICATION PRODUCTS CO., 6245 Lexington Ave., Hollywood, Calif.—TR, CP, PM, TT, PD
 GENERAL ELECTRIC CO., Schenectady, N. Y. & Bridgeport, Conn.—EL, M, PC, RR, WP
 GENERAL INDUSTRIES CO., 3537 Taylor St., Elyria, Ohio—ARC, M, TT
 M. A. GERETT CORP., 2947 N. 30 St., Milwaukee, Wis., *Miracle Point"—N
 THOMAS B. GIBBS & CO., 900 W. Lake St., Chicago, Ill.—EL
 HAMMOND MFG. CO., Guelph, Ontario, Canada—RC
 HARRIS MFG. CO., 2422 W. 7th St., Los Angeles, Calif., *Electrotone"—N, RC, RP, TR
 HARRISON RADIO CO., 12 W. Broadway, New York, N. Y.—ARC, EL, M, N, PC, PD, PM, RP, TR, TT, WP
 HERBERT CORPORATION, 600 N. Albany, Chicago, Ill., *Mel-O-Tone"—CM
 HOME RECORDING CO., 11 West 17th St., New York, N. Y.—R
 HERBERT H. HORN, 1201 S. Olive St., Los Angeles, Calif.—PC
 HOWARD RADIO CO., 1735 Belmont Ave., Chicago, Ill.—N, R, RA
 CHARLES JACK MFG. CORP., 27 E. Philadelphia St., York, Pa.—R, EL
 J. F. D. MFG. CO., 4111 Fort Hamilton Pkwy., Brooklyn, N. Y.—N
 KADETTE RADIO CORP., 200 Hill St., Ann Arbor, Mich.—EL
 *KANTOLA—Canton Trading Co.
 *KNIGHT, Allied Radio Corp.
 LAFAYETTE RADIO CORP., 100 6th Ave., New York, N. Y.—ARC, EL, M, N, PC, PM, R, RA, RC, RP, TR, TT, WP
 *LAFAYETTE, Radio Wire Television, Inc.
 THE LINCROPHONE CO., INC., 1661 Howard Ave., Utica, N. Y.—ARC, EL, TR
 LOWELL NEEDLE CO., INC., Putnam, Conn.—N
 M & H SPORTING GOODS CO., 512 Market St., Phila., Pa.—RP, TR, WP, PC, PM
 MAJESTIC RADIO & TELEVISION CO., 2600 W. 50th St., Chicago, Ill., *Majestic"—WP, EL
 JOHN MECK INDUSTRIES, 1313 W. Randolph St., Chicago, Ill.—ARC, EL, PC, RP
 MEISSNER MFG. CO., 7th & Belmont, Mt. Carmel, Ill.—WPA
 MELLAPHONE CORP., 65 Atlantic Ave., Rochester, N. Y.—PM, PC
 CHARLES MICHELSON ELECTRICAL TRANSCRIPTIONS, 67 West 44th St., New York, N. Y.—R, TR
 MIDWEST RADIO CORP., 909 Broadway, Cincinnati, Ohio, *Midwest"—ARC
 MILES REPRODUCER CO., INC., 812 Broadway, New York, N. Y., *Sound-on-Film"—ARC, EL, M, PC, PM, CP, PD, WP
 J. W. MILLER CO., 5917 S. Main St., Los Angeles, Calif., *Miller"—WP
 MILLS NOVELTY CO., 4100 Fullerton Ave., Chicago, Ill.—CM
 *MIRACLE POINT—M. A. Gerett Corp.
 MIRROR RECORD CORP., 58 W. 25th St., New York, N. Y.—N, TR, TT

MONTGOMERY WARD & CO., 619 W. Chicago Ave., Chicago, Ill.—ARC, EL, M, N, PC, PM, R, RA, RP, TR, TT, WP
 *MOTOROLA—Galvin Mfg. Corp.
 *MUSICAL TOWER—Sundt Engineering Co.
 MUSIC MASTER MFG. CO., 508 S. Dearborn St., Chicago, Ill.—ARC, EL, N, RP, TR, WP
 MUSICRAFT RECORDS, INC., 10 W. 47th St., New York, N. Y., *Duralite"—N, R, RA, EL, RR, RCC, RC, HRB
 NASH RADIO PRODS. CO., 6267 Gravois Ave., St. Louis, Mo.—N, PC, RA, RC, RP, TR
 NATIONAL COMPANY, INC., 61 Sherman St., Malden, Mass.—PD
 OLSON MFG. CO., 362 Wooster Ave., Akron, O.—RP
 OPERADIO MFG. CO., 13th & Indiana Sts., St. Charles, Ill., *Operadio"—TT
 PACENT ENGINEERING CORP., 79 Madison Ave., New York, N. Y., *Pacent"—ARC, EL, TT, PC
 PAN-AMERICAN RECORD CO., 705 S. 1st St., Louisville, Ky.—EL, R, RA, TR
 PAR METAL PRODUCTS CORP., 32-62 49th St., Long Island City, N. Y.—TT
 PEERLESS ALBUM CO., INC., 38 W. 21st St., New York, N. Y.—RA, N, RC
 *PERMO POINT—Permo Products Corp.
 PERMO PRODUCTS CORP., 6415 Ravenswood Ave., Chicago, Ill., *Permo Point"—N
 PHILCO RADIO & TELEVISION CORP., Tioga & C Sts., Phila., Pa.—WP, ARC, EL, M, N, PC, RA, RP, TT
 PHONOGRAPH NEEDLE MFG. CO., INC., 42 Dudley St., Providence, R. I., *Supreme"—N
 PHONOTONE LABORATORIES, INC., S.E. 15th St., Washington, Ind.—ARC, EL, M, N, PC, R, RP, TR, TT
 PILOT RADIO CORP., 37-06 36th St., Long Island City, N. Y.—ARC, EL
 POINSETTIA, INC., Pitman, N. J.—R
 PRESTO RECORDING CORP., 242 W. 55th St., New York, N. Y., *Presto"—PM, TR, TT
 B. A. PROCTOR CO., INC., 230 Park Ave., New York, N. Y.—PM, RC, TR, TT
 RADIO ELECTRIC SERVICE CO., INC., N.W. Cor. 7th & Arch Sts., Philadelphia, Pa.—ARC, EL, M, N, PC, PD, PM, R, RP, TR, TT, WP
 RADIOTONE, INC., 7356 Melrose Ave., Hollywood, Calif.—EL, M, N, R, TR, TT, PC, PM
 RADIO WIRE TELEVISION, INC., 100 6th Ave., New York, N. Y., *Lafayette"—EL, RP, WP
 RADOLEK COMPANY, 601 W. Randolph St., Chicago, Ill., *Radolek"—ARC, EL, M, N, CM, PC, PD, PM, R, RA, RC, RP, TR, TT, WP
 RALSTON RECORD CO., 112 Cedar Ave., Pitman, N. J., *Ralston Radio Code Course"—R
 RANGERTONE, INC., 201 Verona Ave., Newark, N. J.—N, R
 RAY LAB, INC., 211 Railroad Ave., Elmira, N. Y., *Ray Lab"—TR
 RCA MFG. CO., Front & Cooper Sts., Camden, N. J., *RCA," *Victor," *Bluebird"—ARC, EL, N, PC, PM, RA, TR, TT, WP
 RECOTON CORPORATION, 178 Prince St., New York, N. Y.—N
 REGAL AMPLIFIER MFG. CORP., 14 W. 17th St., New York, N. Y.—ARC, EL, WP, RP, TR
 REK-O-KUT CORP., 254 Canal St., New York, N. Y.—R
 REMLER CO., LTD., 2101 Bryant St., San Francisco, Calif., *Remler"—TR
 ROCK-OLA MFG. CORP., 800-867 N. Kedzie Ave., Chicago, Ill.—CM, ARC, EL, TT
 ROWE INDUSTRIES, INC., 3120 Monroe St., Toledo, O.—PM
 *ROYALE—U. S. Record Corp.
 SCHLOSS BROS. CORP., 801 E. 135th St., New York, N. Y.—RC
 MAURICE SCHWARTZ & SON, 710-712 Broadway, Schenectady, N. Y.—ARC, EL, M, N, CM, PC, PD, PM, R, RA, RC, RP, TR, TT, WP
 E. H. SCOTT RADIO LABORATORIES, INC., 4450 Ravenswood Ave., Chicago, Ill.—ARC
 J. P. SEEBURG CORP., 1510 N. Dayton St., Chicago, Ill.—CM
 SELECTOR MFG. CORP., 30 W. 15th St., New York, N. Y.—PM, TR, TT
 SENTINEL RADIO CORP., 2020 Ridge Ave., Evanston, Ill.—EL, WP
 SHURE BROS., 225 W. Huron St., Chicago, Ill., *Zephyr"—PC
 SKY CHIEF RADIO CORP., 345 E. 27th St., New York, N. Y.—ARC, EL, RC, WP
 SILCOX RADIO & TELEVISION CORP., 60 Wall Tower, New York, N. Y.—ARC, EL
 MAXWELL SMITH CO., 1027 N. Highland Ave., Hollywood, Calif.—TR
 SONATA PHONOGRAPH MFG. CO., INC., 410 E. 32nd St., New York, N. Y.—EL, WP
 SONORA RADIO & PHONOGRAPH CORP., 2626 W. Washington St., Chicago, Ill., *Sonora"—RP, WP
 SOUND APPARATUS CO., 150 W. 46th St., New York, N. Y.—M, N, PM, TR, TT, PC, PD
 *SOUND-ON-FILM—Miles Reproducer Co., Inc.
 SPARKS-WITHINGTON CO., E. Ganson Ave., Jackson, Mich., *Sparton"—WP
 *SPARTON—Sparks-Withington Co.
 SPEAK-O-PHONE RECORDING & EQUIPMENT CO., 23 W. 60th St., New York, N. Y., *Speakophone"—TR, TT, PC
 STROMBERG-CARLSON TELEPHONE MFG. CO., 100 Carlson Rd., Rochester, N. Y., *Stromberg-Carlson"—ARC, RP

SUN RADIO CO., 212 Fulton St., New York, N. Y.—ARC, EL, M, N, PC, PD, PM, R, RA, RC, RP, TR, TT, WP
 SUNDT ENGINEERING CO., 4757 Ravenswood Ave., Chicago, Ill.—R, EL
 *SUPREME—Phonograph Needle Mfg. Co., Inc. TALK-A-PHONE MFG. CO., 1847 S. Millard Ave., Chicago, Ill.—EL, RP, WP
 TALKING DEVICES CO., 4451 Irving Park Blvd., Chicago, Ill.—ARC, R, TT
 TONK MFG. CO., 1975 N. Magnolia Ave., Chicago, Ill.—RC
 TRANSFORMER CORP. OF AMERICA, 69 Wooster St., New York, N. Y., *"Clarion"—ARC, EL, RP, TR, WP
 TROY RADIO & TELEVISION CO., 1144 S. Olive St., Los Angeles, Calif.—EL, RP, WP
 TUNNIS BROS., 726 Lake St., Oak Park, Ill.—RIS
 UNITED CINEPHONE CORP., Sound Equip. Div., 43-37 33rd St., Long Island City, N. Y., *"United Cinephone"—PM, TR, TT
 UNITED STATES RECORD CORP., 1780 Broadway, N. Y., *"Royale," *"Varsity"—R, RC, N
 UNIVERSAL MICROPHONE CO., Inglewood, Calif.—M, N, PC, PM, R, TR, TT
 *VARSITY—U. S. Record Corp.
 *VICTOR—RCA Mfg. Co.
 *VOCALION—Columbia Recording Corp.
 J. J. WARNER CO., 1244 Larkin St., San Francisco, Calif.—R, TR, TT
 THE WEBSTER-CHICAGO CORP., 5622 Bloomingdale Ave., Chicago, Ill., *"Webster-Chicago"—ARC, EL, M, PM, RP, TT
 *WEBSTER-CHICAGO—The Webster-Chicago Corp. WEBSTER ELECTRIC CO., Racine, Wis., *"Webster Electric"—PC, PM, PD, N
 WESTERN ELEC. CO., 300 Central Ave., Kearny, N. J.—EL, PM, TR
 WESTERN SOUND & ELECTRIC LABS., INC., 311 W. Kilbourn Ave., Milwaukee, Wis.—N
 WILCOX ELECTRIC CO., INC., 4041 State Line, Kansas City, Kans.—RC
 WILCOX-GAY CORP., Charlotte, Mich.—N, R, RA, WP
 RUDOLPH WURLITZER MFG. CO., North Tonawanda, New York—CM
 ZENITH RADIO CORP., 6001 Dickens Ave., Chicago, Ill.—WP
 ZEPHYR—Shure Bros.

(Part IV next month.)

F.C.C.'S MAIL BAG

With reference to reallocation of frequencies under the North American Regional Broadcast Agreement, the Commission is unable to advise about prospective individual changes pending working out of the reallocation plan in its entirety. Full publicity will be given frequency shifts at that time. Meanwhile, it is not necessary for a station to make application for such change in frequency.

The Commission is likewise without authority to take remedial action with respect to the following complaints:

A Brooklyn, N. Y., man is irked because a network substituted an address by Winston Churchill for the usual baseball program.

A Washington, D. C., man alleges failure of a network to advise the listening audience concerning the reconvening of the Republican National Convention.

A San Francisco listener takes issue with the "man in the street" type of programs.

A Bronx, N. Y., individual would bar the radio to minority groups.

A Lynn, Mass., florist dislikes radio advice to purchase hosiery for Mother's Day gifts rather than flowers.

NEWS SHORTS

Typing speed is indicated directly in words per minute by an electronic device, L. J. Markus reported in *National Radio News* recently. Hitting keys operates a relay that applies a charge to a condenser; a V.-T. Vm. reads condenser voltage as the drop across a resistor on a scale calibrated in w.p.m.

The Board of Directors of the National Assoc. of Broadcasters has urged all stations carrying foreign-language programs "to exercise extreme precautions against the use of their facilities, wittingly or unwittingly, to promote propaganda inimical to the interests of the United States." (Program censorship?) Main plan is to prevent deviations—ad libbing, for example—from script; and to institute a reference file of all foreign-language program script.

Get Your HOWARD COMMUNICATION RECEIVERS FROM ALLIED RADIO

Largest Stock Amateur Equipment

You can depend on ALLIED—the world's largest exclusive Radio House for all of your requirements. ALLIED'S complete radio stocks assure prompt shipment on all HOWARD Communication Receivers and associated apparatus. Every HOWARD Receiver is an outstanding performer and an exceptional value. Buy your new HOWARD Receiver from ALLIED—NOW!

100% RADIO

ALLIED'S big 212 page 100% radio catalog is the most complete index to everything in radio—the minute radio parts, supplies and equipment. It includes specifications, photos and prices on the complete line of HOWARD Communication Receivers and equipment. Send the coupon for your FREE copy. Also send for ALLIED'S new "Dictionary of Radio Terms"—containing the latest word definitions of radio, electronic and television terms—only 10c

EASY TERMS

Save time and money with ALLIED'S popular time payment plan. You don't have to pay all cash at ALLIED. You send just a small down payment and the balance is spread out over 6, 8 or 12 months. ALLIED'S small carrying charge is only 6%. It's easy for you to get the HOWARD Receiver you want quickly and without red tape or delay. Order today from the New ALLIED Super Catalog!

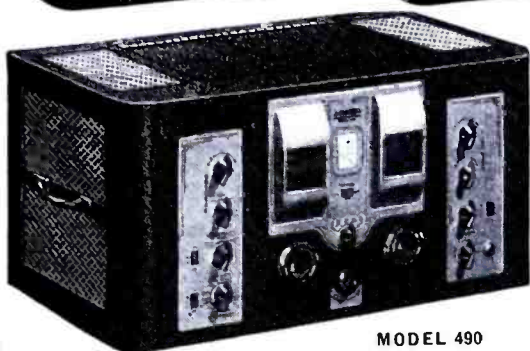

MODEL 490

HOWARD Model 490 has sensitivity that never knows "crowding" and selectivity that may be varied at will from the hairline sharp position required for CW to the wide band requirements of high fidelity reproduction. Contains 14 tubes. Tunes from 540 KC to 43.5 MC in 5 bands. Incorporates 2 RF stages, calibrated band spread, air tuned IF's, temperature compensated oscillator, split stator tuning condenser, 9 position variable IF selectivity, variable audio fidelity, automatic noise limiter and dozens of other spectacular features. Comes complete with 10" matching speaker and crystal filter.

AMATEUR NET \$149.50
 Terms: \$14.95 down, \$11.88 monthly for 12 mos.

HOWARD Model 435, a 6 tube receiver of advanced design, tunes from 540 KC to 43 MC in 4 bands. Bandspread dial electrically spreads out any desired portion of tuning range. Incorporates iron core IF's, BFO, AVC, audio gain control, headphone jack, send-receive switch and built-in dynamic speaker. Has provision for 6 volt power pack. May be converted to Model 436 or 437 at small cost on the Progressive Series Plan.

AMATEUR NET \$29.95
 Time payments: \$4.50 down, \$4.50 monthly for 6 months.

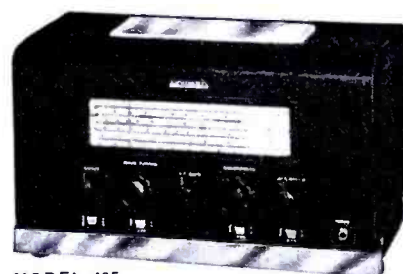

MODEL 435

HOWARD Model 436—7 tubes with noise limiter and inertia tuning controls. AMATEUR NET \$39.95
 Terms: \$5.95 down, \$6.00 monthly for 6 months.

HOWARD Model 437—9 tubes with RF amplifier and two IF stages. AMATEUR NET \$54.50
 Terms: \$5.45 down, \$6.49 monthly for 8 months.

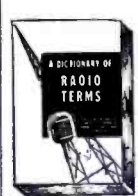

NEW RADIO DICTIONARY

ONLY 10c
 Just out—compiled by leading authorities under ALLIED supervision. Gives concise, easy-to-understand definitions of all commonly used radio words and terms. For everyone in Radio. Send Coupon Today!



FREE
 212 PAGES
 1941's Greatest
 ALLIED RADIO

SEND COUPON ALLIED RADIO CORP.
 833 W. Jackson Blvd.
 Dept. 2-BM-1, Chicago, Ill.

Send your FREE 1941 Radio Catalog.
 I enclose 10c for New Radio Dictionary.

NAME
 ADDRESS
 CITY STATE

ALLIED Radio CHICAGO, ILLINOIS

See Pages 362, 377, 382 for Free subscription offers!



WOODSTOCK TYPEWRITERS

"FLUORESCENT LIGHTING"
 Mr. Serviceman: Do you know how to construct, sell install and service Fluorescent Lights? Read January *Radio-Craft*, in which will appear Part I of an informative article on this popular, money-making subject.

FREE! GIVEN TO YOU

THIS SUPER MAGNET

LIFTS MORE THAN 20 TIMES ITS OWN WEIGHT



LITTLE GIANT MAGNET—The world's most powerful. Lifts 5 lbs. easily. Weighs 4 oz. Made of ALNICO, new high-magnetic steel. The experimenter and hobbyist will find hundreds of excellent uses for this high quality permanent magnet. Measures 1 3/4" x 1 1/2". Complete with keeper. Value \$1.00.

YOURS, AS A GIFT, FOR SELLING ONLY 16 "CASH IN" BOOKS!

No investment needed. We trust you. You simply order the books from us, sell them for 15c each, and when you collect \$2.40, remit to us (within 30 days) and we will send you the LITTLE GIANT MAGNET absolutely FREE! Or you may prefer one of the many other gifts we offer. Fill out and return the coupon today. Be the first in your neighborhood to sell "CASH IN."

300 Ways To Make Money



40,000 Words of Text

"CASH IN" contains 300 tested mail order plans, business secrets, formulas, schemes—real money makers. 68 pages.

This book will sell itself to all of your friends, relatives and neighbors.

—SEND NO MONEY—

National Plans Institute,
246-R Fifth Ave., New York City
Gentlemen: Please send me 16 books "CASH IN," which I will sell at 15c each. I will pay for the books in 30 days. Then you will send me FREE your LITTLE GIANT MAGNET. Also send me immediately your list of other free premiums.

Name

Address

City

PASTE COUPON ON 15c POST-CARD AND MAIL TODAY

EMERGENCY POWER RELAY

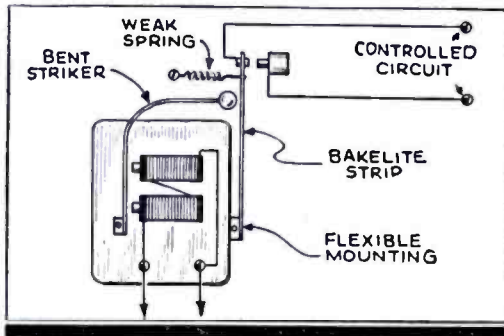

● **NEEDING** a relay in a hurry that would close a heavy current I dove into the Junk Box and came up with an old door-bell, a pair of breaker points from an auto distributor, and a strip of bakelite. The bell was removed and the magnets, together with the armature and striker, were mounted on a baseboard. The drawing shows the complete construction. The result was very satisfactory. Two No. 5 drycells will operate it efficiently.

WILLIAM B. MILLER,
Laguna Beach, Calif.

A SENSITIVITY CONTROL FOR A.F. PREAMPLIFIERS

● **IT** is a common practice in P.A. design to operate the 1st stage "wide open" and place the volume control in the control-grid

circuit of the following tube. This has the advantage of placing the volume control in a part of the circuit having a higher signal level where the control noise is minimized. It also has the disadvantage of giving full amplification to all stray noises and hum picked up in the input stage. Under certain conditions therefore it is very convenient to be able to control the sensitivity of the 1st stage without detracting from any of the advantages of the system.

This is very easily done if the preamplifier stage is a pentode, operating as such, by varying the screen-grid voltage. Circuit A shows a typical arrangement of pentode input. By varying the value of the screen-grid bleeder resistor R the sensitivity of the stage may be raised or lowered. Example: if R is normally 20,000 ohms, change to 15,000 ohms and add a 10,000-ohm variable resistor in series, as shown in circuit B. Decreasing the amount of resistance increases the gain while increasing the amount of resistance lowers the gain. Unless the value of C is over 1 mf. it may be advantageous to increase it when making the change.

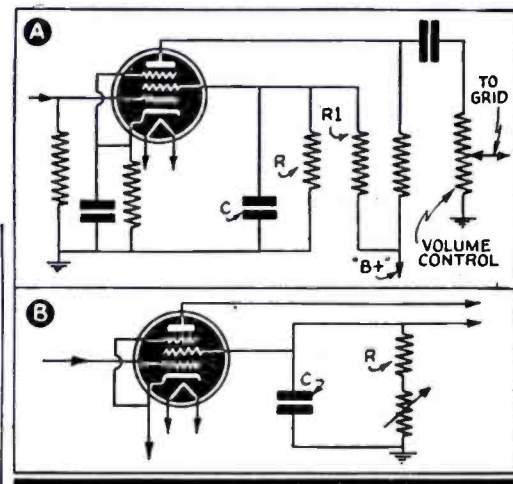

If no bleeder resistor is used a part of the screen-grid dropping resistor R' may be made variable, in which case the effect is reversed, i.e., increasing the resistance increases the gain and decreasing the resistance reduces the gain. In either arrangement the maximum sensitivity wanted for a certain condition is established, the sensitivity control is set for that level and thereafter the regular volume control is used as usual. This trick works only over a portion of the screen-grid voltage range and that portion must be found by experimenting.

E. H. DISNEY,
Lowry City, Mo.

NOVEL TUNING INDICATOR

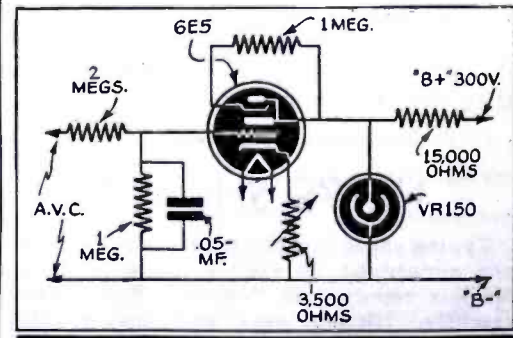

● **A FORM** of zero-center vacuum-tube voltmeter is shown in the diagram, where a 6E5 is biased to cut-off. If positive voltage is applied to the control-grid, the shadow will open, since the net grid bias will then be decreased by the amount of grid voltage applied. When the grid bias is negative, the shadow will overlap as it closes. With no

WARNING TO RADIO-CRAFT READERS

Radio-Craft has no representatives in the field soliciting subscriptions, in the "door-to-door" fashion. Pay no money to any person who comes to your home, store or service shop and represents himself as being an agent for Radio-Craft. Subscriptions may be safely obtained only from authorized subscription agencies, whose names we shall be glad to furnish, or directly from us by mail. Address your letter to Subscription Dept., Radio-Craft, 20 Vesey St., New York, N. Y.



Get This Electric Dry Shaver ABSOLUTELY FREE!

JUST THINK OF IT—you can get absolutely FREE, the useful DRY ELECTRIC SHAVER which is shown at the left. This ELECTRIC DRY SHAVER is sent to you by the publishers with a one-year subscription to RADIO-CRAFT.

Here Are the Features of The ELECTRIC DRY SHAVER

Constructed of metal with attractive red bronze finish. Scientifically constructed to give a perfectly clean shave. 5-foot rubber insulated cord and plug. Constructed to last for many years.

Operates from 110-volt, 60-cycle A.C. electric line. Carries a two-year manufacturer's guarantee. A fine quality, self-sharpening toilet necessity.

Send your subscription to RADIO-CRAFT for One Year (12 issues) and receive absolutely FREE one of these remarkable Electric Dry Shavers. New subscribers are accepted or you may extend your present subscription another twelve months. Mail your remittance of \$2.00 (plus 25c for shipping charges on Shaver) to the publishers. (Canada and foreign \$2.75.) You will receive your DRY ELECTRIC SHAVER immediately by return mail. Use coupon below to enter your subscription.

RADIO-CRAFT

20 Vesey Street, New York, N. Y.

RADIO-CRAFT, 20 Vesey Street, New York, N. Y.

Gentlemen: Enclosed find my remittance of \$2.00 for which enter my subscription to RADIO-CRAFT for one year (12 Issues). Send me immediately FREE, ELECTRIC DRY SHAVER (Canada and foreign \$2.75). In U. S. add only 25c additional to cover shipping charges on Shaver.

New Subscriber Extend Present Subscription

Name

Address

City State

(Send remittance by check, money order or unused U.S. Postage Stamps. Register letter if you send cash or stamps.) RC-1240

WE SHIP ELECTRIC DRY SHAVER THE SAME DAY YOUR SUBSCRIPTION ORDER IS RECEIVED.

CLIP COUPON— AND MAIL!

bias applied, except that through the cathode resistor, the shadow is adjusted so it just about closes in the "tuning eye".

The above circuit finds application in the new Scott custom-built receivers, but may also be used for F.M. alignment in place of an expensive microammeter or V-T. voltmeter.

WILLARD MOODY,
New York, N. Y.

SHOP LAMP

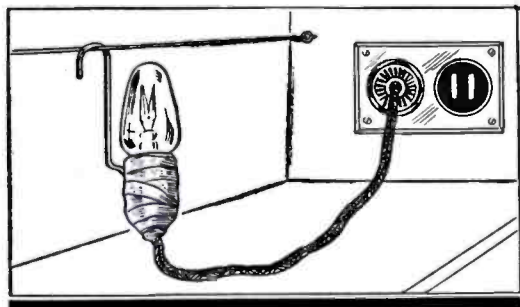

● THE sketch shows a tool which is extremely useful and simple to make. An inexpensive line cord (mine came from a 27c soldering iron that had burned out) is soldered directly to the contacts of a 7-watt, 110-volt light bulb, and then bound with tape. A short length of number 14 enameled wire is wound over the tape and then bent to form a hook. Another layer of tape is added to hold the wire in place.

The unit can be hung from the hook-up wire under any chassis, and gives ample light without bothering your eyes. The heat of the bulb will not damage tubular condensers. You can use the gadget on sets in any position, and you can't do without it for final adjustments on trimmers, and minor wiring jobs when the chassis is mounted in a console. The unit is just as useful in the daytime as it is at night.

JOHN M. KENNEDY,
New York, N. Y.

"INTERMITTENT" INDICATOR

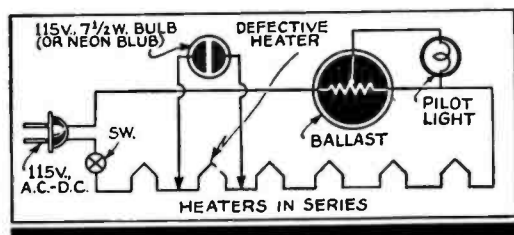

● RECENTLY, I had occasion to service a 7-tube A.C.-D.C. midget, which would intermittently cut out, sometimes after playing satisfactorily for as much as 2 hours. The trouble was found to be caused by an intermittent open in the heater circuit. A careful inspection showed the wiring to be intact, thus localizing the trouble in one of the tubes. Since it would obviously be impossible to test each tube separately in a tube checker, due to the long periods of time involved, I devised the scheme shown here to locate the offending tube under actual operating conditions.

A 115 volt, 7 1/2-watt bulb was clipped into the circuit across the suspected tube, and glowed faintly until the tube's heater opened; then burned with nearly normal brilliance. It was only necessary for me to turn on the set, and glance at the light bulb when I heard the set stop playing.

THOMAS PREWITT,
Plainfield, Ind.

FOOT VOLUME CONTROL

● THE expensiveness of foot volume controls often prohibits their incorporation in circuits in which they might otherwise be useful. To meet the need for an inex-

pensive control of this type, the following make-shift was devised:

An undersized hand-drill (purchased at a dime store) was mounted rigidly by means of angle irons to a platform. Both shaft and gear handles were removed with a hacksaw. A foot pedal formed of plywood was fastened firmly to the gear wheel. A pedal formed of metal would probably serve the purpose better. In this case however the plywood pedal was reinforced with flat strips of iron and fastened to the gear wheel with angle irons. An ordinary volume control of suitable size was then mounted on the platform in such a manner that its shaft entered into the chuck of the drill, which was then tightened.

After the device has been tested to see that movement of the foot pedal gives a full rotation it is suggested that the inside of the chuck and the screw section of the shaft be coated with bakelite cement before tightening. This will prevent the chuck from loosening. In mounting the drill, a little experimentation as to its distance above the platform will probably be necessary in order to allow proper clearance for the pedal.

LENOX ANTONY,
New Orleans, La.

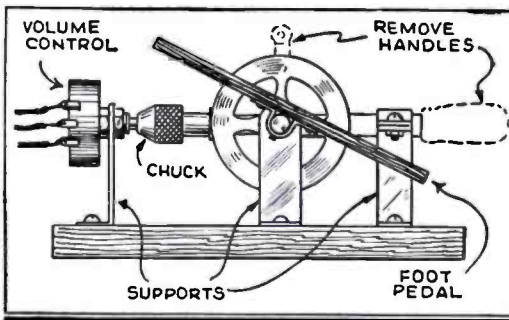

JUST PUBLISHED!

A NEW BOOK TO ADD TO YOUR TECHNICAL LIBRARY

AUTOMOBILE RADIO — Principles & Practice

by B. Baker Bryant

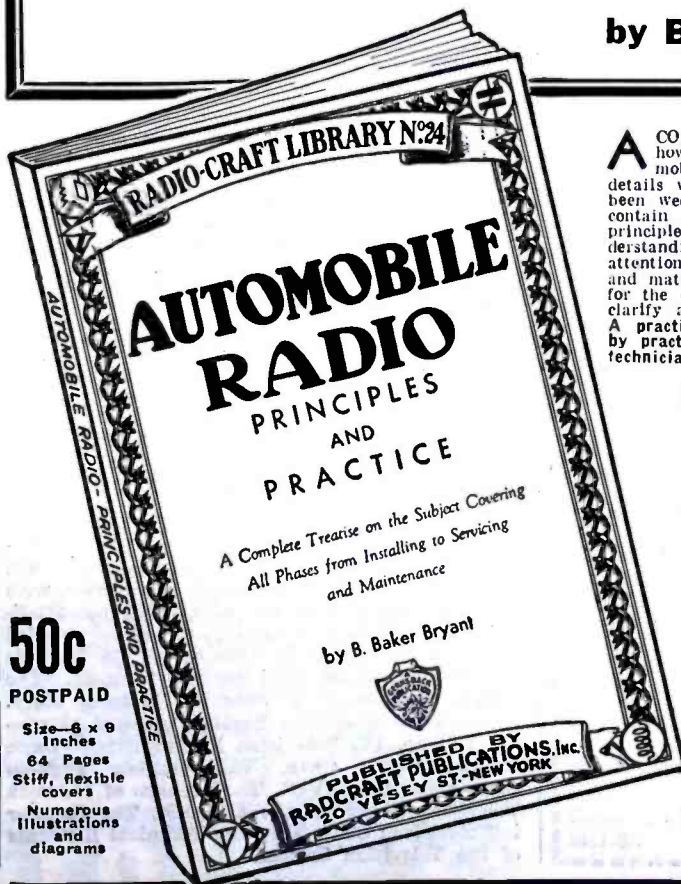

A COMPLETE compilation of pertinent data on how to install and service the modern automobile radio receiver. All of the non-essential details which have crept into the profession have been weeded out. Each topic is treated so as to contain a precise statement of the fundamental principle involved, to assure the reader's clear understanding of this principle, without distracting his attention by the discussion of a multitude of details and mathematical expressions, which are primarily for the engineer, and tend to confuse rather than clarify a statement for the auto-radio-technician. A practical treatise based on practical experience by practical radio people for the practical radio-technician.

Brief Outline of Contents—

Introduction—The Auto-Radio Art.
Features of the Modern Automobile Receiver.
Installations of Automobile Radios and Antenna.
The Automobile High and Low Tension Electrical Systems.
Automobile Electrical Disturbances.
Vibrator Converters and Motor Generators.
Service Hints, Classified Automobile Installation Notes, and Conclusion.

Send 50c check, money order, unused U. S. stamps, or coin for your copy of "Automobile Radio—Principles & Practice"—it will be sent to you postpaid upon receipt of your remittance.

RADCRAFT PUBLICATIONS, Inc.
20 Vesey Street, New York, N. Y.

GEOPHYSICAL PROSPECTING OUTFITS



BLUE PRINTS and INSTRUCTIONS

For Building the Following Treasure Finders and Prospecting Outfits

- Folder No. 1.** The "Radioflector Pilot"—consists of a 2-tube transmitter and 3-tube receiver. Principle: radiated Wave from transmitter loop is reflected back to receiver loop. Emits visual and aural signals. Tubes used: two 1A5G—two 1N5G—one 1H5G.
- Folder No. 2.** The "Harmonic Frequency Locator"—Transmitter radiates low frequency wave to receiver, tuned to one of Harmonics of transmitter. Using regenerative circuit. Emits aural signals. Tubes used: one 1G6G—one 1N5G.
- Folder No. 3.** The "Beat-Note Indicator"—Two oscillators so adjusted as to produce beat-note. Emits visual and aural signals. Tubes used: Three type '30.
- Folder No. 4.** The "Radio-Balance Surveyor"—a modulated transmitter and very sensitive loop receiver. Principle: Balanced loop. Emits visual and aural signals. By triangulation depth of objects in ground can be established. Tubes used: Seven type '30.
- Folder No. 5.** The "Variable Inductance Monitor"—a single tube oscillator generating fixed modulated signals and receiver employing two stages R.F. amplification. Works on the inductance principle. Emits aural signals. Tubes used: six type '30.
- Folder No. 6.** The "Hughes Inductance-Balance Explorer"—a single tube Hartley oscillator transmitter and sensitive 3-tube receiver. Principle: Wheatstone bridge. Emits aural signals. Tubes used: two type '30—one type '32—one type '33.
- Folder No. 7.** The "Radiodyne Prospector"—a completely shielded instrument. Principle: Balanced loop. Transmitter, receiver and batteries enclosed in steel box. Very large field of radiation and depth of penetration. Emits aural signals. Tubes used: two 1N5G—one 1G4G—one 1H5G—one 1Q5—one 1G4.

With any one of the modern geophysical methods described in the Blue-Print patterns, Radio outfits and instruments can be constructed to locate metal and ore deposits (prospecting); finding lost or buried treasures; metal war relics; sea and land mines and "duds"; mineral deposits; subterranean water veins; oil deposits (under certain circumstances); buried gas and water pipes; tools or other metallic objects sunken in water, etc., etc.

Each set of blueprints and instructions enclosed in heavy envelope (9½" x 12½"). Blueprints 22" x 34"; eight-page illustrated 8½" x 11" folder of instructions and construction data... **50¢**

The complete set of seven folders..... **\$3.00**
Shipping weight 2 lbs. (add 25c for shipping anywhere in U.S.A.)

TECHNIFAX

RC-1240
1917 S. STATE ST. CHICAGO, ILL.

TECHNIFAX 1917 So. State, Chicago, Ill.

Enclosed herewith \$..... for which mail to address below:

Treasure Finder No. 1, 2, 3, 4, 5, 6, 7.
Complete set of seven folders.

NAME

ADDRESS

CITY STATE

RC-1240

SERVICING BY SIGNAL SUBSTITUTION, by G. N. Goldberger (1940). Published by Precision Apparatus Co. Size, 5 x 8 ins., stiff paper cover, illustrated, 120 pgs. Price, 35c.

In addition to presenting detailed instructions on dynamic servicing, this book includes chapters on special alignment and adjustment problems as for example in the servicing of F.M. receivers, etc. The section on dynamic servicing illustrates the use of a tube tester, multi-range meter and signal generator in making practically any required test in localizing receiver faults. This book is based on the use of a commercial signal generator.

RADIO OPERATING QUESTIONS AND ANSWERS (7th Edition), by Arthur R. Nilson and J. L. Hornung (1940). Published by McGraw-Hill Book Co., Inc. Size 5 x 8 ins., flexible leather cover, profusely illustrated, 415 pgs. Price, \$2.50.

Revised, "Radio Operating Questions and Answers," now in its 20th year as a standard technical radio review book, represents a rebirth in a new pocket-size and with rewritten contents to cover the scope of the revised Federal Communications Commission license requirements. This book is not intended as a textbook but rather as a review book for readers only technically trained in radio communication and whose requirements are a quick review of essential theory, mathematics and diagrams. Students requiring basic instruction are referred to resident and home study schools specializing in radio communication courses, and to available textbooks. Approximately 1,300 questions and answers cover the scope of commercial radio operator license examinations (Elements I to VI of the F.C.C. requirements). This book is recommended to students and operators about to take a government examination for a radio operator's license.

Chapters: Basic Radio Laws; Basic Theory and Practice; Radiotelephony; Advanced Radiotelephony; Radiotelegraphy; Appendix I. Operating Abbreviations, etc.; Appendix II. Rules Governing Commercial Radio Operators; Appendix III. Extracts from Radio Laws; Index of Subjects; Index of Diagrams and Illustrations.

SAFETY RULES FOR RADIO INSTALLATIONS—Comprising Part 5 of the 5th Edition, National Electrical Safety Code (Handbook H35) (1939). Published by Government Printing Office, Washington, D. C., available from Superintendent of Documents. Size, 5 x 7½ ins., paper cover, 25 pgs. Price, 10c.

This little booklet should be the property of every radio Serviceman. It discusses the following installations in accordance with the procedure of the American Standards Association; Antennas and Constructions; Protective Devices; Protective Constructions; Protective Wiring; Grounds; Power Line Connections; and, Batteries.

G-E HOME WIRING HANDBOOK—A Guide for Planning Electrical Wiring for Homes (1940). Published by General Electric Co., Appliance and Merchandise Dept., Bridgeport, Conn. Size 8½ x 11 ins., profusely illustrated, stiff paper cover, 24 pgs. Available free.

This new manual on home wiring practices is a guide for checking and writing specifications, and the material specifications for home wiring, as well as suggested ways of checking the completed installation. A series of tables useful to radio installers concludes the booklet.

TELEVISION BROADCASTING, by Lenox R. Lohr (1940). Published by McGraw-Hill Book Co., Inc. Size, 6 x 9 ins., cloth cover, 88 illustrations, 274 pgs. Price, \$3.00.

This book is a "must" for anyone seriously interested in any phase of television. Economic, legal and technical problems in connection with programs, as well as the advertising potentialities of television broadcasting, are given detailed attention in this book. Concluding the book is the complete script cued for televising, of "The Three Garridebs," a Sherlock Holmes story. Some of its 13 chapter headings selected at random: Chap. IV, Television Programming—Basic Considerations; Chap. VII, Outdoor Pick-up Broadcasts; Chap. VIII, The Problem of Network Television Broadcasting; Chap. X, The Sponsor in Television; Chap. XII, The Technical Elements of the Television System.

Index to advertisers

PUBLIC ADDRESS EQUIPMENT

Amplifier Co. of America.....	355
John Meck Industries.....	355
Miles Reproducer Co.....	363
RCA Mfg. Co., Inc.....	349
The Turner Company.....	353
University Laboratories.....	353
Montgomery Ward & Co.....	354
Wright-DeCoster, Inc.....	355

PUBLISHERS

Audel, Publishers.....	370
Data Print Co.....	373
Fortuny's, Publishers, Inc.....	363
Miller, Wayne.....	324
National Plans Inst.....	382
Radcrafft Publications, Inc.....	356, 383
Radio & Technical Pub. Co.....	324, 325
Supreme Publications.....	354, 373
Technifax.....	368, 384

RADIO PARTS

Aerovox Corporation.....	360
Amperite Co.....	Inside Front Cover
Hammarlund Mfg. Co.....	343
International Resistance Co.....	333
National Union Radio Corp.....	335
Ohmite Mfg. Company.....	339
Solar Mfg. Corp.....	363

RADIO SETS

Allied Engineering Institute.....	370
Goldentone Radio Co.....	366
Howard Radio Co.....	351
Meissner Mfg. Company.....	323

RADIO SUPPLY HOUSES

Allied Radio Corp.....	369, 381
Anchor Radio Distributing Service.....	370
Burstein-Applebee Co.....	345
Hudson Specialties Co.....	374
Lafayette Radio Corp.....	371
Radolek Co.....	383
Sears, Roebuck & Company.....	357

SCHOOLS

Capitol Radio Eng. Inst.....	368
Lincoln Engineering School.....	324
National Radio Institute.....	321
National Schools.....	325
Radio Training Assoc.....	324
RCA Institutes.....	325
Sprayberry Academy of Radio	

Inside Back Cover

TEST EQUIPMENT

Radio City Products Co.....	347
Readrite Meter Works.....	361
Superior Instruments Co.....	341, 343, 345, 366
Supreme Instruments Corp.....	353
Triplett Electrical Instrument Co.....	344
Weston Electrical Instrument Corp.	

Back Cover

TUBES

Hygrade Sylvania Corp.....	363
----------------------------	-----

MISCELLANEOUS

Atlas Press Co.....	366
Bridge, Harry P.....	368
Classified Section.....	372
Flight Magazine.....	372
Lancaster, Allwine & Rommel.....	370
Radio Servicemen of America.....	360
Remington Rand, Inc.....	326
Wellworth Trading Co.....	372
Woodstock Typewriter Co.....	381

(While every precaution is taken to insure accuracy, we cannot guarantee against the possibility of an occasional change or omission in the preparation of this index.)

FULL EQUIPMENT

Included WITH SPRAYBERRY RADIO TRAINING!

**Experience Easily
Acquired at Home!**

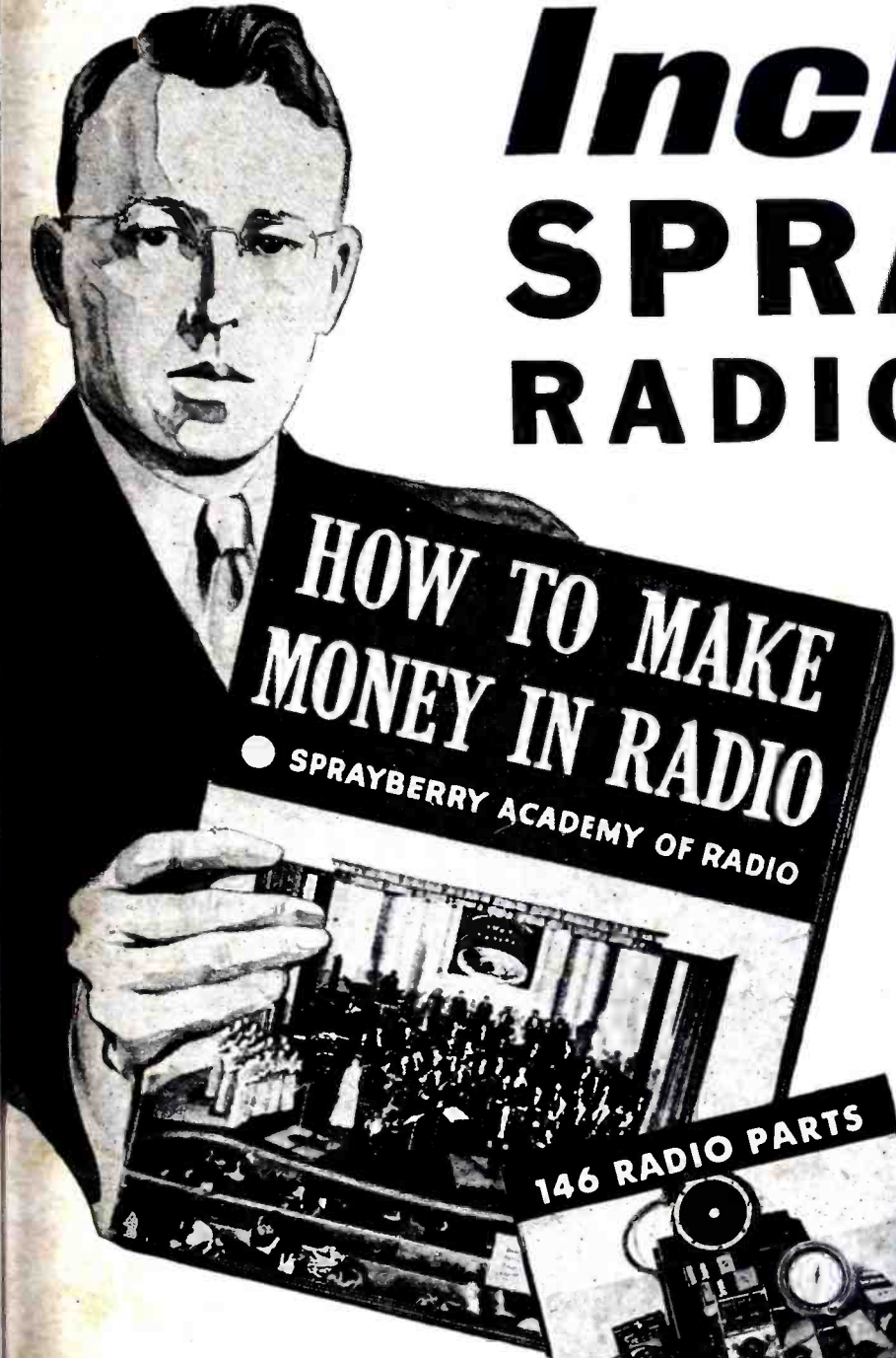

**Over 100 Experiments Plus Many Other Special Features
... ALL DESIGNED TO HELP YOU MAKE FAST PROGRESS!**

SPRAYBERRY Training starts right at the beginning of Radio . . . unfolds each subject in a simplified, logical, understandable style. You easily learn Television, Frequency Modulation, Signal Tracing, Mobile Radio (Auto—Tank), Aviation Radio, Electronics, Facsimile Radio, Radio Set Repair and Installation Work. You learn quickly in your spare hours . . . AT HOME OR AT CAMP.

**Training Prepares You for a Business of Your Own . . .
Or Good Radio Jobs at Excellent Pay!**

The great, fascinating and progressive field of Radio and Television offers many opportunities to the man who wants to get ahead. There is good money to be made. My Training is designed to give you quick access to these opportunities. SPRAYBERRY Methods are thorough and practical. Your Training will not interfere with your present work.

**You Get Professional Test Equipment
Plus Experimental Outfits!**

Includes 146 RADIO PARTS for building a complete Receiver, RADIO TOOLS and a modern TESTER-ANALYZER. You also receive 8 BIG SHIPMENTS OF RADIO EQUIPMENT for conducting actual experiments with your own hands. I show you how to create Radio defects . . . how to correct them.

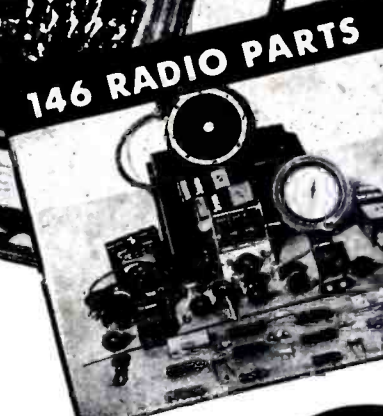

**READ WHAT THESE FELLOWS
SAY ABOUT THE NEW
PRACTICAL SPRAYBERRY
TRAINING**

EARNED \$250 SINCE STARTING

"I have only completed one-third of the Sprayberry Course and I find it very interesting, which makes it easy to learn. "By devoting several hours of my spare time daily to studying and servicing, I have made about \$250 gross since starting the Course." Earl W. Hostetter, R. No. 4, Lebanon, Pa.

"SO MUCH FOR SO LITTLE"

"Now just a few words about your Course—the more I get from it, the more I wonder how you can give so much for so little.

"I believe it to be the finest of its kind obtainable, and I would urge anyone wishing to study Radio seriously to take your Course." George W. Elliott, 521 Elwyn St., Nelson, B. C., Canada.

"MADE OVER \$300 NET IN SIX MONTHS"

"While I have not hung out my 'shingle' yet, I have made over \$300 net in the past six months, doing some full and some part time Radio servicing.

"I am completely satisfied in every way with your Course, and I am mighty glad I signed on the 'dotted line,' making me a student of the Sprayberry Academy of Radio." Wendell M. Caldwell, 93 Hickory St., Rochester, N. Y.

Cash In on Radio's Rich Opportunities

No matter if you desire to BE YOUR OWN BOSS in your own business or hold down a good job in Radio, my Training will give you the useful information and knowledge to win success. Days of delay mean precious time wasted. Start training for a money-making Radio career—right now.

**REMEMBER —THE SPRAYBERRY COURSE IS SOLD
UNDER A MONEY-BACK AGREEMENT**



EARN WHILE YOU LEARN

My BUSINESS BUILDERS show you how to put your equipment to actual use in handling money-making Radio Service Jobs shortly after you begin Training.

**Learn More About the
SPRAYBERRY Method
And How Easy It Is to Start**

The complete details of my fundamental Course and Advanced Training Course . . . all features are fully described in my new, valuable 52-page FREE Book. Send for your copy. No obligation.

**No Previous
Experience Needed**

It makes no difference what your education has been, I can fit you quickly for a good-paying Radio job. I make it easy for you to grasp Radio principles and remember them. Your success is my full responsibility.

**You Get
Personal
Coaching
Service
All The
Way!**

DON'T DELAY! ACT NOW!

SPRAYBERRY ACADEMY OF RADIO

**F. L. Sprayberry, Pres.
320-M University Place, N. W.
Washington, D. C.**

Please send my FREE copy of "HOW TO MAKE MONEY IN RADIO."

Name Age

Address

City State

Tear off this coupon, mail in envelope or paste on penny postcard.

RUSH THIS COUPON for BIG FREE BOOK
GIVING COMPLETE FACTS



**FIRST
INTRODUCED
IN 1936**

Still Tops for 1941!

Owners of Model 772 have experienced the true economy of buying correctly designed instruments which measure in fundamentals

Servicemen who purchased one of the original Model 772's over four years ago have found this super-sensitive Analyzer "up-to-the-minute" all during this period ... and find it still "tops" in the field for today's and tomorrow's measurement needs.

It more than met the test requirements of all A.M. receivers... despite the refinements and circuit changes during these many years. It met the requirements of television, too; and today, it is the outstanding instrument for F.M. servicing... because of its high sensitivity, its sound design and construction, and because it measures in fundamental quantities. There are no trick circuits or gadgets to cause early and costly obsolescence. It is a fundamental instrument that, with usual instrument care, will remain in full service indefinitely.

Be sure to get all the facts on Model 772 and other WESTON fundamental test equipment. Write to Weston Electrical Instrument Corporation, 599 Frelinghuysen Avenue, Newark, New Jersey.

THE WESTON MODEL 772 Super-Sensitive Analyzer



Laboratory Standards... Precision DC and AC Potentials... Instrument Transformers... Sensitive Relays... DC, AC, and Thermo Switchboard and Panel Instruments.

WESTON

WESTON ELECTRICAL INSTRUMENT CORPORATION
599 FRELINGHUYSEN AVENUE
NEWARK, NEW JERSEY

1941 MODEL 772 ANALYZER