

RADIO-CRAFT

HUGO GERNSBACK, *Editor*

**THE IRON HORSE
GOES ON RECORD!**

See Page 264



RADIO POSTMISTRESS



"550 ON YOUR DIAL"!



"PHANTOM RAIDERS"



S. S. AMERICA'S RADIO

NOV.

25c

CANADA 30c

RADIO'S GREATEST MAGAZINE
TELEVISION SERVICING PROBLEMS • SERVICING F.M. RADIOS
NEW RECORDING AMPLIFIER • ELECTRIFIED 2-TUBE SUPERHET.

AMPERITE Announces the **BIGGEST ADVANCE**
in the Dynamic since its Inception!

P.G.
PRESSURE GRADIENT
DYNAMIC

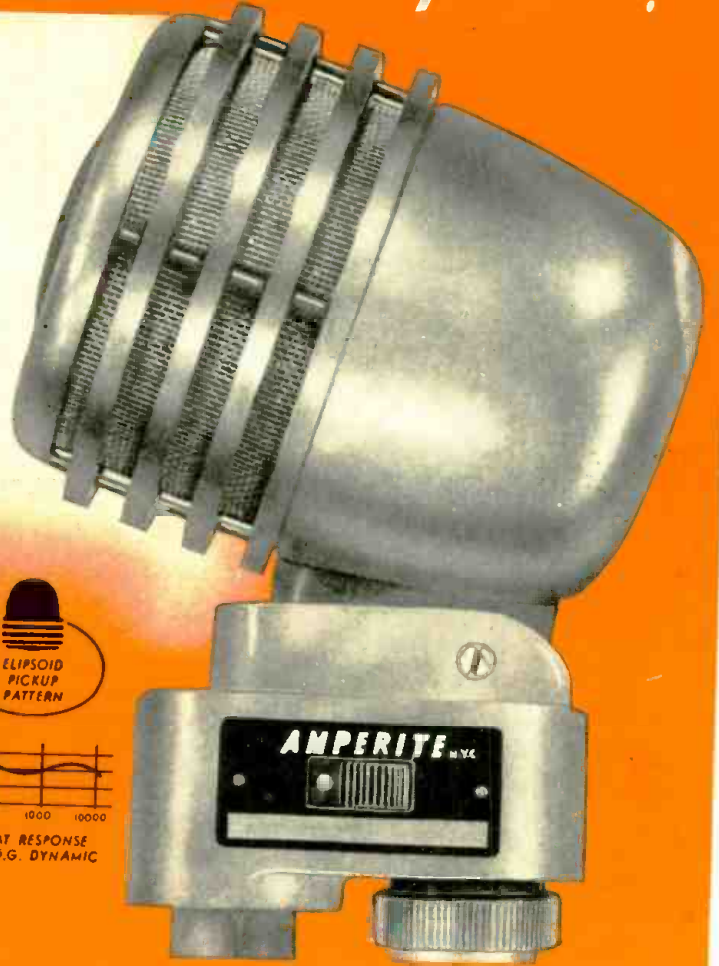

- **UNI-DIRECTIONAL.** NEW SUPERIOR ELIPSOID PICKUP PATTERN
- **ELIMINATES FEEDBACK** TROUBLE BECAUSE IT HAS LOWEST FEEDBACK POINT OF ALL DIAPHRAGM TYPE MICROPHONES
- **FLAT RESPONSE.** FREE FROM ANNOYING PEAKS, GIVING STUDIO-QUALITY REPRODUCTION.

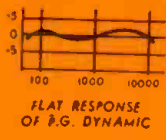

The P.G. diaphragm follows air particle velocity where amplitude is a GRADIENT of the PRESSURE. In ordinary dynamics amplitude is restricted from following air particle velocity.

The P.G. DYNAMIC is a radical improvement in this type of microphone. You can actually hear the difference. Case is designed according to modern acoustic principles. Rugged, not affected by temperature, altitude or humidity. HAS UNUSUALLY HIGH OUTPUT. —55 DB.

MODEL PGH (PGL, 200 ohms). Excellent for high fidelity P.A. installations, broadcast studio, and professional recording. With switch, cable connector, 25' cable. Chrome finish, LIST \$32.00 (40, 10,000 C.P.S.)

MODEL PGAH (PGAL, 200 ohms). For speech and music. 70-8000 C.P.S. Switch, cable connector, 12' cable. Chrome, LIST \$25.00

COMBINATION VELOCITY-DYNAMIC ACHIEVED WITH ACOUSTIC COMPENSATOR



An exclusive Amperite feature: By moving up the Acoustic Compensator you change the AMPERITE VELOCITY to a DYNAMIC microphone without peaks. At the same time you reduce the back pick-up, making the microphone practically UNI-DIRECTIONAL.

WITH ACOUSTIC COMPENSATOR:
MODEL RBHk; RBMk (200 ohms) with switch, cable connector.

Chrome, LIST \$42.00

RSHk; RBSk (200 ohms). Switch, cable connector, Acoustic Compensator.

Chrome or Gunmetal, LIST \$32.00

AMPERITE KONTAK MIKE
Puts Musical Instruments Across



So beautiful is the tone produced with the Kontak Mike, that it was used in the Philadelphia Symphony to amplify a mandolin solo. Gives excellent results with any amplifier, radio sets, and record players.

MODEL SKH (hi-imp)LIST \$12.00

MODEL KKH, with hand volume control..LIST 18.00

Plug extraList 1.50

FOOT PEDAL, for making beautiful crescendosLIST 12.00

WRITE FOR FREE SALES AIDS

AMPERITE ©

561 BROADWAY, N. Y. U. S. A.

Specify **AMPERITE**



A FREE LESSON SHOWED BILL HOW HE COULD MAKE GOOD PAY IN RADIO



I will send you a Lesson on Radio Servicing Tips FREE
 TO SHOW HOW PRACTICAL IT IS TO TRAIN AT HOME FOR
GOOD JOBS IN RADIO



J. E. SMITH, President National Radio Institute Established 25 years

He has directed the training of more men for the Radio Industry than any one else.



J. E. SMITH, President, Dept. OMX National Radio Institute, Washington, D. C.

Dear Mr. Smith: Mail me FREE, without obligation, your Sample Lesson and 64 page book "Rich Rewards in Radio" which tells about Radio's spare time and full-time opportunities and explains your 50-50 method of training men at home to be Radio Technicians. (No salesman will call. Write Plainly.)

Clip the coupon and mail it. I'm so certain I can train you at home in your spare time to be a Radio Technician that I will send you a sample lesson free. Examine it, read it, see how clear and easy it is to understand. See how my course is planned to help you get a good job in Radio, a young, growing field with a future. You needn't give up your present job, or spend a lot of money to become a Radio Technician. I train you at home in your spare time.

Jobs Like These Go to Men Who Know Radio

Radio broadcasting stations employ Technicians as operators and maintenance men and many more. Radio manufacturers employ Testers, inspectors, servicemen in good-pay jobs with opportunities for advancement. Radio jobbers and dealers employ installation and service men. Many Radio Technicians open their own Radio sales and repair businesses and make \$30, \$40, \$70 a week. Others hold their regular jobs and make \$5 to \$10 a week fixing Radios in spare time. Automobile, police, aviation, commercial Radio; loudspeaker systems, electronic devices, are newer fields offering good opportunities to qualified men. And my course includes Television, which promises to open many good jobs soon.

Many Make \$5 to \$10 a Week Extra in Spare Time While Learning

The day you enroll, in addition to my regular course, I start sending you Extra Money Job Sheets which start showing you how to do Radio repair jobs. Through out your course I send plans and illustrations which have helped many make \$5 to \$10 a week in spare time while learning.

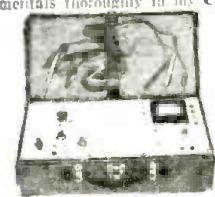

You Get This Professional Servicing Instrument

This instrument makes practically any test you will be called upon to make in Radio service work on both spare time and full time jobs. It can be used on the test bench or carried along when out on calls. It measures A.C. and D.C. voltages and current; tests resistances; has a multi-band oscillator for aligning any set, old or new. You get this instrument to keep as part of your N. R. I. Course.

Get Sample Lesson and 64-page Book Free--Mail Coupon

Act today. Mail coupon now for Sample Lesson and 64-page Book. They're FREE. They point out Radio's spare time and full time opportunities, and those coming in Radio and Television; show many letters from men I trained, telling what they are doing and earning. Read my money back agreement and find out what Radio offers you. Mail coupon in envelope or paste on penny postcard--NOW!

J. E. SMITH, President Dept. OMX, National Radio Institute, Washington, D. C.

Name

Address

City State

14X-1

RADIO-CRAFT

HUGO GERNSBACK, *Editor-in-Chief*

N. H. LESSEM
Associate Editor

THOS. D. PENTZ
Art Director

R. D. WASHBURNE, *Managing Editor*

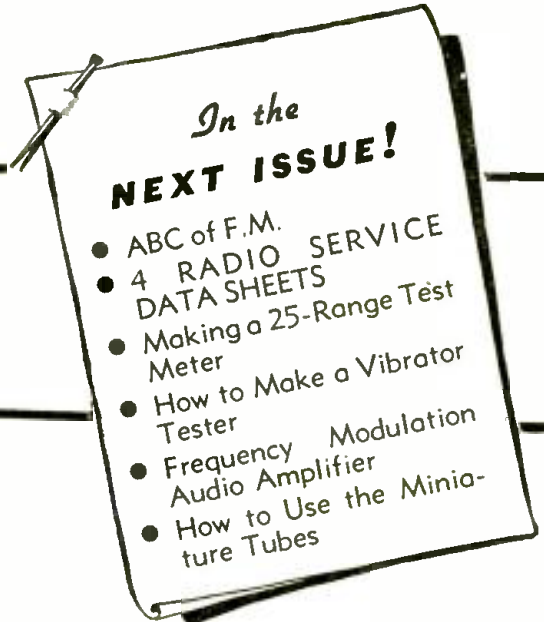

Contents NOVEMBER, 1940 Issue

VOLUME XII -- NUMBER 5

Mailbag	259
Editorial: Radio for Defense	Hugo Gernsback 263
The Radio Month in Review	264

SERVICING

F.M. Servicing Procedure	Charles E. Angle 266
New Circuits in Modern Radio Receivers—No. 38	F. L. Sprayberry 268

RADIO SERVICE DATA SHEETS:

No. 292—Crosley Model 29BA Radio-Phonograph Combination (chassis model 29)	270
No. 293—Emerson DX-356 3-Band Mantel Set (chassis model DX)	272
No. 294—Howard Model 520APC Radio - Phono Combination	274
No. 295—Mitchell Mfg. Co. "Navigator" Globe-Radio (chassis models TW and TWU)	276
Operating Notes	271
Please—Mr. Manufacturer	Don Foard, E.E. 275
Regarding Standardized Service Charges	Charles R. Leutz 277
Television Servicing Problems	M. E. Southall 285
Calculating Impedance at a Given Frequency	J. D. Weiss 289
Servicing Teleceivers	292
An Inexpensive Test Speaker	W. T. Hollowell 302

SOUND

Sound Engineering—No. 11	Conducted by A. C. Shaney 278
Recording - Playback Amplifier as Direct-Coupled Output Circuit and Equalized 30-Watt Output	280
New 2-Way Dynamic Phono Pickup	284
Calculating Impedance at a Given Frequency	J. D. Weiss 289

TELEVISION

Television Servicing Problems	M. E. Southall 285
Servicing Teleceivers	292

ELECTRONICS

The Electronic "Solovox"—Latest Radio-Musical Adjunct to the Piano	290
--	-----

F.C.C.

What is the F.C.C.?	293
---------------------------	-----

EXPERIMENTERS

How to Electrify the 2-Tube Superhet	Leonard Lasky 296
--	-------------------

RADIO DEVELOPMENTS

Your Job in the Aviation Industry—	Staff Sgt. Charles J. Schauers 299
S.S. America's Radio	303
Broadcasting an Aquaplane Race	303

DEPARTMENTS, ETC.

Mailbag	259
The Radio Month in Review	264
New Circuits in Modern Radio Receivers—No. 38	F. L. Sprayberry 268
"Miss America 1940" Records	275
RADIO SERVICE DATA SHEETS (See Servicing) 270, 272, 274, 276	
Operating Notes	271
Sound Engineering—No. 11	Conducted by A. C. Shaney 278
F.C.C.'s Mailbag	298
Latest Radio Apparatus	306
Classified Radio Directory—Section 2	311
Shop Notes—Kinks—Circuits	319
Book Reviews	269, 302, 320

★

Published by Radcraft Publications, Inc. Publication office: 29 Worthington Street, Springfield, Mass. Editorial and Advertising Offices: 20 Vesey Street, New York City. Chicago Advertising Office: RADIO-CRAFT, 520 North Michigan Avenue, Chicago, Ill.

RADIO-CRAFT is published monthly, on the first of the month preceding that of date; subscription price is \$2.00 per year in U. S. and Canada. (In foreign countries, \$2.50 a year to cover additional postage.) Entered at the post office at Springfield as second-class matter under the act of March 3, 1879.

★

Foreign Agents:

London—Gorrings's American News Agency, 9A Green St., Leicester Square, W. C. 2, England.

Paris—Messageries Dawson, 4 Rue Faubourg, Poissonniere, France.

Melbourne—McGill's Agency, 179 Elizabeth St., Australia.

Dunedin—James Johnston, Ltd., New Zealand.

★

Text and illustrations of this magazine are copyright and must not be reproduced without permission of the copyright owners.

★

Copyright 1940 Radcraft Publications, Inc.

MORE V.-T. VOLTMETER ARTICLES

Dear Editor:

Quite often, in service articles, the vacuum-tube voltmeter is recommended to the Serviceman as a very worthwhile addition to the bench. But material on the construction and use of such equipment has been limited. How about some articles in *Radio-Craft* on this subject in the near future? I have found the articles on "Servicing Orphans and Private Brand Receivers" very helpful and I am keeping them in a folder where they are handy for quick reference.

KENNETH L. BURUCKER,
Baltimore, Md.

Yes, this 3-part article in the March, April and May, 1940, issues was well-received by *Radio-Craft* readers. What other topics do you suggest we cover which aren't already covered in available literature? The editors do not profess to be clairvoyant, so tell us what's on your mind.

SIGNAL TRACING

Dear Editor:

In reading over many of the magazines and the trade papers, I notice that there has been quite a good deal of discussion with regard to "signal tracing." Much of the comment appears to pooch-pooch the idea of using any elaborate method such as is advocated by the Rider philosophy, while old and die-hard Servicemen loudly attest their ability to service sets with no more than a volt-ohmmeter. On the other side of the picture, we have the men who, equally vehement in their condemnation of the opposition, refer to non-believers as "screwdriver mechanics."

It seems to me, in view of the above statements, that there must be a middle road which the majority of us may take. First step is to have adequate basic test apparatus of high quality, a tube tester, volt-ohmmeter, signal generator. Next, either a "signal tracer" or a vacuum-tube voltmeter. Finally, an oscilloscope and frequency-modulated generator, adding various other pieces of equipment as resources permit.

Nobody, as yet, seems to realize that many service businesses just can't afford expensive apparatus. The result is that some men, lacking elaborate equipment, become very resentful of their more fortunate fellows and write nasty letters. The whole question, then, seems to be economic.

Incidentally, where will the men who depend on test apparatus to do their thinking wind up when, perhaps under war time conditions, they must do a job and do it quickly?

WILLARD MOODY,
New York City.

RE "RADIO DOCTORS' CODE"

Editor's note: To get the gist of the following letter read "Radio Doctors' Code" on page 162 of Sept. 1940 *Radio-Craft*.

Dear Vic:

Here is another bird who thoroughly agrees with you. This same subject has been on my mind for 7 years now, but it seems that there is nothing that can be done about it unless we have a strong-arm squad out to enforce rules and regulations.

Evidently we have more mice than men in the radio industry; however I am willing to take another crack at it. If agreeable with you, I can cooperate from the New York area in attempting to clean up all the undesirables in this industry and to

UNBELIEVABLE
~but True!

The Famous MEISSNER ANALYST

Completely Wired and Tested

Ready to Operate

for only \$69.50

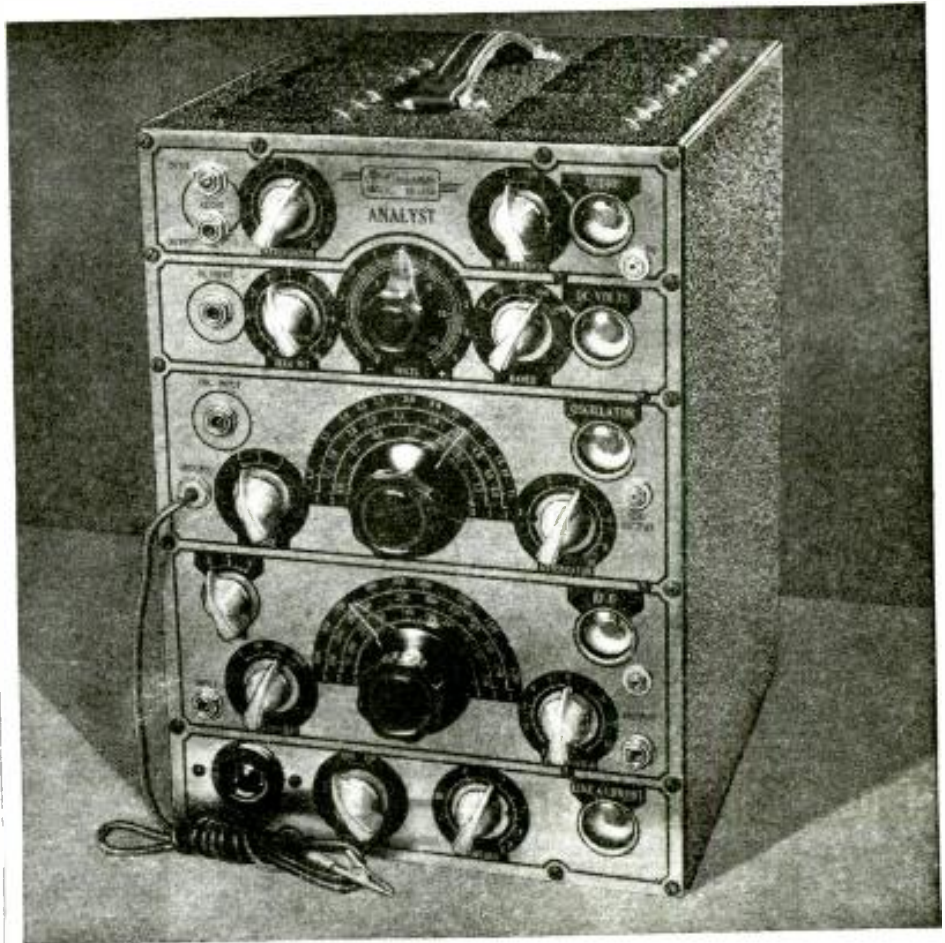

HERE'S YOUR LAST CHANCE!

Before making changes in tool- and shop equipment to prepare for manufacture of new models, we have decided to give the Serviceman a "break" by offering the present model ANALYST at a substantial reduction in price. This is the identical

instrument that has sold by the hundreds, in kit form, less tubes, at \$60 Net! Its time and money saving ability can not be surpassed. Ask the man who is using one. Get in on this remarkable offer at once. See your Jobber TODAY!

TIME PAYMENT PLAN

The complete Meissner ANALYST, with full set of 13 RCA tubes, may be purchased with a small down payment and the remainder in easy monthly installments. Ask your Jobber about the Meissner Time Payment Plan.

1941 CATALOG JUST OUT

The new Meissner General Catalog is now available. Lists complete receivers, kits, replacement coils, and hundreds of other daily needs of the serviceman and experimenter. Send a postal card for yours TODAY!

ADDRESS DEPT. C-11



NEW JOBS for Radio Men!

★ Men with radio training are lucky today! Great opportunities have opened up with the National Defense activities—more radio jobs in industry—more work for service men—and best of all, thousands of new radio jobs that are provided for in the Army expansion plans.

ARMY PAYS A PREMIUM!

★ In the Signal Corps, Air Corps, Mechanized Cavalry, Coast Artillery, Field Artillery, Infantry, Tank Companies—in every branch of the service men are needed with radio and electrical training. These men command a Premium in pay and in rank. In fact, those who reach top rank as non-commissioned officers get 6 times more than a private's base pay!
★ Think that over—a knowledge of radio fundamentals means MONEY and RANK to you, whether you are planning to enlist now or wait for conscription.

PREPARE NOW!

★ With these 2 famous Ghirardi self-training books, you can quickly and easily get the valuable radio background that will mean so much to you. Right now in your spare time in your own home you can—

LEARN RADIO and SERVICE WORK with Ghirardi's BIG 2

RADIO PHYSICS COURSE

BASIC FUNDAMENTALS

Here's your start in Radio! If you are a beginner, this one big, all-inclusive, short-cut, self-instruction book of nearly 1,000 pages with over 500 illustrations will give you a thorough training in the important fundamentals of Electricity, Radio, Sound, Television, Cathode-Ray Tubes, etc.—all the essentials, all the background you need for a complete radio knowledge. No math—no previous training necessary. It starts at the very beginning, teaching you all about Electricity first, and then you learn it all easily by yourself at home, in spare time, checking your progress with the 856 self-examination Review Questions.

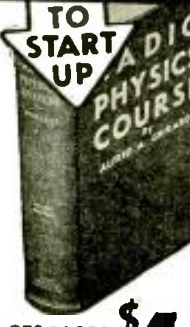

872 PAGES
508 ILLUS.
856 REVIEW QUESTIONS
\$4

USED BY ARMY AND NAVY

Because Ghirardi makes everything so crystal-clear and easy to understand, this very same Radio Physics Course is used by the U. S. Army and Navy, Marine Corps, CCC Camps, and by more radio schools and students than any other radio book!

MODERN Radio SERVICING

LEARN HOW with this!

This famous Ghirardi book will teach you how to test and service all types of electronic and radio equipment. It's an illustrated 1300-page "gold mine" of servicing knowledge. 420 pages explain all types of servicing test instruments—how they work, how constructed, how to build them, how to use them. Then 900 more pages give you a complete step-by-step procedure course in trouble-shooting, testing, aligning and repairing all makes of radio sets and other electronic devices. The very latest advanced scientific Factory Methods of trouble shooting and repairing are explained throughout. You learn service work easily at home with 720 self-examination review questions to check your progress.



1300 PAGES
708 ILLUS.
\$4

Send for these books now—you can return them and your money will be refunded if you're not completely satisfied!

MAIL COUPON TODAY!

RADIO & TECHNICAL PUBL. CO., Dept. RC-110
 45 Astor Place, New York City
 Send postpaid with 5-Day Money Back Guarantee:
 RADIO PHYSICS COURSE \$4. (\$4.50 foreign)
 MODERN RADIO SERVICING \$4. (\$4.50 foreign)

Name
 Address
 City State
 Please send FREE illustrated descriptive literature.

MONEY BACK IF NOT SATISFIED

make it possible for the honest radio man to make an honest and clean living.

As far as the public is concerned, they will save money and finally be able to have an honest-to-goodness job done for a change. It is a wonder half the radio men working aren't thrown in jail by this time, because there are many things to be taken up, and I don't know how you feel about this yet. Let me know what you want to do about this and I'll give you 100% cooperation.

IRVING HOROWITZ,
Brooklyn, N. Y.

RE "RADIO WAR INVENTIONS"

Dear Editor:

Re "Radio War Inventions," Sept. issue. After writing to almost everyone in Washington in an effort to learn where I could send my idea for a military device, I finally received, from Sen. Robert A. Taft, this morning, a letter addressed to him by John D. Biggers, Acting Chairman*. Letter advised me to write to National Inventor's Council, Room 7422, Dept. of Commerce, Washington, D. C. I did!

Hope this information pleases you as much as it does me. Don't thank me—thank "Bob" Taft of Ohio; also the others who finally woke up.

*Mr. Knudsen is the Big Boss.

NATE SILVERMAN,
Lorain, O.

HE LIKES US

Dear Editor:

Let me express my appreciation for your splendid magazine, I would also like to add my two bits and say keep *Radio-Craft* for the Serviceman. After reading Mr. Freedman's excellent article on how to make a Simplified Practical Signal Tracer, I feel like asking for more. I refer to his suggestion at the end of the article, adding an R.F. tuner, and V.-T.Vm. using a 1 ma. meter. If you think such an article would be worthwhile, and could induce Mr. Freedman to write it I would appreciate it very much. How about another True-False quiz by Mr. Freedman? and maybe some more after that.

R. B. GOUGH,
Bloomfield, Conn.

TROUBLE WITH V-T VOLT-METER ARTICLE

Dear Editor:

I have built the V.-T. Voltmeter by Turner in the June issue of *Radio-Craft*. Would you please tell me why, when you short the A.C. input, the meter will read about 0.4-ma. after it has been set at zero?

EVERETT E. COX,
Kansas City, Mo.

This letter was forwarded to the Author, whose reply follows:

Dear Mr. Cox:

When the A.C. input of the instrument is shorted (as when the test prods are touched together), the positive pole of the bias cell is connected directly (with the range selector in the 1-volt position) to the diode plates. The increased static indication is the result of impressing this D.C. potential upon the diode. On the higher voltage ranges, the cell would be connected around to the diode through one or more resistors of the input voltage divider which would reduce the false reading considerably.

RUFUS P. TURNER, WIAY

FROM A NEW ZEALAND READER

Dear Editor:

For some time past I have been going to write you and congratulate you on main-

taining such an excellent magazine as *Radio-Craft*.

I am a radio Serviceman working for the largest radio retail firm in our city and I am always interested in the excellent radio service and public address articles in the magazine.

I get my copies from my newsagent regularly and the April issue in my opinion is the most outstanding of any issue previously published—there seems to be about twice as much information in it as usual and I like the new "streamlined" idea.

Like Frank Mills who writes in the April issue against xmmitter articles, I believe there are plenty of other magazines catering for the xmmitting fraternity and *Radio-Craft* would lose its identity as well as depriving a great number of Servicemen of the excellent material which inspires them to move ahead and become better technicians.

I personally have derived a great amount of benefit from *Radio-Craft* and I am keenly interested too in the Public Address articles by Shaney and the other fellows.

If the magazine can be maintained at the level of the April issue it will be doing a great job. I too am a ham—since 1926—I, like Frank Mills, am unbiased.

KEITH HANE, Ex-ZL2FT,
8 Karaka St.,
Palm. Nth.,
New Zealand.

AN UP-AND-COMING SERVICEMAN

Dear Editor:

I have been servicing radios for about a year-and-a-half, and I learn more every day along that line of work.

I have been purchasing *Radio-Craft* at a newsstand and let me tell you I really enjoy the magazine very much. I have been taking the magazine for the last 10 months, and it's very interesting and also a great help but some of the things are as you might say above my head as yet. It's very interesting to read the different letters in *Radio-Craft* magazine from different Servicemen discussing different questions.

JOHN W. BURGER,
Westphalia, Kansas.

FROM A JAPANESE READER

Dear Editor:

I have very interesting about Supersonic note, and the communication with it, Dear Editor, Please expornent details of new superior and relishfull study at your country in me *Radio-Craft* Mag.

The electric musical instrument is highly appreciated also.

Yours faithfull subscriber,

SIGETAKA MASUDA
No. 421, Fujikata
Tsu-Shi, Miyeken
Japan.

We'd be some pumpkins if we were equally as good in Japanese, all right. We will try to run an occasional article on superonics. Also we will continue to record radio's various developments, including those in electronic music.—Ed.

INCREASED GAIN FOR PUSHBUTTON SETS

Dear Editor:

With the advent of pushbuttons for tuning many manufacturers cut down on the R.F. sections of their receivers in order to avoid the complications and added cost of tuning extra stages with the buttons.

This, of course, caused a lack of selectivity and overall poor performance. Diagrams A



Be a RADIO SERVICE EXPERT
LEARN AT HOME IN SPARE TIME

Clear, simple, fascinating lessons—practical work with experimental kits—make training easy and fast. Up to date R.T.A. methods, under personal guidance of prominent engineer and educator, highly endorsed by leaders in radio industry. Spare-time profits soon pay for training.

START NOW — have your own business or fit yourself for well paid work with radio dealers, in factories, police, marine or television fields. **DON'T DELAY!** Send AT ONCE for complete information and **BOOK FREE!**

RADIO TRAINING ASS'N. OF AMERICA
1559 Devon Ave. Dept. RC-110 Chicago, Ill.

RADIO TECHNOLOGY

RCA Institutes offer an intensive course of high standard embracing all phases of Radio and Television. Practical training with modern equipment at New York and Chicago schools. Also specialized courses in Aviation Communications, Radio Servicing and Commercial Operating. Catalog Dept. RC-40.

RCA INSTITUTES, Inc.
A Radio Corporation of America Service
75 Varick St., New York, 1154 Merchandise Mart, Chicago

RADIO-TELEVISION

Oldest, largest Radio-Television school in West trains you for good pay job. Complete instruction including Radio Construction and Service, Broadcast Operating, Sound, Talking Pictures, Television, Public Address, etc. Flexible plan to meet specific needs of those with or without jobs. Transportation allowed to L.A. Earn room and board while learning. Request Free Catalog.

NATIONAL SCHOOLS Dept. RC-11 Los Angeles

RADIO COURSES
Classes Now Starting

- RADIO OPERATING—BROADCASTING
- RADIO SERVICING — a practical course
- RADIO AMATEUR CODE • TELEVISION
- ELECTRONICS—1 yr. day course 2 yrs. eve.

Day and Evening Classes. Booklet Upon Request.
New York Y. M. C. A. Schools
4 W. 64th Street New York City

LES Correspondence Courses in RADIO and ELECTRICAL ENGINEERING

ELECTRICAL ENGINEERING Get good grasp of wide electrical field. Prepare yourself, at low cost, for secure future. Modern, simplified, you can understand quickly.

RADIO ENGINEERING Extra fine course in radio, public address, photo-electric work.

Trains you to be super-serviceman, real vacuum tube technician. Exper. kits furnished. Diploma on completion. Tuition, \$25. Deferred payment plan.

Get copies of school catalogs, student magazines, complete details. SEND NOW!

FREE

LINCOLN ENGINEERING SCHOOL, Box 891-623, LINCOLN, NEBR.

FREE! GIVEN TO YOU

THIS SUPER MAGNET

LIFTS MORE THAN 20 TIMES ITS OWN WEIGHT

LITTLE GIANT MAGNET—The world's most powerful. Lifts 15 lbs. easily. Weighs 4 oz. Made of ALMICO's new high-magnetic steel. The experimenter and hobbyist will find hundreds of excellent uses for this high quality permanent magnet. Measures 1 3/4" x 1 1/2". Complete with keeper. Value \$1.00.

YOURS, AS A GIFT, FOR SELLING ONLY 16 "CASH IN" BOOKS!

No investment needed. We trust you. You simply order the books from us, sell them for 15c each, and when you collect \$2.40, remit to us (within 30 days) and we will send you the LITTLE GIANT MAGNET absolutely FREE! Or you may prefer one of the many other gifts we offer. Fill out and return the coupon today. Be the first in your neighborhood to sell "CASH IN."

300 Ways To Make Money

40,000 Words of Text

"CASH IN" contains 300 tested mail order plans, business secrets, F. O. M. L. & schemes—real money makers, 68 pages.

This book will sell itself to all of your friends, relatives and neighbors.

—SEND NO MONEY—

National Plans Institute, 246-7 Fifth Ave., New York City

Gentlemen: Please send me 10 books "CASH IN," which I will sell at 15c each. I will pay for the books in 30 days. Then you will send me FREE, your LITTLE GIANT MAGNET. Also send me immediately your list of other free premiums.

Name _____
Address _____
City _____ St. _____
PASTE COUPON ON IC POST-CARD AND MAIL TODAY

and B show how this has been overcome without adding to the button-controlled circuits.

Iron-core coils are used which reduce adjacent-channel interference considerably. In diagram A, the resistance-capacity coupling has some selectivity besides adding greatly to the gain. This arrangement will provide more gain than will an ordinary tuned circuit at the mixer.

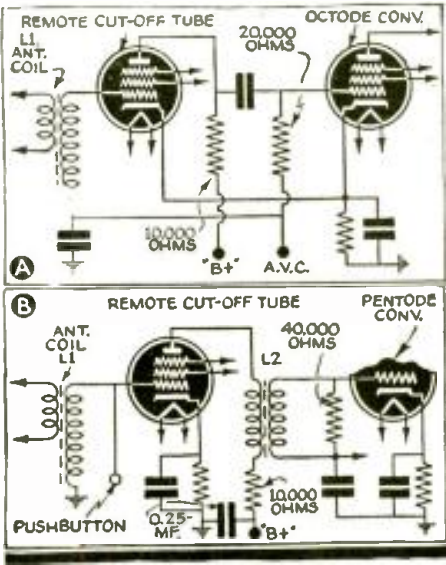

Diagram B makes use of a different method of coupling. Coil L2 is an untuned, close-coupled transformer with an iron core. The resistor across the secondary is to broaden the response. The resistor in series with the primary is also to prevent resonance peaks. The better coupling that the transformer provides results in a greater gain than the arrangement of diagram A. (Phileo is using this system to restore selectivity without adding to the circuits for the pushbuttons to control.)

WILLIAM BOYDSTON MILLER,
Laguna Beach, Calif.

THE CHANGING SCENE

Dear Editor:

Eventually, when all good things come to pass, a radio Serviceman will be paid for his work without being asked, "All that, just for labor?" And if he is the subtle type, and does not charge outright for labor, he will not be asked, "Why does a condenser cost so much?"

This great future day, when it comes, will find the radio Serviceman or dealer ordering tubes which will not be superseded by duplicate types before delivery. Furthermore, his prices will not be beaten down by cut-rate advertising of large distributors engaged in retailing. The Serviceman-dealer will, moreover, in this magical future, find that radio sets are not sold to him at a high price only to be dumped on the market 2 months later, wiping out his chance to realize a profit on his investment.

The Serviceman-dealer may even be so ridiculously fortunate as actually to witness the non-participation of big electric power companies in the retailing of radio receivers and home appliances. He will then begin to make some money, and it is to be hoped the shock will not prove fatal.

Finally, if radio sets are ever again built to last, he will be amazed to the point where he will be rendered speechless. And if the guarantee period on a tube extends more than 90 days, or possibly is lengthened to a year, he will definitely become a Sphinx. If the same applies to radio sets, then he is just a dead pigeon.

WILLARD MOODY,
New York City.

YOU CAN BECOME A MONEY-MAKING RADIO EXPERT

WITH THE **NEW SPRAYBERRY** Personalized HOME TRAINING in **RADIO** and **TELEVISION**

You Learn Easily in Your Spare Hours . . . By Doing Many Experiments with Up-To-Date Equipment

Here's a really fine, up-to-the-minute Radio and Television Training that's specially designed to give you quick results. TRAINING PREPARES YOU FOR GOOD RADIO JOBS . . . AT EXCELLENT PAY. My training starts right at the beginning of Radio, unfolds each subject in a simplified, logical, understandable style. You easily learn Television, Electronics, Facsimile Radio, Radio Set Repair and Installation Work, etc.

NO PREVIOUS EXPERIENCE NEEDED

It makes no difference what your education has been. I can fit you for a good-paying Radio job. Your success is my full responsibility.

YOU GET PROFESSIONAL TEST EQUIPMENT PLUS EXPERIMENTAL OUTFITS

. . . Includes 136 Radio Parts (to build complete Receiver), Tools, All-Wave, All-Purpose Analyzer, and Experimental Outfits for conducting actual experiments with your own hands.

I Supply

My **BUSINESS BUILDERS** show you how to put your Equipment to practical use in handling actual money-making Radio Service Jobs shortly after you begin training.

SERVICEMEN

I offer Advanced Training for those already in Radio. Get complete details in my FREE 52-page Book

The Sprayberry Course is Sold Under a Money-Back Agreement

RUSH COUPON FOR BIG FREE BOOK

SPRAYBERRY ACADEMY OF RADIO
F. L. Sprayberry, Pres.
320 L. University Place, N.W., Washington, D. C.

Please send me FREE copy of "HOW TO MAKE MONEY IN RADIO."

Name _____ Are _____
Address _____
City _____ State _____
Tear off this coupon, mail in envelope or paste on penny postcard. servicemen—check here

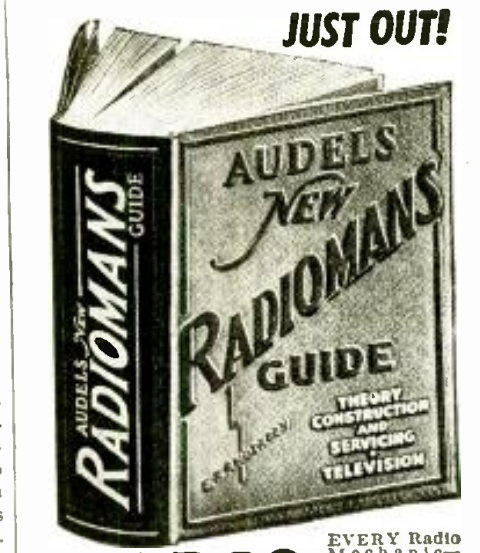

RADIO

The whole subject of Modern Radio—covering the basic Principles—Construction & Operation—Service—Repairs—Troubles—All Easily Understood. Over 750 Pages, 400 Illustrations, Parts & Diagrams—LATE TELEVISION DATA—Valuable for REFERENCE AND HOME STUDY.

4 To get this practical information in handy form for yourself, fill in and mail coupon today.

COMPLETE • PAY ONLY \$1 A MO.

AUDEL Publishers, 49 W. 23rd St., N. Y.

Mail AUDEL NEW RADIOMANS GUIDE for free examination. If O. K., I will send you \$1 in 7 days; then remit \$1 monthly until price of \$4 is paid. Otherwise, I will return it.

Name _____
Address _____
Occupation _____
Reference _____ RCF

For Better Servicing - For Bigger Profits— USE GERNSBACK MANUALS AND BOOKS!



SINCE 1931 Servicemen have been buying more GERNSBACK OFFICIAL RADIO SERVICE MANUALS year after year. The authentic material, easily accessible diagrams and complete service data make them invaluable to dealers and radio Servicemen. Without a Gernsback Service Manual at the repair job, there's time and profit lost. Your service kit or laboratory is incomplete without all the GERNSBACK OFFICIAL RADIO SERVICE MANUALS. There are GERNSBACK MANUALS for servicing auto-radios, also refrigeration and air conditioning equipment.

VOLUME 7 OFFICIAL RADIO SERVICE MANUAL

Over 1,800 Pages • Over 3,000 Illustrations • Stiff, Leatherette, Looseleaf Covers • Size 9 x 12 Inches • Net Weight 10½ lbs. **\$10.00**

1936 OFFICIAL RADIO SERVICE MANUAL

Over 1,200 Pages • Over 2,500 Illustrations • Stiff, Leatherette, Looseleaf Covers • Size 9 x 12 Inches • Net Weight 8 lbs. **\$7.00**

1935 OFFICIAL AUTO-RADIO SERVICE MANUAL

Over 340 Pages • Over 500 Illustrations • Stiff, Leatherette, Looseleaf Covers • Size 9 x 12 Inches • Net Weight 13¼ lbs. **\$2.50**

1934 OFFICIAL RADIO SERVICE MANUAL

Over 400 Pages • Over 2,000 Illustrations • Flexible, Leatherette, Looseleaf Covers • Size 9 x 12 Inches • Net Weight 3½ lbs. **\$3.50**

1932 OFFICIAL RADIO SERVICE MANUAL

Over 1,000 Pages • Over 2,000 Illustrations • Flexible, Leatherette, Looseleaf Covers • Size 9 x 12 Inches • Net Weight 4½ lbs. **\$5.00**

OFFICIAL REFRIGERATION SERVICE MANUAL

(Volume 11)
Over 352 Pages • Over 300 Illustrations • Flexible, Leatherette, Looseleaf Covers • Size 9 x 12 Inches • Net Weight 1½ lbs. **\$5.00**

OFFICIAL AIR CONDITIONING SERVICE MANUAL

Over 252 Pages • Over 600 Illustrations • Flexible, Leatherette, Looseleaf Covers • Size 9 x 12 Inches • Net Weight 2¼ lbs. **\$5.00**

To order these famous Manuals, see or write to your jobber or favorite mail order house. If more convenient, mail coupon directly to publishers.

RADIO-CRAFT LIBRARY SERIES

Get into the swing of reading instructive, authoritative books on technical subjects—radio, air conditioning and refrigeration. It's the easiest, quickest and most inexpensive way to improve your knowledge on these topics. In this series, popularly known as the RADIO-CRAFT LIBRARY SERIES, are all the titles necessary to your personal advancement. Only by careful study of these enlightening books, can you gain adequate experience in fields of radio, air conditioning and refrigeration. Each book is uniform. The volumes measure 6 x 9 inches—contain 64 pages, and have stiff, flexible covers. PRICE 50c PER BOOK. All books are sent to you postpaid.

Here Are The Titles:

- | | |
|---|---|
| Book No. 3
THE SUPERHETERODYNE BOOK | Book No. 18
POINT-TO-POINT RESISTANCE ANALYSIS |
| Book No. 6
BRINGING ELECTRIC SETS UP-TO-DATE | Book No. 19
PRACTICAL RADIO KINKS AND SHORT CUTS |
| Book No. 9
AUTOMOBILE RADIO AND SERVICING | Book No. 20
THE CATHODE-RAY OSCILLOSCOPE |
| Book No. 10
HOME RECORDING AND ALL ABOUT IT | Book No. 21
BREAKING INTO RADIO SERVICING |
| Book No. 13
ABC OF AIR CONDITIONING | Book No. 22
NEW RADIO QUESTIONS AND ANSWERS |
| Book No. 14
POCKET RADIO GUIDE | Book No. 23
PRACTICAL PUBLIC ADDRESS |
| Book No. 15
ABC OF REFRIGERATION | NEW—Book No. 24
AUTOMOBILE RADIO PRINCIPLES AND PRACTICE |
| Book No. 16
PRACTICAL RADIO CIRCUITS | |
| Book No. 17
SERVICING WITH SET ANALYZERS | |

EACH BOOK IN THIS SERIES—50c

RADCRAFT PUBLICATIONS, Inc., 20 VESEY ST., NEW YORK, N. Y.

Gentlemen: Enclosed find my remittance of \$..... for which send me, POSTPAID, the Manuals or Books indicated below by a cross (x) in the panel.

() Volume 7 @ \$10.00 () 1936 Manual @ \$7.00 () 1934 Manual @ \$3.50
() 1935 Auto-Manual @ \$2.50 () 1932 Manual @ \$5.00
() Refrigeration Manual (Vol. 2) @ \$5.00 () Air Conditioning Manual @ \$5.00

RADIO-CRAFT LIBRARY SERIES @ 50c EACH

Circle book numbers wanted: 3 6 9 10 13 11 15 16 17 18 19 20 21 22 23 24

Name Address

City State

(Send remittance in form of check or money order; register your letter if you send cash or unused U. S. Postage Stamps.)

RC-1140

RADCRAFT PUBLICATIONS, Inc.
20 VESEY STREET NEW YORK, N. Y.

RADIO-CRAFT

"RADIO'S GREATEST MAGAZINE"

... it is usually the private individual who crashes through with important inventions

RADIO FOR DEFENSE

By the Editor — HUGO GERNSBACK

I HAD occasion to speak before on the tremendous value of radio for the country's defense and war purposes. There is hardly a science today of greater importance than Radio with all its ramifications; during the coming months this importance will tend to grow.

I find it necessary to come back to the subject time and again, because the average person, and frequently, radio men themselves—because they think they know too much of the subject—hypnotize themselves into believing that everything worthwhile has been invented and that there is no room for improvement in the art.

Independent radio workers also, are apt to lose interest in radio research work, because of false propaganda which makes them believe that the only worthwhile radio improvements and inventions nowadays come out of research laboratories owned by our big radio corporations.

This reasoning is altogether faulty, and does not jibe with the actual facts. While it is true that our big corporations do maintain vast laboratories and spend fortunes in developing new ideas, it will be found that ordinarily these inventions tie-in with the corporation's own developments and their own business; only rarely are new inventions that prove of untold value to the country developed in such laboratories. As a rule, all research laboratories are maintained for definite purposes and research work is nearly always in a given direction.

Research workers in commercial laboratories rarely stray far afield because their work is already cut out for them and they must limit their activities to operations directly related to a specific result. It is true, that this is not so much the case in university laboratories and here the research men have more freedom, but even here, the laboratory personnel is not permitted to work on any and all ideas which might pop into their heads.

The private individual has no such limitations and he can work on anything and everything he wishes to. If he has the time and ingenuity and equipment, the sky is the limit. For this reason, it still holds true that the private individual is often far ahead when it comes to original inventions and the past record shows that it is still the lone worker who is able to satisfy himself and his ambition, and it is usually he who crashes through with important inventions.

A list of the following, which does not by any means exhaust the subject, proves the point. Not one of these individuals was working for huge corporations at the time he made his invention, yet all these radio inventions were important ones.

Guglielmo Marconi	Numerous Radio Inventions
G. W. Pickard	Crystal Detector
Dr. Lee de Forest	Vacuum Tube
Edwin H. Armstrong	Superheterodyne
Philo T. Farnsworth	Television Tube

I do not think conditions have changed very much, and it is my firm conviction that this trend of private invention will continue almost indefinitely.

I am also quite certain that hundreds of patriotic individ-

uals will, in our present emergency, come out on top and produce a new crop of radio inventions, the same as was the case in the past.

History has proven time and again, that any national emergency always proves a tremendous stimulus on inventions, and this period in our history, I am convinced, will not be different from those of the past. Radio is such a vast domain, and is so closely interwoven with our complex Machine Age, that it would indeed be a miracle if no great radio inventions were to come about during the next few years.

A tremendous job remains to be accomplished in our present preparedness effort. There is hardly a single instrumentality that can be used for our national defense which in some way is not closely allied with radio. Many problems remain to be solved and radio often proves the key to the answer.

In the past, history has shown that for every new weapon there has eventually been developed some form of defense mechanism. The airplane, and particularly bombing planes, so far remain a direct threat to all nations, while an effective answer to its menace has not yet been found. Antiaircraft guns are only a partial and incomplete answer. Airplane against airplane also is not the answer, due to the tremendous speed of the airplane itself. Even two countries well matched; with the same number of planes, will still be in a position to do tremendous damage to each other, because defending airplanes cannot be at all points at the same time, and as they can operate at different altitude levels their potential danger is so much greater. When two nations can oppose each other with the same tonnage, armament and speed in battleships, they can stalemate each other, or there will be a predictable draw. But, two hostile airplane fleets, evenly matched, can still get past each other, inflicting immense damage on each other's territories.

I am certain that one of the answers to the warplane and bomber will be radio, or some radio instrumentality, perhaps allied with some other means not as yet known or tried out. Listening devices to herald the approach of bombers today are known to be rather ineffective. Such information comes too late, because in a few minutes the airplane will have traveled such a distance that the 10- or 15-minute advance warning will have come to naught if there are no airplanes in the air at the time and near the region, and at proper fighting altitude, when the attack is coming. All this means speed, and more speed, and radio will probably be the answer to the problem in some way in the end.

This is only one of the major problems that will have to be solved. Entire books could be filled with other problems still unsolved, many of which will be solved by radio.

Remember that radio is not just communication. Here is a list of what radio is doing today, and it is only a *partial* list. Even radio men, themselves, are apt to forget how vast a science Radio is today.

(Complete list will be found on page 304)

• THE RADIO MONTH IN REVIEW •

The "radio news" paper for busy radio men. An illustrated digest of the important happenings of the month in every branch of the radio field.



"FATHER OF RADIO" IS 67

August 26 was an important date to the radio industry. It marked the event of National Radio Day and the birthday of radio's "grand old man" Lee de Forest. Two hundred members of the radio industry threw a banquet for him at Chicago's Drake Hotel where well-earned homage was heaped upon him. Shown at the banquet scene are, left to right, William Halligan, Pres., Hallcrafters, Inc.; Dr. Lee de Forest; E. S. Riedel, gen. sales mgr., Raytheon Production Corp.

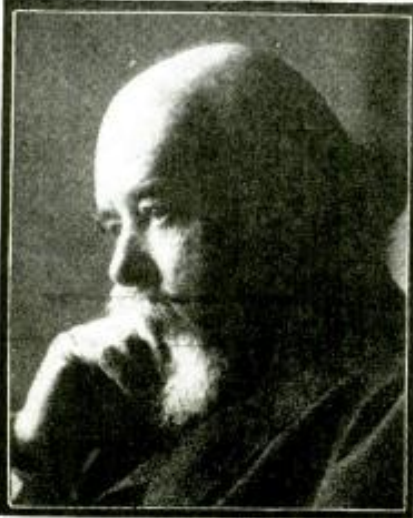

SIR OLIVER LODGE, 1851-1940

Sir Oliver Lodge, eminent inventor, scientist, author and spiritualist died on August 22 at his home in Amesbury, Wiltshire at the age of 89. Among the many brilliant experiments performed during his lifetime, those relating to radio and electricity included research work on the conductivity, thermo and electric, of metals and other substances; mutual and self-induction, resonant circuits, and the radio detector later called the "Lodge coherer." His experiments extended Hertz's demonstration of Maxwell's electromagnetic theory of light. Lodge enriched the radio art with his inspired researches.

PREPAREDNESS

UNCLE SAM is now finding that peacetime developments in the broad field of radio are of inestimable value in the work of "safety first" mobilization of our defense facilities.

For example, last month WOR Transcription Service recorded four 15-minute disks of talks, urging enlistment in the U. S. Army and Navy and training camps, by Col. Frank Knox, Secretary of the Navy; Robert Patterson, Ass't Secretary of War; Col. Hugh S. Johnson; and Col. Julius Ochs Adler, civilian aid to the Secretary of War. The platters were shipped to over 200 broadcast stations as sustaining features.

Television was used, for the first time, for peacetime recruiting when the Army Recruiting Division in Los Angeles inducted a group of recruits into the service before the television cameras of Don Lee Television station W6XAO in Los Angeles. This "Uncle Sam Wants You" television program lasted 1½ hours. . . . The program "Hands Across the Sea" regularly broadcast over International Shortwave Broadcast station WRUL in Boston, and beamed on England, is reportedly doing a great job of bolstering morale of overseas bomb-harassed listeners-in on 11.79 and 15.25 mc. . . . "Trojan Horse," new sustaining program over

WMCA, is specifically designed to spotlight 5th column activities by revealing how they operate in the United States. . . . A slice of the \$15,000,000,000 (yep, that's 15 billion) so far ear-marked for America's preparedness program (2-ocean Navy, 2-million Army, and 50,000-plane air force) will go to establish 7 schools to train 4,000 radiomen and signalmen for the Naval Reserves. Courses last 4 months. Students rate active duty status, and grads become Radiomen and Signalmen, 3rd Class, with 3 months' optional active duty, ashore or afloat, with a top pay of \$60 per month. The Army, too, is planning new radio schools. . . .

This department calls attention to the statement of Sigrid Schultz, WOR-Mutual correspondent in Berlin, in a broadcast from Nazi-land, that Hitler concedes his successes would have been impossible without the aid of radio to maintain substantially uninterrupted contact with all units of the mechanized blitzkrieg machine.

ABROAD

LAST month the *Sunday News* of New York carried a copyrighted article entitled "Boat Run by Radio, Once U. S. Secret, Is New Hitler Weapon." This illustrated article by Sloane Taylor goes on to tell how well-convoeyed Allied shipping, mysteriously sunk, actually was hit by remote-controlled, explosives-laden 16-foot motor launches, or *Ferulcithoot*. These unmanned launches were directed to their objective—and their own annihilation—by an 8-man crew in a second or control boat within telescopic range. One of the controlling signals is capable of causing the destruction of the remote-controlled boat if there seems to be any danger of the boat and its mechanism falling into the hands of, for instance, England. (Hammond in America is generally credited with demonstrating the first craft of this sort around 1920.)

Singapore. -- Remote-controlled planes—about the size of small, American fliwyer planes—are being used at this stronghold of the British Pacific defenses as targets for anti-aircraft gunnery practice.

England.—A "radio searchlight" is reported by the New York newspaper *PM* to be in use by the British to detect approaching airplanes when they are yet scores of miles away. The opinion was advanced that it operates on the principle of the "terrain clearance indicator" or radio altimeter developed by Bell Labs. (and described in a past issue of *Radio-Craft*).



THE IRON HORSE GOES ON RECORD! (Cover Feature)

Robert Monroe, author of N.B.C.'s dramatic serial "Rocky Gordon," is shown in New York Central Yards at Weehawken, N. J., recording the sound of locomotives and railroad yards for the sound effects to be aired.

HEALTH RAY METER

A new instrument designed by Dr. Robert J. Cashman, assistant professor of physics at Northwestern University, is being used by meteorologists and bioclimatologists to record the intensity of ultra-violet solar radiation. Electricity generated when an ultra-violet light falls on a nickel disc coated with magnesium, is caught up on 2 tiny wires suspended above the disc, and is then measured.



London.—Perhaps the first American "radio casualty" case was that of John Steele, WOR-Mutual's London commentator, who collected a bomb splinter while on a dash from the B.B.C. studios during the height of a German air raid.

Norway.—A Nazi court at Oslo last month dealt death sentences to 3 Norwegians, Col. Lund, Medical Officer Solem, and a Mr. Engdahl, said to have been convicted of maintaining a secret broadcasting station, I.N.S. reported.

Sweden.—The Swedish Ericson Co. has marketed an inexpensive air raid alarm—a doorbell and special fittings—which plugs into the regular lightline and can be automatically operated by a slight rise of line voltage at the power house. (The rise is too slight to endanger other apparatus on the line, such as a radio set, etc.)

F.M.

LAST month the total of Frequency Modulation station applications in the hands of the F.C.C. jumped 25 more; total, waiting for the green light: 150. Some of the applicants plan to operate stations estimated to have a service area up to about 35,000 sq. miles. A score are now regularly on the air.

Is New York City going to let other cities pioneer the path of F.M. police-radio? Latest city to vote for F.M. is the Chicago Police Dept., which issued specs. for bids on 200 F.M.-equipped 2-way squad cars and 16 fixed-location stations. . . . *Time* magazine last month took time out to analyze the status of F.M., under the title, "F.M. By Stages." The article offered the estimate that 5,000 frequency modulation receivers have so far been sold. . . . A total of 42 large F.M. stations may soon be joined in a coast-to-coast network! Here are key station owners, etc., in the projected set-up, scheduled to be in operation in 1941: The Yankee Network, Boston (John Shepard, 3rd); KVOO, Tulsa, Okla. (Wm. Way); KXOK, St. Louis, Mo. (Elzey Roberts); WTMJ, Milwaukee, Wis. (Walter Damm); WSM, Nashville, Tenn. (Harry Stone); WSJS, Winston-Salem, N. C. (G. Gray); and, H. L. Petthey, Los Angeles, Calif.

SOUND

CHUCKLE, chuckle. Last month—or maybe it was the month before—W.L.W., in what was practically a tidal wave of economy, said something like this: "Nope, no public address trucks during this campaign. Too expensive." But last month International

COLOR TELEVISION

Dr. Peter C. Goldmark, C.B.S. chief television engineer, is shown at the still projector of the color television device which he invented and which was recently demonstrated before the press. The same frequency band width required for ordinary black and white images can be used for color television. It is possible that in the near future a simple attachment may be sold which can be attached to standard black and white television sets to permit them to receive color images. The present film-scanning equipment used with this system employs 16 millimeter film taken at 64 frames per sec. but run at 60 frames per sec. Image has 343 interlaced lines.

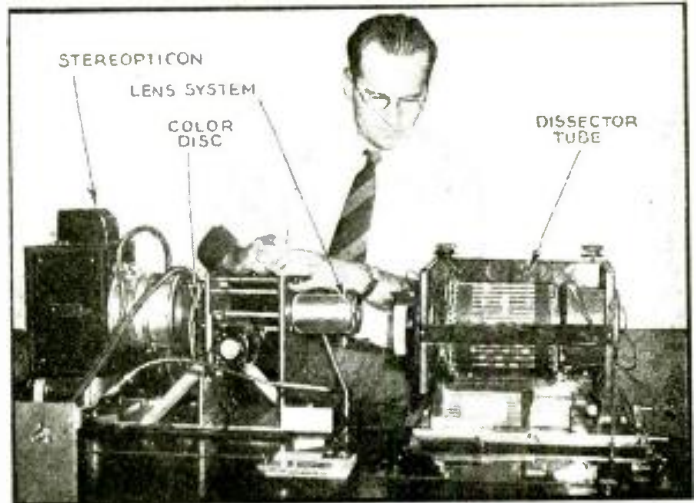

News released a photo showing morning-glory truck-loudspeakers going full blast as Wendell addressed a huge audience in Juliet, Ill. Confidentially, Mr. Willkie, didn't that P.A. system help speed your recovery from that sore throat condition you had?

Acro-Voice, now recording company in New York City, has a mobile unit for making spot recordings anywhere. . . . The new \$3,000,000 recreation project at Ocean Beach, New London, Conn., is said to have the most elaborate sound system in the United States. It's a W.E. job. . . . A cat with impaired hearing has been equipped with a hearing-aid, stated *The Delta Reporter* (Gladstone, Mich.) last month, and sported an illustration to prove it. . . . Here's how WTMJ, the *Milwaukee Journal* station, answered the question of how to be in 2 places at the same instant. Finding that the city's supt. of schools would not be able to leave a broadcast at WTMJ in time to attend graduating classes at Milwaukee's high school, the school set up its P.A. system in the school auditorium and fed the system with the supt.'s radio speech, as part of the graduation exercises.

Paul H. Tartak, pres. of Oxford-Tartak Radio Corp., last month announced his acquisition of a substantial interest in United Teletone Corp. Both companies will continue marketing their respective lines of loudspeakers. . . . *Radio Daily* records the suggestion of an Ohio publication that Wendell L. Willkie use as a play on the well-known radio station slogan "WLW—The Nation's Station," the political slogan "W.L.W.—The Nation's Choice."



RADIO POSTMISTRESS

Vivacious Jean Muir is the only postmistress to date of the U. S. Antarctic Expedition. She is shown reading the fortnightly mail to the 59 men now snow-bound in Little America over G.E.'s shortwave radio station WGE0 in Schenectady. Shortwave radio is the only contact these men have with the outside world. Jean told them she was proud of the work they were doing for our country in the Antarctic. (Photo on cover.)

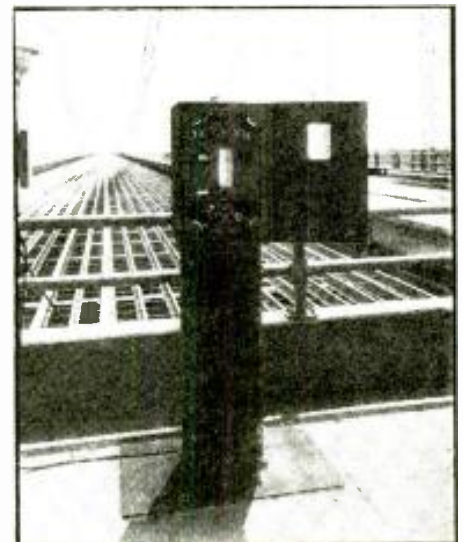

"550 ON YOUR DIAL"

This automatic radio transmitter installed by the Halstead Radio Traffic Control System on George Washington bridge between New York City and New Jersey sends out traffic information to autoists at regular intervals. The messages are picked up on auto receivers tuned to 550 as specified on signs. (See photo on cover.) The traffic messages are recorded on steel tape and can be changed at will by police authorities by remote control. The message is magnetically recorded and erased.

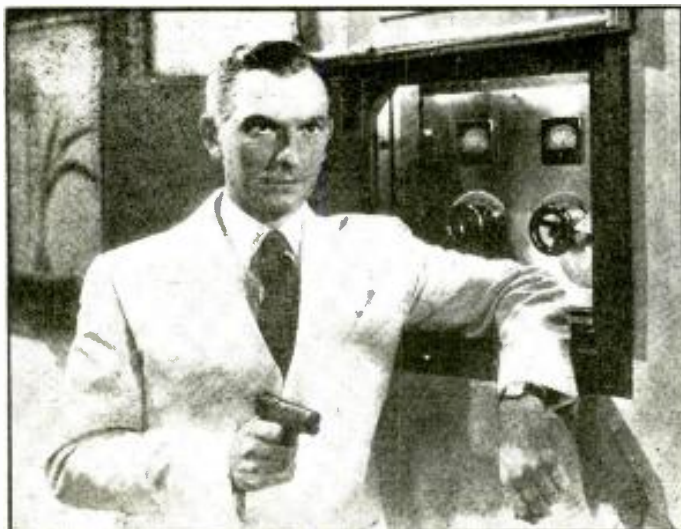

"PHANTOM RAIDERS"

"Don't come any nearer" . . . Joseph Schildkraut holds off enemy gangsters while he prepares to operate a shortwave set that will blow up a freight ship miles away, in "Phantom Raiders", new Nick Carter adventure, featuring Walter Pidgeon with Jacques Tourneur directing for Metro-Goldwyn-Mayer. Frederick Stephani is the producer. (See photo on cover.)

F.M. SERVICING PROCEDURE

The following article contains the recommendations of a factory service manager on procedure for servicing frequency modulation receivers. Frequent comparison with well-known amplitude modulation service procedure is made.

CHARLES E. ANGLE

EVERY Radio Serviceman is vitally interested in the development of Frequency Modulation. Much has been written describing F.M. and how it works and it is the intent of this article to go on from there and point out briefly what the Serviceman's problems will be and how they should be solved.

FUNDAMENTALS

There are 3 fundamental points to be remembered:

- (1) Broadly speaking, the methods to be followed in locating trouble and correcting it are identical with A.M. sets.
- (2) F.M. Receivers are high-frequency receivers and must be treated as such.
- (3) The circuits are essentially the same as A.M. circuits except that the Limiter and Discriminator circuits, and the I.F. and R.F. Alignment procedures, are new and must be handled with great care.

In any F.M. Receiver, the I.F., R.F. and Audio circuits are essentially the same as regular A.M. sets; therefore, service procedure will be essentially the same although some of the test equipment in use today does not have sufficient range to deal with the high frequencies and the wide bands. The minimum test equipment which any service shop should have is as follows:

- (1) A good signal generator (test oscillator) with variable output voltage and a frequency range of 100 kilocycles to 32 megacycles.
- (2) A wide-band signal generator with a sweep circuit of ± 200 kilocycles. These will, undoubtedly, be available shortly.
- (3) Cathode-ray oscilloscope.
- (4) Output meter.
- (5) Center "0" microammeter and a 2nd microammeter with a "0" to 200 microampere range.
- (6) A.C. and D.C. voltmeters with range scales of "0" to 1,000 volts or more and a resistance of at least 1,000 ohms/volt.
- (7) Ohmmeter capable of indicating resistance from "0" to at least 10 megohms.

NOTE: The meters listed do not necessarily have to be individual meters. Many manufacturers of test equipment combine these meters into one combination unit which is very satisfactory.

PROCEDURE

Circuit diagrams, charts, instructions, etc., for locating and correcting trouble are supplied by the manufacturer and the usual procedure for such fault-finding should be followed. Remember, however, that these circuits are high-frequency, and the unit values and locations are very important. In fact, because of the high frequencies and

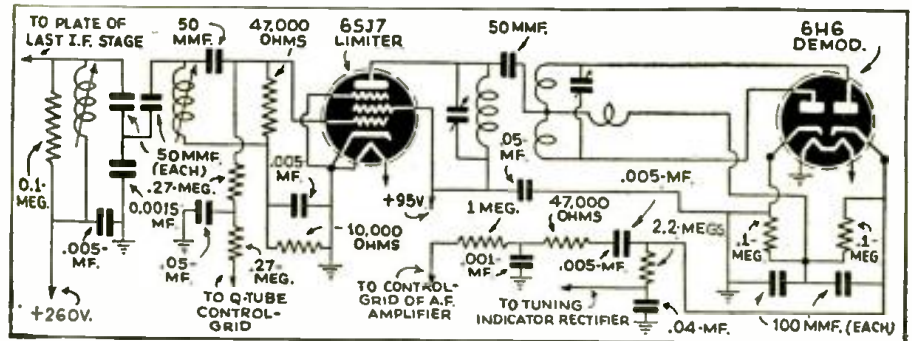

The limiter and demodulator stages of an F.M. circuit are important points for the radio Servicemen to watch. This diagram is part of the Stromberg-Carlson Series No. 480 F.M.-A.M. sets.

particularly the 4.3 megacycle I.F., regeneration is very likely to occur.

This regeneration may be caused by one of a number of conditions. If it is necessary at any time to replace a part, extreme care should be taken to install the replacement part in exactly the same position as the part which was removed. When locating or correcting trouble, the wiring of the chassis should not be disturbed. The plate, screen-grid, control-grid and cathode of all tubes used in F.M. receivers must be bypassed to a ground point directly at the socket as a long ground lead is a common cause of regeneration in these circuits.

Many explanations of the limiter and discriminator circuits have appeared previously and it is not necessary to go into them in detail in this article.

The limiter, in reality, is the last I.F. stage in an F.M. receiver and acts as an amplifier which is very easily overloaded. The primary purpose of this circuit is to limit the variations in the I.F. circuit ahead of it and to pass on to the discriminator a constant-amplitude signal. The discriminator, which also acts as a detector, converts the frequency deviations into amplitude variations.

Trouble in either of these circuits can be located in the usual manner but realignment must be carried out in a new and different way and it is essential that the manufacturer's procedure be followed exactly. In fact, since alignment of frequency modulation receivers is carefully made at the factory with special equipment designed for this purpose, ordinarily no realignment is necessary. However, on rare occasions, it may be necessary and, therefore, a more or less general description of alignment procedure follows:

ALIGNMENT

Each I.F. and R.F. stage in frequency modulation receivers should be adjusted independently and no overall adjustments should be made. If the receiver is not in proper alignment after adjustments are made, start over again.

Adjustment of the discriminator circuit is made by connecting a center "0" micro-

ampere meter with a 1-megohm resistor in series across one-half of the discriminator load. The signal generator with an 0.1-mf. condenser in series is connected to the control-grid of the limiter tube and the signal necessary for making adjustments is approximately 1 V. The primary of the discriminator transformer is then adjusted for maximum reading of the microammeter. The center "0" microammeter should then be connected across the whole discriminator load and the secondary of the discriminator transformer adjusted for "0" reading of the microammeter. The remainder of the I.F. circuits are adjusted by connecting the output of the signal generator to the control-grids of the various I.F. tubes, and adjusting both primary and secondary for maximum signal, making any slight readjustments necessary to produce a symmetrical curve.

R.F. adjustment of F.M. receivers is made at the point specified by the manufacturer. The center "0" microammeter should be left connected across the whole discriminator load and a "0" to 200 microampere meter should be connected in series with the limiter-tube grid resistor.

Adjustments are made for maximum reading of the "0" to 200 microamp. meter maintaining the center "0" microammeter at "0" at all times by rotating (rocking) the receiver's dial slightly back and forth.

Some of the troubles which have been found in the field are as follows:

- | | |
|---------------|---|
| Noise: | Defective tubes.
Poor antenna systems.
Leaky or open bypass condensers. |
| Regeneration: | Chassis wiring not dressed properly.
Loose ground contacts in chassis.
Open by-pass condensers. |
| Distortion: | Limiter circuit not functioning properly.
Incorrect realignment.
Defective audio circuits. |

This article has been prepared from data supplied by courtesy of Stromberg-Carlson Telephone Mfg. Co.

THESE 18



TYPE D ALL-PURPOSE CONTROLS

Handle 60% to 75% of ALL REPLACEMENTS

...The All-Metal Cabinet is Included - AT NO EXTRA COST!

Now, for the first time, you can purchase a stock of only 18 Controls, 6 switches and 5 special, extra shafts . . . and be prepared for quick, efficient service on more than two-thirds of the radios you are called upon to repair!

You save time, because it is no longer necessary to order a control every time you need one! You simplify installations because IRC Type D All-Purpose Controls with their Tap-in Shafts are easier to install and can be used universally to replace midget size or larger, old-style controls! You save money—and you assure your customer of a first-class job!

Best of all, you pay only the standard price for the controls, switches and shafts. The handy new IRC Master Radiotrician's Control Cabinet, as illustrated, is included with your purchase at not one cent of extra cost.

The Cabinet itself is of all-metal construction. Attractively decorated, it is an asset to the appearance of your shop. It is 14½" x 7½" x 4", weighs approx. 6 lbs. complete. IRC Control numbers are marked underneath each compartment so you can tell at a glance just what values should be kept in your stock complete. Three drawers supply ample space for shafts, switches or other spare parts. Front metal cover snaps securely shut for carrying, or may be removed when Kit is used in your shop. The regular net price of the 18 Controls, 6 switches and 5 special, extra shafts is \$14.97—and the Cabinet is included for not one cent extra!

INTERNATIONAL RESISTANCE CO.

401 N. BROAD ST., PHILADELPHIA, PA.

Attached is \$14.97. check, money order (or send C.O.D.) one IRC Master Radiotrician's Control Cabinet complete with the 18 Type D All-Purpose Controls, 6 switches and 5 Tap-in Extra Shafts as described. It is understood that, if this does not meet my full approval, I can return it in good condition for full credit within 5 days.

NAME _____

STREET _____

CITY _____

STATE _____

Name of your regular jobber _____

City _____

(Jobber's name must be given to secure net dealer cost shown)

State _____

TAP-IN SHAFTS *Stay Put!*

Type D All-Purpose Controls are exact reproductions of the larger IRC Type CS Controls, with exactly the same design, exactly the same features and with the added convenience of Tap-in Shafts.

Just pick the control you need, select the proper shaft, tap it into position in the cone-shaped control receptacle following simple instructions enclosed with each control, and the job is done. The shaft won't pull or vibrate loose—and you're sure the quality of the control is the highest money can buy.

HERE IS WHAT YOU GET!

The IRC Master Radiotrician's Cabinet is factory-packed with the following 18 Type D All-Purpose Controls, switches and special shafts of the most popular types shown by records to be capable of handling the big majority of all control replacements.

IRC Control Type No.	Resistance	Purpose	IRC Control Type No.	Resistance	Purpose
2-D13-133	500,000	A	1-D13-133 X	500,000	F
1-D11-116	10,000	B	1-DC13-133 X	500,000	G
1-D11-123	50,000	C	1-D13-137	1.0	A
1-D11-128	100,000	C	1-D13-137 X	1.0	F
1-D11-133	500,000	C	1-D13-139	2.0	A
1-D13-123	50,000	D	1-D13-139 X	2.0	F
1-D13-128	100,000	A	1-D14-116	10,000	H
1-D13-130	250,000	A	1-D16-119	20,000	B
1-D13-130 X	250,000	E			

A—Tone or Audio Circuit Control
B—Antenna Grid Bias Control
C—Potentiometer Voltage Divider
D—Tone Control

E—Tapped for A. V. C.
F—Tapped for Tone Compensation
G—Friction Clutch Auto Radio Type
H—Antenna Grid Bias of 2 Tubes

Switches: 5—No. 41 S.P.S.T.; 1—No. 42 D.P.S.T.
Shafts: 1—Type B Auto Radio; 2—Type C with slotted, knurled terminals; 2—Type D with slotted, unknurled terminals.

Dealer Net on above controls, 6 switches, 5 shafts . . . **\$14.97**
THE CABINET IS INCLUDED FREE!

USE THIS HANDY ORDER FORM

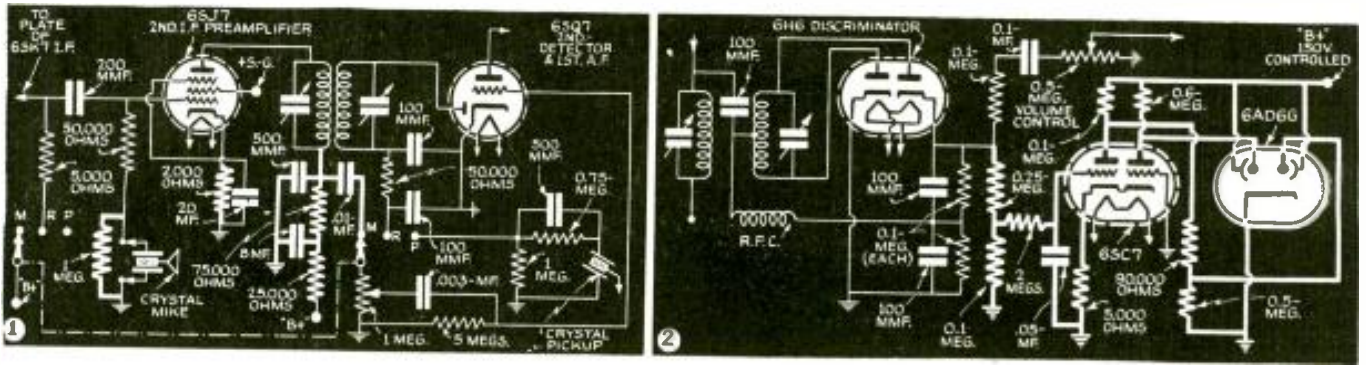

NEW CIRCUITS IN MODERN RADIO RECEIVERS

In this series, a well-known technician analyzes each new improvement in radio receiver circuits. A veritable compendium of modern radio engineering developments.

F. L. SPRAYBERRY

No. 38



(FIG. 1.) I.F. AMPLIFIER SERVES ALSO AS MICROPHONE PREAMPLIFIER

MONTGOMERY WARD MODEL O1BR-615A.—A very worthy design achieving added facilities for recording and microphone amplification with only a few additional parts has been adopted in this circuit.

Instead of a complete additional amplifier with an additional tube, with its added space and transformer load, the last I.F. tube is used as a microphone preamplifier. The circuit, shown in Fig. 1, is such that no substantial sacrifice need be made for either of its 2 modes of operation. Being resistance-capacity coupled to the preceding I.F. tube its grid circuit remains virtually unchanged by the addition of the microphone.

In series with the tuned I.F. load in its plate circuit there is a resistance A.F. load (75,000 ohms) and a 0.01-mf. condenser coupling the A.F. into the A.F. selector switch point. For both I.F. and A.F. amplification the bias of the 6SJ7 is made slightly higher than normal so as to permit high voltage in the plate. The gain of the stage is great enough for either I.F. or A.F. so that a small grid signal is sufficient thus avoiding distortion due to large negative excursions of the grid. Ganged with the audio selector switch is a switch in the 1st

I.F. plate circuit to cut out received signals while using the recorder or pick-up.

(FIG. 2.) SUPPLEMENTARY SHADOWS INDICATE F.M. RESONANCE

MEISSNER MODEL 9-1021.—A double-acting indicator eye tube type 6AD6G indicates zero D.C. voltage at the discriminator output by wiring such that one shadow will expand as this point becomes negative while the other will expand if it becomes positive.

The best test of tuning in a discriminator is the D.C. voltage on the output cathode of the discriminator. This voltage is zero only at resonance when the circuit is in proper adjustment regardless of the carrier intensity or whether or not it is modulated. Operation of the resonance indicator is based on this fact.

As shown in Fig. 2, the voltage at the output cathode of the 6H6 discriminator is filtered practically to D.C. and this voltage is introduced into one grid of a double-triode 6SC7. The plates are individually resistance loaded and the single cathode has a bias resistor in it. One of the plates is directly connected to the shadow control electrode in the 6AD6G tube while the other plate is indirectly connected to the other control electrode.

Circuit values are chosen such that with

a zero grid in the 6SC7 input, both 6AD6G control electrodes will be at -75 volts and both shadows will be closed. Plate voltage regulation of the 6SC7 by a gas tube keeps these voltages constant during operation and produces similar action within any normal line voltage changes.

As the 6SC7 input grid becomes negative due to off-resonance action of the discriminator, the plate of the 6SC7 input section goes more positive and the shadow due to the ray control associated with this plate already being closed does not change. However, decreased cathode current reduces the bias on the other triode section causing its plate current to rise and its plate voltage to fall. This causes the shadow associated with this plate and control electrode to expand.

A positive grid, on the other hand, will cause the other shadow to expand and allow the former mentioned one to remain unchanged. Correct tuning is obtained when both shadows are closed.

(FIG. 3.) ANTENNA TELEVISION INPUT

EMERSON MODELS DP-332 AND DP1-332.—Here is an ingenious idea showing an arrangement which allows us to dispense with the entire audio system including the audio I.F. system in a television receiver.

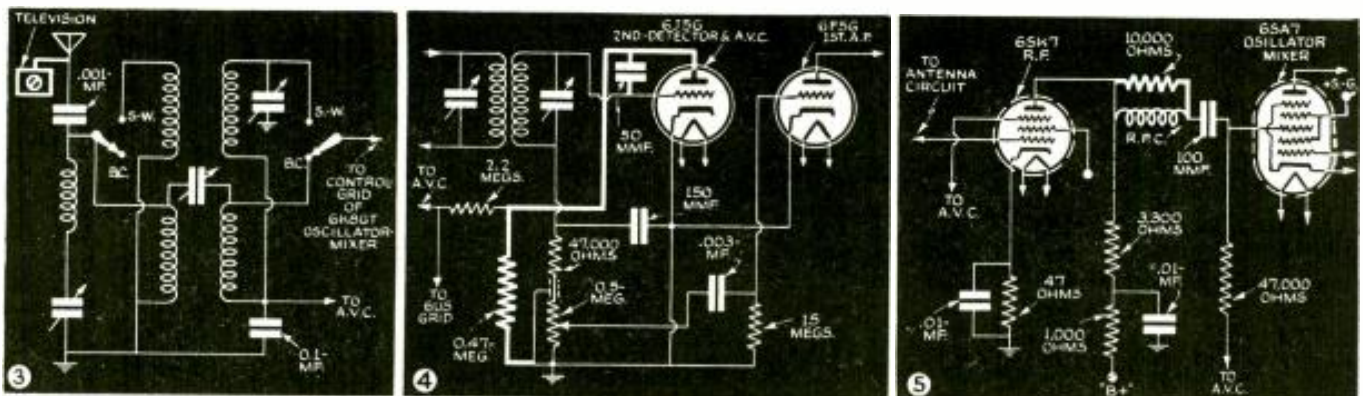

Instead of using a complete I.F. and 2nd-detector system in a television receiver and then picking up the A.F. in a manner similar to that of a phonograph pickup connection, we may connect the antenna of this circuit, shown in part in Fig. 3 to the 1st-detector output of the television receiver. With the television circuit oscillator a beat with the voice carrier will be produced of say 8 mc. This receiver is simply tuned in its high-frequency band to 8 mc. and this beat frequency is received as any other 8 mc. signal. Adequate shielding may be needed to prevent direct pickup by the receiver but this is hardly more than would be required in the television receiver normally anyway.

(FIG. 4.) UNUSUAL TRIODE 2ND-DETECTOR APPLICATION

SILVERTONE MODELS 6321, 6121, AND 6193.—While the control-grid of this triode is used as usual as a diode plate in I.F. rectification for the audio signal, the triode plate is used as a diode rectifier for producing A.V.C. instead of being connected to the cathode as in the usual case.

The circuit connections are shown in Fig. 4. Due to the plate to grid coupling using a 50 mmf. condenser the plate and grid I.F. potentials are substantially in phase and hence, unlike the usual diode circuit, the conductivity of the plate diode is increased by the grid action on positive alternations without a corresponding increase in load on the tuned circuit. Because of the in-phase operation of the 2 elements (grid and plate) the performance of one does not adversely affect that of the other.

(FIG. 5.) SERIES-COUPLED AMPLIFYING COMPENSATOR

GENERAL ELECTRIC MODEL J-105.—An impedance that varies with frequency is placed in series with the R.F.-to-detector coupling condenser so that the energy transfer remains reasonably constant for all bands in this receiver.

Formerly used in series with the R.F. plate circuit between the plate and coupling condenser, it is now placed to allow a direct plate to active load connection. The coupling network as shown in Fig. 5 allows for a change in energy transfer with frequency of the order of 15 or 20% which is more nearly commensurate with the other circuit and tube characteristics which are inverse to this. The other method permitted several hundred per cent over-compensation for circuit characteristics.

BOOK REVIEW

1940-1941 AMPLIFIER HANDBOOK AND PUBLIC ADDRESS GUIDE. Published by Radcraft Publications, Inc. Size, 6 x 9 ins., stiff paper cover, over 75 illustrations, 80 pgs. Price, 25c.

"Amplifier Handbook and Public Address Guide," published last month, was prepared by a practical sound man. Printed on glossy paper it is a convenient pocket-size book crammed with information on the newest developments in the sound field. Approximately 20 companies specializing in sound equipment contributed valuable information which the author has incorporated in this book.

Not a laboratory manual nor an engineer's handbook, the 1940-'41 Amplifier Handbook and Public Address Guide in presenting essential information and practical data for all sound men and P.A. specialists, offers to the technician who makes his livelihood by estimating, installing, maintaining and servicing public-address equipment a useful daily reference book.

The book is divided into Sections as follows: I—Source; II—Amplifiers; III—Distribution; IV—Coordination; and V—Useful Public Address Data and Information.



PORTABLE RADIO BATTERIES

A dependable source of power supply for all types of Portable Receivers.

- The highly efficient "bag type" construction—long associated with BRIGHT STAR quality batteries—eliminates possibility of internal short circuits.
- Special inner casing safeguards battery life from harmful effects of moisture or dampness when receivers are used outdoors.
- Constant laboratory control over raw materials, manufacturing processes and finished product assures high quality, uniformity and top performance.

Build your battery sales with **BRIGHT STAR**—for profits and satisfaction.

FREE! . . .

A comprehensive Replacement Guide, showing recommended BRIGHT STAR Batteries for over 700 models of portable receivers, is available. Send for your free copy today.



BRIGHT STAR BATTERY CO.

Executive Offices and Factory: Clifton, N. J.

Chicago

San Francisco

Houston

Actual Size 4 1/2" by 9 1/4"
—272 fact-filled pages

Get Your Copy of the Big

SYLVANIA

Tube Fact Book

272 Pages of Vital Tube Information Including Operating Conditions Tube Characteristics and Circuit Applications on 374 Tube Types



USE THIS COUPON TODAY



HYGRADE SYLVANIA CORP.
Emporium, Pa. RC110

Enclosed is 35c. Please send me a copy of the latest edition of the Sylvania Technical Manual.

Name

Address

City State

Serviceman Experimenter
 Dealer Amateur

Radio Service Data Sheet

CROSLLEY MODEL 29BA RADIO - PHONOGRAPH COMBINATION (Chassis Model 29)

8-Tube Superhet.; 3 Bands (550 to 1,600 kc., 1,600 to 5,000 kc. and 6 to 18 mc.); Built-in Rotatable Loop Antenna; R.F. Amplifier Stage Pushbutton Tuning for 5 Stations; Bass Compensation; Tone Control; Automatic Record Player; Crystal Pickup; Delayed A.V.C.

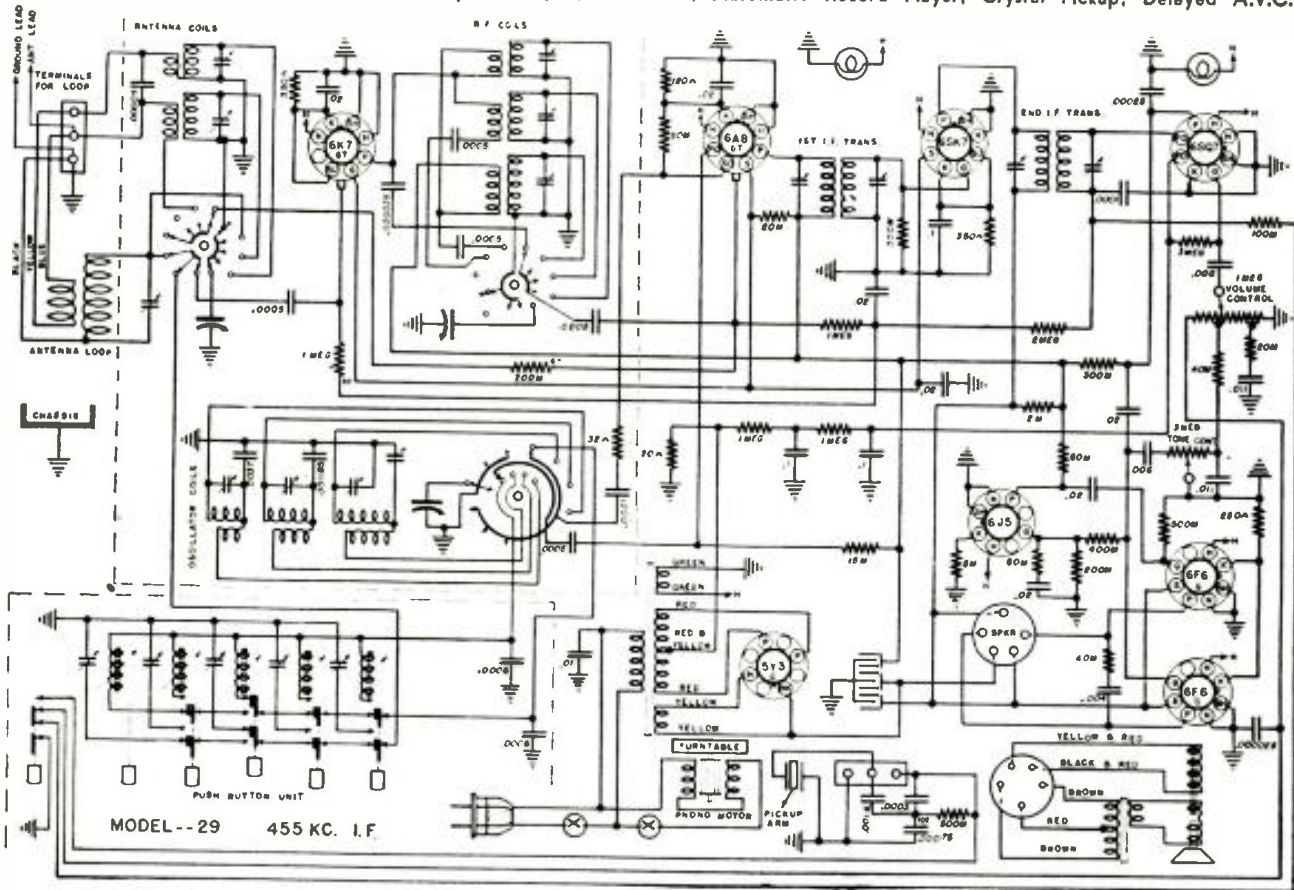

Alignment Procedure.—Connect the output meter from plate-to-plate of the 6F6s. Connect the signal generator ground lead to the receiver chassis or ground lead. Specified dummy antennas should be inserted in series with generator output. Position of volume control should be full-on; tone control in Treble. Align in following numerical order.

Number	Signal Generator Dummy Antenna	Freq. Setting	Input Connection to Receiver	Band Switch	Tuning Cond. Setting	Trimmer Adjusted	Remarks
(1)	0.2-in.	455 kc.	Grid of 6AS6T	B.C.	Fully open	2nd I.F. (2) 1st I.F. (2)	(A)
(2)	200 mmf.	1,650 kc.	Ant. lead (blue)	B.C.	Fully open	B.C. "OSC" Trimmer	(B)
(3)	200 mmf.	600 kc.	Ant. lead (blue)	B.C.	Approx. 60 on dial	B.C. "OSC" Series Trimmer	(C)
(4)	Repeat Step No. 2 to check possible shift due to series adjustment						
(5)	200 mmf.	1,400 kc.	Ant. lead (blue)	B.C.	Approx. 110 on dial	B.C. "ANT" Trimmer	(D)
(6)	400 ohms (carbon)	5.3 mc.	Ant. lead (blue)	Police	Fully open	B.C. I.F. Trimmer	(A)
(7)	100 ohms (carbon)	5 mc.	Ant. lead (blue)	Police	Approx. 5	Pol "ANT" and I.F. Trimners	(B)
(8)	400 ohms (carbon)	18.5 mc.	Ant. lead (blue)	S.W.	Fully open	S.W. "OSC" Trimmer	(C)
(9)	100 ohms (carbon)	18 mc.	Ant. lead (blue)	S.W.	Approx. 18	S.W. "ANT" and R.F. Trimners	(B)

*REMARKS: Adjust to the following outputs—(A) Max.; (B) Peak; not necessary to rock gang. (C) Max.; rock gang. (D) Max.; leave B.C. osc. trimmer untouched.

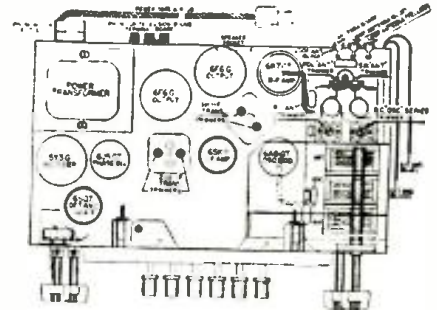

Location of main components and I.F. trimmers.

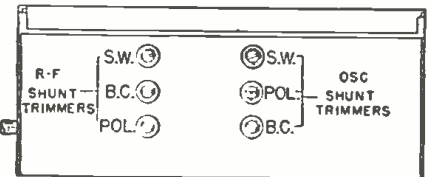

Location of aligning trimmers.



Crosley model 29BA phono-radio.

Important Notes.—When aligning the shortwave-band "OSC" trimmers etc. must be exercised to see that the circuits are aligned on the correct frequency and not on the image which is approx. 310 kc. less as indicated on the dial. To check, increase generator output, tune to generator frequency and then tune to image frequency which should be weaker than the fundamental and come in approx. 310 kc. lower on the dial than the fundamental. If image cannot be tuned in, the "OSC" trimmer is adjusted to the wrong peak. (Correct peak is the 2nd peak on trimmer from the closed position.) Repeat original alignment procedure for more accurate adjustments. Always keep signal generator output as low as possible to prevent action of the A.V.C. circuit.

Operating Voltages

Socket voltages measured to chassis @ 117.5-V. line, with 1,000 ohms/volt, 500-V. range D.C. meter Pin Number

TUBE FUNCTION	1	2	3	4	5	6	7	8
6K7GT—R.F. Amp.	0	0	187	75	0	J.B.	*6.3	3
6AS6T—Det. Mod.	0	0	187	75	0	J.B.	*6.3	1
6SR7—L.F. Amp.	0	0	23	0	2.3	78	*6.3	288
6SQ7—2nd Det.-A.V.C.-A.F.	0	0	0	0	0	110	*6.3	0
6J5GT—Phase Invert.	0	0	120	0	0	J.B.	*0.3	5.5
6F6G—Output	0	0	220	230	0	J.B.	*0.3	14.5
6F6G—Output	0	0	220	230	0	J.B.	*0.3	14.5
5Y3GT—Rect.	N ^o	N ^o	329.0	4.3	378.0	J.B.	329.0	

*Measure with A.C. voltmeter. J.B.—junction block; N.C.—no connection. Max. lower output @ 117.5 V. line 8 W. Power consumption @ 117.5 V. line 85 W. (100) across speaker field 85 W. Voltages may vary 10% of values given.

OPERATING NOTES

Trouble with . . .

... EMERSON T

A common complaint of this set is "oscillation" when the tuning condenser is rotated and when the set is jarred.

The tuning condenser in this set then is usually not making a good mechanical connection to the chassis. Simply bonding the tuning condenser to the chassis will eliminate this trouble. Also check the filter and cathode condensers for possible defects.

... EMERSON "MICKEY MOUSE"

A frequent complaint of this set is "motor-boating and oscillation" when the volume control is turned upward toward maximum.

To correct this trouble, replace the screen-grid bypass condenser. This is one section of the filter condenser block. The best thing is to replace the entire filter block as it will pay in the long run.

... EMERGENCY DIAL CORD

Many times I've used this method of replacing the dial cord on a receiver. Sometimes it's hard to obtain a dial cord for a certain set or it may be an emergency repair. You can save many a customer's good will by this simple method.

Simply get a piece of ordinary string and some bees-wax and draw the string across the wax a few times back and forth and you'll have one of the strongest and most reliable dial cords.

HAROLD R. KUNTZ,
Brooklyn, N. Y.

... REMLER 36 AUTO RADIO

Noisy reception such as interference (or hash) may be caused by an opened filter condenser (0.05-mf. and 0.1-mf.) in the "hot" battery lead into the dynamotor, or a defective R.F. choke. Replace the defective component. Low-volume output frequently is traced to the 2nd A.F. plate resistor having increased in value, thus causing a drop in the plate voltage of the 76 2nd A.F. tube; the value of this resistor is 15,000 ohms. This model has 3 stages of A.F.

... HOWARD HIGHWAYMAN AUTO-RADIO

If this receiver is reported inoperative, the trouble may be caused by the 42 power tube input grid coupling condenser having opened. Replace with one of 0.01-mf., voltage rating 400. Then, if there is no control of tone, check for a defective tone control switch; replacement with a new tone control switch will cure the fault.

... BALKEIT 100

Failure to operate, or interrupted reception, frequently is caused by an open choke. Replace, and at the same time check condensers C11 and C12 for short or open; if either, replace C12 with a condenser rated at 600 V. instead of the usual 400-V. one (capacity 4 mf.). Interrupted reception may also be due to the 56 oscillator not functioning. Continued blowing of the A.C. line fuse sometimes is due to a shorted power transformer primary buffer condenser, value 1 mf. Be sure to replace this condenser with one that is non-inductive and of sufficient voltage rating.

... GRAY BARETTE 4-MIDGET

This set is a dandy when it is working right, but has a common source of trouble in that this model may develop an open or shorted 1st R.F. cathode bypass condenser. It is best to replace the whole unit; this takes in the 1st R.F. cathode, cathode-

(Continued on page 273)

BUY DIRECT FROM THE MANUFACTURER AND SAVE

Announcing for the First Time—The New

DYNAROMETER

Features New Giant 8 1/2" Double Jewelled Meter

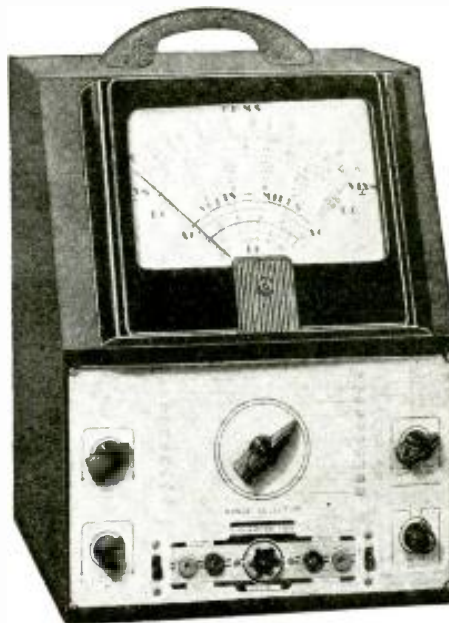

This amazing versatile instrument is our answer to the demands of radiotricians for a combination instrument which, in addition to making the usual V.O.M. measurements, will also permit DYNAMIC D.C. VOLTAGE MEASUREMENTS without interfering with or upsetting delicately balanced circuits, such as tuned circuits, electronic apparatus, control voltages, etc. Actually, as you will note from the specifications listed below, the DYNAROMETER is a combination Vacuum-Tube Voltmeter and V.O.M. besides permitting additional measurements such as Capacity, Decibels, Inductance, etc. All calibrations printed in large, easy reading type on the giant 8 1/2" double jewelled meter. The Input Impedance for the V.T.V.M. is 11,000,000 ohms with 2,000,000 ohms per volt on the lowest range. The 4 V.T.V.M. ranges are 5, 25, 100 and 500 Volts, and because of the zero center no attention need be paid to polarity since the meter will read either in the plus or minus direction, depending on the position of the probes.

HAVE YOU EVER—

Tried to measure Control Voltages such as A.V.C., A.F.C., oscillator, etc.? Impossible with the ordinary V.O.M. due to loading of the circuit BUT the 11 megohm input impedance of the DYNAROMETER enables measurements without molestation at any point in the receiver.

Tried to locate distortion in the audio section of a receiver? A long tedious job with the ordinary V.O.M. but almost instantaneous with this new DYNAMIC method of testing.

Tried to isolate the cause of trouble in an intermittent job? Not only is this possible with the DYNAROMETER, but because of the extreme sensitivity and flexibility measurements are possible at points usually impractical with a V.O.M.

SPECIFICATIONS:

- 4 D.C. VOLT RANGES AT 11 MEGOHMS INPUT: 0-5/25/100/500 Volts
- D.C. VOLTAGE MEASUREMENTS IN 5 RANGES: (at 1000 ohms per volt) 0-70/50/250/500/5000 Volts
- A.C. VOLTAGE MEASUREMENTS IN 4 RANGES: (at approximately 800 ohms per volt) 0-15/150/1500/3000 volts
- RESISTANCE MEASUREMENTS IN 3 RANGES: 0-1,000 Ohms, 0-10,000 Ohms, 0-30 Megohms.
- D.C. CURRENT MEASUREMENTS IN 4 RANGES: 0-1, 0-10/100/1 Amp./10 Amp.
- 4 OUTPUT RANGES: 0-15/150/1500/3000 Volts
- 2 CAPACITY RANGES: .0005-1 Mfd. .05-100 Mfd.
- INDUCTANCE: 1 H.-70 H. 7 H.-10,000 H.

The Dynarometer operates on 90-120 Volts 60 cycles A.C. Comes complete with test leads and all necessary instructions. Shipping weight 20 lbs. Size 13 1/2"x10"x8 3/4". Our net price **\$18⁷⁵**

SUPERIOR INSTRUMENTS CO. 136 Liberty St., Dept. RC-11
NEW YORK, N. Y.

A NEW BOOK ON PUBLIC ADDRESS

An important announcement about the greatest book on the subject of sound and allied subjects appears on Page 315 of this issue. TURN TO THE ANNOUNCEMENT NOW!

FREE!

HAMMARLUND NEW "40" RADIO CATALOG

The latest Hammarlund catalog with complete data, illustrations, drawings and curves on the entire Hammarlund line. Address Department RC-114 for your free copy.

HAMMARLUND MFG. CO., INC.
424-438 West 33rd Street, New York City

IF IT'S RADIO

ALL YOUR RADIO NEEDS

Here in this one big book you will find everything you need in radio... sets, parts and supplies... public address systems... amateur equipment... testers and kits... your nationally known favorites at lowest possible prices. Write today for this big valuable catalog and save money.

FREE CATALOG

PROMPT SERVICE

BURSTEIN-APPLEBEE COMPANY
1012-14 MCGEE STREET, KANSAS CITY, MISSOURI

EMERSON MODEL DX-356 3-BAND MANTEL SET (Chassis Model DX)

5-Tube Superhet.; 3 Bands (540 to 1,750 kc., 2,300 to 7,500 kc. and 6.9 to 22 mc.); 115 V. A.C.; Automatic Volume Control; Power Consumption, 55 W.; 6V6GT Output; Tone Control; Built-In Electrostatic Antenna (termed an all-wave loop antenna).

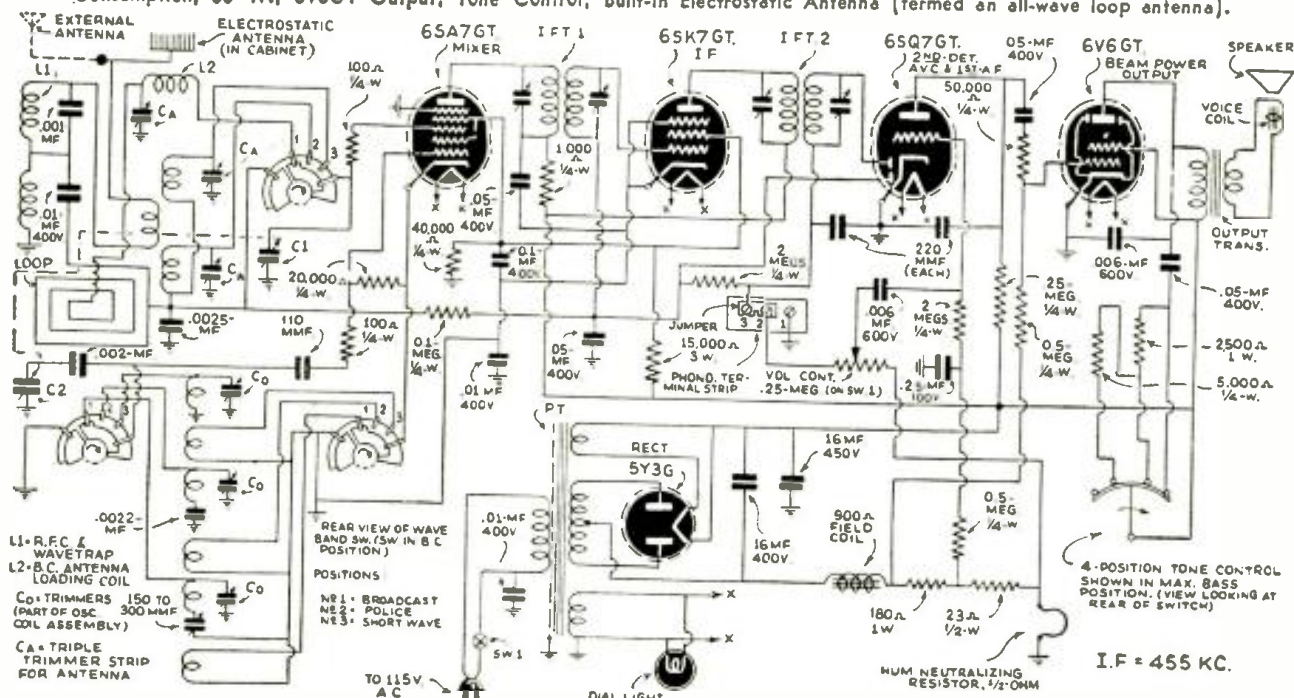

Complete schematic diagram of the Emerson model DX-356 receiver (chassis No. DX).

Alignment Procedure

Test Equipment.—An oscillator with frequencies of 455, 600, 1,600, 6,500 and 20,000 kc.; output meter (across voice coil or output transformer); dummy antenna (for aligning any of the 3 bands; 200 mmf. condenser for broadcast band, and a 400-ohm non-inductive resistor for the police and short-wave bands).

Use as weak an alignment test signal as possible. The set's oscillator is higher in frequency than the signal on all 3 bands, so images should be observed on the low-frequency side of the signals.

The last motion in adjusting trimmers should always be a tightening one, not a loosening one. Never leave the trimmer with the outside plate so loose that there is no tension on the screw. Either bend the plate up or remove the screw entirely. Loose screws are a sure source of noise, drifting, and microphonism.

In aligning antenna trimmers on the high-frequency signals there is always a tendency for the oscillator to drift, due to interlocking. To compensate for this always keep tuning the variable condenser as the trimmers are being adjusted.

I.F. Alignment.—Rotate the wave-band switch to the broadcast (clockwise) position. Set the variable condenser at the min. capacity position and feed 455 kc. through a 0.02-mf. paper condenser, to the grid of the 6SA7 tube. The input may be fed to the stator lug of the front condenser section. Adjust the 4 I.F. trimmers for max. response.

Broadcast Alignment.—Set wave-band switch at broadcast (clockwise) position; pointer at 60. Feed 600 kc. to antenna (using standard dummy antenna) and adjust broadcast-band series padder (beneath the chassis to the rear of the variable condenser) for max. response. Move pointer to 160, feed 1,600 kc. and adjust osc. coil trimmer, then ant. coil trimmer for max. response. Rect pointer at 60, feed 600 kc. and rock the variable condenser while adjusting series

padder for max. response. Return to 1,600 and check alignment. If readjustment is necessary return to 600 and repeat entire procedure.

Police Alignment. Set wave-band switch at police band (central) position; pointer at 6.5. Feed 6,500 kc. to antenna (using 400-ohm dummy ant.) and adjust osc. and ant. trimmer for max. response. The police band padder is fixed.

S.W. Alignment.—Set wave-band switch at the shortwave (counter-clockwise) position. Move pointer to 20 and feed 20,000 kc. to antenna (using 400-ohm dummy ant.) and adjust S.W. osc. trimmer for max. response; if 2 peaks are obtained choose min.-capacity peak. Then adjust the ant. coil trimmer for max. response; if 2 peaks are obtained choose max.-capacity peak.

Voltage Analysis

Readings with a 1,000 ohms/volt meter, measured to ground (chassis). Vol. control full-on; no signal. Line voltage, 117 V., 60 cy., A.C. All readings except "B:" at rectifier, heaters, and cathode voltages on 250-volt scale.

Tube	Plate	S.-G.	Cath.	*Fil.
6SA7GT	250	85	0	6.3
6K7GT	250	85	0	6.3
6SQ7GT	125	—	0	6.3
6V6GT	235	250	0	6.3

*Fil. voltage is A.C. Voltage from power transformer center-tap to ground (red and yellow leads) = 7 volts (neg.). Voltage across resistors R16 and R17—15 volts (neg.).

General Notes

- The receiver should never be turned on with either the speaker plug or the 6V6GT tube out of their respective sockets, since the rapid rise in rectifier voltage will damage the electrolytic condenser.
- When replacing the chassis in the cabinet take precautions to keep any part of the dial and condenser assembly from touching

Figures show frequencies at which each band is aligned. Read Alignment Procedure.

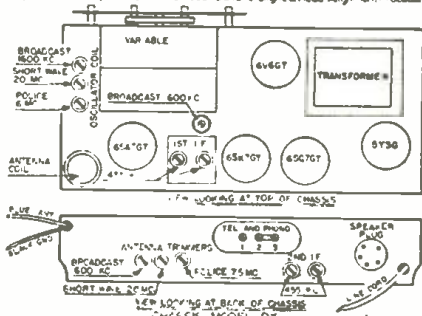

Location of main components and trimmers.



Emerson model DX-356 table receiver.

the cabinet, otherwise microphonism will result.

(3) The color coding of the I.F. transformers is as follows: grid, g'n.; "B-", red; plate, bl.; grid-return, blk.

(4) The color coding of the power transformer is as follows: pri., 2 blk. leads; H.-V. sec., 2 red leads; H.-V. sec. C.-T., red & yel. lead; 6.3-V. sec., 2 g'n. leads; 5-V. sec., 2 yel. leads.

(5) When replacing padders C20 and C29 be sure the tolerance is within 2% of the specified value, otherwise the shortwave coils may not track.

(Continued from page 271)
to-plate, and cathode-to-screen-grid condenser.

... MAJESTIC 380
"Low volume or sometimes dead," an occasional complaint with this set, is usually caused by an audio bypass unit being open or shorted. Replace with a new, can-type condenser. There are 3 condensers in this unit (capacities: 0.03 mf., 500 mmf., and 0.01-mf.).

... FREED-EISEMANN FE 15-18
This is a battery model, and sometimes has a heavy "B" power drain. The trouble is caused by a leaky 0.1-mf. bypass condenser across the "B"-battery circuit.

... WESTINGHOUSE 12
A superheterodyne circuit is used in this set. If inoperative, it may be caused by an open 1st I.F. transformer secondary winding. Replace, and also check the 1st R.F. 8,000-ohm cathode resistor for an open, or an increase in value.

GEORGE F. BAPTISTE,
Howard, R. I.

... CANADIAN WESTINGHOUSE RECEIVERS
The following are production changes which have been made in certain radio sets in this line.

Model W-651 Y (serials above A-256971).—This model is the same as model 651-X with the addition of a dial escutcheon, part No. M 16730. A resistor of 39,000 ohms has been added in series with the high end of the volume control and the common connection of the 2nd I.F. secondary (L12) and resistor R4. Condenser C14 is left connected to the high end of the volume control in the factory diagram. This change was also added to some W-651A and W-651X receivers and stops I.F. signals or oscillations from entering the audio circuits at full volume.

Model W-955 A (serials above 23797).—The 2 left-hand phono. switch contacts (as seen on schematic) are used to close the "B+" supply to the W-6SA7 oscillator plate and the W-6SK7 R.F. screen-grid in the "Radio" position and to open these circuits on "Phono" operation.

The broadcast oscillator circuit condenser, C7, has the same capacity as before (15 mmf.) but is a temperature-compensating type (part No. 594768-8). The 1.0-megohm resistor across C18 referred-to in the schematic is used.

Westinghouse Model B-562A (serials above A-27197).—Molded condensers C6 and C7 have different values from earlier production. Unit C6 was 4.7 mmf.—changed to 8.2 mmf. Unit C7 was 12 mmf.—changed to 8.2 mmf. Condenser C4 (0.01 mf., 400 volt) is not used on this later production. On earlier production no A.V.C. bias was applied to the I.F. tube type W-1N5G. On the later production this tube has the same A.V.C. bias as the W-1A7G. To effect this the winding L-14 is not connected to ground but the previously grounded end is connected to the common point of resistors R6 and R7.

CANADIAN WESTINGHOUSE CO.
Hamilton, Can.

"FREQUENCY MODULATION AUDIO AMPLIFIER"

Here is that article you have been looking for on an A.F. amplifier with a frequency response sufficiently flat, and a noise level sufficiently low, to afford maximum fidelity and minimum background noise for full appreciation of F.M. programs. Look for this article in December *Radio-Craft*—on the newsstands November 1st.

BUY DIRECT FROM THE MANUFACTURER AND SAVE

THE NEW MODEL 1240

TUBE TESTER

- Instantaneous snap switches reduce actual testing time to absolute minimum.
- Tests all tubes 1.4 to 117 volts.
- Sockets for all tubes—No Adapters.

Superior is proud to offer the newest and most practical tube tester ever designed. Unbelievably low in price—unbelievably high in performance.

- * Tests all tubes, 1.4 to 117 Volts. In addition 1, 4, 6, 7, 12, octals, loctal, Radiant Jr. 15 pin, single ended, float ing filament, Mercury Vapor Rectifiers, the new 8 series, in fact, every tube designed to date.
 - * Spring socket included on front panel for any future tubes.
 - * Tests by the well-established emission method for tube quality directly read on the GOOD & BAD scale of the meter.
 - * Total protected beam.
 - * Tests shorts and leakages up to 2 meg ohms in all tubes.
 - * Tests leakages and shorts in all elements AGAINST all elements in all tubes.
 - * Tests BOTH plates in rectifiers.
 - * Tests individual sections such as diodes, triodes, pentodes, etc., in multi purpose tubes.
 - * Latest type voltage regulator.
 - * Features an attractive etched aluminum panel.
 - * Works on 90 to 125 volts 60 cycle A.C.
- Model 1240 comes complete with instructions and tabular data for every known type of receiving tube. Shipping weight 12 pounds. Size 6" x 7 1/2" x 10 1/2". Our Net Price

Portable cover \$1.00 additional



\$11.85



THE NEW MODEL 1230 SIGNAL GENERATOR WITH FIVE STEPS OF SINE-WAVE AUDIO

SPECIFICATIONS

RADIO FREQUENCIES: from 100 KC. to 90 Mcycles in 7 bands by front panel switch manipulation. All direct reading and accurate to within 1% on I.F. and Broadcast bands, 25% on higher frequencies. The R.F. is obtainable separately or modulated by any one of the five Audio Frequencies.

AUDIO FREQUENCIES: 5 steps of SINE-WAVE audio 200, 100, 1000, 5000 and 7500 cycles WITH OUTPUT OF OVER 1 VOLT. Any one of the above frequencies obtainable separately for servicing P.A. hard of hearing aids, etc.

ATTENUATOR: Late design, full range attenuator used for controlling either the pure R.F. or modulated R.F.

- CIRCUIT: The Model 1230 employs an improved electron coupled oscillator circuit for the R.F. affording positive protection against frequency drift and a Hartley oscillator circuit for the A.F. section.
- DIAL MANIPULATION: Large 5 1/2" dial etched directly on front panel, using a new mechanically perfected drive for perfect vernier control.
- APPEARANCE: The front panel is etched by a recently perfected process which results in a life long attractive finish and the instrument housed in a streamlined shielded cabinet.
- CURRENT SOURCE: The Model 1230 operates on 90 to 125 volts A.C. or D.C. any frequency.

The Model 1230 comes complete with tubes, shielded cables, moulded carrying handle and instructions. Size 14" x 6" x 11". Shipping weight 15 pounds. ONLY \$12.85

SUPERIOR INSTRUMENTS CO. 136 Liberty St., Dept. RC-11 NEW YORK, N. Y.

GOLDENTONE...50% OFF

DEAL DIRECT FACTORY PRICES on over 60 models in choice from—4 to 12 tubes. Portables \$8.00 up. Car sets \$8.00 up. \$8.00 up. Shipping 50% off. Quantity discounts. Free 1941 Bargain catalog gives details of 12-day Plan. (Includes 100% satisfaction and 45-day trial.) GOLDENTONE RADIO CO., DEPT. RC, DEARBORN, MICH.

Free Catalog RCA

10 DAY TRIAL 4.95 UP

1 YEAR GUARANTEE

POPULAR PRICE WITH REAL MUSICAL QUALITY!



It has everything you need to bring customers into your store for records and keep them coming back for more. Quality crystal 1 plate, self-starting silent era drive motor (also in 2 1/2, 50 cycle and AC-DC) built in high fidelity amplifier and speaker. Even though model illustrated retails at \$11.95, the excellence of tone is so good that dealers use it as counter or booth record demo strain. SEE and HEAR the MUSIC MASTER. Dealers write for prospectus. MUSIC MASTER MANUFACTURING CO., 508 South Dearborn St. Chicago, Illinois

Solar RED-CAPS

Smaller Diameter Dry Electrolytics

SPEED Servicing

Write for Catalog

SOLAR MFG. CORP. Bayonne, New Jersey

HOWARD MODEL 520APC RADIO - PHONO COMBINATION

12-Tube Superhet.; 3 Bands (540-1,700 kc., 2.2-7.5 mc. and 7-22 mc.); A.C. Operation; R.F. Stage; Built-in Loop Antenna on Broadcast Band; Pushbutton Tuning (6 Buttons, Mechanical); Power Output (max.), 17 W.; Automatic Volume Control.

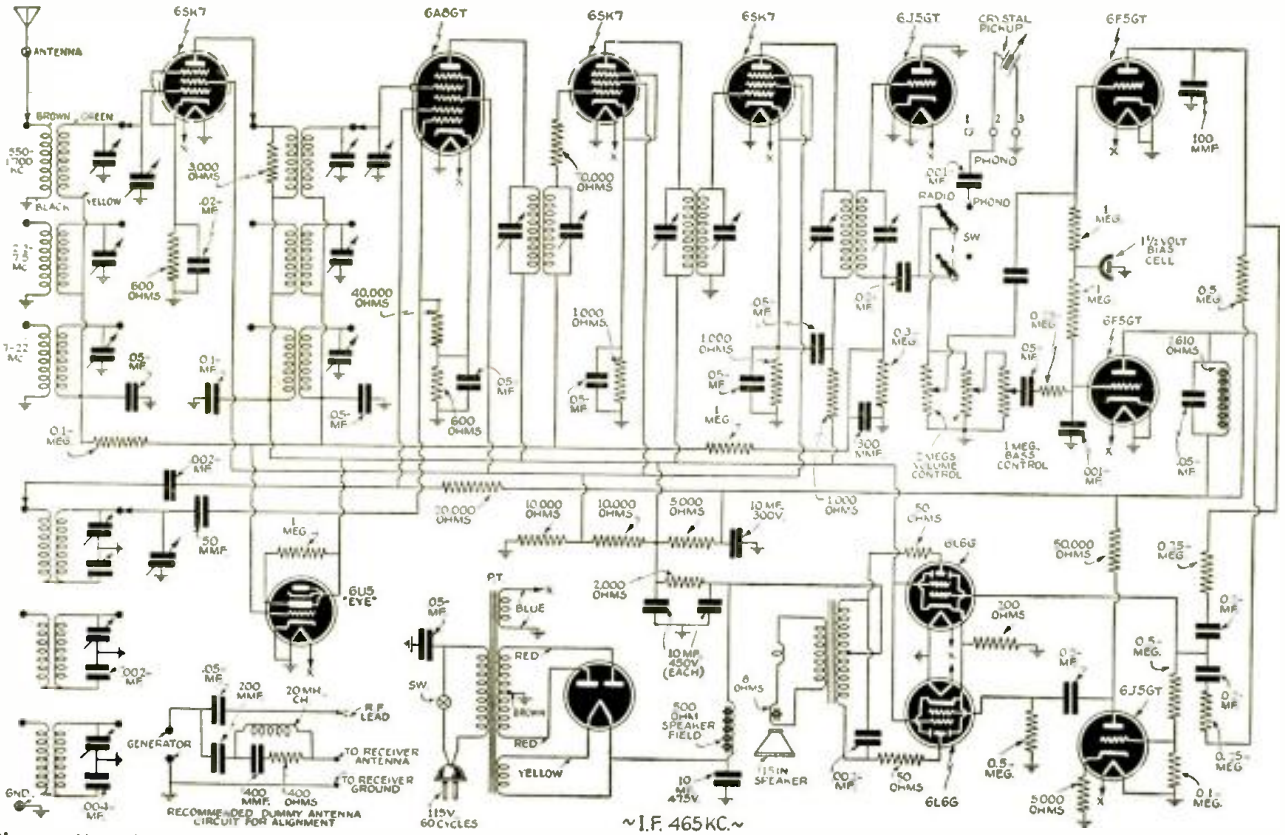

Diagram, Howard model 520APC phono-radio. First (left) section of Vol. Control is coupled to the 6F5GT through a 0.02-mf. unit. Note dummy antenna clip "R.F. lead" should read "I.F. lead"; choke CH. measures 20 microhenries.

SOCKET VOLTAGE READINGS

Voltage taken from ground with line voltage at —117, A.C.
High-voltage reading off rectifier —435 V.
Drop across speaker field —75 V.
Voltage taken with 1,000 ohms/volt meter.

Tube	Function	K	S.-G.	Plate	Tube	Function	K	S.-G.	Plate
6SK7	R.F.	3½	100	250	6F5	Audio	x	x	60
6A8	Mixer	4	100	250	6F5	Bass B.	x	x	115
6SK7	1st I.F.	6	100	250	6J5	Inverter	9	x	195
6SK7	2nd I.F.	6	100	240	6L6	Output	16½	250	350
6J5	2nd-Det.	x	x	x	6L6	Output	16½	250	350

ALIGNMENT PROCEDURE

Wave Band Sw. Pos.	Position of Dial Pointer	Gen. Freq.	Gen. Conn.	See Note	Trimmers Adjusted (In order shown)	Trimmer Function
B.C.	Min. Cap.	465 kc.	6AS Grid	A, E	I1 I2 I3 I4 I5 I6	I.F.
SW.	18 mc.	18 mc.	Ant. Post	B, D	O7 R8 A9	Osc. R.F. Ant.
PB.	6.5 mc.	6.5 mc.	Ant. Post		O10 R11 A12	Osc. R.F. Ant.
B.C.	1,400 kc.	1,400 kc.	Ant. Post		O13 R14 A15	Osc. R.F. Ant.
B.C.	600 kc.	600 kc.	Ant. Post	C	P16	Osc. Pad

NOTES

- A—Each step of the alignment should be repeated in the original order for greater accuracy. Keep output from Signal Generator low. The I.F. trimmers are reached through the 2 holes on the top of each I.F. can.
- B—When aligning the shortwave bands, do not adjust to the IMAGE frequency. For example, if the adjustment is correctly made at 21 mc., then a weaker image will be heard at 21,000 kc. less 930 kc., or about 20,070 kc. on the dial.
- C—When adjusting this pad, move the tuning hand back and forth, and adjust padder until the peak of greatest intensity is obtained.
- D—See that the tuning hand is set exactly on the last line above 540 when the condenser is at maximum capacity.
- E—The dummy antenna circuit shown with the schematic diagram is

~ANTENNA SECTION~

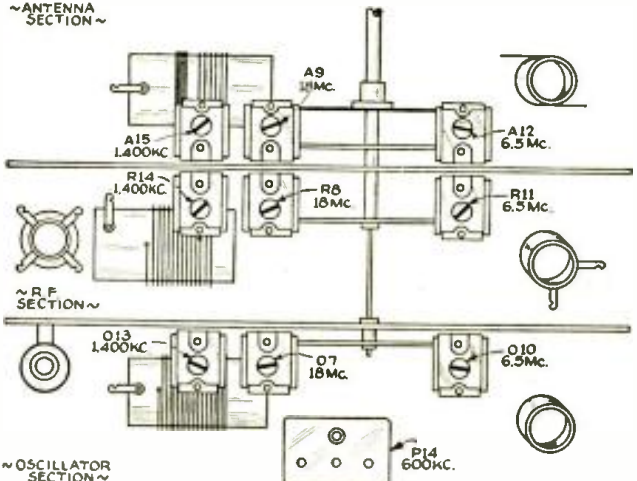

▲ Location of alignment trimmers.
Howard model 520APC phono-radio receiver.

recommended, since it is adaptable to any frequency range. The grid cap should remain in place during alignment.
For best results short the antenna and ground terminals when using the loop on the broadcast band.
The current consumption is 145 W. for the A.P.C. unit plus 30 W. for the radio chassis.



PLEASE—MR. MANUFACTURER
A Plea, by Don Foard, E.E.
Kalamazoo, Mich.

YOU will measurably decrease the use and abuse of profanity in and among radio Servicemen if you will refrain from manufacturing receivers having deep, cavernous chassis in which socket prongs and other vital points are hidden from the repairman's view, and in which the aforesaid vital points are inaccessible to the diagnostic touch of the test prod. Make our work hard, if you must—please don't make it impossible.

(1) Please don't ever use condenser blocks again. P-L-E-A-S-E.

(2) Why not mark capacities and lead codes on all electrolytics? Your part numbers and private codes mean very little to most Servicemen—and not all of your receivers are listed in Rider's.

(3) As everyone knows, it is about time we had fewer tubes. And if you have any ideas, any ideas whatsoever, requiring new or different test equipment, forget it. Most of us like to keep our test equipment awhile, at least until it's paid for. I know one fellow who is still paying for a tube tester that would test 6- and 7-prong tubes. A lot of new tube bases have passed over the counter since then.

(4) One manufacturer staples a circuit diagram of the receiver to the bottom of the cabinet. Talking his name up isn't such hard work.

(5) Must you use cord driven dials? Most of them require frequent repair—and many of us find them a pain in the neck to fix.

(6) A built-in power line filter costs very little and does a lot of good.

(7) Don't let your sales literature writers go off the deep end. You tell them your 4-tube job will get Europe—and we find it hard for them to get strong locals. We don't ask you to talk your product down. Just have a heart for those of us who must meet the customer (who is often bigger than we are) face to face.

(8) Let's quit making a 10-tube receiver out of a 5-tube receiver by the simple process of adding 5 ballast tubes. It is also very embarrassing for a receiver to play as well as ever with half the tubes out. We know, of course, that you don't make sets like this—but some of the others do.

Let's figure out some way whereby we can all make enough to live in reasonable comfort, and still give the customer his money's worth.

MISS AMERICA 1940 RECORDS



Woody Herman and his "Band that Plays the Blues" is introducing a unique entertainment feature in the Lee-Torrance room of the Hotel New Yorker. The recorder having been set up, microphones are passed to the guests at their tables, inviting them to sing or otherwise accompany the orchestra on a home-recording blank. Visitors making these records then have them autographed and mailed to friends or relatives. Photo illustrates Frances Burke, "Miss America 1940," receiving one of the "Recordisc" home-recording blanks (furnished by the Recordisc Corp.) from Mae-tro Woody Herman.

BUY DIRECT FROM THE MANUFACTURER AND SAVE

THE NEW MODEL 1280 SET-TESTER

A complete testing laboratory all in one unit. Tests all tubes, reads A.C. volts, D.C. volts, A.C. current, D.C. current, High Resistance, Low Resistance, High Capacity, Low Capacity, Decibels, Inductance, and Watts.

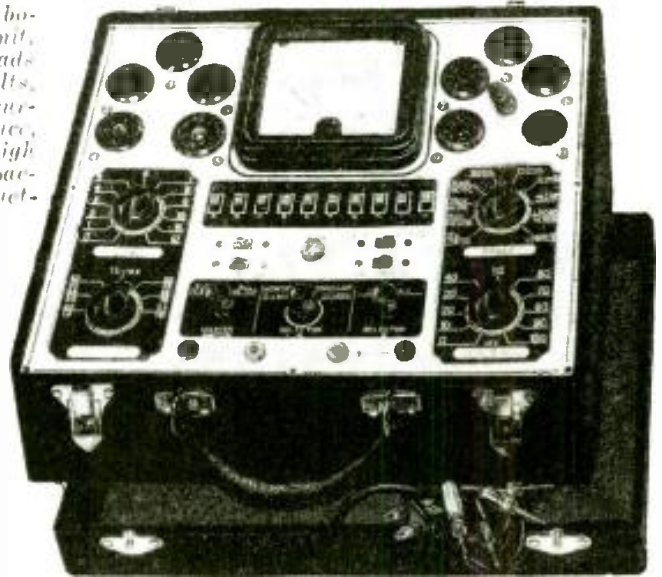

- * Instantaneous snap switches reduce actual testing time to absolute minimum.
- * Spare socket, and filament voltages up to 117 volts make the Model 1280 proof against obsolescence.
- * Latest design 4 1/2" D'Arsonval type meter.
- * Comes housed in attractive, leatherette covered carrying case.
- * Sloping panel for rapid, precise servicing.
- * Works on 90-125 volts 60 cycles A.C.

The primary function of an instrument is, of course, to make measurements accurately and when designing test equipment this is our first thought. However, we also appreciate the important part the appearance of an instrument plays in the impression a serviceman makes on his customers, especially on home calls. We have, therefore, paid special attention to the outward design of all of our new instruments. For instance the panel of this Model 1280 is made of aluminum and styled by a radically new process, which results in a beautiful, confidence-inspiring appearance.

SPECIFICATIONS

- * Tests all tubes, 1.1 to 117 volts, including 4, 5, 6, 7, 7L, octals, octals, Bantam Jr., Peanut, single ended, floating filament, Mercury Vapor Rectifiers, the new S series, in fact every tube designed to date.
- * Spare socket included on front panel for any future tubes.
- * Tests by the well-established emission method for tube quality, directly read on the GOOD ? BAD scale of the meter.
- * Jewel protected neon.
- * Tests shorts and leakages up to 2 megohms in all tubes.
- * Tests leakages and shorts in all elements AGAINST all elements in all tubes.
- * Tests BOTH plates in rectifiers.
- * Tests individual sections such as diodes, triodes, pentodes, etc., in multi-purpose tubes.
- * Latest type voltage regulator.
- * Features an attractive etched aluminum panel.

- Complete A.C. and D.C. Voltage and Current Ranges.
- D.C. Voltage: 0-15, 0-150, 0-750 Volts.
- A.C. Voltage: 0-15, 0-150, 0-750 Volts.
- D.C. Current: 0-1, 0-15, 0-150, 0-750 ma.
- A.C. Current: 0-15, 0-150, 0-750 ma.
- 2 Resistance Ranges: 0-500 ohms, 500-5 megohms.
- High and Low Capacity Scales: .0005 to 1 mfd. and .05 to 50 mfd.
- 3 Decibel Ranges.
- 10 to +19.
- 10 to +35, -10 to -53.
- Inductance: 1 to 700 Henries.
- Watts: Based on 6 MW. at 0 D.B. in 500 ohms .000000 MW. to 600 watts.

Model 1280 comes complete with test leads, tabular charts, instructions, and tabular data for every known type of receiving tube and many transmitting tubes. Shipping weight 14 lbs.

ONLY
\$19.95

PORTABLE COVER \$1.00 ADDITIONAL

SUPERIOR INSTRUMENTS CO. 136 Liberty St., Dept. RC-11
NEW YORK, N. Y.

Turn to Page 313 for important FREE
OFFER for Subscribers to RADIO-CRAFT

COIL REPAIR & REWINDING SERVICE... by coil specialists

IF—OSC.—RF types—all kinds. Send in defective coils—monatel or standard makes—old or new. Save time and money—quick service—quality work—economical—give coil data if known—coil rewinding bulletin available—write. QUALITY RADIO COILS OF ALL KINDS MADE TO ORDER 1 or 1000—state your needs.
BARBER & HOWARD, Inc. East Avenue, Westley, R. I.
Radio engineers and coil mfrs.

DUMONT
Precision Built Condensers
at your nearest jobber or write to
DUMONT ELECTRIC CO., INC.
514-516 BROADWAY NEW YORK, N. Y.
PAPER — MICA — ELECTROLYTIC

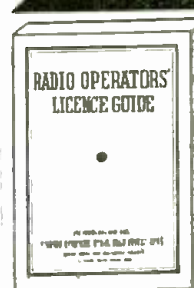

RADIO OPERATORS' LICENSE GUIDE

Containing over twelve hundred and fifty acceptable answers to the new "Six Element" radio operator license examination questions as embodied in the Federal Communications Commission Study Guide.

YOU NEED THIS GUIDE TO PASS YOUR EXAMINATION

\$3.00 Postpaid, refunded if not satisfactory.
Wayne Miller, Suite 200
Engineering Building
Chicago, Illinois

MITCHELL MFG. COMPANY "NAVIGATOR" GLOBE-RADIO
(Chassis Models TW and TWU)

5-Tube Superhet.; A.C.-D.C. Operation; Pushbutton Tuning (Mechanical System); Automatic Volume Control; Built-in Loop Antenna; Broadcast Band Range 55-1,700 kc. (174-560 meters); 1,712 kc. Police Band.

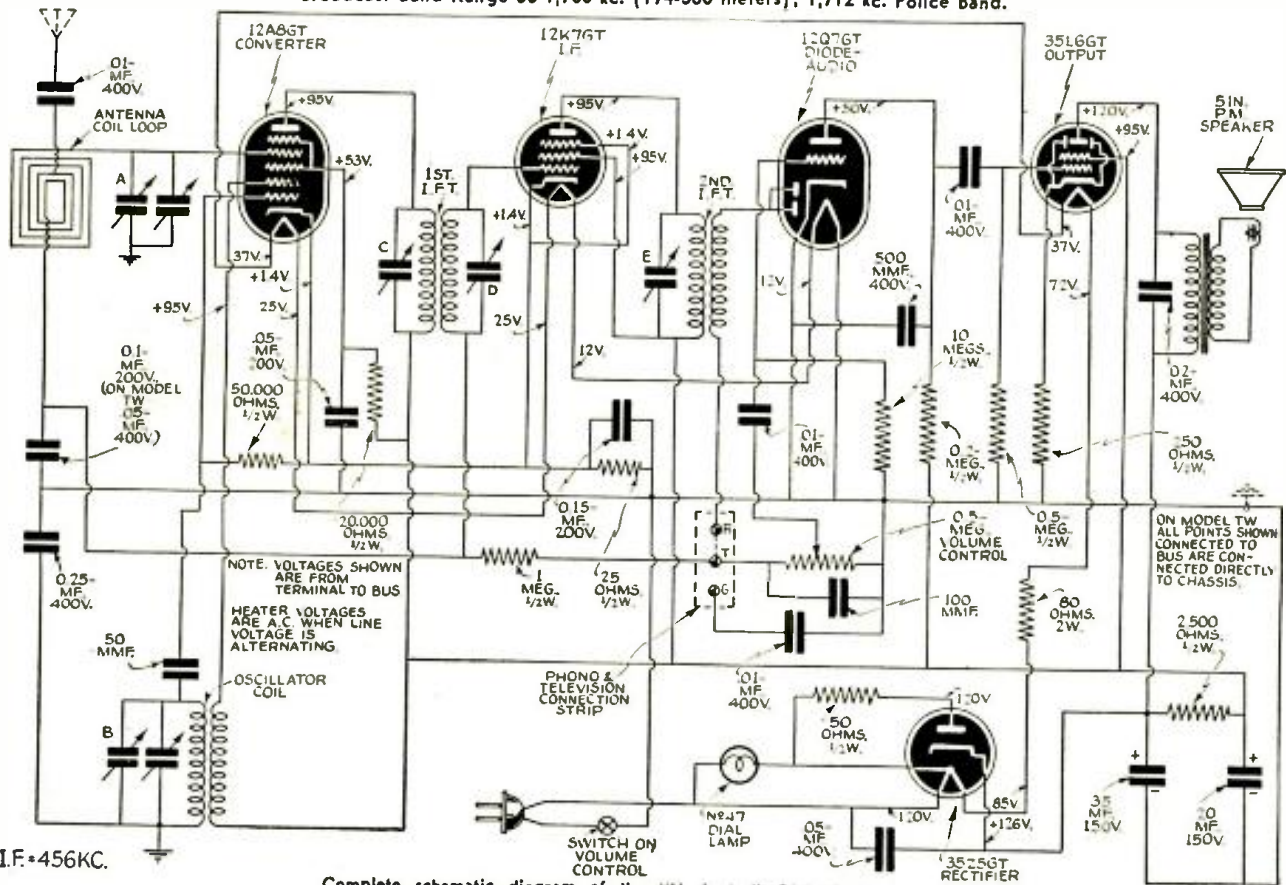

Complete schematic diagram of the "Navigator" Globe-Radio receiver.

SERVICING AND ALIGNMENT DATA

Poor tone quality and lack of sensitivity may be due to any one or a combination of causes such as weak or defective tubes or speaker, open or grounded bias resistor, bypass condenser, etc. Never attempt to realign set until all other possible sources of trouble have been first thoroughly investigated and definitely proved not to be the cause.

NOTE: It is absolutely necessary that an accurately-calibrated test oscillator with some type of output measuring device be used when aligning the receiver and that the procedure be carefully followed, otherwise the receiver will be insensitive and the dial calibration will be incorrect. The trimmers will be referred to by their function as indicated on the parts diagram.

ALIGNMENT PROCEDURE

GENERAL DATA. The alignment of this receiver requires the use of a test oscillator that will cover the frequencies of 456, 600, 1,400 and 1,720 kc, and an output meter to be connected across the primary or secondary of the output transformer. If possible, all alignments should be made with the volume control on maximum and the test oscillator output as low as possible to prevent the A.V.C. from operating and giving false readings.

CORRECT ALIGNMENT PROCEDURE. The intermediate frequency stages should be aligned properly as the first step. After the I.F. transformers have been properly adjusted and peaked, the broadcast band should be adjusted.

I.F. ALIGNMENT. With the gang condenser set at minimum, adjust the test oscillator to 456 kc, and connect the output to the grid of the 1st detector tube (12A8GT) through a 0.05- or 0.1-mf. condenser. The ground on the test oscillator should be connected to the chassis ground. Align all 3 I.F. trimmers to peak or maximum reading on the output meter.

BROADCAST BAND ALIGNMENT. Remove chassis from cabinet and set it up on the test bench taking care to have no iron

or other metal near the loop. Do not make this set-up on a metal bench.

Connect the test oscillator to the antenna of the set through a 200 mmf. condenser. With the gang condenser set at minimum capacity, set the test oscillator at 1,720 kc, and adjust the oscillator (or 1,720 kc. trimmer) on gang condenser. Next—set the test oscillator at 1,400 kc. and tune-in the signal on the gang condenser. Adjust the antenna trimmer (or 1,400 kc. trimmer) for maximum signal. Next set the test oscillator at 600 kc. and tune-in signal on condenser to check alignment of coils.

Voltages shown on the circuit diagram are from socket terminals to chassis base (or bus on model TWU). In measuring voltages use a voltmeter having a resistance of at least 1,000 ohms/volt. Allowances should be made for variations in line voltage.

AUTOMATIC TUNING (Mechanical System)

To make adjustments remove all 4 buttons which pull off readily. The center buttons should be removed first since by depressing the adjacent buttons with thumb and finger a firm grip may be secured on either center button. The side buttons can then be easily removed.

Loosen the screw of the desired button and with the manual tuning knob tune to any desired station. Hold the manual tuning knob in position and depress the button -haft as far as possible. With the button fully depressed tighten up the screw firmly.

Be sure the pushbutton knob is held down in position while being tightened. After the stations are adjusted it is advisable to check each button to assure sufficient tightening.

To assure accurate adjustment, the volume control should be set at a moderate level and the station tuned-in slowly to a point of maximum volume and clarity.

It is not necessary to follow any particular sequence of stations since each button is adjustable to any station.

With each button definitely set and securely tightened to the selected stations, the tuner is ready for operation.

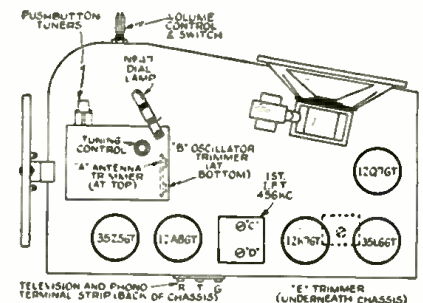

Chassis view of receiver showing locations of tubes, major components and alignment trimmers.



The Navigator Globe-Radio set.

Regarding Standardized Service Charges

By Charles R. Leutz

IN the radio field, apparently some attempts are being made to standardize charges, a practice which has proven very successful in the automotive industry. It must be remembered, however, that the automotive repair field is much older than radio and that there was a time, not long ago, when the question of proper charges for automobile repairs was just as much up in the air as the matter of radio repair charges is today.

Today, the manufacture of automobiles is confined to a relatively small number of different corporations. The set-up covering manufacture, merchandising and service is highly organized. The operations are also fairly profitable. Dealers, by employing skilled labor and using advance service equipment, are able to offer much superior service, and at lower prices, than a free-lance repair shop.

In radio, we have a relatively large number of different manufacturers, offering receivers which are essentially the same as far as performance is concerned, but varying widely in circuit and mechanical designs. Accordingly, the possibility of standardized repair charges becomes greatly involved. A fixed charge for a certain repair to one model may represent a small profit but the same repair to another model may represent a decided loss. The general idea of fixed charges, if they are high, may apply to a dealer operating in a prosperous residential area, but it becomes a very difficult proposition for a dealer having customers in different income brackets.

Price competition need not be feared by qualified radio technicians who are also able to apply modern salesmanship. A good knowledge of salesmanship is as essential as technical ability.

The main reason fixed charges are not profitable is due to the fact that invariably the different customers have incomes which vary between wide limits. Old-established and successful professional men, for example ethical doctors and lawyers, vary their fees according to the circumstances involved. They realize a hundred dollars to one man is no more than one dollar to some other man with a much lower income. The doctor realizes that some patients cannot possibly pay a fair price for the service involved and also that other patients may not be able to pay at all. The doctor also knows that the patients in the upper income brackets are agreeable to paying above the average to equalize matters.

The radio Serviceman can well copy the above-outlined procedure. Repairs for customers in the low-income class can often be completed using serviceable second-hand parts and the total repair cost confined to labor. Trade-in sets which have no ready market can be broken up for such useful parts. Other trade-in sets can be overhauled and sold to customers, in the low-income class, who might otherwise be unable to buy a fair set.

Top service charges cannot be expected unless real value is given in exchange. Wealthy men do not mind spending money but they are the first to demand value. Accordingly it takes salesmanship to get orders of this type and real ability to give satisfaction. The "new" or inexperienced Serviceman without proper equipment, cannot possibly compete for this trade.

The inevitable question always presents itself. It involves the wealthy customer that calls for service for some insignificant repair. The answer centers around modern salesmanship. When a client comes to a doctor with a broken arm, a definitely known difficulty, the break is fixed and the case closed. The doctor does not try to sell the client on the idea of a complete overhaul just because he has a complete set of new test apparatus. However, if the customer has a complaint, the source of which is not immediately apparent, a thorough examination is in order, necessary and justified.

So if the radio customer simply needs replacement of a burned-out filter condenser, it can be taken care of efficiently and at a reasonable cost with the expectation of repeat business.

However, if the radio trouble is complex, a complete shop analysis and possible complete overhaul may be in order.

Salesmanship and intelligence, at this time, are more important than fixed prices. The technician called in to make a minor repair has secured an entry and if well informed technically can tactfully suggest improvements, useful and valuable to the customer and involving more money than any repair job. The information along this line given to the prospect must be presented in an educational manner, leading the receiver owner to appreciate their value and utility. The following possible improvements are applicable to probably more than 50% of all receiver installations:

- (1) A directional aerial or loop to eliminate part of local noise and possible adjacent-channel interference.
- (2) Installation of new tubes with more favorable noise and amplification characteristics.
- (3) Wavetraps to eliminate certain station interference, or a Signal Booster (R.F. Amplifier) to improve Image Ratio and reduce interference.

(Continued on page 279)



TAKES BOTH

PACKED IN ONE CONTAINER

TWO DRAWER STEEL CABINET

Here's a honey of a steel utility cabinet with the drawers partitioned to make it easy for storing small parts. You'll find this cabinet a mighty useful addition to your shop equipment and best of all... you get it FREE on this limited offer. Don't delay, take advantage of this deal and get your FREE steel cabinet. Cabinet size is — length 11½", width, 9½", depth, 5".

Popular
CONDENSER ASSORTMENT

LIST

\$14³⁵*

This fine assortment of popular type N.U. condensers will move fast, give you a good profit and insure the good will of your customers. If you're already using N.U. condensers, you'll be sure to snap up this offer in a hurry. If you don't know yet how really good N.U. condensers are, here's a great opportunity to try them! The assortment you get on this limited offer consists of:

NO DEPOSIT ON CABINET

You can buy the condenser assortment for \$7.50 plus 30 N.U. point contract. Points can be added to present N.U. contract. You get the steel cabinet FREE, now. There is no deposit. (The condenser assortment comes to you packed with the cabinet.)

3—JB8450	1—AT2015
1—JB8845	1—AT8250
1—SC8450	1—AT4450
1—AT8150	3—AT8450
1—AT1615	1—AT1645

3—T604
4—T602
3—T605
5—T610
2—T625

GOOD FOR **60** DAYS ONLY

NATIONAL UNION
Radio Corp.
57 STATE ST., NEWARK, N. J.

Copyright

SOUND ENGINEERING

Free Design and Advisory Service
For Radio-Craft Subscribers

Conducted by A. C. SHANEY

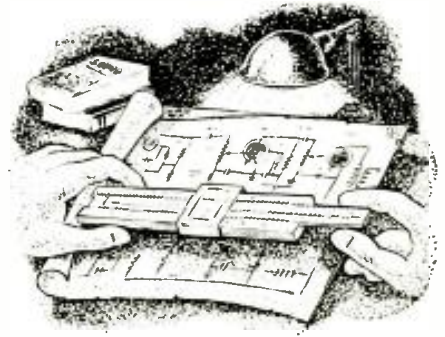

This department is being conducted for the benefit of RADIO-CRAFT subscribers. All design, engineering, or theoretical questions relative to P.A. installations, sound equipment, audio amplifier design, etc., will be answered in this section. (Note: when questions refer to circuit diagrams published in past issues of technical literature, the original, or a copy of the circuit should be supplied in order to facilitate reply.)

No. 11

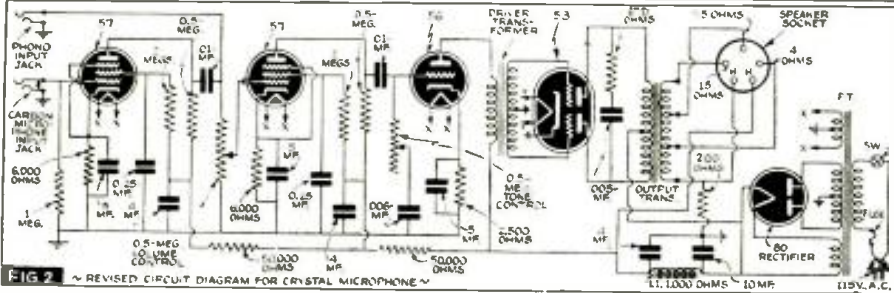
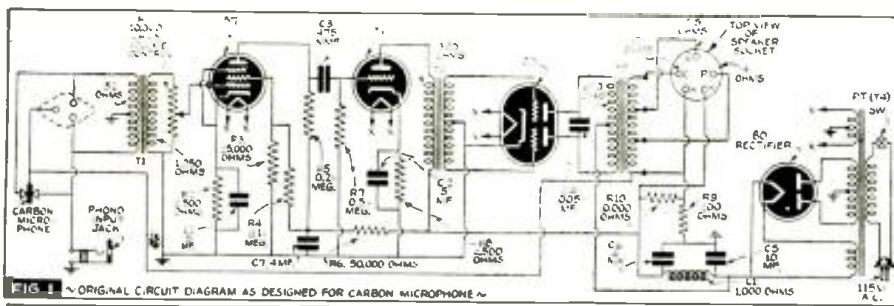

REVISED AMPLIFIER CIRCUIT ACCOMMODATES XTAL MIKE INSTEAD OF CARBON MIKE

The Question . . .

I am very much interested in P.A. systems and amplifiers. We have at the present time about 12 portable public address systems, with which we have had considerable trouble in trying to get good volume and tone. They seem to howl and whistle at the least touch of the volume control. These

amplifiers are made for carbon microphones. I would like to change to crystal. Can you suggest changes we can make in this amplifier, using most of the present parts that are in this unit, to give us fair volume and tone? Would like to incorporate a tone control in this unit also.

I am enclosing a drawing taken from a print we have of this amplifier, with all the type numbers and model numbers in the case of one of these units.

WM. L. PASCHKE,
Chicago, Ill.

The Answer . . .

Figure 1 illustrates the original circuit, which is given for the benefit of our readers. Figure 2 shows the revised circuit.

It will be noted that essentially, an additional 57 pentode stage was added to provide the increased gain required for accommodating a crystal microphone. While the 57 is not the ideal tube for this particular application, it is recommended only because a 6-volt winding is not available. It would have been better to use a metal tube in its place, such as the 6SJ7. The use of a 57 (pentode) in the 1st stage necessitates careful shielding to avoid hum pick-up. It will also be noted that the only changes involved are the addition of one additional stage plus a slight revision of the existing 57 stage. A tone control (of the high-frequency attenuating type) has been added in the grid circuit of the 56 driver. The carbon-mike volume control, R1, has been removed, together with the double-button carbon-mike transformer T1. Precaution should be exercised in wiring the 1st stage, so as to avoid undue hum pick-up.

The feedback trouble that you are experiencing (howl and whistle when volume control is turned up) is no reflection on the construction and design of the amplifier. It undoubtedly is caused by operating the microphone too close to the speaker. This condition would probably be present with any other amplifier, unless of course, the particular model you now have is peaked at or near the frequency of feedback. The chances are that the revised amplifier circuit, with a more sensitive crystal microphone, will aggravate this condition of feedback, unless suitable precautions are taken to adequately separate the microphone from the loudspeaker.

2A3 AND 53 AMPLIFIER

The Question . . .

This section of yours in *Radio-Craft* is one of the best ever placed in any radio

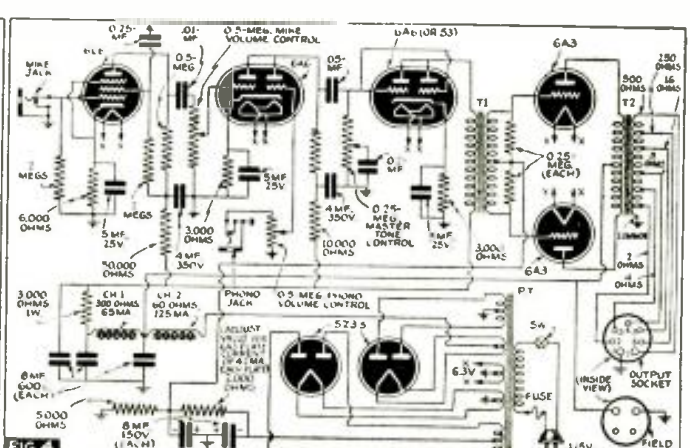
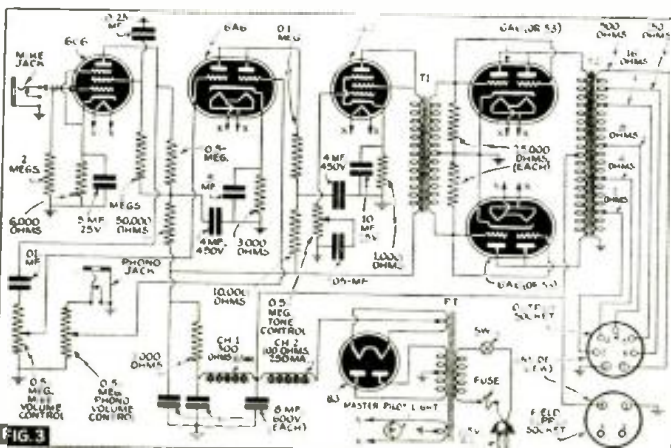

magazine! I believe it's one of the most helpful sections that could possibly be thought of, or put into use.

And now for a little circuit: We would like to get a circuit using a couple of 53s, P.-P. output, and a 53 driver without using a driver transformer, if possible. The balance of the circuit is something similar to the 2.5-V. filament circuit in Fig. 2 of your No. 3 article in the March issue for 1940.

We wish all the gain possible and about 15 watts output. If you have such a circuit that would fill our requirements, even though it must be altered somewhat from the line-up mentioned, we surely would appreciate the same. Even a couple of 2A3s might work best in the output. You know best! That's why we are asking you.

Please give the complete circuit diagram.

B. B. BARTHOLOMEW,
The Bartholomew Sacred Harmonies
of Broadcasting Station KFKA,
College Place, Wash.

The Answer . . .

A circuit diagram of the type amplifier you desire is given in Fig. 3. Although this particular amplifier employs 6A6s in the output stage, these can easily be changed to 53s as the latter are the 2½-volt prototype of the former.

Inasmuch as the output stage is operating in class B a driving transformer should be used. For best results the type 42 (or the 2½-volt, type 2A5) should be employed as a triode driver. The circuit ahead of the triode—which is composed of a 6A6 electronic mixer and 6C6 high-gain preamplifier—may be altered to fit any particular requirements you have in mind. For example, the front end of Fig. 2 of Sound Engineering No. 3 (see March, 1940, issue, page 531) may be used to replace the preamplifier and voltage amplifier section of Fig. 3.

As I do not know just what you intend to use this amplifier for, it is difficult for me to recommend either a 2A3 or 53 type of output stage. A 6A3 amplifier circuit is illustrated in Fig. 4. If 2A3s are desired, it will be necessary to change the other tubes for their corresponding 2½-volt type (6C6 to 57, 6A6 to 53); or if the output tubes are to be changed only, then an additional 2½-volt winding will be required on the power transformer. In this latter circuit, the preamplifier and voltage amplifier stages may be altered to fit any desired requirement.

REGARDING STANDARDIZED SERVICE CHARGES

(Continued from page 277)

- (4) Replace carbon resistors, which vary in resistance in operation, with metallized resistors of constant value.
- (5) Replace all paper and electrolytic condensers of low rating with new high-grade units of higher safety factor or rating.
- (6) Install improved "iron-core" R.F. antenna and oscillator coils for improved gain and more uniform response over their range.
- (7) Replace the I.F. transformer units with improved "band-expanding" types to permit better over-all audio response. This change also provides a control of selectivity vs. fidelity, depending upon the receiving conditions encountered.
- (8) Simplify record playing by installing a phonograph oscillator.
- (9) Replace phonograph pickup head with a modern unit.
- (10) Install one or more extra loudspeakers.

IT'S RCA FOR UNMATCHED QUALITY..UNBEATABLE LOW PRICES!

RCA AERODYNAMIC "MIKE"



Priced right for even the lowest cost job!

RCA Aerodynamic Microphone...MI-6226D (low impedance) MI-6228B (high impedance).



RCA Junior Velocity Microphone MI-4036G.



RCA Uni-Directional Microphone MI-4043. RCA 3-Way Microphone MI-4044.



RCA Pressure Microphone MI-4048A.



RCA Velocity Microphone MI-4027B.

THE RCA Aerodynamic Microphone is typical of the world's most complete line of "mikes"! It's tops in quality, low in cost. Has proved its value through splendid performance under the most difficult conditions. In the air, on the ground—even in a diver's helmet under water, the quality is outstanding.

No matter what kind of installation you make you have satisfied customers when you use RCA microphones. Pressure, velocity, lapel, uni-directional, bi-directional, non-directional—all types are available, for use outdoors or in. And remember—the prices are right.

RCA Commercial Sound
RCA Mfg. Co., Inc., Camden, N. J. • A Service of Radio Corporation of America

Any sound system sounds better, equipped with RCA Radio Tubes

NOW! Get your copy of the NEW book—
AUTOMOBILE RADIO—Principles and Practice—See Page 308

FILMORAPH
VOICE AND MUSIC RECORDINGS

Lengthy or continuous recordings now possible with newly patented "FILMORAPH". Over 13 hours of indexed voice, radio, code, telephone recording on a single 500 ft. reel of film costing \$3.00 and up. No other expense. INSTANTANEOUS and PERMANENT play-back. Can easily be synchronized with Motion pictures. Bulletins free.

MILES REPRODUCER CO., INC. Dept. RCB, 812 Broadway, New York City

University offers a complete line of High Power High Efficiency—Non-Resonant—Medium Price—Loudspeakers.

Write for Catalogue U-6-40
UNIVERSITY LABORATORIES
195 Chrysler St., New York City

NEW AUDIOGRAPH Sound Catalog

AUDIOGRAPH Sound Systems represent the latest in Sound Engineering and Design—a complete line plus pre-tested accessories.

NEW LOWER PRICES
Outstanding quality and performance at prices that help you meet any competition.

WRITE FOR FREE COPY
JOHN MECK INDUSTRIES
1313 W. Randolph St., Chicago, Ill.

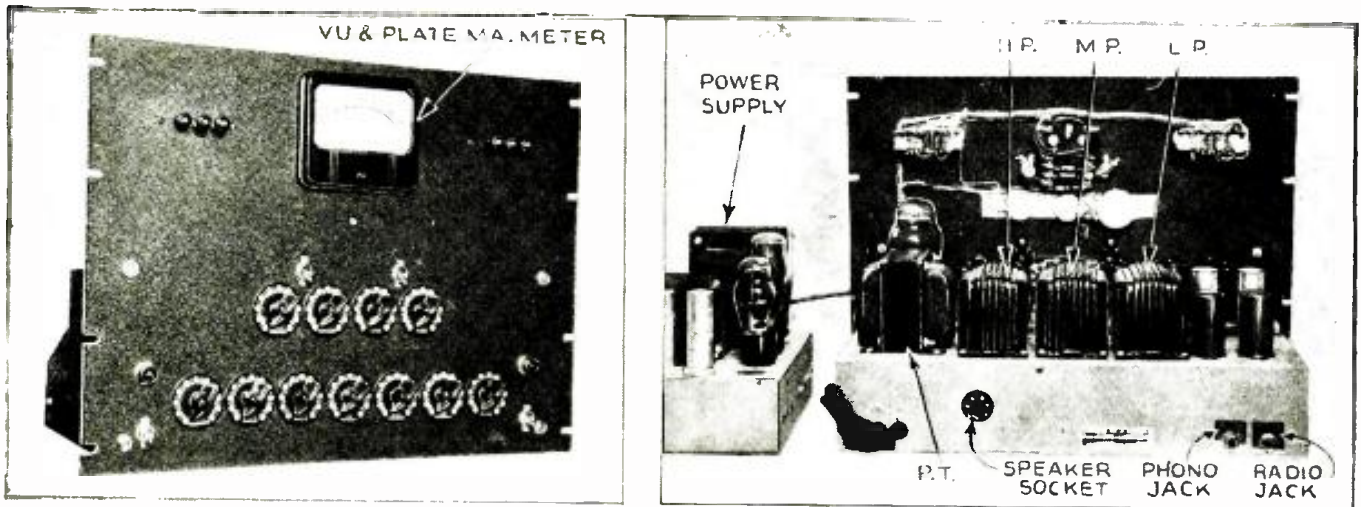

Front (left) and rear views of the Direct-Coupled Recording and Playback Amplifier. All the equipment in the front view is identified, reading from left to right, as follows: The pushbuttons at left of meter are marked P1, P2 and OFF; at right, OFF, +30 and -40. Immediately below the meter are the EXPANDER and SUPPRESSOR switches. Next, 4 controls that read THRESHOLD, SUPPRESSOR, TIMING and AUXILIARY H.F. Extreme lower-left, STANDBY pilot light and, below, STANDBY switch. Controls: PHONO, RADIO, LOW PASS, MEDIUM PASS, HIGH PASS and AUXILIARY L.F. Extreme right, MASTER pilot light and, below, MASTER on-off switch. The Auxiliary Controls are for constant velocity equalization; the Low, Medium and High Pass controls are for constant amplitude equalization.

RECORDING-PLAYBACK AMPLIFIER

Has Direct-Coupled Output Circuit and Equalized 30-Watt Output

A semi-technical discussion of an amplifier specifically designed to fill the requirements for the high-fidelity recording and playback field. A novel feature includes 2 independent equalizer circuits for both constant-velocity recording and constant-amplitude recording.

A. C. SHANEY

THE requirements involved in the design of a semi-professional high-fidelity Recording and Playback Amplifier offer a distinct challenge to the designing engineer, for here it is necessary to carefully balance performance against cost. If these considerations are not kept in mind during the design, the cost may soar, or the performance may be inadequate for universal application.

It was therefore decided to develop a medium-priced amplifier capable of providing more than sufficient flexibility of operation required to cover all unusual recording applications. The desirable features in a truly flexible amplifier of this type should include at least the following:

- Variable Equalizer for Constant-Velocity Recording
- Variable Equalizer for Constant-Amplitude Recording
- Variable Push-Pull Expander
- Variable Expander Delay
- Variable Time-Delay Control
- Non-Frequency-Discriminating Scratch Suppressor
- Feedback Push-Pull Output Amplifier (20 to 20,000 cycles, ± 1 db.)
- Low Hum and Noise Level (± 30 V.U.)
- Adequate Reserve Power (30 watts)
- Correct Level Indicator Meter
- Output-Stage Plate Current Meter

FEATURES—AND WHY

Variable Equalizer for Constant-Velocity Recording.—In constant-velocity recording, the amplitude of the recorded signal varies inversely with frequency. That is, higher frequencies have a lower amplitude swing. This condition is brought about by main-

taining a constant velocity of the cutting needle. It is obvious, therefore, that when the number of oscillatory motions are increased, the amplitude must be decreased so that a constant distance is covered by the cutting needle within a given time.

This arrangement, however, is usually restricted at the lower frequencies (below 350 cycles, which is known as the "crossover frequency"), so as to avoid overcutting within low-frequency ranges. As most magnetic pickups (which is the type commonly employed for constant-velocity recording) have existing frequency response deficiencies which vary directly or inversely with frequency, it is advisable to employ a type of equalizer which will most rapidly compensate for such deficiencies. (*)

Variable Equalizer for Constant-Amplitude Recording.—In constant-amplitude recording, the velocity of the cutting needle is directly proportional to the recorded signal. Under these conditions, the amplitudes of all frequencies are recorded of equal magnitude.

Where equalization is desired for normal deficiencies in the recording head, recording blank, or associated equipment, it is desirable to equalize with a constant-amplitude equalizer which is nothing more than the "audio spectrum equalizer" familiar to Radio-Craft readers. (†) This type of equalizer accentuates or attenuates a given frequency band, equally.

Variable Time Delay.—In automatic volume expansion (A.V.E.) and automatic volume control (A.V.C.), the attack and re-

lease time, or time controls, of these circuits are of critical importance in order to avoid detrimental effects.

For example, in voice recording, it is imperative that the attack time be reduced so as to prevent clipping of initial syllables. For music, fast or slow selections may require individual adjustments for ideal results. Recordings that have both low and rapid tempos should have the timing control set for some arbitrary average.

Non-Frequency-Discriminating Scratch Suppressor.—The scratch suppressor is highly desirable in order to effectively reduce background recording noise. The circuit employed decreases scratch by 10 db. (**)

Feedback Push-Pull Output Amplifier.—The use of a balanced type of feedback provides for looping the output transformer, push-pull driver, and push-pull output stage. This feedback circuit, plus a generously-designed output transformer, provides for a flat frequency response from 20 to 20,000 cycles ± 1 db., which exceeds the most stringent requirements of professional recording equipment. This type of a circuit also insures low hum, noise and distortion levels.

Adequate Reserve Power.—Although the amplifier is rated at 30 watts, it should normally be used as a 20-watt unit at which level it produces less than 1.2% total distortion. At recording levels up to ± 30 V.U., its distortion is practically unmeasurable!

Correct Level Indicator Meter.—This meter is of the new V.U. type designed in accordance with specifications set up by N.B.C., Bell Labs., and C.B.S.

(*) This type of equalizer has been completely described in the November, 1939, issue of Radio-Craft, pg. 268.
(†) Audio Spectrum Control was described in the December, 1939, issue of Radio-Craft, pg. 42.

(**) The operating principles involved were completely described in the July, 1940, issue of Radio-Craft.

Approval of Amateurs Everywhere!

HOWARD

Progressive Series Plan

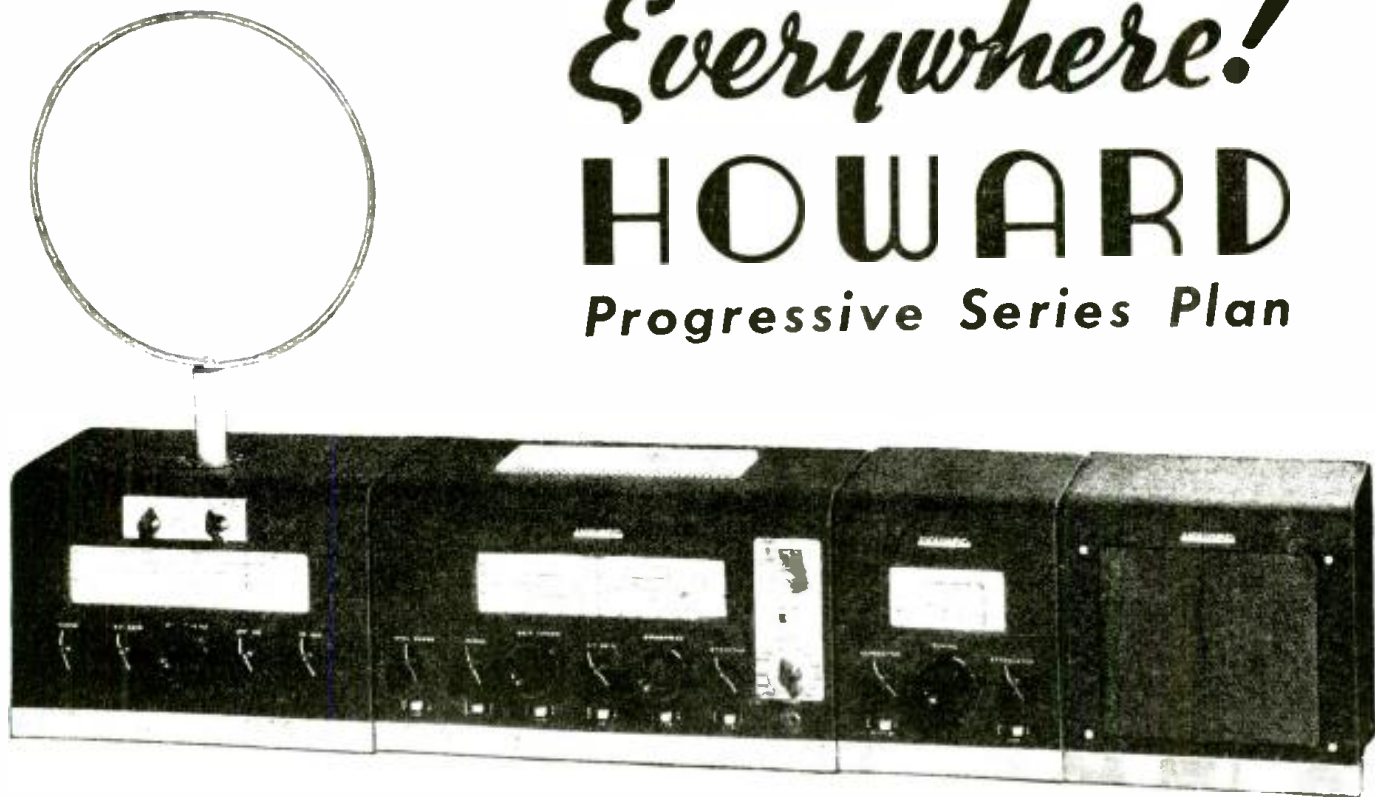

HOWARD'S revolutionary direct factory conversion set-up enables you to own at all times the finest receiving equipment—without risk of obsolescence loss or unfavorable trade-in deals. It is the most flexible and all-in-your-favor purchase plan in existence. If you want the finest receiving equipment your money can buy—with the advantages of adding to your investment at any time you desire—the HOWARD Progressive Series Plan provides the answer.

You can start the HOWARD Progressive Series Plan with basic Model 435 for a protected investment of only \$29.95. Model 436 . . . \$39.95. Model 437 . . . \$54.50. The total cost for the entire *Ideal Receiving Layout* pictured above . . . \$138.35. For complete details see your local amateur distributor or write the factory direct.

(Export and Pacific Coast Prices Slightly Higher)

**See the Howard Progressive
Series Models at Your Distributors!**

The World's Finest!

For those desiring a single unit communication receiver that establishes new standards of performance, the new 11 tube HOWARD 490 is outstanding in every respect. Built to the most exacting electrical and mechanical specifications, the 490 has sensitivity that never knows "crowding" and selectivity that may be varied at will from the hairline sharp position required for CW signals to the wide band requirements of high fidelity reproduction.

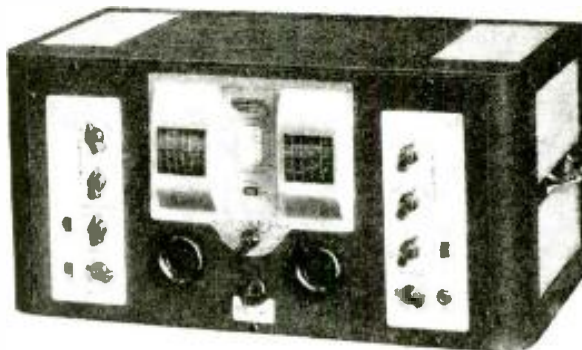

MODEL "490"—With Crystal
Filter and Separate 10" Speaker

\$149⁵⁰

HOWARD RADIO COMPANY

1731-35 Belmont Ave., Chicago, Ill. Cable Address: HOWARDCO., U.S.A.

America's Oldest Radio Manufacturer

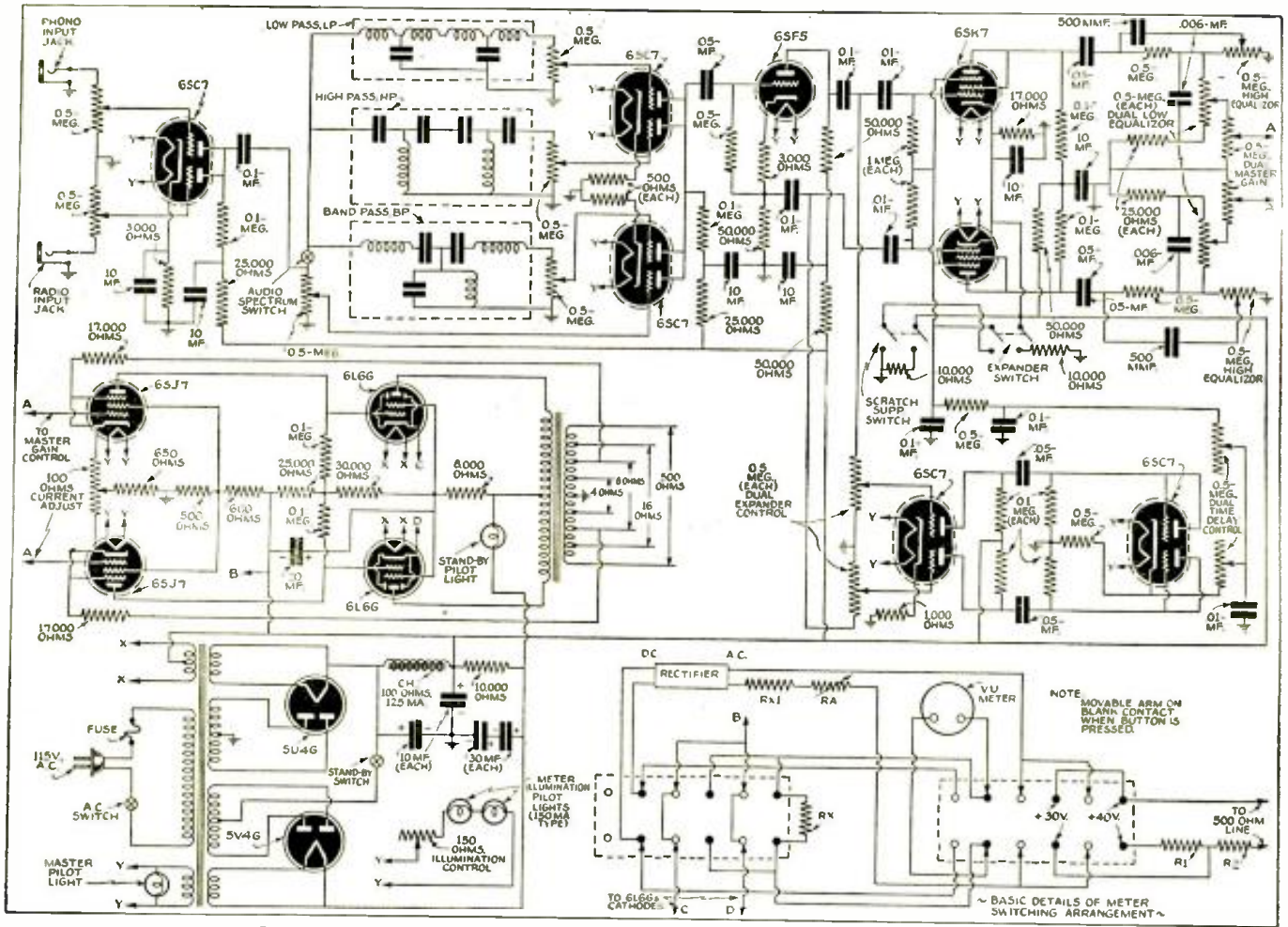

Complete schematic diagram of the 30-W. Direct-Coupled Recording and Playback Amplifier.

It is equipped with a variable illuminating control so that the intensity can be adjusted for any given set of conditions without undue eye-strain when a program must be constantly and accurately monitored. In order to insure against output tube unbalance, a switching arrangement is employed whereby the meter is switched into the plate circuits of each of the output tubes for plate current balancing adjustments. The switching circuit is arranged so that the meter cannot be damaged when push-buttons are indiscriminately operated.

ELECTRICAL CIRCUITS

A 6SC7 dual triode tube is employed for the phono and radio input. Electronic mixing is most easily accomplished in the manner indicated in the circuit diagram. For microphone work, an additional stage should be added. This may be a conventional 6SJ7. This tube should preferably have D.C. applied to its heater (use 12SJ7) which may be obtained from the common return of the high-voltage winding.

The components employed for the audio spectrum circuit follow conventional design. The audio spectrum is split up into the following 3 bands: (1) 20 to 200; (2) 200 to 2,000; and (3) 2,000 to 20,000 cycles. The audio spectrum switch enables the inclusion or exclusion of this portion of the circuit. Electronic mixing of the audio spectrum signals is accomplished through the following two 6SC7 tubes which are in turn coupled to a 6SF5 degenerative inverter. The output of the inverter in turn couples into a pair of 6SK7s which are used for expansion in conjunction with two 6SC7

tubes, one of which is used as a push-pull expanding amplifier and the other as a full-wave expander rectifier.

The direct-coupled portion of the amplifier follows conventional design which has been described in past issues of *Radio-Craft*.

For simplicity of circuit arrangements the values and the circuit of the complete V.U. meter have been omitted. The attenuator employed in the V.U. meter is of the "T" type. Resistors R1 and R2 represent "T" attenuators to provide any degree of attenuation desired. Resistor Rx is a shunt across the meter for changing the basic movement to read the high plate currents of the output stage. Resistor Rx1 is a series resistor of approx. 3,600 ohms and RA is a variable 500-ohm adjustment for absolute calibration of the V.U. meter.

The power supply is composed of 2 individual supplies. A 5U4G supplies bias voltage for the preamplifier, voltage amplifier and driver amplifier, while the 5V4G supplies voltage for the output stage. This latter voltage is added to the bias voltage in order to attain the high voltages required in the direct-coupled portion of the circuit. A standby pilot, in series with the plate supply of the output stage, insures against damaged output tubes should one of the driver tubes be thoughtlessly removed during operation. The power supply is built on a separate chassis to minimize inductive hum pick-up between the power transformer and the audio spectrum circuits.

Although this amplifier has been constructed for rack panel mount (its front panel measures 14½ x 19 ins.) it may be built in any standard cabinet for semi-professional use or home use.

RECORDING EQUALIZING TECHNIQUE

As there are a number of variable factors which tend to prevent the attainment of perfection in recording work, it is desirable to have a suitable number of compensating circuits to offset as many detrimental conditions as possible. If we assume that the amplifier itself will not introduce any frequency discrimination, we have the following additional elements to consider:

- (1) Microphone—its type, response, and placement.
- (2) Cutting Head—its type and associated driving mechanism.
- (3) The Recording Material—its type (degree of hardness) and its surface cutting speed.

As an infinite variety of response variables may be introduced by the 3 elements mentioned it is naturally desirable to locate and classify major frequency discrepancies within the recording system. This task is comparatively simple when modern laboratory facilities are available. For the recording enthusiast, however, who has limited facilities, the relative quality of the finished record may easily be checked against its original sound source, and noticeable discrepancies can easily be detected by trained listeners.

If the recorded signal can not be easily differentiated from the original signal, it is safe to assume that no noticeable discrimination occurs within the entire reproducing system. If noticeable discrimination is present, various "shades" of equalization (utilizing either the constant-velocity or the

constant-amplitude equalizers, or both) should readily correct any noticeable discrepancies. It should be borne in mind that a constant-amplitude cutting head may require constant-velocity equalization, because the frequency losses encountered in cutting a soft material will vary proportionately with frequency. When a crystal cutter is cutting high frequencies in a relatively soft material, all of the material is not cut away. A good portion of the needle displacement may simply be pushing the material from side to side. This "pushed" material nearly completely returns to its original form because of its resilient nature. This phenomenon, in itself, introduces an appreciable high-frequency loss. Under these conditions the constant-velocity equalizer should be placed into the circuit so as to provide a gradual high-frequency boost. A greater degree of equalization will be required, as the needle approaches the center of the record, because of the decreased surface record speed. For 33 1/3 r.p.m. recording a similar type of equalizer is required in order to maintain good high-frequency response. The degree of equalization should, of course, be gradually increased as the cutting mechanism approaches the center of the record.

Automatic electronic equalizer circuits may be incorporated into this amplifier so as to provide for automatic equalization once the exact losses have been established in some standard recording material.

This article has been prepared from data supplied by courtesy of Amplifier Company of America.

RADIO SHORTS

Berlin.—Factories have completed the change-over for the manufacture of army radio equipment on a mass production basis, the American Commercial Attaché to Berlin reports. Midget sets are being made in quantity for Germans repatriated from the East.

Denmark.—The American Commercial Attaché at Copenhagen reports the invention of a "living ear" automatic microphone said to be a "revolutionary innovation in the recording and reproduction of sound." System is applicable to radio sets and electric phonographs.

London.—The Monitoring Service in operation in England (illustrated and described in a past issue of *Radio-Craft*), which 24 hours of the day receives and analyzes some 500,000 words from broadcast stations in all parts of the world, has added dual services that will speed the delivery of interception summaries to Government departments. These services, Intelligence and News, pass information to Govt. depts. by phone; and answer inquiries from these depts.

A bill, with a life of 2 years, passed by Congress recently gives Army and Navy representatives authority, heretofore only available with the United States at war, to examine applications pending in the Patent Office. Declared within the jurisdiction of a "secrecy order," any patent application then could be withheld from the public as a war defense measure; and any subsequent premature disclosures of the application by the inventor would render him liable to having his patent application held "abandoned," which would prevent his ever again getting a patent in America. Advantages to the patentee however also accrue from the new arrangement.

SERVICEMEN

Keep posted on F.M. Read the feature articles on this subject in December *Radio-Craft*.

SELL MOBILE P. A. TO THE POLITICOS this year



Advanced design in combination 6 volt-110 volt mobile equipment results in low hum and noise level, high overload capacity. Hear this new amplifier.



MR. JOHN ERWOOD
President

says "Model 1420-M mobile system—designed by the originator of mobile equipment has plenty of power with ample reserve capacity."

The Sound Engineers' biggest problem is stressed in all Erwood designs. Each item has been designed to insure sound satisfaction under various acoustic conditions and wide variations in power supply.

Write for your free copy of new catalog hot off the press.

Be sure to enter the ERWOOD Slogan Contest, \$350 in merchandise. Write for free information.

Erwood SOUND EQUIPMENT CO.

222 W. HURON ST. CHICAGO, ILL.



Who Makes this FM and AM AMPLIFIER

FREQUENCY RANGE: 13-30,000 c.p.s. 2 db
MUSICAL RANGE: 11 Octaves
DYNAMIC RANGE: 80 db
POWER RANGE: 0.003 to 30,000 Milliwatts

This new amplifier was specifically designed for frequency modulation tuners, standard amplitude modulation receivers and absolute fidelity phono reproducers. Actually has a greater frequency range than FM transmitters. It is an outstanding contribution to the amplifier art and will be vastly appreciated by fastidious listeners, musicians, and technicians.

Guaranteed for FIVE YEARS
AMPLIFIER CO. OF AMERICA

17 West 20th St., New York, N. Y.

Write for literature describing this unusual FM-AM Amplifier



HANDI-MIKES

An indispensable part of all portable sound equipment . . . sports, call gym, sound trucks, am. transmitters, etc. Clear, crisp voice reproduction. Bal. grip, pol. chrome plate, snap switch, 3 ft. flex. cord. Choice of circuits and switches, single and double button carbon, crystals, dynamics, all impedances. At your dealer or jobber.

UNIVERSAL MICROPHONE CO., LTD.
Inglewood, Calif. U. S. A.

The NEW DOENUT Horn

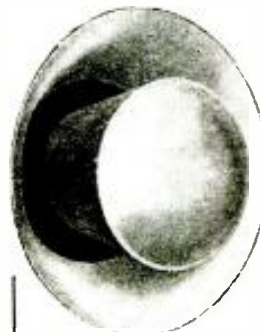

Provides
Wider
Angle
Coverage
Model
DX8BX

List Price \$36.40
15 Watts

- Spreads high frequencies over a wide angle.
- Weatherproof.
- Wide frequency range.
- No metallic sound.
- High conversion ratio
- Low feed-back ratio
- Sturdy steel construction

Write for complete details

WRIGHT-DeCOSTER, Inc.

2251 University Ave., St. Paul, Minn.
Export Dept.: M. Simons & Son Co., New York
Cable Address: "Simontrice"

Canadian Representatives:
Wm. F. Kelly Co., 1207 Bay St., Toronto, Ontario
Taylor & Pearson, Ltd., Edmonton, Alberta

NEW 2-WAY DYNAMIC PHONO PICKUP

A comparatively recent addition to the sound-on-disc field is the Western Electric type 9A permanent-magnet dynamic phono pickup which without any structural changes will reproduce with equal facility either vertical- or lateral-cut records. The response of this pickup is "essentially flat" to about 10,000 cycles! Its precision construction is here briefly analyzed.

A UNIVERSAL-PURPOSE phonograph pickup which plays both the so-called "vertical cut" and "lateral cut" records with a performance said to excel the best *single-purpose* pickup commercially available has been introduced by the Western Electric Company.

At the flip of a switch, the new pickup may be converted for either type of "cut." This convenience simplifies operation and maintenance. It also eliminates all chance of selecting an incorrect pickup when shifting to records of different types because the transfer can be made without lifting the



Here an operator is shown using the new 9A pickup as a part of the 1300A sound-on-disc equipment. The pickup by exerting a pressure on the record of only about 30 grams (0.9-oz., approx.), minimizes record wear and stylus noise. The diamond stylus has practically unlimited life. The output rating (equalized) is about -70 db.

stylus of the pickup from its groove in the record. It also results in obvious economies in equipment costs.

FREQUENCY RESPONSE

The 9A pickup, as the new instrument is known, is built to exceedingly close tolerances. It is rectangular in shape, somewhat smaller than a safety-match box (see photo at lower right). It is finished in satin aluminum and fitted with plug-in terminals. When not in use, a protecting guard is snapped over its diamond stylus. The diamond stylus exerts a pressure of but 30 grams. This feather-light touch prolongs materially the useful life of records.

The response of the 9A is essentially flat up to nearly 10,000 cycles for both types of recording. Most lateral-cut records are made at a slightly higher level than those recorded by the vertical method. Bell Telephone Laboratories, therefore, designed the 9A pickup with increased sensitivity for vertical recordings and thus made the output volume of the instrument approximately the same for both types.

Two main assemblies, a self-contained vibrating system and a permanent magnetic circuit, comprise the internal mechanism.

VIBRATING SYSTEM

The vibrating system of the 9A differs basically from conventional dynamic pickups in that it employs 2 adjacent voltage-generating coils instead of 1.

These coils are mounted on a common framework of duralumin and vibrate axially in a radial magnetic field. Supporting this structure and mounted midway between the 2 coils, is a flat, triangular-shaped spring that can flex up or down and twist axially but cannot flex sideways because of its wide cross-section. Recorded sound vibrations, in the form of undulations in the record groove, impart motion to the coil structure through a thin duralumin tube. This tube, which extends downward from the midpoint of the

coil structure, carries the stylus at its lower end.

During the reproduction of vertical-cut records, the rise and fall of the tube carries both coils up and down *simultaneously* with it. Lateral-cut records, on the other hand, swing the tube sideways like a pendulum. Consequently the coils continue to move up and down; but with lateral records they travel in opposite directions, or *alternately*, after the fashion of a see-saw. Hence, by switching the electrical connections of the coils (series aiding or series opposing depending upon the "cut" of the disc), the pickup becomes bi-functional.

MAGNETIC CIRCUIT

The magnetic circuit consists of a rectangular bar of magnetic alloy to which are riveted 2 soft-iron, "U"-shaped yokes, one of which carries the center pole-piece. The 2 yokes are secured directly to the outside pole plate which serves as a mounting for the vibrating system.

Since good studio practice calls for the introduction of varying amounts of equalization during the recording process to overcome the effects of noise originating in the record material and other distorting factors, an equalizer capable of introducing a series of complementary characteristics has been designed for use with the 9A pickup. (This unit is known as the 171A Repeat Coil and K.S. 10066 Switch.) It serves not only as an adjustable equalizer but as a means of matching the impedance of the reproducer to the input of the amplifiers. These input values may be 30, 250, 500, or 600 ohms.

The 9A pickup works into a 5-ohm impedance and has an output (unequalized) of -45 db. from lateral records and -40 db. from the vertical records. Since it is a dynamic unit its impedance remains constant over its useful frequency range. Use without the associated equalizing equipment is not recommended because the response would be so nearly linear that a true image of the recording characteristics would result and this is undesirable.

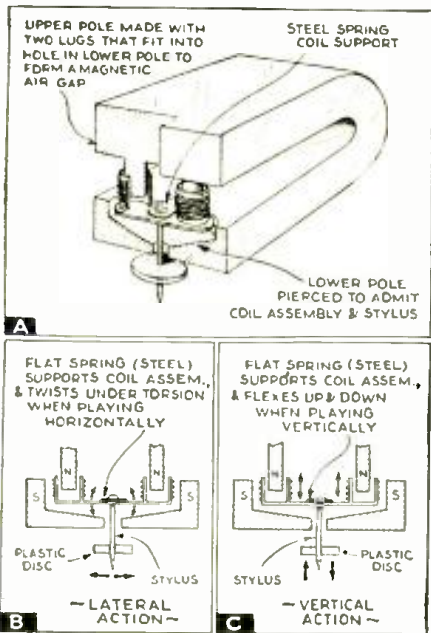

A.—The magnetic system in closeup. B.—Lateral Action. When the stylus moves laterally the coils alternately move up and down the magnetic poles. The coils are connected in series aiding. C.—Vertical Action. When the stylus moves vertically the coils move up and down *simultaneously*. One coil is now reversed so they still act in series aiding.

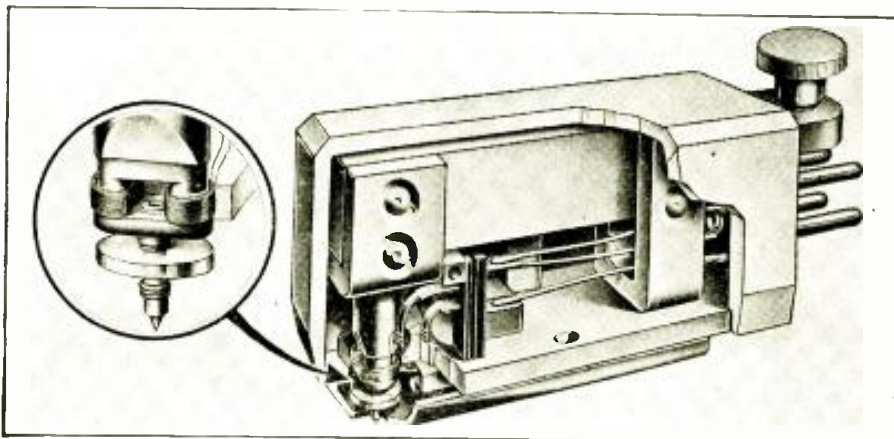

This phantom view of the universal phono pickup reveals its unique use of 2 balanced "speech coils." The 4-prong terminal permits changing the phase of the coils 180 degrees when shifting from vertical to lateral recordings. The view at left shows the vibrating system enlarged. The circular vane of viscous material carried by the stylus support dampens-out unavoidable high-frequency resonances caused by the elastic properties of the record material.

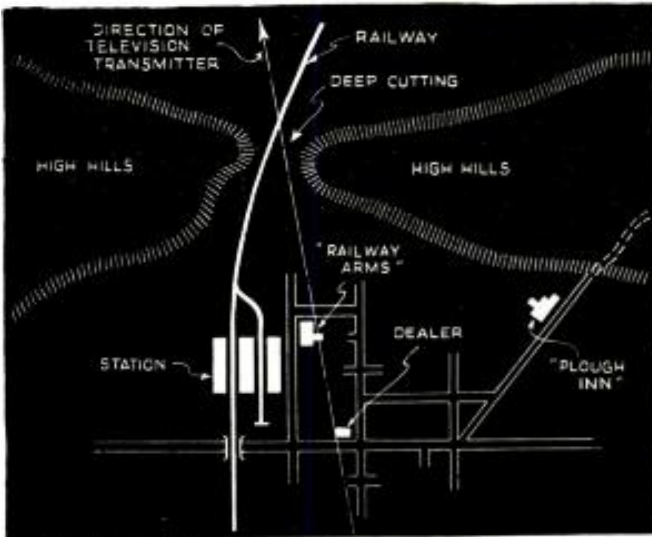

Fig. 1. The effect of a railway and hills upon television reception.

Realizing that "Experience is the best teacher," Radio-Craft is happy to be able to present the following article. It delineates the service problems that beset English Television and shows how these pitfalls may be avoided by those who are developing American Television.

TELEVISION SERVICING PROBLEMS

M. E. SOUTHALL

An English Television Service Engineer

PROLOGUE

WARTIME RADIO AND TELEVISION

It has now been definitely ruled that there is to be no resumption of the English Television programmes (see Footnote) which the British Broadcasting Corporation had to cease radiating at the beginning of the war with Germany.

There is only one station available for the London Area and therefore the transmission would be ideal for direction finding and would surely be used by the navigators of enemy aircraft for directing them to our Capital. Also, of course, there is much activity on the television wavelengths for official purposes and the programme radiations may interfere with these transmissions. And finally, it would be costly to keep the service going not only for monetary

Footnote: The English spelling of the author's words has been retained, in this article, and the English technical terms it contains are self-explanatory.

reasons but for staff considerations as many fellows are joining the colours and others are working on government secret research work in connection with the many uses of the ultra-short wavelengths for war purposes.

The type of radio engineer which has been hit most severely by the cessation of television is the television service engineer. In most cases he has not the academic qualifications necessary for a good research job and yet he feels that going back to ordinary radio service work is a step very much in the wrong direction. It is not surprising therefore, to find that many good fellows had a bad attack of depression which only hard work or joining one of the Services eliminated.

In my own case I had graduated through the ranks of service engineers and supervisors to be the senior and most experienced of the television service engineers of one of

England's largest radio manufacturers. I had been transferred to the research department for 2 years while the first commercial television receivers were being designed and tested prior to line production, and when real Cathode-Ray Tube television commenced (as compared with the disc type of system which had been running for some time), I was put back into the Service department in charge of television installation and maintenance.

The work was terribly hard as we were pioneering and running into new troubles every day. Transmission times were very limited which meant waiting for them to start in order to check the receivers irrespective of the time of day at which the job was started.

Installations for royalty, press demonstrations, exhibitions, etc., etc., all came in the day's work. Late nights and constant worrying over awkward but important jobs wore one's nerves to the very edge. Time passed and as 1939 came in, television was becoming more and more stabilised and we had most of the answers to difficult installation problems. The public interest was growing; prices of receivers were falling to every man's level and the B.B.C. programmes were developing from the scientific interest phase to real entertainment value acceptable to all classes of the growing army of television set owners.

The R.M.A. decided that the main theme of the annual radio exhibition at Olympia in August was to be Television and we set to work to put it over in a big way, but as we worked the war clouds gathered and it was hard to keep one's mind on the job. Was it worth going on with? Would there be war? Well, we all know the answer now and there is no point in this article to go over those unsettled early days of the war. Television stopped dead and we television engineers found ourselves with absolutely nothing to do. After years of unrelenting strain and endeavour it is not surprising that nerves broke down and hatred for the war which had blighted our hopes of the future blurred our common sense. We tried to join up and the younger ones below 30 years of age were able to do so but those of us who were older just could not get in.

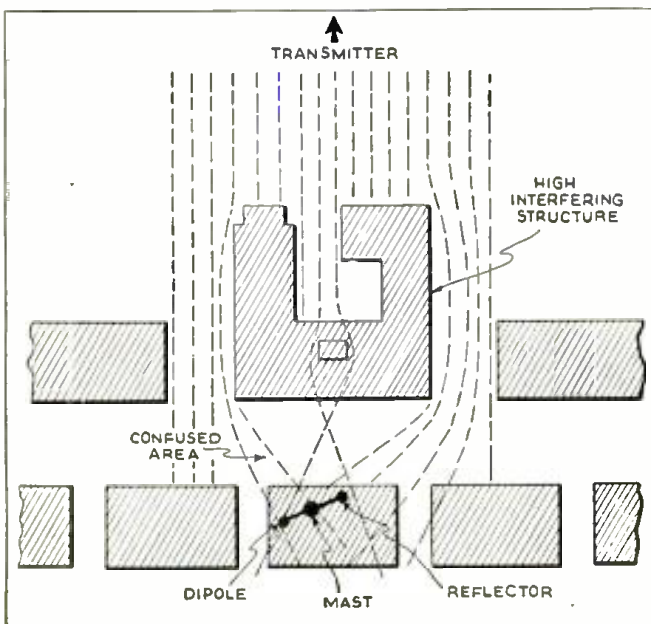

Fig. 2. The effect of high structures upon television signals.

Thirty is the calling-up age limit in the radio industry; this means that for men over that age radio becomes a reserved occupation and the fighting services cannot accept you as the Ministry of Labour say that a certain number of experienced men must be kept in radio otherwise the industry may break down thus throwing out of work thousands of operatives and similar types of labour. In other words we were not wanted except in our own place in the industrial scheme to maintain the home front.

I left the firm I was working with and took control of the Service department of a large West End of London store. There are many of these jobs going as the majority of dealers employed young, low-salaried service engineers and got properly let down when these youngsters were called up and they found themselves with increased service work coming in but no skilled labour to cope with it. In fact many small radio firms have had to close down because of lack of staff. Girls are being trained as radio service engineers by some radio manufacturers to help their dealers but that's another story.

SERVICING TELEVISION RECEIVERS

Getting back to television, here am I back on a radio job with boxes of television servicing and installation equipment and piles of notebooks and service manuals waiting for the war to end.

Meanwhile you fellows across the Atlantic are going ahead with television and many of you will bump up against the troubles we have had when you start installing television receivers every day so I don't see why I shouldn't open up some of those notebooks and pass on any hints and tips which I think may be of value to you together with a description of the equipment used by television service engineers in England. Some of the gadgets were on show at Olympia for the first time last August but have never been used in the field. You may get some ideas from my notes about them which will help you to make up gear for yourselves.

FREAK RESULTS

Every service engineer and those dealers who have the future of television at heart should resolve not to create a boom in a certain district based on a report of a freak reception. It has happened in England and, believe me, it is the rottenest job out, to try to get the same results from one receiver a few hundred yards away from another that is giving perfect results because of some freak phenomenon. An example will help to illustrate what I mean.

Figure 1 is a map of a country town on the fringe of the television station's service area and badly shielded from the station by a range of hills. General reception is out of the question but by a strange freak of locality the dealer's shop in the High Street which ran through the town from the station was within an area in which excellent television images could be received.

Without troubling to investigate the reason for these unexpectedly good results, and against the advice of manufacturer's technicians, he held demonstrations and got many people interested. The proprietor of the Railway Arms near the station arranged for a trial installation and the dealer was delighted at the results obtained at the tavern and the consequent publicity and, naturally, it was not long before another large "house" at the other end of the town—the Plough Inn—ordered an installation.

Then the trouble started.

Results were hopeless. Dipoles with re-

flectors were experimented with; extra-high masts were erected; costly extra-low-loss down lead was tried and finally with the aid of an expensive, multi-stage aerial line amplifier fairly good images were obtained. Even so the signal strength was hardly sufficient to maintain synchronization and everything had to be up to the very top limit to keep things going. Valves had only to drop a little in emission to give rise to a service call and the job was a regular nuisance.

The reason for these contrasting results was soon established when a colleague and I were sent down to thoroughly map out the town with field strength measuring gear so that the Sales Department could decide whether or not to "boom" television in that town or to advise the dealer to frankly admit to the public that his results were, unfortunately, freakish and only to be taken as a guide to what television reception would be like when more transmitting stations were erected giving good field strength all over the country.

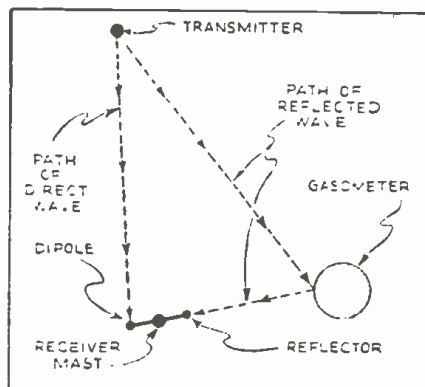

Fig. 3. A cause of ghost images.

As will be seen from a glance at Fig. 1, there was a deep cutting following a natural cleft in the hills to the north of the town and this cutting, the transmitting station and the dealer's shop were all in a straight line. There was thus a narrow "beam" or area of good signal strength running across the town from North to South and the dealer's shop and the Railway Arms were in this area. The Plough Inn was outside this freak zone hence the difficulty in getting results up to the standard obtained at the Railway Arms and the dealer had a difficult time trying to collect from the landlord of the Plough Inn the heavy extra cost of the additional equipment necessary to give even the meagre results obtained.

SURVEY YOUR DISTRICT!

One of the first things that a service engineer or dealer should do directly he finds that television is likely to be a commercial proposition in his district is to buy a large scale map of the area and hang it on a wall in his office or workshop. Then the district should be carefully surveyed by making receiver tests one street at a time and marking up the results after analysis on the large scale map.

Color code your markings something like this: draw a green line alongside streets in which you find reception is good using a simple dipole aerial; use an orange-colour line on streets where installations will probably require a dipole with reflector because of weak signals; a red line could indicate that interference is bad and no promise of results should be given to prospective customers in that area until a

careful survey had been made and receiving tests carried out.

As installations are carried out and experience gained, mark the location of the installations on the map by drawing a small circle with a number inside. Near the map have a sheet of paper with a Key on it to all the colour coding and a list of the numbered locations with notes against them. For example:

No. 1.—Mr. Jones. Type 506 Console Model. Good reception area but reflector necessary because of "ghost" from gasometer. High buildings near here.

No. 10.—Mr. Smith. Type 409 Table Model. Although in normally bad area results good due to high building on which aerial could be erected away from interference.

Such notes are sufficient to call to mind the details of the installations and the map becomes extremely valuable when a prospective customer discusses the type of receiver he wants and asks what the installation charge is likely to be. A glance at the map after getting his address enables an accurate estimate to be given and enables the engineer helping the salesman to take along with him just the equipment required for a home demonstration.

When making tests for compiling such a map and when carrying out demonstrations at prospects' houses a pocket compass is very useful. It enables a note to be made of the apparent direction of the transmitting station at any particular location so that an engineer following on to make a permanent installation knows in what direction to mount a dipole with reflector. The term "apparent direction" is used because merely laying out a line on the map between the transmitter and the receiver will not necessarily give the direction in which best signals are received. There may be large steel structures between the 2 points; or patches of ore-bearing earth that deflect the waves from their normal straight path so that they arrive at the receiving point from quite an unexpected direction and sometimes from 2 directions at once!

Such a state of affairs can occur on the roof of an office building in town surrounded by taller steel structures. Figure 2 illustrates the position. The waves from the transmitter encircle the interfering structure and arrive at the receiving dipole from 2 directions. If they were both exactly in-phase nothing unusual would be noticed but this is seldom the case and one wave is distorted or has a slight lag on the other giving rise to a blurred or double image.

This problem is tackled by using a dipole with reflector in such a way that the reflector "shields" the dipole from one wave enabling the dipole itself to receive the other wave weakly but clearly. An aerial boosting amplifier may be necessary to bring the weak signal up to a strength sufficient to efficiently operate the first stages of the television receiver.

TEST ANTENNA

A type of test aerial very useful for experimenting is one shown at the Radio-lympia Exhibition by a firm specializing in television aerial equipment. It comprised a strong sectional bamboo mast in three 8-foot sections with a bolt and thumb-nut on the top section. On the bolt may be fastened a cross-bar of wood on which can be mounted as desired a single dipole or a dipole with reflector.

The total height of the aerial when extended is about 30 feet yet it is light enough to be held by one man or lashed to any convenient support such as a chimney stack, fence, etc. In use, a dipole is put up first and if signals are not good the reflector

elements are added. The mast can be turned in any direction until the best aerial signal is received or a satisfactory compromise reached between signal and static. If the latter is bad, the aerial may be moved about—still connected to the receiver—until a location is reached that gives minimum pick-up of interference. When these tests have been completed a rough sketch map of the location is drawn and the compass bearing of the dipole and reflector taken and noted on the sketch. The survey is then complete and a permanent installation may be made from the data obtained.

It will be appreciated that 2 people are required for this type of test, one to manipulate the aerial and the other to watch the image on the screen of the receiver and to give instructions to the other engineer. If a table television receiver is available, or can be made up with a rough but sturdy cabinet with handles for easy transportation, a long mains lead will enable the receiver to be operated fairly near to the aerial location so that shouted instructions will suffice. On the other hand, where the distance between receiver and aerial is too great for this method of cooperation other means must be provided and one way that the writer has found satisfactory is to use a cheap 2-way telephone set running from a drycell. The communication lead may be temporarily tied at intervals to the screened aerial cable as both leads follow the same route and will have no electrical effect upon each other.

The engineer managing the aerial can wear headphones so that both his hands are free as he needs to speak back to his colleague only on comparatively rare occasions. For this purpose a hand-mike will suffice and can be strapped to the mast mouth high.

For sales demonstrations at customers' homes in districts which, from information supplied by the map, should be free from serious interference and in a good field strength area, a more simple dipole aerial may be employed. One sold in England comprises a dipole of aluminum in 2 sections each half the length of a normal dipole. These sections screw into sockets on a wooden cross-bar which is used as a winder to accommodate about 100 ft. of screened lead-in cable when not in use.

On the end of one section is a large, insulated hook which allows the whole aerial to be hung from a gutter, coping, tree branch, etc., during the demonstration. This device is one which should certainly find a place in every television service engineer's kit. See Fig. 4.

Another instance of the use of test aerial is shown in Fig. 3 where 2 waves are received at the receiving point. The reflected wave takes a slightly longer path than the direct wave and therefore arrives later at the receiver and the video signal affects the scanning line a little behind the signal caused by the direct wave. The result is a "ghost" or second image on the screen.

The reflected wave is generally much weaker than the direct wave and a directional aerial can be positioned to pick up only the wanted wave. An efficient dipole with reflector is good enough for most jobs although special aerial arrays must be used in bad cases. The portable mast and aerial enables the correct direction of the dipole and reflector to be quickly determined and even if a suspended wire type of directional aerial has to be eventually experimented with, the mast itself, without the dipole and reflector elements, forms a useful support for the high end of the aerial wire during the preliminary investigations.

By the way, 1 or 2 of these lightweight masts are very useful for ordinary radio work where interference problems have to

if it's an



it's your biggest money's worth!

MODEL 446 AC-DC MULTITESTER

25 instruments in one!
Convenient selector switch operation

\$9.95



Net
DC voltmeter 0.5/50/250/500/2500; DC milliammeter 0/1/10/100/1000; DC ammeter 0/10; AC voltmeter 0/10/100/500/1000; 3 range ohmmeter 0/100/100,000/1 Meg.; Meter sensitivity 1 Milliampere or 1000 ohms per volt. 3 inch square D'Arsonval meter accurate within 2%. The equivalent of 25 different complete instruments.

MODEL 309SC TUBE TESTER

Tests all new miniature tubes

Tests all tubes—new miniature, regular receiving, ballast, and tubes with filaments up to full line voltage. Indicates noisy tubes that would otherwise test good. Hot interelement short and leakage test between all individual elements. Spare socket provision for future tubes with new base arrangements. Individual tests of each section of full wave rectifiers, duo diodes and all multi-purpose tubes. High sensitivity neon indication. Accurate calibration. Continuously variable adjustment for all line voltages from 105 to 135 volts by means of a 25 watt power rheostat. Double fused line, celluloid covered tube charts.



\$16.95

RADIO CITY PRODUCTS CO., INC.
88 PARK PLACE • NEW YORK CITY

be tackled. They allow anti-static aerials to be erected and moved about until a zone of minimum or zero static is found in which a permanent aerial installation may be carried out.

SAFETY FIRST

Other kit items not essential but used by many English service engineers are *rubber gloves* and *safety-glass goggles*. It is a matter for argument whether major repairs on a live chassis should be carried out in a customer's home. Many receivers have safety devices which cut off the main supply when the back of the receiver is removed but there isn't a fellow among us who has not at some time or other short-circuited such devices in order to carry out tests and therein lies the danger. Familiarity breeds a tough hide and many of us don't make much fuss of getting a shock

MODEL 432 TROUBLE SHOOTER

Pocket Size Individual Ohm Scale



Here is the lowest priced "legitimate" tester on the market. Multi scale D'Arsonval meter 0.1 mil accurate within 2%. Individual low ohm scale as on expensive instruments. DC volts 0-5/0-50/0-500/0-1000 at 1000 ohm per volt sensitivity. DC milliamperes 0-1/0-10. Ohms 0-500/0-50,000/0-500,000. Self-contained batteries for all ohmmeter ranges.

\$5.95

Net

MODEL 702 SIGNAL GENERATOR



Capable of even finer performance than RCP's famous former signal generator. Has all latest improvements in circuit and mechanical design. Extremely wide all wave coverage continuously variable from 95 Kilocycles to 100 Megacycles. Output modulated at will. 30% modulation at 400 cycles, sine wave from self-contained independent 400 cycle circuit. Attenuation in approximate microvolt calibration by means of five step ladder attenuator. Net

\$22.95

Send for new Catalog 124 describing the complete RCP line of 1940 Dependable Test Equipment. Write today.

RCP Dependable TEST instruments

A NEW BOOK ON AUTO RADIO
See Page 308

Television

ARE YOU prepared to take advantage of the opportunities that the new TELEVISION industry is creating? Train yourself now, while Television is young, for a better job. Write for FREE ILLUSTRATED BOOKLET, "A Tested Plan for a Future in Radio & Television." CAPTOTO, RADIO ENGINEERING INSTITUTE, Dept. RC-11, 3224-16th St., N.W., Washington, D. C.

Attention Dealers

Sell Wright Speakers, Ward Leonard Relays, Resistors, Flechthim Condensers, Supreme Instruments, J. F. D. Ballast and Dial Belt kits, Music Master record players, changers, recorders, Champion Radio Tubes. Pocket trouble light free with first \$5.00 order. ANCHOR RADIO DISTRIBUTING SERVICE, 213 1/2 Dryden Road, Dept. RC, Ithaca, New York



- Big in Value
- Big in Performance
- Sensationally Priced at . . . \$17.85

Here is an AC-DC Volt-Ohm-Milliammeter with all the ranges you want . . . easily readable on the large 7" instrument with extra-long 6" scale . . . in a new up-to-date three-tone case you will be proud to use in your panel, bench or on calls to the home. Check Readrite Big Boy's adaptability for your requirements: DC V. 0-10-50-250-500-1000 at 5000 ohms per volt; AC V. 0-10-50-250-1000 at 1000 ohms per volt; DC Ma., 0-1-10-100; Resistance ranges: 0-1500 ohms shunt type circuit and 0-750,000 ohms; 7.5 and 15 Megohms. Battery furnished for a 0-1500 ohms range. Maroon case with red and silver panel, attached handle . . . Dealer Net Price **\$17.85**

Readrite
RANGER



★ ★ ★
MODEL 510
A Handy Pocket-Size All-Purpose Volt - Ohmmeter . . . Ranges 0-300 DC Volts; 0-10,000 ohms. Complete with Battery Dealer Net Price **\$2.25**

★ ★ ★
MODEL 432-A TUBE TESTER

The Outstanding Tube Tester Value . . . Checks all types including Locals, Single Ends, Bantam Jr., and the new Mid-gets, Gaseous Rectifier, Ballast, High Voltage Series, etc. Filament Voltages from 1.1 to 110 volts. Direct Reading GOOD-BAD Meter Scale. Counter or Portable Leatherette Case with roomy compartment for tools **\$18.85**



Section 1116 College Ave.

READRITE METER WORKS, Bluffton, Ohio

from a few hundred volts but there are much higher voltages in television receivers and a fatality is a distinct possibility if real contact is made with an extra-high-voltage supply. Rubber gloves, therefore, are an insurance and many English firms insist that their engineers wear them when handling live chassis.

With regard to the safety-glass goggles, these, of course, are supposed to be worn by anyone handling a cathode-ray television tube in case it "implodes". Whether or not they are worn depends mostly on the individual or the firm for which he works while in the latter case this again may depend upon the insurance company which will have to pay any compensation in the case of accident. Personally, I have not met a case of personal injury caused by a tube going off on its own although I have been mightily thrilled when I saw a colleague let one slip from his hands on to the floor. We huddled up and waited for it but the tube didn't break!

AERIAL AMPLIFIERS

Under certain conditions the signal passed by the down lead to the television receiver may be too weak to give good results but a "Booster" Amplifier will generally correct this state of affairs and allow satisfactory reception under what were almost impossible conditions.

Bad conditions may be due to: (1) low signal strength area; (2) use of a very long lead between aerial and receiver; (3) weak residual signal after combating local static; (4) comprehensive line network in sales demonstration room with many points for connection to various models; etc.

In England, service engineers had 2 types of amplifiers in their stock to deal with these situations. One comprised a 2-stage flat-frequency-response amplifier of some 30 db. gain housed in a metal case with its own power supply. Being thus independent of the receiver it could be located at the aerial end of the down lead cable in a loft or other convenient situation whence it could be fitted and forgotten.

The second type of amplifier consisted of a single valve in a small metal case only an inch or two larger than the valve all round with the necessary resistances and condensers to make up a single-stage amplifier of about 15 db. gain. The unit was fitted with lugs so that it could be screwed to the inside of the receiver cabinet and leads were provided so that electrical connection could be made to the receiver chassis which provided the necessary L.T. and H.T. supplies.

This cheap and compact little unit was very effective in dealing with less severe cases of the troubles mentioned above. Apart from these there were also large amplifiers for feeding blocks of flats, tenements, etc., but this type does not concern us here.

"BLACK SPOTTERS"

Another useful little gadget similar in physical appearance to the single-stage aerial amplifier was the "Black Spotter" or interference limiter. It was used in cases where complete static suppression could not be achieved and was the means of satisfying many an unhappy customer living in an area of chronic interference which the most elaborate aerial systems failed to clear.

The unit derives its power from the receiver chassis and it employs a single valve for phase reversal of the interfering signal voltages. Thus the vivid white flashes on the screen due to interference are made dark and are much less conspicuous and irritating to the eye.

In a way, it is similar to the method of dealing with uncontrollable interference on

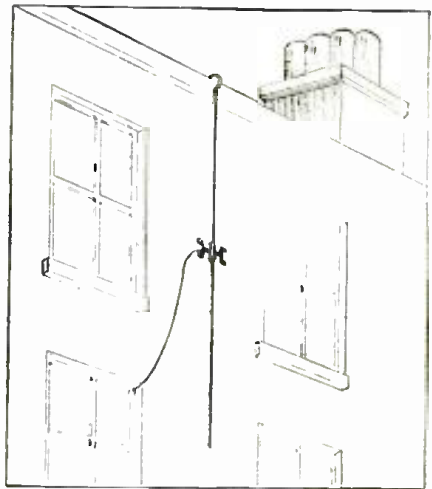

Fig. 4. A portable television antenna solves problems for Servicemen and Servicemen-dealers.

ordinary broadcast wavebands where it is often found that using the tone control to cut the higher frequencies makes the programme tolerable. The high-note interference is more penetrating to the ear and its suppression, although admittedly destroying the fidelity of the reproduction, makes far more pleasant listening.

In television reception, the views on the screen comprise a high percentage of dark or medium tones and a low percentage of really high lights so that white flashes show up over a large area of the screen. Reversing these to black spots or streaks causes them to be practically invisible in the large areas of dark or grey tones comprising the image and the eye is not troubled by them although from the high-fidelity point of view the image on the screen is not perfect.

The effect of reversing white flashes to dark streaks has given to the unit its slang name of "Black Spotter." A potentiometer control on the device enables just the right amount of phase reversal to be achieved otherwise the effect may be overdone and the whole image turned into an appearance of a photographic negative.

LEAD-IN CABLES

Most engineers and dealers carried in their stock 3 or 4 different grades of aerial lead-in cable for the following reasons.

In areas of very good signal strength or where only a short length of cable is required between the aerial and receiver a cheap lead-covered cable is all that is needed. A type of shielded bell wire is quite suitable. It is not necessary to employ expensive low-loss cable where no appreciable benefit is gained by its use; and installation costs can be kept low by using cable suitable for its job but no better.

The other 3 grades of cables were improvements on this economical type. (1) First was a braided screen coaxial cable with a stranded conductor and solid low-loss dielectric. (2) Then a thicker cable with an air dielectric maintained by a spiral thread wound round a crinkled solid conductor could be used for longish runs of cable or in areas of poor signal strength. (3) The final grade of cable was for very long runs, large networks for flats or demonstration rooms, and for use as an aerial cable in areas of weak field strength where the signals from the aerial must be conserved to the utmost. This cable was very expensive and comprised a crinkled solid conductor within an air dielectric and an insulating layer of special paper. A solid lead screen with a waxed paper and a weatherproof outer braiding made up a cable of very low losses and wide frequency

characteristics—essential features for high-quality reproduction.

Television installation and service problems are not so very difficult to solve. It is only their novelty which cloaks them in mystery but if a calm analysis of the symptoms is made the cause is soon apparent and the cure applied. Even if a cut-and-dried cure is not known the line of investigation is generally sufficiently obvious to point the way to the type of experiment most likely to succeed in eliminating the trouble.

CALCULATING IMPEDANCE AT A GIVEN FREQUENCY

DURING the construction of the rather complicated Public Address System at Frank Wiggins Trade School in Los Angeles, we found it vitally necessary to check the impedance of a number of lines, transformers, and coupling devices. For this particular work we had a standard bridge of a well-known, expensive make; however, one impedance that was checked was found to be so glaringly impossible that we were led to mistrust the readings determined by the bridge.

The men in charge of construction were immediately faced with the problem of re-checking these impedances by some other means; and since the work was done when most other places which had a bridge of this type available were closed, we were confronted with the need of some accurate measuring device of this type. This was finally accomplished according to the following diagram.

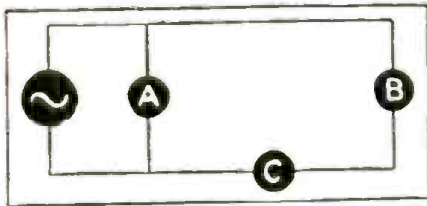

The oscillator was a standard audio frequency oscillator of a common and inexpensive make with an output of about 3 watts. The milliammeter, indicated at C, had a 5-ma. movement which we found in most cases to be ample. Two types of voltmeters were used, first a vacuum-tube voltmeter and later a 0-15 V. voltmeter of 20,000 ohms/volt resistance was used, and in each case the results were so similar as to be immaterial which was used. If a resistance-type voltmeter is used in Position B, it is necessary to find the current drawn by the meter and subtract from the total reading. If the meter is used in Position A, the resistance of the milliammeter (C) must be known in order to be included in your calculations.

This method works with almost any type of oscillator or meters if reasonable care and good judgment are used. We have also found that this method can be used with about the same accuracy as most people can use the more expensive and more complicated bridge. Since most service shops must have these instruments and the few times a measurement of this kind is taken would hardly warrant the expense of a bridge, this method will no doubt be welcome to those needing this type of a measuring device.

J. D. WEISS,
Frank Wiggins Trade School,
Los Angeles, Calif.

FREE
212 PAGES
100% RADIO

RADIO'S GREATEST CATALOG FOR SERVICEMEN—DEALERS—SOUNDMEN—AMATEURS!

If you're in Radio, you can't afford to be without the new 1941 ALLIED Radio Catalog! It's the biggest ever—212 value-packed pages—and the best ever. Shows everything in Radio. Send for your copy now. You'll see why it's universally known as the one reliable Radio Guide—the most complete index to Everything in Radio you'll find anywhere. A copy is yours, FREE for the asking!

1941 Radio Hits!
New style plastic and wood table models; world-wide sets; "Camera" and 3-way Portables; Phono-Radio-Recorders, Combinations, Auto Sets, etc.—all at amazingly low prices—in a big special 40-page section!

83 NEW MODELS

1941 P.A. design—for every Sound application. 24 new Systems—7 to 75 watts—new features throughout! Lowest prices! Attractive Time Payment Plan and 15 Day Trial Offer. Complete P.A. accessory line—big 38-page section!

NEW P.A. SYSTEMS

More than 120 pages, all value-packed—devoted to new Test Equipment, tools, Service books, etc. More than 15,000 quality parts for every radio purpose—all at prices that save you money!

BIG SERVICE SECTION

15,000 PARTS
Radio's most complete Catalog—with everything for everyone in Radio. Don't miss the special Builders' and Experimenters' section and the complete Amateur selection of communications sets, etc.

FREE SEND COUPON

Depend on ALLIED—the World's Largest Exclusive Radio House!

ALLIED RADIO CHICAGO, ILLINOIS

ALLIED RADIO CORP.
833 W. Jackson Blvd. Dept. 2-L-1
Chicago, Illinois

Send me your FREE 1941 Fall Radio Catalog showing Everything in Radio.

Name

Address

City State

NEWS SHORTS . . .

. . . Orrin E. Dunlap, formerly Radio Editor of the *New York Times*, is now Manager, Information Dept., RCA Mfg. Co. Here's congrats to one of radio's old-timers who has earned whatever bounty radio has to offer. . . Dr. Paul Nipkow, inventor of the television pinhole scanning-disc which bears his name, last month died in a Berlin hospital, the *New York Times* reported last month. He was 80 years of age 2 days previously. . . The New York Y.M.C.A. schools are planning a new 6- to 8-week radio course designed to equip radio amateurs to pass Federal examinations for radio operators who wish to step into the communications field as it is now being shaped to suit America's National Defense Program.

TURNER Microphones

Write for free new literature to The TURNER CO. Cedar Rapids, Iowa

Crystals licensed under patents Bush Development Co.

1940 RADIO DIAGRAMS

New manual of most popular latest radio circuits. This single volume will give you (1) over 80% of all 1940 circuits ever needed, (2) acquaint you with recent radio developments, and (3) teach you how to service quickly and efficiently millions of sets sold last year. Includes service hints, alignments and parts lists. Sets of 33 manufacturers. 212 large pages. 8 1/2 x 11 in. Postpaid, only **\$1.50**

SUPREME PUBLICATIONS 3727 W. 13th St. Chicago, Illinois



The following article describes the new and remarkably ingenious Solovox, invented by Laurens Hammond who created the Hammond Organ and the Novachord, and tells how this 14-tube device may be used as an electronic musical supplement to any piano.

← The photos at left illustrate various elements of the Solovox. At A, the attachment in use on a grand piano, a set of 12 control tablets giving any piano an indefinite variety of tone colors that simulate the organ (Note individual volume control.); B, close-up of upper portion of the Solovox showing how the control tablet add-on device is fitted to produce a desired effect; C, the Solovox keyboard being attached to the piano keyboard by thumbscrews.

THE ELECTRONIC "SOLOVOX"

Latest Radio-Musical Adjunct to the Piano

THE Solovox is a new 14-tube instrument—invented by Laurens Hammond, creator of the Hammond Organ and the *Novachord, and expressly designed as a musical supplement to the piano—that even a child can play perfectly. Operated entirely by electricity, the Solovox is a 3-octave keyboard which is attached to the piano so that the fingers of one hand can easily span the 2 keyboards. A total of 12 control tablets give the Solovox a 6-octave range as well as an indefinite variety of tone colors, and being smooth, sustained and capable of "swell," its tone colors make an effective contrast to the percussive brilliance of the piano. A knee lever controls the volume. A slim tone cabinet containing the electrical equipment, including the loud-speaker, is set alongside a vertical piano or underneath a grand piano.

This instrument represents a new source of income for Servicemen and Servicemen-dealers.

MODUS OPERANDI

All the notes of the Solovox are controlled by a single radio vacuum tube *master oscillator* (see diagram) operating at one of the 12 audio frequencies in the highest octave of the instrument (2,093 to 3,951 cycles). Each time a key is depressed, a switch under it tunes this oscillator to the pitch associated with the key in this highest-octave range. This occurs regardless of whereabouts on the keyboard the playing key is depressed. Thus, whenever any one of the "C" keys is depressed, this oscillator is tuned to 2,093 cycles, which is its lowest frequency. If any "B" key is depressed, its frequency will be 3,951 cycles, which is its highest frequency.

The output of this master oscillator controls the frequency of another oscillator called the *buffer oscillator* which operates at the same frequency as the master oscillator. The output of this first controlled (buffer) oscillator in turn controls the frequency of a second controlled oscillator, so interconnected with the first as to oscillate at one-half the frequency of the first oscil-

lator. This new frequency corresponds to a note of pitch one octave lower than the first controlled oscillator.

Similar cascaded oscillators provide pitches of 2, 3, 4 and 5 octaves below that of the master oscillator. In this way, each time the master oscillator is tuned to some one of its 12 possible frequencies (one for each note of the scale), each of these 6 controlled oscillators immediately follows it to produce outputs which are the lower octaves of this pitch, to form a series of 6 frequencies in exact octave relationships. Now the particular oscillator outputs desired for passing through the amplifier and speaker, depend upon the particular playing key depressed (for instance on which one of the 3 "C" keys) and also, upon which of the "BASS-TENOR-CONTRALTO-SOPRANO" controls are employed.

The selection of the desired oscillator occurs when a second contact under each key closes. This second contact operates an electrical relay having contacts to make the desired oscillator selection. It is to be noted that there are 3 relays, one of which is common to each of the 3 octave groups of keys. Thus, we see that a playing key functions in 2 ways—first, it tunes all of the oscillators to the pitch of the key being depressed, and then selects the output of the particular sub-octave frequency controlled oscillator desired.

A further function of the second key contact is to transmit the signal to the speakers with a controlled rate of attack, so as not to be musically abrupt. Tuned electrical circuits and tone controls follow, which control the quality of tone over a very wide range.

The effect of the "MUTE" is produced by passing the signal through a vacuum tube operated non-linearly so as to suppress the sharp curvature of its input wave, and thus render the tone more mellow.

PERMEABILITY TUNED

The "VIBRATO" effect is produced by a vibrating reed (which is put into motion when the volume control lever is brought forward in starting the instrument) which intermittently changes the pitch of the

master-oscillator by varying the inductance of a small coil (L1 in diagram) connected across it.

The volume of sound from the speaker is controlled by a knee-operated rheostat which acts to control the amount of amplification.

The Solovox will remain in tune indefinitely. However, as the pitch of the piano with which it is to be played will vary considerably, a tuning adjustment knob at the top of the tone cabinet has been provided with which the instrument may be easily tuned by the pianist in 10 seconds' time, to the piano. It is not necessary to tune each note—the single tuning knob provided simultaneously tunes them all by varying the inductance (L2 in diagram) that resonates the master-oscillator circuit.

USES

The Solovox, which can be played by even the self-made pianist without any special instruction, adds singing voices like orchestral instruments to the tones of the piano. The player carries the melody on the Solovox with the right hand and the left hand accompanies on the piano. The right hand can easily encompass notes on the Solovox and piano keyboards simultaneously, considerably enlarging the pianist's scope.

On the front of the Solovox are the previously-mentioned, tablet-shaped tone selectors and all that the player must do is to push them in various combinations to extend the range of the instrument to 6 octaves and create hundreds of exciting new tone-colors. Some of these tones resemble flutes, strings, brasses or woodwinds, while others have never been heard before!

The exceptional versatility of the Solovox makes it a flexible addition to the studio equipment of any radio station. With the Solovox attached to the piano, ensembles are heightened and dramatized by its smooth attack. The rich variety of its tones ranging from a brilliant, string-like effect to a deep and penetratingly organ-like quality make it a new and different instrument for music lovers to hear and enjoy.

For a vocalist, the Solovox provides a

*See "Announcing the 'Novachord'—Electronic Music's New 163-Tube 'Baby'". *Radio-Craft*, April 1939.

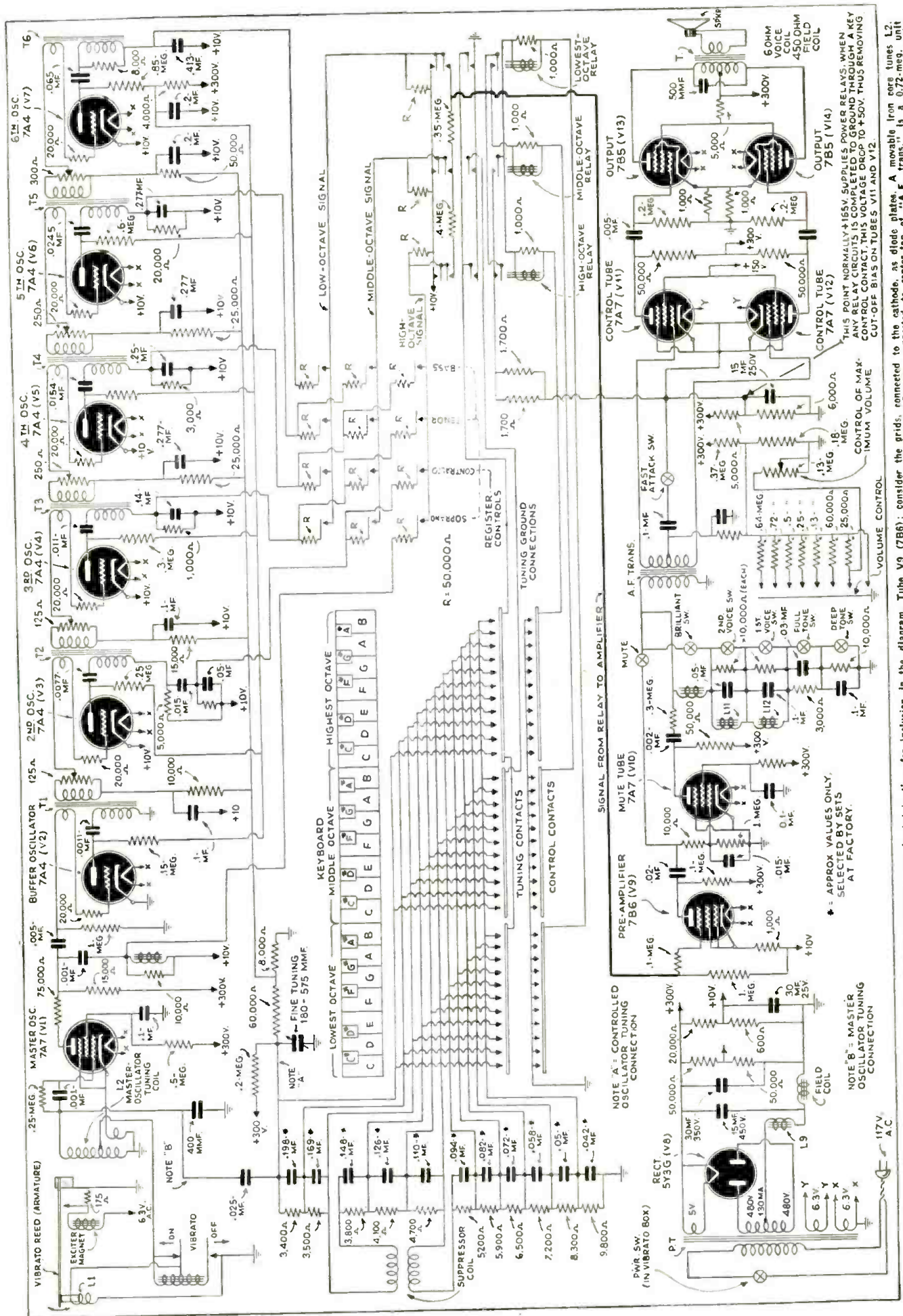

Diagram model J Solovox. Following are circuit notations, including omissions, not located in time for inclusion in the diagram. Tube V9 (7B6): consider the grids, connected to the cathode, as diode plates. A movable iron core tunes L2. Missing component values: V3 plate R.F. load resistor, shunted by 0.05-mf. condenser, 4,000 ohms; V5, plate D.C. load resistor, 0.4-meg.; V10 6-G. after resistor, 0.5-meg.; connected to center tap of 500 MF transformer. F trans is a 0.72-meg. unit shunted by 6.15-mf.; V12-V14 coupling unit, 0.005-mf. Note that contacts shown normally open, nearest to Highest, Middle, and Lowest-Octave relay magnets, should be shown closed; if the 3 pairs of contacts at top, contacting the

RADIO'S FINEST Electronic VOLT METER



\$39.95

Dealer Net Cash Price
S.I.C. Time Payment Plan
\$5.00 cash and 10 monthly
payments of \$3.90.

In Metal Case

MODEL 549
ELECTRONIC VOLT METER

Model 549 is the result of a long period of research in designing a multimeter which will fulfill the serviceman's needs of today and tomorrow at a price he can afford to pay. The instrument will take care of all the serviceman's multimeter requirements since it has standard provisions for A.C. and output volts, direct current measurements, etc., in addition to the electronic circuit for D.C. voltage and resistance measurements.

0.1 TO 6000 D.C. VOLTS—covered by six overlapping ranges of 0.2/0.20/200/2000/20000 volts. These ranges may be extended to 6000 volts, at small extra cost, by use of a SUPREME Type 4875 Probe. The input impedance of all ranges up to and including the 600 volt range is 15,000,000 ohms. The input impedance of the 6000 volt range is 150,000,000 ohms. Both probes for measuring D.C. volts have a built-in resistance so that the D.C. volts developed across oscillator grid leak can be measured without materially affecting the oscillator. Also all plate, screen bias, A.V.C., and A.F.C. voltages can be measured without upsetting the operation of the receiver. Voltages of either negative or positive polarity with respect to chassis or ground may be measured by setting the circuit selector switch to “-” volts or “+” volts. The low range of 2 volt full scale gives a sensitive meter necessary in measuring small control voltages.

0.5 OHMS TO 1000 MEGOHMS—covered by 5 overlapping ranges of 0/1000/100,000/1 megohm/10 megohms/1000 megohms. This electronic circuit permits all resistance ranges, including the 1000 megohm range, to be operated by the self-contained 3 volt bat-

tery. Features incorporated are the extreme accuracy acquired by adjusting the ohmmeter at “zero” position and “full scale” position. After this is once set there are no adjustments to be made between ranges. The low range has a center scale resistance of fifteen (15) ohms which gives a good deflection in checking resistances of radio frequency coils. You will like this type of ohmmeter for its speed and accuracy. Being of an electronic type the meter is fully protected and accidental application of the voltage to the ohmmeter will not injure the instrument.

0.1 VOLT TO 500 A.C. VOLTS—covered by 5 overlapping ranges of 0.5/1.5/50/150/500 volts in a circuit whose calibration is guaranteed to $\pm 3\%$. Copper oxide rectifier is fully protected and carries the same guarantee as all other parts in the instrument. Temperature error of rectifier is corrected over a working range of 40° F to 100° F.

10 MICROAMPERES TO 15 AMPERES D.C. CURRENT—covered by 7 direct ranges of 0.500 microamperes; 0.5/1.5/50/150/500 M.A.; and 0.15 amperes. Such a wide selection of ranges was incorporated to meet all current measurements necessary—from the few microamperes found in control circuits to the ampere drain of automobile receivers.

0.1 TO 500 OUTPUT VOLTS—can be used with any good signal generator (SUPREME Model 571 or 561) for receiver alignment. Covered by five ranges of 0.5/1.5/50/150/500 Volts.

The Model 549 is also available in beautiful oak case as illustrated for \$42.50 cash or \$5.00 cash and 10 monthly payments of \$4.18.

ELECTRONIC SOLOVOX

(Continued from page 290)

full, well-rounded background. The fact that all the technical difficulties, such as perfect pitch intonation, smooth vibrato, smooth tonal attack, and quality control are all taken care of in the design of the instrument makes the Solovox the easiest of all orchestral instruments to play. No special training is necessary, for anyone who can pick out a tune by ear on the piano can play it effectively.

In the studio where space is precious, the Solovox is especially adaptable, for it takes up no extra room. It is entirely electrical in operation and by means of 1 tuning knob can be tuned to the piano with which it has been assembled. The 14 standard, inexpensive radio tubes—the heart of the instrument—may need replacement only in the course of several years' playing time. Radio men will note that the comparatively low cost of the Solovox (under \$200) places it within the range of small as well as large radio stations. (Dealers give to purchasers, without charge, what little instruction may be necessary.)



Laurent Hammond at work on his newest invention, the 14-tube Solovox, which was recently introduced simultaneously in Chicago to the National Music Merchants Association convention and in New York to music notables and to members of the press.

wise to do the work in the customer's home.

95% Are Simple Cases—As you will discover when you become acquainted with television receivers, they are quite different, electrically and mechanically, from broadcast sets. Since the slightest deviation from extremely high standards of precision design shows up in the “picture” tube, such compromises in specifications and tolerances as have been adopted widely in sound receivers cannot be made in television circuits.

The use of high voltage exerts an important influence in television set design. If parts break down in sound equipment, it is easy to replace whatever has gone wrong, but when several thousand volts get loose, expensive damage may result. Finally, cheap materials and inferior designs are not suitable for ultra-frequency circuits.

Thus, the superior materials and construction necessary for television equipment eliminate the source of many failures common to the average sound receiver. There is a sufficient background of experience already to indicate that service work on an average good television receiver is almost entirely a matter of tube failures.

From the foregoing, you can see that there is no high-voltage hazard involved in 95% of the television service work. The 5% to be done by the jobber's service department may require special tests to be made with the current on, but the Serviceman who makes the conventional tests for which he is equipped does not need to take any risk whatever. He can do his work with the power switched off.

SUPREME

SUPREME INSTRUMENTS CORP.
GREENWOOD, MISSISSIPPI, U. S. A.

SEND FOR NEW CATALOG

—Just off the press. Large, two color illustrations, complete descriptions of 22 new 1941 model SUPREME quality testing instruments. Write today!

PATENTS—TRADE MARKS

Booklet concerning Inventions & Patents
Form “Evidence of Conception” with
instructions for use and “Schedule of
Government and Attorneys Fees”—Free

LANCASTER, ALLWINE & ROMMEL

Registered Patent Attorneys

436 Bowen Bldg. Washington, D. C.

SERVICING TELECEIVERS

SERVICE work on television receivers can be divided into 2 parts: 95% can be done with the conventional instruments which every Serviceman has already, plus an ultra-frequency oscillator; 5% requires instruments that individual Servicemen and most dealers would not be justified in buying. Andrea Radio Corp. has found.

It appears, therefore, that the jobbers will have to take upon themselves the investment in instruments required for the 5% part of service problems. Dealers and Servicemen will handle all this very small part of the work, and when a condition arises which they cannot meet, they will have to deliver the set to the jobber's service shop, since the equipment needed in such cases is hardly portable, nor would it be

SCOTT CUSTOM BUILT RADIOS

WHAT IS THE F.C.C.?

The following items are abstracts from, and constitute the major portion of, the recent release of the Federal Communications Commission entitled "ABC of the FCC."



F.C.C. CONFERENCE

One of many conferences, held before a license is granted to a new radio station, is staged here by the FCC Rules Committee; at head of table, General Counsel Telford Taylor. Others are: Wm. J. Norfleet, E. K. Jett, T. J. Slowie, A. D. Ring, A. W. Cruse, Edward L. White, Wm. P. Massing, Joseph Rauh, James A. Kennedy, Theodore Bartlett, Florence Stretch, and Gerald C. Gross. The F.C.C. considered 7,500 applications last year.

Photo—Courtesy Washington (1) Post.

THE following items are presented here in order to clarify many misunderstandings of radio men concerning the functions and limitations of the Federal Communications Commission. This body has been authorized by Congress to license and regulate all communication — principally Radio — in the United States of America and its possessions, except the Philippines and the Canal Zone. To date this control extends over approx. 65,000 radio transmitters (our 45,000,000 receivers do not come within the province of the F.C.C.). A staff of 600 persons is required for proper functioning of the Commission.

What is the Federal Communications Commission? It is the Federal agency charged with licensing and regulating interstate and foreign communication by means of electric energy, principally radio (including broadcast and other radio services), telephone, telegraph, and cable.

Is the FCC under any Government department? No; it is an independent Federal establishment created by Congress, and, as such, reports directly to Congress.

When did the FCC start functioning? July 11, 1934, when the Commissioners took their oaths of office, at which time the Federal Radio Commission was abolished.

Under what authority does the FCC operate? The Communications Act, signed by President Franklin D. Roosevelt on June 19, 1934, as amended.

How were communication matters administered before the FCC was created? Jurisdiction was shared by the Post Office Department, the Interstate Commerce Commission, the Federal Radio Commission, and other agencies. The Communications Act of 1934 not only coordinated supervision under a single agency, the FCC, but established the basis for a national communications policy.

What is the basic purpose of the FCC? This is best explained by section 1 of the Communications Act of 1934, as amended, which reads: "For the purpose of regulating interstate and foreign commerce in communication by wire and radio so as to make available, so far as possible, to all

the people of the United States a rapid, efficient, nation-wide, and world-wide wire and radio-communication service with adequate facilities at reasonable charges, for the purpose of the national defense, for the purpose of promoting safety of life and property through the use of wire and radio communication, and for the purpose of securing a more effective execution of this policy by centralizing authority heretofore granted by law to several agencies and by granting additional authority with respect to interstate and foreign commerce in wire and radio communication, there is hereby created a Commission to be known as the 'Federal Communications Commission,' which shall be constituted as hereinafter provided and which shall execute and enforce the provisions of this act."

To whom does the Communications Act apply? Section 2 (a) of the act says: "The provisions of this act shall apply to all interstate and foreign communication by wire or radio and all interstate and foreign transmission of energy by radio, which originates and/or is received within the United States, and to all persons engaged within the United States in such communication or such transmission of energy

by radio, and to the licensing and regulating of all radio stations as hereinafter provided. . . ." Communication which is wholly intrastate is not included.

Is the Communications Act limited to the continental United States? No, it applies also to Alaska, Hawaii, Puerto Rico, and other possessions, but not to the Philippine Islands or to the Canal Zone.

What are the major activities of the FCC? Allocation of frequencies for all classes of radio stations, except Government; licensing and regulation of radio broadcast stations and all other radio services, including the common carrier services, international, television, facsimile, educational broadcasting, experimental and developmental; licensing of radio operators; promotion of safety of life and property through the use of wire and radio communication by requiring compulsory use of radio, and licensing and regulation of ship and shore, aviation, police and forestry radio services; investigation of complaints as to matters coming under the provisions of the Communications Act; encouraging the larger and more effective use of radio, including the conduct of special studies and engineering research; and regulation of telephone and telegraph companies engaged as common carriers in interstate or foreign communication by wire or radio.

What is a "common carrier"? The Communications Act defines this term to mean "any person engaged as a common carrier for hire, in interstate or foreign communication by wire or radio or in interstate or foreign radio transmission of energy." A person engaged in radio broadcasting is not deemed a common carrier under this act. Broadly speaking, a common carrier for hire must render a public service without discrimination to all who may apply.

What does "wire communication" mean? The transmission of writing, signs, signals, pictures, and sounds of all kinds by means of wire, cable, or other like connections.

What does "radio communication" mean? Transmission by radio of writing, signs, signals, pictures, and sounds of all kinds.

What does "broadcasting" mean? Dissemination of radio communications intended to be received by the public.

How is the FCC administered? By 7 Commissioners appointed by the President, sub-

RADIO DETECTIVE CAR
Specially-equipped auto used in F.C.C. field service for tracing unlicensed stations and otherwise hunting unlawful transmissions. The car is equipped with a direction-finding loop antenna.

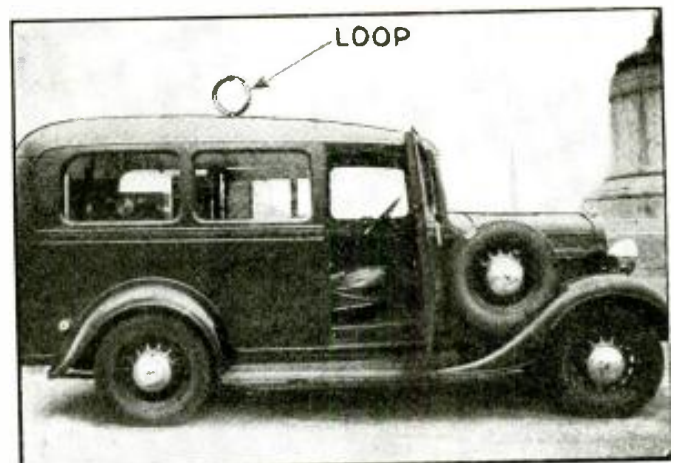

ject to confirmation by the Senate. The President also designates the chairman.

What is the term of an FCC Commissioner? Appointment is for 7 years except in filling out an unexpired term.

How does the FCC function? From 1934 to 1937 the Commission functioned with three divisions—Broadcast, Telephone, and Telegraph—but today it operates as a unit with direct supervision of all activities. Besides sitting at hearings, and at formal and informal meetings, it assigns various commissioners to make special studies, and carry out particular functions. Though routine work is delegated to qualified officials, policy making is retained for the Commission as a whole.

How is the FCC's normal administrative work handled? By 4 departments: *Accounting, Statistical, and Tariff Department*, which handles matters of accounting regulations, compilation and analysis of statistics, and tariff analysis and regulation; *Engineering Department*, which attends to the engineering phases of broadcast, common carrier, and private and ship service regulations and enforcement, international and interdepartmental matters, supervision of the field staff, and technical engineering research; *Law Department*, whose work includes the legal phases of broadcast licensing and regulation and of common carrier licensing and regulation; administration (including legislation, rule making, and international matters), and litigation before the courts; and the *Secretary's Office*, which has charge of internal administration, certain routine licensing, and promulgation of formal orders and decisions.

All the Commission's rules and amendments thereto are published in the Federal Register. Also, copies of the various parts, in convenient pamphlet form, can be obtained from the Superintendent of Documents, Washington, D. C., at nominal cost.

To what extent does the FCC cooperate with other public bodies? In international matters it collaborates with the State Department; in national matters with the various Government departments and agencies concerned, usually through the Interdepartment Radio Advisory Committee, and in State matters with the State regulatory bodies, largely through the medium of the National Association of Railroad and Utilities Commissioners.

Does the FCC assign channels to Government radio stations? It has active participation on the Interdepartment Radio Advisory Committee which advises the President in making such allocations. Of the present 9,500 such assignments to Federal stations, 5,500 were made last year.

Were FCC radio rules and regulations changed last year? FCC rules and regulations governing all forms of radio service were completely revised. More than 2,500 pages of testimony and 200 exhibits were considered as a result of hearings on the subject of the standard broadcast rules and standards of good engineering practice governing standard broadcast stations.

How is the FCC concerned with safety of life and property? A 1937 amendment to the act stipulates: "For the purpose of obtaining maximum effectiveness from the use of radio and wire communications in connection with safety of life and property, the Commission shall investigate and study all phases of the problem and the best methods of obtaining the cooperation and coordination of these systems." Ship radio installations and operations, shipboard auto alarms, and police and forestry protection systems are in this category. Last year the Commission made 15,500 ship inspections, and authorized 550 new police radio systems, and 250 forestry systems.

MONITOR STATION

Typical Monitoring Station similar to 6 others, strategically located throughout the U. S., operated by the F.C.C. Includes a Standard of Frequency, Interpolation Equipment, Receivers, Recorders and Oscillographs. Permits measurements of frequency from 100 kilocycles to 100 megacycles with a high degree of accuracy.

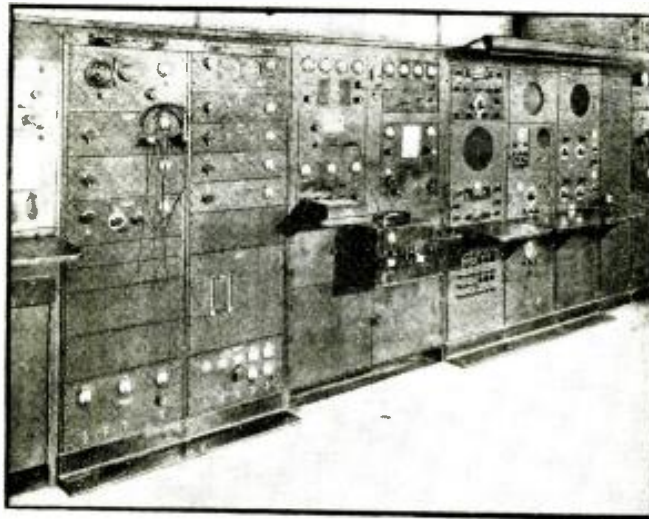

What is the FCC doing in the field of engineering? It is investigating many techniques and refinements in all branches of communication. It has held public hearings on the new FM (frequency modulation) system of broadcast, and on television development. It is working out engineering measures to carry out provisions of the North American Regional Broadcasting Agreement. It has launched the most significant study of sunspot effect on communication yet undertaken. It is working to reduce interference to radio from electromedical and like apparatus, and has contributed to effective use of directional antenna. Facsimile transmission, and new type carrier telephone systems are also receiving the close attention of Commission engineers. The act requires the Commission to "study new uses for radio, provide for experimental use of frequencies, and generally encourage the larger and more effective use of radio in the public interest."

Does the FCC charge for licensing? The Government exacts no fee or charge of any kind in connection with FCC licensing and regulation.

How many radio stations are there in this country? About 65,000 radio stations of all types are licensed by the FCC. This includes 826 standard broadcast stations, 600 broadcast stations other than standard, 332 experimental stations, 3,900 ship radio stations, 1,894 aviation radio stations, 1,100

police radio stations, 526 forestry radio stations, 55,000 amateur radio stations, 263 coastal radio stations, 364 fixed radio stations, and the rest miscellaneous. Last fiscal year 7,500 applications for various classes of broadcast stations were received by the Commission. Of this number 1,650 were for increased facilities, and 2,300 were renewals. A total of 29 new standard broadcast stations were licensed, 76 applications were denied, and 8 licenses were voided.

How many commercial radio stations are there in this country? About 5,000. More than 15,000 commercial operators were licensed last fiscal year. There are approximately 50,000 commercial operators of all classes.

How many radio amateurs are there in this country? Nearly 55,000 amateur operators have been licensed by the FCC.

How many radio receiving sets are there in this country? More than 45,000,000. These are not licensed by the FCC.

How many persons are employed by the FCC? Slightly more than 600, about 200 being in the field service, all under Civil Service.

How many field offices has the FCC? At present, 27, located throughout the United States and its possessions, augmented by seven monitoring stations. In the field some 115 inspectors regularly inspect and investigate all classes of radio stations, examine radio operators for various classes of licenses, look for unlicensed operation, and inquire into complaints of interference to radio reception, etc.

Has the FCC anything to do with national defense? Besides performing important functions in connection with preservation of neutrality, the Commission is expressly charged, by its creative act, with carrying out "the purpose of the national defense." The act gives the President special powers in respect to communications in the event of war or national emergency.

What does FCC regulation of radio embrace? Granting or denial of applications for construction permits or licenses to use radio frequencies, classifications of stations, allocation of frequencies and assignment of call letters, licensing of radio operators, inspection of equipment and regulation of its use, prescribing the nature of the service to be rendered by radio stations, making regulations to prevent interference, and otherwise carrying out provisions of the Communications Act.

What does FCC regulation of common carriers embrace? In addition to licensing functions, its regulation includes supervision of all charges, practices, and classifications; prescription of "just and reason-



MARINE SAFETY WATCH
Section of F.C.C. Marine Safety Watch where observers listen-in 24 hours of the day for distress calls and other radio signals.

able charges"; prevention of discrimination; authorization of new construction, extensions and improvements, and changes in ownership; passing on applications for interlocking directorates; and the formulation and prescription of rules and regulations pertaining to the form and manner of keeping accounts, and pertaining to the preparation and filing of annual and other reports. The rates and regulations of telephone and telegraph companies covering interstate and foreign communication service are on file with the Commission and are open to the public. The carriers are required by law to observe these rates and regulations. Last year about 17,000 new tariff schedules were filed with the Commission.

How are FCC orders enforceable? The orders of the Commission may be enforced through the United States District Courts.

What is an FCC monitoring station? This is a station equipped to listen in, observe, and measure the operating frequencies of all classes of radio stations, to determine that stations are operating on assigned channels, and that the character of service is in accordance with treaties, laws, and regulations. The FCC has 7 such stations. They are located at Atlanta; Baltimore; Boston; Grand Island, Nebr.; Great Lakes, Ill.; Portland, Ore.; and San Pedro, Calif.

Are foreigners licensed to own or operate radio stations in this country? No; this privilege is extended to citizens only. Station licenses are denied corporations "of which any officer or director is an alien or of which more than 1/5 of the capital stock is owned of record or voted by aliens or their representatives."

Can amateurs use secret radiotelegraph code in international communication? The only code permitted amateurs is the International Morse Code. The majority of licensed amateur stations use radiotelegraphy exclusively.

How does the FCC figure in international matters? The Commission is charged with administering communication provisions of certain treaties and international agreements to which the United States is a party. It participates in many international conferences involving mutual radio, telegraph, and cable problems. In 1939 the Commission established fundamental rules governing international broadcast service and, for the first time, opened these channels to commercial programs. Domestic pick-up and rebroadcast of noncommercial international programs on a nonprofit basis was authorized by the Commission in 1940. The Commission also licenses radio equipment on planes and ships departing from this country.

Can the FCC censor radio programs? No; the Communications Act states: "Nothing in this act shall be understood or construed to give the Commission the power of censorship over the radio communications or signals transmitted by any radio station, and no regulation or condition shall be promulgated or fixed by the Commission which shall interfere with the right of free speech by means of radio communication."

On what basis are broadcast stations licensed by the FCC? To serve the "public interest, convenience, and necessity," according to the act. Because the broadcast channels are limited, it is important that they be entrusted to stations which have a high sense of public responsibility.

What matter is definitely barred from the air by the Communications Act? Lotteries and kindred enterprises, and obscene, indecent, or profane language.

Will the FCC consider complaint about a particular radio program? Yes; if the complaint deals with any matter within the

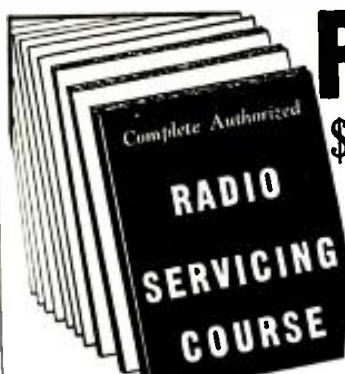

RADIO TRAINING

AMAZING REDUCED PRICE

\$1.95
POSTPAID

This is your chance to get exact reprint of regular \$39.00 Radio Technical Institute course for only \$1.95, the full price. This is the latest Radio and Television Course, complete in every way, and exactly the same as the much higher priced original lessons.

EVERYTHING ABOUT RADIO

The training is remarkably complete. You quickly learn radio servicing from simple circuits to signal tracing. From the very start you are introduced to real radio methods and equipment. After finishing this course you will be able to expertly service every radio set. Take advantage of this unusual bargain in radio education.



M. N. Seitman, radio engineer, author, instructor in Chicago schools, says: "Let Radio Tech. Institute course help you get ahead in Radio. I believe this is the biggest bargain in radio training."

TELLS HOW TO USE INSTRUMENTS, SIGNAL TRACING, TELEVISION

Many active servicemen have found this reduced-price course excellent for brush up and study of new servicing methods. Reprinted in 1940, with added information on signal tracing, television, visual alignment, P.A. application, photo-cells, etc. All about A.V.C., how to use an oscilloscope, what is feedback, resonance action, and every other fact you must know to be the best serviceman. Forty-three radio manufacturers helped to prepare this course. This practical training gives you facts and real data you need on the job.

PREPARED FOR HOME-STUDY

This complete, low-priced course will give you all the training needed to get ahead in the growing field of Radio. No special education or previous experience required. The streamlined lessons are clear, interesting, easy to master and use. Fellows just like you have found this course the stepping stone to better jobs and higher pay. A final examination and diploma available after course is finished. Special \$1.95 price for the entire course can be earned the first hour of work.

Guarantee

You must be satisfied or your money will be refunded immediately.

PARTIAL LIST OF LESSONS

Elementary Electricity, Radio Parts, Batteries, Circuits, Magnetism, Electromagnets, Ohm's Law, Radio Mathematics, Wattage Calculation, Induction, R.F. Coils, I.F. Transformers, Condensers, A.C. Filters, Rectifiers, Mixed Circuits, Vacuum Tubes, Stage Gain, Detectors, R.F. Amplifiers, Superiort Principle, A.V.C. Ballast Tubes, Meters, Testing Methods, Instruments, Service Fundamentals, V.T. Voltmeter, Using the Oscilloscope, Alignment, Sound and Hearing, Public Address, Amplifiers, Loudspeaker Placement, Microphones, Inverse Feedback Methods, Recording, Power Supplies, Auto Sets, Servicing Short-Cuts, Case Histories, Radio Transmission, Modulation, Crystal Oscillators, Photocell, Sound Movies, Television Principles, Setting Up a Radio Business, Extra Profit Ideas, And many others.

Commission's jurisdiction under the provisions of the act.

For what period of time are broadcast stations licensed by the FCC? In 1939 the license period was extended from 6 months to 1 year.

Has the FCC inquired into network broadcasting? During the last fiscal year, a committee of the Commission sat for 73 days, listened to 100 witnesses, examined 700 exhibits and 9,000 pages of testimony in inquiring into so-called "chain" broadcasting policies and practices.

JUMPER FOR CURRENT TESTS

For test circuits, I find it handy to use a pair of tip-jacks which break the circuit, and a jumper permanently fastened under one of the jacks.

For current tests have the jumper free and use the tip-jacks. For voltage tests, plug the jumper into the tip-jack and use the free one for your meter.

R. FRAZER,
New York, N. Y.

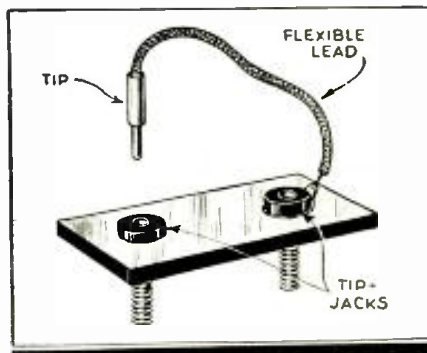

GOOD REVIEW COURSE FOR THOSE IN RADIO

Learn new speed-tricks of radio fault finding, servicing short-cuts, case histories of common troubles, extra profit ideas. Two large lessons on use of regular test equipment, explanation of signal tracing test methods, television to the minute, recording dope. With this information you will save enough time on one radio job to pay the special \$1.95 price for the complete course.

NEW LIMITED EDITION

Rush your order to us today. You may not have another opportunity like this. Only a small number of courses reprinted to sell at the reduced price. You are protected with our money-back guarantee. Catch up with your radio education. Begin studying this course this very week.

FREE EXAMINATION COUPON

SUPREME PUBLICATIONS, Agents
3727 W. 13th St., Chicago, Illinois
Ship the complete Radio Course at the special reduced price. I must be pleased, or will get my money back.
 I am enclosing \$1.95, the full price, sent postpaid.
 Ship C.O.D. I will pay postman \$1.95 and a few cents for postage.

Name
Address
City State 235

DATAPRINTS

- TESLA-LOUDIN HI-FREQ. COILS
20c Ea. in order for 10 (Data and Drawings only.)
36" Sp'k Tesla-Oudin Coil 40c (1 K.W. Exc. Trf. Data, included FREE!)
8" Sp'k Tesla-Oudin Coil 40c (1/4 K.W. Exc. Trf. Data, included FREE!)
8" Sp'k Oudin; 110 Vt. "Kick Coil" type.....40c
3" Sp'k Tesla Works on Ford Sp'k Coil40c
1" Sp'k Violetta Hi-Freq. Coil.....40c
Model Warships—Get List of Plans



Induction PIPE & ORE LOCATOR

Induction Type, Data40c
Radio Type40c

More DATAPRINTS 40c each!

- | | |
|--------------------------|-----------------------------|
| 5 Meter Superhet. | Electric Refrigerator |
| 1/2 Meter Tr. & Rec. | Resistance Measuring Bridge |
| 20 A.C. Probs. & Ans. | Weld. Transf. 2 K.W. |
| 20 Telephone Hook-ups | Rewinding Armatures |
| 100 Mech. Movements | String Galvanometer |
| 20 Motor Hook-ups | 20 Simple Bell Circuits |
| Television Hook-up | Steel Wire Recorder! |
| 20 Elec. Party Tricks | Water Wheels or Turbines |
| Solenoids and Magnets | Photo Cell and Relay |
| —get list. | Ring 4 bells: 2 Wires |
| Fry Eggs on Ice! | 20 Tesla Tricks |
| Experimental Photophone | Polarized Relay |
| Radio Control for Models | Induction Balance |
| Diathermy Apparatus | |
| Inductor Organ | |

Special Prices: 4 prints \$1.00; 10 for \$2.00; Single, 40c each. Get New Catalog 100 A.

The DATAPRINT Co.
Lock Box 322C, Ramsey, N. J.

HOW TO ELECTRIFY THE 2-TUBE SUPERHET.

The addition of a 2-stage, single-tube amplifier, and a rectifier and filter, convert into a full-fledged 3-way portable that gives worthwhile performance anywhere the 2-tube experimental superheterodyne first described in Radio-Craft for June, 1940.

LEONARD LASKY

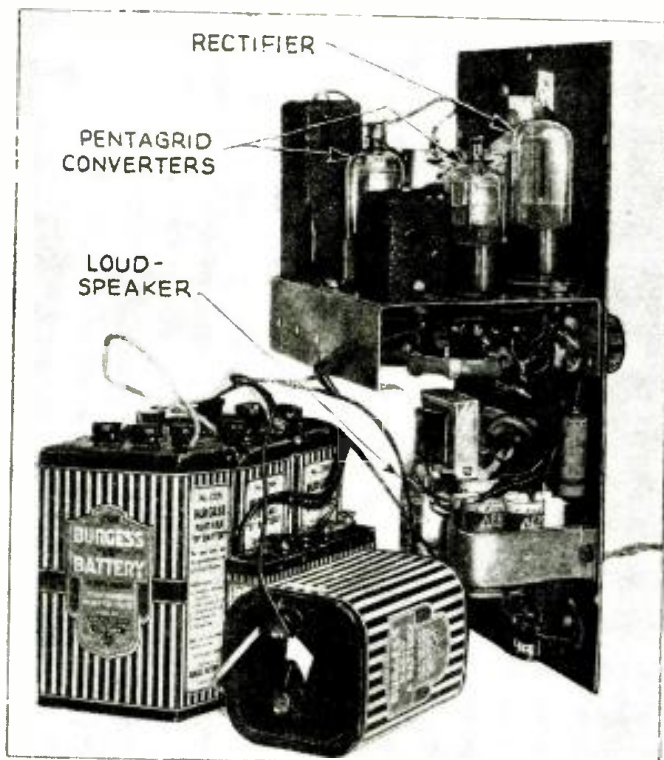

Rear view of the 3-way (battery-electric), 4-tube portable. Comparatively large batteries ensure long operating life throughout the summer, and long shelf-life during the winter period when operation is mainly with light-line power.

NO home-made radio set long remains static. It is generally, sooner or later, changed. A 2-tube superhet, having served faithfully for a summer under varied conditions at home and in the field, in its turn became a problem. To tear it down or build it up, that was the question. In its original form the set showed so much promise as to be worthy of further development. An amplifier providing loudspeaker operation was an obviously desirable improvement; and the advent of winter, with the return of radio activity indoors, made electrification a necessity.

FEATURES

The addition of these features to the many possessed by the original set results in an all-purpose portable which is equal in performance to some commercial outfits employing 5 and 6 tubes.

The original 2-tube superhet, included the following outstanding features:

- (1) The use of pentagrid tubes for both converter and 2nd-detector applications.
- (2) Electron-coupled, stable, non-radiating regeneration at the fixed intermediate frequency (hence the degree of regeneration remains fixed, at any predetermined level, regardless of adjustments of the tuning condenser gang).

The completed set, as described herein,

possesses the following additional attributes:

- (1) Completely self-contained 115-volt A.C., D.C., or battery operation, using only 4 tubes including the rectifier.
- (2) Minimum current consumption on battery or power line.
- (3) High-quality resistance-capacity coupled amplifier. Only one transformer—the output transformer in the entire set.
- (4) Generous 4-in. P.M. dynamic speaker provides excellent tone.
- (5) Headphone reception using the first stage of the audio amplifier provides ample volume and disturbs no one. Perfect tone quality if used with crystal headphones.
- (6) Transformerless, choke-less, power supply saves weight, space, and money. The filament of the 117Z6GT rectifier operates directly from the power line.
- (7) Hum-free operation on A.C. supply.
- (8) Compact, truly portable construction, is actually less bulky than most commercial portables of comparable performance.

DESIGN CONSIDERATIONS

The 1D8GT was an almost obvious choice for the amplifier section of the receiver,

since it provides so much usable value in so little space at a minimum power cost. The 117Z6GT likewise was chosen for the rectifier because it can operate directly from the line without a transformer or dropping resistor.

The 1D8GT has a filament current of 0.10-ampere, while that of a 1A7GT is 0.05-ampere. These tubes cannot therefore be hooked-up in series. If the two 1A7GTs and one 1D8GT were hooked-up in parallel, their total filament consumption would be 0.2-ampere, which is more than the 117Z6GT is rated to deliver; the series-parallel arrangement finally adopted requires only 0.1-ampere at 3 volts. A 3-V. "A" battery was chosen to replace the 1.5-V. cell used in the original receiver. The plates and cathodes of the 117Z6GT are hooked-up in parallel, in which connection they can supply a total rated current of 0.120-ampere, which exceeds by a small margin the current requirements of the set (0.1-A. for the filaments and 0.011-A. for the plates).

The 1A7GT filaments are shunted by a 200-ohm resistor, R9, which carries the plate current of the 1D8GT back to ground. *One precaution must be observed with this filament arrangement:* the set should not be turned on unless all the tubes are good and all sockets are filled. The reason for this is that if one of the 1A7GTs is missing or defective, the remaining one will have an excessively large voltage applied to its filament, which may damage it.

In operation from the power line, whether A.C. or D.C., the filament and plate current needs of the set are supplied by the rectifier independently of the batteries (except the "C" battery). A switch, Sw.2, on the front panel provides for change-over from battery operation. The switch is arranged to turn off the filament of the 117Z6GT when the set is operating on batteries, even though the line cord may be plugged into the 115-volt line.

The rectifier is followed by a filter of the resistance-capacity type popular in portable receivers. Actually there are 2 filters, one for the filaments and one for the plates. The resistors in the filament side of the filter serve also to drop the voltage (approx. 125 volts) at the output of the rectifier to 3 volts for the series-parallel filaments.

An attempt was made to use the diode plate of the 1D8GT in an A.V.C. circuit. The A.V.C. action was not particularly satisfactory, since only 1 tube, the 1st-detector-oscillator, was controlled, and the sensitivity of the set was too-greatly reduced. The use of A.V.C. was therefore abandoned in the final version of the hook-up.

CIRCUIT

The circuit diagram, Fig. 1, shows the complete circuit of the entire set. Practically no changes are necessary in the original 2-tube superhet. wiring. Advantage is taken of the 1st stage of the audio

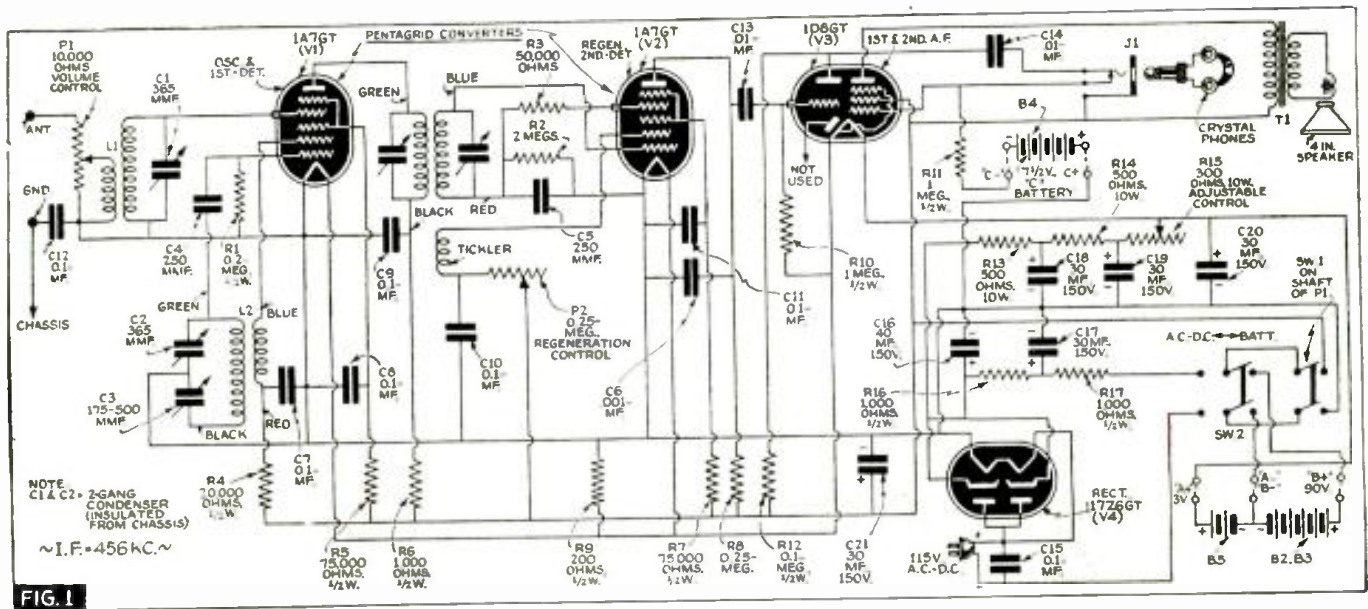

FIG. 1

amplifier to provide greater volume for headphone reception. The original jack may be used, but it must now be insulated from the metal chassis and front panel.

The 1D8GT requires 9 volts of "C" bias for the 90-volt plate supply operating condition. It was decided to use a separate "C" battery and leave the entire 90 volts provided by the "B" batteries available for plate supply, because this would provide maximum power handling ability on the part of the 1D8GT. However, only a 7 1/2-volt battery is necessary because the 1.5-volt drop across the filaments of the 1A7GTs may be used for the balance, making a total of 9 volts.

CONSTRUCTION

In rebuilding the set some rearrangement of parts was necessary to make room for the loudspeaker on the front panel, and consequently the batteries have been shifted to the rear of the cabinet. The speaker opening is finished off with an escutcheon plate taken from an old dial, and a piece of coarse, open-weave, cloth. The D.P.D.T. switch, Sw.2, in the lower-left-hand corner, and a hole in the lower-right-hand corner for the line cord, complete the front panel arrangements. See Fig. 2B.

The 1D8GT and 117Z6GT are mounted on the chassis as shown in the drilling diagram, Fig. 2A. The socket of the latter tube is raised about 1/4-in. above the chassis by spacers on the mounting screws in order to clear the potentiometer, P1, and switch, Sw.1, which are below the chassis. The filter condensers are bunched together by a rubber-band and held against the front panel next to the speaker by an aluminum strap. The output transformer is mounted directly on the speaker on lugs provided on the speaker frame.

To prevent the possibility of short-circuit or shock should the ungrounded side of the power line be connected to the "A-B"-side of the receiver circuit at the same time that the ground terminal, chassis, and cabinet are connected to ground, it was decided to isolate the wiring and parts of the receiver entirely from the chassis and cabinet, and to provide an R.F. bypass condenser, (C12, between the "A-B"-side of the wiring and the chassis. The ground binding post is not insulated from the front panel. If the chassis and panel were used as part of the wiring of the original receiver, this should be corrected. Also, the tuning condenser and dial must be insulated from the chassis

and panel by means of fibre washers. Ninety volts of "B" battery should be used to test for grounds in the wiring of the set and no continuity should be observable between any component of the set or of the wiring, and the chassis and panel.

In the set shown in the photographs, resistors R13, R14 and R15 were mounted below the chassis. It is suggested, however, that they be mounted above the chassis because these resistors must collectively dissipate about 11.5 watts. In any case, they should be mounted as far from the batteries and condensers as possible.

Some holes should be drilled in the back and top of the cabinet to provide ventilation and let out the sound waves coming from the back of the speaker.

OPERATION

Before placing the set in operation for the first time, the wiring should be very

carefully checked, particularly the filament wiring. The set should be made to work successfully on batteries first before operation on A.C. or D.C. is attempted. An adjustment is provided in R15 by means of which the filament current may be set at its proper value. For most practical purposes it is sufficiently accurate to set R15 at about 150 ohms. However, anyone who wishes to be super-precise may connect a milliammeter in series with R15 and adjust R15 so that the filament current is exactly 100 milliamperes. Theoretically this adjustment should be made when the line voltage is 117 volts, according to the R.M.A.

The completed set will operate in much the same manner as the original 2-tube superhet., with the added pleasure of loud-speaker reception. (The article on the original set should be consulted for details and information not given here.)

The completed set, as described herein, is a universal portable which anyone can be proud to own. It is certainly a remarkable performer and bears out the conclusion, reached after the tests on the 2-tube superhet. showed its possibilities, that *the way is now clear for better and more economical superheterodynes.*

The List of Parts here given includes only those parts necessary for adding the amplifier and power-supply to the original 2-tube superhet. For the List of Parts for the converter and 2nd-detector stages, see *Radio-Craft* for June, 1940, p. 747.

LIST OF PARTS

CONDENSERS

- Two Aerovox paper tubular, type 284, 0.01-mf., 200 volt, C13, C14;
- One Aerovox paper tubular type 284, 0.1-mf., 200 volt, C15;
- One Aerovox electrolytic type PRS 150, 40-mf., 150 volt D.C. working, C16;
- Five Aerovox electrolytic, type PRS 150, 30-mf., 150 volt D.C. working, C17, C18, C19, C20, C21.

RESISTORS

- One IRC type BT 1/2, 200 ohms, 1/2-watt, R9;
- Two IRC type BT 1/2, 1 meg., 1/2-watt, R10, R11;
- One IRC type BT 1/2, 0.1-meg., 1/2-watt, R12;
- Two IRC type AB, 500 ohms, 10 watts, R13, R14;
- One IRC type ABA, 300 ohms, 10 watts, adjustable, R15;

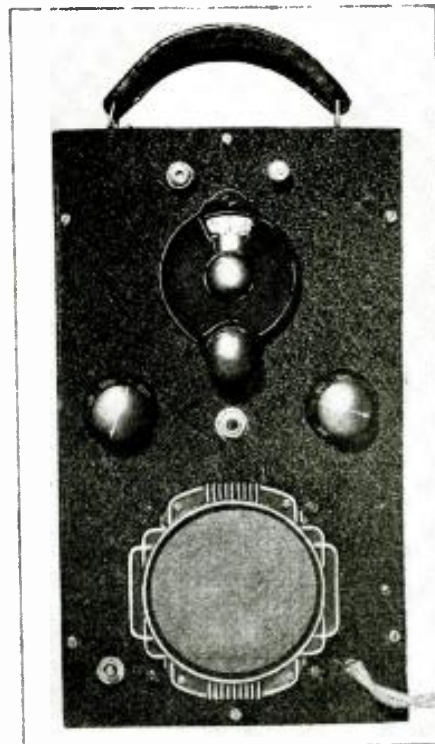

Front view of the completed superhet. It differs but slightly from its original appearance.

OHMITE
Resistors for me
Everytime!

★ "It's the best way I know to be sure of top performance!" Yes, sir—servicemen, amateurs, engineers all know that Ohmite Resistors work for you day in and day out—dependably! They're standard, too, with designers and manufacturers of amateur, commercial and broadcast equipment. Next time, install "Cordohms," "Dividohms," "Brown Devils," or other Ohmite Parts. See Your Jobber.

MAIL COUPON NOW!

OHMITE MANUFACTURING COMPANY
4895 Flournoy St., Chicago, U. S. A.

SEND FREE CATALOG 17

Name

Address

City State



OHMITE
RHEOSTATS RESISTORS TAP SWITCHES

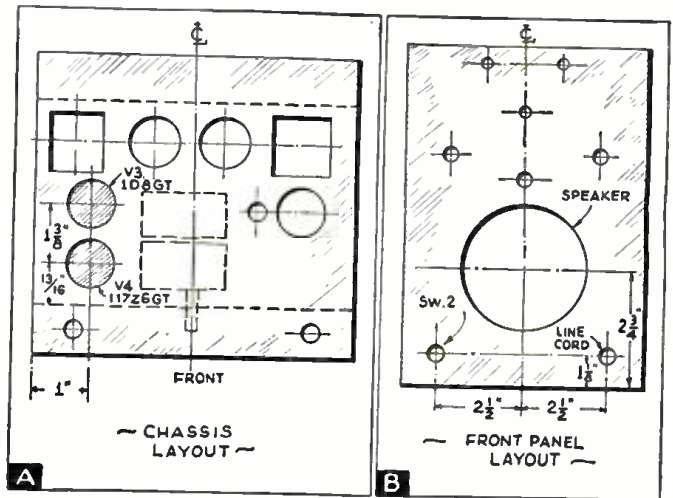

FIG. 2
The chassis and front panel layouts of the electrified 2-tube superhet. show the locations of new holes required for amplifier and rectifier tubes. (For locations of other holes, in both chassis and panel, see preceding article on the original 2-tube superhet.)

Two IRC type BT½, 1,000 ohms, ½-watt, R16, R17.

TUBES

One National Union type 1D8GT;
One National Union type 117Z6GT;

MISCELLANEOUS

One Utah 4-in. permanent magnet dynamic speaker type 4PY1, with output transformer No. 8772;

Two Amphenol octal sockets, type MIP;
One Burgess 3-volt "A" battery, No. 2F2H, B5;
One Burgess 7½-volt "C" battery, No. 5540, B4;
One Cutler-Hammer D.P.D.T. toggle switch, Sw.2;
Line cord and plug, escutcheon plate for speaker hole, hardware, etc.

F.C.C.'S MAILBAG

(No. 11 of a Series)

A NEW YORKER inquires "whether a company operating a commercial radio station is under a duty to quote rates for time not sold and to sell such time if its rates are met." Under the Communications Act a radio broadcast station is expressly declared not to be a "common carrier." Accordingly, except the provision which relates to candidates for public office explained in an earlier information release, a radio broadcast station is under no obligation to quote rates or sell time. Hence a radio broadcast station is unlike some other classes of radio stations—notably radiotelegraph and radiotelephone—which have the status of common carriers and are required to furnish service in accordance with tariffs filed with the Commission.

From the same city comes a lone letter protesting certain restrictions imposed upon amateurs at the present time. By way of explanation, the Commission replies in part:

"Although it is realized that these orders will probably cause inconvenience and annoyance to some of the amateur operators, the Commission feels that the recent restrictions and requirements are not only entirely justified but that they are necessary actions in the interests of neutrality and national defense. From the responses received from amateur organizations and individual amateurs throughout the country, it appears that the amateurs themselves are appreciative of the reasons necessitating the adoption of these orders and that they will fully cooperate in their enforcement. As you are undoubtedly aware, this Commission is cognizant of the valuable services rendered to radio and the nation by its amateurs and has on numerous occasions made public its appreciation of those services. The Commission does not believe that the order requiring more detailed proof of citizenship than has been required in the past can be construed as an indication of distrust of the American amateurs. This is also true as to the commercial operator to whom that order also applies. Requiring fingerprints is not an indication of suspi-

cion. You will be interested to know that all Federal employees under Civil Service have been required to submit fingerprints for a number of years."

Under the circumstances, the Commission regrets that it is unable to accede to request by a New York transformer firm that exceptions be made to permit amateur communication with various scientific expeditions outside of the country.

Although the Commission can not, as a rule, interfere in local interference problems, so many residents of Dennison, Ohio, complained about serious interference to local radio reception that the Commission has asked the Ohio Power Co. to cooperate in remedying the local situation.

A West Virginian wants to obtain a transcript of a certain radio broadcast. Station licensees are not required under law to furnish program transcripts to the public, nor is the Commission empowered by law to secure copies thereof for individuals.

To a Pennsylvanian who complains about interruption of programs for station identification, the Commission points out that whereas such announcements are normally required on the hour and half-hour, these may be dispensed with if they would interrupt a single consecutive speech, play, religious service, symphony concert or operatic rendition.

A Chicago woman objects to a program broadcast by a Dr. Brinkley. The program emanated from a Mexican station, over which the Commission has no jurisdiction.

Since the Commission lacks jurisdiction in the matter, it suggests to a Palm Beach woman that she submit to independent stations and networks a prayer that she wants to be broadcast twice daily throughout the United States.

In response to a query from Chicago, the Commission advises that there is no rule or regulation pertaining to the solicitation of funds over the air, and that the matter is one within the discretion of station management.

YOUR JOB IN THE AVIATION INDUSTRY

The purpose of this article is to acquaint the reader, especially the novice and any radioman not working in the Aviation Radio Industry, with the many branches of the Aviation Radio Industry with which they may associate themselves in a very profitable way; and to outline generally, the qualifications and training necessary for specific jobs in the Aviation Radio Industry.

CHARLES J. SCHAUERS

Staff Sgt., 73rd Bombardment Squadron (M) GHQ AF, Tacoma, Wash.



Left, modern installation of Sperry Automatic Direction Finder, in a Douglas Transport Plane. Special training is needed to service these instruments . . . no "slip-shod" mechanics wanted here!

Photo—RCA Mfg. Co.

specific job. This may be accomplished in the following manner: by giving a test in general radio principles, a code speed test, and typing proficiency test; and then, if possible, a teletype speed test, shop practice principles test, and a psychological examination for determining the prospective aviation radioman's adaptability for public service.

An investigation should also be conducted of the applicant's previous education and habits.

After this has been consummated, the tests are graded and the applicant's choice is considered. It is found that our young radioman desires to operate in a *ground radio station* for the airliners, a specific job.

We then look up the qualifications necessary in order to obtain such a position. The applicant's appearance is 'way above average, and his scholastic marks were investigated and found satisfactory.

Most airlines require a 2nd Class Radiotelegraph license, with a 2nd Class Radiotelephone indorsement. He must obtain one of them.

We now find that he must "brush up" on his theory in order to pass the examination given by the Federal Communications Commission. He could plug diligently, individually, at different textbooks, and peruse volumes upon volumes of radio theory, but this unsystematic method leads to partial and improper training.

What shall we do?

We decide that he needs a school, preferably a resident school, which offers a well-rounded course in general radio theory, along with specialized training in the certain branch that he has picked and found to be fitted for, viz., airline radio operating.

After his graduation from school, and after passing the government examinations, does he belong to the fold of the "full fledged" airlines radio operator? Decidedly not! Now, some of us wonder, "Where is he going to obtain the experience necessary?" Most airlines will not take inexperienced radio operators unless they show more than the usual initiative and learning ability.

If our young novice shows evidence of the two above virtues, he may be put to work as an extra operator, working with one or more experienced radio operators, who at the same time, act as instructors. This is often quite impractical, from a standpoint of efficiency, but is being done every day.

When our radioman has spent from 8 months to a year as a *student operator* in the station, he may be employed as a regular operator.

We've made our airlines radio operator! On the other hand, he may not show more than usual initiative and learning ability, then what are we going to do?

DURING the past few years, most radio Servicemen, amateur radio operators, and those working generally in the radio industry, at one time or other have come in contact with Aviation Radio in some form. Whether it be at air shows, visiting airlines offices, aircraft radio factories, or attending experiments conducted by many manufacturers of aviation radio equipment.

They have realized too, that the aircraft radio field offers many opportunities, but most of them were at a loss as to what they should know, what jobs are actually available, the specific qualifications necessary, and where to apply for those jobs.

After conducting an investigation as to the opportunities offered in the aircraft radio industry, the author compiled the data contained in this article.

TRAINING

Throughout the investigation, it was found that there are many radiomen in the radio industry today, who may, with various amounts of training, qualify themselves for very pleasant as well as remunerative positions in this industry. But the outstanding point of the entire investigation disclosed this important fact: *proper, systematic training for a specific branch MUST be obtained.*

This training, in conjunction with general radio experience, will adapt many radiomen to positions in this gigantic, but highly technical industry.

Radiomen are made (by training), never born!

The radio Serviceman or the general radioman, who contemplates entering the aircraft radio profession has many things to consider, i.e., his training, experience, adaptability, and his general qualifications.

This doesn't mean, however, that every-one who is desirous of entering this field need be a college graduate. But it does mean that the aviation radio industry is in need of those only, who have properly qualified by obtaining proper training, and who have also obtained the necessary "build-up" experience.

This "build-up" experience is obtained in various ways, but all in all, the aviation radio industry is looking for men who will need no large amount of extra training in order to qualify them for their position after acceptance.

There isn't a job in the entire industry that isn't a responsible one!

EFFICIENCY is the key-note of success here!

The average radio technician not only must be a quick, systematic thinker, but he must also possess a very retentive mind, as there are many small, important details that he must know from time to time, which much to his sorrow are not often repeated. This may be attributed to the rapid progression of this highly specialized field.

SAMPLE ANALYSIS

If we were to take a young radioman, say an amateur radio operator who has had, let us say, 4 years' experience, and start to train him for a specific position in the aviation radio industry, how would we do it?

There are many ways in which we may accomplish this, but for the sake of brevity, let us limit ourselves to one method.

The first logical step would be to give the young man an examination in order to ascertain his adaptability for a certain

RADIO DEVELOPMENTS

OTHER RADIO DUTIES

There are a number of answers to that question. But the logical one is, to take whatever job is offered him in the aviation radio industry until such time as he may be able to take the job for which he was trained. *This is the secret to obtaining a specific job in aviation radio.*

Day in and day out, there are men who come to me and ask, "What are the general qualifications necessary for an aircraft radioman?"

Well, to tell the truth, there are very few "general" qualifications, they're all *specific*. This is true because there are many branches in the aviation radio industry which require different training, different experience, and different interests.

There can be no set rule as to what a man should know generally; his knowledge must be specific when working with aviation radio. However, there are radio operators in airline stations who could readily qualify as a *line technician*, servicing aircraft radio equipment in aircraft.

There are others who can repair and install equipment, but who cannot efficiently operate a station, or they do not have the general appearance necessary to work around a ground station.

For simplification, we will list the many positions offered in the Aviation Radio Industry, the qualifications necessary, and the approximate remuneration. We also will list most of the duties performed.

Airlines Radio Operator (Ground Station).—The applicant must possess at least a 2nd Class Radiotelegraph license, if code is used, with a Radiotelephone indorsement.

Some "get by" with 3rd Class Telephone licenses, the new restricted license. However, 1st Class licenses are preferred.

The appearance of the applicant must be considered because of his contact with the public. He must present a trim, clean-cut appearance at all times, and should have had at least 2 years' experience either as an amateur radio operator, commercial ship operator, or as a Serviceman, and be a graduate of a recognized technical school. His code speed, if code is used, should be in the neighborhood of 30 to 35 words-per-minute.

He should have a typing speed of from 50 to 75 words-per-minute, and if possible, and quite desirable, should have had tele-type training and be able to operate the standard machine between 30 and 45 words-per-minute.

He should have some business ability, and should be able to converse intelligently about the services that his company offers the public, when asked!

In order to be a "top-notch" radio oper-

Can YOU put one of these together? Picture at right shows construction of loop antenna for radio compass receiver . . . this takes training!

Photo—RCA Mfg. Co.

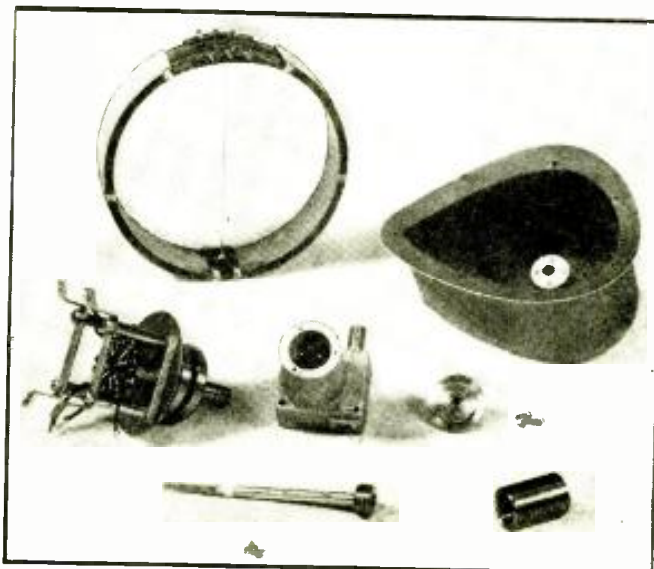

ator, he should hold a Weather Observer certificate, which is easily obtained after a few hours' study.

The pay of airlines radio operators varies from \$85 per month (beginner) to \$185 per month, and advancement is dependent upon ability and initiative.

Radio Operator in Aircraft (Airlines—Commercial Transportation Companies).—The applicant should possess the same qualifications as the ground station operator. However, he need not have had tele-type experience. But a "must" is, that he should possess a 2nd Class Radiotelegraph license with 'Phone indorsement. The applicant for this job must be healthy, and be able to pass the "flying" physical examination required, before acceptance; and those susceptible to air-sickness, are barred.

Many times during a flight, the aircraft radio operator must assist the navigator in taking bearings by utilizing the radio compass or the radio direction finder. This is one of his many important tasks, besides obtaining advance weather reports, transmitting arrival schedules and messages for passengers. His job is a very responsible one, and is not be looked upon with disfavor because of the flying element.

Flying today is the supreme in transportation!

The salary paid aircraft radio operators usually starts at \$125 and sometimes climbs as high as \$350 per month, depending upon the company and the duties.

Factory Radio Installation Technician.—Aircraft manufacturers, making airplanes for military and commercial use are quite

often pressed for properly trained installation men. Those possessing the following qualifications should have no trouble in "landing" a job with aircraft manufacturers employing aircraft radio installation technicians.

One must possess a Radiotelephone 2nd Class license, preferably with Code indorsement, if he is to obtain work in final assembly and testing of the aircraft radio transmitters.

He should be a graduate of a recognized technical school which has given training in aircraft radio installation and maintenance. He must have had at least 3 years' experience as a radio service technician; must be mechanically inclined, and understand thoroughly the intricacies of aircraft radio installation; and he must be able to follow blueprint instructions and the complicated wiring diagrams.

The pay for the above job begins at about 48c per hour and reaches a high of \$1.96 per hour.

Aircraft Electrical Technician.—Every radio technician employed either in the maintenance or installation of aircraft radio equipment, is a potential aircraft electrical technician. This is a branch of the field not very often explored by radiomen.

This is the field that all radio Servicemen should seriously consider, and *now is the time* for consideration.

The average radioman with his understanding of the general principles of radio as a whole may, with a certain amount of study, make himself eligible as an aircraft electrical technician. The many things which he needs to study and understand are:

Ignition systems, electrical wiring diagrams, methods of electrical wire installation, the working principles of gauges which are electrically operated; and, the general principles for the proper installation and maintenance of electrically-operated controls.

If the applicant has had previous experience in wiring radio receivers, wiring modern homes, or/and working with electrical wiring in other branches of the industry of aviation, it doesn't take an immense amount of time nor effort to make himself eligible for work in the electrical department of an aircraft factory.

Although the electrical department is not specifically an integral part of the radio installation and test departments, it does have a bearing indirectly upon the completed radio installation, and it is well that the radio technician employed as a factory

Modern test equipment like this illustrated at left is needed for the proper installation and maintenance of aircraft radio equipment . . . you have to "know your stuff" when the radio equipment you service is to be operated aloft.

Photo—RCA Mfg. Co.

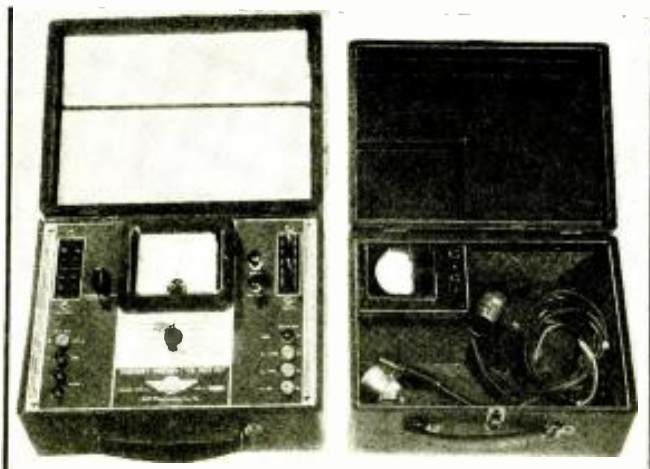

installation man, have a partial understanding as to the methods used in wiring modern aircraft, even though he is not directly concerned with the work.

The salary for the electrical technician averages about the same as the factory radio installation technician.

In any aircraft factory, the work on most equipment is performed on a piece basis. That is, one radio man might have the job of installing the receiver, another the transmitter, another the antenna; still another has the job of actually connecting up and testing the equipment.

It should be remembered here, that no matter what specific job a radioman might be doing, he should know something about what is actually going on around him. This means that he should acquaint himself in a general way with work somewhat closely associated with his, because in aviation radio, every part is "inter-dependent."

The Aircraft Radio Service Technician.—Aircraft radio servicing is a field not yet overly crowded by men who know their "stuff." This is the branch where training is a dire necessity, and constant study a particular requisite. The qualifications for the job of aircraft radio servicing, if a job is desired with one or more of the large servicing agencies established throughout the country, are:

The applicant must have had at least 2 years' experience on home and auto sets; should have been, or is, an amateur radio operator; and above all, should have had specialized training from either a good residence school or a reliable school offering an extension course covering aircraft radio as a whole.

It is quite possible for a radio Serviceman to engage in aircraft radio service from his own shop if there is no immediate service agency in the vicinity of the home airport, but this requires an immense amount of equipment and parts approved for aircraft radio equipment.

The pay of the radio service technician working for an established radio service agency varies. Depending upon the amount of work done, his salary usually runs between \$150 to as high as \$300 per month.

Aircraft Radio Design Engineer.—This branch requires that the applicant have a college education in radio engineering.

Unlike the "home-set" design engineer, the aircraft radio designer must be able to design equipment which must stand up under very strenuous and trying conditions, and which must come up to the Civil Aeronautics Authority standards governing aircraft radio equipment.

The qualifications for this branch of the aviation industry are high. They have to be!

This is the branch for the man who has worked in aircraft radio for at least 2 years; who has graduated from college, majoring in radio engineering; and who has at least a Radiotelephone 1st Class license with Code indorsement. This is necessary if he does the final testing after design.

Due to the steady trend in aircraft radio equipment design, and the many exacting standards as set down by the CAA, it is quite necessary for the engineer working as a designer to be constantly "on his toes" insofar as new innovations and aids to safer flying are concerned.

When manufacturers desire applicants, they usually choose neat-appearing, well-experienced, keen-thinking young college students who have had the prerequisite experience.

The aircraft radio design engineer not only designs aircraft radio receivers, transmitters, interphone equipment and radio aids to navigation, but he also sometimes

has the job of designing control tower equipment, and ground radio station equipment for communication with flying aircraft.

The pay for this branch starts at about \$1,750 a year, and sometimes will reach a high of \$6,500 per year, depending upon the key position assigned to the designer.

Advancement is assured those who show initiative and more than usual ability.

Aircraft Instrument Mechanic.—From time-to-time, radiomen working with aircraft radio receive the opportunity to work with delicate instruments, such as thermocouple ammeters, voltmeters, and milliammeters. The experience gained by working with these instruments, gives the radioman a splendid background for further training as an instrument mechanic.

The duties of the instrument mechanic are concerned mostly with the repair, calibration, and installation of aircraft instruments such as the flight indicator, automatic pilot, rate-of-climb indicator, and the flight indicator.

This is a very highly specialized field and special training is needed. The aircraft radioman is the logical man for the job if he obtains that extra training.

Work in this field is to be had in factories, for the airlines, and at private airports.

The pay for this job varies between \$1,400 to \$3,700 per year, and it should be seriously considered by those who are familiar with sensitive radio instruments.

Aviation Radio Merchandising.—The general qualifications here are that the applicant have had specialized training in general sales and service.

He should have had a well-planned business education coupled with a technical education in aircraft radio.

The pay for this job depends upon ability and is a very lucrative field for those who are willing to work.

Aviation Radio Civil Service Jobs.—The Civil Aeronautics Authority and other governmental agencies hold periodical examinations which afford many radiomen the opportunity to better themselves. The many jobs offered are:

Radio operator (senior & junior), on airways, instrument mechanics working in government depots, radio repair technicians, aircraft radio installation and maintenance technicians, and many engineering jobs.

The qualifications for these jobs are readily obtained by writing to the CAA and consulting the Civil Service Secretary in your district.

MILITARY AVIATION RADIO

Last but not least on our list of positions in the aviation radio industry are the military forces of the United States. The United States Army Air Corps, the Naval Aviation Section, the Coast Guard Aviation Services, and the Marine Aviation Section. These services offer the young men of today countless opportunities to obtain the necessary education and experience for qualification in civilian industry, and the field offers good security with good pay.

The qualifications of the Army Air Corps, generally, requires that the applicant be a healthy individual, able to pass the physical examination given; with no dependents, have at least a high school education or its equivalent; and be between the ages of 18 and 35 years.

The United States Army Air Corps offers training of the highest standards in Aviation Radio Operating and Repair.

Actual operating aboard aircraft, in ground stations (control towers), teletype training, weather forecasting and observation, and a complete, well-rounded training program, is constantly in session for keeping the men well abreast of the times, and

**YOU NEED THIS BIG
Free Catalog**
196 PAGES
OF RADIO VALUES

BIGGER STOCK OF PARTS



BIGGER IN TEST EQUIPMENT



BIGGER IN P. A.



BIGGER RADIO LINE



BIGGER IN HAM EQUIPMENT



All the latest developments in nationally advertised radio parts, plus many items out of manufacture. Everything you need in radio, now within arm's reach. Easy to order . . . easy to have what you want!

Choose your favorite test equipment here. Enjoy real savings. Every known name is represented. Stocks are always complete and up-to-date. Order by catalog—it's quick and it's thrifty.

More models to choose from and more P. A. for your money! In features, performance and watts-per-dollar, Lafayette leads. Three complete lines of portable, permanent and mobile sound systems. A model for every purse and purpose.

Compare Lafayette Radio feature for feature, line for line, and dollar for dollar. Why pay more when Lafayette offers all the wanted features and beauty of styling for so much less? In this book, 64 beautiful models to choose from. 30-day Home Trial.

Nowhere else will you find so complete an array of nationally-famous amateur transmitters, receivers and ham equipment. It's a catalog within a catalog, and low Lafayette prices make it a book you'll want. Time payments.

BIGGER IN EVERYTHING! Be sure to see the complete line of low-priced, easy-to-attach auto radios, the newest record players, radio tubes, tools and guide books. They're all here and priced to save you real money.

RIGHT NOW send for your copy of the greatest catalog in radio—this year bigger than ever. The coupon below, mailed at once, will bring a FREE copy to you.

Lafayette Radio

RUSH COUPON NOW

■ LAFAYETTE RADIO CORP. — Dept. 3L
 ■ 901 W. JACKSON BLVD., CHICAGO, ILL.
 ■ or 100 SIXTH AVENUE, NEW YORK, N. Y.
 ■ Rush FREE Catalog No. 82.

■ NAME
 ■ ADDRESS
 ■ CITY STATE

■ PASTE COUPON ON PENNY POSTCARD

SERVICE MANUAL

427
DIAGRAMS
OF MOST
SERVICED
RADIOS

4 OUT OF 5
CIRCUITS
YOU
NEED

COMPLETE
\$1.95
POSTPAID

DIAGRAMS YOU NEED

In one handy manual you have all the diagrams of the most often serviced radios today. Over 500 of all sets you service every day are included. These important hints giving, trouble-shooting, circuit making your job easier, permit faster and better repairs every time.

HOW TO SAVE TIME

Circuit data, hints, information and time-savers and money-makers for you. Let this diagram manual be your guide to bigger profits and easier service work. Why work blindfolded when 1 out of 5 diagrams you will ever need are included in this handy, low priced manual compiled by M. J. Hutchins, radio serviceman, noted author, teacher of Radio in Chicago schools.

NEW EDITION

Get your copy of this radman's biggest time-saver. No need to spend big money for bulky space-wasting manuals. Only \$1.95 today, brings your copy of the latest "on-the-job" handbook of useful diagrams. (Model 125) to date! Well printed diagrams, with alignment data, and part lists. Large size 8 1/2 x 11 inches. 211 pages, 427 diagrams. In stock.

FREE EXAMINATION COUPON

Supreme Publications, 3727 W. 13th St., Chicago, Ill.
Ship complete Service Manual. I may return the manual for a full cash refund if I am not satisfied.
 I am enclosing \$1.95, send postpaid.
 Send C.O.D. I will pay postman \$1.95 and a few cents postage.

Name

Address



ELEMENTARY MATHEMATICS

● EASY — SIMPLIFIED — PRACTICAL ●

HERE is a book for the business man, the technician and craftsman explaining and answering every operation and meaning with interpreting illustrations and examples.

It is the key to a simple understanding of many perplexing problems in daily life.

In clear, positive and definite language, the author popularizes and clarifies every subject and helps the reader to overcome any apparent difficulty in the study of mathematics.

A real home study-course in mathematics for the student or the man who wants to achieve proficiency or desires to brush-up on his knowledge.

Entire Chapter on Special Mathematics for the Radio Technician

CONTENTS OF BOOK

CHAPTER I. Arithmetic—Addition—Subtraction—Multiplication—Division.

CHAPTER II. Factoring and Cancellation—Fractions—Decimals—Percentages—Ratio and Proportion.

CHAPTER III. The Metric System.

CHAPTER IV. How to Measure Surfaces and Capacity (Geometry).

CHAPTER V. Powers and Involutions—Roots and Evolution.

CHAPTER VI. Mathematics for the Manual and Technical Craftsman—Thermometer conversions—Graphs or Curve Plotting—Logarithms—Use of the Slide Rule.

CHAPTER VII. Special Mathematics for the Radio Technician.

CHAPTER VIII. Commercial Calculations—Interests—Discounts—Short Cut Arithmetic.

CHAPTER IX. Weights and Measures—Useful Tables.

Elementary Mathematics can be carried readily in your pocket. Send Stamps, Cash or Money Order.

ONLY
50c
POSTPAID

TECHNIFAX

1917 S. State St. RC-1140 Chicago, Ill.

well-trained in the field of Aviation Radio.

The Army Air Corps also offers a special course in instrument training, and an opportunity to learn also, the operation of the Link Trainer, etc. This education is had by passing prepared examinations which determine the applicant's adaptability and speed of learning.

The Coast Guard, Marines, and Navy, also have about the same training as the Army Air Corps.

After considering the many advantages offered by the military forces it is readily apparent that these advantages should be taken into consideration by every able-bodied young American who desires the best in training and who has the desire to better himself.

Information concerning the training offered by the Military Aviation Services may be had by consulting the recruiting office in your city.

EMPLOYMENT APPLICATIONS

Many of you readers will begin to wonder as to the method used in getting most of the jobs mentioned so far. "Any road which leads to a good end, is always the hard one to travel."

Commencing with the airlines: it is known that each large concern throughout the nation has a personnel department. The first proper step would be to either drop in personally and see the personnel manager on appointment, or to write a letter giving your qualifications. The former is quite proper, but the latter is to be discouraged.

The addresses of the different airlines may be had by consulting the aircraft directory, or by visiting your local airport where this information may usually be obtained by asking the airport manager; or it may be obtained at a branch airlines office.

Each concern throughout the United States having a personnel office has printed application blanks which are usually sent to an applicant upon request. Usually the application blank sent you will have a list

of the jobs offered in your particular line. It isn't necessary for the applicant to write a lengthy letter giving details of his experiences, qualifications etc.; everything is covered in detail in the application blank. After the application blank is filled out and mailed it is usually from 1 to 3 weeks until acknowledgement is received.

If it is possible for one to visit the main office, and obtain an interview with the Communications Superintendent and personnel manager, much may be accomplished.

For employment in any branch of the aviation radio industry, the personnel manager of the different concerns should be consulted, with a final talk with either the shop superintendent or plant foreman. In these interviews with either the communications superintendent or the shop foreman, it is well to bear in mind their position. They know their jobs or they wouldn't be there. A brief outline of your experience and training, with your intentions should be given, with your past record speaking for itself. Your prospective employer's time is important, yours is also. Don't waste it by talking about your "Cousin Tim's" transmitter, or your ideas on a new type of antenna.

Above all, be brief, and be yourself. (Pretentiousness, no matter how small, is always noticed.) If you don't know your job, your interviewer will usually know that too. The Aviation Radio Industry is the one branch of the industries of today that a man cannot walk into by a "bluffy" sales-talk.

You must know your job when you work in Aviation Radio, because radio is being depended upon more and more every day to add to the safety of modern aircraft as they fly over land and water.

If you are now working in the aircraft radio field, you can feel justly proud, because even though you may be just a small "cog" in the wheel of a big industry every little bit that you do, helps to publicize the slogan, "AIR TRANSPORTATION, ONWARD WITH THE AID OF RADIO!"

AN INEXPENSIVE TEST SPEAKER

● SOME Servicemen do not use a test speaker at all, and a large number of them do not use one that is truly universal. As for myself I certainly would not be without one, and I would not put up with one that was not universal or that wastes time when this one can be built in half an hour at a cost of about \$1 for the new speaker, parts and all.

Any good-grade, permanent-magnet dynamic speaker rated at 5 watts or more with a voice coil impedance of 6 to 10 ohms will do for the speaker itself. The output transformer is a good-grade universal output unit, 1 end of whose output is connected to 1 side of the voice coil. All the other taps are taken to tip-jacks on the panel, while the other side of the voice coil terminates in a phone tip to match different tubes. Leads are also brought out from the voice coil itself to 2 tip-jacks on the panel. Bringing the 3 primary wires out to tip-jacks

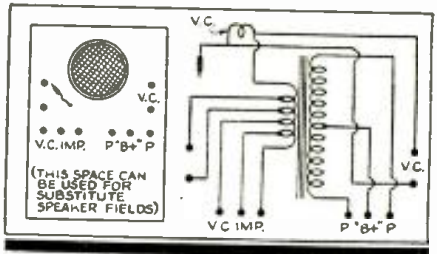

completes the wiring.

All parts are mounted on plywood (wall-board). Parts used other than the speaker and transformer are 10 tip-jacks, 4 phone tips, and 3 alligator clips. The alligator clips and 3 of the phone tips are used in making the 3 leads to connect the test speaker to the set being tested.

W. T. HALLOWELL,
Idabel, Okla.

BOOK REVIEW

A TEXT BOOK ON LIGHT, by A. W. Barton (1939). Published by Longmans, Green & Co. Size, 6 x 9 ins., cloth cover, 272 illustrations, 426 pgs. Price, \$3.

To some technicians a book of this title might seem far afield from radio. However the rapid expansion of television and other types of operation in the ultra-shortwave region, and developments in the use of the electric eye, make it necessary that *Radio-Craft* bring this book to

the attention of its readers.

The book has been written for students with an elementary knowledge of Light who are reading for university scholarships, etc. The first part of the book treats geometrical optics as a scientific analysis of lenses and mirrors. The remainder of the book is devoted to answering the question, "What is light?". The book concludes with an account of the photoelectric effect and Compton effect which demand a revival of the corpuscular theory in a new form. Note that the book assumes a previous elementary acquaintance with the subject.

S.S. AMERICA'S RADIO

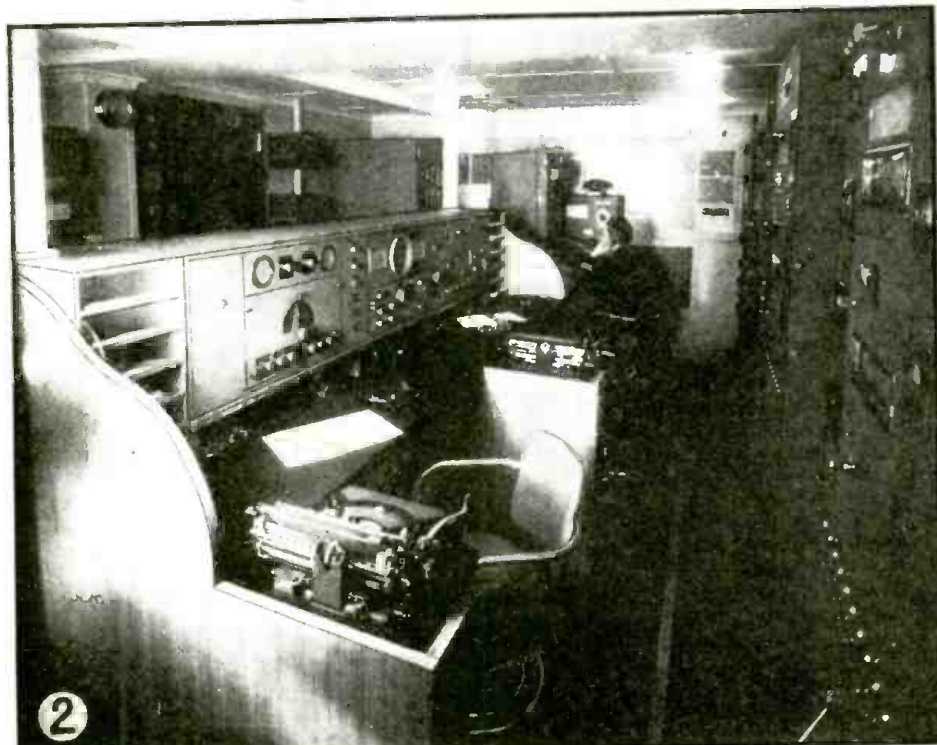

2 Main radio room of the S.S. America. This largest and finest liner ever built in the U.S. is now on the West Indies run.



1 S.S. America, \$17,500,000 flagship of the U.S. Lines.



3 Emergency set-up aboard the S.S. America.

RADIO equipment—valued altogether at \$50,000—aboard the S.S. America, this country's new queen of the seas, is the finest and most comprehensive ever installed on an American luxury liner, Charles J. Pannill, president of the Radiomarine Corp. of America revealed last month coincident with the vessel's arrival in New York harbor. It is the first case in which an American passenger ship has had its radio installation planned and designed in advance of the vessel's construction.

The ship's radio room is in charge of 5 radio officers. A total of 8 radio transmitters, 9 receivers, a radio compass (see photo on cover), and a radio automatic

alarm, give the America a code and voice link with all the important ports and cities of the world, and other ships at sea.

A switching panel affords selection of any of the 5 receiving doublet antennas for either of 2 high-frequency receivers. Switches also control 4 loudspeakers for monitoring by speaker or earphone. Other switches enable a connection between any of 4 receivers and a loudspeaker on the ship's bridge.

Still other panels contain the main radiotelephone controls including a speech inverting or "scrambling" device to obtain privacy in radiophone conversations.

A 50-watt emergency transmitter operates on either emergency generators or a reserve 2 sets of storage batteries; an emergency crystal receiver operates without batteries or tubes!

A 75-watt radiophone on 2 to 3 mc., installed in the ship's chart room, is used only for shipping business (communicating with tugs while docking, and with the pier and home office while the ship is in the harbor).

The 13 antennas aboard ship include the 2 lifeboat antennas, radio compass loop antenna, 75-watt radiophone antenna, 5 doublet receiving antennas, main flat-top antenna, horizontal-V and the forward inverted-V antennas.

BROADCASTING AN AQUAPLANE RACE

WITH 2 land stations, an airplane station and a seagoing station in operation, the Don Lee Broadcasting System for the 6th consecutive year last month again established one of the most elaborate set-ups ever devised to cover an outdoor event—the Catalina-Hermosa-Manhattan Aquaplane Race.

The "ironing-board derby" is aired coast-to-coast over Mutual.

Frank Kennedy, Chief Engineer of the Don Lee net, maintained headquarters with 100-watt KABB at Hermosa Pier, with cueing and communication facilities to all points. The KHJ remote pick-up truck was used as the base for a 60-foot antenna.

In addition to this, elaborate amplifiers and switching systems were used to coordinate all points and several receivers were used to monitor. With Kennedy at this point were technicians Robert Murray and Robert Bullock.

At another spot—Manhattan Pier, a mile away—were announcer Stu Wilson and technician Roy Raglan at an announcing and receiving set-up.

For the 3rd broadcasting unit Kennedy established KABD, a 100-watt shortwave



This 100-W. transmitter aboard the California Fish and Game cutter Marlin did its part in a land-air-ocean hookup to broadcast the annual Catalina Aquaplane Race on the Pacific Coast. Technicians Charles Sherbourne, left, and Glenn Turner man the equipment in the cabin.

RADIO DEVELOPMENTS

OPPORTUNITY AD-LETS

Advertisements in this section cost 15 cents a word for each insertion. Name, address and initials must be included at the above rate. Cash should accompany all classified advertisements unless placed by an accredited advertising agency. No advertisement for less than ten words accepted. Ten percent discount for six issues, twenty percent for twelve issues. Objections or misleading advertisements not accepted. Advertisements for December, 1940, issue must reach us not later than October 7th.

Radio-Craft • 20 Vesey St. • New York, N. Y.

AGENTS WANTED

300% PROFIT SELLING GOLD LEAF LETTERS FOR store windows; Free samples. Metallic Company, 451 North Clark, Chicago.

BOOKS AND MAGAZINES

ASSURE YOURSELF OF GREATER PROFITS BY doing radio service jobs more quickly. Authentic service guides show you the way to locate and correct troubles in any radio receiver. Gernsback Official Radio Service Manuals show you how to complete more repair jobs in less time—how to earn more money by faster servicing. Read the advertisement which appears on page 262 of this issue.

WE HAVE A FEW HUNDRED RADIO ENCYCLOPEDIAS, by S. Gernsback, second edition, originally sold at \$3.98. Book has 352 pages, weighs 3 lbs., size 9 x 13 inches. Red morocco keratol flexible binding. Send \$2.49 in stamps, cash or money order and book will be forwarded express collect. Technifax, 1915 So. State Street, Chicago, Illinois.

DIATHERMY MACHINES

DIATHERMY, SHORT-WAVE THERAPY, AND ULTRA short-wave therapy machines custom-built by radio engineer at considerable saving over commercial machines; 6 meters, 16 meters or any other frequency specified can be furnished. Machines substantially built with high patient safety factor, 250-500 watts output. Neat professional appearance. Automatic safety time switches. All necessary pads and electrodes. For sale only to physicians, hospitals, and sanatoriums. Prices from \$195.00 to \$500.00. Not for sale to the general public. Write, giving your own specifications and requirements. No literature available; custom construction only. Allan Stuart, P. O. Box 56, Teaneck, N. J.

EDUCATIONAL COURSES

USED CORRESPONDENCE COURSES AND SERVICE Books Bought, Sold or Rented. Catalog Free. Vernon Exchange, Henagar, Alabama.

CORRESPONDENCE COURSES AND EDUCATIONAL books, slightly used. Sold, Rented, Exchanged. All subjects. Satisfaction guaranteed. Cash paid for used courses. Complete details and bargain catalog FREE. Write Nelson Company, 500 Sherman, Dept. T-242, Chicago.

INSTRUCTION

COMMERCIAL RADIO OPERATORS LICENSE Questions and answers. Two dollars per element. G. C. Waller, 6540 E. Washington Blvd., Tulsa, Okla.

MANUSCRIPTS WANTED

WANTED—MANUSCRIPTS, POEMS, SONGS FOR publication. Fortuny's, 87 Fifth Ave., New York.

MISCELLANEOUS

WANTED: TEST EQUIPMENT, TRANSMITTER, Walter Wehmer, Sioux Falls, South Dakota.

PHOTOGRAPHY

1/100,000 OF A SECOND SPEED FLASH UNIT FOR Stroboscope Photography. \$200.00. Apt. 63, 782 West 44th Ave., New York City.

RADIO

WE BUY AND SELL USED RADIO TESTING EQUIP- ment. Time payments if desired. Harold Davis, Inc., Jackson, Miss.

WILL SWAP ARVIN AUTOMOBILE RADIO RECEIVER, radio books, experimental receivers, camera or what do you want—for magnetic detector airplane-cloth speaker. Adams-Morgan wood-case variable condenser, navy-type loosecoupler, deForest Audion control box, or what odd apparatus have you? R. Bernard, 40 Manning Ave., N. Plainfield, N. J.

HARD-TO-GET RADIO DIAGRAMS, TRY USUAL sources first. If you can't get them, try us. Price, 50c to \$1.50 if we succeed; no charge if we don't. You lose nothing! Send no money—write first giving fullest information. Enclose return-addressed, stamped envelope. We have helped many servicemen, experimenters and radio fans. We may help you. Allan Stuart, P. O. Box 56, Teaneck, N. J.

STAMPS

THREE SCARCE SETS, NOW OBSOLETE, 25c. WITH new customer, gift: Box 211, Malden, Mass.

TECHNICAL ART SERVICE

DRAFTING AND ART SERVICE—A COMPLETE Service for the Industrial and Commercial Marketers. If your business or plant can't afford a designing or drafting staff, don't let this stop you from going ahead with that new product you intend marketing, or that fine detailed drawings and highly retouched photographs. Any mechanical, electrical or radio problem can be solved for you by our associated staff of designers, draftsmen and artists, and technical copywriters. Write for any additional information as to methods and price for this service. Tee-Art Drafting Service, 228 Charlotte Terrace, Roselle Park, N. J.

DRAFTING SCHEMATIC DIAGRAMS SEND US A rough sketch of your circuit. Estimates by return mail. Our prices are moderate; our work guaranteed. No jobs too big or small. Wm. Kadlcek, Jr., 440 East 85th St., New York, N. Y.

transmitter aboard the California State Fish and Game Cutter *Marlin*. This transmitter was fitted with complete cueing facilities manned by technicians Glenn Turner and Charles Sherbourne.

Homer Welborne and Reid Kilpatrick handled the mike.

They broadcast the start of the gruelling 44-mile race from the Catalina Isthmus and followed the racers, to describe aquaplane riders taking hard spills into the blue water when their muscles could no longer stand the pounding of the rough sea against their wooden sleds towed by fast motorboats.

Overhead, in a trim Beachcraft high-speed airplane rode technician Bob Moody at the controls of KAOG, an 8-watt pack transmitter. Dave Young followed the ironing-boards with field glasses and circled over the Pacific Ocean as the riders held on to their aquaplanes with grim determination. Pilot was Ted Brown. The ship had a trailing wire antenna and complete cueing facilities for the announcer. The airplane served admirably in broadcasting the 5-lap portion of the race between Manhattan and Hermosa.

RADIO FOR DEFENSE

(See Editorial on page 263)

THE RADIO INDUSTRY

- (1) **MANUFACTURING**
 - a—Radio Equipment (including Sets, Tubes and Parts)
 - b—P.A. Amplifiers
 - c—Testing Equipment
 - d—Transmitters
 - g—Communication Receivers
- (2) **MERCHANDISING**
 - a—Mail-Order and Supply Companies
 - b—Distributors, Jobbers and Retailers
- (3) **RADIO SERVICING**
- (4) **RADIO PUBLISHING**
- (5) **RADIO BROADCASTING**
 - a—Radio Engineering
 - b—Sound Effects Engineers
 - c—Transcriptions
 - d—Maintenance Engineers
 - e—Radio Talent
 - f—Educational
 - g—International Shortwave
 - h—Remote Pick-ups
 - i—Police Radio
- (6) **TELEVISION**
 - a—Microwave Experiments
 - b—Cathode-Ray Research
 - c—Color Television
- (7) **FACSIMILE**
- (8) **RADIO COMMUNICATIONS**
 - a—Wired-Radio (Carrier)
 - b—Radio Typewriter
 - c—Transoceanic, Marine and Aviation
 - d—Police Radio
- (9) **POLICE RADIO**
 - a—Via Amplitude Modulation
 - b—Via Frequency Modulation
- (10) **FIRE PATROL RADIO**
- (11) **AMATEUR RADIO**
 - a—Shortwave and Ultra-Shortwave Research
- (12) **AVIATION RADIO**
 - a—Automatic Radio Landing Systems
 - b—Radio Compass
 - c—Radio Direction Finding
 - d—Radio Robot Pilot Systems
 - e—Radio Beacons
 - f—Communication
 - g—Facsimile
- (13) **MARINE RADIO**
 - a—Communication
 - b—Marine Radio Direction Finding
 - c—Radio Compass
 - d—Ship's Public Address System
 - e—Automatic SOS Alarm System
- (14) **SOUND RECORDING AND PLAYBACK**
 - a—Disc
 - b—Film
 - c—Steel-tape
 - d—Transcriptions
- (15) **PUBLIC ADDRESS**
 - a—Inter-Office Communication
 - b—Hearing-Aids
 - c—Sound Movies
 - d—P.A. Systems on Ships
 - e—P.A. Systems in Schools, Hotels, Night Clubs, Auditoriums, etc.
- f—P.A. Rental Business
- g—Stereophonic Reproduction
- (16) **RAILROAD RADIO**
 - a—Train Dispatching by Radio
 - b—Radio Reception (for entertainment on trains)
 - c—Radio "Barkers" on Trains
 - d—Radio Communication with Trains
- (17) **ELECTRONICS**
 - a—Photoelectric Devices—There are over 500 applications of photoelectric cells in commercial and other devices of all types
 - b—Electronic Music
 - c—Telescope Controls
 - d—Photographic Aids
 - e—"Lie" Detectors
 - f—Research
 - g—Insect Exterminators
 - h—Electric Fence Controllers
- (18) **RADIO TELEMECHANICS**
 - a—Remote Control of Ships, Planes, Cars, etc.
- (19) **RADIO IN MEDICINE**
 - a—Shortwave Diathermy
 - b—Radio Surgery
 - c—Radio Stethoscope
 - d—Radio Diagnosis
 - e—Cardioscope
- (20) **RADIO SCHOOLS**
 - a—Engineering
 - b—Servicing
 - c—Communications
 - d—Broadcasting (including Talent)
- (21) **TALKIES (Home, Industrial, School, Theatres)**
 - a—Design, Installation and Servicing
- (22) **FREQUENCY MODULATION**
 - a—Transmission and Reception
 - b—Police Radio
 - c—Emergency Services
- (23) **EMERGENCY SERVICES**
 - a—Utilities (Electric, Gas and Water)
- (24) **—WIRED RADIO (CARRIER)**
 - a—Communication
 - b—Broadcasting
 - c—Remote Control
 - d—Home Phone
- (25) **FORESTRY AND PARKS RADIO**
- (26) **PERSONAL RADIO**
 - a—Miniature Sets and Parts
- (27) **METAL LOCATORS**
 - a—Pipelines
 - b—"Treasure" (bulk metal)
- (28) **GEOPHYSICAL PROSPECTING DEVICES**
 - a—Ore and Oil Locators
- (29) **INTERFERENCE SERVICING**
- (30) **TEST INSTRUMENTS**
 - a—Laboratory and Production
 - b—Servicing (A.M., F.M., Television, Electronics)
- (31) **PLASTICS**
- (32) **TOOLS**
 - a—Manufacturing
- (33) **RADIO ADVERTISING**

SAVE UP TO 50%

On this New 1941

with **FREQUENCY MODULATION**
and **TELEVISION ADAPTATION**

15-TUBE
MIDWEST
RADIO



FACTORY-TO-YOU *only*

EASY TERMS

\$19⁹⁵
COMPLETE
CHASSIS
WITH TUBES
AND SPEAKER

GET THRILLING WORLD-WIDE
FOREIGN NEWS DIRECT!

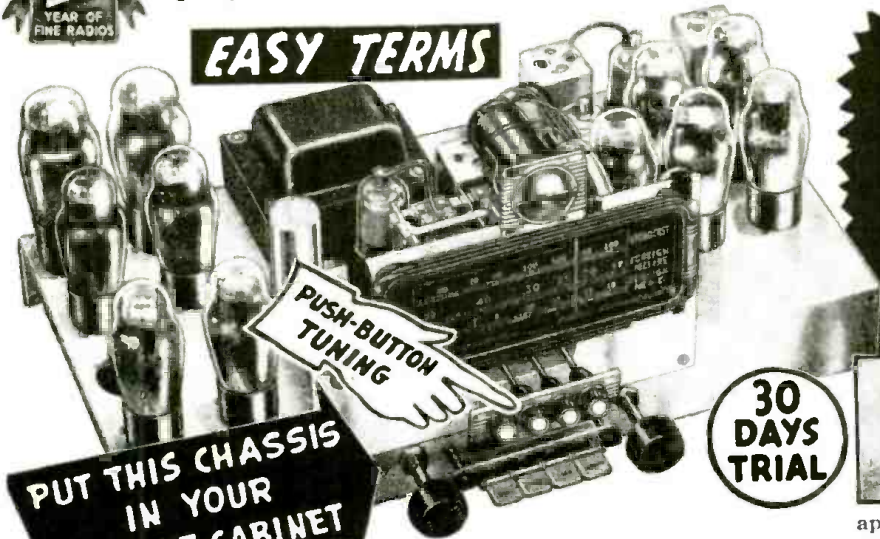

PUSH-BUTTON TUNING

30 DAYS TRIAL

PUT THIS CHASSIS
IN YOUR
PRESENT CABINET

Radio enthusiasts and merchandising experts who have seen the sensational new 1941 Midwest Radios say that they represent today's outstanding values! If you get a big "kick" out of owning a super powerful radio that

will out-perform ordinary sets, you will be particularly delighted with the brilliant performance, beautiful tone and world-ranging ability of these super Midwests. Just imagine being able to pull in world-distant broadcasts from the capitals of Europe—to hear history in the making before it

appears in your local paper or is announced over your local radio. We say: You can get thrilling world-wide foreign news, sports broadcasts and musical programs better and more clearly with a Midwest!

Fifteen tubes include Rectifiers, Control and Tuning Eye Tubes.

THIS
15-TUBE
CABINET MODEL
ONLY
\$29⁹⁵
COMPLETE

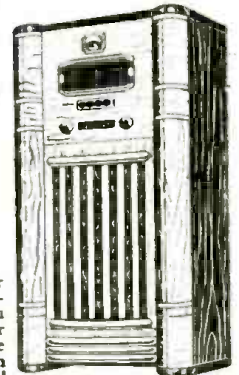

Just think! Here's a super powerful 15-tube radio—complete in cabinet—at a price you would ordinarily pay for a 7 or 8-tube set. Never before have you been offered so much radio for so little money!

UP TO \$25⁰⁰ TRADE-IN ALLOWANCE*
ON YOUR OLD RADIO

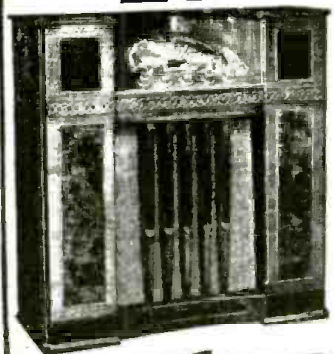

*Now, you can not only save up to 50% by buying direct from the Midwest factory—but, Midwest allows you up to \$25 on your old radio—on many models shown in the big, FREE Midwest Catalog. Send for this catalog and see for yourself that it actually brings the Midwest factory to you, that it pictures and dramatizes many beautiful, 1941 factory-to-you radio values—from 6 to 18 tubes—up to 5 wave bands—including Automatic Record-Changing Radio-Phonographs, Home Recorders, etc.

(Model Z-18 shown at left)
18-TUBES
5-BANDS

FILL IN COUPON AND MAIL TODAY OR JUST SEND YOUR NAME AND ADDRESS ON 1¢ POSTCARD

MIDWEST *factory-to-you* **RADIOS**

MANUFACTURERS OF QUALITY RADIOS SINCE 1920

Midwest Radio Corporation
Cincinnati, Ohio, U. S. A.
Dept. 12-CC

Send me your new FREE Catalog, complete details of your liberal 30-day Trial offer and factory-to-you prices.

Name.....

Address.....

Town..... State.....

User-Agents Make Easy Extra Money. Check here () for details.

1941
RADIO
CATALOG

MAIL COUPON
FOR FREE
CATALOG

Our famous 30-day prove-it-yourself plan fully protects you and enables you to prove Midwest's super performance in the privacy of your own home. Absolutely no obligation.

• LATEST RADIO APPARATUS •

"UNI-VEL" MICROPHONE

The Webster Co.
5622 Bloomingdale Ave., Chicago, Ill.



ONE of a new line of microphones, the "Uni-Vel" velocity microphone claims true cardioid characteristics; wide-angle pick-up in front and "dead" in back, "full-range frequency response," unidirectional characteristics, operation 30% closer to speakers, etc. Mike is housed in modern streamline black and chrome case.—*Radio-Craft*

"WIRELESS" AUTOMATIC RECORD CHANGER

Galvin Mfg. Co.
4545 Augusta Blvd., Chicago, Ill.



MODEL 23RC is a "wireless" automatic record changer with a capacity of 8 10-in. or 7 12-in. records. The unit has an automatic "reject" button, crystal pickup, tangent tone arm, constant speed and self-starting motor, rim-drive turntable. Plays through any radio set by radiating signal. Plugs into the A.C. light line. No connection to radio receiver required. Size, 2½ x 8¼ x 12 ins.—*Radio-Craft*

VICTROLA

RCA Manufacturing Co., Inc.
Camden, N. J.



MODEL V-100 is a combination radio and phonograph. This instrument is one of a series of 14 just introduced. Receiver is a 5-tube broadcast instrument with built-in loop antenna. The phonograph uses a constant-speed self-starting motor and plays

10- or 12-in. records with the lid closed. All audio circuits especially designed for record reproduction. Measures 11 x 16¼ x 13½ ins. deep.—*Radio-Craft*

HIGH-FIDELITY SPEAKER

RCA Manufacturing Co., Inc.
Camden, N. J.

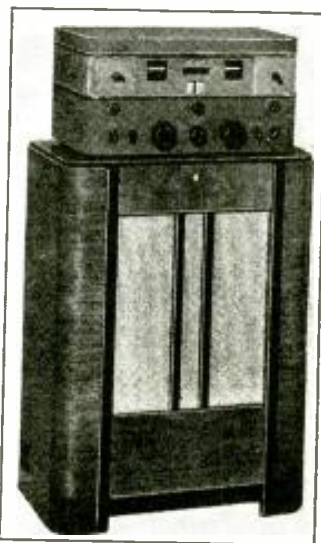

AN "extended range" loudspeaker designed especially for use with communications receivers. Its frequency range is from 60 to 5,000 cycles and its power handling capacity, 10 W. Voice coil impedance is 2.3 ohms at 400 cycles.—*Radio-Craft*

NEW SELENIUM CELL

Bradley Laboratories, Inc.
New Haven, Conn.



AN entirely new type of Selenium Barrier Layer Photoelectric Cell for use with light measurement and control instruments. A new sensitizing process it is claimed gives these cells high current sensitivity as well as high internal impedance. The cell is available in standard sizes or constructed to individual specifications.—*Radio-Craft*

TELEVISION AND F.M. NOISE METER

Measurements Corp.
Boonton, N. J.

THE band-pass of the model 58 square-wave signal generator is sufficiently wide for field-strength measurements of frequency modulation signals; wobbly radiations of diathermy machines; and television signals. Permits closely determining the true nuisance value of ignition and other

pulse-type noise (this is in contrast with previously-available test equipment for this purpose).

Specifications: 15 to 150 megacycles in 5 bands—dial directly calibrated in megacycles; 1 to 100,000 microvolts measuring range across 70-ohm line; 1 to 100 microvolts on semi-logarithmic output scale. Balanced resistance attenuator with ratios of 10, 100, and 1,000 ahead of all tubes; accurate gain standardization from internal "shot noise" diode.

Special calibration dial eliminates need for charts. Tuned R.F. amplifier eliminates image response—all circuits accurately tracked. Provision for direct operation of a 5-milliamperere recorder. Pushbutton switching throughout for rapid operation. Built-in dual regulated power supply for operation from either 115 V. A.C. or 6 V. D.C.—*Radio-Craft*

SOLDERING MACHINE

Electric Soldering Iron Co., Inc.
Deep River, Conn.

A TREADLE-OPERATED soldering machine, model F, used where small parts must be soldered and particularly where it is necessary to hold the 2 parts together until the solder is applied. Feeding of solder may be exactly regulated. Solder up to ½-in. diameter may be used. The average industrial soldering iron is adaptable to this machine. Ideal for work where both hands are required to hold the object being soldered.—*Radio-Craft*

ELECTRIC ETCHER

Ideal Commutator Dresser Co.
Sycamore, Ill.

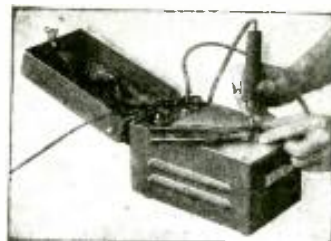

A PORTABLE electric tool for permanently marking tools, parts, dies, bearings, saws, drills and similar apparatus. Etching heats available are rated as 120, 240, 420 and 700 W.—a red indicator lamp burns brightly as the higher heats are turned on. Standard "Universal" No. 13 unit available for 115-V., 60-cycle A.C. operation. Other voltages and frequencies available upon request.—*Radio-Craft*

PORTABLE POWER SUPPLY

Electronic Laboratories, Inc.
122 W. New York St., Indianapolis, Ind.

DESIGNED especially for use with marine transmitting and receiving equipment. One section of the power supply delivers filament current for the transmitter and receiver while the other 2 sections deliver high-voltage D.C. This model S-482 "Portapowr" is constructed for either 12, 32 or 110 V. marine application.—*Radio-Craft*

CODE PRACTICE "OSCILLATONE"

T. R. McElroy
100 Brookline Ave., Boston, Mass.

AN electronic instrument for reproducing the dots and dashes of radio telegraphy. The oscillator may be hooked up for practice or plugged into a circuit for

actual receiving. Switches on the front of the plastic cabinet regulate tone and volume. The unit operates on 115 V. A.C.-D.C. and provides a choice of a 600- or 1,000-cycle note. Circuit includes a key-click eliminator.—Radio-Craft

TUBE TESTER

The Triplett Electrical Instrument Co.
Bluffton, Ohio



THIS model 1620 instrument features "free reference" for all tube elements, a spare socket, 4 separate panel sections (socket, meter, roll chart, switching and power supply)—entirely replaceable at nominal cost to prevent obsolescence due to new tubes, and a new level-type switching which affords individual control for each tube prong. Tests all types of receiving tubes on the market. Designed for 110-V., 60-cycle operation.—Radio-Craft

mon ground. Type "T" switch is heavy-duty press-to-talk, vertical toggle type, non-locking; and "P" switch, also non-locking, is pushbutton type. Other circuits available.—Radio-Craft

NEW BALLAST TUBE

Amperite Co.
561 Broadway, New York, N. Y.



THE new shape and smaller size of this resistor permits it to be used practically anywhere. It puts approx. 80 V. on the receiver when first turned on—increasing to 110 V. after 4 seconds. Equipped with a new fuse which automatically burns out when ballast is connected to set having a 110-V. tie connection to the ballast socket. After fuse burns out the ballast tube automatically adjusts itself to the set, keeping tube filaments between 6 to 6.6 V. with a line voltage variation of 80 to 140 V. It is claimed that for A.C.-D.C. sets 4 types of these ballast tubes will replace 90% of the 1,500 types of resistor tubes now on the market.—Radio-Craft

FREQUENCY MODULATION SIGNAL GENERATOR

The Hickok Electrical Instrument Co.
10514 Dupont Ave., Cleveland, Ohio

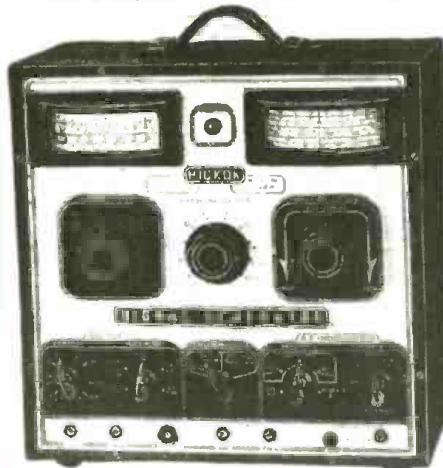

A WIDEBAND crystal-controlled signal generator, model 188X, specifically designed for F.M. but also applicable to amplitude modulation is illustrated. Complete range: 100 kc. to 133 mc.

Twelve output selections are available including electronic control wideband F.M. output with 750 kc. sweep for alignment over F.M. and television receivers; F.M. output, modulated internally, at 400 cycles with F.C.C. standard frequency modulation sweep (150 kc.) for servicing F.M. receivers. Also,

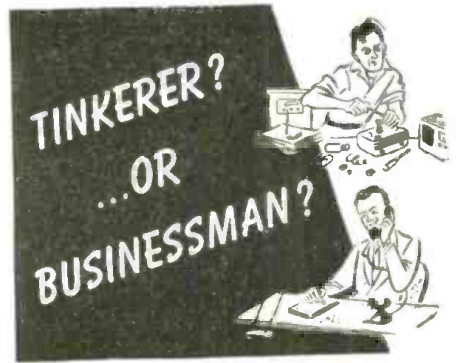

LESS Time to Repair Radios ...
Means MORE Time to Build Business!

RCA RIDER CHANALYST

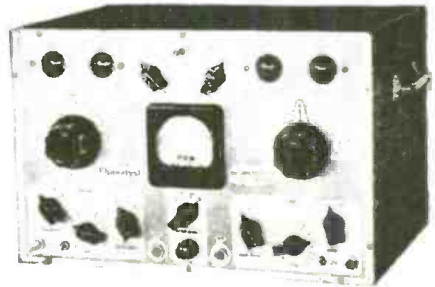

Yesterday's servicing methods were good enough ... for yesterday. But progressive servicemen today demand methods that fix sets quicker. They spend less time bending over receivers—more time going out after business... developing business-getting ideas ... building their business.

Signal-tracing with the Rider Chanalyst takes less time!

Greatest advance in radio servicing instruments since servicing began, the RCA Rider Chanalyst uses the newest method of attack: the signal itself, common to every radio. It's an investment worth investigating! Ask your RCA Distributor for on-the-circuit proof of the Chanalyst's effectiveness by means of the Dynamic Demonstrator.

"Line 'em up" Faster, Easier, Better!
NEW RCA A. C. TEST OSCILLATOR
No. 167 . . . \$34.50 to servicemen

- ★ New, Accurate, Easy-Reading Dial
- ★ 100-30,000 KC. Fundamentals: 6 Bands
- ★ Full 1.0 Volt Maximum Output
- ★ 30%, 400-Cycle Internal Modulation

Over 380 million RCA Radio Tubes have been purchased by radio users. In tubes, as in parts and test equipment, it pays to go RCA All the Way.



Test Equipment

RCA Manufacturing Co., Inc., Camden, N. J.
A Service of the Radio Corporation of America

• LATEST RADIO APPARATUS •

A.F. outputs of 400 cycles fixed and 50 to 10,000 cycles variable are available; crystal-controlled outputs, modulated and unmodulated, with accuracy better than 0.01-% and with frequency coverage from 100 kc. to 10 mc. in 100-kc. steps and from 1,000 kc. to 150 mc. in 1-megacycle steps. Signal generator includes a built-in power supply and is designed for the 110-V. A.C. line, 40 to 65 cycles.—*Radio-Craft*

COMBINATION SET AND TUBE TESTER

Radio City Products Co., Inc.
88 Park Place, New York, N. Y.



MODEL 803
"portable service shop" combines in one instrument the functions of tube tester and set tester. The instrument is compact, measuring but 12 1/4 x 13 x 6 ins., and weighing but 12 1/4

lbs. A single meter, fused against burn-out, is used for all functions. Set tester functions include ranges 0-10/50/500/1,000 D.C. voltages at 1,000 ohms/volt, and ranges for A.C. and output voltages. Direct current ranges are 0-1/10/100 ma./1/10A. Ohmmeter ranges include 0-500/5,000/1 meg./10 megs. Decibel ranges: 8-15, 15-29, 29-49 and 32-55. Self-contained battery serves for the Medium Ohms range and a built-in power supply for the other ranges. Tube testing facilities include those for all old and new tubes including the miniature, bantam junior and ballast types. The well-known "Dynoptimum" circuit is utilized. Tests are at standard R.M.A. plate voltage and loads,

and include hot inter-element short and leakage tests for individual elements; also, all filament voltages. Mechanical roll charts list test data for tubes.—*Radio-Craft*

NEW LINE OF CABINETS

Insuline Corp. of America
30-30 Northern Blvd., Long Island City, N. Y.

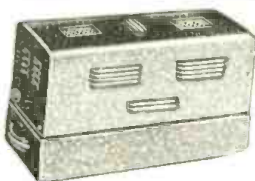

AN entirely new and improved line of metal cabinets, chassis, amplifier chassis, panels, etc. The cabinets are all streamlined and are embellished with chrome molding and chrome air-gate ventilators. Finish is marine gray ripple enamel.—*Radio-Craft*

UNIVERSAL CONNECTOR KIT

Selecter Mfg. Corp.
30 W. 15 St., New York, N. Y.

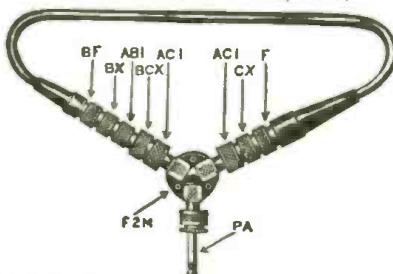

THE kit is designed to expedite servicing. Consists of 10 gadgets which it is claimed will save time in making speaker microphone and chassis connections as well as

in splicing and phone-jack adjustments. The old bug-bear of cable extensions and make-shift splices may now be totally eliminated.—*Radio-Craft*

MIKE CABLE TRANSFORMER

Thordarson Electric Mfg. Co.
500 W. Huron St., Chicago, Ill.

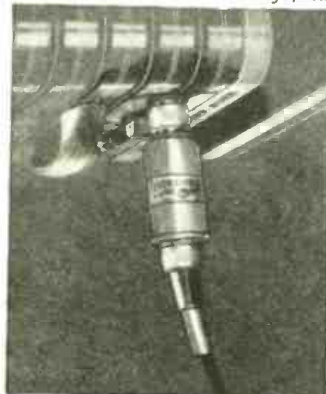

THIS transformer makes it very simple for the sound man to adapt his present amplifiers to the new-type low-impedance dynamic or velocity microphones. Cable transformer mounts directly on the amplifier and is available in 2 types; one is a 30-50 ohm unit designed for voice-coil connection of dynamic or velocity microphones which have self-contained line output transformers. Hum pick-up is reduced to a minimum by the use of magnetic shielding. The transformer connects between the microphone cable and amplifier input connector.—*Radio-Craft*

JUST PUBLISHED!

A NEW BOOK TO ADD TO YOUR TECHNICAL LIBRARY

AUTOMOBILE RADIO — Principles & Practice

by B. Baker Bryant



A COMPLETE compilation of pertinent data on how to install and service the modern automobile radio receiver. All of the non-essential details which have crept into the profession have been weeded out. Each topic is treated so as to contain a precise statement of the fundamental principle involved, to assure the reader's clear understanding of this principle, without distracting his attention by the discussion of a multitude of details and mathematical expressions, which are primarily for the engineer, and tend to confuse rather than clarify a statement for the auto-radio-technician. A practical treatise based on practical experience by practical radio people for the practical radio-technician.

Brief Outline of Contents—

Introduction—The Auto-Radio Art.
Features of the Modern Automobile Receiver.
Installations of Automobile Radios and Antenna.
The Automobile High and Low Tension Electrical Systems.
Automobile Electrical Disturbances.
Vibrator Converters and Motor Generators.
Service Hints, Classified Automobile Installation Notes, and Conclusion.

Send 50c check, money order, unused U. S. stamps, or coin for your copy of "Automobile Radio—Principles & Practice"—it will be sent to you postpaid upon receipt of your remittance.

RADCRAFT PUBLICATIONS, Inc.

20 Vesey Street, New York, N. Y.

50c

POSTPAID

Size—6 x 9
Inches
64 Pages
Stiff, flexible
covers
Numerous
illustrations
and
diagrams

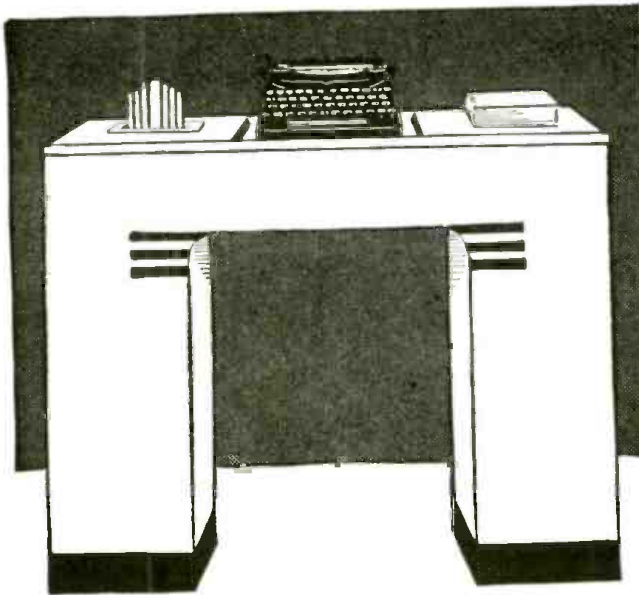

**THIS
BEAUTIFUL DESK
for only \$1.00 EXTRA**

**WITH ANY
REMINGTON
PORTABLE TYPEWRITER**

The
COMBINATION
FOR AS LITTLE AS
10¢ A DAY

How easy it is to pay for this combination of desk and Remington Deluxe Noiseless Portable Typewriter! Just imagine, a small good will deposit with terms as low as 10c a day to get this combination at once! You will never miss 10c a day. Yet this small sum can actually make you immediately the possessor of this amazing office at home combination. You assume no obligations by sending the coupon.

A beautiful desk in a neutral blue-green which will fit into the decorations of any home—trimmed in black and silver—and made of sturdy fibre board—is now available for only one dollar (\$1.00 extra) to purchasers of a Remington Noiseless Portable Typewriter. The desk is so light that it can be moved anywhere without trouble—it is so strong that it will hold six hundred (600) pounds. With this combination of desk and Noiseless Deluxe Portable Typewriter, you will have a miniature office at home. Learn the complete details of this offer. Mail the coupon today.

THESE TWO EXTRA FOR YOU

LEARN TYPING FREE

To help you even further, you get free with this special offer a 32-page booklet, prepared by experts, to teach you quickly how to typewrite by the touch method. When you buy a Noiseless you get this free Remington Rand gift that increases the pleasure of using your Remington Noiseless Deluxe Portable. Remember, the touch typing book is sent free while this offer holds.

SPECIAL CARRYING CASE

The Remington Deluxe Noiseless Portable is light in weight, easily carried about. With this offer Remington supplies a sturdy, beautiful carrying case which rivals in beauty and utility the most attractive luggage you can buy.

SPECIFICATIONS

ALL ESSENTIAL FEATURES of large standard office machines appear in the Noiseless Portable—standard 4-row keyboard; back spacer; margin stops and margin release; double shift key and shift lock; two color ribbon and automatic ribbon reverse; variable line spacer; paper fingers; makes as many as seven carbons; takes paper 9.5" wide; writes lines 8.2" wide. There are also extra features like the card writing attachment, black key cards and white letters, touch regulator, rubber cushioned feet. These make typing on a Remington Deluxe Noiseless Portable a distinct pleasure. Thousands of families now using the Remington Deluxe Noiseless Portable know from experience how wonderful it is!

MONEY BACK GUARANTEE
The Remington Noiseless Portable Typewriter is sold on a trial basis with a money back guarantee. If, after ten days trial, you do not wish to keep the typewriter, we will take it back, paying all shipping charges. You risk nothing in buying a Remington Portable Typewriter on terms as low as 10c a day.



**MAIL
COUPON
NOW!**

Remington Rand Inc., Dept. 189-11
465 Washington St., Buffalo, N. Y.

Tell me, without obligation, how to get a Free Trial of a new Remington Deluxe Noiseless Portable, including Carrying Case and Free 32-page Typing Instruction Booklet on terms as low as 10c a day. Send Catalogue.

Name

Address

City State

• LATEST RADIO APPARATUS •

10 BEST RADIO BOOKS 10¢ ea.

RADIO FANS EVERYWHERE—these fine ten cent text books give you an excellent foundation for the study of RADIO. They are clearly written, profusely illustrated and contain over 15,000 words in each book. You'll be

amazed at the wealth of information contained in these handy books. Excellent for reference—ideal for every technical library. **YOUR MONEY BACK** if you are not satisfied.

PROMPT SHIPMENTS



No. 1 HOW TO BUILD FOUR DOERLE SHORT WAVE SETS

Thousands of radio fans have built the famous DOERLE Short Wave Radio Receivers. So interest has been the demand for these receivers as well as construction details, that this book has been specially published. Contains **EVERYTHING** that has ever been printed on these famous receivers.

No. 2 HOW TO MAKE THE MOST POPULAR ALL-WAVE 1- and 2-TUBE RECEIVERS

This book contains a number of excellent sets, some of which have appeared in past issues of RADIO-CRAFT. These sets have been carefully engineered. They are not experiments. Not only are these sets described in this book, but it contains all of the illustrations, hookups, etc.



No. 3 ALTERNATING CURRENT FOR BEGINNERS

This book gives the beginner a foothold in electricity and Radio. Electric circuits are explained. Ohm's Law, one of the fundamental laws of radio, is explained. The generation of alternating current, sine waves, the multi-volt amperes, and watts are explained. Condensers, transformers, A.C. instruments, motors and generators.

No. 4 ALL ABOUT AERIALS

This book explains the theory underlying the various types of aerials; the inverted "L", the Doublet, the Double Doublet, etc. explains not-free reception, how low-impedance transmission lines work; why transformer lead-ins are used. It gives in detail the construction of aerials suitable for long-wave broadcast receivers for short-wave receivers and for all-wave receivers.

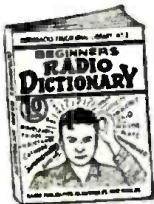

No. 5 BEGINNERS' RADIO DICTIONARY

Are you puzzled by radio language? Can you define Frequency? Kilocycle? Screen grid? Barfio? Anode? Tri-Law? Harmonic? Grid? Cell? If you cannot define these very ordinary radio words and dozens of other more technical terms used in all radio magazines and instruction books, you need this book in your library.

No. 6 HOW TO HAVE FUN WITH RADIO

Stunts for parties, practical jokes, scientific experiments and other amusements which can be done with your radio set are explained in this fascinating volume. It tells how to make a newspaper talk-how to produce silent music for dances-how to make visible music-how to make a "silent" radio unit, usable by the deafened-how to make toys which dance to radio music, etc., etc.

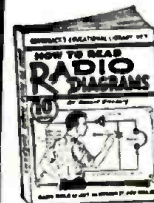

No. 7 HOW TO READ RADIO DIAGRAMS

All of the symbols commonly used in radio diagrams are presented in this book, together with pictures of the apparatus they represent and explanations giving an easy method to memorize them. This book by Robert Eichberg, the well-known radio writer and member of the editorial staff of RADIO-CRAFT Magazine, also contains two dozen picture-wiring diagrams of simple radio sets that you can build.

No. 8 RADIO FOR BEGINNERS

Hugo Gernsback, the internationally famous radio pioneer, author and editor, whose famous magazines, RADIO AND TELEVISION and RADIO-CRAFT are read by millions, scores another triumph with this new book. Any beginner who reads it will get a thorough ground work in radio theory, clearly explained in simple language, and through the use of many illustrations. Analogies are used to make the mysteries of radio clear.

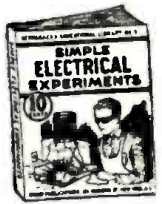

No. 9 SIMPLE ELECTRICAL EXPERIMENTS

Over 100 interesting and practical electrical experiments are described in this book, covering every branch of electricity—from simple experiments with magnets to high frequency "stunts." All of the experiments described can be carried out with simple apparatus, most of which can be found about the home.

No. 10 TELEVISION

Every one is asking the question "How does television work?" This book explains all of the different systems of television from the simplest to the most complex. It describes in A-B-C style just how the image is scanned, how the television camera and broadcast to your home, etc. Various types of television systems are described.



BOOKS ARE ALL UNIFORM

Every book in the GERNSBACK EDUCATIONAL LIBRARY has 32 pages—with illustrations varying from 30 to 66 in number. Each title volume contains over 15,000 words. Positively radio's greatest book buy! If you do not think these books worth the price asked, return them in 24 hours and your money will be instantly refunded.

RADIO PUBLICATIONS • 20 VESEY STREET • NEW YORK, N. Y.

RADIO PUBLICATIONS, Dept. RC-11-40
20 VESEY STREET, NEW YORK, N. Y.
Gentlemen: Please send immediately, POSTPAID, the book numbers circled below. I am enclosing cents—each book being 10c.

1 2 3 4 5 6 7 8 9 10
NEW NEW

Send FREE listing of 39 new 10c publications.

Name Address

City State

Remit by check or money order—register letter if you send cash or unused U. S. postage stamps.

MAIL COUPON TODAY!

AUTOMATIC MINIATURE SOLDER POT

Vulcan Electric Co.
600 Broad St., Lynn, Mass.



AN unusually compact thermostatic control solder pot measuring 3/4-in. inside dia. and 3/4-in. deep. Holds 1 3/4 ozs. of 50/50 solder. Current consumption is 75 W. Supplied for use on either A.C. or D.C.—Radio-Craft

TECHNICIANS' WATCH

Jules Racine & Co.
20 W. 47 St., New York, N. Y.



HERE is a sturly watch of special design which meets needs of radio technicians. Servicemen may wear it in the vicinity of loudspeakers, choke coils, etc., without fear that it will become magnetized; public address men can use it, for example, to check reverberation periods; and, commercial station operators and studio men, and radio amateurs, will find it adequately accurate for split-second timing of programs and test emissions.

Known as the style 230/7B Multichron, this 17-jewel timepiece has the following features: the dial is divided into 5th-seconds for timer purposes; it has regular hour and minute watch indications; circles in the center constitute a tachometer gauge to record miles-per-hour speed; and an outer track indicates distance-per-second traveled by sound.

One button controls the start and stop of a sweep-second hand; another returns it to zero. Hairspring of Nivarox, and balance-wheel of Glacidur metal, reduce temperature effect; and, in conjunction with the stainless-steel case, eliminate magnetic effects. This new model has a black dial (an earlier, 15-jewel model, still available, has a white dial).—Radio-Craft

QUICKLY-SERVICED SOLDERING IRON

Drake Electric Works, Inc.
3654 Lincoln Ave., Chicago, Ill.



AN electric soldering iron with an element that can be replaced in 30 seconds; to remove, simply loosen a lock-nut. Element and handle assembly are connected electrically by means of spring contacts. Soldering irons from 80 to 200 W. are available.—Radio-Craft

Where to Buy It!—

CLASSIFIED RADIO DIRECTORY

Handy Buying Guide, by Products and Manufacturers' Names and Addresses, for the Entire Radio Industry

This DIRECTORY is published in sections—1 section per month. This method of publication permits the DIRECTORY to be constantly up-to-date since necessary revisions and corrections can be made monthly. All names preceded by an asterisk (*) indicate that they are trade names.

If you cannot find any item or manufacturer in this section or in previously-published sections, just drop us a line for the information.

Section I of this DIRECTORY was published in the October, 1940 issue. Presented here is Section II.

While every precaution is taken to insure accuracy, Radio-Craft cannot guarantee against the possibility of occasional errors and omissions in the preparation of this Classified Directory. Manufacturers and readers are urged to report all errors and omissions at the earliest moment to insure corrections in the very next issue.

CONDENSERS, VARIABLE



- Air trimmer AT
- Mica trimmer MT
- Receiver tuning RT
- Transmitting tuning TT
- Transmitting (compressed-gas-filled) TTC

AIRPLANE & MARINE DIRECTION FINDER CORP., Clearfield, Pa.—AT, RT, TT
 ALDEN PRODUCTS CO., 715 Center St., Brockton, Mass., *NA-Ald"—MT, RT
 ALLIED RADIO CORP., 833 W. Jackson Blvd., Chicago, Ill.—AT, MT, RT, TT
 AMERICAN STEEL PACKAGE CO., Squire Ave., Defiance, Ohio *Defiance"—RT
 AUTOMATIC WINDING CO., INC., 900 Passaic Ave., East Newark, N. J.—AT, MT
 BARKER & WILLIAMSON, Ardmore, Pa.—TT
 BROWNING LABORATORIES, INC., 750 Main St., Winchester, Mass.—RT, TT
 BUD RADIO, INC., 5205 Cedar Ave., Cleveland, Ohio, *Bud"—AT, MT, RT, TT
 ALLEN D. CARDWELL MFG. CORP., 81 Prospect St., Brooklyn, N. Y.—AT, RT, TT
 CARRON MFG. CO., 415 So. Aberdeen St., Chicago, Ill.—AT, MT, RT
 *DEFIANCE, American Steel Package Co.
 DE-JUR-AMSCO CORP., Shelton, Conn., *De-Jur-Amsco"—MT
 DE WILD RADIO MFG. CORP., 436 Lafayette St., New York, N. Y.—AT
 DOOLITTLE & FALKNER, INC., 7421 S. Loomis Blvd., Chicago, Ill.—TT
 D-X RADIO PRODUCTS CO., 1575 Milwaukee Ave., Chicago, Ill.—MT
 ELECTRO-MOTIVE MFG. CO., INC., So. Park & John Sts., Williamantic, Conn., *Elmenco"—MT
 ERIE RESISTOR CORP., 644 W. 12th St., Erie, Pa.—MT
 GENERAL INSTRUMENT CORP., 829 Newark Ave., Elizabeth, N. J., *G.I."—RT
 GENERAL RADIO CO., 30 State St., Cambridge, Mass., *G-R"—Special-purpose types
 GENERAL WINDING CO., 254 W. 31st St., New York, N. Y., *Gen.Win"—AT, MT
 *GEN.WIN, General Winding Co.
 *G.I.", General Instrument Corp.
 *G.R.", General Radio Co.
 E. I. GUTHMAN, INC., 400 S. Peoria St., Chicago, Ill., *Guthman"—MT
 HAMMARLUND MFG. CO., INC., 424 W. 33rd St., New York, N. Y.—AT, MT, RT, TT
 HAMMOND MFG. CO., Guelph, Ontario, Canada —TT
 HARRISON RADIO CO., 12 W. Broadway, New York, N. Y.—AT, MT, RT, TT
 HEINTZ & KAUFMAN, LTD., South San Francisco, Calif.—TT, TTC
 *H K, Heintz & Kaufman, Ltd.
 *ICA, Insuline Corp. of America
 INSULINE CORP. OF AMERICA, 30-30 Northern Blvd., Long Island City, N. Y., *ICA"—AT, MT, RT, TT
 E. F. JOHNSON, Waseca, Minn., *Johnson"—TT
 LAFAYETTE RADIO CORP., 100 6th Ave., New York, N. Y.—AT, MT, RT, TT
 M & H SPORTING GOODS CO., 512 Market St., Phila., Pa.—AT, MT, RT, TT
 P. R. MALLORY & CO., INC., 3029 E. Washington St., Indianapolis, Ind., *Mallory"—MT
 MEISSNER MFG. CO., 7th & Belmont Sts., Mt. Carmel, Ill., *Meissner"—AT, MT, RT

JAMES MILLEN MFG. CO., INC., 150 Exchange St., Malden, Mass.—AT, MT, RT, TT
 J. W. MILLER CO., 5917 S. Main St., Los Angeles, Calif., *Miller"—AT, MT
 MONTGOMERY WARD & CO., 619 W. Chicago Ave., Chicago, Ill.—AT, MT, RT, TT
 THE MUTER CO., 1255 S. Michigan Ave., Chicago, Ill., *Muter"—MT
 NA-ALD, Alden Products Co.
 NATIONAL COMPANY, 61 Sherman St., Malden, Mass., *National"—AT, MT, RT, TT
 OAK MFG. CO., 1260 Clybourn Ave., Chicago, Ill.—RT
 PHILCO RADIO & TELEVISION CORP., Tioga & C Sts., Phila., Pa.—MT, RT, AT
 RADIO CONDENSER CO., Davis St. & Copewood Ave., Camden, N. J., *R.C.C."—RT, AT
 RADIO ELECTRIC SERVICE CO., INC., N. W. Cor. 7th & Arch Sts., Phila., Pa.—AT, MT, RT, TT
 RADOLEK COMPANY, 601 W. Randolph St., Chicago, Ill.—AT, MT, RT, TT
 *RCA FARADON, RCA Mfg. Co., Inc.
 RCA MFG. CO., INC., Front & Cooper Sts., Camden, N. J., *RCA, *RCA Faradon"—MT, RT
 *R.C.C., Radio Condenser Co.
 RELIANCE DIE & STAMPING CO., 1260 Clybourn Ave., Chicago, Ill., *Reliance"—RT
 MAURICE SCHWARTZ & SON, 710-712 Broadway, Schenectady, N. Y.—AT, MT, RT, TT
 F. W. SICKLES CO., P.O. Box 920, Springfield, Mass.—AT, MT
 SOLAR MFG. CORP., Bayonne, N. J., *Solar"—MT
 SUN RADIO CO., 212 Fulton St., New York, N. Y.—AT, MT, RT, TT
 TELERADIO ENGINEERING CORP., 484 Broome St., New York, N. Y., *Teleradio"—AT, MT

PREMIER CRYSTAL LABS., INC., 55 Park Row, New York, N. Y.—A, BC, FS
 RCA MFG. CO., INC., Front & Cooper Sts., Camden, N. J., *RCA"—A, BC, FS, H
 SCIENTIFIC RADIO SERVICE, 124 Jackson Ave., University Park, Hyattsville, Md.—A
 VALPEY CRYSTALS, P.O. Box 321, Holliston, Mass.—A, BC, FS, H, IF
 WILCOX ELECTRIC CO., INC., 4014 State Line, Kansas City, Kans.—A, FS

DIALS & PARTS



- Complete dials CD
- Crystals C
- Decalcomanias D
- Dial cables & cords DC
- Dial lamps DL
- Dial pointers DP
- Escutcheons E
- Faces or scales FS
- Faces or scales (machine engraved) FSM
- Indicating lamps IL
- Knobs—molded KM
- Knob springs KS
- Knobs—wooden KW
- Nameplates N
- Nameplates (machine engraved) NM
- Pilotlight assem. PA
- Rubber drives RD
- Silk-screened dials & windows SS

AIRPLANE & MARINE DIRECTION FINDER CORP., Clearfield, Pa.—CD
 ALDEN PRODUCTS CO., 715 Center St., Brockton, Mass.—D, DL
 ALLIED RADIO CORP., 833 W. Jackson Blvd., Chicago, Ill.—CD, C, D, DL, DP, E, FS, KM, KW, N
 AMERICAN EMBLEM CO., INC., P.O. Box 116-J, Utica, N. Y.—CD, DP, E, FS, C, N
 AMERICAN INSULATOR CORP., New Freedom, Pa.—KM
 AMERICAN RADIO HARDWARE CO., 476 Broadway, New York, N. Y., *Arhco"—CD, DP
 ANGELL MFG. CO., 1265 Broadway, New York, N. Y.—N
 *ARHCO, American Hardware Co.
 AUBURN BUTTON WORKS, INC., Auburn, N. Y.—KM
 D. L. AULD CO., 5th Ave. & 5th Sts., Columbus, Ohio—E, N
 O. AUSTIN CO., 42 Greene St., New York, N. Y.—D, FS
 BASTIAN BROS. CO., 1600 N. Clinton Ave., Rochester, N. Y.—CD
 BENDIX RADIO CORP., 920 E. Fort Ave., Baltimore, Md.—C
 BOND PRODUCTS CO., 13139 Hami ton Ave., Detroit, Mich.—CD
 BROWNING LABORATORIES, INC., 750 Main St., Winchester, Mass.—CD
 BUD RADIO, INC., 5205 Cedar Ave., Cleveland, Ohio, *BUD"—CD, DP, KM, N
 CARTON LAMP CORP., 811 30th St., Union City, N. J.—DL
 CLAROSTAT MFG. CO., INC., 285 N. 6th St., Brooklyn, N. Y.—KM
 CONSOLIDATED WIRE & ASSOC. CORPS., Peoria & Harrison Sts., Chicago, Ill.—KM

CRYSTALS (QUARTZ)



- Amateur A
- Blanks B
- Broadcast BC
- Frequency std FS
- Holders H
- I.F. filter IF
- Temperature-control ovens . TO

ALLIED RADIO CORP., 833 W. Jackson Blvd., Chicago, Ill., *Knight"—A
 AMERICAN LAVA CORP., Cherokee Blvd. & Manufacturers Rd., Chattanooga, Tenn.—H
 WM. W. L. BURNETT RADIO LABORATORY, 4814 Idaho St., San Diego, Calif.—A, BC, FS
 COLLINS RADIO CO., 2929 1st Ave., Cedar Rapids, Ia.—A, BC
 GALVIN MFG. CORP., 4545 Augusta Blvd., Chicago, Ill., *Motorola"—BC
 HARVEY RADIO LABS., INC., 25 Thorndike St., Cambridge, Mass., *Harvey"—A, BC
 HIPOWER CRYSTAL CO., 2035 W. Charleston St., Chicago, Ill., *Hipower"—A
 *ICA, Insuline Corp. of America
 INSULINE CORP. OF AMERICA, 30-30 Northern Blvd., Long Island City, N. Y., *ICA"—A, H
 *KNIGHT, Allied Radio Corp.
 *MOTOROLA, Galvin Mfg. Corp.
 P. R. CRYSTALS, Peterson Radio Co.
 PRECISION CRYSTAL LABS., 1211 Liberty St., Springfield, Mass.—A, BC
 PRECISION PIEZO SERVICE, 427 Asia St., Baton Rouge, La.—A, BC, FS, H, TO

• CLASSIFIED RADIO DIRECTORY •

CONTINENTAL DIAMOND FIBRE CO., Newark, Del., *Dilophane"—FS
 COTO COIL CO., INC., 71 Willard Ave., Providence, R. I., *Coto-Wheel"—CD, KM
 *COTO-WHEEL Coto-Coil Co.
 CROWE NAME PLATE & MFG. CO., 3701 Ravestwood Ave., Chicago, Ill., *Crowe"—CD, C, DP, E, FS, KM, N, PA
 DAVEN CO., 158 Summit St., Newark, N. J.—E, KM
 HARRY DAVIES MOLDING CO., 1428 N. Weis St., Chicago, Ill.—E, KM
 *DILOPHANE, Continental Diamond Fibre Co.
 DUAL REMOTE CONTROL CO., 31776 W. Warren St., Wayne, Mich., *Ducon"—E, KM
 *DUCON, Dual Remote Control Co.
 HUGH H. EBY, INC., 4700 Stenton Ave., Phila., Pa.—KM
 EMPIRE NOTION CO., 105 E. 29th St., New York, N. Y.—KM, KW
 *ENAMELOID-CLOISSONNE, Ge Joda Corp.
 ERME RESISTOR CORP., Erie, Pa.—C, DP, E, KM, N
 FEDERAL SALES CO., 2126 South Jefferson St., Chicago, Ill.—KM
 FLOCK PROCESS CORP., 17 W. 3rd St., New York, N. Y.—SS
 *C. General Cement Mfg. Co.
 *SEMILITE CORPORATION, 79-13 Astor Ave., Elmhurst, L. I., N. Y., *Enameloïd-Cloïssonne"—CD, C, D, FS, KM
 GENERAL CEMENT MFG. CO., 1041 Kilbourn Ave., Rockford, Ill., *G-C"—KM, KS, KW, DC RD
 GENERAL ELECTRIC CO., 1 River Road, Schenectady, N. Y.—C, DL, E, FS, KM, N
 GENERAL RADIO CO., 30 State St., Cambridge, Mass.—CD, KM
 CARL GOOR PRINTING CO., 2615 N. Ashland Ave., Chicago, Ill.—E
 GORDON SPECIALTIES CO., 1104 S. Wabash Ave., Chicago, Ill.—CD, DP, FS, KM, N
 L. F. GRAMMES & SONS, INC., 366 Union St., Allentown, Pa.—DP, E, FS, N
 HARRISON RADIO CO., 12 W. Broadway, New York, N. Y.—CD, C, DL, DP, KM, N
 *ICA, Insuline Corp. of America
 INSULINE CORP. OF AMERICA, 3030 Northern Blvd., Long Island City, N. Y., *ICA"—DP, E, FS, KM, KW
 *INSUROK, The Richardson Co.
 E. F. JOHNSON, Waseca, Minn., *Johnson"—DP
 KAAR ENGINEERING CO., 619 Emerson St., Palo Alto, Calif.—FSM, NM
 H. R. KIRKLAND CO., 810 King St., Morristown, N. J.—PA, IL
 *KNIGHT, Allied Radio Corp.
 KURZ-KASCH, INC., 1421 S. Broadway, Dalton, Ohio—D
 LAFAYETTE RADIO CORP., 100 6th Ave., New York, N. Y.—CD, C, DL, E, KM, KW, N
 LEOTONE RADIO CO., 63 Day St., New York, N. Y.—CD, FS
 LIBERTY ENGRAVING & MFG. CO., 2911 S. Central Ave., Los Angeles, Calif.—C, DP, E, N, FS
 M & H SPORTING GOODS CO., 512 Market St., Phila., Pa.—CD, DL, KM, KW, N
 MAJESTIC RADIO & TELEVISION CORP., 2600 W. 50th St., Chicago, Ill.—CD, C
 P. R. MALLORY & CO., INC., 3029 E. Washington St., Indianapolis, Ind., *Yaxley"—DL, KM
 MANUFACTURERS SCREW & SUPPLY HOUSE, 215 W. Illinois St., Chicago, Ill.—KM
 MEISSNER MFG. CO., 7th & Belmont Sts., Mt. Carmel, Ill., *Meissner"—CD, KM
 JAMES MILLEN MFG. CO., INC., 150 Exchange St., Malden, Mass.—CD, KM, DL, DP
 J. W. MILLER CO., 5917 S. Main St., Los Angeles, Calif., *Miller"—CD, KM
 MONTGOMERY WARD & CO., 619 W. Chicago Ave., Chicago, Ill.—CD, C, DL, KM, N
 NATIONAL COMPANY, 61 Sherman St., Malden, Mass., *National"—CD, KM, C
 *NATIONAL UNION RADIO CORP., 57 State St., Newark, N. J., *National Union"—DL
 PARISIAN NOVELTY CO., 3510 S. Western Ave., Chicago, Ill.—CD, C, DP, N
 PHILCO RADIO & TELEVISION CORP., Tioga & C Sts., Phila., Pa.—DL, KM, CD, DP, E, FS, KW
 PHILMORE MFG. CO., 113 University Pl., New York, N. Y.—C
 PREMIER CRYSTAL LABS., INC., 55 Park Row, New York, N. Y.—CD, FS
 RADIO CITY PRODUCTS CO., INC., 83 Park Pl., New York, N. Y.—DP, KM
 RADIO ELECTRIC SERVICE CO., INC., N. W. Cor. 7th & Arch Sts., Phila., Pa.—CD, C, D, DL, DP, E, FS, KM, KW, N
 RADIO KNOB CO., 43 E. Ohio St., Chicago, Ill.—KM
 RADOLEK COMPANY, 601 W. Randolph St., Chicago, Ill.—CD, S, DL, E, FS, KM, KW, N
 RCA MFG. CO., INC., Camden, N. J.—CD, C, DP, E, FS, KM, KW
 TIVARD MFG. CO., Toledo, Ohio—DC
 WALTER L. SCHOTT COMPANY, 5264 W. Pico Blvd., Los Angeles, Calif.—DC
 MAURICE SCHWARTZ & SON, 710-712 Broadway, Schenectady, N. Y.—CD, C, D, DL, DP, E, FS, KM, KW, N
 STAR MACHINE MFRS. INC., 1371 E. 81st Av., Bronx, N. Y.—KM
 F. W. STEWART MFG. CO., 349 W. Hudson St., Chicago, Ill., *Stewart"—CD, C, DP, E, KM, PA
 SUN RADIO CO., 212 Fulton St., New York, N. Y.—CD, C, D, DL, DP, E, FS, KM, KW, N
 SYRACUSE ORNAMENTAL CO., Syracuse, N. Y., *Syracowood," *Woodite," *Syrato"—E, KW
 *SYROCO, Syracuse Ornamental Co.
 *SYROCWOOD, Syracuse Ornamental Co.

TUNG-SOL LAMP WORKS, INC., Radio Tube Div., 95 8th Ave., Newark, N. J., *Tung-Sol"—DL
 *WOODITE, Syracuse Ornamental Co.
 *YAXLEY, P. R. Millor, & Co., Inc.

ELECTRIC FENCE CONTROLLERS



Condensers C

AEROVOX CORPORATION, N. Boston, Mass.—C
 CONTINENTAL ELECTRIC CO., Geneva, Ill.
 FEDERAL SALES CO., 2426 S. Jefferson St., Chicago, Ill.
 HARTMAN ELECTRICAL MFG. CO., Mansfield, Ohio
 LAFAYETTE RADIO CORP., 100 6th Ave., New York, N. Y.
 RADOLEK COMPANY, 601 W. Randolph St., Chicago, Ill.
 SORENG-MANEGOLD CO., 1901 Clabour Ave., Chicago, Ill.
 THORDARSON ELECTRIC MFG. CO., 500 W. Huron St., Chicago, Ill.

ELECTRIC-GENERATING MACHINES



A.C. plants (gas engine) C
 Converters AC
 D.C. generators DCG
 Dynamotors D
 Gas engines GE
 Vibrators V

ALLIED RADIO CORP., 833 W. Jackson Blvd., Chicago, Ill.—ACP, C, DCG, D, GE, V
 CARTER MOTOR CO., 1603 Milwaukee Ave., Chicago, Ill.—C, DCG, D
 EICOR, INC., 515 S. Laflin St., Chicago, Ill.—ACP, C, DCG, D
 ELECTRONIC CONTROL CORP., 2667 E. Grand Blvd., Detroit, Mich.—C
 ELECTRONIC LABORATORIES, INC., 122 W. New York St., Indianapolis, Ind.—C, V
 FISCHER DISTRIBUTING CORP., 222 F. 7th St., New York, N. Y.—ACP, C, DCG, D, GE, V
 GENERAL ELECTRIC CO., Schenectady, N. Y., Bridgeport, Conn.—C, DCG, D
 HARRISON RADIO CO., 12 W. Broadway, New York, N. Y.—ACP, C, DCG, D, GE, V
 JANETTE MFG. CO., 556 W. Monroe St., Chicago, Ill.—ACP, C, DCG, D
 KATO ENGINEERING CO., INC., 530 N. Front St., Markato, Minn.—ACP, C, DCG, GE
 MONTGOMERY WARD & CO., 619 W. Chicago Ave., Chicago, Ill.—C, D, GE
 D. W. ONAN & SONS, 43 Royalston Ave., Minneapolis, Minn.—ACP
 PIONEER GEN-E-MOTOR CORP., 466 W. Superior St., Chicago, Ill.—ACP, C, DCG, D
 RADIO ELECTRIC SERVICE CO., INC., N. W. Cor. 7th & Arch Sts., Phila., Pa.—ACP, C, DCG, D, GE, V
 RADOLEK CO., 601 W. Randolph St., Chicago, Ill.—ACP, C, DCG, D, GE, V
 MAURICE SCHWARTZ & SON, 710-712 Broadway, Schenectady, N. Y.—ACP, C, DCG, D, GE, V
 SUN RADIO CO., 212 F. 7th St., New York, N. Y.—ACP, C, DCG, D, GE, V
 TECHNICAL PRODUCTS INTERNATIONAL, 135 Liberty St., New York, N. Y.—ACP, C, DCG, D, GE
 WINCHARGER CORP., South City, Iowa—DCG

ELECTRONICS



Exciter lamps EL
 Capacity relays CR
 Mirrors M
 Lens systems LS
 Power supplies PS
 Photocell amplifiers PCA
 Photocells (selenium) PCS
 Photocells (vacuum) PV
 Photocells (chemical) PC

Photocells (oxide) PO
 Remote controls RC
 Robot electronic controls REC
 Photocell multipliers PM
 Power rectifiers PR
 Power supplies, vibrator PSV

ADVANCE ELECTRIC CO., 1260 W. 2nd St., Los Angeles, Calif.—RC
 ALLIED RADIO CORP., 833 W. Jackson Blvd., Chicago, Ill.—EL, CR, M, LS, PS, PCA, PCS, PV, FC, PO, RC, REC
 AMPLIFIER CO. OF AMERICA, 37 W. 20th St., New York, N. Y.—EL, CR, PS, PA, RC, REC
 THE BENWOOD-LINZE COMPANY, 1838 Washington Ave., St. Louis, Mo.—PS
 CONTINENTAL ELECTRIC CO., Geneva, Ill.—PV, PO
 CHARLES JACK MFG. CORP., 27 E. Philadelphia St., York, Pa.—PS, RC
 THE DAVEN CO., 158 Summit St., Newark, N. J.—PS
 DE VRY CORPORATION, 1111 Armitage Ave., Chicago, Ill.—E, LS, PS, PCA, PCS
 HUGH H. EBY, 4700 Stenton Ave., Phila., Pa.—CR, M, PCA, PS, RC
 ELECTRONIC CONTROL CORP., 2667 East Grand Boulevard, Detroit, Mich.—CR, M, LS, PS, PCA, PCS, RC, REC
 ELECTRONIC PRODUCTS CO., St. Charles, Ill.—PCA
 FARNSWORTH TELEVISION & RADIO CORP., 3702 E. Portiac St., Fort Wayne, Ind.—PM
 FINCH TELECOMMUNICATIONS, INC., 1819 Broadway, New York, N. Y.—LS, PS, PCA
 FISCHER SMITH, INC., 162 State St., West Englewood, N. J.—CR, PCA, RC, REC
 G-M LABORATORIES, INC., 4326 N. Knox Ave., Chicago, Ill.—PCS, PV, PO
 GENERAL ELECTRIC CO., Schenectady, N. Y., Bridgeport, Conn.—EL
 GUARDIAN ELECTRIC MFG. CO., 1621-27 W. Wall St., Chicago, Ill.—CR, RC, REC
 HARRISON RADIO CO., 12 W. Broadway, New York, N. Y.—EL, CR, M, LS, PS, PCA, PCS, PV, PC, PO, RC, REC
 INDUSTRIAL INSTRUMENTS, INC., 156 Culver Ave., Jersey City, N. J.—CR, PS
 KAAR ENGINEERING CO., 619 Emerson St., Palo Alto, Calif.—PSV
 LAFAYETTE RADIO CORP., 100 6th Ave., New York, N. Y.—EL, CR, M, LS, PS, PCA, PCS, RC, REC
 THE LINCPHONIC CO., INC., 1661 Howard Ave., Utica, N. Y.—PCA
 LUMENITE ELECTRIC CO., 407 S. Dearborn St., Chicago, Ill.—CR, M, PCA, PV, RC
 P. R. MALLORY & CO., INC., 3029 E. Washington St., Indianapolis, Ind.—PS
 T. R. McELROY, 100 Brookline Ave., Boston, Mass.—EL, PCA, PS, PV, PC, PO
 MELLOPHONE CORP., 65 Atlantic Ave., Rochester, N. Y.—EL, PS, PCA, PC, PV
 MILES REPRODUCER CO., INC., 812 Broadway, New York, N. Y.—PS, PCA, RC
 NATIONAL COMPANY, INC., 61 Sherrill St., Malden, Mass.—PS
 PHOTOBELL CORPORATION, 123 Liberty St., New York, N. Y.—CR, M, LS, PS, PCA, PCS, PV, PO, RC, REC
 PHONOTONE LABORATORIES, INC., S. E. 15th St., Washington, Ind.—PCA
 PHOTOSWITCH INCORPORATED, 21 Chestnut St., Cambridge, Mass.—CR, M, LS, PS, PCA, PV, RC
 RADIO ELECTRIC SERVICE CO., INC., N. W. Cor. 7th & Arch Sts., Phila., Pa.—EL, CR
 RADOLEK COMPANY, 601 W. Randolph St., Chicago, Ill.—EL, CR, M, LS, PS, PCA, PCS, RC, REC
 RCA MFG. CO., INC., Camden, N. J.—EL, PS, PCA, PCS, PV, RC
 MAURICE SCHWARTZ & SON, 710-712 Broadway, Schenectady, N. Y.—EL, CR, M, LS, PS, PCA, PCS, PV, PC, PO, RC, REC
 S. O. S. CINEMA SUPPLY CORP., 636 11th Ave., New York, N. Y.—EL, M, LS, PS, PCA, PCV, PO
 SUN RADIO CO., 212 Fulton St., New York, N. Y.—EL, CR, PCS, RC, REC
 TAY BERN EQUIPMENT CORP., 135 Liberty St., New York, N. Y.—REC
 THORDARSON ELECTRIC MFG. CO., 500 W. Huron St., Chicago, Ill.—PS
 TRANSFORMER CORPORATION OF AMERICA, 69 Wooster St., New York, N. Y.—PS, PCA
 WEBSTER ELECTRIC CO., Clark & D's Kiro Ave., Racine, Wis.—RC, REC

ELECTRONIC MUSICAL INSTRUMENTS & PARTS



Contact mikes CM
 Electronic chimes EC
 Electronic piano EP
 Electronic organs EO
 Electronic piano attachment EPA
 Electronic reed instruments ERI

NOW READY FOR DELIVERY!

You receive Valuable subscription to **RADIO-CRAFT**
 PLUS A FREE COPY of 1940 Radio-Television Reference Annual

WITH our compliments, we want to send a copy of the 1940 RADIO-TELEVISION REFERENCE ANNUAL to you FREE, if you will simply take advantage of RADIO-CRAFT magazine's special subscription offer NOW. This offer is being made for a limited time only.

The 1940 RADIO-TELEVISION REFERENCE ANNUAL has 68 pages, large size 8 1/2 x 11 1/2, with over 170 illustrations. The contents of this book has never appeared before in handy book form. Its pages cover practically every branch of radio sound, public address, servicing, television, construction articles for advanced radio men and technicians, time and money-saving kinks, wrinkles, useful circuit information, "ham" transmitters and receivers, and a host of other data.

The Annuals have always been regarded as a standard reference work for every practical branch of radio operation and service. This 1940 edition ably sustains this reputation. Every radio man wants a copy of this valuable book. Just as this book will be of unquestionable value to you, so, too, will every monthly issue of RADIO-CRAFT. This magazine brings you big value every month. It keeps you intelligently informed about new developments in radio and television. You want the news, want it fully but concisely, want it first—that is why you should read RADIO-CRAFT regularly.

This very special offer is made for just one purpose—we want you as a regular subscriber. The Annual, whose contents appears at the right, is not sold, but a copy is FREE to you if you subscribe now.

**SAME SIZE AS
 RADIO-CRAFT**

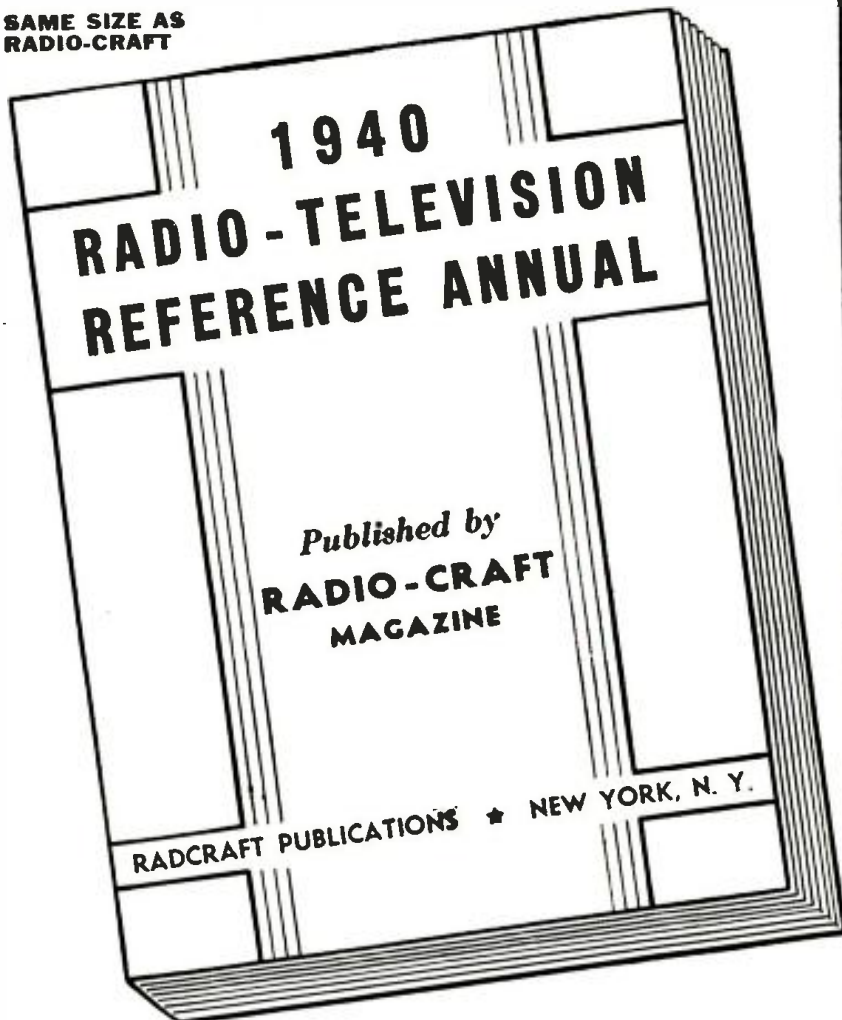

THIS COUPON BRINGS YOU THE ANNUAL

RADIO-CRAFT • 20 VESEY STREET • NEW YORK, N. Y.

Gentlemen: Enclosed you will find One Dollar for which enter my subscription to RADIO-CRAFT Magazine for Eight Months. Send me **ABSOLUTELY FREE** and **POSTPAID**, my copy of 1940 RADIO-TELEVISION REFERENCE ANNUAL.

This is a new order Extend My Present Subscription

NAME ADDRESS

CITY STATE

DON'T DELAY — MAIL TODAY! RC-1140

RADIO-CRAFT for NOVEMBER, 1940

Read the summary of contents in this FREE BOOK!

THE 1940 RADIO-TELEVISION REFERENCE ANNUAL contains a collection of the best and most important articles. Covering as they do nearly every branch of radio, they form a handy reference works. In addition, many time and labor-saving kinks, circuits and wrinkles, tried and tested by practicing Servicemen, experimenters and radio fans have been included. This book cannot be bought anywhere at any price. Yet it is yours by merely subscribing. Use the convenient coupon below.

BEGINNER'S SIMPLE INEXPENSIVE CONSTRUCTION ARTICLES

Beginner's Breadboard Special • a 1-Tube High-Gain All-Wave Receiver—Wiring Pointers for Radio Beginners—A Watch Charm Size 1-Tube Set—Beginner's Simple Volt-Milliammeter—Making a 1-Tube Broadcast Loop Receiver—A.C. D.C. Power Supply for Battery Portables—A 1-Tube Short-Waver with Band Coil Switching.

MORE ADVANCED SET CONSTRUCTION

The "High-Seas 4" Broadcast Lamp Radio—How to Build a 6-Tube 1.4-Volt Short-Wave Superhet for the "Ham" or Short-Wave Fan—Build the "Lunch Box 5" Super Set—a Broadcast Battery Portable—How to Build a Plug-Together 8 Tube Broadcast Set—The "5-in-1" All-Wave Radio for A.C. Operation—An Easily-Built 3-Tube Midset Broadcast Superheterodyne Receiver.

THE SERVICEMEN'S SECTION

Bass Tone Control—Simplified Variable Selectivity—Practical Servicing Pointers—Servicing Universal A.C.-D.C. Receivers—Killing the "Intermittent" Bug—A Service Shop A.C. to D.C. Power Supply—Sideline Money for Servicemen—Adding A.V.C. to any Screen-Grid T.B.F. Receiver—Iron Particles in Speaker Air Gap.

TEST INSTRUMENTS

A Useful Neon Lamp Tester—An Inexpensive Output Meter—Making Milliammeter Multipliers—Home-Made Frequency Modulator—The Busy Servicemen's V.T. Volt-Meter.

PUBLIC ADDRESS AND AMPLIFIERS

Build this Combination A.C.-D.C. Radio and Inter-Communicator—Speaker Placement in P.A. Work—The Design and Construction of an Inexpensive All-Push-Pull 10-Watt Amplifier—Obscure Sources of Hum in High-Gain Amplifiers—How to Build a High-Fidelity 5-Watt Versatile Amplifier.

"HAM" SECTION

Ultra-High Frequency Antennas—The Beginner's Low-Cost Xmitter—Modulator Meter—Phone Monitor—The Beginner's "Ham" Receiver—2 1/2 Meter Acorn Transceiver.

TELEVISION

How to Build a 441 Line T.R.F. Television Receiver—Useful Notes on Television Antennas.

MISCELLANEOUS

Simple Photo-Cell Relay Set Up—Making a Burglar Alarm—How to Build A.C.-D.C. Capacity Relay—How to Make a Modern Radio Treasure Locator.

USEFUL KINKS, CIRCUITS AND WRINKLES

Making a Flexible Coupler—Two-Timing Chime—A Simple Portable Aerial—An Improvised Non-Slip Screw-Driver. NOTE: The book contains numerous other useful Kinks, Circuits and Wrinkles, not listed here.

(approximately)

45 ARTICLES

(approximately)

170 ILLUSTRATIONS

68 BIG PAGES

RADIO-CRAFT
20 VESEY STREET
NEW YORK, N. Y.

• CLASSIFIED RADIO DIRECTORY •

Electronic string instruments ESI
 Harmonies H
 Pedal volume controls . . PVC
 Musical amplifiers MA

ALLIED RADIO CORP., 833 W. Jackson Blvd., Chicago, Ill.—CM, EO, EP, ERI, ESI, H, PVC
 AMPERITE COMPANY, 561 Broadway, New York, N. Y.—CM, PVC
 ANSLEY RADIO CORP., 4377 Bronx Blvd., New York, N. Y.—EP
 THE BRUSH DEVELOPMENT CO., 3311 Perkins Ave., Cleveland, O.—CM
 CHARLES JACK MFG. CORP., 27 East Philadelphia St., York, Pa.—EO
 CRACRAFT, INC., 28 Grove St., New York, N. Y.—CM, EP, ESI, PVC
 ELECTRONIC SOUND & MUSIC CO., 10 Stuyvesant St., New York, N. Y.—CM, EO, EP, ERI, ESI, H, PVC
 ELECTRO-VOICE MFG. CO., INC., 1239 South Bend Ave., South Bend, Ind.—CM, PVC
 EVER-NU PRODUCTS, 919 N. Lathrobe Ave., Chicago, Ill.—CM
 FISCHER DISTRIBUTING CORP., 222 Fulton St., New York, N. Y.—CM
 HAMMOND INSTRUMENT CO., 2915 North Western Ave., Chicago, Ill.—EO ("Hammond" organ), EP ("Novachord"), EPA ("Solovox")
 HARRISON RADIO CO., 12 W. Broadway, New York, N. Y.—CM, PVC
 LAFAYETTE RADIO CORP., 100 6th Ave., New York, N. Y.—CM, PVC
 LEOTONE RADIO CO., 63 Day St., New York, N. Y.—CM
 MONTGOMERY WARD & CO., 619 W. Chicago Ave., Chicago, Ill.—CM, PVC
 NATIONAL DOBRO CORP., 400 S. Peoria St., Chicago, Ill.—ESI, PVC
 RADIO ELECTRIC SERVICE CO., INC., N. W. Cor. 7th & Arch Sts., Phila., Pa.—CM, PVC
 RADOLEK COMPANY, 601 W. Randolph St., Chicago, Ill.—CM, EO, EP, ERI, ESI, H, PVC
 RCA MFG. CO., INC., Camden, N. J.—EP ("Story-tone"), ERI
 POWE INDUSTRIES INC., 3120 Monroe St., Toledo, Ohio—CM, ESI, PVC
 MAURICE SCHWARTZ & SON, 710-712 Broadway, Schenectady, N. Y.—CM, EO, EP, ERI, ESI, H, PVC
 MARK SIMPSON DIST. CO., INC., 16 Hudson St., New York, N. Y.—CM, PVC
 SUNDT ENGINEERING CO., 4745 Ravenswood Ave., Chicago, Ill.—EC
 SUN RADIO CO., 212 Fulton St., New York, N. Y.—CM, PVC
 TRANSFORMER CORPORATION OF AMERICA, 69 Wooster St., New York, N. Y.—CM, MA
 THE VEGA CO., 155 Columbus Ave., Boston, Mass.—ESI, PVC

L. S. BRACH MFG. CORP., 55 Dickerson St., Newark, N. J.—AR, AT
 BROWNING LABORATORIES, INC., 750 Main St., Winchester, Mass.—AA, C, D, R
 THE CLOUGH-BREngle CO., 5501 Broadway, Chicago, Ill.—FSG
 DELTA RADIO CORP., 115 Worth St., New York, N. Y.—C
 ESPEY MFG. CO., INC., 350 E. 63rd St., New York, N. Y.—AA, CA, CR, R
 FARNSWORTH TELEVISION & RADIO CORP., 3702 E. Pontiac St., Fort Wayne, Ind. CA, R, T
 M. M. FLERON & SON, INC., 113 N. Broad St., Trenton, N. J.—AR
 GENERAL ELECTRIC CO., Schenectady, N. Y. & Bridgeport, Conn.—AT, AA, CA, CR, R, T
 E. I. GUTHMAN & CO., INC., 400 S. Peoria St., Chicago, Ill.—C
 HALLICRAFTERS, 2611 Indiana Ave., Chicago, Ill.—CA, R
 D. H. HARRELL, 1527 E. 74th Place, Chicago, Ill.—AR, AT
 HARRISON RADIO CO., 12 W. Broadway, New York, N. Y.—AR, AA, C, DA, DR, D, R, T
 HARVEY-WELLS COMMUNICATIONS, INC., Box 100, Southbridge, Mass.—R, T
 THE HICKOK ELECTRICAL INSTRUMENTS CO., 10514 Davenport Ave., Cleveland, Ohio—Test Apparatus (see Test Equipment)
 E. F. JOHNSON CO., Waseca, Minn.—AR, AT
 LAFAYETTE RADIO CORP., 100 6th Ave., New York, N. Y.—AR, AA
 JOHN E. LINGE & SON, INC., 29th St. & Buren Ave., Camden, N. J.
 FRED M. LINK, 125 W. 17th St., New York, N. Y.—PEU
 MAJESTIC RADIO & TELEVISION CORP., 2600 W. 50th St., Chicago, Ill.—C, CA, CR, R
 MARINE RADIO CORP., 117-19 168th St., Jamaica, N. Y.—R, T
 MEISSNER MFG. CO., Mt. Carmel, Ill.—AA, C, CA, CR, D, R
 JAMES MILLER MFG. CO., 150 Exchange St., Malden, Mass.—C, R, T
 MIMS RADIO CO., P.O. Box 504, Texarkana, Ark.—AR, AT
 NATIONAL COMPANY, INC., 61 Sherman St., Malden, Mass.—C, CA, CR, D, R
 PACENT ENGINEERING CORP., 79 Madison Ave., New York, N. Y.—AR, CR, R
 RADEX CORP., 1733 Milwaukee Ave., Chicago, Ill.—AR, C
 RADIO ELECTRIC SERVICE CO., INC., N. W. Cor. 7th & Arch Sts., Phila., Pa.—AR, AT, AA, C, CA, CR, D, R, T
 RADIO ENGINEERING LABS., INC., 35-54 36th St., Long Island City, N. Y.—AR, R, T
 RCA MFG. CO., INC., Camden, N. J.—AR, AT, CR, R, T
 RADOLEK COMPANY, 601 W. Randolph St., Chicago, Ill.—AR, AA, C, CA, CR, D, R
 MAURICE SCHWARTZ & SON, 710-712 Broadway, Schenectady, N. Y.—AR, AT, AA, C, CA, CR, D, R, T
 SUN RADIO CO., 212 Fulton St., New York, N. Y.—AR, AT, AA, C, CA, CR, D, R, T
 TECHNICAL PRODUCTS INTERNATIONAL, 135 Liberty St., New York, N. Y.—T
 TELERADIO ENG. CORP., 484-90 Broome St., New York, N. Y.—C
 TILTON ELECTRIC CORP., 15 E. 26th St., New York, N. Y.—AR
 UNITED STATES TELEVISION MFG. CORP., 220 E. 51st St., New York, N. Y.—R
 VERTI-FLEX ILLINOIS SEATING CO., 2138 N. Racine Ave., Chicago, Ill.—AR
 WARD PRODUCTS CORP., 1523 E. 45th St., Cleveland, Ohio—AR
 WINCHARGER CORPORATION, Sioux City, Iowa—AR, AT

Washers, fiber FW
 Washers, lock WL
 Grille cloth GRC
 Coil dope CD
 Fuses & Mountings FM
 Engraving & Bakelite Panels EBP
 Bakelite sheet tubes & rods BSTR
 Rubber bumper feet RBF
 Spring Washers SW
 Push on knob spring PKS
 Special washers SPW
 Miscellaneous screws, washers, etc. MISC

ALDEN PRODUCTS CO., 715 Center St., Brockton, Mass.—BP, C, P, SKT, SL, T, CD, J
 ALLIED RADIO CORP., 833 W. Jackson Blvd., Chicago, Ill.—BP, CD, CS, C, GC, G, J, MB, P, SKT, SL, TS, T, MISC
 AMERICAN EMBLEM CO., INC., Box 116-J, Utica, N. Y.—G, MB, SKT
 AMERICAN PHENOLIC CORP., 1250 Van Buren St., Chicago, Ill., "Amphenol"—C, GC, G, P, T, CD
 AMERICAN RADIO HARDWARE CO., 476 Broadway, New York, N. Y., "Arhco"—BP, C, CS, GC, G, MB, P, S, SKT, SL, T, TS, WF, WL
 *AMPHENOL, American Phenolic Corp.
 *ARHCO, American Radio Hardware Co.
 ATLAS SOUND CORP., 1447-39th St., Brooklyn, N. Y.—C, GC, P
 AUDIO DEVELOPMENT CO., 123 Bryant Ave., North Minneapolis, Minn.—J, P
 BANK'S MFG. CO., 5019 N. Winthrop Ave., Chicago, Ill.—BP, C, CS, GC, G, MB, P, S, SKT, SL, T, TS, WF, WL
 BELDEN MFG. CO., 4647 W. Van Buren St., Chicago, Ill.—SL
 BIRNBACH RADIO CO., INC., 146 Hudson St., New York, N. Y.—BP, CP, FS, P, S, SKT, SL, T, WF, WL
 BOND PRODUCTS CO., 13139 Hamilton Ave., Detroit, Mich.—C, CS, P, SKT, SL, T, TS, BP, G, J, MB, MISC
 BRANDYWINE FIBRE PRODUCTS CO., 14th & Walnut Sts., Wilmington, Del.—G, WF
 THE BRUSH DEVELOPMENT CO., 3311 Perkins Ave., Cleveland, Ohio—P, SKT
 BUD RADIO, INC., 5205 Cedar Ave., Cleveland, Ohio, "Bud"—CS, G, MB, P, SKT, SL, T, TS, J, C, MISC
 CANNON ELECTRIC DEVELOPMENT CO., 420 W. Ave. 33, Los Angeles, Calif.—P, SKT
 CARRON MANUFACTURING CO., 415 S. Aberdeen St., Chicago, Ill.—CD, CS, GC
 CINCH MFG. CORP., 2335 W. Van Buren St., Chicago, Ill., "Cinch"—BP, P, SKT, SL, C, G, J, MB, T, TS, MISC, GC, SP
 CINEMA ENGINEERING CO., 1508 S. Verdugo Ave., Burbank, Calif., "Cinema"—P, T, J
 CONTINENTAL DIAMOND FIBRE CO., Newark, Del.—G, SKT, WF
 CONSOLIDATED WIRE & ASSOCIATED CORPS., 512 S. Peoria St., Chicago, Ill.—CD, J
 CRESCENT TOOL & DIE CO., 4140 Belmont Ave., Chicago, Ill., "Crescent"—MB, T, WF
 CRUMPACKER DIST. CORP., 1801 Fanning St., Houston, Tex.—CS, C, GC, G, J, MB, P, SKT, SL, T, TS, MISC
 DAVEN COMPANY, 158 Summit St., Newark, N. J.—BP
 DUAL REMOTE CONTROL CO., 31776 W. Warren St., Wayne, Mich., "Dacon"—P
 *DUCON, Dual Remote Control Co.
 EAGLE ELECTRIC MFG. CO., INC., 59 Hall St., Brooklyn, N. Y.—SKT, C, P, T
 EASTERN MIKE-STAND CO., 56 Christopher Ave., Brooklyn, N. Y.—P
 EDWIN I. GUTHMAN & CO., INC., 400 S. Peoria St., Chicago, Ill.—T
 HUGH H. EBY, INC., 4700 Stenton Ave., Phila., Pa.—BP, P, SKT, T, J
 ECCO HIGH FREQUENCY CORP., 120 W. 20th St., New York, N. Y.—P
 GEORGE D. ELLIS & SONS, INC., 309 N. 3rd St., Phila., Pa.—CS, TS
 EMPIRE NOTION CO., 105 E. 29th St., New York, N. Y.—BP, G, MB, SKT, MISC
 ERIE CAN. CO., 816 Erie St., Chicago, Ill., "Erie"—CS, TS
 *EX-STAT—Tilton Electric Corp.
 FAHNESTOCK ELECTRIC CO., 46-44 11th St., Long Island City, N. Y.—BP, C, J, SL, T
 FEDERAL SALES CO., 26 S. Jefferson St., Chicago, Ill.—G, MB, SL, T, J, P, SKT, MISC
 FISCHER DISTRIBUTING CORP., 222 Fulton St., New York, N. Y.—BP, CD, CS, C, GC, G, J, MB, P, SKT, SL, TS, T, MISC
 *G-C—GENERAL CEMENT MFG. CO.
 GENERAL CEMENT MFG. CO., 1041 Kilburn Ave., Rockford, Ill.—CD, G, SKT, SL, MISC
 GENERAL ELECTRIC CO., Schenectady, N. Y.—SKT, TS
 GENERAL ELECTRIC CO., 1285 Boston Ave., Bridgeport, Conn.—"GE"—P
 GENERAL RADIO CO., 30 State St., Cambridge, Mass.—BP, SKT
 GENERAL WINDING CO., 254 W. 31st St., New York, N. Y., "Gen-Wind"—BP
 *GEN-WIN—General Winding Co.
 GOAT RADIO TUBE PARTS, INC., 314 Dean St., Brooklyn, N. Y., "Goat Form-Fitting"—GC, SL, TS
 GORDON SPECIALTIES CO., 1104 S. Wabash Ave., Chicago, Ill.—G, RBF

FREQUENCY MODULATION EQUIPMENT



Antennas (receiving) AR
 Antennas (transmitting) AT
 Add-on adapters AA
 Coils C
 Combination A.M.-F.M. adapters CA
 Combination A.M.-F.M. receivers CR
 Dials D
 Receivers R
 Transmitters T
 Test apparatus (see Test Equipment)
 F.M. amplifiers (audio) FMA
 Police, emergency services, utility PEU
 F.M. Signal generators FSG
 Lead-ins LI
 Cable CA

ALLIED RADIO CORP., 833 W. Jackson Blvd., Chicago, Ill.—AR, AT, AA, C, CA, CR, D, T, R
 ALPHA WIRE CORP., 50 Howard St., New York, N. Y.—CA
 AMERICAN COMMUNICATIONS CORP., 123 Liberty St., New York, N. Y.—AR, AT, T
 AMERICAN EMBLEM CO., INC., P.O. Box 116, Utica, N. Y.
 AMERICAN PHENOLIC CORP., 1250 Van Buren St., Chicago, Ill.—LI
 AMPLIFIER CO. OF AMERICA, 37 W. 20th St., New York, N. Y.—FMA
 ANSLEY RADIO CORP., 4377 Bronx Blvd., New York, N. Y.—CR
 BELDEN MFG. CO., 4647 W. Van Buren St., Chicago, Ill.—AR, AT
 BOND PRODUCTS CO., 13139 Hamilton Ave., Detroit, Mich.—R

HARDWARE—CONNECTORS AND MISC. PARTS



Binding posts BP
 Cable connectors C
 Coil shields CS
 Coupling CP
 Flex. control shafts FS
 Grid clips GC
 Grommets G
 Jacks J
 Mounting brackets MB
 Plugs P
 Rivets R
 Screws S
 Self-tapping screws SS
 Sockets SKT
 Soldering lugs SL
 Springs SP
 Spring clips SC
 Terminal strips TS
 Tube shields T
 Washers, felt WF

Order your copy NOW—the only

P. A. HANDBOOK



ONLY
25
CENTS
A COPY

THAT no book has yet been published which covers amplifiers and sound systems (also kindred systems) in one complete, authentic volume is almost unbelievable. Yet, it is a fact, there is no book in print which covers Public Address from A to Z. To bridge this wide-spread gap, RADIO-CRAFT will publish a complete, magnificent volume on Public Address of such magnitude—so complete and authoritative—that every man engaged in radio can have both a theoretical and practical knowledge of the function and operation of sound systems. The editorial boxes are so filled with instruction and replete with illustrations that the volume fully justifies its title of 1940 AMPLIFIER HANDBOOK AND PUBLIC ADDRESS GUIDE. This great HANDBOOK on Public Address should be read and studied by those who consistently build, service and sell sound equipment.

A MATCHLESS VOLUME
As complete as you would expect to find any engineering handbook—this is how the radio or P. A. man finds the **AMPLIFIER HANDBOOK AND PUBLIC ADDRESS GUIDE**. With essential technical data compiled from an exceptionally large number of sources, the volume covers nearly a hundred different subjects—coordinating every conceivable branch or sub-division of Public Address.

THE CONTENTS
To actually show the scope and magnitude of the **AMPLIFIER HANDBOOK AND PUBLIC ADDRESS GUIDE**, an analysis of the contents is found at the right, showing the breakdown of the material featured within each particular section. A thorough reading of the contents shows the completeness of this book.

RADCRAFT PUBLICATIONS ■ 20 VESEY STREET ■ NEW YORK, N. Y.

**1st Edition
Almost Gone!
ORDER TODAY**

**A Resume of the Contents of the
AMPLIFIER HANDBOOK
AND PUBLIC ADDRESS GUIDE**

FOREWORD

INTRODUCTION

Definitions—decibels, frequency, input, output, impedance, etc.

SECTION I—SOURCE

Carbon microphones (single-button and double-button)
Condenser microphones
Velocity (ribbon) microphones
Dynamic microphones
Crystal microphones (sound-cell types, crystal diaphragm types)
Cardioid microphones
Contact microphones
Phonograph pickups (magnetic types, crystal types)

SECTION II—AMPLIFIERS

Voltage Amplification

Design of resistance-coupled voltage amplifiers

Commercial voltage amplifier

The Power Stage

Class A amplifiers

Class AB amplifiers

Class AB₁ amplifiers

Class AB₂ amplifiers

Class B amplifiers

When to apply class A, AB, and B amplification

Power Supplies

Half-wave rectification

Full-wave rectification

Voltage doublers

Filter Circuits

Power supply regulation, etc.

Practical Hints on Amplifier Construction

Microphonism

Placement of components

Tone compensation

Inverse feedback

Remote control methods

SECTION III—DISTRIBUTION

The Loudspeaker

Dynamic speakers

Speaker performance (frequency response, efficiency)

High-fidelity speakers

Speaker Baffles and Housings

Outdoor speaker installations

Power cone speakers

Radial (360° distribution) speaker baffles

SECTION IV—COORDINATION

Input impedance matching

Matching speakers to P. A. installations

Phasing speakers

Effect of mismatching speakers to amplifier output

A typical P. A. installation (in a skating rink)

SECTION V—USEFUL PUBLIC ADDRESS DATA AND INFORMATION

Speaker matching technique

The ABC of Db., VU, Mu, Gm and Sm

Charts and formulas useful to the practical P. A. sound man

Handy index to important articles on public address and sound

Order Your Copy NOW—

*Clip Coupon and
Mail Today!*

RADCRAFT PUBLICATIONS, INC. ★ 20 VESEY STREET ★ NEW YORK, N. Y. RC-1140

Gentlemen: Enclosed find my remittance of 25c for which send me POSTPAID, one copy of your NEW—1940 AMPLIFIER HANDBOOK AND PUBLIC ADDRESS GUIDE.

Send me _____ others, for friends, also POSTPAID @ 25c each.

Name _____ Address _____

City _____ State _____

Remit by check or money order; register letter if you send cash or unused U.S. Postage Stamps.

• CLASSIFIED RADIO DIRECTORY •

L. F. GRAMMES & SONS, INC., 364 Union St., Allentown, Pa.—SL, T
 HEGELER ZINC CO., P.O. Box 599, Danville, Ill.—CS, TS
 HARRISON RADIO CO., 12 W. Broadway, New York, N. Y.—BP, CD, CS, C, G, F, MB, P, SKT, SL, TS, T, MISC
 HAMMARLUND MANUFACTURING CO., INC., 424 W. 33rd St., New York, N. Y.—CS, TS
 A. G. HINTZE, 300 W. Adams St., Chicago, Ill.—GRC
 HERBERT H. HORN, 1201 S. Olive St., Los Angeles, Calif.—BP, CD, CS, C, GC, G, J, MB, P, SKT, SL, T, TS, MISC
 HUNTER PRESSED STEEL CO., Lansdale, Pa.—SP
 *ICA—Insuline Corp. of America
 IDEAL COMMUTATOR DRESSER CO., 5, 33-20, 111—SL
 INDUSTRIAL SCREW & SUPPLY CO., 1438 N. Wells St., Chicago, Ill.—BP, G, MB, S, SL, WF, WL
 INSULATING FABRICATORS, INC., 12 E. 121st St., New York, N. Y.—BSTR
 INSULINE CORP. OF AMERICA, 30-30 Northern Blvd., Long Island City, N. Y.—*ICA—BP, C, CS, G, MB, P, SKT, SL, T, TS, CD, MISC, J
 J. F. D. MANUFACTURING CO., 4111 Fort Hamilton Pkwy., Brooklyn, N. Y.—CD, C, TS, MISC
 E. F. JOHNSON, Waseca, Minn., *'Johnson'—P, SKT, SL, J
 HOWARD B. JONES, 2300 Wabansia Ave., Chicago, Ill., *'Howard B. Jones'—C, P, S, SKT, SL
 LAFAYETTE RADIO CORP., 100 6th Ave., New York, N. Y.—BP, CD, CS, C, GC, G, J, MB, P, SKT, SL, T, TS, MISC
 LITTELFUSE, INCORPORATED, 4745 Ravenswood Ave., Chicago, Ill.—FM
 LEOTONE RADIO CO., 63 Dey St., New York, N. Y.—MB
 M. & G. HEARING AIDS CO., 30 N. Michigan Avenue, Chicago, Ill.—P, SKT
 M & H SPORTING GOODS CO., 512 Market St., Phila., Pa.—BP, CS, CD, C, GRC, G, J, MB, P, SKT, SL, T, TS, MISC
 MAJESTIC RADIO & TELEVISION CORP., 2600 W. 50th St., Chicago, Ill.—MB
 P. R. MALLORY & CO., INC., 3029 E. Washington St., Indianapolis, Ind., *'Yaxley'—C, G, MB, P, SKT, SL, T, MISC, J
 MANUFACTURERS SCREW & SUPPLY HOUSE, 215 W. Illinois St., Chicago, Ill.—BP, G, S, SL, WF, WL
 MEISSNER MFG. CO., INC., 7th & Belmont Sts., Mt. Carmel, Ill., *'Meissner'—SKT
 MICARTA FABRICATORS, INC., 4619 Ravenswood Ave., Chicago, Ill.—GC, SKT, T, WF
 JAMES MILLEN MFG. CO., INC., 150 Exchange St., Malden, Mass.—BP, C, CS, SKT, T, CD, TS
 J. W. MILLER CO., 5917 S. Main St., Los Angeles, Calif., *'Miller'—BP, CS, MB, SKT, T, TS
 MONTGOMERY WARD & CO., 619 W. Chicago Ave., Chicago, Ill.—BP, CD, C, G, J, MB, P, SKT, SL, T, TS, MISC, CS
 MUELLER ELEC. CO., 1583 E. 31st St., Cleveland, Ohio, *'Mueller Universal Clips'—C
 MUTER COMPANY, 1255 S. Michigan Ave., Chicago, Ill., *'Muter'—SL
 NASH RADIO PRODUCTS CO., 6267 Gravois Ave., St. Louis, Mo.—GC, P, SL, WF
 NATIONAL COMPANY, 61 Sherman St., Malden, Mass.—CS, SKT, TS, BP, CD, J, MB, P, SL, T, MISC
 NATIONAL VULCANIZED FIBRE CO., Wilmington, Del.—WF
 NEW ART SPECIALTIES, INC., 816 W. Erie St., Chicago, Ill.—MB, SL, MISC, SPW, PK5, SW
 A. OLEK, 4759 Melrose St., Phila., Pa.—GC
 PARKER-KALON CORP., 200 Varick St., New York, N. Y.—SS
 PAUL & BECKMAN, 4250 Wissahickon Ave., Phila., Pa.—CS, TS, MB, MISC
 PHILCO RADIO & TELEVISION CORP., Tioga & C Sts., Phila., Pa.—CS, SKT, TS, BP, C, G, J, P, GRC, MISC, SL, T
 PHILMORE MFG. CO., 113 University Place, New York, N. Y., *'Philmore'—BP, P, J, SKT
 RADIO ELECTRIC SERVICE CO., INC., N. W. Cor. 7th & Arch Sts., Phila., Pa.—BP, CD, CS, C, GRC, G, J, MB, P, SKT, SL, T, TS, MISC
 RADOLEK COMPANY, 601 W. Randolph St., Chicago, Ill.—BP, CD, CS, C, GC, G, J, MB, P, SKT, SL, TS, T, MISC
 REMLER CO., LTD., 2101 Bryant St., San Francisco, Calif., *'Remler'—SKT
 WALTER L. SCHOTT CO., 5264 1/2 W. Pico Blvd., Los Angeles, Calif.—CD
 MAURICE SCHWARTZ & SON, 710-712 Broadway, Schenectady, N. Y.—BP, CD, CS, C, GC, G, J, MB, P, SKT, SL, T, TS, MISC
 SELECTAR MFG. CORP., 30 W. 15th St., New York, N. Y.—C, J, P
 SHAKEPROOF LOCK WASHER CO., 2539 N. Keeler Ave., Chicago, Ill.—WL, MISC
 H. B. SHERMAN MFG. CO., 22 Barney St., Battle Creek, Mich.—C, SL
 MAXWELL SMITH CO., 1027 N. Highland & Hollywood Aves., Hollywood, Calif.—SKT, T
 SORENG-MANEGOLD CO., 1901 Clybourn Ave., Chicago, Ill.—P, SKT, T
 SPAULDING FIBER CO., INC., 310 Wheeler St., Tonawanda, N. Y.—FS
 STANLEY TOOLS, P. O. Drawer 1316, New Britain, Conn.—G
 STEWART STAMPING CORP., 621 East 216 St., New York, N. Y.—MB, SL
 F. W. STEWART MFG. CORP., 340 W. Huron St., Chicago, Ill., *'Stewart'—FS
 SUN RADIO CO., 212 Fulton St., New York, N. Y.—BP, CD, CS, C, GRC, G, J, MB, P, S, SL, TS, T, MISC

SYNTHANE CORPORATION, Highland Ave., Oaks, Pa.—SKT, T
 *TEFTT RADIO CO., Plymouth, Mich.—S
 TELERADIO ENGINEERING CORP., 484 Broome St., New York, N. Y., *'Teleradio'—C, MB, T, CD, CS, SKT, SL
 TILTON ELECTRIC CORP., 15 E. 26th St., New York, N. Y., *'Ex-Stat'—T
 THE TRIPLET ELECTRICAL INSTRUMENT CO., Bluffton, Ohio—BP, J
 UNITED RADIO MFG. CO., 191 Greenwich St., New York, N. Y.—EBP, BSTR
 UTAH RADIO PRODUCTS CO., 820 Orleans St., Chicago, Ill.—GC, P, TS
 S. S. WHITE DENTAL MFG. CO., 10 E. 40th St., New York, N. Y.—FS, CP
 WILCOX ELECTRIC CO., INC., 4014 State Line, Kas 35 City, Kans.—TS
 WILMINGTON FIBER SPECIALTY CO., Wilmington, Del.—WF
 X-L RADIO LABORATORIES, 420 West Chicago Ave., Chicago, Ill.—BP
 *YAXLEY—P. R. MALLORY & CO., INC., ZEIRICK MFG. CORP., 385 Gerard Ave., New York, N. Y.—C, GC, MB, SL, SC, T

MAURICE SCHWARTZ & SON, 710-712 Broadway, Schenectady, New York—C, D, HA, HABC, M
 SUN RADIO CO., 212 Fulton St., New York, N. Y.—C, D, M
 TRIMM RADIO MFG. CO., 1770 W. Berneau Ave., Chicago, Ill., *'Trimm'—HA, M
 UNIVERSAL MICROPHONE CO., Inglewood, Calif.—C, D
 WESTERN ELEC. CO., 300 Central Ave., Kearny, N. J.—HA, M, D
 WESTERN SOUND & ELECTRIC LABS, INC., 311 W. Kilbourn Ave., Milwaukee, Wis.—HA
 ZENITH RADIO CORP., 6001 Dickens Ave., Chicago, Ill.—HA

HEARING AIDS



Complete (desk type) . . . CDT
 Complete (portable, personal) . . . CPP
 Wearable vacuum-tube aids W
 Ladies' comb. vanity . . . LCV

ALLIED RADIO CORP., 833 W. Jackson Blvd., Chicago, Ill.—CDT, CPP
 AMPLIFIER CO. OF AMERICA, 17 West 20th St., New York, N. Y.—CPP
 AUDIO DEVELOPMENT CO., 123 Bryant Ave. N., Minneapolis, Minn.—CPP, GEC
 AUDIOGRAPH SOUND SYSTEMS, 1313 W. Randolph St., Chicago, Ill.—CDT
 CRYSTAL EAR, INC., 2007 S. Michigan Ave., Chicago, Ill.—CDT, CPP
 ELECTRONIC SOUND & MUSIC CO., 10 Stuyvesant St., New York, N. Y.—CPP
 ERWOOD SOUND EQUIPMENT CO., 224 W. Huron St., Chicago, Ill.—CDT
 ESPEY MFG. COMPANY, INC., 305 East 63d Street, New York, N. Y.—CDT
 EXECUTONE, INC., 415 Lexington Ave., New York, N. Y.—CDT
 GLOBE PHONE MFG. CORP., Reading, Mass.—CDT, CPP
 CHARLES JACK MFG. CORP., 27 East Philadelphia St., York, Pa.—CDT
 LAUREHK RADIO MFG. CO., 3918 Monroe Ave., Wayne, Mich.—CDT, CPP
 M & G HEARING AIDS COMPANY, 30 N. Michigan Ave., Chicago, Ill.—CDT, CPP, W
 MAJESTIC RADIO & TELEVISION CORP., 2600 W. 50th St., Chicago, Ill.—CDT, CPP
 MILES REPRODUCER CO., INC., 812 Broadway, New York, N. Y.—CDT, CPP
 MONTGOMERY WARD & CO., 619 W. Chicago Ave., Chicago, Ill.—CDT, CPP
 E. A. MYERS & SONS, 306 Beverly Rd., Mt. Lebanon, Pittsburgh, Pa.—CDT, CPP
 PARAPHONE HEARING AID, INC., 4300 Euclid Ave., Cleveland, Ohio—CDT, CPP
 RADOLEK COMPANY, 601 W. Randolph St., Chicago, Ill.—CDT, CPP
 ROTOPHONE CORPORATION, 26 Journal Square, Jersey City, N. J.—CDT, CPP, LCV
 SHURE BROTHERS, 225 W. Huron St., Chicago, Ill.—M
 TAY BERN EQUIPMENT CORP., 135 Liberty St., N. Y.—CPP
 TELEX PRODUCTS CO., Minneapolis, Minn.—CDT, CPP
 TRANSFORMER CORP. OF AMERICA, 69 Wooster St., New York, N. Y.—CDT, CPP
 VACOLITE COMPANY, 3003 N. Henderson St., Dallas, Texas—CDT, CPP
 WEBSTER ELECTRIC CO., Racine, Wisconsin—CDT, CPP

HEADPHONES



Crystal C
 Dynamic D
 Hearing-aid HA
 Magnetic M
 Hearing-aid (bone conductor) HABC

ALLIED BURNS CO., 1008 Madison Ave., Toledo, Ohio—HA
 ALLIED RADIO CORP., 833 W. Jackson Blvd., Chicago, Ill., *'Knight'—M, C, D, HA, HABC
 AMPLIFIER CO. OF AMERICA, 17 W. 20th St., New York, N. Y.—HA
 AUDIO DEVELOPMENT CO., 123 Bryant Ave., North Minneapolis, Minn.—HA
 AUDIOGRAPH, John Meck Industries
 BRUSH DEVELOPMENT CO., 3311 Perkins Ave., Cleveland, Ohio—C, HA
 C. F. CANNON CO., Springwater, N. Y.—M
 CARRIER MICROPHONE CO., 439 S. La Brea Ave., Inglewood, Calif., *'Carrier'—D
 CARRON MFG. CO., 415 S. Aberdeen St., Chicago, Ill.—*'Carron'—M, HA
 CHICAGO TELEPHONE SUPPLY CO., 1142 W. Beardsley Ave., Elkhart, Ind., *'Frost'—M
 CONNECTICUT TEL. & ELEC. CO., 70 Britannia St., Meriden, Conn.—C, M
 CRUMPACKER DIST. CORP., 1801 Fannin St., Houston, Tex.—C, M
 DE VRY CORPORATION, 1111 Armitage Ave., Chicago, Ill.—HA
 ELECTRICAL INDUSTRIES MFG. CO., Red Bank, N. J.—M
 FISCHER DISTRIBUTING CORP., 222 Fulton St., New York, N. Y.—C, D, HA, HABC, M
 *FROST, Chicago Telephone Supply Co.
 GLOBE PHONE MFG. CORP., Reading, Mass.—HA, HABC, M
 HARRISON RADIO CO., 12 West Broadway, New York, N. Y.—C, D, HA, M, HABC
 HERBERT H. HORN, 1201 S. Olive St., Los Angeles, Calif.—M
 *ICA—Insuline Corp. of America
 INSULINE CORP. OF AMERICA, 30-30 Northern Blvd., Long Island City, N. Y., *'ICA'—M
 *KNIGHT, Allied Radio Corp.
 LAFAYETTE RADIO CORP., 100 6th Ave., New York, N. Y.—C, HA, M
 LAUREHK RADIO MFG. CO., 3918 Monroe Ave., Wayne, Mich.—HABC
 M. & G. HEARING AIDS COMPANY, 30 N. Michigan Ave., Chicago, Ill.—C, HA, M, HABC
 M & H SPORTING GOODS CO., 512 Market St., Phila., Pa.—C, M
 MAJESTIC RADIO & TELEVISION CORP., 2600 W. 50th St., Chicago, Ill.—HA, HABC
 MAICO COMPANY, INC., 83 S. 9th St., Minneapolis, Minn.—D, HA
 JOHN MECK INDUSTRIES, 1313 W. Randolph St., Chicago, Ill., *'Audiograph'—HA
 T. R. McELROY, 100 Brookline Ave., Boston, Mass.—M
 MONTGOMERY WARD & CO., 619 W. Chicago Ave., Chicago, Ill.—HA, M, C
 E. A. MYERS & SONS, 306 Beverly Rd., Mt. Lebanon, Pittsburgh, Pa.—D, HA, HABC, M
 PARAPHONE HEARING AID, INC., 4300 Euclid Ave., Cleveland, Ohio—HA, M
 PHILCO RADIO & TELEVISION CORP., Tioga & C Sts., Philadelphia, Pa.—M
 PHILMORE MFG. CO., 113 University Place, New York, N. Y., *'Philmore'—M
 RADIO ELECTRIC SERVICE CO., INC., N. W. Cor. 7th & Arch Sts., Phila., Pa.—C, D, HA, M, HABC
 RADOLEK COMPANY, 601 W. Randolph St., Chicago, Ill.—C, D, HA, M, HABC
 RCA MFG. CO., Front & Cooper Sts., Camden, N. J., *'RCA'—HA, HABC
 ROTOPHONE CORPORATION, 26 Journal Square, Jersey City, N. J.—HA, HABC

HEARING-AID PARTS



Cases C
 Earphones and bone conductors E
 Microphones M
 Resistors, special ultra-midget variable R
 Tubes T
 Transformers & chokes TC
 Condensers, special ultra-midget S
 Batteries, miniature BM
 Amplifier lamps (home use) AL
 Audiometers A

AEROVOX CORPORATION, New Bedford, Mass.—S
 ALLIED RADIO CORP., 833 W. Jackson Blvd., Chicago, Ill.—C, E, M, R, T, TC

• CLASSIFIED RADIO DIRECTORY •

AMPLIFIER CO. OF AMERICA, 17 West 20th St., New York, N. Y.—C, E, M, R, T, TC
 ARLAVOX MFG. CO., 430 S. Green St., Chicago, Ill.—TC
 ASTATIC MICROPHONE LABORATORY, INC., 830 Market St., Youngstown, Ohio—M
 AUDIO DEVELOPMENT CO., 123 Bryant Ave. N., Minneapolis, Minn.—C, E, TC, A
 BOND PRODUCTS CO., 13139 Hamilton Ave., Detroit, Mich.—C
 THE BRUSH DEVELOPMENT CO., 3311 Perkins Ave., Cleveland, Ohio—E, M
 CLAROSTAT MFG. CO., INC., 285 N. 6th St., Brooklyn, N. Y.—R
 ELECTRO-VOICE MFG. CO., INC., 1239 South Bend Ave., South Bend, Ind.—M
 ELECTRONIC APPLICATIONS, Brunswick, Maine—TC
 GLOBE PHONE MFG. CORP., Reading, Mass.—C, E, M, T, TC
 HARRISON RADIO CO., 12 West Broadway, New York, N. Y.—T
 HYGRADE SYLVANIA CORP., 500 5th Ave., New York, N. Y.—T
 INTERNATIONAL RESISTANCE CO., 401 N. Broad St., Phila., Pa.—R
 LAFAYETTE RADIO CORP., 100 6th Ave., New York, N. Y.—E, M, R, T, TC
 LAUREHK RADIO MFG. CO., 3918 Monroe Ave., Wayne, Mich.—C, E
 M & G HEARING AIDS CO., 30 North Michigan Ave., Chicago, Ill.—C, E, M, P, T, TC
 P. R. MALLORY & CO., INC., 3029 E. Washington St., Indianapolis, Ind.—R
 MONTGOMERY WARD & CO., 619 W. Chicago Ave., Chicago, Ill.—C, R, T, TC
 NATIONAL COMPANY, INC., 61 Sherman St., Malden, Mass.—TC
 RADOLEK COMPANY, 601 W. Randolph St., Chicago, Ill.—C, E, M, R, T, TC
 FOTOPHONE CORPORATION, 26 Journal Square, Jersey City, N. J.—C, E, M, AL
 SELECTAR MFG. CORP., 30 W. 15th St., New York, N. Y.—M
 SOLAR MFG. CORP., Avenue A & 25th St., Bayonne, N. J.—S
 TAY BERN EQUIPMENT CORP., 135 Liberty St., New York, N. Y.—E, M, T, TC, BM
 TELERADIO ENGINEERING CORP., 484-90 Broome St., New York, N. Y.—TC
 TELEX PRODUCTS CO., Minneapolis, Minn.—C
 TRANSDUCER LABORATORIES, 42 W. 48th St., New York, N. Y.—M
 THORDARSON ELECTRIC MFG. CO., 500 W. Huron Street, Chicago, Ill.—TC
 UNITED TRANSFORMER CORP., 150 Varick St., New York, N. Y.—TC
 WIRT COMPANY, 5221-27 Greer St., Phila., Pa.—R

BARKER & WILLIAMSON, Ardmore, Pa.—C, PL, SO
 BEE ENGINEERING CO., 7665 Grand River Ave., Detroit, Mich.—PL, SO, T, VC
 BENTLEY, HARRIS MFG. CO., Conshohocken, Pa., *B.H.—T, FG
 BIRNBACH RADIO CO., INC., 145 Hudson St., New York, N. Y.—C, SO, T, VC
 BOND PRODUCTS CO., 13139 Hamilton Ave., Detroit, Mich.—T
 BOONTON MOLDING CO., 326 Myrtle Ave., Boonton, N. J.—PL
 L. S. BRACH MFG. CORP., 55 Dickerson St., Newark, N. J.—SO
 WM. BRAND & CO., 276 4th Ave., New York, N. Y.—M, T
 BRANDYWINE FIBER PRODUCTS CO., 14th & Walnut Sts., Wilmington, Del.—F
 BUD RADIO, INC., 5205 Cedar Ave., Cleveland, Ohio, *Bud"—PL, SO
 CELLULOSE CORPORATION, 10 E. 40th St., New York, N. Y., *Lumarith Protectoid"—PL
 THE CHICAGO PAPER TUBE & CAN CO., 137 So. Albany Ave., Chicago, Ill.—P, F
 CONTINENTAL DIAMOND FIBRE CO., Newark, Del., *Diamond," *Dilecto,"—F, M, PL
 CORNING GLASS WORKS, Walnut St., Corning, N. Y., *Pyrex"—SO, FG
 COTO COIL CO., INC., 71 Willard Ave., Providence, R. I.—C, SO
 *CROLITE—Henry L. Crowley & Co.
 HENRY L. CROWLEY & CO., 1 Central Ave., West Orange, N. J., *Crolite"—F
 CRUMPACKER DIST. CORP., 1801 Fannin St., Houston, Tex.—TCF, TR
 HARRY DAVIES MOLDING CO., 1428 N. Wells St., Chicago, Ill.—PL
 *DIAMOND, Continental-Diamond Fibre Co.
 *DILECTO, Continental-Diamond Fibre Co.
 E. I. DUPONT DE NEMOURS & CO., INC., Plastics Dept., 626 Schuyler Ave., Arlington, N. J.—PL
 DUREZ PLASTICS & CHEMICALS, INC., North Tonawanda, N. Y., *Durez"—PL
 HAMMARLUND MFG. CO., INC., 424 W. 33rd St., New York, N. Y.—SO
 HUGH H. EBY, INC., 4700 Stenton Ave., Philadelphia, Pa.—PL
 EMPIRE NOTION CO., 105 E. 29th St., New York, N. Y.—TCF, T, VC
 ERIE RESISTOR CORP., 644 W. 12th St., Erie, Pa.—PL
 FEDERAL SALES CO., 26 S. Jefferson St., Chicago, Ill.—T
 FISCHER DISTRIBUTING CORP., 222 Fulton St., New York, N. Y.—C, F, FG, M, P, PL, SO, TCF, TR, T, VC
 M. M. FLERON & SON, INC., 113 N. Broad St., Trenton, N. J.—SO
 FORMICA INSULATION CO., 4638 Spring Grove Ave., Cincinnati, Ohio, *Formica"—PL
 *FYBEROID, Wilmington Fibre Specialty Co.
 GENERAL CEMENT MFG. CO., 1041 Kilbourn Ave., Rockford, Ill.—T, VC, TCF, TR
 GENERAL CERAMICS CO., 30 Rockefeller Plaza, New York, N. Y.—B, C, SO
 GENERAL CERAMICS CO. PLANT NO. 3, Keesbey, N. J.—C, SO
 GENERAL ELECTRIC CO., Lynn, Mass.—M
 GENERAL ELECTRIC CO., Schenectady, N. Y.—C, F, P, PL, SO, T, VC, MY
 HARRISON RADIO CO., 12 W. Broadway, New York, N. Y.—C, F, G, M, SO, TCF, TR, T, VC
 HAWLEY PRODUCTS CO., 201 N. 1st Ave., St. Charles, Ill.—IC
 *ICA, Insuline Corp. of America
 *INSUROK, Richardson Co.
 INSULINE CORP. OF AMERICA, 3030 Northern Blvd., Long Island City, N. Y., *ICA"—C, SO, T, VC, F, PL
 INSULATION MANUFACTURERS CORP., 565 W. Washington Blvd., Chicago, Ill.—F, FG, M, P, PL, TCF, TR, T, VC
 INSULATION PRODUCTS CO., 504 N. Richard St., Pittsburgh, Pa.—PL
 IRVINGTON VARNISH & INSULATOR CO., 18 Argyle Terrace, Irvington, N. J., *Irv-O-Volt"—FG, PL, T, VC
 *IRV-O-VOLT, Irvington Varnish & Insulator Co.
 ISOLANTITE INCORPORATED, 233 Broadway, New York, N. Y., *Isolantite"—B, C, SO
 E. F. JOHNSON, Waseca, Minn., *Johnson"—C, SO
 KELLOGG SWITCHBOARD & SUPPLY CO., 6650 S. Cicero Ave., Chicago, Ill.—TR
 LAFAYETTE RADIO CORP., 100 6th Ave., New York, N. Y.—C, F, FG, M, P, PL, SO, TCF, TR, T, VC
 *LAMICOID, Mica Insulator Co.
 *LUMARITH PROTECTOID, Celluloid Corp.
 MAAS & WALDSTEIN CO., 438 Riverside Ave., Newark, N. J.—E
 MANUFACTURERS SCREW & SUPPLY HOUSE, 215 W. Illinois St., Chicago, Ill.—T, VC
 MEISSNER MFG. CO., Mt. Carmel, Ill.—SO
 MICA INSULATOR CO., 200 Varick St., New York, N. Y.—F, FG, M, P, PL, T, VC
 MICARTA FABRICATORS, INC., 4619 Ravenswood Ave., Chicago, Ill.—F, PL, T
 JAMES MILLEN MFG. CO., INC., 150 Exchange St., Malden, Mass.—C, PL, SO
 J. W. MILLER CO., 5917 S. Main St., Los Angeles, Calif., *Miller"—SO
 MONTGOMERY WARD & CO., 619 W. Chicago Ave., Chicago, Ill.—C, PL, SO, TCF, TR
 MYCALEX CORP. OF AMERICA, 7 E. 42nd St., New York, N. Y.—C
 *N-C, National Company
 NATIONAL COMPANY, 61 Sherman St., Malden, Mass.—SO, PL, C
 NATIONAL VULCANIZED FIBRE CO., Wilmington Del., *Phenolite"—F, P, PL

*OHMOID, Wilmington Fibre Specialty Co.
 PARISIAN NOVELTY CO., 3510 S. Western Ave., Chicago, Ill.—PL
 GEORGE F. PETTINOS, INC., 1206 Locust St., Phila., Pa.—F
 *PHENOLITE, National Vulcanized Fibre Co.
 PREMAX PRODUCTS, Niagara Falls, N. Y.—SO
 *PYREX, Corning Glass Works
 RACON ELEC. CO., INC., 52 E. 19th St., New York, N. Y.—PL
 RICHARDSON COMPANY, 27th & Lake Sts., Melrose Park, Ill., *Irsurok"—PL
 RADOLEK COMPANY, 601 W. Randolph St., Chicago, Ill.—C, F, FG, M, P, PL, SO, TCF, TR, T, VC
 RADIO ELECTRIC SERVICE CO., INC., N. W. Cor. 7th & Arch Sts., Phila., Pa.—G, FG, M, PL, SO, TCF, TR, T, VC
 THE RICHARDSON CO., 27th & Lake Sts., Melrose Park, Ill.—M, PL, HR
 MAURICE SCHWARTZ & SON, 710-712 Broadway, Schenectady, N. Y.—C, F, FG, M, P, PL, SO, TCF, TR, T, VC
 SELF-VULCANIZING RUBBER CO., INC., 605 W. Washington Blvd., Chicago, Ill.—PL
 SPAULDING FIBRE CO., INC., 310 Wheeler St., Tonawanda, N. Y., *Spauldite," *Armitite," *Spauldite"—F, P
 *SPAULDITE, Spaulding Fibre Co., Inc.
 *SPAULDO, Spaulding Fibre Co., Inc.
 STUPAKOFF LABORATORIES, INC., 6627 Hamilton Ave., Pittsburgh, Pa.—C
 SUN RADIO COMPANY, 212 Fulton St., New York, N. Y.—C, F, G, M, P, PL, SO, TCF, TR, T
 SYNTHANE CORPORATION, Highland Ave., Oaks, Pa., *Synthane"—PL
 TAYLOR FIBRE CO., Norristown, Pa.—F, PL
 TELERADIO ENGINEERING CORP., 484-90 Broome St., New York, N. Y.—C, F, M, PL, T
 UNITED RADIO MFG. CO., 191 Greenwich St., New York, N. Y.—HR
 HOPE WEBBING CO., P. O. Box 1495, Providence, R. I.—FG
 WESTINGHOUSE ELEC. & MFG. CO., E. Pittsburgh, Pa.—PL
 WILMINGTON FIBRE SPECIALTY CO., Wilmington, Del., *Fyberoid," *Ohmoid"—PL, F
 ZOPHAR MILLS, INC., 112-130 26th St., Brooklyn, N. Y.—PL, W

INSULATION



Bushings	B
Ceramics	C
Enamel	E
Fiber	F
Fiber-glass	FG
Friction Tape	FT
Mica	M
Paper	P
Plastics	PL
Stand-off insulator	SO
Tubing (varnished)	T
Varnished Cambric	VC
Tape (cloth friction)	TCF
Tape (rubber)	TR
Hard-rubber	HB
Polystyrene	PO
Mycolox	MY
Insulation cases	IC

ACME WIRE CO., New Haven, Conn.—VC
 THE AKRON PORCELAIN CO., Akron, Ohio—C, SO
 ALDEN PRODUCTS CO., 715 Center St., Brockton, Mass.—PL, T
 ALLIED RADIO CORP., 833 W. Jackson Blvd., Chicago, Ill.—C, F, FG, M, P, PL, SO, TCF, TR, T, VC
 ALPHA WIRE CORP., 50 Howard St., New York, N. Y.—T
 *ALSMAG—American Lava Corp.
 AMERICAN LAVA CORP., Cherokee Blvd. & Mfrs. Road, Chattanooga, Tenn., *Alsmag"—C, SO
 AMERICAN PHENOLIC CORP., 1250 Van Buren St., Chicago, Ill., *Amphenol"—C, PL, SO, PO
 AMERICAN RADIO HARDWARE CO., 476 Broadway, New York, N. Y., *Arhco"—PL, SO
 *AMPHENOL, American Phenolic Corp.
 *ARHCO, American Radio Hardware Co.
 *ARMITE, Spaulding Fibre Co., Inc.
 AUBURN BUTTON WORKS, INC., Auburn, N. Y.—PL
 BAKELITE CORPORATION, 247 Park Ave., New York, N. Y.—P

INTERCOMMUNICATING SYSTEMS



Wired W
 Wireless WS

*"ACA", Amplifier Co. of America.
 ALLIED RADIO CORP., 833 W. Jackson Blvd., Chicago, Ill., *Knight"—P, R
 AMERICAN COMMUNICATIONS CORP., 123 Liberty St., New York, N. Y.—W
 AMERICAN TELEVISION CORP., 130 W. 56th St., New York, N. Y.—W, WS
 AMPLIFIER CO. OF AMERICA, 17 W. 20th St., New York, N. Y., *ACA"—W
 AUTOCRAT RADIO CO., 3855 N. Hamilton Ave., Chicago, Ill., *Autocrat-Phone"—W
 BANK'S MFG. CO., 5019 N. Winthrop Ave., Chicago, Ill.—W, WS
 BARKER & WILLIAMSON, Ardmore, Pa.—WS
 *BELFONE, Bell Sound Systems, Inc.
 BELL SOUND SYSTEMS, INC., 1183 Essex Ave., Columbus, Ohio, *Belfone"—W
 DAVID BOGEN CO., INC., 663 Broadway, New York, N. Y.—W
 BRUSH DEVELOPMENT CO., 3311 Perkins Ave., Cleveland, Ohio—W
 CHICAGO SOUND SYSTEMS CO., 200 E. Illinois St., Chicago, Ill.—W, WS
 *CLARION, Transformer Corp. of America
 CONN. TEL. & ELEC. CORP., 70 Britannia St., Meriden, Conn.—W
 CRUMPACKER DIST. CORP., 1801 Fannin St., Houston, Tex.—W
 DE VRY CORPORATION, 1111 Armitage Ave., Chicago, Ill.—W
 DE WALD RADIO MFG. CORP., 436 Lafayette St., New York, N. Y.—W
 ELECTRICAL INDUSTRIES MFG. CO., Red Bank, N. J.—W
 ELECTRONIC CONTROL CORP., 2667 East Grand Blvd., Detroit, Mich.—W
 ELECTRONIC PRODUCTS CO., St. Charles, Ill.—WS
 ELKAY MFG. CORP., 200 5th Ave., New York, N. Y.—W
 ESPEY MFG. COMPANY, INC., 305 East 63d St., New York, N. Y.—W
 EXECUTONE, INC., 415 Lexington Ave., New York, N. Y.—W
 FISCHER DISTRIBUTING CORP., 222 Fulton St., New York, N. Y.—W, WS
 THOMAS B. GIBBS & CO., 900 W. Lake St., Chicago, Ill.—W
 GUIDED RADIO CORP., 118 E. 25th St., New York, N. Y.—W, WS
 HARRISON RADIO CO., 12 W. Broadway, New York, N. Y.—W, WS

CLASSIFIED RADIO DIRECTORY

INTERCALL SYSTEMS, INC., 5th & Norwood, Dayton, Ohio—W
 CHARLES JACK MFG. CORP., 27 E. Philadelphia St., York, Pa.—W
 JONES-ORME CO., 2233 University Ave., St. Paul, Minn.—W
 KARADIO CORPORATION, 2233 University Ave., St. Paul, Minn.—W WS
 KELLOGG SWITCHBOARD & SUPPLY CO., 6650 S. Cicero Ave., Chicago, Ill.—W
 *KNIGHT, Allied Radio Corp.
 LAFAYETTE RADIO CORP., 100 6th Ave., New York, N. Y.—W
 LAKE MFG. CO., 2323 Chestnut St., Oakland, Calif., *"Voycall"—W
 MAJESTIC RADIO & TELEVISION CORP., 2600 W. 50th St., Chicago, Ill.—W, WS
 MILES REPRODUCER CO., INC., 812 Broadway, New York, N. Y.—W, WS
 MILLION RADIO & TELEVISION LABS., 685 W. Ohio St., Chicago, Ill., *"Million"—W
 MONTGOMERY WARD & CO., 619 W. Chicago Ave., Chicago, Ill.—W
 OPERADIO MFG. CO., 13th & Indiana Sts., St. Charles, Ill.—W
 FACENT ENGINEERING CORP., 79 Madison Ave., New York, N. Y., *"Pacent"—W
 PHONOTONE LABORATORIES, INC., S. E. 15th St., Washington, Ind.—W
 RACON ELECTRIC CO., INC., 52 E. 19th St., New York, N. Y.—W
 RADEX CORPORATION, 1733 Milwaukee Ave., Chicago, Ill.—W, WS
 RADIO ELECTRIC SERVICE CO., INC., N. W. Cor. 7th & Arch Sts., Phila., Pa.—W, WS
 RADIO RECEPTOR CO., INC., 251 W. 19th St., New York, N. Y.—W
 RADIO WIRE TELEVISION, INC., 100 6th Ave., New York, N. Y.—W, WS
 RADOLEK COMPANY, 601 W. Randolph St., Chicago, Ill., *"Radolek"—W, WS
 RCA MFG. CO., Front & Cooper Sts., Camden, N. J.—W, WS
 REGAL AMPLIFIER MFG. CORP., 14 W. 17th St., New York, N. Y.—W, WS
 REMLER CO., LTD., 2101 Bryant St., San Francisco, Calif., *"Remler"—W
 SETCHELL CARLSON, INC., 2233 University Ave., St. Paul, Minn.—W
 SILLCOX RADIO & TELEVISION CORP., 60 Wall Tower, New York, N. Y.—W, WS
 SUN RADIO CO., 212 Fulton St., New York, N. Y.—W, WS

TALK-A-PHONE MFG. CO., 1847 S. Millard Ave., Chicago, Ill.—W
 TELEMOTOR CORPORATION, 260 5th Ave., New York, N. Y.—W
 TELERADIO ENGINEERING CORP., 484-90 Broome St., New York, N. Y.—WS
 TELEX PRODUCTS CO., Minneapolis, Minn.—W
 TRANSDUCER LABORATORIES, 42 W. 48th St., New York, N. Y.—W
 TRANSFORMER CORP. OF AMERICA, 69 Wooster St., New York, N. Y., *"Clarior"—W
 TRANSMARINE RADIO, INC., 1184 Broadway, Hewlett L. I., N. Y.—W, WS
 UNIVERSAL MICROPHONE CO., Inglewood, Calif.—W
 VIBRALOC MFG. CO., 1273 Mission St., San Francisco, Calif.—W
 *VOYCALL, Lake Mfg. Co.
 THE WEBSTER CO., 5622 W. 8 comingdale Ave., Chicago, Ill.—W
 WEBSTER ELECTRIC CO., Racine, Wis.—W
 WESTERN ELEC. CO., 300 Central Ave., Kearny, N. J.—W
 WESTERN SOUND & ELECTRIC LABS., INC., 311 W. Kilbourn Ave., Milwaukee, Wis.—W

CRUMPACKER DIST. CORP., 1801 Fannin St., Houston, Tex.—P, R
 ELECTRO PRODUCTS LABORATORIES, 549 W. Randolph St., Chicago, Ill.—P, R
 FISCHER DISTRIBUTING CORP., 222 Fulton St., New York, N. Y.—P, R
 M. M. FLERON & SON, INC., 113 N. Broad St., Trenton, N. J.—R
 GENERAL ELECTRIC CO., Schenectady, N. Y.—R
 GUIDED RADIO CORP., 118 E. 25th St., New York, N. Y.—P
 HAMMOND MFG. CO., Guelph, Ontario, Canada—R
 HARRISON RADIO CO., 12 W. Broadway, New York, N. Y.—P, R
 HERBERT H. HORN, 1201 S. Olive St., Los Angeles, Calif.—P
 INSULINE CORP. OF AMERICA 30-30 Northern Blvd., Long Island City, N. Y.—P, R
 KENYON TRANSFORMER CO., INC., 840 Barry St., Bronx, N. Y.—P
 LAFAYETTE RADIO CORP., 100 6th Ave., New York, N. Y.—P, R
 MEISSNER MFG. CO., Mt. Carmel, Ill.—R
 P. R. MALLORY & CO., INC., 3029 E. Washington St., Indianapolis, Ind.—P, R
 M & H SPORTING GOODS CO., 512 Market St., Phila., Pa.—P, R
 MONTGOMERY WARD & CO., 619 W. Chicago Ave., Chicago, Ill.—P, R
 OHMITE MFG. CO., 4835 W. Flounoy St., Chicago, Ill.—P
 PHILCO RADIO & TELEVISION CORP., Phila., Pa.—P, R
 PHILMORE MFG. CO., INC., 113 University Place, New York, N. Y.—R
 RADEX CORPORATION, 1733 Milwaukee Ave., Chicago, Ill.—R
 RADIO ELECTRIC SERVICE CO., INC., N. W. Cor. 7th & Arch Sts., Phila., Pa.—P, R
 RADOLEK COMPANY, 601 W. Randolph St., Chicago, Ill.—P, R
 MAURICE SCHWARTZ & SON, 710-712 Broadway, Schenectady, N. Y.—P, R
 SPRAGUE PRODUCTS CO., North Adams, Mass.—P, R
 SUN RADIO CO., 212 Fulton St., New York, N. Y.—P, R
 TECHNICAL APPLIANCE CORP., 17 E. 16th St., New York, N. Y.—R
 TOBE DEUTSCHMANN CORP., Washington St., Canton, Mass.—P
 UNITED TRANSFORMER CORP., 150 Varick St., New York, N. Y.—P

LINE FILTERS



Power filters (industrial) . . . P
 Radio set (for the home) . . . R

AMERICAN COMMUNICATIONS CORP., 123 Liberty St., New York, N. Y.—P, R
 AMERICAN CONDENSER CORP., 2508 S. Michigan Ave., Chicago, Ill.—P, R
 AEROVOX CORPORATION, New Bedford, Mass.—R
 BELDEN MFG. CO., 4647 W. Van Buren St., Chicago, Ill.—R
 BUD RADIO, INC., 5203 C. St. A., Cleveland, Ohio—R
 CARRON MFG. CO., 415 S. Ardmore St., Chicago, Ill.—R
 CONTINENTAL CARBON INC., 13900 L. Ave., Cleveland, Ohio—P, R
 CONSOLIDATED WIRE & ASSOCIATED CORP., 512 S. Peoria St., Chicago, Ill.—R

(Continued next month.)

Mr. Radio Serviceman:

RSA MEANS BUSINESS!

New business promotion plans and new member-helps spell increased profits for RSA members at the start of the new season. Watch for the RSA Replacement Parts Guide—New Broadcast Promotions—New Member Helps! Don't be the last man in your neighborhood to join RSA. Send the coupon Today!

MAIL THIS COUPON NOW!

RADIO SERVICEMEN OF AMERICA, INC.
 304 S. Dearborn St., Chicago, Ill.

I am interested in RSA Membership. Tell me about it.

Name

Address

City State

RC-1149

Let's Grow Together
 in 1940!



RADIO SERVICEMEN OF AMERICA, Inc.

Reliable Service Assured

JOE MARTY, JR., EXECUTIVE SECRETARY
 304 S. DEARBORN STREET, CHICAGO, U.S.A.

HUM ELIMINATION

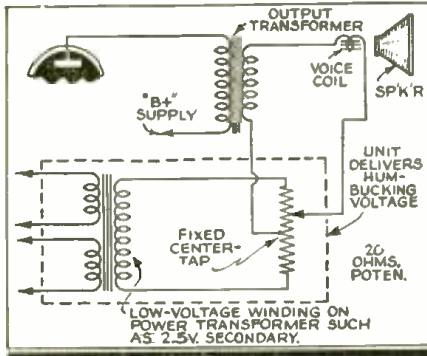

● HUM has always been one of the Serviceman's problems in radio repairing. I've found one way, here illustrated, of effective hum reduction, especially when it originates in the speaker. The trick is to feed a small A.C. voltage to the voice coil in an opposite phase to the hum voltage originating in the speaker. The amount of hum voltage fed to the speaker can be adjusted by means of the potentiometer's slider in order to balance-out the unwanted hum voltage. It has proven very helpful to me, especially in the older sets.

HAROLD R. KUNTZ,
Brooklyn, N. Y.

UNIFORM HOUSINGS FOR TEST EQUIPMENT



● TO bring testing instruments of different panel sizes to a uniform height, and above the level of the receiver under test, the re-installation of the instruments in cabinets of identical height and fitted with drawers for test leads, etc., offers a practical and inexpensive solution. Utilizing separate cabinets, rather than combining the instruments on one panel, permits rapid interchange of their positions to meet the convenience of the technician.

EDDY RADIO SERVICE SYSTEM,
Springfield Gardens, N. Y.

IMPROVED BEAT-FREQUENCY OSCILLATOR

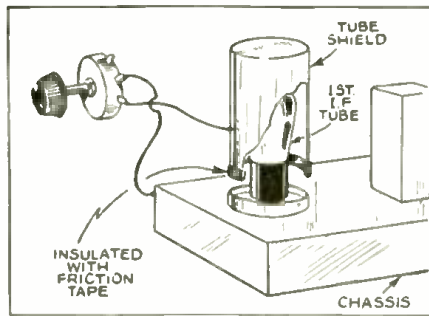

● HERE is a simple way to add a beat oscillator to any superheterodyne receiver with only the addition of a 2,000-ohm volume control which any one can put on externally without interfering with the receiver circuit. Simply raise the tube shield on the 1st intermediate-frequency amplifier tube and use some tape to keep it from

touching the chassis; or in the case of form-fitting shields, bend the grounding prong away from the shield so that the shield has no contact with chassis.

Next fasten a short piece of wire from the center of a 2,000-ohm potentiometer volume control to chassis, and connect another piece of insulated wire from one of the outside connections of the control to the tube shield. When the control arm is rotated so as to remove all resistance between the shield and chassis the tube circuit will not oscillate as before, but when rotated so as to introduce resistance between shield and chassis it will regenerate, and if turned far enough will go into oscillation.

Many radio amateurs who use ordinary receivers will find this a very inexpensive and quickly-constructed beat oscillator for receiving code and locating weak stations; it also makes the receiver twice as sensitive by the regeneration.

Receiver circuits which will not oscillate with the shield removed from tube, will do so if the shield is on the tube but insulated from the chassis. Receiver using metal tubes can be used this way also by substituting a glass tube of the same number (called the G series) and then putting a shield over it as illustrated.

(MRS.) OLE FYGLESTAD,
Powers Lake, North Dakota.

FREE! NEW 1941 PROFIT GUIDE
Everything in RADIO!
At Lowest Prices!



COMPLETE SELECTIONS
GUARANTEED QUALITY

Faster Delivery

Most complete stocks of Universal and Exact Duplicate Replacement and Repair Parts, Radio Sets, and Amateur Supplies.

P. A. EQUIPMENT

Separate amplifiers or complete systems with any desired assortment of speakers, horns, baffles and microphones. Everything from 5 to 100 watts. Prices that save money for you.

ELECTRICAL APPLIANCES

Extra profits for you! Standard Brand Electric Irons, Grills, Toasters, Percolators, Waffle Irons, Vacuum Cleaners, Clocks, Mixers, etc., at lowest prices.

MAIL THIS COUPON TODAY

The RADOLEK Co.
691 W. Randolph St., Chicago, Dept. C-47
Send the New 1941 Radio Profit Guide FREE.
Name
Address Dealer?
Expert? Serviceman? Amateur?

WARNING TO RADIO-CRAFT READERS

Radio-Craft has no representatives in the field soliciting subscriptions, in the "door-to-door" fashion. Pay no money to any person who comes to your home, store or service shop and represents himself as being an agent for Radio-Craft. Subscriptions may be safely obtained only from authorized subscription agencies, whose names we shall be glad to furnish, or directly from us by mail. Address your letter to Subscription Dept., Radio-Craft, 20 Vesey St., New York, N. Y.

Get This Electric Dry Shaver

ABSOLUTELY FREE!



JUST THINK OF IT—you can get absolutely FREE, the useful DRY ELECTRIC SHAVER which is shown at the left. This ELECTRIC DRY SHAVER is sent to you by the publishers with a one-year subscription to RADIO-CRAFT.

Here Are the Features of The
ELECTRIC DRY SHAVER

Constructed of metal with attractive red bronze finish. Scientifically constructed to give a perfectly clean shave. 5-foot rubber insulated cord and plug. Constructed to last for many years.

Operates from 110-volt, 60-cycle A.C. electric line. Carries a two-year manufacturer's guarantee. A fine quality, self-sharpening toilet necessity.

Send your subscription to RADIO-CRAFT for One Year (12 issues) and receive absolutely FREE one of these remarkable Electric Dry Shavers. New subscribers are accepted or you may extend your present subscription another twelve months. Mail your remittance of \$2.00 (plus 25c for shipping charges on Shaver) to the publishers. (Canada and foreign \$2.75.) You will receive your DRY ELECTRIC SHAVER immediately by return mail. Use coupon below to enter your subscription.

RADIO-CRAFT

20 Vesey Street, New York, N. Y.

RADIO-CRAFT, 20 Vesey Street, New York, N. Y.

Gentlemen: Enclosed find my remittance of \$2.00 for which enter my subscription to RADIO-CRAFT for one year (12 issues). Send me immediately FREE, ELECTRIC DRY SHAVER (Canada and foreign \$2.75). In U. S. add only 25c additional to cover shipping charges on Shaver.

New Subscriber Extend Present Subscription

Name

Address

City State

(Send remittance by check, money order or unused U.S. Postage Stamp. Reply by letter if you send cash or stamps.)

RC-1140

WE SHIP ELECTRIC DRY SHAVER THE SAME DAY YOUR SUBSCRIPTION ORDER IS RECEIVED.

CLIP COUPON—
AND MAIL!

GEOPHYSICAL PROSPECTING OUTFITS



BLUE PRINTS and INSTRUCTIONS

For Building the Following Treasure Finders and Prospecting Outfits

- Folder No. 1. The "Radiolector Pilot"**—consists of a 2-tube transmitter and 3-tube receiver. Principle: radiated wave from transmitter loop is reflected back to receiver loop. Emits visual and aural signals. Tubes used: two 1A5G—two 1N6G—one 1H5G.
- Folder No. 2. The "Harmonic Frequency Locator"**—Transmitter radiates low frequency wave to receiver, tuned to one of Harmonics of transmitter. Using regenerative circuit. Emits aural signals. Tubes used: one 1G6G—one 1N6G.
- Folder No. 3. The "Beat-Note Indicator"**—Two oscillators so adjusted as to produce beat-note. Emits visual and aural signals. Tubes used: Three type '30.
- Folder No. 4. The "Radio-Balance Surveyor"**—a modulated transmitter and very sensitive loop receiver. Principle: Balanced loop. Emits visual and aural signals. By triangulation depth of objects in ground can be established. Tubes used: Seven type '30.
- Folder No. 5. The "Variable Inductance Monitor"**—a single tube oscillator generating fixed modulated signals and receiver employing two stages R.F. amplification. Works on the inductance principle. Emits aural signals. Tubes used: six type '30.
- Folder No. 6. The "Hughes Inductance-Balance Explorer"**—a single tube Hartley oscillator transmitter and sensitive 3-tube receiver. Principle: Wheatstone bridge. Emits aural signals. Tubes used: two type '30—one type '32—one type '33.
- Folder No. 7. The "Radiodyne Prospector"**—a completely shielded instrument. Principle: Balanced loop. Transmitter, receiver and batteries enclosed in steel box. Very large field of radiation and depth of penetration. Emits aural signals. Tubes used: two 1N5G—one 1G4G—one 1H5G—one 1Q5—one 1G4.

With any one of the modern geophysical methods described in the Blue-Print patterns. Radio outfits and instruments can be constructed to locate metal and ore deposits (prospecting); finding lost or buried treasures; metal war relics; sea and land mines and "duds"; mineral deposits; subterranean water veins; oil deposits (under certain circumstances); buried gas and water pipes; tools or other metallic objects—sunken in water, etc., etc.

Each set of blueprints and instructions enclosed in heavy envelope (9" x 12 1/2"). Blueprints 22" x 34"; eight-page illustrated 8 1/2" x 11" folder of instructions and construction data. **50¢** Add 3¢ for postage

The complete set of seven folders. Shipping weight 2 lbs. (add 25¢ for shipping anywhere in U.S.A.) **\$3.00**

TECHNIFAX

RC-1140

1917 S. STATE ST. CHICAGO, ILL.

TECHNIFAX 1917 So. State, Chicago, Ill.

Enclosed herewith \$..... for which mail to address below:

Treasure Finder No. 1. 2. 3. 4. 5. 6. 7.
Complete set of seven folders.

NAME

ADDRESS

CITY STATE

RC-1140

PERPETUAL TROUBLE SHOOTER'S MANUAL, Vol. XI. Published by John F. Rider (1940). Size, 9 x 11 1/2, hard cover and loose-leaf binding, over 1,600 pages. Price \$10.

Newest addition to the well-known Rider's Service Manuals is the 1,600-pg. volume No. XI which differs from preceding manuals in 2 respects; the text structure has been changed to afford more complete service information in less space; and, a new principle of indexing has been applied which makes it easier for Servicemen to spot desired circuits. Included with the manual is a special 18-pg. booklet combining a convenient index to circuit; and, an analysis of circuit features in the new radio sets.

Also included with this manual is a "vest pocket manual supplement" containing a convenient index to the manual and important information such as transformer, resistor and condenser color codes, etc., for which the Serviceman finds everyday use.

ESSENDEN—BUILDER OF TOMORROWS, by Helen M. Fessenden (1940). Published by Coward-McCann, Inc. Size, 6 x 9 ins., cloth cover. 362 pgs. Price, \$3.00.

In the biography, "Essenden—Builder of Tomorrows," the wife of the former professor of electrical engineering at Purdue University, Indiana and at Western University (University of Pittsburgh), has erected a monument to the work of Reginald A. Fessenden, one of the pioneer builders of the Radio Empire.

He is perhaps best known for the system of radio telegraphy and telephony which bears his name. The Fessenden System of communication included only some of his 500 patents, others widely known being for example a marine depth finder and a system of submarine signaling.

Here for the first time is presented the inside life story of the trials and problems that beset a man who as early as 1900 had demonstrated his own system of radio telephony; and in 1906 2-way transatlantic radio telegraphy.

TELEVISION RECEIVING EQUIPMENT, by W. T. Cocking (1940). Published by Hiffe & Sons Ltd., London, England. American agent: Nordemann Pub. Co., Inc. Size, 5 x 7 1/2 ins., cloth cover. 167 illustrations. 300 pgs. Price, 7 10; in U. S., \$2.25.

Here is a meaty book on television which preserves for posterity the advances in television which took place in England prior to cessation of activities "for the duration." The book is excellently illustrated. The following chapters selected at random impart an impression of its contents.

Chapter 1—General Principles of Television; Chapter 12—Superheterodyne Interference Problems; Chapter 16—Special Television Circuits; Chapter 19—Faults and Their Remedies; Chapter 20—Television Servicing.

MOTOROLA AUTO-RADIO SERVICE MANUAL—1941 Edition. Published by Supreme Publications. Size, 8 1/2 x 11 ins., stiff paper cover. 96 pgs. Price, \$1.

This diagram, alignment and troubleshooting manual is described as containing "information for repairing every Motorola radio."

In addition to a large number of Motorola (Galvin Mfg. Corp.) radio receiver diagrams, the book contains individual sections titled as follows: service hints, coil color codes, alignment procedure, installation of the Magic Eliminator for elimination of ignition interference, eliminating other types of interference, servicing push-button tuning controls, use of oscilloscope in alignment, and service details on the electric automatic tuner. The book concludes with a general discussion of wheel and tire static.

NOTIONS COMPLEMENTAIRES SUR LES TUBES ELECTRONIQUES, by M. Chauvierre (1940). Published by Dunod, Paris, France. Size, 5 1/2 x 8 1/2 ins., stiff paper cover, profusely illustrated, 201 pgs. Price, 94 francs.

This newest book, by a professor at the Central School of Radio and a consulting engineer, supplements the previously-published work of Mesny in France, Chaffee in America and Barkhausen in England. The book discusses in theoretical terms the elements of electronic operation.

Essentially mathematical, the book is too heavy for appreciation except by those who are familiar with technical French. The following are the titles of a few chapter headings, selected at random: Chapter I is a study of lamps in general; Chapter III, distortion; Chapter IV, power amplification; Chapter VI, detection.

Index to advertisers

PUBLIC ADDRESS EQUIPMENT

Amplifier Co. of America.....	283
Erwood Sound Equipment Co.....	283
John Meek Industries.....	279
Miles Reproducer Co.....	279
Music Master Mfg. Co.....	273
RCA Mfg. Co., Inc.....	279
The Turner Company.....	289
Universal Microphone Co., Ltd.....	283
University Laboratories.....	279
Wright-DeCoster, Inc.....	283

PUBLISHERS

Andel, Publishers.....	261
Data Print Co.....	295
Miller, Wayne.....	275
National Plans Inst.....	261
Rudcraft Publications, Inc.....	262, 308
Radio & Technical Pub. Co.....	260
Radio Publications.....	310
Supreme Publications.....	289, 295, 302
Technifax.....	302, 320

RADIO PARTS

Amperite Co.....	Inside Front Cover
Bright Star Battery Company.....	269
Dumont Electric Co., Inc.....	275
Hammabund Mfg. Co.....	271
International Resistance Co.....	267
National Union Radio Corp.....	277
Ohmite Mfg. Company.....	296
Solar Mfg. Corp.....	273

RADIO SETS

Goldentone Radio Co.....	273
Howard Radio Co.....	251
Midwest Radio Corp.....	305
E. H. Scott Radio Lab., Inc.....	292

RADIO SUPPLY HOUSES

Allied Radio Corp.....	289
Anchor Radio Distributing Service.....	267
Burstein-Applebee Co.....	271
Lafayette Radio Corp.....	301
Radolek Co.....	319

SCHOOLS

Capitol Radio Eng. Inst.....	287
Lincoln Engineering School.....	261
National Radio Institute.....	257
National Schools.....	261
New York Y.M.C.A. Schools.....	261
Radio Training Assoc.....	261
RCA Institutes.....	261
Sprayberry Academy of Radio.....	261

TEST EQUIPMENT

Meissner Mfg. Company.....	259
Radio City Products Co.....	287
Reudrite Meter Works.....	288
RCA Manufacturing Co., Inc.....	307
Simpson Electric Company, Inside Back Cover	
Superior Instruments Co.....	271, 273, 275
Supreme Instruments Corp.....	292
Triplett Electrical Instrument Co., Back Cover	

TUBES

Hygrade Sylvania Corp.....	269
----------------------------	-----

MISCELLANEOUS

Barber & Howard.....	275
Classified Section.....	304
Lancaster, Allwine & Rommel.....	292
Radio Servicemen of America.....	318
Remington Rand, Inc.....	309
Woodstock Typewriter Co.....	302

(While every precaution is taken to insure accuracy, we cannot guarantee against the possibility of an occasional change or omission in the preparation of this index.)

"OOMP!!"

You can't find it in the dictionary but you can find it in **TODAY'S SIMPSON LINE**

If you saw Simpson Instruments at the show you saw something that ordinary words can't describe. In Hollywood they call it "oomph" . . . today's fast way of saying "more of everything".

The Model 400 Tube tester (opposite) is typical of these Simpson Testers that have more of everything . . . more class, more precision, more engineering against obsolescence. We studied your right-now testing problem; then solved it all the way in an instrument as modern as tomorrow.

Right down the line Simpson Instruments have been designed by and for your needs. A few leaders in the 1940 Simpson hit parade are briefly described here. All are covered by the handsome new catalog.

Ask for your copy

SIMPSON ELECTRIC COMPANY
5216-18 Kinzie Street, Chicago, Illinois

**MODEL 310
SIGNAL GENERATOR**

• Reports from independent laboratories prove this to be the most stable and accurate direct-reading signal generator ever offered at a price you can pay..... **\$37.50**



See them at your jobber

SIMPSON

Instruments that STAY accurate



↑ **MODEL 400 TUBE TESTER**

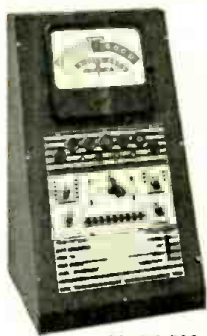

Model 500

NEVER before have so many advanced features been combined in a tube tester. These features include:

UNIT DESIGN—the socket panel and the roll chart can be individually removed. Replacement units can be ordered for those needing reconditioning or replacement while you keep right on using the tester. Obsolescence effects only individual units—not entire tester. Old units can be returned for credit so that you can keep the tester up to date at low cost.

SPARE SOCKETS—Two spare sockets (one large and one small) are provided in addition to sockets for 4, 5, 6, 7 and 8-prong tubes, loctals, bantams, midgets and miniatures.

VISUAL GUIDE—Note guide lines that "tie in" roll chart with switches, preventing errors.

THREE-WAY SWITCHING—Each toggle switch has "off" position so that any prong can be left open. Valuable in testing tubes like ILNG or tapped filament tubes like 3525; also various sections of multipurpose tubes in present or future groupings.

SPEED ROLL CHART—Smoother, better operation than ever before. In addition to regular listing has numerical index which speeds up reading. Also has window for writing data for at least 50 new tubes on blank portion of roll chart. Entire chart easily and inexpensively replaced.

YOUR NAME ENGRAVED ON THE PANEL—Simply send us the plate. No charge whatever.

Your price on Model 400..... **\$36.00**

MODEL 500. Same instrument in display cabinet with big, 9-inch meter (see illustration)—a remarkable tube merchandiser..... **\$43.00**



Model 450

**MODEL 450
"TEST MASTER"**

• Service men have called it more for the money than any all-service tube and set tester on the market. Has new Simpson 3-way switching as described above; sockets for 4, 5, 6 and 7-prong tubes, loctals and bantams. As set tester has 8 A.C. voltage ranges; 5 resistance ranges; 5 milliamp ranges; 5 Decibel ranges. Your price only..... **\$39.75**

TRIPLET

Automatic VOLT-OHM- MILLIAMMETER

**PUSH
BUTTON
TYPE**

MODEL 1200-F

Push-button switching by a new, simpler way makes the Model 1200-F an entirely automatic Volt-Ohm-Milliammeter with maximum speed and minimum switching. Only one button need be pressed for any range and test setting. Ranges: DC 0-10-50-250-500-1000 at 25,000 ohms per volt. . . . AC 0-10-50-250-500-1000 at 1000 ohms per volt. DC Milliamperes 0-1-10-50-250. . . . 0-50 DC Microamperes. . . . Resistance 0-1000 Low Ohms, shunt type circuit; 0-300,000 ohms; 0-3 and 0-30 Megohms, series type circuit. Self-contained batteries for all ranges. RED • DOT Lifetime Guaranteed Instrument, rectifier type. Plug-in rectifier simplifies replacement in case of accidental damage. Metal case with rich brown suede enamel finish. Panel with attractive three-tone finish. Dealer Net Price \$27.84

Model 1200-A . . . Selector Switch Operated . . . 2,000 Ohms per Volt DC . . . Volt-Ohm-Milliammeter . . . Dealer Net Price \$21.84

Model 1200-C . . . Selector Switch Operated . . . 5,000 Ohms per Volt DC . . . Volt-Ohm-Milliammeter . . . Dealer Net Price \$22.84

\$27.84
DEALER NET PRICE

Model 1200-E . . . Selector Switch Operated . . . 25,000 Ohms per Volt DC . . . Volt-Ohm-Milliammeter . . . Dealer Net Price \$25.84



**MODEL 1600-E
ULTRA SENSITIVE TESTER**
DC Volts—0-10-50-250-1000 at 25,000 ohms per volt. AC—0-10-50-250-1000 at 1000 ohms per volt. Plug-in copper oxide rectifier easily replaced in case of overload, is used to obtain AC readings. Current 0-50 Microamperes; 0-1-10-50-250-500 Milliamperes. Resistance 1/2 to 500. Low Ohms, shunt type circuit; 20,000 and 200,000 ohms; 2 and 20 Megohms. In Portable Case . . . Dealer Net Price \$25.50
Model 1600-E for panel mounting, less case . . . Dealer Net Price \$21.00



Write for catalog on complete line of test equipment. Triplet also manufactures electrical measuring instruments in more than 25 case styles. Section 1611 Harmon Drive,

**MODEL
666**

**VOLT-
OHM-
MILLIAMMETER**



A complete pocket-size Volt-Ohm-Milliammeter with AC-DC Voltage ranges: 0-10-50-250-500-1000 at 1000 ohms per volt; DC Milliamperes 0-1-10-50-250; Low Ohms 1/2 to 300; High Ohms to 250,000 with provisions for higher readings by external batteries . . . Molded case and panel . . . Dealer Net Price \$14.00

THE TRIPLET ELECTRICAL INSTRUMENT COMPANY
Bluffton, Ohio