

April/May 2003  
Issue No. 82

# Radio Bygones

£3.25  
ISSN 0956-974X

The  
Torn.E.b  
German  
Portable  
Battery  
Receiver

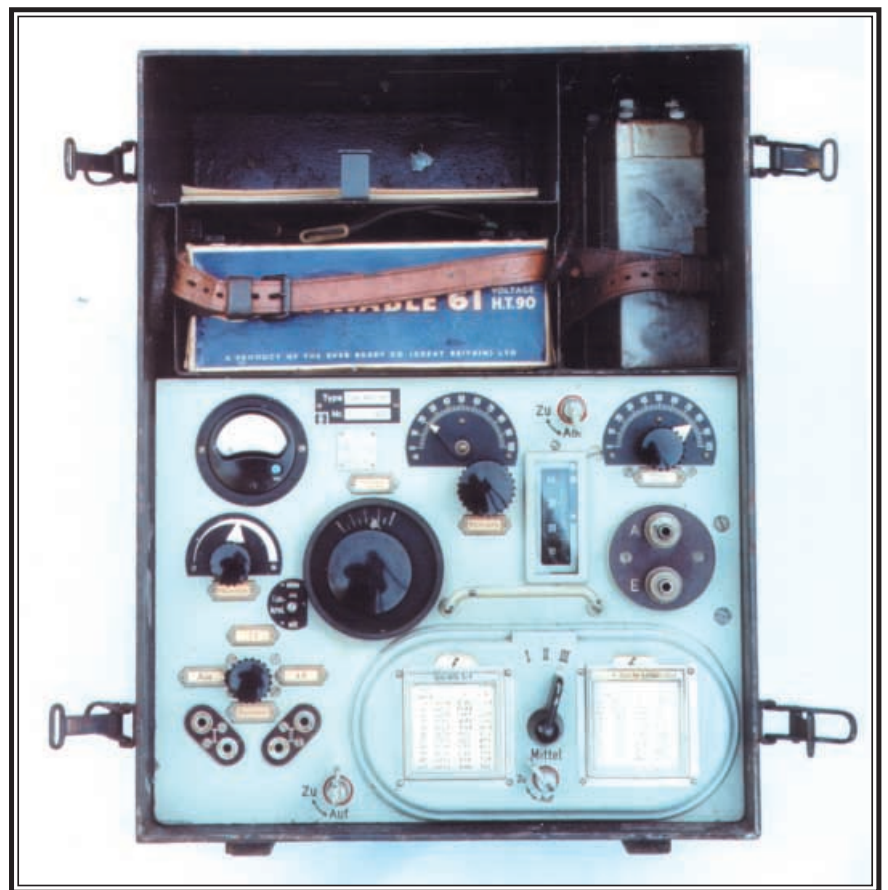

The Marconi Exhibition at Sandford Mill, Chelmsford  
Restoring A Goblin S25 'Time Spot' Receiver  
A Wobbulator Unit – Constructional project

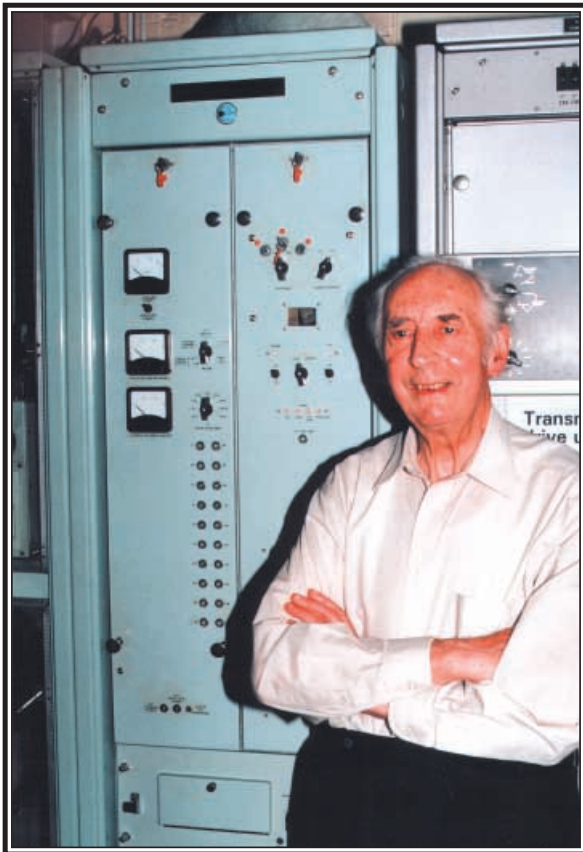

---

# MUSEUM PIECES

---

Photographs of the Marconi  
Exhibition at Sandford Mill,  
Chelmsford – see the article  
in this issue.

Photos by Michael O'Beirne, G8MOB

---

Charles Burnham, G4PC (above), the  
designer of the H1000 linear amplifier,  
in front of his product

Right – the paralleled helically wound  
inductors in the H1000 linear amplifier  
feeding eighteen 4CX250B valves

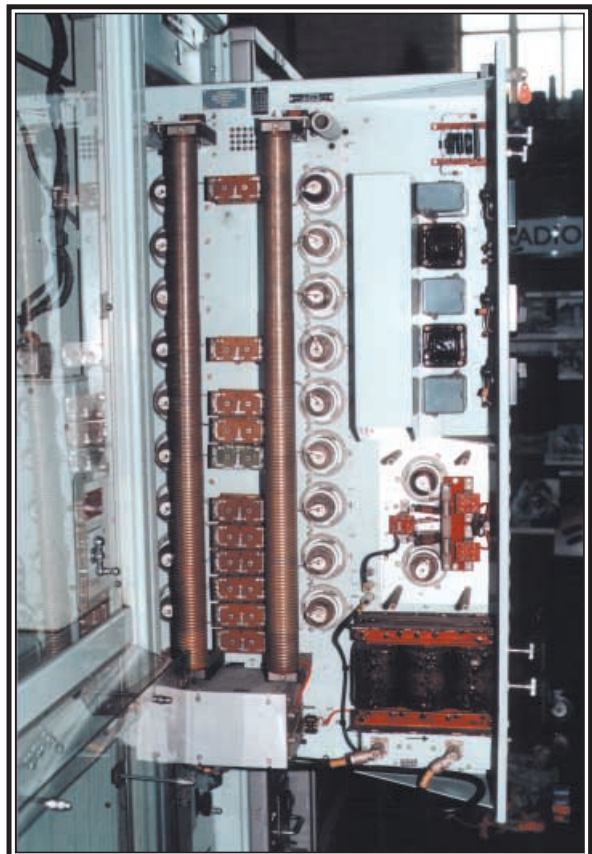

# Radio Bygones

April/May 2003  
Issue No. 82

Published 25 MARCH 2003  
ISSN 0956-974X

**Editor**  
Mike Kenward

**Editorial and Subscription  
Offices**

Radio Bygones  
Wimborne Publishing Ltd  
408 Wimborne Road East  
Ferndown  
Dorset BH22 9ND  
England

**Telephone 01202 873872**

Fax 01202 874562

Email

radiobygones@wimborne.co.uk

Web sites

www.radiobygones.co.uk

www.radiobygones.com

**Advertisement Manager**

Peter Mew

**Advertisement Offices**

Mill Lodge, Mill Lane  
Thorpe-le-Soken,  
Essex CO16 0ED  
**Telephone/Fax 01255 861161**

Printed as part of the Norman  
W. Hardy Printing Group.  
(Telephone 01202 785850)  
by DAP (Sussex) Ltd.,  
Portslade, East Sussex

**ON OUR FRONT COVER**

*The Torn.E.b*

Photograph by R. T. Walker, G4PRI

## Pen In Hand

Every month, and twice a month every other month (if you can follow that), I sit down to write an Editorial. One for *Everyday Practical Electronics* and one for *RB* – fortunately our other publications do not carry Editorials. The problem is always what to write about this time. Maybe the impact of technology on a possible war or the differences in communications since the last one. Possibly I should write something about one of the articles in this issue – recommend the Wobbulator project or discuss Dr. Rogers' underground aerials.

Maybe it should be an insight into the development of TV, thoughts triggered by the excellent book on John Logie Baird we have reviewed – or more correctly *not* reviewed (see page 34) – in this issue. The book consists of 476 pages, so there was plenty to write about there; obviously a great mind was at work in the early 1900s.

Or maybe it should be about something unusual or funny, like why when the magazine is produced on computers my office is still full of piles of paper and we seem to have the ability to generate more of it every day. Or why I still write this rubbish with a pen and can only type with two fingers, little faster than the guy who put new tyres on my car last week.

## So What?

In the end it is often difficult to decide what to say and sometimes all the ideas I have fail to materialise into a viable and interesting piece – hence these three hundred odd words about little or nothing. Sometimes it's just like that – not much going on between the ears. I hope you don't feel too cheated.



## In This Issue

### PRINCIPAL FEATURES

- 4 **The Torn E.b** by R. T. Walker, G4PRI
- 8 **The Marconi Exhibition** by Michael O'Beirne, G8MOB
- 12 **A Wobbulator Unit** by Raymond Haigh
- 20 **Rogers Really Did It** by Ron
- 24 **Restoring a Goblin S25 'Time Spot'**  
by Tony Thompson
- 30 **QRM Sixty Years Ago** by Michael O'Beirne, G8MOB
- 32 **Restoration of a Typical Superhet Valve Receiver**  
– Part 4 by Eric Kempshall

### OTHER ITEMS

- 2 **News & Events**
- 19 **Back Issues CD-ROMs**
- 33 **Book Reviews**
- 35 **Service & Valve Data CD-ROMs**
- 36 **Bookshelf**
- 37 **Feedback**
- 40 **Free Readers' Adverts**

### ADVERTISEMENTS

- 23 **BVWS**
- 23 **Chevet Books and Supplies**
- 31 **Morsum Magnificat**
- 31 **National Vintage Communications Fair**
- 23 **On The Air**
- 31 **Sound Systems of Suffolk**
- 7 **Variable Voltage Technology Ltd**
- 7 **Wilson Valves**

**COPYRIGHT** © Wimborne Publishing Ltd. 2003. Copyright in all drawings, photographs and articles published in *Radio Bygones* is fully protected and reproduction or imitation in whole or in part is expressly forbidden. All reasonable precautions are taken by *Radio Bygones* to ensure that the advice and data given to readers is reliable. We cannot however guarantee it and we cannot accept legal responsibility for it.

# Radio Bygones

RADIO BYGONES is published bi-monthly (six issues per year).

Make certain of getting your favourite vintage radio magazine regularly by taking out a subscription. The magazine is **not available** from newsagents.

Send your name and address (including your postcode), with a cheque or postal order payable to **Wimborne Publishing Limited** to:

**Radio Bygones, Wimborne Publishing Ltd, 408 Wimborne Road East, Ferndown, Dorset BH22 9ND, England.**

Phone: 01202 873872, Fax: 01202 874562  
**Cheques or drafts MUST be in Sterling.**

Payment by Mastercard, Visa, Amex, Diners Club or Switch accepted by 'phone, fax or post. **Quote card number, expiry date and card security code (the last three digits on or just below the signature strip) plus Issue No. for Switch. Please also supply a telephone number.**

**Subscription rate** (post paid):

	1 year	2 years
<b>UK</b>	£18.50	£35.00
<b>Europe</b>	£20.50	£39.00
<b>Rest of the World</b>	£24.50	£47.00

(all overseas copies sent by airmail)

You can also subscribe on-line at [www.radiobygones.co.uk](http://www.radiobygones.co.uk)  
Online issues are available to download from [www.radiobygones.com](http://www.radiobygones.com)

## BACK NUMBERS

<b>UK</b>	£3.25
<b>Europe airmail or Rest of the World surface mail</b>	£3.75
<b>Rest of the World airmail</b>	£4.25

DEDUCT 10% IF YOU ORDER 6 OR MORE ISSUES

Index for *RB1* to *RB72* £3.25

**RB 6, 13, 14, 17, 21, 23, 24, 25, 26, 29, 30, 31, 33, 35, 37, 38 & 43 are now out of print. Stocks of several other issues are almost gone.**

## BINDERS for Radio Bygones

Each binder holds 12 issues, safely retained by strong wires.

Price including postage and packing, and VAT where appropriate:

**UK addresses:**

£7.90 each or £15.00 for two.

**Other EU member countries:**

£9.60 each or £16.90 for two.

**Rest of the World via surface mail**

£8.90 each or £17.00 for two.

# News & Events

## For your diary

### National Vintage Communications Fair

SUNDAY 4 May 2003 is the day of the *National Vintage Communications Fair* at N.E.C. Birmingham. Now in its 11th year, doors are open from 10.30am to 4.00pm, admission £5 (although there is an early entry around 8.30am for £15).

There will be thousands of vintage wireless sets, crystal sets, valve amplifiers, classic hi-fi, horn loudspeakers, record players and gramophones, plus records (both 78s and CDs), valves, spares, early TVs, old telephones, plus mechanical and electrical antiques and collectables. 300 stallholders are due to be present, including *RB*.

For more details and stall booking contact N.V.C.F. 13 Belmont Road, Exeter, Devon EX1 2HF.

Tel: 01392 411565.

Web: [www.angelfire.com/tx/sunpress/index.html](http://www.angelfire.com/tx/sunpress/index.html).

### Race For Kempton Park

SUNDAY 27 April 2003 – don't be "pipped at the post", get there first! The *West London Radio and Electronics Show* is to be held at Kempton Park Race Course, Sunbury on Thames, Middx. It will be the first national show at Kempton Park to be held in 2003. It is a one day event and will consist of private and professional trade stalls.

The RSGB have recognised the importance of this event and are fully supporting it by being on hand to discuss issues of the day. They will have a bookstand too.

The Centre offers enough room for 400 tables. There will be a Bring and Buy sale, organised by Echelford Radio Society. Morse testing facilities will be available, with qualified testers. Refreshments are available, and Public parking will be free, with space for 1200 cars in the all-weather area.

There will also be a radio call-in facility on 2m which will be managed

by Whitton Radio Society, with a call sign of GB2KRT.

Booking contact: Brian Cannon G8DIU, 38 Sandringham Road, Worcester Park, Surrey KT4 8UJ.

Tel/fax 01737 279108.

Email: [Brian.Cannon@btinternet.com](mailto:Brian.Cannon@btinternet.com).

### Race For Epsom

SUNDAY 22 June 2003 is the starting dateline for the *Radio and Electronics Fair* to be held at Epsom Grandstand, Surrey, from 10am to 5pm. After the success of the last rally in 2002, the organisers have been encouraged to stage another. The Fair has become the number one event for the region.

It is a one day event and will consist of private and trade stalls with added attractions throughout the day, amongst which will be a Bring and Buy sale. Also, on behalf of the RSGB, a National Construction Contest will be held, with a trophy. Morse testing facilities will be available as well. There will also be a display of military vehicles by VMARS (Vintage and Amateur Radio Society), plus a WW2 operations room talking station!

Refreshments are available, and further entertainment will be provided by Ken Mackintosh and his 17-member band.

Booking contact: Brian Cannon G8DIU, 38 Sandringham Road, Worcester Park, Surrey KT4 8UJ.

Tel/fax 01737 279108.

Email: [Brian.Cannon@btinternet.com](mailto:Brian.Cannon@btinternet.com).

### G.W.M. Radio Moves

G.W.M. Radio have moved! They are still in Worthing, but now not far from Worthing Central train station at: 63 Victoria Road, Worthing, W.Sussex BN11 1UN. Tel: 01903 234897. Fax: 01903 239050. Email: [info@gwmradio.freeserve.co.uk](mailto:info@gwmradio.freeserve.co.uk). Web: [www.gwmradio.co.uk](http://www.gwmradio.co.uk). There is map of how to find them on the web site.

Thank you to *RB* reader Geoff Hopkins of Worthing for advising us. Geoff says that GWM have been selling ex-WD radio and the like at the previous premises since at least the 1960's

and that some of the best known items he has bought from them are 18, 38, 88, 1154 and CR100 sets, plus 'scopes and signal generators etc. Only recently he bought a Cossor 3343 ganging oscillator that has "already given me hours of pleasure for only £7.50".

## Tudor With Gusto!

IT'S good to see that Tudor Gwilliam-Rees continues to make his presence felt! You will recall that Tudor recently sold Savoy Hill Publications – "the most unique collection of Service Manuals there is!" – to Paul and Alex Ollivier. In his editorial of the *The Antique Wireless Newssheet No.1* February 2003, he says that he's "back again after a short break! But back with a gusto".

Tudor's White Town Vintage business has lots of new stock items, including pick-up cartridges, can HT capacitors, styli, steel gramophone needles, a selection of vintage radios, classic audio equipment, plenty of used and new books, magazines, loudspeaker surround repairs, components new and used, transformer rewinds and valves, etc.

Contact: White Town Vintage, 50 Meddon Street, Bideford, Devon

EX39 2EQ. Tel/fax: 01237 424280. Email: white.vintage@virgin.net.

Savoy Hill Publications can be contacted at Fir View, 7 Rabys Row, Scorrier, Redruth, Cornwall TR16 5AW. Tel: 01209 820771. Email: sales@savoy-hill.co.uk. (We have received their *Savoy News 192* and note that Paul and Alex are "still working though piles of paper" but they "now resemble organised piles"!)

## Newsletters Received

*Radio Waves*, the quarterly publication of the Historical Radio Society of Australia (HRSA). Secretary Les Hodgson, HRSA, PO Box 2283, Mt. Waverley, Vic 3149, Australia.

*Hallo Hallo* is a Norwegian publication (in Norwegian) of the Norsk Radiohistorisk Forening. Contact NRHF, Mekanikerveien 32, 0683, Oslo, Norway.

Tel: 22 75 62 11. Fax: 22 75 62 12.

E-mail: nrhf@nrhf.no.

Web: www.nrhf.no.

*Antique Radio Classified*. The monthly national (USA) publication for buyers and sellers of old radios and

related items. It includes masses of For Sale and Wanted advertisements and details of forthcoming radio events in the USA. Contact PO Box 2, Carlisle, MA 01741, USA.

Tel: (866) 371 0512.

Fax: (978) 371 7129.

E-mail: ARC@antiqueradio.com.

Web: www.antiqueradio.com.

*N.Z.V.R.S. Bulletin* of the New Zealand Vintage Radio Society. Secretary Paul Woodcock, 2 Levy Road, Glen Eden, Auckland, New Zealand. Tel: 09/8184740.

Email: office@nzvrs.pl.net.

Web: www.nzvrs.pl.net.

*TV Graphics Review*. Articles and illustrations relating to TV test cards, identification screens and allied subjects. Editors Keith Hamer and Garry Smith, HS Publications, 7 Epping Close, Derby DE22 4HR.

Tel: 01332 381699.

Web: www.test-cards.fsnet.co.uk.

Note that telephone numbers are quoted as given in the publication listed. Prefix codes are likely to be different if calling from another country.

## REVIVING SILENT HUMBER?



REGULAR *RB* reader and contributor Ron has written in with an interesting suggestion:

"Many an older and seagoing wireless operator", says Ron, "will remember the dulcet tones of Humber Radio's MCW signals 'de GKZ'. I remember as a young lad when I was allowed to see the station, which filled me with a feeling of lasting impression. Later I came to know several of the station's operators.

"It was a former GKZ operator, Stan Bevan, who took me through my Radio Amateur Morse test at the GPO, St Martin's le Grande in London. Gerry Whitehead, the Station Officer, now lives in Mablethorpe in retirement, but still operates his own amateur radio station.

"Humber Radio existed in several technical modes from the 20s until its closure some three years ago. Now it stands 'For Sale' and would make a splendid home for an active

radio amateur. There is plenty of room for masts and a sizeable set of aerials."

Ron enclosed three photographs, taken by Bobby Irving. Two were of Radio Humber's last masts, the third was of the remaining buildings of Humber Radio GKZ, now empty and austere, as shown above.

Doing a web search via [www.google.com](http://www.google.com) revealed that there are around 50 links in which Humber Radio GKZ is mentioned. The link through [www.coastalradio.greater-peterborough.com/humber.htm](http://www.coastalradio.greater-peterborough.com/humber.htm) shows eight photographs of the site, including some of the aerials. The web site says that the station, which was located just south of Mablethorpe, closed 30 June 2000. There is also a click-link from this site to download in Word format the *Humber Radio Story* by David Hopcroft, the last manager of the station.

# The Torn.E.b

## The German Portable Battery Receiver Type 24b-305

by R. T. Walker, G4PRI

I first became acquainted with the Torn.E.b after the end of the German occupation of the Channel Islands. During the occupation, it had become an offence to possess a radio and most domestic sets had been confiscated. Listening was still carried out on secret crystal sets and hidden, under floor, receivers! In 1945 the family pointed out to me that neighbours nearby had acquired a German field radio receiver which worked very well – had I not better go and look for something similar. Diligent searching unearthed a Torn.E.b (with battery box) and, with the aid of a transformer and speaker the household was back on air!

### Most Elegant

It was my humble opinion that the German Torn.E.b receiver was probably the most elegant TRF set ever made, if not the most elegant set overall. However, Arthur Bauer (PA0AOB) and Dick Rollema (PA0SE) have been at pains to point out to me that the Lorenz Lo 6K 39 was probably the most elegant TRF set. I also had to agree with them that “the most elegant overall” was a title to be bestowed on the E52 series of receivers. The E52 series did not appear until 1943 so, I will nominate the Torn E.b/24b-305 as the most elegant pre 1940 TRF receiver!

The Telefunken Torn.E.b /24b-305 (Spez 976 Bs) receiver was the end product of a series of Telefunken ‘portable’ receivers developed mainly for field use from the late 1920s onwards. They were intended for use both as a general purpose field receiver and as an accompanying receiver for a number of transmitters of the type normally found installed in signals trucks. The receiver frequency coverage is from 100kHz to 6670kHz.

The earliest version was designed by Telefunken in the late 1920s as Spez 276 Bs and this was revamped in the early 1930s as Tornister Empfänger (portable receiver) Spez 445 Bs. By later standards it could be described as clumsy. Not unlike the National HRO, it employed plug-in coil units (three of them marked Kurz, Mittel and Lang) to cover the frequency range (see cover photo). The circuit employed four triode valves type RE 074 powered from a 90 volt battery and a 4.8 volt alkaline accumulator (type NC10). Radio, batteries and accessories were all in one case – quite a load for the signalman! With the development of the military general purpose two volt filament pentode valve (RV2 P800) the set was redesigned and split into two cases, one for the radio and one for the batteries and accessories. If necessary, the two cases could be clipped together.



*Torn.E.b with Battery Box including Vibrator EW.b*

The plug-in coil system was dispensed with and replaced by an integral rotating coil turret. Trials with this equipment pointed to a need for some ergonomic improvements and some simplification of controls and other slight changes resulted in a more ‘user friendly’ front panel. The rectangular power supply plug and socket were replaced by a circular five pin connector which became standard for much field equipment. Thus, in 1936/37 the Telefunken Torn.E.b Spez 976 Bs was accepted for Wehrmacht use as the Torn.E.b/24b-305 (also known outside Germany as the AE95).

### Advantages

The TRF receiver had a number of advantages, in the field, over the superhet (at least over the early superhets). It did not suffer from cross modulation nor did it have oscillators that re-radiated (e.g. HRO). However, sensitivity and selectivity depended considerably on the quality of the reaction circuitry.

*Tornister - Empfänger Torn. E.b / 24 b - 305*  
Gesamtschaltbild

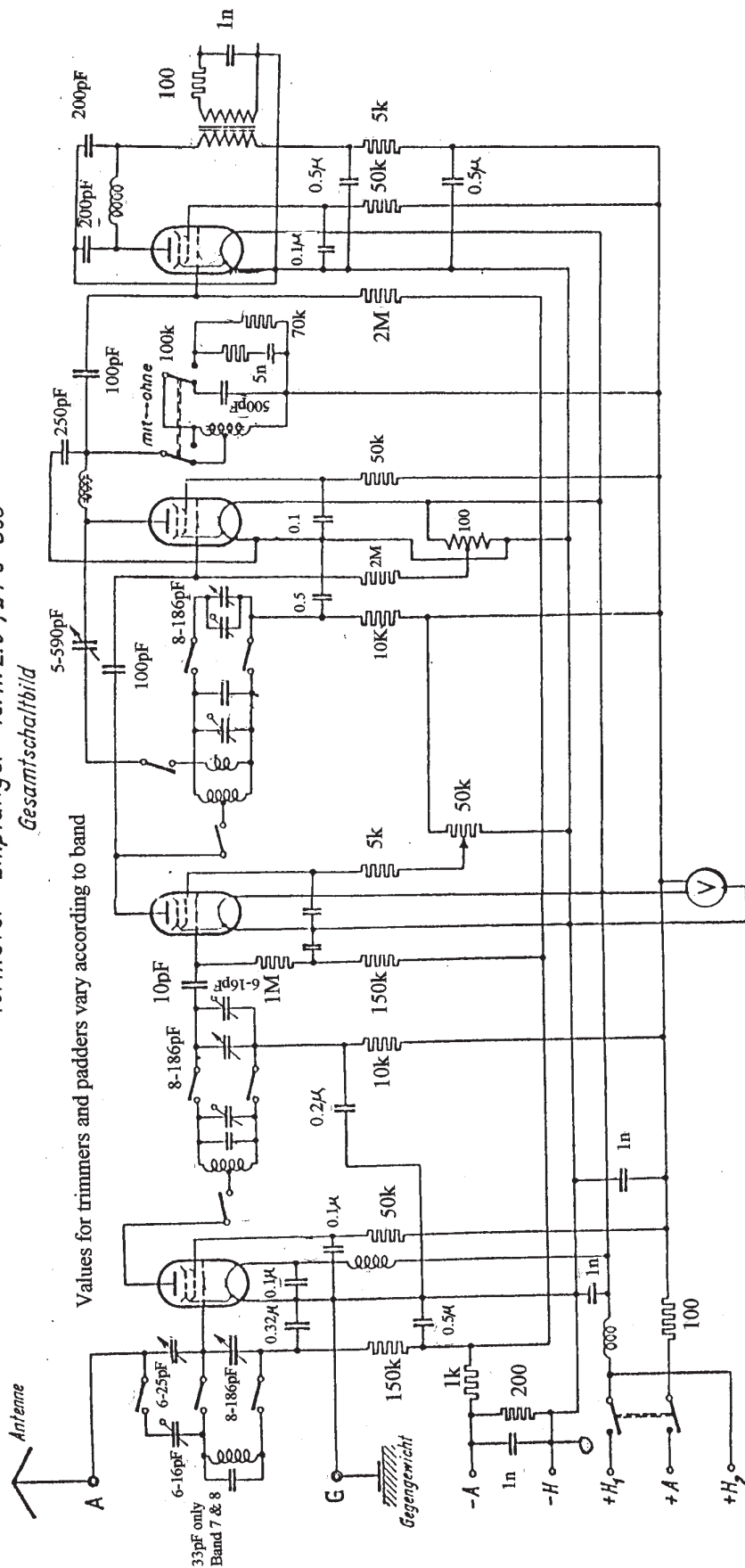

Fig. 1. The Torn.E.b basic circuit diagram

Telefunken engineers paid great attention to the mechanical aspects of the tuning systems and employed superbly made anti-backlash gearing. This ensured not only very fine adjustment of the reaction condenser but, in addition, the capability to return to the exact setting after changing back from another frequency band. The Torn.E.b had been designed essentially as a CW receiver and a 900Hz filter (on the circuit diagram following the detector) could be brought in by activating the Tonsieb switch. General audio quality for speech and music, though acceptable, was not the primary requirement. Post war, a number of amateurs improved the audio quality by adding an external stage of amplification combined with a speaker (a 6V6 or 6F6 valve was used), I never felt that this extra stage was necessary.

The Torn.E.b employed the relatively new multipurpose pentode RV2 P800. These two volt filament valves could be used in a variety of configurations. The receiver had two RF stages, a regenerative detector stage and a low frequency or audio output stage. All stages used the same valve type (see circuit diagram Fig.1) – very useful in the field as only one type of spare need be carried! Perhaps the most outstanding feature was the evolution from plug-in coils to a superb multi-range coil turret covering the frequency range 100kHz to 6670kHz in eight separate sections, easily switched by turning the centre knob on the front panel. A coil turret removed from a Torn.E.b is shown overleaf.

## Accessories

As mentioned earlier, the receiver was designed essentially for field use and as an accompanying receiver for a number of transmitters. Accessories were therefore designed to ensure that the set could be operated not only by footslogging signalmen but also in wireless trucks and armoured trains (anyone who has watched the BBC documentary on the Kursk battle might have noticed the signaller, on the armoured train, tuning up his Torn.E.b). The basic equipment consisted of the set itself in an airtight metal case which could be clipped to an identical size of box containing a two volt accumulator (2B38) and a standard 90 volt HT battery. The box also contained two pairs of high

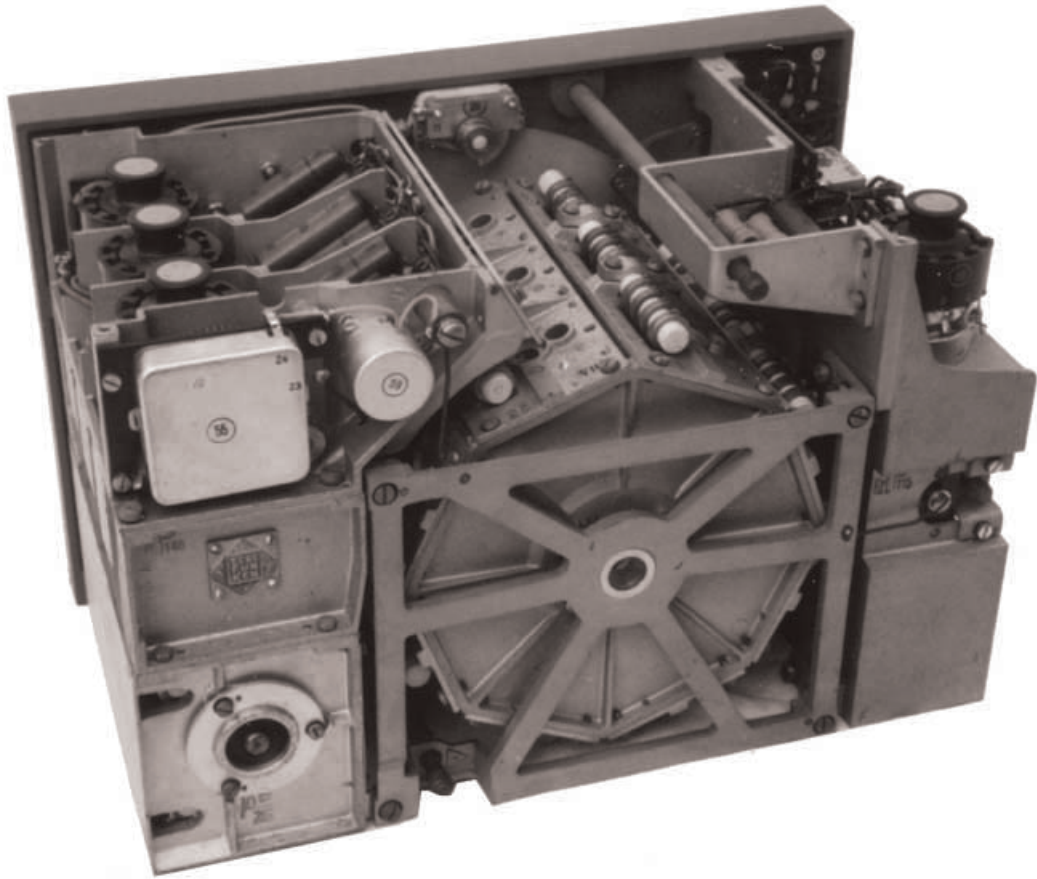

*Torn.E.b Rear View*

impedance headphones (Dfh.a) and instruction manuals. A small door in the lid of the accessories box could be opened to feed out the power cable.

To facilitate saving of HT batteries, the standard 90 volt battery could be substituted with a vibrator pack (EW.b) which generated 90 volts from the two volt lead/acid accumulator. An additional accessory for field use was an aerial kit in a shoulder slung canvas case. (This aerial pack was given to me in 1945 as being for the Torn.E.b though there has been some difference of opinion in recent times as to whether or not it really was part of the Torn.E.b set up.) Where the set was to be used in vehicles it was normally mounted on an anti-vibration mounting and power supplied from the vehicle's batteries via a vibrator pack type EW.c (Empfänger Wechselrichter c). In wireless trucks the receive antenna was normally built into the roof.

## Later Sets

Sets manufactured in the late 1930's were fitted with a voltmeter on the front panel by which both HT and LT could be checked. These sets when withdrawn from their cases exhibited an aluminium screen covering the working parts. Swedish ball-races were fitted to the tuning condenser shaft, anti-backlash gearing was standard and a cast aluminium Telefunken logo was screwed to the rear panel – see photo.

The chassis was formed from diecast magnesium/aluminium alloy sections bolted to the diecast front panel. The diecasting system had been perfected by the Mahle company. The

type label on models made in 1937/38 contained the full designation Torn.E.b/24b-305 plus the serial number and year of manufacture but on models from 1939 onwards the serial number plate was without the 24b-305 designation. The Torn.E.bs were painted in a number of colours depending on the service and even the theatre of war. Army sets were normally standard field grey, with airforce sets the very dark anthracite colour. However, in the desert, such as North Africa, sets tended to be a brown sandy colour. Torn.E.b's produced in 1944/45 were painted a light ground-yellow colour known in Germany as 'Einheitstarnfarbe Europa' which was the standardized camouflage colour for European use.

In the early 1940s manufacturing quality was maintained but some modifications began to creep in. Sets began to appear in 1942 without the voltmeter – the hole for the voltmeter being covered with a small aluminium plate! Whether this was due to a shortage of voltmeters or a whim of production is not clear but the voltmeter was a useful check on the state of the power supplies. The full aluminium screen was also replaced by two smaller screens, one covering the RF and detector stages and the other covering the output stage.

By 1944 screening had been discarded altogether! One other change which was notable occurred with the front panel. Early models had front plate labelling in the form of neatly printed aluminium labels screwed to the face. Later models began to appear with the labelling as an integral part of the diecasting – a sort of embossing. This was sometimes quite difficult to see. By late 1944, the quality of Torn.E.bs reflected the deteriorating state of industry in beleaguered



Germany. The original diecast alloy had been replaced by a poor quality Zinc based alloy resulting in the set weight increasing by 50%! No ball-races were fitted to the tuning condensers and anti-backlash gearing had been replaced by trapped plate mechanisms so that the essential fine adjustment of the reaction condenser was completely lost. Even the aluminium valveholders were being thrown together from punched wrapped sheet (in some cases steel) rather than from drawn aluminium tube.

## Manufacturers

I have to thank Werner Thote (DL1VHF) for allowing me access to his excellent research work on manufacturing locations. Knowing the serial number has allowed me to pinpoint the location of manufacture of a number of Torn.E.bs. Early sets made in 1937/38/39 were exclusively manufactured by Telefunken but after these years production was also farmed out to other manufactures. For some sets, manufactured in 1944/45, Werner has been able to pinpoint the converted furniture factory making the outer cases!

## Modified Sets

Unhappily, down the years, I have come across a number of Torn.E.bs which have been subjected to a variety of modifications. In one case alterations had been made to the coil turret to convert the set to receive amateur bands only. In other cases the RV2 P800 valves had been substituted with DF91s or, in one case, the set had been modified to run from RV12 P2000 valves, thus requiring a 12 volt LT source and various other circuit modifications. This set was not restorable to its original state without a great deal of careful work (and a source of original parts)! Yet another set had modifications made to sections 5, 6, 7 and 8 of the coil turret to cover the twenty, forty, and eighty metre amateur bands!

For unmodified Torn.E.bs which are not working at their best or do not appear to be receiving any signals, the usual checks applicable to fifty to sixty years old sets should be carried out e.g. valves, capacitors etc. One component should be first on the list for checking and that is component No. 59. This is the choke in the anode lead of the detector valve and is to be found under a small aluminium cover next to the reaction condenser. After a number of years these are prone to fail so no signal gets through to the audio stage. This choke, when dismantled, is quite delicate in nature and should be handled with care. Spares are not available but

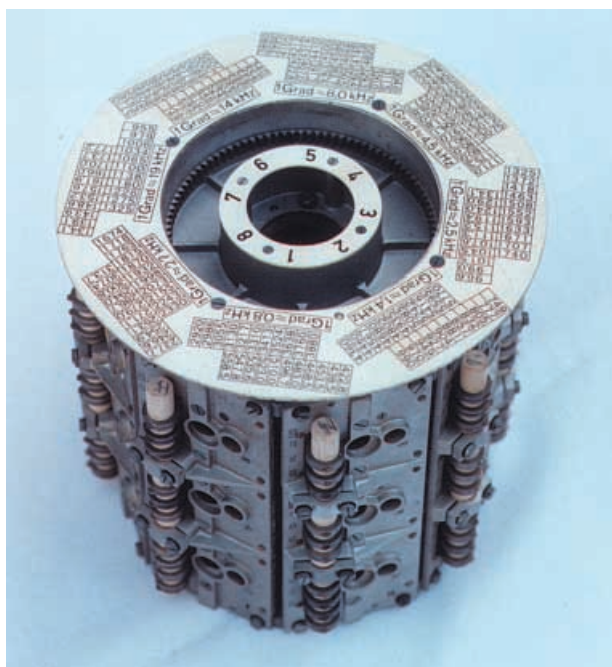

*Torn.E.b Coil Turret*

there is a firm who will rewind the original ceramic former (s.a.e. to me via the *RB* editorial office for further details).

**Acknowledgements:** Thanks are due to Werner Thote, DL1VHF, for data on manufacturing locations and to Rod Burman, G4RSN, for the loan of an early 1930's set.

**Further reading:** *Die deutschen Funknachrichtenanlagen bis 1945, Band 2 "Der Zweite Weltkrieg"*. Fritz Trenkle.

*German WWII Communications Receivers, CQ* August 1980. Dick Rollema, PA0SE.

*Wireless for Wehrmacht in Detail*. Published by RAK-Frantisek Koran, Prague.

*Communication Equipment of the German Army*. Charles L. Barger. Paladin Press. (In this book, no mention is made of the vibrator EW.b. Furthermore, in the 1943 Torn.E.b illustrated, I suspect that the meter has been installed post war!)

Final Note! For anyone fortunate enough to have both radio and battery box, in addition to headphones etc, the battery box should contain copies of handbooks H.Dv D915/1 and D915/5 for army sets or a copy of *Vorläufige Beschreibung und Bedienungsvorschrift des Tornier Empfänger Torn.E.b/24b-305* for Luftwaffe sets. **RB**

## VVT TRANSFORMERS

All types of transformers for all types of circuits  
including specialist valve units  
**Transformers for restoration of old radios**  
Custom design or standard range  
High and low voltage

**Variable Voltage Technology Ltd**  
Unit 3, Sheat Manor Farm, Chillerton, Newport, Isle of Wight, PO30 3HP  
Tel: 0870 243 0414 Fax: 01983 280593  
email: sales@vvt-cowes.freemove.co.uk

[www.vvttransformers.co.uk](http://www.vvttransformers.co.uk)

## WILSON VALVES

(PROP JIM FISH G4MH)

Over 60,000 valves stocked, 2000 different types,  
for ham radio, audio, military.  
Fast service. Send SAE for list

**28 Banks Avenue, Golcar, Huddersfield,  
West Yorks HD7 4LZ**

**Telephone: 01484 654650/01484 649380**  
**Fax: 01484 655699**  
**e-mail: wilsonv@zoo.co.uk**

For vintage radio valves contact: Vintage Valve Supplies,  
prop. Roger Walker, on 01484 650725, mobile 07733 283084.  
78 Scar Lane, Milnsbridge, Huddersfield, HD7 4LZ

# The Marconi Exhibition at Sandford Mill, Chelmsford

by Michael O'Beirne, G8MOB

Despite the gloom that surrounds Marconi shares nowadays, there is some good news in that their former products are on glorious view at the Industrial Heritage Centre at Sandford Mill, Chelmsford (shown below) and are well worth a visit. The site of the centre is the former borough water works on the River Chelmer just to the east of Chelmsford. This centre is run as an extension of the Chelmsford Museum which is located in the town centre at Oaklands Park, Moulsham Street. The Marconi exhibits themselves are displayed in the Engine House at Sandford Mill Water Works, Sandford Mill Road, Chelmsford, CM2 6NY. Access is via the A12 or A138 then Colchester Road (the B1137) to Cuton Hall Lane, Chelmer Village Way and then Sandford Mill Road. Useful telephone numbers are

the Chelmsford Museum (in the city centre) on 01245 615100 and at Sandford Mill on 01245 475498.

When the water company moved downstream they sold the site back to the Chelmsford Borough Council for a nominal £1. The council have been converting the site into a local industrial heritage display with help from the Heritage Fund and a great deal of volunteer effort.

The Engine House is a substantial brick building from the 1930s. It houses exhibits from the local industries including some choice items from Marconi, Crompton Parkinson and Hoffmanns (fabricators of precision ball bearings). Needless to say the Marconi display is largely run by keen volunteers on a shoestring budget, and with that comes the acute limitations of opening times. Right now the

Marconi items are only open to the public from time to time.

The exhibits have been contributed by the public and by scrounging surplus equipment due for scrapping at various Marconi sites around the country. Marconi themselves have been helpful and generous, particularly in the transportation of a giant 30kW linear amplifier that is currently the prize exhibit.

## International Marconi Day

The next Open Day is *International Marconi Day* on Saturday 26th April from 10am to 5pm, and it's a free entry! On these days radio amateur groups set up stations at sites around the world associated with Marconi. The best known is Poldhu, Cornwall.



*The Engine House, Sandford Mill*



*A ship's reserve receiver, transmitter and power supply, normally used when the main equipment has failed*

I attended the last Open Day in July 2002. It was quite a hike by train from Surbiton to Chelmsford and then a taxi ride to the site. But it was a gloriously warm day with hardly a cloud in the sky (we have a few of these each year!). The train service to Waterloo was fast, the service from Liverpool Street to Chelmsford was express and I spent one of the most wonderful days of 2002 looking at possibly the largest collection of Marconi equipment in the country.

## What's On Display

The *Museum Pieces* photos and those on these pages tell the story. There are all manner of maritime receivers, transmitters, radar and peripheral equipment, many in excellent condition and some pristine. The receivers included familiar faithfuls such as the CR100, CR150, CR300, Atalanta, Mercury and Electra, a few rarities such as the Lodestar DF receiver and the even rarer HR110 that looked untouched by the passing of time. I was told that only ten HR110s had been made because they were so expensive. Another rarity was the 2310, in reality a rebadged Eddystone 880/3, the first I had ever seen.

I spotted an Oceanspan transmitter, a ship's reserve transmit/receive station,

a lifeboat transceiver, VHF gear and quite a lot of modern equipment. One of these was the H2540 ISB/SSB/FSK VLF to HF receiver from the 1980s. It's about four generations beyond the

CR100, fully synthesised with a stability in Hz per week and a digital display to 1Hz. I actually have one in my QTH in nearly new condition and can confirm that it is a remarkable beast. There must be over 50 screws securing the top and bottom covers and at least two miles of connection cable contained within beautifully assembled cable looms. For those into numbers, it has a third order intercept spec of +28dBm. I had to design the QTH around its depth of about 25 inches! That said, it is lighter than a CR100 (which is not saying a lot really). The H2540's companion transmitting driver unit is displayed too, the H1540. This would provide a signal of about 250mW to drive a big linear amplifier.

## MST Transmitters

If big is beautiful then Sandford Mill is the place to see it. One area is devoted to Marconi MST transmitters of the 1960s and 1970s used by the Royal Navy and other Navies. MST stands for Marconi Self Tuning. These were also designed to be remotely operable to minimise the time for frequency changing and the number of engineers needed on site. I doubt if the Merchant Navy companies could afford these devices.



*Two Marconi items from the 1980s, at the top is the H1540 driver and below is the H2540 VLF to HF receiver. The H2540 has come a long way since the CR100!*

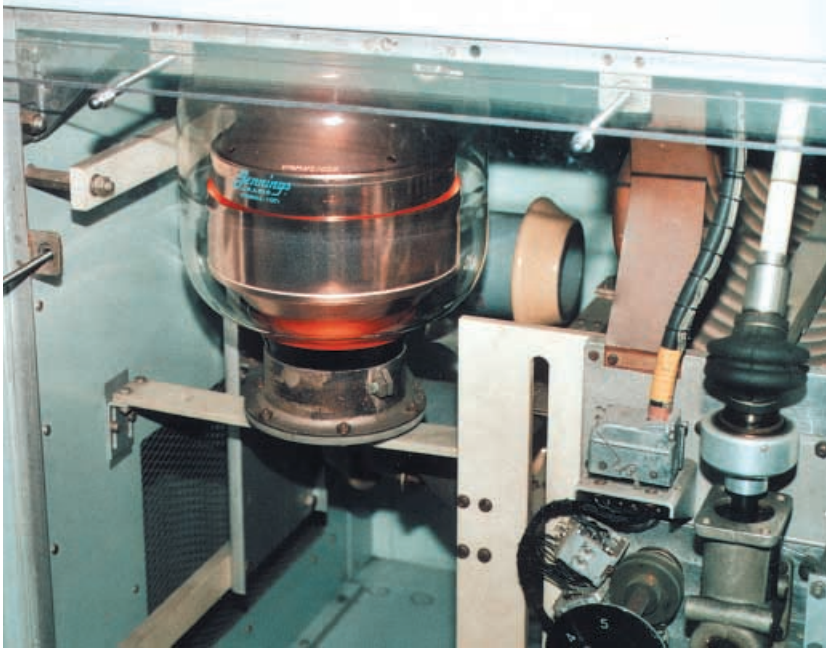

*The Jennings vacuum variable capacitor in the tank circuit of the H1200 amplifier. This capacitor is the size of a chamber pot*

A seven foot cabinet contains the RF drive source, H1602. This is basically the H1500 frequency synthesiser that was also used in many different applications, for example to drive the N2020 naval receiver of the 1960s and 70s. More recently I was given an original manual for this synthesiser by Pat Hawker, G3VA whom we all know of from his *Technical Topics* column in *RadCom* and previous articles in *RB*. I can disclose that the basis of the synthesiser is a series of cascaded Wadley loops, though, unsportingly, Marconi make no mention anywhere of either Barlow or Wadley!

Also in the rack are ISB modulators, a precision 1MHz frequency standard (duplicated in case of problems) a driver unit and a linear amplifier that pushes out about three watts.

Alongside is another seven foot rack that contains one of Marconi's best products, the H1000 broadband 1kW linear amplifier. This has an artificial transmission line design using two parallel helically wound inductors and 18 tetrodes (4CX250s) in a complex parallel arrangement. Each inductor is tapped at intervals to provide an anode feed to a single 4CX250. There are nine tetrodes in each inductor arm. The idea is that at any given frequency only part of this giant tank circuit, about three feet long, will be resonant, and only those valves in the vicinity of the resonant

part will amplify. It's analogous to the concept of a log periodic aerial where only some of the aerial elements are resonant. The valves operate in Class A to improve the intermodulation products to better than 40dB down. The harmonic energy from the 1kW output is below 50mW. I have yet to see a solid-state PA that will come close to those figures.

There are no variable inductors or capacitors, and so the tuning time is limited by the few seconds that it takes

to turn the decade knobs on the synthesiser. The drawback is that the artificial transmission line design is not efficient as only those valves in that area of the tank circuit in resonance are doing anything useful and the rest are coasting along. As a result of this and the Class A operation, the power consumption is 6kW to pump out 1kW RF. My host, Geoff Lovegrove, kindly pulled out the drawers to show me the inside. The internal construction is awesome in its neatness and solidity. The cost? I dare not think.

The Royal Navy loved the system because it enabled them to change frequency in seconds. This transmitter was also much more reliable than their earlier manually tuned transmitters. I hope that the museum will be able to complete the MST system from synthesiser to aerial by acquiring one of the robust automatic ATUs that was mounted on the upper deck of a warship and supported a heavy vertical whip.

During the afternoon I was delighted and privileged to meet the original designer of the H1000 amplifier, Charles Burnham, G4PC, looking well at a sprightly 81. Alas one of the designers of the 30kW power amplifier alongside, Vic Stokes, is no longer alive.

## The Big One

There was more to come. Adjacent to the H1000 is the massive H1200



*The original Marconi hut and venue of 2MT*

30kW linear amplifier that was driven by the H1000. This measures 7ft high, 12ft wide and 2ft 6in deep. Such a device is guaranteed to wipe out every QRO Italian station on 20 metres, but this power comes at a cost – like 60kW from a three-phase mains supply. The wife and neighbours might voice objections too.

This monster amplifier is specified to be fully self-tuning within 30 seconds of a frequency change. The displayed exhibit had been specifically kept at the Marconi factory in Chelmsford to serve as a reference model as a contractual requirement of the MOD and is in original condition. Some of the steel panels have now been replaced with perspex so that the internals are on view. Pride of place is a huge Eimac 4CX10,000 tetrode. It is so heavy that a small gantry crane is built into the equipment to lift and lower it into position. The PSU's transformers are so bulky and heavy that they are fitted with wheels so that they can be run in and out of the chassis like a hotel's laundry basket.

I spotted a giant Jennings vacuum variable capacitor and its tuning motor in the pi match output circuit and a mass of other plumbing, motors, servos and control circuits. The low pass filter in the output is about the shape and size of a dustbin. I have never seen an amplifier like this in the flesh before, nor probably will I ever do so elsewhere, so it really is a must-see.

## The Marconi Hut

Occupying the middle of the exhibition space is a large former Army wooden hut dating from the First World War. This was used as a lab by the Marconi company from 1919 to 1960 at their Writtle site outside Chelmsford. It was from this hut that the famous *Two Emma Toc* first went on the air on the 14th February 1922, five months before the BBC started broadcasting. Every Tuesday evening until 15th January 1923 2MT kept up a mixture of records, live concerts and the humour of Marconi's engineer-in-charge, Captain P.P. Eckersley. He later became the BBC's Chief Engineer. The rest is well-known history. Even the original piano which provided the musical background is there.

After the closure of 2MT in 1923 the hut was used as a research lab and more huts were added. In here was

designed much WW2 airborne equipment including, quite probably, the 1154 and 1155. As a volunteer museum curator, I experienced that rare tingling feeling down the spine that comes when in the presence of the real thing. This is history in bucket loads echoing on all sides.

Another room in the hut houses a collection of Marconi power valves including a huge water cooled device about four feet high that seems to be more plumbing than RF.

On International Marconi Days the local Chelmsford ARS sets up a special event station in the hut. As I type this they are trying to secure GB2MT for the 26th April. For this forthcoming event they are hoping to run two HF stations and a VHF talk-in station.

## Other items

There are numerous other items on view, some modern, others of the brass and mahogany variety. These include a fine collection of Marconi TV cameras and a radar display. The museum's Friends are planning to build a mock up of a ship's radio shack. After five hours in the Engine House there was still stuff to see so I am coming back for a second view, despite the distance.

The labelling is not yet up to Science Museum standard, and in 2002 the collection of receivers was more of a pile than a fully formed display, but the museum staff were the epitome of help. Particular thanks goes to Geoff Lovegrove G7KLV for his patience in dealing with my many questions on the visit and vetting this article for factual errors. Geoff had been one of the Marconi design team in the 1940s developing a variant of the old CR150 receiver.

## Outside

In the fresh air outside were many attractions for children (and their parents too!). One is the Chelmer barge *Susan* that runs up and down the river and is the last of her kind. There is a separate exhibition devoted to locks and canals. A local group of enthusiasts turned up with shiny traction engines and ancient farm machinery some of which looked more suitable for the dungeons of Torquemada and Topcliffe. Various animals were also on display.



*Oceanspan II transmitter*

There was a demonstration of bridge building and a wildlife walk to keep the kids busy while their dads salivated inside the Engine House. In one of the outbuildings ("the Barn") there is a science educational display and a cafe that supplies home-made cake, buns and tea, and not far away was an ice cream van.

## Overall Impressions

Spending an entire day looking at old radio is probably sufficient justification for one's spouse to present a divorce petition – "*The respondent has behaved in such a way that the petitioner cannot reasonably be expected to live with the respondent*". But what the hell, it was a wonderfully nostalgic day, and I didn't even have time to get aboard the barge. Forget the current miserable state of Marconi shares, take a break from domestic chores and see some of Marconi's finest products.

Contact for general inquiries is the Keeper of Science and Industry Collection, Dr. Geoff Bowles on 01245 475498. If anyone has any genuine Marconi items that need a good home do please contact him. The special event station is being orchestrated by Brian Thwaites, G3CVI on 01245 471919.

**RB**

# A Wobbulator Unit

by Raymond Haigh

Alignment of radio receivers can be optimised by means of this simple and inexpensive unit which enables the IF response to be displayed on an oscilloscope screen

A glance through any edition of *Radio Bygones* will reveal the skill and effort readers expend on the restoration of vintage radio receivers. And having lavished so much care on the case, components and chassis, many would no doubt wish to take a closer look at the performance of the set.

Experienced restorers will be able to align an IF strip with a fair degree of accuracy by ear (see *Restoration of a Typical Superhet* elsewhere in this issue). However, the standard servicing procedure, in which a high impedance voltmeter is connected across the AGC line to indicate peak response, speeds up the alignment process and makes it more precise. Although perfectly adequate, this tells us nothing about the receiver's selectivity or its IF passband characteristics.

A servicing aid known as a wobbulator permits the keen enthusiast to give the procedure the same meticulous attention he or she has lavished on the receiver's appearance. It represents the ultimate refinement of the alignment process, enabling the response curve of the IF strip to be displayed on an oscilloscope screen so that performance can be optimised with extreme accuracy.

Bandwidth at various attenuation factors can be checked, thus permitting a compromise to be effected between sensitivity, selectivity and audio frequency response. Moreover, the performance of more complex receivers can be made to accord more closely with the manufacturer's original specifications. Even when perfect alignment is not an absolute priority, the unit will enable the downright curious to take a good look at how the vintage receiver is processing the signal.

## Principle of Operation

A wobbulator is no more than a signal generator, the frequency of which is repeatedly swept over the IF passband of the receiver under test. Frequency variation is controlled by the timebase or horizontal output of the oscilloscope with which the unit is used. In this way the sweep is synchronised, and the oscilloscope displays the response curve of the receiver's IF stages.

Block diagram Fig. 1 shows how the wobbulator, oscilloscope and receiver are connected together. It should be noted



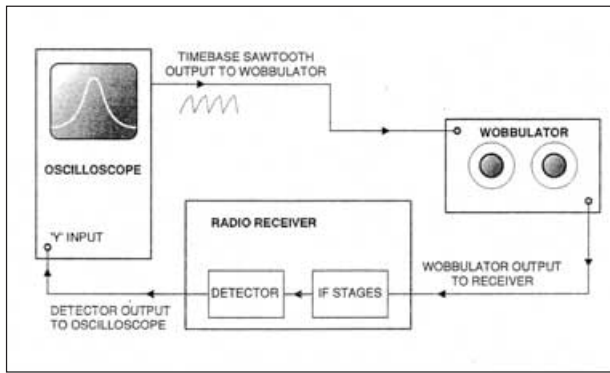

Fig. 1. Connections between the wobulator, oscilloscope and receiver.

that the RF signal is rectified by the detector before being connected to the 'Y' input, and a high performance oscilloscope with an extended frequency response is not required. So long as the timebase sawtooth waveform is available externally, almost any basic oscilloscope will suffice.

## Varying the Wobulator Frequency

Early instruments of this kind used a motor driven tuning capacitor to shift the frequency of the oscillator. During the valve era, reactance valve circuits were developed, and this enabled the frequency to be varied electronically. Subsequent advances in semiconductor technology produced the varactor or varicap diode, which exploits the way the capacitance of a semiconductor junction can be changed (and hence the frequency of the tuned circuit in which it is used) by varying a reverse bias voltage.

Frequency can also be shifted by varying the supply voltage to the valve or transistor in the oscillator circuit. This method carries the risk of introducing amplitude modulation (which would distort the oscilloscope display), and it can be difficult to secure sufficient swing. It is, however, effective as a means of varying the frequency of a multivibrator, and oscillators of this kind, which are tuned by RC (resistor/capacitor) rather than LC (inductor/capacitor) circuits, have formed the basis of some wobulator designs intended for the alignment of 450kHz to 470kHz IF stages.

Unfortunately, the operation of multivibrators becomes less predictable as frequency is increased, and it was decided that using a varicap diode to shift the frequency of a conventional Hartley oscillator would ensure more repeatable results in a unit designed for operation up to 15MHz.

## The Circuit

The circuit of the wobulator is given in Fig. 2. Field effect transistor, Q1, is the active device in the Hartley oscillator circuit tuned by inductors L1 to L4, and varicap diode, D1. Gate and source of Q1 are connected to the appropriate coil by range switch SW1.

Blocking capacitor, C3, prevents the reverse bias that controls the varicap diode being grounded via the tuning inductor, and R9 ensures the correct working conditions for Q1. Diode, D2, limits the amplitude of oscillation and prevents forward conduction of the JFET's gate. It also keeps oscillator output across the four switched ranges reasonably constant. The stage is decoupled from the supply rail by R10 and C6.

Signal output is taken from the source of Q1 and connected to the gate of Q2 via coupling capacitor, C7. This source-follower (or common drain) buffer stage minimises loading on the oscillator and isolates it from the equipment under test

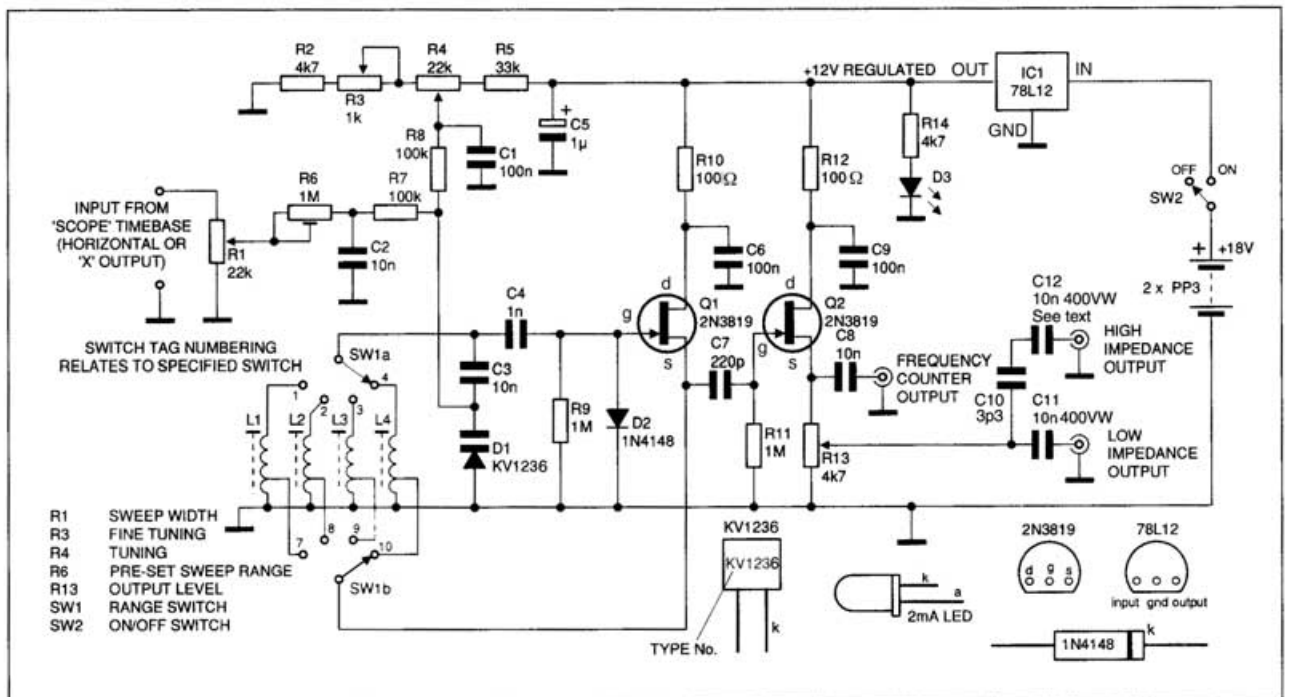

Fig. 2. Circuit diagram of the wobulator

in order to prevent any frequency pulling or other disturbance to its operation. Correct biasing of the buffer stage is ensured by R11, and R12 and C9 decouple it from the supply line.

Output is developed across source load, R13, a potentiometer that sets an appropriate signal level for the equipment under test. The low value DC blocking capacitor, C10, enables the signal to be injected into a high impedance circuit without excessively disturbing its operation. The output via the higher value blocking capacitor, C11, should be chosen when the injection point presents a low impedance or when the connecting lead must be screened.

With valve radios, signal injection points can be held at fairly high DC potentials. The working voltage of C11 and C12 should, therefore, be at least 350V DC. Low value (3.3pF) silver mica capacitors with this working voltage are still manufactured, but are no longer widely retailed. Therefore the High Impedance Output is connected via C12, a 10nF 400V polyester capacitor; this series capacitor will provide the necessary protection.

Readers with access to a frequency counter may wish to use it with the wobulator. It should be connected directly to the source of Q2 via blocking capacitor, C8. (The wobulator output potentiometer is usually turned well down, and the voltage on the slider is not then sufficient to trigger most counters).

Current drawn by the unit is approximately 10mA and operation by batteries is, therefore, perfectly feasible. Bias for the tuning diode is derived from the power supply rails, and precautions must be taken to ensure that tuning doesn't drift with falling battery voltage. Accordingly, two PP3 batteries are connected in series to give a nominal 18V, and this is held at 12V by means of the 100mA regulator, IC1. Tantalum capacitor, C5, is included to bypass any electrical noise generated by the regulator IC.

Equipment of this kind can be inadvertently left switched on. Low current LED, D3, and dropping resistor, R14, are included to minimise the chance of this happening.

## Oscillator Tuning

Wobulators often incorporate a conventional air-spaced variable capacitor to set the oscillator to the IF centre frequency. A varicap diode, wired in parallel with it and coupled to the oscilloscope timebase, produces the necessary frequency sweep.

This wobulator is tuned, and its frequency shifted, by a single varicap diode of the type developed for medium-wave receivers. These devices provide a capacitance swing of around 450pF with a tuning voltage range of 2V to 9V, and exhibit a 'Q' factor of at least 200. Although they are more expensive than a varicap with a smaller swing, the need for a conventional tuning capacitor is avoided and the overall saving in cost is significant. More important, wide frequency sweeps are easy to obtain, and the full IF passband, together with a portion of the RF spectrum on either side, can be displayed.

The capacitance/tuning voltage relationship of the chosen diode is reasonably linear up to about 6V. Between 6V and 9V the rate of capacitance change falls. Below about 1V, the 'Q' factor of the diode reduces.

Tuning bias for the diode is taken from the slider of potentiometer, R4, and fixed resistors, R5 and R2, limit the voltage swing from around 1V to 5.5V. Potentiometer, R3, acts as a fine tuning control, and capacitor, C1, eliminates potentiometer wiper noise.

## Timebase Input

Potentiometer, R1, determines the amplitude of the sweep input voltage, and pre-set resistor, R6, enables the range of this control to be adjusted to suit most modern oscilloscopes.

The timebase sawtooth voltage can be checked by turning down the time/cm controls until the spot drifts slowly across the screen. The pointer of a DC voltmeter, connected between oscilloscope timebase output and ground, should then move slowly enough for the minimum and maximum sweep voltages to be read off. The oscilloscope used with the prototype wobulator generated a sawtooth waveform running from around 15V to 25V. If much higher voltages than this are encountered, wire a resistance in series with R1 in order to reduce the input to the required level.

Again, C2 eliminates potentiometer wiper noise, and R7 and R8 isolate the varicap diode, at signal frequencies, from the tuning voltage networks. (The diode passes virtually no current, so the isolating resistors have no effect on the tuning voltage).

## Components

Most n-channel JFETs should be suitable in this circuit, but base connections vary and should be checked.

Toko coils, varicap diodes, the specified FETs and 350V working silver mica capacitors, can be obtained from JAB Electronic Components, PO Box 5774, Birmingham, B44 8PJ. Tel: 0121 682 7045 (<http://www.jabdog.com>). At the present time this firm can only accept mail orders. Toko coils can also be obtained from Coils-UK, Ltd, 12, Elder Way, Langley Business Park, Slough, Berkshire, SL3 6EP, Telephone 01753 549502.

The varicap diodes are supplied in snap-apart packs of two (KV1236) or three (KV1235) for ganged receiver tuning.

An inexpensive, two-pole, six-way plastic-cased Lorlin rotary switch can be used for S1. This item, together with the remaining parts, is available from a number of suppliers, including JAB. Coils-UK specialise in Toko coils and are unable to supply other parts.

## Construction

All of the components, with the exception of the switches, potentiometers, capacitor C12, and the LED indicator, are mounted on a small PCB. The component side of the board is illustrated in Fig.3 and the full-size copper track layout is given in Fig.4. Solder pins, inserted at the lead-out points, will simplify the task of wiring up the off-board components.

It is convenient, with equipment of this kind, to have the input and output sockets mounted on the front panel. This does necessitate a slightly larger case, but the unit can still be accommodated in a standard plastic box with external dimensions of 198mm x 112mm x 64mm (Maplin catalogue No. H2852).

A photocopy of Fig.5 can be used for the front panel, and the finished panel protected from soiling by a sheet of thin Perspex (the type of material used for DIY double glazing). For reasons which will become clear later, it is neither feasible nor necessary to calibrate the tuning dial.

Switches, potentiometers, terminals and circuit board are all mounted on the lid of the box and the assembly is



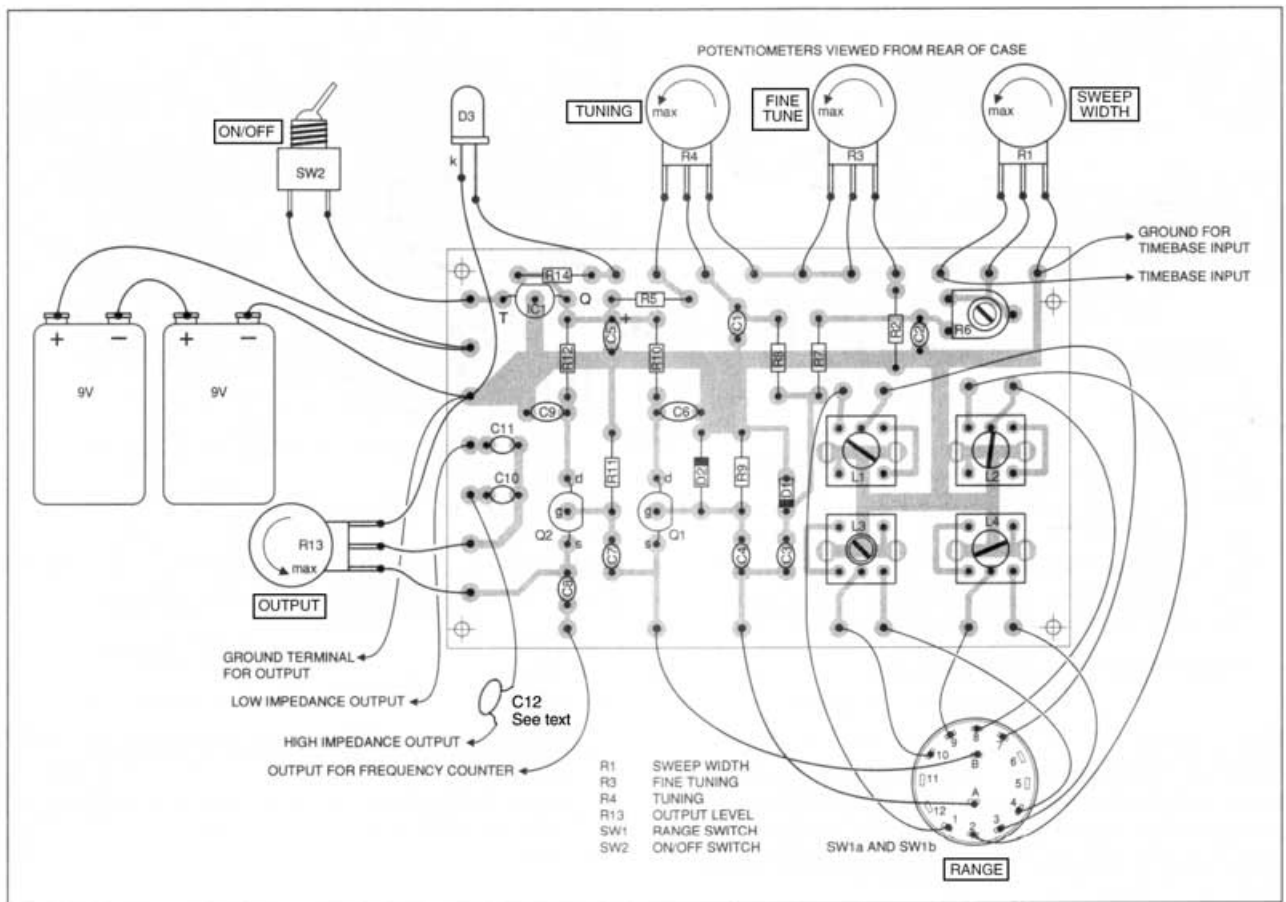

Fig. 3. Printed circuit board layout and wiring to all off-board components

depicted in the photographs. The battery holder is formed from scrap aluminium sheet and held in place by the on/off switch bush and one of the terminals.

Remember to check the orientation of semiconductors and the tantalum capacitor, and to check the PCB for poor soldered joints and bridged tracks, before mounting it in position.

## Setting Up and Testing

Connect up the batteries and switch on. Current consumption should be in the region of 10mA and the voltage at the output of IC1 should be precisely 12V.

Set R1 and R3 to mid travel and use a radio receiver or frequency counter to check that the oscillator is working on all four ranges and can be tuned by R4. With *no* input from the oscilloscope timebase, coverage of the prototype unit is as follows:

Range 1	350 - 600kHz
Range 2	1 - 2MHz
Range 3	3 - 6MHz
Range 4	6 - 14MHz

The above tuning ranges can be varied, within reasonably wide limits, by adjusting the inductor cores. Note that with L1, L2 and L3, inductance increases, and frequency lowers, as the cores are driven down. The core of L4 has to be set flush with the top of the can for maximum inductance.

Connecting the timebase input increases the reverse bias on the varicap diode and, for a given setting of the tuning control, this increases the frequency of oscillation. In

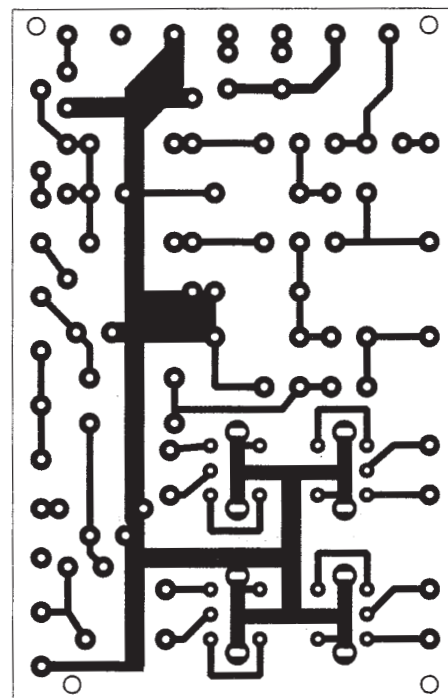
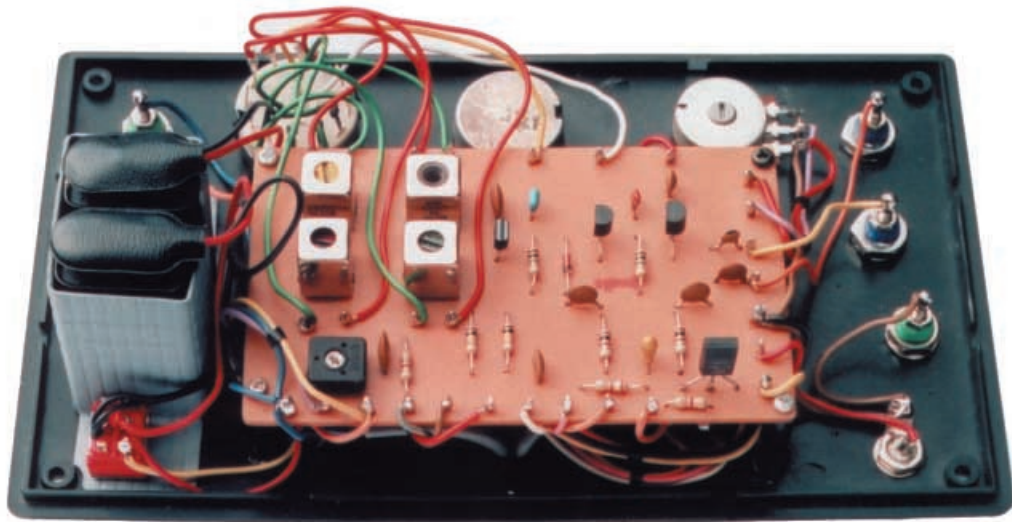

Fig. 4. Full size master foil pattern for the printed circuit board



Interior assembly and PCB of the wobulator

practice, the unit should be capable of producing displays of IF systems centred at up to 15 or 16MHz.

### Using the Wobulator

Connections between the wobulator, oscilloscope and receiver under test are shown in Fig. 1. Keep the wobulator close to the receiver so that the signal injection lead can be as short as possible. The connection between the receiver's detector and the 'Y' input of the oscilloscope may have to be screened, but this was not found to be necessary with the equipment used for the initial trials.

A transistor portable radio can be used for the test and the signal should be injected into the base of the mixer/oscillator transistor. Connect the 'Y' input of the oscilloscope to the audio side of the diode detector. Link the ground terminal on the oscilloscope to the ground terminal on the wobulator and the ground plane on the receiver.

The oscilloscope timebase should be set for the lowest possible sweep rate consistent with an acceptable amount of flicker in the trace. (The display will be distorted, especially when narrow band filters are being checked, if too fast a sweep setting is chosen). The 'X' gain control should be turned well down.

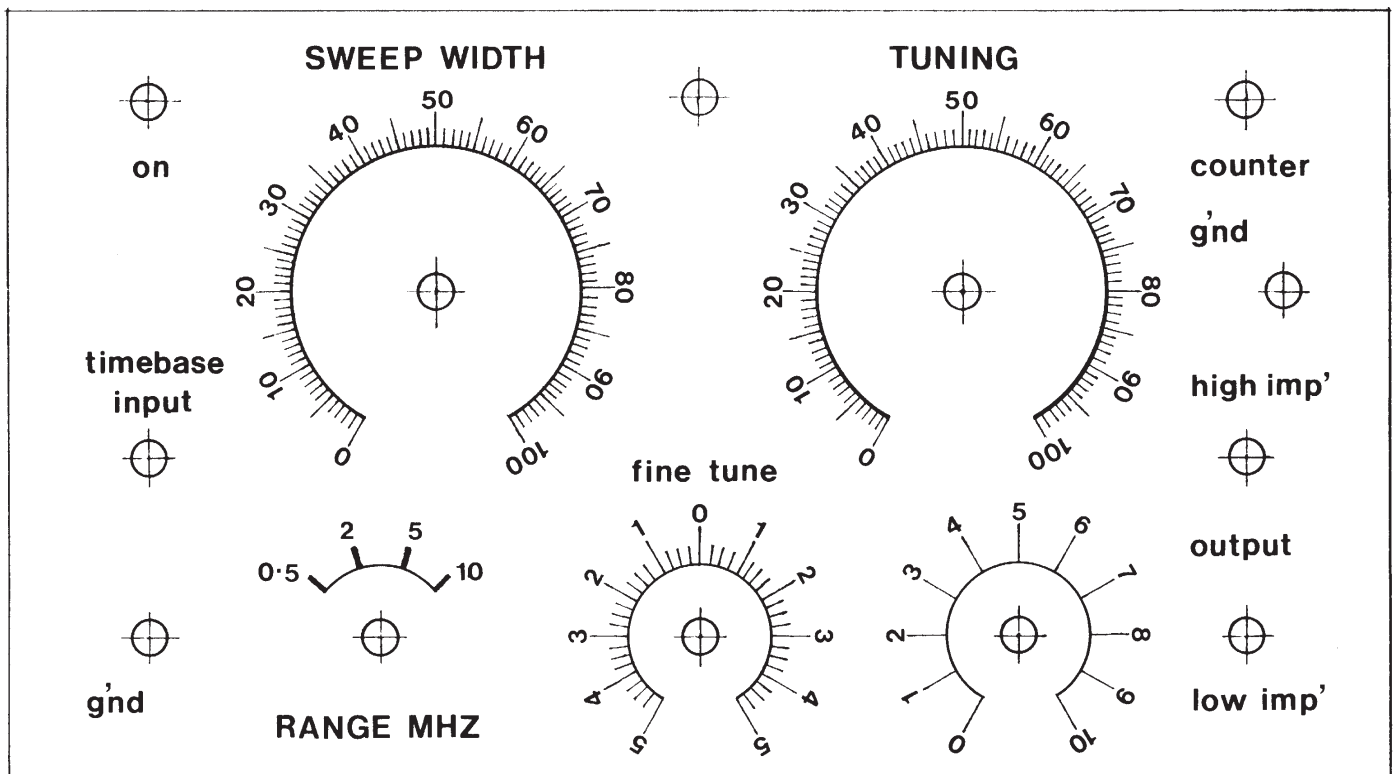

Fig. 5. Front panel of the Wobulator Unit shown actual size

## Wobbulator Components List

### Resistors

R1, R4	22k linear potentiometer (2 off)
R2, R14	4k7 (2 off)
R3	1k linear potentiometer
R5	33k
R6	1M pre-set potentiometer, horizontal type
R7, R8	100k (2 off)
R9, R11	1M (2 off)
R10, R12	100Ω (2 off)
R13	4k7 linear potentiometer

All fixed types ±5% tolerance, 1/4 Watt rating

### Capacitors

C1, C6, C9	100nF (3 off)
C2, C3, C8	10nF (3 off)
C4	1nF
C5	1μF tantalum
C7	220pF
C10	3p3
C11, C12	10nF 400V DC working polyester (2 off)

All ceramic types, 25V working or greater unless otherwise stated

### Inductors

L1	RWO6A7752EK (green core)
L2	154FN8A6438EK (violet/deep red core)
L3	154FN8A6439EK (yellow core)
L4	KXNK3767EK (pink core)

All by Toko – see text

### Semiconductors

D1	KV1236 or KV1235 (varicap diode, see text)
D2	1N4148 signal diode
D3	2mA LED
Q1	2N3819 JFET
Q2	2N3819 JFET
IC1	78L12 (12V regulator, rated 100mA)

See text for details of suppliers of Toko coils and varicap diodes.

### Switches

SW1	2-pole 6-way, Lorlin plastic cased rotary switch
SW2	single-pole, single-throw toggle switch

### Miscellaneous

Printed circuit board (No. RB1 – available from the *RB Editorial Office*, price £5.95). Solder pins and hook-up wire. Stand offs for mounting PCB and self-tapping screws. Control knobs, terminals (5 off), phono socket for counter, LED holder, battery connectors. Plastic box or other enclosure, materials for front panel and scrap aluminium for battery holder.

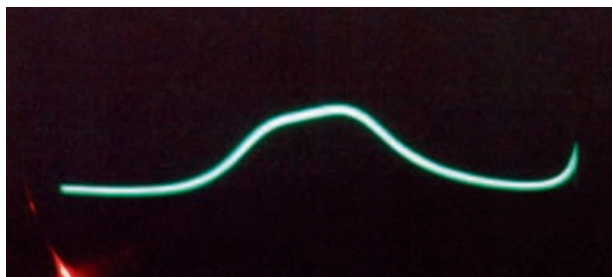

Oscilloscope trace of IF response of a transistor portable radio, before alignment

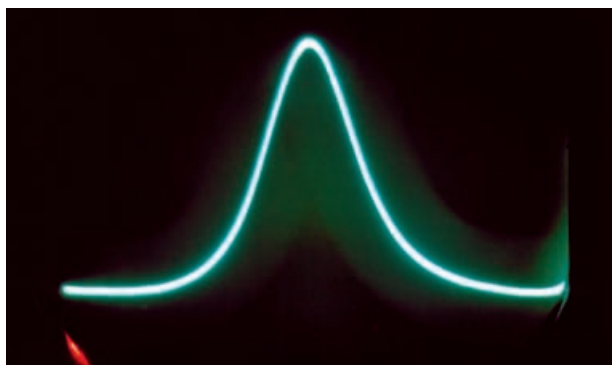

Oscilloscope trace of the same radio, after alignment

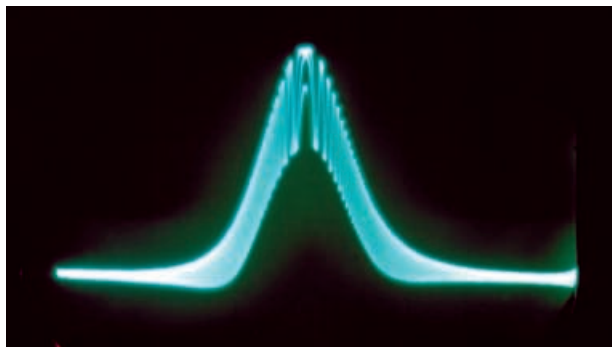

Using a second signal generator to pinpoint frequency along the trace. Zero beat point at crest of peak and second generator dial reading 460kHz

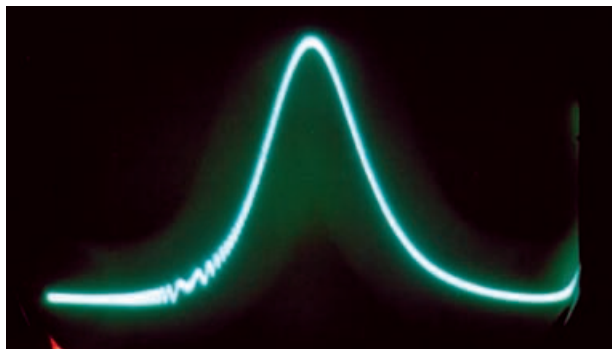

As the previous photo, but zero beat point set close to floor of trace and second generator dial reading 470kHz

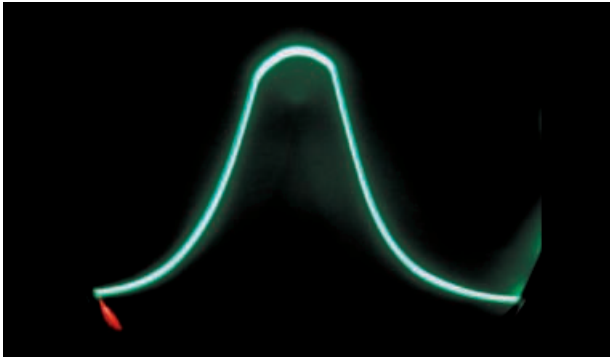

*Flattening of trace caused by too high an injection level resulting in receiver overload*

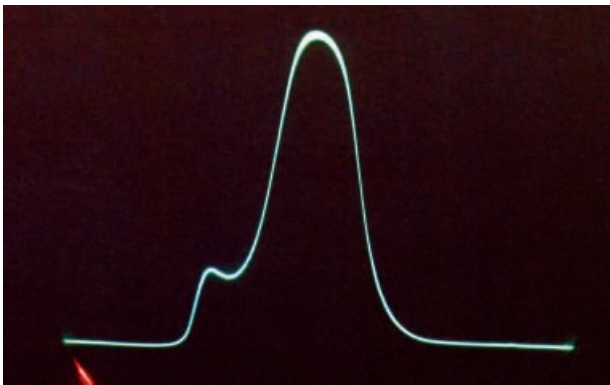

*Trace produced by an IF strip comprising four tuned transformers and an inexpensive 4kHz mechanical filter. Receiver aligned for maximum sensitivity*

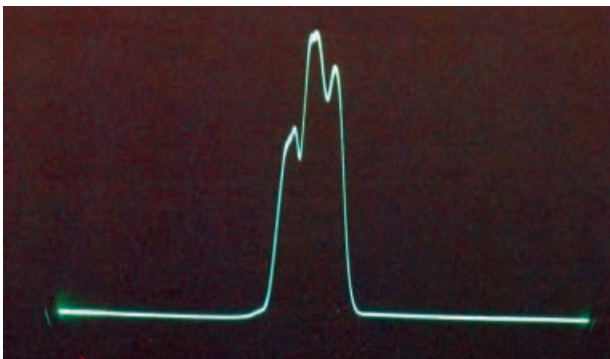

*Trace produced by an IF strip comprising four tuned transformers and a 2.6kHz ceramic filter. Again, receiver aligned for maximum sensitivity*

Switch the wobulator to the appropriate range (invariably Range 1, or 0.5MHz, for a transistor portable AM radio), set the sweep width control to about half travel and adjust the wobulator tuning until the receiver's IF response is displayed on the oscilloscope screen. Turn down the signal level (R13) in order to check that the receiver's IF stages are not being driven into clipping: this results in a flattening of the displayed peak, as illustrated in the top photograph above.

The timebase sawtooth voltage does not drop to zero with respect to ground, and increasing the timebase input will drive the wobulator frequency higher as well as shifting it

more, and the tuning control has to be turned back to compensate for this. Adjustments to the oscilloscope's 'Y' input sensitivity, the 'X' gain control, wobulator output and sweep width all affect the profile of the display. Turning up the sweep width control will *reduce* the width of the pass-band profile because it is occupying a smaller proportion of the frequency range displayed on the screen.

This all sounds rather complicated but, in practice, the unit is very easy to set up and operate.

## Valve Superhets

Superhets of the valve era, other than some very early and primitive designs that did not have AGC circuitry, develop a voltage across their detector diode load resistor that is negative with respect to chassis. Similarly, most transistor receivers in current production have the detector diode wired to give a negative going output. This will generate a trough rather than a peak on the screen, but the trace is still perfectly useable. Early solid-state receivers, with germanium *pnp* transistors (OC44, OC45, OC170, OC171 etc), normally have the detector diode connected to give a positive-going output with respect to chassis. This results in a peaked trace.

Adjustment of the IF transformer trimmers or cores will, of course, change the profile of the display. If the restored radio is to be used for domestic listening, modern band conditions suggest that they be adjusted for the highest and sharpest peak. Turning up the 'Y' sensitivity and adjusting the other oscilloscope controls until the tip of the peak almost fills the screen enables the cores to be set with extreme accuracy.

This is, however, a matter of personal preference, and restorers who like to stagger tune the IFTs to produce a flatter passband and a better audio response will be able to see the results of their efforts displayed on the screen.

Some authorities recommend that the receiver's oscillator stage and AGC network be disabled in order to avoid any distortion of the trace. However, if the injected signal is kept as low as possible, and if the aerial is disconnected from the receiver (tune portables to a silent part of the dial), no problems should be encountered with spurious responses.

The effectiveness of the simple output attenuation control, R13, diminishes as frequency increases, especially when the high impedance feed is used, and it may be necessary to place the signal lead close to the injection point, rather than make a direct connection, in order to keep amplitude sufficiently low.

Some of the traces likely to be encountered are shown in the various photographs.

## Measuring the Bandwidth

Vintage receivers, with their large, high 'Q', double-tuned IF transformers will often out-perform modern transistor receivers. Some readers may wish to determine the frequency at the crest of the peak and at various attenuation points down the skirt of the IF response curve. To do this, place the output lead from another signal generator close to the output terminal of the wobulator. The second generator must be tuned to the receiver's IF, its output turned well down, and modulation switched off. The trace on the oscilloscope will become fuzzy and broader. If the frequency of the second generator is now swept slowly across the IF passband, a gap or notch will move along the broader trace. This represents

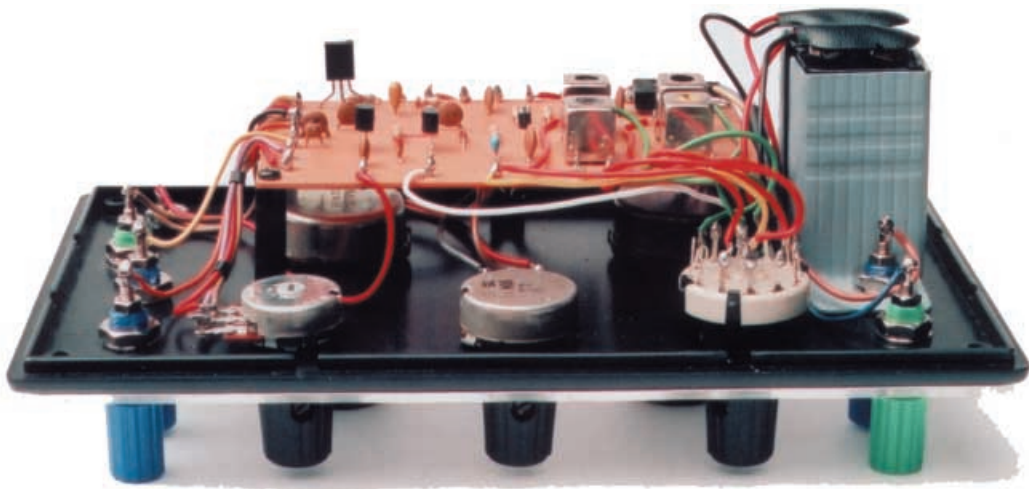

the zero-beat position, where the frequency of the second generator precisely coincides with the frequency displayed on the trace. The notch will be shallow at the bottom of the skirts, where receiver sensitivity is low, and deep at the crest of the peak, where receiver sensitivity is at its greatest. The photographs of actual traces should make this clear.

### Multiple Conversion Receivers

Additional equipment is needed to investigate the response of front-end tuned circuits and IF filters in multiple conversion receivers, as they do not feed directly into the detector.

Moreover, signal levels can be too low to produce a display on the oscilloscope. A suitable RF probe unit, which amplifies and detects the signal, will be described in the next issue of *Radio Bygones*.

Some high performance receivers, designed towards the end of the valve era, have complex, multi-section LC filters after the first frequency changer. Special equipment, produced by the receiver manufacturer, is often needed for the proper alignment of radios of this kind. Enthusiasts are urged to ensure that they have the necessary data and test gear before disturbing the adjustment of these complex and valuable receivers.

**RB**

## STORE YOUR BACK ISSUES ON MINI CD-ROMS

A great way to buy *RB* Back Issues – our mini CD-ROMs contain back issues from the *RB Online* website. Six issues on one CD-ROM for just £12.45 including postage and packing.

### CONTENTS

The full contents of each issue including covers, advertisements, free ads etc. Plus a number of text photos in full colour in addition to the cover photos.

All easily viewed and printed out using Adobe Acrobat Reader, which is a free software package. Each CD-ROM carries all six issues from one year; 2000 includes issues 63 to 68; 2001 includes issues 69 to 74. Earlier issues are *not* available in this format.

**ONLY £12.45** each  
including VAT and p&p



NOTE: These mini CD-ROMs are suitable for use on any PC with a CD-ROM drive. They require Adobe Acrobat Reader (available free from the Internet – [www.adobe.com/acrobat](http://www.adobe.com/acrobat))

### Order on-line from

[www.epemag.wimborne.co.uk/shopdoor.htm](http://www.epemag.wimborne.co.uk/shopdoor.htm)  
or [www.radiobygones.com](http://www.radiobygones.com) (store prices in US\$)  
or by phone, Fax, email or post.

For printed back issues see page 2

### RB BACK ISSUES MINI CD-ROM ORDER FORM

Please send me ..... (quantity) BACK ISSUES CD-ROM 2000

Please send me ..... (quantity) BACK ISSUES CD-ROM 2001

Price £12.45 each – includes postage to anywhere in the world.

Name .....

Address .....

..... Post Code .....

I enclose cheque/P.O./bank draft to the value of £ .....

Please charge my Visa/Mastercard/Amex/Diners Club/Switch

£ .....

Card No. ....

Expiry Date ..... Switch Issue No. ....

Card Security Code ..... (The last three digits on or just below the signature strip)

SEND TO: Radio Bygones, Wimborne Publishing Ltd.,  
408 Wimborne Road East, Ferndown, Dorset BH22 9ND.

Tel: 01202 873872. Fax: 01202 874562.

Email: [radiobygones@wimborne.co.uk](mailto:radiobygones@wimborne.co.uk)

Payments must be by card or in £ Sterling – cheque or bank draft drawn on a UK bank payable to *Radio Bygones*.

Normally supplied within seven days of receipt of order.

Send a copy of this form, or order by letter if you do not wish to cut your issue.

# Rogers Really Did It

by Ron

To an English purist, a grounded aerial is nothing better than an oxy-moron, whilst to many a radio buff, it's an impracticality, yet since the early years of the last century, several dedicated wireless engineers in many countries have applied themselves to the proposition that two-way communication is workable when using buried-wire radiators. The main exponents of this idea were: Marconi; Kiebitz in Germany; Alexanderson, who was known for his many aerial designs and later associated with Chester Rice and Edward Kellogg; Harold Beverage; and J. Harris Rogers of Hyattsville, Maryland in the USA, to name but a few. It is Rogers to whom I have turned my interest.

## Underground wires

Rogers was a man of considerable private means who owned a large home in Hyattsville, surrounded by a large acreage. His early experiments were not entirely disappointing but inclined more towards reception of long distance signals than the transmission of such, and whereas he was able to read signals over thousands of miles, his own signals, which were of less than 0.25kW spark were readable over some 12 to 15 miles distance.

However, he was not discouraged because he had noticed a lack of static when using an underground wire. By comparison, when using an elevated aerial, static increased thus causing a deterioration in readability. His response to this was to count his blessings; and he set about increasing his radiated power, leading him to lay down buried wires of much thicker insulation. He was an extremely practical person whose rationale was based upon a possible breakdown of insulation, but today we know about such things as standing waves.

## Pre 1917

On December 1st, 1916, Admiral W. S. Smith and Commander S. C. Hooper inspected his experimental station and aerial arrangement at his home in Hyattsville. Rogers had

ensured that his efforts had come to their attention, and he proved that transoceanic signals were 'easily readable' whilst using his underground radiators. During the visit of the US Navy Officers, he took a small boat onto a local lake and transmitted via

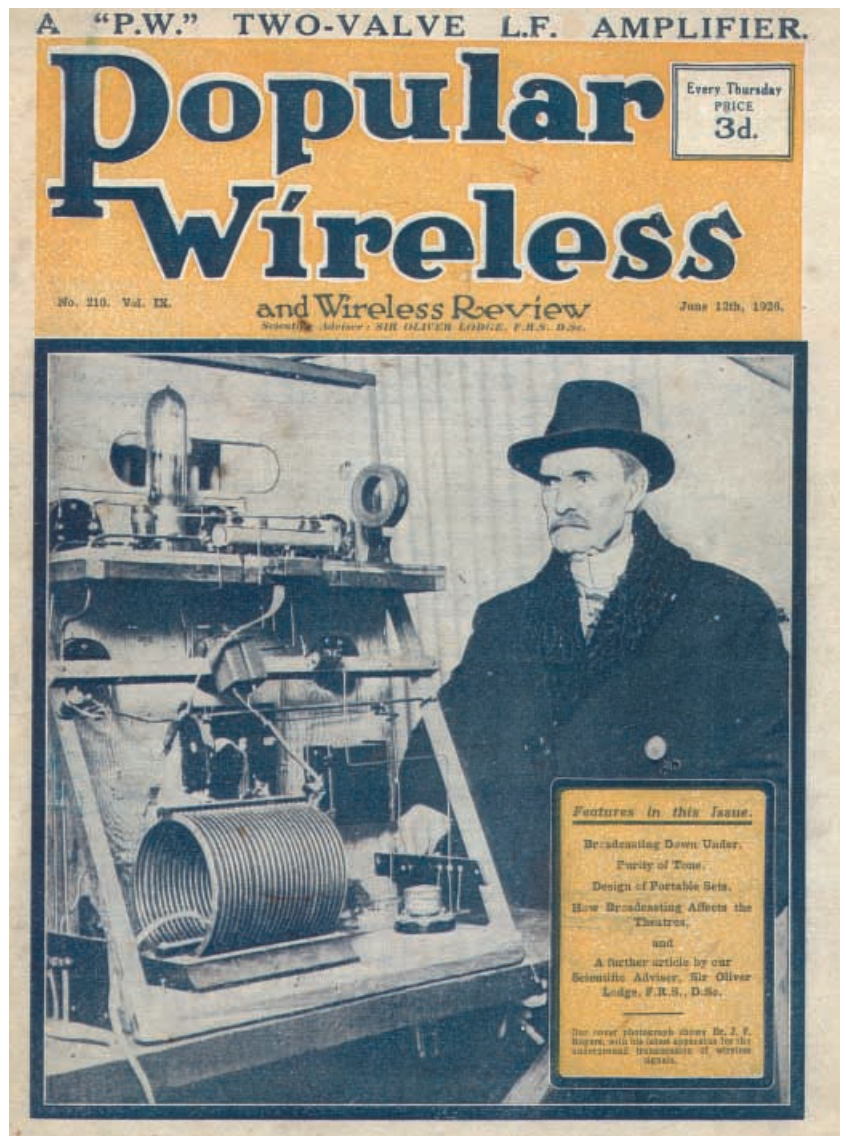

The front cover of Popular Wireless, June 1926 showing Dr. Rogers with his "apparatus for the underground transmission of wireless signals"

'underwater' conductors to the receiving station at his home, which was 3.2km distant.

As a result of his demonstration, Rogers was asked to attend The Bureau of Steam Engineering on March 6th, 1917. It was arranged that Mr. H. H. Lyon, Rogers' associate, should go to New Orleans. The underlying idea was to develop the system for naval use; the aim being to establish control stations for communication with ships, and 'submarines' below water at some distance. Lyon reported to the Commandant of the New Orleans Base, whilst working closely with Lt-Commander E. H. Loftin, the District Communication Superintendent of 8th Naval District. The following report was sent by Loftin to The Bureau on the 14th of April, 1917.

## Underground radio experiments

### VERBATIM

"Experiments have been in progress during the past three or four weeks at this Station to ascertain the adaptability of underground wires for receiving radio signals. These experiments have been conducted by Mr H. H. Lyon, Radio Expert, assigned to this duty by the Bureau of Steam Engineering, and Chief Electrician C. W. Jordan, United States Navy, under the supervision of the District Communication Superintendent.

"A standard copper conductor of 23,000 circular mils (11.6 sq. mm.) (7 twisted strands) having rubber insulation of about 0.15 inches (0.38cm.) thickness, has been used thruout. All wires are buried to a depth of about one foot (0.3m), the earth surrounding being practically saturated with water at all times.

"One conductor was laid in an approximate northeast and southwest direction, 1,400 feet (427m) extreme length, or 700 feet (213m) on each side of the receiver. This wire was cut into sections so that the total length, or several fractions of the total length, could be cut in. In addition to this long wire, two short ones, 300 feet (92m) overall, or 150 feet (46m) each side of the receiver, were laid parallel to and 10 feet (3.1m) from it, one on each side. A switch was arranged to connect either one or both of these wires to the receiver.

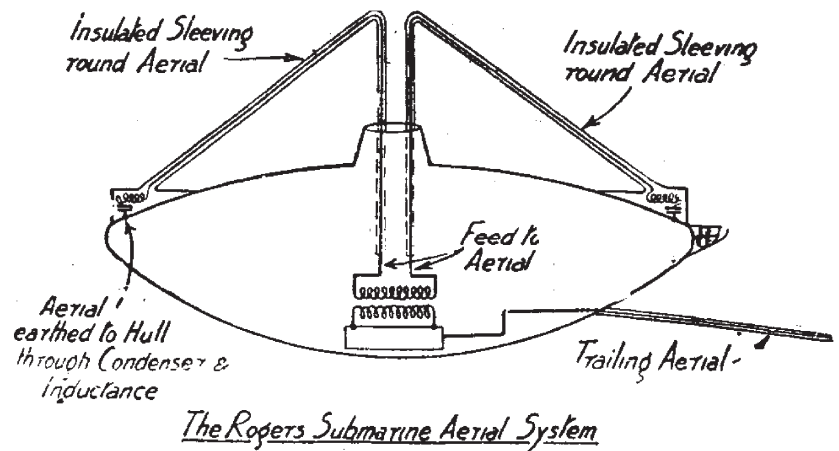

"For arc reception a 'BA' type receiver and an ultra-audion oscillating detector were used. Two pairs of telephones were connected in series, one pair being bridged with a type 'A' audibility meter. This was found advisable on account of disturbance of wing potential by the meter.

"The following results were obtained with arc signals:

"(a) 1,400-foot (427m) antenna, grounded at the extreme ends to large plates buried in moist earth, 0.0025 microfarad variable condenser in series for tuning.

"(b) 1,400-foot (427m) antenna, ends not grounded by plates, 0.0025 microfarad variable condenser in series for tuning:

"NOTE - These arc stations could be read without interference from the Station 5kW spark set 300 feet (92m) away. Interference began when down to about 5,000 meters.

"(c) 300-foot (92m) antenna, ends not grounded. 0.0025 microfarad variable condenser in series for tuning:

"Up to 1,400 feet (427m) of wire, the strength of the signal seems to be about in direct proportion to the length of the wire. The directional effect appears to be pronounced. Darien, which is about 80° off the line of antenna, is weaker than Arlington. On the main antenna, Darien is received about 30 per cent stronger than Arlington.

"The 'BA' receiver with its static (capacitive) coupler, is not very satisfactory for this form of reception on account of its lack of selectivity and smooth variation of primary inductance.

"At 9.00 pm, April 7th, it was possible to copy signals from Tuckerton with ease, while static on the main

antenna made it impossible to read any arc signals.

The following results were obtained with spark signals:

"(a) 300-foot (92m) wires in parallel, ten feet (3.1m) apart, 0.002 microfarad condenser in series with the primary coil of a Telefunken receiver to obtain 600 meters."

## Conclusion

It was concluded that during the tests, practically all of the arc stations throughout the country were received 'with ease', but it was noteworthy that whilst static prevented good reception on the main (elevated aerial), good reception continued on the underground antenna even when severe lightning conditions were evident otherwise. Indeed, it would have been dangerous to operate on the main aerial 'without grounding'. Reception was also directional and permitted the avoidance of interference, and even more-so by using a wire set 'off direction' from the interfering station.

A short time later, construction was begun to lay conductors in terracotta piping in order to compare results with normally buried wires. Plans were also made to use buried wires in order to locate the more distant stations within the Naval Reservation. A point was found in the south-eastern corner of the reservation, this being 2600 feet from the Radio Power House. It was thought possible that at such a distance, reception could be carried on whilst the arc was operating for stations on a line at right angles to the line of bearing of the power house. The long wires were then increased to a length of 2200 feet. Further reports



Dr. Rogers experimenting with his famous underground radio system, with which he has recently sent messages over a distance of 3,000 miles.

*Dr. J. H. Rogers experimenting in the early '20s*

were made on any advantage resulting from the additional length.

## Recommendations

(June 21st 1917 to August 14th 1917)

It was advised that all stations in areas where static interference was encountered should be equipped with underground reception aerials of a length of 1500 feet for arc reception, and shorter wires of 300 feet for the reception of spark transmissions. There was a minimum of two directions covered in order to receive the best signals from different directions. These were used in conjunction with elevated aerials according to conditions at the time of use. Ground conductivity made a difference to the ratio of signals to strays, and these varied in later experiments at Great Lakes, Belmar, New Jersey and Tuckerton, where conductors were buried in salt-marsh. Various types of wire and insulation thicknesses were tried, but conditions improved when equipment was changed to regenerative receivers plus amplification, crystal receivers being used before.

It was mentioned by Lt-Cmdr Loftin that there "is an optimum length for underground wire-length to wave-length, partially dependent upon the size of the wire and the insulation thickness". He also recommended that the underground system be employed in the New Orleans Naval installation. Strays were mainly eliminated by the use of heavily insulated wires and that

in some cases the lowering of insulation resistance seemed to admit static to a considerable degree. Elevated and ground aerials were compared against each other.

## Rogers' experiments

Full credit was accorded to Rogers for having first demonstrated to the Navy Dept that effective reception was possible with subterranean wires, both on long and short waves. Much of his work was done using Audion detectors. He succeeded in convincing the Bureau of Steam Engineering that the possibility of subterranean reception was based on the ratio of signals to strays, and was better than that which would have been obtained with normal aerial reception. He went on to improve upon the results in transmission and reception modes.

## The Rogers submarine aerial

The Rogers submarine aerial comprises a pair of heavily insulated cables, these being carried on short masts from bow to stern of the vessel. The aerial is earthed to the bow and to the stern via a capacitor and an inductance; the aerial *per se* being outside the submarine, and fed down to the transmission and reception apparatus through a watertight seal on the conning-tower, or "bandstand" as it was known in RAF Coastal Command.

## Trailing aerial

Rogers also tried out various lengths of 'trailing aerial' wire which was paid out as and when required, but there was a danger of this being entangled with objects on the seabed. It was necessary to have high insulation, for if excessive current were to be induced in the aerial system, breakdown was possible, and the transmitted energy would be earthed. As in the case of the Rogers underground aerial, insulation thickness was dependent upon the power used, whilst for maximum efficiency the thickness of the conductor was substantial. Directional properties were enhanced by steering the submarine for maximum reception. Rogers made considerable advances in his work during the 1920s.

The US Navy's interest in underwater, or any type of sub-surface antenna, resulted in many further investigations prior to and after WWI.

After WWI, Willoughby and Lowell applied for a patent on the submarine aerial. On June 9th, 1922, J. Harris Rogers contested this. However, the Examiner Of Interferences of the Patent Office arrived at a decision on the case in which it was held that **Rogers was entitled to "prior conception"** of the use of a loop antenna on submarines, but Willoughby and Lowell had independently conceived the device and had brought it into use and were entitled to the patent. **RB**



## Interested in vintage wireless or military radio?

Why not subscribe to *The Vintage Wireless Trader*, Published approx. every four months. Contains 100s of out of print old and collectable wireless books, magazines, ephemera, vintage communication and domestic receivers, government surplus military equipment, valves and components, etc., at affordable prices as well as subscribers wants and sales. Send £6.00 for the next four issues.

**FILAMENT TRANSFORMERS** 6.3V 1½ amp. Mains input. £5.95, p&p £2.00. 6.3V 1 amp £4.95, p&p £2.00.

**DOUBLE GANG 365+365pF TUNING CAPACITOR** Plessey, size 1½in. x 1¼in. with slow motion drive, 1½in. long spindle, £5.00 each, p&p £1.00. Two for £10.00 post free.

**A DIGITAL HANDHELD LCR METER** Measuring inductance, capacitance and resistance, 3.5 digit, 1999 count, i.e.d. display, inductance range 2mH to 20H, capacitance range 2000pF to 200µF, resistance range 200 ohms to 20 megohms. Brand new and boxed with test alligator clip leads and user manual. £44.00 + £4.00 p&p.

**VALVE BASES** Octal B7G, B9A. Any 5 for £2.50. B9G bases £1 each.

**HIGH VOLTAGE CAPACITORS** 0.1µF 1000V wkg mixed dielectric axial. 0.05µF 600V wkg axial. 0.68µF 800V wkg mylar dipped axial. All 60p each. 0.1µF 250V wkg axial type. 10 for £2.00.

**HIGH VOLTAGE ELECTROLYTICS** 10µF 400V wkg axial. 22µF 250V wkg axial. 47µF 385V wkg radial. 68µF 450V wkg radial. All 50p each. 150µF+200µF 350V surge wkg, 4in. x 1¼in. can, £4.00 each, p&p £1.00. 2 for £9 post free.

**HIGH VOLTAGE ELECTROLYTICS** 32µF + 32µF, CAN type, 450V wkg, 3in. x 1½in. with cap clip. £5.00 each.

**VINTAGE CARBON ONE WATT RESISTORS** Useful values. Pack of 50 £3.00.

**VINTAGE CARBON ½ WATT RESISTORS** Pack of 50 £2.25.

**¼ WATT METAL/CARBON FILM RESISTORS** 250 for £1.00.

**SILVER MICA CAPACITORS** 350V wkg, 220pF, 300pF, 560pF, 680pF, 820pF. 10 for £1.00.

**TUBE CERAMICS** 350V wkg, 220pF, 330pF, 470pF, 1000pF, 0.002µF. 15 for £1.00.

**WW2 ARMY MICROPHONES TYPE No. 3** with lead and jack plug, good condition, £6, p&p £2. 2 for £15 including post.

**WW2 ARMY HEADPHONES Type DLR5** with jack plug, good condition. £5 per set, p&p £2.50. 2 sets for £13.50 including post.

P&P £2 under £12.00, over Free unless otherwise stated.

## BOOKS AND MANUALS

**R1155 RECEIVER DATA** 47 pages £12.50 including p&p.

**MULLARD VALVE DATA AND EQUIVALENTS HANDBOOK.** Over 300 pages of valve data, base connections, characteristics and operating conditions for Mullard valves and their equivalent makes. Facsimile reprint. £16.50 + £3.50 p&p.

**EDDYSTONE COMMUNICATIONS RECEIVER DATA 1950-1970.** A facsimile reprint of the circuit diagrams, general description and some service notes. 50 pages. £11.50.

**JANES MILITARY COMMUNICATION 12th EDITION 1991-1992.** Over 800 pages, contains much recently released military wireless equipment. £25.00, p&p £8.50.

**HALLICRAFTERS COMMUNICATION RECEIVER DATA** A facsimile reprint of a selection of the circuit diagrams, general description and notes for Hallicrafters sets. Over 40 large format pages. £11.50 including postage.

**ARMY WIRELESS SET No. 62 SENDER/RECEIVER** Circuits, notes, operation, installation, includes drawings and photos. 70 large format pages. Facsimile copy. £14.25 including post.

**31 RECEPTION SET R209 MK.11 TECHNICAL HANDBOOK** Circuits, layout, Parts list, alignment notes. Facsimile copy. 55 large format pages. £13.50, p&p £2.50.

## WIRELESS AND TV SERVICE SHEETS AND MANUALS

Thousands in stock from 1930s to 1960s. SAE or telephone for quote

## MOST VALVES AVAILABLE AT LOW PRICES

Vintage, amateur radio, audio and military. Phone or SAE for quote.

## WANTED

**GOVERNMENT SURPLUS WIRELESS EQUIPMENT – MOST ITEMS CONSIDERED**  
**VALVE COMMUNICATION RECEIVERS**  
**PRE-WAR DOMESTIC RADIOS**  
**BOOKS AND MAGAZINES**  
**WE CAN COLLECT ANYWHERE IN UK**

## Dept (RB) CHEVET BOOK SUPPLIES



157 Dickson Road, BLACKPOOL FY1 2EU

Tel: (01253) 751858. Fax: (01253) 302979.



E-mail: chevett@globalnet.co.uk TELEPHONE ORDERS ACCEPTED.

## Visit Britain's largest Vintage Radio Shop Without even leaving your home!



- ▶ Britain's widest range of Radio, TV and Gramophone collectables for sale in every issue - 6 issues per year.
- ▶ Illustrated with accurate descriptions and prices.
- ▶ Interesting articles on all aspects of vintage technology.
- ▶ Annual subscription fully refundable against purchases.
- ▶ Top prices paid for quality items - collections bought.

Send S.A.E. for details and sample copy

## ON THE AIR

*The Vintage Technology Centre*

The Highway, Hawarden (nr. Chester) CH5 3DN

Tel/Fax (+44) (0) 1244 530300

[www.vintageradio.co.uk](http://www.vintageradio.co.uk)

## Join the BVWS the British Vintage Wireless Society



The Inflatable Radio



BVWS Bulletin



Quarterly 40 page magazine  
 Newsletters  
 Historical reprints  
 Swapmeets  
 Sales/Wants  
 Regional meetings  
 Auctions

Contact:  
 Mike Barker  
 Membership BVWS  
 59 Dunsford Close  
 Hillside Park,  
 Swindon, Wilts,  
 SN1 4PW  
 Tel: 01793 536040

# Restoring a Goblin S25 'Time Spot'

by Tony Thompson

This AC three-waveband five-valve superhet was marketed post war in 1947 and sold for £24 plus purchase tax. The set was featured in a *Practical Wireless* servicing article by Gordon J. King circa 1955, where he tells us that it was known as the Goblin 'Time Spot'. As far as I am aware it was the only foray of the Goblin Vacuum Cleaner Co. into radio production and is something of an oddity, looking quite distinctive and very unlike most sets of the period. The largish veneered ply wooden cabinet, size 440mm wide × 345mm high × 245mm deep, has two circular dials, one for the clock and one for tuning, making this receiver an early example of a clock-controlled radio.

The clock could be set to provide auto radio switch on at a predetermined time. Controls are, left to right, on/off/auto switch (allowing override of the clock switch), tone, tuning and wavechange. There are two vertical centre thumbwheels, the left one for setting clock radio 'on' time and the right one for volume level, the latter having a drum dial visible through a small aperture in the tuning dial face, with a level scale marked from zero to 12. The clock pointers are adjustable by a spindle at the rear of the set. The steel chassis is a substantial construction, filling the whole of the bottom of the roomy cabinet. The straightforward circuitry makes for ample working space beneath the chassis. Unusually, it is not necessary to remove the control knobs when extracting the chassis from

the cabinet, as they are accessed through large circular holes cut in the front panel with an insulating card behind them, taped to the chassis front rail and carrying the control legends.

## Circuit Description

The clock is directly connected to the mains supply and therefore remains on when the set is switched off at the rotary control (Fig. 1). The aerial signal is filtered by the T1/L1 IF trap and connects to the primary windings L2, L3 and L4 via a section of the wavechange switch S1A. A similar arrangement connects the appropriate secondary winding to the hexode control grid – top cap – of V1, the 6K8, a combined triode oscillator/hexode frequency-changer. The switching circuitry of the oscillator section mirrors the aerial coil arrangements and all switching is ganged on a single spindle. It will be seen that AVC (AGC) is applied to the hexode only for medium and long wave operation and for short wave the valve is biased only by the cathode components, presumably to keep sensitivity high. The 465kHz IF is amplified by valve V2, a 6K7 vari-mu pentode. V3, a 6Q7, is a double diode-triode demodulator/AF amplifier. Although there are two diodes, they are simply strapped together allowing the signal voltage to develop the AGC potential across the integrator circuit formed by R2 and C5.



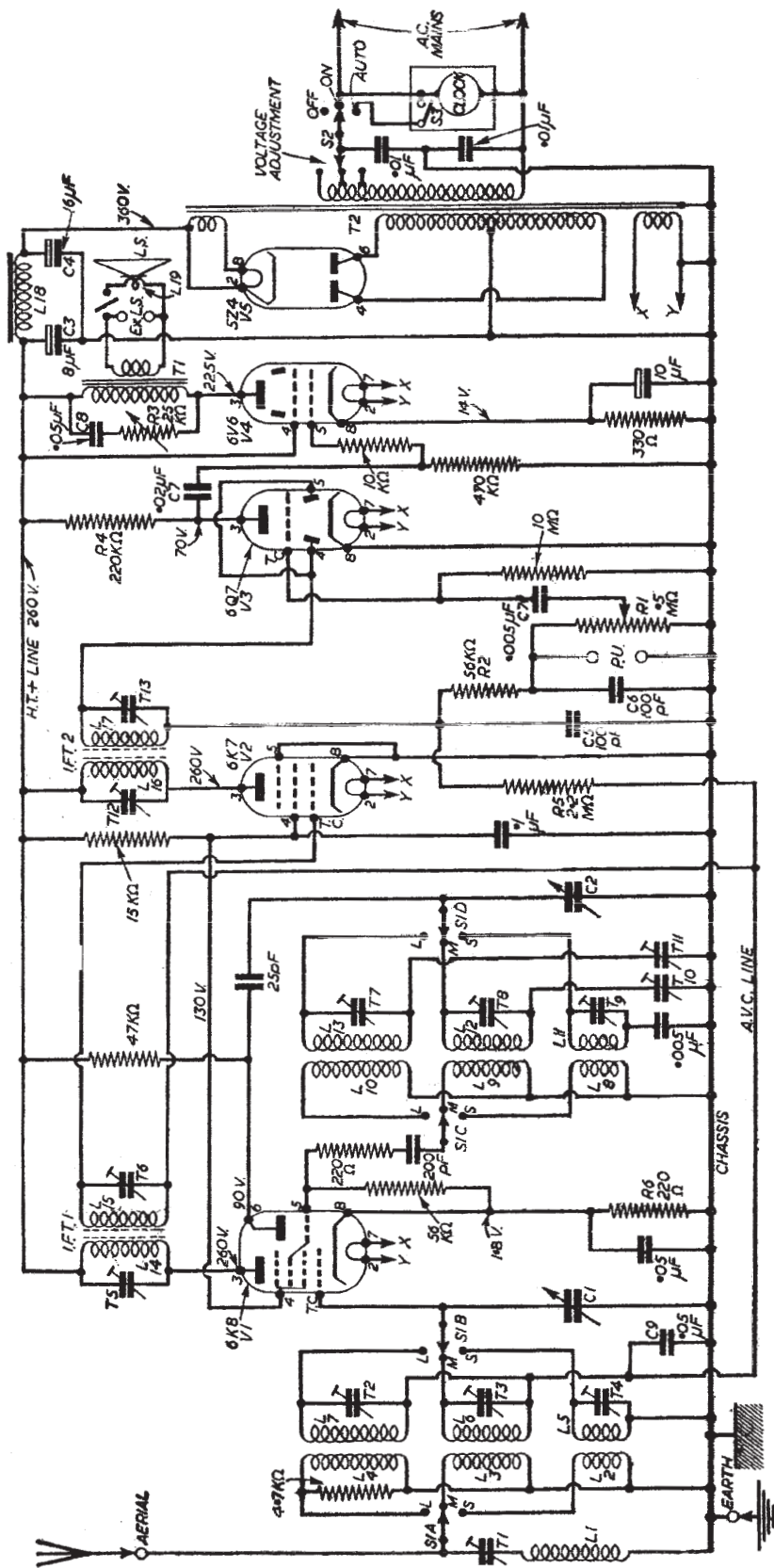

Fig. 1. Circuit diagram for the Goblin S25 'Time Spot' receiver

The AF circuitry is, again, conventional. The triode section of the 6Q7 picks up the AF signal from the slider of the volume control and supplies the amplified signal to the 6V6 output valve control grid. Use of the gram input sockets would require tuning to a quiet part of any of the three bands as there is no isolation switch for the AF stages. The loudspeaker is a mains energized type, the L18 field winding being used as part of the HT smoothing circuitry. The 5Z4 full-wave rectifier is supplied by a substantial double-wound transformer.

## Initial Checks

The cabinet of this particular Goblin had seen better days. The finish was badly damaged and there was penetrating damage confined to an area to the top right of the cabinet as viewed from the front, where some heavy, sharply-pointed object had punched right through, shattering the tough layers of plywood. There was, outwardly at least, no sign of woodworm infestation, though I always treat wooden cabinets internally as a precaution. The mains lead had been changed but was of the thick white variety perhaps more suitable for a washing machine or other similar heavy duty appliance. The knobs appeared to be in good condition, with no cracks or chips. The clock did not, unfortunately, function.

After testing for shorts on input and HT line, I powered the set up via my safety lamp. It was totally dead. A quick check revealed poor connections to the mains transformer, the first of many of this sort of fault throughout the chassis. With the clock wiring bypassed as a temporary measure, I fixed the poor connections and switched on again, still using the lamp of course. The set then functioned fairly well, though both the volume level obtainable and the general sensitivity seemed low, a problem which remained even when the lamp was bypassed and the set came under full power.

I noticed that whoever had fitted the heavy white mains cable had neglected to earth the chassis, even though the cable was three-core. Most of the capacitors in the AF and AGC circuitry were metal-cased Sprague types, sleeved with rubber tubing to insulate them. I have found that these types are generally more reliable than the brown



*The restored unit refitted into the cabinet*

wax sort, but still I decided that to be sure, they would need to be replaced. Two flat Bakelite cased capacitors bypassed the mains input and these too would be changed.

## Valve Testing

Checked on the tester, I found that both the rectifier valve and the triode section of the 6Q7 double-diode-triode were very low emission. Accordingly replacements were found for these two valves. The remainder of the valves tested satisfactorily. As for the chassis condition in general, the dial drive cord was broken, one dial bulb was missing and the other open-circuit. Some of the wiring had crumbling insulation but for the most part, the condition was quite good considering the age of the set, especially beneath the chassis.

I was unable to check the clock movement before dismantling and it remained an unknown quantity, subject at the time to the following possibilities:

1. Hopefully it would be possible to get the clock working again.
2. If the clock proved to be unrepairable, I could bypass the clock switching, leaving the movement and its dial in place to maintain visual completeness.

The chassis condition was evenly dirty but only lightly corroded and required little more than a light clean.

## Dismantling Procedure

There are two sections of rear panel, held by a total of six small dome-headed woodscrews with washers. The energized loudspeaker must be removed before the chassis can be withdrawn. It is mounted at an angle downwards, retained at the sides by wooden strips that form runners for the baffle board, with a couple of woodscrews securing it. Once the loudspeaker is clear of the cabinet, taking the chassis out is a simple and quick process, entailing only the removal of the

four large screws that hold the chassis from beneath the cabinet, best done with the set stood on one end. As mentioned, the knobs do not need to be removed. The loudspeaker connection leads are long enough to allow the baffle board to lie alongside the chassis on the bench. Working with the chassis removed from the cabinet I drew a quick diagram before I disconnected the energized loudspeaker at its terminals, leaving the wires still attached to the chassis.

## Dismantling the Upper Chassis

Chassis stripping commenced by unplugging the valves and removal of the clock and tuner assemblies. Both have metal dials secured by 6BA screws, the clock also having longer screws with short tubular stand-offs. Two 4BA screws anchor the clock plate to the chassis and these were accessed from beneath using a nut driver. It was also necessary to remove the extension spindle that sets the pointers, achieved by rotating the rear plastic knob in the direction indicated by the moulded arrow. I followed the clock wiring through a grommet to the connection points beneath the chassis and noted these before removal. Once this was done the clock was lifted clear of the set and placed aside for testing.

The gang tuning capacitor assembly has a bracket similar to the clock and removal was much the same, although here there was the need to unsolder the connections to the edge-on volume control as well as the connections to the gang. I never trust to memory so to play safe I sketched out another diagram noting the colour codes of the wires and where they came from. The upper chassis metalwork and mains transformer casing cleaned up satisfactorily with WD40 and wire-wool. The valveholders and the IFT cans were cleaned, the latter being polished with fine wire-wool and metal polish. The tuning gang assembly quickly came clean by brushing and vacuuming.

When I tested the clock I was disappointed to find its motor winding open-circuit, effectively making it useless. I decided to refit the clock for cosmetic reasons but to bypass

the clock switch. Once everything was cleaned and sorted, the upper chassis hardware components were replaced and a new length of mains lead installed. This time the chassis was earthed.

The two dials were carefully cleaned with paper towel. They were metal but the screen printing looked delicate and I did not want to risk the loss of markings. Although some fading of the colour had occurred, especially the yellows, overall both dials looked pretty good for their age. The Bakelite knobs were cleaned by a dip in warm washing-up liquid solution before scrubbing with a nail brush, drying with a hair dryer and polishing with metal polish. Later, when the knobs were refitted, to keep things as original as possible I sealed the grub screws with brown wax as they had originally been, although technically there was no reason to do so.

## Below Chassis

During dismantling I had noticed some unsuitable work had been carried out on the wiring to the mains transformer and also to the loudspeaker. Where soldering had been carried out, it was of a poor standard. In fact, some connections had not been soldered at all, just untidily twisted in place. A note was made of the wiring to the transformer before it was partially freed from the tangle of scruffy, meandering wiring and rewired after cleaning and tinning the tags. Not a big

output valve. With the upturned chassis supported, I began the replacement of the larger tubular capacitors, beginning with the output valve bias reservoir electrolytic. This proved to be thoroughly dried up and possessed only very slight capacitance. I noted too that the reservoir section of the large HT double capacitor was also low in capacity. Because the clock could no longer function, I rewired the set's selector switch so that the 'auto' and 'on' positions both brought power directly to the set. I replaced the two  $0.01\mu\text{F}$  filter capacitors bridged across the primary of the mains transformer. The new mains lead was fitted with a three-amp fused plug.

The loudspeaker was of the mains energized type and I took care to ensure correct connections when rewiring. As it turned out, the loudspeaker was faulty anyway. I completed this stage of the work by fitting new tubular capacitors in the AF and AGC circuits. The slow-motion drive arrangements were very straightforward with the useful addition of a simple but efficient mechanical band-spread device. This mechanism, together with the tuning drum and spindles, was cleaned and greased before reassembly and restringing of the system.

## First Trial and Subsequent Problems

Powered up through the test lamp, the valves lit but now the set seemed 'dead' – nothing at the pick-up sockets, hum from

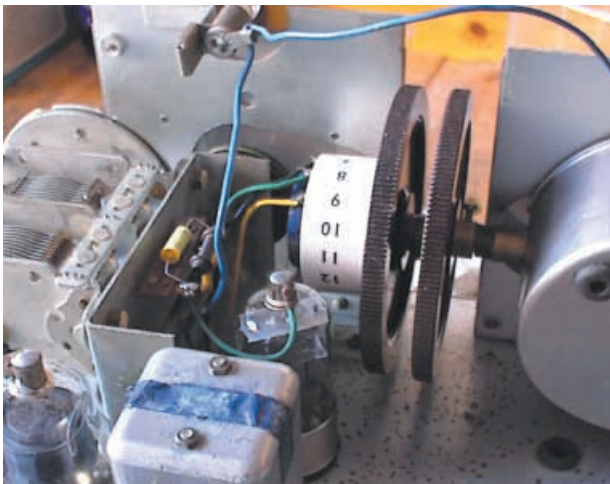

*The restored volume level drum dial and two edgewise controls*

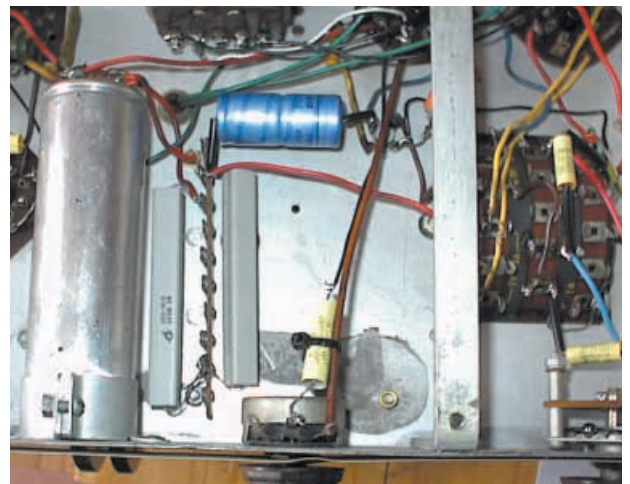

*Two  $1\text{k}\Omega$  wirewound resistors in parallel to replace the loudspeaker field coil*

problem – the transformer was quite clearly labelled in any case. The switch designed to mute the internal loudspeaker was another area of attack by the ham-fisted mystery man, as its tags were overloaded with solder and multiple whiskers of stranded wire. This was cleaned up and the connection remade, including the two scruffy and obviously non-original leads to the output transformer, which appeared to be split strands of transparent flexible bell wire. The problem of the muting switch resurfaced later, though.

In order to remove the dial lamps, I followed the course of the wire through a chassis grommet located beneath the tuning capacitor and unsoldered the lead from pin 2 of the

the loudspeaker regardless of the volume control setting. The voltages on the output valve checked OK but a screwdriver scratching on the grid connection caused no crackling in the loudspeaker. When this kind of problem occurs where previously a set had been functioning, albeit poorly, there is always the temptation to think that a mistake has been made during rewiring and reassembly. I ignored the nagging doubt and instead checked the internal loudspeaker muting switch, which proved to have gone open-circuit. Bridging this brought me faint crackling at the output valve grid but still nothing like there should have been and neither rotating the wavechange switch or touching the gram sockets created any

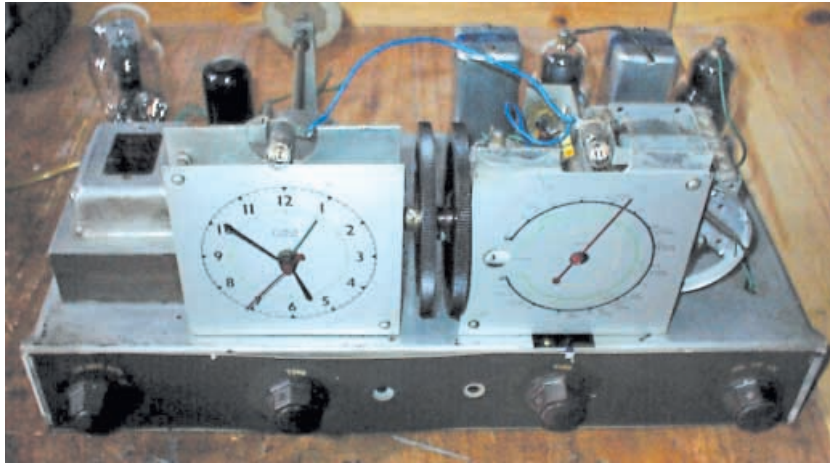

*The finished chassis ready to go back into the cabinet*

healthy crackling. Measuring from the output valve control grid to chassis read very high on the meter, but this was hardly surprising as there was a 10M resistor in series with the grid. However, on the 'earthy' side of this resistor it still read extremely high – hardly right. The problem was corrected by the resoldering of yet more dry joints.

Now the set came to life with very good volume on stations on all three bands – but at high settings of the volume there was a persistent crackling from the loudspeaker. A spare loudspeaker was coupled up, leaving the energized 'field' coil in circuit to maintain HT and this showed that the loudspeaker was indeed faulty. I had to hand an old Ambassador model 548 'bookcase' type set that was in appalling condition and had already been earmarked for scrap. The loudspeaker in the Ambassador was physically similar to the one in the Goblin, but it was a permanent magnet type, not mains energised. I fitted this, adding a couple of parallel two kilohm wirewound resistors to replace the now absent field coil. As there was lots of room below chassis, I mounted these on a length of tag strip and also used the tag strip as an anchor point for the replacement reservoir capacitor, needed because the hum level had risen to an unacceptable level. Perhaps this was because the efficiency of the original field winding had masked the failing reservoir capacitor. I took the opportunity to earth the frame of the replacement speaker to the chassis.

The set now worked extremely well although a slight problem presented itself with intermittency of operation on medium-wave. This was corrected by the replacement of the medium-wave aerial trimmer capacitor T3, followed by a realignment of the tuned circuits and yet more dry joint resoldering, this time around the medium-wave aerial coil. The IFTs were left well alone as they had not been disturbed and the radio's performance was well up to standard. Due in part to the large loudspeaker and in part to the well-constructed cabinet, the sound quality was very pleasing and I was particularly surprised at how wide the range of the tone was, for such a simple top-cut circuit. That concluded the chassis work and I turned my attention to the cabinet.

## Removal of Cabinet Fittings

The loudspeaker grille cloth is held in place by a rather crude timber framework, curved to match the shape of the

cabinet. This can be removed by unscrewing four wood-screws, two at each end of the structure. With the framework removed, there is a strip of wood pinned to the cabinet through the grille cloth and this needs to be levered off carefully with a thin broad-bladed tool such as a steel rule before the cloth itself can be lifted out. The Bakelite centre moulding through which the two edge controls fit is held by a metal strip, with two small screws securing it. The two clear plastic dial lenses are held by circular silver coloured metal strips, the free ends of which are secured by tiny wood-screws. Additionally, the plastic glasses have a small steel pin and again, this needs to be carefully levered free in order to remove the lenses. This is perhaps easier to do from the front of the cabinet rather than the interior, as there is a lip on the lenses that gets in the way.

The usual warm soapy water treatment was given to the small Bakelite escutcheon, metal-polished when dry. The loudspeaker fabric, being of the heavy 'woven string' sort, was found to be very clean on the reverse and could be fitted back-to-front upon reassembly as the weave pattern was identical on both sides. With the loudspeaker removed, I repainted the baffle board with matt black spray on both sides. The dial lenses were cleaned with metal polish. The soft plastic had inevitably become marked and scuffed over the years but the cleaning process minimized this.

## Stripping the Cabinet

The original finish, or more accurately what was left of it, was removed with gel paint stripper and cleaned with white spirit after which the interior was given the five-star wood-worm treatment, ensuring a liberal coating on the softwood inner sections and the edges of the plywood. The stripper had the effect of darkening the timber slightly, as happens sometimes. The penetrating hole through the cabinet top proved larger than I had first thought and the ply had crumbled quite badly so I cut out a neat section of the damaged veneer surface, removing all the loose fragments of veneer to expose the underlying carcass timber surrounding the hole before filling with high-performance two-part wood filler. When this was set, I levelled the filler surface with rough abrasive on a cork block.

At this point it was ready for re-veneering. I chose as near a match of timber veneer as I could find and cut this carefully to



*The damaged section of the cabinet*



*A section of the original veneer was removed and a new piece cut to replace it*



*The cabinet ready to be refinished with toner spray, lacquer and wax*

become an exact fit, allowing some overlap on the outer edge for subsequent trimming. Thin veneer can be cut with a craft knife or with sharp scissors but whichever you use, it is wise to cut through masking tape as this prevents splitting of the delicate sheet. The prepared veneer piece was soaked thoroughly in warm water and padded dry with paper toweling. PVA adhesive was used to bond it in position, with strips of masking tape applying pressure around the curve.

A look around the cabinet revealed several areas of separation, perhaps caused by exposure to moisture and along the bottom front edge the thin ply had delaminated and stood well off the cabinet base. I bonded this with Araldite, again using masking tape to pull and hold it in place until the adhesive had set.

The new veneer piece to cover the filled hole was slightly thinner than the original veneer but careful grading with a sandpaper block eliminated this problem. Because the new piece had open grain, it would have shown up markedly upon refinishing, so I brushed on a couple of coats of undiluted French polish as a grain filler. When dry, this area was sanded again, resulting in a very smooth surface which to the fingertips appeared continuous although visibly there was a disjointed effect due to the slight colour difference between the old and the new veneer, plus the impossibility of exactly matching the original veneer's ray pattern. I tried to fake this slightly with stain applied with a brush in an attempt to mimic the pattern, but this was only partly successful.

## Cabinet Refinishing

Both of the problems of the colour difference and the lack of a ray pattern were overcome by the use of medium mahogany toner spray, applied first to the two curved cabinet sections, with the rest masked off, and then a final unifying coat to the whole cabinet. Two coats of clear lacquer were applied to seal in the toner. When hard dry, the whole cabinet was lightly rubbed down with fine wet and dry, used wet with block soap as a lubricant. Dried with a hairdryer, a couple of final coats of clear lacquer were applied. This was left to harden off for a couple of days before the surface was gently cut back using Rottenstone, applied with a rag dampened in white spirit. This extremely fine abrasive levels the orange-peel effect left by any spray method but must be used with very great care or edges and corners will cut through, always a problem where toners are used as the colour difference becomes immediately obvious and a fresh start – completely re-stripping the finish – becomes the only effective answer.

After removal of all trace of the Rottenstone, the cabinet was waxed with Colron finishing wax before reassembly. The final effect, though inevitably rather darker than the original finish, is most pleasing.

## Suppliers

Rottenstone, French Polish and other woodworking and finishing materials may be obtained from Axminster Power Tool Centre, Chard Street, Axminster, Devon EX13 5DZ. Their catalogue is excellent. Tel: 0800 371822.

Toner and clear aerosol spray lacquer can be obtained from Restoration Materials, Barnside, 194 Wellington Road, Bury, Lancs BL9 9AH. Tel: 0161 764 2741.

**RB**

# QRM Sixty Years Ago

by Michael O'Beirne, G8MOB

I have often wondered whether the considerable technical progress that we have made in HF communications over the last sixty or so years has been put back by the general increase in RF pollution that has raised the ambient noise levels quite considerably – a case of three steps forward and two back.

My thoughts were somewhat crystallised after reading my former regiment's records from the Second World War. In 1944 the regiment's radio equipment comprised mostly 19 Sets mounted in small armoured cars with an 8 or 12 foot whip for an aerial. One squadron went over to France on D-Day while the remainder were quartered near East Grinstead in Sussex, not far from the coast, in preparation for the crossing to France once a bridgehead had been established. In this period of a few weeks the regimental intelligence officer's 19 Set at regimental HQ was able to monitor all the signals traffic from the squadron in France with apparent ease. This greatly surprised me for several reasons:

1. The line of sight distance to the Normandy coast and beyond is about 200km.

2. The squadron's forward troops would have been using AM for most of the time and AM from a 19 Set was never brilliant at the best of times.

3. The low power – perhaps a few watts.

4. The short inefficient vertical whip aerials used by the armoured cars would not have favoured high angle refractive comms via the ionosphere, though one could reasonably assume that the intelligence officer's aerial at East Grinstead was more elaborate, probably some form of inverted L better able to receive skywave.

There are no signals plans or log books surviving which give the frequencies used, but obviously within the spread of the radio – 2 to 8MHz.

My experience of listening to such frequencies both on manoeuvres and

from my home station on a modern professional receiver with a respectable active aerial system that can be switched between horizontal and vertical polarisation is one of considerable noise and QRM. How then did the intelligence officer enjoy such good results? The ionosphere itself has not changed as far as I am aware. I suggest two possible answers:

- a. The bulk of the direct radio path was across water, but even so 200km plus is a heck of a long way for ground wave, and it must have been via sky-wave.

- b. The RF occupancy and pollution levels were considerably lower in those days with a corresponding increase in perceived signal-to-noise ratios. The QRM we take for granted nowadays was largely absent.

## Factors Affecting QRM

Factors affecting QRM levels would include the following:

1. There were vastly fewer broadcast stations blocking up the channels and potentially causing intermodulation, blocking and a general increase in noise levels. Domestically we had just the Home Service, the Light Service and the Third Programme, no local radio and, of course, no VHF. At HF there were also fewer broadcasters and many of those put out less power than today, creating far less of a maelstrom.

2. There was no television broadcasting in the UK and Europe during the war, and so there was none of the dreaded TV timebase buzz at 16kHz intervals that plagues us all today. The hash from some CCTV and cable systems was similarly absent.

3. There was no amateur operation from many parts of Europe, and possibly elsewhere.

4. There was no hash from computers and other microprocessor equipment, exacerbated by their switched mode PSUs, nor from the various PLT

signalling systems over mains power lines which can be very troublesome.

5. There was none of the gunge caused by high powered jammers, over-the-horizon HF radars, spread spectrum and other modern broadband sweeping systems.

6. I suspect that pre-war farm machinery generated far less QRM, particularly the extensive absence of the modern electric fences which carry a sharp pulsed signal which plagues many country listeners.

7. There was far lower national power consumption. The national grid carrying massive power lines was less developed and there were fewer HV transformers. Those who have lived near a noisy one will know all about QRM! I once had the misfortune of having to operate a military net where the command station was sited within a few hundred metres of a 415kV power line carrying about half of the output of the Dungeness B nuclear power station. The command station had the temerity to suggest that our comms were hopeless, but once it got itself off its backside (i.e. in the officers' mess at Lydd Barracks with an endless supply of hot coffee on tap) and moved a few miles down the road, comms suddenly improved dramatically. What a surprise!

8. There were far fewer noisy electrical gadgets in houses such as central heating controllers, vacuum cleaners, microwave ovens, drills, dishwashers, food processors, light dimmers and the like, though it has to be said that the suppression of some early electrical appliances was less good than today.

9. There were far fewer neon lighting tubes in use which can produce blanket RF noise if not carefully suppressed.

10. There were far fewer motor vehicles.

11. The 19 Sets suffered from none of the synthesiser phase noise that we accept nowadays as a fact of life, and they had considerable RF selectivity ahead of the mixer provided from the



ATU/variometer and several tuned circuits.

## Counter Considerations

On the other hand there were a few considerations going the other way, for example:

1. The standards of vehicle RF suppression were generally lower in those days, though they may have been better with military vehicles because those would have been in use at or near many radio sites. It is instructive to compare the electrics of a standard 12 volt Land Rover with the 24 volt FFR ('Fitted For Radio') version used by many armies. The latter has fully screened power cables, extensive panel bonding and capacitor decoupling of the electrical gear.

2. There might have been considerable RF QRM emitted from illumination equipment using carbon arcs, for example film projectors and the massively powerful searchlights, though clearly not during the day!

3. Domestic radios probably caused some QRM through local oscillator radiation from the mixer to the aerial,

and aerials in those days were generally long wires and provided quite efficient radiators compared to the minute signal levels emitted by modern transistor radios and ferrite rods. The HRO was notorious for this at multi-receiver sites and when TV was back on. For example, when the set was tuned to 20 metres, the third harmonic radiation from the LO (on about 44MHz) was strong enough to wipe out nearby Channel 1 televisions.

## Receiver Sensitivity

I do not think that receiver sensitivity then and now is a factor because it has not changed much over the years. Furthermore, sensitivity only becomes relevant above 20MHz at which the natural atmospheric noise drops to a level where a sensitive receiver can actually use its low noise figure. It may surprise some readers to be told that most professional HF receivers have noise figure specifications of 10dB or more and some as high as 17dB, examples being the Eddystone EC958 and the Marconi ICS3 (manufacturers' figures).

## Urban Environment

My own experience of modern military comms over a period of 25 years is that operating in an urban environment on HF is hard work as a result of the dreadful QRM. Once, operating from the roof of Chelsea Barracks and working across London, we found that the best aerial was a home-built tuned diamond-shaped loop with sides of about five feet which had a very high Q and a bandwidth of less than 10kHz (a design I had cribbed from a tactical loop aerial made by Racal). It picked up less signal than a tuned vertical mast, but also far less QRM and so the readability was much enhanced. Yet out in the country, particularly at places remote from noise sources such as Salisbury Plain and Dartmoor, comms generally improved dramatically provided there was no other station close by.

I would expect that the man-made QRM in 1944 was at least 20dB, and probably more, below current levels. I know of no spectrum occupancy plots from those days and welcome views from those OTs who knew what the situation was. **RB**

### VALVE CLEARANCE SALE BY TENDER THE CLOSING STOCK OF AN ESTABLISHED VALVE TRADING COMPANY

5,100 Large Valves and 5,470 Small Valves.  
New and good used. All boxed and sorted.

SALE BY TENDER: A 28-page Tender List listing  
1,590 different valves available on receipt of £4.00  
to cover printing and p&p made out to:

**W. BURCHER**  
**SOUND SYSTEMS OF SUFFOLK**  
**676 FOXHALL ROAD, IPSWICH,**  
**SUFFOLK IP3 8NQ**

  
**Morsum  
Magnificat**

***The bi-monthly magazine for Morse  
code enthusiasts, looking at the past,  
present and future of the art***

**The Nilski Partnership, The Poplars,  
Wistanswick, Market Drayton,  
Shropshire TF9 2BA.**

**Phone 01630 638306. Fax 01630 638051**

## National Vintage Communications Fair N.E.C. Birmingham • UK Sunday 4th May 2003

*Now in our 11th Year!*

10.30am to 4.00pm • £5 admission  
(early entry c.8.30am @ £15)

1000s of VINTAGE WIRELESS SETS  
CRYSTAL SETS • VALVE AMPLIFIERS  
CLASSIC HI-FI • HORN LOUDSPEAKERS  
RECORD PLAYERS • RECORDS (78S/CDs)  
GRAMOPHONES • VALVES • SPARES  
EARLY TELEVISIONS • OLD TELEPHONES  
plus all MECHANICAL and ELECTRICAL  
ANTIQUES & COLLECTABLES

• **300 STALLHOLDERS** •

Stall Bookings/Details  
N.V.C.F., 13 Belmont Road, Exeter  
Devon, EX1 2HF, UK  
(01392) 411565

<http://www.angelfire.com/tx/sunpress/index.html>

# Restoration of a Typical Superhet Valve Receiver – Part 4

by Eric Kempshall

First a word of warning on alignment, if your set is working well and bringing in a good range of stations it is probably best left well alone, particularly if the IF slugs are still held by the original wax that was often applied to them in valved sets. If, however, someone has clearly been ‘twiddling’ and/or the performance of the set is well below par then you will want to adjust it for the best possible performance.

The best and most accurate way to do this is with a wobblator and oscilloscope – see *A Wobblator Unit* on page 12 of this issue. Alternatively, a signal generator and output meter can be used, but many of you will not have access to this equipment and I feel that it is probably not viable to acquire it if you are doing just one restoration. The simple method I shall describe is one that I know a local radio dealer used from 1948 to his retirement four years ago, when he serviced his sets with a minimum of equipment.

## Alignment

You will need a small electrician’s screwdriver, a sharp meter test prod and a double-ended tuning tool with brass blades, possibly also a hair dryer to help when removing wax from coil former slugs.

Tackle the IFs first, removing as much wax (if used) as possible from the coil former with the screwdriver and test prod. Get to the stage where you can move the core both ways easily with the tuning tool. Take care if the tuning slug has only a recessed slot in the top, rather than a slot right the way through, into which the tool will fit, as you must not allow the tool to slip in the recessed slot or use force as it is only too easy to break some cores. It is also very difficult trying to drill out a broken slug and also trying to find a replacement.

Allow the set to run for about 15 minutes and then tune to a fairly weak station about the middle of the medium waveband. Turn the volume control well up so that any increase or decrease in volume will be apparent. Aural assessment of volume is not an ideal method of alignment, but it is easier and probably just as good as trying to use a digital meter as an output meter on a constantly varying transmission.

## Tracking

Align the IFs first, maximising T2 secondary then T2 primary (see page 25 *RB81*). Move to T1 and do the same. Check the calibration of the stations on the dial; Radio 5 is a good marker at the low frequency end of the band and this can be pulled into position with the core of L3 or a padding capacitor in the position of C16 if it is adjustable. At the high end of the band, I can use Southern Counties Radio as a marker, but you may have to find another identifiable transmission to adjust C7. Repeat these two adjustments until you get correct tracking.

Switch to long wave and repeat this procedure using the core of L6 or any adjustable padder in the C15 position together with C8, which works at the high frequency end. Tracking can be checked (we hope) by the French transmission around the “Allouis” marking on the dial and by the position of Radio 4 on 198kHz. The aerial stages require adjustment of C5 on medium and C6 on long waves, after adjustment of L1 and L2 at the low frequency ends of each band.

No great adjustment of any one of these variables should be required although you can get exceptions, particularly if someone has had a “twiddle”.

## Useful Contacts

A list of useful contacts follows, but it is not exhaustive and there are others, to whom I give my apologies.

### SERVICE SHEETS

**Chevet Supplies Ltd** (Dept RB), 157 Dickson Road, Blackpool, FY1 2EU  
Phone – 01253 751858  
Fax – 01253 302979  
Email – [chevet@globalnet.co.uk](mailto:chevet@globalnet.co.uk)

**Savoy Hill Publications**, 50 Meddon Street, Bideford, The Little White Town, Devon EX39 2EQ  
Phone & Fax – 01237 424280  
Email – [paul.pollivier@virgin.net](mailto:paul.pollivier@virgin.net)

**Dave Williams**, 16 Church Street, Owston Ferry, Doncaster, S. Yorks DN9 1RG  
Phone & Fax – 01427 728046

**Mauritron Technical Services**, 8 Cherry Tree Road, Chinnor, Oxfordshire, OX39 4QY.  
Email – [enquiries@mauritron.co.uk](mailto:enquiries@mauritron.co.uk)

Web – <http://www.mauritron.co.uk>  
Phone – 01844 352554

**Vintage Radio World**, 25 Burdale Close, Driffield, East Yorks, YO25 6SG  
Email – [vrw@burdaleclose.freereserve.co.uk](mailto:vrw@burdaleclose.freereserve.co.uk)

Web – [www.burdaleclose.freereserve.co.uk](http://www.burdaleclose.freereserve.co.uk)

### TRANSFORMERS

(New to specification of order)

**Majestic Transformer Co.**, 245 Rossmore Road, Parkstone, Poole, Dorset BH12 2HQ.  
Phone – 01202 734463  
Fax – 01202 733793

**Sowter Transformers**, The Boatyard, Cullingham Road, Ipswich, IP1 2EG  
Web – <http://www.sowter.co.uk>  
Email – [techsupport@sowter.co.uk](mailto:techsupport@sowter.co.uk)  
Phone – 01962 6220135  
Fax – 0870 458 1700

**Variable Voltage Technology Ltd.**,  
Unit 3, Sheat Manor Farm, Chillerton,  
Newport, Isle of Wight, PO30 3HP  
Web – [www.vvttransformers.co.uk](http://www.vvttransformers.co.uk)  
Email – [rb@vvt-cowes.freeserve.co.uk](mailto:rb@vvt-cowes.freeserve.co.uk)  
Phone – 0870 243 0414  
Fax – 01983 280593

#### COMPONENTS

**Maplin Components** – branches in major towns and cities

**Chevet Supplies** (see above) do a limited range

**Farnell Electronic Components Ltd.**, Canal Road, Leeds LS12 2TU  
Sales phone – 0113 263 6311  
Fax – 0113 279 4444

**RS Components** – telephone or web site orders with a credit card only

Web – <http://rswww.com>

Phone – 01536 444079

**Traditional Radio Grilles** (Sid Chaplin), 43 Lime Avenue, Leigh on Sea, Essex, SS9 3PA

Email – [sidney@tradradgrilles.freeserve.co.uk](mailto:sidney@tradradgrilles.freeserve.co.uk)

Web – <http://www.vintage-radio.com/trg/>

Phone – 01702 473740

#### VALVES

**Chevet Supplies**

(see above)

**Savoy Hill Publications**

(see above)

**Wilson Valves**, 28 Banks Avenue, Golcar, Huddersfield, W. Yorks HD7 4LZ

Phone – 01484 654650/844554

Fax – 01484 655699

**Vintage Valve Supplies**

Phone – 01484 650725

**Valve and Tube Supplies**, Woodlands Vale House, Calthorp Road, Ryde, Isle of Wight, PO33 1PR

Phone – 01983 811386

Fax – 01983 563730

**Kenzen** (Ken Bailey), Unit 9, 16-20 George Street, Balsall Heath, Birmingham B12 9RG

Phone – 0121 446 4346

Fax – 0121 446 4245

**RB**

## Book review

by Geoff Arnold

### Vintage Radios – collecting, servicing, restoring

by Tony Thompson



This book is a distillation of the author's many years as a radio and TV engineer, and his experience of running a TV, video and hi-fi servicing business.

Although the book is essentially a practical work, the first chapter is devoted to the historical background to radio, from the days of Maxwell to the 1960s. Chapter 2 looks at cabinet styling, and its interaction with the layout of the internal parts such as chassis, loudspeaker and batteries.

Chapter 3 looks at the ins and outs of collecting valved radio sets; the arguments for and against various levels of restoration; does it matter whether a set is 'working' or not, etc. Chapter 4 offers advice on where and how to obtain sets, from venues ranging from car boot sales to radio rallies, from antique dealers to auctions and the Internet. Plus, of course, the all-important bargaining techniques.

'When to buy . . . and When not to' is the title of Chapter 5, and that pretty well sums up the content. The importance of checking the back, and if possible the innards of any set, even in the cramped conditions of an auction room, is stressed. There are decisions to be made, too, regarding the state and completeness of the cabinet, control knobs and tuning dial, and the power supply requirements. All this apart from assessing the general visual appeal of the design!

Having decided to buy a particular set, the processes involved in cleaning and restoring the chassis are the subject of Chapter 6, whilst Chapter 7 leads readers through the ins and outs of renovating wooden cabinets. Veneering, French polishing, waxing and lacquering and more are described. Chapter 8 completes consideration of the 'externals' with a look at renovating Bakelite cabinets.

Elementary introductions to valves and how they work are given in Chapters 9 and 10. Chapter 11 describes the initial checking and testing of valved radio chassis, while Chapter 12 gets down to more detailed testing. It begins with a run-down on useful data and desirable items of test equipment, then summarises typical problems with mechanical items, valves, resistors, capacitors and inductors. There is even advice on basic alignment checks for restorers lucky enough to have access to a signal generator.

Chapter 13 looks at the causes of common faults and how to locate them, beginning with some very sound advice on using your senses of touch, hearing and smell before ever bringing any test equipment to bear on the problem. To that list I would personally add the sense of sight – in my experience, a large proportion of faults in valved radio equipment can be found by nothing more than the use of one's eyes!

Examples of circuit arrangements of typical receivers are given in Chapter 14, with descriptions of the functions of major components. The circuits include superhets and a TRF covering AC, AC/DC and battery supplies. Chapter 15 takes readers step-by-step through the restoration of an example chassis.

'Things to make' is the title of Chapter 16, which gives design details for a continuity checker, a mains power supply to drive a battery radio, a safety lamp, a dummy aerial for use with a signal generator, plus a simple loop aerial for testing portable radio alignment, and a signal injector/tracer.

A Glossary of vintage radio terms rounds things off, and there are Appendices on sources of spares, materials and information, plus a list of interesting books and magazines.

All in all, this book forms a most useful introduction to collecting and restoration for the newcomer to the hobby, though I have a few minor criticisms.

Bearing in mind the target readership, there are a few places where the addition of one or two words to an

explanation would have made things clearer. In the later parts of the book, the services of a technical editor or proof reader would have been beneficial, although there is really nothing likely to cause too much confusion.

Several of the illustrations are not as clear as they might have been. Some of the line drawings have been printed as if they were in photo format, with a dot-screen over them giving the lines and lettering a fuzzy outline. In some of the photographs, there is a great lack of detail. They are nowhere near as bad as some published in *Radio Constructor* magazine in the 1970s, where a text comment of "As the photograph clearly shows . . ." was accompanied by a picture consisting of a solid black lump against a dark grey background, but they could be a lot better.

*Vintage Radios* comprises 126 A4 pages 210 × 297mm. It is published in spiral-bound format by Vintage Radio World Publications, and is available from the *RB Bookshelf* – see page 36.

## John Logie Baird a life

By Anthony Kamm and Malcolm Baird

Our ability to review this fascinating book is hindered by the fact that we are not in a position to comment on the extensive 'new' information published in it. In no way do we doubt its validity, the work done in investigation and the extensive reference notes (over 50 pages of them) back up highly readable text. The following is taken from the cover blurb of the book:

"In January 1926 Baird was the first publicly to demonstrate real television. Other pioneering achievements followed, including the first transatlantic transmission, the first demonstrations of colour television and stereoscopic television, and the first video recordings. In the 1930s he twice televised the Derby, and was the first to demonstrate cinema television, in black-and-white and colour. During World War II he developed high-definition and stereoscopic television in colour, and invented the first all-electronic colour television tube. He also made significant advances in radio imaging, secret signalling, fibre optics, infra-red scanning, and fast facsimile transmission.

"Throughout his life he struggled with ill health and lack of funding, to the extent that he paid for his initial research efforts and his final, heroic, and perhaps most startling, developments out of his own pocket.

"This balanced, thoroughly documented and splendidly readable account throws new light not only on Baird himself, but on many of those associated with him. Truth is separated from legend, and the facts are uncovered behind Baird's autobiographical memoir, published in 1988 as *Sermons, Soap and Television*, the text of which can now be compared with a recently discovered manuscript containing his own corrections.

"Fresh information is revealed about the 'lost' years in London and Hastings in the early 1920s, which includes for the

first time details of the company Baird established to sell soap, his unconventional romance, and the Falkirk connection.

"Special treatment is given to Baird's troubled relationship with the BBC, and in particular to the role played by the corporation's director general, Sir John Reith. There is a full account of Baird's brave efforts to establish a presence in the USA. Also disclosed is the background to the boardroom coup which resulted in Baird being relieved of his duties as managing director of the company which he had founded.

"In the light of their review of existing sources and examination of fresh evidence, the authors reach several conclusions which modify or challenge received opinion. Much of the documentation from family and other archives, including Baird's wartime letters to his friend Sydney Moseley, extracts from the private diaries of Eustace Robb (the BBC's first television producer), company memos and reports of the early 1930s, and many of the sixty photographs, has never before been published."

A must read for anyone interested in Baird. Written by his son and Anthony Kamm, a former lecturer in Publishing Studies at the University of Stirling.

*John Logie Baird a life* comprises 476 pages in hardback measuring 30mm × 155mm. It is published by National Museums of Scotland Publishing Ltd., and is available from the *RB Bookshelf* – see page 36.



# SERVICE & VALVE DATA CD-ROMS

A range of CD-ROMs containing service sheets for around three thousand different domestic receivers mainly made between the 1930s and mid 1960s, and data on a massive range of valves from the same era.



**£15.95**  
each  
including  
VAT and  
p&p



## VINTAGE RADIO SERVICE DATA – VOLUMES 1 to 3 by Paul Stenning and Peter Foden

These CD-ROMs contain service sheets for domestic receivers from over 100 different manufacturers – Ace, AEI and Aerodyne to World, Zenith and Zetavox. Approximately 1,000 different models from various manufacturers are covered on each CD-ROM.



**VINTAGE TV SERVICE DATA VOLUME 1**  
by Paul Stenning and Jon Evans  
This CD-ROM contains service sheets for TV sets covering approximately 1,500 different models. Sets made by over 70 manufacturers from Ace and Aerialite to Viewmaster and White-Ibbotson. Covers sets from post war to mid 70s.

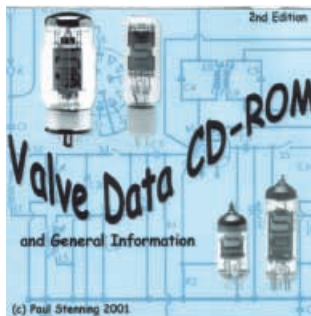

**VALVE DATA AND GENERAL INFORMATION (2nd Edition)**  
by Paul Stenning  
A wide range of period data published by device manufacturers covering thousands of different valves made from the 1920s to the 1970s. British valves from Brimar, Osram, Mazda and Mullard, plus six overseas manufacturers from AWV Radiofran to Taylor Tubes. In addition, the CD-ROM carries around 35 different features covering everything from general valve and early transistor data and equivalents to articles on such things as component markings, valve testers and general servicing information.

A complete list of contents for each CD-ROM is available from our website at [www.radiobygones.co.uk](http://www.radiobygones.co.uk). The list is far too long to publish here, covering approximately 30 sides of A4 paper.

All information contained on the CD-ROMs is in PDF form and requires Adobe Acrobat Reader (included on each CD-ROM). System requirements: Windows 95 or above, 20MB hard drive space. **NOTE:** Since the data on these CD-ROMs can be printed out we are only able to exchange disks if faulty, we cannot offer a money back guarantee.

## RADIO BYGONES – CD-ROM ORDER FORM

Please send me ..... (quantity) Radio Service Data Vol 1  
Please send me ..... (quantity) Radio Service Data Vol 2  
Please send me ..... (quantity) Radio Service Data Vol 3  
Please send me ..... (quantity) TV Service Data Vol 1  
Please send me ..... (quantity) Valve Data  
Price £15.95 each – includes postage to anywhere in the world.

I enclose cheque/P.O./bank draft to the value of £ .....  
 Please charge my Visa/Mastercard/Amex/  
Diners Club/Switch £ .....  
Card No. ....  
Card Expiry Date ..... Switch issue No. ....  
Card Security Code ..... (The last three digits on or  
just below the signature strip)

Name .....  
Address .....  
.....  
.....  
..... Post Code .....

SEND TO: **Radio Bygones, Wimborne Publishing Ltd.,**  
**408 Wimborne Road East, Ferndown, Dorset BH22 9ND.**  
Tel: 01202 873872. Fax: 01202 874562.  
Email: [radiobygones@wimborne.co.uk](mailto:radiobygones@wimborne.co.uk)  
Payments must be by card or in £ Sterling – cheque (payable to Wimborne Publishing Ltd) or bank draft drawn on a UK bank.  
Normally supplied within seven days of receipt of order. Send a copy of this form, or order by letter if you do not wish to cut your issue.  
Note: We use the VAT portion of the cost to pay for overseas postage.



A mail order book service for selected titles in the field of vintage radio. **The letters RB followed by a number indicate the issue in which a review of the title appeared.**

Prices are in pounds sterling, and are inclusive of postage and packing. The figures in the first column are for despatch to UK addresses, using first-class or second-class letter post, depending on the weight. Those in the second column are for despatch to addresses in Europe by airmail, or in the rest of the world via surface mail. The third column is the price for despatch to the rest of the world via airmail.

**SEND YOUR ORDER TO:**

**Direct Book Service, Wimborne Publishing Ltd,  
408 Wimborne Road East, Ferndown, Dorset BH22 9ND,  
England**

Payment accepted by Visa, Mastercard, Amex, Diners Club or Switch, quote your card number, expiry date and card security code (the last three digits on or just under the signature strip) plus the Issue No. for Switch cards, or by cheque, bank draft or postal orders **payable to Direct Book Service.**

Overseas cheques and drafts must be payable in Sterling, and drawn on a London Clearing Bank.

**Please make sure you enclose your full name and address and a telephone number.**

**Telephone 01202 873872 Fax 01202 874562**

**You can also order online from:**

**www.epemag.wimborne.co.uk/shopdoor.htm**

*Books are normally kept in stock and despatched within seven days, but please allow 28 days for delivery (more for overseas orders)*

**NEW**

	UK including p&p	Europe Airmail or Rest of the World via Surface Mail	Rest of the World via Airmail
John Logie Baird a life by Anthony Kamm and Malcolm Baird (RB82) . . .	£28.50	£32.00	£42.00
Restoring Valve Radios – A Comprehensive Guide by Tony Thompson . . . . .	£13.95	£14.95	£15.95
Vintage Radios – Collecting – Servicing – Restoration by Tony Thompson (RB82) . . . . .	£12.95	£13.95	£14.95
Tickling The Crystal. Domestic British Crystal Sets of the 1920s by Ian L. Sanders (RB75) . . . . .	£34.00	£40.50	£45.95
The Inventor of Stereo – The Life and Works of Alan Dower Blumlein by Robert Charles Alexander . . . . .	£17.00	£20.00	£22.50
Valve Radio & Audio Repair Handbook – Second Edition (RB68) by Chas E. Miller . . . . .	£21.00	£24.00	£26.00
<b>ON SALE</b> The Racal Handbook by Rinus Jansen . . . . .	<del>£13.50</del> £9.50	<del>£16.75</del> £12.75	<del>£18.75</del> £14.75
Early Valves . . . . .	£3.45	£3.95	£4.25
Comprehensive Radio Valve Guides in five books: Books 1–5 (each) . . . . .	£3.45	£3.95	£4.25
Set of 5 Guides (with free copy of Master Index) . . . . .	£15.00	£18.50	£20.90
Master Index to Comprehensive Radio Valve Guides . . . . .	£1.50	£2.00	£2.50
Radio, TV, Industrial & Transmitting Equivalents (RB29) . . . . .	£3.45	£3.95	£4.25
Wireless for the Warrior, Volume 1 by Louis Meulstee (RB38) . . . . .	£28.50	£32.00	£42.00
Wireless for the Warrior, Volume 2 by Louis Meulstee (hardback) . . . . .	£40.00	£47.00*	£55.95*
Wireless for the Warrior, Volume 3 by Louis Meulstee (hardback) . . . . .	£40.00	£47.00	£55.95
The History of the British Radio Officer in the British Merchant Navy and on Deep-Sea Trawlers by Joanna Greenlaw (RB81) . . . . .	£21.95	£25.45	£28.00
Radio! Radio! (3rd Edn) by Jonathan Hill (RB45) . . . . .	£39.95	£42.50	£45.95
Audio! Audio! by Jonathan Hill . . . . .	£11.00	£12.00	£13.00
Electronic Classics by Andrew Emmerson (RB58) . . . . .	£21.75	£25.45	£28.00

**\*NOTES** – 1. Because of its weight and value, we recommend the use of airmail to despatch Wireless for the Warrior, Volume 2 outside Europe. 2. This book exceeds the postal weight limit of 2kg for Canada. Orders for that country will therefore be sent by air postal post, at a total price of £57.50 per copy.

Published bi-monthly by Wimborne Publishing Ltd., 408 Wimborne Road East, Ferndown, Dorset BH22 9ND. Printed in England by DAP (Sussex) Ltd., Portslade, Sussex. Annual subscription (6 issues) £18.50 UK, £19.50 Europe, £23.75 elsewhere by airmail. Overseas cheques or postal orders must be in Sterling. RADIO BYGONES is sold subject to the following conditions, namely, that it shall not, without the written consent of the Publishers first having been given, be lent, re-sold, hired out or otherwise disposed of by way of Trade at more than the recommended selling price shown on the front cover, and that it shall not be lent, re-sold, hired out or otherwise disposed of in a mutilated condition or in any unauthorised cover by way of Trade, or affixed to or as part of any publication or advertising, literary or pictorial matter whatsoever.

# Feedback . . .

## . . . where you can air your views

Letters should be original and not copied to or from other publications.

The views expressed are not necessarily those of the Editor

### Gatecrasher

Thanks to those readers – including my detractors – who took the trouble to phone me or write to *Radio Bygones* following my letter entitled *Keep on Punting!* in *RB79*. I received a lot of support, but inevitably I touched a few raw nerves.

This correspondence triggered memories of an entertaining incident from way back when I and an old friend did accidentally gatecrash a major radio rally before opening time. It was my first visit to the annual amateur radio retailers' exhibition at Granby Halls, Leicester and we'd driven there in my ancient Morris Traveller which was loaded to the gunwales with a pile of radio gear intended for a wheeling and dealing session with a well-known radio amateur in Coventry on the way home.

We eventually arrived at the hall, but I hadn't a clue where to park. Whilst anxiously scanning the street for directions, I became aware of someone on the nearside pavement frantically waving his arms at us and gesticulating towards an off-street car park, I was happy to oblige. With our bulky and conspicuous load, we had obviously been taken for dealers by the guy in charge of the traders' parking lot, but what the hell. I parked alongside a large steel shutter at the back of the hall which was partially open and beyond which a lot of frenzied activity could be seen taking place among the trade stands; at the time, we assumed that the rally had already started and innocently clambered beneath the shutter into the hall, where we proceeded to buy several items at incredible bargain (i.e. trade) prices for some time before the official announcement came over the PA that the exhibition was now open! Happy days.

*Neil Clyne, C8LIU*  
*Uxbridge*

### Amusing Memories

I found Mr. Heddle's account of his RAF days very interesting (*RB81*). His account of the radio sets stored in packing cases 15 to 20ft high brought back amusing memories for me.

As a newly qualified Air Wireless Mechanic I was posted to RAF Chivenor in the Spring of 1950. For the first few days I was allowed to settle in at the signals section and I spent some time wandering around the flying control building finding my way about. I enquired of the signals corporal what the large room was at the end of the corridor and was told that this was where the radio packing cases were stored in case

we had to move at a moments notice. A mechanic nearby winked at me and I wondered why. Sure enough when I ventured into the room there was this huge pile of neatly stacked cases virtually filling the whole room. As I turned to leave something caught my attention – vague, very feint muffled voices coming from nowhere. Then the penny dropped.

I walked along the wall of cases and here and there a case was slightly out of alignment forming footholds up the wall. I climbed up and to my amazement found that the apparent solid block of cases formed a hollow rectangle with steps down to the inside, and there seated at the bottom were various signals personnel having a smoke, playing cards, or indulging in a quiet kip.

Needless to say, when I wasn't wanted on the squadron attending to my duties as a mechanic, I would very often melt away to that room, especially as admin. NCOs had a habit of dropping by looking for idle hands to borrow them for fatigue duties.

*George Clayden*  
*via email*

*Back in the 1960s when I briefly worked in a battery factory in the East End of London, a couple of women employees were sacked for "entertaining" mail staff members in a similar area formed in the battery store. – Ed.*

### A Mystery Receiver – R-50M

This very interesting equipment (*RB50* page 18), I thought, has all the appearance, and similar nomenclature, to KAAR company products, but the "Techrad" reference suggests Technical Radio Company, of San Francisco, California. I believe this company built a military entertainment-use receiver during WW2, a very high quality thing called the LRR-6, and also high power fixed airfield transmitters, for which I may have manuals, nomenclatured something like TX-350.

The lack of crystal controlled channels absolutely rules out the marine use suggested by the author. In addition, the quality, although high, has not the robustness for military mobile use of the TCS, and the presence of the front panel mounted speaker is also atypical of military combat communications. The TCS production numbers, I believe, were satisfactory to meet needs for its role, without a competitive model, as TCS production was carried out not only by Collins but also by Air King and possibly other manufacturers. I suggest the intended use was for small airfields, possibly mobile use for temporary frontline airstrips. This then would be a use

similar to the Jefferson-Travis JT-350, which has an approximately similar receiver, although with the advantages of switchable crystal control and better bandwidth.

The “receivers being DF’d by LO radiation” is a canard which by now richly deserves to be put to rest. This topic has been discussed on the internet email groups *Boatanchors* and *Milsurplus*. I have not seen, nor read, any official US Navy literature that warns of U-boats, for example, DF’ing ship’s receivers, nor have I come across any WW2 German literature that mentions the possibility, although the manufacturers of such equipment, namely Scott Co., certainly touted this so-called advantage, for example in ads in early WW2, *National Geographic* magazine. I personally, believe this fear arose from US bewilderment and panic at the horrendous US ship losses at the outset of US entry to WW2, and that the low radiation provision was in reality more necessary for use of multiple receivers in close proximity, rather than any enemy within short distance bothering to listen for receiver oscillator radiation.

No doubt at the outset of WW2 many simple regenerative receivers, of the type with no RF stage, radiated signals, assuming the enemy even found it worthwhile to try to detect and follow such low-level radiation, but such receivers were quickly replaced. I challenge anyone to practically demonstrate that any receiver with an RF stage, radiates a signal over any usefully detectable distance.

**Hue Miller**

**Albany, Oregon, USA**

I am responding to the email to you from Hue Miller. Here are some thoughts on the many interesting points which he raises:

### 1. Manufacturer

Hue’s suggestion that this radio was manufactured by the Technical Radio Company of San Francisco, California is absolutely spot on. This has been confirmed by John Wilson, the well-known technical reviewer, who tells me that he actually owns an R-50M and proposes to review it soon. The panel label verifies the identity of the manufacturer. His one has a non-standard external mains PSU, possibly from an HRO.

### 2. Lack of crystal control

I was mystified by Hue’s assertion that “the receiver’s lack of crystal controlled channels absolutely rules it out of marine use”. (In my article I had suggested that the R-50M might have been used by the US Navy). There were numerous British and German marine receivers of the WW2 era that had no crystal control facility. Most readers will be familiar with the B28/CR100 used extensively by the Royal Navy. There was also the B29, CR150 and CR300.

I cannot speak for the US Navy and it may be that they had a different practice, as typified by the Collins TCS12 which has four crystal positions, but I cannot think of any other marine receiver of the time that had specific crystal control facilities. I cannot recall any of the usual American professional receivers from RCA, Hammarlund, National or Hallicrafters that had crystal control facilities either, except much later with one version of the SP600.

I have spoken to several experienced British marine radio engineers and they were as mystified as me. Their view was

that crystal control was not feasible on a wide scale for two reasons: (a) channels were changed constantly for the obvious tactical and propagation reasons, and (b) in any event there was a dire shortage of crystals during the war.

Later British marine receivers did not have crystal control facilities either such as Marconi’s Mercury, Electra and Atalanta, and Redifon’s R50M and their later R408. The Murphy B40 (which was widely used in the Royal Navy) does have the facility for a single crystal, but it is a facility that does not seem to have had much use.

One post-War receiver which does not have crystal control but which enjoyed extensive use in USN ships is of course the Collins R390A, though some might argue that its superb stability was as good as or better than crystal control. A special version was developed for NASA for use with an external synthesiser but these are extremely rare. Most of the marine receivers that I know which were made by the American firm ITT/Mackay did not have crystal channels either (typically the 3010) until the advent of synthesis. Crystal stability at sea seems to have come in with the introduction of SSB in the early 1960s. Redifon, for example, made an external crystal oscillator adaptor for the R408. This was followed with full synthesis in the late 1960s, as seen in the Redifon R551.

The R-50M owned by John Wilson carries a US Navy badge despite its lack of crystal control, so I wonder whether crystal control was as essential as Hue suggests. Perhaps he or other readers will enlighten us.

### 3. The panel-mounted loudspeaker

I am also puzzled by Hue’s statement that the use of a front panel-mounted speaker on the R-50M “is also atypical of military combat communications”. Hue may have had in mind the tactical radios in use by American forces in WW2 on which I cannot comment, but panel mounted speakers are in fact often built in to tactical equipment or used as free-standing units. Of course, one does not find loudspeakers in backpack infantry sets such as the BC1000 or the 18 set used alongside the FEBA (the Forward Edge of the Battle Area), that is within rifle range of the enemy, but a few miles further back loudspeakers in vehicular radios are common.

The classic British tactical receiver with a panel speaker is the R107 (built like a battleship and looks like one too!). That other tactical stalwart, the Canadian 52 set receiver, has a speaker on the panel as well. So does the CR300 used on many ships in WW2. A quick flip through *Jane’s Military Communications* reveals numerous modern American vehicle-mounted tactical transceivers that have integral speakers such as by Magnavox, E-Systems, Rockwell, Harris, Southcom and Cincinetti, and by many foreign manufacturers including Tandiran, MEL and Philips.

### 4. D/F’ing by radiation from the receiver’s local oscillator

Hue’s thoughts on the D/F’ing of a ship by the local oscillator radiation of its receivers are probably accurate as regards WW2. But there is clear evidence that local oscillator radiation was seen as a serious problem. My article refers to the comments on LO radiation in the manual for the R-50M. After that article had been published I acquired the manual for an equally rare British marine receiver made by the British company, Rees Mace, the MN.100a. This appears to have been primarily a ship’s entertainment AM receiver. I



hope to write this up shortly for *RB* and would appreciate hearing from any readers with some knowledge of it.

The manual describes it as a “non-radiating receiver”. It contains a highlighted warning that unless the special shielded coaxial cable was used and that the screen was not shorted, “there is a possibility that the receiver may radiate signals that can be picked up over a considerable area”. This manual has a date pencilled on it – 19/3/1944 – and the circuitry is definitely WW2 vintage. I cannot say whether this screening was designed to avoid D/F’ing or to avoid mutual interference within the ship. I suspect the latter.

Low level RF signals, however, can radiate over an extraordinary range as QRP operators will readily confirm, particularly if the ambient RF noise level is low (as it used to be once!). One incident will demonstrate this, as told to me recently by John Pegler, G3ENI. In the war John served as a marine engineering officer in the Royal Navy. During an Arctic convoy in 1942 his ship, *HMS London*, picked up some unusual CW which was D/F’ed to one of the ships in the convoy. The source turned out to be an operator practising his Morse with a battery operated buzzer. Despite the very low power, the very low frequency (perhaps around 1kHz) and the lack of any aerial, the harmonics of his simple buzzer somehow found their way through the copious steel screening of the superstructure of his own ship and several miles away to the other ships. I suspect that some of the ship’s wiring, piping or cable ducting may have been acting as a fortuitous radiator, but it illustrates the point that unless you operate inside a perfectly screened environment, something will get out and will be picked up.

The second known exploitation of local oscillator radiation is by the Security Service in the 1950s. In his book *Spycatcher*, Peter Wright describes how the Service was particularly keen to know what HF frequencies were listened to by the receivers in the Soviet Embassy in London because this could reveal if the embassy was monitoring covert channels for spies who operated way beyond the embassy or in other countries. (Canada was of particular interest to the Soviets at the time as it was thought to provide an easier route to infiltrate agents into the USA).

Normal diplomatic HF communications from embassies have to be conducted on defined frequencies and so there was no problem in monitoring those transmissions. MI5 also wanted to know whether the Soviet embassy was listening to the mobile radios operated by MI5’s vehicles who were tailing Soviet diplomats and staff around London because the diplomats seemed to have an uncanny ability to disperse when life was getting “hot”.

The expert view from GCHQ was that LO radiation was probably detectable over a distance of several hundred yards. Wright’s team therefore built a mobile D/F station inside a disguised lorry with side walls transparent to RF (presumably of plywood or plastic). By parking this lorry near the embassy, he was able to detect the LO radiation of the Soviet’s receivers. This confirmed that the Soviets were indeed listening to MI5’s mobile transmitters. As an experiment, the channel of the MI5 tailers’ radios was changed, and sure enough the Russian radios were swiftly tuned to the new channel.

I have also been referred to another independent source on the detectability of local oscillator radiation.

The source is *Britain’s Merchant Navy* edited by Sir Archibald Hurd and published by Odhams Press. There is no publication date, as is common on publications prior to the

Copyright Act of 1956, yet the paper is not of the poorer wartime quality and so publication was probably late 1940s when a spate of official and semi-official WW2 histories emerged.

At the relevant part, the author is describing conditions on board a typical merchant vessel during WW2 and the preparations needed by the Master before his ship could set out on a convoy. This involved a detailed check of the ship’s equipment by the Convoy Equipment Officer. The author continues:

“There is also a Convoy Signal Officer whose business is to deal with all matters affecting his (i.e. the ship’s) wireless equipment. This officer works in with the Post Office inspectors who test his transmitters and receivers, and who also test all the privately owned receiving sets on board.

“Practically all receiving sets reradiate – that is they act as small transmitters. It is this that enables the Post office officials to detect wireless licence dodgers by locating their sets. It is this that might betray a ship to a lurking U-boat, and so every set must be checked meticulously, and in many cases sets have to be sealed up and condemned as unfit for use at sea.”

This book was written within a few years of the cessation of hostilities and provides the clearest independent evidence from a distinguished author that local oscillator reradiation was perceived by the British Admiralty to be a most serious matter requiring a meticulous check on every single receiver on board every merchant ship before the convoy could leave port.

At a symposium last year at Bournemouth University organised by CHiDE (the Centre for the History of Defence Electronics) one of the papers presented was by Lieutenant Commander T. Morgan RN on *Radio Communications in HM Ships During WW2*. Describing the radio fit on his ship, *HMS Greville*, a destroyer built in about 1943, he mentions that much of the equipment was American. One of the units was the Collins TCS transmitter/receiver. He says: “The receiver was a superhet, but had the reputation for radiating and its use was eventually banned during periods of W/T silence.”

Here, therefore, is clear first-hand evidence that the Royal Navy were alert to the problems of local oscillator radiation.

Many of your readers will know that the TCS receiver has considerable local oscillator injection, only one RF stage and a fairly low IF (455kHz). The stages from aerial to mixer will all have been carefully matched to achieve maximum power transfer at the signal frequency, but at higher frequencies the image rejection of the TCS is not particularly good and thus feedthrough of a strong LO in the reverse direction is feasible. Any small LO radiation emerging at the aerial input terminal will then be passed to the Tx/Rx change over relay and radiated by a perfectly matched transmitting aerial via the ATU.

At the relevant time, *HMS Greville* was serving with the British Pacific Fleet and in close liaison with the US Fifth Fleet for the invasion of Okinawa, and with the US Third Fleet under Admiral Halsey for the final assault on Japan. I am, therefore, surprised that this ban on the use of the TCS during periods of wireless silence was not more commonly known.

I suggest that on this aspect Hue and his American colleagues might wish to revise their views in the light of this evidence.

**Michael O’Beirne, G8MOB  
Surbiton**

## FREE READERS' ADVERTS

This free service is for the use of *Radio Bygones* readers for their **private sales and wants** ONLY.

**ANY ADVERTISEMENTS FROM TRADERS, OR FROM APPARENT TRADERS (e.g. THOSE WHO SUBMIT LONG LISTS OF ITEMS ON A REGULAR BASIS), WILL BE REJECTED**

1. **WRITE YOUR ADVERT CLEARLY AND LEGIBLY** preferably in block letters or typewritten.

2. **USE NO MORE THAN 45 WORDS**, including a contact name and telephone number, and preferably your address as well.

3. **KEEP ALL ADVERTS COMPLETELY SEPARATE FROM OTHER CORRESPONDENCE.**

4. **KEEP 'WANTED' AND 'FOR SALE' ITEMS ON SEPARATE SHEETS.**

5. If you wish to you can **SEND A COLOUR PRINT PHOTOGRAPH of ONE ITEM in your advert**, taken against a plain background. The photo *must be in focus*, show the whole of the equipment with a little background all around it and must be *marked with your name and address and the make and model of the equipment on the back*.

**NOTE:** We cannot return these photos, nor can we *guarantee* to publish them, but we will endeavour to use all photos that meet the above requirements. **We cannot accept photos showing more than one item of equipment, nor can we accept transparencies or photostats.**

6. **Every ad must have your FULL NAME AND ADDRESS attached**, even if you do not want them published in full.

7. **SEND YOUR ADVERTISEMENT TO: Radio Bygones, Wimborne Publishing Ltd, 408 Wimborne Road East, Ferndown, Dorset BH22 9ND, England. MARKING EACH PAGE 'RB READERS' ADVERT'.**

**Any advertisements not meeting these requirements may be rejected or modified**

The closing date for receipt of adverts to appear in our next issue, due out on 27 May 2003, is Friday, 2 May.

## FOR SALE

**Sailor 86D** HF Tx 70W AM, £45; Pye Hamble HF Rx/Tx 160/80 mtrs 25W AM, £30; German E10K Rx, £200; Type D RAF WWII Key, £60; ERT-281 HF Tx, 100W, £50. Ben, 01562 743253 (Kidderminster). Email G4BXD@qsl.net.

**Minimixer Rx Converter** 80-10m (old bands) valves, £20; TW 2m Tx AM/CW, £40; TwW 4m Tx, AM/CW, £20; Wire recorder, £30. Tel. 01747 822652 (N. Dorset). Email peterb666@hotmail.com.

**M.S.S. Portable Magnetic Recorder** (tape recorder) type PMR/2/SX, as manufactured by the M.S.S. Recording Co. Ltd. circa 1954. 7½ and 15 i.p.s. half track. Complete with original manual. This machine was formerly used in the control tower of Ford airfield in Sussex. Free to a good home, buyer collects. Please telephone Malcolm on 01256 892533 (Andover) any evening.

**Jane's Military Communication**, 11th edition, 1990-1991, £25 (post free). Offers invited for *Television* magazines, 240 copies, from 1983-2002. John, G8BXO, 3 West Park, South Molton, Devon, EX36 4HJ. 01769 573382.

**Two Type JAN 866** Mercury Vapour high voltage rectifying valves. Richard, tel. 02392 475077 (Portsmouth).

**Marconi Crystal Set**, type RB3 M2, circa 1922 with S. G. Brown & T.E.L. headphones, crystal missing, £175. 01959 572591 (Biggin Hill, Kent).

**CR100 communications receiver, RB31**, working, has some modifications, £27; Murphy A24C floor standing radio in need of restoration, £25. Buyer to collect please. Geoff Hopkins, 27 The Templars, Worthing, West Sussex, BN14 9JT. Tel. 01903 536499 evenings, or email to geoff@e-d-s.freereserve.co.uk.

**Denco modulated test oscillator**, type MTO1, £7.50; H.A.C. one valve receiver, new, in box, model C/D, £30; Richard Allen Baby Baffle speaker, new, in box, £7.50. D. Longstaff, G4WCD, tel. 01482 507244 (Hull).

**HRO 500**, complete with rare LF preselector and speaker, excellent condition and working order. Will exchange for Siemens E52A Kohn receiver in similar order. Alan Morriss, G4GEN, Pippingford Park, Nutley, Sussex, TB22 3HW. Tel. 01825 712205.

**Denco components:** Coils for valve receivers, ranges 3, 4 and 5 with 3 gang tuning capacitor and data; also five off IFT11/465kc/s for G2DAF receiver; box full of WW2 crystals including 44 FT243. Offers? Ross, G3TJC QTHR, tel. 01274 582781 (Shipley).

**Collection of 50 generally immaculate domestic sets**, including Ekco ACT96, Ekco U245, several DAC90 and 90A, Bush TV22 Bakelite, Zenith Transoceanic, Philips 17 TV 1954; also several communication sets including ACL R209 surveillance receiver with several plug-ins and spectrum display, Racal RA153 twin receiver. Many others, list by email: alan.ainslie@lineone.net, or phone 01252 782932 (Farnham).

**Fourteen pre-recorded classical reel-to-reel tapes** of 1950s/60s vintage, 7.5 i.p.s. two-track mono, mostly HMV/Columbia and on 7in. reels. Free to a good home, new owner collects or pays carriage. Tel. 01202 692631 (East Dorset).

**RGB Radio Model No. 1050C**, 1950s vintage, seeks good home, (delivery cost only required if not collected from Ringwood, Hants, area). Condition of free-standing wood veneered cabinet is good and I believe the radio is working on all wavelengths. Tel. 01425 403361, email ijscott@waitrose.com.

## WANTED

**Reception set R101**, £750 offered for example in excellent condition. Email alan.ainslie@lineone.net or phone 01252 782932 (Farnham).

**Information** on German WWII U-boat transmitter LO40K39D, *Radio Bygones* Nos. 6, 14, 23, 26, 30, 35 and 37, complete or partial set. George H. Rancourt, 82 White Loaf Road, Southampton, Mass. 01073 USA. Email kianx@mindspring.com. Tel: 1-413-527-4304.

**Military Sets** WS21, WS11, WS12, BC-191, any Special Forces or Spy sets, have for exchange Mk 128, Mk 123, WS76. Ben, 01562 743253 (Kidderminster). Email G4BXD@qsl.net.

**Crystal Sets** and crystal set bits. Brian, 01795 660077, 92 Vincent Gardens, Sheerness, Kent ME12 1XS.

**Collaro Studio O** or P turnover 78/LP crystal cartridge for AT200 transcription deck. Collaro Studio mono tape deck. Stern Clyne 2 valve preamplifier for Mullard 510 amplifier with black Perspex fascia. Stern Clyne FM or AM-FM tuner. Tony Harwood, tel. 02380 270785 (Hants), email tony@nicholrd.fsnet.co.uk

**Crystal Sets** and components for a private collection which will eventually be donated to a museum for public display. Tel. Brian on 01795 660077 evenings (Sheerness).

**Jane's Military Communications**, early editions, w.h.y. John, G8BXO, 3 West Park, South Molton, Devon EX36 4HJ. 01769 573382.

**Can anyone help me** with a data sheet on, or up to three Mullard AEY25 tunnel diodes please? This is to restore a Cossor Model 3200 oscilloscope Main and Delayed Timebase PCBs A & B in Dual Timebase Model 3122. Richard, tel. 02392 475077 (Portsmouth).

**Handbook for Gould Advance** two-channel oscilloscope type 3000A with timebase delay facility. 01959 572591 (Biggin Hill, Kent).

**AM/FM Board** for F7102 or F7102 Tx/Rx with working board, SP102 speaker or cabinet only. Tel. Brian, G3RKZ, 01332 883035 (Belper) after 6 pm please.

**Any readers** interested in reel-to-reel tape machines please contact me. Also a source for spares for Grundig and Stella tape recorders. Tel. 01562 639744 (Kidderminster).

**Help with research** on the former company Eddystone Radio, also the public retail face Webb's Radio, I am particularly interested in their early days prior to the war, I do know Webb's Radio had a shop in Carr's Lane, Birmingham. Also I am researching on the Eagle Engineering Company who once operated from Warwick between 1923 and 1936 producing Chakophone wireless sets, seek any information on the company or any products. Has anyone got a scrap BC342-N receiver, I seek parts to restore a very tired model, any help welcome. Email andrewhumphriss@tinyworld.co.uk.

**Naval type 618 and 619** Tx's and cables, plugs, mike, key. Handbook for 619. Military transceiver for 50MHz, must be tunable. W.H.Y? Tel. 01747 822652 (N. Dorset). Email peterb666@hotmail.com.

**Two relays** for an FT200 transceiver. Relays AE3254, 100V DC by Yaesu. It's an SOS. Ron, G3SYX. R. A. Irving, Fir-Glen, Beesby Road, Maltby Le Marsh, Lincs LN13 0JJ.

**Racal RA17L** in good working order, also any add-on units to suit the receiver, reasonable price. 01538 385735 (Leek).

**Hallcrafters S-39** Sky Ranger or Sky Buddy, any condition. T1154 parts; cabinet top cover, aerial connectors, EHT plugs, outboard aerial current meter (need not be working). Tel. 0771 223 2770 after 7 pm please, Keith Franklin (Somerset).



The wartime 1475 used by the RAF, sitting on top of another classic, the 1155 receiver

---

# MUSEUM PIECES

---

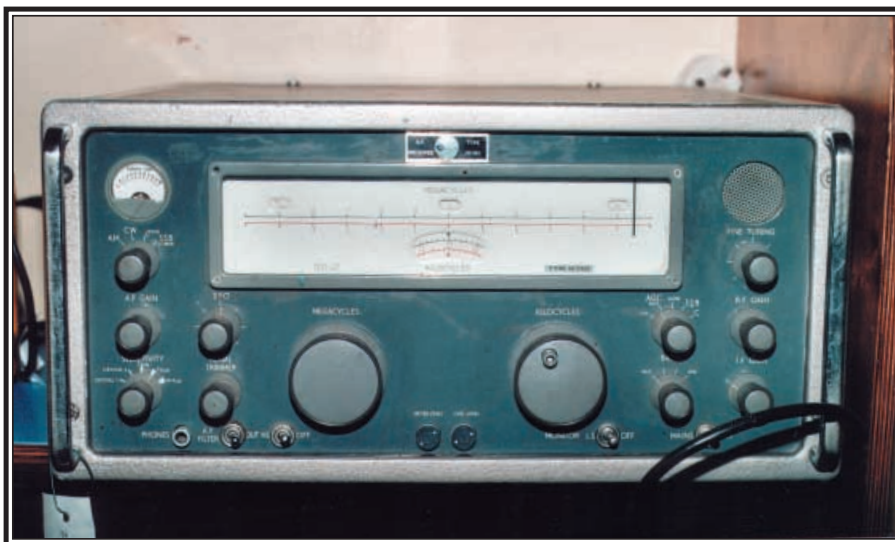

The Marconi H2301 HF receiver, in fact a rebadged Eddystone 880/3



Geoff Lovegrove, G7KLV standing in front of the H1200 30kW transmitter.  
The large cylinder on the top of the cabinet is the low pass filter

---

# MUSEUM PIECES

---



The Marconi HR110  
receiver covering  
500kHz to 30MHz in  
five bands. Only ten  
of these receivers  
were made