

10078
OCTOBER 1929

RADIO BROADCAST

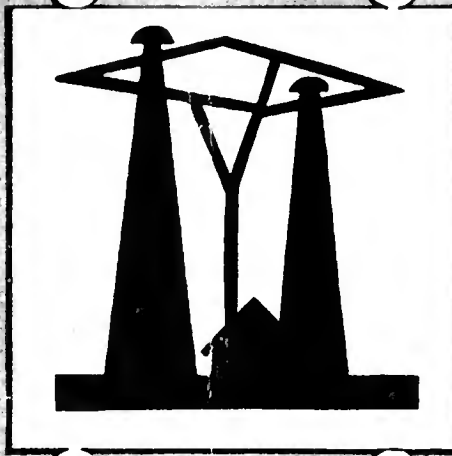

How Shall the Dealer's Advertising Dollar Be Spent?
Lessons from the Automobile Industry
The Telephone Rings the Doorbell Today

**What Are the Coming Changes in Distribution Methods? · News of the Radio Industry · Paths to Profit in Selling
· Tested Sales Ideas · Design of the Colonial Receiver · The Future of the Pentode Tube · The Tube Business**

TONE

Tone depends on many things, but above all, on the design and construction of the audio end of the set. In this department of radio, T·C·A engineers are specialists, serving with matchless production facilities many of the leading set manufacturers in the country. Uniformity, authentic design, perfected construction detail, and dependable deliveries are inherent characteristics in T·C·A products.

TRANSFORMER CORPORATION OF AMERICA
2301-2319 SOUTH KEELER AVENUE, CHICAGO, ILLINOIS
Sales Offices in Principal Cities

Output Transformers
Input Transformers
Audio Transformers
Dynamic Speakers
Power Packs
Chokes

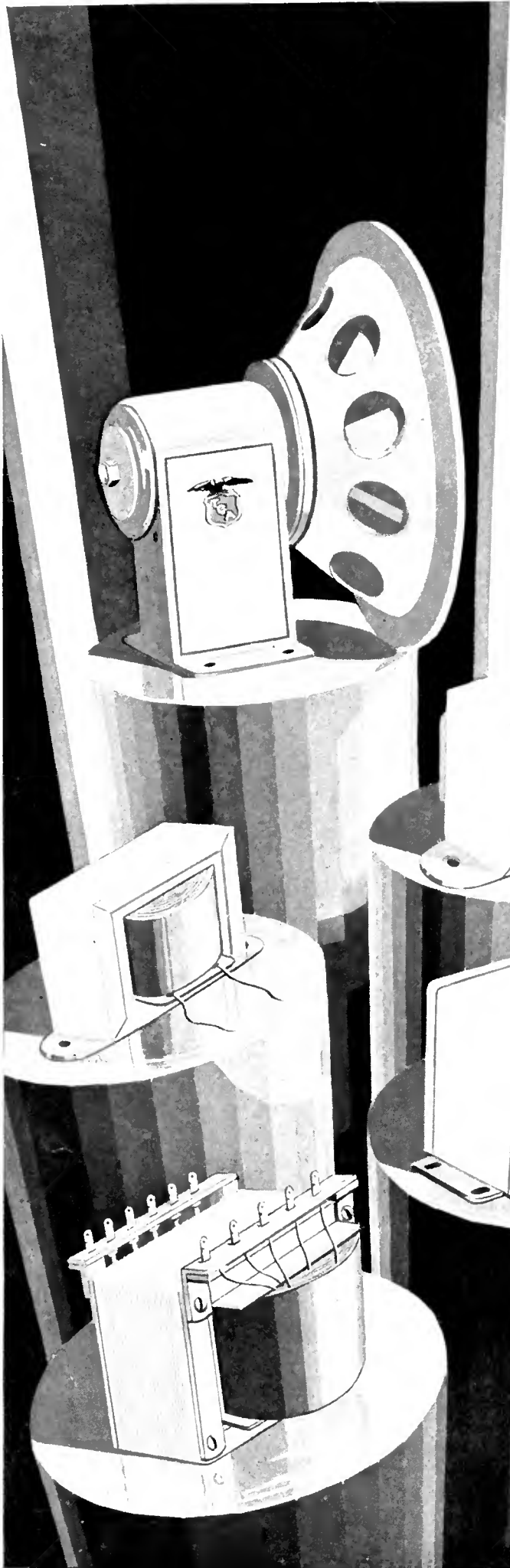

Additional Profits

Have every set sent out on demonstration functioning at maximum efficiency.
 Keep all sets sold in continuous efficient operation at negligible cost.
 Know that the tubes you sell or install are right by testing them under actual operating conditions. Defective tubes cause a large percentage of radio troubles.
 Make real profits in servicing by saving time and increasing efficiency.
 Eliminate expensive and annoying returns to distributor or factory by making all adjustments or repairs in the owner's home accurately and quickly.
 Build "good will" thru the enthusiastic satisfaction

of your patrons—an ever growing asset to your business.

All of this can be accomplished *only* by the use of the SUPREME DIAGNOMETER—the *only* service instrument that insures *thorough, scientific service work*.

If you don't buy a SUPREME you pay for it anyway many times over in wasted time and inefficiency. If you buy a SUPREME you pay for it but once and it becomes a permanent asset for your business, earning dividends daily in actual cash and customer good will.

Don't deprive yourself of these additional profits by delay.

The Only Complete Portable Radio Testing Instrument

Thorough and Complete, yet surprisingly simple. The SUPREME RADIO MANUAL gives full instruction and much valuable radio information.



No other radio testing device can anywhere near approach the range, completeness and flexibility of the SUPREME DIAGNOMETER. A test will show you. Send for ours which is confidently called "A Test that Challenges Attention." Some of the outstanding features of the SUPREME are:

- All tubes tested under actual operating conditions. Provides the only tube test of dependable value.
- Screen grid socket analysis without oscillation.
- 750 Volt 4 scale A.C. and D.C. meters, 3 scale milliammeter.
- Self-contained power plant.
- Modulated radiator for testing, synchronizing, neutralizing.
- External connections to all apparatus.
- Tests both plates '80 type rectifiers.
- All continuity tests without batteries.
- Universal analyzer plugs.
- Handy carrying case providing compartments and space for all tools and spare tubes.

---and a request for complete specifications will reveal numerous other superiorities.

"Set Testers" prove only 29% to 40% efficient in comparison with the SUPREME DIAGNOMETER

Supreme Service League

To Radio Owners: Look for this emblem in your radio shop, on the lapel button or card of your service man. It is your guarantee of dependable radio service. Cash in on the prestige the SUPREME SERVICE LEAGUE is building.



Order NOW

Present production permits immediate deliveries but the momentum of sales is such that buyers are cautioned to place their orders now. Reservations will be made against all orders placed for future delivery on specified dates. Make use of this plan to avoid disappointments.



(Most good distributors carry the SUPREME DIAGNOMETER in stock. If yours cannot supply you, send order direct on form to the right.)

SUPREME

Radio Diagonometer

Makes every ^{conceivable} test on any Radio Set-

Supreme Instruments Corp.
 342 Supreme Bldg.
 Greenwood, Miss.

Please ship SUPREME DIAGNOMETER Model 400-B on basis checked below.

- Net cash \$139.50.
- Time payment plan—\$33.50 cash and 8 monthly payments of \$15.00 each.

All prices are F.O.B. Greenwood, Miss. No dealer's discount.

Date shipment desired.....
 Signed.....
 Firm Name.....
 Street Address.....
 City.....
 State.....

Please give three or more bank or trade references and names of distributors from whom most purchases are made.

The Big News

RADIO TUBE MERGER LINKS 4 COMPANIES

\$16,000,000 Corporation Will
Add Other Independents,
Sponsors Assert.

J. E. DAVIES HEADS BOARD

Ending of "Bootleg" Tube Sales Is
Predicted—RCA Said to Be Allied
With New Concern.

move to create a new unit in
radio tube industry was an-
nounced yesterday.

THE "NEW YORK TIMES," AUG. 24,
devoted almost an entire column to the
announcement of the National Union
Radio Corporation.

NATIONAL UNION RADIO PLEDGES QUALITY TUBES

*"Finest Tubes science
can design" assured by
Executive Vice-President*

"One of the basic features of National Union policy," says Nathan Chirlestein, Executive Vice-President, "is quality tubes. Our plans call for extensive testing systems, expert engineers, every precaution necessary to make National Union Tubes stand for the utmost in quality. We know very well that you can't sell a bad tube twice. So you can rest assured that every effort will be made to assure jobbers and retailers everywhere the finest tubes science can design."



*"A Fair-play-to-all
Sales Policy."*

ASSURES
E. A. TRACEY
Vice-President
in charge of Sales and Advertising

HERE IS THE START!

*These Four Brands
are now in:*

SONATRON
MAGNATRON
MARATHON
TELEVOCAL

NATIONAL UNION

is Out!

Newspapers From Coast to Coast Herald the Entry of a New Giant Into the Tube Business . . .

National Union Radio Corporation

*takes its place beside R. C. A. and Cunningham
. . . experts now forecast the end of
present chaotic trade practices*



On August 23rd at 4:10 P. M. the final papers were signed . . . a clerk released the news to 1100 newspapers . . . the National Union Radio Corporation had at last become a fact!

The radio editors of a big New York paper describe it as "The most important radio news this year."

A prominent jobber from Chicago wired—

"National Union will do much to stabilize the radio tube business."

Retailers the country over are greeting the news with enthusiasm.

National Union with a capacity of 75,000 tubes a day becomes one of the three largest manufacturers of radio tubes in the world.

Capitalized at \$16,000,000, lack of money will not handicap its development.

Directed by a group of the country's ablest radio executives, it should quickly win a position at the head of the radio industry.

Through a reciprocal agreement with R. C. A., National Union will have the benefit of every important existing radio patent.

Look for big things from this new organization. Look for the fairest trade practices in the business. Look for the finest tubes science can devise.

More big news will follow during the next few months. Watch the next issue of this magazine.

RADIO CORPORATION

Digitized by Microsoft®



The
Source
for
Set
Manufacturer

You can choose from several Dongan designs of the approved types of power and audio Parts—each type a production job. Thus you secure at production prices the transformer and condenser unit exactly suited to your individual needs.

Dongan laboratories offer perfected designs of Parts to function with UX 245 and UX 250 Tubes. Dongan production represents the acme of radio power parts manufacture.

Exclusively Manufacturers
of Parts for the Set Manu-
facturer.

Transformers
Chokes
Condenser Units

We are prepared to furnish complete parts for construction of amplifiers for theaters, dance halls or public address systems.

Dongan Electric Manufacturing Co.

2991-3001
Franklin Street



Detroit
Michigan

A Radio Parts Guide

THE NEW

YAXLEY

Catalog



Send for it today for complete listings of Radio Convenience Outlets, Connector Plugs, Rheostats, Fixed and Grid Resistances, Jacks, Jack Switches, Phone Plugs, etc.

YAXLEY MFG. CO.

Dept. B, 1528W Adams St., Chicago, Ill.

The Prescription for Better Radio Reception

By an *Amperite* for every tube. Dr. Radio Engineer

AMPERITE automatically delivers the RIGHT voltage for efficient tube operation. Improves tone, sensitivity, volume. A type for every tube. \$1.10 with mounting (in U.S.A.) At all dealers.

This symbol in a radio diagram means—



AMPERITE The "SELF-ADJUSTING" Rheostat

AMPERITE Corporation
561 BROADWAY, NEW YORK

Free — "Amperite Vest Pocket Tube Chart". Write Dept. R. B. 10.



LONG LIFE
AND SUSTAINED VOLTAGE

EVEREADY RAYTHEON B-H TUBE



Type B-H
125 m. a.
at 300 volts

THE ORIGINAL GASEOUS RECTIFYING TUBE FOR "B" ELIMINATORS

IONIZED HELIUM takes the place of a filament in the Eveready Raytheon B-H Tube. This principle gives long life, efficiency and reliability. Ionized helium supplies millions of electrons a second—over and over.

Most "B" eliminators are designed and built for this famous B-H tube, which is standard in more than 100 makes. If you are using such a unit, a new Eveready Raytheon B-H Tube will make a surprising improvement.

Note to experimenters: If you require a source of steady, powerful D. C., you will find the B-H tube an efficient, heavy-duty rectifier.

NATIONAL CARBON CO., Inc.

General Offices: New York, N. Y.

Branches: Chicago Kansas City
New York San Francisco

Unit of Union Carbide and Carbon Corporation



Trade-marks

LEVI F. WARREN JUNIOR HIGH SCHOOL, WEST NEWTON, MASS., PAM EQUIPPED

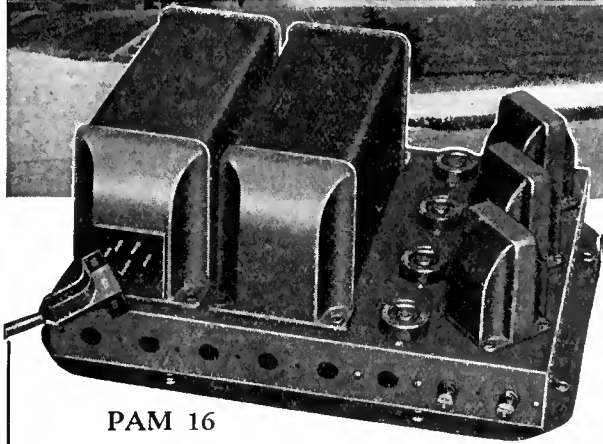

PAM 16

PAM

the new educator

Walter Damrosch and other famous educators are instructing thousands of children in our schools through radio and PAM installations.

The voice of the educators or music received by radio or from phonograph record is amplified by PAMs for loud speakers in class rooms and assembly halls.

The PAM equipment installed for educational purposes is admirably suited to furnish music for class parties or other school social functions.

Many fine installations, such as that at the Levi F. Warren Junior

High School, West Newton, Massachusetts, shown above, can be sold by wide-awake radio dealers.

A new 16-page bulletin giving mechanical and electrical characteristics, representative installations and many new PAM amplifiers will be sent upon receipt of 10c. in stamps to cover postage. When writing ask for bulletin No. R.B.-11.

Main Office:
Canton, Mass.

Samson Electric Co.

MEMBER
RMA

Manufacturers Since 1882

Factories at Canton
and Watertown, Mass.

"I've been in the Radio game fifteen years and it's by far the best book I've ever seen on Radio."

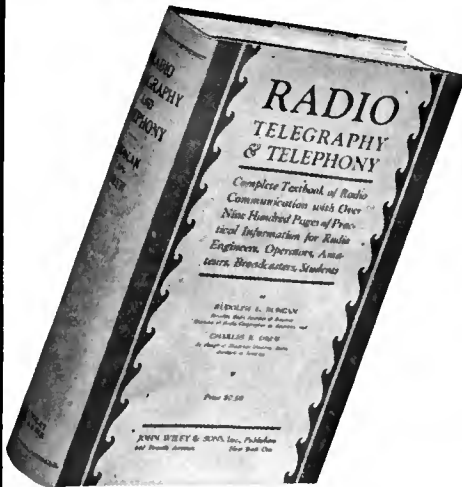

"Radio Telegraphy and Telephony"

By **RUDOLPH L. DUNCAN**
Director, Radio Institute of America

And **CHARLES E. DREW**
Instructor in Radio, and in charge Electrical Division, Radio Institute of America

A Complete Handbook for Radio Students, Operators, Amateurs, Inspectors, and Engineers.

This new book contains most of the information that anyone seriously interested in Radio would want to know. Subjects never before treated in a Radio book are covered here in a thorough, simple, and lucid manner.

26 Chapters: Introduction to Radio; Magnetism—The Electron Theory; The Production of Electromotive Force; Electromagnetic Induction; Motor-Generators—Starters; Curve Diagrams; Storage Batteries and Charging Circuits; Meters; Alternating Current and Frequencies; Condensers—Electrostatic Capacity—Capacity Measurements; Vacuum Tubes; Receiving Circuits; Alternating Current Operated Receivers and A-C Tubes; Telephone Receivers—Loudspeaker Reproducing Units; Commercial Receivers; Rectifier Devices—Rectifier Circuits—Voltage Divider Resistors—Filter Circuits; High Voltage Condensers; Antennae or Aerials; Resonance; Commercial Broadcast and Telegraph Transmitters; Commercial Tube Transmitters; Short Wave Transmitters and Receivers; Spark Transmitters; The Arc Transmitter; Direction Finders—Radio Compass; Radio Telephone Broadcast Transmitter Equipment; Appendix.

"Radio Telegraphy and Telephony" was published in May. You will find in this book the most recent information on current principles, methods, and equipment. Over 900 pages for \$7.50. You may have it on approval for 10 days—but as one radio expert wrote us, "Ten minutes, not ten days, should be sufficient to convince any real radio man that he needs 'Radio Telegraphy and Telephony.'"

A Wiley Book

ON APPROVAL COUPON

JOHN WILEY AND SONS, Inc.
440 Fourth Ave., New York City

Gentlemen:—Please send me for examination "Radio Telegraphy and Telephony." Within ten days after its receipt I will send you \$7.50 or return the book.

Name.....

Address.....

Reference..... RB 10-29

LIKE A SHIP without A RUDDER

the "control" is gone . . . not powerless . . . but rudderless . . . no longer does she respond to the helmsman.

Your radio without a good resistance device, like the CENTRALAB resistance, doesn't respond to the slightest touch of the "helmsman."

You steer your way through the ether by fits and starts . . . augmenting the "static storms" by internal "self-inflicted" noises.

Better be sure that your radio is "Centralab" equipped.

"Volume Control Voltage Controls & Their Uses" is the title of an interesting pamphlet that is yours for the asking.

Centralab

CENTRAL RADIO LABORATORIES
20 Keefe Ave. Milwaukee, Wis.

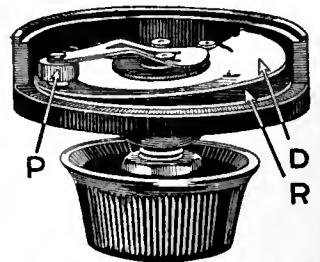

This shows the exclusive rocking disc construction of Centralab volume control. "R" is the resistance. Contact disc "D" has only a rocking action on the resistance. Pressure arm "P" together with shaft and bushing is fully insulated.



This is the action of the usual wirewound control after it has been in use for some time . . . like dragging a stick over a cobblesome pavement.



The tailor uses the same principle as Centralab. He does not want to ruin the garment by placing the iron on it so he places a cloth in between. Centralab controls cannot ruin the resistance because the rocking disc is in between the pressure arm and the resistance.

ELECTRAD PERFORMANCE

Builds Sales

The Perfect Volume Control

U. S. Pats. 1034103, 1034104 and Pats. Pend.

You can sell and recommend the Super-TONATROL because it will stand up under heavy loads. Laboratory tests approximating ten years average use prove its remarkable lasting quality. New type resistance element fused to an enameled metal plate. Pure silver contact. Easily dissipates 5 watts. Metal cover for rapid heat radiation. List price, \$2.40 to \$3.50

ELECTRAD INC.

ELECTRAD, Inc.
Dept. RB-10
175 Varick St., New York
Send me full details of the Super-TONATROL.

Name.....
Address.....

AEROVOX

BUILT BETTER
CONDENSERS AND RESISTORS

Pyrohm Resistors

Accurate — Unchanging

REDUCED sensitivity, low volume, distortion and poor tone quality are the inevitable results of using inaccurate resistors which do not maintain their proper resistance values.

To be assured of satisfactory operation in power supply units and power amplifiers, be sure to specify and use—Aerovox Pyrohm resistors of the proper resistance values and current carrying capacities.

These units are made of the best grade of resistance wire wound on a refractory tube, and protected by a porcelain enamel against moisture, oxidation and mechanical injury.

Send for Catalog

Complete specifications of all Aerovox Pyrohm resistors are contained in a complete catalog which will be sent free of charge on request.

The Research Worker contains, each month, valuable information on radio design. It will be sent free on request.

AEROVOX WIRELESS CORP.

76½ Washington St., Bklyn., N. Y.

PRODUCTS THAT ENDURE

SM

Band-Selector Tuning 3 A.C. Screen-Grid Tubes Custom-Built, \$74.75!

Now—All-Electric Short-Wave Reception

The new S-M 735 Round-the-World Six brings every marvel of the low-wave bands within the perfect convenience of a. c. operation. A 224 screen-grid tube is connected so as to produce $2\frac{1}{2}$ times greater amplification than the '22; the a. f. amplifier (245 push-pull) is free from hum, even in distance reception. Four plug-in coils cover from 16.6 to 200 meters. Two extra coils (cost \$1.65) cover the broadcast band, with an altered connection built into the coil so as to greatly increase selectivity.

Yet the 735 is low-priced—\$64.90 net, wired complete with built-in

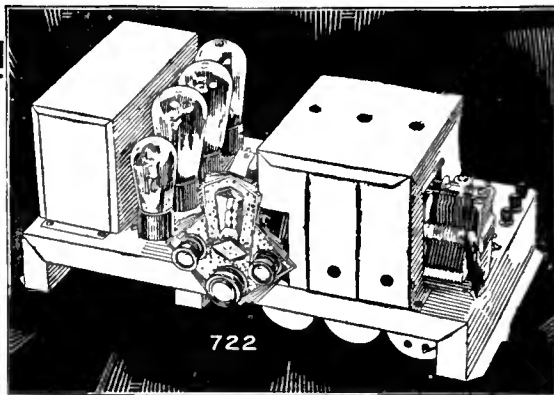

AS trim and stylish-looking a one-dial set as was ever built to "sell on looks"—yet embodying such extreme performance as only Silver-Marshall can build into a set with three screen-grid tubes, band-selector tuning, and even screen-grid power detection—five times as efficient as '27 power detection. Four tuned circuits—highly shielded—an audio amplifier combining resistance coupling and 245 push-pull—complete built-in ABC power unit—chassis only $18\frac{3}{8}$ " by $9\frac{1}{2}$ "—all at the price of \$74.75 net, less tubes and cabinet, in the S-M 722 Band-Selector Seven. Tubes required: 3-'24, 1-'27, 2-'45, and 1-'80. Component parts total \$52.90 net. For use with any 90-120 volt d. c. electro-dynamic speaker.

Ideal for mounting in any of the cabinets mentioned below.

Up-To-The-Minute Cabinets

S-M 707 metal shielding table cabinet in beautiful crystalline brown and gold for 722 or 735, \$7.75 net.

Three beautiful console cabinets, adapted especially for mounting S-M 722, 735, or 712 with 677 by the I. A. Lund Corporation, are available from leading supply houses: see the new S-M Fall Catalog.

Surpassing the Famous Sargent-Rayment Seven

You know the Sargent-Rayment Seven—universally found to be the most sensitive broadcast receiver ever developed. Here, in the new 712 Tuner, is every feature of the 710 Sargent-Rayment—the five tuned circuits, the ultra-perfect shielding—the extra-fine r. f. coils—all built into an all-electric strictly single-dial tuner, with band selector tuning and power detection. Tubes required: 1-'27, 3-'24. Completely wired in satin-finish metal shielding cabinet, less tubes, \$64.90 net. Works into any audio amplifier.

Component parts, including shielding cabinet, total \$40.90. Fits beautifully (with controls central) in any cabinet with space $18\frac{1}{2}$ by $9\frac{1}{2}$ by $7\frac{3}{8}$ -inch high.

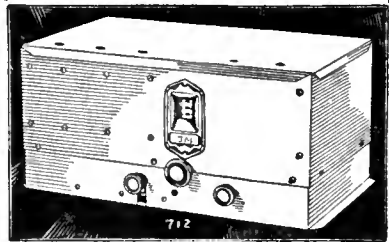

New 677 Amplifier

An ideal audio amplifier for the 712 is the new S-M 677. Fully equipped with the famous Clough system (in push-pull) the 677 takes radio or phnograph input; supplies all ABC power required for the 712 ($2\frac{1}{2}$ volts a. c., 180 volts B). Tubes required: 1-'27, 2-'45, 1-'80. Completely wired less tubes, \$58.50 net (or for 25 cycles \$72.50). Component parts total \$43.40.

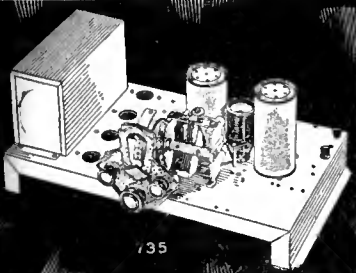

power unit; the component parts total \$44.90 net. Tubes required are: 1-'24, 2-'27, 2-'45, and 1-'80.

735DC, for battery use only, \$44.80 net less tubes and cabinet. Tubes required: 1-'22, and 4-'12A. Component parts total \$26.80 net.

Either set fits perfectly in any of the cabinets referred to at the right.

Over 3000 Authorized S-M Service Stations are being operated; many are proving highly successful and profitable. The nearest one is ready to serve you if you want a custom-built set; write us for address if you do not know it. If you build professionally and do not have the S-M Service Station franchise—write us.

Complete circuit diagrams of the 722 and 735 were first published in the RADIOBUILDER for August. Valuable suggestions on building and servicing are to be found in every issue. Use the coupon.

SILVER-MARSHALL, Inc.

6403 West 65th St., Chicago, U. S. A.

Silver-Marshall, Inc.
6403 West 65th Street, Chicago, U. S. A.
...Please send me, free, the new fall S-M Catalog; also sample copy of the Radiobuilder.
For enclosed.....in stamps, send me the following:
.... 50c Next 12 issues of The Radiobuilder
.... \$1.00 Next 25 issues of The Radiobuilder
S-M DATA SHEETS as follows, at 2c each:
.... No. 3. 730, 731, 732 Short-Wave Sets
.... No. 4. 255, 256, etc., Audio Transformers
.... No. 5. 720 Screen Grid Six Receiver
.... No. 6. 740 "Coast-to-Coast" Screen Grid Four
.... No. 7. 675ABC High-Voltage Power Supply
.... No. 8. 719 Sargent-Rayment Seven
.... No. 9. 678PD Phonograph-Radio Amplifier
.... No. 12. 669 Power Unit
.... No. 14. 722 Band-Selector Seven
.... No. 15. 735 Round-the-World Six
.... No. 16. 712 Tuner (Development from the Sargent-Rayment)
.... No. 17. 677 Power Amplifier for use with 712

Name.....

Address.....

RADIO BROADCAST

PUBLISHED FOR THE RADIO INDUSTRY

WILLIS KINGSLEY WING Editor
KEITH HENNEY Director of the Laboratory
HOWARD E. RHODES Technical Editor
EDGAR H. FELIX Contributing Editor



VOL. XV. NO. 6

Contents for October, 1929

MERCHANDISING SECTION

The Telephone Rings the Doorbell -	Everett M. Walker	317
Features That Sell Radio - - - - -	Dudley Walford	319
Are Used Sets Like Used Cars? - - - - -		320
Clippings - - - - -	What Radio Men Say	322
Saving the Summer Slump - - - - -		323
Have You Personality? Then Sell It	Howard W. Dickinson	324
A Merchandising Plan That Sells Sets - - - - -		326
Keeping Service Sold - - - - -	John S. Dunham	328
Tested Sales Ideas - - - - -	Merchandising Shorts	330
Cooperative Dealer Broadcasting	Novel Window Display	
Sell Your Golf Clubs Receivers	Building a Prospect List	
Striking Window Display	Dramatizing Battery Set's Uselessness	
Value of Good Delivery Trucks	Selling the Farmer	
The Radio Dealer's Advertising	Dollar - - - - -	332
The March of Radio - - -	An Editorial Interpretation	334
How About the Jobber's Place?	A Medal for Commissioner Lafount	
Improving the Dealer's Position	Courts Strengthen Commission's Position	
Professionally Speaking - - - - -	Keith Henney	336
We Still Have Growing Pains	New Features for 1930 Sets	
The Tube Business - - -	News of the Tube Industry	337
News of the Radio Industry - - - - -		338
In the Radio Marketplace -	Offerings of Manufacturers	342
The Serviceman's Corner - - - - -		344

ENGINEERING SECTION

Strays from the Laboratory - - -	Technical Shorts	349
Regarding Band-Pass Circuits	Engineering Limits	
Efficiency of Crystal Control	New Government Books	
Data on Pentodes	Cost of Quartz Crystals	
Eight Good Slogans	Radio Sets for the Farm	
Grid-Leak Vs. Grid-Bias Detection -	J. M. Stinchfield	350
"Radio Broadcast's" Set Data Sheets - - - - -		353
The Edison Model C-1	The Fada Models 55 and 77	
The Steinite Model 40	The Buckingham Model 80	
Automatic Volume Control - - -	Virgil M. Graham	355
Design of the Colonial 32A.C. - - -	Fullon Cutting	358
An English Output Tube, the Pentode - -	W. T. Cocking	360
Radio Broadcast Laboratory Information Sheets	Howard E. Rhodes	364
No. 301. Output Transformer Ratios	No. 303. "Power" and "Lic-car" Detection	
No. 302. Output Transformer Ratios		

The contents of this magazine is indexed in *The Readers' Guide to Periodical Literature*, which is on file at all public libraries

. . . among other things

THIS MONTH we take a few lines to quote the complaint of a dealer who has the problem of selling radio in a rural community. His shop is in North Dakota. He says: "Have the radio manufacturers forgotten there is a rural population? I do not know of a commercial receiver that is practical and at the same time economical in operation for the user of batteries that can even approach the satisfactory performance of the modern socket-powered sets.

AS A DEALER in a rural community I expect approximately fifty per cent. of my business from the rural population who have no electric light service, and I have to get along with magnetic loud speakers and the power output of a 112A tube, unless they can afford an extensive outlay of B batteries and continual charging of storage batteries to operate a larger power tube and dynamic loud speaker.

IT IS MY impression that any manufacturer who would market a practical four- or five-tube screen-grid set with a low plate-current consumption and the volume level of a 171A tube or more would be amply rewarded for his efforts. As it is, sales on battery sets will be bound to slump badly and a large potential market is being sadly neglected."

LET THE rural dealers take heart. It will not be long that the battery-user will be penalized for his lack of electric power service. Some sets are already on the market to meet this requirement—and it is a real one—and more are on the way. We should not be surprised to see new tube design contribute greatly within the next twelvemonth to a more complete answer to this need.

THE ROCHESTER, Buffalo-Niagara, Cleveland, and Toronto sections of the Institute of Radio Engineers are sponsoring a district convention to be held in Rochester, N. Y., November 18 and 19. Papers will be delivered by A. Hoyt Taylor, W. A. MacDonald, W. C. White, and others.

—WILLIS KINGSLEY WING.

TERMS: \$4.00 a year; single copies 35 cents; All rights reserved. Copyright, 1929, in the United States, Newfoundland, Great Britain, Canada, and other countries by

DOUBLEDAY, DORAN & COMPANY, INC., Garden City, New York

MAGAZINES
COUNTRY LIFE . . . WORLD'S WORK . . . THE AMERICAN HOME . . . RADIO BROADCAST . . . SHORT STORIES . . . LE PETIT JOURNAL . . . EL ECO . . . WEST

BOOK SHOPS (Books of all Publishers)

NEW YORK: <LORD & TAYLOR, JAMES MCCREERY & COMPANY, PENNSYLVANIA TERMINAL, 166 WEST 32ND ST., 848 MADISON AVE., 51 EAST 44TH STREET, 420, 526, and 819 LEXINGTON AVENUE, GRAND CENTRAL TERMINAL, 10 WALL STREET> ATLANTIC CITY: <2807 BOARDWALK> CHICAGO: <75 EAST ADAMS STREET> ST. LOUIS: <223 N. 8TH ST. and 4914 MARYLAND AVE.> CLEVELAND: <HIGGEE COMPANY> SPRINGFIELD, MASS: <MEEKINS, PACKARD & WHEAT.

OFFICES

GARDEN CITY, N. Y. NEW YORK: 214 MADISON AVENUE. BOSTON: PARK SQUARE BUILDING. CHICAGO: PEOPLES GAS BUILDING. SANTA BARBARA, CAL. LONDON: WM. HEINEMANN, LTD. TORONTO: DOUBLEDAY, DORAN & GUNDT, LTD.

OFFICERS

F. N. DOUBLEDAY, Chairman of the Board; NELSON DOUBLEDAY, President; GEORGE H. DORAN, Vice-President; RUSSELL DOUBLEDAY, Secretary; JOHN J. HESSIAN, Treasurer; LILLIAN A. COMSTOCK, Ass't Secretary; L. J. McNAUGHTON, Ass't Treasurer

Final Tests to assure *perfection*

Naturally — every TRIAD Tube is constantly, rigorously tested throughout the entire manufacturing process — a special test follows every individual operation. Yet TRIAD does *more than that!* When completed, each TRIAD Tube is subjected to nine *additional* and *final* tests for vital characteristics — tests so stringent that nothing short of absolute perfection can survive them! This infinite care in manufacture has won for TRIADS their reputation for superior quality — and has made possible that guarantee that goes with every TRIAD Tube — a minimum of six months' satisfactory service or a proper adjustment. You can rely on TRIADS — the tubes backed by an actual Insurance Certificate!

Call your jobber or write us direct for complete TRIAD information.

TRIAD MFG. CO., Inc., Pawtucket, R. I.

Tune in on the TRIADORS every FRIDAY evening, 8 to 8:30 Eastern Standard Time, over WJZ and associated NBC Stations.

TRIAD INSURED RADIO TUBES

Ask for the tube in the black and yellow triangular box.



FINAL TESTS

Below are listed the nine *final* tests for vital characteristics to which every TRIAD Tube is subjected.

- 1 Gas
- 2 Emission
- 3 Filament Current
- 4 Plate Current
- 5 Oscillation
- 6 Grid Voltage
- 7 Mutual Conductance
- 8 Plate Impedance
- 9 Amplification Constant

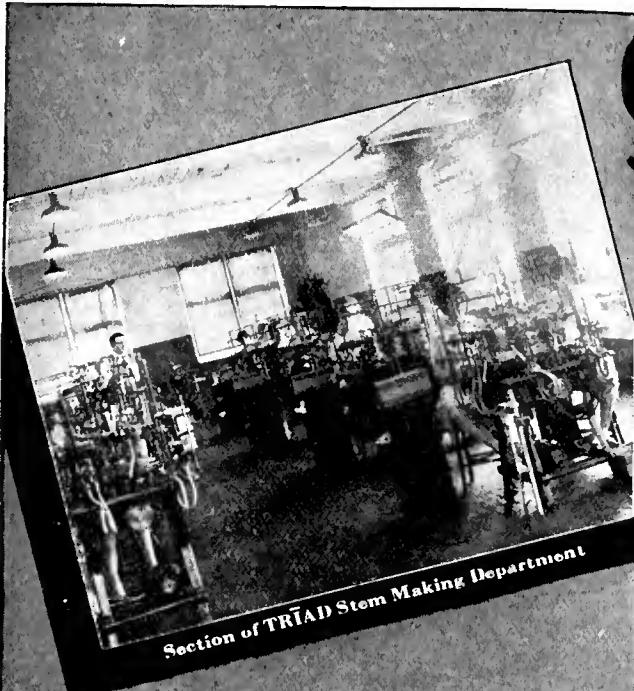

Section of TRIAD Stem Making Department



Section of TRIAD Testing Department

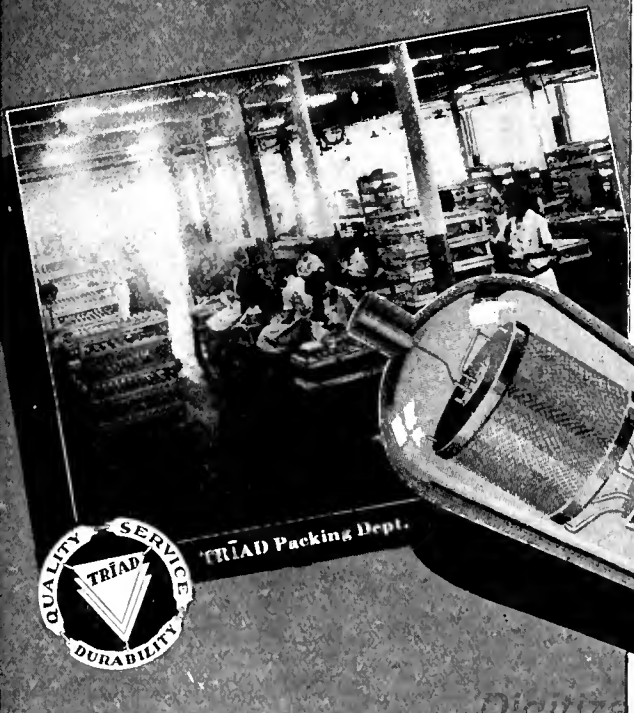

TRIAD Packing Dept.

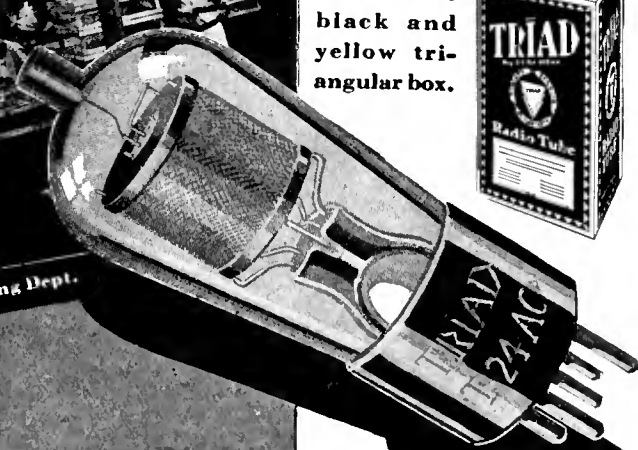

Cut your service calls in half...

sell ARCTURUS Tubes



Service calls cost money. Many of them are due to burnt out tubes... noisy tubes... tubes that soon lose their efficiency.

Arcturus *Blue* A-C Tubes are so well designed and carefully built that they cut costly tube trouble to the minimum. Dealers who equip all their A-C sets with these exceptional tubes have found by actual experience that *Arcturus Tubes cut service calls 50% or more.*

This means greater profits from set sales, and thoroughly satisfied customers. Arcturus *Blue* Tubes make any A-C set do its best because they act in 7 seconds, do away with hum, give true tone and hold the world's record for long life.

If you are not now selling these perfected tubes, write for all the facts and join the ranks of satisfied retailers who are making more money with Arcturus.

ARCTURUS RADIO TUBE COMPANY
NEWARK, N. J.

ARCTURUS

BLUE **A-C**
LONG-LIFE **TUBES**

THE TELEPHONE RINGS THE DOORBELL

By
EVERETT M. WALKER

The 1930 Method to Approach Prospects Who May Be Interested in Purchasing a New Radio Is to Make Use of the Latest and Most Practical Means of Communication, and so—Use the Telephone.



APPROACH YOUR prospect from the inside of his own home and you will have greater chances of selling successfully a new radio receiver, than you would through the more or less antiquated 'doorbell-ringing method.'"

This is the precise form in which Ernest W. Boyce, sales manager of R. H. McMann, Inc., a New York distributor, related to the author a scheme of direct selling which during the past radio season proved to be highly successful in approaching potential new set-owners through a direct canvass method. This plan is also being operated at top capacity during the current fall season to facilitate sales through dealers in the metropolitan area.

Selling the 20th Century Way

"This is the twentieth century," Mr. Boyce points out, "the age of science, with the automobile, radio, and last but not least the telephone. The 1930 method to approach a person who may be interested in purchasing a new radio receiver is to make use of the latest and most practical means of communication, and so—'why not use the telephone?'"

"Certainly, Mrs. Jones, who is home all day, or that is, practically all day, busy with the various duties of keeping the home in order, will answer the telephone more readily than the door-bell, and listen to the 'talk' of a house-to-house canvasser, who may take possibly a half-hour of her valuable time."

This, summed up, is virtually the plan of making use of the telephone to approach a potential set purchaser which Mr. Boyce introduced to aid dealers who are in the territory of the McMann distributing company. Although Mr. Boyce is rather modest about claiming credit for the telephone method of approach, saying that stock houses, and other organizations conducting a direct sales business have demonstrated successfully the practicability of the telephone, as far as is known, this is one of the first instances where it has been used successfully in the radio industry.

The telephone plan is this: The distributor first conducts a simple survey of a dealer's territory to determine the number of residents and the approximate buying power of each (the method of obtaining this information will be related in the following paragraphs). These facts are laid before the merchant, and it is suggested that he adopt the telephone method of approach, employing the services of an experienced operator supplied by the jobber.

After outlining his territory, the dealer is supplied with the telephone number of every resident in his district. This information may be obtained from the telephone company for a nominal cost. A telephone operator is furnished by the distributing company, the requisite being that the dealer pay the salary. Each operator is trained in the technique of conducting a telephone canvass, and is supplied with printed cards which outline the procedure of approaching Mrs. Jones.

The first week the operator is on duty she starts early in the morning and goes down the list of numbers, asking questions on whether or not the home is radio equipped, type of receiver employed, etc., carefully noting down the answer opposite the question on the card. At the end of the day these are filed. The conversation, according to Mr. Boyce's method is as follows:

The First Contact

"Good morning! Is this Mrs. Jones?"

"I represent the American Bosch Company. We are conducting a radio survey in this territory. Would you mind telling me whether or not you have a radio receiving set in your home? Yes! What make did you say it was—and model? How long have you had it? Are you well satisfied with its performance?" etc.

"That will be all, Mrs. Jones. Thank you for giving us this information."

Through this method of approach the dealer may determine exactly who, in his territory, has a radio receiver. The data obtained also enable him to compile an accurate prospect file giving the make and age of each receiver in use.

After the approach, Mr. Boyce points out, a follow-up is essential in order to make a sale, and this should be done about a week after the first contact is made. The operator again calls Mrs. Jones, tells her she represents the manufacturer of a certain radio receiver, and volunteers a demonstration in the home.

Conversation for the second call is something like this:

"Good morning, Mrs. Jones! I represent the American Bosch Radio Company. We are wondering if you would not like to hear one of our latest all-electric receivers. It is quite an improvement over the set you now have, and incorporates

as the average in the final analysis. It represents only a few small territories canvassed to determine the feasibility of the experiment, and, should it be applied to a greater number of territories of varying purchasing power, it is believed that the average might drop to as low as fifty or sixty per cent. By way of comparison, it may be noted that in other trades where such telephone schemes of selling have been applied, forty per cent. successful reaction is considered good. This latter percentage is more than sufficient to warrant wider use of the telephone sales method.

The salesman, Mr. Boyce explains, enters the home completely equipped to install the demonstration set, which is usually a cabinet model. If antenna and ground connections are not readily available, he produces a temporary antenna system which will permit the receiving set to perform at its best under the existing local conditions. His clue to tell of the relative merits and sales points of the particular receiver, is when Mr. Jones asks, either the price, or whether other cabinet models are available.

In a foregoing paragraph mention was made of Mr. Boyce's system of obtaining information on the purchasing power of the average individual in each dealer's territory. This, of course, determines to a large extent what make and price receiver will be exploited. The information is readily available through electric light, telephone, and other public service or public contacting companies, who have such data on hand.

First, the dealer outlines his territory, and determines the number of homes he is adequately equipped to service. The average income of the power company or telephone company is obtained from either organization for small cost. Fifteen per cent. is added as a correction factor to compensate any possible expansion during the ensuing year. The constant for determining the approximate number of receivers which should be sold is, of course,

dependent upon the price of the receiver. In the case of the Bosch set, Mr. Boyce says, sixty per cent. is the mark set for the dealer. At any rate, after computation, it is not difficult to decide what price set should be exploited.

With the telephone plan placed in operation by the R. H. McMann company, the special operators are trained by the distributor and are, after the dealer agrees, assigned to conduct the "1930 method of approaching prospects."

Card No. 1

TELEPHONE SURVEY OF RADIO SALES PROSPECTS

Smith Radio Service Company 1711 Broad Street, East Newton

Name _____ Date interviewed _____

Address _____

City _____ Is name a good prospect? _____

Phone Number _____

(1) Type of set owned? _____

(2) When bought? _____ (3) Battery or A.C.? _____

(4) Performance satisfactory? _____

(5) If he does *not* own a Radio set, place check here _____

(6) Is he interested in radio? _____

(7) Remarks _____

In conducting a radio sales canvass over the telephone Mr. Boyce's representative first asks the questions listed on the above card. Two weeks later she calls to offer a free demonstration and obtains the data required by card number two.

the latest innovations in receiving apparatus.

"What evenings this week would you and Mr. Jones be at home? Thursday! All right, we will have our representative call at 8 o'clock in the evening, if convenient, and we assure you of a pleasant evening's radio entertainment."

Thus, the appointment is made. And, says Mr.

Boyce, according to data taken from dealers employing the system, seventy-eight per cent. of the prospects who permit the home demonstration have purchased a new model receiver of the manufacture demonstrated after the first call. These results were determined after the first tests of the telephone sales method which was conducted in a more or less experimental manner last fall. The seventy-eight per cent. result is very remarkable, and should not be regarded

Card No. 2

TELEPHONE CANVASS FOR RADIO SALES

Smith Radio Service Company 1711 Broad Street, East Newton

Name _____ Date interviewed _____

Address _____ Successful? _____

City _____ Is second follow-up advisable? _____

Phone number _____

(1) Type of set owned _____

(2) When bought? _____ (3) Battery or A.C.? _____

(4) Can appointment be made? _____ When _____ Time _____

(5) Not interested; Why? _____

(6) Will be interested at later date? _____ When _____

(7) Remarks: _____

FEATURES THAT SELL RADIO

By
DUDLEY WALFORD



Designed and photographed by Larry June

A FEW COILS of wire, some sockets, condensers, resistors, and a few soldered connections produce a radio receiver, an instrument that gives more entertainment to more people throughout the world than any other device. And every succeeding year brings improvements and refinements in the instrument, so that the user gets improved operation of one kind or another from a new radio receiver. What are this year's improvements? What are the changes in present receivers over past models that make sets easier to operate, or easier to install, or give better quality, sensitivity, or selectivity? From these viewpoints we analyze, in the following paragraphs, some of the important features to be found in the new receivers. However, we make no attempt in these notes to decide to what extent the advantages inherent in the various features have been actually realized in practice.

Screen-grid Tubes: It seems natural to start with the screen-grid tube for it is the most important new feature. This tube, when properly used, makes a set very sensitive so that more distant stations can be heard or a smaller antenna can be used with satisfactory results. Because of the high amplification obtainable from screen-grid stages, special detector circuits which produce less distortion can be used. In addition, such detectors need be followed by only one stage of audio-frequency amplification—and both of these changes may result in improved quality and decreased hum.

Decreased A.C. Hum

Power Detection: This is a term used to describe a characteristic of certain receivers which use a detector operating at comparatively high signal levels and followed generally by only one stage of audio-frequency amplification rather than customary two stages. Detectors which are followed by only a single audio stage must operate at voltage levels some twenty-five times higher than detectors of the type used a year ago, and because they operate at these high levels they are frequently referred to as power detectors. Probably the major advantage of such a detector is that it permits the use of one audio stage which means that the set will have less hum and also that the quality may be better due to avoiding the dis-

ortion occurring in the eliminated a.f. stage. Sometimes one will see references to "linear high-voltage detectors," which term indicates a detector with linear characteristics. Since detectors which have curved characteristics produce distortion, linear detectors are an advantage from the standpoint of fidelity. A so-called power detector may or may not have a linear characteristic.

The term power detector, as it is now being used, is really not very accurate. When this term was first used it was intended to refer to detectors from which sufficient power could be obtained (without any audio-frequency amplification at all) to permit the operation of a loud speaker directly from the detector tube. It is now used to indicate the use of high-voltage plate-circuit detectors.

Improved Fidelity

Band-Pass Tuning: Band-pass tuning is used in a receiver to improve the fidelity by preventing the elimination or reduction of high audio tones and improving the selectivity by making the sides of the tuning response curve very steep rather than curved. If the use of band-pass tuning in a receiver is of any advantage it will show up in the performance of the set by improving the quality and selectivity.

Automatic Volume Control: Automatic volume control simplifies the operation of the receiver. It removes the necessity of varying the volume control in tuning from one station to another. This variation is accomplished automatically; it is no longer necessary to operate the volume control manually. With such a set the volume from all stations is practically the same up to the limit of the sensitivity of the receiver. Once having set the volume control knob to a satisfactory point the user is assured that all stations will be received at the same volume. Automatic volume control helps to reduce the bad effects of fading by increasing sensitivity automatically as the signal fades and decreasing the sensitivity automatically as the signal strength increases.

A feature of some sets using automatic volume control is a "tuning meter," a milliammeter mounted on the front of the set. In tuning a station the operator watches the meter and adjusts the tuning dial to give the greatest deflection of the

(Concluded on page 368)

ARE USED SETS

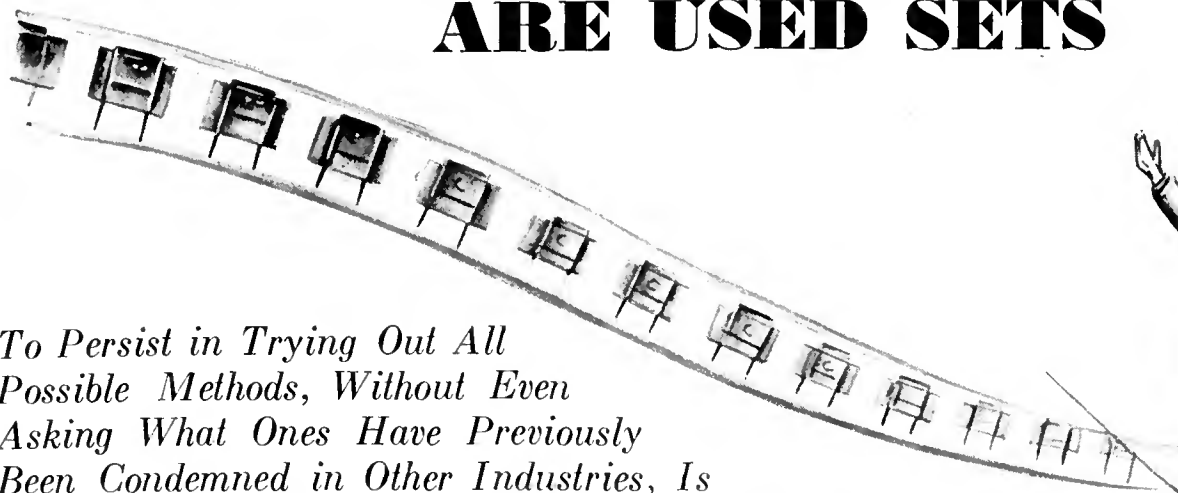

To Persist in Trying Out All Possible Methods, Without Even Asking What Ones Have Previously Been Condemned in Other Industries, Is More Than Shortsighted; It Is Unintelligent

THE AUTOMOBILE industry is thirty years old. The radio industry, in the proportions and perplexities of an industry, has a history less than a third as long. And because even the brightest youngster needs wise counsel to balance and direct his energetic smartness, more and more radio executives are saying, "Look at what the automobile industry has done in different cases."

There is no reason why the radio trade should surrender any of its initiative, no reason why its executives should humble themselves and sit at the feet of the more venerable automotive chiefs, accepting all their words as binding gospel for radio enterprises. That would be more harmful than would an isolation policy of indifference to all that the older industry has experienced.

There is very good reason, however, why the radio industry should make keen appraisal of all the steps in the development of the automotive industry; should study all its past problems, determining what similarities they bear to problems now appearing or likely to appear in the radio business, and surveying the older industry's solutions of its problems with an eye to finding the merits and weaknesses in each.

Such a study is particularly effective in the merchandising end of an industry. Merchandising is an economic science, and as such has basic laws and tenets that are as applicable to radio sets as to sewing machines, to pipe organs as

to chummy roadsters. To overlook that fact, and to persist in trying out all possible methods without even asking what ones have previously been condemned after bitter experience in other industries, is more than shortsighted; it is unintelligent.

"The worst mistake the automobile industry made was in thinking that its problems were unique and unprecedented in the history of merchandising," said H. R. Cobleigh, staff secretary of the National Automobile Chamber of Commerce,

SUCCESSFUL AND UNSUCCESSFUL

Name of Plan	Principle	Operating Method
Saginaw	Maximum Allowance	Dealers fix resale values on all models for past 5 years, and exchange these figures among themselves.
Windsor	Market Price Information	Current sales figures on used cars published in newspapers by cooperating dealers.
National Used-Car Market Report	Maximum Allowance	Published periodically, sets allowance prices, all models and all makes, for 12 zones in United States.
Oklahoma	Market Price Information	Used car transactions reported weekly at meeting of cooperating dealers.
Boston	Maximum Allowance	All used car sales reported to Central Bureau, which in turn reports to all members.
Cincinnati	Maximum Allowance	Similar to Boston Plan.
Cleveland	Coöperative selling of used cars	Central Inspection Bureau, coöperatively maintained, certifies reconditioned cars and approves selling price.
Appleby	Monopoly of used car business	"Motomart," financed by dealer association, appraises, buys, and sells all used cars in district.
Omaha	Coöperative junk-yard	Junk-yard, financed by dealers, scraps all cars unfit for use, salvages and sells secondhand parts.

*"Motomart" buys used car, gives customer a receipt instead of cash, and dealer honors cashes receipt.

LIKE USED CARS?



When Local Dealers Fail to Coöperate, All Trade-In Schemes Fail—Mistakes the Automotive Industry Has Made—What Can the Radio Industry Learn from the Automobile?

during a recent discussion. "For years our people, manufacturers and distributors alike, persisted in using the trial and error method of solving our selling problems. Nothing like the automobile had ever been known before, and the natural but erroneous conclusion was that no similar sales problems had ever arisen before. For years we struggled along with the problem of used-car allowances, trying this and that and the other method of getting a sound policy that would cover a majority of cases; but it didn't occur to us that

the piano trade had faced that same problem and worked out a fair solution to it years before it bothered us."

The mistakes that have already been made are not the ones to be feared; a mistake once made and recognized is a mistake well on the road to correction. It is the errors unwittingly committed in the early stages of a new problem, the wrong steps taken before the magnitude of the problem has become apparent, the mistakes not yet made but in the un-realized process of being made, that are to be feared and fought. And it is just there that the study of the experiences of others is essential; without that study, the budding problems in one's own industry cannot be recognized at their true worth, the first false steps cannot be prevented.

Two problems have been costly, and still are being costly, to the automobile industry: the used-car problem and the service problem. The radio industry is beginning to meet exactly analogous problems, and should decide upon the wisest methods, rather than upon the most convenient makeshifts, for handling the trade-in set allowance and the service problems. Many radio men think they have found satisfactory solutions of those problems; some of them are sure they have. But a review of the various measures tried out by the automobile industry will at least give radio executives food for thought. This article will deal with the used-car problem, since that is the one which bulks largest in the minds of automobile men, and has for twenty years.

AUTOMOTIVE TRADE-IN PLANS

Formula for Resale Valuation	Trade-in Allowance	Remarks
1st yr.—list less 40% 2nd yr.—balance less 20% 3rd yr.— " " 25% 4th & 5th yrs.— " 20%	Resale value less reconditioning cost and 20% commission.	Has operated successfully for 10 years.
The current cash price for reconditioned used cars is the resale valuation.	Resale value less variable commission and reconditioning cost.	Is being used in more than 50 large cities.
The current cash price for reconditioned used cars is the resale valuation.	See operating method.	Started by Chicago Automobile Trade Ass'n. Still in use.
The current cash price for reconditioned used cars is the resale valuation.	Determined by each dealer to suit himself.	Abandoned after a few weeks' trial.
Multiply list price by .58—1st yr. .40—2nd yr. .30—3rd yr. .24—4th yr.	Resale value less cost of reconditioning.	Central bureau staff paid by dealers. Abandoned after 3 years' trial.
1st yr., 60% of list 2nd yr., 45% of list 3rd yr., 36% of list 4th yr., 29% of list	Resale value less reconditioning cost and 10% commission.	Lasted 8 months. Dealers failed to notify Central Bureau.
Determined by Inspection Station.	Resale value less reconditioning cost and variable commission.	Still in use. Has increased market for used cars, has fixed resale values.
The current cash price for reconditioned used cars is the resale valuation.	None*	No dealers permitted to buy or sell used cars. Has been abandoned.
	Very small—determined by each dealer to fit each transaction.	Protects dealers from buying same car 3 or 4 times. Is being adopted all over.

this receipt as part payment on new car. When "Motomart" sells the used car, dealer

The crux of the used-car problem, to the individual dealer, is expressed in the statement that he must take a loss in order to make a profit. The list price of the new car allows him a satisfactory profit; but when he accepts a used car at an arbitrary trade-in valuation, he has decreased the amount of his profit by the amount of the trade-in valuation. The point on which he must make his decision, the consideration that should govern the size of his trade-in allowance, is "How much loss can the total transaction absorb and still leave me a satisfactory profit."

Some dealers still feel that they are the best judges of that point, and that each individual case should be considered on its own merits. But experience has shown them that, for the majority at least, the used car problem is too big for individual solution with safety.

Alfred Reeves, general manager of the National Automobile Chamber of Commerce, gives the following illustration of what the used-car problem has come to mean to the dealer. It is an actual case, and there have been altogether too many of them for the comfort and peace of mind of automobile dealers.

A man, whom we might as well call Brown, decided to buy a car. He had never before owned a car, but he knew what kind of car he wanted, and he knew what it would cost him. He also knew that the trade-in allowance was a very important factor in buying a car. He went to an auto junk-yard just outside the city in which he lived, and asked the proprietor if he could borrow an old car for the afternoon. The proprietor, a friend of Brown and a good fellow not averse to making a dollar or two in rental if he couldn't make a sale, agreed; Brown drove away in a decrepit, but mobile, old ark.

He drove up and parked in front of the salesroom of the dealer whose car he had decided to buy, walked in, and was an easy prospect for the floor salesman. He agreed to buy the model he wanted, and as the delighted salesman started to write out the sales order, Brown waved a nonchalant hand toward the broken-down wreck at the curb

"Of course, you'll give me an allowance on that car of mine," he said.

The salesman looked, swallowed hard, and not wishing to spoil a sale, agreed to allow him \$150 on his old car. Brown seemed satisfied, and the deal went through. As Brown was about to leave the salesroom, he hesitated, and said, "Tell you what. I'm pretty attached to that old tub outside; it's given me years of good service. Rather than part with it, I'll buy it back from you at \$75."

The salesman, glad of the chance to get rid of the white elephant, agreed. Brown drove the ancient bus back to the junk-yard, gave the proprietor \$10 for the loan of the car, and came out a clear winner of \$65 on the deal.

That is not an average case; but it has happened more often than it should. Now, what has the automobile industry done to prevent such dealer losses in handling used-car trade-ins?

A number of plans have been devised and tried by automobile dealers in all parts of the country. The more important of those plans are summarized in the table accompanying this article; from one or another of the nine plans mentioned there, more than forty variations

have been conceived and tested. Almost all of them, together with four of the basic plans, have been abandoned after costly trial periods.

The one feature common to all the plans, and the point particularly important to the radio trade, is that the dealers of each city must cooperate in finding the solution of the problem. Until automobile dealers agreed to make peace among themselves on the trade-in allowance, the problem remained beyond solution, and was actually turning the expected profit on new-car sales into unexpected loss.

A glance at the accompanying table will show that the important factor is the method of determining the resale value of a used car before accepting it in trade. If the dealer can know what he is going to get for the reconditioned used car, he can set his trade-in allowance on it so as to insure a satisfactory profit on the whole transaction.

The first method of determining that valuation, the "maximum allowance" principle, figures theoretical depreciation on each make and model of car, and establishes a "maximum allowance" beyond which the dealer should not go unless he wishes to take a loss. The second, and increasingly popular, is the "market price information" principle, which declares that a used car is worth what it will bring in the used car market, not what it ought to bring. By posting current used car transactions in a given city or area, the current resale value of every make and model of car in that area can be accurately known. This is the principle on which the Windsor plan works, and the Windsor plan is considered the best solution of the trade-in problem. It is being introduced by dealers all over the United States, and has been in use in Canada for some years now.

Under the Omaha plan, automobile
(Concluded on page 368)

clippings

J. M. SKINNER (Philco): "The radio fan of today who is careful in his choice of set should be able to get ten times as good performance as he was able to get a year ago."



C. A. EARL (Earl Radio): "It is now an assured fact that radio is an all-year business."



THOMAS A. EDISON (Edison Radio): "I have always liked my job."



HERBERT E. IVES (Bell Telephone Laboratories): "Color television constitutes a definite further step in the solution of the many problems presented in the electrical communication of images."



M. H. AYLESWORTH (N. B. C.): "We realize that the appeal over radio, in order to bring results, must be brief and interesting and infrequent."



ARTHUR FREED (Freed-Eisemann): "More than three quarters of the population of the United States cannot afford to buy a radio receiver that is priced over \$100 without inconvenience."



GORDON C. SLEEPER (Temple): "Instead of hurting the phonograph industry, radio is now proving to the public the possibilities in reproducing phonograph records. The phonograph industry is now grateful for strides made in radio and in particular for the perfected electro-dynamic speaker."



COMMANDER EDWARD ELLSBERG (U. S. N.): "It is one of the features of our age that, regardless of apparently insurmountable difficulties, what public opinion truly demands speedily becomes feasible."



HAROLD A. LAFOUNT (Radio Commission): "The number of receiving sets in use in the Fifth Zone has more than doubled in the past eighteen months."

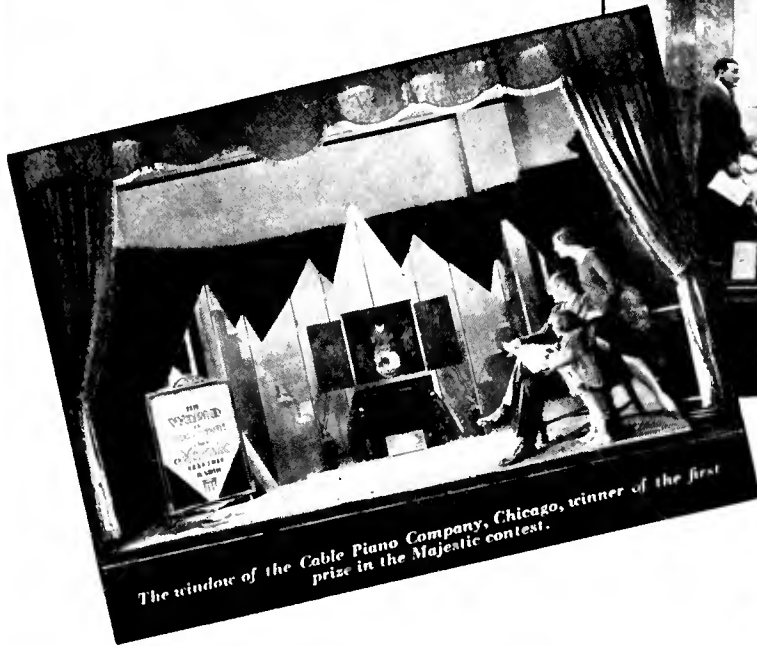

The window of the Cable Piano Company, Chicago, winner of the first prize in the Majestic contest.



J. L. Hudson Co., Detroit, received second prize for this attractive window

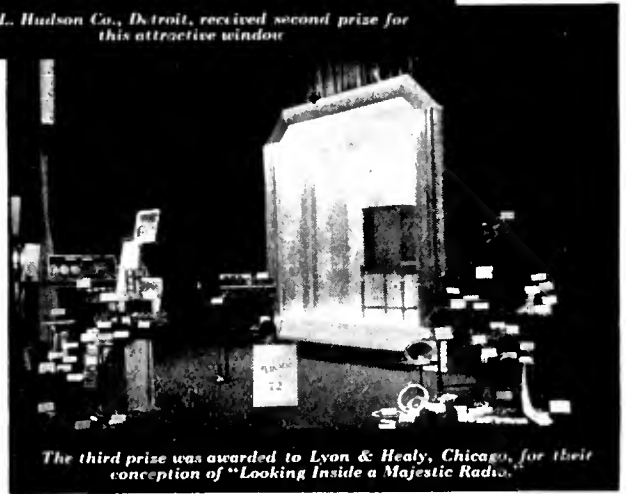

The third prize was awarded to Lyon & Healy, Chicago, for their conception of "Looking Inside a Majestic Radio."

SAVING THE SUMMER SLUMP

IN THE PAST the radio trade as a whole has been content to sit by idly in the summer and allow sales to follow their natural course, chiefly because it was not believed that business could be good during the hot months. This year, however, Duane Wanamaker, advertising manager of the Grigsby-Grunow Corporation, decided that, as far as his products were concerned, he *had* to ward off the summer slump in radio. The plan which was followed included a window trimming contest with district and national prizes in which all Majestic dealers were invited to participate and an extensive national advertising campaign urging the public to watch the windows of Majestic dealers during "National Majestic Week." The nature of the advertising campaign was such that it was of decided advantage to all dealers to coöperate, and, as a result, more than 4000 dealers submitted photographs of their windows to the judges of the contest.

The three windows which won the highest national prizes are pictured at the top of this page. The first prize winner is an especially interesting window, although the most important feature—motion—does not show in the picture. The loud speaker was removed from the set which was exhibited and in the loud speaker opening was placed a piece of ground glass. A small projector inside the set threw a moving picture on the glass.

A Double-Barreled Advertising Campaign Tying in With a Nationwide Dealer Window Trimming Contest is the Plan Followed by One Manufacturer in Boosting Radio Sales in Summer

(Right) Gray, Trimble & Smith Electric Co., Bloomington, Ill., receive honorable mention for "The World in Your Home." (Below left) A consolation prize was awarded to the Maynard Music Store, Salisbury, N. C., for "The Most Humble Home Can Afford a Majestic Radio." (Below right) This modernistic impression of "A Cozy Spot in Springtime" by the Power Furniture Co., Portland, Ore., received honorable mention.



Real Radio for Your Home

A Set That is *Far Ahead*
of Broadcasting

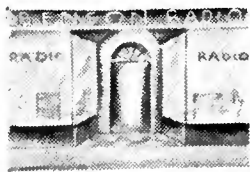
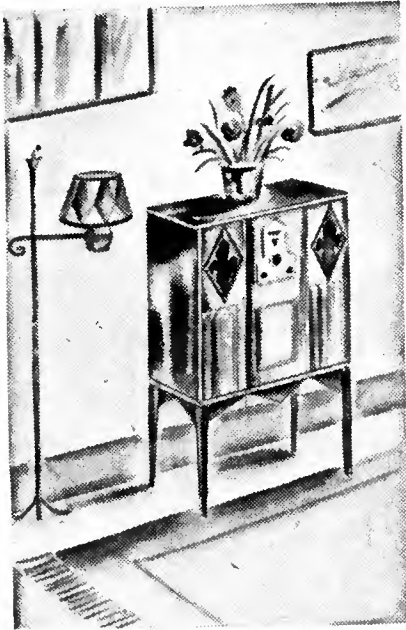

There is radio *refined*—and just radio. It takes a good ear to make that distinction. You will always love the Heroic Radio for its splendid tonal effects. Have you ever listened to the Symphony Hour on the Heroic? Any set will reproduce this fine broadcasting fairly well, but the Heroic picks out all the dainty charm in this music.

Hear the Heroic Play Real Music at the

BENSON RADIO STORE

214 Main Street

By **HOWARD W. DICKINSON**

Merchandising Consultant

THE DEALER must have something worth advertising. This thing is personality. The great house of Tiffany and Company offers jewelry, silverware, precious stones, glass, china, and so on. All are carefully selected and, I verily believe, all sold at very reasonable prices.

That, however, does not explain Tiffany. The charm of house personality on top of modern business intelligence makes that great house.

A Radio Personality

The name, A. Atwater Kent, means a great business in radio receiving sets. It also spells a very colorful personality, a personality which fairly exudes idealism with respect to mechanical perfection and performance. Just try to figure out what the personality of A. Atwater Kent is worth to-day to A. Atwater Kent, the manufacturer.

What started me off this way? A remark of a manufacturer of radio sets somewhat to this effect: "How shall we get our retailers to do the right kind of advertising? Well, they don't know much about advertising, often do not know how to write advertisements very well, so the best thing I know of is to furnish them with copy already written."

This is why so many manufacturers offer you their cut and copy service. Generally, it is good stuff—good advertisements about *their* products which *you* sell. When you are

Have You Personality? —Then Sell It

The Local Shop Needs Personality—Do Your Advertisements Reflect It?—If You Sell Radio as a Well-Built Machine or as a Fine Musical Instrument, Choose that Appeal in Your Advertisements—How Best to use Manufacturers' Cut and Copy Service.

busy, haven't time to write an advertisement or get one written, you use a manufacturer's cut service, putting your own name in the place left for "dealer's name."

Probably it is true that professionals have written these advertisements, presumably the manufacturer's advertising department or his advertising agent. They are about goods which you offer for sale. True, but they are not about *you* and your business in general. They have the manufacturers' personality, rather than your own.

They are good, easy to get, and you should take advantage of them and use them when they fit your needs, but not, in my opinion, all the time.

They have to be written to fit everybody, and consequently cannot quite reflect the individuality of your own shop or your own personality.

When you use them, you tie up your shop with that manufacturer's merchandise (and that is valuable) but in addition to that you have the chance of using the personality of your shop in advertising it as an attractive and interesting radio headquarters, that is, if it is one.

If it isn't, it lacks personality. If it lacks personality, some should be supplied.

How can we supply it? Only by turning our minds out of their ruts and pointing them in a different direction.

Look at Your Display

Here's what I mean. The man who runs a shop has selected (or fallen for) certain lines of merchandise. He has decided how much stock to carry and carries it. He has folders and advertising matter, strewn about for his customers to pick up.

His show cases, display tables and all have been arranged according to spaces in his shop. In nine cases out of ten the arrangement is conventional and uninteresting, the windows are poorly decorated, possibly not changed often enough.

If the customer goes in, he is courteously attended. If he knows just what he wants he can get it. But the feeling that this is a fine place to visit is too often lacking. The "personality content" of the place is low.

Generally, the personality content is low because only merchandise is displayed and not very well displayed either. Suggestion of the use of that merchandise is altogether lacking. It is true that in your shop you can tune-in and demonstrate a radio set. You can get a little hash of broadcasting under most unfavorable conditions, but the customer feels that he is never going to *know that set* till he gets it home. Obviously, it is no pet of the dealer's. He tells the customer that it must be good because the great So and So Company make it. He has been told the same sort of thing for twenty years about most everything he has bought. There is no savor in it.

Now how can we put in the "personality" content? Obviously, according to the personality of the boss himself. If he has or can get any artistic sense, let him show it in the arrangement of his shop.

Selling the "Insides"

If he can only see his job as the sale of machinery, by all means let him get that phase of personality working, let him and his salesmen demonstrate the "insides" of a set. "See what a splendid mechanical job this is!" "How nearly impossible to get out of order." "Notice that fine mechanical finish inside and out." "Precision." "Endurance." "Simplicity." "Fool proof." and all those things. They are effective, always were, always will be. His shop begins to show the personality of exactness, mechanical correctness, durability. The manufacturer's goods gain new saleability and increased reputation through being commended by a dealer of such obvious mechanical ability.

This kind of personality, as all kinds, should breathe forth from the shop's advertising; a house which appreciates mechanical perfection, which offers well-made goods, goods that will stand up and do their work. If I am thinking of a set principally from the viewpoint of its "standing up" and giving long service, the "personality" of this shop will appeal to me greatly.

The man who owns this shop should put his mechanical idealism into his advertising. "We pick our sets for their splendid construction and ease of operation." "The shop where quality and accuracy rule." "We know this receiving set, it should need almost no servicing." "Of the last 100 sets we have sold, only three have been back for repairs, and those only minor ones." "We get these sets in perfect condition for you—and then they should operate for years with little or no care."

Such ideas should be in the advertising of the shop which goes in for mechanical perfection. They are practical ideas, persuasive ideas, ideas which are salable. They give a "personality" impression of a very important kind, which should be borne out by the appearance and the personal work in the shop itself.

The Artistic Approach

The proprietor of another shop may have less of the mechanical sense and more of the artistic sense. He may be able to understand those fine distinctions of tone quality and refinement of reproduction which the average ear cannot get.

Our second proprietor should put the quality of his artistic personality into his advertising. Whatever the prices

LOOKING INSIDE

we pick  our sets for

their splendid construction and

ease of operation  take,

for instance, the Barnes-Newell



we know this receiver; it

needs almost no service

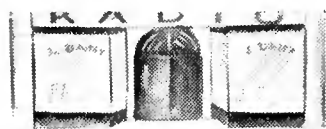

Radio sets installed by Deny's Barnes-Newell sets we sold, are right when they leave our only three have been back for floor and right mechanically and repairs. Buy your Barnes-electrically when we leave them Newell from Deny's where quality and accuracy rule. Of the last 100

J. DENY RADIO STORE

716 East Front Street

of his goods, he is a quality merchant. That fact can be made profitable. Here are points he can stress in his own advertisements which will make that apparent:

"Are you appreciative of tone quality? those fine shades of distinction between *just a receiving set* and a real musical instrument? The new Blank receiver is a truly remarkable reproducer in its tone quality and beauty."

"There is *radio refined*—and—just radio. It takes a good ear to make that distinction." "A set you will always love for its splendid tonal effects." "Have you ever listened to the So and So Hour on the Blank Radio Receiver? Any set will reproduce this fine broadcasting fairly well, but the Blank Receiver seems to pick out all the dainty charm in this music."

Such sentences and paragraphs show taste and musical appreciation in the personality of their sponsor. If he hasn't those qualities it may be expensive for him to claim them. He will be selling, and recommending, on the wrong basis and his customers will find it out. He must be of a personality to carry out in his own conversation what he suggests about himself in his advertising.

Here is a great mistake which many advertisers make. *Instead of turning their advertising to the real personality of themselves and their business, they use their advertising to bluff their readers into thinking they are something which they are not.* This inevitably slows up their efforts instead of speeding up. When we deal personally with a man we discover whether he makes good on what he pretends or not.

Of course, we are living in a period of pretense, bluff, and hypocrisy, but we realize it as never before and consequently

(Concluded on page 366)

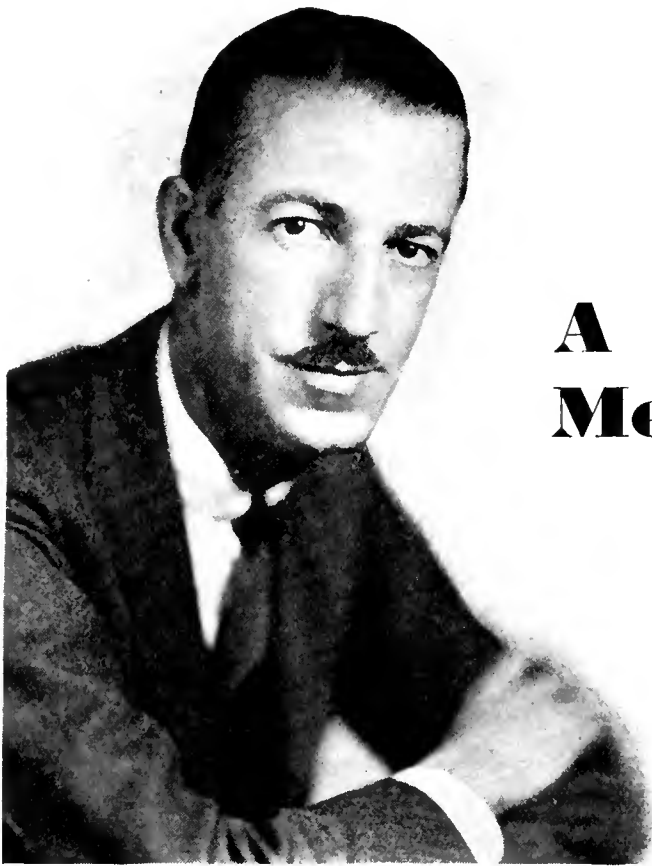

L. T. Breck, sales manager, Kolster Radio Corp.

A Merchandising Plan That Sells Radio

Dealers Participate in the Cost of Broadcasting, Reaching New and Old Customers By Direct Mail, a Follow-Up Plan Producing 40% Returns, Expert Service for the Small Dealer

THE owner of the three- or four-year-old receiver usually says to himself: "Well, the old music box has been good enough for the past three years (and it certainly has tuned-in a lot of distance), why should I buy a new one?" Consequently, unless permitted to hear a new model receiver, either in his own home or at his local dealer's store, he will not be in the market for a new set until his antiquated set ceases entirely to function. New prospects must be had, and old users must be told of new merchandise.

This, according to L. T. Breck, sales manager of Kolster, is exactly why it is necessary for the dealer to resort to a direct selling method in order to keep his sales quota up to par, and incidentally to fill his territory with "good sets for good broadcasting."

The problems of the dealer in preparing his own direct mail advertising copy, window display material, etc., are manifold. Printing in small quantities, particularly where it has to be of high grade in order to accomplish its sales mission, is costly. Manufacturers, however, prepare good sales material on a wholesale scale, and supply it to their dealers through the jobber. The manufacturer can do a more complete job for far less money than the dealer, and probably many times more efficiently. The manufacturer, too, is equipped financially to employ the best obtainable copywriters, artists, and printers, and can produce, for example, four-color folders for far less money than the dealer could have a black and white card printed.

Such a scheme of merchandising sales service has been compiled by Mr. Breck for both the Kolster Radio Corporation and the Brandes Corporation.

This new plan has been initiated in order to aid the small dealer. His merchandising problems are acute with increasing competition. The small dealer holds an important position in the radio merchandising structure and if his success is impaired the manufacturer suffers.

The dealer service provided by the Kolster organization is comprehensive and has elements new in radio selling.

For the amount of \$23.50 the dealer may purchase a window-display unit which stands about seven feet high, with his name across the top in bronze. Twelve insert cards, backed by an automatic flasher, which say in large black

Play the "Law of Averages" and Win
Increased sales come from telling your story in every worthwhile prospect in your vicinity.
Tell them convincingly - tell them often. You can't help but get your share of the radio business at a profit.

Know Who Your Prospects Are
A list of the names of the best prospects in your territory is the key to success. This list should be prepared by the manufacturer and supplied to the dealer. It should include the names of all the best prospects in your territory, and should be kept up to date.

How to Get Salesmen

- Best Sources**
- Advertising for Salesmen**
- Hiring Salesmen**

How to Train Salesmen

- Sales Meetings**
- Use the Vent Packed Painters**
- Demographic Profiles**
- Keeping Busy**

Read These Instructions Carefully

- Your Prospect File**
- How to Add New Names**
- Mailing Schedule**
- How to Use the Prospect File**
- Daily Check-Up on Salesmen**
- An Automatic Follow-Up**

Dealers are furnished with carefully prepared printed matter which helps them solve their problems.

letters, "Our Servicemen Are Experts," "Radio Makes a Lasting Gift," "Out of the Air—Education—Entertainment," etc., not prominently displaying the set manufacturer's name, are supplied—one for each month.

In addition to the window display, the dealer receives a "broadcast diploma" which states "This is to certify (name of dealer) contributes to broadcasting" and a supply of 200 folders printed in four colors for counter distribution. This diploma identifies the dealer to the customer as a member of an organization sponsoring broadcasting, thereby allowing him to share in the credit for radio entertainment. The diploma prominently displayed in the dealer's shop creates good will among the prospective set purchasers and links the dealer closely with Kolster broadcasting in particular.

The second unit of the Kolster merchandising service consists of an elaborate direct-mail service for dealer use in reaching prospects. The dealer supplies the names of 200 prospects to the manufacturer, and for the sum of \$30 five separate pieces are mailed to each prospect by the manufacturer. The first mailing requests the prospect to visit the dealer's store, and inspect his merchandise. The second volunteers a home demonstration—and the third, fourth, and fifth tell of the advantages of owning a radio receiver, without making particular reference to the Kolster company. Bringing the dealer into the spotlight, playing him up to the customer, rather than emphasizing the manufacturer, is an outstanding feature of this service. It is done to bind the customer closely to the dealer using the service, who, rather than the manufacturer, is the actual contact with the customer.

This mailing service, Mr. Breck believes, is the ideal method of approach for house-to-house canvass, and should be followed within reasonable time by a salesman. In order to make it simpler for the canvasser, a complete sales plan is supplied as the third unit, gratis. This gives an outline of

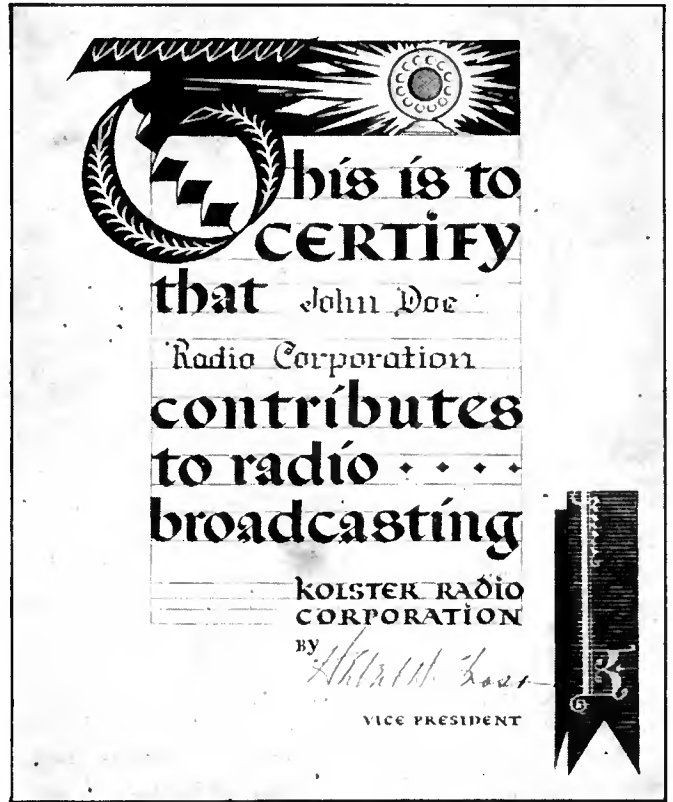

This diploma showing that the dealer contributes to the support of broadcasting has proven an excellent good will builder.

"sales talk" with cross reference to an excellent, illustrated demonstration portfolio. Also, the dealer is supplied with prospect cards to insure his keeping an accurate and readily used list of potential set owners.

(Concluded on page 368)

On the folder illustrated above are described many of the dealer aids furnished by the Kolster Merchandising plan.



KEEPING SERVICE SOLD

By JOHN S. DUNHAM
President, QRV Radio Service, Inc.

LAST MONTH the writer discussed some phases of radio service and compared them with similar ones in the automotive business. In solving our own problems, a few of the things the automotive industry has learned about service can help us all. Some of the methods used in the author's own organization which have proved to be productive of real dividends will, we are sure, interest every dealer. And *all* of the ways of doing things which can be profitably applied in a purely service organization can be applied with *equal profit* in *every* dealer's service department.

It doesn't cost any money to *lose* customers—there are few things which can be more easily and rapidly accomplished—but it *does* cost real money to gain new ones. The fewer customers we lose, the less we have to spend getting "replacements" for them. Likewise, the more names we can keep as steady customers, the less we have to spend in advertising to extend our clientele, because *a satisfied customer is the best advertising medium in existence*. It thus becomes profitable for us to expend a good deal of energy, and some money, for the operation of a carefully planned system for "keeping our radio service sold."

The Customer's Viewpoint

In an excellent talk which the Editor of RADIO BROADCAST gave before a dealer group at the Buffalo Convention of the Federated Radio Trades Association last February (see RADIO BROADCAST, May, 1929), he brought out the rather novel idea that perhaps the average dealer does not consider the effect on the customer of the service he renders. Perhaps the dealer fails to put himself in the customer's place and imagine just how the service rendered would appeal to him were he actually the customer. The average service department is prone to consider that service has been properly rendered when the set has been properly repaired. Actually, proper service has *only* been rendered when the customer has been pleased. If service is to be successful, the fixing of radio receivers, while absolutely essential, must be secondary to the main object of "fixing" the customer as well. He must lose any desire he may have felt to "throw the damn radio out the window," and decide that it is now working better than it ever did before, that the serviceman and the rest of his organization are obliging and efficient workers, and the world, after all, well worth living in.

Office workers of the service department can do much to create a strong and pleasant impression in a set owner's mind. The very first impression made when a new customer tele-

Often, not only the radio, but the customer needs fixing—Little things keep service sold—Cheap and successful ideas which make service pay a profit

phones in to have a serviceman call is extremely important. The voice of the person who answers the telephone is worth a great deal. We have consequently made sure that those who answer the telephone in our office have pleasing voices.

When our Telephone is Answered

When our telephone is answered, correct English is invariably used, by our operator and a definite appointment is made with the customer to suit his convenience always, rather than our convenience; he is asked not only for his address and telephone but also for his apartment number, business address and telephone, the make and model number of the set he uses, and what his specific complaint is. Those details are necessary to the performance of good service and they give the average customer an impression of business-like efficiency. He leaves the telephone saying to himself, "Well, *that* outfit sounds as if they knew their business." If the person who calls has called for service before, that fact—if not remembered immediately—is determined by rapid reference to the active file, which is within easy reach, before the customer has done much more than give his name. In that event no question is asked him other than about his complaint, and if he starts to give details such as type of set and equipment, or his apartment number, we reply: "Thank you, we have all that information," and he again gets an impression of business-like methods that he would not get were he asked all of the details he had given the first time he called for service.

Home Contact

The telephone procedure in the office is only the beginning of the process of making a thoroughly pleasing impression on the customer throughout the service department's business relations with him. The most important part of it is the contact made in his home by the serviceman. Our servicemen are old enough so that they don't look like high school boys. They are neatly dressed, their shoes are polished, their hands and finger nails are clean. They are intelligent, clean-cut and mature young men. Their appearance, manners, and speech instill in the customer confidence in their experience and ability. They endeavor to get more details of the com-

plaint than were given to the office by telephone, before they start to work. They carry the most modern and efficient testing equipment available and their tools and supplies are neatly arranged and always in good condition. If they find it necessary to use any tools after having made tests, they spread out a special cloth on which to lay those tools. If it is necessary to pull the chassis out of the cabinet to do soldering or other work, that is done over the cloth to avoid any possibility of injury to a fine rug or polished floor. When the work has been completed, tools are replaced in an orderly manner, a piece of slightly oiled cheese cloth is wielded to remove any finger marks from the wooden or bakelite panel, and the cabinet, if wooden, is rubbed over. The work-cloth is used and the brief polishing done whether or not the customer is present, as a matter of invariable routine.

If the chassis or the whole set must go to the shop, the serviceman first returns to his car and brings up a heavy, soft covering in which he wraps the chassis or cabinet, which minimizes the possibility of scratches or other damage and impresses the customer with the individual care accorded to his own pet radio. When the set has been repaired without the necessity of removal, or when it has been returned, hooked up, and tested after a shop job, the customer is invited to tune-in the set himself to be sure that he is satisfied with its operation before the serviceman leaves.

These points, which have utility and almost invariably impress the customer, are in themselves small things, but collectively they create an atmosphere of thoroughness and endeavor to please that is vitally important in the gaining of a customer's good will to such an extent that he is entirely willing to pay a good price for that kind of service.

They retain his good will so consistently that he will continue to be a steady customer.

Handling Complaints

Even when the owner of a radio is pleased with its performance immediately following the visit of a serviceman, the job of the service department is not yet completed. The customer must remain satisfied with the operation of that set. A month may be a reasonable interval between service calls for one type of set, and six months for another type, but whatever that length of time is, the customer must be satisfied that the intervals between service calls are not shorter than they ought to be. Always there are a small percentage of cases in which service was not properly rendered in one respect or another. As long as we deal with humans there will be just, and a few unjust, customer complaints. We urge customers on our billheads, in red ink, to do us the very great favor of complaining if they are not entirely satisfied with our service, and we ask for immediate complaint in order to permit prompt adjustment.

Many people, when not entirely satisfied with a service call, or even when actively dissatisfied, will neglect to complain in the pressure of business or other affairs, or will conclude that the service organization is no good and go to another outfit instead of allowing the first concern the opportunity of making good on their own work.

If a man has a complaint to make but does not make it immediately, or perhaps does not make it at all, his woe usually becomes magnified as time goes on. If he can be induced to complain immediately and is not argued with.

(Concluded on page 368)

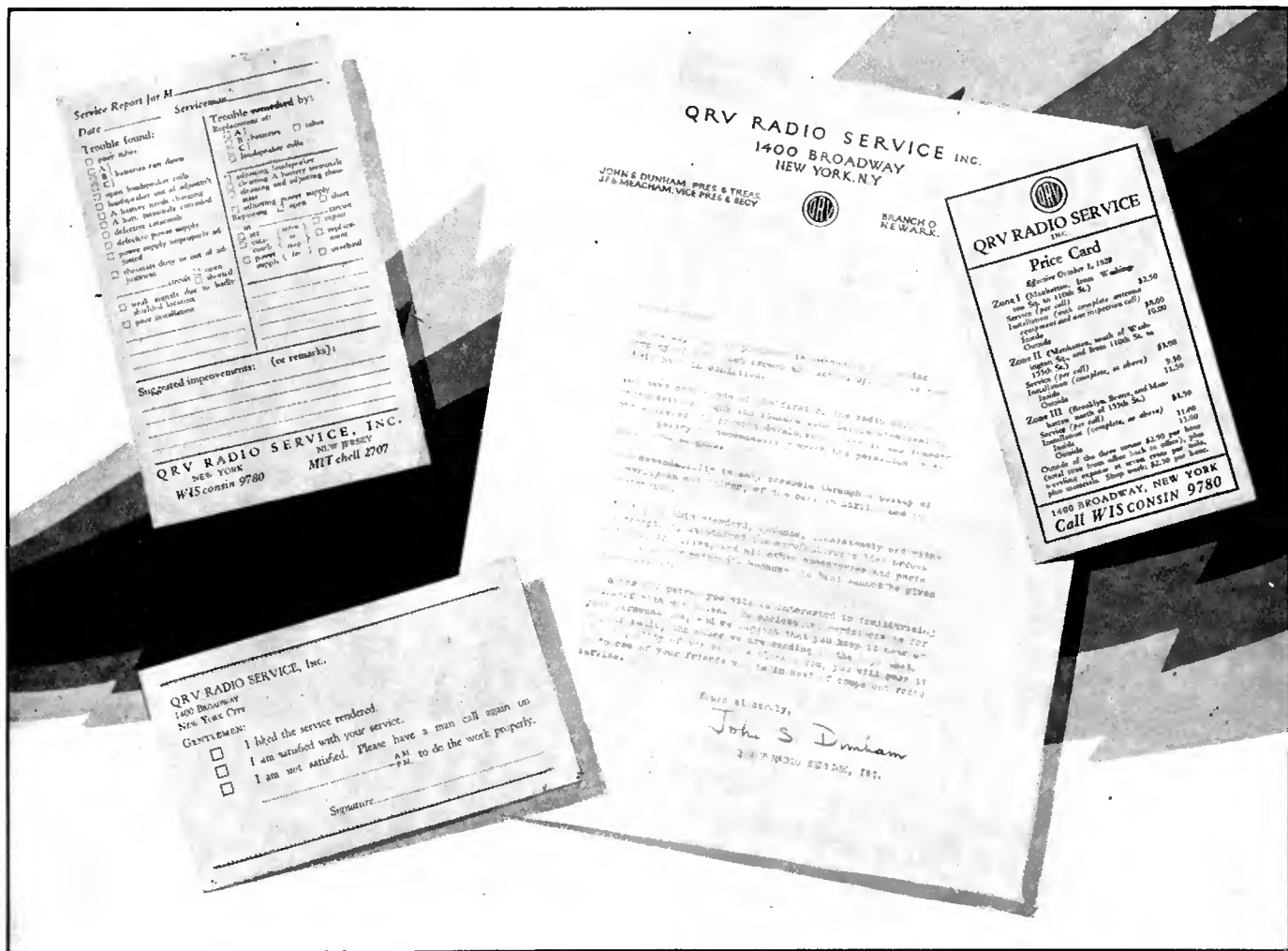

A few of the cards used by the QRV Radio Service, Inc., to build up customer good will



TESTED SALES IDEAS

These Pages Will Serve Each Month as a Clearing House For Merchandising Ideas of Proved Value Which May Be Presented in a Consise Form. This New Department of Radio Broadcast Is one Which Every Dealer Will Find of Definite Value in Making His Business Pay

Coöperative Dealer Broadcasting

St. Louis Atwater-Kent dealers, in conjunction with their local distributor, the Brown and Hall Supply Company, have begun a local program of broadcasting over KMOX and WIL. Programs last fifteen minutes, are primarily musical, and will extend over a fifteen-week period. Each dealer participating—and there are more than seventy-five—receives mention in one of the programs as joint sponsor. Twice during each program, an Atwater-Kent dealer's contest is announced with a new console model as the prize. Listeners are advised that to enter the contest and to be eligible for the prize, an entry card must be secured from their nearest dealer. Newspaper advertisements, containing a directory of dealers, are published during the run of the program. Listeners entering the contest learn that the winner of the essay contest describing what they think of the new Atwater-Kent screen-grid set will receive the prize console set. Each dealer compiles a mailing list from names of entrants in the contest, and a circular letter is sent to each entrant with which is enclosed five cards with the request that they be distributed among friends.

Sell Your Golf Clubs Receivers

An Edison dealer in Richmond, Va., sold the Westwood Golf Club in Richmond a new set, after coöperating in competitive trials. This club, one of the most popular of the



public courses in the city of Richmond, reports that members now spend more time in the club house than ever before because of the use of the radio. After the set had been installed only a week, the dealer secured two live prospects and several others are in the offing. Many clubs are already radio-equipped, but many bought sets in the heyday of battery operation and are in the market for a new set with the convenience and improved operation now possible. Sales to or-

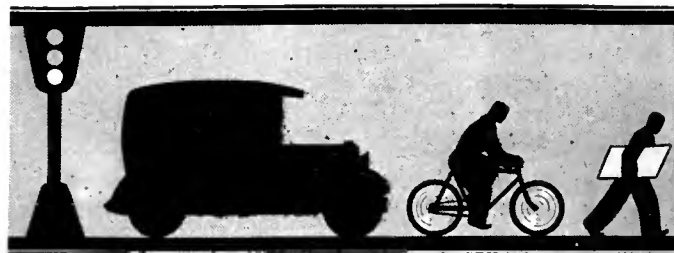

ganizations of this sort usually represent cash transactions, a pleasant thing to most dealers, but their greatest advantage is that the set they have sold is a continual advertisement of itself before a group of men whose buying power is frequently as high as any in the community.

Striking Window Demonstration

To show the dependability of the Fada receiver, we put a Model 10 on life test in our window, with suitable placards announcing the details to those who pass by. We have run this operating test considerably over 6000 hours, which as a marathon, makes Mr. Pyle's bunion derby look like a 100-yard dash. The set is still going strong without sign of set or tube failure.

—CARL ZEITLER, Zeitler Piano Company, Chicago, Illinois.



Advertising Value of Good Delivery Trucks

Some type of automobile or truck is essential to the radio dealer's equipment. Usually, this important item is selected haphazardly without a careful consideration of its utility and advertising value. The type of delivery car best suited to the needs of the radio dealer is the sedan-delivery car. It resembles in appearance a standard two-door sedan or coach, with the exception that the side windows are replaced by solid panels. In the rear of the body, there is a wide door, making the interior easily accessible. At present, this type of body is available from both Ford and Chevrolet as a stock model.

This type of vehicle has definite advantages not found in any other type of car which the radio dealer may be using. First is utility. The rear door and substantial body, as well as easy-riding qualities make the transportation of consoles and other heavy radio equipment possible without incon-





venience in loading or unloading. The second important point is appearance and advertising value. In addition to being smart in appearance, this type of car offers an ideal place to display the name and trademark of the dealer. Thirdly, there is the matter of economy. These cars cost about \$600 and are economical to run. Their bodies are weather-proof and lock more securely than does the body on the average light delivery truck.

Many dealers are content with any car, as long as it possesses four wheels and the ability to run when supplied with gasoline and a driver. Some thought expended on the value of a neat and economical delivery car should result in definite improvement in the status of dealers in their communities. Good looking delivery trucks are directly connected with increases in business.

—ALBERT R. HODGES, Providence, R. I.

Novel Window Display

My window was filled with old Atwater-Kent radio sets and a large banner across it carried this legend: "No orphans in this line." The oddity of the wording on the banner and



the variety of the sets shown attracted much attention from passers-by and showed a comfortable increase in sales at the store of the new Atwater-Kent set. It is believed that this idea is genuinely novel.

—FRANK MULDOON, Freehold, N. J.

Building a Prospect List on New Sales

We mail an attractive card to each of our present customers, bearing the headline "How to Keep Your Radio in Per-



fect Condition Without Cost." Copy on the card goes on to explain the offer which is: for every prospect name furnished by the customer which results in a bona fide sale, the



Have You a Pet Sales Idea?

These pages will be a regular feature of *Radio Broadcast* where we shall present ideas, both big and little, which are of proved service to dealers. If you have a pet sales idea, a stunt that produced results for you, tell us about it. *Radio Broadcast* will pay \$5 for each contribution used. A letter will describe the idea, a rough pencil sketch or photograph will help illustrate it and we shall do the rest. If you have a pet sales idea, send it in. Address Merchandising Editor, *Radio Broadcast*, Garden City, New York.

customer receives credit for \$5.00 which can be used in the purchase of tubes, accessories, or in payment for service. Many sales of new sets have resulted from returns of these cards.

—BOOKER'S MUSIC HOUSE, Lebanon, Pa.

Dramatizing the Uselessness of the Battery Set

Dealers in the San Francisco area cooperated in a positive sales idea on a negative subject—trade-ins. Two thousand battery sets were collected and burned outside the City Hall



in San Francisco. The fire was held on August 17th, the opening day of the Pacific Radio Exposition. A few of the best sets were donated to poor families, but all others were burned. Dealers worked together in telling the public that the sets were out of date and possessed no trade-in value.

Selling the Farmer—At the Right Time

Dealers in Iowa equipped their cars with a battery radio set and visited centers of threshing activities. The visits of the dealers were timed at the noon hour when the threshers had time to stop and listen to broadcasting, when they were in the mood to relax and hear 1929 radio reception. Farmers who too often say they are too busy to talk are overcome by visits at this time and dealers in the Des Moines area reported many new prospects lined up by this method.

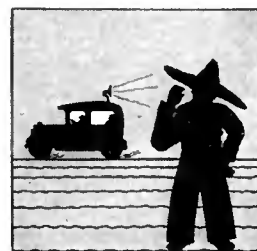



THE RADIO DEALER'S ADVERTISING DOLLAR

No advertising formula fits all dealers, for location and area served bring their own problems in deciding advertising expenditure. The dealer should estimate his gross sales in order to advertise throughout the year intelligently. Three to five per cent. of gross should be spent among all forms

HOW SHOULD the dealer expend his precious advertising dollar? Should the local newspaper receive the greatest share? Is direct mail a force that should be more widely used in helping dealers to ring dollars up on the cash register? How do the advertising problems of the rural dealer differ from those of the large city dealer? And, finally, are *all* large city dealers alike? Up to the present these important questions have been answered, if, indeed, they have been answered at all, by each dealer in his own way, and if the truth be told, manufacturers themselves have not had much really dependable information on which to base their plans for advertising help to the dealer.

Some real answers to these questions have been obtained from a survey in which more than 15,000 dealers were asked to state their experience. The dealers from whom this information was secured represented all classes, handled a wide variety of lines, and their replies were made without the knowledge that any one company was interested in whatever they might say. For the results of the survey and the information in this article, we are indebted to the Radio-Victor Corporation of America, for whom the survey was made.

The results of this tabulation of representative dealer-experience indicate the very important fact that the useful-

ness of various forms of advertising in producing returns depends on whether the dealer is a large one or a small one, and whether he is operating in a large city, small city, or in rural or suburban territory.

In using the information summarized here, the dealer must first decide into which of these classes his store fits. Having decided this, the pie charts on these pages show him at once what percentage of his total advertising expenditure should be allocated in the different classes of productive dealer advertising mediums.

How many different *productive* mediums are there? The

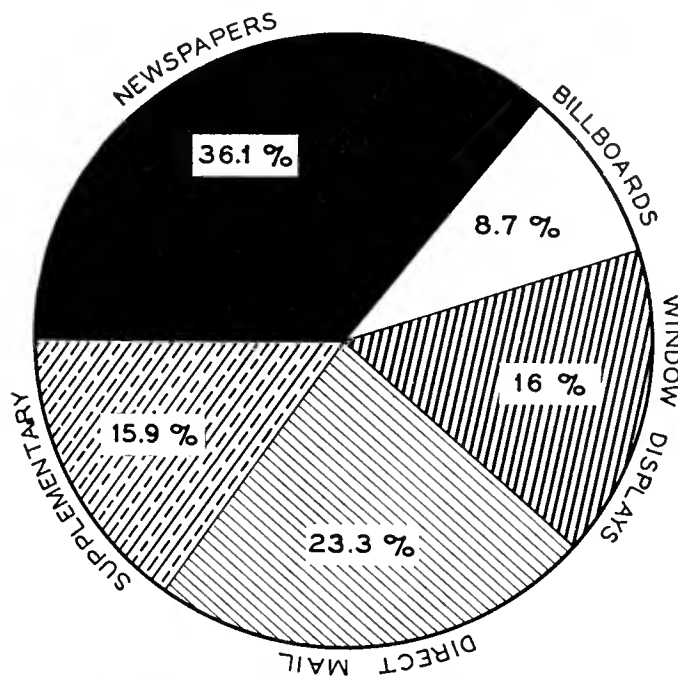

Large dealers located in strategic positions in large cities favor newspaper advertising.

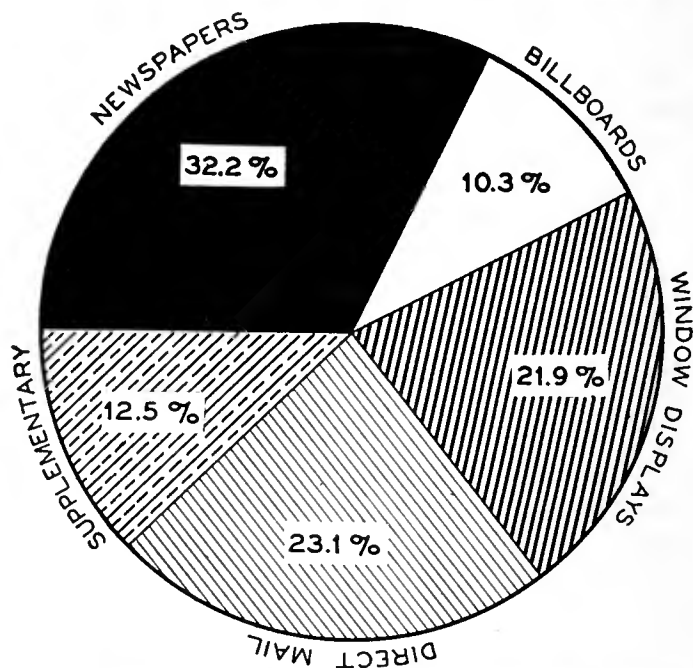

This chart indicates how dealers in small and suburban cities spend their advertising appropriation.

paragraph above suggests how the dealer's dollar should be divided, and five classes are mentioned. Let us review the purpose and value of each of these groups.

Advertising that dealers use falls into certain definite classifications as follows:

1. Newspaper advertising.
2. Billboard poster advertising.
3. Window displays.
4. Direct mail.
5. Supplementary advertising (folders, lantern slides, novelties, etc.)

The amount of money set aside for advertising should depend upon the estimated gross sales volume for the coming

year. The advertising appropriation should be from three to five per cent. of the expected gross sales, the average appropriation being about four per cent. of gross sales. If, for example, gross sales are estimated as \$25,000 then the advertising appropriation would be about \$1000. If these figures applied to a dealer operating in a small city then the charts would indicate that thirty-two per cent. or \$320 should be spent in newspapers, twelve and one half per cent. or \$125 in supplementary advertising, twenty-three per cent. or \$230 in direct mail, twenty-two per cent. or \$220 in window displays, 10.3 per cent. or \$103 in billboards. From such a distribution of his advertising appropriation the average dealer may expect the best results.

Effective advertising by a radio dealer can be expected to do five things.

1. Interest prospects in radio who have no set at present.
2. Sell new equipment to prospects whose radio is out-of-date.

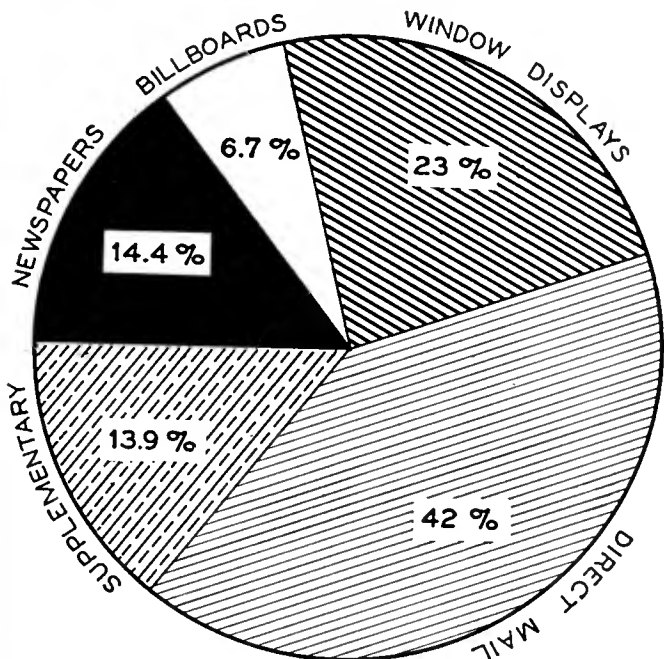

Direct-mail advertising is popular with dealers operating in outlying sections of large cities.

3. Bring prospects to your store.
4. Keep your name continually before your market.
5. Build good will and prestige for you as a radio dealer.

There are certain mental reactions through which a prospect must be led before a sale can be consummated. First, the salesman must get the prospect's attention; second, that attention must be changed to interest; third, the interest must be developed into an appreciation of the value of the merchandise; fourth, appreciation must be carried to the point where desire is created; and fifth, that desire must be generated into the action that completes the sale.

Sometimes these five steps are accomplished in an instant, but more often days and even weeks of intensive salesmanship are required. The most economical form of salesmanship, the form that no modern business ever attempts to do without, is printed salesmanship—or as it is commonly called—advertising.

Advertising and What It Does

Newspaper advertising places the dealer's selling message for a large audience at low cost per reader. It is one of the most effective means for telling a story to all types of people. Newspaper advertising can be used most economically by dealers who draw business from the entire territory in which

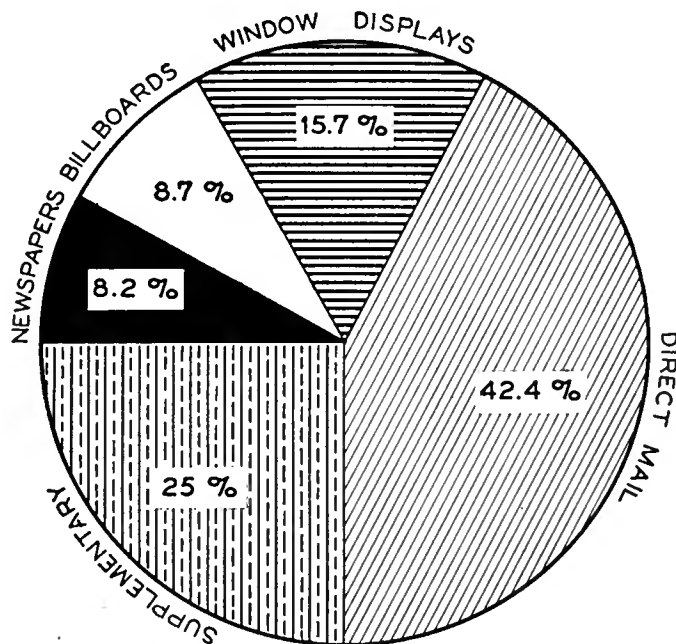

Dealers in rural territories find newspaper advertising the least effective of the five types.

the newspapers circulate. When dealers draw business from only a small portion of the territory covered by a newspaper there is considerable expensive waste circulation and some other form of advertising will usually prove more economical and effective.

Newspaper advertising will yield particularly large returns when the copy is of the announcement or special inducement type. Mention of special terms, service, demonstrations, etc., are necessary to bring prospects to a store in profitable numbers.

Window display advertising has a characteristic possessed by no other type in that it is advertising at the point of sale. A prospect sees something in the window that attracts his attention—interests him, and without undue effort he walks into the store. It has been estimated that the entire population of a town or shopping section pass the store window of a dealer located on a main street within one week.

Large stores whose windows dominate the street find the merchandising display card of great value while dealers with smaller windows find the attention-getting colorful cards more effective.

Billboard posters serve well as reminder advertising to those who read as they run. The poster's particular advantage lies in the portrayal of merchandise in brilliant color and in a most impressive manner. They display your message before people who do not read newspapers, and get your story across the second time to those who do.

The effectiveness of poster advertising depends upon location. Two factors govern good location: its value as measured by pedestrians and vehicular traffic and its position in relation to clear visibility and readability by this traffic. Unless both factors are satisfactory to a dealer a particular location should not be accepted.

Direct-mail advertising as a means of increasing business is of exceptional value in that it is the only form in which the advertising messages can be directed to specific prospects. With this form of advertising you can select definitely the prospects you want to reach with a direct-mail campaign consisting of a number of units. You are assured of getting the full cumulative value of advertising because each advertisement reaches the same prospect.

(Concluded on page 368)

The MARCH

The Problem of Reducing Prices
How Distribution Costs Can be Lowered

How About The Place of the Jobber?

THE AVERAGE purchaser of a radio receiver is usually amazed if he learns that more than half his expenditure is devoted to meeting the cost of distribution. He is even more startled if he discovers that the cost of production of a radio receiver is rarely more than one fifth of its list price. From this, he concludes that the radio industry is blessed with the most inefficient system of distribution imaginable. Actually, practically any specialty product sold to the consumer is as expensive to distribute as radio.

It is impossible to assign average percentages, showing how the consumer's dollar in radio is spent. This is due to the fact that the actual expenditure per receiver for materials and labor fluctuates between wide limits, depending upon how widely the cost of research and tooling up is spread, the percentage of efficiency in utilizing manufacturing facilities, and how successfully the effects of over-production are avoided. For example, a plant with a capacity of 100,000 receivers, utilized to only fifty per cent. of its maximum capacity, has a materially higher cost per set than one operating at one hundred per cent. of capacity. These and many other factors vary greatly, not only among different manufacturers, but season by season with each manufacturer. In general, the substantial reductions in the cost of radio receivers to the consumer have been effected almost entirely through manufacturing economies, and not through increased efficiency of the distribution system.

Over and above the cost of production, the manufacturer meets a substantial national advertising expense, contributes to better broadcasting, pays considerable amounts for royalty, development, and research. Usually the goods pass from the manufacturer to the jobber and from jobber to dealer.

A vital question to the industry is to discover ways that savings may be effected in order to make possible a still further lowering of prices and a consequent broadening of the sales opportunity. Most efforts to reduce selling costs are aimed at the elimination of the jobber or finding some substitute for him. Radio is hardly a perishable product, yet the radio jobber shows little tendency to stock goods. Too often, he chooses chiefly to watch the credit of the individual dealer. He sells when consumer demand is built up by the manufacturer's efforts. Otherwise he may pronounce the line a flop and concentrate on something else.

The jobber's function appears to be easily assumed by the manufacturer and, as a consequence, many have tried the experiment of establishing their own distribution branches at principal centers or distributing through a jobbing house in which they have an interest. But, as in the automotive industry, the jobber is found more or less essential to distribution.

Practically every automobile manufacturer has sought to elimin-

ate the jobber by establishing manufacturer's branches but, in general, this has not been found profitable. Manufacturers could not make branch managers apply the same selling zeal and the same watchfulness of the manufacturer's interests as a jobber whose profits are automatically measured by his ability. When the difficulty of finding suitable representatives is successfully solved, then the factory finds that the cost of maintaining factory branches about equals that of selling direct to the jobber, while the manufacturer's responsibility is considerably increased. Furthermore, automobiles are delivered to dealers with sight draft attached to the bill of lading, so that there is no important credit function involved as in the case of the radio jobber.

The only prospect of economies through the elimination of the jobber is, therefore, the absorption of the jobber's profits by the manufacturer, either through ownership of the jobbing business or the assumption of the jobber's function. This represents little or no saving to the consumer because the increased risk, investment, and organization required under such a plan makes additional profit to the manufacturer essential.

How Can the Dealer's Position Be Improved?

ONLY THE dealer, then, seems a prospect for cutting distribution costs. Anyone who has studied the financial position of the average dealer is convinced that forty per cent. is the minimum with which he may do business. This is not due to the fact that forty per cent. is too small a margin per sale, but because of the seasonal character of the radio business, service costs, end-season dumping and price-cutting, which tend to dissipate the profits made during the more active months.

The fortunes of the radio dealer cannot be judged on the basis of outstanding successes. It is the case of the average dealer which we must consider. The discounts extended to him, when stated in percentage, are large, but, when gross margin with the average annual turnover is considered, it becomes obvious that the discounts cannot be materially reduced in the search for lowered costs.

The solution, in our opinion, lies in altering the radio dealer's function. Fundamental changes are gradually taking place, leading to the development of a specialty retail store with radio as the most important and major item of sale, but not dependent solely upon the radio industry for its profits. Experience will gradually evolve a better combination of items which will increase turnover and gross sales without requiring additional personnel, space, selling expense, or materially increased capital over that at present invested by the radio dealer. Such combinations as radio with electrical refrigeration, home motion pictures, electrical appliances, phonographs and records, sporting goods, toys, and automotive accessories are among the many possibilities.

The day is passing when the radio dealer must be a tech-

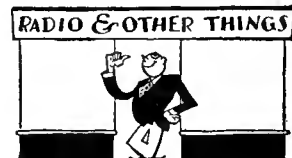
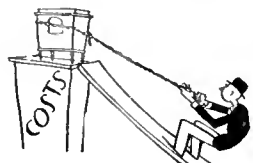
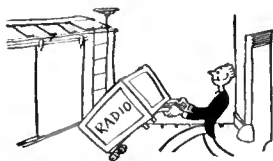

OF RADIO

The Radio Commission's Vacation
Federal Court Upholds the Radio Act

nically trained specialist of such a high order that he cannot be expected to possess other special knowledge. Nor is the day far distant when no installation of any kind will be required to make the radio set function other than plugging it into the light socket. Antenna and ground will not require separate connections because both of these will be obtained through the power line or otherwise. Service is already a decreasing problem and, compared with the day that storage batteries had to be charged and "B" batteries renewed, it has become negligible.

Aside from reducing cost of manufacture, the most effective attack on reducing cost to the consumer is by making the lot of the dealer more profitable and more stable. The present position of the industry, with its large dealer discount, is peculiarly unsatisfactory to all parties. The solution does not lie in larger discounts but in an improvement in retail distribution to insure greater profits with smaller discounts. The function of the radio dealer as a whole is uneconomic because he works at full efficiency only a small fraction of the year. It is needless to say that there are numerous exceptions and that many dealers are making substantial and regular profits. The exceptions do not alter the facts. The important point is that the general level of prosperity of the radio dealer must be improved by making him work efficiently at all seasons and turn in a profit at the end of every month.

A Medal for Commissioner Lafount

WHILE VACATIONING at Grafton, W. Va., Judge Ira E. Robinson, Chairman of the Federal Radio Commission, stated in an address before the Grafton Rotary Club that he had fought a hard battle in order "that radio will always be preserved for the common use and not for the gain of powerful combines. . . I have fought all along for the people's rights as against the demands of the R. C. A. and other companies that would take complete charge of the nation's air channels for commercial uses."

Even when he is resting, the doughty commissioner has his hatchet ready! The only question which is unanswered is whether, in opposing the Radio Corporation, the commissioner is not taking a stand against the ultimate welfare of the nation. Decentralized and competitive communications are bound to be inefficient and costly. The attempt to make communications highly competitive means nothing less than a complete surrender of American solidarity in the spirited international competition for independent worldwide systems of communication.

But it is not hard to understand the commissioner's hesitation in trusting the future of communications to a single group of capital. Our legislators, however, have been able to permit monopolistic operation of other quasi-public functions, such as railroads, telephones, and power systems, by establishing suitable regulation. Would it not be more to the interests of the people at large to permit the continued growth and building up of an efficient and unified interna-

tional communications system and, by suitable regulation, to prevent the monopolistic communication organization, built up under its control, from misapplying its great powers?

While Commissioner Robinson was thus theorizing at home, Harry A. Lafount visited every corner of his extensive fifth zone. He conferred with 276 individuals representing broadcasting stations, 16 desiring construction permits for 31 new stations, 29 representatives of chambers of commerce, 118 spokesmen for listeners' clubs from 19 cities, 172 persons pleading for public or private companies using radio for communication purposes, 27 who want to use radio for private message transmission, 16 amateurs, and the representatives of air transport companies at 16 airports.

Through this active and conscientious study on the ground of conditions within his zone, Commissioner Lafount is thoroughly conversant with the problems as they exist among broadcast listeners and the various fields of communication, including the newest and potentially one of the greatest, aircraft communications.

Commissioner Starbuck spent considerable time on aircraft allocations, held conferences in Washington with short-wave experts and representatives of the air transport companies, and prepared reports and conclusions.

Commissioner Saltzman and Commissioner Sykes were not heard from, presumably because they did not address the chambers of commerce in their home cities. They, doubtless, did not dismiss radio from their considerations during the months of relief from Washington hearings.

We take this occasion to pin an imaginary, but none the less genuine, medal upon the breast of Commissioner Lafount for his conspicuous and outstanding conscientiousness which is only too little appreciated by the radio public and the radio industry which it supports. There is no more thankless job than that of being Federal Radio Commissioner and Commissioner Lafount's devotion to his task is worthy of the utmost public commendation. We have no hesitation in saying that we greatly admire and appreciate his efforts.

The Courts Strengthen Commission's Position

ALTHOUGH IT has not received much attention in the press, the decision of Federal Judge Wilkerson, of Chicago, granting an injunction against the American Bond & Mortgage Company, applied for by the Federal Government to restrain that company from operating station WOK without a license, is a broad and substantial upholding of the Radio Act. The decision not only affirms the Federal Radio Commission's control over broadcasting and its powers to close down stations without violation of the Fifth Amendment of the Constitution, regarding property rights, but it is a most scholarly and studied opinion. Judge Wilkerson fully understood the problem and set forth all the important points bearing on the situation of federal regulation of broadcasting in this masterly decision.—E. H. F.

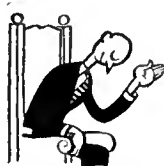

PROFESSIONALLY



SPEAKING

WE STILL HAVE GROWING PAINS

THE RADIO INDUSTRY congratulates itself that it is no longer a boy's experiment—it is a man's business. It says it has graduated from the realm of home-made radio into that of standardized quantity production. The industry would have us believe that radio engineering is in a state of almost zero excitement; that as fast as new developments come along they are assimilated by set designers. But we are of the opinion that radio engineering continues to suffer from growing pains.

We shall not mention the fiasco of a.c. tubes and receivers put into hurried production in 1927; but now that the screen-grid tube is here let us look the situation in the face calmly before other new tubes make their appearance.

It may be a fact that set designers have their business organized so well that once a receiver is turned over to the production department, they can look forward to another year's receiver—but visits to prominent set manufacturers disclose the fact that too many engineers are design men part of the year and production men the rest. There is too little time to sit down and think. It may be a fact that tube engineers know pretty well how to add another element to a tube, how to make machinery to speed up the production of a new tube, but our impression gained from walking the long aisles in tube plants is that the tube engineer is always too near the day when a new tube is actually needed by the sales force. There is too little time to work on a new project; too little time to experiment.

There is still a greater source of trouble in the present set-up. It is the lack of liaison between set engineers and tube engineers.

This lack of liaison is aptly illustrated by the present screen-grid rage. In May a prominent manufacturer of receivers announced that he would make screen-grid sets to meet the demand of those who liked to experiment and to try out things, but he hesitated to recommend or promote the sale of anything until it had been thoroughly proved. The announcement concluded with the statement that although the screen-grid set which had been developed was equal to any other set about to be put on the market, it was little or no better than a receiver constructed on older principles using three-element tubes.

In July, a well-known manufacturer told us that of the many screen-grid sets sent into the field, nearly all, sooner or later, got into trouble. The difficulty is one of tubes rather than one of circuit. Some sets of tubes work properly; others work very poorly. Some tubes "paralyze" when the volume control is varied, and the ordinary tube tests do not show up what is wrong. Apparently the trouble is gas or secondary emission which changes the characteristics of the tube when the volume control reduces the plate current.

In August, the Research Division of RADIO BROADCAST got in touch with many representative dealers, asking them "What effect will screen-grid radio have on set sales?"

Some dealers felt it would have no effect; others thought that 90 per cent. of their sales would be of the new type. The consensus was that about half of this year's sales will be screen-grid sets.

This is interesting. But the note of warning and hesitation that was in nearly every reply is more impressive. One dealer crystallized the general feeling by stating "We will endeavor to push sets that do not have screen-grid tubes. We have tried eight different makes of tubes and found that only a very small percentage of screen-grid tubes will function properly. The sets themselves operate very effectively when proper tubes are installed but the service problem will be tremendous."

Why, may we ask, did not the set engineers and the tube engineers find out this potential grief before so many sets got into the field?

The matter is put succinctly by Ernest Kauer, president of the CeCo Manufacturing Company.

"There is too little preliminary contact between tube and set engineers. The ideal condition will be when the two branches of engineers consult together in advance of a desired development; define their problem together and work to meet it together. Just as a set can be no better than the tubes that are in it, by the same standard the tubes cannot give their full value if the set engineering fails to utilize the tube's characteristics."

So long as tube engineers do not get together with set engineers, the public must pay for the early days of experimenting. We have long advocated that every tube plant should be equipped with a well-trained circuit engineer; we must add that every set plant should have a good tube engineer on its staff. The difficulty, probably, is to find the required engineers.

FEATURES FOR 1930 RECEIVERS

WILL 1930 be a remote-control year? At the present moment there is no single feature in sight for next year which equals the screen-grid tube as a new talking point. The manufacturing department and the engineering department of radio plants are thankful for this; by the same token the publicity department and the sales department are worried. No new gadget to sell!

Controlling a radio receiver from a distance seems to be the predominantly recurring thought in most receiver engineers' minds to-day. As one engineer-president puts it, "Remote control removes the talking point from radio and projects it into the realm of mechanics."

We have seen several of these remote-control mechanisms and we have the same awe and respect for them that a mechanical engineer has for an intricate radio circuit. One such device has a time clock attachment which enables the user to pretune his entire evening's entertainment. By punching a series of buttons, or setting a series of levers, his radio will be tuned automatically to the Red network at 8:00 o'clock, to the Blue at 9:00, to another station or back to the

(Concluded on page 368)

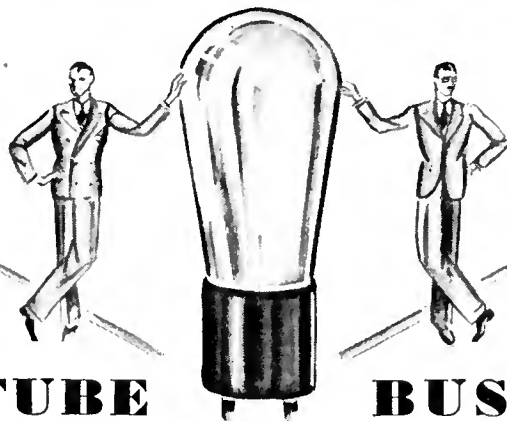

THE TUBE BUSINESS

FINANCIAL NOTES

SONATRON TUBE earned \$3.29 per share in year ending March 31 compared to 71 cents a year ago. Pilot net sales for the first six months of 1929 amounted to \$706,399 compared with \$552,110 for the same period of 1928, a gain of approximately 27 per cent. A stock issue of 38,000 shares of no par value common stock of the Hly-Vac Radio Tube Co., Newark, has been decided upon. The outstanding capitalization upon completion of this financing will consist solely of 125,000 shares.

PRODUCTION NOTES

PRODUCTION OF Speed (Cable Radio Tube) tubes has been speeded up to 25,000 daily, 15,000 a.c. and 10,000 d.c. tubes. A plant has been acquired to produce tools and parts needed for the manufacture of tubes. Altogether 47,000 square feet of floor space are devoted to Speed production.

An entire unit of the new Arcturus plant (we have seen it and it is a beauty) is being devoted to the manufacture of 180-type rectifier tubes.

Marvin is operating six tube plants in an effort to satisfy the demands of Marvin jobbers. No tubes are being sold to set manufacturers—all go through normal distribution channels.

CeCo is confining the activities of its old plant to the production of screen-grid tubes only. The daily output is 10,000. The new plant (four acres) will have a capacity of 35,000 daily by mid-August and 45,000 by mid-October. It produces all types except screen-grid tubes.

A new Sonatron plant is coming into full production of screen-grid tubes. It will have a total capacity of some 40,000 tubes of this type a day.

REGARDING QUICKER HEATING

WE QUOTE the following letter from Allen B. DuMont, Chief Engineer of DeForest:

"Quick heating in a.c. tubes is no longer a deep mystery. There are several ways of achieving this desired end. However, to make a tube heat quickly, operate quietly, and live a long time, is quite another story.

Many methods resorted to in obtaining quick heating are not sound. The desired end is obtained at the sacrifice of mechanical and electrical strength, as well as the span of useful life. The elimination of the insulating tube in the heater

cathode, for instance, makes for quick heating. But it also makes for a weaker mechanical construction, and paves the way for short-circuited tubes even with normal handling. The practice of overloading the heater wire makes for quicker heating, but also for shortened life. The use of less insulating material without compensating such reduction by using a stronger material makes for quicker heating but also for a weaker tube.

No one can deny the need for quicker heating. However, I hope that the industry will not run a race on heating time at the expense of the more important factors involved. Also, let us not forget that in many of our quick-heating tubes we are rapidly approaching the heating time of the -45 power tube and the -80 rectifier, so that nothing can be gained by faster heaters."

EIGHT TUBE MAKERS BROADCAST

PEOPLE WORRIED a lot in the early days of broadcasting about who was to pay the bills. The following table of tube manufacturers who take time on the air shows how the tube business contributes toward broadcasting maintenance:

TUBE MANUFACTURER	DAY	HOOR	NETWORK
Sonatron	Sunday	8:30 P. M.	Columbia
DeForest	Sunday	10:00 "	Columbia
CeCo	Monday	8:30 "	Columbia
Ken-Rad	Monday	10:00 "	wjz chain
Eveready	Tuesday	9:00 "	WEAF chain
Sylvania	Wednesday	8:30 "	wjz chain
Triad	Friday	8:00 "	wjz chain
Marvin	Saturday	8:30 "	wjz chain

A NEW FILAMENT METAL

A SAVING of \$250,000 a month in the manufacture of radio tubes has been effected by the development by Westinghouse engineers of Konel, a new metal useful for filaments. This metal is a substitute for platinum and costs but a few

dollars a pound compared to \$180 an ounce for the rare white metal. The life of filaments using this new metal is approximately ten times as long as that of other filaments; they produce the same emission but at a temperature 175 degrees colder. The new metal is harder to forge than steel and is very tough at high temperatures where most metals lose their strength.

SELLING S. G. SETS

A WHOLESALER in Newark, N. J. sends us the following instance of how screen-grid sets are sold—sometimes. He actually witnessed this sale.

Customer to dealer: "Well, has this set a screen grid?"

Dealer to customer: "Oh, yes, Madam, here is the screen," pointing to the covering over loud speaker, "and the grid is inside."

NEWS FROM SYLVANIA

FROM our friend Monte Sohn of Pickard Sohn (who writes the good-looking Sylvania copy) comes the news that a half-million Sylvania listeners prefer the classics and old-time songs to jazz. This note is prefaced by the remark that "I think this vastly better than the conventional literary contribution as to who is the biggest manufacturer of radio tubes, who has the most millions of acres of floor space, and whose officials think the radio industry is enjoying prosperity."

We agree heartily with Mr. Sohn. We have been compiling, recently, a table of "discounts." It started when we went through two radio factories. In one the chief engineer said he was turning out 200 sets a day, and in another plant the number of dealers was slated to be 1500. On returning to the office, we discovered press releases stating that the first manufacturer had a daily output in excess of 1000 sets,

and the second had 3000 dealers. Evidently the discount figure on daily set production is about 5 to 1 and on dealers is about 2 to 1. We are attempting to find out by what amount to discount the extraordinary tales of daily tube production with which we are flooded.

Incidentally, the hard-looking gang at the bottom of the page is the Sylvania Foresters who may be—and are—heard from wjz's chain on Wednesdays at 8:30 p.m. New York time.

Come again, Mr. Sohn.



The Sylvania Foresters in Action

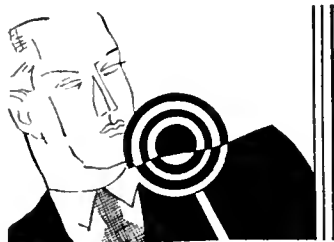

RADIO

New Merchandising and Other Services by R.M.A.

Several new services to radio manufacturers and expansion of other services to R.M.A. members and the industry generally have been ordered by the Board of Directors of the Radio Manufacturers Association. The R.M.A. Board provided for new and comprehensive merchandising service, and enlargement of its engineering, traffic, legislative information, patent, and other services.

The Merchandising Department, in charge of Major H. H. Frost of New York, chairman of the R.M.A. Merchandising Committee, and William Alley, merchandising manager, was authorized by the Board of Directors to launch at once the new merchandising service for manufacturers, and approved an extensive program recommended by the Committee. Efforts will be made immediately to guard against any possible prospect of over-production of radio products, particularly during the next few months. Strictly within the limitations and in observance of the law, the Merchandising Department will recommend to manufacturers that their production schedules be checked against the present and prospective future orders, to guard against undue expansion.

The R.M.A. Engineering Service, under the direction of Walter E. Holland, new Director of Engineering, also will be extended and reorganized.

For the public and in support of broadcasting also, the Board of Directors decided to undertake to present another series of special R.M.A. programs this fall, to be contributed by various manufacturers, and broadcast on national chains. This enterprise will be in charge of B. G. Erskine, of Emporium, Pa., Chairman of the R.M.A. Broadcasting Committee. It follows the successful series of nearly a score of R.M.A. programs presented last spring.

Research at Temple

A visit to the new Temple factory in the Chicago Clearing district disclosed, under the guidance of Paul Andres, chief engineer and vice-president, the amazing fact that complete laboratories are established and working at full steam for all the major departments of radio engineering. Such departments, each under the guidance of an expert, are audio frequency design, radio frequency design, loud speaker design, production tests methods, over-all receiver measurements, mathematical research, research into raw products, etc. In each of these laboratories was a group of men measuring everything that entered—or which would ever enter—a Temple product. In the words of "Prof" Andres, Temple is building heavily on future security, and security does not lie in following what someone has already done.

New Jensen Plant Built in Record-Breaking Time



The picture above shows the Jensen Radio Manufacturing Company's plant in the Clearing Industrial district at Chicago as it appears with the completion of the new unit which was built in record-breaking time. Less than a month elapsed from the time ground was broken for the foundations until the installation of machinery and equipment was started. The Jensen plant is now a city block long and measures 140 feet deep, providing over 60,000 square feet of manufacturing floor

space. It is said to be the largest single factory in the world devoted exclusively to the manufacture of loud speakers and reproducers.

In the foreground of the picture is the Jensen day shift numbering approximately 600 employees.

Switch tracks of the Chicago Belt Railroad which run directly into the building for the loading and unloading of factory output and materials enter at the rear of the structure.

Less Income for R. C. A.

The recent quarterly financial statement of the Radio Corporation of America shows a smaller income than that reported for the previous quarter. For the first half year, earnings are estimated at 35.2 cents per share on 6,526,000 common shares and amounted to \$1,996,187 available for dividends.

In the past, the first half has been the least profitable for the R. C. A. The second quarter of 1929 is the most unfavorable for some years. Net earnings for the June quarter were \$1,409,299 against \$3,587,188 earned in the March quarter. Accurate comparisons with former years cannot be made because the two quarterly reports of this year include operations of the Victor Talking Machine Company which was merged with R. C. A. at the start of the year. A tabulation of earnings follows:

	2nd qtr. 1929	1st half 1929
Gross income . . .	\$28,796,766	\$60,439,593
Expenses, etc. . .	27,387,467	55,443,106
	1,409,299	4,996,487

The balance remaining, after preferred dividend requirements are met, for the second quarter is \$58,896, and \$2,295,682 or 35.2 cents a share on the common shares outstanding.

Kolster In Germany

Ellery W. Stone, president of the Kolster Radio Corporation, announced recently that an agreement had been signed in Berlin between Kolster-Brandes Limited and Telephonfabrik Berliner Aktiengesellschaft, of Berlin, for the manufacture and sale of Kolster and Brandes models in Germany.

Under the proposed plan the radio division of Telephonfabrik Berliner Aktiengesellschaft, one of the oldest telephone and radio companies in Germany, will be merged with Kolster-Brandes' German operations. In the future, the Kolster-Brandes receivers will be manufactured in the factories of Telephonfabrik Berliner Aktiengesellschaft in Berlin and Hanover, and will be sold in Germany by a company to be known as Kolster-Brandes Tefag. Control of the latter company will be held by Kolster-Brandes Limited, but there will be no public offering of the minority stock, since it will be subscribed for by Telephonfabrik Berliner Aktiengesellschaft.

"The arrangements with Telephonfabrik Berliner," said Mr. Stone, "will permit Kolster-Brandes Limited to avoid the German duties on Kolster-Brandes models imported from our British plants. In addition, Kolster-Brandes Limited will secure the benefit of the strong radio patent situation which Telephonfabrik Berliner now holds in Germany.

East Battles West for Next Trade Show

Whether the RMA trade show will be held in New York City, Atlantic City, some other Eastern city, or returned to Chicago is providing spirited conversation for the entire radio industry.

So aggressive has become inter-city competition for this major industrial event, that Jess Hawley, vice-president of United Reproducers Corp. and chairman of the R.M.A. show committee, is now engaged in personally inspecting the facilities which each competing city has to offer.

At the conclusion of a visit to Atlantic City in August, Mr. Hawley said that he had not reached a definite conclusion.

Kansas City Radio Show

The Kansas City Electrical and Trade Show will be held in Convention Hall during the week September 21 to 28. Sam Furst is trade show manager and reports that all 80 booths and 14 demonstration booths have been sold.

Chicago Radio Show

The Chicago Radio Show will be held this year from October 21 to 27 at the Coliseum. It is held, as usual, under the auspices of R.M.A. and managed by G. Clayton Irwin, Jr. Raw products manufacturers will be represented at the public show for the first time this year.

C. R. Leutz, Inc. to Move

C. R. Leutz, Inc., manufacturers of "Phantom" and "Silver Ghost" receivers, for many years located in Long Island City, are removing their manufacturing plant to Altoona, Pa. A New York sales and executive office will shortly be established. It is planned to increase the sales of Leutz sets by general advertising, and different distribution methods.

Personal Notes

The thousands of friends of B. G. Erskine, president of the Sylvania Products Company, who make Sylvania Radio Tubes, will be delighted to learn that he is once more back on the job and almost completely restored to health.

Mr. Erskine was stricken with a bad cold in Buffalo on April 27, and this developed into pneumonia.

George H. Kiley, a director of R.M.A. of New York, presented his resignation because of his new connection with Radio-Victor. The Board elected Leslie F. Muter of Chicago as his successor. Mr. Kiley also was compelled to resign as Chairman of the Foreign Trades Committee and was succeeded by H. H. Pollock of New York. Mr. Muter was elected Chairman of the Credit Committee to succeed Donald MacGregor of Chicago who resigned.

W. F. McAuliffe, who has been a member of the Kolster Radio merchandising division since 1925 and stationed at times on both the Pacific and Atlantic coasts, has been appointed assistant to the executive vice-president, St. G. Lalitte. Mr. Lalitte and Mr. McAuliffe have their offices at 39 Broadway, New York.

An official of the Temple Corporation, A. J. Bovier, traffic manager, has been appointed as a member of the traffic committee of the Radio Manufacturers Association. The appointment has just been announced by R.M.A.

F. C. Scrimsher, who recently joined the Ken-Rad Corporation as special sales representative, has been assigned to the Southeastern territory. Under this plan he will serve jobbers of Ken-Rad tubes in

Reorganization of Daven Corp. Complete

The Daven Corporation has been reorganized, having been through receivership proceedings. The new concern is known as the Daven Company. Lewis Newman is the new president. The Daven Company has purchased stock on hand, trade name, good will, and manufacturing equipment of the former company. The address remains as before, 158 Summitt Street, Newark, N. J.

The Daven Company now is doing approximately 65 per cent. of its business directly with manufacturers and the remainder is jobber trade. Products made are tubes, resistors, voltage dividers, grid leaks, etc.

New Michigan Short Wave Law

A new law in Michigan provides a fine of \$1,000, imprisonment for six months, or both, for equipping or using an automobile with a short-wave receiver unless the car is used and owned by a police officer or a police permit has been granted. The law is intended to prevent unauthorized receipt of police broadcast warnings.

Virginia, North and South Carolina, Tennessee, Georgia, Florida, Alabama, Mississippi, and Louisiana. Before his connection with Ken-Rad, Mr. Scrimsher was for years associated with the automotive industry and has a wide acquaintance among jobbers throughout the country.

Dr. O. E. Brown, eminent mathematician on the faculty of Northwestern University for the last five years, who has just received his Doctor of Philosophy degree at the University of Chicago, has joined the research staff of the Temple Corporation.

His duties will consist of a mathematical analysis of circuits and research work from a purely technical angle to determine ideal circuits and their constancy, in which work he will be assisted by J. Swallow and a group of practical radio engineers.

A. Crossley, formerly of the Bureau of Standards and lately chief engineer of the Steinite Radio Company, has joined the Howard Radio Company, of Chicago and South Haven, Michigan, as chief engineer.

H. Bobker, whose name is well known in radio tube circles, is now associated with the Triad Manufacturing Company, makers of Triad tubes of Pawtucket, R. I.

Howard W. Sams has just been appointed director of territorial sales for Silver-Marshall, Inc., Chicago. He resigned as New York district sales manager of E. T. Cunningham, Inc., to accept the new position, which makes him McMurdo Silver's personal sales representative throughout the United States.

Sparton Demonstrate Utility of Airplanes



Coöperating with the Jackson, Michigan, Chamber of Commerce in its aggressive program of aviation promotion, the Sparks-Withington Company of that city have arranged an interesting demonstration of the handling of heavy merchandise by airplane. This year's program is a "State to State Tour" by members of the aviation committee of the Chamber of

Commerce, the tour including capitals of states. Accompanying the tour the plane "Sparton" will carry a Sparton Radio receiver to each capital for presentation to the governor of the state. After the presentation a new instrument will be taken aboard from the local distributor's warehouse, and this in turn transported to the capital of the next state.

Grigsby Forms British Subsidiary

The Grigsby-Grunow Company, makers of Majestic all-electric radio sets, is forming an English subsidiary, according to William C. Grunow, vice-president of the company. B. J. Grigsby, president of the concern, is in England relative to the formation of the Grigsby-Grunow, Ltd., he said.

"Plant sites are being selected and within the next few months the English company will be in quantity production," he declared.

England and the Continent, in the opinion of Mr. Grunow, are six years behind America in the utilization of radio sets.

Bosch Users Report

For some time, American Bosch has put customer questionnaires in their sets. They asked for helpful criticism. Bosch owners have used them and sometimes write long letters going into detail. An analysis of the returned questionnaires indicates how Bosch customers classify the desirable features of the set. The analysis:

Tone	18.7%
Volume	17.3
Appearance	16.8
Distance	14.2
Operating Simplicity	16.4

News of Patent Suits

No. 1,173,079, E. F. Alexanderson, Selective tuning system; 1,195,632, W. C. White, Circuit connections of electron-discharge apparatus; 1,231,764, F. Lowenstein, Telephone relay; 1,251,377, A. W. Hull, Method of obtaining constant direct-current potentials; 1,426,754, R. S. Mathes, Circuits for electron-discharge devices, appeal filed January 4, 1929, C. C. A., 3d Cir. Doc. 4027, Shamrock Mfg. Co. v. Radio Corporation of America.

No. 1,266,988, Pridham & Jensen, Amplifying receiver; 1,448,279, 1,579,392, same, Electrodynamical receiver, filed April 30, 1929, D. C. E. D., Pa., Doc. 5029, The Magnavox Co., v. Atwater-Kent Mfg. Co.

Recently Issued Patents

No. 1,724,191, Combined Radio Receiver and Phonograph Reproducer and Recorder. Alfred N. Goldsmith, New York, N. Y., assignor to Radio Corporation of America. Filed June 12, 1925.

No. 1,724,399, High-Frequency Transformer. Harold F. Elliott, Palo Alto, Calif., assignor, by direct and mesne assignments, to Victor Talking Machine Company, Camden, N. J., Filed September 17, 1927.

No. 1,724,819, Method and Means for Reducing Retroactive Currents in Audion Amplifiers. Stuart Ballantine, White Haven, Pa., assignor to Radio Frequency Laboratories, Inc., Boonton, N. J., Filed June 2, 1925.

New Location for Steelman

Stelman, Inc., exclusive Fada wholesalers in New York City have moved from 24 Murray Street to 235 Fourth Avenue.

President's Message

By Michael Ert

President, Federated Radio Trade Ass'n.

The officers of the Federated Radio Trade Association wish to take this opportunity to extend to every radio tradesman, a welcome to participate in the activities of our Association and its affiliated groups.

In order that the general conditions within the industry may be improved, the Federated Radio Trade Association has built itself as a national organization of associations engaged in the development of the radio industry.

It has as its prime purpose, the encouragement of friendliness and cooperation between all branches of the industry in the great battle for the consumers' dollars. It constantly watches Federal, State, and local legislation so that any legislative acts will not be detrimental or hamper the progress of the industry, but rather that all acts will be for its betterment and advance.

In a series of articles throughout the coming year we will outline the various activities that might be engaged in by radio trade associations to a profitable advantage. Many unbusiness-like practices in the trade can be eliminated through joint cooperation and we appeal to you to cooperate with our organization in attempting to bring about greater stabilization in the industry and better conditions for all concerned.

News of the F.R.T.A.

It is vitally necessary in an industry as new as radio that all members of the trade cooperate in eliminating evils which arise. It is the belief of the officers of the Federated Radio Trade Association that the best and quickest way to stabilize the industry and eliminate the practices which are eating at the core of the industry is to form local associations in every city and municipality, teaching in this way cooperation by the manufacturers, wholesalers, retailers, and the consumer.

The Federated Radio Trade Association issued a book, *How to Organize a Local Radio Trade Association*. This book emphasizes the requirements for a local radio body and lists the more common organization errors. Among the subjects covered are initial meetings, constitution and by-laws, officers and board of directors, dues, meetings, committees, incorporation, and legal counsel. Model constitution and by-laws are provided, suitable for adaption to local conditions. Logical policies for local associations on legislative matters are outlined and a model interference ordinance is provided.

A number of associations maintain an interference department and employ a capable man for the tracing down and elimination of the community's interfer-

ence problems. Forms and reports for this work have been developed. These show the causes of interference and outline the ways to remedy them.

One of the industry's most difficult problems—that of satisfactory servicing—has already been solved in such cities as Chicago, Milwaukee, St. Louis, Minneapolis and San Francisco by a means of a system of examining, grading and registering servicemen. This activity, logically carried on by their local headquarters, provides one of the biggest opportunities for service because it is now generally recognized that the efforts of the sales department and the service department are just about inseparable. A good serviceman is also a salesman; in addition to his technical qualification he should have some measure of sales ability including good appearance and address.

It is recommended that every registered serviceman carry an identification card and that grades be set up so that they are in conformity with the classification of other local associations which will enable servicemen making changes in the locality to carry on to their own best interests and the best interests of the industry.

Some local associations stimulate interest and increase public good will by joint newspaper advertising, joint broadcasting, and sometimes by the provision of suitable programs upon special occasions.

Because cost accounting is one of the principal factors in merchandising, several local associations have uniform cost accounting systems so that members may compare cost of doing business with a view to increased profit. Some groups employ an accountant to make a monthly check-up of members' books which is an invaluable service to all the dealers privileged to enjoy it.

One local association has succeeded in instituting among local finance companies a system of insurance to cover radio sets on which there is an unpaid balance and also on radio sets sent out on demonstration but not yet sold. The insurance on demonstration equipment is contingent on the dealer giving all his business to one finance company and covers the full amount of the set's value. Insurance on unpaid balances covers not only fire but theft, tornado and conversion for and by any cause.

The power obtained through local organization can influence the proper wiring of apartment buildings for radio, the quality of programs broadcast locally.

A partial list of the achievements of the Federated Radio Trade Association includes publication of the *F.R.T.A. News*, exploitation of National Radio Week each fall; efforts to obtain reduction of insurance rates on radio stocks in store and warehouse; a study of the possibilities of a national credit and collection service.

Other outstanding contributions of the Association to the industry include the conduct of an annual forum for the secretaries of local radio trade associations; ironing out radio show dates in fall so that the various shows will not conflict to the disadvantage of manufacturers planning exhibits; the conduct of an annual meeting of radio show managers; provision of membership trade-mark cuts and certificates to all members.

Distributors Appointed

TRIAD: The Spencer Company, of Memphis, Tennessee, has been appointed factory representative for Triad Tubes covering the entire southern territory.

KELLOGG: The Fleer-Petty Auto Supply Company, 2823 Locust Street, St. Louis, Mo., has been appointed to handle Kellogg sales in the St. Louis district and surrounding counties.

The Louisville territory will be handled for the Kellogg Company by the L. & L. Tire and Battery Company, 307 N. Kentucky Ave., Louisville, Ky. The territory consists of a number of counties around Louisville in Kentucky and a few counties in Indiana.

The Raub Supply Company, Mulberry, James and Concord Sts., Lancaster, Penna., has been appointed to cover the central Pennsylvania territory. They will operate in Lancaster, Harrisburg, York, Wilkes-barre and the surrounding territories.

The southeastern territory has been taken over by the Universal Motor Company, Inc., 1710 Altamont Ave., Richmond, Virginia.

SPEED: The Martwel Corporation, 1501 Broadway, N. Y. C., special sales representatives for Speed radio tubes, has just announced the appointment of several new Speed distributors. G. J. Seedman Co., Inc., of Brooklyn, for Greater New York; Northern Distributing Co., of Newark, for Northern New Jersey and the Syracuse Auto Supply Co. for Central New York State.

A. C. DAYTON: The Ideal Radio Cabinet Mfg. Co. Inc., of 151 West 19th Street, New York, will distribute A. C. Dayton Co. receivers.

TEMPLE: The Temple Corporation announces appointment of the following distributors: Wisconsin Auto Supply Co., of Wausau, Wis.; Maass Radio Corporation, of Baltimore, Md.; Broom Distributing Co., of Binghamton, N. Y.; Johnson-Ferrill, of Louisville, Ky., and Henry L. Walker, of Detroit, Michigan. About 70 jobbers and over 3000 dealers are now selling Temple receivers, according to Gordon C. Sleeper, vice-president and sales manager.

GREBE: Brothwell H. Baker, sales manager of A. H. Grebe & Co., Inc., of Richmond Hill, N. Y., announced the appointment of Stewart-Downey, Inc., 700 Beacon Street, Boston, Mass., as distributors of Grebe products in the Boston territory which consists of Massachusetts, Vermont and the western half of New Hampshire.

Stewart-Downey, Inc. is a newcomer to the ranks of radio distributors but it enters the field with a wealth of personal experience in back of it. John Stewart and Joseph A. Downey organized the Radio Department of The Boston Post in 1923 and have been in charge of this department ever since.

SONORA: Appointment of the K. W. Radio Co., Inc. as New York Metropolitan distributor of Sonora radio, Sonora phonograph and Sonora radio-phonograph combinations, including the well-known Melodon, has been announced by Eugene P. Herrman, president of the Sonora Phonograph Co., Inc. Headquarters of the K. W. Radio Co., are at 350 Hudson

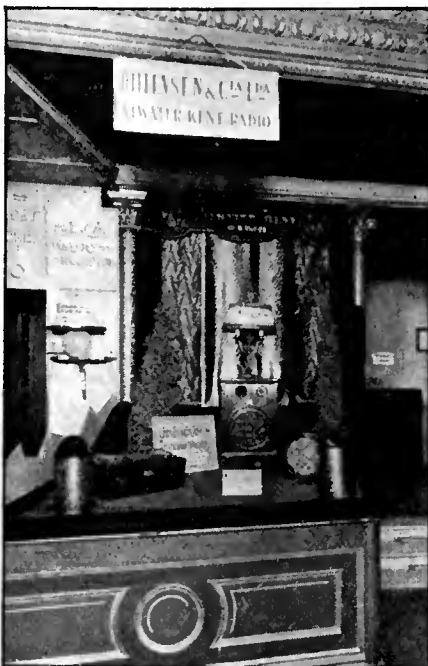

This interesting booth was set up recently at the Buenos Aires 1929 Radio show by Dittlesen and Co., Atwater-Kent distributors.

Street, New York City. The officers are Leonard Welling, president, and Gus Krouse, treasurer.

KELLOGG: In Cleveland a factory branch has been established by the Kellogg Switchboard & Supply Company. Office and warehouse space has been leased at 1531 W. 25th Street.

The branch will be in charge of F. W. Lorenz, formerly sales representative for the Ohio territory. Assisting Mr. Lorenz are Mr. Shilber and Mr. Moran.

Crosley Distributor Appointment

The Dallas branch of the Shield Company, Crosley distributors, is under new management, E. B. Howard having succeeded C. B. Wakelind who has resigned to go into the wholesale furniture business.

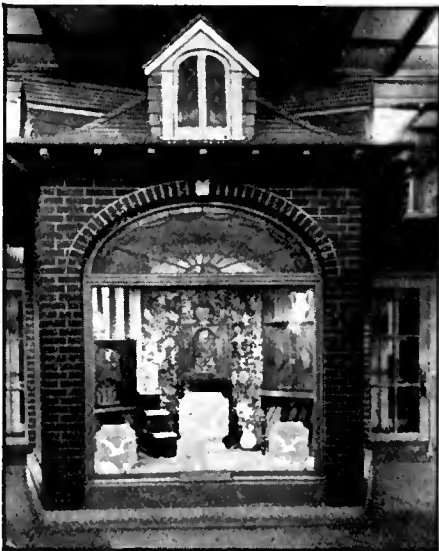

Inside the Spear and Company store, New York City, there has been erected a miniature brick house in which they exhibit their outstanding features.

Distributors Sales Meetings

TENNESSEE: The Atwater-Kent dealers of the Memphis territory, held their annual Dealers Conference at the Hotel Peabody, Memphis, Tenn., August 14th, under the auspices of the Braid Electric Company, Atwater-Kent distributors.

Luncheon was served at 12 o'clock and the business meeting followed immediately after the official photograph and the address of welcome by E. E. Hyde, Braid Electric Co. W. W. Gambill, Braid Electric Co., opened the meeting, and was followed by E. L. Hollingsworth, A-K territory manager, John F. McCoy, A-K Mfg. Co., Ben B. Barber, Atwater-Kent sales promotion dep't. Luther Still, assistant territory manager and W. W. Gambill, Jr., Braid Electric Co.

The next day, Thursday, was devoted to a service school conducted by Atwater-Kent service officials, for dealers' servicemen.

TEXAS: The Shield Company, Inc., of Dallas and Ft. Worth, announces that their regular Crosley dealer convention was held on the top floor of the Texas hotel in Ft. Worth on August 7th. Short talks were given by officials of the Crosley Radio Corporation and representatives of the Finance Companies who will handle the finance paper for the dealers this coming season. This year promises to be a big one in radio and from the speedy replies which the dealers are making on the invitation letter, this year promises to be the largest and most enthusiastic convention, which The Shield Company has held. Practically all the dealers have expressed their enthusiasm for the new Crosley line for the coming season by ordering heavier at this time of the season than at any time in the past.

PENNSYLVANIA: The dealers served by the Edison Distributing Corporation of Pittsburgh had their first opportunity to view the new Edison Light-O-Matic models at a special exhibit in the William Penn Hotel, Pittsburgh, on July 26, 27 and 28. The exhibit was arranged and conducted by H. F. Andre, branch manager at Pittsburgh, assisted by H. H. Silliman, eastern sales manager of Thomas A. Edison, Inc. Several hundred dealers attended.

NEW YORK: The Majestic Distributors, Inc., sponsored a novel and interesting banquet, tendered to the Morison Electrical Supply Co., of New York City, on the evening of July 31, 1929. The banquet was held in the ballroom of the Hotel Pennsylvania, New York City.

There were present 170 salesmen, sale managers and executives of the Morison Electrical Supply Co., together with the executives and salesmen of Majestic Distributors, Inc. Herbert E. Young, general sales manager for the Grigsby-Grunow Co., of Chicago, Ill., was the guest of honor and delivered a message on "Outside Selling and Sales Promotion." C. T. Morison, president of the company bearing his name, also talked, outlining the plans and policies to be employed in the campaign which were to be directed on Majestic Radio Receivers during the month of August.

IN THE RADIO MARKETPLACE

News, Useful Data, and Information on the Offerings of the Manufacturer

Improved Philco Speaker

PHILADELPHIA STORAGE BATTERY COMPANY: A seamless fabric cone ten inches in diameter and entirely moisture proof is responsible to some extent for the improved reproduction obtained from the new Philco dynamic loud speaker. In the Philco receiver there is an acoustic equalizer by which the user can vary the reproduction to suit his personal preference. The dial is calibrated in channel numbers reading from 55 to 150.

Trav-Ler Portable Sets

TRAV-LER MANUFACTURING CORPORATION: Deliveries of the new portable radio receivers were started near the end of July. The line comprises three models in prices from \$65 to \$100. All of the sets may be adapted readily for operation on batteries, 110 volts a.c., or 110 volts d.c. The sets use four tubes consisting of one screen-grid tube, detector, and two audio tubes. The Standard model lists at \$65.00, the De Luxe model at \$75.00, and the Aristocrat at \$100.00.

New Bosch Radio Tubes

AMERICAN BOSCH MAGNETO CORPORATION: This company will market a complete line of tubes under its own name. Bosch tubes in all standard types will be available.

The Radiola Model 66

RADIO-VICTOR CORPORATION OF AMERICA: The new Radiola 66 employs an improved a.c. super-heterodyne circuit which includes the tuned antenna coupling circuit, one stage of r.f. amplification, oscillator, first detector, two



stages of intermediate-frequency amplification, second detector and one stage of audio-frequency amplification. The power output tube is the 245. The single tuning control is marked with readings from 0 to 100 which are projected and magnified for easy tuning. List price: \$225.00.

Mountford Resistors

C. E. MOUNTFORD: This company has designed a resistance capable of meeting all usual requirements for use in modern radio receivers. The resistor has been designed for manufacturer's use to sell at a low price.

Oxford Loud Speakers

OXFORD RADIO CORPORATION: An auditorium type loud speaker having a diaphragm diameter of approximately 12 inches has been added to the regular line of dynamic loud speakers. The auditorium type is designed especially for use in theatres or in receivers where exceptional volume is required. According to Frank Reich-

mann, vice president and chief engineer, the plant is working at full capacity supplying dynamic loud speakers to set manufacturing companies.

Portable Phonographs

CASWELL MANUFACTURING COMPANY: This company manufactures portable phonographs and completely a.c. operated portable turntables with magnetic pick-ups. The Powertone



model illustrated above uses a General Electric synchronous motor and a Patent Phonovox electric pick-up. A record album is built into the cover. List price: \$19.50. The following portable phonographs are made: The Aristocrat, \$35.00; the Monarch, \$25.00; the Gypsy, \$20.00; the Melody, \$15.00; and the Model 12, \$12.50.

United Air Cleaner Line

UNITED AIR CLEANER CORPORATION: This company is manufacturing a complete line of magnetic and dynamic loud speakers, two complete screen-grid receivers, and also an electric turntable and a magnetic pick-up unit. The receivers are made by the Sentinel Manufacturing Company, a division of the United Air Cleaner Corporation.

DeJur-Amsco Condensers

THE DEJUR-AMSCO CORPORATION: This company announces a new line of multiple condensers of the "bath-tub" type, complete with dial assembly. They may be had in from one to four gang units with or without dial and with from two to eight gang units with dial.

Phonograph Equipment

MOTOR PLAYER CORPORATION: This company manufactures portable electric turntables and phonograph pick-up units. Style H portable contains an electric motor and phonograph pick-up and lists at \$65. The Style I at \$60 is similar but is contained in a somewhat less expensive cabinet. Separate phonograph pick-up units list at from \$10.45 to \$19.00.

Electric Phonograph Units

ALLEN-HOUGH CARRYOLA COMPANY: This company manufactures electric turntables designed for use by manufacturers in making either phonographs or combination radio-phonographs. The motor is of the synchronous type and revolves the turntable at 80 r.p.m. The Rotrola is an electric turntable and phonograph pick-up

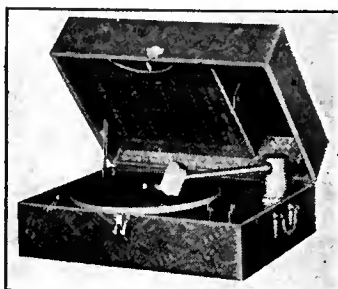

unit housed in a small cabinet and designed for use in conjunction with radio receivers to permit the reproduction of phonograph records. List price: \$45.00.

Transmitting Apparatus

JENKINS AND ADAIR, INC.: A number of different styles of transmitting condensers and inductances are being manufactured by this company. Type KA variable condenser has a maximum capacity of 0.0006 mfd. with three-inch spacing between plates. The overall height is 68 inches and the overall weight is approximately 120 lbs. The condenser is priced at \$550.00 net f.o.b. Chicago. The Type D inductances are made up with from 14 to 20 turns and are priced at \$10.00 per turn. Ordinarily the inductances are built of copper strip but they are made of copper tubing if desired.

Supreme Diagonometer

SUPREME INSTRUMENTS CORPORATION: The Model 400-B is a complete instrument for making all types of tests on tubes, receiving sets, power units, etc. The instrument is known as a "Diagonometer" and is, according to the manufacturers, equivalent to a complete portable laboratory. Approximately 40 different tests can be made.

New Zenith Models

ZENITH RADIO CORPORATION: Four new receivers were announced recently by this company. They are known as the Models 52, 53, 54, and 55 and are priced at from \$175 to \$700. All of them incorporate automatic tuning and screen-grid circuits. Double push-pull amplification is used with two 227-type tubes in the



first push-pull stage, and two 245-type tubes in the second or output stage. The Model 55 includes a device for remote tuning. Models 54 and 55 are designed for operation with a built-in loop antenna.

Super Akra-Ohm Resistors

SHALLCROSS MANUFACTURING COMPANY, manufacturers of Super Akra-Ohm resistance units: The Type 7-M units have an accuracy within 0.5 per cent. and the type 14-M has accuracy within 0.25 per cent. The break down voltage of the insulation on the wire is approximately 250 volts.

New Patent Line

PACENT ELECTRIC COMPANY: Phonograph pick-up units and electric turntables of the following models are now available. Type 106-A, a pick-up without tone arm, \$12.00; type 106-B, a phonograph pick-up with counterbalanced tone arm, adapters, and volume control, \$15.00; type 106-C, Ultra Phonovox consisting of special pick-up with counter-balanced tone arm, gold finished, \$25.00; type 140 electric phonograph

motor, \$25.00; type 301 Electrovox consisting of a type 140 motor installed in a cabinet, \$75.00.

Motors for Phonographs

GENERAL INDUSTRIES COMPANY: A complete line of spring and Electric motors for phonograph and phonograph-radio combinations are

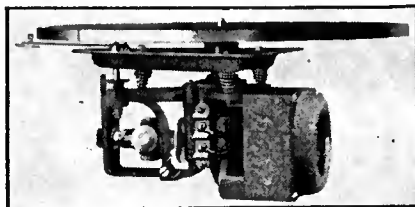

manufactured by this company. The standard electric motor types are designed for 110-volt 50-60 cycle a.c. operation. The large spring motors have a capacity of about five standard 10" records from one winding.

New Dynamic Chassis

TRIMM RADIO MANUFACTURING COMPANY: A dynamic loud speaker chassis has been developed by this company. The Model d100 is designed to be supplied with field power from the power unit. The Model dvl02 is supplied with an output transformer to match conventional types of power tubes.

Phonograph Apparatus

ULTRAPHONIC PRODUCTS CORPORATION: This company is manufacturing the Upco electric phonograph pick-up unit which is sold complete with tone arm and volume control. The impedance is 600 ohms at 1000 cycles and the output is 1.2 volts at 200 cycles. Lists complete at \$20.00.

Radio Service Material

LOUIS P. HORNING, JR. LABORATORIES: This company supplies radio service material such as record cards, service call cards, letter heads, etc. A test bench has been designed with the requirements of radio service work in mind. It is made of heavy material with ample space for handling complete sets, and space for a large test panel. Net price: \$29.00.

New Lightning Arrestor

L. S. BRACH MANUFACTURING CORPORATION: The Arres-Tenna is a new protective device designed to protect radio receivers against lightning which may reach the set either through the antenna or through the lighting system. The device lists at \$2.50 and carries a \$100 insurance guarantee.

Belden Antenna Kit

BELDEN MANUFACTURING COMPANY: A new complete antenna kit containing every item

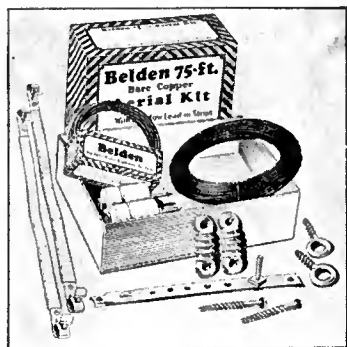

of material needed to install a complete antenna and ground system has been placed on the market by this company.

New Eveready Series 30

NATIONAL CARBON COMPANY: The Eveready Series 30 (Models Nos. 30 to 40) receivers employ a seven-tube single-dial antenna-operated all-electric a.c. chassis, having three stages of r.f. amplification, detector, and two

stages of a.f. amplification. The power stage consists of two 171A tubes in push pull. The rectifier is a type 280. The receiver employs a variometer in the first tuned circuit, thus making the sensitivity of the set more uniform throughout the entire broadcast band.

Electrad Resistors

ELECTRAD, INCORPORATED: Several new lines of fixed and variable resistors are being manufactured as follows: Super Tonatrols, a group of heavy-duty volume-control resistors, in values from 10,000 to 50,000 ohms; Truvolt sliding contact resistors, in values up to 5000 ohms; Truvolt air cooled resistance banks, in values up to 21,000 ohms; Wire-wound grid leaks, in values from 5,000 to 50,000 ohms.

Amperite Line Control

RADIALL COMPANY: The Amperite self-adjusting line voltage controls for a.c. receivers are designed to handle a line fluctuation of about 30 volts maintaining the output constant within about 10 per cent. The voltage drop across the control varies from about 20 to 40 volts, so that the transformer primary must be wound for about 80 volts. The manufacturers guarantee a life of about 2000 hours.

Automatic Tuning Control

CARTER RADIO COMPANY: An automatic control (tuning device was recently announced by this company. It cannot be attached to an existing receiver but is designed to be incorporated into the set during its manufacture. The

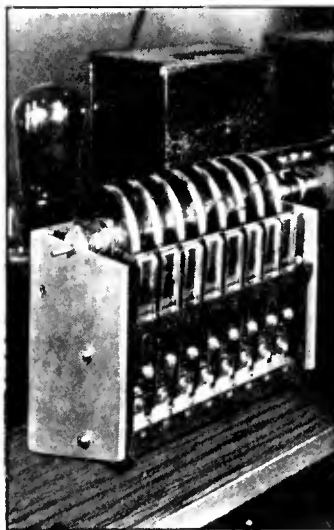

device is operated by pressing push buttons each of which functions to tune the receiver to the station whose call letters are indicated on the button which was pressed. When a button is pressed an arm makes contact with a drum. This closes the motor circuit which immediately begins to revolve and continues to do so until the variable condensers have been brought to the correct point to receive the desired station. The device is also adaptable to remote-control operation. Any number of remote-control devices may be employed to control the receiver from various locations. The device was designed by A. W. Plenser, engineer of the Carter Radio Company.

New Diaphragm Material

STEVENS MANUFACTURING COMPANY: This company makes a special diaphragm material which is used in a number of dynamic loud speakers being made by various set manufacturers. The diaphragm material is known as Burtex and consists of a special fabric which can be pressed into any desired shape and impregnated with a water-proofing compound to make it impervious to moisture.

Burton-Rogers Tube Checker

BURTON-ROGERS COMPANY: The new Model B tube checker is equipped to test both a.c. and d.c. screen-grid tubes as well as all other standard types of tubes. It is completely supplied with power from the a.c. lines and a tube is checked by simply putting it into the ap-

propriate socket and noting the reading of the single meter. The net price to dealers is \$22.75.

New Phonograph Pick-up

E. TOMAN AND COMPANY: The Toman Super Pick-up is designed for use in electrically reproducing phonograph records. List price is \$17.50.

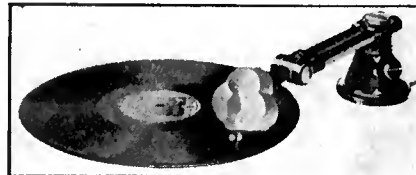

Phonograph Pick-Up Units

BUCKINGHAM RADIO CORPORATION: This company makes several types of electric pick-up units as follows:

Model A—Pick-up only. Manufacturer's type	\$10.00
Model A-1—Pick-up only with bracket	10.45
Model B-201—Pick-up with bracket, volume control unit, and adapter for d.c. sets	15.45
Model B-227—Pick-up with bracket, volume control unit, and adapter for a.c. sets	15.55
Model C—Pick-up only with tone arm, Manufacturers' type	14.00
Model C-201—Pick-up with tone arm, volume control unit, and adapter for d.c. sets	19.00
Model C-227—Pick-up with tone arm, volume control, and adapter for a.c. sets	19.00
201—Adapter model for d.c. sets	1.25
227—Adapter model for a.c. sets	1.35

"X-Core" Dynamic Speakers

THE MAGNAVOX COMPANY: The "X-Core" dynamic loud speakers made by this company are available in a number of different models. Either the unit alone or the unit mounted in a cabinet may be purchased. The units are priced as follows:

No. 106—7 1/2" cone, 110-190 v. d.c.	\$21.00
No. 107—10 1/2" cone, 110-190 v. d.c.	23.00
No. 108—7 1/2" cone, 180-300 v. d.c.	21.00
No. 109—10 1/2" cone, 180-300 v. d.c.	23.00
No. 200—7 1/2" cone, 6-12 v. d.c.	22.00
No. 201—10 1/2" cone, 6-12 v. d.c.	24.00
No. 400—7 1/2" cone, 105-120 v. a.c. 60 cycles	31.00
No. 401—10 1/2" cone, 105-120 v. a.c. 60 cycles	33.00
No. 402—7 1/2" cone, 105-120 v. a.c. 25 cycles	32.00
No. 403—10 1/2" cone, 105-120 v. a.c. 25 cycles	31.00

Jewell Set Analyzer

JEWELL ELECTRICAL INSTRUMENT COMPANY: A new four-instrument set analyzer designed to meet all the requirements of modern set testing has been designed by this company. Space is

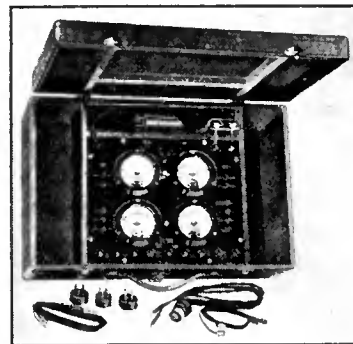

provided for carrying tools and replacement tubes.

Automobile Receiver

AUTOMOBILE RADIO CORPORATION: This company makes the Transitone radio receiver designed for installation on the dash board of automobiles. The antenna is concealed in the top of the car and the loud speaker is attached above the windshield or hidden under the dash board.

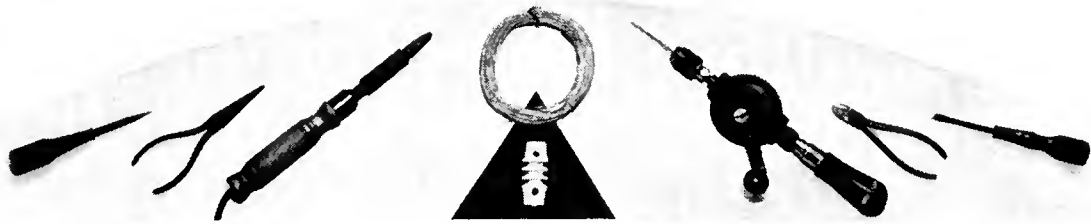

THE SERVICEMAN'S CORNER

TO START off the "Corner" this month we have a short article describing a peculiar short circuit trouble. This contribution comes from B. B. ALCORN, of the Kew Radio Electric Company, of Kew Gardens, Long Island, N. Y. Most readers of this department will remember Mr. Alcorn as the author of a series of articles on "Practical Service Methods" which was published in RADIO BROADCAST.

"An unusual complaint which will be of interest to the readers of the "Serviceman's Corner" has recently come to the attention of the writer. It concerns a Zenith receiver having a Jones type plug used for the connection. The same type of trouble could easily develop in any set using this connector and might for a time prove as baffling as it did for the writer.

"The set was found to be inoperative with all the indications of a short. It was checked carefully, but no fault could be found in any of the parts. Then the power pack was checked and here the test showed a decided short, yet each individual part seemed to be O.K. Finally the short was run down to the cable and finally to the connection plug.

"These plugs are made of small brass cotter pins run through holes in a block of insulating material. If the ends of these split pins are open a trifle too wide it is easy for them to catch on the edge of their socket and bend over. This is what happened and, in bending, it had become firmly wedged against the next pin, effectively shorting out the filament supply for the ux-226's. This particular point was about the last place that one would look for trouble and in the writer's experience it is the first time that a short of this kind has come to his attention."

Metal Eyelets Cause Trouble: H. W. HENDELSON, Radio service and merchandiser, of Vandalia, Mo., cracks another hard nut.

"We recently had a short that was a hard one to locate. We knew this short was in the r.f. plate circuit, but could not locate its position. We tested the by-pass condensers and found them O.K. The r.f. coils were attached to the subpanel with metal eyelets and one resistance strip in the filament circuit was also attached by an eyelet. These eyelets also furnished the hole for the wiring to pass through to the r.f. stages. The wires going through these holes were rubber covered with a cotton covering between rubber and wire, and this insulation appeared to be O.K. where it went through subpanel. However, it seemed to me that there was no other place for a short, so I opened one wire at a time, watching the meter as I did so. As I opened the wire going through the

eyelet that held the filament resistance I got a zero reading on meter, thus locating the short. I placed a piece of spaghetti tubing around all wires going through eyelets and in this way corrected the trouble."

On the Use of Relays: J. P. KENNEDY, senior student in E. E. at Notre Dame,

Screen-grid receivers have been on the market just about long enough to develop characteristic faults and ailments. The screen-grid set by now has become a part of the serviceman's daily routine. We particularly solicit contributions from servicemen on the problems of screen-grid servicing, which direct attention to characteristic troubles and their correction. These troubles seem to be lack of selectivity, noisy tubes, short life, and marked fluctuation in signal strength.

We will pay special rates for unusually interesting contributions on screen-grid trouble shooting.

—THE EDITOR

and radio serviceman of South Bend, Ind., sends through a couple of notes on relays:

"The most troublesome feature about relays used in conjunction with sets having fixed resistors for filament control has been the excessive voltage drop across the series actuating coil. As three-quarters of

an ampere is usually enough to work these relays, a shunt of microme or other resistance wire may be bridged across the series coil terminals. The amount of wire will vary for different sets and relays but can always be determined by leaving the set turned on and attaching the resistance wire to one terminal and touching various points on the wire to the other terminal. When the relay clicks, it means the resistance wire shunt has too low a resistance and the desired length is that which just permits the relay to operate when the set is turned on and off.

"One of my customers has a double outlet plug in the B-power unit side of the relay box and a floor lamp alongside the radio connected to the extra outlet plug. When the radio is turned on, of course, the floor lamp lights. The effect is charming."

Reducing QRN in D.C. Districts: "The writer, whose job is servicing radio sets around the West End Avenue section of Manhattan, has had quite a bit of experience in curing artificial static caused by electric refrigerators, sparking motors, heating pads, and other electrical appliances. Sometimes it has been difficult to locate the offending instrument and then again there have been so many of them that it would have been impossible to fix them all.

"Most of this artificial static is picked up by the lead-in wire and the writer has found that a marked reduction of static is obtained, especially where the set itself is of the shielded type, by raising the antenna as high as possible above the roof and replacing the ordinary rubber-covered lead-in wire by some Belden shielded hook-up wire (\$3.50 for a 100-foot roll) and connecting the shielding to the ground binding post of the set."

J. FUTTERMAN, Bronx, N. Y.

A Few Fireworks: Albert Corideo, radiotrician and authorized S-M service station, of Waterbury, Conn., linds hurry calls diverting.

"A woman living two doors away from me came dashing into my laboratory pale with fright shouting that her radio was on fire. I made a dash for her house, and got there before her. There was a curl of black smoke rising from the receiver in the dining room. I pulled the plug from the socket, pulled the console away from the wall, and through the smoke in the set observed a bright red spot.

"After giving the receiver and power pack a testing which lasted an hour I found it in good condition. The part that was burning was the insulating material on the power rheostat.

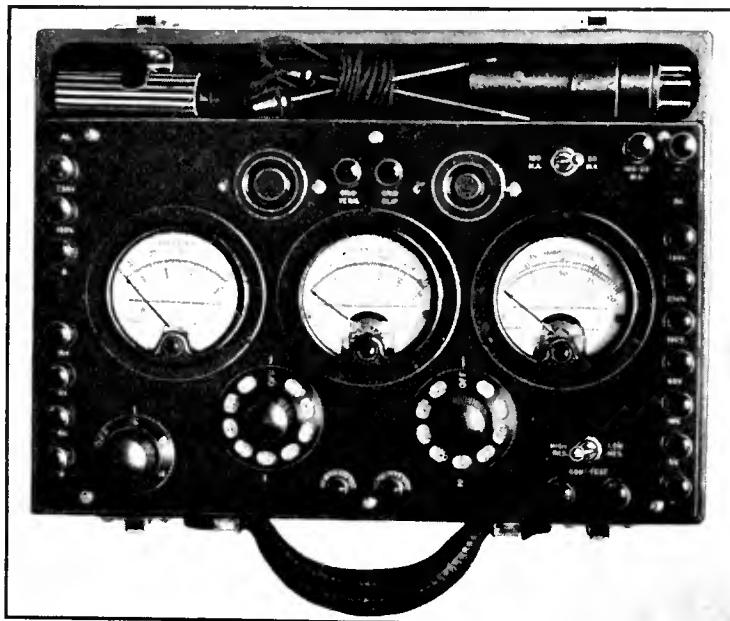

This model, No. 547, is Weston's latest test equipment. It is designed to run every practical test on d.c. and a.c. receivers, including screen-grid sets.

"I replaced the tubes again and turned on the current. The tubes did not light, but a bright red spark showed up in the 281-type tube. I replaced this tube with a new one, and the set was back in working condition again. In examining the rectifier, I noticed that the filament had broken, and one of the broken ends was touching the plate, causing a short in the tube, which in turn heated the winding of the rheostat."

C. WASHBURN, JR., of Jacksonville, Fla., suggests reversing antenna and ground posts on many receivers suffering from low sensitivity. The improvement in sensitivity is generally due to increased regeneration with the removal of the stabilizing effect of the ground.

A Useful Voltmeter Formula:
BORIS S. NAIMARK, service engineer with the Riverside Radio Service Company of New York City, notes the formula in "Strays from The Laboratory" for August for determining the value of an unknown resistor with a voltmeter and a battery.

$$R = \left(\frac{E_1}{E_2} - 1 \right) R_m$$

Where R is the unknown resistor
E₁ the voltage indicated on the meter itself
E the voltage of the battery
R_m the resistance of the meter

Mr. Naimark points out that this same formula can be used to determine the correct value of a resistor to be used as a voltage multiplier to secure any desired range with any voltmeter.

Let R equal the value of the resistor
E₁ full-scale voltage of the meter itself
E the voltage desired at full scale
R_m the resistance of the meter

If, for instance, we have a meter reading up to 100 volts, having a resistance of 1000 ohms per volt, and we desire to place a resistor in series with it so that it will indicate full scale on 500 volts, what value of resistance should we use?

The calculation is simple:

$$R = \left(\frac{500}{100} - 1 \right) \times 100,000 = 400,000 \text{ ohms}$$

A Grounded Transformer: "After an electrical storm last week I was called upon to service an Eveready set. I first discovered that the fuse was blown in the light line, and, in trying to replace it, I found that the line was grounded. After disconnecting the radio set the fuse stayed put.

"Upon close inspection of the set I found the socket panel of the power pack was badly burned near the transformer, and, upon testing the transformer, found the primary to be grounded. Everything else OK.

"After removing the transformer from the set I failed to test it, which was careless of me. Replacing it with a new transformer I was surprised to find that I still had the same ground.

"The primary taps on an Eveready set run to spring contacts which are set in the rubber socket

panel and the panel is supported by angle strips along each side.

"The spring contacts on one side are about an inch from the angle strip support, but I found that the lightning had burned the panel and left a smoke or carbon deposit thick enough to ground these spring contacts to the angle supports that held the panel in place.



This is an ideal type of truck for radio service work. Note the ladder for making antenna installations.

"After sanding off this deposit of carbon everything was OK."

BLAINE MARTIN, Cleveland, Ohio.

Installation and Operation of Moving Coil Speakers: "Many times you will run across a customer who wants receptacles for a dynamic loud speaker of either the 6-volt field type or the 90-volt field type, in two rooms.

"The easiest method to use for this purpose is to attach an old tube base on the speaker leads and wire a radio tube socket on the floor in the rooms desired, thus providing the necessary four contacts for the field and moving coils."

C. H. JENKINS, Radio Service Audubon, New Jersey.

Pepping up a Crosley: EUGENE O. WHITAKER, in charge of service with the American Electric Company of St. Joseph,

Mo., notes a cause of sensitivity drop in a Crosley.

"Sometimes a Crosley Showbox set, model 706, loses its kick after a few months use and new tubes do not always remedy the trouble.

"I have found that in some cases this loss of volume is caused by a sideway movement of the stator plates of the condenser in the first tuned r.f. stage. This can be remedied easily by loosening the two set screws holding the rotor plates to the shaft and slipping the plates to the center of the stator plates again. This puts the condenser in resonance with the other two and the set will tune as sharply as ever."

How Long Do A.C. Tubes Last?:

George Lewis, of the Arcutury Radio Tube Company, thinks that the average set owner should get along for two years on one set of tubes. Offhand, service contacts tend to indicate that two sets of tubes a year is nearer the mark. We should appreciate first-hand data on this.

A Home-Made Tube- and Set-Tester

WE PRESENT the following service contribution from G. WESLEY TAYLOR, of Berkeley, California, for the benefit of those servicemen who make their own test equipment, and who endeavor to incorporate, in single test devices, as large a number of functions as is effectively practical. While there are several commercial types of testing equipment that may effect individual tests more conveniently than Mr. Taylor's arrangement, the versatility and economy of this device will recommend it to many servicemen.

"The average tester tests tubes with the current supplied by the receiving set. The tester described on this page tests tubes regardless of the condition of the batteries in the receiving set, and will rejuvenate them if necessary. An oscillator is built into the circuit to facilitate adjusting the receiver in case it is not possible to pick up a broadcasting station.

"The d.c. voltmeter is a Weston with an 0-5 range. By removing the resistance, this instrument was converted into 0-8 milliammeter. The proper resistances and shunts were determined by the use of Ohm's Law to give the desired ranges. The a.c. voltmeter is a Jewell with a range of 0-15. Removing the resistance from this meter provided an instrument with a range of about an 0-8. The above meters were on hand—therefore the extra work. If it is necessary to buy the meters an 0-1.5 d.c. milliammeter and an 0-8 a.c. voltmeter should be selected. The ammeter was purchased from an auto wrecking house for the sum of fifty cents. The shunt and the coils were removed and replaced with new coils having more turns to lower the range below that desired. The range was then adjusted to suit by means of a new shunt.

OPERATING AND SERVICE MANUALS AVAILABLE

IN RESPONSE to a recent questionnaire submitted by RADIO BROADCAST, the radio manufacturers listed below have indicated their willingness to supply operating and service data on their receivers to us for distribution to legitimate servicemen. In order to secure this material it is necessary to direct your request to RADIO BROADCAST on your business stationery, enclosing the correct amount in stamps or money-order when a charge is indicated.

F. A. D. Andrea, Inc.: Wiring diagrams and special sheets covering current models. No charge.

All-American Mohawk Corporation: Instructions and Service Manual (specify model). No charge.

Bremer-Tully Manufacturing Company: Instruction Books and Service Manuals. No charge.

Colonial Radio Corporation: Instruction Books, Service Sheets and Service Manual, at 50c., 25c., and 50c., respectively. Bulletins number 31A-C, 31D-C, 32A-C and 32D-C are also available.

Continental Radio Corporation: (Slagle), Service Manual. No charge. Columbia Phonograph Company, Inc.: Service Manual. Nominal charge not yet determined.

Crosley Radio Corporation: Instruction Sheets or Service Manuals (indicate receiver model numbers) No charge.

Day-Fan Electric Company: Complete Service Manual. Price: fifty cents.

Electrical Research Laboratories, Inc.: Instruction Bulletins and Service Bulletins. No charge.

Charles Freshman Company, (Earl

and Freed receivers): General literature. No charge.

Federal Radio Corporation: Instruction Books and Service Manuals (specify receiver model). No charge.

A. H. Grebe and Company: Operating and Service Data (specify receiver models). Nominal charge.

Grigsby-Grunow Company (Majestic Radio): Operating and Service Sheets. No charge.

Stewart-Warner Speedometer Corporation: Instruction Books, Service Manuals and Wiring Diagrams (specify receiver types). No charge.

Steinite Radio Company: Service Manual in standard binder, 50c., leather binder, \$1.00.

Silver Marshall, Inc.: Service Bulletin, Silver Radio Instruction Booklet. No charge. Data Sheets, two cents each. General catalog, no charge.

Temple Corporation: Service Bulletins. No charge.

United Reproducers Corporation: Operating Data, Service Data. No charge.

U. S. Radio and Television Corporation: Service Manuals. No charge.

"Constructional details other than those suggested in the pictures, and the diagram are not really necessary.

"The regular circuit tests are made with a test cable-plug made from the X base of an old '99-type tube and a cable with phone tips on the other end. The cable used should have leads sufficiently heavy so that there will not be an appreciable voltage drop when testing a.c. tubes. The phone tips are attached to the four tip jacks on the right of the panel, starting with the grid on the left, the filament leads in the middle, and the plate on the right. The tube base is plugged into the socket that it is desired to test, using a suitable adapter if necessary, and the tube is placed in the tester. The two switches below the a.c. voltmeter and the rheostat should be in the off position.

"Placing a shorted phone plug into the phone jack on the extreme left of the panel will cause the d.c. voltmeter to read the grid circuit. The 500-volt range should be used when testing the grid circuit of a power tube. This test will not give a true voltage reading because of the resistance in the grid lead and will indicate continuity only. The next jack will read the plate voltage on a 500-volt scale. If the set is d.c. operated the third jack will read the filament voltage on a 50-volt scale. Pushing the button on the left below the a.c. voltmeter will short the 50-volt resistance and the voltage can be read on the 5-volt scale. If the polarity is reversed it can be changed by turning the switch above the button for the 5-volt range. The fourth jack reads the plate current. The switch below the plate-current jack is for the shunts for the milliammeter, 1 being for the 8 mA. scale, 2 for 25 mA., and 3 for 100 mA. If the set is a.c. operated, the filament voltage is tested by turning the a.c. switch, being the one to the right below the a.c. meter, to the 'on' position, making sure that the rheostat is in the 'off' position.

"If it is desired to use the meters independently the tip jack to the extreme left is the plus lead. The second tip jack is for the millimeter lead. The switch below the plate current jack controls the millimeter shunts.

"The third tip jack is for the d.c. voltmeter. The switch to the extreme left and above the plus lead controls the voltmeter resistances, 1 for 5 volts, 2 for 50 volts, and 3 for 500 volts. The fourth tip jack is for the 3-0-3 ammeter in the upper right corner of the panel. This meter is used for testing chargers, etc., it being connected so that if the plus lead is connected to the plus of the battery the meter will read discharge when the set is turned on and charge when the charger is turned on. The ammeter is used whenever there is any question about the polarity of the charger or its charging ability. The two middle tip jacks of the four on the right of the panel are for the a.c. meter. The a.c. switch should be on and the rheostat off.

"A toy transformer with adjustable voltages is used for filament supply. The one used gave from 2.5 to 25 volts in steps



The Beynon Radio Shop insure the neat appearance of their servicemen by providing the coats shown above.

"The testing of a tube is accomplished by attaching the cord to a convenient light socket and placing the tube in the socket. The a.c. switch should be in the 'on' position and the filament voltage adjusted by means of the voltage switch and the rheostat. The phone plug should be placed in the plate current jack. The meter should now read about 1.6 mA. for an A tube. Pushing the button below the a.c. switch will short the grid resistance, and the plate current should now be about 5 mA. The voltage on the plate is about 80 volts. It is also possible to test 280- and 281-type tubes in the same way.

"A coil is connected in the grid and plate circuits in the proper relation so that the tube will oscillate when making the tube test. It may be necessary to reverse the plate voltage leads to make the tube oscillate. The desired frequency is obtained with a 0.0005-mfd. variable condenser that can be adjusted with a screwdriver. The oscillator is tuned to about the middle of the broadcast band

and may be used in place of a broadcasting station whenever needed for set adjustment. The condenser is mounted inside the case and may be varied if necessary with a screwdriver through a small hole in the back.

"The rejuvenation of tubes is accomplished by placing the tube to be rejuvenated in the socket and the adjustment of the filament voltage to the baking value, 4 volts being correct for the '99- and '20-type tubes, and 7 volts for the A-type tubes. The phone plug is placed in the phone jack nearest the socket which disconnects the voltmeter and applies the flashing potential of 12 volts for the '99- and '20-type tubes. The other jack disconnects the voltmeter and applies the flash voltage of 17.5 for the A-type tubes.

"The line voltage may be checked by turning the voltage switch to the 5-volt tap and reading the meter. By testing the line voltage at various times a reading can be obtained which will represent 110 volts. Any variation above or below will indicate a similar change in line voltage proportional to the voltage being read on the meter.

"A duplicate phone plug was made from a piece of 1/4" brass rod threaded on one end to take a rubber binding post top and the opposite end turned to the shape of a phone plug. To facilitate construction the wiring diagram is drawn as the instruments appear from the back of the panel, but the operating instructions are given as the instruments appear from the front.

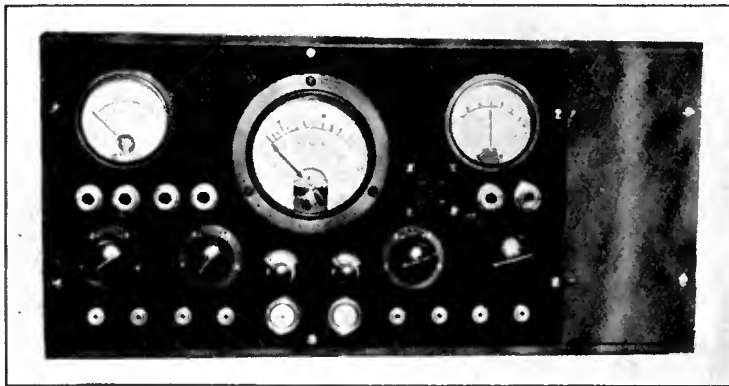

Front panel view of the home-made test set described by Mr. Taylor.

of 2.5 volts. The plate voltage is supplied by a tapped resistor across the 110-volt leads. The switch below the socket controls the filament voltages, 1 for 2.5 volts, 2 for 5 volts, 3 for 7.5 volts, and 4 for 10 volts. The rheostat is connected in the circuit to give closer regulation of voltage.

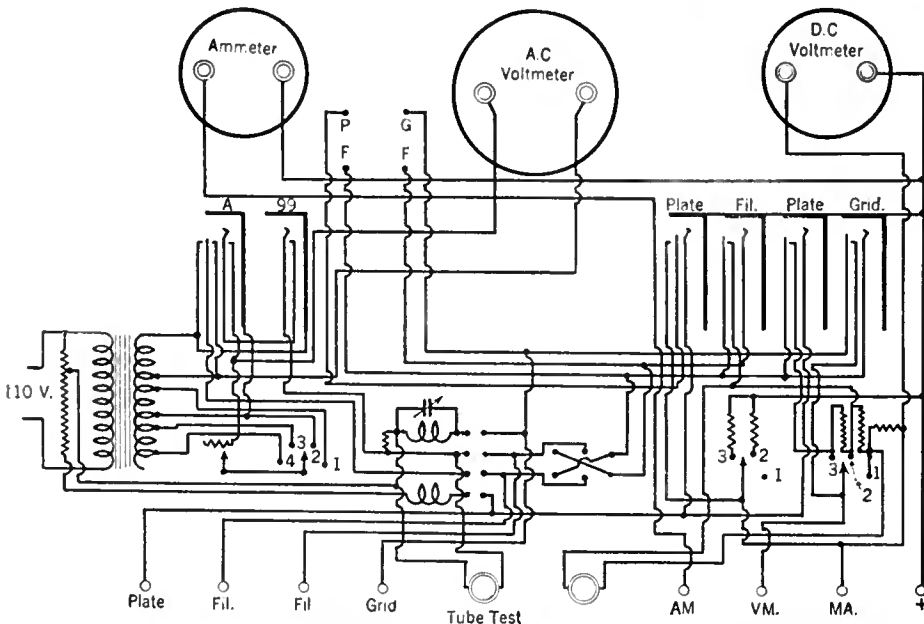

Complete wiring diagram of Mr. Taylor's test set.

What Every Radio Dealer Should Know About His Tube Business

By J. J. STEINHARTER

President, Cable Radio Tube Corporation

IN 1927, 30,000 dealers sold 33,662,247 tubes—an average of 1123 tubes per dealer.

In 1928, 31,000 dealers sold 61,552,846 tubes—an average of 1985 tubes per dealer.

In 1929, 39,000 dealers will sell 100,000,000—an average of 2564 tubes per dealer!



1927 sales
33,662,247



1928 sales
61,552,846



1929 sales
100,000,000
(estimated)

Courtesy "Radio Broadcast"

The tube business is growing—more sets, more tubes per set, new type tubes, more tube sales per dealer. Are you getting your share?

Of course, half the story is in the line you carry.

Is It A Quality Line?

Speed tubes are triple-tested . . . first quality tubes. Made by a company making tubes since 1924. Speed executives served an apprenticeship of over 20 years in incandescent lamp manufacture.

Is It A Complete Line?

Speed tubes include types 201A, 199, X140, WD11, WD12, 200AA, 112A, 171A, 171AC, 245, 210A, 250, 226, 227, 280, 281, 224AC.

Is It A Progressive Line?

Speed had a 224AC type in 1928. Speed's 227 has been perfected to heat in 5 seconds—by test. Speed adopted solid carbonized plates months ago.

Speed's new manufacturing equipment is the very latest and best. Speed raw materials are A1.

Is It A Well-Advertised Line?

Speed tubes are advertised in full pages in the *Saturday Evening Post* . . . in all the leading trade and fan radio magazines . . . in great newspapers from coast to coast . . . with direct mail, counter cards, window displays, and every dealer help.

Is It A Profit Line?

Speed's quality makes for satisfaction, sales, and resales. Speed's return policy is most liberal. Speed's discounts are right. Speed is the tube for profit.

Remember, 100,000,000 tubes this year! Get your share—handle the right line. Franchises are going fast.

As we say in consumer advertising, "Step Right Up And Call For Speed."



J. J. STEINHARTER



CABLE RADIO TUBE CORPORATION

84-90 N. NINTH ST., BROOKLYN, N. Y.

MAKERS OF RADIO TUBES
SINCE 1924

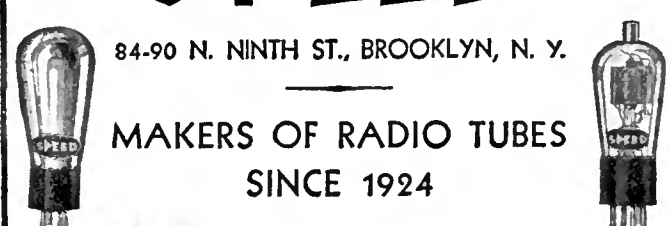

FROM THE FAINTEST WHISPER...



TO THE
MIGHTIEST
VOLUME

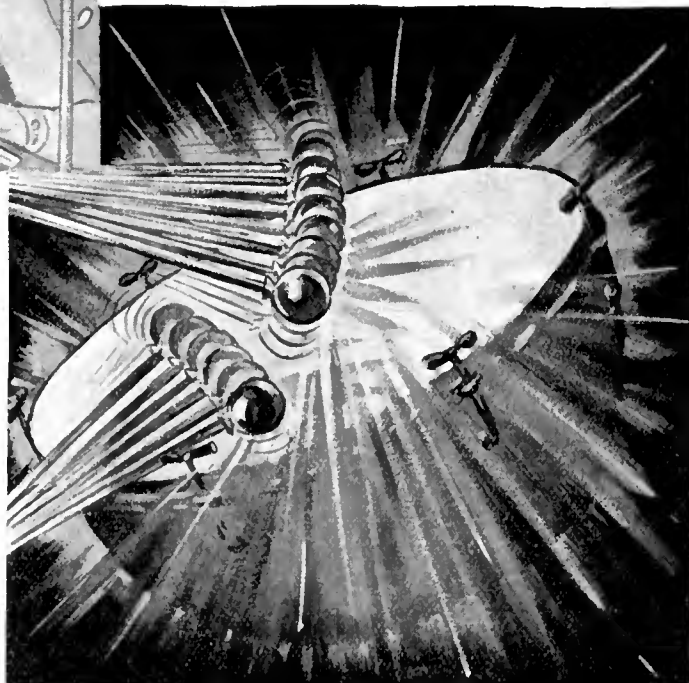

the Webster Electric Pick-up Reproduces Perfectly!

OVER the entire range of recorded music . . . from the faintest soprano inflection to masterful passages on the tympany . . . the Webster Electric Pick-up reproduces faithfully. This fidelity of tone, this ability to capture the most delicate harmonies and intonations of voice and instrument, has won for the Webster supremacy in its field.

As a result of Webster's supremacy in everything that counts in an electrical pick-up, its dealers have enjoyed a profitable success with it everywhere . . . a success based on tremendous public demand.

The public wants the Webster Pick-up because it alone embodies all those fea-

tures that mean true tone quality. Every part in its construction is perfectly matched and balanced. Greatest travel freedom of the needle is assured by a frictionless stylus bearing. The built-in volume control in Model 2-A is a distinct Webster feature, making the unit extremely compact and easy to install.

If you have not yet investigated the sales possibilities offered by the beautiful appearance, matchless tone qualities, and precision workmanship so evident in the Webster Electric Pick-up, do so today. Many leading jobbers have already placed orders for their stocks.

Order direct if your jobber has not received his.

WEBSTER ELECTRIC COMPANY, Racine, Wisconsin

Webster
W Electric Pick-up



The New Webster Model 2-A includes Pick-up head, supporting arm, built-in volume control and adapters. List Price \$17.50.



The Webster Electric Theater Pick-up for use with 16" records. Two Models—Standard and Low Impedance. Model 2-D \$25.00. Model 2-D-1 \$30.00. Matching Transformer \$6.50.



Pick-up head, Model 2-B. Both models readily adaptable to either battery operated or A. C. sets.

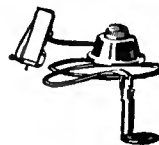

Model 2-B includes Pick-up head, separate volume control, and necessary adapters. List Price \$13.00.



STRAYS from THE LABORATORY

Regarding Band-Pass Circuits

A letter addressed to the engineers of a number of large receiver manufacturers recently asked the question, "Why is it that you do not recommend the use of band-pass filter circuits in your receivers?" The general opinion seemed to be, to judge from the replies, that such circuits were more expensive than simple resonant circuits and the result secured therefrom did not pay. In this connection it is interesting to quote from a recent communication from Dr. F. K. Vreeland.

"It is possible to convert one of the popular-priced and widely-sold radio receiving sets into a band receiver at a cost of only thirteen cents. All that is necessary in such an operation is the removal of several feet of wire. Of course, this is but one of several possible applications of one element in the Vreeland system, and is cited merely as an answer to the question of the added cost involved in the use of the band receiving system. No doubt, in production this small item could probably be reduced materially."

Efficiency of Crystal Control

DR. J. H. DELLINGER of the U. S. Bureau of Standards is authority for the following figures giving the efficiency of crystal control of transmission frequency: the usual broadcasting station frequency is maintained accurate within one part in 1000; with constant-temperature crystal control the accuracy of adjustment and maintenance may be within a few parts in 100,000; with extraordinary efforts the frequency can be maintained to within one part in 10 million.

Data on Pentodes

We are still keeping in mind the interest in the pentode tube in Europe, and the growing interest in this country in tubes of greater efficiency for the power stage. The curves in Figs. 1 and 2 are published through the courtesy of the manufacturers of Igranic output transformers designed for use between pentode tubes and their

corresponding loud speaker loads. The curves show the characteristic obtained by working a pentode (Mullard PM 24) into various resistive loads with various turns ratios in the transformer.

The curves show that reasonably good fidelity may be secured from such tubes and transformers. One point upon which we hope to have data soon is the purity of the output obtained from such tubes. Whether or not the output has a high percentage of harmonics is the question that may ultimately decide whether pentodes will be used in this country.

Eight Good Slogans

The following lines appear on the margin of the circular describing the 1929 Standards Year Book of the Bureau of Standards. They are good slogans:

Standardization—Keynote of Industrial progress, Science—the Guide of Industry.
Standardization—Essential to Mass Production.
Measurement—The Master Art.
Standardization—A Basis of Efficiency.
Standardization touches every human activity.
Standardization is an active continuing process.
Standardization applies New Experience and Science.

Engineering Limits

An article is being prepared for RADIO BROADCAST which will discuss the problem of the engineering limits to be imposed upon broadcast receivers. That is, should a receiver be held within a five-to-one ratio in overall sensitivity, or is a closer limit desirable? In the meantime it is interesting to note that two engineers representing fairly large set manufacturers feel that a two-to-one variation in sensitivity is about all that can be expected in production—that is, receivers between the limits of 4 to 8 microvolts per meter in sensitivity would be passed out of the production department. In this regard we wonder how many manufacturers have the courage to reject sets which have too great sensitivity? Certainly it was common practice not so long ago for manufacturers to pick out the best sets for members of the firm, influential jobbers, etc.

One engineer suggests that the best

method of setting production limits is to push about 1000 sets through under careful supervision, and to measure the receivers and therefrom set the production limits. It would be interesting to the Editors to have other engineers' ideas on this matter.

New Government Books

Research Paper No. 70 of the Bureau of Standards is entitled "Some Observations of Short-Period Radio Fading" and details the work of T. Parkinson, associate physicist. It is a reprint from the *Bureau of Standards Journal of Research*.

The 1929 edition of the *Standards Year Book* may be obtained from the Superintendent of Documents for one dollar. Its contents includes chapters on the standardization of weights and measures; standardizing the calendar; international, national, and federal standardizing agencies; a bibliography, etc. It is the third edition of this invaluable book.

Cost of Quartz Crystals

A letter from S. J. Wise & Co., 47 Rue Nationale, Antwerp, Belgium, encloses the prices of crystal control apparatus made by this concern. Quartz crystals can be supplied for wavelengths from 35 meters to 500 meters at prices varying from \$8.00 for 3 per cent. precision to \$16.00 for 0.1 per cent. precision. For wavelengths above 500 meters the crystals cost \$7.50 for 3 per cent. precision and \$15.00 for 0.1 per cent. precision. Crystal blanks can be supplied at \$4.50 for thicknesses varying from 0.5 millimeter to 5 millimeters.

Radio Sets for the Farm

WE ARE glad to quote from a letter from J. C. Gilbert, specialist in market news and radio of the Department of Agriculture, who read our recommendation that set manufacturers get busy on a cheap economical battery operated receiver for rural communities (page 144, July, 1929, RADIO BROADCAST).

"I wish to congratulate you on having
(Concluded on page 364)

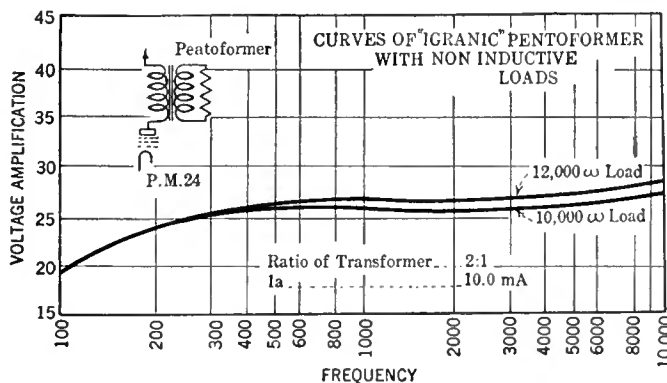

Fig 1.

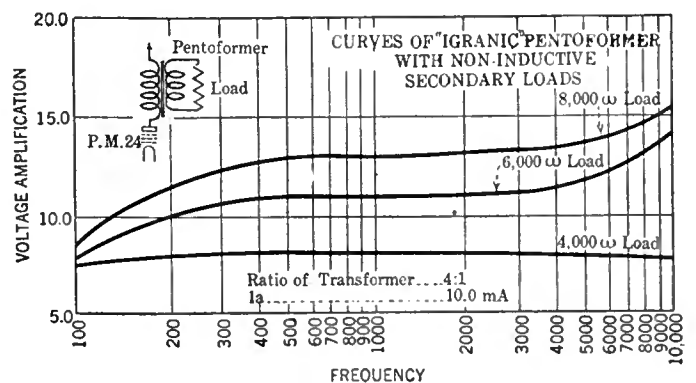

Fig. 2.

GRID-LEAK VS. BIAS DETECTION

By J. M. STINCHFIELD

Engineering Department, E. T. Cunningham, Inc.

MANY RECENT advances in the theory of detection of a modulated r.f. carrier have given the development engineer a good theoretical basis for improving the performance of the detector stage in radio sets. The work of Carson, Llewellyn, Chaffee, and Ballantine in this country, and of Colebrook in England, was of fundamental importance. The relation of tube and circuit components has been investigated and the influence of these factors on the performance of the detector stage has been indicated.

The theory indicates the following factors to be of importance in the design of the detector stage.

Grid-leak Detection

(1) The modulated r.f. voltage is applied from a resonant circuit through a grid condenser to the grid and cathode terminals of the tube. A loss of r.f. voltage will occur in the grid condenser. Usually this loss is determined principally by the effective input capacity of the tube to r.f. and the capacity of the grid condenser.

(2) Rectification takes place in the grid circuit due to the change in slope (where the action is essentially that of high-vacuum electron conduction) of the grid-current grid-voltage curve. Small internal grid resistance and small external grid-circuit impedance to the r.f. increase the rectification. The grid resistance is that due to electron conduction and is entirely analogous to plate resistance. The tuned r.f. input circuit will be damped some depending upon the grid resistance of the tube and to a less extent upon the grid-leak resistance. This will affect both the gain and selectivity from the r.f. stage.

(3) Among the rectified components will be direct current and audio frequencies. The direct-current component of the rectification will flow through the grid leak producing a small change in the effective d.c. bias voltage. In traversing the grid circuit the audio frequencies will encounter the high impedance of the grid condenser and the high resistance of the grid leak. The tuned r.f. circuit obviously offers negligible impedance to the audio components. The audio-frequency voltage developed between the grid and cathode terminals, due to the impedance of the grid leak and condenser combination, are amplified by the tube in the usual way. When considering the plate circuit load impedance of an amplifier tube, a load impedance that is much larger than the tube's internal plate resistance at all frequencies will give uniform output. Since nearly all of the voltage in the circuit is developed across the load, no change can occur as the load impedance changes with frequency. In the same way, when the a.f. load in the grid circuit is high at all frequencies with respect to the tube's internal grid resistance, the voltage across the load will be independent of frequency.

The a.f. input capacity of the tube must be added to the grid condenser capacity when calculating the impedance.

(4) The tube will also amplify the r.f. This r.f. in the plate circuit will produce some plate-circuit detection, depending upon the change in slope of the plate-current curve. The plate detection is

plate load, removing the plate-filament by-pass condenser had a negligible effect on the output when the r.f. input was supplied by a potentiometer, but when supplied by a tuned stage the voltage gain in the r.f. stage was changed from 7.4 to 3.1. The r.f. amplifier was a c-327 giving a gain of 10 when feeding a biased detector.

The r.f. bypass and an r.f. choke in the plate circuit also help to prevent the r.f. from loading up the audio amplifier and from being radiated back to the input. If the impedance of the r.f. bypass at the highest a.f. is not several times larger than the impedance of the a.f. load and the tube resistance, the output at higher audio frequencies will be reduced.

Bias Detection

(1) When the grid is biased negatively beyond the point at which grid current begins to flow, no rectification will occur in the grid circuit. The modulated r.f. voltage applied to the grid and cathode terminals is amplified by the factor μ and appears in the plate circuit. The rectification takes place in the plate circuit. Since the amplification factor is not absolutely constant, particularly in the region of the plate-current cut-off, some non-linear amplification results. This increases the rectified a.f.

(2) Small internal plate resistance and external plate circuit impedance increase rectification. The external plate-circuit impedance can be kept low to r.f. by a by-pass condenser connected between the plate and cathode terminals. This also helps to maintain a high input impedance in the grid circuit by reducing feedback through the grid-plate capacity.

The rectification produces a number of component frequencies which include direct and a.f. currents. If the d.c. resistance of the plate circuit load is high there will be an appreciable decrease in the effective d.c. plate voltage. The a.f. voltage output will depend upon how large the a.f. load impedance is with respect to the internal plate resistance of the tube. The r.f. bypass may reduce the load impedance at the higher a.f.

In the following the overall performance characteristics of some tube types widely used as detectors are compared.

Fig. 1, shows a comparison of a CX-301A tube and a c-327 tube operated in a grid-leak detector circuit. The voltages and the circuit constants are favorable to both types. It is evident that the detector sensitivity is greatest with the c-327. The lower curve of Fig. 1 shows the a.f. output of the c-327 as a bias detector. The load of the biased detector in this figure was a 150-henry choke shunt by an 0.25-megohm resistor and an 0.0001-mfd. condenser. The other detectors looked into an Amertran DeLux first-stage transformer.

The sensitivity, i.e., the a.f. output for any given r.f. input,

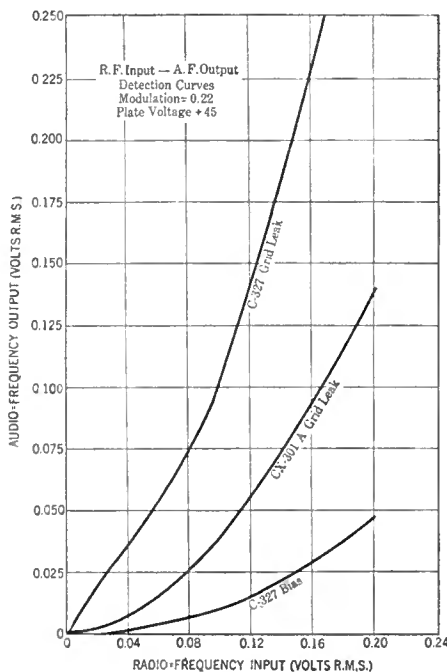

Fig. 1

nearly in phase opposition to the grid detection, though usually much smaller in magnitude, so that a small decrease in the audio output results. A by-pass condenser for the r.f. is usually connected from plate to cathode. While this tends to increase the plate rectification, it has a large effect in reducing the input capacity and increasing the input resistance resulting from feedback through the grid-plate capacity. For example, with a c-327 grid-leak detector and a 50,000-ohm resistance

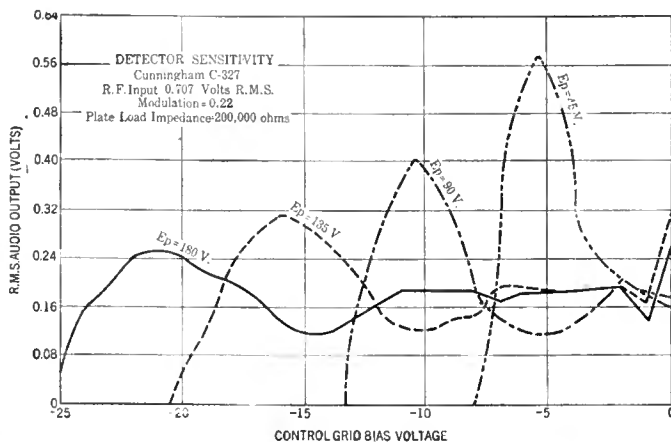

Fig. 2

is greater for the grid-leak detector than for the biased type. Increasing the number of a.f. stages or r.f. stages in receivers increases greatly the problems of stability and fidelity. Due to this fact, and to the desire to get weak or distant stations, the grid-leak detector has been universally popular in the past. The trend toward high-quality, low-ratio audio transformers, and power tubes requiring large signal input voltages has increased the output required from the detector. Improvements in the r.f. amplifier have been toward more selectivity and better fidelity, which involved more tuned stages and incidentally more amplification.

The use of the screen-grid tube increases greatly the stable r.f. amplification. All of these factors put higher input and output demands on the detector.

The grid-leak detector at normal recommended operating voltage shows a rapid falling off in output when the signal exceeds a few tenths of a volt. The operating range may be extended some by adjustment of voltages and circuit constants. The higher voltages required for increased output, increase greatly the internal dissipation, and at the same time increase the possibility for gas and grid emission. Also, the high resistance in the grid circuit tends to aggravate this condition. At the voltages most favorable to grid-leak detection the grid-cathode input resistance is so low that the performance of a preceding stage of tuned r.f. amplification is greatly impaired.

The bias detector has not been popular in the past because of low sensitivity. It is, however, well adapted for use with larger signals. It is readily adapted to any range of operation by increasing both the grid-bias and plate voltages. The plate current and internal dissipation is so small that the c-327 tube with a maximum rating of 180 volts as an amplifier may be operated at a plate voltage of 250 volts (maximum) provided the d.c. plate current with normal maxi-

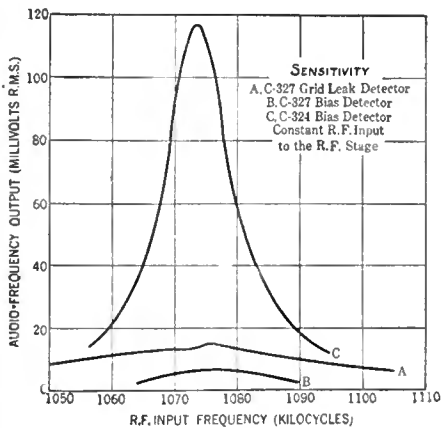

Fig. 6

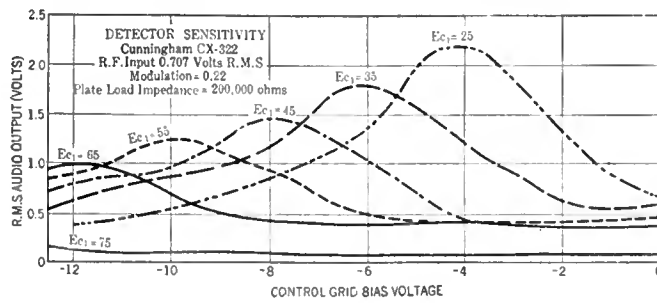

Fig. 3

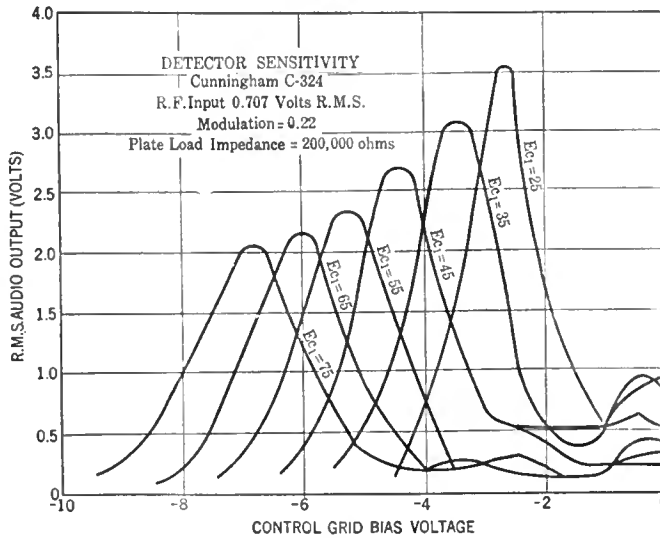

Fig. 4

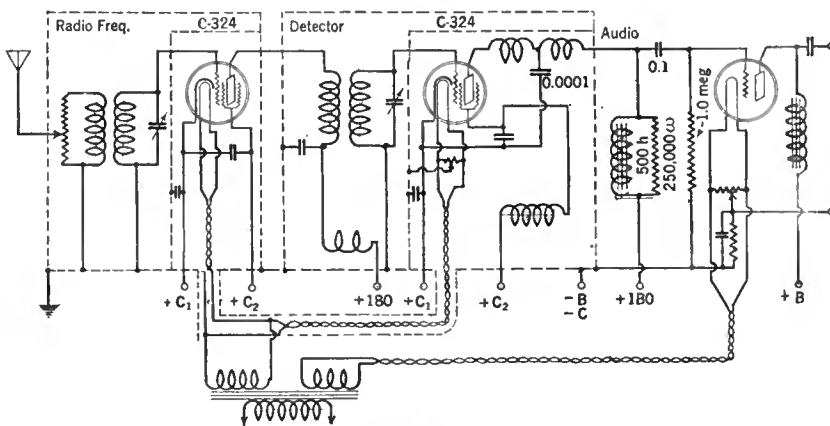

Fig. 5

imum signal does not exceed 5 mA. The selectivity and gain in the preceding r.f. stage are not reduced by the bias detector.

There are other advantages of a high-output detector. Small a.f. disturbance such as microphonic noises or a.c. hum, become negligible with low gain a.f. amplification. Improved a.f. characteristics are obtained with a simplified and less expensive a.f. amplifier. The effects of stray coupling between the power pack and the audio stage are less.

The detector sensitivity characteristics of a c-327 bias detector are shown in Fig. 2. A signal of 0.7 volt r.m.s. was maintained on the grid. The a.f. output is plotted against C-bias voltage, for several plate voltages. These curves show that there is a decrease in sensitivity as the plate voltage is increased. They also show the best bias voltage for a given plate voltage. The range of bias voltages for peak sensitivity in several tubes were within one volt. At the higher bias voltages, the shift in sensitivity for several tubes operated at a fixed bias was not great enough to create a decided preference for any one tube. On the negative side the detector sensitivity curve falls rapidly to zero. The plate current is

approaching cut-off and the internal plate resistance becomes high. The positive side of the detector sensitivity curve gives more uniform sensitivity and a lower plate resistance.

The best operating condition for small signals would be slightly on the positive side. This would give best a.f. fidelity consistent with high sensitivity. A low plate voltage increases sensitivity, but decreases uniformity of performance between individual tubes. As the signal amplitude is increased there is some change in sensitivity. No serious overloading or objectionable distortion occurs until the signal amplitude has exceeded the point at which grid current begins to flow. The signal amplitude can be extended somewhat into the grid-current region before an actual decrease in a.f. output occurs. At this point the harmonic distortion rises rapidly. Continued increase of signal amplitude may reduce the a.f. output to zero.

Operating Characteristics

Up to the grid-current point the variation of a.f. output with r.f. input usually is found to follow a law somewhere between the first and second power, that is, between square-law and linear detection. The per cent. distortion decreases as a linear law is approached. Beyond the grid-current point the output falls below a linear law and distortion increases rapidly. Damping of the r.f. input stage begins at the grid-current point. This would seem to be the upper limit which the signal peak should not exceed for best results. The maximum signal limit may be increased somewhat for a given plate voltage by increasing the bias. Biasing beyond the plate current cut-off may badly distort small signals.

The increase of d.c. plate current with signal causes a loss of d.c. plate voltage if the resistance of the load is too high. The plate voltage should be high enough to avoid this condition, especially when

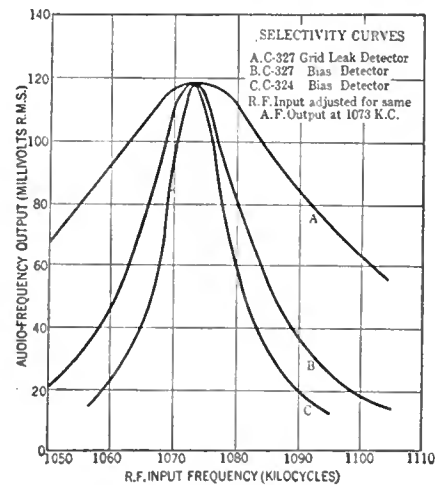

Fig. 7

the detector is biased by its own plate current. In calculating overloading of this type the peak a.c. voltages on the grid and plate must be considered in addition to the changes in d.c. voltage. The grid voltage goes positive from the dynamic d.c. operating point by the amount of the amplitude of the modulated carrier voltage. At the same time the instantaneous plate voltage may swing below the dynamic d.c. point by the amount of the audio peak output voltage. To avoid overload distortion the minimum instantaneous plate voltage should always be greater than the maximum instantaneous grid voltage. When a screen-grid tube is used the minimum instantaneous plate voltage should always be about ten volts above the screen-grid voltage to avoid distortion. This type of overloading may be avoided easily by a suitable choice of operating voltages.

The desire to realize the full advantage of the high-output detector has, in some instances, resulted in operation too near the overload point. While it is entirely practical to eliminate the first a.f. stage, the use of a low-gain a.f. stage permits operation well below the overload point. Since it is difficult to design an a.f. transformer that will give high-quality reproduction with a biased detector, impedance coupling is preferable. The first a.f. stage may be coupled through a relatively inexpensive yet high-quality, one-to-one-ratio a.f. transformer to a single or push-pull power stage. In this way the overload capacity of the detector and a.f. system may be increased greatly, especially with the push-pull power stage.

Plate Vs. Bias Voltages

Plate voltages and corresponding bias voltages satisfactory for the type c-327 tube as a bias detector are:

Plate Voltage	Bias Voltage
45.0	-5.0
90.0	-10.0
135.0	-15.0
180.0	-20.0
250.0 (max.)	-30.0*

*The 250-volt maximum is recommended only when, with normal maximum signal, the d.c. plate current does not exceed 5 mA.

High-Output

Figs. 3 and 4 show detector sensitivity curves for types cx-322 and c-324. Bias detection is recommended as most satis-

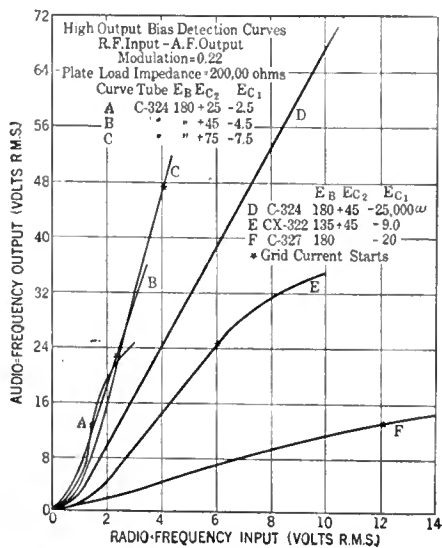

Fig. 10

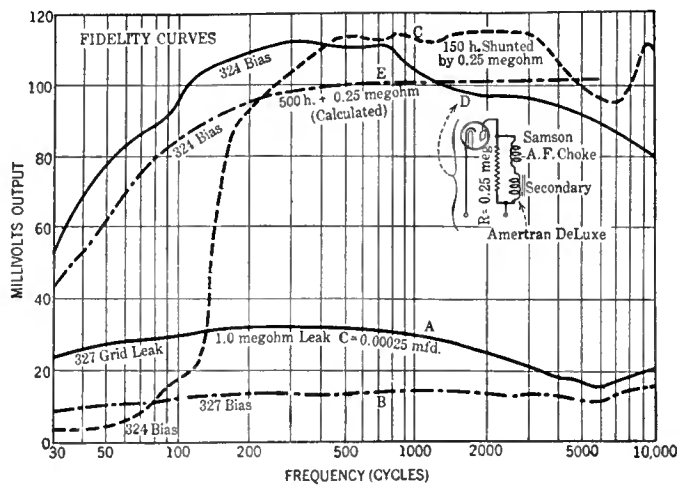

Fig. 8

factory with either tube. The screen-grid types combine the advantages of sensitivity and high output. Radio-frequency inputs of a few volts can be applied without overloading. Outputs large enough to operate a cx-345 directly from the detector are readily obtained.

To show the actual performance of the detector stage the signal was applied to a c-324 r.f. stage with the tuned secondary of the r.f. transformer coupled to the de-

shunted by a 0.25-megohm resistor. The plate-cathode r.f. bypass was 0.0001-mfd. The characteristic is uniform except for the large loss below 200 cycles. The use of a 500-henry choke shunted by a 0.25-megohm resistor is recommended as a satisfactory load for the c-324 bias detector. A choke employing a series of pie windings to reduce distributed capacity is preferable. One that does not saturate with 1.5 to 2.0 milliamperes is adequate.

Input-Output Characteristics

In Fig. 9 the a.f. output voltage is plotted against r.f. input voltage for the c-327 tube operating as a high-output bias detector. The modulation was 22 per cent. and the plate load was 200,000 ohms.

Fig. 10 shows the input-output characteristics of several tubes operating as high-output bias detectors. Curves A, B, and C are for the c-324 tube with screen-grid potentials of 25 volts, 45 volts, and 75 volts, and bias potentials of -2.5 volts, -4.5 volts, -7.5 volts, respectively. The plate supply was 180 volts, the load impedance 200,000 ohms, and the modulation 22 per cent. Curve D shows the output from the c-324 self biased by its plate current through a 25,000-ohm resistor. Curve E shows the output from a type cx-322 tube at 180 volts on the plate, 45 volts on the screen-grid, and -9.0 volts of grid bias. Curve F is for the c-327 at 180 volts on the plate and -20.0 volts grid bias. The points at which grid current starts to flow (for 22 per cent. modulation) are marked.

Fig. 11 shows the output obtainable (Concluded on page 364)

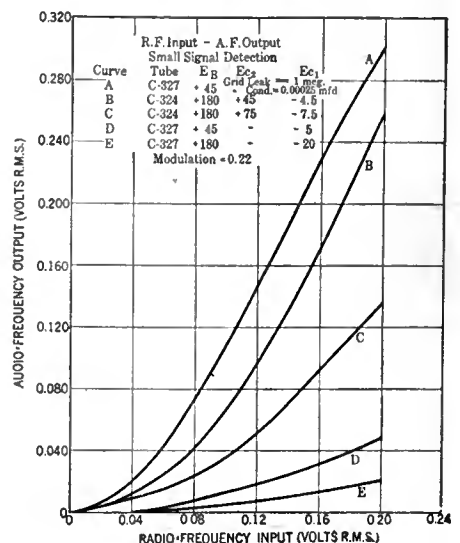

Fig. 11

tor, as in Fig. 5. The detector plate load impedance was 200,000 ohms. (power factor 0.96; d.c. resistance 3000 ohms.)

In Fig. 6 the sensitivity with the c-327 grid-leak detector is shown by curve A. Curve B shows the sensitivity with the c-327 bias detector, and curve C with the c-324 bias detector. All three curves were obtained with the same signal at the input to the r.f. stage. It is evident that both the sensitivity and selectivity is decidedly superior with the c-324 tube. The difference in selectivity is shown best in Fig. 7. The operating conditions are the same as for Fig. 6, except that the r.f. input was increased until the same a.f. output was obtained at resonance. If a horizontal line is drawn through these curves at 0.5 of the maximum ordinate, the frequency width between intercepts on this line is a measure of the selectivity. The width of curve A for the c-327 grid-leak detector is 57 kc. For curve B, the c-327 bias detector, the width is 22. kc., and for curve C, the c-324 bias detector, the width is 12.5 kc. The load in Figs. 6 and 7 consisted of five Amertran 854 type choke coils in series, and shunt by an 0.25-megohm resistor and an 0.0001-mfd condenser.

The fidelity characteristics are shown

THE EDISON MODEL C-1

Two 250-type tubes in push pull are used in the output circuit of this receiver. Field supply for the dynamic loud speaker is obtained from the filter system. The circuit shows the switch

controlling the connections to a phonograph pick-up unit. One detail which is not shown in this diagram is a grid suppressor connected in the grid circuit of the third 226-type tube.

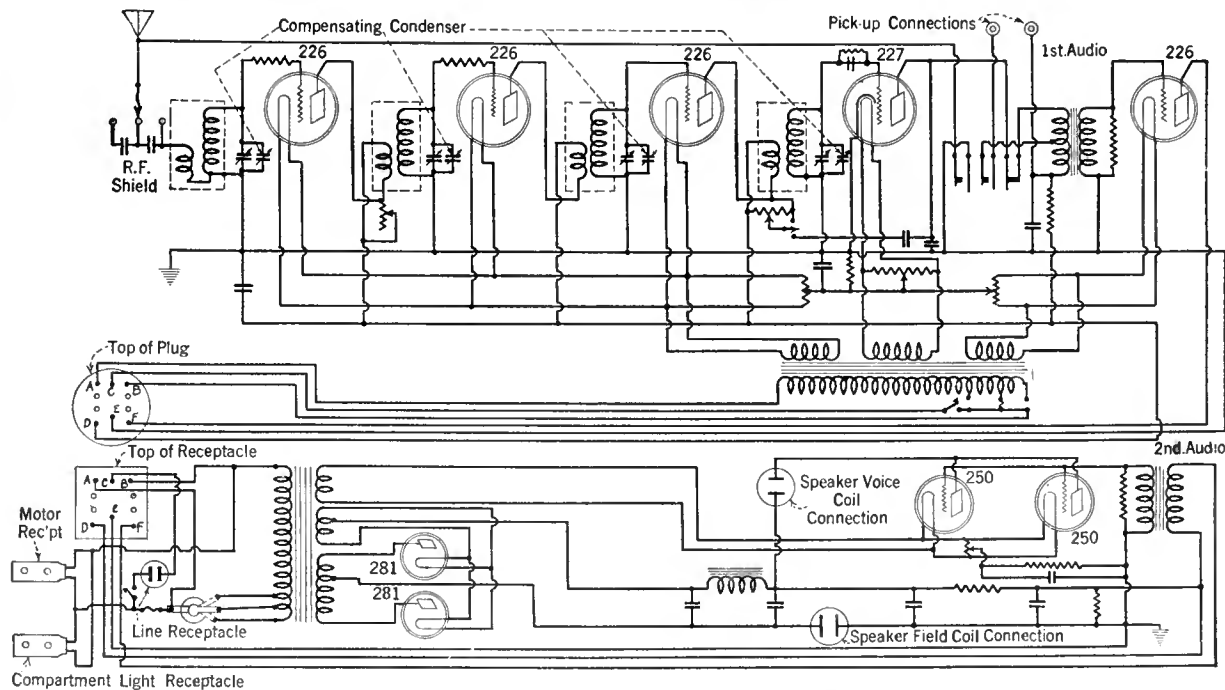

THE STEINITE MODEL 40

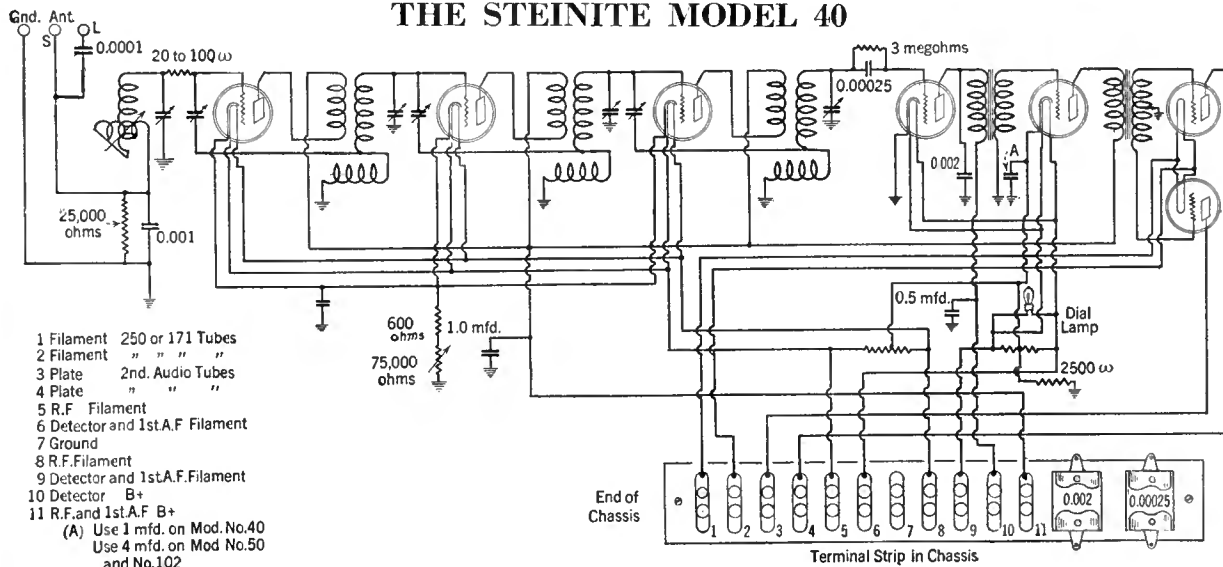

- 1 Filament 250 or 171 Tubes
 - 2 Filament " " "
 - 3 Plate 2nd. Audio Tubes
 - 4 Plate " " "
 - 5 R.F. Filament
 - 6 Detector and 1st.A.F. Filament
 - 7 Ground
 - 8 R.F. Filament
 - 9 Detector and 1st.A.F. Filament
 - 10 Detector B+
 - 11 R.F. and 1st.A.F. B+
- (A) Use 1 mfd. on Mod. No.40
Use 4 mfd. on Mod. No.50
and No.102

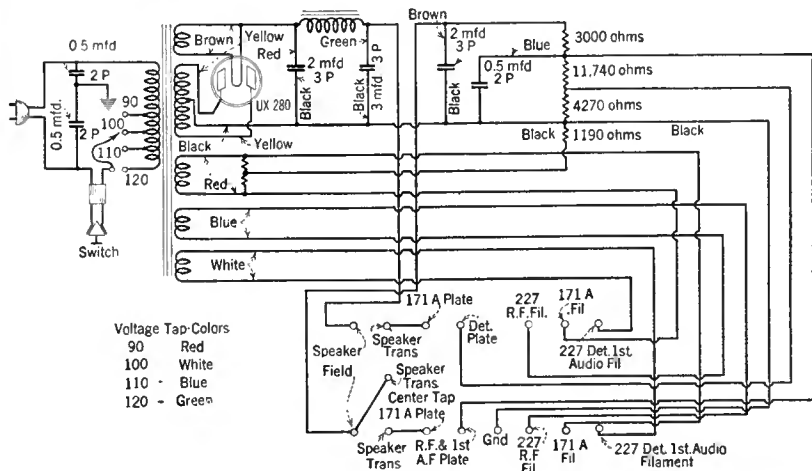

- Voltage Tap-Colors
- 90 Red
 - 100 White
 - 110 Blue
 - 120 Green

A six-tube receiver using a rather interesting arrangement for maintaining resonance between the first and other tuned circuits. The power unit is of conventional design using a 280-type full-wave rectifier. The power transformer primary is tapped at four points to permit satisfactory line voltage control from 90 to 120.

AUTOMATIC VOLUME CONTROL

By VIRGIL M. GRAHAM

Radio Engineer, Stromberg-Carlson Telephone Manufacturing Company



Virgil M. Graham

A SCREEN-GRID receiver is generally considered as one employing at least two screen-grid tetrodes in a radio-frequency amplifying system. The automatic volume control feature is a circuit arrangement which maintains the signal level at the detector practically constant, when, of course, the received signal is above a certain minimum value.

The R. F. Amplifier

The radio-frequency amplifying system of the Stromberg-Carlson No. 816 Receiver is very similar to that employed in the receiver described by the writer in August, 1929, RADIO BROADCAST. Therefore, only the portions of the r.f. amplifier that have been changed or that have to do with the addition of the automatic volume control circuit will be discussed here. Fig. 9, the complete schematic circuit of the receiver, illustrates the arrangement of the r.f. amplifier. It will be noted that a grid capacitor and resistor are included in the control grid circuit of each radio stage. This arrangement allows the bias voltages to be supplied to these control grids without disturbing the ground connections on the "low" sides of the secondaries of the r.f. transformers.

The control-grid biases of the first two r.f. tubes are obtained from two sources. The minimum values are determined by the IR drop in the resistors connected in series with the cathodes of these tubes. These minimum biases are connected in series with the voltages supplied by the automatic volume control circuit (which are, of course, zero when no signal is being received). The function of the automatic volume control circuit will be described in a later portion of this discussion. The control-grid bias for the third r.f. amplifier is obtained from the voltage drop across the cathode resistor only, as the automatic control does not operate on this stage.

Automatic Volume Control

The automatic volume control circuit consists of a 227-type tube with the necessary resistors and capacitors as shown in the schematic circuit. The function of this arrangement is to supply bias voltages to the first two r.f. amplifier tubes, the voltages being proportional to the strength of the received signal. These biases, increasing as the signal strength is increased, keep the r.f. voltage practically constant at the detector grid.

The grid of the volume-control tube is coupled to the plate of the last r.f. amplifier tube through an 0.00025-microfarad capacitor. This arrangement allows the proper radio voltage to be supplied to the control tube without getting the effect of the whole input capacity and losses of this tube in the tuned secondary of the last r.f. transformer. The turns ratio of the transformer being close to 1:2, the effect of this capacity and loss will be re-

duced to approximately one quarter when reflected into the tuned secondary circuit. This amount, of course, is negligible. Bias voltage is fed to the grid of the control tube through a 2-megohm resistor.

The plate circuit of the control tube consists of two 100,000-ohm resistors in series, with a 0.5-microfarad capacitor between the plate and ground to bypass the radio-frequency current and to prevent it from feeding back to the control grids of the r.f. amplifier. The voltage drops of the plate current in the two 100,000-ohm resistors are used to supply the "controlling" biases to the grids of the first two r.f. amplifiers. The bias of the first r.f. tube is secured from across both resistors and that to the second r.f. tube is obtained from across one resistor only. Thus, the "controlling" bias on the first r.f. amplifier is twice that of the second. This plan is followed because the signal voltages are greater on the second r.f. amplifier than on the first, so that the second cannot have as high a control-grid bias (when these biases approach the cut-off points of the tubes) if overloading is to be avoided. These "controlling" biases are, as mentioned above, in series with the minimum biases supplied by the cathode resistors.

The grid bias of the control tube is fixed so that with no signal there is practically no plate current flowing. When a signal of the proper value to operate the automatic control is received, sufficient r.f. voltage is applied to the grid to cause plate current to flow, the amount of plate current being in proportion to the strength of the received signal. In other words, the action is similar to that of a peak vacuum-tube voltmeter. The plate current, flowing through the 100,000-ohm resistors and varying proportionally with signal strength, gives varying control-grid biases on the first two r.f. amplifiers. These varying biases regulate the gain of these two r.f. stages. These actions, reaching an equilibrium for any strength of signal, maintain the strength of the signal at the detector substantially constant, after a certain value of input is reached.

Fig. 5. shows the relative output of the

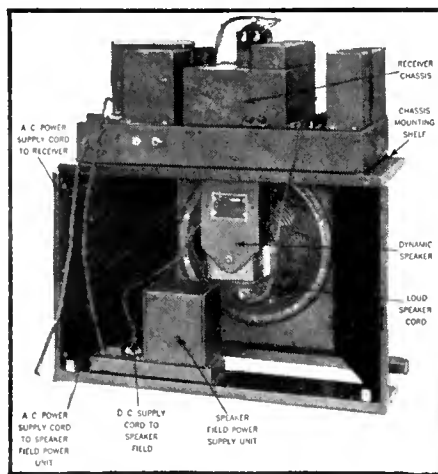

Fig. 1—The three units composing the receiver mounted on the box-type baffle. This assembly forms a complete operating unit which is placed in the housing cabinet.

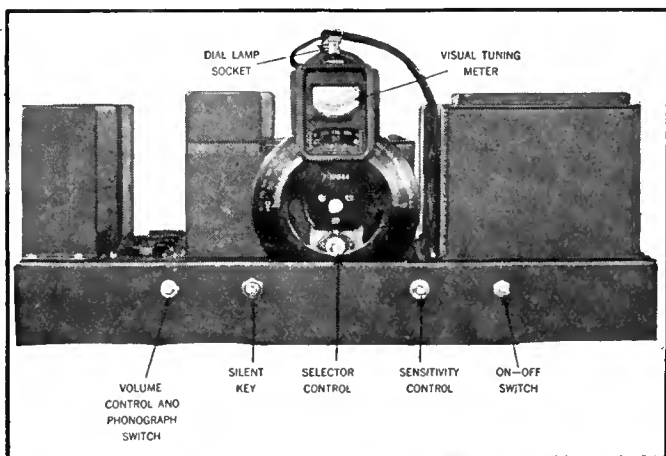

Fig. 2—Front view of chassis illustrating location of controls and the arrangement of the visual tuning meter and selector dial in one escutcheon.

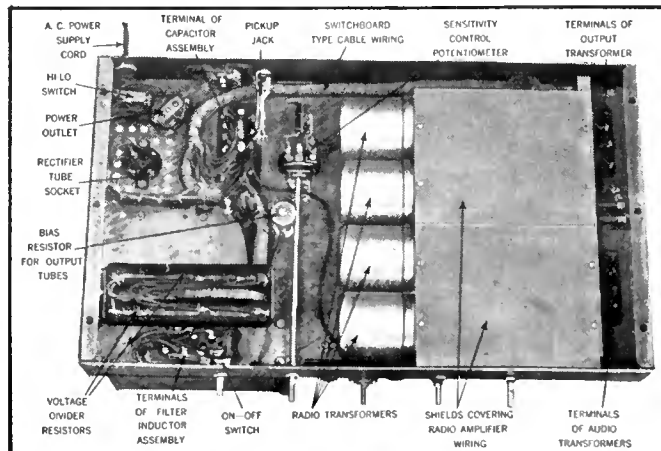

Fig. 3—Bottom of chassis showing the location of the shielding for the radio transformers and other apparatus in the radio amplifier.

receiver with variation of signal input in microvolts at the antenna terminal. This curve does not represent the absolute sensitivity of the receiver, but is used to show the action of the automatic volume control. Thus, it can be seen that after the signal input to the receiver passes 50 to 60 microvolts (at the knee of the curve), the output is practically constant up to 100,000 microvolts or one-tenth volt. Above this value of input, the first r.f. amplifier tends to overload and it is necessary to use the "sensitivity control" to reduce the input from the antenna to the r.f. amplifier. This control is discussed further in a following paragraph. The slight rise in the curve at 100,000 microvolts shows the beginning of this overloading effect. It should be remembered, however, that this value represents a very strong local signal.

The proper operation of a receiver equipped with the automatic volume control necessitates some sort of resonance indicator; that is, some means which will indicate when the receiver is tuned exactly to the carrier of the signal being received, is necessary. The resonance indicator in this receiver is a "visual tuning meter" which is connected in series with the cathode circuit of the second r.f. amplifier and operates on the plate current of this tube. When the received signal increases in strength, as it does when it is "tuned in," the automatic control bias on this tube is increased and the plate current decreases. Thus, the station received should be tuned so that the minimum indication of current is obtained. The meter is mounted in an inverted position so that the receiver is tuned for the greatest deflection of the needle which moves from left to right (in the direction of the arrow on the meter dial).

When operating this receiver, it will be found that some stations will come in with good volume without affecting the needle pointer. This is due to the high sensitivity of this receiver as shown by Fig. 6. The r.f. inputs in microvolts, shown on this graph, give a standard signal of 50 milliwatts output. Fig. 5 shows, as mentioned above, that the automatic volume control is designed so as to start to function at an r.f. input of from 50 to 60 microvolts, as this has been found to be the most satisfactory value in all respects. This indicates that quite a strong signal could be obtained from the loud speaker before the automatic volume control starts to function. Furthermore, such a signal would not give a volume in the loud speaker greater than that set by

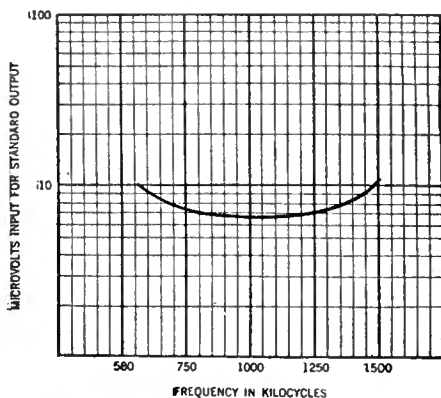

Fig. 6—Sensitivity curve of No. 846 receiver. Note that the ordinate is plotted in microvolts input and not in microvolts per meter.

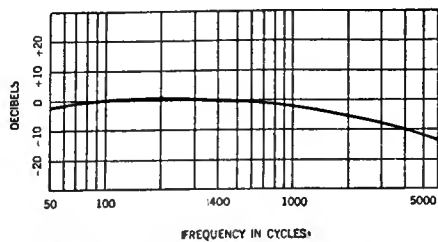

Fig. 4—Overall fidelity characteristic of chassis of No. 846 receiver.

the manual volume or level control. It should be borne in mind, however, that such signals are comparatively weak, and would not be recognized at all by many receivers.

The Power Detector

The linear power detector is of practically the same design as used in the Nos. 641 and 642 receivers, except that the grid leak and capacitor arrangement is omitted because the phonograph pick-up connec-

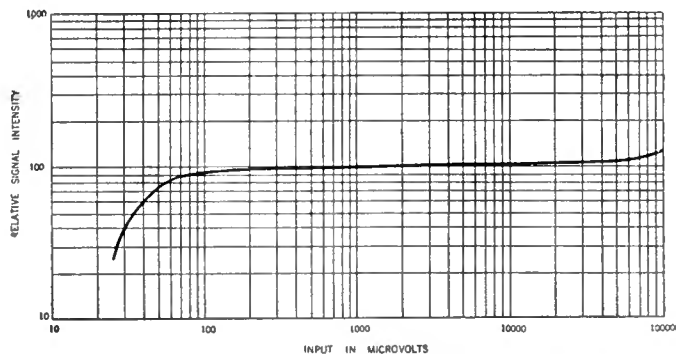

Fig. 5—Graph illustrating the action of the automatic volume control.

tion is not made to the detector grid in this receiver.

The output of the detector feeds a very high impedance 1:1 ratio audio transformer. In order to obtain maximum possible plate voltage on this tube, it is necessary to carry the cathode (in series with which is the biasing resistor) and the grid return to the negative "B" line. The negative "B" line, in this case, is "below" ground potential on account of the voltages necessary for the automatic volume control circuit, where ground is the most positive potential used. This arrangement accounts for the rather unusual bypassing in the detector circuit.

The Audio Amplifier

The audio amplifier of the No. 846 receiver consists of two stages. The first stage uses a 227-type tube, and the second or output stage employs two 245-type tubes in push pull.

The manual volume or level control, is a voltage divider across the secondary of the 1:1 input transformer, used to vary the signal voltage applied to the first audio grid. The moving contact, or lever, of this unit is connected to ground while the grid is connected to one side of the transformer (through the pick-up switch). This greatly simplifies the insulation problem and eliminates troubles due to hand capacity which would be present if the grid were connected to the moving element. The "Volume Control" in a set which provides a substantially uniform signal at the detector, must be at the input of the audio amplifier for satisfactory operation.

The pick-up switch acts so as to connect the output of the pick-up outfit to the grid of the first audio tube in place of the secondary of the first audio transformer. This

switch is actuated by turning the volume-control knob in a counter-clockwise direction as far as it will go. At this position a cam acts on the switch levers. When the pick-up switch is in position for phonograph operation, both terminals of the secondary of the audio transformer are grounded, greatly decreasing the possibility of capacity coupling of the signals from the r.f. to the audio amplifier. The push-pull input transformer is of large size, having a turns ratio of 1:3.6 on each side in order to obtain enough amplification for operation of the phonograph pick-up unit.

The Power Supply

The power supply for this receiver consists of the usual power transformer with the necessary secondary windings. There are three low-voltage windings; one for the heaters of the r.f. amplifier, first audio, and volume control tubes, one for the detector heater, and one for the power output tubes. The detector heater winding is provided with an adjustable hum balancer and the winding for the output tubes filaments has a fixed mid-tapped resistor. The remaining winding has a grounded mid-tap.

The rectifier is of the conventional 280-type and supplies current to a special two-stage filter. Each stage of this filter is equipped with the tapped inductor, which, in combination with proper capacitors, gives much better filtering action with smaller coils and capacitors than does the conventional "brute-force" type.

The B supply for the output tubes is taken from the junction point of the two sections of filter. This allows the second inductor to be made considerably smaller.

This connection also prevents "motorboating" due to coupling in the power supply between the output tubes and any of the preceding tubes as it introduces a whole stage of filter between the respective "B" supplies.

The plate voltage to the detector is supplied through a 10,000-ohm resistor connected to the output of the second filter stage. The remaining voltages are supplied from the voltage-dividers resistors and where necessary have filtering capacitors shunting the resistors.

The built-in electrodynamic loud-speaker is very sensitive and, in order

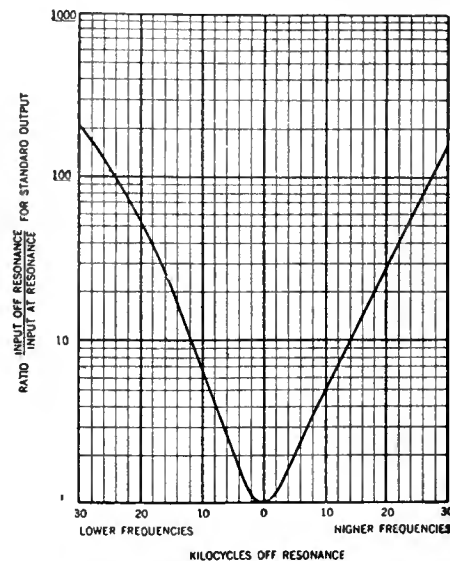

Fig. 7—Selectivity curve of screen-grid receiver with automatic volume control taken at 1000 kilocycles.

that no sacrifice of this characteristic be made due to low field excitation, a separate power supply unit is provided to furnish field current. This unit includes a power transformer, a 280-type rectifier, and a filter capacitor. The use of the extra rectifier tube allows full voltages to be applied to both the output tubes in the chassis and to the loud speaker field without overloading either rectifier.

The operation of this receiver is very simple and extremely convenient. As stated above, there is a "visual tuning meter" provided which indicates when the received station is tuned to resonance. This arrangement is essential in a receiver employing automatic volume control as when a powerful station is tuned in, the control functions to keep the volume from the loud speaker at the same level while the dial is rotated over the audible range of that station. However, it can be noticed readily that the fidelity of reproduction is correct only at the resonance point. For this reason the meter is provided in order that proper tuning can be obtained easily and accurately.

It should be remembered that the automatic volume control circuit varies the sensitivity of the receiver in proportion to the strength of signal. That is, when a strong signal is received the receiver is relatively insensitive and when a weak station is received the sensitivity is increased. Thus, when no signals are being received the sensitivity is at maximum, and when tuning from station to station the sensitivity is extremely high.

In order to achieve "silent tuning" whereby the listeners would not be an-

noyed by "static noises" picked up on account of this high sensitivity and by undesired stations, a "Silent Key" is provided. This key shorts the moving coil of the dynamic speaker through a predetermined resistance. This arrangement allows just enough signal to come through the loud speaker to let the operator know

can never be overloaded due to the action of this automatic control. Normally, the manual volume control is set for the desired room level and does not need to be touched unless a station is tuned in which has very low percentage modulation or the signal strength goes down below the value required for operation of the automatic control. In regard to the latter case it should be emphasized that such a signal is a very weak one, and on most receivers would not be "received" at all.

The "Sensitivity Control" previously mentioned is a potentiometer connected in such a manner as to vary the input from the antenna to the r.f. amplifier. This is used to reduce any extremely strong local signals which would cause the overloading effect in the r.f. amplifier (indicated in Fig. 5) when signals above 100,000 microvolts are received. In locations where there are a number of powerful stations nearby, it is advisable to keep this control partially turned down all the time, particularly when only the local stations are desired. Of course, when very distant stations are being searched for, this control should be at maximum sensitivity.

One can readily check the action of the automatic volume control by tuning in a strong signal and varying the sensitivity control. The signal from the loud speaker will not change over a wide range of movement of the dial, but the visual tuning meter will vary, indicating the different strengths of signal supplied from the antenna to the r.f. amplifier. The capacity-resistance series network between the

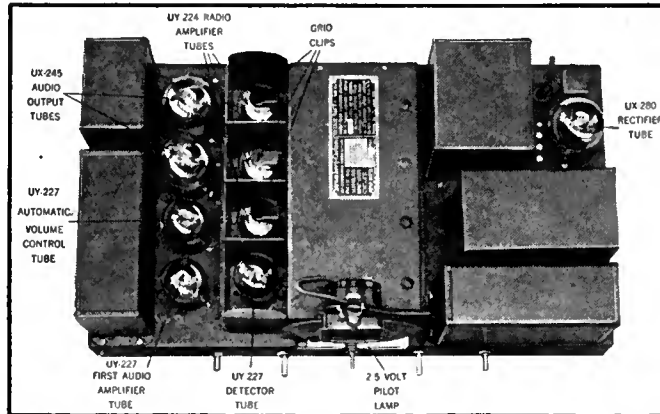

Fig. 8—Top view of chassis with cover over radio and detector tubes removed, showing the location of all the tubes and parts on the chassis.

if the carrier wave he has tuned in by the "tuning meter" is being modulated. The necessary resistance in this case is obtained by properly proportioning the lead wires to the key.

The manual volume or level control, in a receiver employing the automatic volume control circuit, must be a control to vary the signal input to the audio amplifier as the signal level at the detector is practically constant when the received signal is at or above the value that actuates the automatic control. Of course, the detector

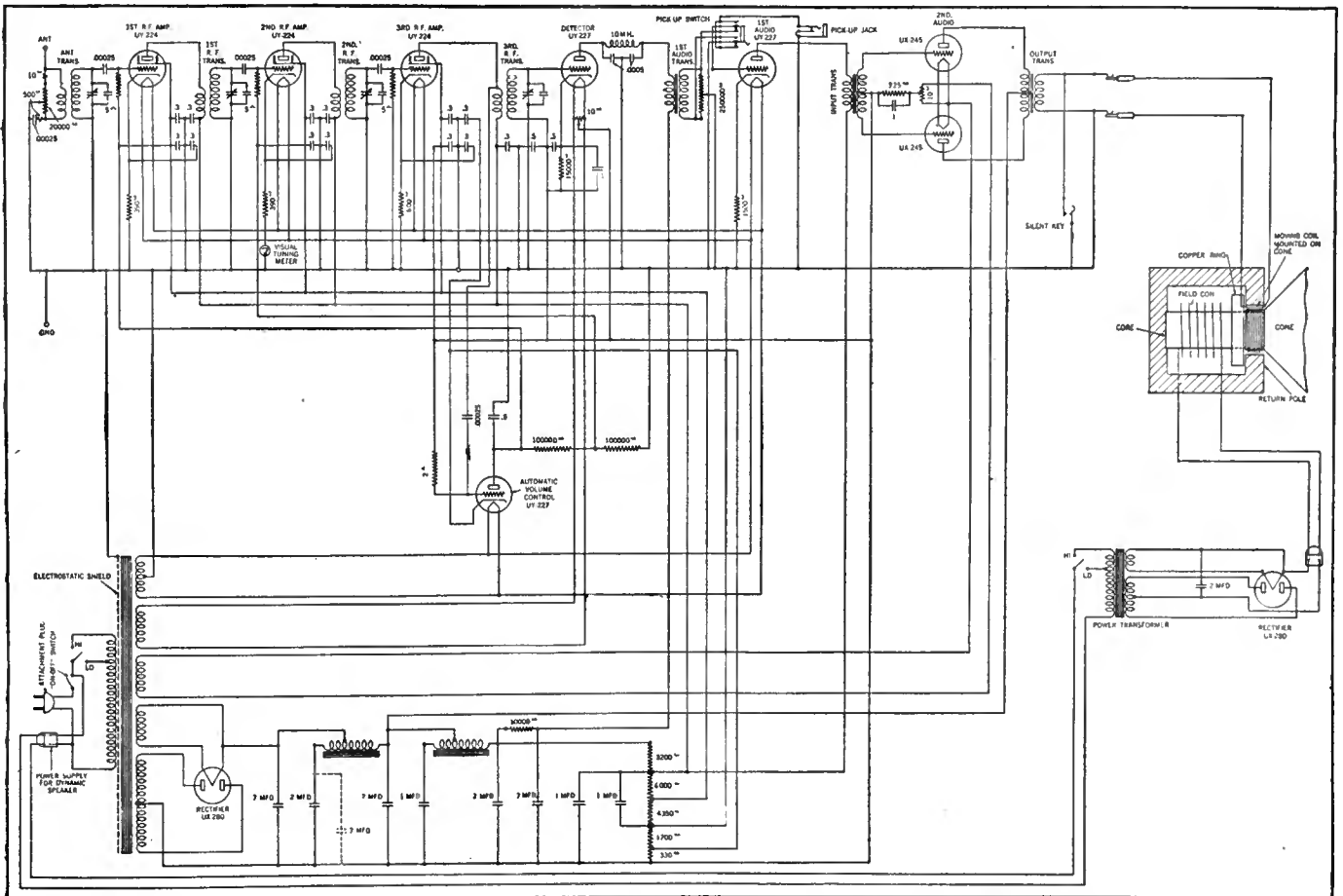

Fig. 9—Complete schematic diagram of the Stromberg-Carlson No. 846 receiver, showing the circuits of the chassis, the loud speaker, and the speaker field power supply.

DESIGN OF THE COLONIAL MODEL 32A.C.

BY DR. FULTON CUTTING

President, Colonial Radio Corporation



Dr. Fulton Cutting

IN THE laboratories of the Colonial Radio Corporation, experiments in the use of screen-grid tubes have been in progress for the past two years, having been started when the d.c. screen-grid tube first became available. The experiments with d.c. screen-grid tubes were found helpful in many ways in further

work with the a.c. screen-grid tube. The essential results of this laboratory work have been incorporated into the latest Colonial receivers. In this article we will describe in detail some of the interesting features to be found in the Model 32 A.C. receiver.

The schematic circuit diagram of this receiver is given in Fig. 1. As the diagram indicates, the set consists essentially of a three-stage r.f. amplifier, a plate-circuit detector, and a two-stage transformer-coupled audio amplifier. Screen-grid tubes

are used in the three r.f. stages and in the detector circuit. The first audio tube is a 227 and the second audio stage contains two type 245 tubes in push pull.

There are only two essential controls: the station selector and the volume control. The selector control drives the shafts of four variable condensers through the medium of a vernier gear and a series of phosphor bronze belts. A pointer, traveling across a one hundred division scale on the panel, indicates the setting of the selector.

If all four stages were accurately tuned to a single frequency, side-band cutting would result to a degree which would depend upon the shape of the top of the resonance curve for the entire tuner. However, if each stage were tuned to a different frequency, the four resultant peaks being spread out over a 5000-cycle band, much less side-band cutting would result. By properly adjusting these circuits, a resonance curve for the entire tuner could be obtained which would have a nearly flat top, 5000 cycles wide. In the Model 32 receiver, this principle has been followed, and successive stages are tuned

to carrier frequency, 2000, 3000, and 4000-cycle side bands, respectively. The graph of Fig. 2 emphasizes the advantages of this system by contrasting the shapes of the resonance curve for the entire tuner before and after the "staggering" of the tuning. Mistuning in this manner of course decreases the gain (in this particular case the overall gain with all circuits in resonance was twice that indicated in Fig. 5).

System of Coupling Audio Stages

An ingenious coupling scheme is employed between the detector and first audio amplifier. This consists of a resistance and capacitance network designed to compensate automatically the deficiencies of the second stage coupling transformer, so that the amplification between the detector and the output of the second audio stage will remain constant on all frequencies in the lower half of the audio scale.

The mathematics of this arrangement are very interesting. In Fig. 3 are shown the

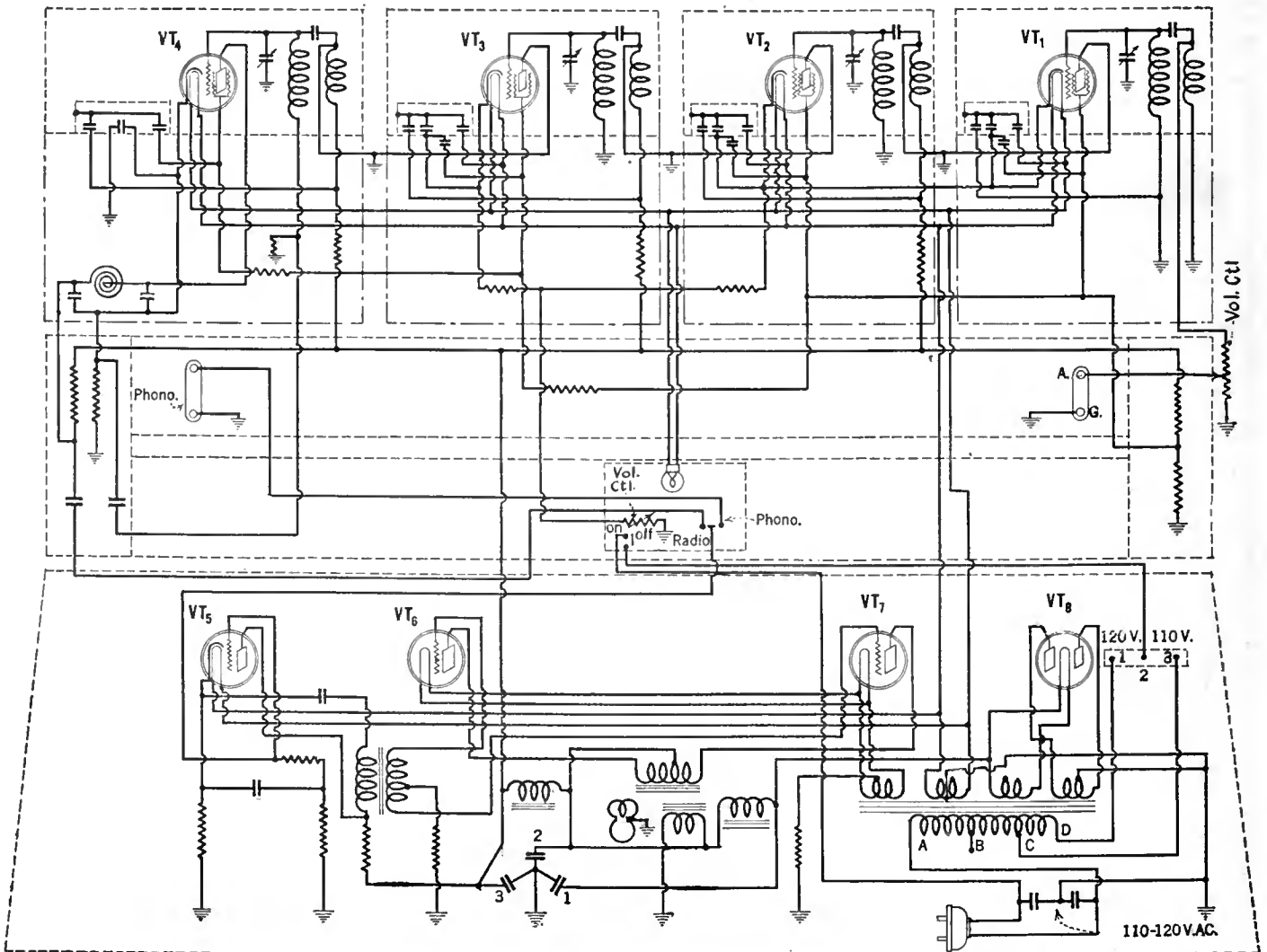

Fig 1—The complete schematic diagram of the Colonial Model 32 A.C. receiver.

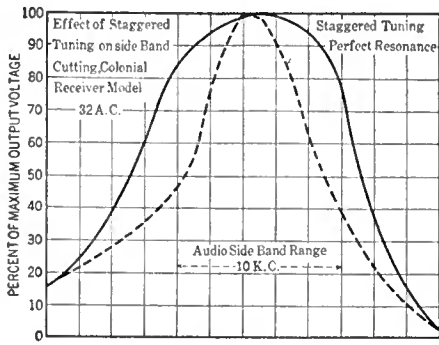

Fig. 2

essential qualities of the audio circuits under consideration. The detector output is represented by a generator having a voltage $\mu_1 E_{g1}$, the plate resistance of the tubes are represented by R_{p1} and R_{p2} , respectively. R and C , together, form the coupling impedance between the detector and the first audio stage, and L is the inductance of the primary of the second stage

coupling-transformer. The relation $\frac{E_{g2}}{E_{g1}}$ will be represented by α_1 and $\frac{E_L}{E_{g2}}$ by α_2 .

When the plate resistance of the detector is very high with respect to its load impedance, as is the case in this particular instance where R_{p1} is in the order of several million ohms, the expression for the amplification in the detector circuit may be approximated with sufficient accuracy by the equation:

$$\alpha_1 = \frac{\mu_1 \left(R^2 + \frac{1}{\omega^2 C^2} \right)^{\frac{1}{2}}}{R_{p1}} \quad (1)$$

and that for the amplification in the first stage by

$$\alpha_2 = \frac{\mu_2 \omega L}{R_{p1} (R_{p2}^2 + \omega^2 L^2)^{\frac{1}{2}}} \quad (2)$$

The combined amplification of both circuits is obviously the product of α_1 , and α_2 . Referring to equations (1) and (2), the total amplification may evidently be expressed by the equation

$$\alpha_1 \alpha_2 = \frac{\mu_1 \mu_2 L \left(\omega^2 R^2 + \frac{1}{C^2} \right)^{\frac{1}{2}}}{R_{p1} (R_{p2}^2 + \omega^2 L^2)^{\frac{1}{2}}} \quad (3)$$

Within limits, the amplification will be constant at all frequencies in the lower portion of the audio scale when

$$\frac{\left(\omega^2 R^2 + \frac{1}{C^2} \right)}{(R_{p2}^2 + \omega^2 L^2)} = k \quad (4)$$

Transposing,

$$\omega^2 R^2 - k \omega^2 L^2 = k R_{p2}^2 - \frac{1}{C^2} \quad (5)$$

which condition, when satisfied, will give the uniformity of amplification that is so desirable. Solving equation (5) for R , L , and C , and simplifying:

$$R = \frac{L}{R_{p2} C}$$

$$L = C R R_{p2}$$

$$C = \frac{L}{R R_{p2}}$$

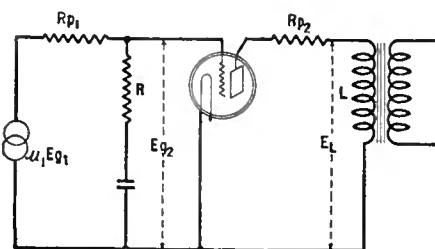

Fig. 3

Fulfilling these requirements actually peaks the first audio amplifier at the lower frequencies to a degree which accurately compensates the decreasing impedance of the second-stage transformer primary at the low end of the scale.

The principal limiting factor in this scheme is the possibility of overloading the grid of the first a.f. tube by reason of the high amplitudes attained at low frequencies with this arrangement. In the Model 32 receiver, this is provided for by the use of a second-stage coupling-transformer having a characteristic that requires only moderate compensation in the equalizer.

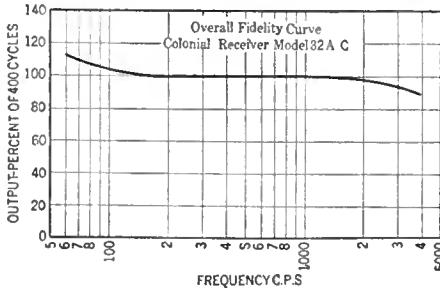

Fig. 4

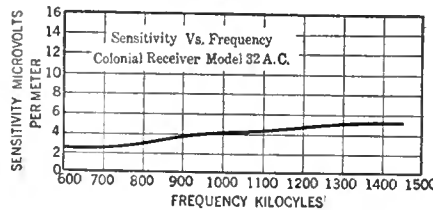

Fig. 5

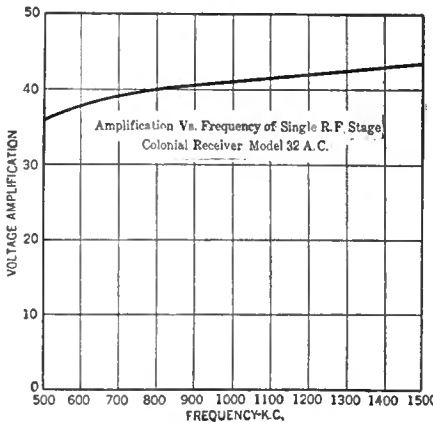

Fig. 6

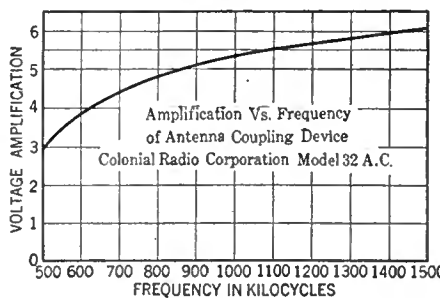

Fig. 7

The fidelity characteristic—antenna to output circuit—is given in Fig. 4.

Sensitivity of the Set

The sensitivity, in terms of microvolts per meter, averages about $2\frac{1}{2}$ microvolts over the entire broadcast band. The sensitivity curve is given in Fig. 5. It will be observed that it is practically flat throughout the entire range. This was accomplished with a unique coupling scheme be-

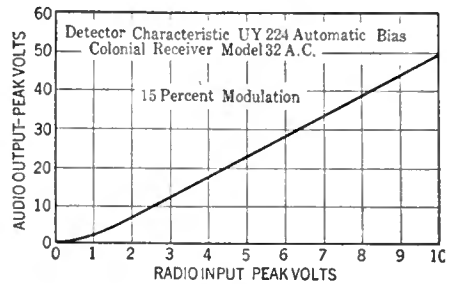

Fig. 8

tween stages in the r.f. amplifier. This coupling, as indicated in the circuit diagram, consists essentially of a tuned r.f. transformer having a 450-turn primary with a 5-mmfd. capacity connecting the high side of the primary with the high side of the secondary. The primary, with its distributed capacity and circuit capacity in shunt is resonant at some point below 500 kc. At 1500 kc. the arrangement functions essentially as tuned-impedance coupling, as the greater part of the current flows directly to the high side of the tuned secondary.

Radio-frequency filters in the leads supplying voltages to the screen-grid tubes are, of course, essential, for one of the most serious causes of feed-back is conduction through common leads. Filters comprised of resistances in series and condensers in parallel were found to serve admirably. Several such filters are used in each tuned stage. Each filter serves three purposes.

- (a) As an r.f. filter
- (b) As a means for securing a desired d.c. voltage drop
- (c) As an a.f. filter, to reduce the line frequency ripple in the d.c. applied to the 224's.

This last effect is particularly important in the case of screen-grid tubes as they have a tendency to rectify readily. Any ripple applied to their elements, especially their control-grids, modulates the signals and results in more disturbance in the output than would occur with any other type of tube. It is necessary to keep the peak value of the ripple on the plate below 0.15 volts, that on the screen grid below 0.05 volts, and that on the control grid below 0.03 volts. Figs. 6 and 7, respectively, indicate the gain per stage in the r.f. amplifier and the gain in the antenna circuit.

The r.f. transformers are constructed as follows. The secondary consists of a single layer wound with $102\frac{1}{2}$ turns of No. 30 enamelled wire. The primary, consisting of 450 turns of No. 36 d.s.c. enamelled wire, is wound on a wooden bobbin inside one end of the secondary.

Cross-Talk

This term is used to describe the condition that exists when the same station is

(Concluded on page 362)

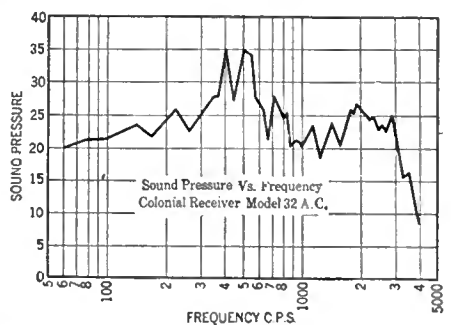

Fig. 9

AN ENGLISH OUTPUT TUBE, THE PENTODE

By W. T. COCKING

Radio Engineer, Receptite Company, London



W. T. Cocking

A FEW MONTHS ago RADIO BROADCAST published a brief description of the pentode, a new power output tube which is now common in England. Although, as far as the writer is aware, there is none available in America at present, it is certain that if it offers a

real advantage over other tubes some firm will market it before long; but before this happens it is desirable that its advantages and disadvantages should be well known. In this article the writer gives a description of the tube's special characteristics, and explains what it will and will not do; together with data which he has collected in the course of a year's experimenting with it in receivers intended for commercial production. At first sight it may seem that there are no special conditions to be observed when using the pentode, but this is not the case, although many people in England still seem to believe so.

Several Types Available

The tube which the writer has chosen for the purpose of illustration in this article is the Mullard P. M. 22; he has chosen this tube because it was the first pentode on the market, and because he has therefore had more experience with it than with any other. As a matter of interest, pentodes are now available with filaments for a two-, four-, or six-volt A battery, and of several different makes.

As the name pentode implies, the P. M. 22 has five electrodes, a filament, three grids, and a plate. It is fitted to the standard English four-pin base, to which the connections for filament, control-grid and plate are taken in the usual way; on the side of the base, however, a binding-post is fitted for the connection to the auxiliary grid. The electrodes are all mounted inside each other in the following order: filament, control grid, auxiliary grid, outer grid, and plate.

The filament is of the coated type, and in the two-volt pattern takes a current of 0.3 ampere, but in the six-volt pattern

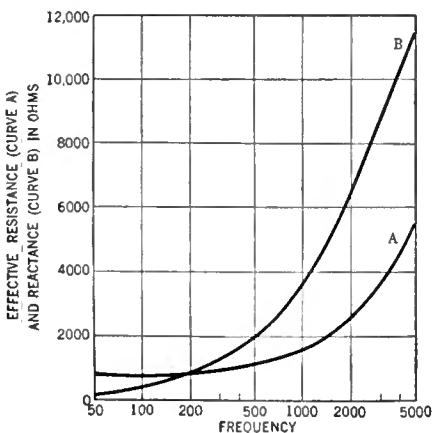

Fig. 2

only 0.1 ampere, like the majority of English tubes. The electrodes are all assembled in a horizontal position, but they cannot be seen clearly as the tube is heavily gettered. In use, the control grid and plate are treated in exactly the same way as those of a triode, the auxiliary grid is connected to the same source of high potential

The writer of this article is a radio engineer by profession and can vouch for the accuracy of the facts given; he has for the last five years been radio engineer of the Receptite Co., London, England, in whose laboratory the data given have been obtained in the course of experimental work in connection with the design of receivers intended for commercial production in England.

—THE EDITOR.

as the plate; the outer grid, however, is connected internally to the centre of the filament, and it is impossible to make any connection to it.

In Table I are given the maker's published figures for the characteristics of the P. M. 22. It is important to note that when the tube is used at its maximum plate

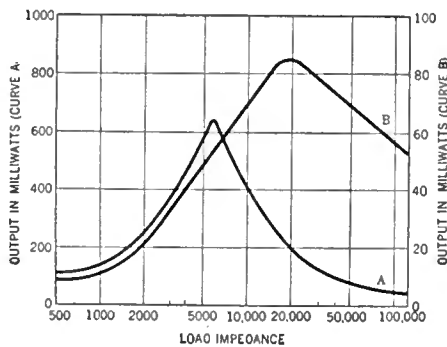

Fig. 1

and auxiliary grid potentials, the amplification factor and plate resistance are very different from the rated figures, at the working point, A (Fig. 4); they are 47 and 27,000 ohms, respectively. This large difference is principally due to the higher voltage used on the auxiliary grid, the maker's curves being taken at 100 volts only, although individual specimens vary far more than is the case with triodes.

The plate-current plate-voltage curves of the P. M. 22 with a voltage of 150 on the auxiliary grid are given in Fig. 4; it will be seen that they are totally different from those of any triode. If a perfect pentode could be made, its curves would be horizontal straight lines, just as the curves of a perfect triode would be straight lines inclined at an angle to the base. Although the perfect pentode cannot be obtained, Fig. 4 shows that for

plate voltages above about 60 volts the curves are almost completely straight. When voltages lower than 150 are applied to the auxiliary grid the curves are not nearly so straight, they commence curving at about 120 volts plate potential; but when the auxiliary grid potential is higher than 150 volts the curves approach more nearly to the ideal, for they are straighter at low plate voltages and they are nearer to the horizontal. More than 150 volts, however, is in excess of the maker's rating, and if it were used it would probably result in a short life for the tube.

To those accustomed to high-resistance triodes the high plate current of the pentode comes as a surprise. A triode of the same internal resistance will take perhaps 2 mA., but the pentode takes 22 mA., and requires a negative C bias of 10½ volts with 150 volts on the plate; while the total current requirements are still greater, for the auxiliary grid takes a current equal to about 25 per cent. of the plate current, so at 150 volts the total current will be in the neighborhood of 27 mA.

Question of Power Output

In investigating the conditions under which a power tube must operate, the first thing to do is to find out what the maximum power output is with various load impedances in the plate circuit, and at the maximum rated plate voltage and current for the tube. The easiest way of doing this is by drawing straight lines through the point A, the working point, Fig. 4, which represent the effect of a pure resistance in the plate circuit, the slope of the lines being inversely proportional to the value of the resistance. The maximum output is calculated by taking the values for plate voltage and plate current at the points where the resistance load line crosses the grid voltage curves for the maximum signal voltage which can be applied without distortion. In this particular case, if the load is such that it is possible to apply to the control grid a signal voltage the peak value of which is equal to the negative C bias, then the plate voltage and plate current should be taken at the points where the load line crosses the curves for 0 and negative 21

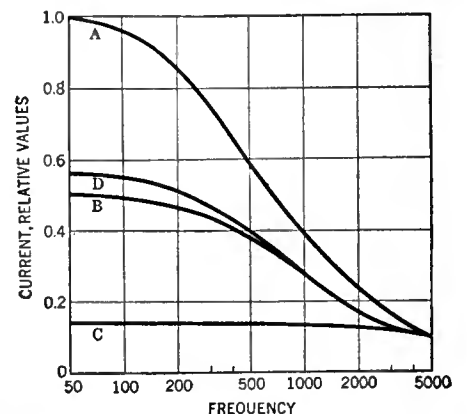

Fig. 3

volts. Then the power output can be calculated from the usual formula:

$$P = \frac{(I_{max} - I_{min})(E_{max} - E_{min})}{8}$$

current being expressed in amperes and powers in watts, and the percentage distortion from the formula:

$$D = \frac{100 \{ (I_{max} + I_{min}) - I_{no} \}}{(I_{max} - I_{min})}$$

I_{no} = no-signal plate current

If the curves of Fig. 4 are carefully examined it will be seen that for high values of load impedance, above about 6000 ohms, the peak value of the input voltage to the control grid must be reduced below the figure equal to the negative C bias in order to avoid distortion due to the curvature of the tube characteristics at low plate voltages. With a load of 50,000 ohms, the input must not exceed 3 volts peak value to avoid distortion. This is not a peculiarity confined to the pentode, for it occurs with triodes also, but it usually passes unnoticed for with a triode grid current usually occurs first. Curve B of Fig. 1 shows the power output with all loads, and with the input constant at 3 volts for all loads; this curve shows also that the greatest gain, not undistorted output, is obtained when the load impedance is approximately equal to the internal plate resistance of the tube. Throughout this article the word "gain" is used to mean the relation between the output power and the voltage input to the control grid, therefore, maximum gain is obtained when the output per input grid volt is greatest, which occurs when the load resistance and plate resistance are equal. It will be seen that for the higher values of load impedance the output for a given input voltage is much greater than with any three-electrode power tube.

Power Output of Pentode

The maximum undistorted power output of which the pentode is capable when the grid peak voltage is the maximum which can be applied for a given load is shown by curve A of Fig. 1, in which the input voltage is constant at 10½ volts peak value for loads up to 6000 ohms only. For loads of higher values the input steadily decreases to 3 volts at a load of 50,000 ohms. It will be seen that the maximum output when the load resistance has a value of about 6000 ohms, or roughly one fifth of the tube resistance, is totally different from the results with triodes; and considering the plate voltage used the figure for the output with this load is quite high, being 640 milliwatts. The grid peak voltage required to produce this output is only 10½ volts. Compare this with a ux-171A tube, with an output of 700 milliwatts with 180 volts on the plate, at an input peak voltage of about 40.

As far as the gain per stage is concerned, then, it is obvious that no other power tube can compare with the pentode. But, unfortunately, there is the relative gain at different loads to be considered. No loud speaker which has yet been invented offers the same load impedance to the tube at all frequencies, consequently

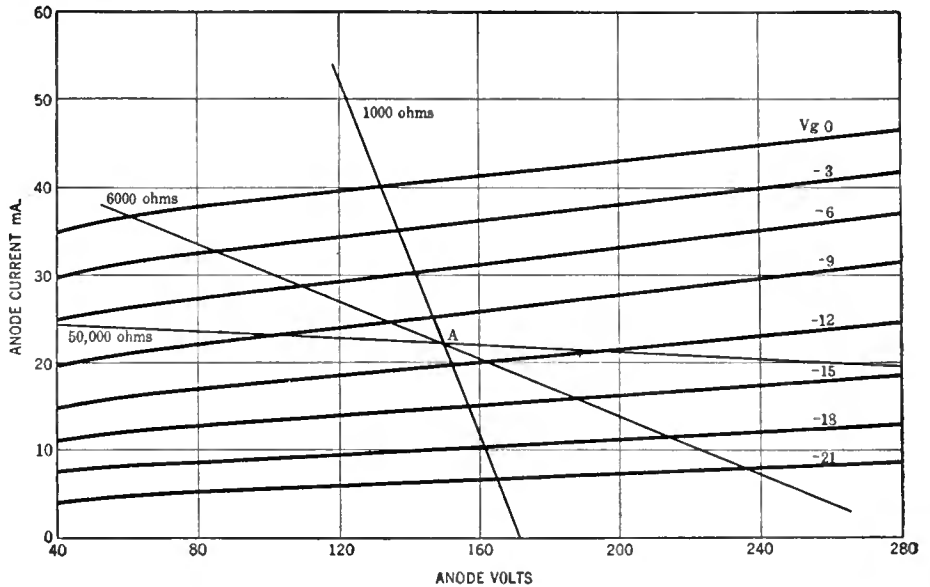

Fig. 4

at different frequencies the gain is different, with the result that both high and low notes are reproduced less strongly than those in the middle of the scale. Usually, however, this loss is not serious with a triode, and if desired adequate compensation can be obtained, either in the

Table I

Constants of Mullard P. M. 22.

Max. Fil. Volts	2	PLATE VOLTS	NEG. C. BIAS
Filament Current	0.3 amp.	75	-3
Max. Plate Volts	150	100	-6
Auxiliary Grid Volts	150	125	-7½
Plate Resistance	62,500	150	-10½
Amplification Factor	82	} at anode and auxiliary grid } 100 volts, control grid zero.	
Mutual Conductance	1310		

The anode and auxiliary grid should always have the same potential applied to them.

amplifier or in special output circuits.

There are two ways in which the relative gain at various frequencies can be found. One way is similar to that employed to find the output of a tube with various load resistances. But, as the loud speaker load is usually inductive, a straight line cannot be drawn on the tube curves to represent it accurately; it is necessary to draw an ellipse, and the method then becomes more complicated. Another way, and by far the easier, is to calculate the current through the loud speaker at various frequencies. It is, of course, necessary to know what the relative currents at various frequencies should be, otherwise any results would be useless, for there would be no standard of comparison. It is unfortunate that data as to the constants of so many of the loud speakers on the market are unknown, except to their makers, and sometimes even to them! The writer has chosen for illustration one of the best English reed-drive type loud speakers (similar to an ordinary magnetic cone—Editor), the Amplion "Lion," and its effective resistance and reactance are given in Fig. 2, curves A and B, respectively. It is necessary to give a curve showing the reactance at various frequencies, as the inductance is not constant, but decreases with an increase of frequency; the effective resistance increases with frequency owing to losses in the iron.

In Fig. 5A is shown the circuit of the output stage when a pentode is used, and in Fig. 5B the equivalent electrical circuit assuming that the transformer is free from losses and that the leakage inductance is negligible. In this circuit L represents the inductance of the loud speaker and the effective resistance, both multiplied by the square of the transformer ratio. R_a is the tube's plate resistance, and G is an alternator supplying a voltage equal to mE_g where m is the amplification factor of the tube and E_g is the r. m. s. voltage applied to the control grid. At any frequency, then, the current flowing through the circuit is given by:

$$I = \frac{mE_g}{\sqrt{\{(R + R_a)^2 + \omega^2 L^2\}}}$$

where

$$\omega = 2\pi f +$$

In Fig. 3 curve c, this current is shown for a pentode of 27,000 ohms plate resistance with the Amplion loud speaker, and in curve d for the same tube and speaker when the output transformer has a step-down ratio of 4-1 instead of 1-1. It must be emphasized that these curves do not show actual values of current, but merely relative values, and that for easy comparison they are all made to coincide at one frequency. Now these two curves alone are useless, for the shape of the correct curve is unknown; that is, the shape of the curve which, in practice, would give the best results. Curves A and n of Fig. 3 give the relative current with triodes of 1000 and 2000 ohms resistance respectively, and it can be taken that any curve falling between these two limits will be satisfactory; for the loud speaker manufacturers recommend for best results an output stage having an impedance of between 1000 and 2000 ohms. It is worthy of note that the current must be very much greater at low than at high frequencies, as with all reed-drive type loud speakers; and that at any frequency the sound output is proportional to the square of the current.

Moving Coil Speakers and Pentode

The curve (c) for a pentode with a 1-1 output transformer shows that the current variation over the entire frequency band is but small, as the variation of the speaker impedance at different frequencies is almost completely swamped by the high tube resistance. This curve cannot be

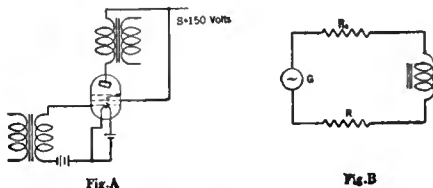

Fig. 5

considered satisfactory, for it indicates poor reproduction of the bass notes; a note of 50 cycles would be reproduced at only one-tenth of the amount with a 2000-ohm triode. This is amply proved in practice, for bass notes are almost inaudible. Curve D, however, when a 4-1 transformer is used is very similar to those for 1000- and 2000-ohm triodes, and as would be expected there is no audible difference between a 2000-ohm triode and a pentode with a 4-1 transformer, provided that the volume is small. That is where the trouble comes in, for, from what has just been said, it can be seen that for use with the best reed-drive type loud speakers, the pentode is useless unless a suitable output transformer is used to make the load impedance high. But, if the load impedance is high, the undistorted power output is greatly reduced, although the stage gain is increased. In the particular case mentioned, when the 4-1 transformer is used with the Amplion loud speaker, the load varies between 13,000 and 200,000 ohms, and the maximum undistorted power output is consequently only about 85 milliwatts; which can hardly be considered sufficient for good quality if reasonable volume is desired. The control grid input for this output is but 3 volts peak.

When a loud speaker of the moving-coil or dynamic-cone type is used the results are different, for this type of loud speaker requires constant current at all frequencies; so that it would seem to be ideal with a pentode. The usual impedance variation is between 1000 and 4000 ohms over a range of 50 to 5000 cycles, being greatest at high and low frequencies and least at a frequency somewhere about 500 cycles. [The author is speaking of English speakers—*Editor*].

In practice, with a low-resistance triode, this causes a falling off in the current at both high and low frequencies; the plate resistance of the pentode is so high, however, compared with the speaker impedance that the variation makes a negligible difference to the total circuit impedance; and it is this total circuit impedance which alone limits the current. The result is that the current remains constant over the whole frequency range, which, with this type of speaker, is what is wanted. It should be carefully noted that the current will only remain constant provided that the speaker impedance is small compared with the tube's plate resistance, for only then is any variation in its impedance swamped. This means that if a

transformer ratio is used to get a large stage gain, the tone of the reproduction will be neither better nor worse than with a triode, but that the power output will be small due to the effective speaker impedance being high compared with the plate resistance. On the other hand, if the effective impedance is adjusted to be about 6000 ohms, the power output will also be at its maximum (640 milliwatts) and the variations of the speaker impedance will be swamped by the relatively high tube resistance, with the result that the current will be constant at all frequencies and a fair output will be obtained. Theoretically, the moving-coil loud speaker would work much better with a pentode than with a triode as regards tone, but in practice so much depends upon the whole design of the loud speaker. With some speakers the results are improved, with others they are the same, while with still others they are distinctly worse. Many speakers of this type have a pronounced resonance at some high frequency, and while this is not serious with a triode, and is even sometimes advantageous owing to the falling current at high frequencies, with a pentode it often makes reproduction sound shrill.

A Look at the Future

It will be seen from the foregoing that it is useless to expect good quality from a pentode with a reed-drive loud speaker unless only a small output is required, when a step-down output transformer can be used. With many moving-coil loud speakers, however, the results are at least as good as with a triode, while the power output is not much different from that of a triode on the same plate voltage, the input voltage to the control grid to produce this output will be only about one-third to one-quarter of that necessary with a triode.

The chief use for the pentode seems to lie in inexpensive receivers which make no pretense of giving the best quality, and where compactness and low cost are of prime importance. It is worthy of note that no English firm is at present using it in their best receivers; it is confined to their cheaper models and to portable sets, where weight is a great consideration. In this connection the large gain which can be obtained from the pentode with a high-impedance load often enables the audio-frequency tube between the detector and the power stage to be

omitted. Also, most of the cheap cone loud speakers, such as are used with these sets, have a fairly high impedance, usually about 20,000 ohms and upward, so that no output transformer is necessary for tone correction.

Any output transformer or choke which is to be used in the plate circuit of a pentode must have a much higher inductance than is necessary with a triode, owing to the higher plate resistance. An inductance of between 40 and 80 henries is usually considered satisfactory.

As the present tendency in radio is toward better and better quality, it seems probable that the present popularity of the pentode will decline; particularly as, even now, triodes are available giving larger power outputs with a fairly large stage gain. In this connection a recent addition to power tubes in England is the Marconi P. 625, which is rated to withstand 250 volts on the plate with a current of 24 mA., and a negative C bias of 24 volts. It has an plate resistance of 2400 ohms and an amplification factor of 6, giving a mutual conductance of 2.5 mA./v; the undistorted power output is approximately 1000 milliwatts. The filament is of the coated type and requires a current of 0.25 ampere at 6 volts. Now this tube will give a stage gain of about one-fifth of that which can be obtained with a pentode with a load of 20,000 ohms, but it will give an undistorted output of about 12 times that with the pentode. It is true that the plate voltage required is nearly double, but this is of little moment nowadays when socket power units are commonly used. If the pentode is used with the best load for power output the stage gain is about three times that of the P. 625 tube, but the latter tube still gives a greater output, about 1.5 times.

It is the writer's opinion, therefore, that there is little advantage to be gained by using a pentode in place of a really good triode power tube, the only thing in which it scores is in stage gain; and its superiority here is not sufficient to make its use worth while, except in receivers where quality is only a secondary consideration, such as lightweight portable sets. This latter type of set is very popular in England, and the pentode is becoming very common in them, due solely to its high stage gain, for the high plate current does not make for economical operation from small dry batteries, which have nearly always to be used in these sets.

DESIGN OF THE COLONIAL MODEL 32 A.C.

(Continued from page 359)

picked up at several different points in the band. It results from poor selectivity in the first r.f. tube on signals of sufficient intensity to overload this tube. When the first tuned circuit is not sufficiently selective to prevent two different carriers from simultaneously reaching the grid of the first r.f. tube, a series of beat frequencies will be set up in the plate circuit of the first tube as well as the interference caused by the modulation of either carrier, by the audio component of the other carrier. Their amplitude will vary with the combined amplitudes of the two carriers. When the receiver is located in the vicinity of several broadcasting stations, these beat frequencies become very important in the creation of cross-talk. To prevent the cross-talk which occurs when the voltages impressed on the grid of the first tube are sufficiently high to cause it to draw current, a 750,000-ohm resistance shunted by an r.f. by-pass condenser is placed in series with the r.f. inductance in the d.c.

path of the grid current. This reduces the d.c. voltage on the grid without reducing the r.f. signal. At the same time any slight grid current flowing through it increases the negative voltage on the grid due to the IR drop through the resistor. In this manner the selectivity of the first tuned circuit is preserved and cross-talk eliminated.

Volume is controlled by variation of the cathode potential with respect to the other elements of the tube, at the same time varying the antenna input by means of a 10,000-ohm potentiometer on the same shaft as the bias unit. The volume control is a 75,000-ohm variable resistance which acts as a grid-biasing resistor or more properly as a cathode bias and resistor.

A screen-grid tube is used in this receiver as a detector. By shunt feeding through a 400,000-ohm resistor, 280 volts are applied to its plate. Plate rectification is used and the graph of Fig. 8 shows the gain of this tube as a detector as well as the high audio-frequency output available without overload.

The characteristics of the loud speaker were taken by a series of sound pressure measurements. The procedure employed was as follows: A radio-frequency carrier of constant amplitude, modulated at audio frequencies by a variable beat-frequency oscillator, was introduced into the input of the receiver. A correction for the pressure increase due to the reflection from the microphone was made on the basis of an equivalent sphere. A typically representative curve of the Model 32 receiver is shown in Fig. 9.

This measurement is actually a complete overall fidelity measurement of the entire receiver. It tells the complete story of the fidelity of reproduction and takes every factor into account, including side-band distortion, audio amplifier characteristics and speaker characteristics. The characteristics of the speaker itself may be determined by comparing the sound pressure curve with the fidelity curve previously given.

Ready Now!
the New "HiQ-30"

The PERFECT Custom Built RADIO

9 TUBES INCLUDING
"AMPERITE" AUTOMATIC
VOLTAGE CONTROL

COMPLETE
UNITS
Factory-wired
and Tested
ASSEMBLED
and
OPERATING
PERFECTLY
in
TWO HOURS

3 STAGES SCREEN-GRID
WORLD-WIDE RANGE

3 STAGE
BAND-FILTER

245
PUSH-PULL
AMPLIFIER

FACTORY TESTED
UNITS



Ten-Kilocycle Tuned
Band-Filter with flat-
top, straight-side tuning
curve.

Tuned Screen-Grid
R. F. Amplifier with
World-Wide Range.

Push-Pull Power Am-
plifier, using new
"245" tubes.

Tremendous volume,
with a rich, vibrant
tone that is revolu-
tionary in radio.

One-Dial Operation.

Choice of Finest Cabi-
nets and Speakers.

Completely-Shielded A.
C. and Battery Models,
with Cadmium-plated
metal chassis.

IT HAS EVERYTHING!

THE new Hammarlund "HiQ-30" caps the climax of five years of custom-radio designing with two years of Screen-Grid development. Its epoch-making "Band-Filter" Circuit, *originated and used exclusively by Hammarlund* the past year, is the most advanced obtainable. Its parts are the finest—precision-designed especially for this truly great receiver.

The distance-getting ability of the "HiQ-30" is amazing. Stations do not merely "roll" in—they "SNAP" in, *one at a time*, free from cross-talk and background noises. No hum, no buzz—nothing but the crystal-clear program with startling realism and rare richness of tone.

A connection is included for reproducing phonograph records through the amplifier—as you have never heard them before.

Here is engineered radio perfection, clothed with beauty that delights the most fastidious. And all so easily acquired by either assembling it yourself with *factory-tested units*, or having it installed by your local custom-radio builder—at a price far less than any factory-built receiver that even approaches the "HiQ-30" in quality.

Don't buy or build *any* radio at *any* price until you get all of the "HiQ-30" facts. *The 48-page "HiQ-30 Manual" tells the story. Use the convenient coupon.*

HAMMARLUND - ROBERTS, INC.
424-438 W. 33rd Street, New York

COMPLETE
(less tubes)
\$139.50 to
\$1175.00

MAIL COUPON AND 25¢ FOR "Hi Q-30" MANUAL!
HAMMARLUND-ROBERTS, Inc., Dept. RB10, 424-438 W. 33rd St., N. Y.
Enclosed 25c (Stamps or Coin) for the "HiQ-30" Manual.
Name _____ Address _____

STRAYS FROM THE LABORATORY

(Continued from page 349)

the courage to make this plain and straightforward statement in the face of what is apparently a distinctly different tendency.

"For the past eight years the writer has had charge of the radio market news broadcasting for the United States Department of Agriculture and I feel that anything said in the interest of the farmers by technical radio men indicates an appreciation of a situation with which we have been dealing for a long time.

"At the present time there are more than a hundred radio stations broadcasting crop and market reports for the benefit of farmers. This information is handed to the radio stations by the branch office representatives of this Bureau located in different parts of the country. All of these offices are connected by leased wire and all of the wire lines lead into the Washington office, so that every branch office is in touch with every other branch office and with headquarters. In a sense our service is that of chain broadcasting although the information is not poured into a single microphone but the information is disseminated over our leased wires and broadcast by each station.

"In order to avail himself of this vital market information, upon which the success of his farming largely depends the farmer must have a radio set that is selective enough to make certain selections among radio stations and sensitive enough to bring in clearly stations during the daytime that may be 100 or 150 miles away.

"Although the aim of the electric power interest is to provide the farmer with electric light and power as rapidly as good business will permit, nevertheless there is a potential market of nearly six million homes not provided with the facilities for using modern electric sets.

"In the last eight years this office has tried out a great many types of battery operated radio receiving sets and I believe that if a three- or four-tube set capable of meeting the requirements which I have briefly sketched could be devised there would be a very good market for it."

GRID LEAK VS. BIAS DETECTION

(Continued from page 352)

with very small signals. The lower plate voltages give somewhat better small-signal sensitivity. The sensitivity of the c-324 bias detector is slightly less than the sensitivity of the c-327 grid-leak detector. Fig. 6 shows that the sensitivity of c-324 bias detector exceeds the sensitivity of the c-327 grid-leak detector when the effective amplification in the preceding radio-frequency stage is included.

In conclusion the writer wishes to thank D. F. Schmit for helpful comments and suggestions and to acknowledge the assistance of members of the Cunningham Laboratory.

Bibliography

- 1—F. B. LLEWELLYN—"Operation of Thermionic Vacuum Tube Circuits," *Bell System Tech. Jour.*, 5, 433; July, 1926.
- 2—E. L. CHAFFEE and G. H. BROWNING—"A Theoretical and Experimental Investigation of Detection for Small Signals," *Proc. I. R. E.* 15, 113; February, 1927.
- 3—F. M. COLERBROOK—"The Rectification of Small Radio-Frequency Potential Differences by means of Trade Valves," *Experimental Wireless*, 2, 865; 1925.
- 4—STUART BALLANTINE—"Detection by Grid Rectification with High-Vacuum Triodes," *Proc. I. R. E.*, 16, 593; May, 1928.
- 5—L. P. SMITH—"Theory of Detection in a High-Vacuum Thermionic Tube," *Proc. I. R. E.*, 14, 649; October, 1926.
- 6—J. R. NELSON—"Detection with the Four-Element Tube," *Proc. I. R. E.*, 16, 822; June, 1928.

No. 301

RADIO BROADCAST Laboratory Information Sheet October, 1929

Output Transformer Ratios

OUTPUT transformer ratios required for use with cone or horn type loud speaker are shown on the chart on Sheet No. 302. This chart, reproduced from a recent bulletin of Ferranti, Inc., covers the range of loud speaker impedances from 0 to 6500 ohms and tube impedances from 0 to 15,000 ohms. On Sheet No. 297 in the Sept., 1929, issue, a chart was given of output transformer ratios for use with moving-coil type loud speakers.

In the case of horn and cone type loud speakers the bulletin suggests that the impedance used in determining the transformer ratio should be the impedance of the loud speaker at about 200 cycles. The impedance at this frequency may with fair accuracy be taken as 2.5 times the d.c. resistance of the winding. That is, a loud speaker with a d.c. resistance of 2000 ohms has an impedance at 200 cycles of approximately 2000 times 2.5 or 5000 ohms.

Owing to the fact that the impedance of cone type loud speakers fre-

quency varies from 1000 to 30,000 ohms between 200 and 5000 cycles, ideal results are not possible but transformer ratios determined as indicated above will give best results. As an example of the manner in which the impedance of a magnetic loud speaker varies we show on this sheet an impedance curve the Western Electric 540 AW.

An example will help to make perfectly clear the use of the chart on sheet No. 302.

Example 1. A loud speaker has an impedance of 4000 ohms at 200 cycles. It is to be used in a push-pull circuit using two tubes each with a plate impedance of 5000 ohms. What transformer ratio is required?

Two 5000-ohm tubes in push-pull give a total impedance of 10,000 ohms. Referring to the chart we find the horizontal line corresponding to a loud speaker of 4000 ohms impedance intersects the vertical line corresponding to a tube impedance of 10,000 ohms at a point corresponding to a transformer ratio of 1.6 to 1.

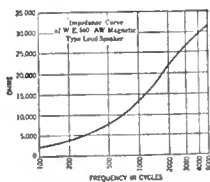

No. 302

RADIO BROADCAST Laboratory Information Sheet October, 1929

Output Transformer Ratios

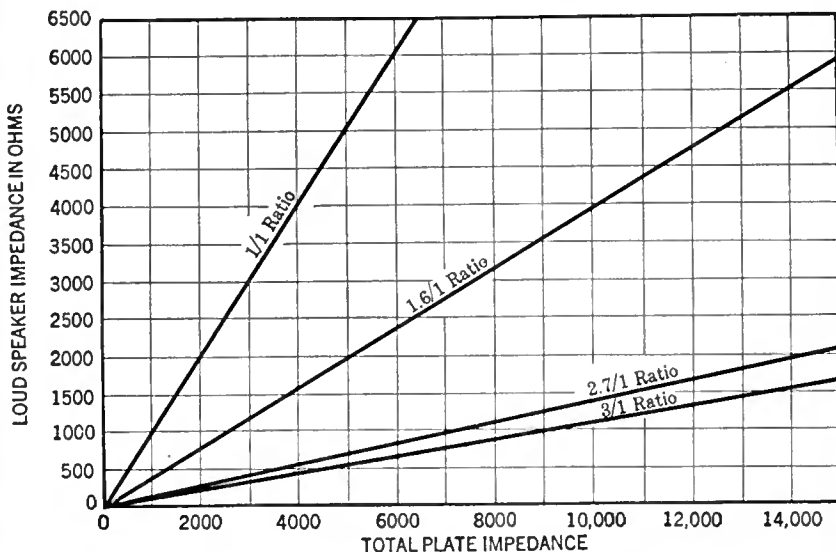

No. 303

RADIO BROADCAST Laboratory Information Sheet October, 1929

"Power" and "Linear" Detection Explained

"POWER detection" and "linear detection" are two terms frequently used to describe certain characteristics of new receivers. On this sheet we explain briefly what these two terms mean.

A power detector (according to the popular definition) is one operated at fairly high values of input voltage. Power detectors are frequently followed by a single stage of audio frequency amplification because sufficient a.f. voltage can be obtained from them to load up a power tube. It should be realized, however, that power detectors are not always followed by single audio stages but may be followed by a two-stage audio amplifier. The important factor is the signal level at which they operate. Accurately defined, however, the power detector is one from which sufficient power may be obtained to operate a loud speaker directly.

Ordinary detectors operate on what is called a "square law," that is the a.f. output voltage is proportional to the square of the r.f. input voltage. Such detectors produce some distortion especially if the r.f. input is modulated at

fairly high percentages. The distortion reaches a maximum of 25 per cent. when the input signal is modulated 100 per cent. The present tendency in broadcasting is to increase the modulation to 100 per cent. so as to utilize as completely as possible the output of the transmitter. Linear detectors will produce very little distortion on 100 per cent. modulated signals and it is for this reason that this type of detector is increasing in use.

A detector is "linear" when its a.f. output is directly proportional to the r.f. input. Such detectors produce a distortion of about 10 per cent., with 100 per cent. modulated signals in comparison with the 25 per cent. distortion produced by square-law detectors. The decreased distortion (from 25 to 10 per cent.) due to the linear detector is readily noticeable to the ear.

It should be pointed out that the fact that the detector operates at high signal levels does not necessarily mean that it is linear. C-bias detectors are linear over only a small portion of their operating characteristic.

▶▶▶
**EVEREADY
 RAYTHEON TUBES
 FOR
 TALKING
 PICTURES
 AND
 TELEVISION**



ARE DEFINITE CONTRIBUTIONS TO THIS NEW SCIENCE

EVEREADY RAYTHEON is at the front in television . . . with both transmitting and receiving tubes of proved dependability and performance.

The Eveready Raytheon Foto-Cell is a long-life transmitting tube for talking pictures, made in several standard types. Also used in television. Foto-Cells to special specifications will be made at reasonable prices.

The Eveready Raytheon Kino-Lamp for television reception is the first tube developed commercially which will work with all systems. Its glow is uniform over the entire plate. Its reproductive qualities are perfect, without the need of mirrors or ground glass. The performance of each tube is carefully tested in our laboratories.

Correspondence is invited from every one interested in television and talking pictures.

NATIONAL CARBON CO., Inc.
 General Offices: New York, N. Y.
 Unit of **UCC** and Carbon Corporation
 Union Carbide



Does your radio set stand the "visitor test"?

Your set may seem "good enough" but do your friends share your opinion of its quality? It will always be open to unpleasant criticism until you get exact reproduction of the studio broadcast. No matter what kind of a set you have it can be made tone-true by replacing the inferior transformers with one of the AmerTran audio systems.

You will get music from your old set that you never thought possible before—and it doesn't make any difference how old or out of date it is either. With the AmerTran Power Amplifier (Push-Pull for 210 tubes) and the ABC Hi-Power Box you can make your old set as modern as any set, regardless of price—and have the finest toned set possible commercially.

See your dealer or write to us.

AMERICAN TRANSFORMER COMPANY
 Transformer Manufacturers for more than 29 years
 73 Emmet St. Newark, N. J.

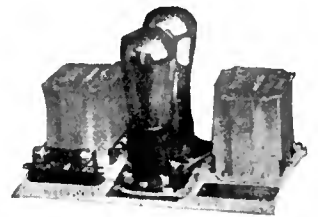

AmerTran Push-Pull Power Stage (illustrated above)—completely wired with input transformer and a choice of 4 output transformers depending on speaker and power tubes. Price, east of Rockies—less tubes—\$36.00.

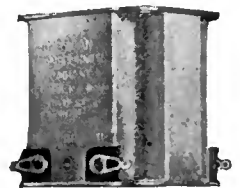

AmerTran DeLuxe Audio Transformer, (illustrated above.) Standard of Excellence, 1st Stage; Turn Ratio, 3; 2nd Stage; Turn Ratio, 4. Price, each \$10.00.

AMERTRAN

A BIG Load Off
the Service Man's Chest

Trouble Shooter's Manual

by JOHN F. RIDER

The first comprehensive volume devoted exclusively to the topic uppermost in the mind of every man who repairs or builds a radio receiver. . . . No more torture tracing circuits . . . Instant service information . . . How to be a successful service man . . . The most valuable Radio Service Book ever published.

22 Chapters Cover: Service Procedure, Practical Application of Analysis, Vacuum Tubes, Operating Systems, Aerial Systems, A Battery Eliminators, Troubles in A Eliminators, Trouble Shooting in A Eliminators, B Battery Eliminators, Troubles in B Eliminators, Trouble Shooting in B Eliminators, Speakers and Types, Audio Amplifiers, Troubles in Audio Amplifiers, Trouble Shooting in Audio Amplifiers, Troubles in Detector Systems, Radio Frequency Amplifiers, Trouble Shooting in Radio Frequency Amplifiers, Series Filament Receivers and Testing and Testing Devices.

Wiring Diagrams of these Commercial Receivers:

Radio Corp. of Amer.	Federal
Atwater-Kent	Crosley
Zenith	Majestic
Fada	Stromberg-Carlson
Stewart-Warner	Grebe
Philco	Freshman
Freed-Eisemann	Kolster
All-American	Day-Fan
Colonial	Workrite
Amrad	Spartan
Deforest	Ware
Garod	Kennedy
Operadio	Sleeper
Magnavox	Grimes

More than 200 different models of commercial radio receivers . . . old and new . . . many never published before.

240 pages 8½" x 11"

Black Flexible Fabrikoid Binding

PRICE \$3.50 POSTPAID

This book will be worth hundreds of dollars to you

RADIO TREATISE CO.

1440 Broadway, New York City

.....USE THIS COUPON.....

Send me the Trouble Shooter's Manual. Here is my money.

Name.....

Address.....

City.....

State.....

R. B.

AUTOMATIC VOLUME CONTROL

(Continued from page 357)

"free" end of the sensitivity potentiometer and ground is an equalizing arrangement which tends to keep the attenuation constant over the whole broadcast band. The ten-ohm resistor in series with the sensitivity potentiometer is to prevent the signal from being cut off entirely by this control.

To select a station with this receiver the operator depresses the "silent key" and rotates the "station selector knob." To make the approximate tuning adjustment he observes the selector dial, and after this he observes the needle of the "visual tuning meter" for the accurate tuning. The selector knob is moved slowly back and forth over a short distance until the maximum deflection of the meter pointer, in the direction of the arrow on the meter dial, is obtained. The silent key is now released and the signal is heard from the loud speaker. Now the manual volume control is adjusted, if necessary, to secure the proper room volume. When tuning from station to station the above procedure is also followed, but the manual volume control seldom will require re-setting.

Mechanically this receiver is of similar construction to the Nos. 611 and 612 receivers. The pictures accompanying this article, Figs. 1, 2, 3, and 8, illustrate the construction of the chassis.

HAVE YOU PERSONALITY? —THEN SELL IT

(Continued from page 325)

genuine sincerity stands out as it never did before. We are in a hypocritical period, not because we like it, but because we haven't yet worked out of it and beyond it.

It is a fault of this period that we fail sometimes to make a real profit and build true friends out of acting naturally, but think that to succeed, we must put up a bluff at seeming to be something which we are not.

My advertising advice to radio retailers, concretely, is as follows:

- (1) Use manufacturer's cut and copy service, but put something of your own into its use.
 - (a) Occasionally, perhaps often, run such advertisements as they come to you.
 - (b) Study them for style, approach, display, and learn from them something about how to have your own advertisements prepared.
 - (c) If they seem to lack anything, write your opinions to the people who put them out and thus help to make them better.
- (2) Treat your own advertising very seriously. It is your message to your own trade. If a true message it should win friends by its sincerity. If you are a good, honorable chap at heart, the most profitable thing for you is to have everybody feel that to be true. Most people are really that way. The biggest response there is the response to sincerity. If you are a successful fakir by nature, you won't come here for advice anyway and you won't take it when it is given.

Both merchandise and merchandisers can win on their merits, provided those merits include the very important one of *being able to present their case well*. This means for you the development of sales and advertising skill. Don't leave all your advertising work to the manufacturer. Get in to it up to your neck yourself.

ROBERT S. KRUSE

Consultant and Technical Writer

103 Meadowbrook Road, West Hartford, Conn.

Telephone Hartford 45327

SERVICING

—is it an asset or a liability to you?

HOW many radio dealers are there who having tried to operate their own servicing department have given it up in disgust and "farmed out" the work to an outside service agency? Throughout the retail trade radio servicing has occasioned more grief and put more red figures in the ledger than any other branch of the radio business.

Yet it has been demonstrated time and again since the Weston Model 547 Radio Set Tester was brought to perfection and put on the market that radio servicing can easily be made one of the most profitable departments of radio retailing. With this set tester the service man's work is reduced to a certainty. No more is it necessary for the service man to waste time hunting for trouble. Model 547 gives him the answer instantly. The speed with which his work is accomplished reduces the cash loss occasioned by waste of time and enables him to do ten jobs in the same time it formerly took him to do four. Furthermore, his work is final.

Once the job is done there is no necessity for a return call and the customer is satisfied and becomes a friend of the organization which uses the Model 547 Weston Radio Set Tester as its "trouble shooter."

Weston Model 547 is provided with three instruments—all 3¼" diameter and furnished

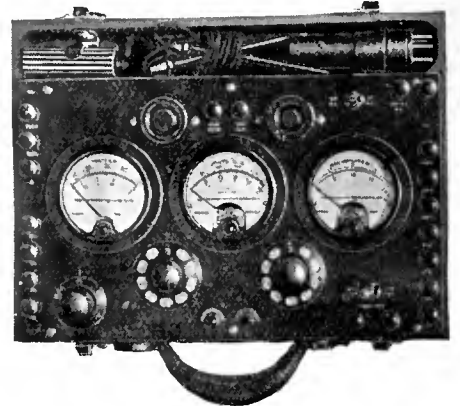

with bakelite cases. Carrying case, movable cover, panel and fittings also are made of sturdy bakelite.

A. C. Voltmeter—750/150/16/8/4 volts. The three lower ranges are brought out to the Tester plug, and all five ranges are brought out to binding posts. 750 volt range is for testing secondaries of power transformers. 16 volt range is to provide for 15 volt A. C. tubes. Operations have been reduced—only one selector switch being necessary.

D. C. Voltmeter—High range increased to 750 volts. Other ranges—250/100/50/10/5—all six ranges brought out to binding posts and Tester plug.

D. C. Milliammeter—Double range—100/20 M. A. provides for lower readings with better scale characteristics.

Tests—On A. C. sets the heater voltage and plate current can be read throughout the test while the D. C. voltmeter may be indicating plate bias or cathode voltage.

Self-contained, double sensitivity continuity test provided. This can also be used for measuring resistance as well as testing for open circuits. Grid test can be made on A. C. or D. C. screen grid tubes—also the '27 tubes when used as a detector—without the use of adapters. Two sockets on the panel—UY tube adapters eliminated.

**WESTON ELECTRICAL
INSTRUMENT CORPORATION**

604 Frelinghuysen Avenue Newark, N. J.



Thordarson Transformers and Chokes

For Use With

"245" Type Power Tubes and "224" Screen Grid Power Detectors

Input Couplings

Single "245" tube, from any audio amplifying tube, use any one of three transformers. (R-400 especially suited to "226" and "227" tubes)	R-260	\$5.00
	R-300	5.00
	R-400	9.00
Push-Pull "245" tube, from any audio amplifying tube. Use 1-to-1 ratio input transformer	T-2408	\$8.00
Use 2-to-1 ratio input transformer	T-2922	12.00
Screen grid power detector "224" to any single power tube, use "Autoformer" for choke-resistance type of standard circuit	R-190	\$5.00
Screen grid power detector "224" to any push-pull power tubes use R-190 Autoformer for parallel feed to detector plate and 2-to-1 coupling transformer	T-2922	\$12.00

Speaker Couplings

Single "245" tube to dynamic speaker with built-in transformer, to cone speaker, or to magnetic speaker—Use either one or two transformers	T-2876	\$6.00
	T-2901	12.00
Use choke-condenser coupling, employing one choke	R-195	5.00
Single "245" tube to moving coil of dynamic speaker—Use transformer	T-2902	\$12.00
Push-pull "245" tubes to dynamic speaker with built-in transformer, to cone speaker, or to magnetic speaker—Use coupling transformer	T-2880	\$12.00
Use choke coupling, employing double choke	T-2420	8.00
Push-pull "245" tubes to moving coil of dynamic speaker—Use either one of two transformers	T-2629	\$10.00
	T-2903	12.00

Filament Supplies

For six "224" screen grid tubes or six "227" tubes—Use filament transformer (10.5 amps at 2.5 volts)	T-3660	\$9.00
For two "224" tubes or two "227" tubes and one or two "226" tubes use double voltage transformer	T-3081	\$6.00

Power Compacts

For filament current, plate current and bias on "245" push-pull power stage, also plate current for set. Contains filter chokes. Uses one 280 rectifier tube	R-245	\$21.00
For filament current, plate current and grid bias on single "245" power tube and one "226" audio tube, also plate current for set. (Requires extra T-3081 filament transformer.) Contains filter chokes	R-480	\$17.00

THORDARSON RADIO TRANSFORMERS

Thordarson Electric Mfg. Co.

Transformer Specialists Since 1895

WORLD'S OLDEST AND LARGEST
EXCLUSIVE TRANSFORMER MAKERS

Huron and Kingsbury Streets
Chicago, Ill., U.S.A.

TYPE 360 TEST OSCILLATOR



One of the new test oscillators for the radio service laboratory is now ready. It will deliver a modulated radio-frequency voltage at any point in the broadcast band (500 to 1500 kilocycles) and at 175 and 180 kilocycles. The tuning control is calibrated with an accuracy of 2 per cent.

The Type 360 Test Oscillator is intended to be used for neutralizing, ganging, and tuning of the radio-frequency stages in a receiver, and it is fitted with an output voltmeter for indicating the best adjustment.

Price \$110.00

GENERAL RADIO COMPANY

30 State Street
Cambridge, Massachusetts

274 Brannan Street
San Francisco, California

BALANCED TUNING

At Its
Best

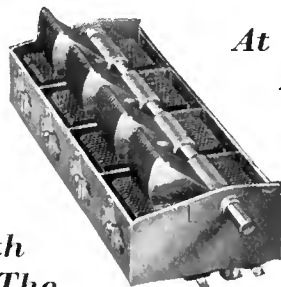

With The HAMMARLUND "BattleShip" Condenser

REAL One-Dial Control! Units are matched to within 1/4 of one percent of each other. Absolute precision obtained by mounting a Hammarlund Equalizing Condenser in the recess of each section.

Warpless, die-cast frame, with terminals on Bakelite strip underneath. Non-corrosive brass plates.

Two capacities: (350 mmfd. and 500 mmfd.) 2, 3, and 4 gang models.

Write Dept. RB10 for Folder

Hammarlund Manufacturing Co.
424-438 W. 33rd Street, New York

For Better Radio
Hammarlund
PRECISION
PRODUCTS



John H. Morecroft

Zeh Bouck says:

"MORECROFT is the finest engineering interpretation of Radio's first quarter century we have."

Second Edition—Revised and Enlarged

Principles of Radio Communication

BY JOHN H. MORECROFT

Again Mr. Bouck says: "No radio book has ever been of greater utility to the engineer and student than this classic—the only reliable reference of its kind six years ago and today the most astounding collection of answers to technical questions from the analysis of radio frequency phenomena in terms of complex formulae to why a particular amplifier howls."

\$7.50

JOHN WILEY & SONS, Inc.

440 Fourth Ave., New York

Please send me Morecroft's RADIO COMMUNICATION for free examination. Within ten days after its receipt, I will either return the book or send you \$7.50.

Name.....

Address.....

Firm..... RB 10-29

ARE USED SETS LIKE USED CARS?

(Continued from page 322)

dealers in Omaha, Kansas City, St. Louis, Cincinnati, Milwaukee, Louisville, Chicago, Pittsburgh, Boston, and other large cities have found a way to slaughter the useless, decrepit old cars that, though worth no more than a ten dollar bill in the used car market, are continually reappearing as trade-ins on new sales. Furthermore, the coöperatively operated junkyards are in many cases paying dividends out of the proceeds of the secondhand parts business they do; and, even in the one or two cases where the junkyards are not yet paying their own way, the dealers who finance them consider the investment a wise insurance against the loss that the old cars might cause them if permitted to return into the used car market.

The used-set problem is just commencing to assume serious proportions in the radio trade. Those proportions, however, will become more serious as the years go on. And if the radio dealers, by adapting one of the proved successful automobile plans to their needs, or by devising a sound plan of their own, can avoid the experiments and costly mistakes that will come if they wait until the problem is beyond control, it seems that a little study of the accompanying table wouldn't be wasted effort.

THE RADIO DEALERS' ADVERTISING DOLLAR

(Continued from page 333)

Where newspaper and billboard advertising is used to blanket the territory, direct-mail advertising should be used for a concentrated drive on a list of preferred prospects.

Supplementary Advertising

The most effective forms of supplementary advertising in use by dealers are:

1. Catalog and Individual Folders. These can form a remarkably complete and effective supply of literature covering every possible requirement.
2. Store Signs. Large outdoor advertising signs, illuminated window displays, decalcomanias and other attention-compelling items for store fronts and interiors.
3. Lantern slides. These can well consist of an assortment of colorful slides illustrating receivers and loud speakers for advertising in any of the various ways slides are used.
4. Novelties, such as blotters, balloons, calendars, matches, fans, etc.

When the dealer is pressed by printing salesmen who wish him to use their direct-mail circulars, by newspaper advertising representatives who extol the merits of their medium, the combined experiences of the dealers covered by this survey should be of great help. The dealer's dollar must be effective.

PROFESSIONALLY SPEAKING

(Continued from page 336)

first station at 9:30 and so on, through the entire evening.

The call for remote-control apparatus has been felt in the "high-brow" service shops on Park Avenue. In July, one such service organization had orders for two sets of apparatus which would enable the radio set, installed in the servants' quarters, to be operated from any part of a large apartment. The cost of the apparatus could go as high as \$2000 for each installation. At that time no apparatus was generally available, and the service engineer either had to design his own equipment—which would eat up his

profits—or to delay on the sale until such apparatus was available.

Cabinet manufacturers may see some cause for worry in the advance of remote-control apparatus. They may reason that future sets will be installed in a closet, or in the basement, or somewhere else out of sight, and controlled by plugging a loud speaker and a push-button arrangement into outlets in each room in the house. The radio set may come to look like an electric meter, stuck up on the wall in some out-of-the-way place where it can be serviced easily.

At the present moment remote control is confined to expensive receivers, but at least one designer of this new radio apparatus is planning to sell two receivers next season, one with and one without such a control feature. The difference in price is said to be only \$20.

Whether or not 1930 will be a remote-control year, it behooves radio engineers to brush up on their mechanics and strength of materials.

KEEPING SERVICE SOLD

(Continued from page 329)

but every effort is made quickly and cheerfully to remedy the thing about which he has complained, the importance to him of that short period of dissatisfaction becomes very greatly lessened and he soon forgets about it.

We have in operation a highly satisfactory plan to secure early complaints. When the report card of a job has been turned in and the information transferred to the permanent record, that card is placed in a numerical file under the date which is a week after the job was performed. Each day the cards under that date are removed and each customer is telephoned to find out whether the radio is operating satisfactorily. If the customer is not satisfied, a man is immediately sent back without further charge to remedy the difficulty. If there is no one at home when we telephone, we send a special return postcard which expresses to the customer our desire to know whether he is entirely satisfied with our service. The card has provision on the return portion for him to signify, merely by making a cross mark in a square, whether he is pleased, barely satisfied, or dissatisfied, and in the latter case just what day and time he would like to have a man call to take care of the complaint. The result of the telephone call, or the postcard, is that the number of dissatisfied customers is reduced to a low figure and a large reduction is made in the loss of customers who were dissatisfied and who, instead of complaining, went elsewhere for service. Incidentally, but of great importance, the percentage of bad debts is lowered concurrently with lowering of the percentage of dissatisfied or only quasi-satisfied customers.

Another small thing we do to try to make the customer realize that he is dealing with an established dependable concern and to make him feel that we are really interested in him is a form letter which goes out to each new customer the day after the first service has been completed. It welcomes him to the ranks of those who use our service, implies a solid background of many years in business, outlines our policy of maintenance of list prices, explaining that good service cannot be given at cut prices, and encloses a convenient sized card containing our prices, telephone number, and address. While the letter is multigraphed and the signature a cut, it is a very carefully done job and the fill-in is done so that it almost exactly matches the multigraphing.

HOW ONE DEALER-MERCHANTISING SERVICE WORKS

(Continued from page 327)

Another unit consists of "follow-up" or "thank-you" cards, designed to be mailed to the customer within a short period after a sale. Contained in each of the cards is question, "How do you like your radio receiver?" Request is made for the names of two people who "would like to hear a Kolster receiver in their home." The service is completed with a wide assortment of copy and layout for newspaper tie-up advertising. Some of the newspaper copy suggestions feature the dealer's store and subordinate the manufacturer.

Mr. Breck, in commenting on the "thank-you" cards, says that on an average so far dealers are receiving approximately forty per cent. return on the cards mailed. Forty per cent. of, let us say, two hundred cards mailed, would mean the dealer received eighty, and providing each contained two names, the prospect file would be richer by a total of 160 names. In this manner the dealer who subscribes to the whole service will always have a large prospect file and a good card system to keep it readily operative.

The total cost of the complete Kolster service to the dealer is \$59.50. While this cost actually covers only half of what it requires to prepare the entire service, Mr. Breck says, "by paying for it, the dealer cannot escape an active appreciation of the service. If the dealer himself were to undertake a sales plan as comprehensive as this on his own initiative it would probably cost considerably more than double."

FEATURES THAT SELL RADIO

(Continued from page 349)

indicator. Exact tuning of the set to the carrier of the station is possible—and it is only when a set is accurately tuned that the best possible fidelity is obtained.

Remote Tuning Controls: With remote control one can tune the set from a box located at some distance from the receiver. Several controls may be wired so that the tuning and volume can be controlled from various rooms. Pressing the proper button on the control box automatically tunes the set to the desired station. Pressing the button closes an electric circuit which causes a small motor in the receiver to revolve the tuning condensers to the correct point to receive the station. Generally a maximum of eight stations can be tuned-in in this manner. We can now sit in an armchair with the control box alongside and tune from one station to another without even taking our feet off the footrest! Like the burlesque show, it's a good device for that tired business man.

Other Features: Reduced hum from the loud speaker is an improvement apparent in many of the new sets. It is made possible by more carefully engineered circuits and by the use of single-stage audio amplifiers. Few features of the new receivers will have more appeal to a prospective customer than the lack of hum—which many have come to associate as a necessary evil of a.c. receivers. To many other prospects the various new types of tuning dials will have a very definite appeal. Many new receivers use a "tone control" with which it is possible for the user to vary the relative prominence of the high or low frequencies to suit his individual taste. From a modern well-designed receiver a purchaser may expect a fidelity of reproduction and general performance that leaves little to be desired.

WITH PARDONABLE PRIDE

WE POINT
to These Expressions
of Confidence by
Several Leading Radio
Set Manufacturers
in the **QUALITY,
SERVICE and
DEPENDABILITY** of

**POLYMET
PRODUCTS**



FADA

"We use Polymet Products because a specialized part is needed to complete the high quality of Fada sets".

ZENITH

"We use Polymet Products because they are definitely superior specialized parts".

STEWART-WARNER

"We specify Polymet Parts in the Console 35 and other Stewart-Warner sets because we know that Quality radios can be made only with Quality parts".

KING

"We want King sets to give complete satisfaction, with Polymet specialized parts we know that perfect service is assured".

Is it any wonder then that Polymet supplies over 80% of the large set manufacturers with radio essentials?

POLYMET MANUFACTURING CORPORATION

837 East 134th St., New York City

CONDENSERS • RESISTANCES • COILS • TRANSFORMERS

Something
NEW



An Accurate Resistor

5 OHMS TO 5,000,000 OHMS

THE Super Akra-Ohm Resistor, wire wound, has been designed with the primary thought of commercial acceptability. In order to insure an accuracy of 1% and permanency of calibration, it is manufactured by a special process, (patent pending).

BULLETIN NO. 62

which fully describes the use of the Super Akra-Ohm Resistor as a Voltage Multiplier, also contains the first complete chart for the employment of accurate resistors with microammeters and milliammeters. The Super Akra-Ohm Resistor is also especially recommended for use as Laboratory Standards, High Voltage Regulators, Telephone Equipment and Television Amplifiers, and Grid and Plate Resistors, etc.

Send Now for your copy of this useful Bulletin

Shallcross Mfg. Company
ELECTRICAL SPECIALTIES
700 PARKER AVENUE
Collingdale, Pa.
Super Akra-Ohm Accurate Resistor

A NEW Edition

Thoroughly revised—greatly enlarged and offering a wealth of new up-to-the-minute information

THE RADIO MANUAL

Revised Edition

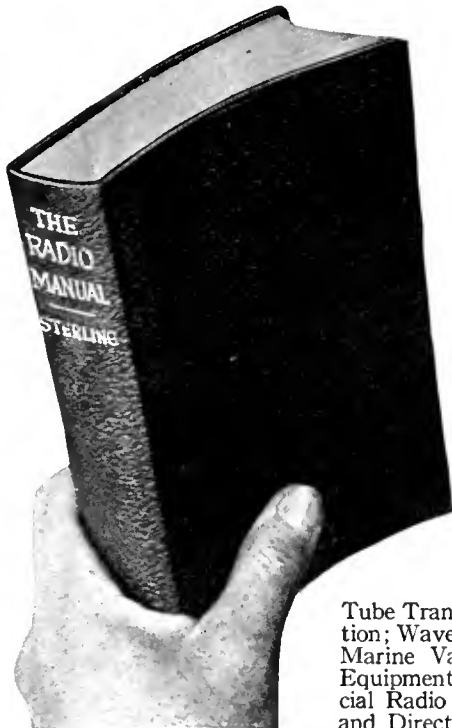

Complete new chapters on aircraft radio equipment; Practical Television and Radiomovies with instructions for building a complete outfit; radio interference; 100% modulation; latest equipment of the Western Electric Co.; the Marconi Auto-Alarm System; and many other developments of the past year. All this information is added in the new edition and, besides, the entire book has been brought right up to date with much new material. **The Radio Manual** continues to be the one complete and up-to-the-minute handbook covering the entire radio field.

A Complete Course in a Single Volume

20 big chapters cover: Elementary Electricity and Magnetism; Motors and Generators; Storage Batteries and Charging Circuits; the Vacuum Tube; Circuits Employed in Vacuum Tube Transmitters; Modulating Systems and 100% Modulation; Wave-Meters; Piezo-Electric Oscillators; Wave Traps; Marine Vacuum Tube Transmitters; Radio Broadcasting Equipment; Arc Transmitters; Spark Transmitters; Commercial Radio Receivers; Marconi Auto-Alarm; Radio Beacons and Direction Finders; Aircraft Radio Equipment; Practical Television and Radiomovies; Eliminating Radio Interference;

Radio Laws and Regulations; Handling and Abstracting Traffic.

New Information Never Before Available

including detailed descriptions of standard equipment is presented, such as a complete description of the Marconi Auto-Alarm System; the R. C. A. Direction Finders; the Western Electric 5-C Transmitter including all the newest equipment; description and circuit diagram of Western Electric Superheterodyne Radio Receiving Outfit type 6004-C; Navy Standard 2-Kilowatt Spark Transmitter; etc., etc. Every detail up to the minute.

Prepared by Official Examining Officer

The author, G. E. STERLING, is Radio Inspector and Examining Officer, Radio Division, U. S. Dept. of Commerce. The book has been edited in detail by ROBERT S. KRUSE, for five years Technical Editor of QST, the Magazine of the American Radio Relay League. Many other experts assisted them.

FREE EXAMINATION

The Revised Edition of "The Radio Manual" has just been published. Nearly 900 pages. 369 illustrations. Bound in Flexible Fabrikoid. The coupon brings the volume for free examination. If you do not agree that it is the best Radio book you have seen, return it and owe nothing. If you keep it, send the price of \$6.00 within ten days.

Clip and Mail This Approval Order Form

D. VAN NOSTRAND CO., Inc. (Radio Broadcast 10-29)
250 Fourth Ave., New York
Send me the Revised Edition of THE RADIO MANUAL for examination. Within ten days after receipt I will either return the volume or send you \$6.00—the price in full.

Name.....
St. and No.....
City and State.....

**A Simplified
"MORECROFT"**

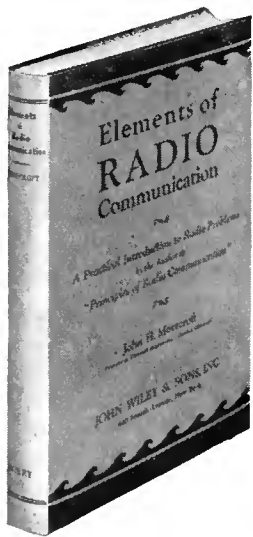

**Elements of
Radio
Communication**

By **JOHN H. MORECROFT**
*Professor of Electrical Engineering,
Columbia University*

For several years Morecroft's "Principles of Radio Communication" has been recognized as the last word on the subject. But as it is highly technical, there have been many suggestions to the effect that a similar but shorter and simplified work would be welcomed by thousands of people.

In response to this, Professor Morecroft has just written "Elements of Radio Communication." It embraces all the major features of the larger work, but it is treated in a much simpler fashion. While technical, it requires no mathematical training further than a knowledge of elementary algebra. The whole field of radio is discussed from broadcasting to receiving, and the latter from a simple crystal set to the most modern A.C. operated receiver. Also, the book is completely illustrated with charts and diagrams, and is supplemented with sets of problems taken from actual radio circuits and apparatus.

Let a free examination convince you that "Elements" furnishes an ideal introduction to radio.

Price \$3.00

A Wiley Book

FREE EXAMINATION COUPON

JOHN WILEY & SONS, Inc.
410 Fourth Avenue, New York

Gentlemen: Kindly send me on ten days' examination Morecroft's "Elements of Radio Communication." I agree to remit the price of the book within ten days after its receipt or return it postpaid.

Name.....
Address.....
Position or Reference.....
Subscriber Yes No..... RB 10-29

ДОБРЫЙ ДЕНЬ!

(Dobroe den—"Good Day", Russian)



The great bell
of Moscow

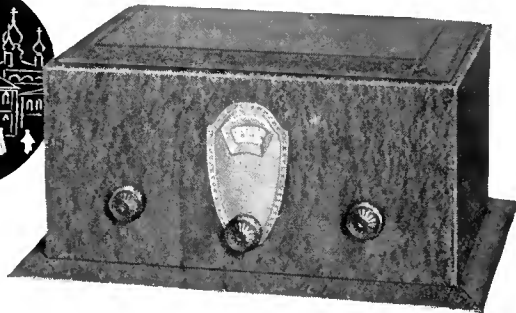

Not so easy for all of us to read, and it is much easier to hear this cheery greeting and lively music all the way from Russia when you tune in on station RDW with the Thrill Box.

Get BOTH Short
Waves AND
Broadcasts
Write us today for
full details

Words and music from 20 different countries in a dozen different languages, may be heard with the NATIONAL Screen-Grid THRILL-BOX. This new Radio is full of new and ingenious features for your convenience and pleasure.

NATIONAL

4-Tube THRILL BOX SW-4

NATIONAL CO. INC., Malden, Mass.

Est. 1914

**! ATTENTION!
SERVICE MEN**

**Quality Replacement
Blocks and By-Pass
Units**

for

**Radio Receivers
"B" Eliminators
Power Supply Units**

Information upon request

Potter Filter Blocks

- RR-245 Condenser Block for single and push-pull 245 type tube amplifier..... \$19.75
- T-2900 Condenser Block for the single 250 type tube amplifier..... \$20.00
- T-2950 Condenser for the push-pull 250 type tube amplifier..... \$22.50
- T-2098 Condenser Block for single 210 type tube amplifier..... \$20.00
- T-280-171 Condenser Block for power pack with 280 type tube rectifier..... \$18.00

The Potter Co.

North Chicago, Illinois
A National Organization at Your Service



23 Years of Leadership

All radio tubes are made under the basic patents of Dr. Lee De Forest but only De Forest Audions include all the latest developments of the De Forest Laboratories.

DE FOREST RADIO CO.
NEW JERSEY
JERSEY CITY



**de Forest
AUDIONS**

