

# RADIO BROADCAST

JULY, 1928

WILLIS KINGSLEY WING, Editor  
KEITH HENNEY  
Director of the Laboratory

EDGAR H. FELIX  
Contributing Editor

Vol. XIII. No. 3

## CONTENTS

Cover Design . . . . .	From a Design by Harvey Hopkins Dunn													
Frontispiece	A Giant Radio-Equipped British Passenger Airplane	124												
What Hope for Real Television?	R. P. Clarkson	125												
The March of Radio . . . . .	An Editorial Interpretation	129												
<table border="0"> <tr> <td>Aviation Must Come to the Use of Radio</td> <td>The Commission Eliminates Its First Station</td> </tr> <tr> <td>No Innovations or Revolutions for 1928</td> <td>The Engineers' Plan of Allocation</td> </tr> <tr> <td>Broadcast Regulation at a Standstill</td> <td>The High-Frequency Spectrum</td> </tr> <tr> <td>The Inequalities of "Equalization"</td> <td>Recent Radio Events</td> </tr> <tr> <td>Another Non-Radio Man for the Commission</td> <td></td> </tr> </table>			Aviation Must Come to the Use of Radio	The Commission Eliminates Its First Station	No Innovations or Revolutions for 1928	The Engineers' Plan of Allocation	Broadcast Regulation at a Standstill	The High-Frequency Spectrum	The Inequalities of "Equalization"	Recent Radio Events	Another Non-Radio Man for the Commission			
Aviation Must Come to the Use of Radio	The Commission Eliminates Its First Station													
No Innovations or Revolutions for 1928	The Engineers' Plan of Allocation													
Broadcast Regulation at a Standstill	The High-Frequency Spectrum													
The Inequalities of "Equalization"	Recent Radio Events													
Another Non-Radio Man for the Commission														
A New Principle in Audio Transformer Design	Kendall Clough	133												
"Radio Broadcast's" Home Study Sheets . . . . .		135												
<table border="0"> <tr> <td>No. 1. The Nature of Radio and Electricity</td> <td>No. 2. Determining the Capacity and Inductance of a Radio Circuit</td> </tr> </table>			No. 1. The Nature of Radio and Electricity	No. 2. Determining the Capacity and Inductance of a Radio Circuit										
No. 1. The Nature of Radio and Electricity	No. 2. Determining the Capacity and Inductance of a Radio Circuit													
Making an A-Power Unit From Your Battery Charger	Robert Burnham	137												
New Apparatus . . . . .	Useful Information on New Products	139												
A Good Amplifier-Power Unit for the 250 Tube	Howard Barclay	141												
"Strays" from the Laboratory . . . . .	Keith Henney	143												
<table border="0"> <tr> <td>New Crystal Control</td> <td>Technical Smoke Screen</td> </tr> <tr> <td>Prices of British "Components"</td> <td>Recent Interesting Technical Articles</td> </tr> <tr> <td>Present Interesting Trends in Radio</td> <td>Present Compression Type Resistors</td> </tr> <tr> <td>Radio Gossip</td> <td>From a Lab Circuit Fan</td> </tr> <tr> <td>Publications Worthy of Note</td> <td>Who Our Readers Are</td> </tr> <tr> <td>"Skim Milk Masquerades as Cream"</td> <td>A Flux for Nichrome Wire</td> </tr> </table>			New Crystal Control	Technical Smoke Screen	Prices of British "Components"	Recent Interesting Technical Articles	Present Interesting Trends in Radio	Present Compression Type Resistors	Radio Gossip	From a Lab Circuit Fan	Publications Worthy of Note	Who Our Readers Are	"Skim Milk Masquerades as Cream"	A Flux for Nichrome Wire
New Crystal Control	Technical Smoke Screen													
Prices of British "Components"	Recent Interesting Technical Articles													
Present Interesting Trends in Radio	Present Compression Type Resistors													
Radio Gossip	From a Lab Circuit Fan													
Publications Worthy of Note	Who Our Readers Are													
"Skim Milk Masquerades as Cream"	A Flux for Nichrome Wire													
An Interesting A-B-C Power Unit and One-Stage Amplifier	J. George Uzmann	145												
A Universal Set and Tube Tester . . . . .	D. A. R. Messenger	148												
Broadcast Station Calls with a Past . . . . .	William Fenwick	150												
"Our Readers Suggest" . . . . .		151												
<table border="0"> <tr> <td>Checking Power Unit Voltages</td> <td>Additional Amplification for Phonograph Pick-Up</td> </tr> <tr> <td>A Convenient Telephone Jack Arrangement</td> <td>To Stop That Whistling</td> </tr> <tr> <td>Neutralizing the Short-Wave Amplifier</td> <td></td> </tr> <tr> <td>Wave Trap Tuned Antenna Combination</td> <td></td> </tr> </table>			Checking Power Unit Voltages	Additional Amplification for Phonograph Pick-Up	A Convenient Telephone Jack Arrangement	To Stop That Whistling	Neutralizing the Short-Wave Amplifier		Wave Trap Tuned Antenna Combination					
Checking Power Unit Voltages	Additional Amplification for Phonograph Pick-Up													
A Convenient Telephone Jack Arrangement	To Stop That Whistling													
Neutralizing the Short-Wave Amplifier														
Wave Trap Tuned Antenna Combination														
A Short-Wave Adapter for the R.B. Lab Receiver	Hugh S. Knowles	153												
How to Build a Beat-Frequency Oscillator . . . . .	G. F. Lampkin	156												
"Radio Broadcast's" Service Data Sheets on Manufactured Receivers . . . . .		159												
<table border="0"> <tr> <td>No. 3. The Grebe A.C. Six</td> <td>No. 4. The Kolster 6 K A. C.</td> </tr> </table>			No. 3. The Grebe A.C. Six	No. 4. The Kolster 6 K A. C.										
No. 3. The Grebe A.C. Six	No. 4. The Kolster 6 K A. C.													
As the Broadcaster Sees It . . . . .	Carl Dreher	161												
<table border="0"> <tr> <td>Note on Programs</td> <td>Design and Operation of Broadcast Stations</td> </tr> <tr> <td></td> <td>21. Water-Cooled Vacuum Tubes</td> </tr> </table>			Note on Programs	Design and Operation of Broadcast Stations		21. Water-Cooled Vacuum Tubes								
Note on Programs	Design and Operation of Broadcast Stations													
	21. Water-Cooled Vacuum Tubes													
A Space-Charge Amplifier and B Supply . . . . .	H. P. Manly	163												
A Fine Program You Will Never Hear . . . . .	John Wallace	165												
<table border="0"> <tr> <td>The Listener's Point of View</td> <td></td> </tr> </table>			The Listener's Point of View											
The Listener's Point of View														
A Receiver for Short-Wave Broadcast Reception	Bert E. Smith	167												
Manufacturers' Booklets . . . . .		170												
"Radio Broadcast's" Laboratory Information Sheets . . . . .		174												
<table border="0"> <tr> <td>No. 201. Tube Life</td> <td>No. 206. A Screen-Grid Resistance-Coupled Amplifier</td> </tr> <tr> <td>No. 202. Farm Lighting Systems</td> <td>No. 207. Equalizing Wire Lines for Broadcasting</td> </tr> <tr> <td>No. 203. Tuned Circuits</td> <td>No. 208. Power Values in Radio Receiving Antennas</td> </tr> <tr> <td>No. 204. Line Voltage Variations</td> <td></td> </tr> <tr> <td>No. 205. Electrical Measuring Instruments</td> <td></td> </tr> </table>			No. 201. Tube Life	No. 206. A Screen-Grid Resistance-Coupled Amplifier	No. 202. Farm Lighting Systems	No. 207. Equalizing Wire Lines for Broadcasting	No. 203. Tuned Circuits	No. 208. Power Values in Radio Receiving Antennas	No. 204. Line Voltage Variations		No. 205. Electrical Measuring Instruments			
No. 201. Tube Life	No. 206. A Screen-Grid Resistance-Coupled Amplifier													
No. 202. Farm Lighting Systems	No. 207. Equalizing Wire Lines for Broadcasting													
No. 203. Tuned Circuits	No. 208. Power Values in Radio Receiving Antennas													
No. 204. Line Voltage Variations														
No. 205. Electrical Measuring Instruments														
Letters from Readers . . . . .		179												

The contents of this magazine is indexed in *The Readers' Guide to Periodical Literature*, which is on file at all public libraries.

## AMONG OTHER THINGS.

MANY favorable comments have been received about the list of stations throughout the world transmitting below 100 meters which occupied three pages of our May, 1928, issue. Although this list was very carefully checked for accuracy against the best lists of stations we could find, some errors undoubtedly crept in. Some of our readers have been kind enough to send us information which should be included when the list is published again in RADIO BROADCAST. In the course of the next four or five months we shall reprint the list, completely revised. We urge our readers to help us by sending in any corrections which should be included at that time.

IN THIS issue we begin a new feature, "RADIO BROADCAST's Home Study Sheets" prepared by Keith Henney, director of the Laboratory. Back in September, 1925, Mr. Henney's first article, "New Fields for the Home Experimenter" undertook to lead the radio experimenter who had tired of merely building radio sets and who desired to learn more about what makes the wheels go 'round. Since that time, many articles of a similar nature have been published in these pages. With this issue we begin the "Home Study Sheets," which are arranged so that the interested readers can remove them with a razor blade and keep a complete file. The Sheets to follow will contain a great deal of practical information in what we believe is the most useful form. We shall be glad to have our readers' opinions on the innovation. It is a policy of RADIO BROADCAST to print as much useful information as possible with due thought to the form in which it is presented. The "Lab Sheets"—the 208th appears in this issue—were the first in this series. Next follow the "Service Data Sheets on Manufactured Receivers" and we have now added the "Home Study Sheets." Still other services, similarly valuable, are in prospect.

UNLESS we are greatly mistaken, several of the articles in this issue are going to excite a great deal of interest. The leading article by R. P. Clarkson, "What Hope for Real Television?" attempts to explain television systems in general and to point out what now seems to be the only possibility of success.

OUR August issue will contain, among other things, a description of the d.c. operated "Lab" circuit, another timely article on television, a really fine article by David Grimes on phonograph pick-up units, a constructional and operation article on the Cooley Rayfoto system, first introduced to our readers in our September, 1927, issue, a story on a new short-wave receiver, and the first article of a series by Robert S. Kruse. Mr. Kruse for a number of years was technical editor of QST. His first article deals with the mystery of 5-meter work and will be of especial interest to all our amateur friends who read RADIO BROADCAST. All the regular features will appear in our August issue as well.

AS THIS issue goes to press, a correction has been noted in the list of parts (p. 142) for the article "A Good Amplifier-Power Unit for the 250 Tube." The Dongan Condenser Unit, C<sub>1</sub>, is listed at \$16.50, instead of \$23.00, as printed in the list.

—WILLIS KINGSLEY WING.

## DOUBLEDAY, DORAN & COMPANY, INC., Garden City, New York

**MAGAZINES**  
COUNTRY LIFE  
WORLD'S WORK  
GARDEN & HOME BUILDER  
RADIO BROADCAST  
SHORT STORIES  
EDUCATIONAL REVIEW  
LE PETIT JOURNAL  
EL ECO  
FRONTIER STORIES  
WEST  
THE AMERICAN

**BOOK SHOPS (Books of all Publishers)**  
NEW YORK: LORIN & TAYLOR; JAMES MCCREERY & COMPANY  
PENNSYLVANIA TERMINAL AND 166 WEST 32ND ST.  
848 MADISON AVE. AND 51 EAST 44TH STREET  
420 AND 526 AND 819 LEXINGTON AVENUE  
GRAND CENTRAL TERMINAL AND 38 WALL STREET  
CHICAGO: 75 EAST ADAMS STREET  
ST. LOUIS: 223 N. 8TH ST. AND 4914 MARYLAND AVE.  
KANSAS CITY: 920 GRAND AVE. AND 206 WEST 47TH ST.  
CLEVELAND: HIGBEE COMPANY  
SPRINGFIELD, MASS.: MEEKINS, PACKARD & WHEAT

**OFFICES**  
GARDEN CITY, N. Y.  
NEW YORK: 244 MADISON AVENUE  
BOSTON: PARK SQUARE BUILDING  
CHICAGO: PEOPLES GAS BUILDING  
SANTA BARBARA, CAL.  
LONDON: WM. HEINEMANN, LTD.  
TORONTO: DOUBLEDAY, DORAN & GUNOY, LTD.

**OFFICERS**  
F. N. DOUBLEDAY, Chairman of the Board  
NELSON DOUBLEDAY, President  
GEORGE H. DORAN, Vice-President  
S. A. EVERITT, Vice-President  
RUSSELL DOUBLEDAY, Secretary  
JOHN J. HESSIAN, Treasurer  
LILLIAN A. COMSTOCK, Asst't Secretary  
L. J. MCNAUGHTON, Asst't Treasurer

Copyright, 1928, in the United States, Newfoundland, Great Britain, Canada, and other countries by Doubleday, Doran & Company, Inc. All rights reserved.  
TERMS: \$4.00 a year; single copies 35 cents.

*New*  
**Hammarlund**  
*Space-Wound*  
**COILS**

**For Low-Wave  
and  
Screen-Grid  
Circuits**

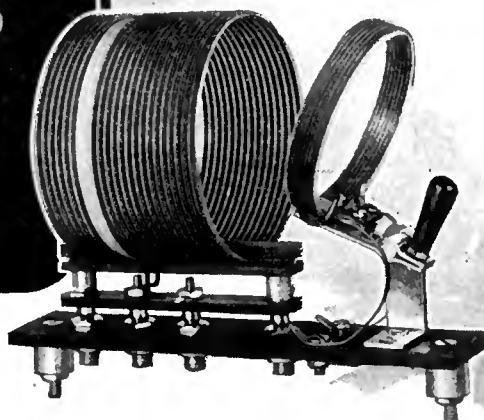

**For LOW-WAVE RECEPTION**

**20, 40 and 80 Meter Bands**

Set of Three Coils and Plug-In Base... \$10.00 complete  
Plug-In Coils..... 2.50 each  
Base Only..... 3.00 "  
Special Plug-In Coils for higher wave-lengths.

*Write for interesting low-wave folder*

**LOW-WAVE  
INDUCTOR COILS**

**20, 40 and 80 Meter Bands**

Set of Three Coils and Plug-In  
Base..... \$6.00 complete  
20 and 40 Meter Coils... \$1.50 each  
80 Meter Coils..... 2.00 "  
Base Only..... 1.00 "  
Special Plug-In Coils for higher  
wave-lengths.



**No. 222  
COILS**

**For Screen-Grid  
Circuits**

Antenna Coupler and R. F. Transformer, each  
with four taps on the primary coil. Two  
sizes, for use with .00035 and .0005 con-  
densers..... \$2.50 each

**A** amazing results now obtained by experimenters with low-wave reception provide real thrills for the radio fan. The new Hammarlund Plug-In Coils insure the utmost efficiency in low-wave work.

Secondary and tickler are space-wound on a film of high-test dielectric material. Losses are low. Results are exceptional. A set of three coils with plug-in base (base includes variable primary coil with flexible phosphor-bronze connections) covers the 20, 40 and 80 meter bands, with a range from 15 to 107 meters. Special coils available for higher waves.

Hammarlund Low-Wave Inductors for R.F. stages, using either standard or screen-grid valves, are now also provided with plug-in base for convenient change to any wave-length from 15 to 107 meters. They are constructed like the coils described above, without tickler or variable primary.

The remarkable efficiency of the new screen-grid valves is further increased when used with Hammarlund No. 222 Coils, specially designed for screen-grid circuits covering the broadcast range. A feature of both the antenna coupler and R. F. transformer is the four-tap primary, which allows the greatest amount of coupling consistent with selectivity required. Only two inches in diameter, they may be mounted vertically within shields or other small space. The antenna coupler may be used also for other standard circuits, where great latitude of primary coupling is desired.

*If your dealer can't supply you,  
write direct to us.*

*Ask for Hammarlund literature.*

**HAMMARLUND MANUFACTURING COMPANY**  
424-438 W. 33rd Street, New York

For Better Radio  
**Hammarlund**  
PRECISION  
PRODUCTS





*A Giant British Radio-Equipped Passenger Airplane*

**T**HIS is a close-up of one of the giant DeHavilland 66 Hercules multiple-engined airships, fitted with three Bristol Jupiter 450-horsepower engines, built for the British Imperial Airways for the new passenger air route between England and India via Egypt, Palestine, Mesopotamia, and Persia. The radio cabin is the most spacious yet fitted in any airship and contains the best apparatus now available.

Under the new international aerial regulations, a radio operator and mechanic is carried to attend to the apparatus and operate it. Previously the radio equipment was carried in the cockpit and operated by the pilot. The power of the transmitter is 150 watts. The set is slung on elastic bands to reduce vibration; the wind-driven generator, minus its propeller, is visible just under the top wing



BEFORE THE BAIRD "TELEVISOR"

In spite of the miles of type expended on television, it is not yet possible by any known system to receive images which have much detail. All the systems known are generally similar. Although it is possible for experimenters to construct simple receivers to pick up television signals, "when, as, and if" transmitted, the results are difficult to achieve. The illustration shows Mrs. Howe, said to be the first woman whose features were "televised" across the Atlantic by the Baird system

## What Hope for Real Television?

By R. P. CLARKSON

Author of "The Hysterical Background of Radio"

THE promise of television is that we may see events as they occur, no matter where we are, provided we have a television receiver and provided, also, that a televisor operator is present at the event. Televising is the broadcasting of images, the annihilation of distance for the eye as aural radio has done for the ear. In place of the microphone we want to use the camera lens together with some device that translates light reflected from the object, into electric current impulses which speed to our receiver where those impulses are translated back into light and are projected on a screen

This is the promise. It seems so simple. Yet long before regular broadcasting of programs commenced, we were as far ahead in method as we are now. It violates no confidence to say that only within the last month one of the most prominent workers has abandoned the problem in favor of research on the facsimile transmission of telegrams. Another, C. Francis Jenkins, writes that it is a stubborn problem but the solution seems to be right around the corner. In England, Sir Oliver Lodge raises a note of warning against the public expecting success, stating that other scientists are in accord with him. Theodor



EIGHTEEN LINES TO THE INCH

This drawing shows what slight modulation is required to portray the features. The image received in some television outfits is no larger than the actual size of the cut above. The reader may imagine the detail of the received picture where the image of an entire head, for example, must be included in this space

Nakken, whose researches have made the photoelectric tube available for this work, states flatly that the thing is impossible with the methods now being tried, except at enormous costs. With this weight of authority against success, let us look for a moment at the problem.

The eye is a camera, but a very defective one. It retains an impression for a definite period, normally about one-tenth of a second, and because of this, moving pictures are possible. On the other hand, an impression must affect the eye for a certain definite minimum of time, depending upon the intensity of light, or it won't register in the consciousness at all. This makes possible the magician's tricks in dim light, and makes almost impossible the achievement of television.

To see any image dot by dot, the first essential is that the eye must see each dot for a period long enough to awake the consciousness, and yet it must see the last dot of the image before the impression of the first dot is lost. To put this in figures means that the last dot must be shown within a tenth of a second after the first dot, and yet each dot must appear for at least the five-hundred-thousandth part of a second, strongly

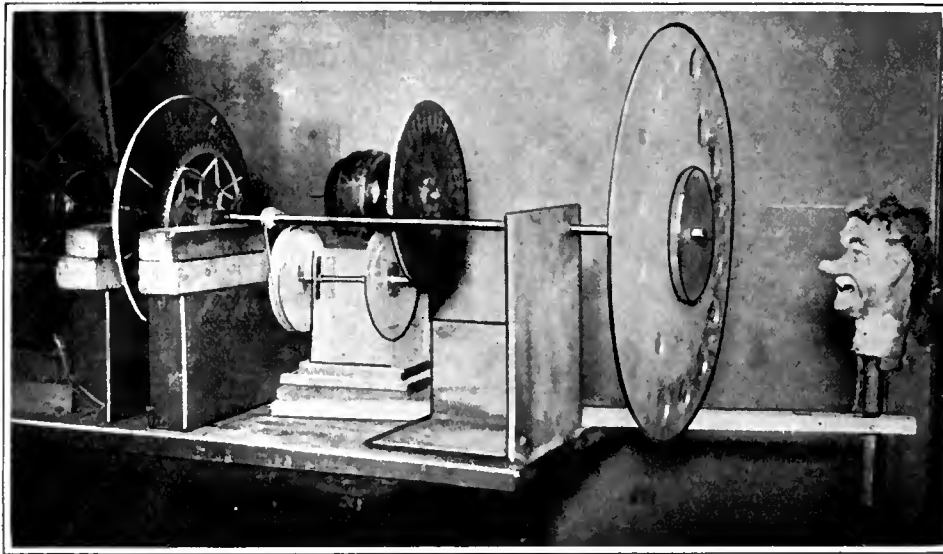

BAIRD'S FIRST "TELEVISOR"

This crude but workable apparatus, undoubtedly the result of much labor on the part of Baird, who, like most inventors dependent upon their own resources, had very little money with which to carry on his experiments, gives an idea of how simple is the essential apparatus required for the production of television signals. The various disks function to break up the object to be transmitted into many tiny dots so that the light finally reaching the photoelectric cell is broken up into many consecutive impulses each of which corresponds in intensity to one particular spot of the subject. This original model has been placed on view at the Science Museum, at South Kensington, London

illuminated. These two figures determine the size and quality of the possible image. They indicate 50,000 dots to the picture as substantially the possible maximum and strong artificial illumination as essential at the receiver, unless some way is found to maintain the illumination of the dots beyond the period of their stimulus.

Transmitting an image and transmitting a musical composition are accomplished in the same way. The music is sent note by note in ordered sequence. We enjoy it as it is produced. A picture is similarly subdivided into dots of light and shade and these dots sent in any sequence, but they must all be received and placed in proper relationship before there is any picture. There is nothing to see until the transmission is ended. In telephotography, time is no bar to

transmission because each dot is permanently recorded as received, and when transmission is ended we have a complete record. In television, each image is fleeting. There is no record. It is all over in a tenth of a second and the next image is on the way. Time is of the essence of television. It is largely the problem of time that makes successful telephotography meaningless with respect to television. A small picture sent in five minutes is commercially perfect but to send 3000 pictures of the same size in the same length of time is another story.

## REQUIREMENTS OF A GOOD PICTURE

**N**EGLECTING color and form, for the moment, all pictures and images differ from each other only in the distribution of light and

shade. The range of light intensities is of the order of one to thirty, as we go from deepest shadow to brightest light. But all these intensities are not usually sharply defined. They may shade into each other abruptly, however, as in the case of a church steeple standing out against a white cloud. Draw an imaginary line across the steeple and follow in your mind the changing light and shade along that line. From the white of the cloud you may change suddenly to a very dark edge of the steeple, and then come a continual series of changes through all shades as the detail of the steeple is recorded. Across a peaceful landscape even greater variations may be found as you follow a straight line through clouds, trees, leaves and grasses, flowers, dirt, stones, pebbles, and whatnot. These changes in light and shade are the "modulation" of the picture.

Long experience with half-tones has shown that to produce a really good picture, provision must be made to reproduce 130 to 150 changes in light and shade to each lineal inch. This same modulation may be required up and down a vertical line as well as sideways along the horizontal. In other words, the modulation figure for a square inch may be of the order of 20,000 changes. If the figure is made up of dots, 20,000 of them have to be printed to give the detail of a fine half-tone. On cheap news print, where the surface itself is rough, as low as 2500 dots per square inch are used in the poorest of newspaper reproductions. Most of the New York papers use 3969 dots per square inch, while this magazine and other popular ones on good paper uniformly use 14,400 dots to the square inch. Even with the highest of all these figures, however, details of cloud effects cannot be reproduced and the beautiful lights and shadows of woodcuts are impossible.

In our television screen image let us aim no higher than the detail of a news print photograph. For each square inch of the picture there must be 2500 dots transmitted. For an image one foot square, which wouldn't give much of a view of a spectacle such as a ball game, there would be 360,000 dots. The last dot must arrive within a tenth of a second after the first dot, so the rate of transmission over a single waveband would be 3,600,000 dots or impulses per second. Each dot would exist only that small fraction of a second

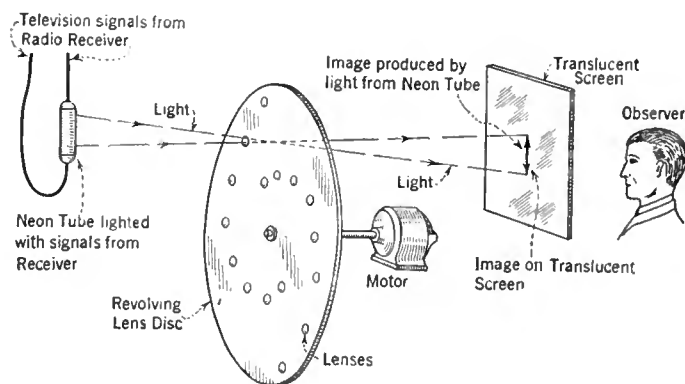

BAIRD'S TELEVISION RECEIVER

This shows the arrangement of the revolving disc, neon tube and translucent screen used in one model of the Baird television receiver. The light from the neon tube, varying in accordance with the picture signals, passes through the lenses in the revolving disc (which must rotate in synchrony with the transmitting apparatus) which focus the light on the screen; the image is viewed from the opposite side of the screen. The general system used here is very similar to that used by Dr. E. F. W. Alexanderson of the General Electric Company in his recent demonstration at Schenectady. The only difference was that the lenses in the disc and the screen were dispensed with and the observer saw the image by looking at the neon tube directly through the revolving disc. The received image is red in color—a characteristic of all television reception using neon tubes, with their characteristic red glow.

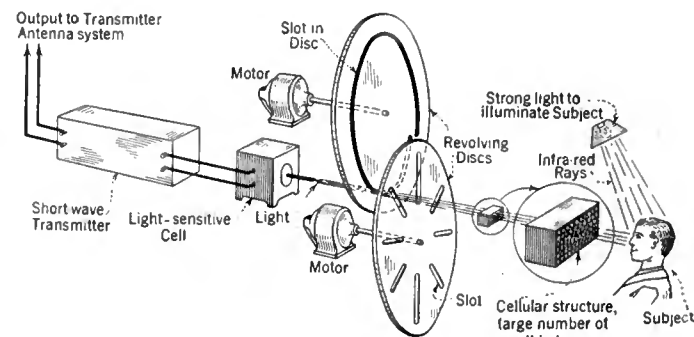

THE BAIRD "TELEVISOR"

This transmitter, the result of experiments by J. L. Baird, makes use of infra-red rays, invisible to the human eye, but capable of affecting the photoelectric cell which converts the varying light signals into corresponding electric impulses. The infra-red rays, reflected from the subject transmitted, pass through the cellular structure which breaks up the light into many small sections or dots. The light then passes through the two revolving discs which rotate in such a manner as to expose to the light-sensitive cell at any moment only one of the light beams from the cellular structure. The resulting electric impulses are then caused to modulate the radio transmitter. The use of infra-red rays is not essential to the operation of this camera. Electrically, the system will function satisfactorily with any type of rays to which the photoelectric cell will respond. The amount of illumination required is quite intense, however, and, if ordinary lights were used, one would not be able to endure the intense glare for very long.

and would obviously never register on the eye unless it happened to be repeated in successive pictures, and possibly not then. It would be so repeated, of course, unless motion had ensued in the intervening tenth of a second. If there had been motion that part of the picture would be blank. This is the first difference we find between motion pictures and television. In the movies we see a blow start and see the arrival of the fist. We imagine the rest of it just as we see the successive positions of a speeding automobile and imagine the continuity. Only by speeding up the camera to get intervening snaps and presenting them in slow motion do we get detail. Each complete picture flashes at once. In television, because of subdivision into dots, only one dot is shown at a time and the mind will not retain this short flash during the remainder of the picture. We must make the screen retain the dot for us.

A second distinction comes from the fact that we cannot enlarge the picture received in television with any increased detail in the result. We have chosen the minimum number of dots per square inch to give a passable image. If this is enlarged by a projecting lens, we simply separate

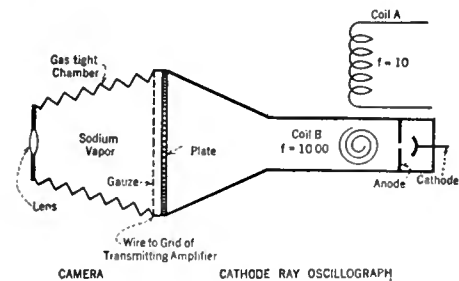

THE SWINTON-CLARKSON TELEVISION CAMERA

In this device the person or object to be televised is located in front of the lens, the lens functioning to focus the reflected light from the object onto the plate. A stream of electrons from the cathode is attracted to the positively charged anode and a great many of the electrons pass through the hole in the anode plate and reach a group of photoelectric cells. In passing through the space between the hole in the anode and the plate the electrons come under the influence of the two coils A and B; coil A causing the stream to be deflected up and down the plate and coil B causing the stream to move back and forth across the cells. The image on the plate is scanned in this manner

rate the dots. If we magnify the size ten times we'll have only 250 dots per square inch and only at a distance will this give the effect of a photograph. We haven't even the value of a printed half-tone where the dots are of varying size and shape as well as shade. Our dots are uniform except in shade. This may be overcome by the screen in the device described later.

Now, getting back to the 3,600,000 impulses per second. This is equivalent to the modulation frequency in aural radio. The minimum frequency of the carrier would be about ten times that, or a frequency of 36,000 kilocycles, approximately eight meters. A larger picture or a better picture would drive us down to still shorter waves.

A FOUR-INCH SQUARE IMAGE

SUPPOSE, instead of a foot square, we make the image four inches square. Even this would mean 40,000 dots for each picture or 400,000 impulses per second. Our carrier maximum would be 75 meters. Even suppressing one side band, the 400,000 modulation frequency

calls for a receiver to amplify evenly over a band of 400 kilocycles or as much as 40 of our present broadcast channels. This is for a tiny picture of poor quality and minimum speed. For any fast event, for a larger picture, or for even newspaper quality, what a complex receiver must be devised! One such station would blanket the entire broadcast spectrum.

Go down in size and quality, if you will. A three-inch square picture with 25 modulations to the lineal inch or 625 dots to the square inch, means only 56,250 impulses per second. The carrier could be as high as 535 meters but our tuning and amplification would be over five channels 10,000 cycles wide. To get within the legal separation of stations we can use a modulation of only 5000 impulses per second which, for a barely recognizable image, would give us only one square inch, remembering that we must send 10 pictures a second.

What, then, is Baird in England doing, for example? Obviously the only thing he can do and basically the only thing that has ever been done in television. That is, to select as the object to be televised, something that has few gradations of light and shade and extremely slow movement. This is the human face. It is a familiar object, almost entirely white space with the shadows around eyes and nose very ill defined and their outline of no particular importance in recognition. The cartoonists have taught us that we need no detail of a face to recognize the person. There is always some outstanding characteristic that suffices. Slight blurring would rather soften the result instead of spoiling it.

Television is not achieved merely because seeing faces at a distance has been and will be accomplished. It was in recognition of this fact that the English publication *Popular Wireless* unsuccessfully sought to induce Baird to televise a simple cube in slow motion to win the sum of \$5000 that magazine offered. That Baird ignored the challenge must merely mean that he, too, recognizes the limitations of his apparatus.

There are other problems besides that of time in its relation to the defects of vision. There is the question of synchronizing the mechanically moving parts of transmitter and receiver. When things happen in the hundred-thousandth part of a second, there is need for absolute accord on both ends of the line. If the same power line is available at both ends, synchronous motors may be kept in step, but this exists only in few localities and over short distances. Synchronizing by this means it is not a real solution of the problem.

AS THIS brief review indicates, the real drawback is the fact that the picture must be subdivided and sent as a sequence of impulses. We would face similar difficulties with sound broadcasting if, for example, we had to send the whole of an opera selection as one blare of noise in a tenth of a second. It could be done, of course, by securing a sufficient number of musicians so that each need sound but one note. Then, at a given signal, every musician in this enormous

THE REAL DIFFICULTY

orchestra would sound his note and go home. We would receive the opera selection but it would hardly be worth while. Yet this is exactly what the eye demands in television.

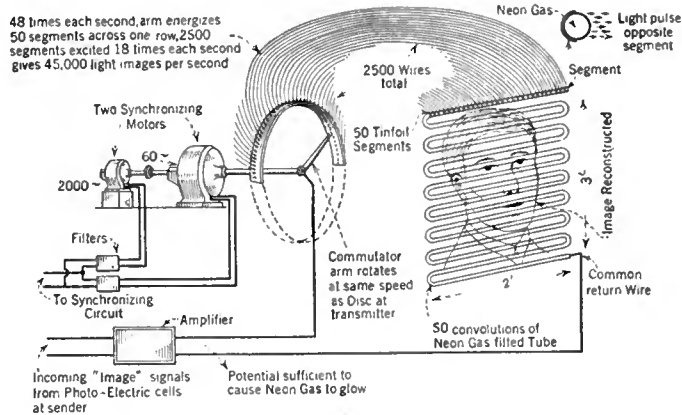

THE BELL TELEPHONE LABORATORIES' TELEVISION RECEIVER

A large neon tube forms the basis of this television receiver. On the back side of the tube 2500 segments of tin foil are cemented, connecting by means of individual wires to 2500 segments on the commutator, which revolves in synchrony with the apparatus at the transmitter. The incoming signals, modulated in accordance with the shading of the subject being transmitted, are amplified and cause segments of the neon tube to glow with a brilliancy dependent upon the shading of the subject being transmitted

One thought has been to divide the object into units. That is, in terms of pictures, not to send the whole picture over one carrier but, in effect, send, say, 144 pictures, each an inch square, and at the receiver these would make up into a single image one foot square. This was one of the first ideas suggested as long ago as 1880. Carried to its extreme, perfect results would be achieved but, within the limits of costs and apparatus, we merely multiply our troubles. Sixteen pictures 3 inches square might be managed if we could send anything but a crude 3-inch-square picture. It would be at 16 times the cost and 16 transmitters as well as 16 receivers would be needed and all would have to be synchronized. Along similar lines was Doctor Alexanderson's bundle

of a television receiver, sometimes called a television receiver, uses an arrangement similar to that incorporated in the Campbell Swinton camera suggested in 1908. The electron stream from the cathode is caused to scan the fluorescent screen due to the action of the coils A and B, their intensity being varied by means of the two deflecting plates. Potential from the receiver amplifier is impressed on the deflecting plates and causes the number of electrons passing through the opening in the stop plate to vary in accordance with the image signals from the transmitter. The screen at the left of the camera becomes fluorescent under the action of the electron stream and the image then becomes visible to any one standing in front of the screen

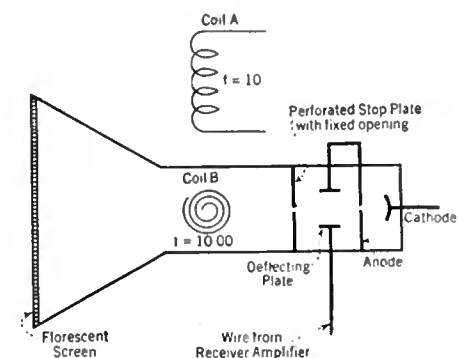

CAMPBELL SWINTON TELEVISION PROJECTOR

Digitized by Microsoft®

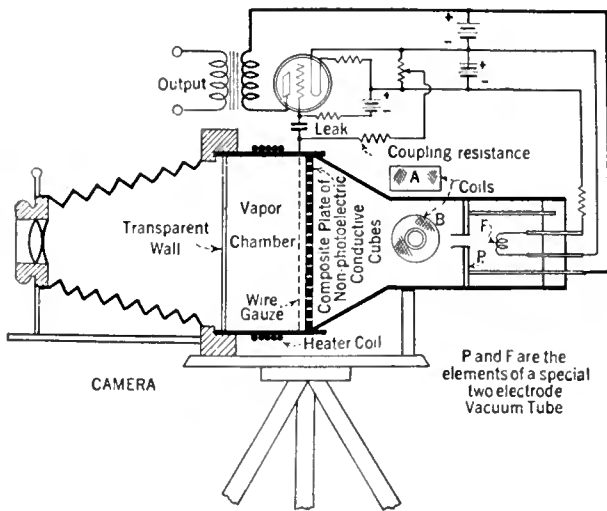

THE CLARKSON TELEVISION PROJECTOR

This projector makes use of a three-electrode tube, the grid of which functions to control the electron stream from the filament F. The electrons passing through the opening in the plate P are caused to scan the screen due to the action of the two coils A and B. A phosphorescent screen (rather than a fluorescent screen) is used so that the screen will continue to glow for an interval after the impulse stimulus is removed. This results in considerable improvement for it reduces the amount of light required and also permits the use of a greater number of impulses so that greater detail may be obtained

of seven light rays analyzing the object, instead of one, and Doctor Ives' experiment with subdivided photoelectric cell and screen.

The Englishman, A. A. Campbell Swinton, in a letter to *Nature*, June 18, 1908, and more in detail in his Presidential Address to the Röntgen Society, November 7, 1911, set forth the genesis of an idea along these lines but one never given publicity and never tried out. I have taken the liberty of modifying this idea and present it herewith as a last desperate hope.

IS THIS THE WAY OUT?

IN ALL other television devices before the public at present the method of telephotography is being used, speeded up to the tenth-second requirement. At the transmitter is a photoelectric cell. A beam of light explores the object to be "televised" and is reflected to the cell. This cell modulates the carrier wave, just as though it were a microphone. Varying light actuates it just as varying sound actuates the microphone. At the receiver, in place of the loud speaker, is a glow lamp—usually a neon tube in one form or another—which changes its brilliancy in step with the received impulses from the photoelectric cell. The light from this lamp is made to explore a screen in synchronism with the beam at the transmitter. The usual method of swinging the beams of light up and down and over the object and screen, is a mechanically revolving disc perforated spirally with holes, a device patented by Nipkow in 1884, this inventor being the first to see the advantage of breaking up a picture into lines.

In the Swinton method there is no mechanically moving part. The object is illuminated strongly and we have a "television camera," let us say, which projects the image to be transmitted, not on a film, but on a composite plate made of tiny cubes of photoelectric material insulated from each other. The camera is gas tight and filled with sodium vapor, which conducts negative electrons more readily under the influence of light. Between the projecting lens and the composite plate, in the vapor chamber, is a gauze wire screen. The charge on this gauze screen modulates the transmitting tube.

In effect, the gauze screen is connected by radio to a plate in the receiver projection apparatus. A beam of cathode rays is directed past this plate towards a sensitive fluorescent screen. Only when the rays are slightly bent by the repulsion of the plate can they pass through a fixed opening and actually be directed to the fluorescent screen to cause a luminous spot.

At the transmitting end there is also a cathode-ray beam continually searching the composite plate of the camera but on the back side from where the image illuminates it. As this stream strikes each little photoelectric cube, it charges it negatively but the charge is dissipated unless that cube is illuminated on the front by light from the object. In the latter case, the charge of the cube will pass away through the ionized vapor along the illuminating beam of light until it reaches the gauze screen, whereupon that charge becomes an impulse carried over to the receiver projection apparatus where it charges the deflecting plate which bends the synchronized cathode ray so that a luminous spot is formed on the fluorescent screen.

Each received impulse must correspond in position to the illuminated cube of the composite plate, requiring the synchronizing of the two cathode ray beams. This may be done at each end separately through the same construction as the cathode ray oscillograph, the beam being moved by the magnetic field of two coils at right angles to each other and having widely differing frequencies as 10 and 1000 cycles or 10 and 10,000 cycles. Substantially

the two rays are merely tracing curves of great amplitude and rather low frequency.

In this method the object itself is not explored but its projected image is automatically subdivided by the composite plate of the camera, which has no electrical connections. Only one carrier wave is required but we still have the broad band of frequencies to detect and amplify at the receiver. No mechanically moving parts are used. A telephoto lens, a wide angle lens or any usual camera arrangement may be used at will. Synchronizing presents no difficulties and the method is as adaptable to wire as to radio. But as yet it has not been found practical, the main reason being that the use of photoelectric material in the composite plate means that electrons will be given off continually as long as light falls on the plate, and in mass when the image shifts.

In the writer's proposed modification of the Swinton device, the material of the composite plate is non-photoelectric but conductive. The writer uses a closed electric circuit of which the exploring electron beam is a part, the conductive cube is a part when the beam strikes it, and the ionized path in the vapor is the varying part of the circuit. An amplifying tube is readily coupled to this circuit.

In the projector proposed by the writer, he suggests the use of a three-electrode vacuum tube, using a heavily biased grid, the incoming signal modulating that grid, as usual, and permitting the flow of an electron beam. The observing screen must be phosphorescent, instead of fluorescent. That is, it must glow for a time after the impulse strikes it.

If any method within our knowledge has possibilities, this is it. If it fails, television will await the genius who conceives some new way of breaking up an image. There is no other hope.

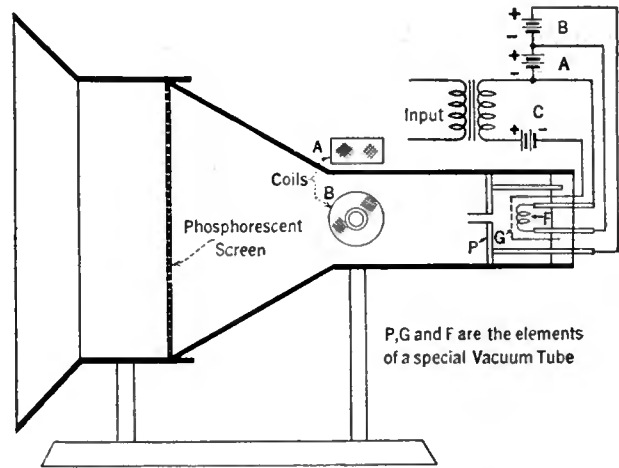

THE CLARKSON TELEVISION CAMERA

In this arrangement a closed electric circuit exists from the source of electrons F through the beam of electrons, which act as a flexible conductor, to any conductive member of the non-photoelectric composite plate, through the plate to the wire gauze screen, along the screen to the coupling resistance and back to the filament circuit. The object to be televised stands in front of the lens at the left

# THE MARCH OF RADIO

## NEWS AND INTERPRETATION OF CURRENT RADIO EVENTS

### Aviation Must Come to the Use of Radio

THE question of wireless received serious consideration," wrote Commandant James C. Fitzmaurice in the *New York Times*, after the first westward airplane flight across the Atlantic, "but it was decided that an efficient and useful wireless set would weigh approximately 180 pounds. It was decided that this weight of benzol would be better. This was the one weak point in the organization of the flight, as we now realize that had we had a wireless set on board, upon our estimated arrival in the neighborhood of Newfoundland, we could have been given almost our exact position by the direction-finding stations along the coast and informed of the precise direction and velocity of the wind over the area, and we would have made New York easily and accomplished our objective. We consider wireless absolutely necessary for all future undertakings of this nature."

If radio could have enabled the German fliers to reach their goal, it may be argued with equal force that Nungesser, Coli, Hinchcliffe, Hamilton, St. Roman, and the other transatlantic fliers might well have made safe landings, guided through the hazardous Newfoundland region by compass bearings from Cape Race, Belle Isle, and Chebucto Head. Had the *Bremen* been properly equipped with radio, she would have landed in an airport and Floyd Bennett's tragic flight to aid the German aviators would have been unnecessary. Last year, the *Bremen* started a westward flight across the Atlantic but, warned by radio of unfavorable weather, returned to safety. Byrd's transatlantic flight was successful largely because of radio beacon signals although he did not make the most of his installation. Those who attempt long-distance flights without the aid that radio can give them, heroes or not, are both unscientific and foolhardy. The fact that some succeed in their undertaking without radio is no justification for recklessness.

Only when transatlantic and international flights become common and scheduled occurrences will long-distance flying take its place among the useful arts of human society. Like radio, aviation must become a regular service which is expected to function satisfactorily and without failure.

The scientific development of aeronautics has already advanced to the point where we have aircraft and aircraft motors which are entirely serviceable and reliable. Ships can be built to meet almost any reasonable requirement. Motors are still uneconomically shortlived, but their limitations are so well known that an ample factor of safety for any reasonable flight can be provided.

The principal obstacles to everyday use of aviation are safety and cost. When the problem of safety is solved, the public will so quickly accept the airplane as a means of rapid travel that the cost of flights will fall to a point justified by the time which they save. Public confidence, based on reliable service, rather than spectacular feats, is the greatest need of aviation.

The development of radio communication as an integral part of our commercial flying struc-

ture is the most important and the most neglected step to promoting safety in aviation. Its general adoption is not so much a matter of developing new equipment as one of convincing the aircraft industry of the value of radio.

Radio serves the aeronaut in several distinct capacities. At all important landing fields, radio stations are required for the exchange of weather reports, to report the leaving and arrival of ships, to issue orders to aircraft in flight and to disseminate periodic weather reports. With a properly coordinated system of collecting and distributing weather information, storm warnings can be issued in ample time to assure the comfort of passengers and the safety of cargo. At least 500 low-power transmitting stations for this purpose will ultimately be required, as well as a few high-power transmitters to broadcast information to these landing field stations.

Another important function of radio is to mark out the highways of the air and to keep the aviator on his course. The aircraft direction beacon, which radiates two directional signals at forty-five degrees from the prescribed course, has demonstrated its usefulness. The radiated signals consist of mechanically sent dots and dashes, so timed that, when a flier is exactly on his course, the combined signal received from both directional stations equally forms a single series of dashes. But should the pilot deviate from his course, the signal from one of the directional antennas predominates and produces a

distinctive signal, enabling him to determine whether the plane is to the right or to the left of the prescribed course. At a distance of more than fifty miles, short-wave beacons become erratic in their behavior and directional readings unreliable. Therefore aircraft direction beacons should be placed in operation each one hundred miles along the principal highways of the air.

A third service is the aircraft beacon or radio lighthouse which gives a distinctive signal to a ship in flight when it is within a definite distance of a given marker point. In foggy and heavy weather, the radio beacon enables the flier to come sufficiently close to the landing field that its neon light beacon can guide him to a safe landing. Literally thousands of these low-power marker beacons are required to serve as the sign posts on the highways of the air.

Recently, the Department of Commerce awarded a contract covering radio equipment for twelve radio-controlled stations, six radio beacons and twelve markers, at a total cost of slightly more than \$150,000. The Assistant Secretary of Commerce for Aeronautics, William P. MacCracken, stated:

"Radio telephone communication to the airplane is expected materially to decrease accidents and provide for stability of schedules with greater comfort to air travelers and may be considered the greatest need of air transportation to-day."

The leaders of research in the radio industry have by no means neglected the requirements of aviation. The General Electric Company and the Westinghouse Company have developed standard models of directional signal transmitters and beacon equipment. The American Telephone & Telegraph Company has recently added an airplane to its experimental equipment at Whippany in order to perfect various types of aircraft radio-communication apparatus. Receivers which give visual indication of direction have been developed.

The principal obstacle to the use of radio on aircraft arises out of the fact that radio is considered by the greater number of pilots only as an additional burden and nuisance. The airman's opposition is singularly reminiscent of the ridicule which sea captains accorded radio when the first installations were being made on passenger ships. It required more than a decade of education to make the sailor welcome the radio operator. The aircraft pilot remembers radio as a necessary evil to his course in military flying. He complains of the radio helmet which he must wear, because it prevents him from hearing the functioning of his motors. His ear must be ever alert to observe the slightest irregularity in their functioning.

But newly developed forms of radio equipment are day by day lessening the attention required on the part of the pilot to operate the radio equipment. A recent innovation, for example, is the installation of microphones in the fire wall at the aircraft's motors so that the pilot, wearing a radio helmet, can, by the flip of a switch, choose between the radio signal or the microphone's output. The latter gives him



ABOARD A PRIVATE MOTOR YACHT

The motor yacht *Crusader*, owned by A. K. Macomber of California is one of the most elaborately fitted yachts afloat, from the radio point of view. The ship has elaborate broadcast receiving equipment with loud speaker outlets in nearly every cabin. The illustration shows the 0.5-kw. voice transmitter aboard the *Crusader*



a better indication of the motor's functioning than any direct aural observation.

The highways of the air will become routes of commerce and travel with the establishment of low-power beacons, close together on the line of flight, directional beacons, and an aircraft communication network. Adequate radio sign posts of the air will do more to help the development of commercial aviation than foolhardy transatlantic publicity stunts, performed in the name of science, often by pilots who prefer to fly without scientific equipment.

### No Innovations or Revolutions for 1928

THE June trade show in Chicago will be under way by the time these lines appear in print. Last year, the exhibit inaugurated what the public accepted as a radically new type of radio set with the effect of making the previous year's offerings quite obsolete. The hurrahs with which the alternating-current receiver was greeted upset the stability of the industry.

This year's improvements are much less radical and represent much more normal and sounder progress. Appearance and simplicity of control are becoming the outstanding factors by which the public selects its radio receivers. The most interesting developments along these lines are the new receivers shown by the Zenith Company. Instead of turning a dial to select his station, the listener now presses a button. As a practical improvement, the advantage gained is not startling, but the public, ever ready to jump at novelties, will undoubtedly greet the new receiver with an amazing show of interest.

There is a powerful undercurrent of talk aroused by the announcements regarding television and picture transmission. Having had so many experiences with premature announcements of progress, the industry is not greeting television talk with any great enthusiasm. It fears the public will develop the attitude of mind that it is worth while to defer purchasing a radio receiver so that they may have one in which a television receiver is incorporated. This development is not definitely in prospect. No one has yet made a true television device in commercially marketable form nor have we heard of any television transmitter which can be used in the broadcast band. Every one of the existing systems depends upon the building up of an entirely new short-wave broadcasting structure together with a new audience using short-wave receivers. Both the industry and the public will be greatly benefited if the television propagandists would give adequate demonstrations of the experimental apparatus they plan to market.

Our British contemporaries have found it necessary to warn their public of the danger of misleading announcements regarding television. We would welcome with open arms the development of practical television, but would regret any stagnation of radio at this time on account of its prospective development. In the hope of contributing practical information on the situation, we quote the statements on a few technical authorities which bear on the situation.—F. B. Jewett, President, Bell Telephone Laboratories, Dr. Michael I. Pupin, engineering authority and inventor of the loading coil, Dr. J. H. Dellinger, Director of the Radio Laboratory of the Bureau of Standards, Dr. Lee DeForest, inventor of the three-element tube, C. Francis Jenkins, tele-

vision research engineer and inventor, David Sarnoff, Vice-President of the Radio Corporation of America, and Percy W. Harris, British technical writer.

Some of these statements follow:

F. B. JEWETT (in the *New York Times*): At the public demonstration which we made on April 7, 1927, of the results then obtained, Mr. Gifford, President of the American Telephone and Telegraph Company, stated, among other things: "The elaborateness of the equipment required by the very nature of the undertaking precludes any present possibility of television being available in homes and offices generally." Nothing which has developed as a result of our work in the past year has tended to alter this opinion of Mr. Gifford.

DR. MICHAEL I. PUPIN: I do not know when television will be practical for the home. I do not know anything about the latest improvements which have been developed by those who are directly interested in the development of this art. But as far as I do know this art has a great many complications in its operation, and I do not see clearly how these complications can be eliminated so as to make television fool-proof in operation and thus make it practical for the home.

DR. J. H. DELLINGER: There is no doubt that the development of television will go forward and that eventually television will be commercially used. It seems likely, however, that it will continue to be an expensive process, requiring complicated apparatus and careful synchronization and adjustment of high-frequency electric currents.

DR. LEE DEFEST: Until some radically new discovery in physics is made which will simplify the present problems of television, we cannot expect to find this in the home in a practical, commercial form and at a price which even the wealthy can afford. There are so many factors to be considered besides the mere physical and electrical problems. . . . I am willing to go on record to the effect that practical, commercial, reasonably priced television equipment for the home will not be on the market within five years, and very likely not within twenty-five years.

C. FRANCIS JENKINS: Transmission by wire or radio of a baseball game from the ball field as the game progresses is unlikely

to be attained short of three to five years more of research.

DAVID SARNOFF: At the present time an entirely new era of radio communication—radio television—is opening before us. We are not now manufacturing television apparatus for the home, because, frankly, we do not yet know how to make a simplified and low-priced television receiver practicable for home use. Nevertheless, I firmly believe that within the next few years such equipment and service will be developed and made available to the home.

PERCY W. HARRIS, in *Popular Wireless* (London): In common with a large number of other experimenters, I have closely watched the progress of television both in this country and abroad, and I have not the slightest hesitation in stating that in my humble opinion we have not even measurably approached the time when the home constructor, as distinguished from the skilled experimenter, can try his hand at the game. The home constructor comes into his own when the fundamental problems have been solved and when the development of a particular art is a constructional one and a question of detail. The fundamental problems of genuine television have not been solved either in this country or abroad, nor can I see that they are likely to be along the lines so far pursued.

RADIO BROADCAST has enthusiastically fostered and encouraged the development of equipment which will enable the amateur experimenter to familiarize himself with progress in the new art. We have been careful throughout, however, to point out that the new field is yet distinctly one of experiment, and that it is not yet a regular service to the listener. Still picture reception is a fascinating field for the experimenter and gratifying results are obtainable with home-built apparatus, but the day has not yet come when the general public may look forward to a television attachment for his set.

### Broadcast Regulation at a Standstill

IT IS with distinct disappointment that we make reference to the broadcasting situation, which we hoped might be favorably influenced by the Davis Amendment to the Radio Act, made law by the President's signature on March 28. The amendment might have been used by the Federal Radio Commission as a means of greatly reducing the number of broadcasting stations on the air. Everything pointed to that course when the Commission announced the details of a plan, submitted by a special committee of the Institute of Radio Engineers, as a result of their exhaustive study of the capacity of the broadcast band. The plan recommended that the number of stations on the air simultaneously be reduced to three hundred and forty.

The National Association of Broadcasters, the Radio Manufacturers Association, and the Federated Trade Association raised a loud howl when the Commission's inclination to adopt this plan was indicated and, in deference to their protests, the Commission called a hearing in Washington at which these three associations, together with the N. E. M. A., presented their views.

The committee representing these three bodies offered a series of charts involving an impressive amount of long division. One set of charts worked out the power allotment to each state, based on the ratio of its population to the popu-

### Progress in Television

IT WAS announced by the General Electric Company on May 11 that experimental television transmissions would be made through WGY on Tuesday, Thursday, and Friday afternoons from 1:30 to 2:00 p. m., Eastern daylight saving time on the usual WGY wave-length, 379.5 meters (790 kc.). The pictures consist of 24 scanning lines, repeated 20 times a second. This transmission is a part of the experiments in charge of Dr. E. F. W. Alexanderson which have been under way for the past several years. It is probable that some other transmissions, made by Nakken, Jenkins, Baird and others will be on the air within a reasonable length of time.

In our next issue we expect to include an article analyzing the present television systems—which are generally quite similar—telling frankly what results can be expected from each, and to include a general description of the apparatus necessary at the receiving end. As soon as there is assurance of sufficiently regular transmissions and that the apparatus for receiving television signals is available, RADIO BROADCAST will describe its operation and assembly. A number of well-known experimenters are working on this problem now, in cooperation with RADIO BROADCAST; as soon as results warrant, their work will be described in these pages. The leading article this month explains some of the difficulties of television and an editorial on this page points out some pertinent facts on the subject. The reader should not forget that any television system now delivers but crude pictures and that "perfection" is not now in sight.—THE EDITOR.

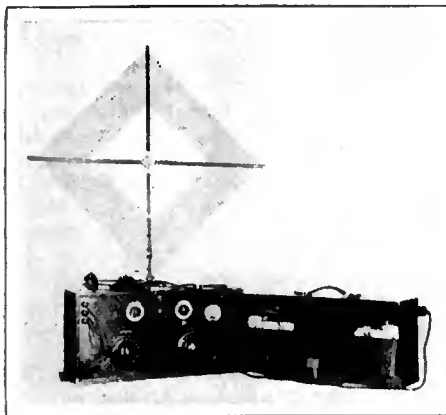

**INTERFERENCE PREVENTION IN CANADA**  
Part of the license revenues received from radio listeners in Canada is used to make listening more pleasant. The Radio Service has established an interference-tracing and prevention service, with specially equipped cars to locate the trouble. The illustration shows the portable superheterodyne set which is part of the equipment of each of these cars

lation of its zone. The total zone powers computed were 137,000, 217,000, and 250,000 watts. A second chart based equalization upon the number of station licenses issued per zone. The zone totals offered were 110 and 140 stations, or 550 and 700 stations for the United States. The committee actually suggested increases in number of stations in most of the states of the Union and only very slight decreases in New York and a reasonable decrease in the Chicago area. It had no suggestion to offer as to how any of these figures could be applied in practice. When asked specific questions regarding the application of its plan to the actual situation, its proponents claimed they offered only a method of procedure and that any basis of total power or total number of stations might be substituted. In short, the associations disclosed how long division might be used in dividing power, number of stations, or anything which may come to mind, among the states in each zone in proportion to each state's share of its zone population. The nearest approach to a concrete suggestion offered was the advice that the Commission proceed cautiously and gradually in altering the present structure and postpone any real action as far in the future as possible.

The Federal Radio Commission has so emphatically demonstrated its lack of courage and understanding of the broadcasting problem that encouragement to continue its vacillation and its jellyfish policies is bound to be harmful. The broadcasters may be excused for seeking to protect their property interests, but the set manufacturers displayed an amazing lack of foresight, because receiving set sales certainly are curtailed by the listeners' widespread disgust with congested broadcasting conditions.

The listener, as usual inarticulate, has never, and apparently will never, present his case before the Federal Radio Commission. Radio will continue to be guided by such persons as Representative Davis, who believes that a power of 10,000 watts is the maximum that should be permitted on a clear channel. Ten thousand watts creates no less interference than 50,000 watts, yet such powers would make it impossible for rural listeners to hear the better stations at any great distance and would deprive large metropolitan areas of their principal program sources. "Furthermore," says Mr. Davis, "in spite of the statement of interested engineers

to the contrary, chain programs can be successfully broadcast on the same wavelength." We wish Representative Davis were right, but simply to call qualified engineers liars does not solve the problem.

*The Inequalities of "Equalization"*

**A** FEATURE of the so-called equalization amendment which has generally escaped attention is that equalization of power by zones and state populations within zones will deprive large areas of the country of adequate radio service or else force confusion on other areas. Broadcast carriers of a given power travel certain distances regardless of whether the areas covered are highly populated or not and regardless of the geographic dimensions of the zones in which they are located. Under any method of applying "equalization," states of large area and small population must be deficient in radio service while congestion is forced upon states of large population. This is due to the ridiculous manner in which the five zones were prescribed by Congress, or rather to the error of using the zones as the basis for power allotment.

The fifth zone is approximately 1190 by 1160 miles in dimension, while the first zone is but 700 by 570. The third zone has about the same width north and south as the first, but it is three times as long from east to west. Under the equalization amendment, therefore, the South, which Representative Davis claims to protect, cannot legally have more than one third the service in broadcasting allotted to the first zone. The first zone, furthermore, is so intertwined with the second that, if the same standards of channel separation and powers which must be adhered to in order to give any kind of service to the listeners of those zones are applied to the third and fifth zones, large areas in the latter two zones must be without adequate broadcasting service.

If equalization is applied to Representative Davis's own state of Tennessee which, according to the latest figures, now has 3.3 per cent. of the nation's total broadcasting power, its total must be reduced to 1.1 per cent., i.e., 33 1/3 per cent. of its present power. The reduction is likely to be still larger, however, because the complaints of excess power in the more progressive zones will require lower total powers per zone than the present average. Whatever the amount of power assigned to each zone under any equalization plan, according to the law, it should be divided among states according to their population. For example, California, with a population of four and a half million, will have 41 per cent. of the power of the fifth zone, while Texas, with a population of 5,487,000 will have but 19 per cent. of the total power of the third zone. Since both zones are required to have equal power, California must have double the radio service of Texas. The blatant Mr. Davis has done a wonderful job of protecting the interests of the South!

The state of Massachusetts, with a population slightly less than that of California, will have but little more than a third the power allotted to California. Porto Rico will have ten times the power of Alaska. The entire New England states will have but three fourths of the power assigned to Pennsylvania.

The suggestion is frequently made that channels be borrowed for congested areas. A free channel, available to Arizona or Oregon, cannot be loaned to New York or Pennsylvania, because that channel is presumably already occupied there. There is no surplus of cleared channels.

Borrowing offers no substantial relief to mitigate the abuses of so-called equalization.

Hampered by the asinine equalization clause, the Federal Radio Commission must adopt a standard of power for each zone sufficiently high so that the large areas of the West and South can have reasonable service. This will require hopeless congestion in the first and second districts, and in the eastern part of the fourth district, which are compact geographically and have numerous large cities worthy of local service stations. The only effect of the law will be that, rather than to destroy what is left of radio, the Commission will disregard it and conditions will be made neither worse nor better than they are to-day. The hoped-for improvement of conditions, which the establishment of the Federal Radio Commission was intended to accomplish, has been made a practical impossibility through the muddling of Congress and nearly every other body involved in the problem.

*Another Non-Radio Man for the Commission*

**W**E HAVE hesitated to comment on the appointment of such an estimable gentleman as Judge Ira E. Robinson as a member of the Federal Radio Commission. Later he was unanimously elected its Chairman. We weary of complaining of the President's appointment to the Commission of men totally unfamiliar with the problem. Judge Robinson is a delightful character and adds decidedly to the social grace of the Commission. Years of legal training have vested him with what might be termed as an excess of caution, and the President may rest secure that, while the Commission is under his leadership, nothing but well-considered steps will be taken. The Judge is totally unqualified from the radio standpoint, having not the least understanding of service and heterodyne ranges, and broadcast congestion. He was confirmed by the



**A TELEPHONED MOVIE FILM**  
Recently, the American Telephone & Telegraph Company transmitted a motion picture film between New York and Chicago. The strips of film were cut, three were placed side by side and these transmitted by "telephoto"

Senate, together with his confrères, Caldwell, LaFount and Pickard, on March 31.

What the Commission most needs is one or two commissioners who have some understanding of radio. Much time is lost in familiarizing men unacquainted with the allocation problem with its technical aspects, and each appointment hampers and delays the Commission's progress. The wisdom of appointing experts in their respective lines to regulatory bodies such as the Federal Reserve Board and the Interstate Commerce Commission has been recognized, but radio's engineering problems have been turned over largely to lawyers for solution.

### *The Commission Eliminates Its First Station*

FOR the first time since the Government has controlled radio, the Federal Radio Commission has taken the decisive step of ordering a station off the air. The station in question is WNBA of Forest Park, Illinois, one of scores which has caused continuous complaints about frequent wabbling. It would have been fairer to apply this elimination process to all stations equally guilty with WNBA. But, being warned by this instance, it is likely that many of the radio mosquitoes will get busy and make a belated effort to comply with the Commission's regulations and thereby another means of station elimination, which does not involve the threat of court action of any serious consequences, is lost to the muddled Commission.

### *The Engineers' Plan of Allocation*

THE engineers' plan of broadcast allocation, which has been described as being too drastic, actually represents the least possible hardship upon the broadcasting station owner. The plan provides for 10 stations of 10,000 watts power or more on full time in each zone, 9 of 500 watts on full time, 18 of 500 watts power on half time, 40 of 250 watts on half time, 60 of 250 watts power on one third time. This totals 137 stations for each zone, or a grand total of 685 for the five zones.

### *The High-Frequency Spectrum*

THE report to the Federal Radio Commission, relative to the assignment of short-wave channels, rendered by Commander S. C. Hooper, who was assisted in its preparation by Dr. J. H. Dellinger of the radio laboratory of the Bureau of Standards, Dr. C. B. Jolliffe, and W. E. Downing, suggests that, until further progress in frequency stabilization is made, stations be assigned only to alternate channels in the short-wave spectrum. By gradually increasing the stability required over a period of years, it is hoped that room for additional stations will be found as they are required in commercial service.

On a basis of one tenth of one per cent. channel separation, the report states, there are 398 channels in the "mobile" bands. Of the 190 channels between 1500 and 4000 kilocycles, 89 are in use and 101 are available to all the countries of the world. The United States will lay claim to ten of these channels.

In the band between 4000 and 23,000 kilocycles, the number of "mobile" channels is 208, of which a hundred are now in use. That leaves 108 immediately available to all the nations of the world, of which the United States plans to utilize twenty.

In the "fixed service" bands, using alternate channels, there are 710 channels. Between 1500 and 4000 kc. are 130 fixed service channels, of

which 42 are in use and 88 available. Ambitious short-wave applicants in the United States have made application for 128 channels in this band. Between 4000 and 23,000 kc. there are 508 channels of which 370 are being used. The United States is at present occupying 260 of these. For the 210 channels remaining immediately available for assignment to all the nations of the world, there are 292 American applications.

Considering that fully half the applications for short-wave channels are made by companies totally unacquainted with short-wave transmission which hope to save some money on their telegraph bills thereby, and the other half are made by communication companies which are, one suspects, bluffing in order to prevent the channels falling into the hands of their competitors, the Commission is up against another hopeless problem, totally unsuited to its uncertain and hesitant temperament.

### RECENT RADIO EVENTS

THE Federal Radio Commission has granted nineteen permits to the Boeing Air Transport Company of Seattle in order that they may erect radio stations at as many landing fields, scattered from Chicago to the Pacific Coast.

THE Radio Corporation of America has applied for license to construct 65 short-wave transmitters in order to establish an overland short-wave system and to counterbalance, apparently, the applications of the Mackay interests for channels for similar purposes.

THE Radio Committee of the American Railway Association has asked for a band 144 kc. wide between 2250 and 2750 kc. for train communication. They claim that the range of train equipment is limited to about five miles and that the interference range is but ten miles. These frequencies for which they ask are wisely selected from a standpoint of creating minimum interference.

THE new 10,000 watt station KSTP, National Battery Company of St. Paul, Minn., went into operation early in April. This is now one of the most powerful stations west of Chicago.

#### RADIO EQUIPMENT AT THE RUGBY STATION

THE frontispiece illustration of RADIO BROADCAST for February, 1928, showed a view of the interior at one of the transmitter buildings of the Rugby radio station of the British Postoffice. The caption under the illustration suggested that it was built by the British Marconi Company for the Government. We are informed by the International Telephone and Telegraph Company that the radio telephone transmitting equipment at Rugby was provided by Standard Telephones and Cables, Ltd., one of the manufacturing companies associated with the I. T. & T. The radiophone equipment was constructed with the advice of the American Bell Telephone Laboratories who were responsible for the design of the American end of the transatlantic telephone circuit equipment now in daily use at Rocky Point, New York. The radio telegraph equipment at Rugby was designed by British Postoffice engineers and was supplied by a number of different makers. Readers who are interested will find complete descriptions of this installation in the *British Post Office Engineers' Journal* (January, 1927, E. H. Shaughnessey), and (April, 1927, Lt. Col. A. G. Lee and R. V. Hansford).

#### TO REVISE THE PATENT LAW

SENATOR KING is endeavoring to bring about an investigation of the present patent procedure. He points out that there are 95,000 patent applications awaiting action in the Patent Office, many from six to eight months, and it requires from two to seven years after an application is made to secure actual protection. Congress might well investigate the patent situation because our present industrial structure requires a new and different patent law, with compulsory licensing at reasonable royalties. The present patent monopoly is no longer a protection to the public because patents are grouped by such large and powerful interests that, in many fields, the independent inventor cannot profit from his discoveries unless he turns them over to existing combinations. This applies particularly in the radio industry.

#### RAPID WIRE PICTURE TRANSMISSION

THE Bell System broke all records for rapid transmission of a moving-picture film from Chicago to New York. The method employed was to take a moving picture of a well-known film actress, Vilma Banky, in Chicago, and to transmit the negative by wire to New York, where it was received, three sections of strip in tandem, as a regular still photograph. The film was then re-mounted in strip form in New York and reproduced within a few hours after it had been originally made in Chicago. It required two hours of transmission to send ten feet of film as still picture. This is really the first successful transmission of high-grade television. It is an illustration of how still picture photography may prove the gateway to television.

THE Canadian Government has refused to renew the broadcasting license of the International Bible Students' Association in Toronto and elsewhere. It announces that these licenses are cancelled at the request of thousands of listeners. The same group of religious propagandists is asking for one or two channels for 50,000 watt stations in the United States. Proponents of sectarian religious groups urge that, since jazz and commercial broadcasting have all the channels they want, religious stations should not be refused the opportunity of going on the air. The only fallacy of their argument is that jazz and commercial programs tend to be universal in their appeal, while any particular religious station serves only a minority of listeners within its area. It is difficult, however, to apply the principles of justice to the assignment of channels for religious interests because each sect firmly believes that, if discrimination is shown and its privileges curtailed, the Federal Radio Commission and the Government are instruments of the devil. A well-conducted broadcasting station is a profitable enterprise for any religious organization.

THE R. C. A., G. E., and Westinghouse companies have formed a new subsidiary to be known as R. C. A. Photophone, Inc. The company will market a home talking movie machine. David Sarnoff is President of the new company, Elmer Bucher, Vice-President, and Dr. Alfred N. Goldsmith, Vice-President in Charge of Technical Matters. The apparatus is especially adapted for use in schools and churches. It uses standard films without synchronized speech as well as the talking film.

FEDERAL-BRANDES, Inc., is changing its name to the Kolster Radio Corporation and is applying for the listing of its securities on the New York Stock Exchange.

—E. H. F.

# A New Principle in Audio Transformer Design

By KENDALL CLOUGH

Research Laboratories of Chicago

THOSE who go to the market for audio transformers have noted, no doubt, the disparity in size of the devices that are offered. It will also be noted that, as a general rule, the physical size increases as the claims for fidelity of reproduction increase. This article proposes to explain the basic reason for these variations in physical size as well as to describe a new principle in the design of transformers. By the use of this new principle it is possible to produce the ideal audio curve, impossible with the conventional transformer, as well as eliminate a type of distortion that is present in the latter but which is not indicated by its characteristic curve no matter how good it may appear.

The circuit of Fig. 1 shows the representative stage of amplification as ordinarily used in radio sets. The signal voltage,  $e_g$ , impressed on the grid of the first tube may be of any frequency between 30 and 10,000 cycles corresponding to the range of frequencies concerned in the reproduction of speech and music.

The tube on which the voltage,  $e_g$ , is impressed has an amplification factor of  $\mu$ , and a plate resistance,  $r_p$ . In the plate circuit of the tube we have connected a transformer having an inductance,  $L_1$ , and the turns ratio,  $N$ . Consider that the secondary operates into an infinite impedance, an assumption that is justified when the transformer operates into a tube with sufficient C bias. We will modify this assumption later for the high frequencies.

In such a circuit as this, the amplification may be expressed by the equation:

$$A = \frac{e_2}{e_g} = \frac{\mu N}{\sqrt{\left(\frac{r_p}{\omega L_1}\right)^2 + 1}} \quad \text{where } \begin{array}{l} A = \text{amplification} \\ \omega = 2\pi f \\ L_1 = \text{primary inductance} \end{array}$$

This equation first defines amplification as the ratio of the voltage impressed on the second grid circuit to the voltage impressed on the first grid circuit. We note that the amplification is directly proportional to the amplification factor of the tube and the turns ratio of the transformer. This might lead one to believe that almost any degree of amplification could be accomplished by the use of a high- $\mu$  tube and a high ratio transformer. This is not the case.

Using a transformer having a primary inductance of 44.2 henries and a turns ratio of three, we have, by use of the above equation, plotted in Curve 2, Fig. 2, which shows the amplification at various frequencies when used with a tube having an amplification constant of 8 and a plate resistance of 10,000 ohms. This corresponds approximately to a 201-A tube. It will be noted that the curve is not ideal by any means, for at 30 cycles (the lower limit of the frequencies we are concerned with for the reproduction of music) the amplification has fallen off to 15.5 while

THE author of this article is no stranger to RADIO BROADCAST'S readers. He has designed several of the popular receivers we have described, and is well known as an excellent radio engineer. In this article he discloses for the first time his new audio amplifying system on which he has been at work for some time. The advantages of this system are several. It provides an amplifier that is flat from 30 cycles to above 6000, or, if desired, a rising characteristic between 30 and 100 cycles. This is done at less cost than that of a conventional transformer-coupled amplifier, and with somewhat greater voltage gain. At the same time the introduction of harmonic frequencies in the output due to saturation of the core of audio transformers due to the d.c. plate current which flows through them, is avoided. Although we have not seen the data, we understand that a study of this effect at Cruft Laboratory proved that at times the third harmonic in the output of an amplifier in which d.c. flows through iron cores rises as high as 30 per cent. and that no adjustment of bias or plate voltage would eliminate it. Mr. Clough's system prevents such distortion. He is at work upon another article which we hope to present soon.

—THE EDITOR.

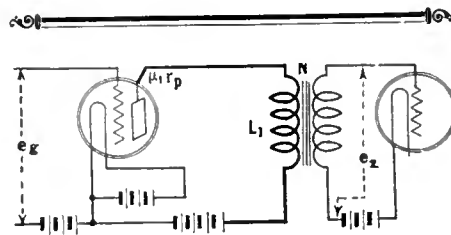

FIG. 1

the amplification at the high frequencies is 25.0. Now as was suggested, we might believe that we could secure a higher amplification such as is shown in Curve 3, Fig. 2, using a tube having a higher amplification factor, such as 30. Such a curve could be secured if we had a tube with an amplification factor of 30 and plate resistance of 10,000 ohms. This would be a very difficult tube to design and produce, however, and we see by reference to a tube chart that the 240 type ( $\mu = 30$ ) has a plate resistance of 150,000 ohms. Thus we can compute such a curve as is shown in Curve 4, Fig. 2, using the same transformer as was used in Fig. 2 and the

new value of plate resistance, i.e. 150,000 ohms. We see in Curve 4, Fig. 2, while the amplification has been improved at the high frequencies, the amplification of the lows is very poor indeed.

The nature of the equation above indicates that we could improve the amplification of the bass notes shown in Curve 4, Fig. 2, by an increase in the primary inductance say to 672 henries. All of this seems very simple but there is a practical aspect worthy of our consideration.

## BETTER RESPONSE WITH INCREASED PRIMARY INDUCTANCE?

IN MAKING the latter transformer we would require many more primary turns than we did on the 44.2 henry design, in fact about 3.9 times as many. In addition, to keep the ratio 3:1 we would need 3.9 times as many secondary turns. We assumed that the secondary operated into an open circuit. Now, if we attempted to build the transformer with a primary inductance of 672 henries we would find that the secondary turns would have a large self-capacity and that at the higher frequencies we could no longer assume operation into an open circuit because the self-capacity would practically short-circuit the secondary causing the curve to slump off as is shown in Curve 5, Fig. 2. This drop in amplification at the higher frequencies is not noticeable to the ear so long as the frequencies below 4000 or 5000 cycles are not materially impaired. But we see that Curve 5, Fig. 2, begins to drop badly at 1000 cycles so that the actual transformer fails to approach the ideal at either the high or the low frequencies. This is the reason why a transformer for the 240 tube has never appeared on the market.

Referring to the data that was used to prepare the Curve 2, Fig. 2, we might consider the possibility of producing a transformer which would have a high turns ratio in order to raise the amplification. Thus let us assume that we desire a transformer of 5:1 ratio. This would necessitate increasing the number of secondary turns by the ratio of 5:3 which would cause the amplification curve to appear theoretically as in Curve 6, Fig. 2.

However, in attempting this, we find that when the transformer is actually measured the curve would drop off at the higher frequencies as shown in Curve 5, Fig. 2, due to the fact that the secondary distributed capacity would reduce the secondary voltage at the high frequencies in the same manner as was shown in connection with the curves on the 240 tube. Practical experience indicates that a transformer with the degree of bass amplification shown in Curve 5, Fig. 2 cannot be built at ratios in excess of 4:1 without impairing the high frequencies more than the average ear will allow.

Refer to Curve 2, Fig. 2. Let us consider what

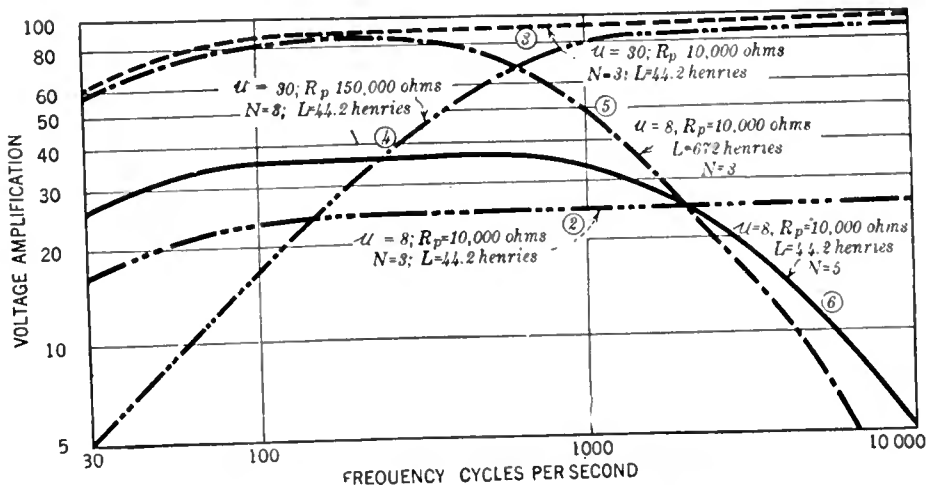

FIG. 2

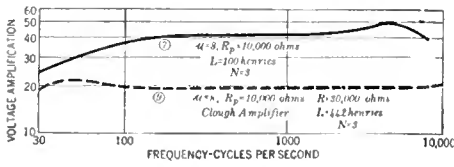

FIG. 3

can be done with the same design in the way of approaching perfection of the bass response. Using the same tube constants as were used for Curve 2, Fig. 2 and increasing the primary inductance we could plot curves for increasing values of inductance. It is plain that the bass response improves as we increase the primary inductance. Here again we run into the difficulty of secondary capacity for with each increase in the primary inductance we would have to put more turns on both the primary and the secondary. In practice we would find that after the primary had been brought to a value of about 100 henries, we could not increase it further without either decreasing the turns ratio or putting up with the deleterious effects of secondary capacity. Curve 7, Fig. 3, shows a measured characteristic of a commercial 3:1 transformer which represents about the limit along this line of procedure without reducing the turns ratio. It will be noted that in this case the amplification is yet not ideal at 30 cycles, while the self-capacity of the secondary starts to impair the amplification at 8000 cycles.

Under some conditions it is desirable that the amplification from 100 cycles, or thereabouts, down to 30 cycles should be greater than that on the flat portion to compensate losses in other parts of the circuit, the loud speaker, for example. In reproduction of phonograph records we could compensate the fact that the records are not cut up to full volume from 30 to 100 cycles, due to practical difficulties in record-cutting. By means of a new transformer circuit, an amplifier can be produced with either the ideal flat curve or a rising bass characteristic.

WHAT THE NEW CIRCUIT IS

THE circuit is shown in Fig. 4. Note that the plate current of the tube is carried by a resistor, R, and a condenser, C, connects to the primary. In this way the primary of the transformer carries no direct current, a feature of importance.

The equation for this form of amplification involves a resonance which may be controlled or placed, by proper design, in any part of the frequency band. Naturally, the most desirable place for this resonance is in the bass frequencies. When the amplification is computed for this system, using the same transformer and tube which was used in the illustration, Curve 2, fig. 2, together with a resistance  $R = 30,000$  ohms, the resultant curve is as shown in Curve 9, Fig. 3, it will be seen that this curve approaches the ideal very closely and with the same amount of material as in the designs illustrated by Curve 2, Fig. 2. Here the amplification is lower than was previously obtained with the same transformer, but this condition can be corrected by connecting the transformer as shown in Fig. 5. This

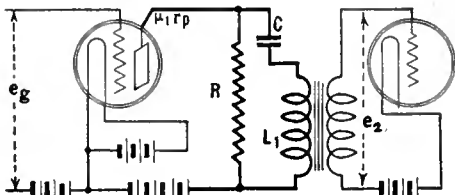

FIG. 4

auto-transformer connection increases the effective ratio to 4:1, using the same amount of copper windings that we have considered for a 3:1 ratio in ordinary transformer connections. The curve by this connection is shown in Fig. 6, Curve 11, where the amplification in the high-frequency portion is the same as we obtained with the same core and windings that were used in Curve 2, Fig. 2. The amplification at 30 cycles has been brought up to a par with the high-frequency amplification while using a transformer having a primary inductance of only 44.2 henries which may be compared with Curve 7, Fig. 3, which shows 27 per cent. decrease at 30 cycles in spite of the fact that it has a primary inductance of 100 henries. It is apparent that having a method of producing an ideal curve with a lower value of primary inductance than was necessary with the ordinary transformer connection to produce only approximately an ideal curve, we will need less secondary turns on a core of smaller cross-section. This mitigates largely the limitations caused by the secondary distributed capacity so that it is perfectly feasible,

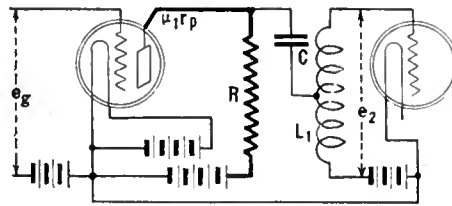

FIG. 5

ible, where large amplifications are needed, to extend the ratio of the transformer greatly by the addition of secondary turns.

It was previously mentioned that in the event we need amplification of the low frequencies more than the highs that it could be done by means of this transformer circuit. In order to illustrate this system as well as possible, the value of the primary inductance, 44.2 henries, was chosen in order to satisfy the conditions for a flat characteristic with the particular circuit constants used. This value of inductance is prescribed by the mathematics of the circuit and the equation for the new transformer indicates that if a value in excess of this is used in design that a rising bass characteristic may be produced. Thus let us assume that the primary (in Fig. 5.) is wound to an inductance of 80 henries. The circuit would then produce a characteristic such as is shown in Curve 12, Fig. 7.

FINE RESPONSE CURVE

WHILE several makes of this device will be on the market during the coming season, it may be interesting to the reader to see what can be accomplished in the way of faithful reproduction by means of measured curves on experimental laboratory designs. The solid Curve 13, Fig. 8, shows a transformer winding of a 3:1 ratio when operated out of a 226 tube with the customary voltages and with the conventional transformer connection. The solid line Curve 14, Fig. 8, shows the same transformer operated as shown in Fig. 5 with the same tube. It will be noted that this design provides reinforcement of the low frequencies and a slight reinforcement at the high frequencies in the vicinity of the cut off. Reducing the size of the windings produces the ideal curve rather than over accentuation of the bass frequencies as shown.

A second illustration is shown in Curve 15, Fig. 9. This dotted curve was taken using a small 4:1 transformer in the usual connection; the full line, Curve 16, Fig. 9, with a transformer with

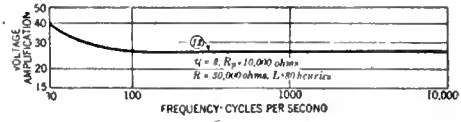
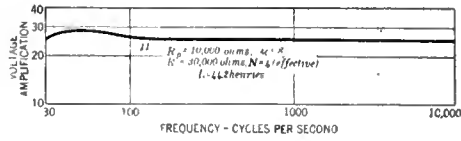

ABOVE—FIG. 6. BELOW—FIG. 7

the new connection. This curve does not go to 30 cycles, but many feel this low limit is not entirely necessary, in view of loud speakers and radio transmission shortcomings in the lowest octave of the musical register. The real point in the above curve is in its extreme departure from the ideal curve when operated in the usual connection, while with the new circuit, the curve resulting from proper design can be carried substantially flat down to any preassigned frequency.

It has, no doubt, occurred to the reader that due to the drop in d.c. potential through the resistance, R, of Fig. 4, that it will be necessary to use a battery supply of greater voltage on the detector and first-stage amplifier tubes than is usual to supply the rated plate potential on the tube. This is no serious limitation of the design, because the detector is usually operated on 45 volts and the first audio stage at 90 volts while 180 volts are usually available from the B-power supply. In all the illustrations both resistors will permit operation on 180 volts and yet operate the plates of the tubes at their rated voltages. By supplying both stages from the 180-volt tap of the power unit, we save the voltage-divider necessary for B voltages of 45 and 90, as well as saving the by-pass condensers usually necessary across these taps. Such models have been prepared in the laboratory for operation with the a.c. tubes, producing an effective transformation ratio of 5:1 in the first stage and 4:1 in the second as against values of 3:1 and 4:1 respectively, which have been found to be the practical limit for a high grade audio-amplifier using the conventional circuit.

This amplifier then has the following advantages: high quality reproduction, due to its flat characteristics from the very low frequencies to above 5000 cycles, secured at a lower cost than is now possible with standard transformer connections. This is because of the new scheme of connecting the apparatus in the circuit. There is one additional advantage which has not been mentioned here, but which is important. In any transformer in whose primary direct current flows, there is liable to be distortion introduced due to core saturation. Since there is no d.c. in this method of connecting the transformer into the circuit, such distortion cannot result. The writer hopes to present more of this side of his development later.

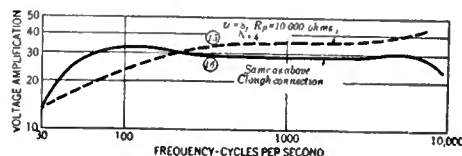
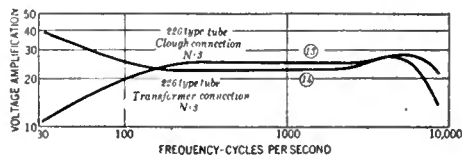

ABOVE—FIG. 8. BELOW—FIG. 9

○ No. 1

RADIO BROADCAST'S HOME STUDY SHEETS

July, 1928

*The Nature of Radio and Electricity*

THERE can be little doubt that radio is one of the most attractive fields for home experiment that has ever presented itself. Radio problems are not to be solved in a day; the apparatus required for intelligent experiment is not too complicated or expensive for the layman, the interesting theories involved may be mastered by anyone who cares to study; and the ramifications of radio experiment deal not only with electricity but, for example, with chemistry and acoustics as well, so the tired feeling of having solved all, is never to be experienced.

Radio is closely allied to electricity, that more or less intangible force which our senses normally refuse to recognize. We cannot see it, or hear it, and are not aware of its presence unless it is in motion, doing work of some kind. And yet it is always present ready for action, to be generated and controlled by man, and at his will to spend its energy doing useful work.

The radio experimenter plays with this force, and thereby finds out for himself many of the facts about the force that runs our street cars, lights our homes, transmits our messages, brings music out of the silent ether, and does innumerable small tasks that are no longer considered remarkable. To find out the most important facts about electricity and radio, one must experiment, not in a hit or miss fashion but with some object; he must have a good knowledge of the tools with which he works, and a clear picture of what happens when he uses those tools.

While it must be acknowledged that many inventions and discoveries have been made by individuals who work in attics and cellars without adequate mental or electrical equipment, by far the greater part of real advancement comes from research that is intelligently planned and systematically carried out.

The Laboratory Staff has planned a number of experiments which shall be described each month in RADIO BROADCAST, experiments which shall first be performed in the Laboratory of this magazine and which the home experimenter may repeat if he desires. These experiments deal with electricity and radio and should give the experimenter a wide knowledge and experience in radio matters.

The apparatus needed for each experiment will be given in exact detail so that the experimenter can build or buy it if he desires; the exact procedure of the experiment will be followed by the results obtained, and by a series of questions or problems or suggestions for further experiment. These questions and problems are for the experimenter to answer. If he desires to send the answers he has worked out to the Laboratory Staff, they will be glad to look them over and will always be interested to know how to make the experiments more helpful.

These pages are so prepared that it will not be necessary for the interested reader to repeat the experiments; but if apparatus is at hand, or if he desires to equip himself with sufficient instruments so that he too can take part in the great business of radio experiment, he will do well to carry out the procedure, or to amplify it at his leisure.

It is possible of course to carry out the calculations of many

experiments without actually doing them physically at a patent saving. In fact, it will always be wise to check over the data given in these pages, working out what mathematics may appear so that almost the same effect is secured as if the actual experiment had been repeated.

The experimenter will need, first of all, a loose-leaf note book. Those used in the Laboratory are McM (Manhattan Stationery) ring books No. 518D. The actual make is not important so long as it is large enough to hold sheets the size of RADIO BROADCAST'S pages. In this notebook should go these pages in RADIO BROADCAST which are marked on the margin ready for punching—there will be no excuse for having an incomplete file of experiments! There will be needed, in addition to the binder and these sheets from the magazine, a stock of paper to fit the binder, both blank and cross section. A good cross section paper is Keuffel and Esser No. N355-2R. It costs two cents a sheet and may be obtained from Keuffel and Esser, 127 Fulton Street, New York City. Another requisite is a good ruler, preferably a triangular scale graduated in 10, 20, etc. parts to the inch. Keuffel and Esser No. 8883 is a good one. One or more "French curves" are useful in making complicated graphs.

If the experimenter feels that he can afford a slide rule, he should invest in this extraordinarily useful instrument. It is a device which simplifies computations involving multiplication, division, percentages, squaring or cubing or extracting the square or cube roots, or using logarithms. With it one can save hours of time and bother and exasperation. The one used in the Laboratory is a Keuffel and Esser No. 4053-3 costing about \$8. A booklet comes with it showing exactly how to use it. Of course the calculations which a slide rule—a "slip stick" as the engineer calls it—make simple may be done with pencil and paper and—when the problem in hand requires their use—with the aid of a book of logarithms. This roundabout method requires ten times the labor.

The experimenter should have a supply of pencils, pens, India ink, scrap paper, as well as a good place to work. Mathematical calculations may be carried out anywhere, so that the reader may follow this part of the experiments which will follow at his convenience. To do the actual experiments, however, in case the experiments are to be duplicated by the reader, a good light place is desirable where apparatus will not be disturbed by the domestic broom or dust cloth! A corner of the basement, the den, or attic may be used. Even the kitchen may be impressed into service with the disadvantage that the experimenter probably may have to pack up his apparatus each evening.

A good way to keep your own notebook is to work out the problems or repeat the experiment on a loose-leaf sheet which is inserted directly after that clipped from the magazine. If sent to the Laboratory for checking, the problems must be on a standard punched sheet to enable us to examine them with the least difficulty and so that the experimenter can place them in the notebook when they are returned.

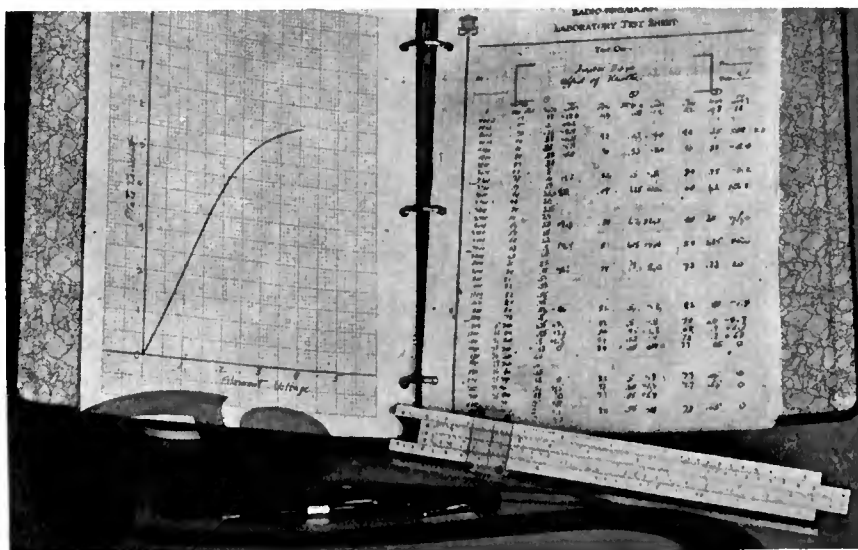

Some Useful Tools for the Home Experimenter

Determining the Capacity and Inductance of a Radio Circuit

COILS and condensers are the foundation on which every radio circuit is erected. The coils possess an electrical quantity known as Inductance, and as every radio experimenter knows, the quantity that makes a condenser useful is its Capacity for storing electricity. When a current flows through the coil, lines of force surround it; the sum total of these lines is known as an electromagnetic field. The word *magnetic* is important here, for a compass—which normally points one end of its swinging needle toward the earth's north magnetic pole—will be deflected when brought near such a coil. When a current flows through a condenser, lines of force surround it. The total of these lines is known as the electrostatic field. It can be detected, not by a compass needle or any other device using the magnetic principle, but by a charged body such as a small bit of paper which had been rubbed on the sleeve.

The unit of capacity is the farad, named after Michael Faraday, a distinguished English experimenter. In radio circuits, however, the millionth of a farad, a microfarad, is ordinarily the quantity dealt with, or even the micro-microfarad, the million-millionth of a farad. The unit of inductance is the henry, named from Joseph Henry, a famous American experimenter. In radio circuits the unit dealt with is the milli- or microhenry, thousandths or millionths of henries. The table on this page shows how to convert farads and henries to microfarads or milli- or microhenries. For example, to change henries to millihenries, you multiply by one thousand. To convert mmfd. to mfd. you divide by one thousand; and so on.

It is the size of the coil and the condenser that controls the wavelength or frequency to which a circuit tunes. The designer of the world's best receiver must know within very close limits what the inductance of his coils must be; he knows how large a capacity he must have to cover a certain band of frequencies. It is always important to know the exact value of these two electrical quantities, capacity and inductance. The following experiment will enable anyone to find out the capacity of a condenser, and the inductance of a coil.

APPARATUS REQUIRED

1. A coil of wire. The dimensions of the coil used in the Laboratory are given in Fig. 1.
2. A variable condenser fitted with a dial. About 500 mmfd. is the best size of condenser.
3. A radio receiver, preferably with an oscillating detector; or a tube wavemeter.

PROCEDURE

1. Connect the coil and condenser across each other and bring the coil near the coil in the receiver or that of the tube wavemeter.
2. Tune the receiver to a known station near the center of the broadcast band, or if a wavemeter is used, set its wavelength to about 300 meters.
3. Change the setting of the variable condenser across the coil whose inductance is unknown, until resonance with the receiver is indicated by a decrease in signal strength, or by a click if the oscillating detector is used, or by a dip in the indicating needle of the tube wavemeter. A good meter is the modulated oscillator in the June, 1927, RADIO BROADCAST. A good meter is the modulated oscillator in the June, 1927, RADIO BROADCAST.
4. Tune the receiver, or wavemeter, to other wavelengths above and below the first medium wavelength setting until the whole of the condenser has been used, at each wavelength noting down the data as is shown in Table 1.
5. Compute the inductance of the coil from the following formula—which is one used by Professor Hazeltine.

$$\text{Inductance in Microhenries} = \frac{0.2 \times d^2 \times N^2}{3d + 9b}$$

where *d* is the diameter of the coil in inches  
*N* is the number of turns of wire  
*b* is the length of the winding in inches

As an example below is the manner in which the inductance of the coil illustrated in Fig. 1 is calculated.

$$\text{Inductance} = \frac{0.2 \times 3.06^2 \times 64^2}{3 \times 3.06 + 9 \times 1.875} = \frac{0.2 \times 38400}{9.18 + 16.85} = \frac{7570}{26.03} = 292 \mu\text{h}$$

6. Compute the capacity of the condenser at each of several of the long wavelength settings from the formula

$$\text{wavelength} = 1884 \sqrt{L \times C}$$

where *L* is the inductance in microhenries  
*C* is the capacity in microfarads

For example, the 292-microhenry inductance tuned to 527 meters at 55° on the condenser dial. What is the capacity of the condenser at that point? To simplify the problem let us change the above formula to read

$$(\text{wavelength})^2 = 3.54 \times 10^6 \times L \times C$$

$$527^2 = 3.54 \times 10^6 \times 292 \times C$$

$$C = \frac{527^2}{3.54 \times 10^6 \times 292} = 270 \text{ mmfd.}$$

To provide additional examples, the capacity column in the data Table 1 has been left blank.

7. Plot this data as shown in Fig. 1
8. Make a tap at the center of the coil and repeat the above calculations and experiment.
9. Pick out some condenser setting on each set of calculations, say 60 degrees, and see how nearly the calculated capacities check.

DISCUSSION

IN THE experiment we have demonstrated the phenomenon known as resonance: that is, a circuit composed of inductance and capacity absorbing energy from another also composed of inductance and capacity, to which it is properly tuned. We have calculated the inductance of a coil by means of a formula which will give us a result accurate to within two or three per cent., provided, *a*, we measure the dimensions of the coil accurately; *b*, we make no mistake in our arithmetic, and *c*, provided the length and diameter of the coil are not too different in dimensions. The formula will be most accurate when the length of winding equals the diameter of the coil.

We have demonstrated that knowing the wavelength to which a coil-condenser combination tunes, and knowing the inductance, we may calculate the capacity. This is one means of calibrating a condenser, that is, determining the relation between dial degrees or divisions and microfarads of capacity. The accuracy with which we determine the capacity by this method is none too great, but for all practical purposes it is good enough provided, *a*, we make no error in our arithmetic; *b*, we know the wavelength accurately; *c*, we can set the condenser dial accurately to the wavelength of the receiver or wavemeter, and *d*, the capacities being measured are fairly large, say 250 mmfd. and more. This latter proviso is because the actual capacity across the coil is made up not only of the capacity of the condenser but of the leads connecting coil and condenser and the distributed capacity of the coil. This latter capacity is a bothersome factor in all experimenters' calculations and experiments. It is discussed in the Signal Corps book, *Principles Underlying Radio Communication*, page 244, in the Bureau of Standards Bulletin 74, on pages 137-8 and in Morecroft's *Principles of Radio Communication*, page 230-235.

The capacity of the condenser used in the Laboratory, a General Radio "tin can" Type 247E, was actually 300 mmfd. at 55° while our calculations showed it to be 270 mmfd.—an accuracy of 10 per cent. The coil as measured on a bridge had an inductance of 280 microhenries instead of 292 as calculated—an accuracy of 95.6 per cent.

TABLE 1

condenser setting in degrees	condenser capacity in mmfd. (calculated)	wavelength in meters	frequency in kilocycles	(wavelength) <sup>2</sup>
78.5	270	621	483	385,000
55.0		527	568	277,000
41.0		458	655	210,000
32.0		408	735	166,600
26.5		370	810	133,700
22.0		338	888	114,000

TABLE 2

Name of unit	abbreviation
farad	f.
microfarad	mfd.
micromicrofarad	mmfd.
henry	h.
millihenry	mh.
microhenry	μh.

TABLE 3

f.	= one million	mfd.	= 10 <sup>6</sup> mfd.
f.	= one million million	mmfd.	= 10 <sup>12</sup> mmfd.
mfd.	= one million	mmfd.	= 10 <sup>6</sup> mmfd.
mfd.	= one millionth	f.	= 10 <sup>-6</sup> f.
mmfd.	= one millionth	mfd.	= 10 <sup>-6</sup> mfd.
mmfd.	= one million millionth	f.	= 10 <sup>-12</sup> f.
h.	= one thousand	mh.	= 10 <sup>3</sup> mh.
h.	= one million	μh.	= 10 <sup>6</sup> μh.
mh.	= one thousand	μh.	= 10 <sup>3</sup> μh.
mh.	= one thousandth	h.	= 10 <sup>-3</sup> h.
μh.	= one thousandth	mh.	= 10 <sup>-3</sup> mh.
μh.	= one millionth	h.	= 10 <sup>-6</sup> h.

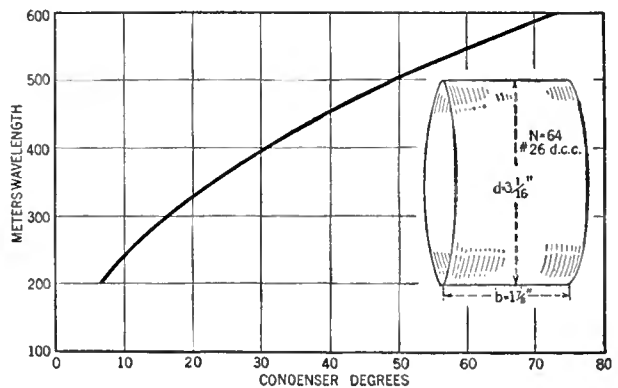

FIG. 1

PROBLEMS

1. Calculate the inductance of two coils which have the same diameter and length of winding, but of which one has twice as many turns as the other, obtained by using smaller wire.
2. The coil used in the Laboratory was too large to cover the broadcast band effectively with a 500-mmfd. condenser. Half the number of turns is too few. What is the correct number of turns, providing the diameter and length of winding is the same?
3. With a condenser whose maximum capacity is 150 mmfd. what is the coil inductance required to tune to 40 meters, 80 meters?
4. How many microhenries is 0.370 millihenries?
5. How many microfarads is 500 mmfd.?
6. If the minimum wavelength a broadcast receiver can be tuned to is 240 meters, and if the condenser has a minimum capacity of 5 mmfd. and at 500 mmfd. the receiver tunes to 600 meters, what is wrong? Why will not the receiver tune to shorter waves?

# Making an A-Power Unit From Your Battery-Charger

By ROBERT BURNHAM

THERE are probably many among our readers who have a source of 110-volt a.c. and who are still hesitating to supply the filaments of their tubes directly or indirectly with a.c. We described in recent issues the ease with which the adaptor kits with cable and attendant filament transformer may be used to avoid the A-battery. Now, the faithful battery-charger occupies a new place and the present article by Mr. Burnham describes how a very serviceable A-supply may be constructed. A power unit was constructed in the Laboratory in accordance with the data given in this article. We used a Tungar 2-ampere charger in conjunction with A-filter condensers and the proper chokes. With this form of filament supply for a standard storage battery set, the hum audible in a high-quality loud speaker was quite low.

—THE EDITOR.

THE owner of a battery-operated radio receiver who desires to convert it to a light-socket operation has before him a definite problem. How shall the conversion be accomplished? To many, converting a receiver to light-socket operation means only revising the set for the use of a.c. tubes. This is one way to do it. Another method of making a set light-socket operated, which in some cases may prove cheaper and easier, is illustrated in this article.

In the first place we should realize that the part of the power equipment of a radio receiver which in most cases makes the set not light-socket operated is the storage battery. The B and C potentials for the set are now generally supplied from the light socket through the use of a B-power unit. Therefore, any device which enables us to obtain filament current from the power mains without the use of a storage battery, supplies the missing link in the a.c. chain. It should be realized that "light-socket operated" does not necessarily imply the use of a.c. tubes; any method whereby a receiver is operated with power from the light socket is a method of socket-power operation no matter what types of tubes are used in the set.

## THIS A-POWER CIRCUIT IS SIMPLE

THE method used in B-power units to obtain B and C potentials from the light socket is quite familiar to our readers. For these potentials we take the current from the light socket, rectify it, filter it and then apply it to the radio receiver. It seems reasonable to suppose that the same method might apply equally well for the A supply. So it can, and the various A-power units now on the market make use of a rectifier-filter system to deliver sufficient current at six volts for the operation of radio receivers containing up to about 8 or 10 storage battery tubes.

An A-power unit consists, as we have mentioned above, of a rectifier and a filter system. The rectifier may be any of the types ordinarily used in battery chargers capable of supplying enough current (about 2 amperes) and the filter system should consist of a combination of a choke coil and two special condensers designed for use in A-power units and containing a large amount of capacity—several thousand microfarads. Condensers for use in A-power units are now available as are the choke coils and it follows therefore

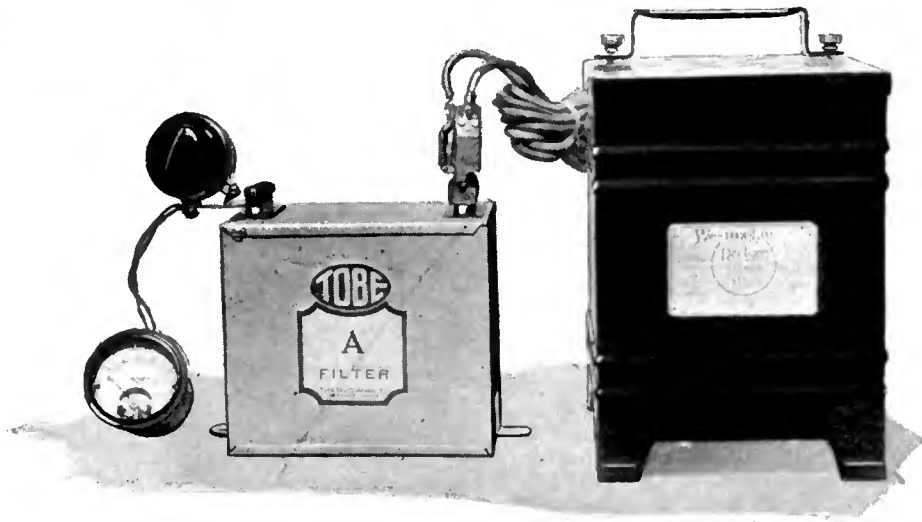

FIG. 1. HOW TO ASSEMBLE AN A-POWER UNIT AT HOME

A battery-charger, an A-filter, a rheostat, and a voltmeter are combined to produce a source of filament current directly from the light socket. In this illustration we show the use of a complete Tobe A-filter consisting of choke coils and condensers, all combined in a single container; the input terminal of the filter connect to any good battery-charger of not less than 2-ampere rating and the output of filter goes through a 10-ohm power rheostat to the filament terminals in the radio receiver. The voltmeter reads the output voltage which should be adjusted to 6 volts. A unit such as this can supply up to 8 or 10 201-A tubes or their equivalent, and makes it possible to do away with the storage battery, and obtain complete a.c. operation of the radio receiver

that by making use of these two units any owner of a battery charger can make himself an A-power unit. The storage battery can be discarded and your present radio receiver—with no other changes—in the future operated directly from the light socket. This is the particular subject of this article—how to make an A-power unit using your battery charger. Thus the millions of battery-chargers in use around the country can be used with an A-filter to give the owner of the receiver

a.c. operation requiring no rewiring, harnesses, or new tubes. Certainly this is worth considering.

The essential parts required are the battery-charger and A-filter, a power rheostat to control the output voltage of the unit, and a voltmeter to read the output voltage. Most of the companies making these various parts are listed in the table accompanying this article.

The story of how to do it is told quite completely in the illustrations accompanying this

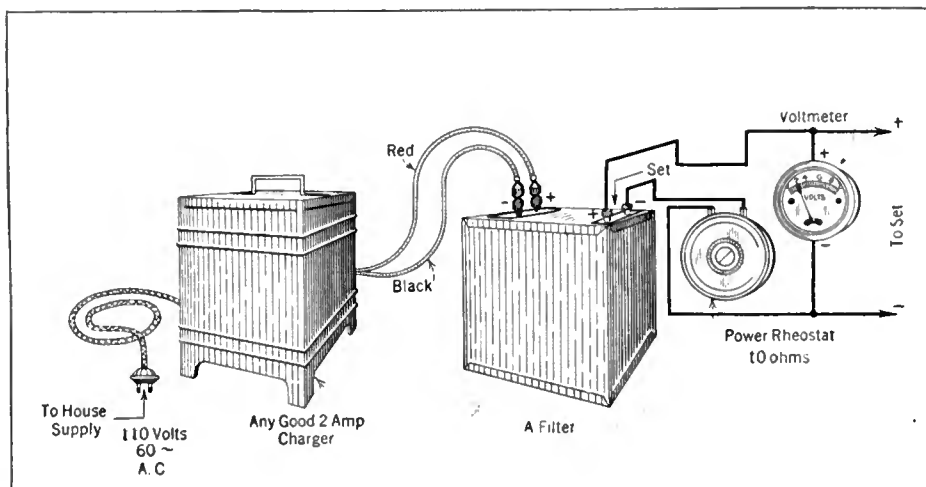

FIG. 2. HOW THE PARTS SHOULD BE CONNECTED

This picture-diagram shows clearly how the units are wired. The various parts can all be mounted on a single baseboard and then located at some point convenient to the radio receiver. Be sure to use a power rheostat, for ordinary types will not safely carry enough current. With the receiver turned on, adjust the power rheostat so that the voltmeter reads six volts. If the line voltage varies it may be necessary to readjust the rheostat in the course of an evening



article. Those who buy the Tobe A-filter need only connect it between the battery-charger and the A-terminals of the receiver and the job is done; those that want to make up their own filter circuit need to get a choke coil and two A-condensers. The completed unit will be as fool-proof as it is possible for any power unit to be. [Those receivers which make use of a rheostat in the r.f. filament circuit to control the volume may find the means of superseding the storage battery suggested in this article of some disadvantage. The regulation of the system is quite poor (a characteristic of all A-power units, as far as we know) and when the volume is lowered by decreasing the filament current to the r.f. tubes, the other tubes in the receiver will be supplied with excessive filament voltage. In such cases it will be better to change over to some other type of volume control which does not function by varying the filament voltage. Several methods of alternative volume control were discussed in "New Apparatus" in our June number—*Editor*.] These condensers require no attention—they are dry and may be operated in any position. Don't try to use these condensers in B-power circuits, in circuits where there is a.c., or in circuits in which the voltage exceeds about 10 volts d.c. The condensers have been designed for use only in low voltage d.c. circuits, such as are found in A-power circuits.

THE BEST FILTER SYSTEM

THE arrangement of the filter system which will prove best is shown in the illustration Fig. 3. The condensers,  $C_1$ ,  $C_2$ , and  $C_3$ , are A type condensers and the chokes,  $L_1$  and  $L_2$ , are rated at about 2 amperes and 0.25 henries. The condenser,  $C_3$ , is not always necessary, but if the audio amplifier in the receiver is a very good one, giving good gain at low frequencies, it may be necessary to include the third condenser,  $C_3$ , in

Where to Get the Parts				
A-CONDENSERS	CHOKE COILS	COMPLETE A-FILTERS	10-VOLT VOLT-METERS	RHEOSTATS
Aerovox Wireless Corp.	American Transformer Company	Tobe Deutschmann Company	Burton-Rogers Jewell	Carter Centralab Clarostat
Dubilier Condenser & Radio Corp.	Knapp Electric Company	Knapp Electric Company	Sterling Weston	Frost Ward Leonard Yaxley
Elkon Works, Inc.				
Tobe Deutschmann Company				

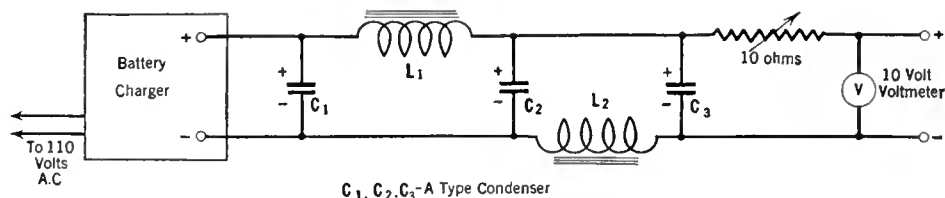

$C_1, C_2, C_3$ —A Type Condenser

FIG. 3

The circuit of an A-power unit. The filter circuit for an A-power unit made from a battery-charger consists of two choke coils and three A-type condensers arranged as indicated in this circuit diagram. Note that one of the chokes is connected in the positive lead and the other in the negative lead. These A-condensers, unlike ordinary condensers such as are used in B-power units, have a definite polarity and the red lead or the terminal marked *plus* must always be connected to the positive side of the circuit. The choke coils should have an inductance of about one quarter of a henry and should be able to carry about 2 amperes of current. The 10-ohm rheostat regulates the output voltage. The entire filter circuit may be easily laid out on a wooden baseboard or arranged in more compact form to suit local conditions. Manufacturers making the various parts that can be used are listed in the table accompanying the article

Fig. 3. On most commercial receivers with audio amplifiers of indifferent quality the third condenser is not required; good home-constructed receivers generally require the use of the third condenser. In arranging the apparatus, the two choke coils should be placed at right angles to each other.

To control the output of the unit it is necessary to use a heavy duty rheostat with a

value of about 10 ohms. [A 10-ohm rheostat may not prove satisfactory if the receiver contains only two or three tubes. A 15-ohm rheostat is more satisfactory in such cases.—*Editor*.] Manufacturers of satisfactory rheostats will be found listed in the table accompanying this article. It is also wise to include a voltmeter (range 0-10 volts) in the installation so that the rheostat may be accurately adjusted to the point where the correct voltage is applied to the receiver. This voltmeter will also serve to indicate when the line voltage varies and the rheostat can then be adjusted to compensate the variation in line voltage. How the rheostat and the voltmeter are connected in the circuit is shown in the diagram Fig. 3.

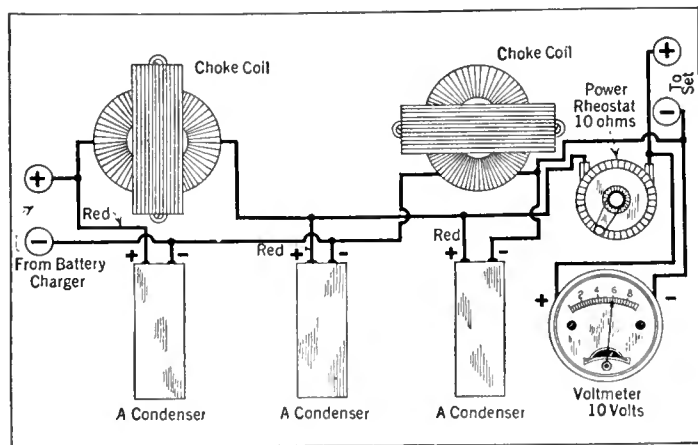

FIG. 5. A BASEBOARD LAYOUT OF THE FILTER SYSTEM

Two choke coils, three A-type condensers, a rheostat, a voltmeter, and four binding posts are indicated in this baseboard layout of a filter system for an A-power unit. Connect a battery-charger to the two left hand terminals and you have a source of filament current for your radio receiver. Operation of your radio receiver direct from the light socket is then possible using standard storage battery type tubes, such as the 201-A. Note in this baseboard layout of apparatus that the two choke coils have been placed at right angles to each other so as to eliminate any possibility of coupling between them. Be sure to note the markings (or color of the wire) on the A-condenser and connect them as indicated in this drawing



FIG. 4. PARTS FOR USE IN AN A-POWER UNIT

# New Apparatus

## To Help Cure Interference

X39

**Device:** Davis Trouble Finder, Model T. F. 2. A compact portable radio receiving set for use in locating sources of radio interference. The set uses five CX-299 (UX-199) tubes in a circuit consisting of two stages of r.f. amplification, detector and two stages of a.f. amplification. A single dial is used to tune the receiver. The other controls are a volume control, a rheostat and an "audio-radio" switch.

The set is designed for use with headphones, which are furnished with the receiver. An external loop of larger dimensions than the regular internal loop is provided. There is also provided a small exploring coil to be used as a loop where minimum sensitivity is required. Size: 14 x 10½ x 5½ inches. Weight: 20 lbs. **Manufacturer:** DAVIS EMERGENCY EQUIPMENT COMPANY. **Price:** \$225.00 complete.

**Application:** This excellent receiver, an earlier model of which proved exceedingly useful in the Laboratory some months ago, is the only one of its kind—that we know of—being manufactured for the specific purpose of locating sources of interference. With the receiver is supplied a small booklet giving data on the use of the device. The "audio-radio" switch is a valuable feature. It functions, when thrown to the "audio" side, to cut out of the circuit the r.f. stages, so that only the audio amplifier is operating. The manufacturer's pamphlet describing the receiver states that, "No case has yet been observed where interference was audible, on the audio side, beyond a limited area, usually within 150 feet of the source of interference."

After the source of interference has been located, it must be repaired and in this connection the series of articles in RADIO BROADCAST, by A. T. Lawton, on how to eliminate interference, will be useful. These articles appeared in the following issues: November, 1927, January, 1928, and March, 1928.

## A. C. Tube and Set Tester

X40

**Device:** Sterling A.C. Tube and Set Tester. Universal Model No. R-512. Contains an a.c. voltmeter with two ranges, 0-3 volts and 0-15 volts and a volt-milliammeter reading voltages up to 200 and milliamperes up to 30. It is possible with the tester to check the plate current



STERLING A.C. TUBE AND SET TESTER

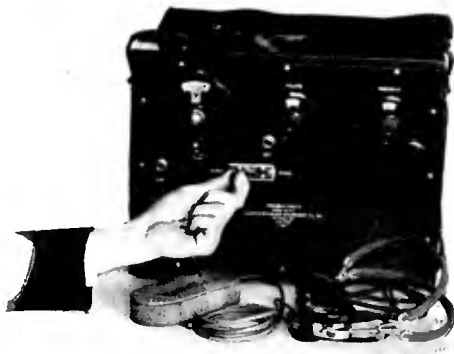

DAVIS TROUBLE FINDER

of all types of tubes in an a.c.-operated receiver, test for open circuits, shorts, defective transformers, defective sockets, etc. The tests possible with this tester are divided into two general classes, so called "service tests" and "tube tests." The "service tests" check the characteristics of the receiver; determine whether or not the tube is being supplied with its rated filament and plate voltages, etc. The "tube tests" check the performance of the tube, determine if it has sufficient emission, whether it is amplifying, etc.

The tester can be used with receivers using R. C. A. and Cunningham, Ceco, Arcturus, Marathon, McCullough, Sonatron, Van Horne and any other a.c. tubes requiring filament voltage not in excess of 15 volts (the maximum voltage which can be read on the filament voltmeter). **Manufacturer:** THE STERLING MANUFACTURING COMPANY. **Price:** \$35.00

**Application:** Radio service men, dealers, set builders, experimenters, will all find this tester useful. It is comparatively inexpensive and is accurate enough for all ordinary testing.

To use the device a tube is removed from the receiver under test and the plug from the tester inserted in the tube socket. The tube itself is plugged into a tube socket on the tester. By pressing the button on the tester it is possible to read plate voltage, plate current and filament voltage. All of the readings are taken under operating conditions and are therefore exact indications of the voltages applied to the tube when it is actually in operation. Either four-prong or five-prong tubes can be tested by means of adapters supplied with the tester.

**P**RODUCTS of radio manufacturers whether new or old are always interesting to our readers. These pages, a feature of RADIO BROADCAST explain and illustrate products which have been selected for publication because of their special interest to our readers. This information is prepared by the Technical Staff and is in a form which we believe will be most useful. We have, wherever possible, suggested special uses for the device mentioned. It is of course not possible to include all the information about each device which is available. Each description bears a serial number and if you desire additional information direct from the manufacturer concerned, please address a letter to the Service Department, RADIO BROADCAST, Garden City, New York, referring to the serial numbers of the devices which interest you and we shall see that your request is promptly handled.—THE EDITOR.

## Phonograph Pick-Up

X41

**Device:** Erla Phonograph Pick-up Unit. This device, illustrated in the photograph, is sold complete with the tone arm and volume control. The small movable arm carrying the actual pick-up is counterbalanced so that the needle will not press too heavily on the record.

To install the device, it is mounted on the phonograph in such a position that when the arm is moved to the center the needle is directly over the center of the record. The base of the tone arm is then fastened in this position with three wood screws.

**Manufacturer:** ELECTRICAL RESEARCH LABORATORIES. **Price:** \$19.50

**Application:** Designed for use in conjunction with a phonograph turn table and an audio amplifier (contained in a radio receiver or separately) to enable one to reproduce phonograph records electrically.

The counterbalancing arrangement used in this device to offset some of the weight in the pick-up is to be recommended. Some of the pick-ups which have been tested in the laboratory press altogether too heavily on the record. A member of the Laboratory's staff, witnessing a



ERLA PICK-UP

demonstration a short while ago of a Hewlett loud speaker located at the Schenectady plant of the General Electric Company, noted that the pick-up unit used in the demonstration was arranged with a counterbalance, similar to that used in the Erla pick-up.

The Erla unit gave a quality of reproduction apparently about equal to that of other pick-ups the Laboratory has received for test, but the volume output was somewhat less. However, the Erla unit gave all the volume needed for ordinary home reproduction.

## Five New Audio Coils

X42

**Device:** Sangamo Audio Apparatus. The following units are available:

Audio Transformer Type A. Turns ratio 3, primary resistance 1960 ohms, secondary resistance 7100 ohms, primary inductance 200 henries with no direct current, with 2 mA. direct current, 145 henries. **Price:** \$10.00. Output Impedance Type E. With 25 to 28 mA. of d.c. flowing through the coil the inductance is 30



SANGAMO OUTPUT TRANSFORMER

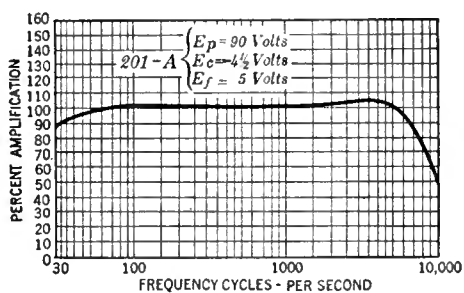

AMPLIFICATION CURVE OF THE SAGAMO TYPE A AUDIO UNIT

henries. *Price:* \$5.00. Plate Impedance Type F. Designed for use in impedance-coupled amplifiers or as audio-frequency choke coils in the plate leads to prevent oscillation and motor boating in audio-frequency amplifiers. Inductance about 200 henries. *Price:* \$5.00. Push-pull Input Transformer Type B. Ratio 4.5 to 1. *Price:* \$12.00. Push-pull Output Transformer Type C171. For use in push-pull amplifiers using 171 type tubes. Impedance step down ratio 2:1. Total primary inductance 80 henries. *Price:* \$12.00. Push-pull Output Transformer Type D-210. For use with push-pull amplifiers using 112 and 210 type tubes. Total primary inductance 100 henries. *Price:* \$12.00.

*Manufacturer:* SANGAMO ELECTRIC COMPANY.

*Application:* The above apparatus may be used in constructing transformer impedance-coupled amplifiers. The Type A audio transformer, using a special alloy core, has the disadvantage that the ratio is somewhat low so that a two-stage affair will not have any too much gain. With two of these transformers and a 201-A type tube in the interstage the voltage gain from the output of the detector to the grid of the power tube will be about 6.3. To load up a 171 type tube the detector output will have to be about 0.7 peak volts. However, the frequency characteristic of the transformer, as announced by the manufacturer, and which we consider to be trustworthy, is very good and the excellent frequency transmission which the transformer will give compensates their rather low gain.

The output impedance, Type F, is arranged with terminals so that it is possible to use it with different types of power tubes, and adapt their impedance to that of ordinary types of loud speakers. A condenser with a capacity of about 4.0 mfd. must be used in constructing a complete output device using this impedance.

### Center-Tapped A. C. Tube Resistors

X43

*Device:* Center-Tapped Resistors type CU-20. Small and convenient center-tapped resistors designed especially for use across the filament circuits of a.c. tubes. They measure about 2 inches long and about 3/16 inches wide. Available in resistances up to 100 ohms. *Manufacturer:* CARTER RADIO COMPANY. *Price:* \$0.25.

*Application:* Circuits using a.c. tubes generally require one or more center-tapped resistances across the filament circuit. The 20-ohm size in this type of resistance may also be put to very satisfac-

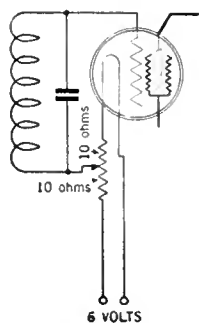

CENTER-TAPPED RESISTOR  
In the grid circuit return

tory use in the filament circuits of screen-grid tubes. Twenty ohms is just right to reduce the storage battery voltage of six to the 3.3 volts required by the screen-grid tube. The center tap in the resistance may be used for the grid circuit return as shown in the circuit diagram, and a C bias of 1.3 volts obtained in this way.

### Antenna Tuning Unit

X44

*Device:* Sickles Intensifier. A unit to be attached to a receiver to obtain greater volume. It consists of a coil and a condenser mounted in a small box and functions to tune the antenna circuit to resonance. *Manufacturer:* F. W. SICKLES COMPANY. *Price:* \$7.50

*Application:* If the antenna circuit of a receiver is tuned by means of a coil and a condenser it is generally possible to obtain somewhat greater volume than can be obtained if the circuit is untuned.

Many modern single-control radio receivers



SICKLES INTENSIFIER

use untuned antenna circuits and if one does not mind adding another control to the set it will be possible to increase the volume considerably by tuning the antenna circuit. The Intensifier is such a device and may be easily added to most any type of receiver. The idea is not new—especially to radio experimenters—but in this device the idea has been put into workable form so that an average person, knowing little or nothing about radio circuits, may be able to use it to advantage. This is a good gadget for the radio service man to handle and to make use of in those cases where a customer complains of insufficient volume.

### A. C. Tube Filament Transformers

X45

*Device:* A. C. Filament-Lighting Transformers. Ten different types of filament transformers are made with specifications as given below.

No. 6512. Designed for one to four UX-226, one UV-227 and one UX-171 or two UX-171A. Transformer is mounted in crystallized lacquered case equipped with lamp cord and plug outlet, also tap for control switch. 1 1/2 V., 4.2 amp.; 2 1/2 V., 1.75 amp.; C. T., 5 V., 1/2 amp. *Price:* \$5.75. No. 6515. Same as above without plug outlet and control switch tap. *Price:* \$4.75. No.

6570. Same as 6512 but with terminals on secondary. *Price:* \$6.50. No. 4586. Designed for one to eight UX-226, two UV-227 and two UX-171, 1 1/2 V., 8.4 amp.; 2 1/2 V., 3.5 amp. C. T., 7 1/2 V., 2 1/2 amp. C. T. *Price:* \$8.00. No. 4587. Designed for one to eight UX-226, two UV-227 and two UX-210, 1 1/2 V., 8.4 amp.; 2 1/2 V., 3.5 amp. C. T., 7 1/2 V., 2 1/2 amp. C. T. *Price:* \$8.00. No. 6513. Designed to operate one to six Arcturus a.c. tubes. Transformer is mounted in crystallized lacquered case equipped with lamp cord and plug outlet for B power unit, also tap for control switch. 15 V., 2.1 amp. *Price:* \$5.25. No. 6511. Same as above without plug outlet and control switch tap. *Price:* \$4.25. No. 286. Designed for heating filament of one UX-210. 7 1/2 V., 1 1/2 amp. C. T. *Price:* \$2.50. No. 287. Designed for heating filaments of two UX-171 or UX-112 power tubes, 5 V., 1 amp. C. T. *Price:* \$2.50. No. 820. Designed for heating one to eight McCullough (Kellogg) a.c. tubes, 3 V., 8 amp. C. T. *Price:* \$6.00. *Manufacturer:* DONGAN ELECTRIC MANUFACTURING CO.

*Application:* These transformers are to be used as a source of filament current for a.c. tubes in the construction of light-socket-operated receivers making use of any of the well-known types of a.c. tubes. This line of transformers satisfies the demands of the wave-combinations found in most receivers in use to-day.

### Choke-Condenser Unit

X46

*Device:* Audichoke. A combination of a choke coil and a by-pass condenser, both contained in a single case. The chokes are rated at 100 henries with a d.c. resistance of 445 ohms and the condensers have a capacity of 1.0 mfd. *Manufacturer:* LESLIE F. MUTLER COMPANY. *Price:* \$5.00.

*Application:* The internal impedance of power units and old B batteries is frequently sufficiently high to cause an audio amplifier to begin to oscillate and, sometimes, to motorboat due to common coupling owing to the power unit's impedance. In the ideal case, the amplifier should be absolutely independent of its power supply so that it is entirely unaffected by the impedance of the source of power—but unfortunately in practice this is rarely the case. The receiver may be made practically independent of the power supply by properly filtering the plate by means of choke coils or resistances in conjunction with by-pass condensers. This Audichoke is a device of this sort making use of a choke coil and 1.0-mfd. by-pass condenser. The connection of the unit in a typical amplifier is shown in the circuit diagram.

There is no reason for the use of this device in an amplifier that is giving satisfactory operation, but in cases where the amplifier oscillates or motorboats these choke-condenser units may be included in the circuit. In making use of these units it is generally not necessary to revise the amplifier; the chokes may simply be connected in series with the B-plus leads.

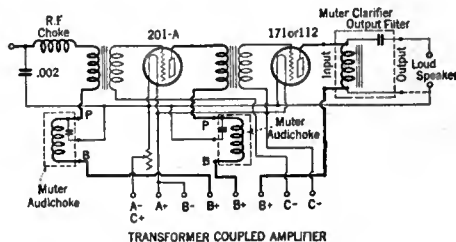

MUTER CHOKES IN AN AUDIO SYSTEM

### THE COMPLETED POWER AMPLIFIER AND A DYNAMIC TYPE LOUD SPEAKER

This high-quality power amplifier, built around the type 250 tube, must be used with the better types of loud speakers if the builder is to obtain from the unit the quality it is capable of producing. This photograph shows the amplifier in conjunction with the Jensen dynamic loud speaker

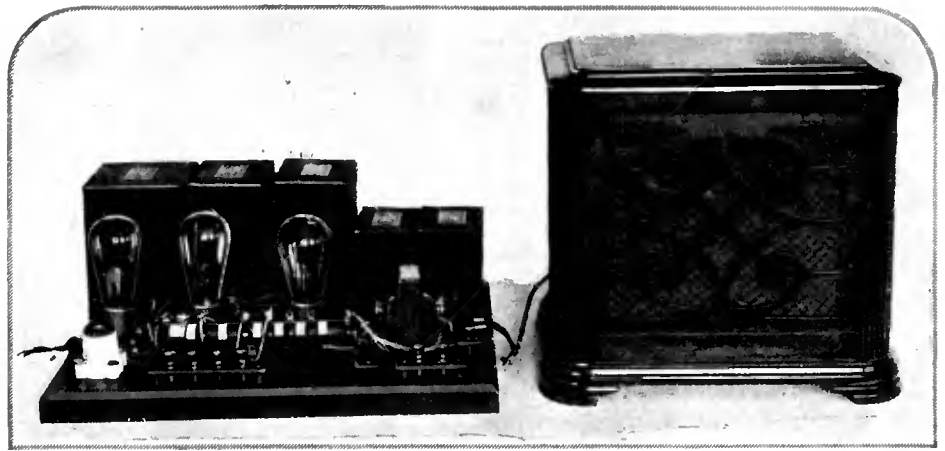

## A Good Amplifier-Power Unit for the 250 Tube

By HOWARD BARCLAY

**WE PROPOSE** to describe here a single-stage power amplifier and B supply designed for use with the new type 250 tube. In the following paragraphs we review the general characteristics of this power amplifier and call attention to the interesting features that have been incorporated in it. Sufficient constructional details are given so that the amplifier may be readily constructed by those interested readers to whom this unit appeals.

This power amplifier and B supply is designed for use as a last-stage amplifier. The receiver proper must contain at least two stages of resistance-coupled amplification or one stage of transformer-coupled amplification in order that the overall gain of the system shall be sufficient to operate the power tube. A combination amplifier and B-supply unit of this type can also be used to considerable advantage to replace the output stage in a radio receiver not using power tubes or in cases where more volume is desired than can be obtained from the smaller types of power amplifier ordinarily used in radio receivers. Service men and professional set builders may find the construction of an amplifier of this type advisable for customers desiring the utmost in quality reproduction and who desire comparatively large amounts of volume such as is necessary in reproducing radio programs for dances in clubs, and in other large public rooms.

The output of this single type 250 tube is about equal to the power output of an amplifier using type 210 tubes in push-pull. More specifically, the rectifier-filter system used in this power unit is such that the plate of the 250 tube receives about 400 volts at which voltage the tube can deliver 3.25 watts. This amount of power is in excess of what is ordinarily required for home reproduction but will not be excessive when the radio installation is called upon to supply more volume—sufficient, for example, for dancing. The construction of a power amplifier that can deliver more power than is ordinarily required falls into the same category as the purchase of an automobile with an 80 horsepower engine. The maximum output of the device may seldom be required, but is available when necessary. [The reader should refer to the article "The Newest Power Tube," by Howard E. Rhodes on page 74, RADIO BROADCAST, June, 1928. Here the potentialities of the 250 type tube were most thoroughly analyzed and compared with other power tubes that are available to the radio fan and professional set builder.—Editor.]

#### THE CIRCUIT IS INTERESTING

**THE** circuit diagram of this power amplifier and B supply is given in Fig. 3. The circuit contains two innovations. In the first place a small flashlight bulb, indicated as B in the diagram, is connected in series with the output of the rectifier tubes, to protect the rectifier tubes from damage in case the output of the filter system is accidentally short-circuited or in case the type 250 tube is placed in the socket and operated at less than normal bias so that the plate current is excessive. In such cases the small flashlight bulb will glow very brightly or will burn out and thereby warn the user of the device that there is some defect in the circuit.

The filter system used in this device is unusual in that the condenser connected across the input to the filter system is eliminated and in this case is connected instead to the center point of the two filter choke coils,  $L_1$ . There is no condenser connected across the input to the filter system. This revised circuit is used in accordance with recommendations to be found in the *Cunningham Tube Data Book*. [Available from E. T. Cunningham, Inc. at \$2.50.—Editor.] Curves are given in this book indicating that with the familiar type of rectifier and filter circuit, Fig. 1A, the load on the rectifier tube is quite heavy, reaching during each cycle, current values as high as 300 milliamperes although the average current drawn from the filter system was only 125 milliamperes. Under such conditions the rectifier tubes are therefore called upon to supply a peak current about two and one half times as great as the load current (300 divided by 125) and thus the fila-

**THIS** article describes a very satisfactory power supply and amplifier unit using the new type 250 amplifier tube. Technically, the device has two especially interesting and unusual features. In series with the rectifier output a small flashlight bulb is included. This operates to protect the rectifier tubes from damage in case of an accidental short-circuit. A new type of filter circuit is used, which gives longer rectifier tube life than that usually obtained in the usual type of filter system. This unit tested out very well in the Laboratory. The quality was very good and the a. c. hum was practically inaudible in the dynamic loud speaker which was used.

—THE EDITOR.

ment of the rectifier must be made heavy and long enough to supply this large amount of current.

A very great improvement in these load conditions can be obtained by removing the condenser,  $C_1$ , across the input to the filter system, as indicated in Fig. 1B. Under such conditions the peak value of current which the tube must supply is reduced to only 140 milliamperes in comparison with the value of 300 milliamperes which the tube is called upon to deliver when the condenser was included in the circuit. This reduced current drain on the tube results in much longer filament life. The omission of the first condenser from the filter system would normally cause a reduction in output voltage but this can be compensated by slightly increasing the transformer voltages. The power unit described and illustrated in this article makes use of this new filter system so that the user can obtain from the rectifiers as long a life as possible. The list of parts on page 142 are those used in constructing this amplifier.

#### ASSEMBLY AND OPERATION

**THE** wiring of the amplifier is not difficult, using the information given in Figs. 2 and 3. The various transformers, chokes and condensers are supplied with insulated leads sufficiently long so that most of the wiring may be done with them. The leads are colored in accordance with the markings on the diagram. If it is necessary to use any additional hook-up wire it should be of the heavy insulated rubber type not smaller than size No. 18. [The unit described here was made with parts from the Dongan Company and it performs very satisfactorily indeed. Obviously, if the builder prefers, he can assemble a similar amplifier and power supply employing the necessary units made by other reliable manufacturers. We recommend that only 1000-volt test condensers be used in the filter. The "New Apparatus" department, page 85 June issue, and that department in this issue, as well as our advertising pages, give information on the products which might be used.—EDITOR.]

As indicated in the picture diagram, Fig. 2, all of the cases of the transformers, filter chokes, and condenser blocks should be wired together and connected to the negative B. The filament leads of the rectifier tubes should be twisted together as should the filament leads to the type 250 power amplifier tubes to minimize any a. c. hum.

It is useless to construct a quality amplifier

of this type unless all of the apparatus used in conjunction with it is also of the best. The output of the amplifier should be fed into a good cone or dynamic type loud speaker such as the Magnavox or Jensen. In operating the unit care must be taken that it is so located to provide sufficient ventilation for the tubes. The 250 type amplifier, especially, becomes very warm in operation. If the unit is placed inside of a cabinet it will be a good idea to tack a piece of asbestos above the amplifier to protect the cabinet from the heat.

Take care in constructing this amplifier. Remember there are many kinds of accidents. One is the useful that leads to discoveries and inventions. Another kind, somewhat different, and sometimes associated with the construction of high-voltage amplifiers, leads to burnt finger tips or perhaps to severe shocks. The voltages used in this and other types of amplifiers using 210's and 250's are positively dangerous and every precaution must be taken in wiring and handling the amplifier so that there is no possibility of shock. Do not make any changes in the amplifier while the power is on.

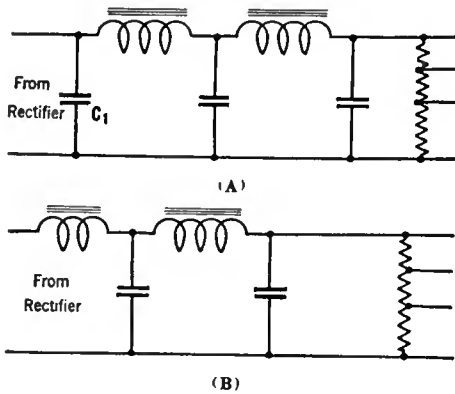

FIG. 1

Sketch A illustrates a typical filter circuit such as is incorporated in the usual B-power unit. Sketch B shows a modification of this circuit, condenser C<sub>1</sub> being omitted, which greatly reduces the peak value of current which the rectifier tube is called upon to deliver. This improvement has been incorporated in the power amplifier described in this article

LIST OF PARTS

T <sub>1</sub>	Dongan Transformer No. 7568	\$ 13.50
T <sub>2</sub>	Dongan Output Transformer No. 1177	12.00
T <sub>3</sub>	Dongan Type H Audio Transformer Ratio 3½-1	4.50
L <sub>1</sub>	Dongan Double Choke Unit No. 6551	15.00
C <sub>1</sub>	Dongan Condenser Unit No. D-600	23.00
C <sub>2</sub>	Dongan Condenser Unit No. D-307	10.00
R <sub>1</sub>	Ward Leonard Resistor No. 507-6	6.75
R <sub>2</sub>	Ward Leonard Resistor No. 507-55	1.00
2	UX-281 or Cunningham cx-381	15.00
1	UX-250 or Cunningham cx-350	12.00
3	Benjamin Sockets	2.25
1	Porcelain Socket for Fuse	.25
1	3 Amp. Clearsite Fuse	.15
8	Eby Binding Posts	1.20
B	Flashlight Bulb and Socket	.50
1	25-ft. length Belden colorubber hookup wire	.50
	Baseboard, Wood Screws, Bakelite Strips, etc. Approx.	1.00
	TOTAL	\$116.25

The following additional items are required in order to make the device operative.

- 2 CX-381 (UX-281) Rectifier Tubes
- 1 CX-350 (UX-250) Power Amplifier Tube

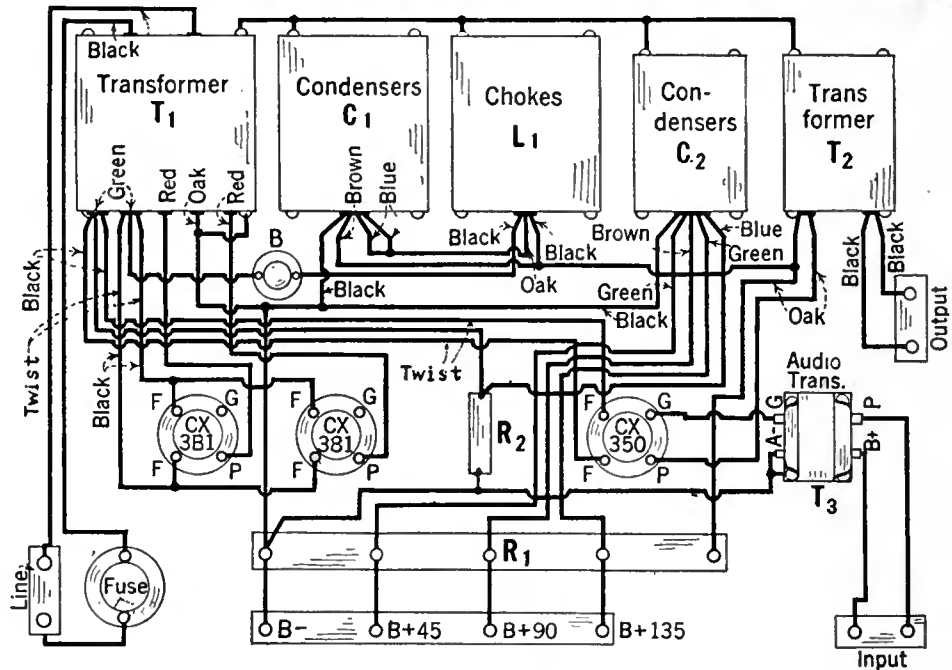
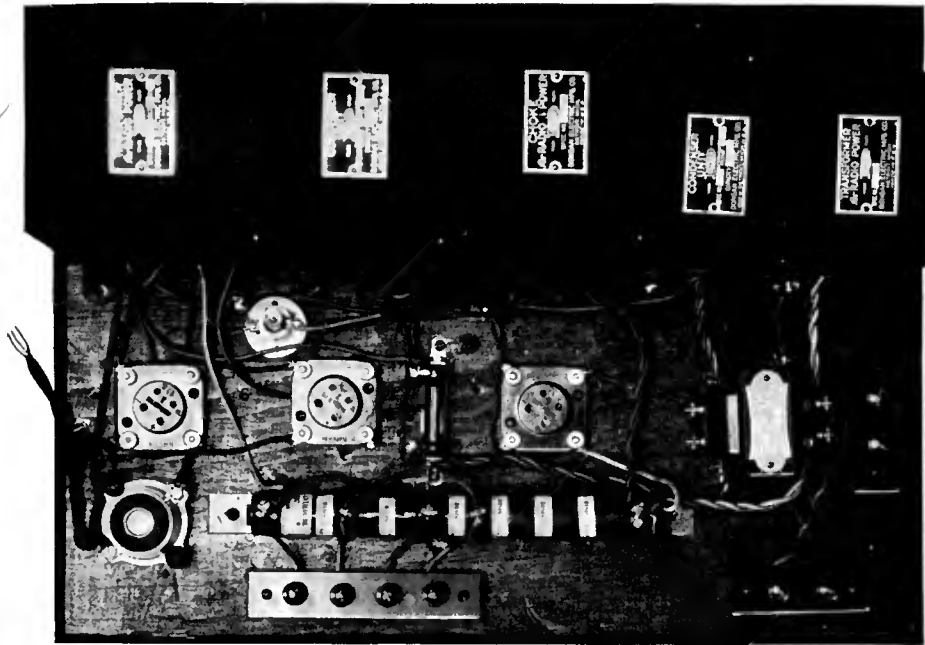

FIG. 2

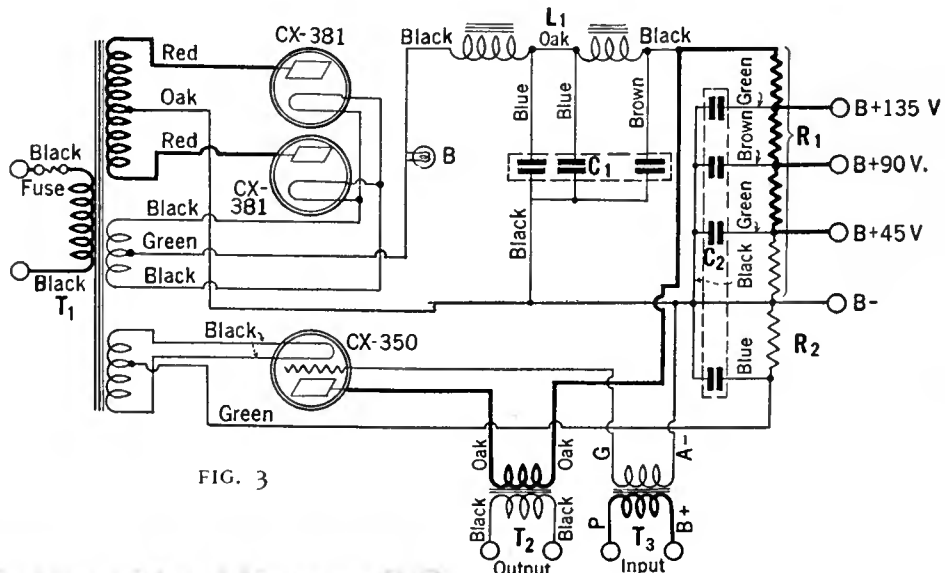

FIG. 3

**New Crystal Control**

WE HAVE already mentioned the extreme accuracy to which broadcasting stations must be kept on their required frequencies if there is a general exodus of stations down to the short waves—or into the higher frequencies. Now we learn from the March, 1928, *Bell Laboratories Record* that crystal control apparatus has been developed for use with television equipment which is capable of holding oscillators to a constant frequency to within one part in ten million. This is equivalent to one cycle in 10,000 kc. (30 meters). At present, broadcasters seem to have difficulty in holding to 500 cycles at 1000 kc. This shows that such accuracy of adjustment and maintenance can be obtained.

The objection, from the broadcasters of course, is that such equipment costs a great deal of money. We do not believe this is a valid objection. There is a great deal of money invested in radio receiving equipment at the present time—much of which is wasted because of present conditions in the ether. It costs a lot of money to wage war, and many years afterward to pay for it, but at the time nearly everyone gets highly enthusiastic about it.

When controlled by these crystals, a driving motor of a television receiver would require a week to get out of step with a transmitting motor by as much as one revolution. This eliminates the tendency of a television image to slowly float off the screen.

THE FOLLOWING prices taken from a recent issue of the British publication *Wireless World and Radio Review* are indicative of what the Britisher has to pay for his radio apparatus:

Amplion Cone Speaker . . . . .	\$ 7.00
Siemens B batteries, power type . . . . .	3.00
Weston Set Tester . . . . .	75.00
Cosmos High- $\mu$ tube, $\mu$ -35, $R_p$ -50,000 . . . . .	2.00
Cosmos power tube $\mu$ -6.5, $R_p$ -4500 ohms . . . . .	2.50
Brown phonograph pick-up . . . . .	20.00
Carborundum resistance-capacity unit . . . . .	1.75
Ferranti output transformer 1-1 . . . . .	6.50
Dubilier phonograph pick-up . . . . .	7.00
Marconiphone power supply unit . . . . .	37.00
Magnavox dynamic speaker unit . . . . .	47.00
Mullard audio transformer, high quality . . . . .	5.00
Ormond five-tube portable receiver . . . . .	122.00
Benjamin sockets . . . . .	.50
General Radio speaker filter . . . . .	6.00

In this issue are no less than twelve advertisements of moving coil loud speakers, represented in this country by the Magnavox, the R.C.A. 104, and the Jensen, there is also an extraordinary radio-phonograph outfit consisting of two tone-arms, two pick-ups, two turn tables, and two motors—all for \$180.00. The reason for the duplicate list of parts is not stated.

IT BEGINS to look as though the English have been considerably in advance of us in the development of moving coil—dynamic type, if you will—loud speakers. For many months the English papers have had descriptions of such instruments pointing out their superior characteristics compared with both

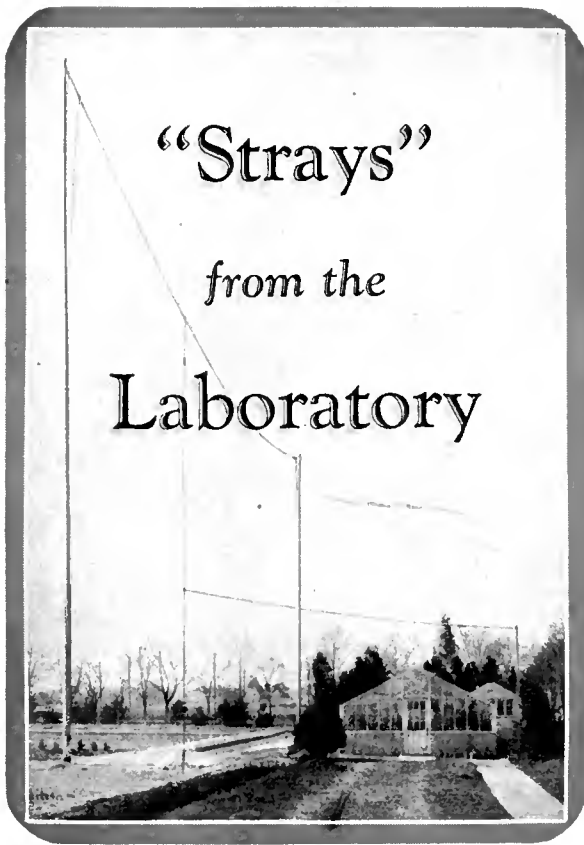

horn and cone speakers, and the advertising pages of these magazines have been correspondingly full of copy from manufacturers of the newer type of speaker. We predict that next year will see a flood of moving coil speakers in this country, mounting to a new craze on the part of our radio public.

We have already mentioned the superior qualities of the Magnavox and Jensen speakers. We have recently seen a curve which we believe to be truthful—which shows a uniform response from below 35 cycles to above 6000 when a unit of this type is used with a rather large and awkward baffleboard. We do not believe it necessary to go down to 35 cycles for excellent quality—but it is comfortable to know your automobile can go 75 miles an hour even though you haven't the nerve to drive it at that rate.

The trend toward dynamic speakers is already evidenced in the interest shown on Cortlandt Street, the cut-rate market of New York. Here are a half dozen imitations of the real thing which the gullible radio public is buying as fast as it can. It is reported that several receiver manufacturers whose names are well known are interested in the dynamic speaker and that several have already made arrangements for using it in 1929 models.

There is another trend which seems to be becoming more and more pronounced. This is the search for some method of solving the a.c. re-

ceiver problem whether by series-filament systems or by voltage control units which maintain voltages both A and B constant in spite of varying line voltages.

We have seen several of the voltage regulators which as yet are not ready for the market. One in particular delivered A and B voltages with variations of not over 1 per cent. in spite of line fluctuations of over 30 per cent.

There is some interest at this time in running filaments in series, such as was described by Roland F. Beers in *RADIO BROADCAST* many, many months ago. The advent of eighth-ampere filament tubes will make this problem much simpler, for it is not difficult to obtain currents as high as 135 milliamperes from modern rectifier-filter systems. Just when these tubes will appear is not known, although a recent Sonatron catalogue lists them as being ready for sale at once.

And speaking of trends—someone has suggested that people who object to the high voltages necessary for 210 and 250 type tube operation, where considerable audio power is desired or necessary, might use four 171's in parallel. The plate current drain would be about the same as for a 250 type tube, but the voltage need not be over 220 for a combined B and C voltage supply system. This is to be compared with 500 necessary to provide the newest power tube with proper operating conditions. Four 171's will deliver nearly 4 watts of power, and will present an output impedance of about 500 ohms

which ought to bring out enough low notes, without distortion, to suit anyone. With the proper output transformer this amplifier output ought to work into a dynamic speaker with its usual 5- to 10-ohm impedance.

The curve in Fig. 1 is that of the Amertran output transformer designed to couple push-pull 210 tubes to a dynamic speaker.

THE KODEL RADIO CORPORATION announces it has paid \$250,000 for the invention which led to the development of Kuprox, a rectifying element. This sum bought approximately 35 patents. During the past six months royalties in excess of \$100,000 were paid to the Leibel-Flarsheim Company of Cincinnati for devices using this material which was developed in their laboratories.

THE ARCTURUS RADIO COMPANY, makers of tubes, announced a '27 type replacement tube with a guaranteed life of 1000 hours. This has been possible by designing a heater and cathode combination in which the filament or heater burns at a very low temperature. The lag in time between turning on the current into this new tube and its functioning properly, which in some tubes is about 42 seconds, has been reduced to six from fifteen seconds by decreasing the spacing between heater and cathode. The increase in heating varies roughly as the square of the de-

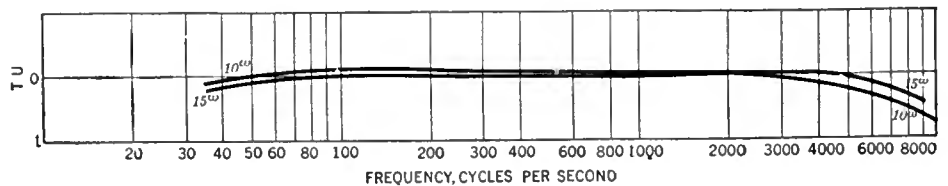

FIG. 1  
Frequency characteristic of the Amertran type 200 push-pull output transformer working out of two 3000-ohm tubes into 10- and 15-ohm resistances

crease in spacing. Variations of line voltage up to 25 per cent. can be tolerated with this tube.

FORTY-EIGHT months ago we watched Austin G. Cooley transmit pictures across the RADIO BROADCAST Laboratory and wondered when it would be possible to turn his work over to the thousands of experimenters in this country. We now have a circular from the Radiovision Corporation, 62 West 30th Street, New York City, which announces that the Cooley Rayfoto kit is ready for sale and that pictures are being regularly transmitted from WOR.

**Publications Worthy of Note**  
 THESE BOOKLETS have come to our attention and deserve the praise of a review. However, their titles indicate enough of their contents to be of interest to those working in any of the subjects covered:

GENERATOR FOR AUDIO CURRENTS OF ADJUSTABLE FREQUENCY WITH PIEZO-ELECTRIC STABILIZATION, BY AUGUST HUND. *Scientific Paper of the Bureau of Standards*, No. 560. Price 10 cents.

How to Operate Any Receiver from the House Current without Batteries. ARCTURUS RADIO COMPANY, 255 Sherman Ave., Newark, New Jersey.

A RADIO-FREQUENCY OSCILLATOR FOR RECEIVER INVESTIGATIONS, BY GEORGE RODWIN AND THEODORE A. SMITH. *Institute of Radio Engineers*, (reprint). February 1928 issue.

CALCULATION OF CAPACITIES OF RADIO ANTENNA AND THEIR RESULTANT WAVELENGTH, BY FREDERICK W. GROVER. *Scientific Paper of the Bureau of Standards* No. 568, price 20 cents.

National Electrical Safety Code, Fourth Edition 1926, HANDBOOK SERIES OF THE BUREAU OF STANDARDS, No. 3. Price \$1.

Data on the Voltage Amplification of Radio Frequency Transformers, by BURR K. OSBORN. BULLETIN No. 15, Michigan Engineering Experiment Station, Michigan State College, East Lansing, Michigan.

What B Eliminator Shall I Buy? *Electrad*, 175 Varick Street, New York City.

**"Skim Milk Masquerades As Cream"**

ONE OF our service-dealer friends sends us what he considers a good joke on himself. Recently he gave a wholesale firm a trial order for some output transformers which would retail at \$1.50. When the transformers—so called—arrived he attempted to measure the resistance, to get an idea of the inductance, and found that the coils would pass one ampere at 85 volts, and when the cover was torn off he discovered a solid pig-iron core and two coils connected as shown in Fig. 2. When the coils were so connected between tube and loud speaker that energy transfer was inductive rather than conductive, nothing got through because of the extremely low inductance. In other words instead of a transformer, our friend had bought two coils which were to be placed in series with the loud speaker. The iron was thrown in. How many of RADIO BROADCAST's readers have been taken in by such devices?

**Technical Smoke Screen**

WILL ANY technically minded reader interpret this quotation from the April, 1928, *Popular Radio* (page 303),

During tests that were conducted in the *Popular Radio* laboratory it was found that this cone could easily take an output of two 210 amplifier valves arranged in a push-pull stage. The output current during the test ran as high as 40 milliamperes, with voltage on the lower end of the frequency range varying between 1000 and 1280. The speaker performed remarkably well with this great load

and was free not only from standing waves, but from harmonic distortion as well.

**Recent Interesting Technical Articles**

- Measurement of Choke Coil Inductance, *Proceedings I. R. E.*, March.
- Mutual Inductance in Radio Circuits, *Experimental Wireless*, April.
- Calculations for Resistance Amplifiers, *Experimental Wireless*, April.
- Low-power Crystal-Control Transmitters, *QST*, April.
- Design of Iron-Core Inductances, *QST*, April.
- Photoelectric Cell Applications, *Popular Radio*, April.
- Geophysical Prospecting, *Scientific American*, May.
- The Stabilized Oscilloscope, *Radio Engineering*, April.
- The Neuroheterodyne, *Radio News*, May.
- Regeneration, What it is, *Radio News*, May.

**Present Compression-Type Resistors**

WE ARE glad to quote the following from a letter of Mr. Austin C. Lescarboua, apropos of an article on page 421 of the April RADIO BROADCAST in the department "Our Readers Suggest."

Because of my extensive experience with all types of resistors, I wish to point out that the "additional precaution" of Mr. Harries is somewhat misleading. There are variable resistors to-day quite as reliable and as silent in operation as the wire-wound type. While it is true that the carbon-pile type is often noisy and microphonic, due to loose contacts between the carbonized paper disks made necessary in attaining a wide resistance range, there is none of this feature in the compression type utilizing graphite and pulverized mica. In the latter type there is always sufficient compression of the resistive material to insure perfect contact free from microphonism, although the widest possible resistance range is obtained in several turns of the knob. While in the past there may have been limited use for the compression type variable resistance, to-day, with various sizes up to and including a power type capable of handling 40 watts of energy, there is no reason to turn to fixed wire-wound resistors even in the large power packs and A-B-C power units.

**From a Lab Circuit Fan**

THE FOLLOWING letter from A. S. Penoyer of Saginaw, Michigan, pleased the Laboratory Staff a lot; fortunately it is but one of many in a similar vein:

To you this letter will mean just another from a new R. B. Lab. circuit fan; but to me

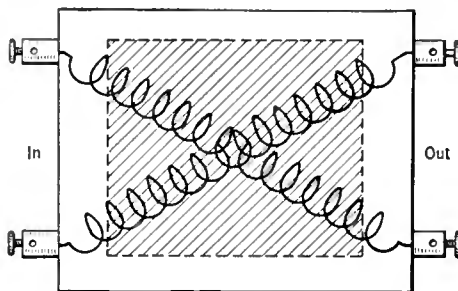

FIG. 2

What was actually inside an "output transformer" purchased at a low price by a radio service man. Pig iron was used to give the unit weight!

the circuit is little less than a revelation. I am well repaid for having disassembled a mighty fine seven-tube super to acquire parts for the Lab. circuit.

I have been an ardent super fan since the days when you published Haynes' super article four or five years ago, and during that time have built and rebuilt several. Your last article in the April issue convinced me that you have something good. Yet it was with misgivings that I removed the first wire from Old Faithful; and when, due to the omission of a wire to ground from by-pass condensers the Lab. circuit motor-boated mightily, I cursed my temerity in proportion. But now, well it's a "wow" and I wouldn't trade it for anything I have seen.

The coils I am using are home-made, but judging from results must be pretty good. All of the other parts are of the best and the layout is approximately as suggested in your April article. Selectivity is excellent and I am listening to stations I haven't heard in some time. The volume equals the super and the tone is round, full and very real and I'm critical too.

Just why more than four tubes are necessary, I can't understand. I am fully "sold" and wish to express my appreciation of your April article. The May issue has not as yet arrived so I don't know what your constructional article is to be, but am sure it can't improve my set.

**Who Our Readers Are**

WE OFTEN wonder who the thousands of RADIO BROADCAST's readers, from whom we never get letters, are; what their business is, how they are interested in radio; how it is possible to get better acquainted with them. The following tabulation of one thousand readers is one year old but gives a good idea of who the magazine's audience was in February, 1927. What we should like is for one thousand present readers of these pages to write us a note, letting us know where on this list they are.

OCCUPATION	PER CENT. OF 1000
Radio dealers	26.7
Miscellaneous skilled workers	23.8
Engineers	11.0
Clerks	5.4
Executives	4.5
Salesmen	4.3
Electricians	4.1
Draftsmen	3.3
Accountants	2.5
Mechanics	2.3
Machinists	2.1
High school students	1.8
Technical institute students	1.3
Physicians	1.2
College students	.9
Lawyers	.9
Bookkeepers	.8
Tellers	.7
Chemists	.7
Dentists	.4
Pharmacists	.3
Miscellaneous	1.0

**A Flux for Nichrome Wire**

USERS OF nichrome and other resistance wire and who have had difficulty in soldering it will be relieved to know that John Firth of the Firth Radio Company, 25 Beaver Street, New York City, has developed a special flux with this difficulty in mind. It is known as Perfecto No. 2 and may be obtained in 25 and 50 cent bottles from the Firth Company.

—KEITH HENNEY

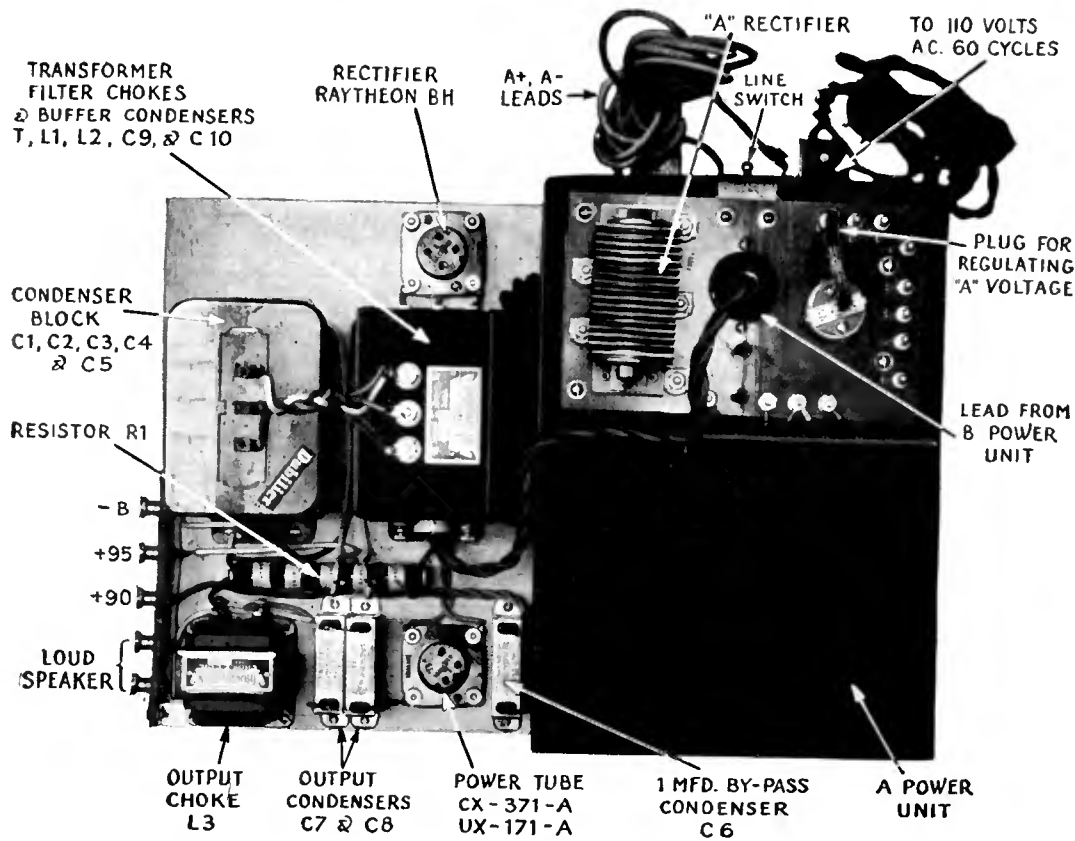

THE COMPLETED A-B-C-POWER UNIT

Assembled from parts generally available this A-B-C-Power unit may appeal to many constructors who have a good receiver which they do not wish to discard but who still would prefer to displace their battery supply and provide a modern last audio stage

# An Interesting A-B-C-Power Unit and One-Stage Amplifier

By J. GEORGE UZMANN

Dubilier Condenser and Radio Corp.

SAY Frank, I have a radio problem on my hands, and knowing all the time you've spent on broadcast receivers I thought perhaps you can help me out," was the way a friendly chat began.

"Surely, only too glad to be of service," and his friend inquired, "tell me all about it."

"Well I suppose I'm just like everybody else these days and want a completely electrified set. But in a way I hate like blazes to scrap my Neutrodyne which is just a little over a year old and tunes about as fine, and has tone quality almost as good as any I've heard; still on the other hand if it isn't the B-battery going bad why then it's the old storage battery quitting at just the wrong time. Yes, I suppose my trouble is simply batteries, batteries and then more batteries.

"Frank, tell me," he continued, "what make of electrified set would you buy? I can't make up my mind on this point, but it seems to me as though the cheapest receiver in the electrified class costs about \$125 with tubes, if the ads mean anything at all. My present set cost a little over \$175, and to think there is a 100 per cent.

depreciation to be taken after a year's operation is hard to believe—that state of affairs surely would not get by in everyday business."

"Just a second, Lawrence; pardon my interruption, but I think I pretty well understand your problem, and if you will let me tell you of my experience along these lines during the past

year, or say, ever since this a.c. tube question made itself felt, then perhaps you shall be better able to purchase the correct type of set or equipment with not only the least cash outlay but also without running into the usual grief." The radio expert with these few words had the pulse of the situation.

WHAT IS AN ELECTRIFIED RECEIVER?

THE complete power unit supplying all receiver voltages and containing a type 171 audio amplifier stage described here is an excellent unit. Tested in the Laboratory of RADIO BROADCAST on a standard battery-operated receiver, very little hum was audible on a high-quality loud speaker. Home constructors may be interested in duplicating this unit for it is highly satisfactory and comparatively inexpensive. The professional set-builder and service man will find in this device a popular replacement outfit for the power supply of battery-operated receivers with an insufficient last-stage audio amplifier.

—THE EDITOR.

THE above paragraphs in a few words describe the general thoughts and impressions which exist to-day in the minds of many who now own radio equipment. Gaining momentum, it seems as though everyone is interested in an "electrified set."

Yet strange as it may seem, very few people really realize just what sort of a set it must be. Evidently any receiver is "electrified" just so long as it operates without batteries. A radio trade paper recently made a canvass in effort to learn just what the public was thinking about regarding "electrified" equipment, and it is interesting to note that less than 10 per cent. of set owners had any conception at all about what



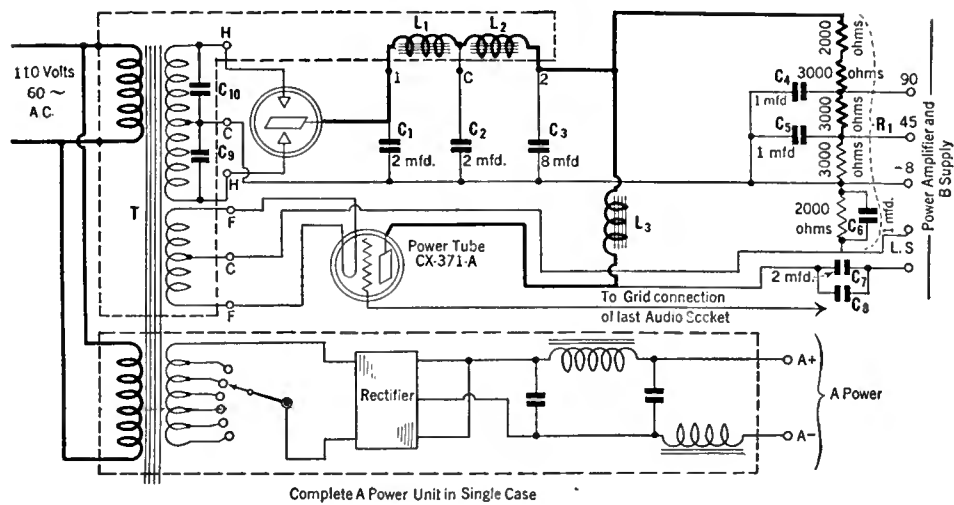

FIG. 1. THE CIRCUIT OF AN A- B- C-SUPPLY AND POWER AMPLIFIER

A power-amplifier and B-supply have been combined with an A-power unit in this unit so that the combination not only gives the constructor a stage of power amplification but also supplies to the receiver all the necessary A- and B-voltages. The various pieces of apparatus in this drawing have been lettered to correspond to the lettering on the picture diagram and photograph, and list of parts in this article

made up such a set—evidently its name alone, or possibly the vague impressions of a.c. tubes, together with their novelty, etc., etc. has been the cause of building up the present runaway market.

It is true that with a.c. tubes plus the proper power supply modern receivers can readily be built which operate without the use of a single battery. The a.c. source of B and C voltage has been practically solved for two years or more because of socket-power devices but it is the appearance of the various substitutes for the A battery that have suddenly built the recent excessive demand for "electrified sets."

It does not make a particle of difference what sort of tubes one employs because each is a three-dimensional device and thus calls for an A potential for heating the filament, a B voltage for its plate circuit, and in most cases an additional C voltage for biasing its grid. Many experimenters have worked on the problem for many years in effort to produce a tube which would operate satisfactory when its filament was energized by alternating current instead of d.c. It has always been a major problem, and even to-day is far from being solved, regardless of what the average broadcast listener may think.

The trouble, and there has been much of it too, during our short experience with a.c. tube sets is that set owners simply demanded such receivers a little early; this growth should have been gradual, and not the overnight demands such as we have all seen. Radio haste always makes waste.

201-A and 199 types of receiving tubes require direct current for heating their filaments and may be considered standard because their efficiency and operating characteristics have been generally accepted through almost five years of usage. These are excellent tubes and give faithful service for better than 1000 hours of life—a feature in which a.c. tubes in most cases have fallen down badly. [The rumored short life of a.c. type tubes may be due more to excessive line voltage which causes the tubes to be supplied with filament voltages above normal than to defects in the tube itself. It is interesting to note that at least one maker of a.c. filament transformers has reduced the rated output voltage from 2.5 volts to 2.25.—*Editor.*] It is important,

too, to note that 201-A and 199 type tubes cost less than the present a.c. varieties.

#### A COMPLETELY ELECTRIFIED 201-A RECEIVER

FROM the above remarks it is quite apparent that the only real difference as far as the user is concerned, between a.c. and 201-A or 199 type tubes lies in the method of energizing their filaments—one employs so-called "raw" a.c. house lighting current and the other pure direct current.

In the last analysis it is the A storage or dry battery which is the real bone of contention. How the use of these batteries, and also other substitutes such as electrolytic rectifiers, chargers and trickle-chargers, can be avoided is described in this article.

This unit consists of a unique dry or "electronic" full-wave rectifier for converting the house current into a pulsating direct current. The latter is then filtered in quite the usual way by means of heavy choke coils and a condenser network. The A-filter condenser, like the rectifier, is also of novel design. The condenser is bone dry and has a capacity of approximately 1500 to 2500 mfd. stored in a space of but 2 x 2 x 7 inches.

For a description of this unit, which is the Knapp A-power unit the reader is referred to the March, 1928, issue of RADIO BROADCAST.

In view of the excellent results obtained through the use of the latter equipment, and also considering (1) its low first cost, (2) cheapness of operation, (3) complete elimination of both storage battery and charger, and (4) faithful radio service at all times, it was decided to incorporate the Knapp unit together with a B and C power unit and also a one-stage audio amplifier as an integral assembly. The power unit and amplifier were mounted in the smallest possible space so that it could operate efficiently any type of receiver, such as the Atwater Kent, Crosley, Freshman, Fada, Grebe, or home-constructed receivers such as the Browning-Drake, Universal, etc.

In its final form this unit as shown in the illustrations occupies a space of 12 x 17 inches. It will supply A power for all receivers up to 10 tubes, and also B voltages up to 180 or 200 volts, in addition to a C bias voltage of 40 for its own amplifier stage.

#### NOT A RECEIVER WIRE OR TUBE CHANGED

NOT a wire of the receiver proper need be changed. Simply connect cable leads from the receiver which ran to the storage and B batteries over to this device. And by means of a Thordarson plug connector fitting into the old last audio stage tube socket, the latter becomes automatically replaced with a modern and up-to-date last stage audio amplifier.

This feature is most important to users of factory-made sets. Many of these do not permit operation of a last-stage power tube, either because the output tube does not employ a C battery or because the latter is in common to both audio stages, a system found in many Atwater Kent and Crosley models.

#### ASSEMBLING THE ELECTRIFIED PACK

A KNAPP A-Power unit may be assembled from a kit of parts or it can be purchased fully assembled; the latter arrangement is probably the better to follow for those who are not familiar with or do not care to make up the kit.

Since the Knapp steel casing measures 8½ x 12 inches, the last dimension determines one side of the general mounting board. The writer found that a standard 12 x 17-inch drafting board, which can be obtained from any stationer, is strong, and saves all wood-working time.

For the B-supply section of the pack a simple and efficient type of B power circuit was adopted. In view of the well-designed transformer and choke coil arrangement put out by Thordarson their standard R-171 Power Compact was employed.

The steel housing of the R-171 unit encloses the transformer, choke coils and buffer condensers for the Raytheon type BH rectifier tubes.

It is important that a well built and sturdy filter condenser block be installed. A standard Dubilier type PL-574 power block condenser was used.

By means of a Thordarson type R-508-1 wire-wound resistor, B voltages of 45, 90 and 135 volts become available for the radio-frequency, detector, and audio circuits of the receiver. This resistor also supplies a 40-volt C bias potential for the CX-371-A power tube. A Dubilier type 907 1-mfd. by-pass condenser, C<sub>6</sub>, is connected

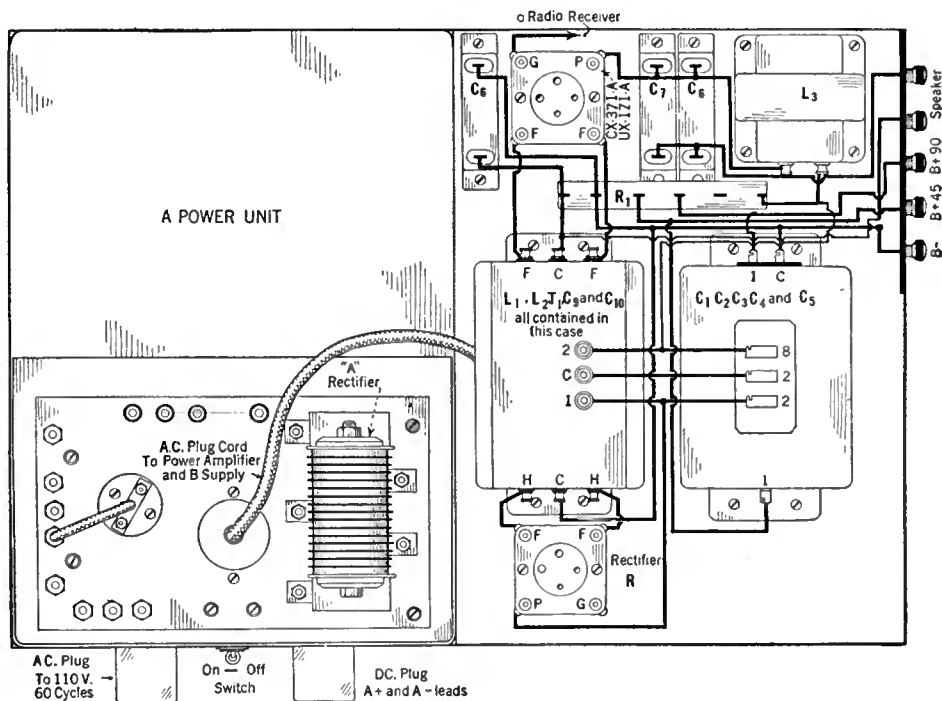

FIG. 2. HOW THE APPARATUS IS ARRANGED AND WIRED

This picture-diagram shows clearly how to place the apparatus on the baseboard and how it should be wired. The power lead from the power transformer used in the B-supply is plugged into the socket on top of the A-power unit. The entire unit is then controlled by the small toggle switch on the A-power unit

across the C bias end of resistor, as shown in Fig. 1.

6X371-A tube is employed in the output stage. Its filament is operated by means of a.c. supplied directly from the Thordarson R-171 transformer. A standard choke coil and condenser is also required for keeping the high voltage d.c. out of the loud speaker. A Thordarson R-196 choke coil together with two Dubilier type 907 1-mfd. condensers make up this arrangement.

To the grid terminal of the power stage tube socket connect a Thordarson R-172 power input plug. This plug is merely inserted in the second audio stage of the receiver proper and in the same manner as a tube; it transfers the first stage audio output directly to the power amplifier in this unit.

The illustrations show just where each component is placed. Fig. 2 combines suggestions on how to dispose the various parts and a wiring diagram in picture form for those who prefer to follow this kind of diagram.

THE LIST OF PARTS

THE following parts were used in the unit assembled by the writer. Parts mechanically and electrically equivalent to those mentioned below may of course be used.

- L<sub>1</sub>, L<sub>2</sub> } Filter Choke Coils.
- T } Power Transformer.
- C<sub>9</sub>, C<sub>10</sub> } 0.1-Mfd. Buffer Condensers.
- All contained in the Thordarson Power Compact R-171.
- L<sub>3</sub> } Output Choke, Thordarson Type 196.
- C<sub>1</sub> } 2-Mfd. 600-Volt Filter Condenser.
- C<sub>2</sub> } 2-Mfd. 400-Volt Filter Condenser.
- C<sub>3</sub> } 8-Mfd. 400-Volt Filter Condenser.
- C<sub>4</sub> } 1-Mfd. 400-Volt Bypass Condenser.
- C<sub>5</sub> } 1-Mfd. 400-Volt Bypass Condenser.
- All contained in the Dubilier Condenser Block Type PL-574.
- C<sub>6</sub> } 1-Mfd. 160-Volt Bypass Condenser, Dubilier Type 907.
- R<sub>1</sub> } Voltage-Dividing Resistor, Thordarson Type R-508-1.

- C<sub>7</sub>, C<sub>8</sub> } 1-Mfd. 160-Volt Bypass Condenser, Dubilier Type 907.
- Two } Benjamin Sockets.
- One } Roll Belden Colorrubber Hook-up Wire.
- One } Power Input Plug, Thordarson Type R-172.
- Five } Binding Posts.
- One } Kit of Parts, or Completely Assembled Knapp A-Power Unit.
- One } Baseboard 12X17 inches.
- The following tubes are required:
- One } Raytheon 6H Type Rectifier
- One } 6X371-A Power Amplifier

The writer feels that this A-B-C-Power unit and amplifier possesses many excellent features. Its total cost is quite small considering its general utility and large improvement over battery-operated equipment; further, it is thoroughly dependable in operation and the unit makes it possible for any radio constructor to realize full set electrification of all existing battery-operated receivers.



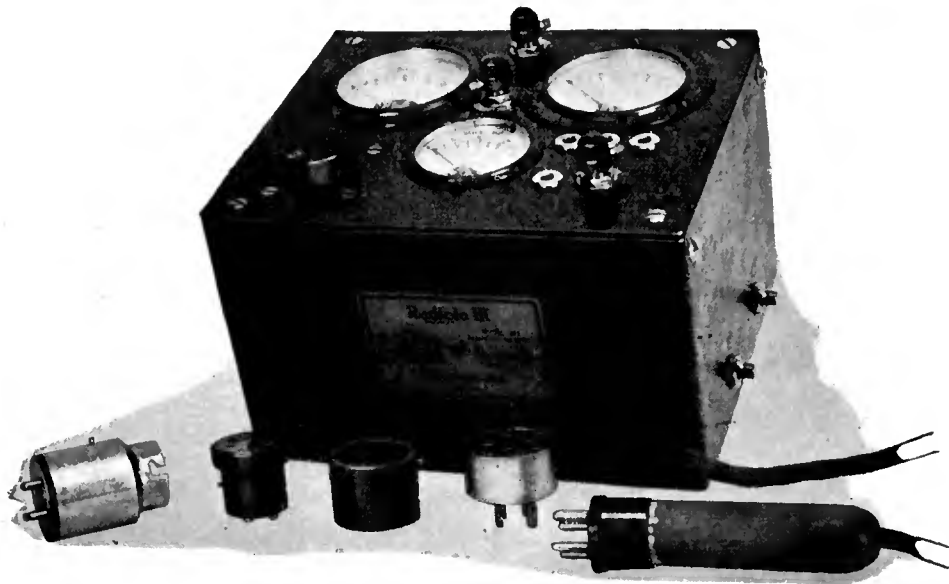

Fig. 1. READY FOR ANY TEST

This compact tester combines the functions which once required the use of a varied array of meters and testing equipment. It is adapted for continuity tests on all the circuits of a. c. or d. c. sets, filament, plate and grid voltage test, and individual tests on tubes.

## A Universal Set and Tube Tester

By D. A. R. MESSENGER

I AM a radiotrician practicing general servicing, repairing and installation of all types of radio receivers.

Given a couple of meters, some knowledge of the subject and some common sense, the testing of the older types of battery receivers and tubes was a fairly simple matter. But when all types of A, B and C voltage-supply devices and, later, when the new a.c. sets and tubes came on the market, the matter of testing and troubleshooting became something else again.

In order to eliminate the necessity for a multiplicity of meters and other accessories, I devised an instrument that, used properly, would enable me to make all routine tests on all types of receivers, both a.c. and d.c. At the time, I could find nothing on the market which answered my requirements, so I designed and built such a tester, which is herewith described.

The tester will assist in making the following routine tests:

- (a). Continuity of plate circuit.
- (b). Continuity of grid circuit.
- (c). Continuity of filament circuit.
- (d). Voltage applied to plates of tubes.
- (e). Voltage applied to filaments of tubes.
- (f). Voltage applied to grids of tubes in some sets.
- (g). Each tube in receiver.
- (h). Milliampere drain of each tube and of the whole set.

The actual construction of the tester is simple enough if you consult the accompanying photographs and wiring diagram. The paragraphs which follow may be useful to other service men and to those who wish to duplicate this unit.

### PREPARING THE PANEL

THE panel is drilled for the meters by scribing on the reverse side a circle which has a diameter the same as that of the meter, and drilling around this circle with a  $\frac{1}{8}$ " drill, making each



THE writer of this article, who is a service man in Washington, D. C., describes in straightforward style the assembly and use of a universal set tester. This useful instrument was designed especially for routine service work. With it all manner of tests on d.c. and a.c. radio receivers are possible. The various tubes in the set can be tested, and the voltage of batteries or B-power units can be determined. This universal tester should be the service man's most useful tool, but it should also appeal to home experimenters who want to add an inexpensive and useful test set to their home laboratory equipment.

—THE EDITOR.



drilling as close to the previous one as possible. When you have drilled the complete circle, break out the center and finish the rough edge with a small half-round file. The Benjamin socket is mounted by scribing a square  $1\frac{1}{8}$ " on a side. Drill a  $\frac{3}{16}$ " hole in each corner, and a 1" hole in the exact center. The switches are mounted in  $\frac{7}{16}$ " holes, and the tip jacks in  $\frac{5}{16}$ " or  $\frac{3}{8}$ " holes.

Lay out instruments on the panel in such a manner that the completed tester will present a neat and symmetrical appearance. The illustrations may be of some assistance in this respect.

Care must be exercised in wiring so that no exposed wire can come in contact with any other wire or any of the jacks, switches or measuring instruments.

The C battery can be fastened in the bottom of the cabinet with a couple of small brackets or strips of thin brass or aluminum. The cable is soldered into the circuit and the free end brought out through the same hole that was provided for the old cable from the Radiola 111. The cabinet from this receiver served nicely to house the apparatus for this tester. Those who do not find such a cabinet can house this unit in any

similar cabinet which, if desirable, can be home made.

### MAKING THE TESTING PLUG

THE testing plug is made up as follows: Drill a  $\frac{3}{8}$ " hole lengthwise through the center of the 1" x 3" piece of wood. Round one end off to make a convenient handle and taper the other end slightly to make a snug fit in a UX-199 tube base. Clean the old glue thoroughly from the inside of the tube base and melt the solder from the prongs. It may be necessary to drill out the center of the prongs with a  $\frac{1}{16}$ " drill. Pass the cable through the handle and strip the insulation for about an inch from the end of each of the four wires. Connection to the tube base is made by passing each wire in turn through the proper prong (from the inside—with reference to the bakelite collar) and soldering in place. Make nicely rounded ends with the solder or you will have difficulty getting the plug into a socket later. The wood handle is now pushed into the tube base as far as possible and glued in place.

Now prepare the UX-227-to-UX adapter by soldering a phone tip to the end of each of the rubber-covered filament leads. Do not cut these leads short, for they should be long enough to reach from the tester box to any set which may be tested.

Now prepare the UX-227 tube base as you did the UX-199 base. Take one of the UX-10-UX-199 adapters and break off the bakelite from the lower part. The section which makes contact with the socket prongs is a separate piece and has four brass studs riveted to it. Cut each of these studs off to about  $\frac{1}{4}$ " long. Solder a short piece of bare flexible wire to each stud. Slip a piece of spaghetti  $\frac{3}{8}$ " long over each of these four wires. Then pass each wire through the proper prong in the UX-227 tube base, that is, the wire from the plate opening of the adapter through the plate prong, etc. Leave the cathode prong

open, as it is not used. Push the upper part of the adapter into the tube base as far as possible and glue in place. Solder the ends of the wires to the prongs, leaving rounded ends as before. Now solder a phone tip to each end of the 5-foot flexible rubber-covered wires.

You should now have a tester completely wired with a cable and plug attached, two flexible rubber-covered leads with phone tips on each of the four ends, one UY-227-to-UX adapter with phone tips on the filament leads and one UX-to-UY-227 adapter, in addition to the five other adapters named in the list of parts. The panel layout of apparatus is shown in Fig. 3 and the complete apparatus, tester and adapters in Fig. 1.

FUNCTION OF THE VARIOUS PARTS

THE d.c. voltmeter is for indicating the filament voltage in d.c. sets and the plate voltage and grid voltage in any set. The a.c. voltmeter is for indicating filament voltages in a.c. sets and power amplifiers. The switch, S<sub>3</sub>, is for connecting the proper filament meter into the circuit. The push button on the d.c. meter must be depressed to read plate voltage. The d.c. milliammeter is for indicating the plate current of the tube being tested, and in conjunction with switches, S<sub>1</sub> and S<sub>2</sub>, for testing tubes. With S<sub>2</sub> on "Test" and S<sub>1</sub> on "C—," a bias of 4½ volts negative is put on the grid of the tube with respect to the negative leg of the filament. With S<sub>1</sub> on "C+," a bias of zero is put on the grid. With S<sub>2</sub> on "Set," the grid of the tube is connected through the cable to the set. The switch, S<sub>4</sub>, is for reversing the d.c. filament voltmeter in the filament circuit to conform to different methods of wiring the filaments in receivers with respect to polarity. If this provision were not made, the meter would read backward in some sockets. The switch, S<sub>5</sub>, is for switching the d.c. filament meter from the filament circuit to the grid circuit for testing. Switches S<sub>4</sub> and S<sub>5</sub> are on the cabinet as shown in Fig. 1; S<sub>1</sub>, S<sub>2</sub>, S<sub>3</sub> are on the panel. The cable and plug with its wooden handle is for plugging into the sockets of the receiver. The various adapters provided make possible the testing of any and all types of receivers, a.c. and d.c., old or new. The two flexible leads are for connecting to the a.c. and plate voltmeter meters for external tests by means of the tip jacks or binding posts provided. In my model no jacks have been provided for the d.c. filament meter because the a.c. meter gives an indication on d.c. although it does not indicate polarity. The socket is for inserting the tube to be tested. The UY-227-to-UX, WD-11-10-UV standard and the UV-100-to-UX standard adapters are for adapting any type of tube to the UX socket. The two filament leads from the UY-227 adapter are plugged into the tip jacks connected to the a.c. meter when testing UY-227 tubes. The Benjamin socket will accommodate the short prongs of UV tubes and adapters.

METHOD OF TESTING D.C. SETS AND TUBES

HAVE set to be tested connected up and turned on as for operating. Take out first tube in the set and insert plug of tester in its place, using one of the adapters provided if necessary. Throw switch, S<sub>2</sub>, to "d.c.," switch, S<sub>3</sub>, to "A.," and switch, S<sub>2</sub>, to "SET." Read filament voltage from d.c. voltmeter, making adjustment of filament rheostat in set, if necessary to obtain proper voltage for type of

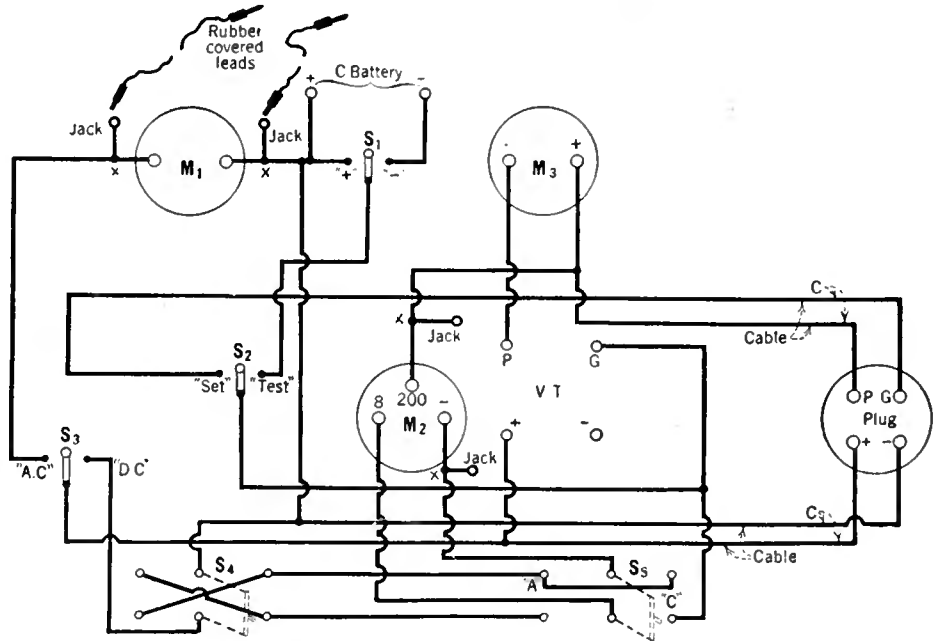

FIG. 2

tubes in set; that is, 5 volts for 201-A tubes or 3 volts for 100's. If the meter tends to read backward, reverse the polarity by throwing switch, S<sub>4</sub>, until the meter reads correctly. If no reading is obtained, see that the A battery is charged and that the leads are making proper contact, both at battery and set. If no reading is now obtained there is an open circuit in the filament circuit. Try another socket and if the same result is had you are safe in assuming that either the battery switch, the rheostat or one of the main filament leads are open. Short-circuit each one in turn to locate open portion of circuit. When found the remedy is obvious. If no reading is obtained in only one socket, it may be that the socket springs are either dirty or are not in the proper position to make contact with prong of tube or adapter, or one of the filament leads to the socket is broken or disconnected, or there may be a high resistance joint in the circuit wiring. Check each item in turn until the fault is located, and then remedy. This must be done

before going forward with further tests. If the voltage indicated is excessive there is either a short circuit or wrong connection indicated. Check connections to batteries or power units. After making certain that the filament circuit and voltage is correct, depress d.c. voltmeter button and read the plate voltage. If the voltage indicated is incorrect for the socket being tested, that is, 45 volts for the detector or 90 for a radio-frequency amplifier, adjust, after making certain the voltage source is connected and functioning correctly. (The two flexible leads can be plugged into the d.c. voltmeter jacks shown in Fig. 3 and used to test either batteries or power unit, keeping button depressed while using. Pull plug out of set while making this test). If no reading is obtained with the plug in the set and meter button depressed, it indicates an open circuit in the plate circuit. Short each portion of the circuit, such as the primary of a transformer or a radio-frequency coil and any stabilizing or volume control resistances which may be in the

plate circuit. When the defect is located, remedy either by replacing or repairing defective part. The resistance of audio-transformer primaries, etc., must be taken into consideration when computing voltages. After making certain that the plate circuit and voltages are correct, throw switch, S<sub>3</sub>, to "C." The grid bias voltage, if any, should now be indicated on the d.c. voltmeter. If no reading is obtained, reverse switch, S<sub>4</sub>. If the detector socket is being tested, it will be necessary to short-circuit the grid leak and condenser with a small clip or piece of wire. Watch your meter closely as there may be a deflection of only a small fraction of a volt, depending on how much resistance and C-bias there is in the grid circuit. As this test is for continuity of circuit and not for accuracy of grid voltage, any deflection of the meter should be an indication that grid circuit is correct. Defects are located and remedied in the same manner as for the plate circuit. Check each socket in the set for these values in the same manner.

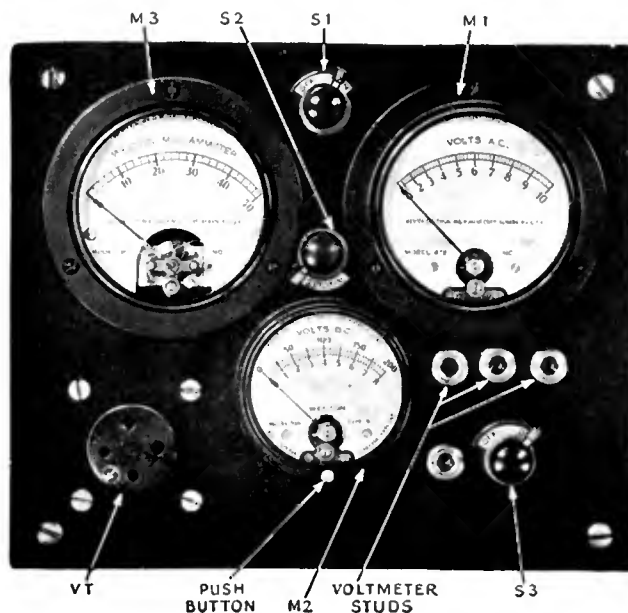

FIG. 3

## TESTS FOR TUBES

AFTER making certain that filament, plate and grid circuits are correct, you are ready to test the tubes. Insert the plug of the tester into a socket in the set having a relatively high plate voltage (90 volts is best) and adjust filament and plate voltages to proper values. Now insert the tube to be tested in the socket of the tester, using one of the adapters provided, if necessary. With switch,  $S_2$ , on "TEST" and  $S_1$  on "C—," read milliammeter and make note of plate current. Throw  $S_1$  to "C+" and make note of the plate current. The difference in the two readings shows the worth of the tube when compared with a known good tube. Suppose the good tube (a 201-A) gives a reading of 8 mils with switch,  $S_1$ , on "C+," and a reading of  $4\frac{1}{2}$  mils with switch,  $S_1$ , on "C—," the difference is  $8 - 4\frac{1}{2}$  or 3 mils, a very good reading at 90 volts plate potential. If the tube being tested gives a reading of  $7\frac{1}{2}$  mils with switch,  $S_1$ , on "C+" and 4 mils with switch,  $S_1$ , on "C—," the difference would still be  $3\frac{1}{2}$  mils showing the tube to be at least almost as good as the sample tube. If the difference was only 3 mils the tube could be rated as only fair and should be reactivated. These sample readings are given only to make the method of testing clear and not to indicate readings which should always be found. Test each tube in turn, replacing or reactivating all those not up to the proper standard of performance. Gaseous detector tubes are very deceptive when tested in this manner, a tube of very poor quality often giving a good reading. This is due to the high conductivity of the gas in

the tube. The only sure test is to replace the tube with a new one and note results. A shorted tube, that is, one with either of the three elements touching either one of the other elements in the tube, will cause the pointer of the milliammeter to be deflected off or nearly off the scale, and must be removed from tester at once to prevent damage to the meters.

The method of using the tester on a.c. sets is the same as for d.c. sets except that switch,  $S_3$ , should be on "AC" and the switch,  $S_4$ , is not used because a.c. meters have no polarity. The rules for testing apply to a.c. tubes as well as d.c. tubes. Many other uses will be found for this tester by the practical radiotrician, such as testing the filament voltage applied to rectifier tubes in B-power units. Used correctly this instrument will prove its worth many times over and will save many a weary hour over a shop bench.

The manufacturer's name and model of the various parts listed below are given merely as a guide, and not because they must be used. The experienced constructor will of course use his own judgment as to the make and model of parts he prefers. The Weston No. 506 voltmeter has an internal resistance of about 125 ohms per volt. I prefer such an instrument, rather than the more expensive 1000-ohm models, for testing B-power units because the milliamperer drain more nearly matches that of a tube, giving, in my estimation, a more accurate reading for my purpose. A valuable accessory would be a Weston No. 528 a.c. voltmeter, although this is not a necessity.

## PARTS EMPLOYED

THE parts and instruments used in the model described are comparatively inexpensive, and are listed as follows:

- $M_1$  1 a.c. voltmeter 0-10 volts, Weston No. 476
- $M_2$  1 d.c. voltmeter 0-8-200 volts, Weston No. 506 with 3 studs and push button.
- $M_3$  1 d.c. Millimeter 0-50 mils, Weston No. 301.
- $S_4, S_5$  2—Double-pole double-throw panel switches, Yaxley No. 60.
- $S_1, S_2, S_3$  3—Single-pole double-throw panel switches, Yaxley No. 30.
  - 1—UX socket, Benjamin.
  - 4—Tip jacks or binding posts.
  - 1—Cabinet from old Radiola 111.
  - 1—Bakelite panel to fit cabinet.
  - 1—25-ft. roll flexible Celatsite.
  - 1— $4\frac{1}{2}$ -volt C battery.
  - 1—4-wire cable 4 ft. long. The cable used by the writer came from an old Radiola balanced amplifier.
  - 1—Piece wood 1-inch diameter and 3 inches long for handle of plug.
  - 1—UX-199 tube base with bakelite and prongs intact for base of plug.
  - 1—UY-227 tube base with bakelite and prongs intact for adapter.
  - 2—Rubber-covered flexible wire leads about 5 ft. long.
  - 6—Phone tips.
  - 2—UX-to-UV-199 adapters.
  - 1—UX-to-UV standard adapter.
  - 1—UY-227-to-UV adapter.
  - 1—UX-to-WD-11 adapter.
  - 1 WD-11-to-UV standard adapter.

## Broadcast Station Calls With a Past

By WILLIAM FENWICK

THROUGH the years that broadcasting has been with us, the listener has interested himself, among a multitude of other things connected with a station, in the biography of practically every member of the personnel and the contributing performers. Occasionally, in the beginning of radio the former rôles the transmitter and other instruments had played elsewhere were disclosed and eagerly absorbed by the radio devotee, but this ceased as the practice came into being of making the radio broadcasting equipment to order. Few, though, have ever paused to think of what might have been the past of their favorite station's call letters, a reflection, as will be seen, that revives the memory of many heroic deeds and horrible occurrences.

## WSB TWICE WRECKED

A SEARCH through old records will bring to light several calls now popular in broadcasting that once were well known in shipping circles, the original owners of many of which have met with disaster. The reason the greater number of these were not reassigned to other vessels is due mainly to a seamen's superstition that is at variance with the idea. WGR, as an instance, was at one time a familiar steamship call all along the Pacific coast when it was being used by the passenger steamer *Governor* previous to its allocation to the widely known Buffalo broadcasting station of the Federal

Radio Corporation. The *Governor* sank following its collision with the freighter *West Hartland* in April of 1921, resulting in the loss of eight lives.

Another quite famous call and one which has twice been the central factor in perilous episodes of the deep, is WSB, now of the Atlanta, Georgia, *Journal*. The S. S. *Francis H. Leggett* was the first possessor and, after foundering off the Oregon coast on September 18, 1914, taking a toll of two of the 67 lives aboard, it was reassigned to the *Firewood*, the name of which forms a grim coincidence with its fate, it being burned off Peru on December 18, 1919, with 28 persons on board, all of whom were saved.

KLZ of the Reynolds Radio Company of Denver, Colorado, presents an even more exciting life story. It belonged to the *Speedwell* in 1920 when the vessel on September 29 of that year found itself suddenly amidst the sweep of a tropical hurricane in the Gulf of Mexico. An idea of the severity of the storm may be had from the report that upon the flashing of the SOS and the ship's position, the engine room became flooded, disabling the dynamo, and the only other source of power for the station, storage batteries, became useless when the whole afterdeck was torn off and swept away by the sea. Nine of the 25 people on board were lost in this tragedy.

The most sorrowful memories, however, lie behind the letters KRE now of the Berkeley, Cali-

fornia, *Gazette* and formerly of the *Florence H.* which was wrecked by an internal explosion on April 17, 1918, in Quiberon Bay, taking a toll of 45 lives of the 77 present in the catastrophe. The greatest monetary waste to the sea of those mentioned was in the case of the *Princess Anne*, carrying the call KOB, subsequently given to the radio station of the State College of New Mexico. The *Princess* stranded on February 2, 1920, on Rockaway Shoals, Long Island, and though she broke in two and all of the 106 passengers and crew were saved, the cargo valued at \$500,000 was practically a total loss.

Another call sign which has its past marred with tragedy is the now familiar WHN of New York City. This call was at one time assigned to the ill-fated steamer *Hanalet*. Later it was passed to the steamer *Santa Isabel*, which vessel was subsequently sold to Chile. In cases of this sort, where a ship is bought by a foreign country, the letters are changed to those given by the government having jurisdiction over the purchaser. A few other examples of this where the calls are now in use in broadcasting are: WJ, well known as the Detroit *News*, was formerly of the steamer *Peru* which was sold to France. KLS, familiar now as the Oakland, California, station of Warner Bros., was once possessed by the steamer *Kermansbah*, transferred to Hungary. Likewise, KNX of the Los Angeles *Express* was the signal of the vessel *Susana*, which was later purchased by an Italian company.

# “Our Readers Suggest—”

## Checking Power Unit Voltages

MANY readers of RADIO BROADCAST have constructed socket power devices providing B and C voltages. The adjustment of the resistors in such apparatus is generally a matter of guesswork, the values being varied until the reproduction sounds about right. An accurate determination of voltage values is generally a matter of purchasing an expensive high-resistance voltmeter.

The former method is generally unsatisfactory because modern receivers are designed to operate at maximum efficiency with certain definite plate voltages.

The following paragraphs describe a simple manner of checking the voltage outputs of a power unit using parts generally on hand:

The average experimenter possesses one or two 45-volt B batteries, an ordinary voltmeter, and a pair of earphones.

The power unit and the receiver are both set in operation and rough adjustments are made by ear. Ninety volts of B battery is connected with its negative terminal to the minus post of the unit. Let us assume that we wish to adjust the 45-volt tap, supplying the detector tube, to the correct voltage. One lead from the phone should be connected to the 45-volt tap on the battery and the other should be placed on the tap of the power unit. Each time the connection is made or broken, a click will be heard in the receiver, provided the two voltages are not identical. It is therefore simply a matter of slowly adjusting the tap on the power unit until no sound is heard in the phone receiver when the circuit is made or broken, or until the click is at a minimum. Under these conditions, the voltage at that tap is exactly equal to the voltage at the battery tap. The ordinary voltmeter can be used to check the battery voltage.

The same steps are taken for the 67.5 volt and 90-volt taps. Should only one 45-volt battery be available, we simply “step up” the voltage by connecting B-minus of the battery to plus 45 of the power unit as previously determined, and then use plus 45 of the battery to adjust the 90-volt tap of the power unit.

Where small C bias voltages are obtained

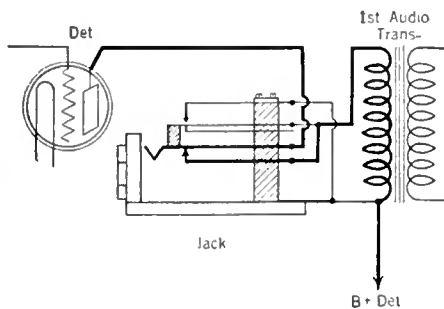

FIG. 1

The preferred jack arrangement in the plate circuit of an a.c. detector tube

from the same unit through the drop in a resistance, the same method of adjustment can be used by making use of a C battery with a 3-volt and 4.5-volt tap.

W. A. GROBLI,  
New York City.

## STAFF COMMENT

THE arrangement suggested by Mr. Grobli is more useful as a means of checking plate voltages than for setting them at some predetermined value. It often happens that receivers

“OUR Readers Suggest” is a clearing house for short radio articles. There are many interesting ideas germane to the science of radio transmission and reception that can be made clear in a concise exposition, and it is to these abbreviated notes that this department is dedicated. While many of these contributions are from the pens of professional writers and engineers, we particularly solicit short manuscripts from the average reader describing the various “kinks,” radio short cuts, and economies that be necessarily runs across from time to time. A glance over this “Our Readers Suggest” will indicate the material that is acceptable.

Possible ways of improving commercial apparatus is of interest to all readers. The application of the baffle board to cone loud speakers, is a good example of this sort of article. Economy “kinks,” such as the spark-plug lightning arrester, are most acceptable. And the Editor will always be glad to receive material designed to interest the experimental fan.

Photographs are especially desirable and will be paid for. Material accepted will be paid for on publication at our usual rates with extra consideration for particularly meritorious ideas.

—THE EDITOR.

operate most efficiently from socket-power plate voltages which are different from the optimum battery voltages. In the majority of instances the problem will be to determine the plate voltages applied to different portions of the receiver rather than to adjust these values to a given potential. When this is the case, a 2000-ohm potentiometer should be shunted across the B block with the lead from the telephone receiver wired to the movable arm. This will make it possible to obtain practically any voltage within the range of the battery.

## A Convenient Telephone Jack Arrangement

IT IS often desirable to plug the telephone receivers into the plate circuit of the detector tube without upsetting the audio-frequency amplifier. However, most jack arrangements in the detector plate circuit open the primary of the first amplifying transformer resulting in a loud howl from the loud speaker unless the amplifying tubes are turned off.

The sketch in Fig. 1 shows a simple cir-

cuit arrangement employing a double contact jack such as the Yaxley No. 5, which short-circuits the primary of the transformer when the phones are plugged-in, preventing amplifier instability and howling. The current drain of the receiver remains practically constant regardless of whether phones or speaker are employed.

P. H. GREELY, Washington,  
District of Columbia.

## Neutralizing the Short-Wave Amplifier

WHILE experimenting with radio-frequency amplifiers on waves between 15 and 200 meters, I found it next to impossible to neutralize the grid-plate capacity of the r.f. tube. I tried all of the popular circuits for neutralizing with discouraging results. I experimented with dozens of different plate coils having from one to ten turns and with different values of coupling to the detector grid coil. I finally decided to stick to one circuit and fight it to a finish. The Rice circuit was chosen. With this circuit, if the filament tap is in the exact center of the coil and the capacity of the neutralizing condenser has the same value as the grid-plate capacity of the tube, it remains neutralized regardless of the setting of the tuning condenser.

Even with this circuit I could not completely neutralize the r.f. stage although the detector and its associated parts was enclosed in a copper shielded box. I came to the conclusion that the plate coil offered too much capacity coupling to the detector grid coil. In this case an electrostatic shield would be needed to eliminate the capacity coupling. I took the primary of three turns of No. 20 d.c.c. wire as a form and wound it toroid fashion, full of No. 26 d.c.c. wire as in Fig. 2. When connected in the circuit one end of the shield winding is left open and the other was connected to the ground. It is now possible to neutralize the grid-plate capacity of the r.f. tube properly.

The same shielded plate coil was used for all

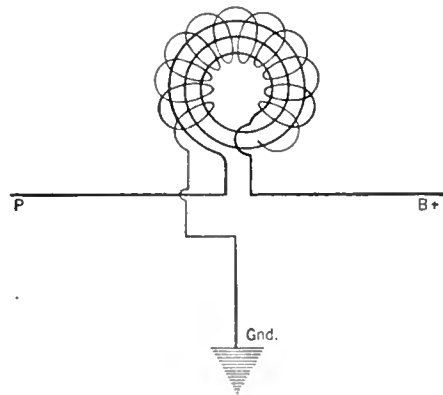

FIG. 2

The method of winding the shield coil about the short wave r.f. primary. One side of the toroidal coil is grounded

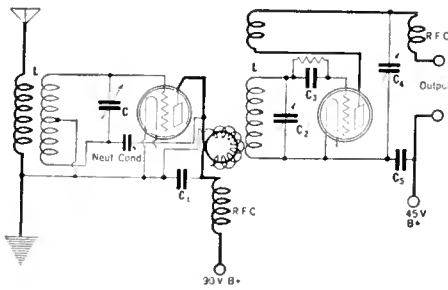

FIG. 3  
The Rice short-wave receiver circuit employing the shielded coupling coil

waves between 15 and 200 meters. More than three turns would, possibly, give greater signal strength above about 75 meters. In some cases better results may be had by reversing the leads to the plate coil. Fig. 3 shows the complete circuit. The condenser "Neut. Cond." was a Silver-Marshall type 340 balancing condenser. Coils, R.F.C., are Samson r.f. chokes.

The following parts are indicated on the wiring diagram: L—Plug-in coils, C—Pacnet 0.000135-mfd., C<sub>1</sub>—Sangamo 1.0-mfd., C<sub>2</sub>—Pacnet 0.000135-mfd., C<sub>3</sub>—0.0001-mfd. Micadon, C<sub>4</sub>—Cardwell 0.0005-mfd., C<sub>5</sub>—Sangamo 1.0-mfd.

Without a doubt an electro-static shield would be desirable in many broadcast receivers.

R. WM. TANNER, Berkeley, California.

STAFF COMMENT

THE problem of constructing a satisfactory short-wave r.f. amplifier involves the difficulty of obtaining stable operation. Our contributor seems to have overcome the difficulties to a satisfactory extent, although we doubt that the completed receiver is very efficient.

The problem of short-wave receiver stabilization should be relatively a simple matter using a screen-grid tube. This department will be interested in receiving data from readers who have experimented along these lines.

Wave Trap Tuned Antenna Combination

OPERATING a six-tube neutrodyne (Crosley "Bandbox") the writer is able to obtain more volume in case of weak distant stations during daytime reception by connecting in series with the outdoor antenna, 75 feet of bell wire wound on a 1½" cardboard tube plus a (Steinitz) wave trap in parallel connection across this coil and receiver. This arrangement is sketched in Fig. 4A.

A. KLINGBEIL  
Astabula, Ohio.

STAFF COMMENT

The improvement secured by Mr. Klingbeil is due to the tuning effect of the wave trap on the antenna circuit. In some cases similar results will be obtained with the very simple connection shown in B, Fig. 4.

Additional Amplification for Phonograph Pick-Up

I HAVE found that insufficient volume is obtained with the some phonograph pick-ups when using high grade low-ratio audio amplifying transformers and a low-mu power tube such

as the 171 type. The conventional phonograph pick-up arrangement plugs into the detector socket, inputting the output of the pick-up into the audio amplifier. The volume can be increased by connecting the pick-up to the grid of the detector tube. Additional amplification, due to the detector, will then be obtained.

R. T. ANDERSON, Shreveport, Louisiana.

STAFF COMMENT

THERE are several ways in which this can be done, two convenient connections being shown in Fig. 5.

Drawing A shows the more simple arrangement. The plug which ordinarily is placed in the detector socket, is disconnected from the flexible braid leading to the pick-up unit. One of the two wires in the lead is connected to the grid prong on the detector socket and the other to the negative terminal on the A battery (or the negative A binding post on the set, but not to negative A on the socket).

The arrangement shown in sketch B is preferable because of the better impedance relationship between the pick-up and the input to the tube. Almost any amplifying transformer can be used at T. The pick-up wires are connected to the primary, and the secondary is wired to the detector tube—one lead to the grid prong and the other to the negative A post on the set.

A simple switching arrangement can be devised by the thoughtful user to throw the receiver from radio to phonograph pick-up.

To Stop That Whistling

IN SOME cases a receiver of the tuned radio-frequency type will cause trouble by oscillating (whistling) so badly, especially on the lower

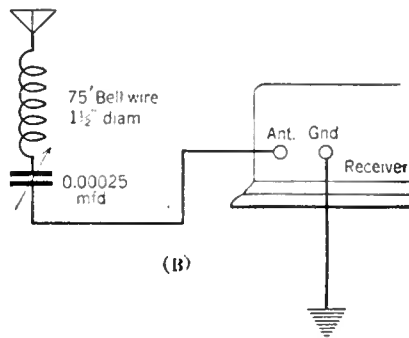
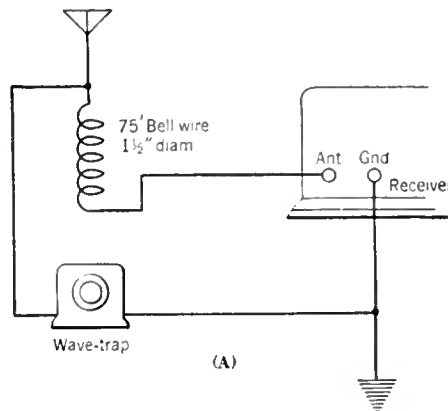

FIG. 4

Unusual wave-trap circuits which may be found effective in increasing volume on distant stations

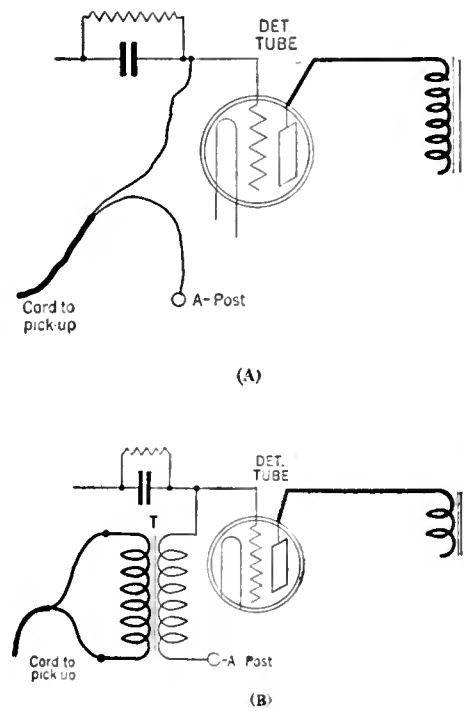

FIG. 5

Phonograph pick-up circuits utilizing the detector tube as an additional amplifier

wave bands, that it is impossible to obtain satisfactory reception of broadcast programs.

In a set having the radio-frequency transformer coils mounted directly in back of and parallel to the variable condensers, the writer recently stopped such oscillations by a very simple expedient, *i. e.*, by moving the three coils slightly closer to their respective condensers. It was really surprising how quickly the unwelcome oscillations were reduced and finally completely stopped.

This result is caused by a slight additional loss introduced in the coils due to their closer proximity to the metal end-plates of the condenser. These losses are not large enough to make any appreciable difference in the operation of the receiver, and the owner should have no qualms in applying this method. If, for some reason, it is desired to make the receiver oscillate more easily, it is only necessary to move the coils further away.

JACK L. BAKER,  
Cooper, Texas.

STAFF COMMENT

IT IS not always a simple matter to affect the mechanical rearrangement suggested by our contributor. The same results can be obtained with less labor by cutting a narrow strip from a sheet of tin, brass, or copper, and bending it so that it can be clipped around one of the radio frequency coils, preferably that one preceding the detector coil. This strip should not be more than one-half inch wide and should extend only about three-quarters of the way around the coil. The degree of stabilization can be varied by changing the size of the strip. The more metal in the strip the greater will be the stabilization attained in the circuit. Many methods of stabilization are in effect "losser" systems, as is this one.

# A Short-Wave Adapter For the R. B. Lab Receiver

By HUGH S. KNOWLES

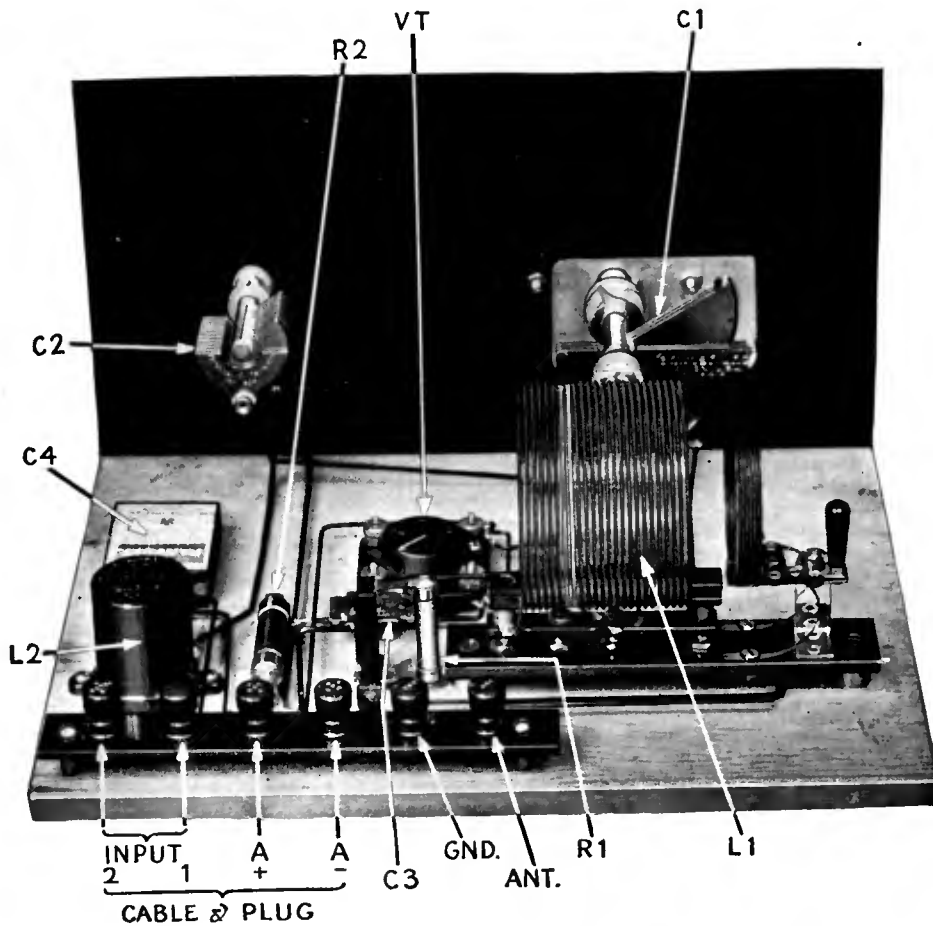

FOR SHORT-WAVE RECEPTION

The layout of parts for the short-wave adapter is simplicity itself, as this photograph shows. By the use of the correct coils in the plug-in set, it makes available to the ordinary broadcast receiver the short wave-bands from about  $8\frac{1}{2}$  to 200 meters

**I**N THE article on the a. c. R. B. "Lab" receiver in the June RADIO BROADCAST mention was made of the fact that special provision had been made for a very valuable adjunct, namely a short-wave receiver which would extend the wavelength range of the set down to 16 meters.

The use of short waves has become increasingly important during the past few years. At first they were considered the playground of the amateur—a portion of the spectrum with which he could amuse himself without interfering with "serious" business. Since that time they have showed such promise that they are in many instances replacing long-wave communication channels.

An idea of what is being done in this respect may be gained by glancing at the list of short-wave stations published in the May RADIO BROADCAST, pages 44-46. This is the most complete and up-to-date list that has come to our attention.

The receiver is simplicity itself. Like nearly all of the present-day short-wave receivers it uses a straight regenerative detector with no radio-frequency amplification. This is quite satisfactory because of the better field strength of the short-wave stations at moderate and long distances. The factors involving the attenuation or

absorption of these waves are quite complex and so far only a few generalizations have been made, although a great deal of data has been collected. It is interesting to note, however, that

---

**T**HE short-wave adapter described here can be used on any broadcast receiver, a. c.- or d. c.-operated. This unit is especially designed to be used with the a. c.-operated "Lab." receiver described in our June issue by Mr. Knowles. With it you can listen in the vast range of frequencies below 200 meters. It opens the "door" of your receiver and enables you to listen-in on the thousands of stations occupying a region which no broadcast-range set can cover. It is easily possible to hear England, Holland, and—at the proper time, before daylight in the United States—Java and Australia. This is not necessarily code reception, but voice and music. This unit can be used on the "Lab" receiver, operated from a. c., but a six-volt battery must be used for the filament: if used with a d. c. set, the regular battery is pressed into additional service. Mr. Knowles is now working on a long-wave attachment for the "Lab" receiver that will broaden its usefulness in another direction.

—THE EDITOR.

certain bands are valuable for daylight transmission when frequencies employed for broadcast transmission are unsatisfactory.

THIS UNIT CAN BE USED WITH ANY SET

**A**LTHOUGH the short-wave adapter described in this article was especially designed to be used in conjunction with the four-tube a. c. "Lab" receiver described in RADIO BROADCAST for June, 1928, this unit can be used with any receiver which now is used only for broadcast reception on the usual wave-bands. This article describes what slight circuit changes are necessary when the present short-wave adapter is plugged into the detector tube socket of the a. c. "Lab" receiver; the instructions apply also to the use of the adapter in any other a. c. operated set.

Those who have read of the experimental broadcast transmissions now being made from various stations in this country, in England, Holland, Australia and elsewhere will find the adapter described easy to build and successful in operation. [Other articles published in RADIO BROADCAST on short-wave receivers contain interesting and useful information about what is to be heard on these high-frequency channels. The reader is especially referred to Lieutenant



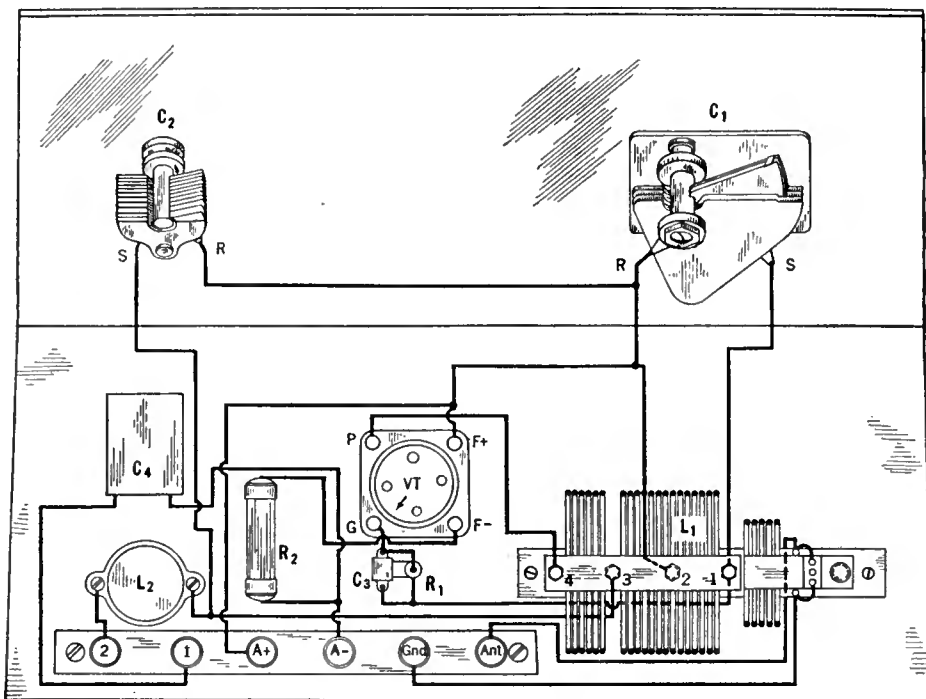

FIG. 1

A picture diagram showing exactly where the apparatus goes and how to connect it

Wenstrom's "The Cornet Multiwave Receiver" in the June RADIO BROADCAST, page 77.—*Editor.*]

A standard set of three coils used in this receiver covers the bands between 17 and 107 meters. Other coils of the same type may be secured which cover the bands from 107 to more than 200 and from about 8½ to 17 meters.

There are several respects in which the design and construction of a short-wave regenerative detector circuit differ from the type used at broadcast frequencies. The principal problems arise from the difficulty of securing good, stable regeneration at the very high frequencies, say more than 10 megacycles (less than 30 meters.)

This difficulty is due to a number of factors. To secure close tuning and more particularly to tune to the high frequencies with a reasonable value of inductance the variable capacitances must be small. This means that the stray circuit capacitance and the inter-electrode capacitances of the tube itself may be of the same order as those used in tuning.

Dielectric losses increase with the square of the frequency and these become important at high frequencies. In many cases the advantage of "debasing" the tubes lies not so much in a reduction of the inter-electrode capacity as in a decrease in the dielectric losses.

If a radio-frequency choke is to be a "universal" one it must be designed to have capacitive admittance, that is, act as a capacity at all the frequencies for which it is used. This follows from the fact that if it were inductive and used in a shunt plate-feed circuit this load would make the circuit unstable. In a short-wave receiver a tremendous frequency range must be covered and this makes it difficult to insure a high impedance at all frequencies.

Since most of the frequencies to be received are very high, a low-capacity grid-condenser may be used and a high-resistance leak is then used to increase the "time constant" of the grid-leak and condenser combination and therefore the sensitivity.

In this receiver a neutralizing condenser of the "fixed-adjustable" type is used. This has a maximum capacity of 40 mmfds. At very high

frequencies, the effective input capacity of the tube which shunts the tuning condenser is high and this decreases the maximum frequency that can be received. This may be offset slightly by reducing the grid condenser capacity at these frequencies. The reason for this lies in the fact that the grid condenser and the tube capacity are in series.

The only point to watch in the construction is the mounting of the tuning condenser. The vernier dial has a sleeve which goes through the panel and this makes it necessary to mount the condenser itself on small bushings.

The layout is clearly shown in the photograph. It may be slightly improved by rotating the

socket 90 degrees in a clockwise direction (when viewed from the front). Such change will make a better arrangement of the high-frequency leads which should be well separated to minimize their mutual capacity.

It is common practice to use a 250-mmfd. condenser to control regeneration. The reason for this is not quite clear since only half of the capacity is normally used. The amount of capacity necessary will vary with the layout and with the tube used but for the receiver described 100 mmfds. was found to be ample. For this reason a "midget" condenser was used resulting in a saving of several dollars. At the point where the condenser is used, that is, near maximum capacity, the rate of change of capacity per degree of rotation is lower than that for the usual logarithmic type of plate so that control is very good.

THE 112A AS A DETECTOR

A 112A type tube is recommended. This has a good detection coefficient, high mutual conductance and requires no more filament current than the 201A type. It is a better oscillator even at high frequencies.

The calibration curves (Fig. 2) were made with the antenna very loosely coupled. No universal calibration curve could be plotted with close coupling since the antenna characteristics then affect the tuning. The calibration also varies slightly with different regeneration condenser

COIL DATA TABLE

Wavelength	Sec.	Space	Tick.	Wire	Turns per inch	Diam.
20	3	1	3	No. 16	10	3"
40	7	1	4	No. 16	10	3"
80	16	2	6	No. 16	10	3"
160	32	3	15	No. 20	21	3"
Primary	7 turns			No. 18	18	2½"

IN THE photograph accompanying this article, the spacing of the turns is clearly indicated. The information above is given for those who prefer to make their own coils and should be sufficient for the purpose. The copper wire used may be of any kind the builder may have at hand.

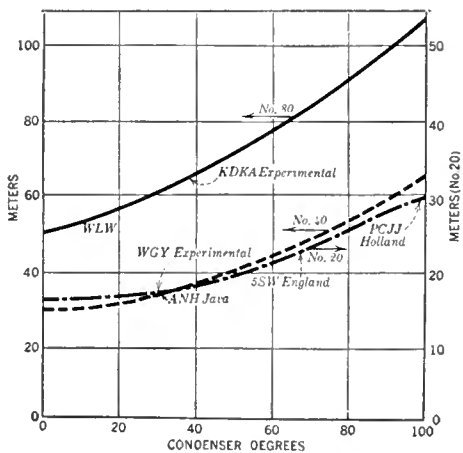
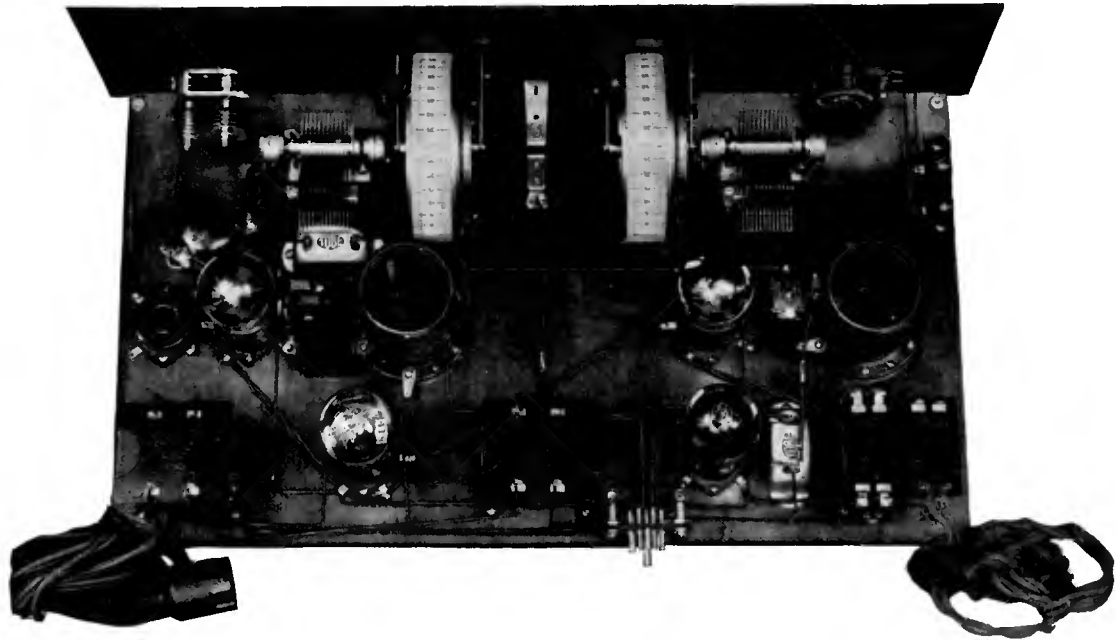

FIG. 2

Mr. Knowles's unit tunes as shown on this curve. Different tubes and slightly different wiring will naturally change these curves somewhat

settings but this is not serious. Different types of tubes also alter the calibration due to the difference in effective input capacity.

To use this set with the a.c. R. B. "Lab" receiver, the following should be done: Break the bulb and remove the elements from a ux or cx type "dud" tube. Remove the leads by heating the tips of the prongs with a soldering iron. Solder a lead to either of the large prongs. Hold the socket base in an inverted position with the large prongs, which normally go to the filament, toward you. The left hand small prong is then the one which goes to the P terminal and a lead should be connected to it. This lead is connected to the binding post which is connected to the choke, that is, post 2 on Fig. 1 and 3. The other lead goes to the binding post next to it, Post 1 on Fig. 1 and 3. If the unit is to be used with a Lab Circuit receiver whose filaments operate from batteries the posts marked A minus and A plus may be attached to leads which may be cabled with the leads from posts 1 and 2 and of course attached to the proper filament prongs of the plug which goes into the receiver's detector socket. Thus all connections to receiver and batteries will be made when the plug is in the correct socket. Unfortunately the a.c. tubes modulate signals too much to make it possible to use them in an oscillating receiver for code reception. With such connections utilizing the A-



THE RECEIVER FOR WHICH THE ADAPTER WAS DESIGNED

The a. c. model of the R. B. Lab. receiver, for which the short-wave adapter described in this article was especially designed, is shown above. This receiver was described in the May number of RADIO BROADCAST. As explained in the article, the adapter may be used with any other standard a.c. receiver.

battery connections or the receiver detector, the Amperite will no longer be needed and may be shorted out or left out of the assembly.

Where only broadcasting is to be received and the set is not used in an oscillating condition it is possible to use a 227 type tube. In this case a 5-prong socket is necessary and four flexible leads may be run to the receiver. Two should go from the H pins of the plug to the filament binding posts, one from the P to the B plus and another from the K to the blank binding post. The K terminal of the short-wave tube should then be grounded and the return to the receiver secured through the common ground. A 227 type amperite should be used.

For intermittent operation, 8 dry cells connected in series-parallel will give very satisfactory results with the 112A tube.

Where, because of the layout or for any other reason, there is poor regeneration on the very high frequencies, a 10,000-ohm resistor (a Durham grid leak for example) should be connected in series with the choke. This increases the impedance of this circuit at these high frequencies without introducing sufficient resistance in the circuit to lower the plate voltage appreciably. Increasing the detector plate voltage to 67.5 will result in better oscillation too. It may be thought that omitting the choke coil in the detector plate lead and substituting a fixed resistance—such as is often done in amateur code receivers—would result in as good a receiver at a reduced cost. This is true provided broadcasting is not to be received, but the 10,000- or 25,000-ohm resistance, which is often used, offers appreciable impedance to low voice frequencies in comparison to the

impedance of the audio amplifier looked at from the detector tube. This would naturally result in poor low-frequency reproduction. The choke offers sufficient impedance at all except the very high frequencies for good regeneration and has no effect on quality of reproduction.

PARTS EMPLOYED

IN THE parts list which follows, the only special parts are the coils. [For best results, the coil and the condenser used with it should be

carefully chosen for in the high-frequency channels, slight differences in coil turns and condenser size—differences from those suggested here, that is—greatly affect the tuning range. In RADIO BROADCAST, June, 1928, page 78, appeared data on some short-wave coils which can be home-wound. See also, pages 13-14 of our May, 1928, issue for details of other home-made coils.—Editor]. Any other parts from well-known manufacturers may be used, provided their respective electrical and mechanical characteristics are similar to those given in the list.

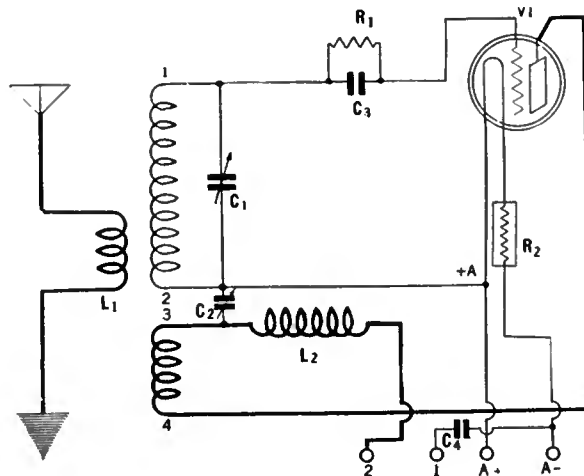

FIG. 3

In many amateur's receivers the plate choke is connected on the plate side of the regeneration coil. Better oscillation control is obtained by placing it at the ground end of the coil, as this diagram shows

- L1 1 Set (3) Hammarlund Short-Wave Coils.
- L2 1 No. 85 Hammarlund Radio-Frequency Choke
- C1 1 .00014-Mfd. Hammarlund ML-1 Condenser
- C2 1 .0001-Mfd. Hammarlund MC-23 Condenser
- C3 1 Neutralizing Condenser—Hammarlund or Sangamo .000050-Mfd. Fixed Condenser
- C4 1 0.5-Mfd. Parvult Series A Condenser
- R1 1 10-Megohm Durham Grid Leak
- R2 1 Amperite Type 1A
- 1 Benjamin Socket
- 1 Durham Grid-Leak Mount
- 6 Eby Binding Posts
- 1 National Velvet Vernier Dial
- 1 7 x 12 x 1/8 Westinghouse Micarta Panel
- 1 10,000- or 25,000-ohm resistor (optional)

ACCESSORIES

- 1 CX-312A tube
- Six-volt filament supply: storage battery or 8 dry cells.

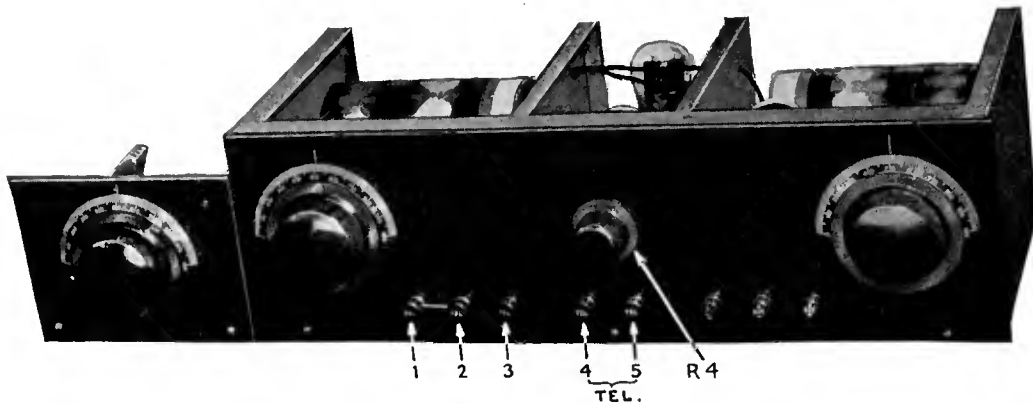

FOR THE EXPERIMENTALLY INCLINED

A beat-frequency oscillator of the type shown here is one of the most valuable pieces of testing equipment that the home experimenter can have. This one is built entirely of standard parts, with the exception of the home-made coils, which any radio fan can make for himself. It employs two oscillating tubes, a detector and a stage of audio to raise the detector output to the desired level.

# How to Build a Beat-frequency Oscillator

By G. F. LAMPKIN

COMBINING the factors of simplicity, portability, and flexibility, a beat-frequency oscillator is a most useful piece of apparatus to have in the laboratory. It utilizes, as may be known, two radio-frequency oscillators, one of which has its frequency varied so as to yield in the audio range beat frequencies with the other oscillator. A detector takes out the audio components, and amplification as desired may be used to bring up the level of their power. A range of audio frequencies of reasonable purity from 30 to 10,000 cycles may be had with adjustment of but one dial; an output of approximately 15 volts r.m.s. can be obtained using only four tubes; and finally, the output over the above mentioned range may be held constant within ten per cent. Such an oscillator was constructed by the writer for use in thesis work at the University of Cincinnati; and constructional data may be helpful to others who have use for a similar instrument.

The selection of the radio frequency at which the oscillators should work is made by compromise. If the frequency carrier is low, it becomes difficult to eliminate that frequency in the output of the oscillator. The resistance-coupling between detector and amplifier is capable of passing too low a carrier frequency, and the ordinary vacuum tube voltmeter is likewise capable of responding to such a frequency, so that even at zero beat between the radio-frequency oscillators, the output meter shows a deflection. Increasing the carrier frequency permits more perfect discrimination between it and the audio frequencies. On the other hand, at high carrier frequencies, the inherent coupling between the oscillators causes "pulling." This means that, as the frequency of one oscillator approaches that of the other, a point is found where the two "pull" into synchronism, and the beat note disappears. The point at which the oscillators pull into step may be as high as two or three thousand cycles—the closer the coupling the higher is this frequency.

The carrier-frequency determined for the particular oscillators was 175 kc. At this frequency, the magnitude of carrier present in the output was less than one-tenth of a volt, the

A MOST convenient type of audio-frequency oscillator that anyone can make is what is known as a "beat to frequency" oscillator. Two radio frequencies beat together to produce an audio frequency note. This note is amplified and may be used to test loud speakers, audio-frequency amplifiers, or for bridge measurements of capacities and inductances. All frequencies from zero to 10,000 are obtainable from a single dial.

Such an oscillator is described in this article by Mr. Lampkin who is Baldwin Fellow in Electrical Engineering at the University of Cincinnati. The apparatus is such as may be found in any experimenter's laboratory: the only special part is the coil—which anyone can make.

—THE EDITOR.

lowest calibration of the vacuum-tube voltmeter that was used. Only partial shielding is necessary between the two oscillators to reduce the coupling to a point where the beat note can be lowered to 15 cycles without the occurrence of pulling. Complete shielding was provided for, however, with the idea in mind that the carrier

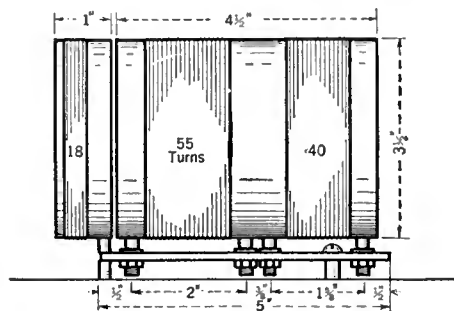

FIG. 1

Two coils of this type are used for the two oscillators. They should be made exactly alike in dimensions. The wire used in all these coils is No. 24 cc

frequency of the oscillators may be made to cover the broadcast band—by means of another coil, of course. At any particular radio frequency setting for the one oscillator, the frequency of the other is varied to either side by vernier control to yield in effect a modulated radio frequency, so that the instrument becomes a miniature broadcasting station for receiver testing. To this end, provision is made for leading out the modulated radio-frequency currents from one oscillator by means of an external coupling coil to be connected to posts 1 and 3 on Fig. 2. Provision is made also for exterior vernier control. Plug-in coils in the oscillators make it possible to cover other frequency ranges.

A FOUR-TUBE UNIT IS BEST

AN ATTEMPT was made to use one of the oscillators also in the rôle of detector. The beat-frequency oscillator thus used one radio-frequency oscillator, one oscillator-detector, and one amplifier. The output voltage obtained from such an instrument was comparatively low, and varied in the ratio of four to one over the 100 to 10,000 cycle range. When the circuit was reconstructed to use a separate detector, the resulting output of the device averaged three and a half times larger than before, and was approximately constant over the same frequency range as above. In point of both magnitude of output and constancy of output the inclusion of the fourth tube is well worth while. Still more tubes may be included as audio-frequency amplifiers if it is desired to raise the level of the output. However, the 15-volt output that can be obtained from four tubes is enough to give a fair output when comparing and testing loud speakers, and it easily fulfills the requirements when the user is measuring amplifiers, transformers, and similar work.

The schematic for the beat-frequency oscillator is presented in Fig. 2. The two radio-frequency oscillators are made as alike as possible so that changes in operating conditions will affect both of them simultaneously. A tickler-feed-back oscillating circuit is used; a 0.002-mfd. fixed

condenser,  $C_3$ , and the variable tuning condenser,  $C_1$ , are across only the grid coil, which allows the rotor and end plates of the variable to be grounded. The plate voltage is series-fed to the tubes. The oscillator ( $VT_1$  in Fig. 2) has the tuned circuit opened at the filament end and brought to a binding post on the panel (No. 1 in Fig. 2) in order that the external coupling coil can be connected for the dummy transmitter use as outlined above. In normal work as a beat-frequency oscillator, terminals 1 and 2 are shorted. From the same oscillator is brought out a lead (No. 3 on Fig. 2) to a binding post where an external vernier condenser of about 70 mmfd. may be connected. The radio-frequencies from the two oscillators are combined through the 18-turn pickup coils and impressed on the detector. Resistance-coupling is used into the final amplifier tube because of its excellent response on all frequencies. The tubes used are UX-201A's for the oscillators, a UX-200A detector and a UX-112A amplifier.

The panel drilling, coil dimensions, and other constructional details are indicated in Fig. 1 and 3. An idea of the baseboard layout can be gained from the photographs. The oscillators are put at opposite ends of the panel, and the detector and amplifier occupy the smaller,  $4\frac{1}{2}$ " wide, compartment. The copper shielding is cut to the given sizes and the panel sheet drilled so that it is held in place by the apparatus. The other sections are soldered in place. The top and back sections of the shielding are used only for the miniature-transmitter function, when they are held in place by screws to the side flanges. As the filament voltages are not critical, they are all controlled by a single ten-ohm rheostat,  $R_4$ . Other binding posts on the panel are for battery-supply input, and for the audio-frequency output from the plate of the amplifier tube.

The voltage output characteristic for the finished oscillator is given in Fig. 4. It was taken for the normal operating voltages of 90 volts B supply to the oscillators and detector, 135 volts B and 9 volts C-bias on the amplifier, and filament voltage at 5. The audio-frequency output was measured with a vacuum-tube voltmeter across a 10,000-ohm resistance in the output. The B and C voltages for the amplifier tube are chosen so that at no point does it overload. The change in amplifier plate current from zero beat to full output is negligible. The output is, as may be seen, constant to within ten per cent. over the entire range from 30 to 10,000 cycles. The values of resistance  $R_3$ , given in Fig. 2 for

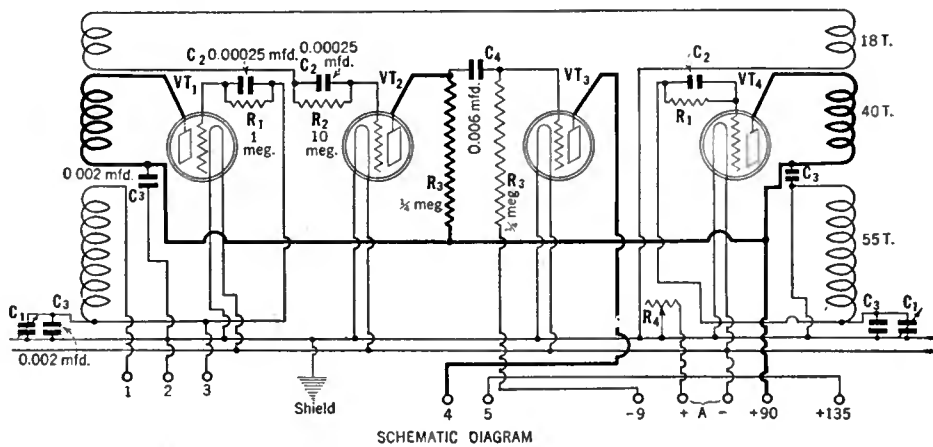

SCHEMATIC DIAGRAM

FIG. 2

Many times we have promised RADIO BROADCAST'S readers an article on how to make an audio oscillator. This is the circuit—at last! It uses parts which are easily obtainable or home constructed

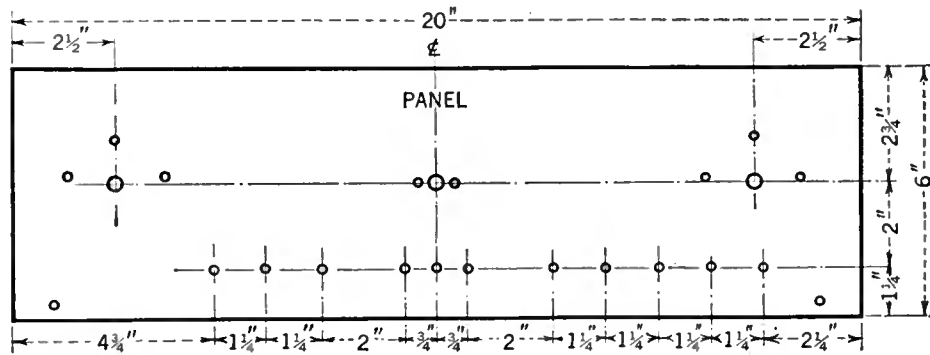

FIG. 3

The dimensions of Mr. Lampkin's oscillator panel are given here

the coupling unit, is rather important, and should be adhered to if nearly constant output is desired. For instance, when the grid leak was changed from .25 to 1 megohm, and other conditions unaltered, the output voltage at 300 cycles was 18.2 and at 10,000 cycles 10.5—a variation of over 75 per cent.

LAYOUT OF THE APPARATUS

THE layout of the instrument calls for a Cardwell type 192E, 0.0005-mfd. maximum, taper-plate condenser for tuning each oscillator.

In operation of the instrument, one condenser is set at or near zero dial reading, and the other turned to give zero beat; in other words, the second condenser is used for trimming. Then from these settings the first condenser is varied to give the beat frequencies. The beat, or audio-frequency calibration for settings of the 192E condenser is plotted in Fig. 5. This beat curve starts from zero beat at 5 on the dial. At the low end of the spectrum the calibration is rather too steep to permit of accurate setting at these frequencies. A Pilot straight-line-frequency con-

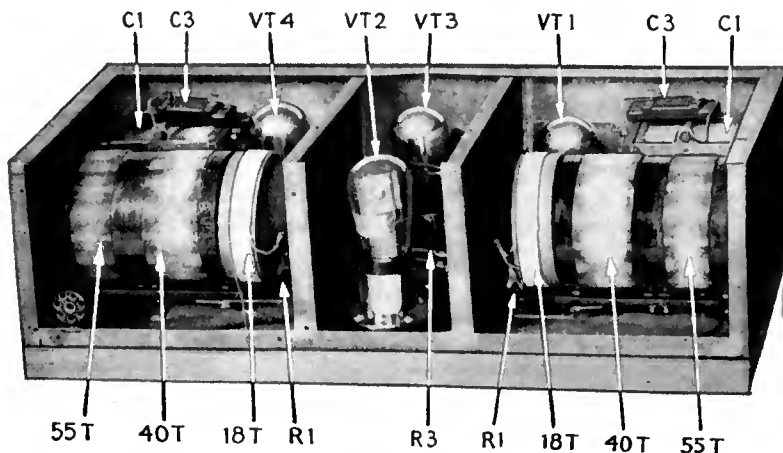

BEHIND THE PANEL

The two oscillators are at the left and right of the main panel. The detector and audio tubes are mounted in the center. The shielding panels are cut and flanged from copper plate

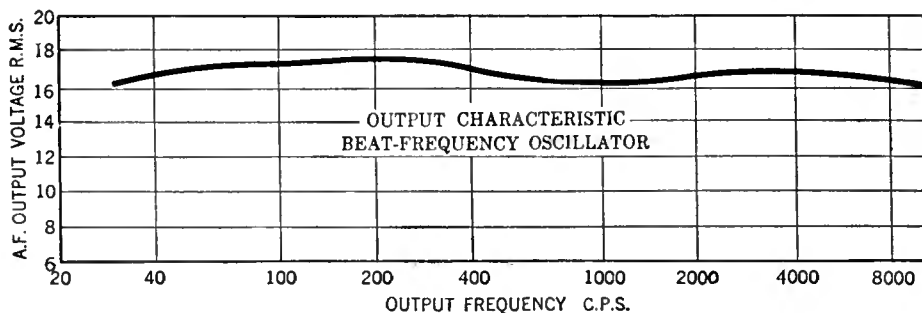

FIG. 4

This beat-frequency oscillator has a characteristic that makes measurements with it an easy matter—straight from below 40 to above 8000 cycles, and every cycle obtainable from a single dial!

denser of 70-mmfd. maximum capacity was used as an external vernier to open up the lower range, resulting in the dotted curve in Fig. 5.

The two Figures, 5, in which frequencies are plotted logarithmically and 6, in which frequencies are plotted linearly, give a comparison of the types of calibrations that may be expected for various condensers. A National 0.0003-mfd. semicircular plate—straight-line-capacity—condenser gives a frequency calibration that is linear with respect to dial reading, as in the solid curve of Fig. 6. Although the frequency of the oscillator varies inversely as the square root of the capacity, the tuning condenser is only a small portion of the total capacity in the radio-frequency circuit. Its variation swings the frequency over only a small part of the capacity-frequency curve, and to all intents the curve is linear over this small portion. Plotted also in Fig. 6, for comparison when using the linear frequency axis, are curves

for the 0.0005-mfd. type 192E Cardwell and for the Pilot 0.00070-mfd. straight-line-frequency condenser which was used as an external vernier condenser. The Cardwell condensers were used in the writer's oscillator.

The frequency calibrations in all cases were made by comparing the sound output of the beat-frequency oscillator with standard frequencies from a Western Electric 8A oscillator. One pair of phones was connected to the beat-frequency instrument and another pair to the 8A oscillator. For any given setting of the standard, the beat oscillator was brought to approximately the same pitch and then tuned accurately by listening to the beats between the two sounds. As regards the purity of output, the beat-frequency oscillator seemed to be as good as the Western Electric 8A. The most distinct beats were found when the intensities of the two sources were approximately equal.

Each time the apparatus is used the variable oscillator is set at the dial setting arbitrarily chosen as zero, and zero beat obtained by varying the trimming condenser,  $C_1$ . This means that the constancy of the calibration is dependent primarily on the constancy of the tuning-condenser capacity. When a heavy condenser with substantial bearings is used for tuning, the accuracy to which the calibration may be used is limited only by the closeness to which the dial may be set. For the same reason, changes in the various operating voltages have negligible effect on the calibration; and it is not a hardship when a tube, with which the instrument was calibrated, is misplaced.

#### CALIBRATING WITH A PIANO

IT IS entirely possible to use a piano as a source of standard frequency when no other source is available. The range from 30 to 4096 cycles may be covered in this way. Another auxiliary audio-frequency oscillator may then be set to the piano frequencies, and harmonics of it picked out to calibrate the beat-frequency oscillator in the 4000 to 10,000-cycle range. The fundamental frequencies of the notes starting from middle C, are: C 256, D 888, E 320, F 341, G 384, A 487, B 880, and C 512. Notes an octave higher are twice the frequency of the corresponding lower note; and likewise, notes an octave low are half the frequency of the higher note. [See Laboratory Sheet No. 52, RADIO BROADCAST, Dec., 1926, for a chart of piano frequencies.—Editor].

The oscillator is useful for comparison by ear of loud speakers and other electro-acoustical

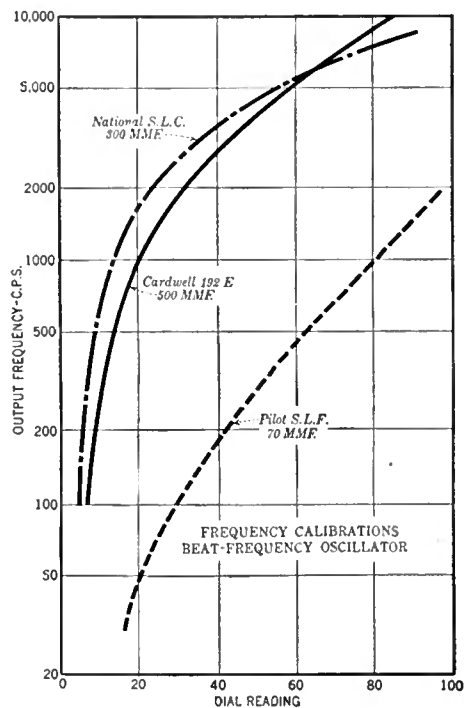

FIG. 5

The calibration curve of the oscillator can be plotted in two ways; one way is with the frequencies plotted logarithmically, or in octaves, as shown here

devices. Peaks and dips in the response stand out when the input frequency is varied rapidly over the spectrum, and upper- and lower-cutoff frequencies may be approximately determined. A 10,000-ohm potentiometer, such as is used as a volume control, across the output of the oscillator allows any desired magnitude of audio-frequency voltage to be taken out for audio-transformer testing, determination of amplifier characteristics, bridge measurements, and so on.

#### PARTS EMPLOYED

THE parts used in the writer's oscillator follow.

The parts not mentioned by name are not at all critical and any standard make may be used. The only special apparatus in the entire equipment are the coils which are described in Fig. 1

- $C_1$  2—Cardwell 500-mmfd. taper-plate condensers type 192E
- 4—General Radio ux Sockets
- $C_2$  3—0.00025-mfd. fixed condensers with grid-leak mounts
- $C_3$  4—0.002-mfd. Sangamo fixed condensers
- $C_4$  1—0.006-mfd. Sangamo fixed condensers.
- 8—General Radio No. 8745 plugs and 874P jacks
- 2—lengths bakelite tubing,  $5\frac{1}{2}'' \times 3\frac{1}{2}''$
- $R_1$  2—1-megohm
- $R_2$  1—10-megohm
- $R_3$  2—0.25-megohm
- $R_4$  1—Filament rheostat, 10-ohm
- 10—Binding Posts
- 2—Bakelite dials, 4''
- Seven square feet 1-64'' copper sheet

#### Shielding:

- Sides—4 pcs.  $7'' \times 10''$ —Turn up  $\frac{1}{2}''$  flange all around
- Bottom—1 pc.  $10'' \times 20''$ —Turn up  $\frac{1}{2}''$  flange all around
- Top—1 pc.  $9'' \times 20''$
- Front & Back—2 pcs.  $5\frac{1}{4}'' \times 20''$
- 1—Formica panel  $6'' \times 20''$
- Baseboard  $9'' \times 20'' \times \frac{3}{4}''$ , wire, screws, etc.

The following tubes are required to put the apparatus in operation:

- 2 201A type for the oscillators
- 1 200A type for the detector
- 1 112A type for the amplifier

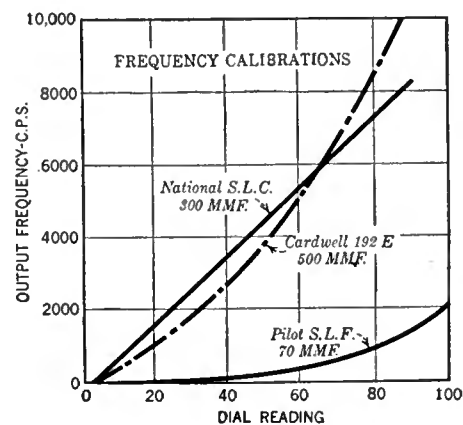

FIG. 6

The second manner of showing what frequencies the oscillator grinds out—that is, where the frequencies are plotted "straight" and not in octaves—is shown in this curve

No. 3.

RADIO BROADCAST'S Service Data Sheets on Manufactured Receivers

July, 1928.

# The Grebe A. C. Six

THE Grebe A C Six is a six-tube receiver designed for a.c. light socket operation. By light socket operation is meant the use of a.c. tubes and the use of A B and C power units.

The receiver employs three stages of tuned radio-frequency amplification, a non-regenerative detector and two stages of transformer-coupled audio-frequency amplification. In many respects, particularly in the tuning system, this receiver is very similar to the design of the standard Synchrophase receiver. The antenna circuit is arranged for use with two lengths of antennas. The long antenna connection includes in series a capacity of .000225 mfd. The short antenna connection leads directly to the coil proper. The secondary circuit of the antenna coupler, that is, the input circuit of the first radio-frequency tube, is arranged for a tapped inductor permitting variation of the inductance tuned by the first radio-frequency condenser. In this manner it is possible to compensate the effects of various lengths of antennas and still permit accurate operation of the ganged condensers, which provide single tuning control.

The tuning system employed in the other stages is conventional and employs the peculiar method used by the engineers of the Grebe organization. Type 326 a.c. tubes are employed for the three radio-frequency stages and the first audio-frequency amplifier. A 327 tube type is employed as the detector and a 171 as the output audio tube.

A novel "local" and "distance" switch is incorporated into the set. This shunts a resistance of 170 ohms across the plate coil of the second radio-frequency transformer, thus broadening the tuning and permitting better sideband response, with consequent improvement in tone quality. For distant reception this fixed resistance is disconnected from the circuit with accompanying increase of sensitivity and selectivity. The electrical balance in the filament circuit of the four 326s is obtained by means of a variable midtapped resistance across the filament circuit. All the grid return leads in the receiver with the exception of those which convey the bias voltages are connected to ground; and the midtap of this resistance is also connected to ground. Its value is 27 ohms.

The volume control employed in the receiver is a variable resistance of 2500 ohms placed in shunt with the primary winding of the fourth tuned radio-



THE RECEIVER IN ITS CABINET

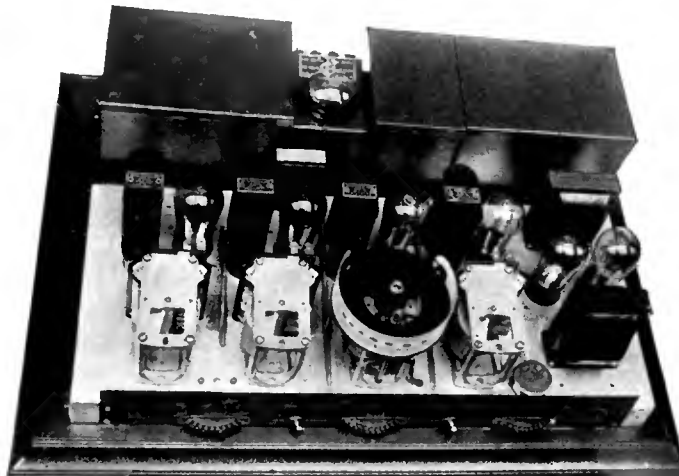

HOW THE PARTS ARE ARRANGED

frequency transformer. By manipulating this resistance it is possible to vary the amount of radio-frequency voltage generated across this coil and transferred to the secondary, thence onto the grid of the detector tube. By employing this arrangement, the filaments of the various tubes are not

disturbed and annoyance from "hum" due to an unbalanced filament circuit is avoided.

The power pack consists of two separate transformers, one to supply the filament voltages and the other to supply the plate voltages of the tubes by means of the rectifier tube. The electrical balance of the various filament circuits, of which there are three, a 1.5- for the 326s, a 2.25-volt for the 227, and a 5-volt winding for the 171, is obtained by the use of a midtapped resistance across each filament circuit. Particular notice should be made of the fact that the 327 is now rated at 2.25 volts rather than 2.5 volts, the previous rating. This permits much longer life.

The B and C supply is obtained from a full-wave rectifying system employing a 380 tube with a single section "brute force" filter. The condensers employed in the filter are of 4 and 5 mfd. each. The voltage dividing resistance consists of six sections. One resistance E of 750 ohms reduces the eliminator voltage to the required 180 volts. Another resistance F of 2800 ohms reduces the voltage to 100 for the first audio and the three radio-frequency tube plates. Another resistance G of 5900 ohms reduces the voltage to the prescribed 45 volts. The 4.5 volts negative C bias applied to the grids of the three radio-frequency and the first audio tube is obtained by means of the voltage drop across the resistance I of 95 ohms. The grid bias for the 171 is obtained by means of the additional drop across the resistance J of 695 ohms. The receiver is a single tuning control affair with an antenna compensating control. The primary power circuit is arranged for 110 or 120 volt 60 cycle a.c. supply. The "on" and "off" switch controlling the operation of the complete receiver is located on the face of the panel, between the tuning and the volume control drums. The tuning dial is graduated in kilocycles. No method of coupling the speaker to the output tube is provided, that is to say, binding posts are provided but one should not permit the current of 20 mls to flow through the speaker. Any transformer designed for use with the 171 or any choke-condenser combination of suitable electrical values will be sufficient.

The power unit is contained within the cabinet which houses the receiver proper, but all units inclusive of the rectifier tube are contained within shields.

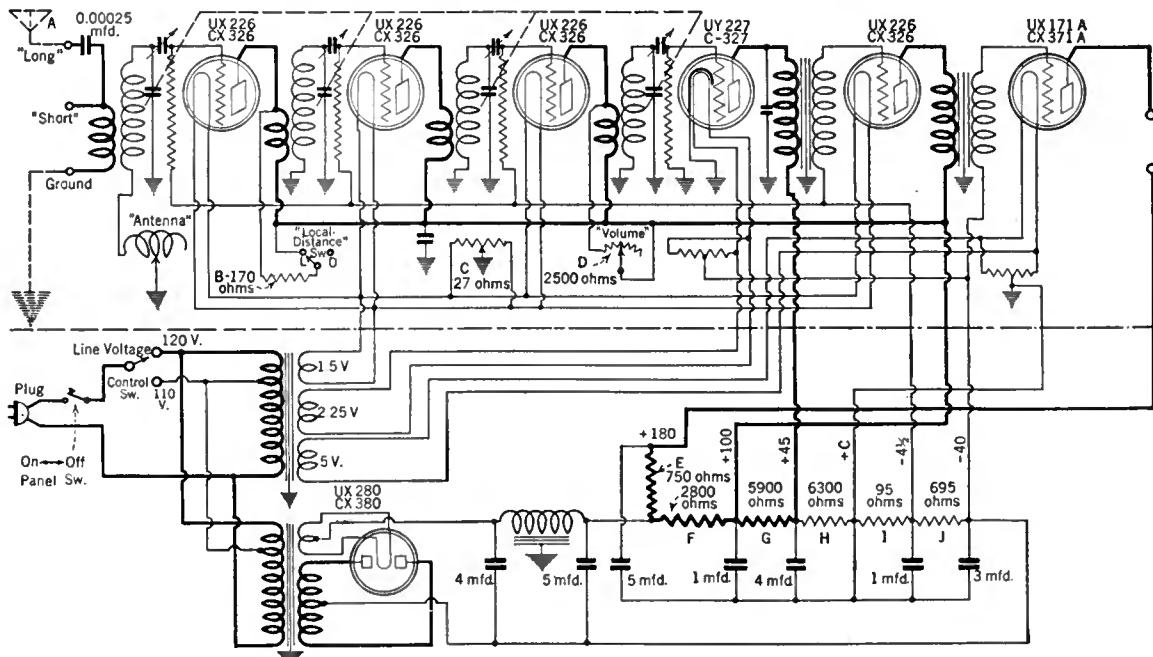

CIRCUIT OF THE GREBE A. C. SIX. THE POWER UNIT IS INCLUDED

No. 4.

July, 1928.

RADIO BROADCAST'S Service Data Sheets on Manufactured Receivers

# The Kolster 6K A. C.

THE Kolster 6K A. C. receiver is an example of conventional a.c. receiver design utilizing the standard types of a.c. tube. The receiver consists of three stages of tuned radio-frequency amplification, a non-regenerative detector and two stages of transformer-coupled audio. The tuned radio-frequency stages are of two types. The input stage consisting of a tapped primary inductance coupled to a variometer which in turn is tuned by means of a shunt variable condenser. The other three radio-frequency stages are of the conventional type, utilizing fixed primary and secondary inductances and tuned by variable condensers. Stabilization of the radio-frequency system is effected by employing resistances in the grid circuits of the radio-frequency tubes. These grid suppressor resistances are of the order of 800 ohms each. The three radio-frequency and first audio tubes are CX-326. The detector is a C-327 and the second audio is a CX-371. The detector utilizes the grid condenser and leak arrangement; the grid condenser being of .00025 mfd. capacity and the grid leak of 2 megohms.

The power supply for this receiver is a full-wave rectifying system employing a CX-380 tube. The power transformer consists of five secondary windings and a tapped primary winding suitable for various line voltages operating at 60 cycles a.c. The five secondary windings supply five volts for the CX-380, 300 volts for each plate of the rectifying tube, 2½ volts for the detector, 5 volts for the CX-371 power tube, and 1½ volts for the CX-326. A center-tapped transformer winding is employed in order to obtain the electrical balance in the filament circuit of the C-327 tube. The electrical balance in the

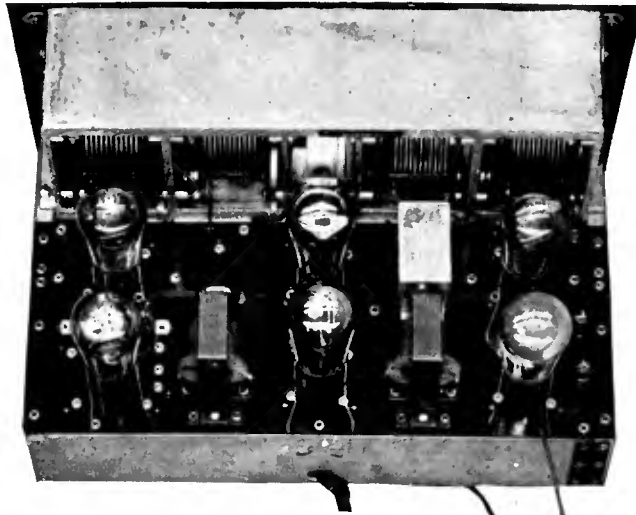

A VIEW BEHIND THE PANEL

326 tube circuit is obtained by means of a potentiometer shunted across the filament circuit with the center tap connected to the B-minus. The filter system of the rectifier consists of a two section "brute force" choke and condenser arrangement. The condensers used in the filter are of 2 mfd. each.

A four-section voltage divider resistance is employed to obtain the various output voltages from the rectifier. The 180 volts necessary for the power tube are obtained by tapping the mid-section of the rectifier output occasioned by the drain across the voltage divider resistance reduces the output voltage to a value suitable to the application of the plate of the three r.f. amplifiers and the first a.f. amplifier. These four tubes receive like values of plate voltage. A 3000-ohm resistance is employed to reduce the rectifier output voltage to a value suitable for the detector plate voltage. A 220-ohm resistance is employed to produce a C voltage which is applied to all tubes other than the output power tube. The C-bias for this tube is obtained by means of another resistance of 910 ohms located within the power unit. Control of the r.f. and first a.f. filament is made possible by means of a rheostat rated at 0.2 ohm in series with the 1½-volt filament winding. The speaker is coupled to the output tube by means of a choke condenser system where the condenser is of 2 mfd capacity. The panel light mounted on the front panel is operated by means of the power switch and the filament potential is obtained from the five-volt winding which supplies the power tube filament. The filament leads for the power tube and the CX-326 tubes and the B and C voltage leads for all tubes other than the power tube are contained in one cable.

The photograph shows the parts lay-out of the receiver exclusive of the power system. The receiver is equipped with a single tuning control. Supplementing this control, however, is another in the form of a vernier for the r.f. input system.

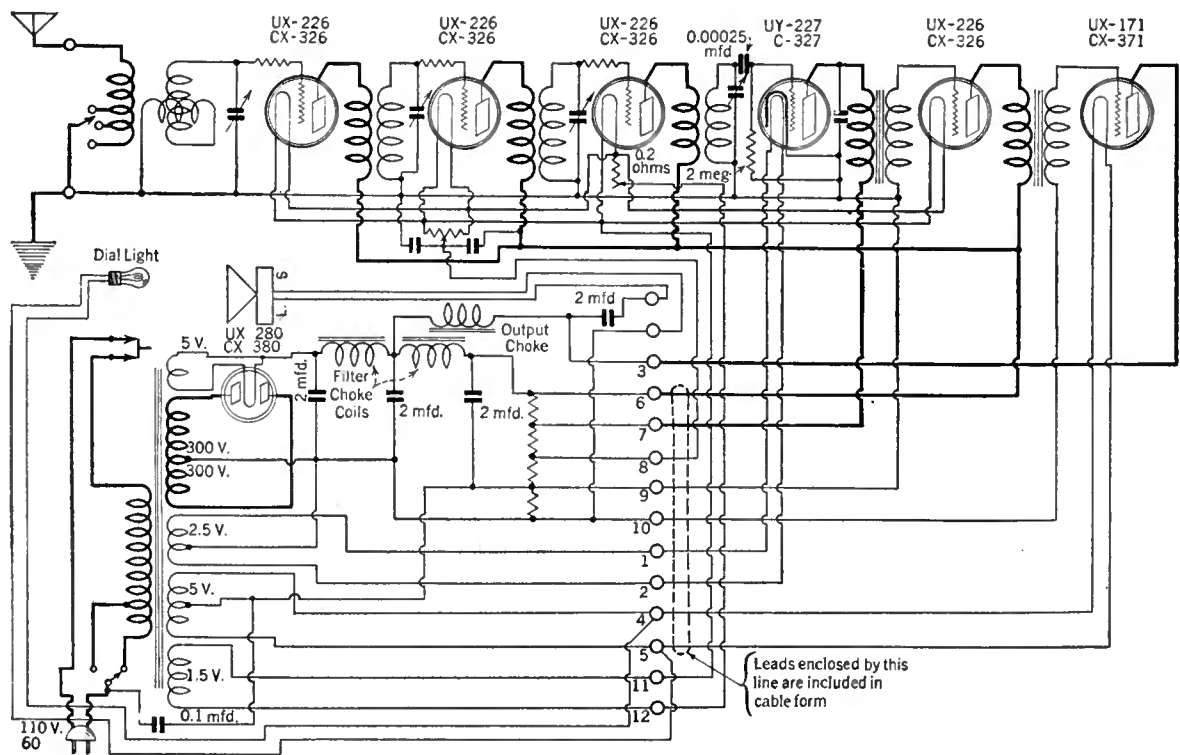

THE CIRCUIT OF THE KOLSTER 6K A. C. RECEIVER

# AS THE BROADCASTER SEES IT

BY CARL DREHER

## Note on Programs

IT DOES a man good to theorize, once in a while, on a subject about which he really knows little. It may not benefit anyone else, but every writer is entitled to such holidays. Writing with a considerable degree of knowledge and experience is deadening to the spirit. I, for example, am an engineer in the ways of broadcasting. I am not risking much when I recite Ohm's Law for the customers or tell them they should not use 378-W microphones for paperweights. That is not to say that I know all about such things, but I can't help knowing something, and the readers give me the benefit of whatever doubt there is, sometimes, even, with more confidence in the accuracy of my opinions than I have myself. But concerning broadcast programs I know nothing. I have never composed one; I have never even sat in the same office with any of the lyric poets who are entrusted with this duty.

Usually I do not cogitate particularly about programs. I am satisfied if they leap from the antennas with reasonable fidelity and no interruptions. What got me to thinking about them was an evening (and morning) I happened to spend at a Russian cabaret on Lenox Avenue in New York. Not being a connoisseur of cabarets, I did not find the place for myself; some friends took me there. It was a small place in a very ordinary neighborhood, with tables ranged closely along the walls, a two-by-four dance floor, and grotesque frescoes of moujiks in blouses. The patrons were mostly Russians, with an admixture of Americans, including the handsome young cops on the near-by beats, who, in civies, appeared around 2 A. M. with their girls. At one end of the room a small platform held an upright piano, competently played by a faded lady in an evening gown. She accompanied, by turns, a violinist and a baritone. The violinist played numbers which, with some exceptions, I had heard often enough on the radio. The songs offered by the baritone, however, were novelties to me—native Russian melodies which were sweet in my jaded ears, calloused by thousands of repetitions of the "Song of the Volga Boatmen"—I wish to God they could be sunk five fathoms deep in their river if there is no other way of suppressing their chantey. Later an accordion player, who records for one of the phonograph companies, performed on his instrument with an astonishing virtuosity. Sitting at a table opposite a girl, this man could make violent love simply by looking at the object of his admiration and playing the accordion, sometimes with wistful softness, sometimes with violent crashes which, in the small room, sounded like the swells of Roxy's organ. The customers joined in the choruses, and I am bound to say that everybody seemed to be having a nicer time—and at less expense—than at any of the Broadway clubs where I have left two days' salary. It was interesting to see how naturally all these different people—the Russian émigrés, the young Irish-American patrolmen, a few people from the phonograph companies, some normally hard-boiled business men, and a scattering of nondescripts, were able to have a good time together. And they were able to have it with much less drinking than in average night clubs. It was this apparent community of interest

which madame thinks of radio program technique. Here a lot of Russians, ordinary U. S. business men, the constables and their girls, were all having a good time in an exotic milieu as far removed from the usual scenes of radio as anything I could imagine. It made me wonder whether the program managers do not underestimate the flexibility of their audiences, whether their fear that any offering which is not the radio equivalent of the *Saturday Evening Post* must fail is altogether justified.

Of course, I can see why the program concoctors feel they must play safe. Radio programs are essentially a means of cultivating public friendship, of acquiring the good will of a large number of people. The idea is to give the public what it wants and not to offend it. What the public wants is an indefinite quantity; the business of the show business is constantly to try out things and see whether the public likes them or not. You succeed and make money, or you fail and lose money. Nobody knew that the public, or a section of it, would want "What Price Glory" and pay \$3.85 per individual to see it, but that turned out to be the case, luckily for Messrs. Stallings, Anderson, and Hopkins. But the break might just as easily have gone the other way. If, then, you can draw on a large body of material which is fairly certain to have general appeal and not to hurt anyone's feelings, you are doing the wise thing from the commercial standpoint. Such a body of material exists. It is based on the primal occupations of ordinary human beings. A girl with a charming voice singing "Thank God for a Garden" will offend no one but a few atheists, and it may afford a mild pleasure to a lot of listeners who like gardens, sweet voices, and tunes they have heard before. The "Four Indian Love Lyrics," the Barcarolle from the "Tales of Hoffman," "O, Promise Me" and a few thousand other things are in the same category. The broadcasters, with occasional exceptions, inevitably slide into that category. Why should they monkey with dangerous artistic creations which, while they are new, are likely to arouse passions and interfere, perhaps, with the sale of goods. Walter Damrosch told us over the radio the other night that when his father first conducted the "Ride of the Valkyrie" half the audience hooted and whistled and the piece had to be played over again. At the premiere of *The Playboy of the Western World* there was a

riot. Walt Whitman lost his job because he wrote *Leaves of Grass*. So we stick to "My Blue Heaven" and "My Ohio Home." "Old Black Joe" is nice, too.

But there is always the specter of boredom in the background. Nothing venture, nothing have. As a relative outsider, I am unable to say how much should be ventured. I would suggest, however, that both extremes are dangerous. Certainly I am far from arguing that radio broadcasting should become an experimental theater for any of the arts. There is not the slightest chance of such a move being made or of its succeeding if anyone has the temerity to make it. But extreme conservatism is also dangerous, the more so because it presents a deceptive appearance of security. What does the broadcaster gain by providing a musical background for home conversation about the stock market, automobile accidents, and golf? An intermediate position would seem to be most rational for broadcasters who want to plan for the future rather than to let the future do what it likes with them. A lot of interesting novelties could be dug up by a broadcaster who wanted to scout around in places like the Russian cabaret I described. Properly staged, some of those gypsy songs might go over better than "Annie Laurie." I haven't the ideas myself; I am simply expressing the feeling that the material is there and is being neglected because the people doing the job are afraid to go off the beaten track. Or take a literary instance. Has anybody ever tried radio-dramatizing Conrad's *The Shadow Line*? It contains in the story of an ill-starred sea voyage a matchless description of the bravery of a young sailor during the hours of danger, and his collapse when safety has been reached, because he has a weak heart and is afraid he will die—he who faced death intrepidly from the outside cannot face it from the inside. If part of that novel cannot be done successfully on the radio, plenty of others in its class can be done—but as things now stand such attempts are seldom even considered. The nearest approach to it I can think of is the Eveready portrayal of a somewhat inebriated young woman acting up in a night club. The world contains enough interesting situations, stories, and music to make radio programs more alive than most of them are, but we must get rid of a good deal of our caution, our fear for our incomes, and our Pecksniffian ideas before we can utilize them. That will not be, I suspect, until we have to utilize them, but that day may be nearer than some of the brethren realize.

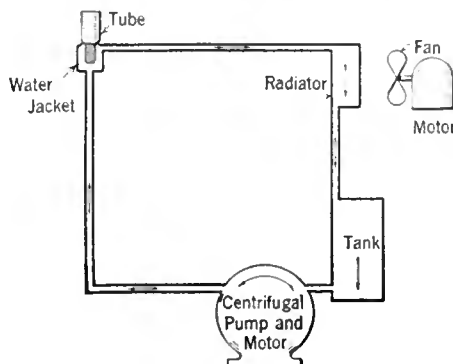

FIG. 1

## Design and Operation of Broadcast Stations

### 21. Water-Cooled Vacuum Tubes

THE water-cooled vacuum tube falls into the class of energy converters in which each unit is required to handle so much power that its internal losses endanger its further existence. Lost power, in general, must be dissipated as heat. Usually by making the machine large enough we can keep the temperature rise within safe limits, but it is often more convenient to make the dimensions relatively small and to



use special means of cooling. Water and air are generally used cooling agents, sometimes without special means to secure motion, as in the ordinary small vacuum tube which radiates heat like an electric lamp, sometimes with forced air cooling, as when a fan is directed on a hot bearing, and sometimes, as in the water-cooled vacuum tube, in the form of a stream of water constantly pumped past the surface which requires cooling. The last means is the most effective and also the most elaborate and inconvenient. It has the added disadvantage that, once the apparatus is designed to rely on it, the flow of cooling liquid must be maintained whenever the power is on, or destruction of the unit will result.

Fig. 2 is a sketch of a water-cooled vacuum tube. Looked at from the outside such a tube is about half glass and half metal. The cathode or filament end is glass. At this end the filament leads are brought out, and generally the grid lead issues along the side of the glass cylinder a few inches below the filament terminals. The anode or plate is the portion of a tube which gets hottest from the electron bombardment, as may be seen in a radiation—or air-cooled—tube when the metal of the plate becomes red hot. The obvious device is then to make the anode a part of the vacuum-enclosing wall of the tube and to cool it on the outside by running water over it. The lower half of the tube shown is, accordingly, the plate itself in the form of a hollow cylinder, with the grid and filament inside. This construction entails an air-tight seal between the glass and metal, and until the development of such seals to commercial practicability, water-cooled vacuum tubes could not be built. A tube is conceivable in which the entire outer container would act as the anode and the filament and grid leads would be brought out through hermetically sealed insulating bushings, but to make such outlets air-tight and at the same time capable of standing up under thousands of volts potential between the leads and the metal of the plate-container would be an excessively difficult job. The practicable form of the water-cooled tube is that shown, in which a glass cylinder is used to support the low tension elements and to bring out conductors from them safely, and the water surrounds the metal anode only.

In the water-cooled tube all three methods of transfer of heat mentioned in physics courses—conduction, convection, and radiation—are active. Heat is radiated from the outside of the tube and water-jacket, and within the water-jacket convection takes place, as well as direct conduction from the hot metal of the anode to the water. The last mode of transfer predominates and the tube cannot survive unless it is kept up. Water is not the only possible cooling liquid for vacuum tubes. Other non-conducting or very poorly conducting liquids may be used; oil, in fact, is superior in some instances, as at very high radio frequencies.

The weakest portions of a vacuum tube are naturally the seals, and, in a water-cooled unit, especially the anode seal, because of its special construction and large size. The principle used is to make the metal at the seal very thin (a few thousandths of an inch) and soft, so that it will adhere to the hot glass in cooling, during the process of manufacture. This leaves a highly vulnerable belt at this point, where a break or puncture may readily be caused.

Usually one side of the filament in these large tubes is at ground potential, and the plate is maintained at a positive potential of several thousand volts. The tube plates must accordingly be insulated from the ground, but as the water supply system, containing tanks and mains, is normally grounded, it becomes necessary to use

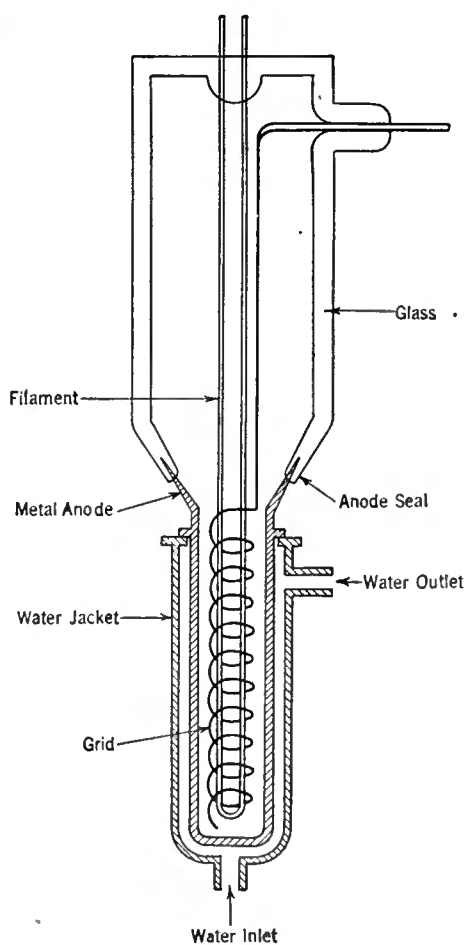

FIG. 2

some special device to insulate the anodes while supplying water to them. This is accomplished by the use of such long columns of water in hose made of insulating material that the resistance is of the order of a megohm. Usually it is convenient to wind the length of hose required around a cylindrical form; such water coils, as they are called, are one of the principal outward features of large vacuum tube transmitters. The length of hose needed depends, of course, on the specific resistance of the water; fifteen feet for each tube is a common length.

Fig. 1 illustrates schematically the layout of such a cooling system, showing a vacuum tube, its water jacket surrounding the anode, the water coil, a pump for maintaining the water flow, and a radiator for cooling the water before it returns to the anode. Any of the methods of water cooling used in steam plants, such as cooling towers in which the water falls successively into vertically arranged troughs, or cooling ponds with or without sprays, are applicable to radio transmitters requiring special cooling measures. When the cooling system is closed the same water may be used over and over. Such circulatory systems are of course essential when the cooling fluid is too expensive to be wasted, as in the case of distilled water. If a plentiful supply of suitable water under sufficient pressure is available an open system is less expensive. For example, a radio station might take water from a river sufficiently far upstream to get the required head and then discharge it through a tail race like that of a hydro-electric power plant. In some instances radio stations get cooling water from city water supply systems. But water from the usual sources, even if it is clean, apparently free from suspended matter, and drinkable, may not be useful for cooling vacuum tubes. Impurities in

the water may cause the formation of scale on the outside of the hot anode, as in boiler tubes. But in the case of a vacuum tube, this deposit is much more serious, because it interferes with the rapid transfer of heat from the plate to the water stream and results in gassing and destruction of the tubes. The rate of deposition of scale depends on the chemicals in the water, the temperature of the anode, and the rate of flow of the water; for a given quality of water more scale is deposited in a given time as the temperature increases. Hence, in modern water-jacket design rapid water flow is the objective; a relatively thin stream is shot past the plates. Soft or distilled water is much to be preferred to hard water for radio cooling purposes. The suitability of the water may be determined by analysis. The table below shows the chemical content held in solution in the cooling water of four different radio stations:

SUBSTANCE	GRAINS PER GALLON			
	1	2	3	4
Calcium carbonate	4.73	0.26	3.85	None
Calcium sulphate	None	2.76	Trace	0.45
Sodium carbonate	3.91	None	None	None
Sodium sulphate	3.09	0.28	0.24	None
Sodium chloride	1.02	1.02	0.85	0.67
Sodium and potassium nitrates	0.41	None	None	None
Magnesium carbonate	1.37	0.13	1.68	None
Magnesium sulphate	None	0.76	0.19	0.47
Aluminum and iron oxides	0.36	Trace	Trace	Trace
Silica	1.22	0.17	0.81	0.15
TOTAL	16.11	5.38	7.62	1.74

Specimen No. 1 came from the water supply of a mid-western town, and the station using it had a poor tube record as might be expected. The second and third samples were from wells, and the stations using them were only a few miles apart in the eastern part of the country. Although the total grains per gallon figures are not so far apart for the two, it will be noticed that the distribution among the substances listed is quite different. These two samples are probably average, and each deposited considerable scale under normal operating conditions. Specimen No. 4 came from a spring near by. As far as these salts go it is almost as good as distilled water. However, organic matter is also found and may play a considerable part in the deposition, as was shown in one case where scale formed rapidly during the summer and more moderately during the winter, although the difference in operating temperature was not enough to explain the effect. When all is said and done the best course, with tube prices what they are, is to use a closed circulatory system employing distilled water.

The temperature of the water is usually measured at two points on each frame before and after it has passed the anodes. Tube manufacturers generally specify an outlet temperature of 70 degrees Centigrade as the limit. As a matter of fact this is much too high for the best conditions of operation, especially by broadcast standards. A figure around 30 degrees Centigrade is more to be desired. If the flow is adequate the inlet and outlet temperatures will not differ by more than five degrees Centigrade.

When the temperature and composition of the cooling water are such that scale deposition cannot be avoided, the only remedy is to institute a regular cleaning schedule for the anodes. Dilute hydrochloric acid in a four-to-one solution may be used. Each tube must be removed from the transmitter periodically and the anode immersed in this solution, which may be held in a stone or crockery container. If the scale forms rapidly each tube must be cleaned once a week or even oftener. Such frequent removal of the tubes from the transmitter entails added danger of breakage. The acid may be run through the water jackets to obviate this, but of course it must be thoroughly washed out before power is again applied to the set.

# A Space-Charge Amplifier and B Supply

By H. P. MANLY

Thordarson Electric Manufacturing Company

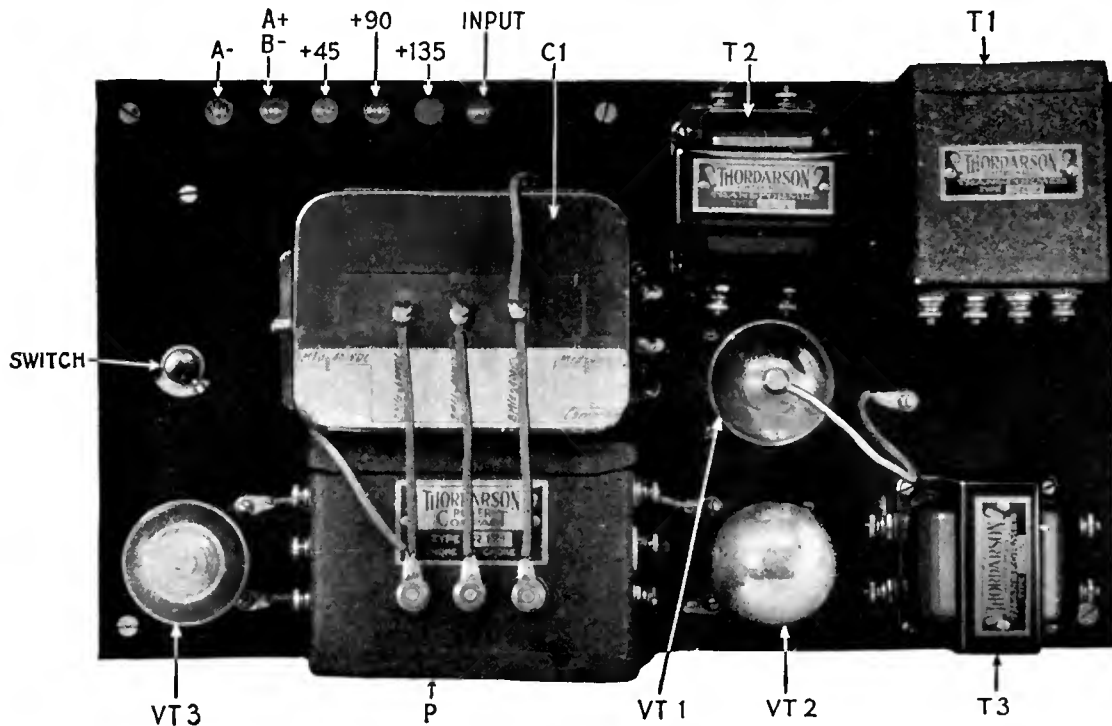

HOW THE INSTRUMENTS ARE MOUNTED

THE popular quest for greater volume generally leads to a multiplicity of tubes which add to the cost and complication of the receiver while opening the way to various troubles difficult to overcome. An amplifier which adds the effect of more tubes, without the tubes, forms an interesting and worth-while solution of the problem.

This unit is of the two-stage type and in its first stage uses one of the new screen-grid tubes as a space-charge amplifier connected to the power tube through a Z-coupler, a device which consists of two high-impedance windings built on two separate cores and placed within one case.

As employed in this amplifier, the inner grid of the tube takes no part in handling the signal but is used solely to reduce the effect of the space charge around the filament. This space charge, which in other tubes strongly opposes the flow of electrons between filament and plate, is a negative charge. By maintaining the inner grid, near the filament, at a rather strong positive voltage, the troublesome space charge is reduced and the amplification is greatly increased.

The outer grid, which almost completely surrounds the plate, is used as a control grid and receives the voltage changes which represent the signal to be amplified. Such use of the two grids is the reverse of the practice followed when the tube is used as a screen-grid amplifier.

With a strong voltage from the detector stage almost any audio amplifier will deliver all the voltage a power tube will handle with only moderate amplification in the first audio stage. But with a weak signal and correspondingly weak voltages from the detector, this moderate amplification will not be sufficient to produce good loud speaker volume. It is under such conditions the space-charge amplifier stage affords real

THE new screen-grid tube may be used in two ways, one as a screen-grid amplifier at radio frequencies, the other as a space-charge tube at audio frequencies. So far as we know this is the first description of an amplifier using this tube as a space-charge audio-frequency amplifier. A unit built in the Laboratory and operated from d.c. shows a good low-frequency characteristic, but fell off somewhat above 2000 cycles due to the high input capacity of the screen-grid tube. The ratio of voltage (across 4000 ohms) in the output to the input 0.1 volt at 1000 cycles, was 2.50, which indicates a voltage step-up in the system from input to the grid of the power tube of 120, compared to 72 which is the step-up in the average two-stage transformer-coupled amplifier.

The Thordarson amplifier power-supply illustrated here when tested in the Laboratory had a tendency to motorboat which was corrected by connecting a 25,000-ohm resistance in the 45-volt lead and by passing it to ground as shown in the circuit diagram. Owing to the fact that the entire unit is built in a rather small space, the output is not too free of hum, and the experimenter is advised to arrange his apparatus with a little more room between parts.

—THE EDITOR.

improvement because it steps up the weak voltage and delivers a comparatively strong impulse to the power tube's grid.

#### FACTORS DETERMINING VOLUME IN OUTPUT

AS IS well known, the effective or overall amplification of any tube and its coupling device depends not only on the amplification factor of the tube but also on the amount of impedance in the external circuit of the tube.

Using the 222 type tube as a space-charge amplifier it is found to have a plate impedance of about 125,000 ohms and an amplification factor of approximately one hundred. The greater the external impedance, the greater will be the proportion of this theoretical amplification actually realized and impressed as grid voltage on the power tube.

The required high impedance for the external plate circuit is secured from one winding of the Z-coupler, connected between the plate of the space-charge tube and the plate current supply for that tube. The other winding is placed between the grid of the power tube and the filament circuit of that tube. The a.c. voltage variations across the plate circuit winding are passed on to the grid of the power tube through a coupling condenser, C<sub>3</sub>, in Fig. 1.

With an impedance type of coupling using a resistance grid-leak there is a decided tendency for the power tube's grid to block on strong signals. The second coupler winding, connected between the power tube grid and the filament circuit, provides an escape for the excessive collection of electrons which produce the blocking. It has a relatively high impedance and comparatively low d.c. resistance.

Heretofore, the screen-grid tube has been used chiefly in radio-frequency amplifiers, and then with the screen-grid method of connection. The screen-grid connection is especially favorable for such use because it reduces the tube's grid-plate capacity and lessens the consequent internal feedback. In audio-frequency amplification, this capacity is of comparatively little importance and using the tube as a space-charge device secures advantages which are especially desired for this kind of work. As a space-charge amplifier, the tube is free from a tendency to howl which,

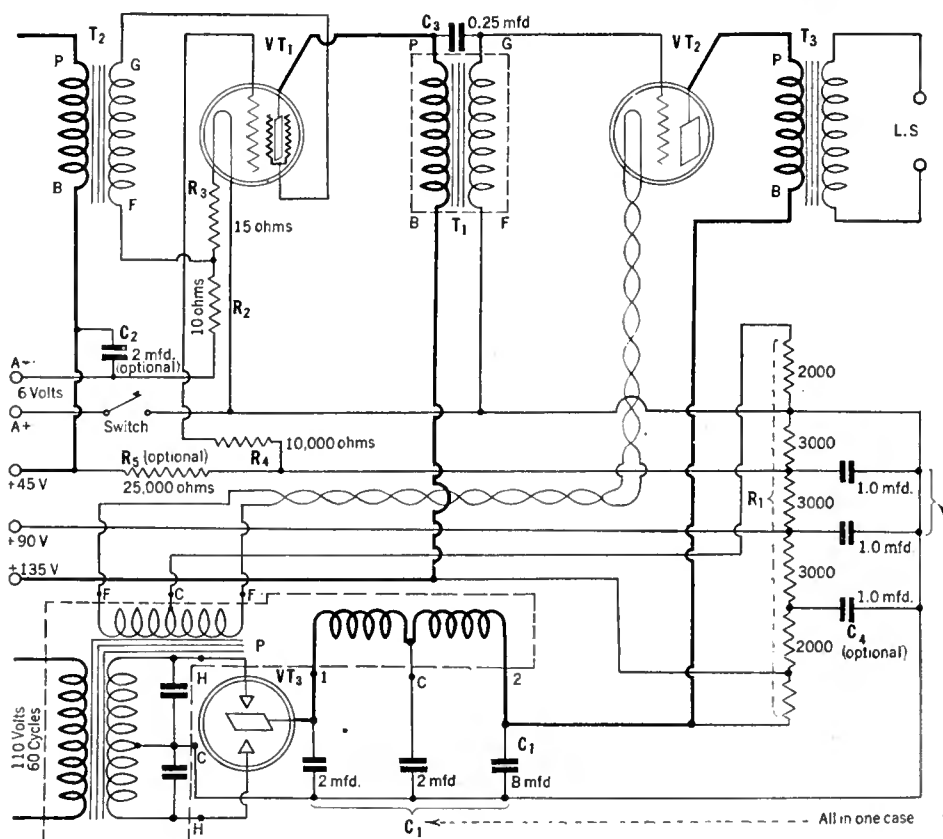

FIG. 1

The resistance,  $R_5$ , and the 2.0-mfd. condenser on the receiver side of it,  $C_2$ , is a trap into which motor-boating tendencies fall. It is applicable to resistance-and impedance-coupled audio amplifiers and was first described in April RADIO BROADCAST. The one-mfd. condenser,  $C_4$ , from the 135-volt tap to ground may not be necessary. The Thordarson engineers state that a 0.02 mfd. condenser at  $C_3$  will cause the circuit to amplify still more at 90 cycles without decreasing the high frequencies

using a screen-grid connection, is sometimes produced by a microphonic feedback from the loud speaker.

USES OF THIS AMPLIFIER

THIS amplifier has been developed primarily as a replacement unit for use with a radio-frequency system which, with its original audio amplifier, does not produce sufficient output to deliver good loud speaker volume on weak incoming signals.

The complete device includes a two-stage audio-frequency amplifier and also a B power-supply unit capable of handling not only the audio-frequency requirements but several radio-frequency tubes and a detector as well. It will take the place of the audio-frequency system in any existing receiver when connected to the output or plate terminal of the detector. The space-charge tube takes only one eighth ampere of filament current, which may be furnished by an A-battery of either the storage or dry cell type.

The audio-frequency amplifier uses transformer coupling between the detector tube and the space-charge tube. The Z-coupler is used between the space-charge tube and the power tube. Direct current is kept out of the speaker by a coupling transformer which follows the power tube.

The power unit for this amplifier includes a "compact," P, having a transformer, two filter chokes and two buffer condensers for the rectifier tube, all within one case. In addition to the high voltage winding on the transformer there is also a center-tapped filament winding for the power tube. The condenser block contains filter condensers and also the two 90- and 45-volt tap bypass condensers,  $C_2$  and  $C_3$ . An additional 1.0-

mfd. condenser may be necessary across the 135 volt top as indicated on Fig. 1 and if the 25,000 ohm anti-motorboat resistor is used, it needs a 2.0-mfd. condenser. These are not shown on the photographs.

All plate voltages are secured from a single voltage-dividing resistance unit,  $R_1$ , having taps at the proper places. Grid bias for the space-charge tube is secured by the drop across the filament resistor,  $R_2$ . Grid bias for the power

tube is secured from a part of the voltage-dividing resistance,  $R_1$ . The inner, or space-charge grid, is supplied with a positive charge of approximately twenty-two volts through the 10,000-ohm resistor,  $R_4$ , connected to the forty-five volt line.

There are six binding posts. One is for a connection to the detector tube plate, two are for A-battery connections and the remaining three provide connections at 135 volts, 90 volts and 45 volts for a radio-frequency amplifier of any type.

In utilizing this amplifier with a previously built radio-frequency system no additional controls are required. Volume is controlled from the radio frequency end of the combination.

PARTS LIST

- T<sub>1</sub> 1 Thordarson Z-Coupler, T-2909
- T<sub>2</sub> 1 Thordarson A. F. transformer, R-300
- T<sub>3</sub> 1 Thordarson speaker coupling transformer, R-76
- P 1 Thordarson power compact, R-171
- R<sub>1</sub> 1 Thordarson-Ward Leonard resistance unit R-508-1
- C<sub>1</sub> 1 Dubilier B-block, R-171
- C<sub>2</sub> 1 Dubilier fixed condenser 2 mfd. (optional)
- C<sub>3</sub> 1 Dubilier fixed condenser, 1/4 mfd.
- C<sub>4</sub> 1 Dubilier fixed condenser, 1 mfd. (optional)
- R<sub>2</sub> 1 Yaxley 10-ohm filament resistor
- R<sub>3</sub> 1 Yaxley 15-ohm filament resistor
- R<sub>4</sub> 1 Ward Leonard 10,000-ohm resistor
- R<sub>5</sub> 2 Ward Leonard Resistance 25,000-ohms (optional)
- Sw 3 Benjamin cushion sockets, 9044
- Sw 1 Yaxley switch s. p. s. t.
- 6 X-L bakelite top push posts (Input, A + B-, A-, B + 135, B + 90, B + 45)
- VT<sub>1</sub> 1 Power tube, UX-171A or CX-371A
- VT<sub>2</sub> 1 Screen grid tube, UX-222 or CX-322
- VT<sub>3</sub> 1 Raytheon BH rectifier tube

[The only special part in the above list is the Thordarson Z-coupler. Naturally, any dependable input and output transformer or condensers may be used, provided they are electrically similar to what the author specifies. The resistors must have the correct resistance and be able to dissipate the proper amount of heat. Readers may obtain the manufacturer's literature in this amplifier from RADIO BROADCAST or from the manufacturer direct—Editor.]

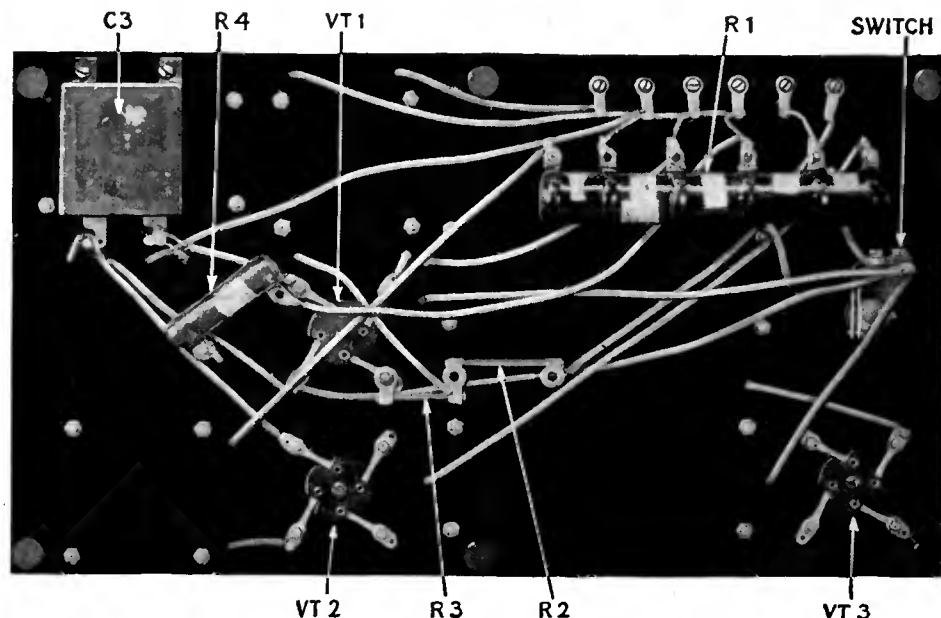

THE INSTRUMENTS AND WIRING UNDER THE SUBPANEL

# A FINE PROGRAM YOU WILL NEVER HEAR

By JOHN WALLACE

WE HAVE recently received an announcement—now old news, but still good news—which we consider the most significant manifesto so far issued in the history of radio in America. Significant and important in spite of the fact that probably not more than one out of a dozen readers of these lines will ever hear one of the programs promised in the announcement.

The long heralded course of music education programs by Walter Damrosch is now assured and will definitely commence next fall. A series of twenty-four educational orchestral concerts will be broadcast beginning October 26. The Radio Corporation of America is sponsoring the series, which will be given Friday mornings at 11 o'clock Eastern Standard Time. It is planned to use twenty-eight stations, the Blue Network and associated stations, covering the entire country between the Atlantic Ocean and the Rocky Mountains. The concerts will be received in the class rooms of both grammar and high schools and the hopes are to reach an audience of from twelve to fifteen million children.

We claim that the announcement is an important one in spite of the fact that it doesn't mean a whoop, personally, to either you or ourself. We shall both, doubtless, be far removed from radio loud speakers at 11 o'clock of Friday mornings. Its significance lies in the fact that it is really the first move toward making radio a definitely educational factor in this country. There have been sporadic attempts at educating by radio before, but none on more than a local scale, and none of any very efficient organization.

We do not intend to slight the fact that radio has already proven its worth as an informational medium. Under this heading comes its vast service to farmers in giving them market and weather reports and other valuable information. But the RCA Music Education Hour is in our opinion the first radio service which can honestly be labeled *educational*. In a history of radio written fifty years hence, its inception will constitute one of the first important early chapters.

Its purpose, according to Mr. Damrosch, will be

“primarily to arouse enthusiasm and a better understanding of music as an artistic expression of human emotions. Secondly, to encourage self-expression in music among the pupils and, therefore, the study of music in the regular curriculum of the schools. This should develop, first of all, singing, a knowledge of musical notation, and in the high schools and colleges, the formation of school orchestras. My experience of over thirty years in this field has proven to me that all these things come inevitably and naturally.

“At all of these concerts I shall give very short and simple explanations of the music that the orchestra will play, of the nature and character of the different orchestral instruments, and something about the composers.

“It is my purpose to prepare this summer the entire twenty-four programs, and at the same

time to formulate a list of about twelve questions for each program which will embody the principal points of my explanatory comments, and which will be sent to all the schools connected with us by radio, so that the teachers may use these questions, all or in part, some time after each concert. We will also send the proper answers to these questions for the use of the teachers only, and follow these answers by additional information which the teachers can impart to their pupils at their discretion.”

## A New Plan for School Broadcasts

THERE have been various attempts at broadcasting courses other than music appreciation. There is hardly a single branch of learning that hasn't been essayed at some time or other. These attempts, as we have made known in these columns before, have filled us with large snorts of derisive laughter. We cannot be convinced that any of them have been of any great value. We doubt if radio home study courses will ever prove much; they offer no points of superiority over extension courses such as are now offered through other agencies, or home-study from books.

But the use of radio as an adjunct to the or-

other words, that radio may give every teacher valuable assistance in the class room.”

This committee has attacked the problem in an expert fashion and has carried it to the point where it is a definite plan to accept or reject. However, its acceptance or rejection is entirely in the hands of the educators. The radio structure is ready to be employed provided the more difficult educational problems are solved. This preliminary committee has very well anticipated most of the problems—probably by consulting the British Broadcasting Corporation, which has had several years' experience in such broadcasting—and has answered in advance most of the possible objections. A few of the objections are answered thuswise:

1. Curriculum already too full!

*Not a single branch will be added. The Plan merely substitutes occasional expert instruction in certain studies and presentations by great national leaders, the living leaders whom succeeding generations will study about in text books.*

2. Instructions cannot be given satisfactorily over the radio, because:—

- (a) the loud speaker lacks the personality of a teacher—the flash of the eye, the smile, the frown, the gesture. It cannot hold the attention of the pupil.

*It can hold the attention. Experience proves that it can, not only during the novelty period, but whenever the broadcasting is properly done. The teacher does not leave the room. She is on hand—her personality is as effective as ever and her time is free to follow the lesson with pointer to map, with notes on the blackboard, with supervision in the doing of things in which the radio instructor may be guiding the class.*

*It is not a substitution—it is adding an assistant to the teacher staff—there is no excuse for a flagging of interest, but every reason for two teachers accomplishing more than one.*

3. It lacks the socializing value of the regular teacher's conduct of a lesson.

*Again a misimpression. The teacher is present, and has more time to check up on the fine points of the lesson because the Visiting Teacher of the Air is doing the heavy work. Moreover, the feeling of the student that others all over the nation are listening with him, gives him a lift in spirit and a challenge that makes him more receptive, more ambitious. Special regional, state, and national contests might be offered to stir definite rivalry.*

4. It is a fad and will pass away.

*The automobile was a fad, the telephone was a plaything, etc., etc.—yet they have taken their places and are unchallenged. The radio will take its place in education and*

- (1) provide an assistant teacher to every teacher who tunes-in;
- (2) give inspiration through acquaintance with great leaders in world progress;
- (3) provide features the smaller schools could not possibly enjoy otherwise—music instruction—appreciation, etc.;
- (4) offer a Normal School course by master teachers at the microphone;



A WGR ARTIST

Edna Zahm, soprano, is a regular artist on the staff of station WGR, at Buffalo

ganized work of the class room has always seemed to us feasible. With the Damrosch lectures as an opening wedge there is no reason why other courses should not follow. To this end there is already in existence a committee which styles itself the Preliminary Committee on Educational Broadcasting, which is, in its own words “an informal committee working together because of our interest. We believe that there is a wealth of material, that schools can satisfactorily receive the programs, and that if educators show sufficient interest the broadcasting will be financed. In

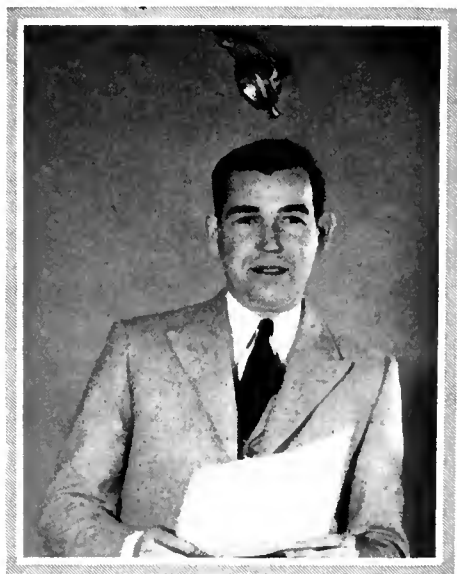

**BILL RAY, OF KFWB, HOLLYWOOD**  
Mr. Ray is standing under a new type of microphone in use at the Hollywood station

- (5) *Weld home and school, because both will listen to the broadcasts;*
- (6) *Brighten the life of both pupil and teacher—add zest, inspire and energize the whole day's schedule.*

It is our guess that conservatism, the basis of the last mentioned objection, will prove the most difficult stumbling block in arousing widespread demand for the innovation. Various and sundry are the complaints leveled against education to-day. Most of them are based on the assumption that there should be progress in education. Education cannot progress; it will produce no greater minds in the twentieth century than it did, say, in the fifteenth. But it can adapt itself to the changing conditions in the world. Civilization, according to the German philosopher Spengler, is the enemy of culture. Since the best way to handle any enemy is to turn his own weapons against him, it follows that radio, a product of civilization, should be utilized as an instrument of culture. A conservatism that ignores this fact is a stupid one.

#### RADIO'S EDUCATIONAL LIMITATIONS

**T**HERE is no subject in the world on which it is easier to spill a lot of words than education—unless it be religion or prohibition. Present anyone with one of these three topics and he or she immediately feels qualified to spout forth lengthy and expert opinions on the subject. We shall attempt to steer clear of this pitfall by refraining from telling the Preliminary Committee on Educational Broadcasting how to run their business. They are educators by profession and should know how to handle the pedagogical end of the affair, and judging from the very complete outline of their plans which we have at hand they have done this part of the preliminary work well. However, we do concede ourself some slight knowledge of what radio can and cannot do, and since we suspect that this knowledge is not shared to any great degree by the educators we will stick in our oar.

The schedule they tentatively suggest for the "National School of the Air" is as follows:

#### GRADE SCHOOLS—Monday, Wednesday and Friday

##### HALF HOUR PERIODS

Music Appreciation (Instructor and musicians to illustrate)  
English and Literature  
Dramatics—Plays, Dialogues, etc.  
Geography (Travelogues)  
History Dramalogues  
Health Talks  
Holiday Talks  
Miscellaneous

#### HIGH SCHOOLS—Tuesday and Thursday

Music Appreciation  
Dramatics—Shakespeare and others  
Talks by Great Men and Women—20-minute talks and 10-minute interview

President of U. S.	Musicians
Vice-President	Physicians
Speaker of House	Naturalists
Cabinet	Inventors
Chief Justice	Explorers
Governor of State	Painters
Diplomatic Service	Sculptors
Senator	Botanists
Representative	Chemists
Authors	Physicists
Educators	Business Men
Statesmen	

#### SUPPLEMENTAL LIST OF SCHOOL RADIO MATERIAL

Opening Exercises  
Public Speaking and Parliamentary Practice  
Nature Study  
Programs for Parent Teacher Associations  
Current Events and Civil Government  
Spelling  
Art Appreciation  
Boys' and Girls' Clubs  
Games for School and Playground  
Foreign Languages

In general we consider this a very intelligently worked out schedule. Our principal quarrel is with the relative importance attached to the various items by the teachers to whom it was submitted. The first five hundred replies to a questionnaire sent to school authorities expressed the opinion that music appreciation courses should receive the greatest stress. With this we are in entire agreement. But the teachers disclosed their ignorance of radio by placing second on the list a subject which should have received

a negligible vote and by their apparent indifference to the very subjects which radio is best fitted to put across. Geography lessons were, by an overwhelming margin, placed second! This is obviously silly. Geography hasn't got anything to do with sound; it is entirely a matter of sight. Radio, a sound medium, can't do much to elucidate or enliven geography. The motion picture, evidently, is the contraption to haul in to aid this study.

Literature and English, Health and Hygiene were rated way ahead of History, Current Events, Civics and Citizenship. Another absurdity. One of the best things developed by radio impresarios is the "Great Moments in History" type of program.

And if the sense of personal contact formed by having the President of the United States speak directly to the school children is not of more importance than having some M.D. lecture them on how to wash their teeth our judgment is cock-eyed. The first question to be asked before inflicting a radio course on the children is "Can it be done better orally than in print?" Evidently the school child can learn how to wash his teeth quite as well from a pamphlet, and there be aided by illustrations too. But a forty-page booklet containing a message from the President could never approach in vividness, or stimulating appeal, the actual hearing of his voice in the class room.

The list of preferences teems with further incongruities. Nature Study and science is given a large number of votes. Foreign Languages are given none at all. Outside of a lecture by some gifted individual who could imitate bird calls we can think of no other Nature Study broadcast that could be an improvement on the same thing as taught in a book. But suppose a French class were to be treated to a lecture in the French language by some famous French personality. That would make them open up their ears and attend.

Before committing themselves to any schedule of courses the educators should be expected to put themselves through a laboratory course in what radio can and cannot do. It will take them at least two or three weeks of conscientious listening to many types of programs before they will be qualified to state with any authority just what sort of programs should be stressed.

To any who would shun the ordeal of such a laboratory experiment we offer the suggestion that the conclusion to which they will come is that *sound* must be a common factor to tie up any study with radio. From the point of view of *sound* music of course comes first. The *sound* of the voices of great leaders would be of infinite value in helping to bridge the gulf that necessarily exists between the ordinary person and the outstanding personality in this over-size nation of ours. The *sound* of foreign languages can be put to good use. The *sound* of great literature, particularly the sound of poetry, is quite as important as its appearance in print. The *sound* of a great historical event, reproduced in faithful accordance with the way it probably transpired can give the school child a vivid mind picture of the event. If any subject, considered according to this standard seems to gain nothing in vividness and aliveness by being intrusted to the loud speaker there is no excuse for adding it to the curriculum of any "University of the Air." Radio education must be made an improvement before it will become worth being realized in actuality.



**THE PROGRAM SUPERVISOR OF WBAL, BALTIMORE**  
Gustav Klemm has distinguished himself through his compositions, many of which are on the repertoire of concert artists. In addition to his duties of arranging WBAL programs, Mr. Klemm also finds time to plan and direct many WBAL feature programs

# A Receiver for Short-Wave Broadcast Reception

By BERT E. SMITH

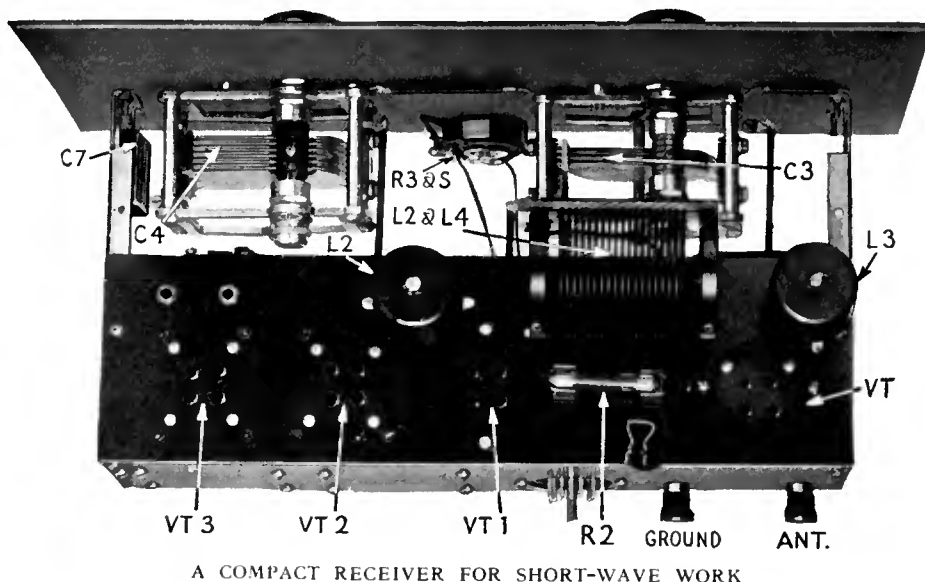

A COMPACT RECEIVER FOR SHORT-WAVE WORK

**T**HIS short-wave receiver uses a screen-grid tube preceding a conventional oscillating detector and a two-stage, transformer-coupled audio amplifier. In the Laboratory it was possible to hear code stations which were inaudible without the screen-grid tube. This means that this tube not only acted as a blocking tube to prevent the detector oscillations from getting into the ether, but contributed some amplification as well.

The receiver can be operated from a conventional plate supply device provided it is well filtered. On the very short waves—20 meters and below—any electrical noise, which may be a.c. hum, or the spark-plug system of passing trucks disturbs the receiver. A 45-volt B-battery for the detector plate circuit will give much quieter operation and enable the listener to get down to the bottom of the signal level. At the present time it is not feasible to use a.c. tubes on a short-wave receiver.

—THE EDITOR.

**I**N THE design of a short-wave receiver for broadcast reception, several factors must be considered in order to produce a satisfactory product.

1. *The receiver must be essentially non-radiating.* Due to the surprising distances which may be covered by short-wave transmitters with a limited amount of power, it is essential that little or none of the high-frequency oscillations generated locally by the receiver shall reach the antenna, for otherwise, the ether would be filled with an annoying congestion of squeals and howls.

2. *Adaptability to phone or c. w. operation.* This requirement applies principally to the type of audio amplification employed in the receiver. It has been customary in receivers for c. w. operation to employ transformers having little amplification of the bass notes because c. w. signals are usually heterodyned to a high-pitched whistle and very low grade transformers are adequate for the amplification of the signals, although they amplify but little the low frequencies now transmitted by good broadcasting stations.

3. *Smooth oscillation control without extraneous*

noises. This requirement will be discussed more fully and is very important, due to the fact that many "noise producing" features of a design which are completely negligible in the broadcast band, assume astounding proportions in the vicinity of twenty to thirty meters.

4. *Ease of operation.* It is quite important that a short-wave receiver should be as easily controlled as the average broadcast receiver so that the operator may not be forced to learn new procedure and new methods.

5. *Adequate range of wavelengths.* Short-wave broadcasting stations have not yet assumed a permanent status because they all have experimental licenses, and it is important that the receiver should be adapted to cover a rather wide band of frequencies.

## USE OF THE SCREEN-GRID TUBE

**I**N ORDER to limit the radiation of the receiver, the screen-grid is at once considered as a new contribution to the short-wave receiver.

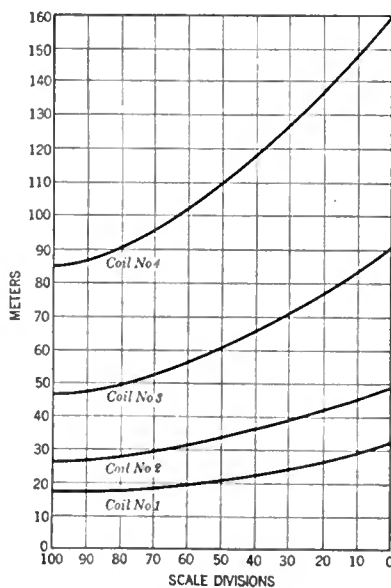
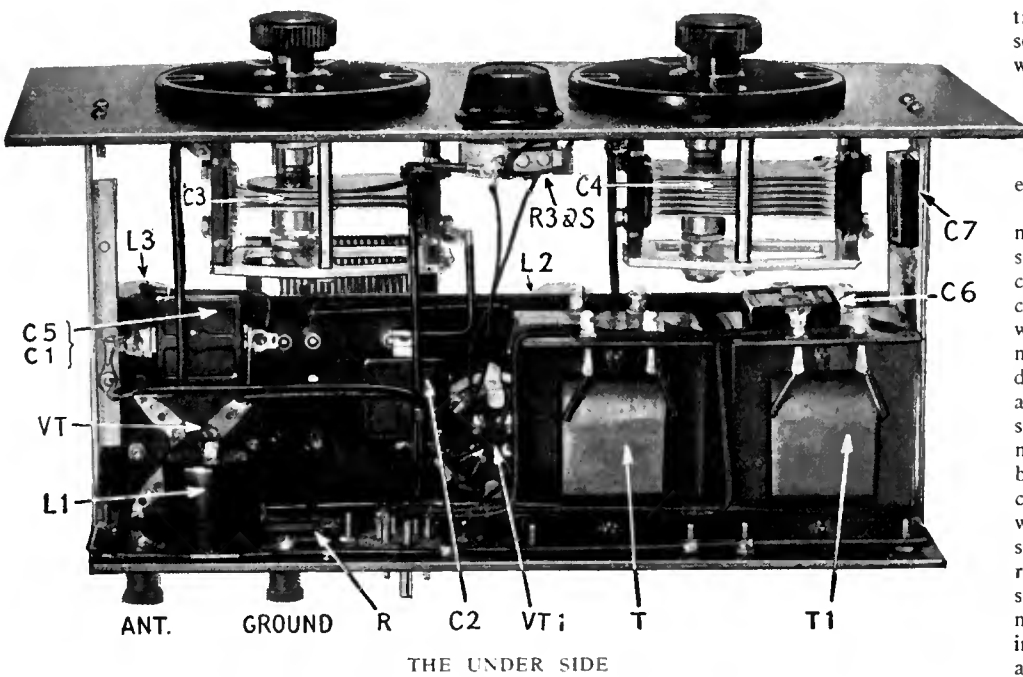

FIG. 1

The insertion of this tube between the antenna circuit and the oscillating tuned circuit of the short-wave receiver will limit the transfer of energy from the tuned circuit to the antenna, due to the extremely low grid-to-plate capacity of the 222 type of tube.

It was the original intention as the plan of this receiver was made to use the screen-grid tube as a radio-frequency amplifier with a tuned-grid circuit coupled to the antenna, but the idea was abandoned for two reasons; the first being that the tube is not strictly a non-oscillating one, and when connected with tuned circuits in the grid and plate, they must be adequately and carefully shielded; also, plug-in coils must be used in order to cover the necessary band of wavelengths, and to have shielded these circuits would have made necessary the removal of two shield tops and the replacement of two coils for each change of wave band. In addition, there is the fact that the tube possesses not zero, but an appreciable grid-to-plate capacity, which causes a disagreeable "hang-over" effect in regeneration resulting in lack of control when there are two controls to handle. It was found experimentally that a low distributed capacity r.f. choke coil served very well as an aperiodic input circuit to the screen-grid tube. This choke is shown at  $L_1$  in the diagram, Fig. 2. It was also found that by the use of this connection a considerable degree of amplification was produced by the screen-grid tube as against coupling the antenna directly to the coil,  $L_2$ , as would be done in the conventional radiating type of receiver. This amplification was "velvet," since all we had hoped from the screen-grid tube was a blocking action, keeping detector oscillations from reaching the antenna circuit.

As connected in Fig. 2, the screen-grid tube also contributes to the ease of operation by the elimination of the so-called "holes" in the tuning range of the conventional short-wave receiver. These "holes" are due to the fact that when the set is tuned to the natural wavelength or submultiples of the natural wavelength of the antenna, sufficient energy is subtracted from the tuned circuit to cause the detector tube to cease oscillating, whereupon the antenna coupling must be reduced and again increased as the "hole"



THE UNDER SIDE

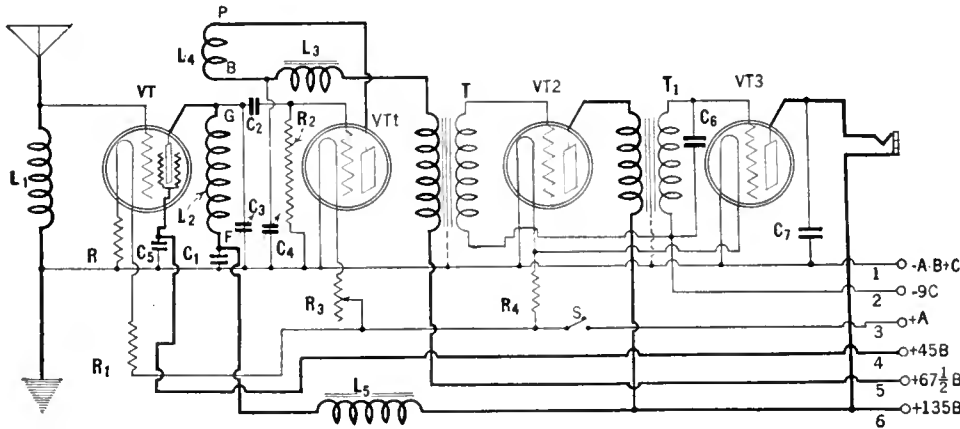

FIG. 2

is passed on the tuning dial. As was stated, the screen-grid tube, due to its low grid to plate capacity, eliminates this objectional feature and permits a band of waves to be swept by the tuning condenser,  $C_3$ , without other adjustments except a minor manipulation of the regeneration condenser,  $C_4$ .

The receiver has also been adapted to the receiving of broadcast programs by the employment of high-grade audio transformers together with a CX-312 power tube in the output circuit.

Smooth control in operation has been attained by no small amount of effort. A portion of the success of this feature is due to the splendid characteristic of the choke,  $L_3$ , which isolates the regeneration circuit,  $L_4$ ,  $C_4$ , at all frequencies to which the tuner is capable of responding. Stability of control is also obtained by isolating the various circuits as completely as possible. Thus the 0.005-mfd. condenser,  $C_6$ , assures that the screen-grid will be maintained at ground r.f. potential. In the same way the plate circuit of the screen-grid tube is isolated by means of the 0.005-mfd. condenser,  $C_1$ . Because several portions of the receiver are operating from the 135-volt tap of the battery, another choke,  $L_5$ , is inserted. In order to prevent small radio-frequency currents from being carried through the stray wiring

capacities of the audio amplifier, which would cause objectionable hand capacity and prevent the detector going into and out of oscillation quietly when wearing the head phones, the cores of the audio transformers are connected to the panel brackets and thence to ground; in addition

tion the capacity,  $C_6$ , is employed across the secondary of the second audio transformer,  $T_1$ , as well as another capacity,  $C_7$ , across the output terminals of the receiver.

It is a fact that these improvements for eliminating audio noises in the output of the receiver contribute materially to the ease of operation of this set.

A further source of troublesome extraneous noises has been neglected by the unique construction of the Amsco 0.000014-mfd. (140 mmfd.) condenser,  $C_3$ . With a condenser of ordinary construction, unbearable noises are produced when the receiver is tuned at twenty to thirty meters due to the contact voltages set up by the dissimilar metals usually employed in the shaft and bushings of the condenser as well as to the scraping between the metal parts. Strange as it may seem at the first blush, these noises cannot be eliminated by "pig-tailing" the shaft of the condenser, because at these extremely short wavelengths the inductance of the "pig-tail" is sufficiently appreciable to prevent the variable resistance caused by the scraping contact to be short-circuited by it. This difficulty has been met very well by completely insulating the bearings of the rotor from the frame of the condenser and then running the "pig-tail" directly from the shaft to the frame. In this way the variable resistance caused by the shaft-bearing contact is eliminated entirely and the whole circuit is carried by the "pig-tail."

The wavelength range of the receiver with the four plug-in coils is from seventeen to one hundred and fifty-five meters, arranged to include all short-wave stations experimentally broadcasting at present or contemplated, as well as the principal amateur phone and telegraphic bands.

It should be noted that the construction of the Aero plug-in short-wave coils has been altered from a 3-inch diameter to a 2-inch. This change has improved the structure and rigidity of the coil; it limits the magnetic field of the coil materially by increasing the ratio of length to diameter for a given inductance; it minimizes the pickup from powerful near-by stations, and also provides a more favorable coefficient of coupling between the tickler and secondary for operation at extremely low waves.

The constructional work on this receiver has been reduced to a minimum. A foundation unit is available with drilled and engraved front panel, subpanel provided with sockets, and back panel, all of Westinghouse Micarta.

NOTES ON ASSEMBLY

THE top view of the unit on page 167 shows the arrangement of this sub-panel. It will be noted that the socket for the CX-322 tube, at the right, is depressed and held with machine screws and short bakelite studs, in order that this taller tube shall not project above the top of the front panel. The plug-in jacks usually contained in the Aero coil mounting have been dismantled and are supplied mounted directly in the subpanel. To the left and right of the coil mounting are the radio-frequency chokes,  $L_5$  and  $L_3$ , respectively, and the grid leak mounting directly behind the coil.

It is wise in assembling the receiver to do as much of the work as possible on this subpanel before assembling it into the mounting proper. It will be necessary to solder long leads to the plate and grid terminals of the audio and detector sockets in order to facilitate their connection to the audio transformers after assembly.

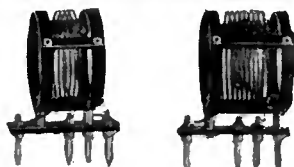
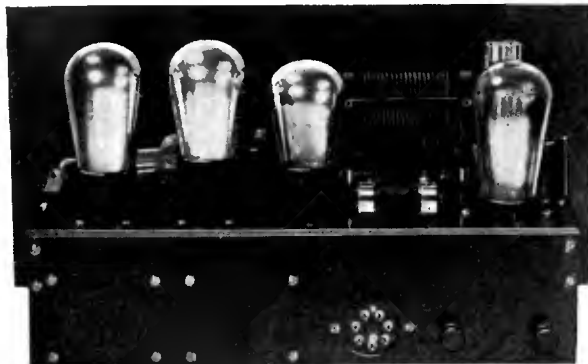

THE COMPLETED RECEIVER

The back panel, seen in the illustrations, should also be assembled separately with the antenna and ground binding posts, the antenna input choke, L<sub>1</sub>, the Yaxley cable plug connector and the audio transformers, and as much work accomplished on the separate units as possible before the final assembly.

It will also be noted that the battery leads from the Yaxley connector to the audio transformers are cabled in soft wire and laced together with ordinary string. A careful application of shellac to this cable will stiffen it and make a neat appearance.

The other assembly details are made sufficiently clear, we believe, in the photographs and the wiring diagram, Fig. 2.

OPERATION

THE operation of the receiver is very simple. With suitable tubes inserted in the sockets and with the battery voltages in the circuit diagram applied, one of the coils may be placed in the socket. With the regeneration condenser, marked "Volume," all the way out, the filament rheostat is turned up to about half brilliancy. Then, advancing the "Volume" condenser to a certain point, the detector tube should go into oscillation with a soft "thud," accompanied by a considerable hissing and increase in static. Should the tube fail to oscillate with the volume condenser fully advanced, the filament rheostat should be turned up further. In the event that it should go into oscillation sharply or with disagreeable noises, it should be retarded to the point where oscillation can be accomplished with the soft "thud" mentioned. After oscillation is obtained, the wave band covered by the coil may be swept with the tuning condenser, always simultaneously manipulating the volume condenser in such a way as to keep the tube just on the verge of oscillation. On passing a broadcast signal, a distinct heterodyne whistle will be heard, which may be chopped up somewhat by the modulation carried by the signal. After locating the heterodyne point of the broadcaster, the "Volume" condenser is retarded somewhat until the tube is just out of oscillation. The setting of the tuning condenser is then corrected for maximum signal strength and it will then be found that the volume control can be advanced with some increase in signal strength up to the oscillating point of the tube.

In order to facilitate the location of stations whose wavelengths are known, the tuning chart shown in Fig. 1, has been prepared. It should be understood that this chart will vary somewhat with individual receivers due to small variations in coil and condenser characteristics as well as tube characteristics and wiring leads, but at any rate it will give those not familiar with the short wavelength stations a very definite idea of where to look for the experimental broadcasting station in which one is interested.

LIST OF PARTS

THE list of parts used in the construction of model illustrated here is given below. Other parts electrically and mechanically similar may be used, of course. It is not advisable to attempt the construction of the coils. The Aero kit comes as a unit, and at the present date it seems possible that the complete list of parts may be sold by the Aero Products company. Readers may obtain the manufacturer's constructional data and blueprints by writing to RADIO BROADCAST.

- (1) Aero International Foundation Unit, complete with tube sockets and grid-leak mount.
- L<sub>1</sub>, L<sub>2</sub>, L<sub>3</sub>, L<sub>4</sub> (3) Aero No. 60 choke coil.
- L<sub>2</sub>, L<sub>4</sub> Aero International Coil Kit.

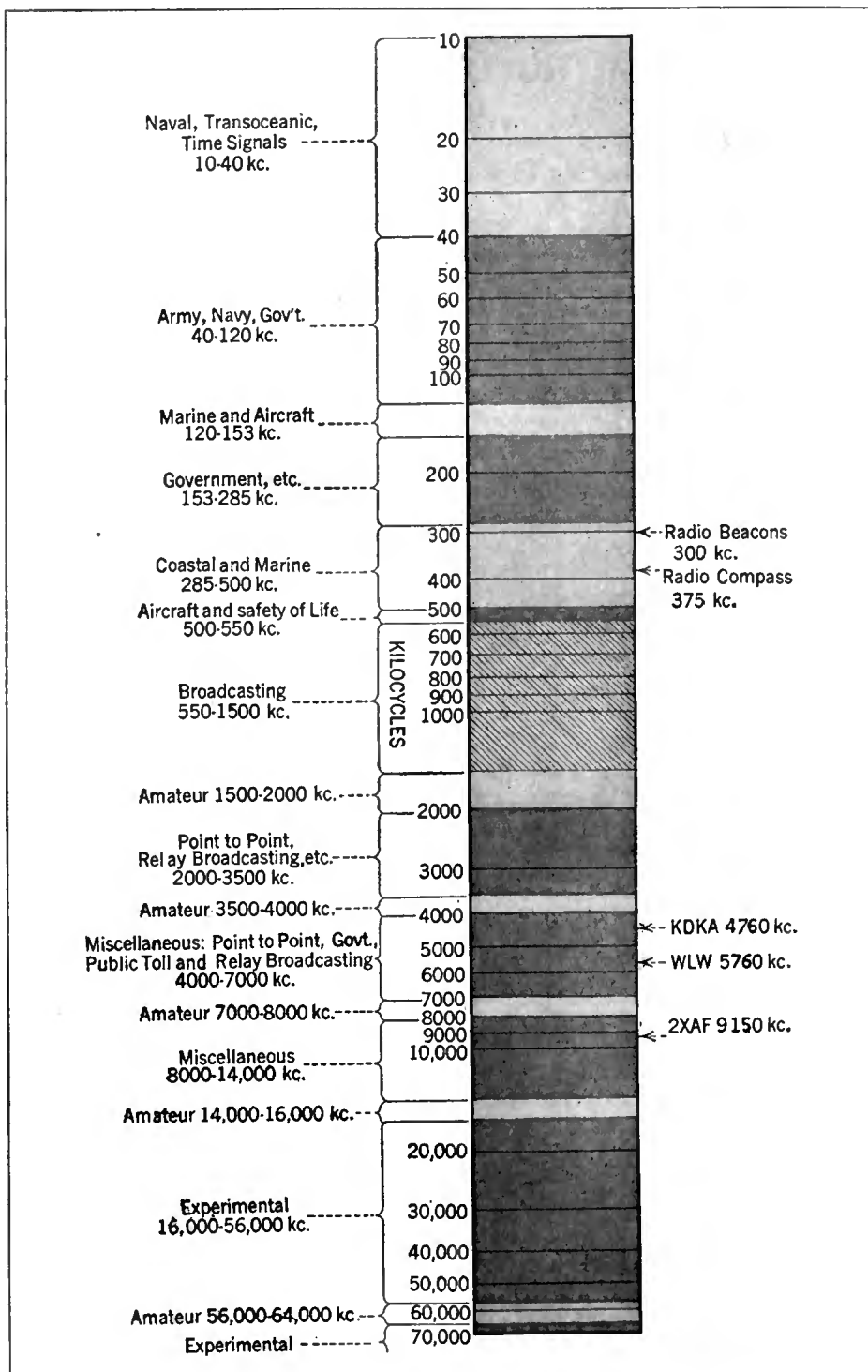

WHERE THE SHORT-WAVE BROADCASTS MAY BE FOUND

This chart shows the allocation of wavelengths from 10 to 70,000 kilocycles; the portions of the spectrum set apart for short-wave relay broadcasting and amateur work are clearly indicated

- |                                 |  |   |
|---------------------------------|--|---|
| C <sub>3</sub>                  | (1) Amsco 140-mmfd. short-wave condenser.                | (1) Yaxley 7-prong plate.                     |
| C <sub>4</sub>                  | (1) Amsco 250-mmfd. short-wave condenser.                | (2) Binding posts (Antenna & Gnd.).           |
| C <sub>1</sub> , C <sub>5</sub> | (2) Carter .005 fixed condenser.                         | (2) Carter tip-jacks.                         |
| C <sub>6</sub>                  | (1) Carter .0001 fixed condenser.                        | (2) National dials.                           |
| C <sub>2</sub>                  | (1) Carter .00015 fixed condenser.                       |   |
| C <sub>7</sub>                  | (1) Carter .001 fixed condenser.                         | <i>Accessories</i>                            |
| R                               | (1) Yaxley 10-ohm fixed resistor.                        | (1) Yaxley cable connector                    |
| R <sub>1</sub>                  | (1) Yaxley 15-ohm fixed resistor.                        | (1) cx-322 tube.                              |
| R <sub>2</sub> & S              | (1) Yaxley 20-ohm No. 520 rheostat with switch and knob. | (2) cx-301-A tube                             |
| R <sub>3</sub>                  | (1) 7-megohm grid-leak.                                  | (1) cx-312-A tube.                            |
| R <sub>4</sub>                  | (1) Yaxley 1-ohm fixed resistor.                         | (1) 6-volt storage battery.                   |
| T, T <sub>1</sub>               | (2) Silver Marshal No. 240 audio transformers.           | (1) pair Trimm head phones (or loud speaker). |
|                                 |  | (1) 9-volt C. battery.                        |
|                                 |  | B-battery supplying 135 volts.                |



# Manufacturers' Booklets

## A Varied List of Books Pertaining to Radio and Allied Subjects Obtainable Free With the Accompanying Coupon

READERS may obtain any of the booklets listed below by using the coupon printed on this page. Order by number only.

1. FILAMENT CONTROL—Problems of filament supply, voltage regulation, and effect on various circuits. RADIALL COMPANY.
2. HARD RUBBER PANELS—Characteristics and properties of hard rubber as used in radio, with suggestions on how to "work" it. B. F. GOODRICH RUBBER COMPANY.
3. TRANSFORMERS—A booklet giving data on input and output transformers. PACENT ELECTRIC COMPANY.
5. CARBORUNDUM IN RADIO—A book giving pertinent data on the crystal as used for detection, with hook-ups, and a section giving information on the use of resistors. THE CARBORUNDUM COMPANY.
9. VOLUME CONTROL—A leaflet showing circuits for distortionless control of volume. CENTRAL RADIO LABORATORIES.
10. VARIABLE RESISTANCE—As used in various circuits. CENTRAL RADIO LABORATORIES.
12. DISTORTION AND WHAT CAUSES IT—Hook-ups of resistance-coupled amplifiers with standard circuits. ALLEN-BRADLEY COMPANY.
15. B-ELIMINATOR AND POWER AMPLIFIER—Instructions for assembly and operation using Raytheon tube. GENERAL RADIO COMPANY.
- 15A. B-ELIMINATOR AND POWER AMPLIFIER—Instructions for assembly and operation using an R. C. A. rectifier. GENERAL RADIO COMPANY.
16. VARIABLE CONDENSERS—A description of the functions and characteristics of variable condensers with curves and specifications for their application to complete receivers. ALLEN D. CARDWELL MANUFACTURING COMPANY.
17. BAKELITE—A description of various uses of bakelite in radio, its manufacture, and its properties. BAKELITE CORPORATION.
40. AUDIO-FREQUENCY CHOKES—A pamphlet showing positions in the circuit where audio-frequency chokes may be used. SAMSON ELECTRIC COMPANY.
47. RADIO-FREQUENCY CHOKES—Circuit diagrams illustrating the use of chokes to keep out radio-frequency currents from definite points. SAMSON ELECTRIC COMPANY.
48. TRANSFORMER AND IMPEDANCE DATA—Tables giving the mechanical and electrical characteristics of transformers and impedances, together with a short description of their use in the circuit. SAMSON ELECTRIC COMPANY.
49. BYPASS CONDENSERS—A description of the manufacture of bypass and filter condensers. LESLIE F. MUTER COMPANY.
50. AUDIO MANUAL—Fifty questions which are often asked regarding audio amplification, and their answers. AMERICAN SALES COMPANY, INCORPORATED.
51. SHORT-WAVE RECEIVER—Constructional data on a receiver which, by the substitution of various coils, may be made to tune from a frequency of 16,660 kc. (18 meters) to 1090 kc. (150 meters). SILVER-MARSHALL, INCORPORATED.
52. AUDIO QUALITY—A booklet dealing with audio-frequency amplification of various kinds and the application to well-known circuits. SILVER-MARSHALL, INCORPORATED.
56. VARIABLE CONDENSERS—A bulletin giving an analysis of various condensers together with their characteristics. GENERAL RADIO COMPANY.
57. FILTER DATA—Facts about the filtering of direct current supplied by means of motor-generator outfits used with transmitters. ELECTRIC SPECIALTY COMPANY.
59. RESISTANCE COUPLING—A booklet giving some general information on the subject of radio and the application of resistors to a circuit. DAVEN RADIO CORPORATION.
63. FIVE-TUBE RECEIVER—Constructional data on building a receiver. AERO PRODUCTS, INCORPORATED.
70. IMPROVING THE AUDIO AMPLIFIER—Data on the characteristics of audio transformers, with a circuit diagram showing where chokes, resistors, and condensers can be used. AMERICAN TRANSFORMER COMPANY.
72. PLATE SUPPLY SYSTEM—A wiring diagram and layout plan for a plate supply system to be used with a power amplifier. Complete directions for wiring are given. AMERICAN SALES COMPANY.
81. BETTER TUNING—A booklet giving much general information on the subject of radio reception with specific illustrations. Primarily for the non-technical home constructor. BREMER-TULLY MANUFACTURING COMPANY.
82. SIX-TUBE RECEIVER—A booklet containing photographs, instructions, and diagrams for building a six-tube shielded receiver. SILVER-MARSHALL, INCORPORATED.
83. SOCKET POWER DEVICE—A list of parts, diagrams, and templates for the construction and assembly of socket power devices. JEFFERSON ELECTRIC MANUFACTURING COMPANY.
84. FIVE-TUBE EQUAMATIC—Panel layout, circuit diagrams, and instructions for building a five-tube receiver, together with data on the operation of tuned radio-frequency transformers of special design. KARAS ELECTRIC COMPANY.
85. FILTER—Data on a high-capacity electrolytic condenser used in filter circuits in connection with A socket power supply units, are given in a pamphlet. THE AROX COMPANY.
86. SHORT-WAVE RECEIVER—A booklet containing data on a short-wave receiver as constructed for experimental purposes. THE ALLEN D. CARDWELL MANUFACTURING CORPORATION.
88. SUPER-HETERODYNE CONSTRUCTION—A booklet giving full instructions, together with a blue print and necessary data, for building an eight-tube receiver. THE GEORGE W. WALKER COMPANY.
89. SHORT-WAVE TRANSMITTER—Data and blue prints are given on the construction of a short-wave transmitter,

- together with operating instructions, methods of keying, and other pertinent data. RADIO ENGINEERING LABORATORIES.
90. IMPEDANCE AMPLIFICATION—The theory and practice of a special type of dual-impedance audio amplification are given. ALDEN MANUFACTURING COMPANY.
91. B-SOCKET POWER—A booklet giving constructional details of a socket-power device using either the BII or 313 type rectifier. NATIONAL COMPANY, INCORPORATED.
94. POWER AMPLIFIER—Constructional data and wiring diagrams of a power amplifier combined with a B-supply unit are given. NATIONAL COMPANY, INCORPORATED.
101. USING CHOKES—A folder with circuit diagrams of the more popular circuits showing where choke coils may be placed to produce better results. SAMSON ELECTRIC COMPANY.
22. A PRIMER OF ELECTRICITY—Fundamentals of electricity with special reference to the application of dry cells to radio and other uses. Constructional data on buzzers, automatic switches, alarms, etc. NATIONAL CARBON COMPANY.
23. AUTOMATIC RELAY CONNECTIONS—A data sheet showing how a relay may be used to control A and B circuits. YAXLEY MANUFACTURING COMPANY.
26. DRY CELLS FOR TRANSMITTERS—Actual tests given, well illustrated with curves showing exactly what may be expected of this type of B power. BURGESS BATTERY COMPANY.
28. B BATTERY LIFE—Battery life curves with general curves on tube characteristics. BURGESS BATTERY COMPANY.
30. TUBE CHARACTERISTICS—A data sheet giving constants of tubes. C. E. MANUFACTURING COMPANY.
32. METERS FOR RADIO—A catalogue of meters used in radio, with diagrams. BURTON-ROGERS COMPANY.
33. SWITCHBOARD AND PORTABLE METERS—A booklet giving dimensions, specifications, and shunts used with various meters. BURTON-ROGERS COMPANY.
36. CHARGING A AND B BATTERIES—Various ways of connecting up batteries for charging purposes. WESTINGHOUSE UNION BATTERY COMPANY.
37. WHY RADIO IS BETTER WITH BATTERY POWER—Advice on what dry cell battery to use; their application to radio, with wiring diagrams. NATIONAL CARBON COMPANY.
53. TUBE REACTIVATOR—Information on the care of vacuum tubes, with notes on how and when they should be reactivated. THE STERLING MANUFACTURING COMPANY.
69. VACUUM TUBES—A booklet giving the characteristics of the various tube types with a short description of where they may be used in the circuit. RADIO CORPORATION OF AMERICA.
87. TUBE TESTER—A complete description of how to build and how to operate a tube tester. BURTON-ROGERS COMPANY.
92. RESISTORS FOR A. C. OPERATED RECEIVERS—A booklet giving circuit suggestions for building a c. operated receiver, together with a diagram of the circuit used with the new 400-milliampere rectifier tube. CARTER RADIO COMPANY.
102. RADIO POWER BULLETINS—Circuit diagrams, theory constants, and trouble-shooting hints for units employing the BH or B rectifier tubes. RAYTHEON MANUFACTURING COMPANY.
103. A. C. TUBES—The design and operating characteristics of a new a. c. tube. Five circuit diagrams show how to convert well-known circuits. SOVEREIGN ELECTRIC & MANUFACTURING COMPANY.
58. HOW TO SELECT A RECEIVER—A commonsense booklet describing what a radio set is, and what you should expect from it, in language that any one can understand. DAY-FAN ELECTRIC COMPANY.
67. WEATHER FOR RADIO—A very interesting booklet on the relationship between weather and radio reception, with maps and data on forecasting the probable results. TAYLOR INSTRUMENT COMPANIES.

In sending the coupon below, make sure that your name and address are included and are plainly written.

USE THIS BOOKLET COUPON	
RADIO BROADCAST SERVICE DEPARTMENT RADIO BROADCAST, Garden City, N. Y. Please send me (at no expense) the following booklets indicated by numbers in the published list above:	
.....	
.....	
Name.....	
Address.....	
(Number)	(Street)
.....	
(City)	(State)
ORDER BY NUMBER ONLY	
This coupon must accompany every request. RB 7-28	

73. RADIO SIMPLIFIED—A non-technical booklet giving pertinent data on various radio subjects. Of especial interest to the beginner and set owner. CROSLLEY RADIO CORPORATION.
76. RADIO INSTRUMENTS—A description of various meters used in radio and electrical circuits together with a short discussion of their uses. JEWELL ELECTRICAL INSTRUMENT COMPANY.
78. ELECTRICAL TROUBLES—A pamphlet describing the use of electrical testing instruments in automotive work combined with a description of the cadmium test for storage batteries. Of interest to the owner of storage batteries. BURTON ROGERS COMPANY.
95. RESISTANCE DATA—Successive bulletins regarding the use of resistors in various parts of the radio circuit. INTERNATIONAL RESISTANCE COMPANY.
96. VACUUM TUBE TESTING—A booklet giving pertinent data on how to test vacuum tubes with special reference to a tube testing unit. JEWELL ELECTRICAL INSTRUMENT COMPANY.
98. COPPER SHIELDING—A booklet giving information on the use of shielding in radio receivers, with notes and diagrams showing how it may be applied practically. Of special interest to the home constructor. THE COPPER AND BRASS RESEARCH ASSOCIATION.
99. RADIO CONVENIENCE OUTLETS—A folder giving diagrams and specifications for installing loud speakers in various locations at some distance from the receiving set. YAXLEY MANUFACTURING COMPANY.
105. COILS—Excellent data on a radio-frequency coil with constructional information on six broadcast receivers, two short-wave receivers, and several transmitting circuits. AERO PRODUCTS COMPANY.
106. AUDIO TRANSFORMER—Data on a high-quality audio transformer with circuits for use. Also useful data on detector and amplifier tubes. SANGAMO ELECTRIC COMPANY.
108. VACUUM TUBES—Operating characteristics of an a. c. tube with curves and circuit diagram for connection in converting various receivers to a. c. operation with a four-prong a. c. tube. ARCTURUS RADIO COMPANY.
109. RECEIVER CONSTRUCTION—Constructional data on a six-tube receiver using restricted field coils. BODINE ELECTRIC COMPANY.
110. RECEIVER CONSTRUCTION—Circuit diagram and constructional information for building a five-tube set using restricted field coils. BODINE ELECTRIC COMPANY.
111. STORAGE BATTERY CARE—Booklet describing the care and operation of the storage battery in the home. MARKO STORAGE BATTERY COMPANY.
112. HEAVY-DUTY RESISTORS—Circuit calculations and data on receiving and transmitting resistances for a variety of uses, diagrams for popular power supply circuits, d. c. resistors for battery charging use. WARD LEONARD ELECTRIC COMPANY.
113. CONE LOUD SPEAKERS—Technical and practical information on electro-dynamic and permanent magnet type cone loud speakers. THE MAGNAVOX COMPANY.
114. TUBE ADAPTERS—Concise information concerning simplified methods of including various power tubes in existing receivers. ALDEN MANUFACTURING COMPANY.
115. WHAT SET SHALL I BUILD?—Descriptive matter, with illustrations, of fourteen popular receivers for the home constructor. HERBERT H. FROST, INCORPORATED.
104. OSCILLATION CONTROL WITH THE "PHASATROL"—Circuit diagrams, details for connection in circuit, and specific operating suggestions for using the "Phasatrol" as a balancing device to control oscillation. ELECTRAD, INCORPORATED.
116. USING A B POWER UNIT—A comprehensive booklet detailing the use of a B power unit. Tables of voltages—both B and C—are shown. There is a chapter on trouble-shooting. MODERN ELECTRIC MFG. CO.
117. BEST RESULTS FROM RADIO TUBES—The chapters are entitled: "Radio Tubes," "Power Tubes," "Super Detector Tubes," "A. C. Tubes," "Rectifier Tubes," and "Installation." GOLD SEAL ELECTRICAL CO.
118. RADIO INSTRUMENTS, CIRCULAR "J"—A descriptive manual on the use of measuring instruments for every radio circuit requirement. A complete listing of models for transmitters, receivers, set servicing, and power unit control. WESTON ELECTRICAL INSTRUMENT CORPORATION.
120. THE RESEARCH WORKER—A monthly bulletin of interest to the home constructor. A typical feature article describes the construction of a special audio amplifier—AERVOX WIRELESS CORPORATION.
121. FILTER CONDENSERS—Some practical points on the manufacture and use of filter condensers. The difference between inductive and non-inductive condensers. POLYMET MFG. CORP.
122. RADIO TUBES—Specifications and operating characteristics of vacuum tubes. Twenty-four pages. E. T. CUNNINGHAM, INC.
123. B SUPPLY DEVICES—Circuit diagrams, characteristics, and list of parts for nationally known power supply units. ELECTRAD, INC.
124. POWER AMPLIFIER AND B SUPPLY—A booklet giving several circuit arrangements and constructional information and a combined B supply and push-pull audio amplifier, the latter using 210 type tubes. THORADSON ELECTRIC MFG. CO.
125. A. C. TUBE OPERATION—A small but complete booklet describing a method of filament supply for a. c. tubes. THORADSON ELECTRIC MFG. CO.
126. MICROMETRIC RESISTANCE—How to use resistances for: Sensitivity control; oscillation control; volume control; regeneration control; tone control; dete tor plate voltage control; resistance and impedance coupling; loud speaker control, etc. AMERICAN MECHANICAL LABORATORIES.
127. VITROHM NEWS—A monthly bulletin dealing with the resistance problems of the home constructor and experimenter. WARD LEONARD ELECTRIC CO.
128. SANGAMO CONDENSERS—A helpful table for converting capacities from microfarads to micromicrofarads. SANGAMO ELECTRIC CO.
129. TONE—Some model audio hook-ups, with an explanation of the proper use of transformers and chokes. SANGAMO ELECTRIC CO.
130. SCREEN-GRID AUDIO AMPLIFICATION—Diagrams and constructional details for remodeling old audio amplifiers for operation with screen-grid tubes. THORADSON ELECTRIC MFG. CO.

**SM**

# *New!* SHORT WAVE SET! PUBLIC ADDRESS AMPLIFIER!

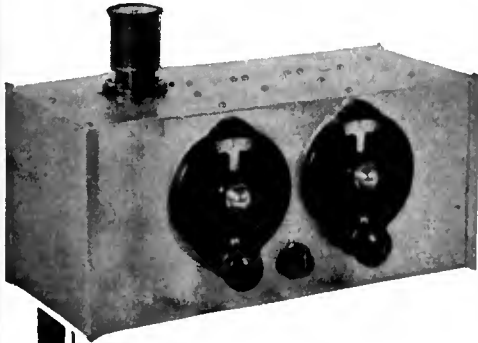

## “Round the World Four”

**A**ND now—an entirely new type of short wave receiver is ready, incorporating all of the sound engineering principles and advanced developments that have made S-M the most popular quality parts today. Heralding Silver-Marshall's definite entry into the short wave field, the new “Round the World Four” and “Round the World Adapter” introduce advanced features and an entirely new design technique. This set, the first to include screen

grid R. F. amplification with one-dial tuning for a range of 17.4 to 204 meters, is simply irresistible. Completely shielded in a thick aluminum cabinet, it can be had as a two-tube tuner to adapt any standard set to short wave reception, or as a complete 4-tube set with loud speaker range of half way round the world and back.

These new S-M short wave sets are the first to be offered designed especially for broadcast and phone reception primarily, and for code secondarily. They alone have the smooth regeneration control that provides the enormous sensitivity necessary to long distance voice and music reception—yet they are absolutely non-radiating.

If you're after the thrill of real, world-wide DX, the “Round the World Four” is the set for you. Amateur station 9VS reported loud-speaker reception from six continents in an evening. Station 9BBW, operating the set, conducted amateur two-way communication with Germany, France, England, and Italy in one evening. In daylight, east and west coast amateur stations are heard in Chicago—Nauen, Germany, and England come in like locals. Five, ten, fifteen, and fifty-watt amateur telephones all over America and Canada are regular reception on the “Round the World Four.”

Type 730 “Round the World Four” kit, ready to assemble, including all parts and cabinet just as illustrated, is \$51.00. Type 731 is the two-tube “Round the World Adapter” kit, to adapt any broadcast set to long distance short wave reception, and is priced at \$36.00 complete, with identical aluminum cabinet. Price, 131T, -U, -V, and -W. coils, tuning from 17.4 to 204 meters, \$1.25 each, or \$5.75 for set of four plug-in coils with 512 socket. Type 130 winding forms cost but 50 cents each. Type 732 “Round the World” essential kit includes all above coils, coil socket, .00014 tuning condenser, .00035 tickler condenser, and three R. F. choke coils, with complete instructions, \$16.50.

## 685 Public Address Unipac

**T**HE S-M type 685 Public Address Unipac is a high power socket-power amplifier that can be heard by from 2,000 to 30,000 people at once. It will operate one to twelve loud speakers and can be used interchangeably for voice, phonograph record or radio amplification. Good electrically cut symphony orchestra or jazz band records will be reproduced at volume equal to or greater than original, and with tone both natural and perfect.

Using the microphone, clear, understandable announcements or speeches can be made to crowds of 5,000 to 10,000 people, either indoors or outdoors. Record or radio music can be heard half a mile away on clear days.

Type 685 Unipac fills a long-felt want for an economical portable or permanent public address amplifier. It is complete in itself, requiring only one UX226, one UY227, one UX250, and two UX281 tubes and connection to a 110 volt, 60 cycle lamp socket for operation. Any speakers may be used, with any microphone, radio set, or magnetic record pick-up.

With political conventions, sporting events and elections coming on, for the wide-awake experimenter there is a wide and profitable market, both in sale and rental, to conventions, lodges, clubs, theatres, schools, churches, amusement parks, dance halls, and many other places. For thoroughly high quality outdoor demonstrations the 685 Unipac has no equal. (685 Unipac is not suited to nor intended for home use.)

Price, factory assembled, ready to use, less tubes and accessories, \$160.00. Type 685 Kit, ready to assemble, with complete instructions, is priced at \$124.00.

**SILVER-MARSHALL, Inc.**  
870 W. Jackson Blvd., CHICAGO, U. S. A.

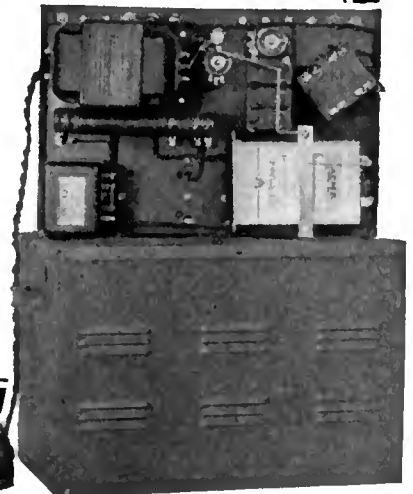

For 6c in stamps, complete constructional data sheets will be mailed.

# FAHNESTOCK CLIPS

RADIO'S GREATEST CONVENIENCE

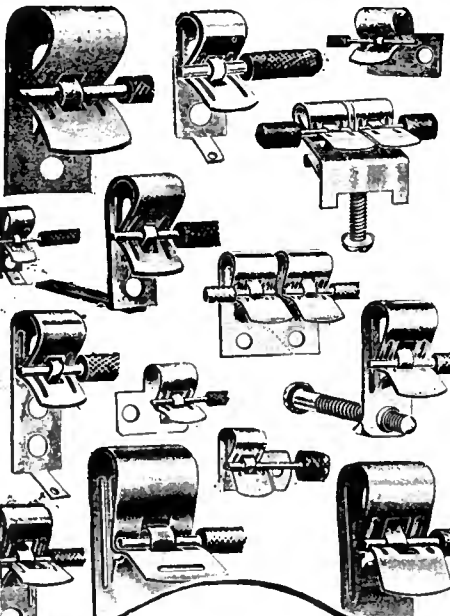

Accepted as standard by the most exacting and conscientious manufacturers

There are 48 standard sizes and styles to meet any requirement. The largest manufacturers of radio apparatus depend upon our unexcelled facilities and our ability to supply them with any quantity of clips on short notice. They save you time and expense and add to the convenience of your products. Send us specifications and blue prints to meet special requirements. Genuine Fahnestock Clips have our name stamped on the thumb piece.

The World's Largest Makers of Clip Terminals



**FAHNESTOCK ELECTRIC CO.**  
L.I. City - New York

## The Radio Broadcast

# LABORATORY INFORMATION SHEETS

THE RADIO BROADCAST Laboratory Information Sheets are a regular feature of this magazine and have appeared since our June, 1926, issue. They cover a wide range of information of value to the experimenter and to the technical radio man. It is not our purpose always to include new information but to present concise and accurate facts in the most convenient form. The sheets are arranged so that they may be cut from the magazine and preserved for constant reference, and we suggest that each sheet be cut out with a razor blade and pasted on 4" x 6" filing cards, or in a notebook. The cards should be arranged in numerical order. In July, 1927, an index to all sheets appearing up to that time was printed. Last month we printed an index covering the sheets published from August, 1927, to May, 1928, inclusive.

All of the 1926 issues of RADIO BROADCAST are out of print. A complete set of sheets, Nos. 1 to 88, can be secured from the Circulation Department, Doubleday, Doran & Company, Inc., Garden City, New York, for \$1.00. Orders for the next set following can also be sent. Some readers have asked what provision is made to rectify possible errors in these sheets. In the unfortunate event that any serious errors do occur, a new Laboratory Sheet with the old number will appear.

—THE EDITOR.

No. 201

RADIO BROADCAST Laboratory Information Sheet

July, 1928

### Tube Life

#### EFFECT OF EXCESSIVE LINE VOLTAGE

THE life obtained from a vacuum tube depends very much upon the filament voltage at which it is operated, for voltages slightly above normal produce a marked decrease in life. This is true of all types of tubes, a. c. or d. c., storage-battery or dry-cell-operated. In a battery-operated receiver we are able to control the filament voltage applied to the tubes quite accurately and normal life is therefore generally obtained from the ordinary types of storage-battery or dry-cell tubes. In an a. c.-operated receiver, however, where the filament voltages are obtained directly from the power lines, the operator of the receiver has little or no control over the filament voltage applied to the a. c. tubes. Most filament transformers are designed for a line voltage of about 115 but in many communities, rural ones especially, voltages in excess of this are frequently encountered. This higher line voltage of course affects the output voltages of the filament transformer so that the tubes are subjected to a filament voltage above normal.

It is suggested that experimenters working on a. c.-operated receivers include in the circuit some device which will enable them to control the voltage applied to the filament transformer. In cases where the line

voltage is found to vary considerably so that at times it is above normal and at other times normal or below normal, it will be preferable to include in the circuit a variable resistance in the primary side of the filament transformer having a value of about 25 ohms. In those cases where the line voltage is found to be above normal but constant at this value, a fixed resistance may be placed on the primary side of the filament transformer to absorb the excess voltage so that the transformer receives its rated voltage or slightly less, for it has been found that a. c. tubes will generally give satisfactory service on somewhat less than the operating voltage at which they are rated.

When remedies for excessive line voltage, such as we have suggested here, are made use of, each case must be treated more or less individually, and when, as is usually the case, the line voltage is not constant, a manually controlled resistance may be essential. These facts have been appreciated by many receiver and parts manufacturers. It is probable that devices will soon be available to home constructors which when placed in the primary side of a transformer will automatically control the voltage actually applied to the receiver, so that the tubes will always receive rated voltage despite fluctuations in the actual line voltage.

No. 202

RADIO BROADCAST Laboratory Information Sheet

July, 1928

### Farm Lighting Systems

#### AS A SOURCE OF FILAMENT CURRENT

THIS Laboratory Sheet is provided in response to requests from several readers for information on how to make use of power from a farm-lighting installation for the operation of the filaments of the tubes in a radio receiving set.

Farm-lighting systems are of two types, those using a generator powered by a gas engine in which the energy for the lights is obtained directly from the generator and those systems in which the generator is used to charge a bank of storage batteries which in turn supply energy for lighting. The voltages of these systems are generally either 32 or 110 volts.

To make use of this current in the radio receiver it is necessary to reduce the voltage by means of the resistance, *R*, the value of the resistance depending upon the number of tubes in the set and upon the voltage of the supply, as indicated below.

#### 32 VOLT SYSTEM 110 VOLT SYSTEM

NO. OF TUBES IN RECEIVER	32 VOLT SYSTEM		110 VOLT SYSTEM	
	<i>R</i> IN OHMS	WATTS IN <i>R</i>	<i>R</i> IN OHMS	WATTS IN <i>R</i>
1	51	15	190	57
2	35	22	130	84
3	27	30	100	105
4	21	37	80	135
5	18	43	65	160
6	15	50	58	90
7	13	57	50	210
8	12	66	45	240

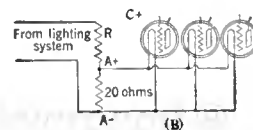
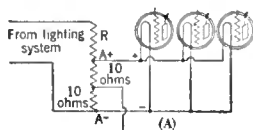

Two circuits are given, circuit B being the easier to use, but sometimes with this arrangement there may be some hum audible in the loud speaker. In such a case it is necessary to use circuit A.

With circuit B it is simply necessary to connect the resistance *R* in series with a 20-ohm resistor and connect the plus and minus A terminals to the corresponding terminals in the radio receiver.

Using circuit B the same changes must be made but in addition the B minus and C plus leads are removed from where they connect on the receiver and are connected instead to the center point of the 20-ohm resistor. When this arrangement is used the C voltages should all be increased by minus 3 volts to compensate the positive bias produced with the C plus and B minus leads connected to the center tap.

# AMERTRAN PF-250

Power Transformer  
for  
UX 250 Power Tubes

A husky transformer built for doing the job, not for looks. The PF-250 is rated at 1200-600 volts plate, 7½ volts power tube, 7½ volts rectifier tube filament. Center taps are provided on each of the filament windings. Continuous rated capacity of plate windings, 160 MA., continuous rated capacity of each 7½ volt winding, 3 Amperes. DC plate output with two UX 281's full wave, up to 450 volts with sufficient excess for "C" Bias.

Ask for Bulletin No. 1033 describing fully the PF-250.

Price, each—\$30.00  
Slightly higher West of Rocky Mountains

American Transformer Co.  
Transformer Builders for more than 28 Years  
201 Emmet St., Newark, N. J.



## AERO Corona Coil

Used in New  
Cooley "Rayfoto"

Of course the new Cooley "Rayfoto" uses an AERO Inductance Coil. This special coil is designed to meet the exact specifications of A. G. Cooley, whose "Rayfoto" receiver so many experimenters will build. For every inductance requirement AERO Coils are proved best—by experts and amateurs as well. Always specify AERO Coils if you want the finest in radio performance.

AERO PRODUCTS, Inc.  
1722 Wilson Avenue Chicago, Ill.

## NATIONAL CO. INC., Announces

A new precision Dial with type A Velvet Vernier Mechanism, German Silver face and precision Vernier, for Short-Wave Radio Use.

A new Short-Wave Condenser, built on the NATIONAL Girder Frame with pigtail and wide spacing for high voltages.

A new 2000 volt Transmitting Condenser, Pyrex Insulated.

Write us for Bulletin B-130

National Company Inc.  
W. A. Ready, Pres. Malden, Mass.



# Approved Parts

## Transformers, Chokes and Condensers

For the  
New UX #250 Power Amplifier Tubes

For the popular new UX #250 P. A. Tube Dongan laboratories have perfected a complete line of power unit parts. You can assure yourself of the maximum in performance with the proper Dongan parts, designed especially for use with this tube.

Illustrating No. 1177 Output Transformer. Chokes and Condensers are also mounted in matched cases similar to the one shown here.



Description of the Dongan Parts, used with the UX 250 Tube, is given in detail in this issue of Radio Broadcast.

- #7568—A power supply transformer.
- #1177—A straight power amplifier output transformer.
- #1176—An output transformer for push pull amplification, designed for all types of dynamic speakers.

## Condensers and Chokes for the complete Filter Circuits

Set Manufacturers and Custom Set Builders  
You are invited to consult the Dongan engineering department for any desired information for your particular requirements. Production on all types assures satisfactory deliveries.

See our Exhibit—Booth 152—R. M. A. Show

DONGAN ELECTRIC MANUFACTURING CO.  
2991-3001 Franklin Street  
Detroit

TRANSFORMERS of MERIT for FIFTEEN YEARS

### Helpful Technical Information

A regular feature of RADIO BROADCAST is the series of Laboratory Information Sheets, which cover a wide range of information of immediate value to every radio worker, presented in a form making it easy to preserve them. To insure your having every issue, send your check for \$4.00 for one year's subscription, to

Subscription Department, Doubleday, Doran & Co.,  
Garden City, N. Y.

## RADIO PANELS

BAKELITE—HARD RUBBER

Cut, drilled and engraved to order. Send rough sketch for estimate. Our complete Catalog on Panels, Tubes and Rods—all of genuine bakelite or Hard Rubber—mailed on request.

STARRETT MFG. CO.  
521 S. Green Street Chicago, Ill.

## Cardwell Condensers

ARE

**RUGGED —  
SIMPLE —  
STRONG —**

They are used and specified by the leaders—the Giants of Radio—not where a few pennies count in meeting competition, but when performance is a serious business and reputations are at stake. Need we suggest the reason?

RECEIVING CONDENSERS  
TRANSMITTING CONDENSERS

Write For Literature or  
State Your Requirements

The Allen D. Cardwell Mfg. Corp.  
81 Prospect Street Brooklyn, N. Y.  
Dent. B

for  
**BETTER RADIO**

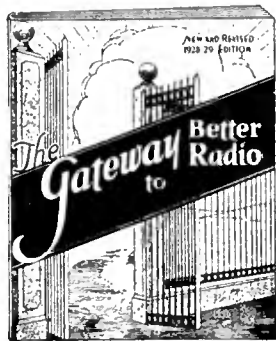

A manual of 36 pages and cover—with 88 illustrations and over 20,000 words of practical, concise, readily understood text—prepared by Austin C. Lescaurba in collaboration with our engineering staff. "The Gateway to Better Radio" tells what's what for bettering your radio receiver, amplifier or power unit! what's what in A-C tubes, short-wave reception, improved tone quality, added sensitivity and so on! and what's what in interpreting radio circuits and innovations for best results. Usable. Unselfish. Unbiased. Just the plain radio truth, such as you can put to work. All for 25 cents, to defray mechanical costs of publishing!

Order your copy of this manual now—before it is out of print—from your local radio dealer, or direct from us by remitting 25c in stamps or coin

American Mechanical Laboratories, Inc.  
Specialists in Variable Resistors  
285-7 N. Sixth St. Brooklyn, N. Y.

**-CLAROSTAT-**  
Reg. U. S. Pat. Office

**Solve All B Eliminator Problems!**

- Can you adapt a B eliminator to various receivers?
- Can you calculate resistances for various output voltages?
- Do you understand B eliminator design?
- Can you effect economy when constructing a B eliminator?
- Do you know how to use B eliminator parts most economically?

An 86-page "Laboratory Treatise on B Eliminator Design and Construction" has been written by John F. Rider, a national authority on radio practice and design . . . 86 pages just full of data and 71 wiring diagrams you can easily understand. Every possible question pertaining to B eliminators is answered . . . every phase of B eliminator design and construction is considered. Price \$1.00.

This book will save you money!

**RADIO TREATISE CO.**

270 Madison Ave. New York City

MAIL THIS COUPON

Here is my \$1.00 for the "B Eliminator Treatise" to be mailed postpaid to

Name .....

Address .....

City ..... State .....

No. 203

RADIO BROADCAST Laboratory Information Sheet

July, 1928

**Tuned Circuits**

CALCULATING EFFECTIVE RESISTANCE

LABORATORY Sheet No. 198 published in the June issue explained how to calculate the gain of a radio-frequency amplifier using a screen-grid tube. In calculating the gain we had to make use of the factor  $R$  which denoted the effective resistance of a tuned circuit at resonance. In this Sheet we will explain how this effective resistance is calculated.

A simple tuned circuit is indicated in the sketch and it can be proved mathematically that, at resonance, the circuit between points  $a$  and  $b$  acts like a high resistance with a value equal to

$$R = \frac{\omega^2 L^2}{r}$$

where

$R$  is the effective resistance of the circuit at resonance as measured between points  $a$  and  $b$

$\omega$  is equal to  $2\pi$  times the frequency

$L$  is the inductance of the coil in henries  
 $r$  is the series resistance of the circuit.  
The value  $r$  is the series resistance of the tuned circuit when actually connected in a tube circuit.

EXAMPLE: What is the effective resistance of a tuned circuit whose resonant frequency is 1000 kc. (300 meters), the series resistance of the circuit being 20 ohms and the inductance of the coil 0.25 millihenries (0.00025 henries)

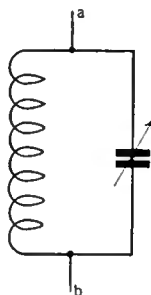

$$R = \frac{(2\pi \times 1,000,000)^2 (0.00025)^2}{20}$$

= 115,000 ohms, effective resistance

If this circuit were to be used in conjunction with a screen-grid tube the gain, calculated using the formula given in Sheet No. 198 would be:

$$\text{Gain} = G_m \times R$$

$$= 0.000350 \times 115,000$$

$$= 40$$

No. 204

RADIO BROADCAST Laboratory Information Sheet

July, 1928

**Line Voltage Variations**

EFFECT ON TUBE LIFE

LETTERS from readers have been received by the Laboratory from time to time to the effect that the life of the 171 type tube used in their power unit was very short, sometimes lasting only about 100 hours. The normal life of a 171 type tube should be at least 1000 hours. The probable cause, in many cases, of such short life is excessive filament voltage.

The transformer in a power unit is designed generally to operate with a line voltage of 110 volts a.c. With this voltage across the primary the voltage across the filament terminals of the 171 type power amplifier should be 5 volts. If the voltage across the primary is less than 110 volts, then the voltage across the filament of the tube is less than 5 volts and conversely, with input voltages higher than 110 volts the voltage across the filament of the tube will be excessive, i.e., more than 5 volts.

If the filament voltage drops very much, the electronic emission from the filament will decrease and distortion of the signal will result. If, on the other hand, the filament voltage is excessive, the output of the system is not audibly affected and so with no audible indication of the excessive voltage,

it is likely that it will go by unnoticed. It is excessive filament voltage which must be guarded against however, if a normal length of life is to be obtained from any tube.

The extent of the fluctuations in line voltage is, of course, different in different parts of the country—in large cities the voltage is generally quite constant, while in rural communities comparatively large variations in line voltage are probable.

These problems, brought about by inconstancy of line voltage, are becoming more serious as the use of a.c. operated receivers becomes more popular. In such receivers, all of the tubes are operated directly from the power line and decreased tube life due to excessive filament voltage is to be carefully guarded against.

The solution of these difficulties lies in the design of a device which will automatically control the voltage actually applied to a power unit. The type 886 tube is a device of the sort, designed to insure constant input to power operated radio receivers, despite fluctuations in line voltage. Several devices to accomplish regulation by other means are also being developed by other manufacturers and will probably be available shortly.

No. 205

RADIO BROADCAST Laboratory Information Sheet

July, 1928

**Electrical Measuring Instruments**

THE GALVANOMETER

THIS is the first of a series of Laboratory Information Sheets to be devoted to the subject of electrical measuring instruments. In this Laboratory Sheet we discuss what is probably the oldest instrument for measuring current and voltage. This instrument is the galvanometer, and most of our modern ammeters and voltmeters are merely adaptations in one form or another of the galvanometer.

The galvanometer in its earliest form consisted of a compass needle suspended in the center of a coil of wire. When a current passed through the coil the compass needle was deflected from its normal position. It was termed a tangent galvanometer, for the current flowing in the coil is proportional to the tangent of the angle through which the needle is deflected. The tangent galvanometer is not very sensitive and, finding no practical use to-day, its major interest is historical.

Sir William Thomson (Lord Kelvin) did considerable work to improve the galvanometer and succeeded in developing an instrument of high sensitivity. Instruments made in accordance with his recommendations are known as Thomson galvanometers. Thomson made use of two coils in his galvanometer arranged to neutralize each other and found it possible to make the needle of the instru-

ment move with only an exceedingly small current flowing in the coils. Galvanometers of this type have been made so sensitive that a billionth of an ampere would cause the pointer to deflect. A Thomson galvanometer, although very sensitive, has the disadvantage that in its simplest form it does not return to the zero point very quickly when the current flow through the coil is stopped and also the pointer oscillates back and forth for quite a long period of time before it finally comes to rest at any position. Thomson galvanometers can be made more satisfactory by attaching a vane to the suspension so that the air resistance created as the vane turns tends to bring the galvanometer to rest more quickly. This mechanical type of "damping" is the only type that can be applied to the Thomson galvanometer and for this reason another form of the instrument has come into more general use, known after its inventor as the D'Arsonval galvanometer.

In the Thomson galvanometer we had a stationary coil and a moving magnetic needle; in the D'Arsonval type we use a stationary magnet and a moving coil. The magnet is a very strong one and the coil moves in a small air gap in the magnetic circuit. The constructional features of such an instrument will be given in a Sheet to follow this.



**Never Wears Out**

Your first cost is the only cost. Then why not enjoy permanently the better tube performance and prolonged tube life alone offered by

**AMPERITE**

REG. U. S. PAT. OFF.

**The "SELF-ADJUSTING" Rheostat**

Keeps filament voltage constant despite "A" battery variations. Simplifies wiring, panel design, tube control, tuning. Insist on AMPERITE. Nothing else can possibly perform as well. Unconditionally guaranteed.

Price \$1.10 with Mounting, (in U. S. A.)  
For sale by all dealers.

**RADIALL CO.**  
50 Franklin St., N. Y.

**FREE**  
"Amperite Book" of latest circuits and construction data.  
Write Department R. H. - 7

**FERRANTI**

**Audio Frequency Transformers and Chokes**

There is a Ferranti for every audio requirement. Each unit is built to the highest standards and tested to 1,000 volts throughout.

The 1928 Ferranti Year Book contains 60 pages of helpful information, with instructions for building receivers, power amplifiers, etc.

Mailed anywhere for 15c in coin, stamps not accepted.

**FERRANTI, INC.**  
130 W. 42nd St. New York, N. Y.

**Master the Code**



Wireless or Morse—at home with the Teleplex Automatic Code Instructor. No better method for self-instruction exists. Quick—Easy—Thorough. Endorsed by U. S. Navy. The only instrument that reproduces actual sending—messages, Radiograms, etc. Any speed. Complete Course (6 tapes) FREE. Thirty times as many words as any other instrument. Avail yourself of the Teleplex for a quick mastery of the code. Write for booklet BR. TELEPLEX CO., 76 Cortlandt St., New York.

**BROADCASTING FROM THE INSIDE**

EVERY month in RADIO BROADCAST appears the department "As the Broadcaster Sees It," written by Carl Dreher, one of the best known broadcast engineers in the country. Alive with humor, news, apt and searching comment, Mr. Dreher's writings have become one of the most popular features of radio writing anywhere. Are you reading it? Subscribe by the year and make sure of not missing a single issue. Mail your check for \$4.00 to Subscription Department, Doubleday, Doran & Co., Inc., Garden City, N. Y.

**BROWNING-DRAKE**

Plans for the coming season are now ready for dealers. A wonderful new line of receivers, loud speakers and kit parts has just started Browning-Drake on its greatest year.

**BROWNING-DRAKE CORP.**  
CAMBRIDGE, MASS.

**TOBE SIMPLIFIED A SUPPLY**

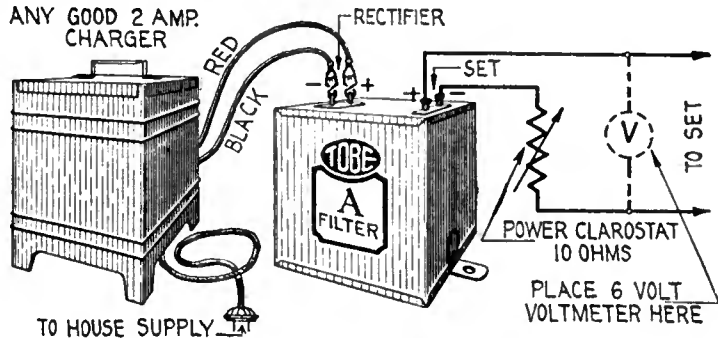

An A FILTER consisting of a new and different DRY condenser of 7600 Mfd. with two especially designed choke coils of proper size combined in one unit to supply HUMLESS A CURRENT to any radio set.

This new filter can be attached to any good two-ampere charger as shown, for completely eliminating the A Battery.

Without a charger, only a rectifier and step down transformer are needed to assemble this eliminator in a few moments as the principal wiring is done inside of the TOBE A FILTER.

TOBE A CONDENSER is also sold separately.

TOBE-A-FILTER \$18.00. TOBE-A-CONDENSER \$6.00

For sale by all the better dealers.

**TOBE DEUTSCHMANN COMPANY**  
11 WINDSOR ST., CAMBRIDGE, MASS.

Please send me Pamphlet B-1 on your new A FILTER and A CONDENSER.

Name .....

Address .....

**POWER AND QUALITY**

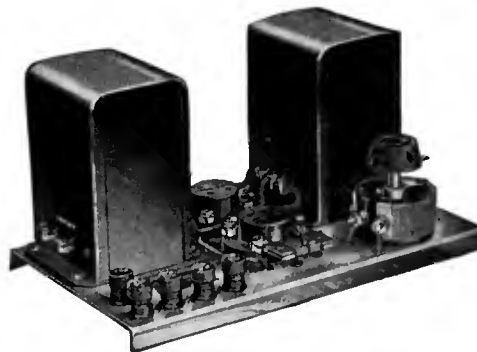

Type 441 Push-Pull Amplifier

A PUSH-PULL amplifier in the last stage provides the speaker with ample power to sustain a high volume level without tube overloading, transmitting the full effects of large swings in intensity common in orchestra music.

**TYPE 441 AMPLIFIER**

For use with UX 226, CX 326, UX 171, CX 371, UX 210 or CX 310 tubes

Input inductance .....	30 henries
Input turns ratio .....	1:2.25
Output impedance ratio .....	10:1
(whole primary to secondary)	

Price, completely wired - - - \$20.00

Licensed by the Radio Corporation of America for radio, amateur, experimental and broadcast reception only, and under the terms of the R. C. A. license the unit may be sold only with tubes.

**GENERAL RADIO COMPANY**

We welcome your correspondence in regards to technical problems. Bulletin No. 929 describing our complete line of radio parts will be sent on request.

30 State St., Cambridge, Mass. 274 Brannan St., San Francisco, Cal.

# "Ionized Helium"



**List Price \$4.50**

**RAYTHEON TYPE BH**

## THE SECRET OF THE STANDARD REPLACEMENT TUBE for "B" ELIMINATORS

The use of Ionized Helium, gives to the Raytheon "BH" Tube a superior ruggedness, a far longer life and a sustained voltage. Be sure you get a Raytheon BH for your eliminator when the tube needs replacing which is generally every nine to twelve months.

**Raytheon**  
LONG LIFE RECTIFYING TUBE

No. 206

RADIO BROADCAST Laboratory Information Sheet

July, 1928

### A Screen-Grid Resistance-Coupled Amplifier

**ITS FREQUENCY CHARACTERISTIC**  
THE frequency characteristic of a resistance-coupled amplifier using screen-grid tubes is included on this sheet and indicates clearly the excellent quality which such an amplifier is capable of delivering. The screen-grid amplifier used in making this curve was described in the June, 1928, Laboratory Information Sheets Nos. 195 and 196.

The frequency characteristic which is obtained from an amplifier of this type depends upon several factors. One of the most important is the voltages at which the screen-grid tubes are operated. The power unit supplying the amplifier should be capable of delivering 135 to 180 volts and the screen-grid voltage should generally be 22½ although 45 volts is satisfactory if the 180 volts is used. This curve was made using 0.25-megohm plate resistors, 2.0-megohm grid resistors and 0.01-mfd. coupling condensers.

The high-frequency response of the amplifier would be poorer with higher values of coupling resistance because under such conditions the input

and output capacities of the tubes, forming a shunt around the resistors, would produce a decrease in high-frequency response. The high-frequency response in this screen-grid amplifier is much better than is ordinarily obtained from a resistance-coupled amplifier using type 240 tubes. There is this to say, however, that the high-frequency response of this amplifier as indicated by the curve on this sheet is really better than it need be, for frequencies above 6000 or 7000 cycles do not contribute very much to the naturalness of the reproduction.

The low frequency response of the amplifier is determined by the size of the coupling condenser; the smaller the capacity the poorer the low-frequency response. The value of 0.01 mfd. which was used is evidently satisfactory judging from the curve, and probably values considerably smaller than 0.01 mfd. would also be satisfactory.

The high gain of this amplifier has some disadvantages which were pointed out in Laboratory Sheet No. 195 to which we refer the reader for further information.

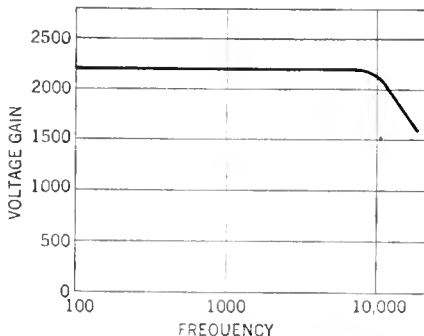

No. 207

RADIO BROADCAST Laboratory Information Sheet

July, 1928

### Equalizing Wire Lines for Broadcasting

VALUES INVOLVED

IT IS obvious that the fidelity of reproduction obtained from a radio receiver cannot be any better than that transmitted by the broadcasting station and in discussing the subject it is therefore of value to know what frequencies are at present being transmitted by the better broadcasting stations. Some data on this subject was published in the article by C. E. Dean in the June, 1928, RADIO BROADCAST.

What frequencies are transmitted by broadcasting stations depends, among other things, upon the audio-frequency characteristics of the apparatus—microphones, amplifiers, modulators—used at the broadcasting station and upon the characteristics of the wire lines used to connect the broadcasting studio with the transmitter. Many of the better transmitting stations are now located outside of cities and therefore must use a wire connection between the transmitter and the studios located within the city. At the present time the characteristic of the wire lines is very important in determining what audio frequencies will finally be impressed upon the carrier wave.

The wire lines used with the broadcasting stations

are at present equalized, that is made to transmit equally well, frequencies from 100 cycles to 5000. The characteristic of these lines below 100 cycles is probably quite good, but in no case can it be certain that a station is actually transmitting any frequencies, at their proper amplitude, below about 100 or above about 5000.

It is certain that as better loud speakers become available capable of reproducing frequencies below and above the limits given above that higher and lower frequencies will be included in the transmissions of broadcasting stations. In fact we may expect that the characteristics of the wire lines will be improved even before such loud speakers are generally available. The Telephone Company controlling the wire lines has always followed a policy of being prepared to furnish lines better than are actually essential at the time, considering the quality of the remainder of the apparatus included in the link between the microphone in the studio and the loud speaker at the listener's home.

A wire line ordinarily tends to transmit the lower frequencies much better than the higher frequencies and it is therefore the function of the equalizer to lower the high-frequency response so that a flat characteristic is obtained over the entire band.

## Big, New Summer Radio Catalog

Dealers — Set Builders — Agents

Write for this Catalog. New Summer and Fall Book. Save money on newest hookups, sets, kits, parts, accessories at lowest prices.

The "Big, Friendly Radio House"

**WESTERN RADIO MFG. COMPANY**

126 W. Lake St. Dept. 47 Chicago, Ill.

No. 208

RADIO BROADCAST Laboratory Information Sheet

July, 1928

### Power Values in Radio Receiving Antennas

RELATION OF DISTANCE AND MEASURED RECEIVER VOLTAGE

IT IS interesting to compare the amount of power ordinarily intercepted by a radio receiving antenna with the power which is required to operate an ordinary 60-watt incandescent lamp, for example. In Professor Morecroft's book, *The Principles of Radio Communication*, some figures are given for the amount of current in a receiving antenna which had a resistance of about 60 ohms. In the figures which he gives for received antenna current, we find that when the receiver was located about a mile from the particular transmitter which was used (the power rating of the transmitter is not given) that the current in the receiving antenna was approximately 70 microamperes. If we square this current and multiply it by the resistance of the receiving antenna which is 60 ohms, we obtain the power in the receiving antenna, which proves to be approximately  $3 \times 10^{-9}$  watts. For those who do not realize what this exponent signifies, the power specified in the ordinary way is

0.000000003 watts

The power required to operate an ordinary electric light bulb is 60 watts. Therefore the power required by the electric light would be sufficient to supply antenna power to operate approximately

twenty billion radio receivers each requiring 70 microamperes of current in the receiving antenna as specified above.

The figures given at the end of this Laboratory Sheet, which have been taken from Morecroft, also indicate that the amount of power in the receiving antenna varies approximately inversely with the distance between the transmitter and the receiver. At a distance of 100 feet the received current is twice as great as when the separation is 200 feet. The power is proportional to the square of the current and therefore a ratio of two in current means a ratio of four in power. Twice the distance therefore gave one fourth the power.

DISTANCE IN FEET BETWEEN ANTENNAS	CURRENT IN RECEIVING ANTENNAS (MICROAMPERES)
100	12320
200	6435
300	4548
400	3108
1260	715
2420	283.5
3700	105
4600	96.5
6220	69.5

# YAXLEY

APPROVED RADIO PRODUCTS

## Radio Convenience Outlets

Wire your home for radio. These outlets fit any standard switch box. Full instructions with each outlet.

- No. 135—For Loud Speaker. . . . \$1.00
- No. 137—For Battery Connections 2.50
- No. 136—For Aerial and Ground 1.00

With Bakelite Plates

Now furnished with a rich satin brown Bakelite plate, with beautiful markings to harmonize, at 25 cents extra. See Illustration.

At Your Dealers

**Yaxley Mfg. Company**  
Dept. B, 9 So. Clinton St.  
Chicago, Ill.

# Letters From Readers

## Direct Selling on the Air

THE president of the Iowa Radio Listeners' League, Francis St. Austell, described in RADIO BROADCAST for May, direct radio selling which assails the ears of listeners out Iowa way. The letter below, from a reader in Burlington, Iowa, is interesting as the opinion of a listener located in the center of things.

To the Editor;

Permit me to say that I read RADIO BROADCAST regularly, and have, in fact, almost since it was established. I have many clippings from it and among my most valued, is a complete file of "Laboratory Sheets," which I have accumulated from my own copies of R. B. I am heartily in sympathy with your editorial policy.

I read, with much interest, Mr. St. Austell's article. Being out here in the heart of the "direct selling" area, I may speak accurately. That was a "warm" session in Des Moines, too. I am not interested in direct selling, either for or against. I am only interested in merchandising as everyone interested in the social structure should be. But I have no direct connection with it.

First, I have never heard any outstanding values offered over the radio. True, I do not consistently listen to those stations, but I do occasionally drift into them when the better stations are off the air. But I am impressed with their statements about the merchandise, when goods of equal or superior quality may be bought at retail in our own city at corresponding prices. But I am impressed with the carelessness with which the truth is handled. I believe a half truth often more misleading than an entire falsehood.

For instance, during the time when the increased postal pay and rate bill was pending, I heard Mr. Field address his radio audience asking them to write their senators and representatives urging them to vote against the bill, telling them it would surely mean greatly increased parcel post rates. The increase was actually two cents per parcel, I believe, and regardless of the merits of the bill, I do not believe it was parcel post rates, but rather the increased cost of circular mailings that worried Mr. Field.

I took occasion to write Mr. Field once criticizing his broadcast on some occasion and received in reply—a seed catalogue. And I have received them regularly since then!

Mr. Baker of KINT makes statements which are possible of several interpretations. So does Mr. Henderson, KWKH, not a seller. I once wrote Mr. Henderson questioning some statement. His reply was to the effect that he regretted that I did not agree with him—that less than six in a thousand letters received by him were uncomplimentary. No answer to my criticism at all. Maybe the people who would write uncomplimentary letters just don't write.

I've played with wireless since along about 1912. And short waves since amateurs were forced on them. And I've listened to Baker harp on Monday nights about opening up short-wave channels to broadcasting. He is squawking now about the short wave he is on. Why not open up, say 50 meters, and ask him to take it! Obviously, short-waves are all right—for someone else. I read your articles on this subject with much interest.

Direct selling, no doubt, does offer undue advantage. Seems to me the solution would be organization of legitimate business men. But I would like to see the Radio Commission out of politics, unhampered, with equal authority to enforce their dicta and a censorship authority of some sort that would make station owners and announcers adhere rigidly to facts.

Why should it be possible to say over a radio anything that could not be printed in a newspaper or magazine? Yet they can say anything they choose and get away with it.

Anyone with a reasonably good receiver can choose his own programs. Of course, there are a

lot of people in, for instance, Muscatine, who must listen to Baker's ravings, or nothing. He is located in the heart of the city, with almost enough power to blanket the average five-tube set any place in the city.

It appears to me that the real solution would be to close up about 150 or 200 of the last ones licensed. Of course, a few good ones would have to go. But what other equitable arrangement could be made rather than closing the last ones licensed? Probably WJAZ ought to be closed because they were perhaps more nearly entirely responsible for the present condition than any other one thing.

But I'm surely with you. And may it all get out of politics, yet, before it is entirely doomed to oblivion.

SMITH TRUMP, Burlington, Iowa.

## "Fading" Due to Street Cars

MR. A. H. Klingbeil of Ashtabula, Ohio, writes as follows:

To the Editor;

Commenting on your April issue. In "Strays" from the Lab. the mentioned street car effect in a receiver has been noticeable for a long time at my home. While I have never checked the action for data, I have noticed that some stations faded completely while street cars were passing the house for perhaps 50 or 75 feet either side or a total distance of about 200 feet maximum, and on other occasions, the street car effect was to "increase" the volume temporarily of the station tuned-in.

My antenna is approximately 125 feet straight in from pole in rear, at approximate trolley wire height, also street car feeder wires, power wires, arc lamp circuit, on same poles in front of my residence. Antenna is at right angles to street wires. There are no stations within 50 miles of my location and the ones fading or increased by street car action have been farther away than that and with receiver adjusted to low volume.

House supply wires lead-in to same room where the set is, and interior wires parallel the antenna for 15 feet, four feet apart. Until two weeks ago I used a waterpipe ground, later a drilled well ground, and last two weeks a chemical B power unit requiring no receiver ground, and effects seem to be the same, but not on all stations at any of the time past or present.

One of the first receivers I owned was a Fada 160 and at that time a suburban electric line operated a 1:30 A.M. car into Ashtabula from a distant point; no other cars operated at this hour. I usually could hear the "motor whine" for some minutes before the car arrived when I was listening to a weak station.

## The Popular R. B. "Lab" Circuit

READERS have written in great numbers reporting their results with the R. B. "Lab" circuit. This was described first in our June 1926 and in November, and December 1926 and January and February, 1927. The receiver was redesigned with more modern parts, and in our April, 1928, issue Keith Henney described measurements on the set, showing how it was designed and the results achieved. Among the many letters which came in the following is of interest.

To the Editor;

I built the Lab circuit from your schematic diagram in the April 1928 issue and am immensely pleased with it. I live in a fearful radio locality: West 76th street, New York; no antennas permitted on the apartment building, and direct house current, so you may imagine what I am up against. For my antenna, I drop a wire out of the window and get splendid local reception.

JOSEPH C. EGGART, New York City.

## Jenkins & Adair Condenser Transmitter

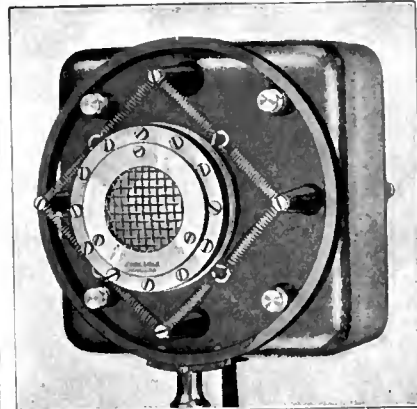

### For Broadcasting, Phonograph Recording, and Power Speaker Systems

THIS transmitter is a small condenser which varies its capacity at voice frequency, and is coupled direct into a single stage of amplification, contained in the cast aluminum case. The output, reduced to 200 ohms, couples to the usual input amplifier. The complete transmitter may be mounted on the regulation microphone stand. It operates on 180 v. B and 6 or 12 v. A battery.

This transmitter contains no carbon, and is entirely free from background noise. Its yearly upkeep is practically nothing. It is extremely rugged, and will withstand hard usage.

Price, complete with 20 ft. shielded cable, \$225.00 F.O.B. Chicago.

J. E. JENKINS & S. E. ADAIR, Engineers  
1500 N. Dearborn Parkway,  
Chicago, U. S. A.

Send for our bulletins on Broadcasting  
Equipment

## Read Radio Broadcast

every month. You can't afford to miss an issue. Order your copy from your Newsdealer or Radio Store. If you wish to subscribe direct send \$4.00 for one year or \$6.00 for two years.

DOUBLEDAY, DORAN & COMPANY, Inc.  
Garden City, N. Y.

## ROBERT S. KRUSE

Consultant and Technical Writer

103 Meadowbrook Road, West Hartford, Conn.  
Telephone Hartford 45327

AEROVOX Filter Condenser Blocks and Resistors are Built Better. They will

**ENDURE!**

The Aerovox Research Worker is a free monthly publication that will keep you abreast of the latest developments in Radio. A postcard will put your name on the mailing list.

**AEROVOX**

"Built Better"

78 Washington St., Brooklyn, N. Y.



# CROSLLEY



New Dynamic Speaker  
**DYNAONE**  
\$25

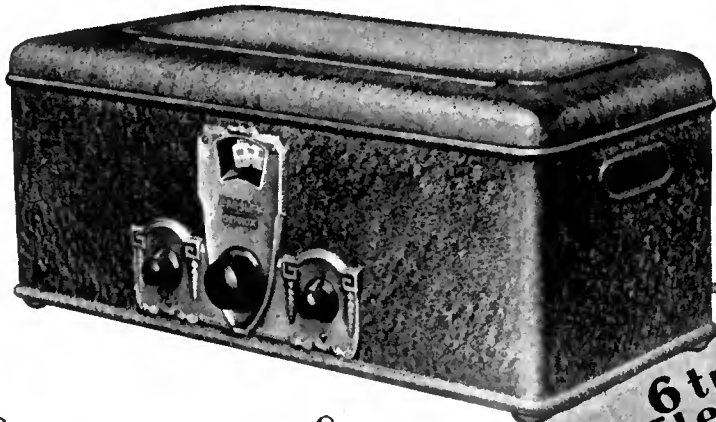

AC Electric  
**GEMBOX**  
\$65

The first AC set of any type ever offered at so low a price. Highly selective; coils shielded; illuminated dial; genuine Neutrodyne; powerful, efficient, proven!.....\$65.00

## The crowning achievement in a history of successes!

### FEATURES OF THE 1928-29 CROSLLEY RADIO RECEIVERS

Genuine Neutrodyne radio amplification with all the increased efficiency this superior circuit introduces.

Complete shielding which adds so greatly to the amazing selectivity of Crosley receivers.

Full voltage delivered to the plates of the tubes. Tone and volume assurance.

A sensitivity that delights the "old" radio fans and thrills the new ones by the ease with which weak distant stations are brought in.

Positive volume control reduces volume without detuning set.

Adaptability to any type of console. Simple construction permits quick and easy installations.

Modern illuminated dial eliminates the annoyance of shadows, searching for lights in the dusk, etc.

Beautiful gold and brown finish of receivers and matching Musicone and Dynacone delight the eye.

Here, in a new line of radios for the season of 1928-29, Crosley presents VALUE such as Radio has never seen . . . an engineering triumph in *quality* . . . a production miracle in *price*. Crosley represents fine radio—perfect performance and utmost enjoyment of broadcasting at seemingly impossible prices. These prices are possible only through years of experience, a skilled organization and the resources of a financially sound and economically operated company.

These values are yours today because of the powerful advantage gained through study, work and development acquired in the Herculean task of building and selling nearly 2 million pieces of radio apparatus.

Satisfied by laboratory and actual home installation comparisons that Crosley radio has NO equal Crosley NOW makes it possible for every prospective radio owner to know how well Crosley radio will perform in his or her home before they buy. Try, test and prove the amazing Crosley receiving sets before you buy!

## 5 DAYS FREE TRIAL IN YOUR OWN HOME

This is the NEW way . . . the CROSLLEY way to buy radio. First advertised nationally by Crosley last April.

Study the sets shown at the left. Then go to the nearest Crosley dealer. Ask for a FREE trial. Learn in the quiet and privacy of your own home what wonderful sets the 1928-29 Crosley's are. Enjoy their performance! Delight in their beauty! Congratulate yourself on their prices!

Over 18,000 Crosley dealers serve the United States, but if you cannot locate one near you send us this coupon and we will arrange a home demonstration for you at once.

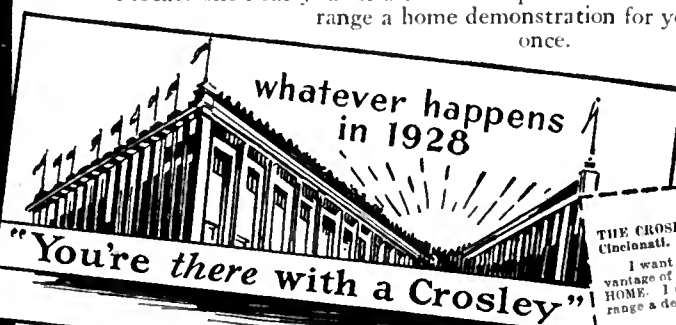

THE CROSLLEY RADIO CORPORATION

POWEL CROSLLEY, Jr., President Cincinnati, Ohio  
Montana, Wyoming, Colorado, New Mexico and West prices slightly higher



The 8 tube AC Electric **JEWELBOX**  
Genuine Neutrodyne entirely self-contained; full 180 volts on output tube plates; 2 111 output tubes, push-pull. Illuminated dial; Accumulators for very sharp tuning. Power! Beauty! Performance.....\$90.00



The 8 tube AC Electric **SHOWBOX**  
A new completely shielded genuine Neutrodyne, self-contained receiver; illuminated dial; full 180 volts on the plates of 2 111 output tubes, push-pull. Think of it.....\$80.00



The 8 tube Improved Battery type **BANDBOX**  
Proven star of Crosley radio Neutrodyne; shielded, illuminated dial; Accumulators providing acute sensitivity. Refinements make it unequalled in its field regardless of price.....\$55.00



The 5 tube Dry Cell Operated **BAHOX, Jr.**  
Modern radio reception for places where electric current is not available or storage battery recharging is inconvenient. Wonderful volume and exquisite tone. Construction features the same that make other models such outstanding values.....\$45.00  
**DYNAONE MUSICONE**  
\$25.00 \$15.00  
New Amazing dynamic **DYNAONE** reproduces every note audible to the human ear with remarkable fidelity, naturalness and realism.  
The famous **MUSICONE** still leads the world as its greatest magnetic type of speaker.

USE THIS COUPON FOR FREE TRIAL  
THE CROSLLEY RADIO CORPORATION  
Cincinnati, Dept. 20  
I want to know more about Crosley Radio. I want to take advantage of your offer to let me try one 5 DAYS FREE IN MY OWN HOME. I cannot locate the nearest Crosley dealer so please arrange a demonstration for me.  
Name.....  
Address.....  
Send literature.....  
Send set.....

# SM

# S-M LEADERSHIP *means Better Radio*



**I**N four short years Silver-Marshall, Inc. has forged up from obscurity to the position of dominant leadership in the radio parts and kit field—interesting, you say, but just what does that mean to you?

S-M leadership means just one thing—better radio for less money. Ask any one of the thousands upon thousands who enjoy radio to the full thru S-M kits and circuits. Ask the multitude of experimenters who have literally used and recommended S-M into first place; who two years ago swept S-M audio transformers into unquestioned leadership thru a veritable avalanche of approving purchases and who have held S-M audios at the top ever since. Ask the thousand odd Authorized S-M Service Stations who have built a profitable business and satisfied customers on S-M stability and worth. Or ask the dealers and jobbers who have seen S-M rapidly crowd competitors from their shelves, to become in four seasons the largest selling, most profitable parts line.

They'll all tell you that S-M leadership means better radio at less cost. And S-M will lead again in 1928 and 1929 by giving you new developments that enable made-to-order or home-built radio sets to equal in external finish the finest factory productions, parts that place the performance of such sets utterly beyond competition, and, thru knock-down kits, radio receivers that will consistently and positively outperform all ready-made sets at anywhere near their amazingly low prices.

### New S-M Offerings

The 720 Screen Grid Six, a six-tube dual control screen grid receiver kit at \$69.75 complete with all-metal assembly, individual stage shielding, and averaging 10 KC selectivity against powerful locals—a set that brings in forty to a hundred stations in one evening. This set can be had for A.C. operation at \$74.00 for 171, 210 or 250 power tubes.

And at \$49.75 S-M offers the 740 "Coast to Coast" Screen Grid Four—a kit that is a revelation in four-tube results. Type 700 metal shielding cabinet as illustrated is but \$8.50 additional, for either set, finished in attractive duo tone brown. It gives to each a new standard of style and distinction.

The Sargent-Rayment Screen Grid Six, type 710, is the wonder set of the season, and S-M offers, exclusively, the approved kit at \$120.00. It is complete with aluminum shielding cabinet and will bring in 100 stations on any average evening.

The S-M "Round the World" Short Wave sets are the trimmest, most efficient short wave sets yet, priced from \$36.00 to \$51.00 complete with shielding cabinet. New S-M condensers are marvels of rigidity and flexibility in Universal single, and triple types. The 685 Public Address Unipac—the first really high-powered amplifier yet offered—is priced at only \$160 wired, or \$124 for the kit. It will turn out music or voice that can be heard by 1000 to 10,000 people.

Of course, the most startling audio development of the last two years would logically come from S-M laboratories, as it did two years ago. The new Clough audio transformers have been deservedly the sensation of the June radio trade show. In open comparative tests S-M 255 and 256, \$6.00 transformers have excelled the performance of all competitive types tested, regardless of cost. The 225 and 226 transformers at \$9.00 each simply leave the most skeptical marveling.

These and many other startling new S-M parts leave small wonder at S-M leadership. They prove that you can get the best radio for the least cost from S-M.



Are you receiving THE RADIO-BUILDER regularly? This little house magazine is printed occasionally to provide you with new and advance information on forthcoming S-M developments, and to pass along operating hints and kinks that will help you to get the most out of radio building. Issues, numbers one and two, pictured above are good examples of what THE RADIO-BUILDER contains—a practical description of the first light socket public address amplifier available for home construction, and the inside, advance story on the practical phases of the new Clough audio system, with all curves.

THE RADIO-BUILDER is newsy, and timely, and, above all, it is the condensed, monthly key to all the detailed constructional data you desire, for in it are listed and previewed all new S-M DATA SHEETS each of which can be had for a two cent stamp.

Fill out the coupon below if you'd like to keep abreast of new radio developments.

If you want a veritable mine of Radio information, fill out the coupon and it's yours!

Silver-Marshall, Inc.  
838 -W. Jackson Blvd., Chicago, Ill.

Enclosed find.....in stamps for which please send me

.....(50c) next 12 issues of THE RADIO-BUILDER, or

.....(1.00) next 25 issues of THE RADIO-BUILDER

Please send me the following S-M DATA SHEETS, at 2c each:

.....No. 1—670B—670ABC RESERVOIR POWER UNITS

.....No. 2—685 PUBLIC ADDRESS UNIPAC

.....No. 3—730, 731, 732 "ROUND THE WORLD" SHORT WAVE SETS

.....No. 4—HOOKUPS FOR 223, 225, 226, 255, and 256 AUDIO TRANSFORMERS.

.....I am a professional setbuilder. I am interested in your Authorized Service Station plan.

**SILVER MARSHALL, Inc.**  
838 -W. Jackson Blvd., Chicago, Ill.

