

# RADIO BROADCAST

JUNE, 1928

WILLIS KINGSLEY WING, Editor

KEITH HENNEY  
Director of the Laboratory

EDGAR H. FELIX  
Contributing Editor

Vol. XIII. No. 2

## CONTENTS

Cover Design . . . . .	From a Design by Harvey Hopkins Dunn	
Frontispiece . . . . .	In the Grand Canyon of the Colorado	64
How Chain Broadcasting Is Accomplished . . . . .	C. E. Dean	65
The March of Radio . . . . .	An Editorial Interpretation	68
Broadcasting Needs Capable Leadership	British Skeptical of Baird Television Accomplishments	
Mergers in the Radio Industry	Present Distribution of Broadcast Stations Here and There	
More High Power Broadcasting		
Automatic Tuning for the Radio Receiver . . . . .	Leroy S. Hubbell	72
The Newest Power Tube . . . . .	Howard E. Rhodes	74
Book Reviews . . . . .	Carl Dreher	76
Lefax Radio Handbook	A Popular Guide to Radio, Dashiell	
Radio Engineering Principles, Lauer and Brown		
The "Cornet" Multiwave Receiver . . . . .	W. H. Wenstrom	77
From Milliammeter to Multi-Meter . . . . .	G. F. Lampkin	80
"Strays" from the Laboratory . . . . .		83
Output Transformer Characteristics	Short-Wave Notes	
High Powered Press Releases	Recent Interesting Contemporary Articles	
A.C. Troubles	Another Useful Publication	
May Standard Frequency Signals	Radio School Scholarships	
New Apparatus . . . . .	Useful Information on New Products	85
A Screen-Grid Booster for Any Receiver . . . . .	Glenn H. Browning	87
Our Readers Suggest . . . . .		89
An Emergency Detector B Supply	Some Baffle-Board Experiments	
Emergency and Experimental Connections	Antenna Tuning Device	
Volume Control for Resistance-Coupled Amplifiers	A Spark Plug Lightning Arrestor	
"Radio Broadcast's" Service Data Sheets on Manufactured Receivers . . . . .		91
No. 1. The Amrad A.C. 7	No. 2. The Pfansteihl A.C. 34 and 50.	
Building and Operating the A. C. "R. B. Lab" Receiver	Hugh S. Knowles	93
Using the Screen-Grid Tube in Popular Circuits	Laboratory Staff	96
A Good Crystal Receiver for the Beginner . . . . .	Keith Henney	97
A Three-Tube A.C. Operated Roberts Receiver	Elmer G. Hery	99
As the Broadcaster Sees It . . . . .	Carl Dreher	102
The Simplest Receiver	20. Field Strength Measurements	
Design and Operation of Broadcasting Stations:		
How Can Good Radio Programs Be Created? . . . . .	John Wallace	104
The Listeners' Point of View		
The Month's New Phonograph Records . . . . .		106
"Radio Broadcast's" Directory of Vacuum Tubes . . . . .		107
Manufacturers' Booklets . . . . .		108
"Radio Broadcast's" Laboratory Information Sheets . . . . .		110
No. 193. Motorboating	No. 197. Amplification Constant	
No. 194. Push-pull Amplifiers	No. 198. The Screen-Grid Tube as an R.F. Amplifier	
No. 195. A Resistance-Coupled Amplifier with Screen-Grid Tubes	No. 199. Current	
No. 196. Circuit of a Resistance-Coupled Screen-Grid Amplifier	No. 205. Resistors	
The Haven of a Sea-Going Audion . . . . .	Raymond Travers	116

The contents of this magazine is indexed in *The Readers' Guide to Periodical Literature*, which is on file at all public libraries.

## AMONG OTHER THINGS.

IT HAS not been possible to reply with a personal letter to each of our readers who filled out and returned the readers' questionnaire recently sent many of those who are regular subscribers. The desires and opinions of readers expressed have been very helpful. Many interesting conclusions are at once apparent. Our policy of giving complete information about the manufactured parts described in constructional articles is overwhelmingly approved. The type and form of the articles dealing with the construction of apparatus—such articles as those in this issue for example—are welcomed. The many special features and articles which distinguish RADIO BROADCAST from its contemporaries are especially praised.

SOME readers who have read elaborate statements of policy appearing in some of our contemporaries have asked us, in effect, if we were going to announce a changed policy, too. All we have to say about the editorial policy of RADIO BROADCAST has been said in this column in the May issue. This magazine is edited for the reader and what he finds in RADIO BROADCAST is information—lots of it, as interestingly, as completely, as accurately presented as we know how. This magazine will neither be full of inconsequential and slightly sensational articles about the marvelous potentialities of radio nor will it overflow with constructional articles on every possible subject having the apparent purpose of merely using the products of a selected group of radio manufacturers. Our policy of making each article complete in itself and not "continued on page 96" is still in force. The special sections which have so wide a following: the Laboratory Data Sheets, the March of Radio, Strays from the Laboratory, Our Readers' Suggest . . . , As the Broadcaster Sees It, the Service Department, are to be continued. With this issue, we introduce a new regular feature: "RADIO BROADCAST's Service Data Sheets on Manufactured Receivers" which present all essential data on various makes of sets now in use. Several other important new features are in the course of preparation.

EDGAR H. FELIX, contributing editor, attended the public hearings before the Radio Commission April 23 and 24. He appeared as an expert witness and presented the suggestions for the solution of the broadcasting problem which have attracted such wide attention in our editorial section. The March of Radio. Incidentally, we are told that Mr. Felix's May article "Will New Transmitting Methods Be the Remedy?" is accepted in Washington as the most clear and fair presentation of the difficulties and possibilities for solution of the present broadcast situation.

OUR July issue promises many interesting features. There is an excellent non-radiating short-wave receiver using a screen-grid tube, a searching analysis of the almost overwhelming obstacles to practical television, the description of a fine B supply and power amplifier using the 250 type tube, a practical set tester, and many other articles, selected because of their unusual interest.

—WILLIS KINGSLEY WING.

DOUBLEDAY, DORAN & COMPANY, INC., Garden City, New York

### MAGAZINES

COUNTRY LIFE  
WORLD'S WORK  
GARDEN & HOME BUILDER  
RADIO BROADCAST  
SHORT STORIES  
EDUCATIONAL REVIEW  
LE PETIT JOURNAL  
EL ECO  
FRONTIER STORIES  
WEST  
THE AMERICAN SKETCH

### BOOK SHOPS (Books of all Publishers)

NEW YORK: LORO & TAYLOR; JAMES MCCREERY & COMPANY  
PENNSYLVANIA TERMINAL AND 166 WEST 32ND ST.  
848 MADISON AVE. AND 51 EAST 44TH STREET  
420 AND 526 AND 819 LEXINGTON AVENUE  
GRAND CENTRAL TERMINAL AND 38 WALL STREET

CHICAGO: 75 EAST ADAMS STREET

ST. LOUIS: 223 N. 8TH ST. AND 4914 MARYLAND AVE.

KANSAS CITY: 920 GRAND AVE. AND 206 WEST 47TH ST.

CLEVELAND: HIGBEE COMPANY

SPRINGFIELD, MASS.: MEEKINS, PACKARD & WHEAT

### OFFICES

GARDEN CITY, N. Y.  
NEW YORK: 244 MADISON AVENUE  
BOSTON: PARK SQUARE BUILDING  
CHICAGO: PEOPLES GAS BUILDING  
SANTA BARBARA, CAL.  
LONDON: WM. HEINEMANN, LTD.  
TORONTO: OXFORD UNIVERSITY PRESS

### OFFICERS

F. N. DOURLEADAY, Chairman of the Board  
NELSON DOURLEADAY, President  
GEORGE H. DORAN, Vice-President  
S. A. EVERITT, Vice-President  
RUSSELL DOUBLEDAY, Secretary  
JOHN J. HESSIAN, Treasurer  
LILLIAN A. COMSTOCK, Ass't Secretary  
L. J. MCNAUGHTON, Ass't Treasurer

Copyright, 1928, in the United States, Newfoundland, Great Britain, Canada, and other countries by Doubleday, Doran & Company, Inc. All rights reserved.  
TERMS: \$4.00 a year; single copies 35 cents.

# Protect your A-C tubes from high line voltages with

## Ward Leonard Vitrohm Resistors and Rheostats

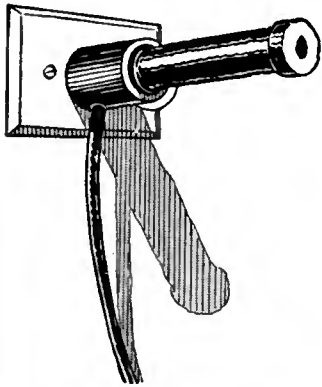

Radio receivers, made for complete operation from the power lines, are designed, usually, to operate at a fixed line voltage. Where the line voltage exceeds the arbitrary value assumed by the set manufacturer, damage to the tubes may result unless means are used to reduce the line voltage to the value at which the set is designed to operate.

Two methods are used, ordinarily, to correct for excessive line voltages; a resistor or rheostat placed in series with the input to the power unit of the receiver. The resistance value and current carrying capacity of these units is determined by the receiver primary current and the maximum potential drop required.

Vitrohm Resistors, fitted with Edison medium screw bases, are the most convenient units to use where fixed resistance is desired. These resistors screw into a series tap which is in turn plugged into the convenience outlet or socket. They are priced at \$2.00 each and are available in the resistances listed below:

Catalog Number	Resistance In Ohms	Catalog Number	Resistance In Ohms
507-96	2.5	507-97	15
507-39	3.5	507-98	22
507-41	5	507-99	31
507-43	7	507-100	45
507-44	10	507-101	62
507-45	12.5		

Vitrohm 4-inch, 11 step, Rheostats are used where adjustment of voltage is desirable or necessary. Mounting may be either front or back of panel. The price is \$5.50 each.

Catalog Number	Maximum Resistance In Ohms
507-83	12.5
507-59	20
507-63	50

Your dealer stocks Vitrohm Resistors and Rheostats, or can get them for you. Circular 512 describes methods of line voltage control and shows complete diagrams of circuit connections. It will be sent to you promptly upon request without charge.

### WARD LEONARD ELECTRIC CO.

MOUNT VERNON, N.Y.

RESISTOR SPECIALISTS FOR MORE THAN THIRTY-SIX YEARS

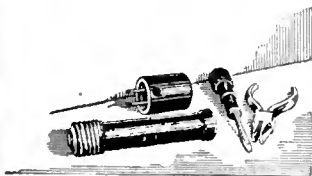
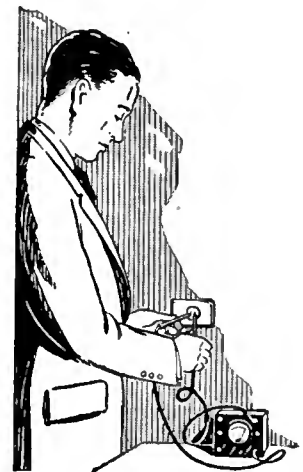

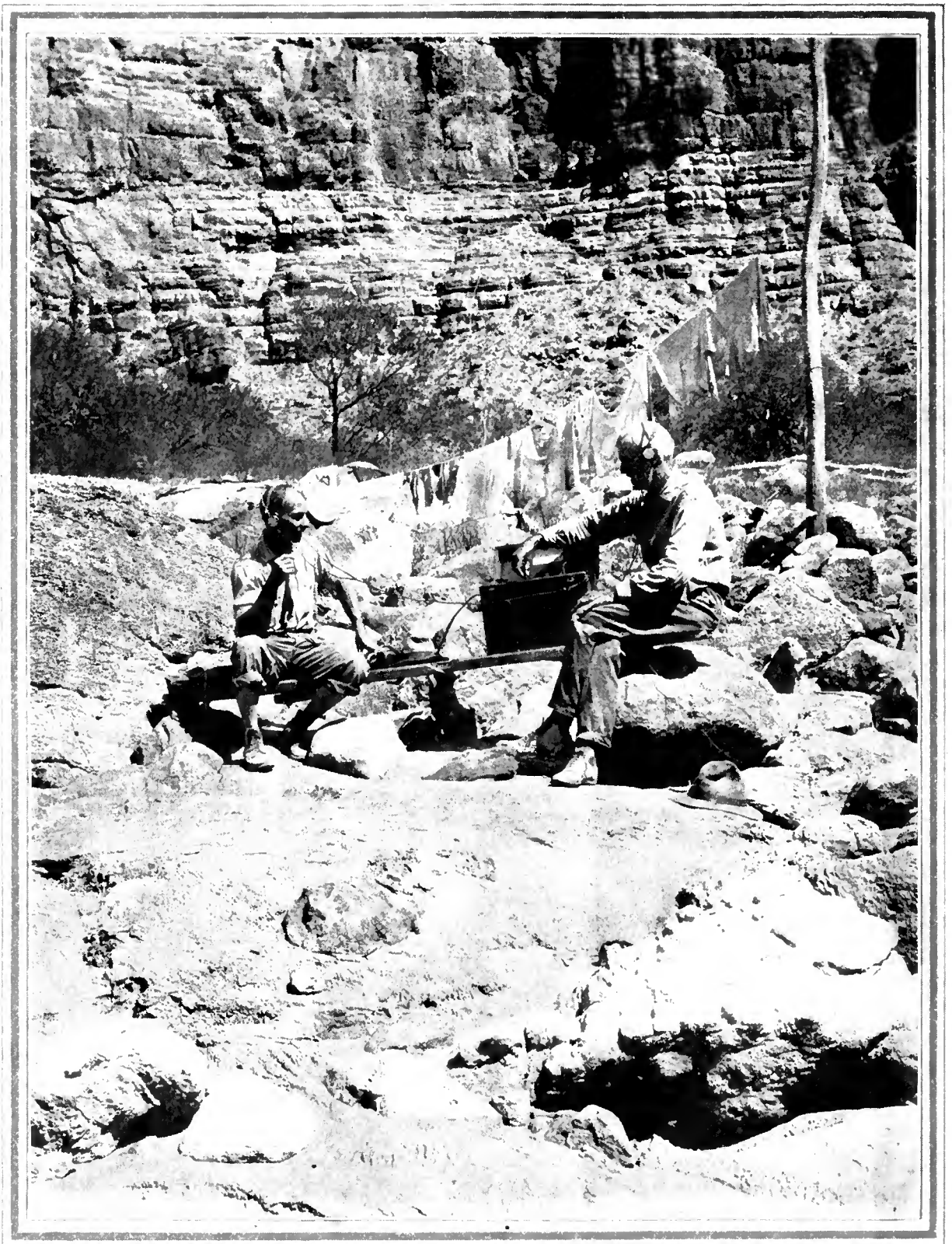

*In the Grand Canyon of the Colorado*

A PORTABLE radio receiver in use in the Grand Canyon in 1923. A special receiver was built for the expedition by the Bureau of Standards which was carried on a geological survey of the Canyon under the auspices of the United States Geological Survey. This illustration is from a photograph by Lewis R. Freeman, of the Explorers' Club, New York, who was a member of the expedition.

Mr. Freeman explains that at the time the expedition was undertaken, there was some doubt as to whether radio reception would be possible in the Canyon. It was conclusively demonstrated that excellent reception was possible. The receiver performed as well at depths of 500 feet as at 5000, Mr. Freeman says. The antenna in the illustration also, it seems, served the party as a clothesline.

**C**HAIN broadcasting is known to radio listeners as a means whereby a radio program may be transmitted by several or even dozens of radio stations. Regular networks furnish entertainment every day, and on important occasions great extensions are made so that practically the entire United States is covered. The estimated audiences at such times include one fourth to one third of the entire population of the country. More people have thus listened to the voice of one person than ever before in history.

The apparatus and methods whereby such important and remarkable results are accomplished are, therefore, interesting subjects to the radio fan. His knowledge of vacuum tubes, audio-frequency amplifiers, and electrical principles will enable him to appreciate various interesting points in the equipment and operation of the wire lines used in chain broadcasting.

In addition to the long lines connecting to radio stations in distant cities, there are many shorter lines transmitting programs, such as from studios centrally located in large cities to the powerful radio broadcasting apparatus out beyond the suburbs. Similar circuits are used to broadcast sporting events, banquets, and other occurrences outside the studio, thus greatly extending the range of program features.

It is one of the duties of telephone engineers and operating men to plan and supervise both the short and long lines which carry radio programs. These connections differ in various respects from regular local and long distance telephone lines, and have, therefore, been given a special name, "program circuits." One difference is that ordinary telephone circuits transmit the voice in both directions (on long circuits "two-way" amplifiers are therefore necessary), but in program circuits it is necessary to transmit only in one direction, that is, from the pick-up microphone to the one or more radio transmitting stations. "One-way" repeaters are therefore sufficient. In the drawing on page 66 arrows indicate the direction of transmission along each program circuit which was used on January 4th, 1928, the date of the first Dodge Brothers program. The regular route of the voice of Will Rogers, acting as master of ceremonies at Los Angeles, may be followed by way of San Francisco and Denver to Chicago and the East. Also an additional circuit for use in case of emergency is seen passing through southern New Mexico, Dallas, and St. Louis to Chicago.

#### MEETING THE TRANSMISSION REQUIREMENTS

**A**NOTHER important difference between ordinary telephone circuits and program circuits is in the width of the frequency band transmitted. In a telephone conversation, clear, intelligible speech is desired, and it has been found that this can be obtained if frequencies from about 300 cycles per second to about 2000 cycles per second are transmitted, although modern telephone circuits are engineered to carry a somewhat wider frequency range. However, with program circuits, not only satisfactory intelligibility is desired, but also a very high degree of naturalness and faithfulness in the transmission of music and speech when reproduced through loud speakers. To meet these requirements, a much wider band of frequencies is necessary. In the present art it is generally considered desirable to transmit a range of frequencies from about 100 cycles per second to about 5000 cycles per second, and to do this with approximately uniform efficiency. In this way the low, medium

# How Chain Broadcasting Is Accomplished

By C. E. Dean

American Telephone and Telegraph Company

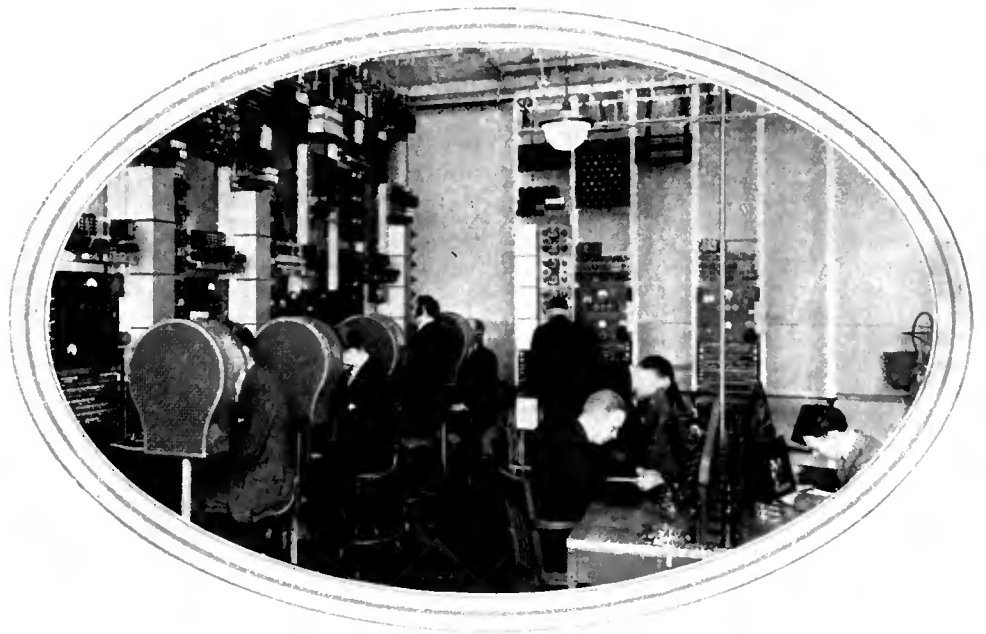

THE CHAIN BROADCASTING CONTROL ROOM IN CHICAGO

Similar control rooms are located in Boston, Cincinnati, Detroit, St. Louis, Atlanta, San Francisco, and New York, each in charge of a "transmission supervisor." Repeaters, oscillators, equalizers, transmission measuring devices, and other apparatus necessary in the exacting work of transmitting the programs are shown in the illustration. Cone loud speakers are mounted in the protecting frames at the left. During operation, one cone is connected to the Red network, another to the Blue, a third to the Purple; the fourth is a spare.

and high pitch ranges of music and other program material are transmitted with a considerable degree of faithfulness.

In addition to the wider frequency-range requirements, program circuits are called upon to transmit greater volume variations than ordinary telephone circuits. For example, the music of a symphony orchestra will vary from a very loud intensity, when many instruments are sounding, to a very faint intensity at other times.

### What Radio Owes to Chain Broadcasting

**T**HE Washington air, in and near the halls of Congress, has been full of pointed and often unpleasant comments about chain broadcasting during the recent weeks when the last radio bill was under consideration. Aside from the political aspects which so fascinate our legislators, it can be said without fear or favor that chain broadcasting is responsible almost entirely for the growth of high-grade programs in this country. Chain broadcasting has partially solved the old question: "Who is to pay for broadcasting?" As the use of the wire network, linking stations, has increased, so has the radio audience, and with it the time, money, and effort expended on programs. This article explains some of the technical aspects of the accomplishment, much of which appears for the first time.

—THE EDITOR.

At all times extraneous noise on the circuit must be slight in comparison with the volume of the music. The critical times are during the faint portions of the program, and to transmit these satisfactorily, a very quiet circuit is obviously necessary.

The large variations in the volume of orchestral music (which are of the order of 50 TU, an energy ratio of 100,000) are greater than radio stations can transmit without overloading on the loud signals and losing the faint portions in local noise, static, etc., at the receiver. So at the microphone amplifier one of the broadcast station control operators manipulates the amplification control so as to reduce these variations, cutting down somewhat the loud portions and bringing up somewhat the faint portions, taking care to preserve as nearly as possible the naturalness of the music. The program circuits, i. e., wire lines are quiet enough to be able to more than handle all the volume variation which the broadcasting radio stations desire to transmit.

Besides the requirements just considered, the program circuits must of course function harmoniously with the other circuits of the telephone plant, so that program transmission will not be overheard on the ordinary circuits, nor vice versa.

For short connections in cities and at other places, circuits in cable are usually employed. The attenuation, the loss, introduced by a seven-mile length of 19-gauge cable pair (consisting of No. 19 B & S copper wire), with no loading coils or other apparatus connected, increases considerably with increase of frequency. One TU of loss means a reduction of power to 79½ per cent. of its original value, two transmission units means a further reduction to 79½ per cent. of what is left, or to .795 x .795 = .63 = 63 per cent. of the original amount.

Three TU is a power ratio of 50 per cent., four is 40 per cent., and five TU 32 per cent. Twenty TU is a power reduction to 0.01 or 1 per cent. of its original value, as shown by the bottom line of the chart. (TU are also used to express the amount of amplification, or "gain," of an amplifier, the ratio being the reciprocal of that for loss. Thus, 20 TU gain is  $\frac{1}{20} = 100$  times, meaning that the output power is 100 times as great as the input power. For further information on TU see Martin, *Journal, A. I. E. E.*, June, 1924).

If the cable mentioned were used without any correcting agency there would be a serious reduction in the strength of the high-pitch components which give music its charm and brilliancy. But frequency distortion, if not too great, can be offset by introducing an opposite distortion, a veritable case of two bad elements combined to achieve the desired good result.

To correct the frequency characteristic of short cable, special devices called "equalizers" are used. These consist of inductance, capacitance, and resistance, three of the elements forming a parallel resonant circuit, such as is familiar to radio amateurs from its use as a wave-trap. However, here the elements are so chosen that the resonant frequency is far lower, lying a little above the range of frequencies which the circuit transmits. As in a wave-trap, the impedance is high at the resonant frequency, so that here the equalizer introduces little loss since it is shunted across the line. But at lower frequencies the impedance is much less, and by proper adjustment of the two resistances and the equalizer is made to have characteristics just the opposite of those of the cable pair. The resulting curve for the cable with the equalizer is practically horizontal, which is the result desired. The volume is then raised to a higher level by a distortionless amplifier.

For the long connections between cities in chain broadcasting, "open wire" circuits are largely used, that is, circuits consisting of wire on insulators supported by cross arms. Most of this wire is hard-drawn copper (No. 6 B. & S.) 0.165 inches in diameter, the most rugged type of open wire line used in the Bell System. The energy loss along this type of line is much less than along an equal length of the cable just considered, but after the current has traveled about two or three hundred miles it must be reinforced. For this purpose an audio-frequency amplifier, called a "repeater," is used.

An open wire circuit is similar to cable in that the energy loss is greater at high frequencies, but somewhat different methods are used to make the open-wire frequency characteristic horizontal. Repeaters which introduce greater amplification for the high frequencies are used in conjunction with equalizers. These equalizers are different from the cable equalizer since the conditions are not the same.

TELEGRAPH AND AMPLIFIER ARRANGEMENTS

**P**ARALLELING every long program circuit is a telegraph circuit over which reports and instructions are transmitted. With keys and sounders at every repeater station this provides an auxiliary communication channel for the use of those responsible for the program circuit. Other telegraph circuits connect the radio stations on each chain with the key station for the coördination of station announcements and other program details.

One of the most interesting features of a program network is the means employed to restrict the effect of an accidental short-circuit of the line at any point. Without the methods used, such a short-circuit, besides preventing any transmission beyond the particular point, would greatly reduce the voltage for a considerable distance back along the line. Now an amplifier, besides its primary purpose, has the important property that a change in the condition of the output circuit (such as a short), has practically no effect on the input circuit. So, wherever a program circuit forks, an amplifier is inserted into each outgoing branch, with the result that a short-circuit across one branch will not affect the transmission along the other branch. This is done regardless of whether or not amplification is needed—the one-way feature of an amplifier is taken advantage of in this way to increase the reliability of the system. For this reason repeaters average about 125 miles spacing in the East, when otherwise two or three hundred miles would be sufficiently close, for there are numerous forking points in this part of the country.

The drawing on page 67 illustrates, by a typical case, the manner in which the power decreases along each section of a program circuit and is built up to its original value at the repeater points. For example, at the New York repeater station the incoming power from the radio studio is given a net amplification of 9 TU, and then begins the trip to Troy, New York.

Along the circuit the power decreases steadily until at Troy it is only 3 TU above the original input at New York. Here it is amplified again, and continues on toward Syracuse. The maintenance of a horizontal frequency characteristic, the importance of which has already been stated, necessitates the introduction of losses at the repeater points which are offset by amplification; for simplicity these are not indicated, the net gain at each repeater station being shown. The final output power of the circuit at Chicago is seen to be four times greater than the input power at New York. The scale at the right gives for any point the number of TU by which the power at that point exceeds the input to the circuit at New York. The left scale gives the corresponding power ratio.

THE AMPLIFIERS OR "REPEATERS"

**O**F COURSE, the transmission of music and speech over program circuits is by alternating currents having frequencies the same as those which are present acoustically in the sound at the microphone. So the repeaters in the circuit are audio-frequency amplifiers. At the end of each program circuit in chain broadcasting is a radio transmitting station which sends the program out on the ether at a radio frequency.

Special study has been devoted to the design of telephone repeaters, and various types have been developed. Those used in program circuits are two-stage, transformer-coupled amplifiers using 130 volts plate supply. The first main element of the repeater is an input transformer whose secondary is tapped to allow adjustment of the amplification given by the repeater. The tapped voltage from this transformer is applied to a high-mu tube having an amplification factor of about 30, and an output resistance of about 60,000 ohms. From this tube the energy goes through an inter-stage transformer to the second stage. Here there is a tube having an amplification factor of about 6 and an output resistance of about 6000 ohms, similar to the 216-A or 112 type tubes which have been used in other amplifiers. There is an output transformer for delivering the amplified energy to the outgoing program circuit. Provisions are made for close adjustment of amplification and for adjustment of the frequency characteristic. The amount of amplification or "gain" in the repeater may be adjusted to any value over a range of 37 TU in steps of as little as 0.3 TU so that very accurate setting is possible. At 1000 cycles this adjustment varies the gain from 5 TU to 42 TU, which is the same as varying the power amplification from 3.2 to 15,800, or the voltage amplification from 1.8 to 126.

TESTING AND OPERATION OF PROGRAM CIRCUITS

**A** FEW years ago the testing and operation of all the program circuits then in use was in charge of one "transmission supervisor" located in New York. Since then, the extent of program circuits has grown by such bounds that it has become necessary to have additional transmission supervisors, and these are now located at Boston, Cincinnati, Detroit, Chicago, St. Louis, Atlanta and San Francisco. Each transmission supervisor is responsible for the program circuits going out from his control point. He, therefore, has charge of hundreds of miles of circuits and a number of repeater stations, through which the circuits pass. At each of the repeater stations there are trained men who are on duty during the hours that the program circuits are being tested or used, and these men make reports to the transmission supervisor, as directed, and adjust their apparatus in accordance with his instructions.

It is very important to maintain the program circuits in the best of condition, for many thou-

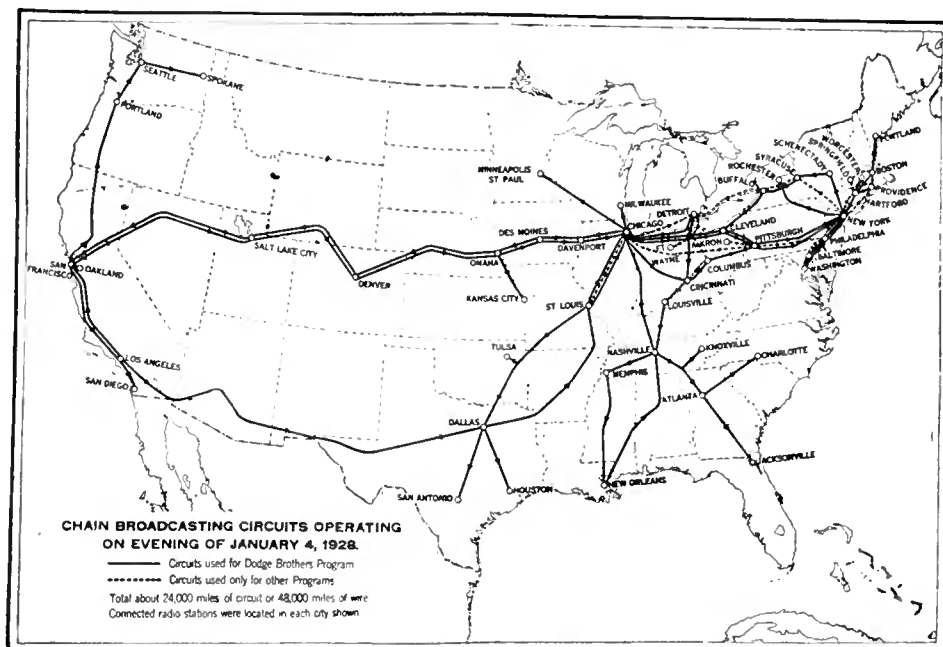



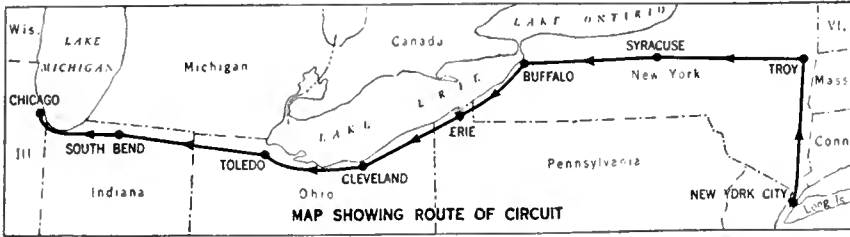
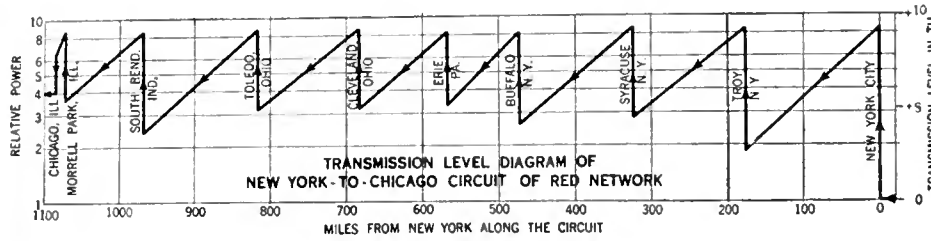

WHAT HAPPENS TO ENERGY IN WIRE CIRCUITS

How the voice-frequency currents are attenuated as they travel over long lengths of wire. Note the effect of amplification at the repeater points

sands of radio listeners are dependent upon them. Each transmission supervisor, therefore, conducts every morning a thorough test and adjustment of all the circuits under his charge. Transmitting a tone of 1000 cycles over the program circuits, he receives reports by telegraph and directs adjustments at the nearest repeater station, then at the next repeater station, etc., until, in this way, the entire group of circuits under his charge is "lined up." Then a low frequency, about 100 cycles per second, is transmitted and any necessary auxiliary adjustments are made to see that this low pitch is transmitted with the same efficiency as the 1000 cycles. Then a high frequency of about 5000 cycles is transmitted to check the characteristics at this end of the frequency range, and if necessary, appropriate adjustments are made. Finally, music from a phonograph is sent over the circuits to give a working check on their condition.

The transmission supervisor is also responsible for the operation of the program circuits during use. As soon as a report of transmission difficulty reaches him, he must take immediate steps to correct it. Whether the trouble is noise on the circuit or low volume, he must proceed immediately with the proper steps. Sometimes the volume delivered by a circuit will diminish or the circuit will become noisy so as to suggest approaching failure. In this case he endeavors to obtain an alternative circuit and substitute it; sometimes this may be done before the radio listeners realize that any trouble has occurred. At other times a circuit may, without warning, fail completely, and at such times the transmission supervisor's general knowledge of the situation is put to the test. He may sometimes succeed in obtaining an alternative circuit with only three or four minutes interruption to the program. Sometimes alternative circuits follow different routes and far exceed in length the facilities they replace, such as during the Democratic Convention in 1924 when a connection 1,400 miles long was substituted in place of one only 200 miles long. The transmission supervisors even keep informed of the weather conditions over a large part of the country so that, in case of threatening storms, they may obtain emergency routes and hold them in readiness.

The heading shows the program circuit control point at Chicago. Repeaters, equalizers, oscillators, transmission measuring devices, and other apparatus, may be seen mounted at the left and in the rear. One cone is connected to the Red Network program, another to the Blue Network,

another to the Purple Network (the Columbia Chain), and the fourth is a spare. In this way, constant check is kept on the quality of the program transmission. At the right are telegraph operators who transmit messages between the transmission supervisor and the different repeater stations under his direction.

NETWORKS REGULARLY OPERATING

THERE are now four networks in daily operation, namely, the Red, Blue and Purple networks in the East, and the Pacific Coast network in the West. The eastern networks are supplied with studio programs from New York City and the Pacific Coast network from San Francisco. The total length of program circuits permanently connected into these four networks, or connected on a regular recurring basis, was, on April 1, more than 15,000 miles. To maintain and operate this great amount of program facilities required more than 25,000 miles of telegraph circuit. The daily audiences listening to the programs from these chains are estimated in the millions of persons.

Perhaps the reader has wondered how the designation of networks by colors originated. This occurred several years ago when the only network then operating received programs from

WEAF in New York. The telephone engineers drew in red pencil, on a map, the circuits regularly connected and drew in blue the extensions which were occasionally added. In this way the regularly operating chain became known as the "Red network." Later, when a network was organized with wjz in New York as the key station, the name "Blue network" was, of course, given to this. At the important program control points the designation of the networks by colors is a considerable aid to the transmission supervisor in the necessary switching operations.

HISTORICAL SPECIAL HOOK-UPS

ON DEFENSE Day, September 12, 1924, two-way conversation between General Pershing in Washington and the Commanding Generals of the various Corps Areas in New York, Chicago, San Francisco and other points was transmitted to a number of radio stations and heard by many thousands of listeners. This occasion remains an unbroken record for the broadcasting of two-way conversation.

The largest number of radio stations ever connected was during the Radio Industries Banquet held in New York on September 21, 1927, when a total of 85 radio stations broadcast the proceedings. All four of the regular networks were used and 13 additional points were added.

Doubtless many readers will recall the first Dodge Brothers broadcast of January 4, 1928, when well-known persons in Los Angeles, New Orleans, New York, Chicago and Detroit were heard. The circuits used in this broadcast are shown in heavy lines in the drawing on this page, totaling over 20,000 miles of circuit, or over 40,000 miles of wire. Other program circuits operating on this date but not transmitting the Dodge program bring the total program mileage to about 24,000 miles of circuit or about 48,000 miles of telephone wire. In addition to this telephone mileage, about 40,000 miles of telegraph circuit was employed for lining-up and operating the program circuits. As the pick-up point was changed from one city to another, the circuits had to be switched at correspondingly widely separated switching-points. To perform these operations in the necessary order within the allotted five seconds required thorough training and a high degree of intelligence. All the pick-up circuits not in use for a few minutes were kept under continuous test to guard against the development of line troubles during these intervals.

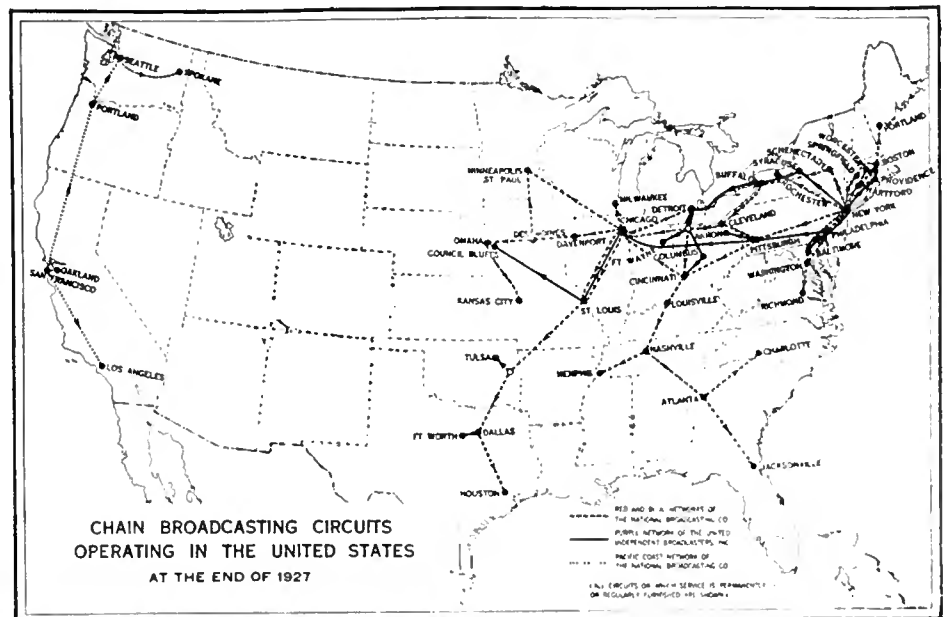

# THE MARCH OF RADIO

## NEWS AND INTERPRETATION OF CURRENT RADIO EVENTS

### Broadcasting Needs Capable Leadership

RADIO broadcasting is indeed a healthy structure to survive successfully the machinations of the politician, the cupidity of the direct advertiser, the absence of articulate listener sentiment and the regulation of an impotent and hesitant administrative commission. Only its real service to millions of listeners gives broadcasting its vitality. On every hand, radio is the victim of conflicting interests. The powerful, well-financed broadcaster is assailed for his supremacy by the less capable station; the vote-seeking politician, with a local point of view, hampers regulation by those who understand frequency assignment as a scientific and national problem; the ethical goodwill broadcaster is tempted by the example of the blatant radio advertiser. Only one influence can lead the way out of this welter of confusion and that is a crystallized listener sentiment.

In its riotous career, broadcasting has had many tormentors. Of these, the most disturbing is the belated and superfluous broadcasting station which has brought congestion, interference, and confusion. Throughout its history, broadcasting has lacked capable independent leadership to bring it through the wilderness of uncontrolled growth. It is illuminating to review the causes of present-day congestion because they point the way to a solution.

When radio held the center of the stage of public attention, the number of stations grew rapidly to the full capacity of the broadcast band. Room for greater power and more stations could be gained only at the cost of curtailing the service of an existing station. Two years ago, the fight of one station for another's time on the air upset the Department of Commerce's assumed authority over broadcast regulation, which was valiantly stemming the rising tide of stations. An effort was then made to preserve order by a gentleman's agreement among the existing stations. But the success of such a course was unfortunately predicated upon the requirement that all of those concerned be gentlemen.

During that period of chaos, broadcasting stations were erected with reckless abandon and total disregard of the capacity of the broadcast band. All broadcasting was conducted in a bedlam of shrill whistles and sullen groans. Stern parents punished their children by making them listen to the radio nightmare. But did a voice, representative of listener sentiment, arise in powerful protest? Did any leader of the industry face the facts squarely? On the contrary, the press was flooded with statements that there was really nothing wrong with the radio situation.

After several months of torture, Congress began to grapple with the situation. But did anyone come forward with the insistent demand that the number of radio stations be promptly and emphatically reduced? The leaders of the radio industry unremittingly labored to get some kind of legislation passed. When debate centered upon two forms of regulation—by a commission politically subservient to Congress or by a government bureau reporting to a cabinet officer and relatively free of political instability—

did the industry declare itself squarely against political regulation? Indeed it did not; it meekly favored both bills and, naturally, the bill giving political influence the greatest sway became the Radio Act of 1927.

Then came the *régime* of the Federal Radio Commission. Did the Commission display the courageous qualities of leadership essential to success in its onerous task? Its every act indicates that internal strife vitiated any constructive measures. For six months, it dabbled with its job. Credit must be given for its success in one respect; the Commission did manage to work out the best allocation possible *without* invoking the only course which would be successful—the elimination of excess stations in congested districts. The Commission talked about strong-arm methods one day and adopted weak-kneed policies the next; it announced that it would eliminate 300 stations from the broadcast spectrum and then promptly changed its mind. The progressive members of the Commission were invariably overruled because they could not successfully face the political pressure of Congressional overlords who invariably backed the weak against the strong.

When chivalry is applied to broadcasting, it means the support of less competent stations against the so-called chain monopoly. But to what stations does the listener turn his dials?

He selects the powerful stations offering high-grade programs. As Representative Davis of Tennessee pointed out, two chain organizations, operating through seventy-two stations, slightly more than ten per cent. of the total number of stations on the air, have 50 per cent. of the total broadcasting power. The remaining stations on the air might be classed in two groups: promising independents, offering high-grade programs and worthy of expansion, and the small, advertising and propaganda stations, which now stifle the growth of the better independents. The predominance of the chain stations is founded entirely upon the crowding of the more worthy independent stations by the host of worthless ether busybodies. The elimination of 300 small stations, particularly in large cities where powerful locals exist, would give a well-balanced structure of chain and independent stations.

In all the vast amount of conversation precluding the passage of the amendment demanding equalization of broadcasting, no one succinctly and forcefully stated the position of the broadcast listener. The vilification of the leading stations on the air went unchallenged. The equalization amendment is a farcical grandstand play, which glibly overlooks the fundamental causes of concentration of stations in the more populous areas. Merely to declare the sound principle that broadcasting shall be geographically equalized will not create the needed stations in the sparsely populated areas or the necessary channels so that they might operate.

To equalize the power in the five zones, only three possible courses exist:

- (1) Power in the weaker zones may be increased so that it equals that in the more progressive zones;
- (2) power in the strong zones may be reduced to the level of the weaker;
- (3) a middle course between these two extremes may be adopted.

Commissioner Caldwell showed that to bring up the power of the weaker zones to that of the highest would require the addition of 276 stations with 460,000 watts power. Inasmuch as the broadcasting band is already hopelessly overcrowded, any such increase, in fact any increase at all, would bring nothing less than chaos. Averaging the present total power among the zones would require a power cut in the first zone of 92,000 watts, curtailing the service of the most valuable stations on the air. At the same time, there are no stations in the South ready to bring that section up to average. Reducing the power of all districts to that available in the weakest would be wholesale destruction of good broadcasting.

The broadcasting industry should be encouraged to erect more great stations; the better independents should be given the opportunity to serve, unmarred by the excessive number of weaklings on the air. Unless the Commission develops an unlooked-for independence and courage, it will respond to the temper of Congress by hampering the growth of bigger and better stations. What we need is more, and not less, powerful stations in every section of the country. Only if listener sentiment becomes suddenly and

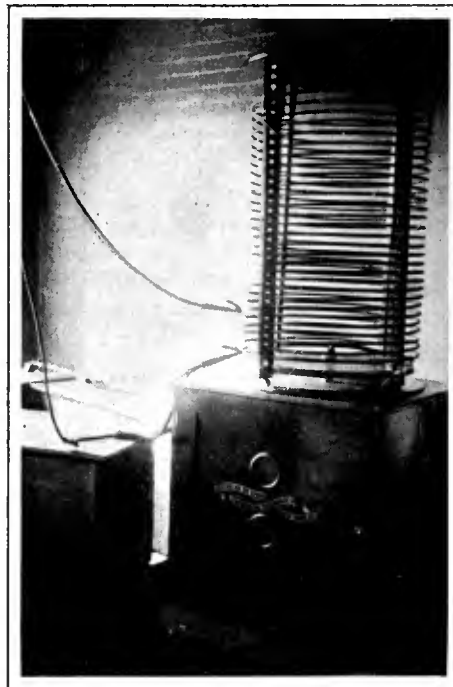

ANCIENT TRANSMITTING HISTORY

Parts of the first wireless telegraph installation in Porto Rico, built for and operated by the United States Navy. The station was located near San Juan and was completed in December 1903. The coil is the antenna tuning helix and below it is the spark gap case. To the left is the box containing the glass condenser plates. The spark gap was enclosed in the wooden box because of the terrific noise produced

*Present Distribution of Broadcast Stations*

THE following is an analysis of broadcasting stations licensed as of February 29, showing the inequitable distribution of stations by zones.

Commissioner Sykes, representing the southern zone, has pointed out that every legitimate

request for power increase and improved channels, made by southern stations, has been granted and that the inequalities are due rather to lack of progressiveness with respect to broadcasting in the South than to any discrimination.

	POPULATION	POPULATION (per cent.)	AREA (square miles)	AREA (per cent.)	NUMBER OF STATIONS	TOTAL STATION POWER IN WATTS	PERCENTAGE OF STATION POWER	STATIONS WITH OVER 1000 WATTS
<i>Zone 1</i> (New England Sts N. Y. & N. J.)	24,378,131	22.73	129,700	3.63	138	213,055	35.30	10
<i>Zone 2</i> (Central West & Middle Atlantic)	24,337,341	22.69	247,517	6.93	115	116,805	19.34	8
<i>Zone 3</i> (Southern)	24,826,050	23.14	761,805	21.33	102	47,105	7.80	4
<i>Zone 4</i> (Northwest)	24,492,986	22.83	648,148	18.42	215	164,870	27.31	30
<i>Zone 5</i> (Western & Pacific Coast)	9,213,720	8.59	1,774,447	49.68	131	61,785	10.24	8
<b>TOTAL</b>	<b>107,248,228</b>	<b>100</b>	<b>3,571,770</b>	<b>100</b>	<b>701</b>	<b>603,620</b>	<b>100</b>	<b>60</b>

immediately articulate, and a powerful sweep of opinion champions the two or three hundred favorite stations, can the destructive effects of the selfish and uninformed propaganda of Congress against good broadcasting be overcome.

*Mergers in the Radio Industry*

THE proposed merger of the Radio Corporation and the Victor Talking Machine Company would be a vital step in bringing us that combined broadcast receiver, phonograph, home motion-picture projector and television receiver which we forecast in these editorials for January, 1928, as the ultimate home entertainment machine. The total assets of the Victor Company are about sixty million dollars; those of the Radio Corporation about sixty-five million dollars. The merger will make available to the combination the services of renowned artists, both for radio purposes and for talking movies. The announcement that negotiations for this merger were under way was greeted with the usual monopoly accusations in Congress. Unquestionably the merger would result in a still stronger company. The consolidation of these interests is, however, certain to enhance the entertainment value of broadcasting and hasten the further development of diverse visual and tonal amusement in the home.

Another merger of vital importance to the American radio industry is the combination of the Marconi Wireless Telegraph Company of England with the Eastern Telegraph Company. This forms a one-hundred-million-dollar, world-wide communication corporation which may impose the pressure of severe competition upon the Radio Corporation of America. In spite of the comparative youth of the Radio Corporation, it has become a sufficiently vital factor in international communications to make this consolidation of British communications necessary.

A third merger which will ultimately affect the radio communication business is that of the International Telephone & Telegraph Company with the Mackay interests. The former controls telephone properties in Cuba, Spain, and South America and has exclusive rights for foreign manufacture of Western Electric Company products. The Mackay interests have an ambition to set up an international radio telegraph network and may ultimately become serious rivals to the Radio Corporation of America. The Mackay radio patent rights are based on their acquisition

of the Federal Telegraph Company and Federal Brandes.

*More High Power Broadcasting*

IT IS understood that the Crosley Radio Corporation, operating WLW, has applied for a 50,000-watt assignment and that, likewise, KFI in Los Angeles is to have a similar increase. The only southern station to seek a substantial power increase is KWKH. It is unfortunate that some of the more reputable broadcasting stations in the South are not aiming at substantial power increases, because there are many good reasons why KWKH in particular should not be favored by the Federal Radio Commission. This station, in plain defiance of the Commission, increased its power surreptitiously and utilized its facilities for vilification of members of the Commission. It has established little reputation for high-grade programs, although it is by no means at the bottom of the list in that respect. We regret to see this progressiveness for much needed substantial power increases in the South largely confined to a station which has virtually thumbed its nose at the Federal Radio Commission and defied the simplest precepts of law and order.

*British Skeptical of Baird Television Accomplishments*

A PUBLICITY statement from the Baird company says that a picture of Miss Dora Selvey, transmitted by Baird television from London to the *Berengaria*, a thousand miles at sea, was considered recognizable by the radio operator. It must be realized that any kind of a radio transmission, which is interpreted by any form of television machine, makes some kind of impressions on the screen. The photographs of long distance television reception, published in the newspapers, which we have examined, have all been faked, the image drawn on the screen being the work of a retoucher. Newspapers, with a nose for news, however, do not hesitate to fool the public.

*Popular Wireless*, a British home constructor's magazine, offers to pay Mr. Baird £1000, if he will successfully televise by radio, over a distance of not less than twenty-five yards, certain items such as a series of three recognizable faces, five simple solid geometric models in slow motion, four animal toys, grouped and in slow motion, and a tray, containing dice and marbles to a number not exceeding twelve, all of these objects to be sufficiently clear that a committee of judges can recognize them and state their number. The same publication points out that the television sets being marketed in England, which are not true television but shadowgraph machines, require a high voltage supply of six or seven hundred volts, which is quite capable of giving a fatal shock.

Dr. Herbert E. Ives of the Bell Laboratories, who demonstrated the first television apparatus between Washington and New York in April, 1927, stated recently that bringing into the home by radio an actual spectacle like a great athletic event is unthinkable because its cost would be simply enormous. Television is most effectively accomplished through wire lines and displayed in theatres and auditoriums so that large numbers of people will divide the cost of the presentation.

WHEN the S. S. *Robert E. Lee* ran on the rocks while en route from Boston to New York on March 9, several broadcasting stations, tending to interfere with the handling of SOS traffic, were very slow in getting off the air. Among the stations named by the Federal Radio Supervisor, were WJZ, WRNY, and WGL.



© Harris & Ewing

**THE FEDERAL RADIO COMMISSION IS COMPLETE**

After long delay, the vacancy on the Commission was filled by the President and all the members confirmed by the Senate. *From left to right:* Sam Pickard, O. H. Caldwell, Carl H. Butman (secretary), E. O. Sykes, H. A. Lafount, and I. E. Robinson, chairman



Laxity in this respect is rarely displayed by the more important stations and the lesser, having high-frequency assignments, are least likely to cause dangerous interference. Since it may be a matter of life and death, leniency to those who fail persistently to shut down promptly for distress traffic should hardly be tolerated. The violations so far noted have been only spasmodic and quite accidental.

### Here and There

THE Public Health Service broadcasts, which were begun in 1924, are now being used semi-monthly by fifty-four stations. 310 radio lectures have so far been delivered.

AS A result of the forty per cent. reduction in transatlantic telephone rates, there has been a fifty per cent. increase in the number of calls handled.

WCDA, a broadcasting station licensed in the New York area, for some mysterious reason, after the Federal Radio Commission went into operation, has sued WOR for \$100,000. for an alleged harmonic, attributed to WOR, which causes heterodyne interference with its programs. WOR's frequency is 710 and that of WCDA 1420. As a matter of fact, two predominant heterodynes assail WCDA's carrier, both of which cannot be attributed to WOR. The technical standards, maintained by WOR, are beyond question and whatever radiation there may be on its harmonics, are certainly suppressed to the minimum which the present standards of the radio art permit. Should WCDA's pretentious suit be successful, it would inevitably lead to other suits because harmonics cannot yet be entirely avoided. The second harmonic of all stations, having a fundamental frequency lower than 750 kilocycles, falls in the high frequency end of the broadcast band. The successful prosecution of WCDA's suit would place in jeopardy all the broadcasting stations which are assigned to frequencies below 750 kc. WCDA should never have been given a license in the first place.

#### THE SET BUILDER IN DETROIT

EARLY in April, manufacturers of radio parts and accessories exhibited at Convention Hall in Detroit, featuring the newest a. c. developments, units for the use of custom-set builders, equipment for converting battery sets to a. c., parts for improvement of receiving sets now in use. The large attendance is indication of the power and numbers of the knights of the soldering iron.

A JOBBER section has been formed by the Federal Radio Trade Association. The manufacturers' relation committee of the section is headed by Harry Alter, the membership committee by J. M. Connell.

#### RADIO SALES IN FIGURES

THE average business done by radio jobbers is \$218,000 annually, according to figures from a survey made by the Electrical Equipment Division of the Department of Commerce and the National Electrical Manufacturers' Association. Three hundred and seventy-five jobbers in New York, New Jersey and Philadelphia did an average volume of \$298,000; the New England group \$264,000; Great Lakes region \$240,000 and southern states \$118,000.

Small-town radio dealers, according to a survey by the same Bureau, average \$5200 a year, as compared with \$22,800 by the average New York dealers. The Philadelphia average was \$21,000;

Chicago \$32,200. A group of cities, including Boston, Baltimore, Cleveland, Detroit and St. Louis, show an average of \$44,300.

Radio Retailing estimates the sales of radio sets in 1926 at \$506,000,000 and in 1927 at \$446,550,000. Radio is now installed in 27 per cent. of American homes. If broadcasting conditions are not soon improved, radio set sales will continue to decline.

#### NO NEW IDEAS IN PROGRAMS

COMMENTING editorially on commercial broadcasting, *Editor & Publisher* states: "The rare incidence of new ideas in the program departments of large radio studios is beginning to worry the men assigned to the development of new converts in broadcasting. The monotony is beginning to pall on its makers and the feeling is expressed that the pall may extend to the payroll unless expert direction is found to steer programs into new channels. . . . As a rule, the radio program staffs are competent to provide a well-balanced evening of entertainment. They know nothing of selling merchandise and the application of advertising to the development of sales. They have constructed a program and stuck into it, like splinters into a fruit cake, occasional mention of the sponsor's name and goods. The advertising interludes to the entertainment have, in recent weeks, become more and more blatant."

*Editor & Publisher's* charges are, in the main, true. There have been very few instances of originality in the form of program presentation during the last few years. One answer may lie in the fact that successful moving picture directors get from fifty thousand to two hundred thousand dollars a year, while the number of program directors in the radio field who make more than five thousand dollars a year can be counted on the fingers of two hands.

#### PENDING SHORT-WAVE APPLICATIONS

ONE hundred and fifty applications for short-wave channels by new commercial and public short-wave stations, requiring 350 channel assignments, are now pending before the

Federal Radio Commission. Communication companies are making 45 applications for 137 channels; newspapers 31 for 97 channels; oil companies 28 for 29 channels; brokerage houses 12 for 22; steamship companies 7 applications for 13 channels; banking houses 6 applications for 6 channels; motion picture producers 5 applications for 10 channels; rubber companies 3 for 4 channels; coal 1 application for 2 channels; automobile and transportation companies 1 application for 1 channel; and miscellaneous businesses 5 applications for 7 channels.

If these assignments are granted and the channels placed in use, the rivals of these companies will also want channels and, since further channels will not be available, the Federal Radio Commission will, of course, be charged with discrimination. The principle of first come, first served, which must apply when a limited number of any commodity is being dispensed, always carries in its wake the cry of discrimination.

#### NEW AMATEUR BANDS

GENERAL order No. 24, by the Federal Radio Commission, opens the 20,000-to 30,000-kc. band to the amateur. The assignments are now as follows:

64,000—56,000 kc.	4.69—5.35	meters
3,550—3,500 kc.	84.5—85.7	meters
2,000—17.5 kc.	150—175	meters

A SHORT-WAVE radio picture receiver, installed on the Hamburg American liner *Resolute*, is said to be successful. Small pictures and letters can be sent for moderate distances at a cost of one dollar.

#### THE NEW G. E. HIGH-FREQUENCY TUBE

DR. W. R. WHITNEY of the General Electric Company recently described a new high power, high frequency, short-wave tube, generating fifty million cycles. It radiates ten to fifteen kilowatts. Interesting psychological effects have been noted, particularly a warming

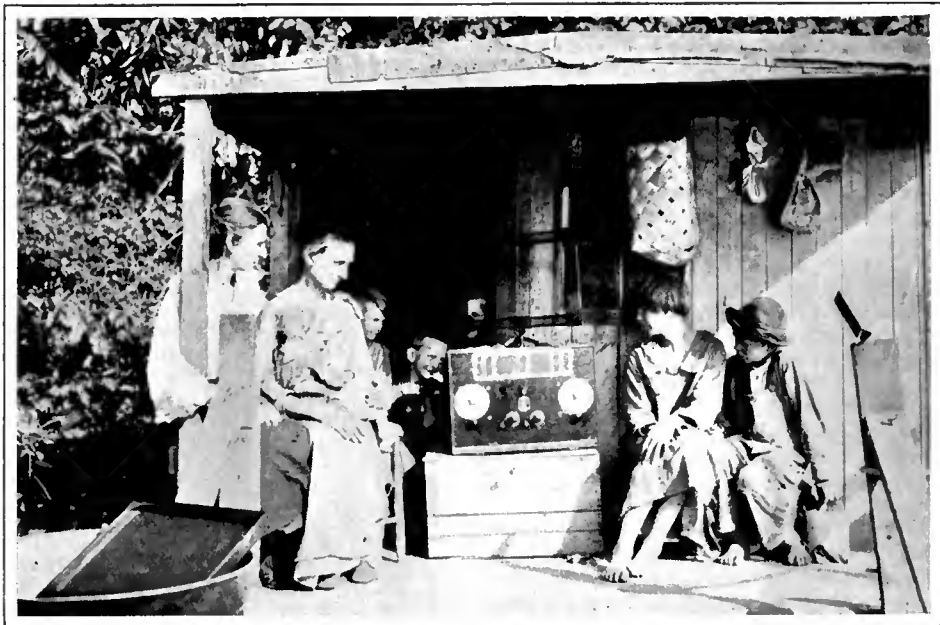

#### RADIO BRIGHTENS THE LIFE OF OHIO RIVER FOLK

House-boat dwellers along the Kentucky shore of the Ohio River. The receiver is pulling in wgy and is the first radio reception these folk have ever heard. The set was an important part of the equipment of Lewis R. Freeman, member of the Explorers' Club of New York who traveled from Pittsburgh to Cairo—a distance of 1000 miles along the Ohio River. This set was used to bring in weather forecasts while navigating the river and in one case, at Louisville, picked up a cyclone warning, enabling Mr. Freeman to avoid a tornado that might have destroyed his expedition

effect on the blood of persons within its influence. Small arcs are readily established by metallic conductors. Eggs and sausages have been fried by the heat generated on a single wire.

NEW RADIO AVIATION BEACON

THE visual indicator, developed by the Bureau of Standards of the Department of Commerce, to show the aviator his course, employs a needle-like reed, moved by electrical impulses received from the radio beacon. It does away with headphones and trailing antenna. It works on the familiar balanced signal principle and gives indications for distances of fifty miles. In mountainous regions, however, its directional accuracy varies but the device should be of inestimable help in locating a landing field through a fog when the aviator is not far distant from the field. Guided by the beacon, he can come within range of the fog-penetrating neon light and thus make a successful landing which might not be possible without the radio direction finder.

OWEN D. YOUNG flatly stated recently that the British lead America in international cable and radio communication. "The English Government," said Mr. Young, "fearing predominance of the American radio group in the world of communication, has practically coerced the interests in England to combine cables with radio in order that the English domination of cables may continue. In America, Congress has enacted directly a piece of legislation stipulating that there can be no cooperation or relation between the cables and radio. Congress had disintegrated our strength into small units and put each one of them at the mercy of a large centralized foreign group."

GOVERNMENT officials in Czecho-Slovakia estimate that the saturation point in the possible number of receiving set owners has been reached in that country unless more broadcasting stations are erected. There are now 206,000 listeners in Czecho-Slovakia which has a population of some thirteen million.

RUMORS have appeared in the press that several large holders of R. C. A. licenses have stopped payment on their license contracts and served notice to the effect that at the present time they are not able to carry out their agreements because of heavy declines in sales and the inability to realize on large stocks of battery sets.

THE Brunswick Phonograph Company announced that it will place records of certain commercial broadcast programs on the market the day following their presentation. It's bad enough to hear most radio programs but once!

BRITISH SHORT-WAVE EXPERIMENTS

WITH characteristic caution, the British broadcasting monopoly announces, through its Chief Engineer, Captain Eckersley, that the 5 sw high-frequency transmissions are being attempted largely to permit foreign and dominion experts to ascertain field strength on various frequencies. "It would be criminal foolishness," says the announcement, "to let these encourage one into saying that there is yet a guarantee of satisfactory service worthy of the object served."

International broadcasting, through short-wave interconnecting links, is still a spectacular demonstration with all the hazards of uncertainty. But any new art must begin in this way and the experiment should be encouraged. Its

success will accomplish much more than all the peace conferences and pacifist disarmament propaganda.

BROADCAST AREA SERVED IN AUSTRALIA

THE interests operating station 3 LO in Melbourne, Australia, have shown, by superimposing a map of Europe upon that of Australia, that six Australian broadcasting stations, all fringing the coast, serve an area equal to that of Europe, including Great Britain and Ireland. Most of the population of Australia, however, is distributed in centers along the seacoast. There is no problem of frequency shortage to hamper the increase of broadcasting stations, but it appears that the government authorities hesitate to permit an increase in the number of broadcasting stations.

BROADCAST COÖPERATION IN EUROPE

THE Union International de Radiophonie, which consists of delegates from all European countries operating broadcasting stations, is concerning itself with such problems as frequency assignments, accurate frequency measurements and the formulation of the frequency requirements of the various nations. This body serves the same function as the Federal Radio Commission in the United States, except that it has no legal authority and must settle its affairs by mutual agreement and conference.

PCJJ, the Dutch short-wave broadcasting station, frequently heard by American enthusiasts, has adopted a schedule as follows: Tuesdays and Thursdays, 16 to 19 Greenwich mean time, and Saturdays 14 to 17 G. M. T

AUSTRIA now claims to be the most progressive country in the broadcasting field, so far as percentage of registered listeners is concerned. 300,000 out of its 6,500,000 population are registered radio listeners. Radio manufacturing is also developing rapidly, exports being four times greater than imports.

FACSIMILE TRANSMISSION USED

THE extent to which financial enterprise is utilizing the modern means of electrical communication is illustrated by the recent floating of ten million dollars in bonds for Warsaw, Poland, simultaneously in Europe and America. A 1,400-word descriptive circular was compiled and sent by radio to London and Stockholm. Quarter-page ads were then set up in London and mats made and distributed by air mail to other European capitals. The circular was cable to South America and put into type. In New York, it was set up and distributed by telephoto to cities as far west as the Pacific Coast. Thus transatlantic radio picture circuits, airplanes, telephoto, and cable were used in this international financial venture.

THE transatlantic telephone service was extended to Belgium on January 19 and to Holland on January 30.

HERBERT H. FROST, formerly General Sales Manager of E. T. Cunningham, Incorporated, has resigned to become Vice-President of Federal-Brandes, Incorporated.

RADIO beacon service is to be installed along the French coast. One station is to be built at the mouth of Cherbourg harbor and another ten miles northeast of that point so that bearings can be given to incoming ships.

A DECISION of the U. S. District Court in Cincinnati declares that the Crosley Musicone does not infringe upon the Lektophone patents. The Musicone, says the decision, is drawn from the same prior art that the Hopkins invention is made and is an improvement thereof.

The Supreme Court of Canada holds that the patent granted by the United States to the German inventors Schoelmich and Von Bronk is prior art over the Alexanderson tuned radio frequency patent. This is directly opposite to the opinions of American courts.

- F. H. F.

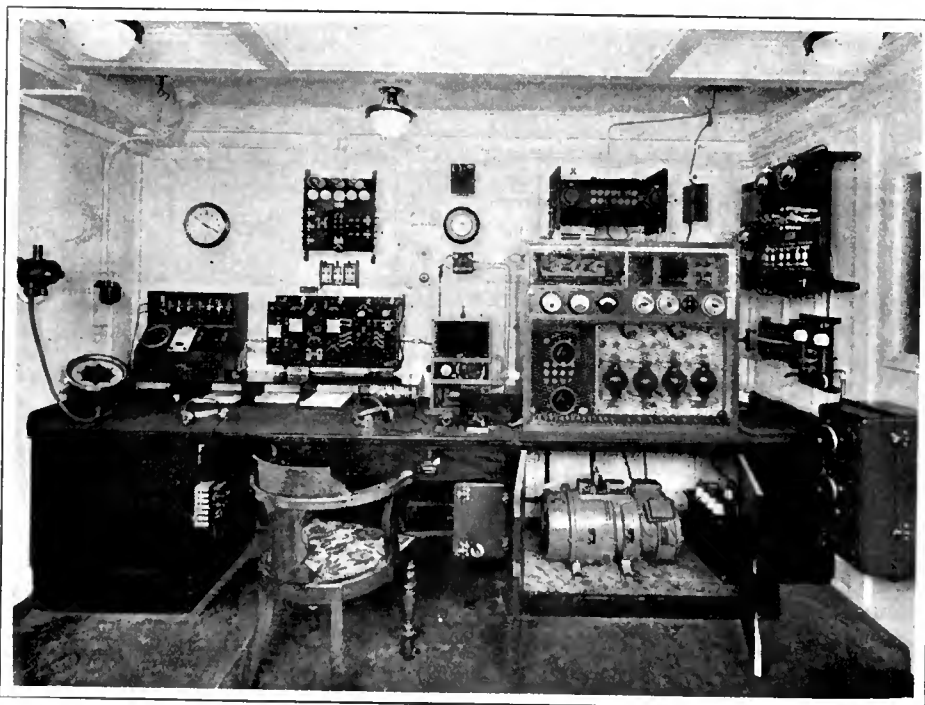

RADIO CABIN OF THE MOTORSHIP "BERMUDA"

This is the latest type Marconi installation for ships and shows (left to right) gyro-compass repeater; direction finder; receiver operating on all wavelengths from 300-20,000 meters; 1/2-kw. quenched spark transmitter; 1 1/2-kw. c.w. and i.c.w. tube transmitter working between 600 and 2200 meters

# Automatic Tuning for the Radio Receiver

By LEROY S. HUBBELL

IF WE review the development of the mechanics of a radio receiving set we remember a panel resembling a small switchboard which had primary and secondary inductance switches, an A battery control switch, several variable condenser controls and other minor control switches. Gradually, over several years, these numerous controls began to disappear until now, on the panels of many of the recent designs, not more than three controls exist, namely, the on-off switch, a single dial for controlling the variable condensers, and sometimes a volume control.

While there have been many improvements toward simplifying the tuning of a radio receiver, it is still necessary to manipulate a dial and if a particular station is desired it is necessary to consult a schedule. If no tuning schedule is available the settings are oftentimes haphazard. In a large number of cases, particularly in the metropolitan areas, the dial settings are usually confined to not more than five to ten stations.

When one is comfortably seated, whether in a favorite armchair by the fireside or at the table enjoying a dinner or participating in a card game it is annoying to interrupt one's activity to adjust the radio to some other station in search of a more delectable program. The partial elimination of the multi-controls on the radio receiver has reduced immensely the trials and tribulations of many a lover of radio entertainment. Probably there will always be at least two controls, one for the station setting and another for the volume from the loud speaker. Take these two controls to the armchair by the fireside or to the table and the ideal radio entertainment is at hand.

In this article we discuss a means for automatically tuning a radio receiver at a remote point, although the same equipment may be used in connection with a transmitting station where the tuning elements are adjustable. The advantages may be summarized as follows.

1. The set may be tuned to any one of several definite stations by pressing a button.
2. The set may be controlled at any point of convenience.
3. The radio receiver may be housed in a closet or other out-of-way place reducing considerably the cost of expensive furniture.
4. An outdoor directional loop type antenna may be used instead of the present antenna.

[Judged by present standards, Mr. Hubbell's automatic tuning mechanism has certain drawbacks, as well as obvious advantages. These limitations hold for all automatic tuning mechanisms with which we are familiar. The apparatus takes up considerable space, and although, as Mr. Hubbell suggests, the receiver and the tuning mechanism may be located elsewhere than in the living room or the den—or wherever receivers now in common use are located—it is necessary to place the automatic mechanism quite close to the radio apparatus and in most cases that involves rearranging at least the radio frequency and detector circuits of the receiver. Neither Mr. Hubbell's arrangement or any other can readily be applied to the average existing receiver. That is, of course, not a serious disadvantage, for it is not difficult to rearrange a "pet circuit" so that the relay tuning controls are operative. Cost, too, is a factor, but a very real gain in convenience is achieved which should equalize that.—Editor.]

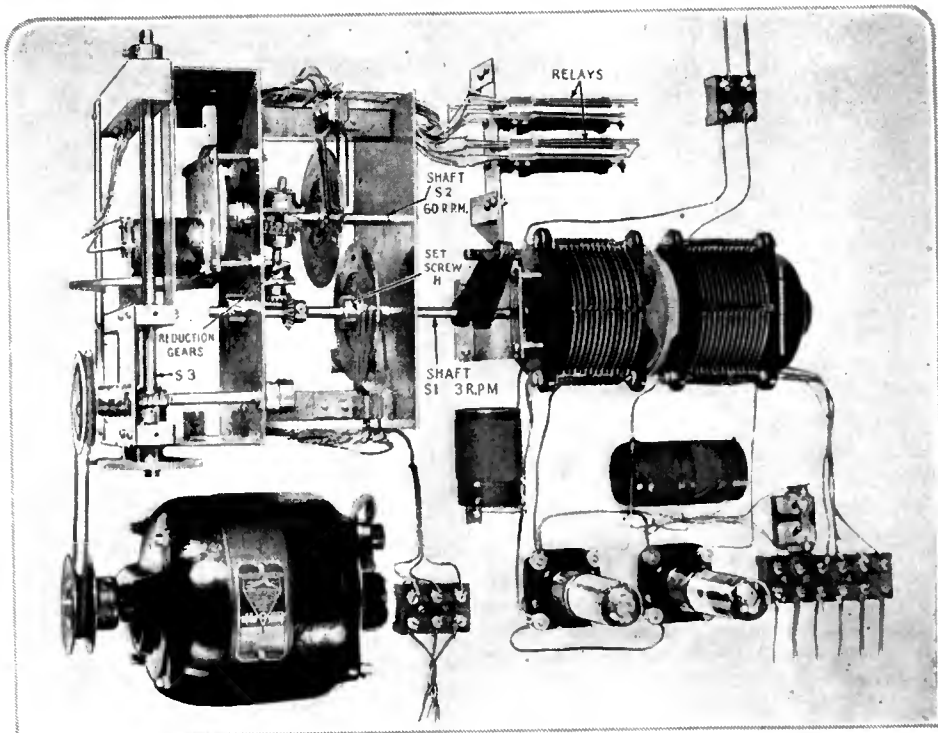

AN EXPERIMENTAL SET-UP OF THE HUBBELL AUTOMATIC TUNING CONTROL  
The photograph shows a rough model of the tuning control apparatus and the radio and detector circuits of the receiver. The motor in this illustration is much larger than necessary. The model shown is equipped for tuning only to one broadcast station, two more cams, one on each shaft will be required and one additional relay for each station

## THE APPARATUS USED

THE equipment designed by the author for automatically tuning radio apparatus consists essentially of a small commercial type motor of about  $\frac{1}{10}$  h.p. or less, depending on the number of stations the equipment must tune to, connected to a revolving iron disc through a reduction gear. The revolving iron disc is caused to engage at right angles another iron disc by means of an electro-magnet (magnetic clutch). The second disc is connected to a series of cams to which spring contacts engage. Two cams, one acting as a vernier to the other and a relay are

required for each wavelength setting. If the radio apparatus has more than one variable control the clutch and cams are duplicated, but the motor and reduction gear are common to any number of controls.

At a distance from the radio set there is a small button box which contains a button for each wavelength and associated with each button is a small display lamp to indicate the station to which the set is tuned. The button box also contains a rheostat or potentiometer for controlling the volume at the loud speaker.

Except for the push buttons, display lamps and volume control switch, the tuning mechanism may be housed within the radio cabinet. For those who are not interested in distant stations and confine their entertainment to local broadcast programs it would be practical and desirable to place the radio equipment in a closet or other out-of-sight place thus reducing the cost of the receiver.

In the accompanying Fig. 1 is shown the fundamentals underlying the operation of the automatic tuning equipment designed by the author. In the lower left hand side of the drawing is shown a revolving iron disc,  $D_1$ , whose shaft is connected to a small motor (not shown) through a reduction gear. When the motor is energized, the iron disc to which it is connected revolves at about 60 revolutions per minute. Adjacent to this disc is another iron disc,  $D_2$ , the axis of which is at right angles to the former. These two discs have about  $\frac{1}{8}$ " clearance between their edges. There is a magnet,  $M_1$ , mounted closely against the driving disc, but not touching it, with one of its poles facing the driven disc. There is a return pole piece on

OF LATE there has been a considerable interest in the automatic tuning of radio receivers. Remote tuning control of radio transmitters has been used for some time, in various forms by both commercial and military radio stations, but until recently, little had been done to explore the possibilities in the radio receiver. This timely article by Mr. Hubbell describes the mechanical principles of the system which he has devised; the illustrations show a rough model. A commercial model would probably be quite different in arrangement and appearance. Practically, the device suggested by Mr. Hubbell is limited to the control of from ten to fifteen stations, but it does permit the manual control of the receiver at any time. No effort has been made to treat this subject from the constructional point of view. Our readers will nevertheless be interested in the description of the present method. All patent rights are reserved by the author.

—THE EDITOR.

the magnet to concentrate the flux at the driven disc end. On the driven disc there is mounted a six-fingered suspension spring which connects at its center the shaft, S, to the driven disc at the extremities of the fingers. This spring permits the driven disc to hold up against the driving disc when the magnet is energized.

On the shaft, S, a cam is mounted consisting of copper punchings riveted to a fiber disc. The front of the cam is shown in perspective while the rear of the same cam is shown at the right of the drawing in full view. On the front of the cam it will be noted that the copper punchings are cut so that the brushes resting against the cam pass over segments and interrupt any current which may be passing through the brushes. On the rear of the cam there are no breaks in the copper punchings. These copper punchings are electrically connected to the punchings on the front of the cam by rivets. In the upper portion of the drawing a conventional relay is shown. In the lower right hand side a push button and a display lamp is indicated. The shaft, S, is connected to the proper variable tuning element of the radio set such as a variable condenser, a variometer, etc.

TUNING FOR STATIONS

BY PRESSING the push button a circuit is closed beginning with the ground side of the battery through the contacts of the push button, and the relay to battery. The relay operates and in so doing establishes a circuit to lock itself up. The circuit is as follows: beginning with ground at the left of the relay through the making contacts to the upper spring pressing against the rear of the cam, through the rivets of the cam to the upper brush on the front of the cam back to the right hand contact spring of the relay, through the winding of the relay to battery.

At the same time that ground is connected to the upper brush on the front of the cam, a ground is placed on the middle brush which operates the magnet. Also a ground is supplied to the motor lead which operates a relay in the motor circuit causing the motor to rotate. The shaft, S, now rotates and continues to rotate until the top and middle brush fall into the open-shaded segment of the cam. The set screw, A on the cam hub permits the cam to be set at any angular adjustment so that the variable element in the radio set can be rotated to any predetermined setting. In practice there is another shaft, S<sub>2</sub> (see the accompanying illustrations) paralleling the shaft, S, on which is mounted a similar cam and brushes. The second shaft is connected to shaft S, through a gear, reducing the speed from 60 r.p.m. to 3 r.p.m. The brushes of the second cam are connected in multiple with the brushes shown so that by connecting the variable condenser or other variable element to the second shaft, a micrometer adjustment is obtainable.

When the cam on shaft S has arrived at the break in the copper punching the circuit to the motor, clutch and relay is opened. A contact is made however on the lower brush at both sides of the cam which completes a circuit from the ground at the relay (the relay now being released) through the lower brushes on both the front and rear of the cam through the display lamp to battery. The display lamp is lighted to indicate that the variable element in the radio receiver is tuned to a wavelength as predetermined by the adjustment of the cam on shaft S.

It should be noted that the lead marked "To battery switch" is connected to battery through the released contacts of the relay. With this arrangement all undesirable noises in the loud speaker are eliminated when the variable elements are passing over unwanted stations. As

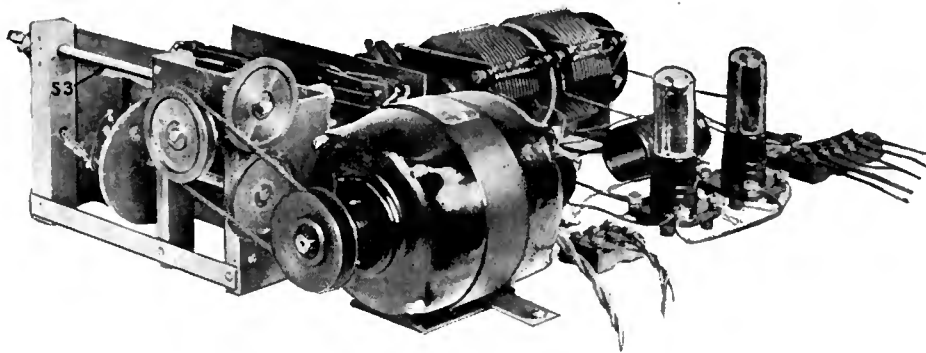

A SIDE VIEW OF THE EXPERIMENTAL UNIT

This illustration shows the mechanical relation of the reduction pulley and the main shaft, S<sub>2</sub>

soon as the cam has arrived at its predetermined station setting the relay releases and through its contacts supplies current over lead "To battery switch" to the A battery rheostat.

The push button and display lamp indicated in the drawing together with a plurality of push buttons and lamps are mounted in a button box away from the tuning equipment, the latter as suggested above are housed within the radio cabinet. From the push button box there are two wires for each button, a pair for the two poles of the battery and a lead for controlling the volume at the loud speaker. For a six-station controlled set, there would be about 15 wires in a flexible silk covered cable leading from the position of the button box to the radio set.

The relays used are of commercial manufacture having resistances of approximately 200 ohms and operating on 6 volts. The magnet is part of the construction of the tuning mechanism and is wound to operate on a 6-volt battery at about 15 watts. The battery used may be either a 100-ampere storage battery or may be replaced by an a.c. rectifier which would operate only when required. Low voltage a.c. for operating the relay and lighting the display lamp would also be required if the storage battery is eliminated.

In the photographs, the relays referred to and the magnetic clutch are marked. The motor, which rotates at about 1750 r.p.m. is connected to the device by means of a belt. Between the motor shaft and the driving disc shaft the speed is reduced to about 60 r.p.m. through the pulleys on both the motor and the device and the reduction gears on the device itself. The magnetic clutch being energized by the relay as mentioned above, is holding the driven disc up against the driving disc causing the cam on

the left hand shaft to revolve clockwise and the cam on the opposite shaft to revolve counter clockwise.

The cam on the left hand shaft revolves at about 60 r.p.m. while the cam on the right hand revolves about 3 r.p.m. the reduction taking place through the gears connecting the two shafts.

It will be noted that the tuning device and the variable condensers are not directly connected. The means shown permits a free movement of the condensers through nearly 360 degrees. By this feature it is possible to tune the radio set manually to any desired station free of the automatic tuning device. The experimental model is equipped to tune-in automatically only one broadcast station, that station being dependent upon the settings of the two cams. For each additional station two more cams, one on each shaft will be required. One additional relay will also be required for each additional station. The practical limit is probably about 10 or 15 stations.

For cases where there is another adjustable tuning element in the radio set and which can not be directly connected to a single control, it is possible to tune automatically that element independently. To do this a shaft is extended to another device which is similar to that shown. In this case, however, the only parts which require duplication are the cams and magnetic clutch and the spur gears which connect the upper shaft to the driving disc shaft.

The second relay shown in the photographs is connected between the push button relay (shown in diagrammatic form in Fig. 1) and the motor. The use of this relay merely separates the direct current circuit used to operate the radio set from the 110-volt alternating current lighting circuit which is used to operate the motor.

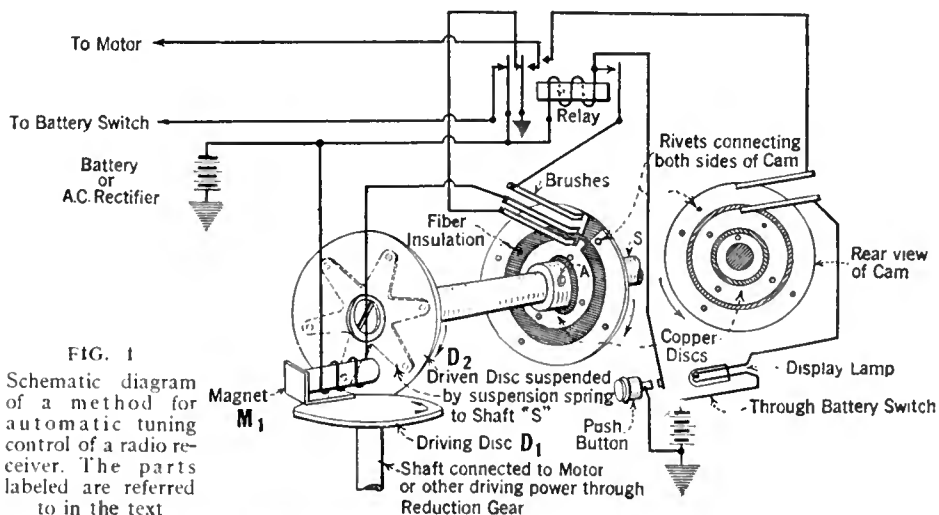



# THE NEWEST POWER TUBE

By Howard E. Rhodes

Radio Broadcast Laboratory

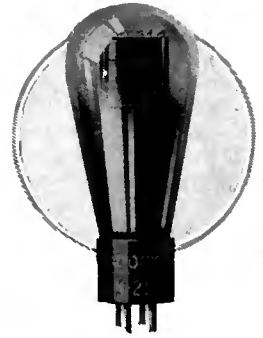
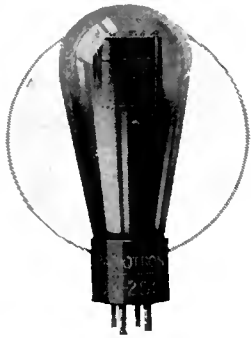

**T**HIS UX-250 (CX-350) "special purpose" tube is the newest and probably the last of the line of power amplifier tubes designed for use with radio receivers, for according to its designers, the power output is about as large as may be obtained from a tube mounted in a standard receiving tube base. The glass bulb enclosing this tube, which determines the amount of heat that can be dissipated, is as large as is feasible using this base.

To what use can this power tube be put? What advantages and disadvantages has it over other types? Let us compare it with others to get a clear picture of the relation between the 250 and other tubes.

Fig. 1 shows how the power output of this tube compares with that of the other types of power tubes at various plate voltages.

This table is very interesting for it shows that at all plate voltages, the 250 tube is capable of delivering more than twice the power output of a 210 tube. For use in a straight amplifier (not push-pull) the tube, from the analysis given above, seems to be much the best for it is capable of delivering much more power than any other type of tube. When operated at maximum voltage, the 250 can deliver a power output of 4.6 watts which is about as much as can be obtained from two 210 type tubes in push-pull. In the following paragraphs a more complete comparison is given of a single 250 vs. 210's in push-pull.

### POWER SUPPLY EQUIPMENT

**A**BOUT 450 volts are required in both cases and the plate current requirements (about 40 mA. for 210's in push-pull and 55 mA. for a single 250) are not sufficiently different to make the power supply equipment much cheaper for one of the two arrangements. In so far as the power supply is concerned, therefore, there is no distinct advantage in favor of a single 250 rather than two 210's in push-pull or vice versa.

### A COMPARISON OF COST

**S**INCE ordinary transformers are cheaper than push-pull transformers it is somewhat less expensive to construct a power amplifier using a single 250 type tube than two 210's in push-pull. For example, suppose that transformers costing about as much as Amertran's were to be used in the amplifier,

### SINGLE 250 TUBE

Input transformer	\$10.00
Output device	10.00
One 250 type tube	12.00
One socket	1.00
<b>Total</b>	<b>\$33.00</b>

210'S IN PUSH-PULL	
Input transformer	\$15.00
Output transformer	15.00
Two 210 type tubes	18.00
Two sockets	2.00
<b>Total</b>	<b>\$50.00</b>

Here we see a distinct advantage in favor of a power amplifier using a single 250 tube and delivering to the load about as much power as 210's in push-pull, which will cost only about 65 per cent. as much as a push-pull amplifier.

### A COMPARISON OF QUALITY

**I**N THIS characteristic, the push-pull arrangement is theoretically better than the single tube because the former arrangement eliminates second harmonic currents—currents which represent distortion and which are passed on to the loud speaker when only a single tube is used. However, even with a single low-plate-impedance tube such as the 250, there isn't much second harmonic current generated by the tube in the load circuit when the tube is delivering its rated power, or less for under the condition that the tube is working into a load impedance approximately twice as great as the tube's plate impedance the amount of second harmonic current in the output is not greater than 5 per cent.—an amount of distortion which is considered small enough not to be appreciable to the ear. If the load impedance is smaller than twice the tube's impedance, there is more distortion; if it is equal to the tube's impedance, the amount of distortion due to second harmonic currents will be about 15 per cent., this latter figure being calculated from some curves on the tube to be published in the *Proceedings of the I. R. E.* ("Development of a New Power Amplifier Tube," Hanna, Sutherland, and Upp). The impedance of many loud speakers, at the very low frequencies, will be about the same as that of the 250 type tube (2000 ohms) and therefore there will be about 15 per cent. second harmonic current generated by the tube. However, the sounds created by musical instruments contain many harmonics and the ear itself probably generates others, so it may be that the above figure of distortion is not large enough to be serious.

The 210 push-pull arrangement has an advantage over the single 250 when the filaments are to be operated on raw a. c. In the push-pull amplifier, any hum due to the a. c. operation of the filaments is cancelled out, while with the single tube arrangement this does not occur. However, the 250 tube uses a heavy ribbon type filament (similar to that used in the 280 type tube) which has a high thermal inertia tending to prevent the production of any a. c. hum when its filament is operated on raw a. c. The 250 type has a low plate impedance, (about 1800 ohms) and can therefore be used with ordinary loud speakers without any need of an impedance-adjusting transformer. Two 210's in push-pull have a plate impedance of about 10,000 ohms and in this case it is best to use an impedance-

TABLE I  
UNDISTORTED POWER OUTPUT IN MILLIWATTS

PLATE VOLTAGE	112	171	210	250
90	40	130		
135	120	330		
157	195	500	90	
180		700	140	
250			340	900
350			925	2350
400			1320	3250
450			1760	4650

The figures in Table I together with data on several push-pull combinations have been plotted in Fig. 1. This graphic representation of the power output of various tubes and combinations of tubes, as a function of plate voltage, serves well to illustrate the relative position of each tube from the standpoint of power output.

When interpreting these curves, it should be appreciated that a considerable increase of power output is necessary in order to make the effect appreciable to the ear. Twice the power output is equivalent to an increase of 3 TU which is not very great. 1 TU being a just audible increase. It is necessary that the available power be increased two or three times in order for the increase to be worth while.

The choice of which type of tube is used depends, obviously upon how much power output is desired. If not more than 200 milliwatts are required, the 112 may be used; for a power output up to 700 milliwatts the 171 type tube is used. If greater power than this is required we can use either a 210 or a 250 type tube. A more detailed analysis of these two tubes, showing how their power output varies with the applied plate voltage is given below.

### POWER OUTPUT OF 210 TUBE

PLATE VOLTAGE	POWER OUTPUT (Milliwatts)	PLATE CURRENT (mA)	GRID BIAS (volts)
250	340	10	18
350	340	16	27
450	1700	18	39

### POWER OUTPUT OF 250 TUBE

PLATE VOLTAGE	POWER OUTPUT (Milliwatts)	PLATE CURRENT (mA)	GRID BIAS (volts)
250	900	28	45
350	2350	45	63
450	4650	55	84

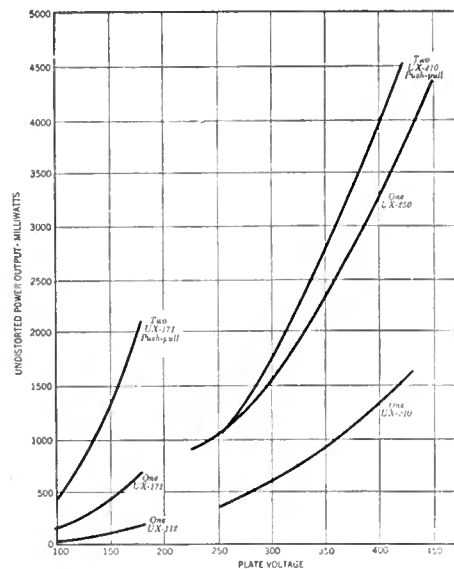

FIG. 1

How the power output of the 250 type power tube compares with other types of power tubes, at various plate voltages



adjusting output transformer to adapt the tube impedance to that of the loud speaker. Although an impedance adjustment is not necessary when using a 250 type tube, it is necessary to use an output device to protect the windings of the loud speaker from the high plate current of the 250 tube.

COMPARISON OF SENSITIVITY

UNDER this caption we discuss how the two arrangements compare with regard to power output for a given input voltage. Let us, therefore, calculate the power output, for a given input, for both arrangements. If each arrangement works into a load impedance equal to twice the tube impedance, then, per volt input squared, there will appear in the load the amounts of power, as indicated below.

ARRANGEMENT	POWER IN LOAD, PER VOLT SQUARED, ON GRID OF TUBE
Single 250	0.8 milliwatts
Push-pull 210's	3.0 milliwatts

In this table the 250 shows up very poorly, being only about one-quarter as sensitive as 210's in push-pull. However, the turns ratio of the average push-pull input transformer available to-day is lower than an ordinary transformer and if we assume that with a single tube the input transformer has a ratio of 4 and that the push-pull transformer has a ratio of 2 (many push-pull transformers have a lower ratio than this) between the primary and one side of the secondary, we then obtain the following figures:

ARRANGEMENT	POWER IN LOAD, PER VOLT SQUARED, ACROSS TRANSFORMER PRIMARY
Single 250	12.8 milliwatts
Push-pull 210's	12.0 milliwatts

These figures give a truer picture than those given previously. The difference between the two arrangements—a matter of 0.8 milliwatts per volt squared—is too small to be appreciable to the ear but at least we may be sure that an amplifier using a push-pull arrangement with average transformer ratios and with 210 tubes won't give any greater volume, with a given input, than an amplifier using a single 250 tube.

This analysis, summarized in the accompanying table, shows the 250 tube to be about equal to a 210 push-pull amplifier in most respects excepting that of cost.

The complete characteristics of the 250 tube are given in the table accompanying this article which shows that this tube requires a plate voltage of about 450 volts and takes a plate current of 55 mA. The power supply must provide this amount of current and voltage. The loud speaker must be isolated from this high plate current by an output device.

In some cases it will be found possible to substitute a 250 type tube for a 210 tube in an amplifier, but frequently this will not be possible because the 250 takes three times as much plate current as a 210 and the rectifier-filter system may not be able to supply sufficient voltage at this higher current drain. The higher current drain may reduce the voltage output of the power unit from 450 volts, when a 210 type tube is used, to 300 volts or so and it is not worth while to operate a 250 at this voltage. Under such conditions the tube cannot deliver much more power output than a 210 type tube, operated at 450 volts.

ALLOW ONE WATT PER LOUD SPEAKER

THE 250 type can be used in a properly designed push-pull amplifier and such a use for the tube should prove useful where sufficient power is required for the operation of several loud speakers or for auditorium work. A push-

CHARACTERISTICS OF THE TYPE 250 TUBE

	RECOMMENDED				MAXIMUM	
	250	300	350	400	450	Volts
Plate Voltage	250	300	350	400	450	Volts
Negative Grid Bias	45	54	63	70	84	Volts
Plate Current	28	35	45	55	55	Milliamp.
Plate Resistance (a-c)	2100	2000	1900	1800	1800	Ohms
Mutual Conductance	1800	1900	2000	2100	2100	Micromhos
Voltage Amplification Factor	3.8	3.8	3.8	3.8	3.8	
Max. Undistorted Output	900	1500	2350	3250	4650	Milliwatts
Filament	7.5 Volts				1.25 Amperes	
Max. Overall Base	Height 6 1/2"				Diameter 2 1/4"	
	Large Standard UX					

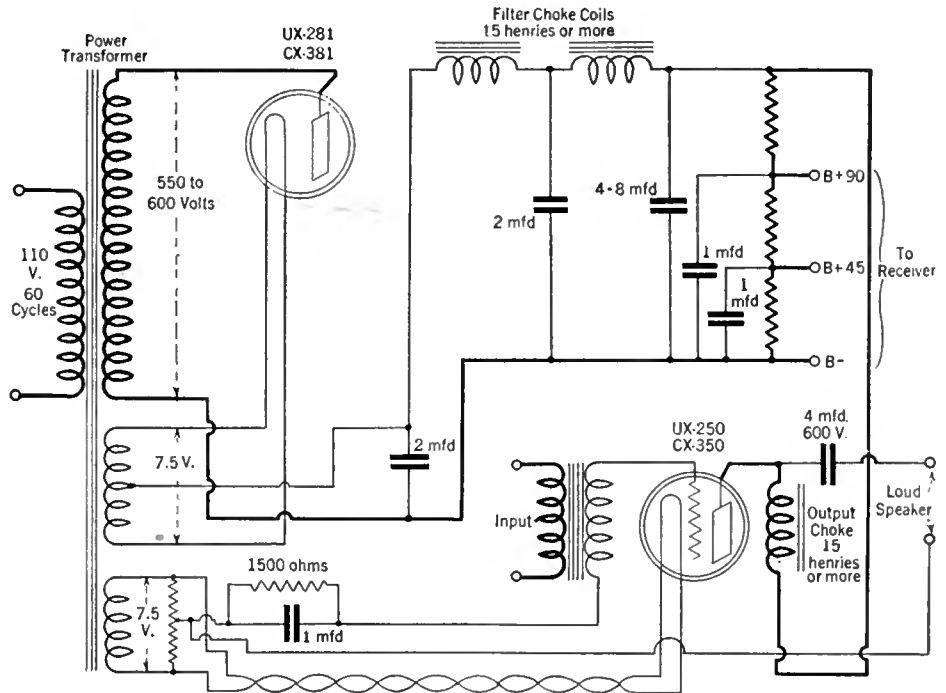

GENERAL CIRCUIT REQUIREMENTS FOR THE 250 TYPE TUBE

All values are indicated except the voltage dividing resistances which vary according to the receiver to be supplied

Comparing the 250 Type Tube With Other Power Tubes

IN THIS article the new type 250 power amplifier tube is compared with other power tubes now available. A summary of the points developed more fully in the article follows:

- (a). The maximum power output of a type 250 tube is 4.6 watts, which is about three times as much as can be obtained from a 210 type tube and about seven times as much as can be obtained from a 171 type tube.
- (b). The power output of a single 250 is about equal to the power that can be obtained from a push-pull amplifier using 210 tubes.
- (c). The power supply equipment necessary for the operation of the 250 type tube is about the same as is required for the operation of a push-pull amplifier with 210 type tubes.
- (d). Because ordinary transformers are generally cheaper than push-pull transformers, it is cheaper to construct a power amplifier with a single 250 type tube than it is to construct a push-pull amplifier with 210's.
- (e). An amplifier using a 250 will give excellent quality. When the tube

- is worked into a load impedance equal to twice the tube's plate impedance, rated output will be delivered to the load without creating more than 5 per cent. of second harmonic current.
- (f). The volume output of a single-stage amplifier using a 250 will be about equal to that from a push-pull amplifier with type 210 tubes, assuming that the input voltage is the same in each case and that the transformer feeding the 250 has a ratio of 4 and the input push-pull transformer has a ratio of 2 (average figures).
- (g). A single 250 tube will supply all the power, with plenty in reserve, that will be required for the operation of any radio receiver in the home. Where only moderate volume is required, smaller tubes such as a 171, may be used but where reserve power is desired to take care of greater volume, the type 250 may be used.

pull amplifier with 250 type tubes will be able to deliver to a load about 12 watts of voice frequency power—which is no mean figure! A push-pull amplifier using 210 type tubes, outputting about four watts, can be used to supply about four loud speakers, and a push-pull amplifier with 250 tubes will be able to supply about fifteen loud speakers, assuming in both cases that each speaker will require about one watt of energy. In a home installation a single 250 tube should give all the power that will ever be required, with plenty in reserve.

Several manufacturers have already announced apparatus suitable for use with the 250 type tube. The General Radio Company has designed a complete line of transformers, filter units, and output devices for use with the 250 tube and a description of this apparatus will be found in the New Apparatus section of this issue.

The Silver-Marshall Company has designed two amplifiers for the use of the 250 tube; one a single-stage affair, and the other a complete two-stage amplifier. The two-stage amplifier is illustrated herewith. It uses a type 226 tube in the first stage and a 250 in the second stage. Plate supply is



obtained from a rectifier-filter system using two type 281 tubes in a full-wave circuit. A glow tube is used. The single-stage amplifier is similar to the two-stage unit that is illustrated except that the apparatus for the first stage is omitted. This latter amplifier may well be used to replace an unsatisfactory last-stage amplifier in any radio receiver. From both of these amplifiers can be obtained the necessary B voltages for the operation of the other tubes in the receiver proper, and in addition the two-stage amplifier will also supply a. c. voltages for the filaments of any a. c. tubes that may be used in the set. The two-stage amplifier is also especially satisfactory for use with a phonograph pick-up to play phonograph records. Both of these amplifiers can be home constructed with little trouble, from data obtainable from Silver-Marshall through

RADIO BROADCAST.

#### A COMPLETE A.C. AMPLIFIER

This commercially available unit employs one CX-350 as the power tube. The second and third sets of binding posts at the top, reading from the left supply a. c. filament voltages for the set. This unit is from Silver-Marshall

## Book Reviews

LEFAX RADIO HANDBOOK—(Seventh Loose-Leaf Edition). Published by Lefax, Inc. Philadelphia, Pennsylvania. Subscription, \$5.00 a year.

THIS Lefax Handbook is in the familiar form of a loose-leaf notebook about seven by five inches. The first chapter, "What Radio Does," is largely a summary of the various uses of radio communication, from the distribution of time signals to television, with some discussion of special devices like chain broadcasting. Next, under "Fundamental Principles of Radio" the behavior of direct and alternating currents, waves, and modulation methods is described. The following chapters are on "Elements of Receiving and Transmitting Apparatus," "Assembly of Receiving Sets," "Operation of Receiving Sets and Their Accessories," "Antennas." The next-to-the-last section contains conversion tables, definitions of radio terms, codes, formulas, tube characteristics, etc. A complete index is supplied. The material is gleaned from such journals as the *Proceedings of the Institute of Radio Engineers*, the *Bell System Technical Journal*, Bureau of Standards publications, RADIO BROADCAST, manufacturers' bulletins, etc. It is clearly abstracted and an extensive survey of practical radio engineering material is crowded into this loose-leaf book. The editor is Dr. J. H. Dellinger, Chief of the Radio Laboratory of the Bureau of Standards. The system is based on the issuance of sixteen sheets a month, ready to be inserted in the binder. Obviously the rate of progress of radio technology is such as to require some such scheme as a supplement to scientific textbooks which can appear only in widely separated editions.

RADIO ENGINEERING PRINCIPLES, by Henri Lauer and Harry L. Brown. Second Edition, January, 1928. McGraw-Hill Book Co., Inc. 301 pages. \$3.50.

THIS text, first issued in 1919, follows Morecroft into a second edition. Unfortunately the death of one of the authors, Harry L. Brown, occurred just before the volume appeared. With Mr. Lauer, he was able to com-

plete a creditable piece of work before he died. The book is less extensive than Morecroft's, but it is excellent for those whose requirements are satisfied with a shorter and less expensive text. The treatment is based on the electron conception of matter, with only moderate resort to mathematics and no recourse to mechanical analogies, with which, frequently, the student is even less familiar than with the radio theory he wants to learn. The book, as the title indicates, is concerned with principles rather than with concrete apparatus. It begins with a consideration of the underlying electrical theory, the properties of oscillatory circuits, antenna systems and radiation, proceeds to a description of damped and continuous wave telegraphy, devotes four long chapters to vacuum-tube theory, and ends with chapters on radio telephony and miscellaneous applications of radio. The principal additions to the first edition are in the chapters on three-electrode tubes. Numerous special topics, such as aircraft radio compass work, the mathematical theory of the push-pull amplifier and frequency doubler, the theory of the balanced modulator, piezo-electric resonators and oscillators, are adequately treated. The book is a very scholarly presentation. Pages 69-73 contain one of the few adequate descriptions of the wave antenna to be found in radio texts. The references to little known articles, especially foreign sources, are alone sufficient to warrant inclusion of the second edition in every radio engineer's library.

A POPULAR GUIDE TO RADIO, by B. Francis Dashiell, The Williams and Wilkins Company, Baltimore, 289 pages, \$3.50.

THIS book is written for the non-technical reader, according to the publishers. The author is only incidentally a radio man; his regular employment is in the Weather Bureau at Washington. The job of presenting the principles and mechanism of radio appears to this reviewer, who is a professional radio man and technically inclined, to have been competently done. Apparently Mr. Dashiell knows quite as much about the art as if he had lived in it all his life. But it is not clear, and this book does not make

it clearer, just how a technical subject can be expounded to a non-technical audience. In so far as *A Popular Guide to Radio* elucidates and instructs, it is moderately but quite definitely technical. It is not made less technical by the insertion of a frontpiece showing Carlin and McNamee broadcasting a football game. If "non-technical" means free from mathematics, then the book is non-technical, true enough. But this merely results in passages like the following description of "Impedance in an Alternating Current Circuit": "A circuit may have inductance and capacity in addition to its natural electrical resistance when an alternating current is flowing. When this combined reactance and natural resistance operates to obstruct the flow of an alternating current it is known as the *impedance*. However, as inductive and capacitive reactances are the reverse of each other, the *total* reactance of a circuit is the difference between the two reactances measured in ohms and giving the impedance designation to the predominating reactance. The electrical resistance in ohms cannot be added to this total reactance to obtain the impedance. Graphically, they should be combined as straight lines in proportionate lengths. Assuming them as two forces acting together at right angles, their *resultant* is the impedance." This sort of writing is neither wholly accurate, readily comprehensible, nor compact. Its somewhat puffy and labored quality arises from the fact that it is the wrong way of doing the thing. And incidentally impedance is just as natural as resistance.

When Mr. Dashiell does not attempt the impossible he turns out a creditable piece of work.

There is a lot of sound, up-to-date information, with a few platitudes intermingled, and here and there a debatable statement, such as that on page 170 about the neutrodyne circuit, where the names of Hogan, Hazeltine, and Atwater Kent are mentioned, and not a word about Rice and Alexanderson. The photographs are well-chosen and the figures nicely drawn. After reading it one is left with the impression that this is a worthy book, but exactly for whom was it written?

—CARL DREHER.

# The "Cornet" Multiwave Receiver

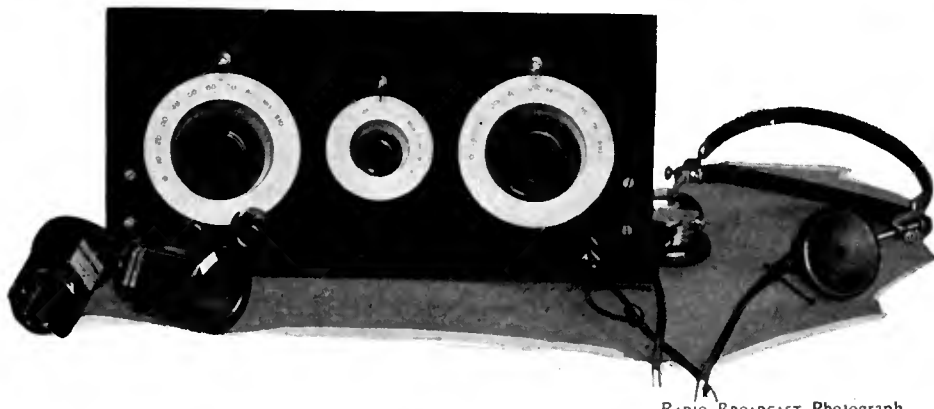

RADIO BROADCAST Photograph

By W. H. WENSTROM

Lieut., Signal Corps, U. S. A.

## CONSTRUCTIONAL DETAILS

THE arrangement of parts is shown in the photographs. First, drill the metal and insulating front panels; then assemble the front panels, the sub-panel brackets, and the sub-panel. All are bolted together with small nickle-plated machine screws. For best appearance, the front panel should slope back about 15 degrees from the vertical.

Three Cardwell condensers, with their associated General Radio dials, are mounted on the front panels. The right condenser, viewed from front panel, is of 0.00025-mfd. maximum capacity, and may be either the old, flat-plate type, which sells very cheaply in many stores, or the new taper-plate type. The left condenser should have a maximum capacity of about 0.000165 mfd. This is obtained from an old type 0.00025 by removing two rotor and two stator plates, leaving four rotors and three stators. If the old type 0.00025 cannot be secured, the new taper-plate 0.00015 may be used, though with this latter condenser, minute uncovered frequency bands will appear between the coil ranges. Of course, the coils may be slightly redesigned to cover these breaks; or the standard S-M coils

may be used, with some loss of tuning range. The center condenser is a Cardwell "Balancet" of the smallest size, with all plates removed except the back stator and the front rotor. The "phones" jack is placed at the lower right corner of the front panel, insulated from the metal by a bushing of bakelite, hard rubber or fibre. Because the set must often be switched on and off without jarring it or disturbing the wavelength setting, an external knife switch is used by the writer rather than a filament switch on the panel.

On the upper side of the sub-panel are mounted the coil socket, the two tube sockets, two filament ballasts, two grid leaks and knobs for the antenna condenser and the potentiometer. On its lower side are the potentiometer, the audio transformer, the r.f. choke, the grid condenser, and the antenna coupling condenser, for which a Silver-Marshall midget is chosen because of its low minimum capacity. The binding posts are set into the back edge of the sub-panel. The amplifier grid leak is clipped in when wanted for phone work; the glass casing of the detector grid leak should be washed free of paper and glue.

Wiring is best done in definite steps. The filament circuit is first wired and tested. Then come the other circuits in natural order: antenna-ground, detector grid, detector plate, amplifier grid, and amplifier plate. Grid leads, of course, are reasonably short, and all leads are fairly straight without sharp angles. Though No. 14 wire is used in places for rigidity, most of the wiring is done with solid, rubber covered wire of about No. 20 size, known in telephone parlance as "pothead" wire. It is plainly absurd to insist on large wire leads in series with coils, high resistances and the like. Acme Celatsite is also quite satisfactory and convenient.

The four plug-in coils are those supplied in the Silver-Marshall No. 117 short-wave set, rewound with No. 26 enameled copper wire except as otherwise indicated. They are completely described in the coil table. Three optional extra coils are also listed.

The detector tube is preferably a Ceco type "H," though it may be any good make of high-mu tube, or even one of the 201-A type. [The 201-A is satisfactory as a detector in this circuit, of course. If the Ceco type H, or other special detector tubes, or even a standard high-mu tube is used, the "gain" will increase. However, in the latter case, quality may be impaired to some extent when this set is used for headphone reception.—Editor.] The amplifier tube is a 201-A.

—THE EDITOR.

SOME of the most fascinating fields of radio lie outside that narrow band in which the broadcasting stations do battle. Voice and music from Europe, code from tossing ships or lonely airplanes, faint signals from amateurs at the antipodes or explorers in arctic cold and equatorial heat—all these are echoing along the lanes of the ether. To hear them we must have a receiver that is simple, reliable, accessible, efficient and flexible. As the Navy recently applied the name "Cornet" to an unusually flexible transmitter, so this receiver, able to shift rapidly from one frequency to another—to play a variety of tunes—is also called "Cornet."

The general design is apparent from the circuit diagram, Fig. 1, and the photographs. For simplicity we go back to that venerable amateur mainstay, a capacitatively controlled regenerative detector with one stage of audio; and we avoid tuned radio-frequency and screen-grid tube arrangements. On the front panel are one main and two auxiliary controls, while two adjusting controls are on the sub-panel.

Reliability is secured by using the best parts that we can buy. We avoid the pitfalls of some poorly made pig-tail condensers, noisy grid leaks and the like. Each radio part must meet two exacting standards—the electrical and the mechanical.

Accessibility is often neglected in radio design. The best set in the world will occasionally develop trouble, which must be located and remedied at once. This set is accessible because of sub-panel construction and general openness of design.

In pure efficiency, the regenerative detector has never yet been equalled. Unusual features of this set include a micro-vernier condenser of about 3.0-mmf. maximum capacity and a grid biasing potentiometer which controls the sensitivity, selectivity and oscillating characteristics of the detector tube. All three tuning condensers are mounted directly against a panel backed with aluminum which in turn is connected through the sub-panel brackets to ground; so that body capacity, as found in the usual short-wave receiver, simply does not exist.

Above all, the receiver is flexible. The Silver-Marshall plug-in coil system is used on account of its electrical efficiency, convenience, and compactness. The set is primarily designed to cover, with four coils, the range from 14 to 200 meters. This range is obtained by using a tuning condenser somewhat larger than usually recommended by Silver-Marshall. Additional bands can be covered, as desired, by extra coils.

THE set described here by Lieut. Wenstrom has two features unusual in receivers designed to cover the high frequencies: (a), a potentiometer across the A battery to adjust the bias voltage on the grid of the detector so that the best operating point may be found; and (b), a small vernier condenser across the main tuning condenser to enable the operator to tune very closely to a given frequency, or to follow a fading signal with greater ease. On test in the Laboratory, this receiver worked very well, 5 sw at Chelmsford, England, being heard at 6 p. m. E. S. T., without difficulty. The biasing potentiometer adds much to the sensitivity of this set. It is common amateur practice to use a high-ratio transformer, working out of the detector into the first audio tube. Lieut. Wenstrom has used a low ratio transformer which provides better reproduction when the set is used for receiving short-wave broadcast transmissions. A vernier dial with a greater reduction ratio than the one employed—such as the Karas—might make tuning somewhat easier, perhaps even obviating the necessity for the auxiliary tuning condenser.

COIL TABLE

COILS for the first four bands listed below are those supplied in the Silver-Marshall No. 117 short-wave coil set, rewound with No. 26 enameled copper wire, except as otherwise indicated in the last column.

BAND	COIL RANGE	GRID TURNS	TICKLER TURNS	REMARKS
20 m.	14-28 m.	3	3	No. 24 wire, with triple (the standard S-M) spacing
40 m.	26-52 m.	6	5	Grid 1 less; tickler 2 less than S-M standard
80 m.	51-110 m.	15	8	Grid 3 more; tickler 2 less.
160 m.	100-200 m.	36	16	Grid, 10 more; tickler same.
Shortest wave	10-21 m.	2	3	No. 24 wire; quadruple spacing.
Ship waves	550-1100 m.	Standard S-M No. 111-D		
Long wave	1100-2000 m. approx.	Standard S-M No. 111-E		

No cabinet is included in the plans, as a small writing desk serves the purpose, and the builder may have his own especial preferences anyhow.

OPERATION

TO place the set in operation, connect the 6-volt filament leads, see that the tubes light, and then connect the 45-volt B battery. Next,

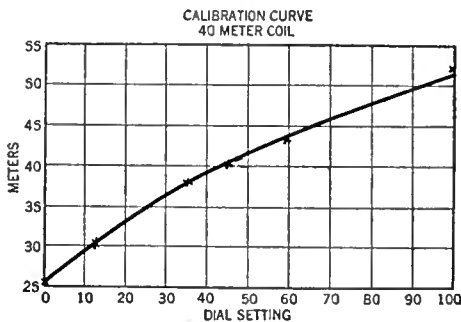

FIG. 2

Calibration curve of the 40-meter coil and condenser combination used in this set. Slight electrical differences in parts used by constructors may make their calibration different from this

place one of the coils, say the 40-meter one, in the coil socket. With the left-hand condenser set at any reading, increasing the right-hand condenser should put the set into oscillation with a weakly audible "plop." The potentiometer is adjusted to minimize this "plop" so that the set

goes smoothly into and out of oscillation. In general, the potentiometer arm is turned toward the positive side of the circuit for phone work and slightly toward the negative side for code reception. As the left dial is moved to a higher reading, a correspondingly higher reading on the right dial will usually be necessary to produce oscillation. If the r.f. choke is doing its work, there should be no "dead spots" in the tuning range. At any wavelength setting of the left dial, the most sensitive right dial setting for phone is just below or at the oscillating point; for code, just above it.

With these preliminary tests completed, the set is connected to the ground and to the antenna, a single wire anywhere from 20 up to 750 feet in length. [A small indoor antenna with this set in most locations will probably serve very well for all purposes.—Editor.] The 40-meter coil being in place, signals should be heard as the left dial is moved over its entire range, for this band is busy at any hour of the day or night. If any "dead spots" now occur, blame them on the antenna, and decrease the antenna coupling condenser to the point where they are not troublesome. This antenna condenser is always set at the maximum capacity which will not interfere with the convenient operation of the oscillation control. After a signal has been tuned-in with the left dial and brought to full strength with the right one, apply the finishing refinement of tuning with the center dial and its diminutive condenser. This control is so fine that a single beat note spreads over 5 to 10 degrees, and the "zero beat" for phone reception is easily produced.

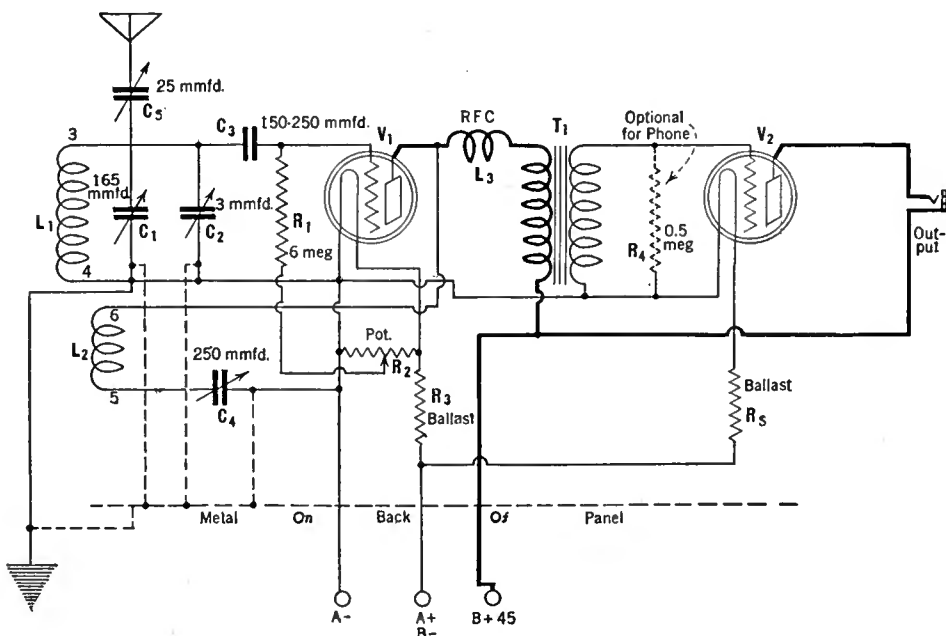

FIG. 1

Circuit diagram of Lieut. Wenstrom's receiver

CALIBRATION

FOR maximum usefulness, all coils should be carefully calibrated. The data, including the settings of the left dial for various wavelengths, may be plotted as a graph, which is scientific and thorough (see Fig. 2); or they may be listed in a table, which is more convenient to read. Such a table for the 40-meter coil employed by the writer is: 0-26m., 13-30m., 36-37.5m., 45-40m., 59-43m., 100-52m. While this table is approximately correct for the set here pictured, changes in detector tube, wiring and variations in coils used by those who duplicate this set, or other circuit constants would make it practically useless for another. Each set must be calibrated individually.

First, a wavemeter must be bought, borrowed or made. Then, the left receiver dial is set at some convenient reading (say 0), the antenna condenser is set to minimum, the vernier to 50, and the right dial to two points above oscillation. Place the wavemeter coil in what would be a

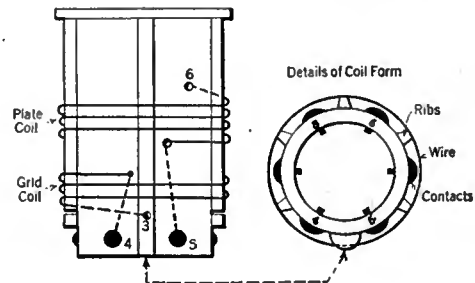

FIG. 3

General instructions on altering the coil form for the 20-, 40-, 80-, 160- and 10-meter bands. (See the coil table on this page)

prolongation of the set coil, and rotate the wavemeter dial slowly. Two "plops" are heard, one as the set goes out of oscillation and another as it goes back into it. Now move the wavemeter a little farther away, and repeat the performance until the two "plops" are practically one. Or note the point midway between the two "plops." This point on the wavemeter scale is the wavelength to which the receiver is tuned. The left dial is now moved to a new setting and everything is repeated. All the coils are calibrated in the same way. If you wish to find the receiver dial reading for any particular wavelength, set it on the wavemeter and rotate the receiver dial.

A wavemeter is simple enough to make. The basic circuit consists essentially in a coil and a variable condenser. The homemade product must be calibrated from a standard one. By checking both against the receiver, data is secured for a homemade wavemeter curve similar to the curve of Fig. 2. Of course it is possible to calibrate one's receiver by picking up signals from well-known stations. For example the amateur 40-meter band is bounded by NAA at about 37.4 meters at one end and by W1Z at 43 meters at the other. Standard frequency signals are sent out at regular intervals by wvw, the Bureau of Standards station, (see page 84) and others.

WHERE TO FIND THE STATIONS

WE NEED have no illusions about the quality of short-wave broadcasting, nor any fear that it will replace the present system of allocation of stations in the 1500-550-kc. band. Fading is usually quite severe, and the signal strength of distant stations varies widely from day to day. In America, WGY on 21.9 and 32.77 meters and KDKA on 25 and 62 meters transmit

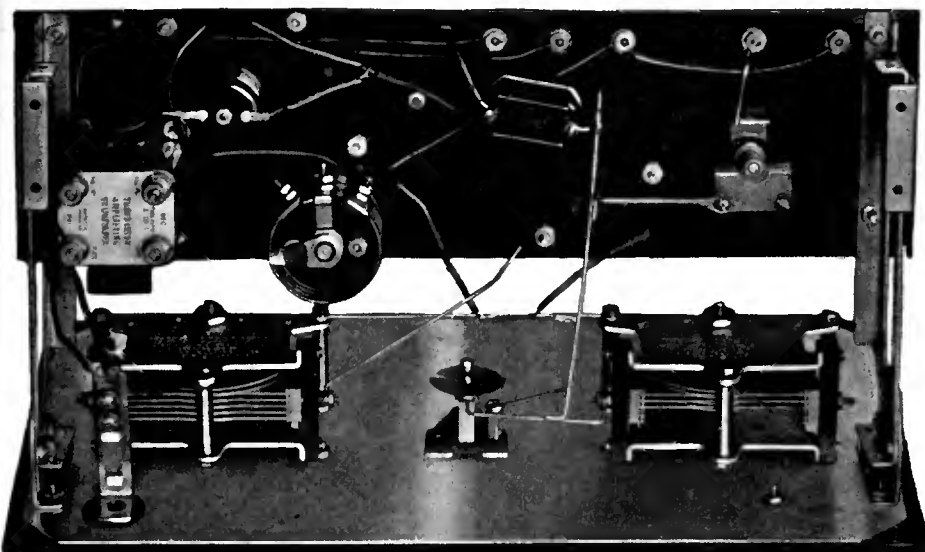

RADIO BROADCAST Photograph  
THE CORNET MULTIWAVE RECEIVER

the regular programs of their standard-wave broadcast plants. Their signals have world-wide range, and quality dependent on the atmospheric and Heavyside layer conditions. In England, 5 sw at Chelmsford carries the regular London programs on 24 meters, and is heard any weekday afternoon up to 7:00 p. m. E. S. T. Reception of this station is really good perhaps one or two days a week. The signal of PCJJ at Eindhoven, Holland, is weaker and more variable than that of 5 sw. It comes through at present late Tuesday, Thursday, and Saturday afternoons (Eastern time). So far, these two have been the only foreigners regularly heard, and their programs have appealed chiefly by their novelty. Perhaps within a few years most important nations will have high power, short-wave telephone transmitters, and fading will be minimized by separated, synchronized transmitters or some such scheme. Then international broadcasting will truly begin, and this receiver will be able to choose its programs between five continents.

For one who reads code the pleasures of this receiver, and of all radio, are greatly extended. NAA at Washington, on approximately 24.9, 37.4 and 74.8 meters, broadcasts weather at 8.15 and 10:30 a. m. and p. m.; time at 12:00 noon and 10:00 p. m.; and press at 1:30 a. m., E. S. T. Station NPG at San Francisco, on 36 and 72 meters, sends weather at 6:15 and 7:30 a. m. and p. m., P. S. T. To keep up to date on these schedules, one must consult the weekly radio sections of large newspapers. [A list of Navy transmissions appeared in this magazine for May, 1928.—Editor.] The biggest nuisance in the short-wave spectrum is the harmonics of long wave broadcasting stations, which delude the listener in this short-wave section of the band into thinking he hears something new.

Many important exploring expeditions transmit code. Most of them favor the waves around 30 meters. This summer there will be at least one expedition near the North Pole, one near the South Pole, plenty of transocean flights, and at least one round-the-world dirigible flight. Some far distant amateurs come in from 18 to 24 meters during many of the daylight hours, though most of these experimenters use the 40-meter band. In this region, Europeans between 43 and 47 meters, just above the United States band, begin to be heard about an hour or two before sunset. Before sunrise signals from the Australians and New Zealanders come through around 33 meters. There are some

United States amateur telephone stations between 84 and 85 meters.

Six hundred meters is the international marine calling wave. Rapid dots and dashes from ship sparks are always audible near the seacoast. On this wave, too, sounds at times the staccato sos for which broadcasting stations shut down. Copying signals from a ship in distress and the vessels going to her assistance is the most exciting thing in radio. Of course it is in no sense a pleasure; the lesson of Robert Louis Stevenson's *Merry Men* is plain. For actual message handling, ships use waves around 700 and 900 meters. On 1000 meters in foggy weather, the coastal radio beacons flash their distinctive groups. Radio compass bearings are given on 800 meters. For data on the coils which cover all the bands discussed in this article, see the table on page 78.

This "Cornet" multiwave set opens the door to reception interesting and unlimited, or limited

only by the skill and patience of the operator. And what more could he ask?

THE PARTS WHICH WERE USED

THE following list of parts gives the apparatus used in the writer's receiver. Naturally, other parts, electrically and mechanically similar may be used. Coils and condensers mentioned here are of well-known manufacture and have been altered in ways indicated in the text.

- C<sub>1</sub> Cardwell type 141-B 250-mmfd. variable condenser. (revised as indicated in the text)
- C<sub>2</sub> Cardwell Balancet 5-mmfd. (approx.) variable condenser
- C<sub>3</sub> Sangamo 150-mmfd. fixed condenser
- C<sub>4</sub> Cardwell type 141-B 250-mmfd. variable condenser
- C<sub>5</sub> Silver-Marshall type 340 midget condenser
- L<sub>1</sub>, L<sub>2</sub> Coils wound on Silver-Marshall forms (as described in text)
- L<sub>3</sub> Silver-Marshall Type 275 R.F. choke
- R<sub>1</sub> Tobe Tipon 6-megohm grid leak
- R<sub>2</sub> General Radio type 301, 200-ohm potentiometer
- R<sub>3</sub> Daven ½-ampere filament ballasts with mountings
- R<sub>4</sub> Tobe Tipon 0.5 megohm resistance (optional, see text)
- T<sub>1</sub> Thordarson small type 2:1 audio transformer
- 1 Silver-Marshall coil socket type 515
- 1 Benjamin navy spring type socket
- 1 Hoosick Falls navy plain type socket
- 2 Grid leak mountings
- 2 Knobs, Kurz-Kasch, 1½-inch
- 1 General Radio type 303 4-inch vernier dial
- 1 General Radio type 317 4-inch plain dial
- 1 General Radio type 310 2½-inch plain dial
- 5 Eby plain binding posts
- 1 Pacent open circuit jack
- 1 Insulating bushing for jack
- 1 panel 7" x 14", hard rubber or bakelite
- 1 back panel, 7" x 14", aluminum
- 1 Sub-panel, 4" x 14", hard rubber or bakelite
- 2 Benjamin adjustable sub-panel brackets

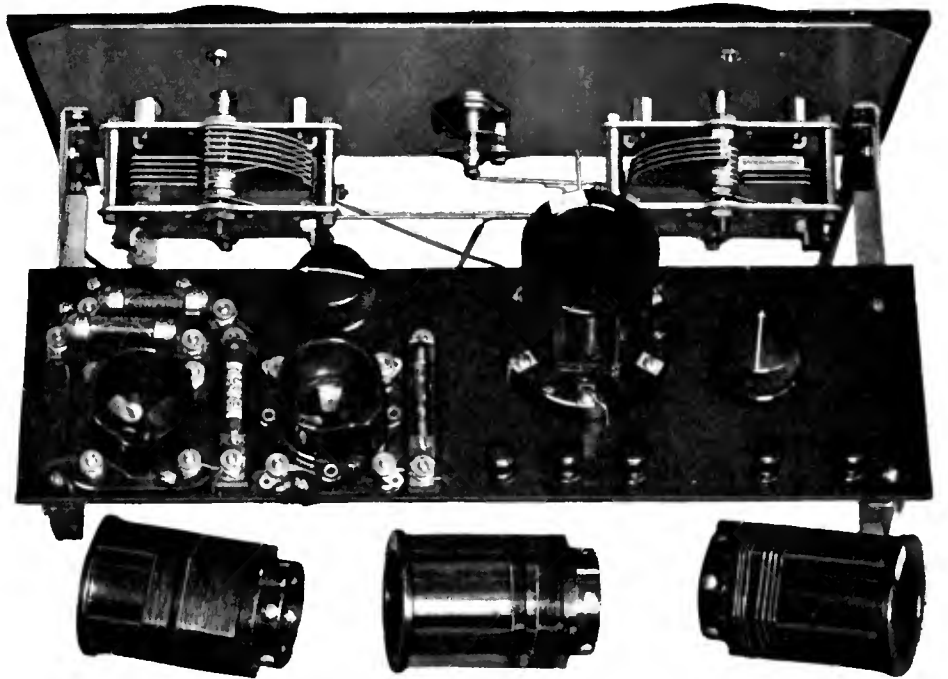

RADIO BROADCAST Photograph  
HOW THE MULTIWAVE SET LOOKS FROM THE TOP  
Four of the coils used are shown with their convenient adhesive tape labels



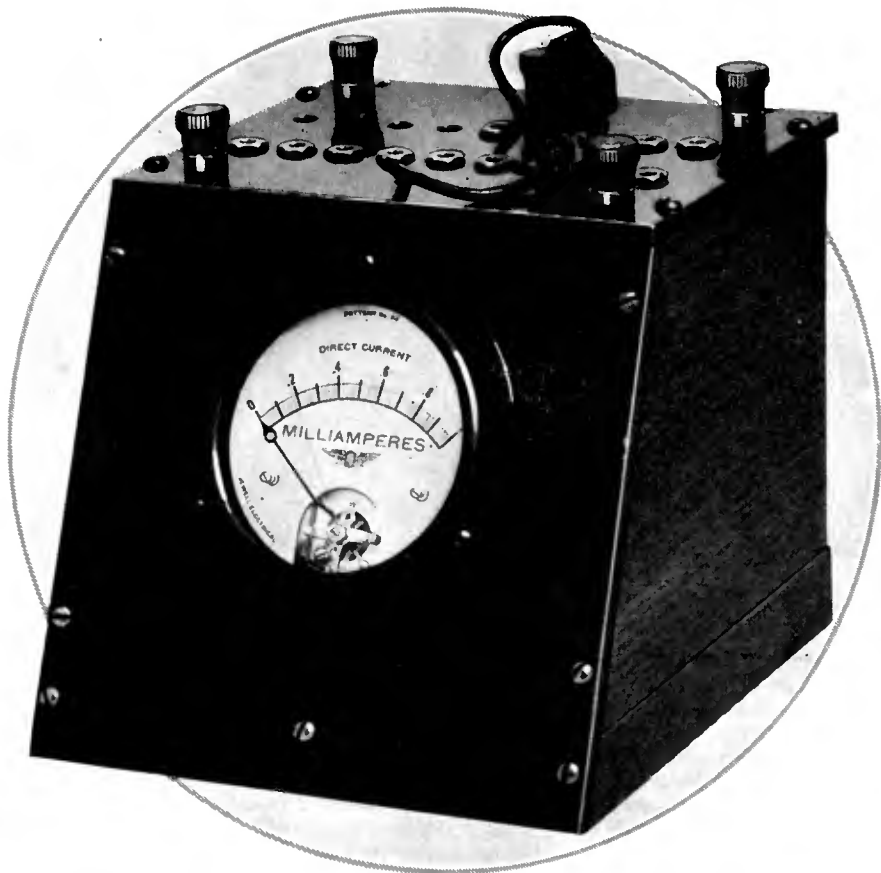

### AN INSTRUMENT OF WIDE USE TO EVERY RADIO EXPERIMENTER

With an inexpensive milliammeter arranged as described in this article, a portable and very useful measuring set can be made. The set will measure practically all of the common d.c. voltages and currents up to 5 amperes and 1000 volts. It is especially useful in testing B power units. The crystal detector circuit makes this unit useful as an r.f. resonance indicator in transmitter circuits

## From Milliammeter to Multi-meter

G. F. Lampkin

PERHAPS one of the fundamental reasons why electrical science has grown so tremendously in its comparatively short life span is the ease and accuracy with which electrical measurements can be made. An ability to determine accurately the magnitudes and relations of the quantities involved in any work naturally leads to intelligent interpretation and utilization of those quantities. Applying the last statement to the radio worker, an ability to measure the B-battery voltage at 17 volts per 22-volt block is much more conducive to results than wondering if low B batteries are spoiling the reception; and plugging-in to measure the plate current of a tube can be made to save many minutes, if that particular tube has gone dead.

It is surprisingly simple to take a low-range milliammeter and make an almost universal measuring instrument of it. The instrument can be made to measure the whole gamut of d.c. radio voltages, from the voltage of a dry cell on up through the various A, B, and C voltages to those used for plate supply in transmission work. Starting with a meter of one milliamper full-scale deflection, the current range can be run up as high as desired; and then the meter can be used for indicating a few other quantities on the side. The extension of the milliammeter range to read both voltages and currents of various magnitudes is accomplished by means of what are known as multipliers and shunts.

Suppose two resistors are put in parallel in a circuit; the current will naturally divide, part going through one resistor and the rest through the other. An idea as to how the current divides

through the two paths can be had if the values of the two resistors,  $R_1$  and  $R_2$ , are known. The current,  $I_2$ , in resistor  $R_2$  is equal to:

$$\frac{R_1}{R_1 + R_2} \times \text{TOTAL CURRENT}$$

And similarly, the portion  $I_1$  in the path  $R_1$  is equal to:

$$\frac{R_2}{R_1 + R_2} \times \text{TOTAL CURRENT}$$

The idea of the shunt is to bypass a part of the total current around the milliammeter, and let only enough current go through the latter to give full-scale deflection when the total current to be measured is flowing. If the total current is less than that required to give full-scale deflection, with a given shunt, the meter reading will be less in the same proportion. By properly choosing the resistance of the shunt, the meter can be used to read any magnitude of total current. If the shunt resistance is very low, the meter can be used to read large total currents; or, conversely, if the shunt resistance is high, small currents can be measured. With no shunt, the meter of course indicates the current as shown by its scale. Another consideration in choosing the shunt, besides its resistance, is its physical size. The shunt must be of large enough carrying capacity that it does not get hot when passing its part of the current. If it should get hot, its resistance would change and destroy the accuracy of the readings.

To use the milliammeter as a voltmeter requires a multiplier. The latter is simply a resistance that is connected in series with the

meter. Suppose the milliammeter, with a current scale of 0.1 milliamperes, has a resistance of 3 ohms. With full-scale deflection, the voltage drop across the meter is 0.001 amperes times 3 ohms, or 0.003 volts. Another way of stating the requirement for full-scale deflection of this meter is, therefore, to say that 0.003 volts must be impressed across it. When the multiplier is placed in series with the meter, its resistance causes a voltage drop, and leaves remaining a small value of voltage to operate the meter. By choosing the right values of series resistances, the meter can be used to measure a wide range of total voltages. For a meter resistance of  $R_1$  ohms and a multiplier resistance of  $R_2$  ohms, the voltage on the milliammeter will be:

$$\frac{R_1}{R_1 + R_2} \times \text{TOTAL VOLTAGE.}$$

The economy resulting from the use of shunts and multipliers is obvious. A 0.1 Jewell d.c. milliammeter can be had for \$7.50 list. With this one meter as an indicator, as many shunts and multipliers as desired can be made, at a fraction of the meter cost, and each shunt, or multiplier, will extend the use of the meter.

The meter shown in the photographs is designed to cover pretty well the field of d.c. measurements in radio. In addition, it utilizes a fixed crystal detector to yield an instrument somewhat similar to a thermo-galvanometer. While it cannot, in the latter rôle, be calibrated to read actual current values, still it is extremely useful in radio- and audio-frequency measurements, for showing relative values, or for indicating re-

sonance or null settings. The plug-in system which is used makes it a matter of seconds to change from one range to another, or from voltmeter to ammeter, or a.c. indicator. In the particular instrument shown, the layout provides for five current ranges: 0-1 mA., 0-10 mA., 0-100 mA., 0-1 Amp., and 0-5 Amps. The voltage ranges are 0-10, 0-100, and 0-1000 volts. The a.c. indicator requires approximately 5 mA. a.c. for full-scale reading. Fig. 1 gives the panel and cabinet layouts.

In Fig. 2 is given the diagram of connections. The double plug is simple to construct. The material for it is cut to shape as shown in Fig. 1, and then two General Radio type 274P contact plugs are screwed into the two threaded  $\frac{3}{16}$  slots. The receptacles for the double plug consist of General Radio type 274J jacks.

Only one connection to the double plug is needed when the instrument is used as a voltmeter or a.c. indicator, so the rear sockets for these connections are left blank on the panel top. Thus a total of fourteen 274J jacks will be necessary. For appearance's sake, however, the blank holes might be hidden by using four more jacks, to which no connections are made. The negative binding post is made common for all the functions of the meter. It is brought out at both sides of the panel to facilitate connections. The milliammeter is placed in the negative side of the circuit so that it will be at ground potential when the device is used as a voltmeter. The positive binding posts are separated for the three functions of the meter. This makes for safety in that it lessens the chance of using the ammeter connection when trying to measure a voltage. It also allows connecting the device in the circuit to measure both voltage and current, and doing one or the other by changing only the plug. The end of the carborundum detector marked "A" by the manufacturer goes to the positive binding post. The 0.0005-mfd. condenser is shunted across the meter to protect it from radio-frequency currents; its use is not an absolute necessity, however. The supports for the shunts, multipliers, and detector are made of bus wire. The common rear support for the three multipliers is made of sheet copper or tin. The multipliers used are Tobe Veritas 5-watt resistors. The power expended in the resistor for the highest range is 1000 volts times 0.001 amperes, or only 1 watt, which is sufficiently low to avoid heating the multiplier.

The table of Fig. 2 shows the shunts that are used for the different ranges. For the lower ranges, *i.e.*, 10 and 100 milliamperes, No. 32 tinned hair wire was obtained from the hardware store. The 10-milliamperes shunt is so long that it must be wound on a form, the dimensions of which are given in Fig. 1. The other shunts are short enough to be suspended between their bus-wire supports. The smallest sizes of copper wire consistent with freedom from heating effects are used as shunts for the higher ranges. Smaller sizes than these should not be used; should larger sizes be used, the lengths given in the table must be increased. The lengths specified may be slightly on the long side, in which case they should be clipped when calibrating. All the connections in the instrument should be soldered.

As shown in the photograph, the connections between the top panel and the meter are flexible; thus the top panel can be turned over to an easily accessible position when adjusting the shunts. It is wise to mark the sockets



THE FINISHED INSTRUMENT—INSIDE

plainly with the appropriate data—100 Volts, 1 Ampere, etc.

CALIBRATION

THE calibration of the meter is the most important part of the job. The straightforward and accurate method is to compare the meter directly with standard instruments. It should be possible for the experimenter to obtain the use of voltmeters and ammeters from a friend, a radio dealer, radio laboratory, educational laboratory, power company, or other such source. But, failing in these, it is still possible to obtain reasonably accurate calibrations. In any case, the readings of the meter should not be relied upon for greater accuracy than two or three per cent.

To compare the voltmeter ranges of the device directly with a standard voltmeter, the two in-

struments should be put in parallel and connected to the voltage source, as in Fig. 3. The source may consist of a storage battery or dry cells, for the ten-volt range, and a bank of B batteries, or a B device for the higher ranges. Both meters should be connected when the readings are made, and the latter should be taken nearly simultaneously. It is not necessary to take more than three or four points uniformly spaced along the scale. If only one or two readings are possible, these should be made near the top of the scale. On a piece of graph paper a scale from 0 to 10 should be drawn on the horizontal axis, to correspond to the meter scale. A scale from 0 to 1000 is drawn vertically to correspond to the readings of the standard instrument. When the calibration points for the 10-volt range are plotted, the vertical scale is assumed to run from 0 to 10, that is, the decimal point is placed by inspection, and the curve is labeled 0-10 volt range. The points for the 100- and 1000-volt ranges are treated similarly, so that the entire voltmeter calibration is on one sheet. The calibration curves are really straight lines running through the zero point. One accurate point is sufficient to determine the line, but more than one serves as a check. If all the points do not lie on the line, the latter should be made to run an average course through them. The calibration curves for the particular meter shown are given in Fig. 4. It must be borne in mind that these curves will fit no other meter.

The drawing of the calibration curves is necessitated by the inaccuracies of the resistance values of the multipliers. The 1-megohm multiplier should have yielded a full-scale range of 1000 volts, where in fact it gave only a range to 702 volts. In other words, its resistance is 702,000 ohms, and not 1,000,000 ohms. Incidentally, when using a 0-1 milliammeter as indicator, the number of thousands of ohms in the multiplier is equal to the full-scale range of the voltmeter; *i.e.*, a 1000-ohm resistor gives a 1-volt range, a 10,000-ohm resistor a 10-volt range, etc. The disadvantage of the inaccurate resistor is only that the calibration is not a multiple of 10. Once the

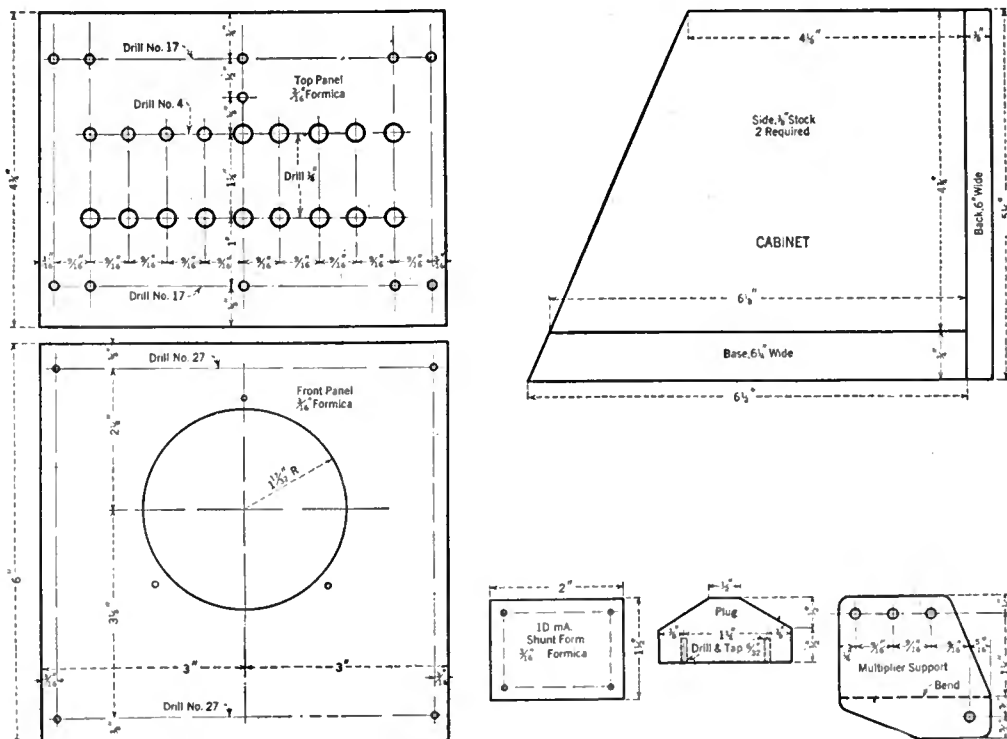

FIG. 1

Layout for panel and cabinet of the useful home tester described here. The photograph above shows the disposition of the shunts, meter, and fixed detector

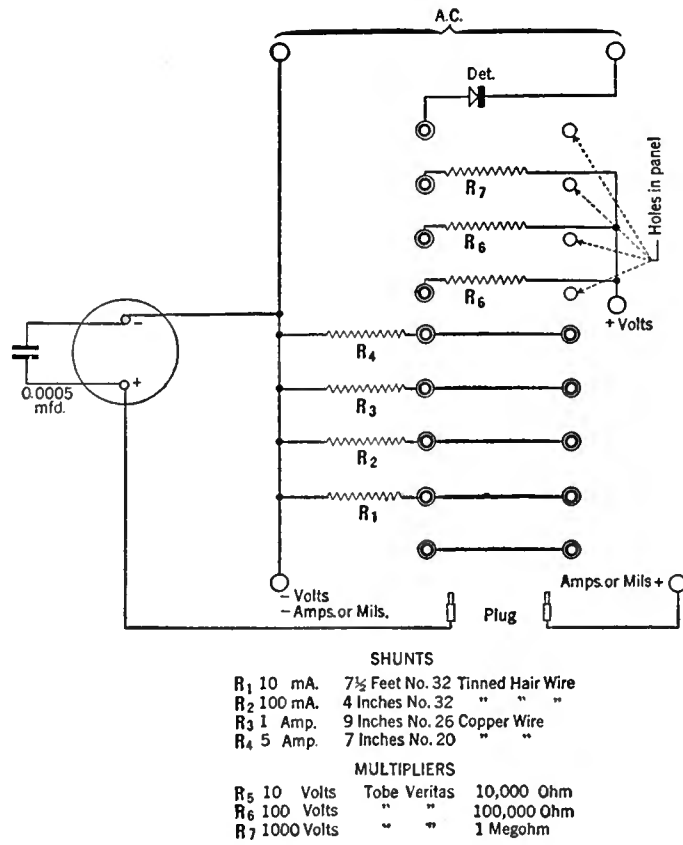

FIG. 2  
Circuit connections and values of apparatus

no standard meter is available, place the meter in the circuit, plug in on the 1-milliampere range, and adjust the current to exactly 1 milliamperes. Then plug-in on the 10-milliampere range; if the reading is high, shorten the shunt—or vice versa. Bring the reading to exactly 0.1 on the scale, corresponding to 1 milliamperes on the 10-milliampere range. Finally, re-check the current on the lower range. For the 100-milliampere range, set the filament voltage at the socket terminals of a 199 type tube at 3 volts. The previously calibrated 10-volt voltmeter may be utilized. Then with rheostat setting unchanged, remove the voltmeter and place the 100-range milliammeter in series with the filament. Change the shunt till the meter reads 60 milliamperes. Again re-check the voltage. The same procedure may be followed in calibrating the 1- and 5-ampere scales, by using

it was 0.500 amperes, and for a UX-171 it was 0.493 amperes, at the same voltage. The a.c. indicator is the part of the device that needs no calibration. If it were calibrated, the readings might be 50 per cent. off the next day. It is, however, a most convenient attachment. With a loop of wire connected to its terminals and coupled loosely to a radio-frequency circuit, it will show resonance points sharply. This function is of course applicable to wave-

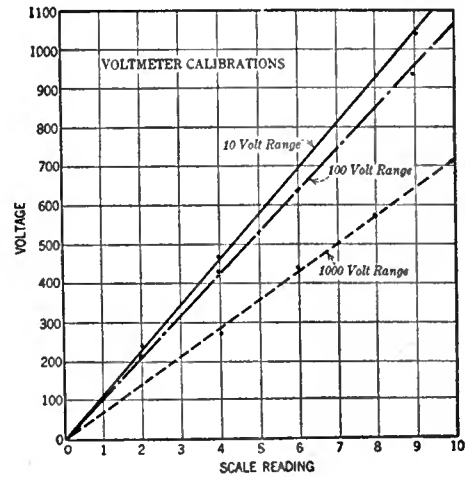

FIG. 4  
Calibration curves made by the author for meter used in the original model. These calibrations are not standard, varying with apparatus used by the individual constructor

instrument has been calibrated, readings may be taken as accurately as with correct-value resistors. If a standard voltmeter cannot be obtained, new dry cells and B batteries may be used as voltage standards. The voltage of a single dry cell should be taken as 1.58 volts, and that of a 22½-volt B block as 23.7 volts. Voltages of larger blocks should be taken in proportion—47.4 volts for a 45-volt block, and so on. Some half dozen calibration points should be taken, and the average curve drawn. The method will allow results of good accuracy. Of ten blocks whose voltages were measured, the maximum discrepancy from the voltage value given above was only 0.7 of a volt. Taking the average of several calibration points will tend to iron out any discrepancies.

In the case of the shunts, their lengths can be adjusted to make the scale come out even, so that no calibration curves are necessary. Although the milliammeter scale reads from 0, 0.2, 0.4, up to 1 milliamperes, it must be remembered that with the shunt, say for 100 milliamperes, the scale is read 0, 20, 40, up to 100 milliamperes. It is another case of placing the decimal point. To calibrate the meter and shunts by direct comparison the meter is placed in series with the standard ammeter, as in Fig. 3. Suggested current sources and loads for the current calibrations are given. The load resistor is adjusted to give full-scale reading on the meter. If the reading on the standard ammeter is lower than the total current should be, first open the load circuit, then melt the solder and shorten the shunt. Or if the standard meter reads high, lengthen the shunt. Reclose the circuit and check again. A few trials will suffice to bring the reading to the dot. If the load circuit is not opened before loosening the shunt, the total current will pass through the meter and ruin it. Each shunt must be adjusted as above.

To calibrate the 10-milliampere shunt when

larger tubes. The 201-A tube gives 0.25 amperes at 5 volts, or the 112 or 171 tubes 0.50 amperes at the same filament voltage. For the higher loads, several tubes in parallel can be used, and the currents added up. The accuracy of this tube-load method is surprisingly high. Of four Radiotron UX-201-A tubes picked at random, the filament currents were 0.250, 0.247, and 0.249 amperes at 5 volts. For a UX-112

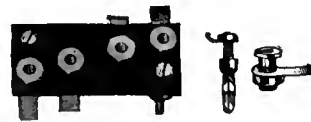

GENERAL RADIO PLUGS AND JACKS USED

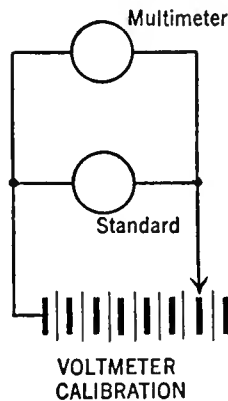

VOLTMETER CALIBRATION

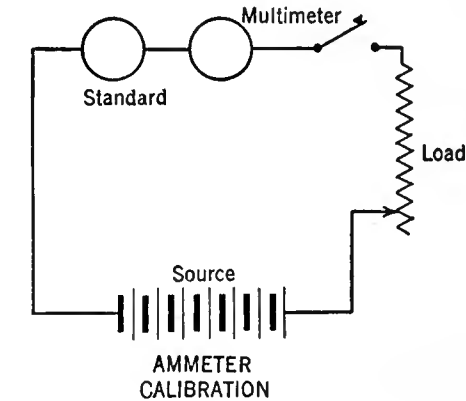

AMMETER CALIBRATION

CURRENT CALIBRATION SOURCES AND LOADS:

- 10 mA. - Dry Cell, 400-Ohm Potentiometer
- 100 mA. - 4.5-Volt Battery, 199-Tube Filament
- 1 Amp. - 6-Volt Battery, 201-A, 171 Tube
- 5 Amp. - 6-Volt Battery, 4-Ohm Rheostat

FIG. 3  
How to calibrate the home-made meter set with a standard

**Output Transformer Characteristics**

AN OUTPUT transformer connecting a loud speaker to a power tube serves two purposes: (a). to keep the direct current flowing in the plate circuit of that tube from circulating through the windings of the loud speaker; (b). to correct any large impedance differences which may exist between the speaker and the tube. The user has a right to expect that the use of the transformer will not perform the tasks mentioned above at a loss in either power or fidelity.

The curve shown in Fig. 1 shows the frequency characteristic of the Pacent 1:1 output transformer. The upper curve represents the voltage across 5000 ohms when 15 volts were applied to the grid circuit of a 210 tube which was properly biased and taking about 20 milliamperes of plate current. The lower curve shows the same characteristic translated in TU. Anyone desiring to know the power delivered to the output load resistance may calculate it by dividing the voltage squared by the resistance. The extreme variation obtained in this manner is from 395 milliwatts at 60 cycles to 610 milliwatts at 2000 cycles, or less than 2 TU, which is quite good.

The loss in power occasioned by the use of a transformer instead of placing the loud speaker directly in the plate circuit of the tube may be calculated by dividing what one actually gets into the 5000 ohms by what would be obtained without the transformer. The power output of a tube working into its own impedance (in this case the 5000 ohms is sufficiently near that of the tube) is equal to

$$W_o = \frac{(\mu e_g)^2}{4 R_p}$$

where

$\mu$  is the amplification factor of the tube  
 $e_g$  is the input volts r.m.s.  
 $R_p$  is the tube impedance

Using this formula, the power into 5000 ohms with 15 volts r.m.s. on the grid of the tube should be 720 milliwatts. Actually we get only 395 at 60 cycles and 610 at 2000 cycles. These are losses due the transformer of only 2.6 and 0.7 TU respectively.

**High Powered Press Releases**

LISTEN TO this from the Radio World's Fair: "The last frontier of radio resistance will bow before this final stroke of air-mastery, the automatic broadcast receiver," said Rear Admiral Bradley Allen Fiske, leading inventor of the United States Navy for the past fifty years, as he declared himself as being much interested in the automatic broadcast receiver which was disclosed to the press during the past week by Harry N. Marvin, millionaire inventor of Rye, New York."

We hope Admiral Fiske didn't say any such thing because the inventor of the torpedo plane and the naval telescope sight which, again quoting from the release, "has been adopted by all the navies of the world and its use has been the main cause of the improvement in accuracy of modern naval gunnery," should know that automatic tuning has been in use many years in the navy, commercial, and amateur stations.

It is a simple matter to change the frequency to which a station, or a receiver, is tuned by pressing a button. How does the Admiral, or his press agent, think the frequency of wcc, that high-pressure coastal station of the Radiomarine

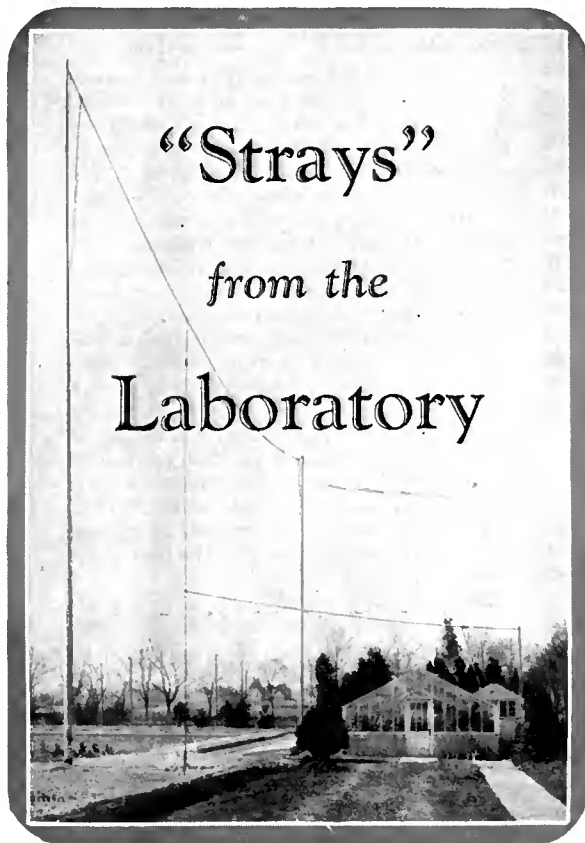

**"Strays" from the Laboratory**

Corporation at Chatham Massachusetts is changed? The operator is some miles away, and while there is an attendant at the transmitter, does he listen for a call on the 'phone, "Say buddy, how's for tuning-up wcc to 2000 meters?" We have been at Marion, Massachusetts, where the transmitter is and have seen the thing in operation. There is a click of a relay and the signals go out on 2100 meters, another click and the wavelength has been changed to 2000 meters, another click and the transmitter is turned off. No one has been near it for an hour or so.

No, the problem of turning on and off your receiver, or of changing its frequency setting, or regulating the volume control, all from a distance is not new. Neither is the idea that in the navy in time of war the frequency of a transmitter could be changed rapidly and at the will of the operator. Such schemes are as old as the apparatus itself and the business was reduced to practice many years ago.

If anyone wants to know how to tune his radio by pushing a button instead of whirling a

knob, we'll tell him, and at the same time give him data on how to turn the thing off—in case of sopranos singing, for instance—or to change the volume. As a matter of fact, the interested reader may find an article on such matters in this issue. This scheme is at least old enough to have gone through the patent office, and in these days of radio inventions, this means something! Incidentally, Commander E. F. McDonald of the Zenith Radio Corporation states that his company has acquired Mr. Marvin's invention and that he, too, believes the last frontier of radio will bow etc., etc.

**A. C. Troubles**

THE A. C. receiver seems to be causing dealers and service men no end of worry. A dealer in New Hampshire writes us typical complaint: "I wish to state that the a.c. tube sets around this section are a decided failure. Fluctuating line voltages ruin tubes in a few weeks. I know of one individual that has had four sets of tubes this winter. I spent an hour explaining why a.c. tubes were no good to one prospective customer after which he agreed with me and thanked me. However, the next day he promptly went to my competitor and purchased an a. c. set."

We should like to point out that the trouble is by no means altogether with the a.c. tube. For example, we know an editor of a nationally known magazine who owns a Radiola 17 receiver. He lives in a section of New York where line fluctuations are very severe, so severe in fact that he purchases a new 171 power tube and a.c. tubes, too, about every two months. The trouble here is patently not with the tubes, but with the bad voltage regulation.

Any tube operated at a temperature above normal will not last long. This means that a tube whose manufacturer states should be operated at 2.5 volts cannot be expected to lead a long or useful life if the voltage about half the time is 3.0 volts. Tubes operated from a.c. will last a long time if the voltage is normal or slightly below.

From time to time we hear rumors of voltage adjusting gadgets which are in process of development; units that plug between the house lighting socket and the receiver. Their duty is to keep the voltage down to some fixed figure. We predict a million dollar business for the first reasonably priced and successful equipment of this type.

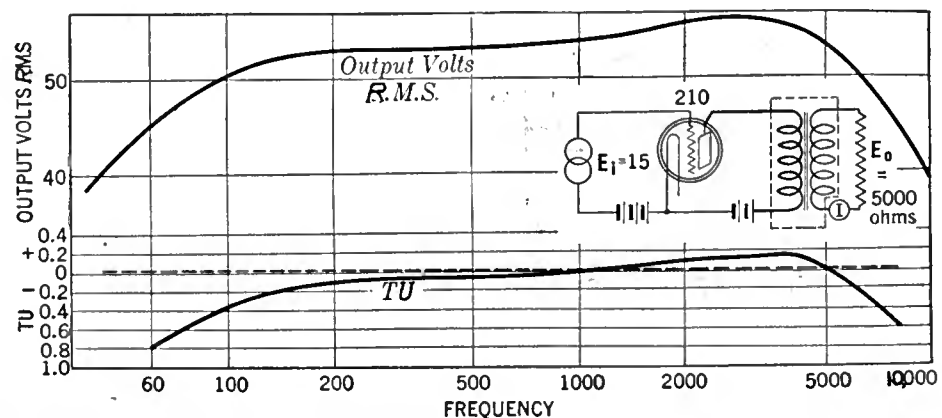

FIG. 1

### May Standard Frequency Signals

STANDARD FREQUENCY signals from the Bureau of Standards have been used by amateurs, laboratories and experimenters for several years. These signals are sent out about the 20th of each month and begin at 10:00 P. M. E. S. T. On May 21, signals will be sent on frequencies of 650 to 1500 kc. and should serve as calibrating signals for wavemeters and oscillators working in the broadcast range of frequencies. The signals begin at 10:00 and continue until 11:32 P. M. They consist of slightly modulated c.w. telegraph and take place as follows: at 10:00 a general call will be sent consisting of the statement of the frequency, the call letters of the Bureau station, wv, then a series of very long dashes and call signals on the stated frequency, then the statement of the frequency transmitted and the next frequency. These signals require about 8 minutes, and are repeated on the next frequency after a lapse of four minutes during which the transmitter is adjusted.

Anyone within 500 to 1000 miles of Washington, D. C. should be able to use the signals provided he has a receiver in which the detector can be made to oscillate, a Roberts or Lab. Circuit, for example. The receiver should be adjusted to the approximate frequency, the detector oscillating, with a pair of receivers in the output of the amplifier which may be one or two stages. At the proper time, indicated below, the receiver should be adjusted until wv's signals are heard beating with the oscillations of the local detector circuit. This circuit should then be adjusted to zero beat with wv, and a wavemeter, preferably an oscillating tube attached to a coil and condenser, is tuned also to zero beat. The wavemeter and the receiver and wv are then all on the same frequency. A record should be kept of the frequency and the setting of the wavemeter condenser as well as that of the receiver in case it is desired to calibrate the receiver. The schedule follows:

E. S. T.	MAY 21	FREQUENCY	WAVELENGTH
10:00—10:08	P. M.	650 kc.	462 meters
10:12—10:20		750 "	400 "
10:24—10:32		850 "	353 "
10:36—10:44		950 "	316 "
10:48—10:56		1060 "	283 "
11:00—11:08		1200 "	250 "
11:12—11:20		1350 "	222 "
11:24—11:32		1500 "	200 "

### Short-Wave Notes

GENERAL ORDER NO. 24 of the Federal Radio Commission opens up a new telegraph band for amateurs between 28,000 and 30,000 kilocycles, or 9.99 to 10.71 meters. It also defines an amateur station as one "operated by a person interested in radio technique solely with a personal aim and without pecuniary interest." It also makes slight revisions in the telephone bands open to amateur traffic. Radio telephones are now permitted to operate in these bands:

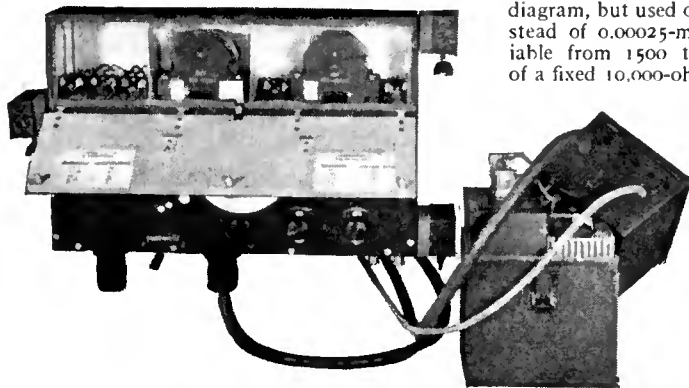

NEW RCA AIRPLANE SET

KILOCYCLES	METERS
64,000 to 56,000	4.69 to 5.35
3,500 to 3,500	84.5 to 85.7
2,000 to 1,715	150.0 to 175.0

On March 17 a six-passenger Stinson-Detroit monoplane left Curtiss Field on a coast-to-coast flight bearing five passengers and considerable radio equipment. A photograph of some of this apparatus, built by the R.C.A. is shown here. By the time this appears, many amateurs will have worked the plane whose radio gear was under the key of H. C. Leuteritz, and which was licensed to transmit on 120 meters using the call letters 2XBK.

Attempts were made to get into contact with the plane from the RADIO BROADCAST magazine station, 2GY, but by the time we got the receiver wound up to operate on the rather unusual wavelength of 120 meters, the plane was apparently too far away. We heard several commercial stations calling her, and found a lot of interesting things going on between 100 and 200 meters. For example the coast guard boats using Western Electric radio equipment could be heard all up and down the coast hammering out information about the rum fleet—probably. The stuff was in code.

Not long ago we got up at 5 A. M. E. S. T. and hammered out a CQ on our 40-meter station, 2EJ (See our April, 1927, issue). Two stations came back at once, and on about the same frequency, one fairly loud and the other quite weak. We clicked with the louder of the two asking the weaker to QRX for a few minutes. The louder station turned out to be in Colorado and very glad to be QSO the east coast because he was using low power. After some conversation we signed off and gave the weaker station a call, not knowing, of course, whether he was still standing-by or not. Sure enough he came back, and he too was most anxious to chat. He was using 180 volts on a 112 type tube and had a call which indicated he was in Oklahoma. A few days ago we received a card from this operator stating that he was on a boat in San Francisco harbor on the night in question using about 1 watt input to his 112, and not having a better one used his Oklahoma call. The distance from San Francisco to Garden City is something over 3000 miles which is not bad for an input of 1 watt.

The following letter from M. W. Pilpel, London, England, relates the success he has had with a transmitter described in RADIO BROADCAST. Mr. Pilpel's call letters are 6PP and his wavelength is about 45 meters. He states that he is on the air every evening up to about 7 P. M. E. S. T. In this letter "NC" refers to a station in Canada, "AQ" to Iraq, "AS" to Siberia and "FM" to Morocco.

"I feel that I must write and tell about the splendid results I have obtained with a set described in your paper.

The set concerned is the "B Battery Transmitter" described in your November, 1926, issue. I built this set almost exactly as your diagram, but used 0.0003-mfd. condensers instead of 0.00025-mfd., and a grid leak variable from 1500 to 100,000 ohms instead of a fixed 10,000-ohm one.

The plate supply is from accumulators, 180 volts, and the tube used is a Marconi DE5, more or less the English equivalent to your 201-A. The antenna is a small cage with four wires and is only 15 feet long and 20 feet high. The direct ground is used.

Now for the results, with an input of 27 m/a (4.8 watts) or less I have succeeded in

working four continents. Actually the best distance worked is Manoa, Pennsylvania where my friend NU-3PF gave me R2-3 during a QSO lasting nearly 1½ hours. Two first district NUs have also been worked. Then, NC (R2-3), AQ (R1!!) AS (R3), and FM (R6) outside Europe. Only three European countries possessing hams have not been worked yet, Rumania, Switzerland and Lithuania, all others have been worked on more than one occasion. LPJ at Spitzbergen gave me R3 in daylight, and OIK, when 400 miles south of Greenland, R5. The best miles-per-watt is over 900, ED 7HJ of Bornholm, Denmark, 750 miles away giving me R4 when using 0.8 watts.

I attribute these results chiefly to the steadiness of the note emitted by the set and must congratulate you on bringing this excellent little "perker" to general notice and describing it so well."

### Recent Interesting Contemporary Articles

EACH MONTH we look through the welter of radio magazines and papers that come into the office. Occasionally, we read some of them. QST, for example, disappears from the office the moment it comes from the mail room and does not come back until whoever took it has perused every word. Then someone else grabs it. *Experimental Wireless and Wireless Engineer* (England) suffers the same experience. The rest of them from a technician's standpoint, seem mediocre, a sad fact true even of the *Proceedings of the I. R. E.* at times. The following recent articles are worth reading.

TITLE	MAGAZINE	DATE
Double Detection Detectors and Screen-Grid Amplifiers	QST	March
Directional Properties of Antennas	QST	March
The Photoelectric Cell	Radio	February
Frequency Stabilization on Short Waves by Quartz Crystals	L'Onde Électrique	January
Theory of the Antenna	Wireless Experimenter	March
A Radio-Frequency Oscillator	I. R. E.	February
Theory of Power Amplification	I. R. E.	February
Ideals of the Engineer by John J. Carty	Journal, A. I. E. E.	March
Use of Very High Voltage in Vacuum Tubes by W. D. Coolidge	Journal, A. I. E. E.	March

### Another Useful Publication

IN SPITE of the fact that our friend C. T. Burke of the General Radio *Experimenter* catches us up, publicly, whenever we make a mistake, we still believe that every serious radio thinker should be on the list of those getting this excellent trade publication.

A similar sheet has arrived in the Laboratory. It is called the *Aerovox Research Worker* and is published by the Aerovox Wireless Corporation, 70 Washington Street, Brooklyn, New York. It, too, is worth having regularly. In our list of "Manufacturers' Booklets Available," regularly listed in the back advertising pages of this magazine this publication is listed as No. 120.

### Radio School Scholarships

ANYONE WANTING a free ticket to the Radio Institute of America should get in touch with J. V. Maresca, Room 1889, Hotel Roosevelt, New York. He has charge of applications for two scholarships offered by the Veteran Wireless Operators' Association and the two offered by A. H. Grebe. Awards will be made to those American born youths over eighteen years of age who write the best letters of essays on "Why the American Merchant Marine Needs Perfect Wireless Communication."

—KEITH HENNEY.



# New Apparatus

## An Inside Antenna

X30

**Device:** INDOOR AERIAL. Consists of a seventy-foot spool of indoor aerial wire, a twenty-five foot length of rubber-covered ground wire, and a ground clamp. The aerial wire is made of stranded copper covered with a brown braid. **Manufactured by the BELDEN MANUFACTURING COMPANY. Price: \$1.35.**

**Application:** Designed especially for indoor antennas, the wire is flexible and can be easily wired around a room, over window frames, and because of the neutral brown color of the braid, the wire is practically invisible.

## Fine New Drum Dial

X31

**Device:** NATIONAL TYPE F VELVET VERNIER DRUM DIAL. Dial light is readily removable, and has both terminals insulated from the dial. Dial numbers are engraved on strip. Drum is made of brass, with nickel plating and the dial front is silver plated. The movement has



NATIONAL DRUM DIAL

absolutely no back-lash. **Manufactured by THE NATIONAL COMPANY. Price: \$4.50.**

**Application:** May be used in constructing any receiver. One of the best drum dials that have been received in the laboratory.

## A Good Phonograph Pick-Up

X32

**Device:** Amplion Phonograph Pick-Up Unit. **Device** is complete with tone arm and volume control. **Manufactured by the AMPLION COMPANY. Price: \$15.00.**

**Application:** To be used in conjunction with a phonograph turn-table and an audio amplifier to make possible the electrical reproduction of phonograph records. The tone arm is screwed down on the turn-table bed of the phonograph in such a position that the unit on the end of the tone arm can be correctly placed on a record. The Laboratory's sample of this pick-up has given very satisfactory reproduction of records and it has the advantage over some other pick-ups that it exerts but slight pressure on the record resulting in less record wear.

## Resistor for the Screen-Grid Tube

X33

**Device:** AMPERITE No. 622. Filament-control resistance for screen-grid tubes. When placed in series with the tube filament and a six-volt battery, this resistance will reduce the voltage to 3.3 volts, the correct voltage for a screen-grid tube. **Manufactured by the RADIAL CO. Price: \$1.10.**

**Application:** May be used for filament control of the screen-grid type tubes in a receiver.

Amperites for each type of tube are made. Complete data on the different styles available may be obtained by writing the manufacturer through RADIO BROADCAST.

## Set Tester of Wide Use

X34

**Device:** RADIO SET TESTER, A. C. AND D. C. MODEL 537. This set tester is designed for the testing of all kinds of radio receivers operated from either alternating or direct current light socket power or from batteries. It will measure the various voltages used in the radio set both at the tube sockets or at any part of the set; it will test continuity of circuits, and test the tubes under the same conditions as exists when in their sockets. All tests can be made by using the voltages normally supplied to the set by its batteries or socket power with no change in connections, so that no auxiliary power supply is required. Socket adapters are supplied so that UV, UX and UY type tubes may be tested.

All of these tests are possible using the two meters contained in the instrument, which are an a. c. voltmeter having three ranges 150, 8, and 4 volts, and a d. c. volt-milliammeter which has four voltage ranges, (600, 300, 60, and 8 volts) and two current ranges, (150 and 30 milliamperes). The voltmeter has a resistance of 1000



AMPLION PHONOGRAPH PICK-UP

ohms per volt and can therefore be used satisfactorily to measure the output voltages of B power units. Tests on tubes can also be made independent of any radio receiver by connecting a plug supplied with the instrument into a light socket.

**PRODUCTS** of radio manufacturers whether new or old are always interesting to our readers. These pages, a feature of RADIO BROADCAST explain and illustrate products which have been selected for publication because of their special interest to our readers. This information is prepared by the Technical Staff and is in a form which we believe will be most useful. We have, wherever possible, suggested special uses for the device mentioned. It is of course not possible to include all the information about each device which is available. Each description bears a serial number and if you desire additional information direct from the manufacturer concerned, please address a letter to the Service Department, RADIO BROADCAST, Garden City, New York, referring to the serial numbers of the devices which interest you and we shall see that your request is promptly handled.—THE EDITOR.

**Manufactured by the WESTON ELECTRICAL INSTRUMENT CORP. Price: \$100.**

**Application:** An essential instrument for the radio dealer and the professional radio service man, for it makes possible the thorough, accurate and rapid testing of a receiver.

## For the 250 Type Tube

X35

**Device:** Power Equipment for the 250 type tube. The apparatus listed below has been designed for the 250 type tube. This tube requires much more plate current than other types of power amplifier tubes and therefore the apparatus for use with it must be constructed to prevent overheating and saturation effects at high currents.

**TYPE 565-B FULL-WAVE TRANSFORMER.** Designed for full-wave rectification using two type 281 tubes. The plate voltage winding is 1200 volts with a center tap. There are also two



WESTON SET TESTER

7.5-volt secondaries for the filaments of the rectifier and power amplifier tubes. **Price: \$20.00.**

**TYPE 565-A HALF-WAVE TRANSFORMER.** This transformer is designed for half-wave rectification in conjunction with one 281 type tube. There are four secondaries: one of 600 volts for the plate voltage; two of 7.5 volts each for the filaments of a rectifier and power amplifier tubes; and one of 2.5 volts for the filaments of 226 and 227 type of tubes in case this transformer is incorporated in a complete two- or three-stage amplifier. Rated at 200 watts. **Price: \$20.00.**

**TYPE 587-A SPEAKER FILTER.** A speaker filter that thoroughly insulates the speaker from the high plate voltage and current of the last-stage tube. The choke used is of unusually heavy construction and has an inductance of approximately 15 henries and a continuous current rating of 100 milliamperes. The direct current resistance is 250 ohms. Two microfarad condensers are used on each side to completely insulate the speaker from high voltage. Connections to the input side are in the form of leads while the speaker is connected to two binding posts. **Price: \$10.00.**

**TYPE 527-A RECTIFIER FILTER.** This unit consists of a combination of two heavy-duty chokes with an inductance of approximately 13 henries each and a continuous current rating of 100 milliamperes and a condenser assembly consisting of a 4-2-4-mfd. combination rated at 1000 volts d. c. The direct current resistance of each choke is 175 ohms. **Price: \$25.00.**

All the above apparatus **Manufactured by the GENERAL RADIO COMPANY.**

**Application:** This apparatus may be used in

constructing power amplifiers using the 250 type tube especially, although the equipment is of course suited to the construction of any power unit from which it is desired to obtain comparatively large amounts of current, say 60 milliamperes or more.

*Dynamic Speaker Models*

X36

**Device:** JENSEN DYNAMIC SPEAKER: A moving-coil type loud speaker. It may be connected directly to the output of a receiver without any need of an output device, for the transformer contained within the loud speaker insulates the windings of the moving coil from the plate current of the power tube. The field winding of the speaker must be supplied with energy from an A battery (Model D-44), or from a 90-volt d. c. source (Model D-45) or from the 110-volt a. c. mains (Model D-44 a. c.). *Manufactured by the JENSEN RADIO MFG. CO.*

**Price:** Model D-44, \$65.00; Model D-45, \$67.50; Model D-44-AC, \$75.00.

**Application:** A sample of this loud speaker has been in use in the Laboratory for some time and has proved to be an excellent instrument. An elementary diagram of the loud speaker appears

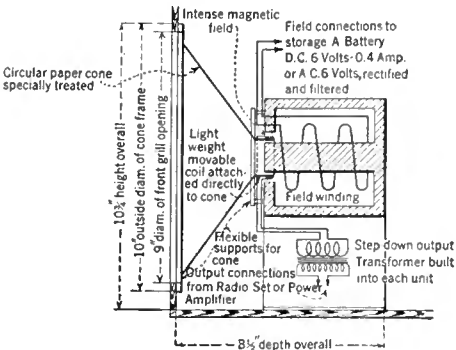
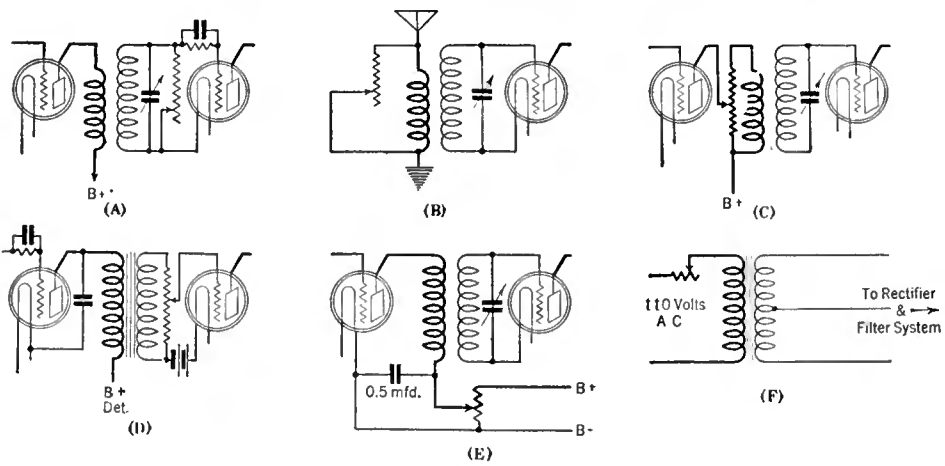

DIAGRAM OF JENSEN CONE

herewith. The cross-sectioned part represents a magnet, energized by the current flowing through the field winding. As a result there is produced across the gap in the magnet an intense magnetic field. The paper cone is arranged as indicated, projecting into the gap, and around this portion of the cone is wound a small coil of wire. This coil is connected to the secondary of the step-down transformer, the primary of which connects to the output of the radio receiver. The signal currents flowing through the coil react with the magnetic lines of force flowing across the gap and produce a torque which makes the coil move left and right. The cone, attached solidly to the moving coil, must also move with the coil and its movements produce the sounds. This loud speaker gives best results when operated in conjunction with a large baffle but will also work very well in the cabinet supplied



TRUVOLT RESISTORS AND BELDEN ANTENNA KIT



CIRCUITS FOR CENTRAL LAB VOLUME CONTROLS

by the Jensen Company. The cone unit can also be purchased without the cabinet for installation in radio or phonograph consoles.

*Resistors for A. C. Sets*

X37

**Device:** VOLUME CONTROL RESISTANCES, for a. c. receivers. The method of volume control commonly used in d. c.-operated receivers, i. e., a filament rheostat in the filament circuit of the r. f. tubes, cannot be applied to a. c. circuits because lowering the filament potential of 226 type tubes will tend to produce a hum in the loud speaker and because with 227 type tubes the emission from the heater will lag behind changes in the current through the heater filament. It is therefore necessary to use some other type of volume control. The devices listed below will be found very satisfactory.

**RX-100 Radiohm**, a special tapered resistance for use across the secondary of one of the r. f. transformers, preferably the detector stage. See Fig. 1-A. **Price:** \$2.00.

**RX-025 Radiohm**, a special tapered resistance for use as a volume control across the primary of an r. f. transformer or across the primary of a tuned antenna coil. See Fig. 1-B. **Price:** \$2.00.

**P-112 Potentiometer**. A 6000-ohm potentiometer with a special tapered resistance at the end to be used in the antenna circuit or across the primary of a tuned r. f. stage. See Fig. 1-C. **Price:** \$2.00.

**M-500 Modulator**. A potentiometer with a special tapered resistance for the grid circuit of one of the audio stages. Used principally as an auxiliary control in a. c. circuits. See Fig. 1-D. **Price:** 2.00.

**HP-050 Heavy Duty Potentiometer**. A wire-wound, non-inductive potentiometer used as a plate circuit control. See Fig. 1-E. **Price:** \$2.00.

**PR-050 Power Rheostat**. A specially constructed rheostat to carry heavy currents and an

excellent control for use in the primary of a power transformer. See Fig. 1-F. **Price:** \$1.25.

All of the above units are manufactured by the CENTRAL RADIO LABORATORIES.

**Application:** The application of these units to a. c. circuits has been covered in the data given above. A useful pamphlet is obtainable from the manufacturers through RADIO BROADCAST describing these units in detail and giving further information regarding the circuits in which they are to be used.



JENSEN DYNAMIC CONE

*Resistors for Power Supply Use*

X38

**Device:** TRUVOLT RESISTORS. Wire-wound resistors, using Nichrome wire wound on an asbestos covered enamel core. Available as fixed and variable resistors as follows:

**TYPE T**, variable resistors, with maximum resistances of 200 to 50,000 ohms.

**TYPE B**, fixed resistors, rated at 25 watts, and available in sizes from 200 to 50,000 ohms.

**TYPE C**, fixed resistors, rated at 50 watts, and available in sizes from 200 to 100,000 ohms.

**TYPE D**, fixed resistors, rated at 75 watts, and available in sizes from 200 to 100,000 ohms.

**TYPE V**, center-tapped fixed resistors, available in sizes from 10 to 200 ohms, and designed especially for use as center-tapped resistors across the filaments of a. c. tubes.

**GRID RESISTORS**, available in sizes from 10 to 2000 ohms, and designed especially for use as grid suppressors, in radio-frequency amplifiers.

**SPECIAL TAPPED FIXED RESISTORS**, designed for use with the popular types of power packs such as those made by Silver-Marshall, Amertran, Samson, Thordarson, etc.

*Manufactured by ELECTRAD, INC. Prices:* vary according to the style and rating of resistors. **Application:** The Truvolt line of resistors is very complete and units are available to meet almost every need in the construction of radio receivers and power packs. Complete data can be obtained from the manufacturer through RADIO BROADCAST.

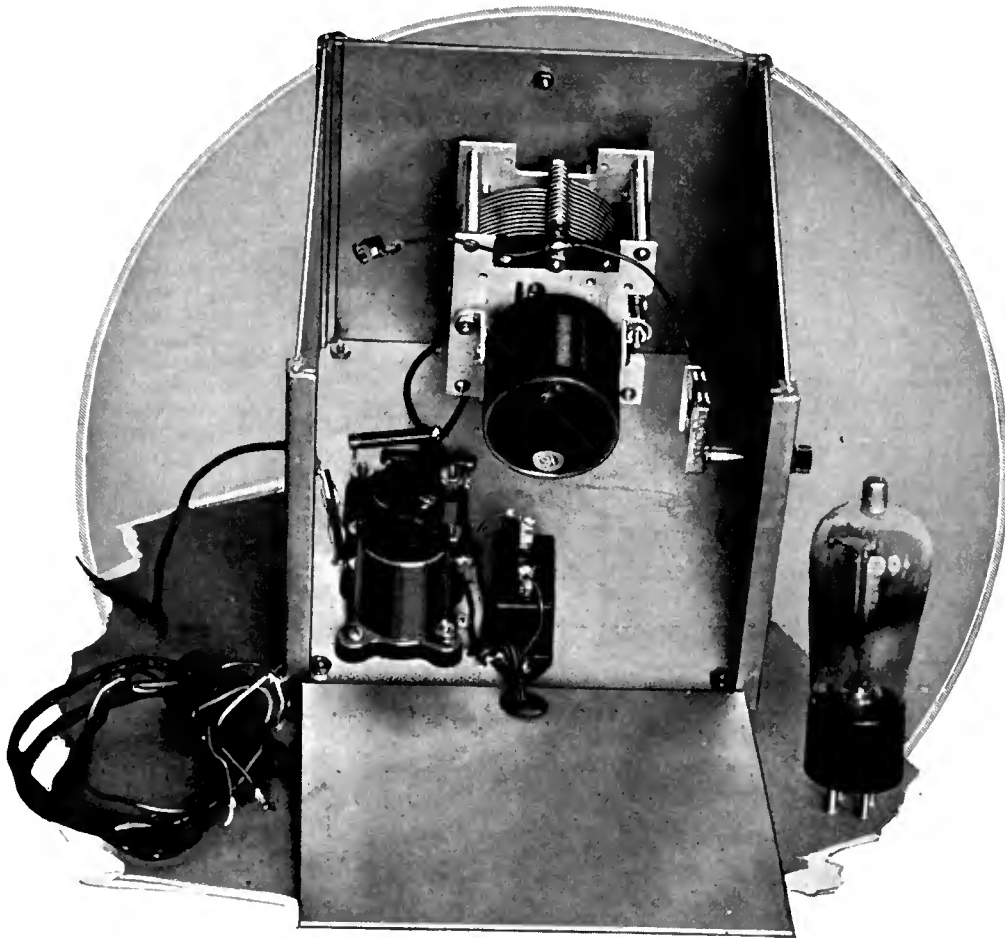

### NEW LIFE FOR A WEAK RECEIVER

The screen-grid tube can be added to any receiver, and—at the cost of one additional control—will add a respectable amount of sensitivity and some selectivity. Directions are given for using this unit with any receiver

## A Screen-Grid Booster Unit for Any Receiver

By Glenn H. Browning

*Browning-Drake Corporation*

**T**HE introduction of the screen-grid tube has opened a new field in r.f. amplification, for not only does this tube make possible at broadcast frequencies an amplification much greater than is possible with a 201-A type, but because of its very small capacity between control grid and plate, relative stability as an r.f. amplifier is secured.

As most experimenters know, the screen-grid tube has two grids, one forming a nearly complete shield around the plate and known as the screen grid, while the other is practically the same as the grid in the ordinary tube, and is called the control grid. The screen-grid has two effects; it shields the plate as its name indicates, and also increases the mutual conductance in such a manner that the amplification of the tube may be at some frequencies as high as 100. The function of the control grid is, as in the 201-A tube, to regulate the flow of electrons between filament and plate.

The construction of the tube may be seen in the accompanying photographs. The metal cap on top of the tube is the terminal for the control grid while the prong on the socket, marked "grid," is the terminal for the screen-grid. These connections should be carefully noted.

To get the utmost from the screen-grid tube involves careful shielding of the tube and the circuit in which it is used. There are thousands of sets which are not now shielded nor could they readily be shielded. This difficulty, in addition

---

**M**R. BROWNING'S "booster" provides at one time a means of improving the DX ability of any receiver and its selectivity. In the Laboratory, it was possible to hear stations that were not audible without it. It was also possible here to listen to KDKA with very little interference from WABC, only 8 miles away, while under usual conditions this is not possible at all. In our estimation, this booster should be a gold mine to service men—because nearly every one wants some little gadget like this that will make an otherwise almost-dead receiver come to life.

We hope that Mr. Browning will design a set of plug-in coils so that this single stage of r.f. amplification may be used with short-wave receivers. It will then eliminate nearly all radiation from these receivers, as well as improve signal strength.

—THE EDITOR.

to the fact that it is very rare indeed that any existing circuit can be efficiently and easily altered for the successful use of the screen-grid tube makes it wiser in most cases to find ways of utilizing the high gain to be secured from the screen-grid tube elsewhere than in the receiver proper.

For the last year there has been an insistent demand for another stage of tuned radio-frequency amplification to be added to the Browning-Drake receivers. The writer has worked a great deal on this problem only to come to the conclusion that it was not feasible for the home-builder because of the high gain in the Browning-Drake transformers which entails careful construction, and critical adjustment of the neutralizing condensers. However, with the availability of the screen-grid tube, the problem simplifies itself considerably.

For some time the writer has been experimenting with a one-stage r.f. amplifier which could be added to the large number of Browning-Drake sets which are in use. This amplifier employs the screen-grid tube, and not only gives a tremendous r.f. amplification, but increases selectivity to a marked degree. It has also been found that the one-stage amplifier can be used

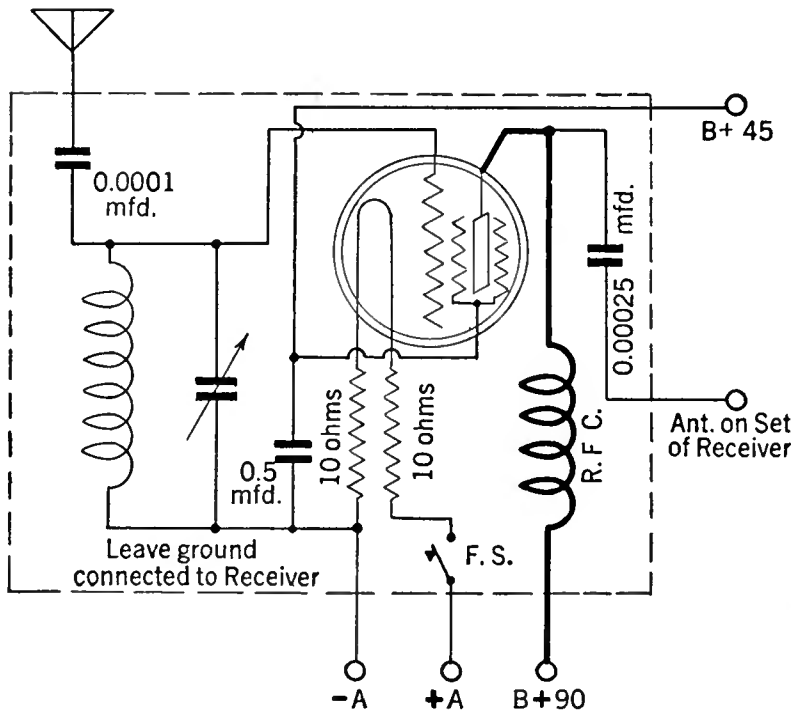

CIRCUIT OF THE BOOSTER UNIT

The antenna connection indicated will work with all Browning-Drake type receivers; with others, it is best to connect the antenna lead to the set directly to the stator plates of the first tuning condenser

adding the booster. Volume may be controlled as before on the receiving set.

HOW TO CONNECT THE BOOSTER

WHEN using this one-stage booster with other receivers, the wire on the right of the shield casing, is connected to the stator plates on the first tuning condenser. The other connections are unchanged, except that the antenna lead is connected to the proper post on the booster. The operation of the booster is very simple indeed as all that is necessary to do is to tune-in the receiver by means of the regular control and then tune the booster.

Tuning on the booster unit is not extremely critical though it increases the selectivity of the set in a marked degree. The antenna used on the receiver when this booster is employed should be very short, in fact, not more than 25 to 40 feet, and as nearly vertical as possible. The vertical antenna will pick up relatively a stronger signal.

LIST OF PARTS

- 1 Browning-Drake Booster 322 Kit assembly. (Includes shields, the coil and tuning condenser with dial, two 10-ohm resistances, a four-wire cable, shield wire, and r.f. choke).
- 1 6X tube socket.
- 1 0.0001-mfd. mica Condenser.
- 1 1/2-mfd. mica Condenser.
- 1 0.00025-mfd. Condenser.

not only on Browning-Drake sets, but on any existing receiver, simply by making a connection to the stator plates of the first tuning condenser. [The lead from the "booster" may be connected to the antenna posts of some receivers, but not all, and it is best to follow the suggestion here which is certain to work.—EDITOR.] By using this one-stage device, the writer has received signals that were inaudible before.

The assembly of the one stage screen-grid booster is quite simple. The Browning-Drake Corporation furnishes a kit consisting of the coil, condenser and dial, together with a set of aluminum shields, a radio-frequency choke, a four-wire cable, 10-ohm resistances and the mounting hardware, and all that is necessary for the constructor to purchase is a tube socket, and the three following condensers; a 1/2 mfd., a 0.0001 mfd. and a 0.00025 mfd.

The picture wiring diagram and the schematic wiring diagram are presented on this page. It should be noted that the stator plates of the tuning condenser go to the top of the screen-grid tube. The two 10-ohm resistances, put in as indicated, cut down the six volts from the storage battery to 3.3 volts which is the correct voltage for the screen-grid. It is noted that the one-stage booster is run from a battery as the writer does not believe it feasible to light the filament of the cx-322 from raw a.c. In using the one-stage booster on any Browning-Drake assembly, all that is necessary to do is to disconnect the antenna from the set, connect it to the antenna post of the booster, which is shown on the left, and to connect the wire lead, which is on the right of the booster to the antenna post on the Browning-Drake receiver. The ground is left in its position on the set proper. From the wiring diagrams, it may be noted that a filament switch is inserted in the plus-A battery lead to control the filament of the cx-322 tube. This makes the separate amplifier unit independent of the receiving set proper and permits it to be used on any radio set. When using the booster on Browning-Drake receivers, particular care should be taken that the set is well neutralized before

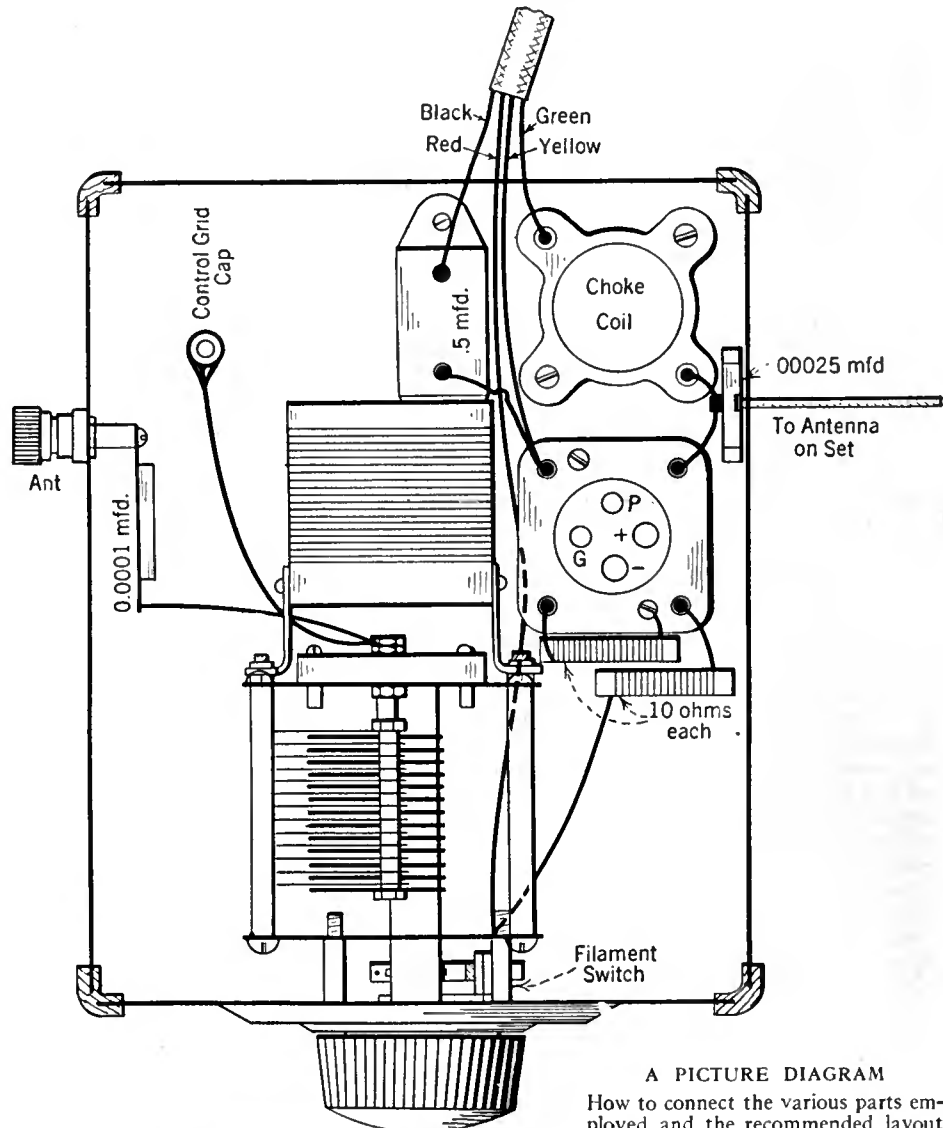

A PICTURE DIAGRAM

How to connect the various parts employed and the recommended layout

# “Our Readers Suggest—”

OUR Readers Suggest” is a clearing house for short radio articles. There are many interesting ideas germane to the science of radio transmission and reception that can be made clear in a concise exposition, and it is to these abbreviated notes that this department is dedicated. While many of these contributions are from the pens of professional writers and engineers, we particularly solicit short manuscripts from the average reader describing the various “kinks,” radio short cuts, and economies that he necessarily runs across from time to time. A glance over this “Our Readers Suggest” will indicate the material that is acceptable.

Possible ways of improving commercial apparatus is of interest to all readers. The application of the baffle board to cone loud speakers, is a good example of this sort of article. Economy “kinks,” such as the spark-plug lightning arrester, are most acceptable. And the Editor will always be glad to receive material designed to interest the experimental fan.

Photographs are especially desirable and will be paid for. Material accepted will be paid for on publication at our usual rates with extra consideration for particularly meritorious ideas.

—THE EDITOR.

## An Emergency Detector B Supply

IT HAS been my experience that the voltage distributing resistor system in the average B-power unit is the weak point of these devices. On several occasions the resistor passing the current to the detector tube in my receiver has gone bad. I found that an emergency connection could be effected in a few seconds, by wiring an outside resistor from the “detector B” post on the set to the “amplifier B” post on the unit. A 100,000-ohm resistor is about the correct value. The set works quite as well operating the detector tube from the 90 volts power-unit tap, through the external resistor, as it did from the original “detector B” supply post.

I rigged up the resistor mounting, shown in Fig 1, to enable me to try different values of resistors. The mounting is wired, as shown, to the “amplifier B” positive post, and the detector lead is caught under the Fahnestock clip.

PERRY WHITE, New York City.

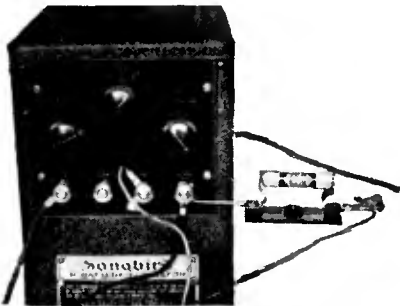

FIG. 1

This simple arrangement can be used to supply either detector or intermediate-amplifier plate potential from a high voltage tap in the case of resistor break-down.

## STAFF COMMENT

IN SOME cases it may be desirable to bypass this extra resistor. This can generally be accomplished by leaving the lead to the “detector B” post on the set (now wired to the special resistor) also connected to the original “detector B” supply post on the power unit, taking advantage of the bypass condenser included in that circuit. As the faulty resistor is probably “open” this will have no effect on the potential. If desired, the resistor may be bypassed by connecting any convenient condenser from 1.0 mfd. up, across the resistor. It is also possible to connect the external resistor directly across the “amplifier B” plus and the “detector B” plus posts on the receiver itself, without going back to the power supply unit.

The clip-wired Clarostat and the clip-wired

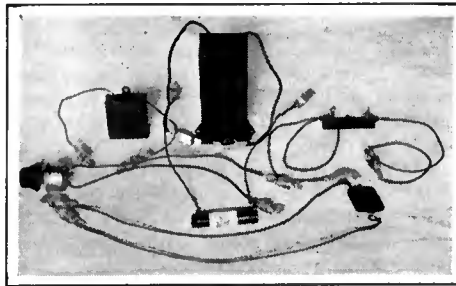

FIG. 2

The use of clip connectors permanently fastened to flexible leads for condensers and resistors greatly facilitates experimental and emergency work for many uses around the radio set

bypass condensers suggested by Mr. Graham, elsewhere in this department, are particularly convenient in effecting temporary arrangements of this kind.

## Emergency and Experimental Connections

IN MY experimental work, as well as in emergency set-ups in the perpetual endeavor to keep the family set functioning properly, I have found it very convenient to have a complete set of parts available for immediate connection by means of clips. The idea, illustrated by a few of the parts so arranged, is made clear in the accompanying photograph (Fig. 2.).

The clips used are of the small battery type, obtainable at most electrical and radio supply houses. Any type of ordinary hook-up wire may be used for the leads—I used flexible Celatsite. In the cases of certain parts, such as the condensers which already have long and flexible leads, these may be soldered directly to the clips.

The following parts which I happened to have on hand, were arranged with two-foot leads and clips:

- 1 Volume control Clarostat (variable resistor)

- 1 Universal range Clarostat (variable resistor)
- 1 Low range Clarostat (variable resistor)
- 1 Amsco 2000-ohm Duostat
- 1 400-ohm potentiometer
- 2 Fixed condensers, 0.001 mfd.
- 1 Gridleak mounting
- 2 Bypass condensers with leads, 0.1 mfd.
- 3 Filter condensers with leads, 4.0 mfd.
- 1 1000-ohm fixed resistor
- 1 2500-ohm fixed resistor
- 1 5000-ohm fixed resistor
- 1 10,000-ohm fixed resistor
- 3 60-ohm center-tapped resistors

It is also a good idea to have on hand a half dozen or so three-foot lengths of flexible wire with clips on the ends. The above parts arranged for instant clip connections, will be more than handy in all experimental work.

HERBERT GRAHAM, Chicago, Illinois

## Volume Control for Resistance-Coupled Amplifiers

SOME receivers, particularly sets using a.c. tubes, employ a type of volume control such that the signal cannot be reduced without impairing selectivity to a serious extent. This consideration justifies the control of volume at a point in the circuit following the detector tube where it will have no effect on selectivity. Some circuits employ a high resistance potentiometer across the secondary of the first audio transformer in a transformer-coupled amplifier.

When using a resistance-coupled amplifier a somewhat similar arrangement can be used, and is suggested in Fig. 3. The coupling resistor in the detector plate circuit is a high range potentiometer (.1 to .25 megohms maximum) such as the Electrad Royalty, with the movable arm connected to the coupling condenser.

This arrangement provides adequate volume control without changing the frequency characteristic of the amplifier.

H. F. KUCKS, New York City.

## STAFF COMMENT

AS MR. KUCKS points out there are certain types of volume controls which impair the selectivity, as for example a variable resistance across the primary or secondary of an r. f. transformer. Such difficulties can be prevented by

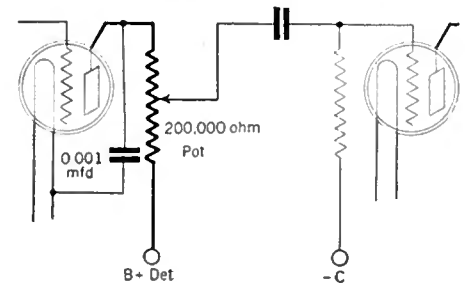

FIG. 3

A volume control circuit for use with resistance-coupled amplifiers



placing the volume control in the audio amplifier but this control has the disadvantage that it will not prevent the detector overloading on strong signals. There are several satisfactory volume controls that can be applied to a.c. receivers which will not affect the selectivity and which will also prevent detector overloading on strong signals. We mention two types.

One fairly good control is a variable resistance connected in series with the B-plus lead to the primaries of the r. f. transformers. This resistance should have a maximum value of about 200,000 ohms and a 0.1-mfd. or larger bypass condenser should be connected across it. As the amount of resistance in the circuit is increased, the effective voltage applied to the plates of the r. f. is lowered and the volume is thereby decreased. Such a control will not impair the selectivity, but, with some receivers will cause an undesirable increase in voltage applied to the other tubes in the set.

A simple type of volume control that may generally be used merely consists of a variable resistance connected between the antenna and ground posts on the set. The resistance should have a maximum value of about 50,000 ohms. Centralab, Yaxley, and others make a special resistance for this purpose.

### Some Baffle Board Experiments

STAFF COMMENT

THE baffle board consists of a reflecting surface applied near a cone speaker. In many cases this takes the form of a large box, in which the cone is placed. In others it is a short horn having a relatively large bell, the cone being used as a diaphragm. In many instances, the use of baffle boards will improve reproduction of the low frequencies especially. As experimental boards are easily constructed, they are worth trying.

The two following contributions consider the possibilities of the use of baffles.



FIG. 4

A baffle arrangement with a 540 AW cone speaker

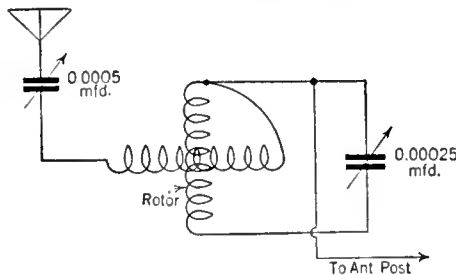

FIG. 5

An antenna tuning circuit for use with neutrodyne and other receivers having an untuned primary circuit

IN EXPERIMENTING with a Western Electric 540 AW cone I found it possible to attain a marked improvement in the reproduction of the lower audio frequencies, without apparent impairment of the higher notes through the use of a baffle board. The accompanying photograph, Fig. 4, illustrates the baffle arrangement employed by the writer.

I made a 36 by 36-inch wood frame, 12 inches deep. The front was faced with heavy roofing paper, with a circular hole, eighteen inches in diameter, cut out in the center. The cone was placed in this cabinet with the face of the cone brought as close to the opening as the frame of the loud speaker would permit. The assembly was then mounted on top of the chest of drawers as shown in the photograph, and placed in the corner of the room so that the sides of the enclosing cabinet touched the walls. By so doing the baffle effect of the sides was greatly increased, and the supporting furniture also functioned as part of the baffle.

The power tube used is a UX-171 outputting to the speaker through a 100-henry choke coil and a 9.0-mfd. condenser. This tube outputs adequate distortionless power to the baffled loud speaker with 135 volts on the plate.

A slight barrel effect in speech was counteracted by placing a piece of heavy cloth on the back of the cabinet, thus avoiding sound reflection.

PAUL S. FOSTER, New York City.

\* \* \*

A CAREFUL consideration of the most effective method of mounting a free-edge baffle type cone speaker is necessary if the best results are to be secured. Fairly good results can be expected by using a flat baffleboard of sufficient thickness and rigidity to be nonresonant throughout the audio range. A deep cabinet or console, however, will tend to improve the lower frequency response of the speaker by allowing a greater effective baffling area. The greater the baffling area the better will be the reproduction of the low notes.

Deep box baffles of the type to which we have reference often give rise to a resonance effect within the audio range, resulting in the exaggeration of certain frequencies, noticeable as a

booming sound or barrel tone. One method of correcting this condition is to vent the baffle by cutting holes or louvers in the sides of the console. This has the disadvantage of reducing the effective baffling area and often impairs the appearance of what otherwise would be a handsome bit of furniture. At best my present suggestion is a trial and error method.

In mounting a free-edge cone in a baffling arrangement of this type, the writer finds that resonance can be completely eliminated by lining the interior with felt. Felt packing of a thickness of  $\frac{1}{4}$  inch was used, although a somewhat thinner lining would probably have worked just as well. The entire interior of the cabinet, was lined with the packing and secured by glue and tacks.

D. C. REDGRAVE, Norfolk, Virginia.

### Antenna Tuning Device

THE apparatus described below is an indispensable portion of my receiver equipment for distant reception. Many broadcast fans, located like myself at some distance from broadcast centers, will find this simple device of use to them.

On many evenings, when stations two hundred to three hundred miles away are practically inaudible, a variometer and two variable condensers, connected as shown in Fig. 5 boost the volume from ten to twenty times, often making enjoyable loud speaker reception possible. The device does not change the original dial settings of the receiver. Once the variable condensers are set to the proper capacity (to be determined experimentally) they need not be touched again, all tuning being effected on the variometer. However, the 0.00025-mfd. variable is very effective as a volume control. This apparatus is not effective on all receivers, but is designed primarily for use with sets having untuned antenna primaries, such as the average neutrodyne and tuned r.f. receiver.

A. GAUDETTE, Lewiston, Indiana.

STAFF COMMENT

THE arrangement described above is an antenna tuning device. The control described by Mr. Gaudette is really a combined antenna tuning device and a wave trap. In the majority of instances it can be simplified to the circuit shown in Fig. 6. Coil L may be the secondary of any available radio-frequency amplifying transformer, or sixty turns of wire wound on a three-inch diameter form. This device will be most effective on short indoor antennas.

### A Spark Plug Lightning Arrester

HERE is a simple and effective lightning arrester. It consists of a good heavy spark plug, and a piece of pipe, three or four feet long, into which the plug can be screwed.

The pipe is driven into the ground and the spark plug screwed into it. The ground connection is automatically taken care of. The wire from the antenna is led to the binding post on top of the spark plug and from there to the receiver. That is all there is to it.

GEORGE KOETHER, JR., Round Bay, Maryland.

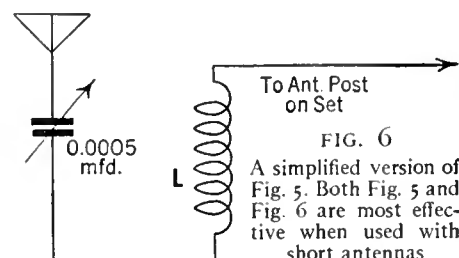

FIG. 6

A simplified version of Fig. 5. Both Fig. 5 and Fig. 6 are most effective when used with short antennas

No. 1.

June, 1928.

RADIO BROADCAST'S Service Data Sheets on Manufactured Receivers

# The Amrad A. C. 7

THE Amrad A. C. 7 is another representative of the a.c. electric receiver of the neutrodyne type. This receiver utilizes seven tubes, six of which are of the a.c. type while the seventh is a 171. A study of the wiring diagram of the complete receiver installation will bring to light several novel features in design. There are four stages of radio-frequency amplification, a non-regenerative detector, and two stages of transformer-coupled audio-frequency amplification. The power is obtained from a full-wave B power unit which simultaneously supplies the B voltage for the plates of the tubes and the a.c. voltages for the filaments.

The r.f. system consists of an antenna coupling stage and three stages of Hazeltine-neutralized tuned radio-frequency amplification. The receiver is designed for a short antenna and the first r.f. stage is really a coupling stage, being untuned. The input circuit of this coupling tube consists of a radio-frequency choke, tapped for the antenna, in series with a fixed resistance, which is grounded. By utilizing this coupling tube the tuned settings of the other three stages are not disturbed by variations in antenna length or capacity. A very novel method of volume control for the entire receiver installation is incorporated in the plate circuit of this coupling tube. It consists of a variable resistance connected across the bifilar primary winding. Under normal circumstances a volume-control of this type would manifest an effect upon the grid circuit of the average tuned stage but since the grid circuit of this tube is untuned the effect of this variable resistance is that of only a volume control, without any detrimental effects upon other circuits. Each of the r.f. stages is contained in a separate can. The audio stages are not shielded and are of the conventional type, with an output transformer utilized to couple the loud speaker to the output tube.

All four stages of radio-frequency amplification are neutralized, and the neutralizing condensers are designated as  $C_2$  in the wiring diagram. The bifilar primaries utilized in this system of neutrali-

zation are marked  $L_1$  in the drawing. The receiver is a single-control unit, the four tuning condensers being ganged together and operated from one point. A filter system, consisting of a resistance and a capacity, is incorporated into the detector plate circuit, probably to keep the a.c. hum at a low value. The plate voltages for the r.f. tubes and the detector are obtained from one tap on the power unit, but voltage-reducing resistances located in the plate circuit of each radio-frequency

frequency choke is wired into the plate-voltage system in the r.f. circuit.

As was stated, the filament circuits are all a.c. and electrical balance is obtained by means of potentiometers. These are designated as  $P_1$ ,  $P_2$ , and  $P_3$  in the wiring diagram. The grid bias for the various tubes is obtained by means of a resistance through which the plate current flows and results in a predetermined voltage drop. These voltage-drop resistances are marked  $R_3$  and  $R_6$ . As is evident from the drawing, the grid bias voltage is of like value for the r.f. and the first audio tube, while individual grid bias is obtained for the output tube.

The power unit is of conventional type with two-variations. The rectifying tube is of the 280 full-wave type. As a contrast to other filter systems employed in rectifiers, this installation utilizes but one filter choke. The required filtering action is obtained by the use of large values of capacity. A Mershon condenser of several sections (each section being of relatively high capacity) is employed. As is evident in the wiring diagram, two sections of this condenser are connected across taps of the voltage distributing resistance. This aids materially in the lowering of the effective resistance of the output circuit, and in the reduction of regeneration due to the action of this resistance as an impedance common to all circuits. The power transformer utilized consists of six windings. The primary winding is tapped for three values of line voltage. One secondary winding supplies the filament voltage for the rectifying tube, another supplies the plate voltage for this tube. The other three supply the a.c. filament voltages necessary for the various tubes in the receiver. Since a shunt potentiometer method of obtaining electrical balance is utilized, center taps on the a.c. filament windings are unnecessary. Control of the complete receiver is accomplished by means of a switch in series with the house supply circuit and the transformer primary. This switch is located on the face of the receiver panel.

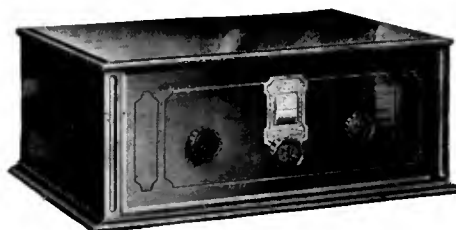

THE SET IN ITS CABINET

zation are marked  $L_1$  in the drawing. The receiver is a single-control unit, the four tuning condensers being ganged together and operated from one point. A filter system, consisting of a resistance and a capacity, is incorporated into the detector plate circuit, probably to keep the a.c. hum at a low value. The plate voltages for the r.f. tubes and the detector are obtained from one tap on the power unit, but voltage-reducing resistances located in the plate circuit of each radio-frequency

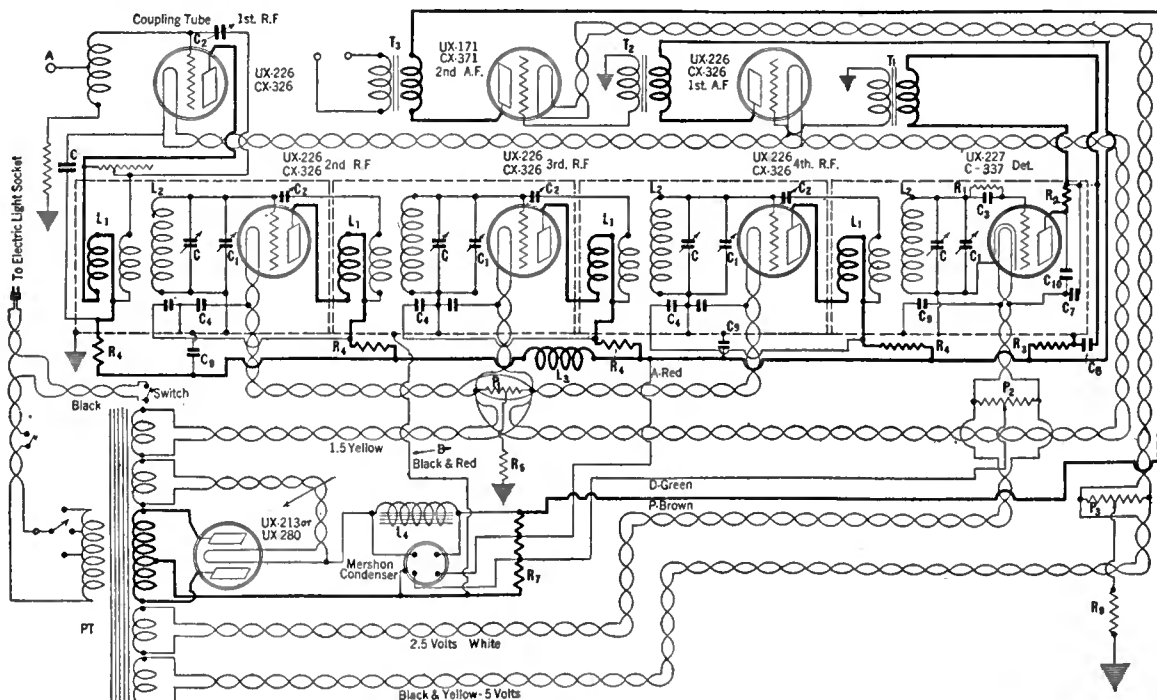

THE CIRCUIT DIAGRAM OF THE AMRAD A. C. 7

# No. 2.

# June, 1928.

RADIO BROADCAST'S Service Data Sheets on Manufactured Receivers

## The Pfansteihl A. C. 34 and 50

**SIMPLICITY** of design marks the development of the Pfansteihl line of radio receivers. The photograph and wiring diagram shown herewith apply to both the Nos. 34 and 50 a.c. electric receivers. The 34 is the console model, whereas the 50 is the table model of the same receiver.

This receiving system employs 6 tubes, apportioned as three stages of tuned radio-frequency amplification, non-regenerative detector, and two stages of transformer-coupled audio amplification. The wiring diagram of the system is shown herewith. As is evident from the drawing, 226 type a.c. tubes are used for the three radio-frequency amplifiers and for the first stage of audio. A 227 type detector is employed and a 171 is the output audio tube, arranged in conventional transformer-coupled fashion. The four 226's are wired in parallel and obtain their filament potential from a 1.5-volt winding on the power transformer. The tuning system used in the tuned radio-frequency stages is conventional, consisting of fixed inductances and variable capacities. The method of stabilization employed makes use of grid resistances, commonly known as grid "suppressors."

In order to attain utmost simplicity, only two values of plate voltage are applied to the receiver. The three-radio-frequency stages and the two audio-frequency tubes obtain their plate voltage from the same voltage tap, while there is another tap for the detector. The first radio-frequency tube's plate voltage is governed by a potentiometer type of resistance which shunts the plate coil of the first radio-frequency tube. The standard grid-leak condenser system of detection is employed.

The audio system is conventional in every way. The volume control is a voltage divider shunting the secondary of the first audio-frequency transformer, with the center tap of this control connected to the grid of the amplifying tube.

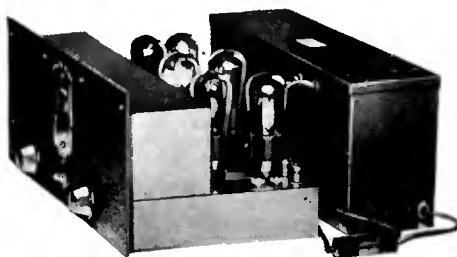

THE RECEIVER WITH ITS POWER UNIT

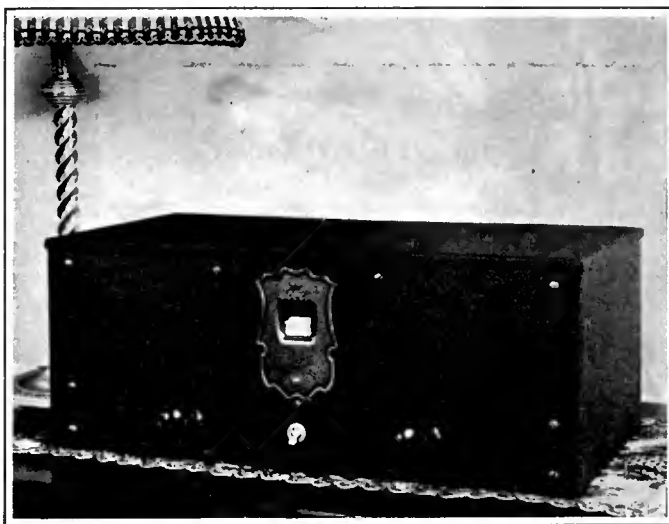

THE PFANSTEIHL MODEL 50 A.C. RECEIVER

The secondary of the second audio-frequency transformer is shunted with a fixed capacity. The C bias for the output audio tube is obtained by causing a voltage drop across a resistance in the grid return lead.

The receiver is divided into two parts, the radio and audio systems being contained in one can, while the power unit is in another can. The wiring system employed in the power unit is standard. Two transformers are employed. One is the power transformer supplying the filament and plate voltages required for the full-wave filament type rectifying tube, and the other is the filament transformer supplying the 1.5-, 2.5-, and 5-volt windings for the tube filaments. The primaries of these two transformers are connected in parallel and are designed for a 115-volt a.c. line. The filament windings supplying the 1.5 and the 2.5 voltages are equipped with voltage control resistances thus safeguarding the tube filaments in the event of an excessive line surge or increase in line voltage. The filter system consists of a two-section filter, with a single distributing resistance across the output. The "high" side of this resistance supplies the plate voltage for all tubes other than the detector tube. A tap supplies the detector plate voltage.

The electrical balance and the electrostatic balance in the filament circuit is obtained by means of mid-tapped resistances placed in parallel with the tube systems, rather than by tapping the filament voltage winding.

The loud speaker coupling to the output audio tube is direct, without any transformer or choke-condenser system. Two output binding posts are provided for the loud speaker terminals. If desired, a loud speaker coupling unit can be added to the receiver.

Tuning is accomplished by means of single-dial control, the second knob on the front panel being for volume control.

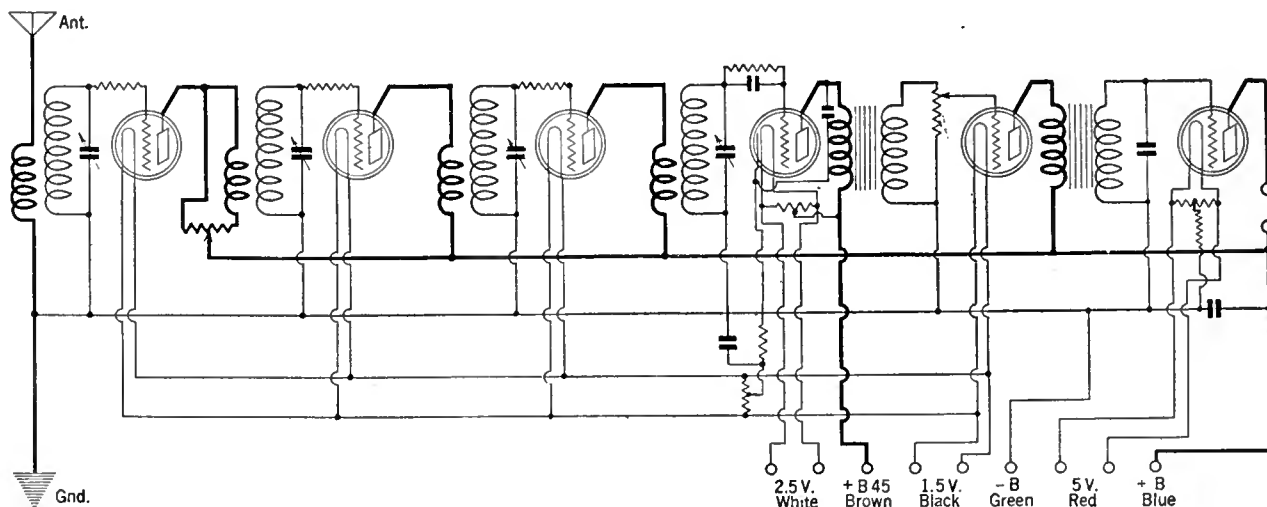

CIRCUIT OF THE PFANSTEIHL MODELS 34 AND 50. THE POWER UNIT IS SEPARATE

# Building and Operating the A. C. "R. B. Lab" Receiver

By Hugh S. Knowles

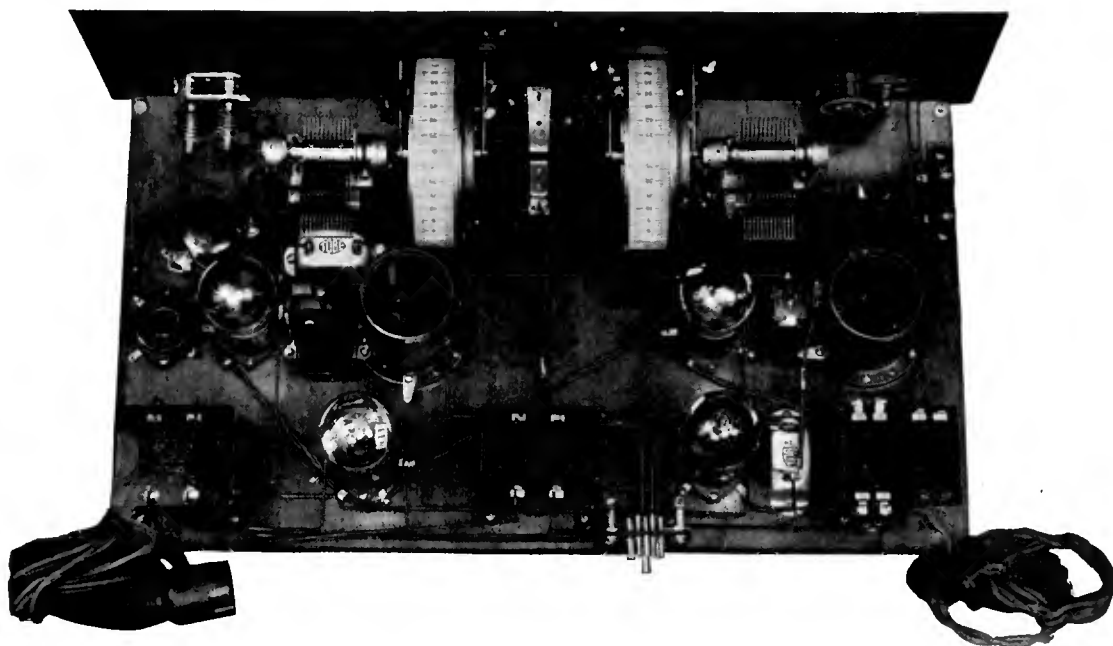

HOW THE NEW A.C. LAB RECEIVER LOOKS—BEHIND THE PANEL

**I**F THE experience of those who manufacture both battery and a.c. operated receivers is any criterion there is no question about the present being an "all electric" season. This demand for a.c. receivers has been reflected in the custom set-building field where experimenters are looking askance at any circuit which cannot be modified to permit operation from the lighting circuit.

The use of a.c. tubes does not alter the fundamental operation of a circuit and for this reason it is quite natural to look for receivers using well-known and tried circuits which have been modified slightly to make the use of these tubes possible.

In this connection the receiver we are about to describe should be of particular interest to the readers of RADIO BROADCAST. It uses the familiar R. B. Lab circuit, with its possibilities for excellent performance with a minimum number of tubes together with selected parts which make possible the realization of this performance.

The circuit itself needs no introduction, since the original and several variations have appeared in RADIO BROADCAST. Those who are interested in an exposition of the special features of this circuit are referred to the June, 1926, and April, 1928, issues. The principal advantage of this over other similar four-tube arrangements lies in its "gain" or sensitivity and in the fact that the balancing circuit of the Rice type gives accurate neutralization over the whole frequency range. The grid "suppressor" or lossier method of stabilization is not used in the radio-frequency stage. This element of design improves the selectivity of this circuit and makes it more uniformly selective over the whole frequency range.

The advantages of a.c. operation have been obtained together with an actual improvement in performance, due to the fact that a.c. tubes in general are somewhat better amplifiers than the standard 201-A type. Direct comparative

tests between this receiver and one of the battery types indicates an improvement in gain or sensitivity, better stability and negligible hum or a.c. modulation even on the more distant stations.

One addition has been made to the circuit; a dummy socket has been connected in parallel with the detector socket. This makes it possible to plug-in a phonograph pick-up permanently. The small switch between the drum dials permits an instantaneous change from receiver to pick-up. This convenience will be appreciated by those who have had to open the cabinet, remove the detector tube, plug-in the pick-up and then perform the inverse operation to operate the receiver again.

An inspection of the schematic wiring diagram in Fig. 2 will show that two minor changes have been made in the radio-frequency circuits. The resistance  $R_2$  has been substituted for the radio-frequency choke previously used in the mid-tap of the first coil, and the condenser  $C_3$  has been added.

The resistance prevents very high frequency oscillations which would block the first tube. For this purpose it is just as satisfactory as the choke and less expensive. This resistance is not

---

*THE set described here is a straight four-tube "Lab" circuit receiver, arranged to operate entirely from the a.c. line. The results achieved are rather better than those from the average four-tube set, due to the high gain in the radio frequency circuit. Mr. Knowles' receiver is a well arranged set based on exactly the same circuit, with the exception of provision for a.c. operation for the filaments, that was described on page 423 in this magazine for April, 1928. That unusually interesting story dealt with the engineering design which went into this receiver and exact measurements of its performance.*

---

—THE EDITOR.

in any sense a "grid suppressor" at broadcast frequencies since a high-impedance choke may be used, or the circuit left open, for that matter. In practice the mid-tap connection is used to provide a means of biasing the first tube.

#### THE CIRCUIT

**T**HE principal circuit modifications are those made necessary by the a.c. tubes. Three 227 type tubes are used and a 171-A type in the last audio-frequency stage. Heater type tubes have been used in the radio-frequency, detector, and first audio-frequency stages because of their comparative freedom from hum or ripple. Tubes of the raw a.c. type may be adjusted to give very little hum but any change in the effective plate voltage increases the a.c. modulation considerably.

The filament current for the tubes is supplied by a step-down transformer  $T_3$ . To insure long heater life, care should be taken to see that this transformer is one of the new types designed to give 2.25 volts. The old type supplies 2.5 volts.

Bias for the radio-frequency and first audio-frequency circuits is secured by taking the drop across a resistor in the plate circuit of the tubes. This method is quite satisfactory where a single stage of radio-frequency amplification is used.

No B socket-power device has been used in the receiver since it was felt that many constructors would have ones which were previously used with battery-type receivers and others would have power amplifiers in which such a B-power supply was included. Where this is not the case any good quality power unit may be used and the receiver made "all electric."

In most cases it is advisable to use a C battery for the power tube. There is really little or no objection to this practice since the life of the C battery is determined by its "shelf life" which may be in excess of a year. Details for avoiding the use of this battery will be given later. (See Fig. 1).

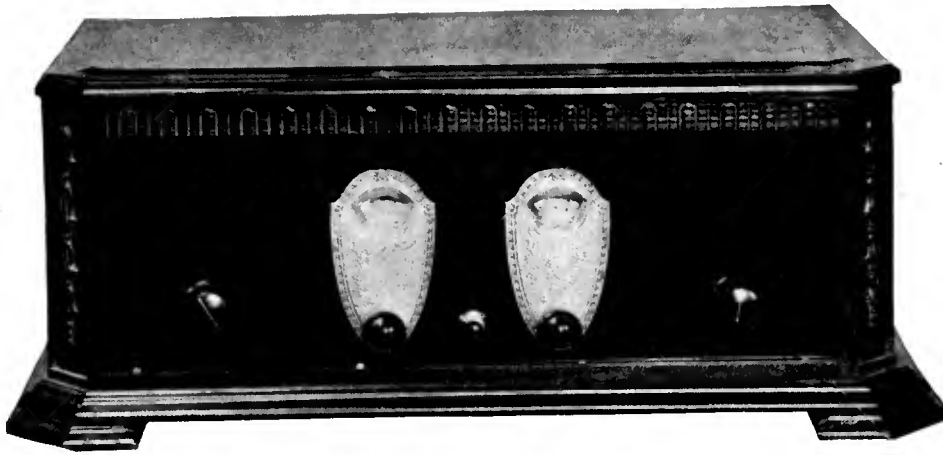

THE LAB SET IN ITS CABINET

Special coils are available for this circuit and receiver which require no alterations. Any of the coils designed for a 0.0005-mfd. condenser may be used however. The Aero U95 set has two coils and will be discussed as a convenient and typical set which may be modified.

## REVAMPING STANDARD COILS

**R**EMOVE the hinged primary winding from the antenna coil leaving nothing but the main secondary winding connected to terminals 1 and 6. Remove the primary from the detector coil by carefully breaking the bakelite tubing on the inside and unsoldering the leads going to terminals 2, 3, 4 and 5.

Tap one of the coils at the center turn vertically above terminal No. 1. Tap the other coil one third of the way up from the bottom vertically over terminal No. 2. Wind a thin strip of insulating material such as thin celluloid or varnished cambric about half an inch wide over the center of the mid-tapped coil. Pierce a small hole in the insulation and bring out the center-tapped strip through it. Wind eight turns of wire (No. 28 d.c.c. is all right, but the size is electrically not at all important) on each side of the midtap for the primary. Anchor the two end turns by looping them under the vertical bakelite coil support.

The baseboard and panel should be prepared in the usual manner. The template drawing, packed with the drum dials may be used as a drilling template.

Because of the height of the drum dials, the condensers,  $C_1$  and  $C_2$ , must be mounted on "stilts" or bushings. In this case two pieces of brass tubing cut to the proper length were used. As the condensers are mounted in this receiver, the reading of the drums increases with wavelength. If the readings are to increase with frequency the condensers should be reversed. The full floating shafts make this possible. This feature also permits bakelite or hardwood shafts to be substituted. These will be discussed under the operating details.

The location of the parts is very important. In experimenting with the layout, for example, it was found that moving the choke, ( $L_4$ ), over between the drum dials made the set unstable. This trouble was found to be due to the greater length of the "hot" plate lead and not to coupling between the choke and coil as might have been supposed. A discussion of the important leads to watch appeared in the June, 1926, RADIO BROADCAST under the title "Additional Notes on the R. B. Lab Circuit."

There is nothing "tricky" about the wiring. All a.c. filament leads should be twisted. Bus bar wiring was used in this set so the connections could be easily traced in the photographs. All the battery leads may be cabled if flexible wire is used. There is no objection to using "bee" line or direct point to point wiring if the leads are carefully spaced. For details on the arrangement of the leads see the photographs and Fig. 3.

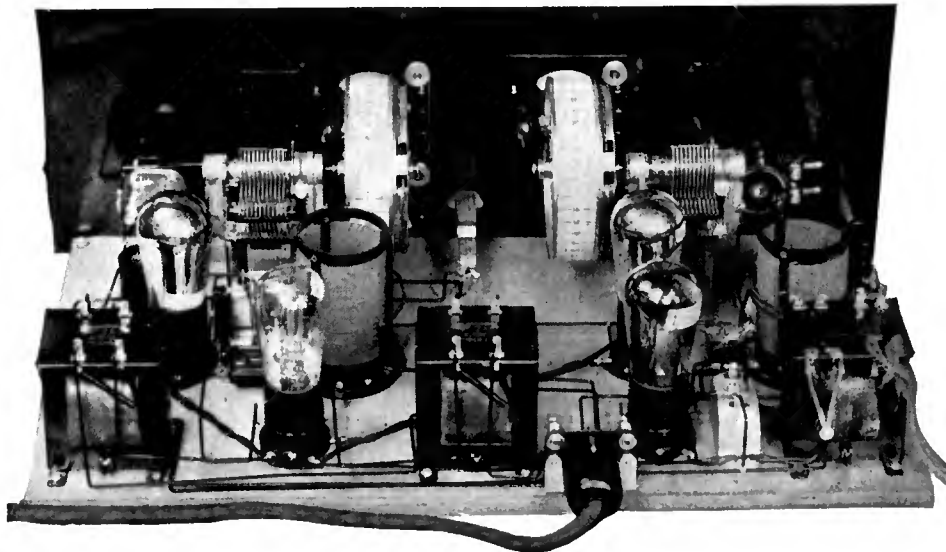

AN UNUSUALLY EFFICIENT SET IN SMALL SPACE

The two A-battery leads on the cable are not used. If an outside C battery is to be used for the radio-frequency and first audio-frequency stages it may be added by making the following changes: Remove  $R_3$  and  $C_7$  and connect the leads going to the K terminals on the 227 sockets to the minus B or yellow cable terminal. Connect the lead going to the minus C terminal of the first audio-frequency transformer and the one connected to  $R_2$  to the black cable terminal. Connect  $C_7$  across the black and yellow cable terminals. The C battery is then connected externally by using the yellow and black leads as the positive and negative leads respectively.

## WHEN A B-POWER UNIT IS USED

**I**F B-power unit which supplies 180 volts is used, a C battery with proper potential for the tube employed should be used for the power tube. Where the power device supplies 200 volts or more, an arrangement such as indicated in Fig. 1 may be used. A 30-henry choke and 2.0- or 4.0-mfd. condenser should be used to keep the direct current out of the speaker. When the speaker return is connected as shown, the 2000-ohm grid biasing resistor is not in the return circuit and this insures better reproduction of the lower audio frequencies.

No output device is used in the receiver. This reduces the cost of the parts when a 112-A type tube is used or a 171-A type with only 135 volts on the plate. If an external power amplifier is to

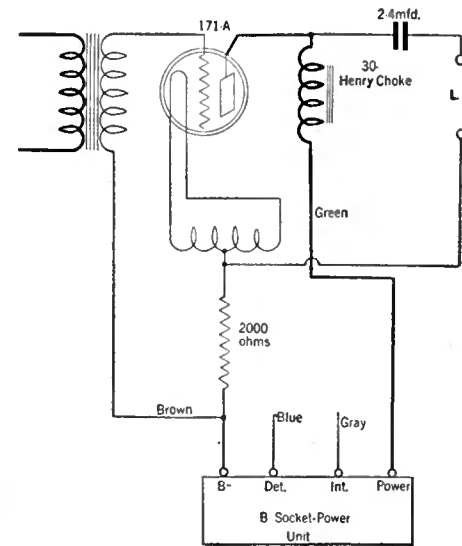

FIG. 1

be used the last audio-frequency transformer may be omitted. In some cases the power amplifier includes an audio stage ahead of the power tube and in this case the detector output may be connected directly to the speaker jacks on the cable terminal.

The dial lights should be connected in parallel across the filament of the 171-A tube.

Very little adjustment should be necessary after the receiver is completed. In adjusting the balancing circuit the "dead filament" method is not very desirable nor convenient in this case. Tune-in a carrier in the short-wave section of the broadcast band and set the detector regeneration control so the set just oscillates. Use a screw driver made from a bakelite or fiber strip to adjust the balancing condenser. Tune the radio-frequency stage first to one side of the carrier and then to the other slowly while adjusting the "equalizer."



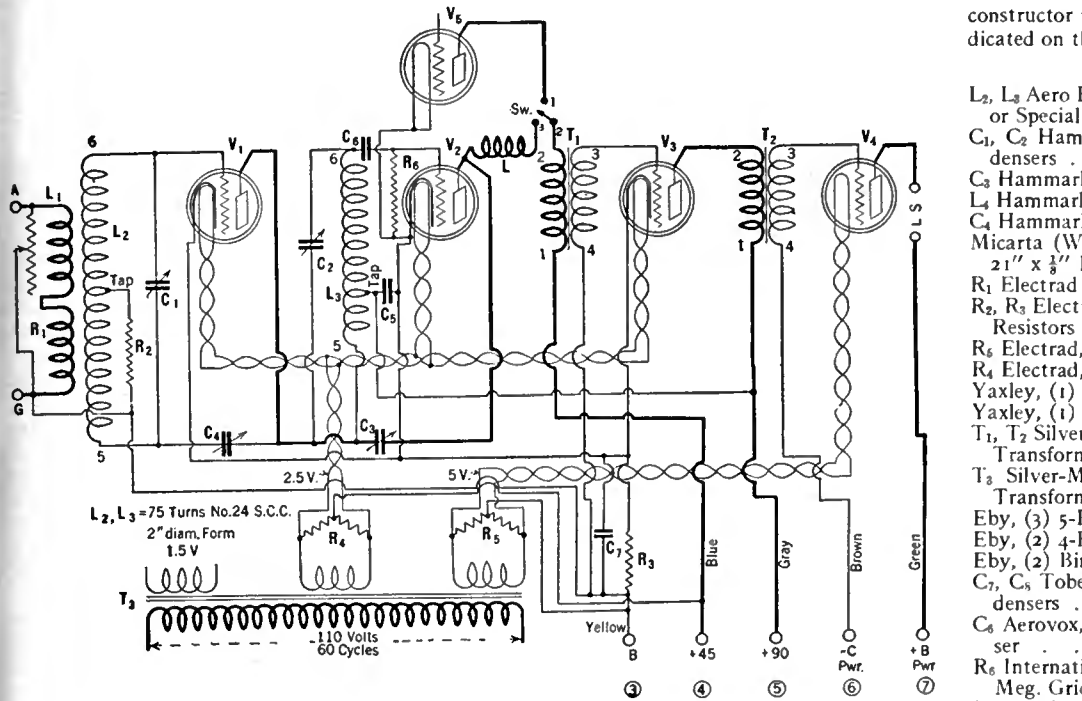

FIG. 2

constructor prefers to make his own coils, are indicated on the diagram, Fig. 2.

PARTS LIST	
L <sub>2</sub> , L <sub>3</sub> Aero Products Co., (1) Pr. U-95, or Special Lab. Coils	\$ 8.00
C <sub>1</sub> , C <sub>2</sub> Hammarlund, (2) ML-23 Condensers	11.00
C <sub>3</sub> Hammarlund, (1)-MC-15 Midget	2.00
L <sub>4</sub> Hammarlund (1) RFC-85 Choke	2.00
C <sub>4</sub> Hammarlund, (1) Equalizer	.50
Micarta (Westinghouse Co.), (1) 7" x 2 1/2" x 3/8" Black Panel	2.20
R <sub>1</sub> Electrad (1) Type P Volume Control	1.50
R <sub>2</sub> , R <sub>3</sub> Electrad (2) 500-Ohm Grid Type Resistors	.50
R <sub>4</sub> Electrad, (1) V-30 Resistance	.75
R <sub>5</sub> Electrad, (1) V-10 Resistance	.75
Yaxley, (1) 669 Cable	3.25
Yaxley, (1) S.P.D.T. Switch No. 30	.90
T <sub>1</sub> , T <sub>2</sub> Silver-Marshall, (2) 240 Audio Transformers	12.00
T <sub>3</sub> Silver-Marshall, (1) 247 Filament Transformer	5.00
Eby, (3) 5-Prong Sockets	1.50
Eby, (2) 4-Prong Sockets	.80
Eby, (2) Binding Posts	.30
C <sub>7</sub> , C <sub>8</sub> Tobe, (2) 1.0-mfd. Bypass condensers	1.80
C <sub>6</sub> Aerovox, (1) 0.00025 Grid Condenser	.40
R <sub>6</sub> International Resistance Co. (1) 2.0 Meg. Grid Leak	.50
International Resistance Co., (1) Leak Mount	.50
National Co., (2) Single Drum Dials	9.00
	\$65.15

ADDITIONAL PARTS

- (Needed to complete the set as described).
- (1) Phonograph pick-up, with volume control.
  - (1) B Power-Unit, furnishing a maximum voltage of 220, at 40 mils., with taps as follows: 45, 90, 180, -40.
  - (3) a. c. 227 type tubes.
  - (1) Power tube, Type 112-A or 171-A (See Text).
  - (1) C Battery (Optional, see text; rating depends on power tube used).
  - (1) Corbett cabinet to accommodate panel (7 x 21 x 1 1/2").

When the adjustment is properly made there will be a slight "swishing" sound as the r.f. circuit is tuned to the station and the signal will clear up. If the detector is placed on the point of oscillation, there will be no tendency for the r.f. stage to make it oscillate as the r.f. dial is turned. It may be necessary to readjust the regeneration control, (C<sub>3</sub>), slightly to make the balance adjustment more exact although the setting is not very critical.

After the set is balanced, the effect of hand-capacity should be tried on a weak station. If there is any appreciable effect, a bakelite or hardwood shaft should be substituted for the brass one used with each condenser. The effect may be further reduced after this change has been made by grounding the metal frame of the dials.

If the antenna stage tunes broadly it is an indication that the antenna is too large and the effective capacity should be reduced by connecting a fixed condenser about 0.0001-mfd. capacity in series with the antenna lead. The selectivity of the first stage should be measured with the volume control in the full "on" position since this resistance reduces the selectivity. When the set is tuned to a station where the volume control is near the "off" position, the question of selectivity is never important.

Since the volume control is in the radio-frequency circuit, special provision must be made for controlling the volume of the phonograph pick-up arrangement. Nearly all of the standard pick-ups with which we are familiar are sold with a special volume control.

To minimize hum, the B-power circuit should be grounded. Usually the ground works most satisfactorily on the minus B lead. In some cases the hum is reduced by grounding the plus 45-volt tap which in this set connects to the heater winding mid-tap. Only one of these leads should be grounded, however.

If an outdoor antenna is not available, the experimenter may try connecting a 0.002-mfd. fixed high quality mica condenser from one side of the house-lighting circuit to the antenna binding post. Both sides of the line should be tried since one side may be grounded. In this

case the line acts as the collector and the signal is brought to the receiver much as it is in carrier-current telephony.

The list of parts below are those used in the model described here. Other parts, electrically and mechanically similar, may of course, be used.

The coils L<sub>2</sub> and L<sub>3</sub> are special and are supplied by Aero Products. If the builder desires to revamp the standard Aero coil set, No. U95, he should follow instructions on page 94. The dimensions for all the coils, in the event the

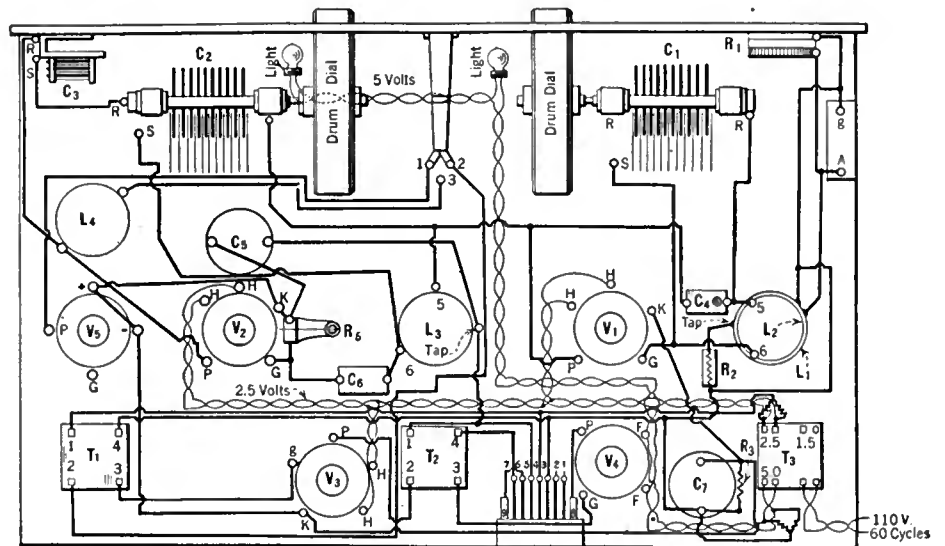
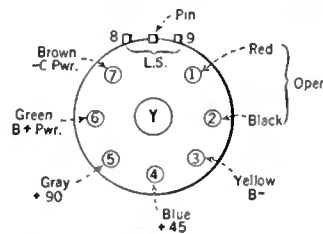

FIG. 3



# Using the Screen-Grid Tube in Popular Circuits

By THE LABORATORY STAFF

MANY experimenters have written the laboratory for information to enable them to use a screen-grid tube in the r.f. stage of such circuits as the R. B. Lab., Universal, Aristocrat, Browning-Drake, and other sets consisting essentially of a stage of radio-frequency amplification followed by a regenerative detector. The adaptation of this tube to the latter receiver has been described in the May RADIO BROADCAST and, in the same issue was described an a.c.-operated all-wave receiver using a screen-grid r.f. stage with the tube operated with a.c. on its filament.

There were no special problems involved in the design of an a.c. Lab set using a type 227 tube in the r.f. stage and the construction of such a receiver was completed with little trouble; the result of this work has been described in the preliminary article in the April issue and in the construction article appearing in this issue. After the construction of the a.c. set had been completed, experiments were made to determine how satisfactorily the type 222 could be substituted for the 227 in the r.f. stage.

The tests described here have been confined to the "Lab" receiver, and since individual tests on the various receivers mentioned in the first paragraph have not been made it cannot be stated positively that the tube will work equally well in all these circuits. However, since they are all essentially the same, the operation of the screen-grid tube as an r.f. amplifier, in these various sets, shouldn't differ very much.

The experiments on the "Lab" circuit were begun by first setting up the receiver for operation with a 227 in the r.f. stage. A modulated oscillator (the construction of which was described in the June, 1927, issue) was located about 10 feet away and its output cut down until the signal from it was just audible in the output of the "Lab" set. The 227 was then removed and the circuit rewired for the screen-grid tube in place of the type 227 tube in the r.f. stage with the filament of the screen-grid tube operated from a storage battery. The circuit is given in Fig. 1. The plate of the screen grid is coupled, through a fixed condenser, C, with a value of 0.0001 mfd. or larger, to the grid end of the coil in the detector grid circuit. The plate voltage for the cx-322 is obtained through the r.f. choke. Using the 322 there was quite a definite increase in the output of the "Lab" receiver. The change in detector plate current—which is a measure of the signal impressed on the grid of the detector—was too small to measure when the 227 was used. With the screen-grid tube, the change in plate current was quite noticeable indicating a definite increase in gain due to the screen-grid tube. This circuit has the disadvantage that the 322 must be supplied with filament current from a battery source. The filament of a 322, being the same as that in a 120

type tube, requires 0.132 amperes at 3.3 volts which may be supplied economically from three dry-cells but it would, of course, be an advantage if the filament could be operated by a.c. supplied by the filament transformer used to heat the filaments of the tubes in the circuit.

The next step, therefore, was to rewire the "Lab" circuit for a.c. operation of the cx-322 using the same circuit as was used in the all-wave receiver. The plate voltage was 135 volts and the screen voltage 45 volts, both obtained from B batteries. Filament voltage is obtained by connecting the 1.5- and 2.5-volt windings on the filament transformer in series as indicated in the circuit, Fig. 2, so that the voltages add. The voltage is then reduced to 3.3 by means of a 5-ohm resistance connected in series with one side of the filament circuit. If the two windings are connected so that the voltages buck each other the filament of the screen-grid tube will not light and the connections to one of the wind-

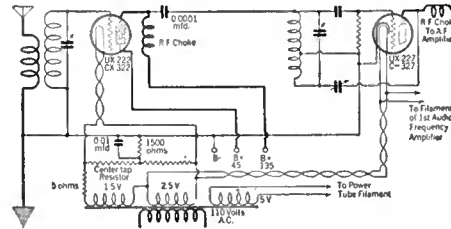

FIG. 2

ings should then be reversed. A 1500-ohm resistor, by-passed with a 0.01-mfd. (or larger) fixed condenser, is connected between the center-tapped resistance and minus B to supply C voltage for the grid of the 322 type tube. The complete circuit is given in Fig. 2.

This complete a.c. circuit for some reason, not yet determined, seems much more tricky than the d.c. circuit of Fig. 1, and in general, the performance of the circuit with a.c. on the 322 filament was not altogether satisfactory. The operation of this complete a.c. model had the disadvantage that the output of the receiver contained a loud hum when the detector was put into oscillation and the two tuning circuits brought into resonance. Apparently under such conditions the 322 began to oscillate. A definite increase occurred in the current flowing in the screen grid circuit. This trouble was not caused by common coupling in the battery supplying the screen circuit for the same effect was noticed with a separate battery supply to the screen grid.

When the detector circuit was not oscillating the output of the receiver was quiet. Therefore, the only practical disadvantage of the arrangement was that it made it difficult to tune-in signals, especially weak ones, by means of a squeal for the hum is loud enough to make a faint heterodyne whistle inaudible.

Some experiments were now made using a neutralized circuit. In this model of the "Lab" receiver, the lead from the plate of the r.f. amplifier to the detector coil is several inches long and, although when using a 227 in a Rice-neutralized amplifier the long lead will have no effect on the stability of the circuit, it was thought that it might be causing some trouble when using a 322 without neutralization. We therefore changed the circuit of the r.f. stage to that given in Fig. 3. The small twisted lead con-

nected to the grid and plate of the 322, consisted of two 2-inch lengths of insulated wire twisted together. These wires constituted a small condenser and were used to increase the grid-plate capacity of the tube to about 0.00001 mfd. (10 mmfd.) so that the circuit might be neutralized with a standard neutralizing condenser. The neutralized receiver gave somewhat more stable operation than the unneutralized circuit but the hum, with the detector oscillating, was still present.

As a result of these experiments we are unable, for the present, to recommend the use of a 322 in the "Lab" circuit with its filament operated on a.c. Those of our readers who have a d.c. operated "Lab" receiver may use a 322 in accordance with the circuit given in Fig. 1 and the receiver will give somewhat greater gain than was obtained using a 201-type tube.

In some cases it may be found that the selectivity of the circuit using a screen-grid tube is not as good as when using a 201-A type tube as the r.f. amplifier. The selectivity may be improved, however, by substituting a midget variable condenser with a maximum capacity of 0.0001 mfd. for the fixed 0.0001-mfd. condenser connected between the plate of the screen-grid tube and the grid end of the detector coil. The selectivity of the circuit may be adjusted to a satisfactory value by varying the setting of this small condenser.

The results of these experiments will be applicable to other receivers of the same type as the "Lab" set. To revise these other receivers for screen-grid operation, it is simply necessary to remove the connection to the NP winding, i.e., the primary and neutralizing windings of the r.f. transformer and then connect a lead from the plate of the 322 through a condenser with a capacity of about 0.0001 mfd. or larger to the grid end of the secondary coil in the detector's grid circuit. Voltage for the plate of the screen grid tube should be supplied through an r.f. choke, Fig. 1, which should have an inductance of 85 millihenries or more.

Experiments, as have been described here, can readily be duplicated in a home laboratory. To many of our readers, experimenting with sets and circuits in their own small lab., equipped in many cases with instruments made from descriptions that have been given in RADIO BROADCAST, is proving an intensely interesting part of their radio training. How much one really knows quantitatively about radio engineering, depends almost directly upon how many and how systematically experiments have been made; experiments not carried out with a definite aim in view, generally yield no concrete results and do not greatly increase one's knowledge of radio phenomena. The Laboratory will always be glad to hear from any readers who do, or have done, any such experimenting.

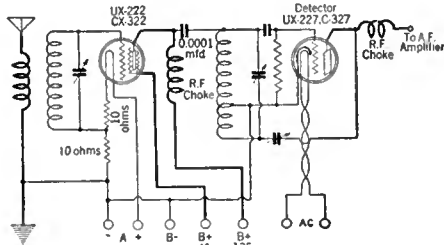

FIG. 1

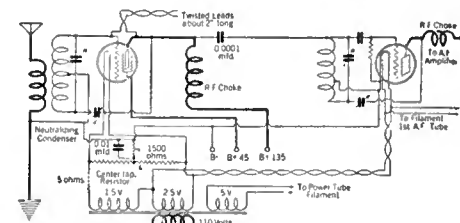
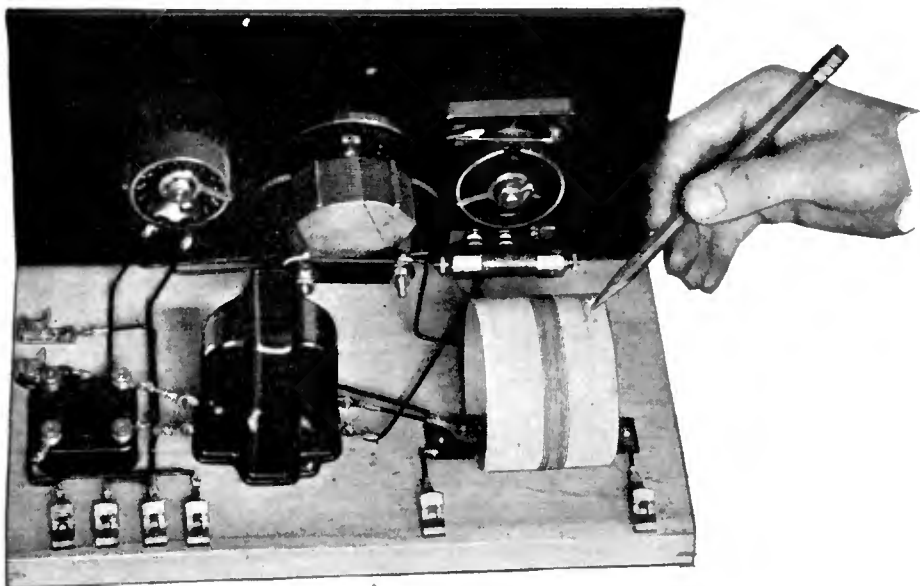

FIG. 3



### AN EASY SET TO BUILD

Little explaining need be done if this illustration is compared with Figs. 1 and 2. The "loop tap" indicated by the pencil is not used in this set but is shown merely to indicate how this type of tap is made. In this coil, the tap employed is near the detector and cannot be seen in this photograph.

## A Good Crystal Receiver for the Beginner

By KEITH HENNEY

Director of the Laboratory

THE receiver illustrated above is simple to build, costs but little, delivers high-quality signals, and is reasonably selective. It provides an excellent receiver for the beginner to try his hand at—after having put together this array of apparatus he has the whole world of radio home construction at his feet. There are many people who would like to listen to local broadcasting without a great expenditure of cash, either for the radio set or for its upkeep. This set will provide good signals from broadcasting stations not too far away at small cost.

The receiver consists of a tuner, a crystal detector, an amplifier and a pair of head phones. Anyone with a soldering iron and a pair of pliers can assemble it in an hour. The disadvantages of the receiver are few: it is not selective enough to distinguish between stations operating within 30 kc. of each other; it will not receive the "coast"; but for reception from locals or powerful stations up to 100 miles away it is excellent.

Because of the special electrical characteristics of the crystal—in this case, a piece of carborundum—it is possible to use a high-ratio audio-frequency amplifying transformer. The step-up as between primary and secondary circuits in this case is 6:1. Any present-day transformer of such high ratio, used with a vacuum tube detector circuit would give comparatively poor quality—the low notes especially would suffer.

The coil can be made at home, or any commercial coil may be employed provided it has the proper number of turns to cover the broadcasting band with the condenser used and provided it is not too difficult to solder a few taps on it. The condenser may be any assembly that happens to be in the builder's junk box. Naturally, the better the coil and the condenser the better the final result.

A good way to wind the coil is to place a rat tail file, a pencil or a piece of dowel rod through the spool containing the wire which is to be wound on the coil form and to place the

spool on the floor. Two holes are drilled in the ends of the coil form and one end of the wire from the spool is looped through one of these holes. A weight, one's feet for example, is placed on the rat tail file, and the wire wound on the form. The purpose of the weight is to keep the wire taut so that it goes on the form tight enough that it will not fall apart under temperature or humidity changes. When the proper number of turns has been wound, the wire is cut and the end looped through the second hole in the coil form. The diagram, Fig. 1, indicates the exact number of turns recommended for this receiver. Taps should be made at three places, dividing the coil into four equal parts. These can be made by twisting a loop of wire when it is wound on the form or by soldering short lengths of wire to places where the insulation has been scraped from the wire after winding. The loop method is shown in the photograph above.

Strongest signals will be obtained with the antenna wire attached to one end of the coil and the ground to the other. At the same time the selectivity will be poorest. To improve the selectivity, the antenna may be tapped on to the coil as shown in the accompanying illustration, or an additional winding of about 10–20 turns may be wound about the larger coil and the antenna and ground attached to it. The antenna should be about 75 feet long.

Still greater selectivity may be obtained by tapping the detector circuit to only a part of the coil. Note that this was done in this receiver. See Fig. 1. This is because the crystal is a low impedance detector and increases the effective resistance of the tuned circuit consisting of the coil and condenser. When tapped across part of the coil this increase in resistance, and resulting decrease in selectivity, is not so marked. The arrangement used in the Laboratory is shown in Fig. 2. In the Laboratory, signals freer from outside noise or "interference" were secured by not grounding the crystal circuit.

This may not be the case generally and for this reason the constructor should try grounding the circuit as shown in the dotted lines.

With this receiver, tested in our Laboratory, and using the tapped arrangement, it is possible to hear WJZ 30 miles away when WEAJ is operating 8 miles away although with bad interference. With a wave-trap tuned to WEAJ, considerable improvement in WJZ's signals is noted. WJZ cannot be heard at all if the detector is connected across the entire coil.

The parts actually used in the set photographed follow, and any similar apparatus may be used. It is even possible to hear signals with a crystal, home assembled, such as galena or silicon—a very cheap detector. The home constructor is advised against such procedure. The Carborundum unit is recommended because it is a compact, stable, and sensitive unit, and because it is possible to use a biasing voltage on it to increase its sensitivity.

The constructor may use a small flash-light cell as the biasing battery or he may use the voltage obtained from dry cells used to light the filament of the amplifier tube. Using the extra cell is simpler, but has the disadvantage that it is an additional unit which needs replacement. If the dry cells are used, the dotted lines in the diagrams should be followed, or as in the insert in Fig. 2, where the voltage drop across the rheostat is used.

It does not matter where the various parts are located on the base board. One arrangement is shown in the photograph. The picture wiring diagram, Fig. 1, shows where the wires go.

The signals from this receiver may be amplified by any of the power amplifier units now readily obtainable. If a two-stage amplifier is used, such as is made by Samson, Amertran, Silver-Marshall or others, the output of the detector may be used and the amplifier tube, transformer, and accessory apparatus shown in this model may be eliminated. (Dotted lines in Fig. 2)

The rheostat is used to turn on and off and to control the current through the amplifier filament. It should never be turned on further than is necessary to bring in the signals at proper volume. An experiment will show that turning it beyond this point does not increase signal strength. As a matter of fact such a procedure only decreases the life of the batteries and the tube. One 45-volt B-battery block and three dry cells will last several months with such a simple receiver.

After constructing such a receiver there is the possibility of adding another stage of audio amplification for loud speaker signals, and the Laboratory will be pleased to supply information on how to do this to those who write. There is also the possibility of adding a stage of radio-frequency amplification to such a receiver,

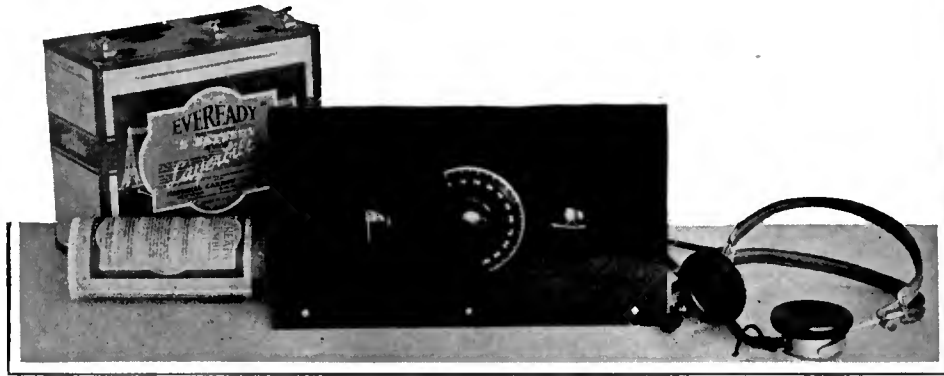

SIMPLICITY ITSELF

The panel is 7" X 12" and can be fitted into any cabinet which suits the owner. The Remler dial noted in the parts list was not available when this photograph was taken

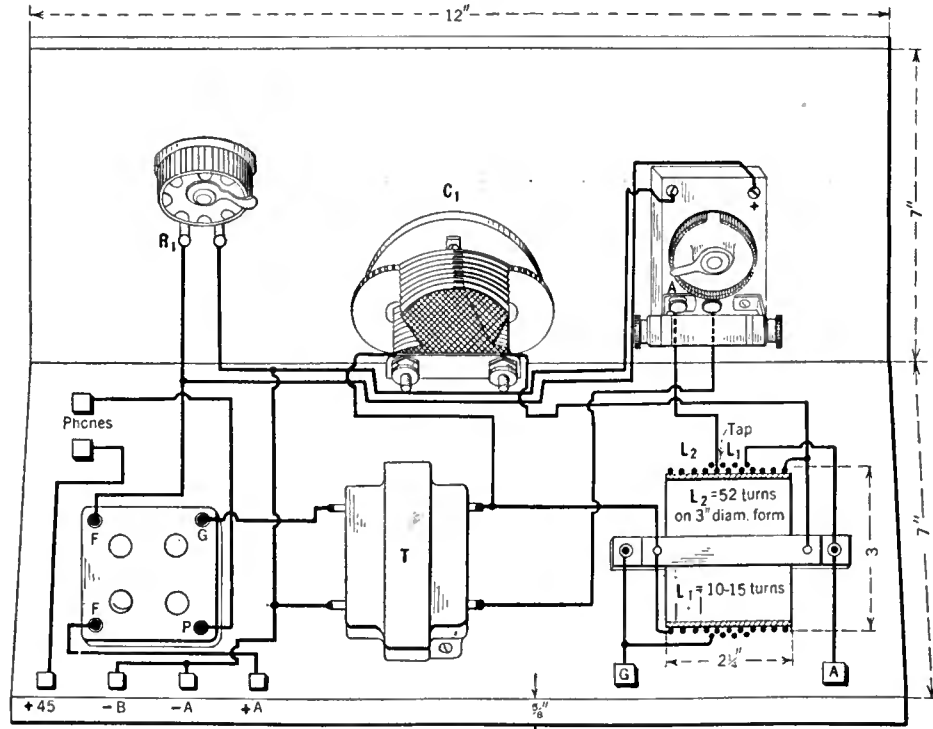

FIG. 1  
How to place and connect the parts employed

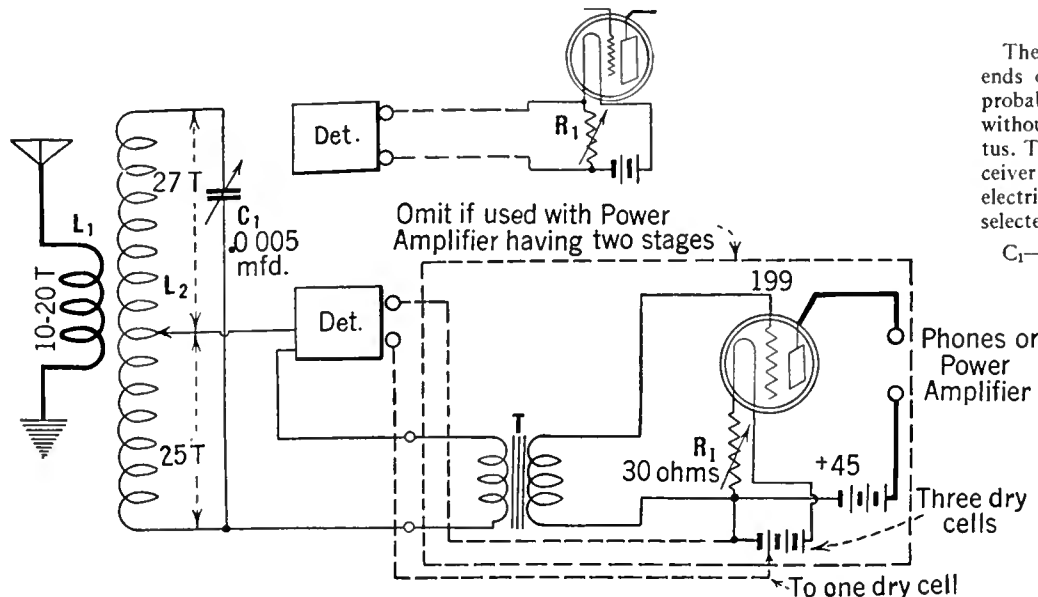

FIG. 2  
Circuit diagram of the crystal set and one stage of audio amplification. The insert shows how the detector bias may be obtained from the voltage drop in the rheostat

thereby making it much more selective and sensitive and as a result to increase its distance-getting ability. In fact, a three-tube set using the Carborundum unit as a detector provides the listener with a high quality, reasonably selective receiver for reception from stations within several hundred miles. The Laboratory has received a number of letters from readers who have done very creditable DX work on such an outfit.

How such a receiver as is described here is used in RADIO BROADCAST Laboratory may be of interest. At times considerable noise is picked up in the Laboratory from the presses, which print RADIO BROADCAST and many other magazines, making the testing of receiving equipment impossible. Down at the shack, a distance of about 1000 feet from the Laboratory where 2 GY is located the "air" is quiet. The receiver illustrated here is installed there and permanently tuned to WEAF. The output from the detector is sufficiently high that it can be placed on a wire line coming to the Laboratory where it is fed into a two-stage amplifier and thence to a loud speaker. When necessary, the first-stage amplifier on the base board with the detector is thrown into the circuit by means of an extra line and the output from it is put on a third pair of wires. This output may be used in connection with a single power stage or loud speaker operation. At all times, when near-by broadcasting stations are on the air we have good signals available in the Laboratory for testing purposes.

THE LIST OF PARTS

The experimenter who already has odds and ends of radio apparatus in his possession can probably assemble the receiver described here without the purchase of much additional apparatus. The parts listed below were used in the receiver described, although of course any others, electrically and mechanically similar may be selected.

- C<sub>1</sub>—Remler 0.0005 mfd. type No. 639 condenser
- Remler standard dial
- L<sub>2</sub>—52 turns No. 24 s.c.c. copper wire wound on 3" form
- L<sub>1</sub>—10-20 turns No. 28 a.s.c. copper wire
- T<sub>1</sub>—General Radio No. 285 audio transformer
- R<sub>1</sub>—Frost 30-ohm rheostat
- Carborundum Company detector unit
- Frost UX type socket
- Fahenstock spring clips (8)
- One—ux-199 vacuum tube
- One—Westinghouse Micarta panel
- One—Wood baseboard
- 3—dry cells
- One—set Trimm headphones

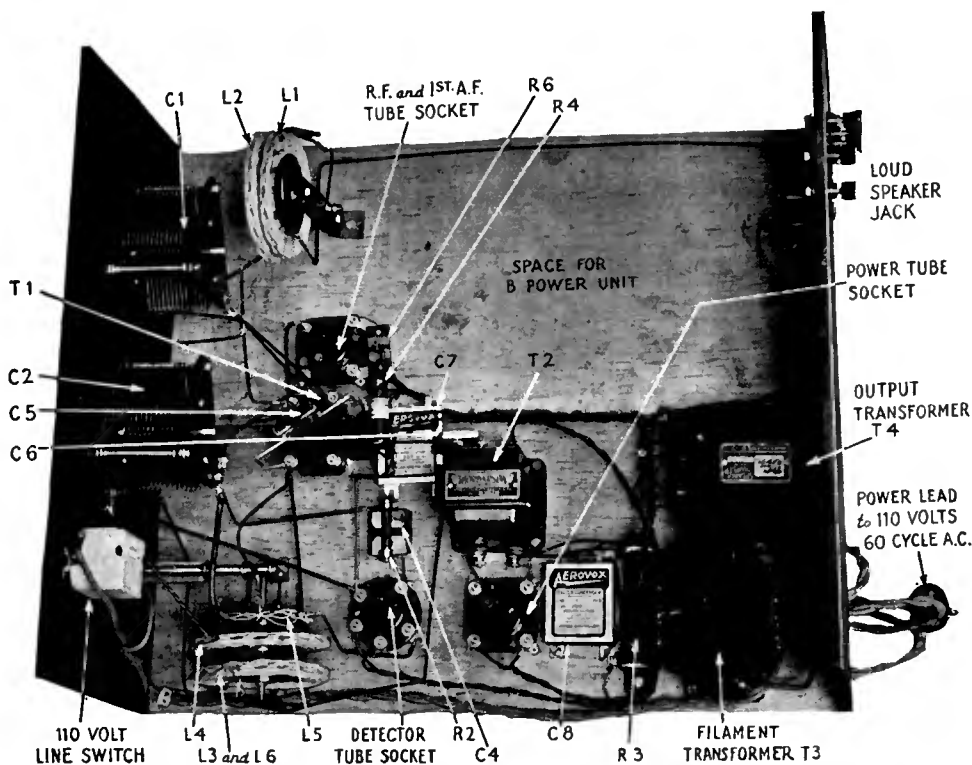

### THE EVER-POPULAR ROBERTS SET WITH A. C. OPERATION

The illustration is lettered to agree with the list of parts on page 101 and with Fig. 3. The circuit diagram. This model of the a.c. Roberts reflex circuit was built to fit in a phonograph cabinet. It is unnecessary for the constructor to follow this layout for wide latitude is allowed by this circuit in this respect

# A Three-Tube A. C. Operated Roberts Receiver

By ELMER G. HERY

OF THE thousands of set-builders who have constructed the original three-tube Roberts, few have been won over to any other circuit unless they have gone to a much more elaborate and expensive layout. For those who know the merits of the Roberts circuit, a.c. operation as described in this article is almost inevitable.

Beginners will find in this receiver a set which is easy to construct and uniformly excellent in results as to the quality, selectivity, sensitivity, volume, and distance reception.

An important feature is that this circuit does not require the most expensive pieces of equipment. It may be constructed from whatever materials are at hand. The skeptical may make a rough assembly of old parts, and then convince himself that the substitution of any good low-loss parts will give better results. [The list of parts and the photographs show exactly what was used in the set described by the writer. The parts are all standard and readily available. Wide substitution can be made, according to the desire of the constructor.—Editor.]

Another good feature is the fact that the arrangement of parts and the panel shape do not affect the results. This circuit has been built by the writer on square panels and on long narrow panels, and to fit in all kinds of cabinets with excellent reception in all cases.

The first thing to consider is the coils. Manufactured coils may be used if desired. The writer has used Sickles and Hammarlund-Roberts with perfect satisfaction. If the set-builder desires to make up his own coils they can easily be made.

Thirteen-point spider-web fiber forms are required. They may be obtained from the 10-cent stores. The antenna coil consists of thirty-five turns wound over-two-and-under-two spokes, with a twisted loop or tap every five turns. There are two secondary coils  $L_2$  and  $L_4$ , and each consisting of forty-four turns wound over-two-and-under-two spokes. The tickler coil,  $L_5$  consists of twelve turns wound over-two-and-under-two spokes. These four coils are all made of No.

22 double cotton covered wire. The NP coil  $L_3$  is made of No. 26 double cotton covered wire. This coil consists of a double winding; that is, two parallel wires wound over-one-and-under-one spoke, with eighteen turns. In other words, there are two concentric coils of eighteen turns each. The wire may be twisted or kept flat, preferably the latter.

The antenna coil and its secondary coil are mounted on the same shaft about  $\frac{1}{8}$ " apart. A long brass machine screw ( $3\frac{1}{2}$ " or more) makes an ideal mounting arrangement, using a nut on either side of each coil to hold it rigid. The machine screw is bent to give any desired mounting angle to the coils, and fastened through the baseboard with a nut. (See Fig. 1) Fig. 1-B also provides a very simple mounting through one of the spokes of one coil.

A standard mounting for the tickler coil is an arm with knob for panel mounting. The NP and secondary coils may then be mounted on a screw through the baseboard as shown in Fig. 2. The dotted lines show the tickler coil in the raised position.

It is important that the antenna coil and its secondary be mounted so that the direction of rotation of the windings is the same for both coils. Likewise the NP, Secondary, and Tickler coils should be wound in the same direction. One way to avoid trouble from this source is to proceed as follows: when the coils are wound, mark on the forms an arrow which points around the form in a clockwise direction. Then, starting from the inside and proceeding to the outside of the form, the wire should be wound

## The A. C. Roberts Receiver

THE Roberts receiver, first introduced by RADIO BROADCAST in 1924 won many friends for radio and many for this magazine. It has been constructed by more than 100,000 radio fans and, in one form or another, is still giving satisfactory service all over the world. The circuit is so efficient—considering the number of tubes employed—and so easy to build and operate that its popularity, like a certain famous cigarette, is deserved. Many readers are still interested in building the circuit and Mr. Hery's article here gives them full instructions and a wide latitude in construction. For those who are interested in making over their present Roberts set for a.c. operation, the last part of this article provides sufficient information. The circuit shown here employs the original reflex arrangement. Those who desire to employ a straight audio stage and eliminate the reflex may secure information by writing to our Technical Information Service.

—THE EDITOR.



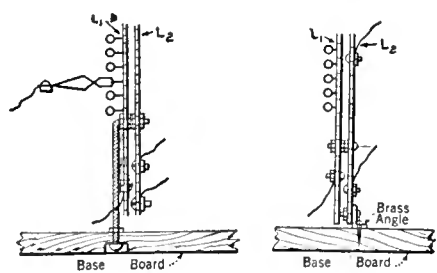

FIG. 1A-B

Details for mounting and tapping the coils

on in a clockwise direction. The coils in each assembly should be arranged so that all of the arrow marked sides face in the same direction. The two groups of coils should be mounted as far apart as mechanically possible, and at right angles to each other.

After the coils have been mounted and the positions of the other pieces of equipment have been determined, the inside and outside leads of each coil may be brought to the most convenient spoke of the spider-web form, and fastened through a hole in the spoke by means of a screw and nut (see diagrams). Then the spokes may be cut off to within  $\frac{1}{8}$ " of the wire on the coil, thus reducing the over-all size of the coils. For connections, the outside and inside leads of coils are indicated on the wiring diagram by "O" and "I" respectively. The center point of the NP is coil indicated by "M." The coils as they appear on the wiring diagram, Fig 3, from left to right are as follows: Antenna,  $L_1$ , antenna secondary,  $L_2$ , NP,  $L_3$ , and  $L_4$ , secondary,  $L_5$ , and above the secondary, the tickler coil,  $L_5$ .

The taps on the antenna coil may be connected to an inductance switch if desired, but a simpler method is to place a test clip (See Fig. 1A) on the end of the ground lead, and clip to the tap which gives the best results. The longer the antenna in use, the fewer turns will be required on the antenna coil. One tap will be found which will give satisfactory results on all wavelengths.

The method of obtaining the mid-point "M" of the NP coil may require some explanation. "M" is obtained by connecting the inside end of one winding with the outside end of the other winding. Two different colors of wire may be used to avoid confusing the two windings, or a flashlight bulb may be lighted through each

winding to locate the corresponding inside and outside ends.

LOCATING THE APPARATUS

THERE is nothing special to be said about the locating or mounting of the remaining equipment, with the exception, of course, that the grid and plate leads should be kept short. The photographs give an idea of a good baseboard layout which was designed to fit a phonograph cabinet and to include all the a.c. power supply apparatus. The panel layout suggested may easily be modified by the constructor who duplicates this receiver.

The switch mounted on the panel controls the line current supply and should be of a size and capacity equal to wall switches used for house lighting. A simple method is to use the body of any ordinary 110-volt tumbler switch and mount it directly on the panel with a slot cut in the panel for the lever.

No rheostats are needed when the a.c. tubes are used, and the volume control may be a 25,000-ohm potentiometer in the antenna circuit or the volume control may be as indicated in the model described here, i.e., a variable resistance such as a Clarostat or Bradleyohm across the secondary of the first audio transformer. No loud speaker jack is shown on the panel, as modern practice tends toward mounting this at the back of the set if it is used at all, with the antenna and ground binding posts.

As to the make of tubes to be used, there is little choice between standard, reliable products. There has been considerable doubt on the part of prospective set-builders as to whether the a.c. tubes will give very long usage. For those who prefer to make certain, a written guarantee is given with some makes to replace tubes free of charge if they fail to function for one year. This should satisfy the demands of the most exacting buyer. This article describes the use of a.c. tubes which employ the Radiotron type bases, although the set will work excellently with the Sovereign or Kellogg a.c. tubes. In the event that the builder uses this type of tube, the major difference between that construction and this is in the a.c. filament circuit.

No rules need be observed in the assembling of the set, except that the filament leads should be isolated as far as possible from all other leads, and especially from grid leads. The pho-

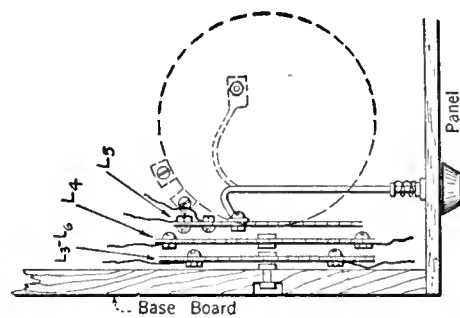

FIG. 2

The coils and their relation to the panel

graphs show how this may be accomplished. It is undoubtedly wise to complete all other wiring of the set before starting the filament wiring, to avoid any possibility of connecting filament leads to any other part of the circuit.

The filament current may be obtained from a filament transformer. If a 112 or 171 type tube is to be used for the last amplifier, the filament transformer should have three voltages; namely,  $1\frac{1}{2}$  volts,  $2\frac{1}{2}$  volts, and 5 volts. Some B power units provide a 5-volt winding which may be used for the amplifier tube, in which case only the two lower voltages need be supplied by the filament transformer. If a 210 type tube is used for an amplifier  $7\frac{1}{2}$  volts are required for the filament, and this voltage is usually provided in the power pack or powerizer being used for plate current.

Any good filament transformer may be used, some makes furnishing mid-taps for the  $2\frac{1}{2}$ -volt and 5-volt windings. It is not wise to use a mid-tap in the transformer on so low a voltage as  $1\frac{1}{2}$ , so that instead a mid-tap resistance or a potentiometer,  $R_6$ , is used to obtain the mid-point of the  $1\frac{1}{2}$ -volt winding. The mid points of the  $2\frac{1}{2}$ -volt and 5-volt windings may be obtained in the same manner if the transformer is not provided with mid-taps.

SECURING GRID BIAS

FOR grid bias on the reflexed tube, the center point of the mid-tap resistance is connected to one side of a 1000-ohm resistor,  $R_4$ . The other side of the resistor is connected to ground and there is a 1.0-mfd. condenser,  $C_7$ , across the resistor. For grid bias of the power tube, the mid-tap of the filament transformer winding supplying this tube is connected to a resistance of 2000 ohms,  $R_3$ , the other side of which is connected to ground. A 1.0-mfd. condenser  $C_8$  is placed across this resistance. This value of resistance is satisfactory for 112 and 171 type tubes.

Some tube manufacturers recommend a positive grid bias for the heater of the detector tube, and some recommend negative bias. In this circuit no bias has been found necessary. The mid-tap lead of the  $2\frac{1}{2}$ -volt winding may be connected to plus 45 instead of to ground in the event that there is excessive hum in the output of the receiver.

A 227 type tube may be used in the reflex position if desired, but satisfactory results should be obtained with the 226 type, and this type is somewhat cheaper than the 227 type.

Each pair of filament leads must be twisted with about two or three twists to the inch to avoid hum. Likewise, the leads which go to the tumbler switch on the panel should be twisted, as well as any other a.c. leads in or around the set. For filament wiring, no smaller wire than No. 14 should be used, as the a.c. tubes draw a much heavier current than the d.c. tubes. For

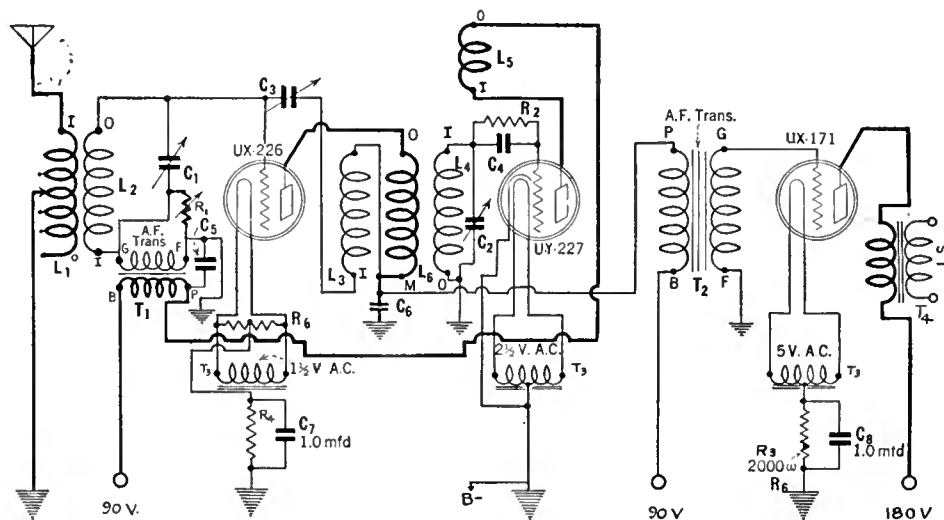

FIG. 3

Diagram of connections. Those who desire to convert their d. c. Roberts sets can follow this diagram and instructions on this page and the one following

wiring the balance of the set Celatsite or similar hook-up wire is recommended.

CONVERTING YOUR D. C. ROBERTS

FOR the conversion of a storage-battery-operated Roberts set to complete a.c. operation, the wiring diagram and the instructions already given are perhaps sufficient. The substitution of a B- power unit for a B battery needs no explanation. Obtaining grid bias without C batteries, though sometimes confusing, should be clear from the diagram. A C-battery in the grid circuit puts the grid voltage below the filament voltage, whereas a resistance between the filament circuit and ground places the filament voltage above the grid voltage. The effect is the same in either case. The C batteries may first be removed and connections made in their place as shown in the diagram. Next, the filament leads of each tube in the d.c.-operated set may be increased in size if necessary to carry the heavier current taken by a.c. tubes. [Wire tables showing current carrying capacity will give this information. Or see RADIO BROADCAST Laboratory Information Sheet No. 141, November, 1927, issue.—*Editor.*] Care must be taken in this changeover to a.c. not to remove any leads which serve some purpose other than lighting the d.c. filaments. A "UY" socket may now be substituted for the UX socket in the detector position, and the same grid and plate leads that were connected to the UX socket go to the UY socket. If an output transformer or filter is not in use, one should be installed as shown.

In the list of parts given here, some names of equipment are mentioned because of successful experience with these makes. Perhaps other makes will give equally good or even better results, but some experimenters often like to have something definite in mind when they do their purchasing. In the case of the variable conden-

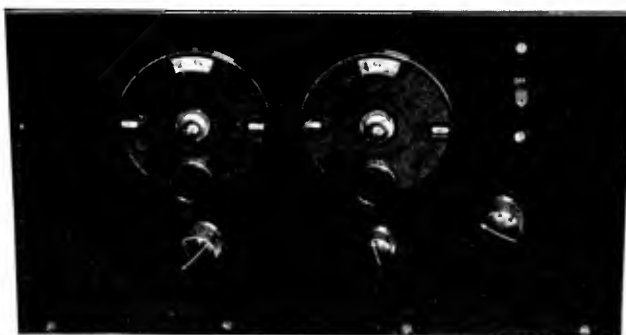

THE ALL IMPORTANT CONTROLS ARE HERE

sers, a rugged low-loss construction such as General Radio is strongly recommended. The parts required for conversion of the d.c. set to a.c. are indicated separately at the end of the list.

The values given for fixed condensers, resistances, etc., will generally be found satisfactory, but they may be experimented with after the set is in operation, for possible improvement to suit the taste of the user.

LIST OF PARTS USED

- C<sub>1</sub>, C<sub>2</sub>—General Radio 0.0005-mfd. variable condensers.
- C<sub>3</sub>—Hammarlund 9-plate neutralizing condenser.
- C<sub>4</sub>—Dubilier 0.00025-mfd. fixed condenser with clips.
- C<sub>5</sub>—Dubilier 0.0005-mfd. bypass condensers.
- C<sub>6</sub>—Dubilier 0.0025-mfd. bypass condenser.
- C<sub>7</sub>, C<sub>8</sub>—Aerovox 1.0-mfd. bypass condensers.
- R<sub>1</sub>—Clarostat volume control resistor.
- R<sub>2</sub>—Tobe Tipon grid leak (about 2.0-meg. although various values should be tried).
- R<sub>3</sub>—Hardwick-Field C-bias resistor, 2000-ohms.
- R<sub>4</sub>—Ward-Leonard C-bias resistor, 1000 ohms.
- R<sub>5</sub>—General Radio center-tapped resistor.
- T<sub>1</sub>—Amertran AF-6, 5:1 audio transformer.

- T<sub>2</sub>—Thordarson R-200 audio transformer.
- T<sub>3</sub>—Acme Apparatus AC-2 filament transformer.
- T<sub>4</sub>—Bremer-Tully output device.
- Frost open-circuit jack.
- General Electric tumbler switch.
- 5—Spiderweb coil forms and 2 coil mounting arms.
- Wire for coils: ¼-lb. No. 22 d.c.c.; ½-lb. No. 26 d.c.c.
- 2—Benjamin UX sockets.
- 1—Benjamin UY socket.
- 2—Marco dials.
- 5—Ehy binding posts.
- No. 14 lamp cord for a.c. circuit.
- 25 ft. Celatsite hook-up wire.
- Test clips, screws, nuts, baseboard, and Westinghouse Micarta panel.

ADDITIONAL PARTS

- 1—B-power unit supplying the following voltages: 45, 90, 135, 180
- 1—Type 227 a.c. tube
- 1—Type 226 a.c. tube.
- 1—Semi-power tube, either 112 or 171 type

The coils used in the set described are home-constructed according to directions in the article. Sickles or Hammarlund-Roberts coils may be used if the builder prefers to use manufactured coils.

The circuit and building instructions deal with the 226 and 227 type of a.c. tube although as indicated in the article, the Sovereign or Kellogg heater type a.c. tubes can be employed equally well if the constructor makes the necessary filament circuit and mechanical changes required.

If one has on hand a d.c.-operated Roberts receiver which is to be changed over to a.c. operation, it will of course be possible to use in the revised set most of the parts contained in the d.c. model. Only the following items in the above list of parts need be purchased, in changing a set from d.c. to a.c. operation: C<sub>7</sub>, C<sub>8</sub>, R<sub>3</sub>, R<sub>4</sub>, R<sub>5</sub>, T<sub>3</sub>, one Y type socket and a line switch.

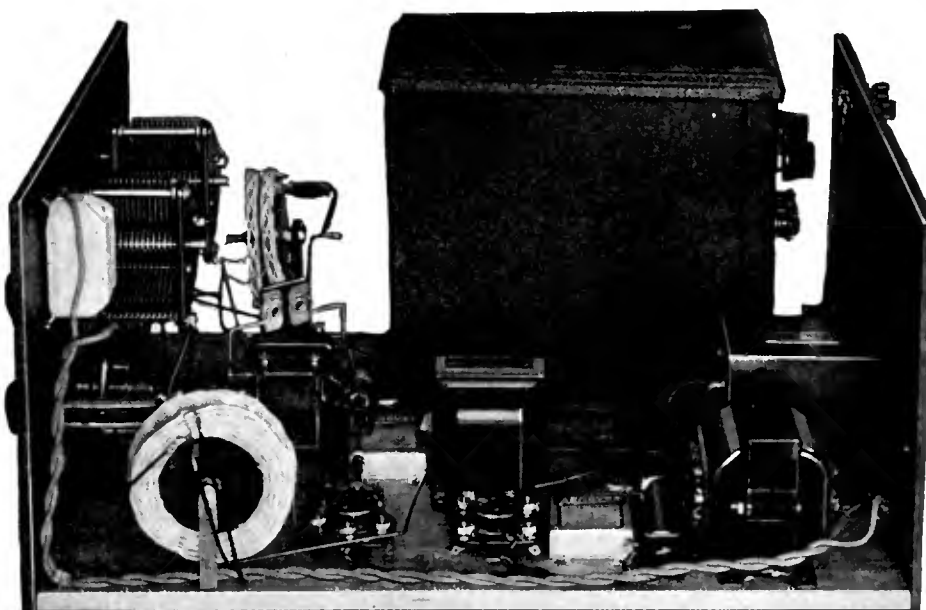

THE BASEBOARD ALLOWS ROOM FOR A B-POWER UNIT  
This provides complete a.c. operation with maximum simplicity

# AS THE BROADCASTER SEES IT

BY CARL DREHER

## The Simplest Receiver

ON A recent visit to KDKA I had demonstrated to me the simplest and most inexpensive radio receiver in the world. Although generally cautious in the use of superlatives, in this case I use them without fear of contradiction. The cost of the receiver in question is precisely nothing. It is exceedingly compact; you could hide it under either half of your mustache, although it might not be convenient to keep it there. It is portable; you can carry it around the house, or outside, set it up in an instant, and when you don't want it, it disappears. It provides a loud speaker signal of moderate intensity. The loud speaker is contained in the set. There are no knobs, tuning controls, or adjustments of any kind; a child can operate this receiver just as well as a radio engineer. It requires no antenna and no battery or power supply of any description. The maintenance cost, it follows, is nil. In these respects it is certainly the ideal broadcast receiver.

It has only two faults, which, in all honesty, I shall now reveal. It will not receive any other station than KDKA. The tone is decidedly thin.

The technical gentlemen of the Westinghouse Company can produce any reasonable number of these radio receivers on the transmitter grounds on a moment's notice. All they do is to pick up a nail or piece of metal and touch it to a spike in one of the wooden poles which support the antenna. Withdrawing the bit of metal slightly, the experimenter pulls out an arc a quarter or half inch long. He is thus drawing out of the air, according to orthodox radio principles, a few watts of the fairly considerable number which KDKA is flinging prodigally over the Pennsylvania hills. As this radio-frequency arc is modulated, it sings shrilly in accordance with the voice or music which is agitating the KDKA carrier at the moment. It is a radio receiving set, with all the virtues that I have claimed for it. And when you are through with it you toss the nail away.

This receiver possesses one other convenience which, as far as I know, is incorporated in no other instrument of its class, and is found lacking even in \$3000 outfits built for barons and millionaires. You can light a cigarette with it!

### Operation of Broadcasting Stations

#### 20. FIELD STRENGTH MEASUREMENTS

MOST operators of broadcast transmitters have only the vaguest sort of idea of what their outfits are actually doing, in the way of providing a signal for listeners, even in their immediate neighborhoods. A broadcasting station depends on its listeners just as much as a newspaper depends on its readers, or a gas or electric power company on its customers. The newspaper comparison is closer from the practical commercial angle, while physically the gas or power company analogy is quite exact. The broadcast transmitter must provide a certain radio-frequency pressure for the listeners whom it wants to reach, just as the gas company must maintain a certain gas pressure if it wants to sell gas, and the electric power concern must keep a fixed electric potential between its wires. The difference is that the power and gas companies know what that pressure is, whereas the broad-

caster generally does not. Yet there is no great mystery about the matter. The field intensity of a radio transmitter can be measured, not as simply as gas and electrical pressures, but with an amount of cost and trouble which is certainly not prohibitive considering the fundamental importance of the knowledge gained and the fact that a large investment is often involved. Every broadcast technician should at least know the general theory of field intensity measurements and calculations.

The principal articles in the I. R. E. *Proceedings* are the following:

- Englund, C. R.: "Note on the Measurement of Radio Signals," Vol. 11, No. 1, Feb., 1923.  
 Bown, Ralph; Englund, C. R.; and Friis, H. T.: "Radio Transmission Measurements," Vol. 11, April, 1923.  
 Austin, L. W. and Judson, E. B.: "A Method of Measuring Radio Field Intensities and Atmospheric Disturbances," Vol. 12, No. 5, October, 1924.  
 Jensen, A. G.: "Portable Receiving Sets for Measuring Field Strengths at Broadcasting Frequencies," Vol. 14, No. 3, June, 1926.  
 Friis, H. T. and Bruce, E.: "A Radio Field-

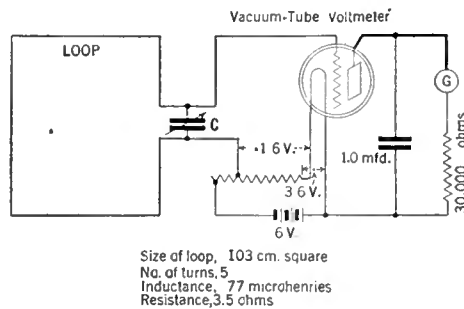

FIG. 1

*Strength Measuring System for Frequencies up to Forty Megacycles.* Vol. 14, No. 4, August, 1926.

For those who do not wish to consult the sources listed above a brief outline of the subject is presented here.

A transmitting antenna, with a certain amount of radio-frequency current flowing in it, sets up a moving field of electric force which is expressed in volts per meter, or in some more convenient units, such as millivolts or microvolts per meter. This simply means that if a receiving antenna is put up within range it will be charged by that field to a certain radio-frequency potential for each meter of its electrical height. The field strength of a 5-kw. broadcasting station, about ten miles away across fairly good transmission territory, may be of the order of 30 millivolts per meter, to give a practical illustration. Then if a listener puts up an outdoor antenna with an electrical height of 3 meters, he will get 90 millivolts from that transmitter to put into his receiver. The electrical height is less than the physical height (one-half is a common ratio). It is a measure of electro-magnetic effectiveness in transmission and reception. Its meaning may be better understood after a study of the basic absorptionless transmission formulas:

$$I_r = 120 \pi \frac{I_s h_r h_s}{\lambda d R} = 40 \times 10^5 \pi \frac{I_s h_r h_s f}{d R} \quad (1)$$

where  $I_r$  is the received antenna current in amperes,  $I_s$  the transmitter antenna current in amperes,  $\lambda$  wavelength in meters,  $f$  the frequency in kilocycles,  $h_r$  the effective or electrical height of the receiving antenna, in meters,  $h_s$  the effective height of the transmitting antenna, in meters,  $d$  the distance in meters between the antennas, and  $R$  is the resistance of the receiving antenna.

The transmitting current may be measured by means of a thermo-ammeter in the base of the antenna. The wavelength and frequency are known, if only because the Federal Radio Commission and the Department of Commerce insist on quite accurate data on this point. The resistance of the receiving antenna at the particular frequency in question may be measured by the added resistance method. (See Circular of the Bureau of Standards, No. 74. "Resistance Measurement.") The distance  $d$  is a factor which may be set by placing a receiver a few wavelengths from the transmitter, and then  $I_r$  will be sufficiently high so that it may be measured in the receiving antenna directly by means of a thermo-galvanometer or thermo-milliammeter, or the voltage across a receiving loop may be found by means of a vacuum-tube voltmeter. Thus the product of the two effective antenna heights,  $h_r h_s$  may be calculated from (1), rewritten as follows:

$$h_r h_s = \frac{10^5 d R I_r}{40 \pi I_s f} \quad (2)$$

Of course this does not give us either  $h_r$  or  $h_s$  individually. As stated before,  $h_r$  may be approximated by taking half the physical height of the flat-top of the receiving antenna above ground, if it is well removed from absorbing objects. Or, in the case of a loop antenna, it may be calculated by a formula which is derived from our knowledge of the mechanism of radio transmission and the nature of radio-frequency pick-up by a loop or coil antenna, which responds to the electro-magnetic component of the wave. With the loop turned end-on to the direction of radiation, and the antenna effect disregarded, the effective height is given by:

$$h_r = 2 \pi \frac{\text{Area} \times \text{Number of Turns}}{\lambda} \quad (3)$$

Thus  $h_r$  and  $h_s$  may both be determined.

The quantity  $h_s$  is also of importance in that it is a measure of the radiating efficiency of the transmitting antenna. This radiation resistance, as it is called, is a part of the total resistance of the antenna. An antenna, like any other energy-converting device, has losses. The ohmic or heat loss incidental to currents flowing in a conductor is one of them. Then there are dielectric losses in the ground or in objects near the antenna. These are actual losses of energy similar to the losses caused by windage, winding resistance, and mechanical friction in an electric motor. But an antenna is peculiar in that it has one type of loss of energy which it is definitely designed for, which is its reason for existence. It radiates energy, which is purposely lost so that it may be picked up elsewhere for the communication of intelligence. The total power dissipated in the antenna is given by:

$$P_t = I_s^2 R_t \tag{4}$$

The radiated portion is given by:

$$P_r = I_s^2 R_r$$

$$R_r = 1600 \frac{h^2}{\lambda^2} \text{ Ohms} \tag{5}$$

where  $R_t$  is the total transmitting antenna resistance,  $R_r$  is the radiation resistance, and  $h$ , and  $\lambda$  are in the same units of length. Thus when we have determined the radiation resistance of the transmitting antenna by the procedure which is outlined by formulas 1 to 5, we have some idea of the energy radiated by the transmitting antenna, which means that we know the fundamental quantity in the physical functioning of the station when it is "on the air." We know how much of the power we put into it is getting away from the station.

A practical little summary of work in field intensity determinations is the pamphlet by R. O. Cherry, prepared under the direction of Professor T. H. Laby, on "Signal Strength Measurements of 3LO, Melbourne." The measuring set consisted of a loop, a tuning condenser, and a thermionic voltmeter to measure the potential induced in the loop by the broadcasting station. The voltmeter was an instrument of the Moullin type, manufactured by the Cambridge Instrument Company, using plate rectification to cover a scale of 0-1.5 volts. Cherry's pamphlet does not show the voltmeter circuit, but this has been reproduced in Fig. 1 of the present description, from page 35 of Moullin's "The Theory and Practice of High-Frequency Measurements" (Charles Griffin & Co., Ltd., London), an excellent work which has been reviewed in this magazine. Moullin's Fig. 25, added to Cherry's Fig. 1, gives us our Fig. 1. In the manufactured form of the instrument the plate battery is dispensed with and the 1.6-volt negative grid bias is secured from the 6-volt battery used to light the filament of the tube. Aside from this battery the voltmeter is self-contained. The calibration is stated to be independent of frequency and the galvanometer reads directly in volts, 1.5 volts r. m. s. being full-scale. When the applied potential difference exceeds 0.4 volt, grid current flows at the peak of the positive half cycle, and the instrument draws a slight amount of power, the apparent resistance at full scale being of the order of 0.75 megohms, corresponding to a power absorption of 2.5 microwatts. The voltmeter is used with British valves intended for a 4-5 volt filament potential, which is reduced to 3.5 volts in this case, thereby prolonging the life of the valve and the calibration of the voltmeter, barring accidents, almost indefinitely.

The 3LO report starts off with Formula (3) of the present discussion, followed by an expression for the field strength, whose equivalent is:

$$E = \frac{V}{h r \sqrt{1 + \frac{w^2 L^2}{R^2}}} \tag{6}$$

where  $E$ , in volts per meter, is the field strength at the point of reception;  $V$ , in volts, is the potential difference measured across the loop;  $h$ , in meters, is the effective height of the loop  $w = 2\pi f$ , where  $f$  is the radiated frequency;  $L$  is the inductance of the loop in henrys; and  $R$  is the high-frequency resistance of the receiving circuit, at the frequency  $f$ .

It is easy to see how, according to (6) the field strength, by definition, will equal the received voltage divided by the effective height of the receiver, but the origin of the square root factor may not be clear. Cherry gives no explanation, so it may be added that the expression without the added factor would be true for an open loop picking up a voltage from the transmitting station in question, but in practice it is necessary to tune the loop, as shown in Fig. 1, both in

order to select the e. m. f. from the desired station, and in order to get enough voltage to measure. But then we are measuring the resonance e. m. f. of the loop circuit, and this must be corrected by  $\sqrt{1 + \frac{w^2 L^2}{R^2}}$  before we can deduce the field strength.

The next step is to measure or calculate the inductance of the loop. For the calculation process the reader is referred to the Bureau of Standards circular cited above. If a calibrated local oscillator is available, and the condenser across the loop also has a known calibration, the distributed capacity of the loop may be determined, and the inductance is then easily calculable from the wavelength formula:

$$\lambda = 1.885 \times 10^8 \sqrt{LC} \tag{7}$$

where  $C$  is the total capacity (loop capacity plus condenser capacity).

Fig. 2 shows a curve of wavelength against various capacities of the tuning condenser when the loop circuit is tuned to different frequency settings of the oscillator coupled to it. The line being extrapolated, the point where it cuts the X-axis (zero wavelength) gives the dis-

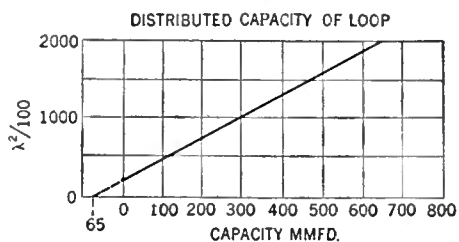

FIG. 2

tributed capacity of the loop. In the case of the 3LO experiment the wavelength was 371 meters, and the loop capacity was found to be 65 micro-microfarads, which, added to the condenser capacity for resonance, gave a total capacity of 505 micro-microfarads, whereupon substitution in (7) gives:

$$371 = 1.885 \times 10^8 \sqrt{L \times 505 \times 10^{-12}}$$

$$L = 7.668 \times 10^{-8} \text{ Henry}$$

$$= 77 \text{ Microhenrys}$$

The resistance of the loop, condenser, and voltmeter circuit must also be measured. Cherry gives the procedure, but instead of repeating it I shall refer those who have a practical interest in the problem to *Circular No. 74* again. The mean of several measurements in the particular example we are following was 3.5 ohms. A source of inaccuracy which must be considered at this point is that the resistance of the thermionic voltmeter is not quite constant, introducing a variable loss, which Cherry believes is between 0.5 and 0.9 ohm equivalent series resistance. This will result in a slightly low value for the higher field strengths, but as such measurements, made with a loop, are not good to better than 5-10 per cent., a mean value for the high-frequency resistance of the receiving circuit is sufficient for practical purposes.

All the other quantities needed for the calculation, first of the effective height of the loop. (Formula 3), then of the field strength (Formula 6), are known. Using Formula 3, we may write:

$$h r = 2 \pi \frac{(1.03)^2 (5)}{371}$$

both the length of the side of the loop, which, squared, gives the area, and the wavelength, being expressed in meters; the result gives  $h r$ , also in meters, as 0.090. To get  $E$  from (6) we must find the value of  $\frac{wL}{R}$ ;  $w = 2\pi f$ , and  $f$  is the frequency corresponding to a wavelength of 371 meters; this may either be looked up in a wavelength-frequency table or calculated from

the basic relationship that the frequency is the velocity of light ( $3 \times 10^8$  meters per second) divided by the wavelength, whence:

$$w = 2 \pi \frac{3 \times 10^8}{371} = 5.08 \times 10^6$$

$$\text{and } \frac{wL}{R} = \frac{(5.08)(10^6)(77)(10^{-8})}{3.5} = 112$$

$$\text{So finally we get } E = \frac{V}{(0.09)(112)} = \frac{V}{10.1}$$

This gives us the field strength in terms of the reading of the thermionic voltmeter, divided by a substantially constant factor, as long as the same loop, condenser, and voltmeter are used, and the wavelength remains the same. The loop, of course, is turned to secure a maximum deflection for each observation. If the apparatus were to be used for only one station, the wavelength of which is fixed, the voltmeter scale could be arranged to read the field strength directly.

In the case of 3LO, the following field strengths in m/v per meter were found, using the procedure outlined:

DISTANCE	DIRECTION		
	North	East	West
1 Mile	400	250	200
5 Miles	90	60	50
10 Miles	45	30	25

From such data it is possible to draw contour maps of the field pattern of a station, such as those secured in the elaborate investigation of the distribution of WEAf and WCAP (Bown and Gillett: "Distribution of Radio Waves from Broadcasting Stations over City Districts," *Proc. I. R. E.*, Vol. 12, No. 4, August, 1924). Bown and Gillett used one of the short-wave measuring sets developed by Bown, Englund, and Friis, and with this more elaborate apparatus were able to get down to field strengths of the order of a fraction of a millivolt per meter; some of their curves extend to a distance of over a hundred miles from the transmitter. The simple apparatus described by Cherry is, of course, restricted to a much smaller radius, but it illustrates the principles involved just as effectively. The contour lines in the case of 3LO form a group of quite regular concentric ellipses, which would be expected with the transmitter located in fairly open country. The pattern from a station located, like the old WEAf, in the heart of a city like New York, is far more irregular, naturally.

Within the radius of neglectable absorption the product  $E_d$  (field strength times distance from transmitter) is approximately a constant; this relation may be used as a check on the accuracy of the field strength measurements.

Goldsmith ("Reduction of Interference in Broadcast Reception," *Proc. I. R. E.*, Vol. 14, No. 5 October, 1926) gives the following table of program service as a function of field strength:

SIGNAL FIELD STRENGTH	NATURE OF SERVICE
0.1 millivolt per meter	Poor service
1. millivolts per meter	Fair service
10. millivolts per meter	Very good service
100. millivolts per meter	Excellent service
1000. millivolts per meter	Extremely strong

Edgar Felix has pointed out that the commercial value of a broadcast transmitter, other things being equal, is a function of field distribution. This is true, and, when the owners of stations realize it, more field strength measurements will be made in divers neighborhoods. If the field strength is not being produced in the sections where it is wanted, the artists and the advertisers might as well go home, and the studio be converted into a salesroom for artificial flowers.

The limitations of space will not permit a longer technical discussion of the subject. Readers who are interested beyond this point are again referred to Moullin's book, in which Chapter VIII (pages 218-254) is devoted to a thorough study.

# HOW CAN GOOD RADIO PROGRAMS BE CREATED?

By JOHN WALLACE

IN THIS department last month we proposed the question "Can the Broadcaster Improve Broadcasting?" and averred that in our opinion he could not and that the time was ripe for him to call in outside help. The suggestion is a sound one and we are further confirmed in our conviction of its essential truth by our discovery that the same idea occurred, at almost the identical time, to several other professional reformers of radio.

Since we think the point is an important one and worth acting upon, and since it is best emphasized by repeating it, we quote from two other scribes. Mr. Zeh Bouck, in his estimable column in the *New York Sun* said in part:

"Our asseveration that the program departments of large broadcasting companies were, in principle and practice, incapable of turning out more than a small percentage of meritorious programs—originality, interest, intelligence and esthetics being the criteria of merit—has aroused a certain amount of controversial interest. The question arises, if the program departments of the large broadcasting companies should, as we have suggested, be eliminated in some relatively painless manner, who, then, should prepare the programs? Or rather, let us say, conceive the programs, for the actual preparation, the manual labor, could still be left to the studio hacks. There remain three possibilities. The advertiser can prepare his own programs, making broadcasting a section of his advertising department. Second, the advertising agency is a logical consideration, preparing material for broadcasting in a manner comparable to the preparation of printed advertising. Both of these systems are in operation to-day, and are producing programs notably superior to the rubber stamp variety turned out by the broadcast organizations themselves. . . .

"On the other hand, the program department of the large broadcasting organization, turning out programs by the hundreds, fitting a Swiss cheese classic and a rather extenuated ode to Persian rugs into pretty much the same skeleton after the manner of Martin Eden writing his pot boilers, necessarily exhibits the creative talents of a child making mud pies.

"There is still a third possibility which we originally suggested a few weeks ago, namely, the purchase by the broadcasting company or advertising agency, for that matter, of ideas and radarios submitted by free lances, in much the same manner that stories are submitted and bought by magazines. In this manner, a wealth of new material and ideas would supplement the rather wornout traditions of radio Cook's tours and songs of yesteryear.

"These ideas, and the radarios themselves when necessary, could be readily adapted to broadcasting by the station organization, which is often as adept in the mechanics of broadcasting as it is inept in creative brilliance."

Mr. Morris Markey, not a professional observer of radio, but a writer of special articles, leaped immediately to this same conclusion in a story written recently for the *New Yorker*.

"A small amount of work is being done among the four hundred employes of the National Broadcasting Company in the way

of experimental programs. There have been hesitant, and on the whole unsuccessful, efforts to create visual images, of setting and atmosphere, through the loud speakers. And there have been sporadic trials of dramatic episodes, snatches of plays and such. But like most enterprises organized solely for the pursuit of money, the broadcasting industry is conservative. An experiment itself, it looks upon experiment in the entertainment it provides as something to be avoided. It has failed to recognize that radio has thus far produced not one suggestion of showmanship. It has failed to observe that the showmanship of the microphone, when once it is developed, will be a vastly different thing from the showmanship of the camera or the stage. The employes whose duty it is to keep the performance going are, in the large part, hacks. They are routine men who are not hired for imagination or invention, but for their ability to fill every hour on the air with something or other, preferably of a revenue-producing nature. There is not in all the radio world a figure comparable to the producer in the theatre or the director in the movies—and most of the gods of the trade are unconscious, apparently, of their need for such a figure. Vaguely it is realized that something will have to be done about the programs, but few in the industry appear to understand that these programs must have the touch of a creative person upon them."

## How Long Can the Ballyhoo Last?

THE second big splurge of the Dodge Brothers Company, its much touted Movie Star Hour turned out to be "just another program." The foregoing review is a decidedly unfair one, for at the time we write, the program referred to has not yet taken place and will not for several days. It is to be made up—or at the time you read this, was made up—of the voices of Norma Talmadge, Charlie Chaplin, Douglas Fairbanks, D. W. Griffith, John Barrymore, and



AMOS 'N' ANDY; ALIAS CORRELL AND GOSDEN

The former "Sam 'n' Henry" team so popular with listeners to WGN have transferred their attentions to the microphone of WMAQ of Chicago where they are heard nightly at 7:11 P.M. central time, except Sunday and Wednesday

Dolores del Rio. It required the usual million miles or so of telephone wires, the conventional thousand or so engineers, and of course the trillion or so dollars of investment and commanded the listening attention of every man, woman, and child in the United States over the age of thirteen months. And it served to convince this particular reviewer that most of the individuals heard had selected their profession with great wisdom and ought to be encouraged to stick to the silent drama. Mr. Barrymore, to be sure, contributed an excellent reading of the Hamlet soliloquy, but the only reward for listening to the others was a satisfied curiosity concerning the pitch of their voices.

Just to show us up as an inaccurate prognosticator, that program may turn out to be a wow. But it hardly seems likely. There is no reason to expect that because Norma Talmadge is perfectly entrancing on the screen her voice is going to prove anything in our parlor. We would be far more willing to lay a wager with Lloyd's that she will be a fizzle. But we don't intend to write indignant letters to the sponsoring company arguing this point for they are just as aware of it as we are. Our opinion of their fancy program, and indeed the opinions of any of our fellow scribes, mean quite nothing at all to them. And rightly so: they are not concerned with devising a good radio program but with getting something up to ballyhoo. They have craftily selected six of the biggest names in the movie world. They will get countless miles of newspaper space, probably not only in the radio sections, but perhaps in the movie sections as well, and even in the news columns and editorial pages. In other words, though it costs them a fortune to hire the movie stars and the broadcasting facilities, they will probably get more newspaper space than they could have paid for with ten times the sum, and they'll get the air advertising to boot.

Nobody, not even the querulous critics, actually got riled about their thousand-dollar-a-minute Victory Hour; we were all too bowled over with admiration of the really beautiful advertising coup that it was. But nobody pretends that it ranked very high in entertainment. In a list of the best programs of the year it would have placed well down in the second hundred. The movie star hour will probably take even lower rank.

The two programs mentioned have not been the only Ballyhoo Hours in radio's history. Others have been the inaugural hours of Palmolive, Wrigley and General Motors. Of any Ballyhoo Hour this is true: the sponsor's interest in the program is decidedly secondary to his interest in the printed stuff it gives him a chance to cook up and perchance, to have published. In other words the program is no end in itself but merely the excuse for deluging editor's desks with mimeographed mouthings.

In some ways it is idle for us to rail at the Ballyhoo Hour. It is both big business and good business. If it appears to exploit the sucker strain in the Americano the answer is that he likes to have it exploited. But as a gent whose waking hours are supposed to be concerned with the vital matter of seeing radio programs improved it is our bounden duty to eye such stuff aghast.



WE DO SOME EYEING AGHAST

OUR objection to the Ballyhoo Hour is precisely, that, while it doubtless does much good for the advertiser, it does nary a bit of good for radio. Furthermore it pains our frugal soul to see so much mazuma spent in such a wasteful way. Wasteful, as far as radio is concerned, because after one of these hours is over nothing remains, except perhaps an unpleasant taste. Nothing has been contributed to the "art" of broadcasting, no new precedent has been established upon which bigger and better developments may be built. Suppose some of the fifty or so thousand dollars that is commonly planked down for one of these programs were used for the employment of talented persons to create something new—such as the Sound Drama we suggested last month—that would be a real step.

But such arguments can carry no weight. It is too much to ask the advertiser to worry about the future of the radio art. We shall have to search another point of attack. Here's one: the novelty of these Big Splurge, Ballyhoo programs can't last forever. Since public interest in them is at bottom simply curiosity concerning the amount of money spent and the magnitude of the names employed, each succeeding big splurge is going to have to outdo its predecessor in order to pique the jaded curiosity of that public. Eventually it will be necessary to bill the crowned heads of Europe and transmit the stuff over jewelled platinum wires costing \$9.85 an inch in order to get a rise out of the radio editors. So the Ballyhoo Program will very soon exterminate itself.

However, there is still another reason why the commercial broadcasters themselves ought to take steps to eliminate the ballyhoo program and that is that it doesn't serve to increase radio's prestige very much. The Big Splurge program attracts what the storekeeper knows as a Bargain Day Crowd. The merchant, on the day of a big sale, lures a lot of strangers into his store who have never crossed its threshold before. Most of them never will again; but a few of them may observe that his everyday merchandise is of good quality and may become habitual customers.

The Big Splurge program sucks in perhaps a couple million listeners who ordinarily disdain radio, refuse to purchase receivers and are only submitting to the pleas of friends to "come over and play a hand of bridge and listen to Such and Such." This is a swell chance to corral these prospective customers and make 'em come back for more. But the Pomp and Circumstance Program is prone to have one or other of the two following effects: A. The program turns out to be merely ordinary as entertainment, thus confirming the transient listener's opinion that radio is a moron's pastime or; B. Great musical artists are lavished with such profusion (as in some Victor Hours) that his follow-up essay at listening is dimmed to nothingness by contrast.

*A Thursday Evening on the Blue Network*

PERHAPS our eternal weeping in these columns over the fact that radio so seldom attains great art, and so frequently succeeds in being bad art, conveys the impression that we never get any enjoyment out of it at all. Not so. For instance last night, a Thursday evening in March:

Arming myself against the ordeal with an entertaining novel, we plugged-in KYW, the local

vendor of the Blue Network's wares, at 7:00 o'clock, Central Time. Well we didn't get in any reading during the first half hour. O. Henry's story, "The Clarion Call," was being presented in the "Re-Told Tales" series. Our listening was mostly a matter of conscientiousness for the first ten minutes, but after that the thing carried itself along for the remainder of the half hour and stacked up as one of the best radio plays we have heard. A two-character play, making use of a conventionally far-fetched O Henry plot it was "put across" by the expectationally fine voice acting of the villain. Sorry we don't remember his name; the good job of script preparation was done by one Henry Fisk Carlton and the production was directed by a Gerald Stopp.

At 7:30 when the Ampico Hour came on we commenced to look for our place in our book—for we have heard some rather dismal Ampico Hours. But unfortunately for novel reading the program opened with some of Smetana's music for "The Bartered Bride" which we like too much to miss. Then Marguerite Volavy, playing the piano both in solo and in concerto, kept our willing attention for the rest of the program.

We got in a little reading during the Maxwell House concert, but not much. This program is always craftily arranged and expertly presented. The "Old Colonel March" and the "Indian Love Lyrics" we could have got along very nicely without, but Richard Crooks called for sitting up and taking notice when he sang the "Prize Song" and the Siciliana from "Cavalleria." This grand singer—deservedly popular—even



AT STATION WGR, BUFFALO

Nancy Cushman, daughter of Howard B. Cushman, director of the station, confiding to the world that she is two years old. "Microphone fright" does not seem to bother her

put beauty in the banal "Little Bit of Heaven." The orchestra kindly included a grand waltz from Komzak's "Bad'n Mad'n."

The Continental's program followed at 9:00 o'clock. This hour, too, is an ever reliable one, made up, as you know, of opera selections and not exclusively of the hackneyed ones. However, as two hours of attentive listening is enough for anybody to put in consecutively, we at this point took up our book and enjoyed the perfectly swell radio voices of Astrid Fjelde, Frederic Baer, et cie., as a rather vague background.

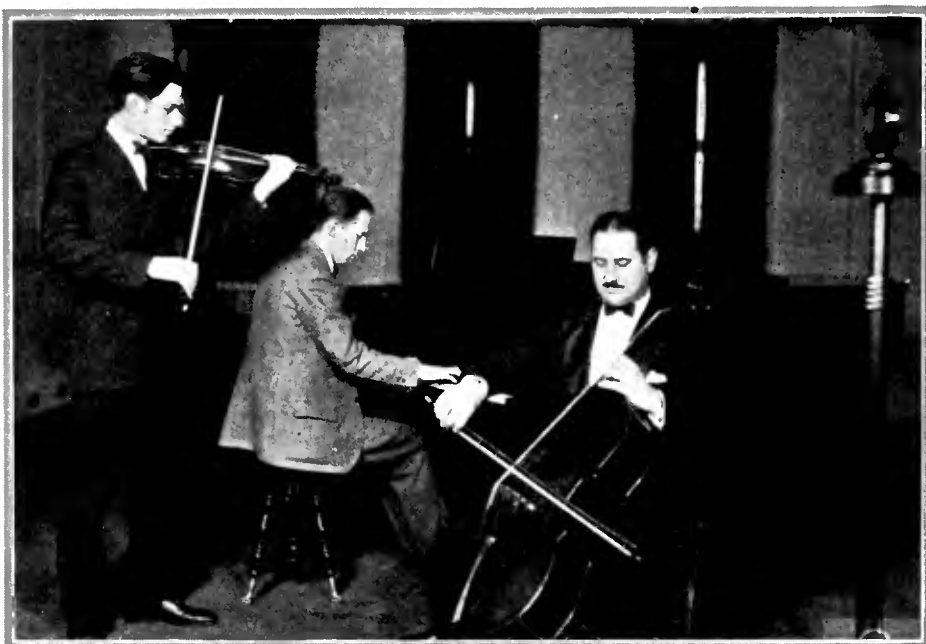

THE WBAL ENSEMBLE

This group is heard every Friday night from WBAL Baltimore. The group includes (left to right): Michael Weiner, violinist-conductor; Leroy Evans, pianist and Samuel Maurice Stern 'cellist. Michael Weiner is the orchestral supervisor. WBAL is one of the few stations that takes its music seriously

SO MANY good words must be said for this month's supply of records that we feel we ought to offer a word of explanation at the start. Readers grow suspicious when any reviewer waxes consistently eulogistic. They picture all critics as mean creatures, shriveled in body and soul, who starve themselves on a diet of vinegar and sour grapes that they may the better enjoy the flaws which they pick, gloating over the bones of their victims. It fills us with joy to find a collection of records so good that we can honestly be lavish with praise. Such is the present collection.

### Good and Popular

In the *Sing Song Sycamore Tree* and *Four Walls* played by the Ipana Troubadours directed, of course, by S. C. Lanin (Columbia). What is so rare as a really good tune? Two of them, of course. And here they are! Superbly played by the Troubadours and expertly sung by Scrapy Lambert.

*The Whip* and *We'll Have a New Home in the Morning* played by Nat Shilkret and the Victor Orchestra (Victor). Lyrics that are different, harmony that's grand, and an orchestra that's infectious.

*Can't Help Lovin' Dat Man* and *Make-Believe* played by Ben Bernie and His Hotel Roosevelt Orchestra (Brunswick). Smooth—in the best Bernie tradition, and with Vaughn De Leath and Scrapy Lambert doing neat vocalizing.

*Say Sol* and *Oh Gee!*—*Oh Joy!* played by Ben Selvin and His Orchestra (Columbia). Yes, and we'll add a few more exclamation marks just for good measure!!!!

*Mary Ann* and *If I Can't Have You* played by Hal Kemp and His Orchestra formerly of the University of North Carolina. (Brunswick). Where they got their M. A. (musical acrobat) degrees, no doubt. No? Well, they got very proficient somewhere.

*Call of Broadway* and *Without You Sweetheart* played by Vincent Lopez and His Casa Lopez Orchestra (Brunswick). Mediocre music made more than a little danceable by a swell orchestra.

*Sensation Stomp* and *Whiteman Stomp* played by Paul Whiteman and His Orchestra (Victor). Whiteman conducts a class in orchestral gymnastics. Proving what?

*Who Gives You All Your Kisses* played by the Troubadours (Victor). As usual you can safely put your money on the Troubadours. They will even carry the weak sister on the other side. *What Are We Waiting For* played by Edwin J. McEnelly's Orchestra.

*Tin Pan Parade* played by the Troubadours (Victor) is another prize winner; *Chloe*, on the reverse, by the All Star Orchestra is just an also-ran.

*Somebody Lied About Me* and *Chloe* played by the Colonial Club Orchestra (Brunswick). Something old, nothing new, something borrowed, something blue.

■ *Ol' Man River* and *Can't Help Lovin' Dat Man* played by Don Voorhees and His Orchestra (Columbia). Two good numbers from the popular Ziegfeld musical comedy, "Show Boat."

*My Ohio Home* and *Here Comes the Showboat* played by Jean Goldkette and His Orchestra. (Victor). The second number is novel—and excellent.

*Rose Room* and *Golden Gate* by Herb Wiedoeft and His Orchestra (Brunswick). Musical publicity for the Land of Sunshine.

*For My Baby* and *The Man I Love* by Leo Reisman and His Orchestra and Fred Rich and His Hotel Astor Orchestra, respectively (Columbia). F. f. f. or fine for foxtrotting.

*Tin Pan Parade* and *I Told Them All About You* sung by Ford and Glenn (Columbia).

# The Month's New Phonograph Records

Easily the best of the recent vocal records.

*Sweetheart of Sigma Chi* and *Charmaine* sung by Allen McQuhae (Brunswick). A better tenor voice than you usually hear warbling these grand old favorites!

In an *Oriental Garden* and *Roses for Remembrance* played by the Anglo-Persians under the direction of Louis Katzman (Brunswick). Mr. Katzman is the best musical gardener we know.

*Lolita* and *Yesterday* played by the A. and P. Gypsies under the direction of Harry Horlick (Brunswick). Very nice indeed.

### More or Less Classic

*Lucia—Sextette* (Donizetti) and *Rigoletto—Quartet* (Verdi). (A) sung by Galli-Curci, Homer, Gigli, De Luca, Pinza, Bada; (B) sung by Galli-Curci, Homer, Gigli, De Luca (Victor). What's good enough for Gatti-Casazza is good enough for us.

*Song of the Flea* (Moussorgsky) and *Barbiere Di Siviglia—La Calunnia* (Rossini). Sung by Feodor Chaliapin (Victor). The name of this abysmal basso is sufficient guarantee of satisfaction on any record. This in particular is delightful.

*Meistersinger-Kirchenchor* (Wagner) and *Meistersinger-Wach' auf! Es Nabel Gen Den Tag* (Wagner). Sung by the State Opera Chorus of Berlin, with Orchestra, conducted by Leo Blech (Victor). A very effective imported recording of this beautiful choral music from Wagner's merry opera.

*Pagliacci—Son Qua!* and *Pagliacci—Andiam!* (Leoncavallo). Sung by the Metropolitan Opera Chorus, with Metropolitan Opera House Orchestra, conducted by Giulio Setti (Victor). More choral music that is worth several times the price of admission.

*The Masked Ball—Is It Thou?* (Verdi) and *Pagliacci—Prologue* (Leoncavallo) Sung by Heinrich Schlusnus (Brunswick). A competent baritone presents these two operatic selections.

*Andante Cantabile* (Tschaiakowsky) and *Canzonetta* (Tschaiakowsky). Played by Albert Spalding (Brunswick). Creating one paramount impression: that of charming grace.

*Chanson Arabe* (Rimsky-Korsakoff—Kreisler) and *Le Deluge* (Saint-Saens). Played by Toscha Seidel (Columbia). Mr. Seidel is assisted in the first selection by Max Rabinovitch at the piano, and in the second by Emanuel Bay—because it is the custom and not because this talented violinist needs assistance.

*Ave Maria* (Carnevali) and *Stabat Mater* (Pergolesi). Sung by Giuseppe Danise (Brunswick). A rich baritone voice lending itself very successfully to ecclesiastical music. The accompaniment of chimes in the *Ave Maria* is particularly nice.

*Traviata—Prelude* (Verdi) and *Sylvia Ballet—Corlege de Bacchus* (Delibes). Played by the Victor Symphony Orchestra directed by Rosario Bourdon (Victor). No home is complete with-

out these familiar but none-the-less lovely selections.

*Poet and Peasant Overture*, Parts 1 and 2 (von Suppé). Played by the Brunswick Concert Orchestra (Brunswick). Part 1 is the dreamy poet; part 2: the rollicking peasant . . . but you know it; it has appeared on every "pop" concert program for years.

*Emperor Waltz* and *Wine, Woman and Song Waltz* (Strauss). By Jacques Jacobs' Ensemble (Columbia). Here are the waltzes of yesteryear!

*Jolly Fellows Waltz* (Wollstedt) and *The Skaters* (Waldteufel). Played by the Brunswick Concert Orchestra under the direction of Louis Katzman (Brunswick). Sweet memories of the old skating rink and the creaking calliope! The tunes are the same, that's all!

### Recent Album Record Sets

WAGNER BAYREUTH FESTIVAL RECORDINGS (Columbia). In one album, Masterworks Set No. 79) the Columbia Phonograph Company offer the following excerpts from four Wagnerian operas: (1) *Parsifal: Transformation Scene*, Act 1; *Grail Scene*, Act 1; *Flower Maidens' Scene*, Act. 2; *Prelude*, Act 3; and *Good Friday Music*, Act 3; (2) *Rheingold: Entry of the Gods into Valhalla*; (3) *Die Walkure: Ride of the Valkyries*; (4) *Siegfried: Forest Murmurs*, Act 2; *Prelude*, Act 3; *Fire Music*. The orchestra is that of the Bayreuth Festival, over which three famous conductors share the honors of wielding the baton. They are Dr. Karl Muck, one time director of the Boston Symphony Orchestra, Siegfried Wagner, and Franz von Hoesslin. The recordings were made in Bayreuth during actual performances of the operas in the summer of 1927 and have been approved by Siegfried Wagner.

We will not go into a detailed description of the records. You either know and love the music or you don't. If you do, you will want the album anyway. If you don't, you should get the album and learn to know the music.

The set contains eleven double-faced records and costs \$16.50.

*Symphony No. 4, D Minor*, (Op. 120) by Robert Schumann. Played by the New Symphonic Orchestra, Berlin, under the direction of Hans Pfitzner. Complete on three and a half double-faced records (Brunswick).

Schumann conceived the Fourth Symphony as a whole rather than as four distinct movements. The same thematic material runs through the entire work. The symphony is very colorful, very warm and full of lovely melodic phrases. The fourth movement is particularly beautiful.

*Concerto for Organ and Orchestra, F Major*, (Op. 4, No. 4) by George Frederic Handel. Played by Walter Fischer accompanied by orchestra. Complete on two double-faced records. *Concerto for Organ and Orchestra, F Major* (Op. 177) by Joseph Rheinberger. Played by Walter Fischer accompanied by orchestra. Complete on three double-faced records. (Brunswick).

The Brunswick-Balke-Collender Company would have acted more wisely had they separated these two concertos rather than offered them together in one album. The Rheinberger Concerto, which is in spots uninteresting to the point of dullness suffers sadly by contrast with the exquisite Handel composition. Both concertos are beautifully played by the famous organist of the Berlin Cathedral.

*Death and Transfiguration* (Op. 24) by Richard Strauss, played by the State Opera Orchestra under the direction of the composer. Complete on three double-faced records (Brunswick).

This tone poem dealing with the struggle between life and death is one of the most powerfully dramatic of modern orchestral compositions.

# "Radio Broadcast's" Directory of Vacuum Tubes

THE table below is as complete as is possible to make it and should be a constantly useful reference for all radio workers. The data on some Western Electric tubes are included because some of our readers live in Canada and in other countries where tubes of this manufacture

are available. We have followed the RCA-Cunningham tube terminology; other manufacturers make types of tube similar in each class, although each manufacturer has his own terminology. The reader who desires to use a CeCo tube for example, need only ask his dealer or the

manufacturer for a CeCo of the 201-A type, etc. The same follows naturally for any of the vacuum tubes in the classifications below made by Arcturus, Sovereign, Sylvania, Marathon, Gold Seal, Sonatron, Kellogg, Magnetron, Speed, and others.

## AVERAGE CHARACTERISTICS OF RADIO VACUUM TUBES

GENERAL		DETECTION						AMPLIFICATION										
MODEL	USE	CIRCUIT REQUIREMENTS	INTER-ELECTRODE CAPACITIES IN MMFO. FILAMENT COLD	"A" SUPPLY	FILAMENT TERMINAL VOLTAGE	FILAMENT CURRENT (AMPERES)	DETECTOR GRID RETURN LEAD TO	GRID LEAK MEGOHMS	DETECTOR BATTERY VOLTAGE	DETECTOR PLATE CURRENT (MILLIAMPERES)	AMPLIFIER "B" BATTERY VOLTAGE	AMPLIFIER "C" BATTERY VOLTAGE	AMPLIFIER PLATE CURRENT (MILLIAMPERES)	A.C. PLATE RESISTANCE (OHMS)	MUTUAL CONDUCTANCE (MICROMHMS)	VOLTAGE AMPLIFICATION FACTOR	MAXIMUM UNDISTORTED OUTPUT (MILLIWATTS)	
C-11 WD-11					Same as below, except for base, which is old UV type													
CX-12 WX-12	Detector or Amplifier	Transformer Coupling	G-F 6; G-P 5.5; P-F 7.5	Dry Cell 1 1/2 V Storage 2 V	1.1	.25	+F	3 to 5'	22 1/2 to 45	1.5	9D 135	4 1/2 10 1/4	2.5 3.5	15,500 15,000	425 440	6.6 6.6	7 35	
CX-112A UX-112A	Detector or Amplifier	Transformer Coupling	G-F 9; G-P 11; P-F 7.5	Storage 6 V	5.0	.25	+F	3 to 5	45	1.5	90 135	4 1/2 9	5.5 7	5,300 5,000	1,500 1,600	8 8	30 120	
C-299 UV-199					Same as below, except for base, which is old UV type													
CX-299 UX-199	Detector or Amplifier	Transformer Coupling	G-F 3.6; G-P 3.5; P-F 4.5	Dry Cell 4 1/2 V Storage 4 V	3.0 3.3	.060 .063	+F	2 to 9	45	1	90	4 1/2	2.5	15,500	425	6.6	7	
CX-300A UX-200A	Detector	Transf. or Resistance Coupling	G-F 3.4; G-P 8.8; P-F 1.5	Storage 6 V	5.0	.25	-F	2 to 3	45	1.5	Following UX-200 A characteristics apply only for Detector connection			30,000	666	20	—	
CX-301A UX-201A	Detector or Amplifier	Transformer Coupling	G-F 5.8; G-P 10.1; P-F 6.1	Storage 6 V	5.0	.25	+F	2 to 9	45	1.5	90 135	4 1/2 9	2.5 3	11,000 10,000	725 800	8 8	15 55	
CX-322 UX-222	Radio Freq. Amplifier	Special Shielding	G-P 0.025	Dry Cell 4 1/2 V Storage 4 1/2 V	3.3	.132	—	—	—	—	135	1 1/2	1.5	850,000	350	300 <sub>M</sub>	—	
CX-322 UX-222	Audio Freq. Amplifier	Resistance Coupling	—	Dry Cell 4 1/2 V Storage 4 1/2 V	3.3	.132	—	—	—	—	180 1/2	1 1/2	.3	160,000	400	60	—	
UX-226	Amplifier A.C. Filament Type	Transformer Coupling	G-F 3.65; G-P 8.2; P-F 2.1	Transformer 1.5 V	1.5	1.05	—	—	—	—	90 135 180	6 9 13 1/2	3.5 5 7.5	9,400 7,400 7,000	875 1,100 1,170	8.2 8.2 8.2	20 70 160	
C-327 UY-227	Detector A.C. Heater Type	Transformer Coupling	G-F 3.6; G-P 3.7; P-F 2.75	Transformer 2.5 V	2.5 <sub>H</sub>	1.75	K	2-9 1-1	45 90	2 7	Following UY-227 characteristics apply only for Detector connection			10,000 8,000	800 1,000	8 8	—	
CX-340 UX-240	Detector or Amplifier	Resistance Coupling	G-F 3.4; G-P 8.8; P-F 1.5	Storage 6 V	5.0	.25	+F	2 to 5	135 1/2 180 1/2	.3 0.4	135 1/2 180 1/2	1 1/2 3	.2 2	150,000 150,000	200 200	30 30	—	
CX-112A UX-112A	Power Amplifier	No L.S.C. Required	G-F 9; G-P 11; P-F 7.5	Storage 6 V, Transformer 5 V	5.0	.25	—	—	—	—	135 157 1/2	9 10 1/2	7 9.5	5,000 4,700	1,600 1,700	8 8	120 195	
CX-220 UX-120	Power Amplifier	No L.S.C. Required	G-F 4.5; G-P 5.4; P-F 4.4	Dry Cell 4 1/2 V Storage 4 V	3.0 3.3	.125 .132	—	—	—	—	135	22 1/2	6.5	6,300	525	3.3	110	
CX-371A UX-171A	Power Amplifier	L.S.C. except at 90V.	G-F 6.8; G-P 9.5; P-F 6.5	Storage 6 V, Transformer 5 V	5.0	.25	—	—	—	—	90 135 180	16 1/2 27 40 1/2	10 16 20	2,500 2,200 2,000	1,200 1,360 1,500	3.0 3.0 3.0	130 330 700	
CX-310 UX-210	Power Amplifier	L.S.C.	G-F 7; G-P 8; P-F 7	Transformer 7.5 V	7.5	1.25	—	—	—	—	250 300 350 400 425	18 22 1/2 27 31 1/2 35	10 13 16 18 18	6,000 5,600 5,150 5,000 5,000	1,330 1,450 1,550 1,600 1,600	8 8 8 8 8	340 600 925 1,340 1,540	
CX-350 UX-250	Power Amplifier	L.S.C.	G-P 8.7	Transformer 7.5 V	7.5	1.25	—	—	—	—	250 300 350 400 450	45 54 63 70 84	28 39 45 55 55	2,100 2,000 1,900 1,800 1,800	1,800 1,800 2,000 2,000 2,100	3.8 3.8 3.8 3.8 3.8	900 1,500 2,350 3,250 4,650	

## AVERAGE CHARACTERISTICS OF WESTERN ELECTRIC TUBES

"N" 215-A	Detector or Amplifier	Transformer Coupling	G-F 4.4; G-P 6; P-F 3.8	—	1.0	0.25	+F	2-9	45	1.0	67	6.0	1.0	20,000	300	6	8
"V" 1020	Amplifier	Resis. or Impedance Coupling	—	—	2.0	0.97	—	—	—	—	130	1.5	0.75	60,000	500	30	4.2
"L" 216A	Amplifier	Transformer Coupling	—	—	5-6	1.0	—	—	—	—	130	9.0	6.0	6,000	980	5.9	60
"D" 104D	Power Amplifier	Transformer or Imped. Coupling	G-F 6.2; G-P 5.46; P-F 8.0	—	4-5	1.0	—	—	—	—	130	22.5	20.0	2,200	1,100	2.4	14.5
"E" 205D	Power Amplifier	Transformer or Imped. Coupling	—	—	4.5	1.6	—	—	—	—	350	22.5	33	3,500	2,000	7	890

## SPECIAL PURPOSE TUBES

MODEL	USE	CIRCUIT REQUIREMENTS	BASE	MAXIMUM OVERALL HEIGHT	MAXIMUM OVERALL DIAMETER	PURPOSE	CHARACTERISTICS
CX-380 UX-280	Full-Wave Rectifier	Full-Wave Circuit	Large Standard UX Base	5 3/8"	2 3/16"	Rectification in Eliminators	Filament Terminal Voltage... 5 Volts Filament Current... 2 Amperes A.C. Plate Voltage... 300 Volts (Max. per Plate) R.M.S. Max. D.C. Output Current (both Plates)... 125 Milliamperes D.C. Output Voltage at Max. Current as applied to filter of typical rectifier circuit... 260 Volts
CX-381 UX-281	Half-Wave Rectifier	Half or Full Wave Circuit	Large Standard UX Base	6 1/4"	2 7/16"	Rectification in Eliminators	Filament Terminal Voltage... 7.5 Volts Filament Current... 1.25 Amperes A.C. Plate Voltage... 750 Volts (Maximum) R.M.S. A.C. Plate Voltage... 650, 750 Volts D.C. Output Current... 65, 110 Milliamperes D.C. Output Voltage as applied to filter of typical rectifier circuit... 620, 620 Volts
CX-374 UX-874	Voltage Regulator	Series Resistance	Large Standard UX Base	5 3/8"	2 3/16"	Constant Voltage Device	Designed to keep output voltage of B Power Units constant when different values of B current are supplied Operating Voltage... 90 Volts D.C. Starting Voltage... 125 Volts D.C. Operating Current... 10-50 Milliamperes
C-376 UX-876	Current Regulator (Ballast Tube)	Transformer Primary of 65 Volts for use on 115 Volt Line	Standard Mogul Type Screw Base	8"	2 1/16"	Constant Current Device	Designed to insure constant input to power operated radio receivers despite fluctuations in line voltage Operating Current... 1.7 Amperes Mean Voltage Drop... 50 Volts Permissible Variation... ±10 Volts
CX-386 UX-886	Current Regulator (Ballast Tube)	Transformer Primary of 65 Volts for use on 115 Volt Line	Standard Mogul Type Screw Base	8"	2 1/16"	Constant Current Device	Designed to insure constant input to power operated radio receivers despite fluctuations in line voltage Operating Current... 2.05 Amperes Mean Voltage Drop... 50 Volts Permissible Variation... ±10 Volts
C-377	Protective Tube	—	Double Contact Bayonet Auto Type	1 7/8"	2 1/2"	Current Limiting Device	Used in B Battery circuits to prevent excessive current resulting from short-circuit which might damage tubes or wiring Voltage Drop Across: Half Filament... 2.5 Entire Filament... 90 At 20 Milliamperes D.C. At 90 Milliamperes D.C.

1 (1) Note other use of this Radiotron above (below)  
 a Inner Grid - 1 1/2 Volts; Outer Grid + 45 Volts, .015 Milliamperes  
 b Outer Grid - 1 1/2 Volts; Inner Grid + 2 1/2 Volts; 6 Milliamperes  
 c Applied thru plate coupling resistance of 250,000 Ohms  
 d Connection to shell of base for third terminal which is the lead to mid-point of filament

Note: All grid voltages are given with respect to cathode or negative filament terminal  
 Maximum values not to be exceeded

Except for half ampere filament, UX-112 and UX-171 characteristics are identical respectively to UX-112-A and UX-171-A.  
 K... Cathode  
 H... Heater Voltage  
 L.S.C... Loud Speaker Coupling, consisting of either Choke Coil and By-Pass Condenser or Output Transformer of 1:1 or step down ratio, recommended wherever plate current (D.C.) exceeds 10 milliamperes.  
 M... With a screen-grid tube, on account of circuit limitations, the actual voltage amplification obtainable does not bear as high a relation to the voltage amplification factor as in the case of three element tubes.

# Manufacturers' Booklets

## A Varied List of Books Pertaining to Radio and Allied Subjects Obtainable Free With the Accompanying Coupon

READERS may obtain any of the booklets listed below by using the coupon printed on this page. Order by number only.

1. FILAMENT CONTROL—Problems of filament supply, voltage regulation, and effect on various circuits. RADIALL COMPANY.
2. HARD RUBBER PANELS—Characteristics and properties of hard rubber as used in radio, with suggestions on how to "work" it. B. F. GOODRICH RUBBER COMPANY.
3. TRANSFORMERS—A booklet giving data on input and output transformers. PACENT ELECTRIC COMPANY.
5. CARBORUNDUM IN RADIO—A book giving pertinent data on the crystal as used for detection, with hook-ups, and a section giving information on the use of resistors. THE CARBORUNDUM COMPANY.
9. VOLUME CONTROL—A leaflet showing circuits for distortionless control of volume. CENTRAL RADIO LABORATORIES.
10. VARIABLE RESISTANCE—As used in various circuits. CENTRAL RADIO LABORATORIES.
12. DISTORTION AND WHAT CAUSES IT—Hook-ups of resistance-coupled amplifiers with standard circuits. ALLEN-BRADLEY COMPANY.
15. B-ELIMINATOR AND POWER AMPLIFIER—Instructions for assembly and operation using Raytheon tube. GENERAL RADIO COMPANY.
- 15a. B-ELIMINATOR AND POWER AMPLIFIER—Instructions for assembly and operation using an R. C. A. rectifier. GENERAL RADIO COMPANY.
16. VARIABLE CONDENSERS—A description of the functions and characteristics of variable condensers with curves and specifications for their application to complete receivers. ALLEN D. CARDWELL MANUFACTURING COMPANY.
17. BAKELITE—A description of various uses of bakelite in radio, its manufacture, and its properties. BAKELITE CORPORATION.
21. HIGH-FREQUENCY DRIVER AND SHORT-WAVE WAVE-METER—Constructional data and application. BURGESS BATTERY COMPANY.
46. AUDIO-FREQUENCY CHOKES—A pamphlet showing positions in the circuit where audio-frequency chokes may be used. SAMSON ELECTRIC COMPANY.
47. RADIO-FREQUENCY CHOKES—Circuit diagrams illustrating the use of chokes to keep out radio-frequency currents from definite points. SAMSON ELECTRIC COMPANY.
48. TRANSFORMER AND IMPEDANCE DATA—Tables giving the mechanical and electrical characteristics of transformers and impedances, together with a short description of their use in the circuit. SAMSON ELECTRIC COMPANY.
49. BYPASS CONDENSERS—A description of the manufacture of bypass and filter condensers. LESLIE F. MUTER COMPANY.
50. AUDIO MANUAL—Fifty questions which are often asked regarding audio amplification, and their answers. AMERTRAN SALES COMPANY, INCORPORATED.
51. SHORT-WAVE RECEIVER—Constructional data on a receiver which, by the substitution of various coils, may be made to tune from a frequency of 16,660 kc. (18 meters) to 1999 kc. (150 meters). SILVER-MARSHALL, INCORPORATED.
52. AUDIO QUALITY—A booklet dealing with audio-frequency amplification of various kinds and the application to well-known circuits. SILVER-MARSHALL, INCORPORATED.
56. VARIABLE CONDENSERS—A bulletin giving an analysis of various condensers together with their characteristics. GENERAL RADIO COMPANY.
57. FILTER DATA—Facts about the filtering of direct current supplied by means of motor-generator outfits used with transmitters. ELECTRIC SPECIALTY COMPANY.
59. RESISTANCE COUPLING—A booklet giving some general information on the subject of radio and the application of resistors to a circuit. DAVEN RADIO CORPORATION.
63. FIVE-TUBE RECEIVER—Constructional data on building a receiver. AERO PRODUCTS, INCORPORATED.
70. IMPROVING THE AUDIO AMPLIFIER—Data on the characteristics of audio transformers, with a circuit diagram showing where chokes, resistors, and condensers can be used. AMERICAN TRANSFORMER COMPANY.
72. PLATE SUPPLY SYSTEM—A wiring diagram and layout plan for a plate supply system to be used with a power amplifier. Complete directions for wiring are given. AMERTRAN SALES COMPANY.
81. BETTER TUNING—A booklet giving much general information on the subject of radio reception with specific illustrations. Primarily for the non-technical home constructor. BREMER-TULLY MANUFACTURING COMPANY.
82. SIX-TUBE RECEIVER—A booklet containing photographs, instructions, and diagrams for building a six-tube shielded receiver. SILVER-MARSHALL, INCORPORATED.
83. SOCKET POWER DEVICE—A list of parts, diagrams, and templates for the construction and assembly of socket power devices. JEFFERSON ELECTRIC MANUFACTURING COMPANY.
84. FIVE-TUBE EQUAMATIC—Panel layout, circuit diagrams, and instructions for building a five-tube receiver, together with data on the operation of tuned radio-frequency transformers of special design. KARAS ELECTRIC COMPANY.
85. FILTER—Data on a high-capacity electrolytic condenser used in filter circuits in connection with A socket power supply units, are given in a pamphlet. THE AROX COMPANY.
86. SHORT-WAVE RECEIVER—A booklet containing data on a short-wave receiver as constructed for experimental purposes. THE ALLEN D. CARDWELL MANUFACTURING CORPORATION.
88. SUPER-HETERODYNE CONSTRUCTION—A booklet giving full instructions, together with a blue print and necessary data, for building an eight-tube receiver. THE GEORGE W. WALKER COMPANY.

89. SHORT-WAVE TRANSMITTER—Data and blue prints are given on the construction of a short-wave transmitter, together with operating instructions, methods of keying, and other pertinent data. RADIO ENGINEERING LABORATORIES.
90. IMPEDANCE AMPLIFICATION—The theory and practice of a special type of dual-impedance audio amplification are given. ALDEN MANUFACTURING COMPANY.
93. B-SOCKET POWER—A booklet giving constructional details of a socket-power device using either the BH or 313 type rectifier. NATIONAL COMPANY, INCORPORATED.
94. POWER AMPLIFIER—Constructional data and wiring diagrams of a power amplifier combined with a B-supply unit are given. NATIONAL COMPANY, INCORPORATED.
101. USING CHOKES—A folder with circuit diagrams of the more popular circuits showing where choke coils may be placed to produce better results. SAMSON ELECTRIC COMPANY.
22. A PRIMER OF ELECTRICITY—Fundamentals of electricity with special reference to the application of dry cells to radio and other uses. Constructional data on buzzers, automatic switches, alarms, etc. NATIONAL CARBON COMPANY.
23. AUTOMATIC RELAY CONNECTIONS—A data sheet showing how a relay may be used to control A and B circuits. YAXLEY MANUFACTURING COMPANY.
26. DRY CELLS FOR TRANSMITTERS—Actual tests given, well illustrated with curves showing exactly what may be expected of this type of B power. BURGESS BATTERY COMPANY.
27. DRY-CELL BATTERY CAPACITIES FOR RADIO TRANSMITTERS—Characteristic curves and data on discharge tests. BURGESS BATTERY COMPANY.
28. B BATTERY LIFE—Battery life curves with general curves on tube characteristics. BURGESS BATTERY COMPANY.
30. TUBE CHARACTERISTICS—A data sheet giving constants of tubes. C. E. MANUFACTURING COMPANY.
32. METERS FOR RADIO—A catalogue of meters used in radio, with diagrams. BURTON-ROGERS COMPANY.
33. SWITCHBOARD AND PORTABLE METERS—A booklet giving dimensions, specifications, and shunts used with various meters. BURTON-ROGERS COMPANY.
35. STORAGE BATTERY OPERATION—An illustrated booklet on the care and operation of the storage battery. GENERAL LEAD BATTERIES COMPANY.
36. CHARGING A AND B BATTERIES—Various ways of connecting up batteries for charging purposes. WESTINGHOUSE UNION BATTERY COMPANY.
37. WHY RADIO IS BETTER WITH BATTERY POWER—Advice on what dry cell battery to use; their application to radio, with wiring diagrams. NATIONAL CARBON COMPANY.
53. TUBE REACTIVATOR—Information on the care of vacuum tubes, with notes on how and when they should be reactivated. THE STERLING MANUFACTURING COMPANY.
69. VACUUM TUBES—A booklet giving the characteristics of the various tube types with a short description of where they may be used in the circuit. RADIO CORPORATION OF AMERICA.
87. TUBE TESTER—A complete description of how to build and how to operate a tube tester. BURTON-ROGERS COMPANY.
92. RESISTORS FOR A. C. OPERATED RECEIVERS—A booklet giving circuit suggestions for building a. c. operated receivers, together with a diagram of the circuit used with the new 400-milliamperer rectifier tube. CARTER RADIO COMPANY.
102. RADIO POWER BULLETINS—Circuit diagrams, theory constants, and trouble-shooting hints for units employing the BH or B rectifier tubes. RAYTHEON MANUFACTURING COMPANY.
103. A. C. TUBES—The design and operating characteristics of a new a. c. tube. Five circuit diagrams show how to convert well-known circuits. SOVEREIGN ELECTRIC & MANUFACTURING COMPANY.

41. BABY RADIO TRANSMITTER OF 9XH-9EK—Description and circuit diagrams of dry-cell operated transmitter. BURGESS BATTERY COMPANY.
42. ARCTIC RADIO EQUIPMENT—Description and circuit details of short-wave receiver and transmitter used in Arctic exploration. BURGESS BATTERY COMPANY.
58. HOW TO SELECT A RECEIVER—A commonsense booklet describing what a radio set is, and what you should expect from it, in language that any one can understand. DAY-FAN ELECTRIC COMPANY.
67. WEATHER FOR RADIO—A very interesting booklet on the relationship between weather and radio reception, with maps and data on forecasting the probable results. TAYLOR INSTRUMENT COMPANIES.
73. RADIO SIMPLIFIED—A non-technical booklet giving pertinent data on various radio subjects. Of especial interest to the beginner and set owner. CROSLY RADIO CORPORATION.
76. RADIO INSTRUMENTS—A description of various meters used in radio and electrical circuits together with a short discussion of their uses. JEWELL ELECTRICAL INSTRUMENT COMPANY.
78. ELECTRICAL TROUBLES—A pamphlet describing the use of electrical testing instruments in automotive work combined with a description of the cadmium test for storage batteries. Of interest to the owner of storage batteries. BURTON ROGERS COMPANY.
95. RESISTANCE DATA—Successive bulletins regarding the use of resistors in various parts of the radio circuit. INTERNATIONAL RESISTANCE COMPANY.
96. VACUUM TUBE TESTING—A booklet giving pertinent data on how to test vacuum tubes with special reference to a tube testing unit. JEWELL ELECTRICAL INSTRUMENT COMPANY.
98. COPPER SHIELDING—A booklet giving information on the use of shielding in radio receivers, with notes and diagrams showing how it may be applied practically. Of special interest to the home constructor. THE COPPER AND BRASS RESEARCH ASSOCIATION.
99. RADIO CONVENIENCE OUTLETS—A folder giving diagrams and specifications for installing loud speakers in various locations at some distance from the receiving set. YAXLEY MANUFACTURING COMPANY.
105. COILS—Excellent data on a radio-frequency coil with constructional information on six broadcast receivers, two short-wave receivers, and several transmitting circuits. AERO PRODUCTS COMPANY.
106. AUDIO TRANSFORMER—Data on a high-quality audio transformer with circuits for use. Also useful data on detector and amplifier tubes. SANGAMO ELECTRIC COMPANY.
108. VACUUM TUBES—Operating characteristics of an a. c. tube with curves and circuit diagram for connection in converting various receivers to a. c. operation with a four-prong a. c. tube. ARCTURUS RADIO COMPANY.
109. RECEIVER CONSTRUCTION—Constructional data on a six-tube receiver using restricted field coils. BODINE ELECTRIC COMPANY.
110. RECEIVER CONSTRUCTION—Circuit diagram and constructional information for building a five-tube set using restricted field coils. BODINE ELECTRIC COMPANY.
111. STORAGE BATTERY CARE—Booklet describing the care and operation of the storage battery in the home. MARCO STORAGE BATTERY COMPANY.
112. HEAVY-DUTY RESISTORS—Circuit calculations and data on receiving and transmitting resistances for a variety of uses, diagrams for popular power supply circuits, d. c. resistors for battery charging use. WARO LEONARD ELECTRIC COMPANY.
113. CONE LOUD SPEAKERS—Technical and practical information on electro-dynamic and permanent magnet type cone loud speakers. THE MAGNAVOX COMPANY.
114. TUBE ADAPTERS—Concise information concerning simplified methods of including various power tubes in existing receivers. ALDEN MANUFACTURING COMPANY.
115. WHAT SET SHALL I BUILD?—Descriptive matter, with illustrations, of fourteen popular receivers for the home constructor. HERBERT H. FROST, INCORPORATED.
104. OSCILLATION CONTROL WITH THE "PHASATROL"—Circuit diagrams, details for connection in circuit, and specific operating suggestions for using the "Phasatrol" as a balancing device to control oscillation. ELECTRAD, INCORPORATED.
116. USING A B POWER UNIT—A comprehensive booklet detailing the use of a B power unit. Tables of voltages—both B and C—are shown. There is a chapter on trouble-shooting. MODERN ELECTRIC MFG. CO.
117. BEST RESULTS FROM RADIO TUBES—The chapters are entitled: "Radio Tubes," "Power Tubes," "Super Detector Tubes," "A. C. Tubes," "Rectifier Tubes," and "Installation." GOLD SEAL ELECTRICAL CO.
118. RADIO INSTRUMENTS, CIRCULAR "J"—A descriptive manual on the use of measuring instruments for every radio circuit requirement. A complete listing of models for transmitters, receivers, set servicing, and power unit control. WESTON ELECTRICAL INSTRUMENT CORPORATION.
120. THE RESEARCH WORKER—A monthly bulletin of interest to the home constructor. A typical feature article describes the construction of a special audio amplifier—AEROVOX WIRELESS CORPORATION.
121. FILTER CONDENSERS—Some practical points on the manufacture and use of filter condensers. The difference between inductive and non-inductive condensers. POLYMET MFG. CORP.
122. RADIO TUBES—Specifications and operating characteristics of vacuum tubes. Twenty-four pages. E. T. CUNNINGHAM, INC.
123. B SUPPLY DEVICES—Circuit diagrams, characteristics, and list of parts for nationally known power supply units. ELECTRAD, INC.
124. POWER AMPLIFIER AND B SUPPLY—A booklet giving several circuit arrangements and constructional information and a combined B supply and push-pull audio amplifier, the latter using 210 type tubes. THORDARSON ELECTRIC MFG. CO.
125. A. C. TUBE OPERATION—A small but complete booklet describing a method of filament supply for a. c. tubes. THORDARSON ELECTRIC MFG. CO.
126. MICROMETRIC RESISTANCE—How to use resistances for: Sensitivity control; oscillation control; volume control; regeneration control; tone control; detector plate voltage control; resistance and impedance coupling; loud speaker control, etc. AMERICAN MECHANICAL LABORATORIES.

In sending the coupon below, make sure that your name and address are included and are plainly written.

**USE THIS BOOKLET COUPON**

RADIO BROADCAST SERVICE DEPARTMENT  
RADIO BROADCAST, Garden City, N. Y.

Please send me (at no expense) the following booklets indicated by numbers in the published list above:

.....

.....

.....

Name.....

Address.....

(Number) (Street)

.....

(City) (State)

**ORDER BY NUMBER ONLY**

This coupon must accompany every request. RB 6-28



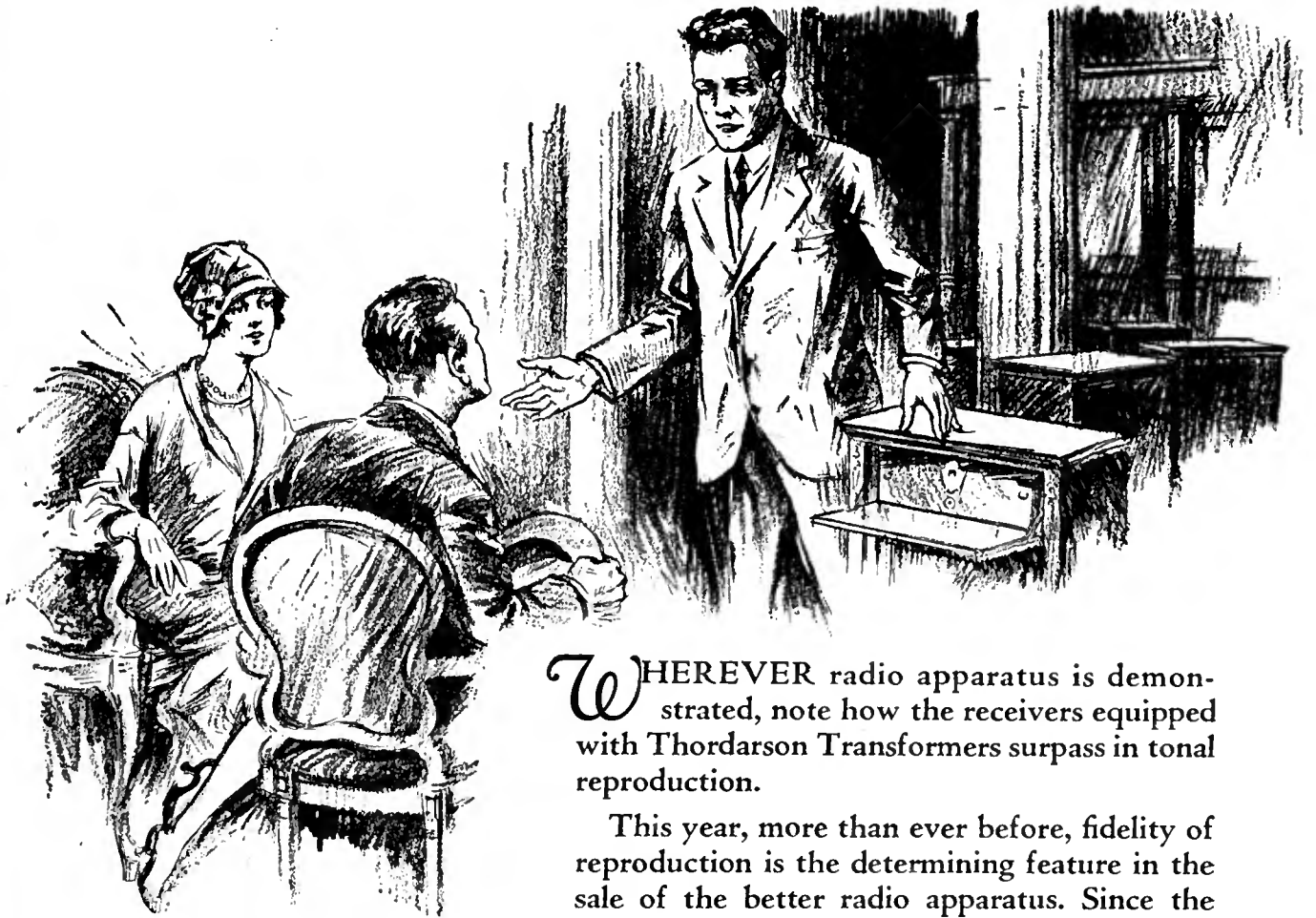

*These quality instruments are Thordarson equipped:*

ZENITH  
 SPARTON  
 HOWARD  
 FINECO  
 Willard  
 Pfannstiel  
 GILFILLAN  
 KENNEDY  
 MAGAYOR  
 Neutrowound  
 Prest-O-Lite  
 Radiodyne  
 Mohawk  
 Buckingham  
 MURDOCK  
 WALBERT  
 OZARKA  
 ARGUS  
 AUDIOLA  
 ERLA  
 and many others



WHEREVER radio apparatus is demonstrated, note how the receivers equipped with Thordarson Transformers surpass in tonal reproduction.

This year, more than ever before, fidelity of reproduction is the determining feature in the sale of the better radio apparatus. Since the musical characteristics of a radio instrument depend to such a great extent on a wise selection of the audio and power supply transformers, it is significant that so many leading manufacturers have turned to Thordarson as the logical transformer source.

Equally significant is the fact that not once since Thordarson transformers became available to radio manufacturers has any other transformer approached the manufacturer popularity of Thordarson.

# THORDARSON

RADIO TRANSFORMERS

*Supreme in musical performance*

{ Thordarson transformers are universally available to custom set builders as well as manufacturers. Wherever radio parts are sold, there you will find a complete stock of Thordarson Audio and Power Supply apparatus. If you are building for real musical performance, insist on Thordarson Transformers. }

**THORDARSON ELECTRIC MANUFACTURING CO.**  
*Transformer Specialists Since 1895*  
 WORLD'S OLDEST AND LARGEST EXCLUSIVE TRANSFORMER MAKERS  
 Huron and Kingsbury Streets - Chicago, Ill. U.S.A. 3551



# These Men Tell How They Make \$350 to \$450 a month in Radio

## \$350 a Month

"I feel proud of my success in Radio to date. My profit during the last two months amounts to \$700. I am making good and I have not finished my N.R.I. course yet. I am grateful for your training and cooperation to date and look forward to still bigger success when I graduate."



Clarence Heffelfinger, Temple, Penna.

## \$450 a Month



"I want to say a few words in appreciation of the benefits received from your training. In addition to my regular work in what I believe to be the largest and best equipped Radio Shop in the Southwest, I am now operating KGFI. I am proud of the fact that I installed and put KGFI on the air without N.R.I. I am averaging \$450 per month."

Frank M. Jones, 922 Guadalupe St. San Angelo, Texas.

## I'll Help You Become a Radio Expert



Trained men are needed for this new live-wire industry. Big and little fortunes are coming out of Radio every year. Get your share of the profits. This field is your big chance. Don't miss it. My book "Rich Rewards in Radio" tells you where the big jobs are and how you can quickly qualify as a Radio Expert.

## I Will Train You at Home in Your Spare Time

Two months from now you can be making \$10, \$20, \$30 a week on the side. Many of my students do it. That will pay your tuition and swell your bank account too. I teach you to begin making money almost the first week you enroll. G. W. Page, 1807 21st Avenue, Nashville, Tenn., made \$935 before graduating. In six to twelve months you can be a graduate Radio Expert. Your spare time is all I ask you to give to my course.

## Six Big Outfits of Radio Parts Given

Not toys but real parts. You can build approximately 100 different circuits with them. This kind of training gives you practical experience while learning. It shows up in your pay envelope. I am so sure that my training will put you ahead that I agree to give your money back if you are not satisfied upon completion.

## Investigate Without Cost

What others have done and are doing is proof of what you can do if you try. Do you want more money? Sure you do, enough to get the good things of life. Radio will give it to you.



**This 64-Page Book FREE**  
Send the coupon for a copy. Men from 16 to 50 without Radio experience or full grammar school education have found success in Radio through this book. I will send you a copy without the slightest obligation.

**J. E. Smith, President**  
Dept. 6-O, NATIONAL RADIO INSTITUTE  
Washington, D. C.

Mail **COUPON** Today

**J. E. SMITH, President**  
Dept. 6-O, National Radio Institute  
Washington, D. C.

Dear Mr. Smith: Send me a copy of your book "Rich Rewards in Radio." I am interested in getting ahead and want to know all about Radio money-making opportunities and about your practical way of teaching with six big outfits of Radio parts. I understand this request does not obligate me in the least.

Name ..... Age .....  
Address .....  
City ..... State .....

# The Radio Broadcast LABORATORY INFORMATION SHEETS

THE RADIO BROADCAST Laboratory Information Sheets are a regular feature of this magazine and have appeared since our June, 1926, issue. They cover a wide range of information of value to the experimenter and to the technical radio man. It is not our purpose always to include new information but to present concise and accurate facts in the most convenient form. The sheets are arranged so that they may be cut from the magazine and preserved for constant reference, and we suggest that each sheet be cut out with a razor blade and pasted on 4" x 6" filing cards, or in a notebook. The cards should be arranged in numerical order. In July, 1927, an index to all Sheets appearing up to that time was printed. Last month we printed an index covering the sheets published from August, 1927, to May, 1928, inclusive.

All of the 1926 issues of RADIO BROADCAST are out of print. A complete set of Sheets, Nos. 1 to 88, can be secured from the Circulation Department, Doubleday, Doran & Company, Inc., Garden City, New York, for \$1.00. Orders for the next set following can also be sent. Some readers have asked what provision is made to rectify possible errors in these Sheets. In the unfortunate event that any serious errors do occur, a new Laboratory Sheet with the old number will appear.

—THE EDITOR.

## No. 193

RADIO BROADCAST Laboratory Information Sheet

June, 1928

### "Motorboating"

#### HOW IT CAN BE PREVENTED

MANY amplifiers at times show a tendency to "motorboat" due generally to interaction coupling between stages, due to common coupling in the plate-supply unit. This effect can generally be eliminated by using the circuit shown on this Laboratory Sheet. This circuit was suggested in a recent bulletin from the E. T. Cunningham Company.

The anti-motorboating circuit consists of a network of condensers and resistances connected between the power unit and the B-plus detector terminal on the radio receiver. The effect of this circuit apparently is to eliminate coupling effects at the low frequencies at which such effects are most troublesome. The circuit has been used with good results in the Laboratory, in connection with resistance-coupled amplifiers which generally show the strongest tendency to motorboat, but the circuit may be satisfactorily used with any type of amplifier.

It is not difficult to add this circuit to any existing receiver installation. To do this it is simply necessary to connect the resistance *R* in series with the lead connecting between the B-plus detector terminal on the receiver and the B-plus detector

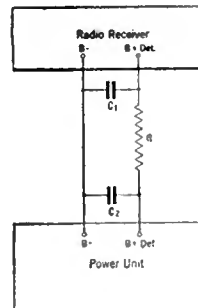

terminal on the power unit. One 2.0-mfd. condenser *C*<sub>1</sub> must then be connected between the B-plus terminal and the B-minus on the receiver and another condenser *C*<sub>2</sub> connected between the B-plus detector and minus B terminal on the power unit. It is preferable to locate the resistance at a point close to the receiver rather than near the power unit.

The value of the resistance depends to some extent upon the characteristics of the receiver and the power unit. With some amplifiers we have found a value of 10,000 ohms to be satisfactory, and with other amplifiers, a resistance of 50,000 to 100,000 ohms was required to prevent motorboating. A value of about 50,000 ohms seems to be satisfactory in most cases.

## No. 194

RADIO BROADCAST Laboratory Information Sheet

June, 1928

### Push-Pull Amplifiers

#### HOWLING

PUSH-PULL type amplifiers in many cases exhibit a tendency to howl at some audio frequency due to feedback through the interelectrode capacity of the tubes. When this occurs it is obviously impossible to obtain satisfactory operation from the amplifier. The howling in push-pull amplifiers can generally be readily prevented by connecting a choke coil or resistance at the point marked *X* in the circuit diagram. When constructing an amplifier of this type it is wise to include such a choke or resistance in the circuit; no by-pass condenser should be placed across the unit.

The inclusion of choke or resistance in this circuit will not affect the quality for this circuit does not have to carry any audio-frequency currents. In some instances it will be found necessary to prevent howling to include also a choke coil in the lead from the center tap of the output transformer and the B-plus terminal of the plate supply.

If a resistance is used in the grid circuit it should have a value of about 50,000 ohms. Since it does not have to carry any current, any ordinary grid leak type of resistance unit may be used. The chokes used may be any type with an inductance of about 10 henries or more. The primary of an old audio-frequency transformer might be used in the grid circuit but is not satisfactory for inclusion in the plate circuit between the center tap of the output transformer and the plate supply for when connected at this point, the choke must carry the plate current of the two tubes, which may be enough to

burn out the windings of an ordinary audio transformer. Use at this point some device designed to carry 50 or 60 milliamperes. The circuit given on this sheet also shows the use of a resistance *R*<sub>1</sub> to supply C bias to the two tubes. Its value, depending upon the type of tubes used, is given below

Type of Tube	<i>R</i> <sub>1</sub>
112-A	750 ohms
171-A	1000 ohms
210	1100 ohms

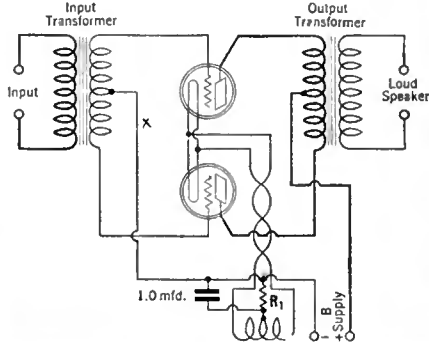



*A  
confidence well  
placed*    †    †    †

In the finest radio receiving and broadcasting equipment, where performance must uphold the manufacturer's integrity, you will find Faradon Capacitors.

It has been demonstrated that Faradon merits acceptance in exacting assignments.

On railroad duty, in Signaling Systems and Automatic Train Control, in Marine Direction Finders—where protection of life and maintenance of operating schedules is essential—there you will find Faradon, the electrostatic condenser of proven reliability.

*Our engineering staff will gladly cooperate on special condenser problems not covered by our regular production of more than 200 types of units*

WIRELESS SPECIALTY APPARATUS COMPANY  
Jamaica Plain, Boston, Mass., U. S. A.  
*Established 1907*

# *Faradon*

*Electrostatic Condensers for All Purposes*

**Cunningham**  
RADIO TUBES

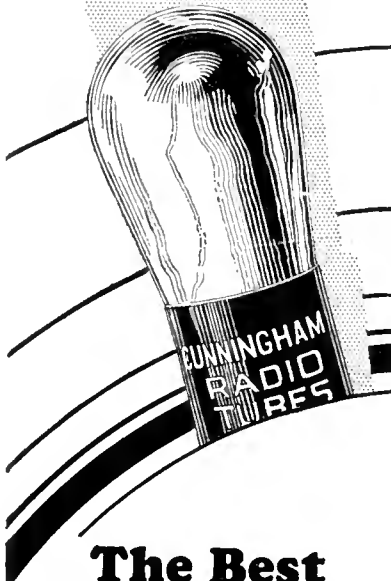

**The Best Guarantee**

of hidden value and unseen protection in a radio tube is in the name

**Cunningham**

—a reputation for quality zealously guarded for thirteen years.

Manufactured and sold under rights, patents and inventions owned and/or controlled by Radio Corporation of America

E. T. CUNNINGHAM, Inc.  
New York Chicago San Francisco

**Since 1915**  
**Standard**  
**for all**  
**Sets**

No. 195

RADIO BROADCAST Laboratory Information Sheet

June, 1928

**A Resistance-Coupled Amplifier With Screen-Grid Tubes**

CONSTRUCTIONAL DATA

THE February, 1927, RADIO BROADCAST reported some experiments made in the Laboratory on the use of the screen-grid tube in audio-frequency and radio-frequency amplifiers, and in the article there appeared a circuit diagram of a resistance-coupled, audio-frequency amplifier using two screen-grid tubes. Many letters have been received requesting constructional data on this amplifier and we have therefore reprinted the circuit diagram on Laboratory Sheet No. 196 and the list of parts necessary to construct the amplifier appears at the end of this Sheet.

The publication of this circuit diagram and list of parts should not be taken to indicate unqualified endorsement of the amplifier for its high voltage gain of 2200 (the voltage gain of an average two-stage transformer coupled amplifier is 250) in some cases will prove more of a disadvantage rather than an advantage. The disadvantage of a high gain audio-frequency amplifier will become evident when an attempt is made to operate it from a B-power unit. When an ordinary amplifier is used with a plate-supply unit which provides hum-free operation no difficulty may ensue; but when this same supply is connected to a high-gain, screen-

grid amplifier, the hum is greatly magnified and may be of entirely too high a value. If the screen-grid tubes are operated from batteries, however, this amplifier will give very satisfactory results.

To construct this amplifier the following parts are necessary:

- R<sub>1</sub>, 0.25-Megohm Resistors
- R<sub>2</sub>, 2.0-Megohm Resistors
- R<sub>3</sub>, 20-Ohm Filament Resistors
- R<sub>4</sub>, 4-Ohm Resistor
- R<sub>5</sub>, 0.1-Megohm Resistor
- C<sub>1</sub>, 0.01-Mfd. Fixed Condensers
- C<sub>2</sub>, 4.0-Mfd. Fixed Condensers
- C<sub>3</sub>, 2.0-Mfd. Bypass Condensers
- Three Sockets
- Binding Posts

No special care is required in the construction of this amplifier although it is wise to arrange the layout so that the various grid and plate leads are short. The condensers C<sub>2</sub> and the resistor R<sub>4</sub> are incorporated in the circuit to prevent the amplifier from motorboating. This circuit will also help to keep the hum low if the device is operated from a B-power unit.

A frequency characteristic curve of this amplifier made in this Laboratory showed it to be flat from 100 to 10,000 cycles.

No. 196

RADIO BROADCAST Laboratory Information Sheet

June, 1928

**Circuit of a Resistance-Coupled Screen-Grid Amplifier**

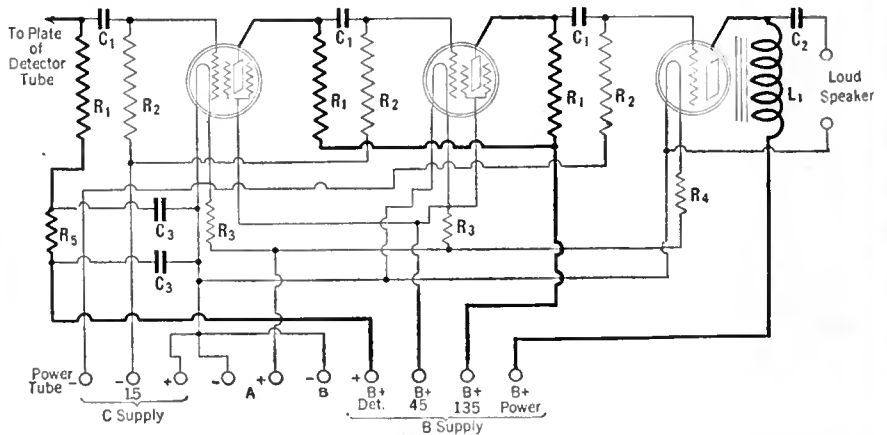

No. 197

RADIO BROADCAST Laboratory Information Sheet

June, 1928

**Amplification Constant**

HOW IT MAY EASILY BE MEASURED

IT IS not difficult with simple apparatus to measure the amplification constant of any tube. The important apparatus required to make such a test are two accurate resistances, one variable, the other fixed, and a milliammeter capable of carrying the normal plate current of the tube under test. The circuit diagram to be followed in making this test is given here. The following parts are used in the circuit:

- E<sub>c</sub>—C-battery with a value correct for the tube under test.
- E<sub>b</sub>—B-battery with a value correct for the tube under test.
- E<sub>a</sub>—Source of filament voltage.
- E—45 volt B-battery.
- R<sub>1</sub>—Filament rheostat.
- R<sub>2</sub>—Accurate 10-ohm resistor.
- R<sub>3</sub>—Accurate variable resistor, having a maximum value of 300 or 400 ohms.
- I—Milliammeter having a maximum range of about 20 milliamperes.
- K—Key to open and close the circuit.

The important resistor in this circuit is R<sub>1</sub> which must be calibrated. A good potentiometer may be used, provided it is supplied with a dial so that the amount of resistance included in the circuit can be calculated. For example, if the potentiometer has a resistance of 400 ohms and the dial reads from 0 to 100 then each degree would include 4 ohms.

The test is conducted as follows. With K open, adjust E<sub>c</sub> and E<sub>b</sub> so that the tube is being operated under the correct conditions of grid and plate voltage. Note the plate current reading. Now depress

K and note the change in the reading of the milliammeter. Adjust R<sub>1</sub> so that as the key is opened and closed no change takes place in the reading of the milliammeter. When resistor, R<sub>1</sub>, has been adjusted so that the plate current remains constant, calculate the amount of resistance at R<sub>1</sub> included in the circuit. Divide this resistance by 10, the value of R<sub>2</sub>, and the quotient will be the amplification constant of the tube.

EXAMPLE: A 201-A type tube is being tested and a balance is obtained when there are 83 ohms included in the circuit at R<sub>1</sub>. Dividing 83 by 10 we get 8.3, the amplification constant of the tube.

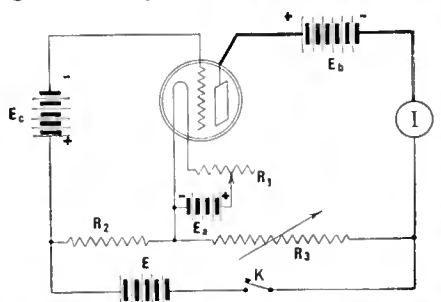



## Concentrated Effort!

IN specializing on and perfecting condensers and resistors which have stood up under every test made to determine their worth, the Aerovox Wireless Corp. has attained a goal made possible only by perfect co-ordination, co-operation, and concentration of every element in an organization devoted exclusively to the production of high quality condensers and resistors.

The Aerovox Research Worker is a free monthly publication that will keep you abreast of the latest developments in Radio. A post card will put you on the mailing list.

**AEROVOX**  
78 WASHINGTON ST.  
BROOKLYN, N. Y.

# PARALLEL PLATE FEED



TYPE 369 IMPEDANCE

A unit suitable for use in parallel plate feed systems.

Price \$5.00

Are you troubled with motor-boating in your audio frequency amplifier—or perhaps you have purchased a pair of really good audio frequency transformers and after placing them in use, find that results are not quite up to your expectations? If your tubes and plate supply are functioning properly your trouble can, in most cases, be eliminated by the use of parallel plate feed. A folder describing the advantages of this system will be sent on request.

# GENERAL RADIO

We welcome your correspondence in regards to technical problems. Bulletin No. 929, describing our complete line of Radio parts, will be sent on request.

30 State St., Cambridge, Mass.

274 Brannan St., San Francisco, Calif.

## Master the Code

Wireless or Morse—at home with the Teleplex Automatic Code Instructor. No better method for self-instruction exists. Quick—Easy—Thorough. Endorsed by U. S. Navy. The only instrument that reproduces actual sending—messages, Radiograms, etc. Any speed. Complete course (6 tapes) FREE. Thirty times as many words as any other instrument. Avail yourself of the Teleplex for a quick mastery of the code. Write for booklet BR. TELEPLEX CO., 76 Cortlandt St., New York.

## BROADCASTING FROM THE INSIDE

EVERY month in RADIO BROADCAST appears the departments "As the Broadcaster Sees It," written by Carl Dwyer, one of the best known broadcast engineers in the country. Alive with humor, orew, apt and searching comment, Mr. Dwyer's writings have become one of the most popular features of radio writing anywhere. Are you reading it? Subscribe by the year and make sure of not missing a single issue. Mail your check for \$4.00 to Subscription Department, Doubleday, Doran & Co., Inc., Garden City, N. Y.



For best performance your tubes require a variable filament control to supply the definite current they need, despite "A" battery variations. AMPERITE is the only self-adjusting and automatic filament tube control that does this. Takes the "guess," inconvenience and unsightliness out of panel rheostats. Simplifies wiring, panel design, and tuning. Prolongs tube life. Order by name. Accept nothing else. Price \$1.10 mounted (in U. S. A.). For sale by all dealers. Write for FREE "AMPERITE BOOK" of season's best circuits and latest construction data. Address Dept. R.B.-6.

RADIALL COMPANY  
50 Franklin St., New York

**AMPERITE**  
The "SELF-ADJUSTING" Rheostat

This is a good time to subscribe for RADIO BROADCAST Through your dealer or direct, by the year only \$4.00 DOUBLEDAY, DORAN & COMPANY, Inc., Garden City, N. Y.

## RADIO PANELS

BAKELITE—HARD RUBBER  
Cut, drilled and engraved to order. Send rough sketch for estimate. Our complete Catalog on Panels, Tubes and Rods—all of genuine bakelite or Hard Rubber—mailed on request.

STARRETT MFG. CO.  
521 S. Green Street Chicago, Ill.

## Fixed Voltage means Variable Resistance!

Variables exist in any radio circuit. You correct them by changing the controlling resistance. If you want fixed voltages, use the

# CLAROSTAT

Reg. U. S. Pat. Office



1928 Edition, complete, up-to-date. Full information on A. C. and Screen Grid Tubes. Over 900 pages, 1025 illustrations. For Service and Repair Men, Dealers, Salesmen, Experimenters and Designers. At dealers or by mail, \$6.00.

FREDERICK J. DRAKE & CO. PUBLISHERS  
10135 Michigan Ave. Chicago

# FROST RADIO



FROST-RADIO

## Frost Variable High Resistances

Think of a variable high resistance with a marvelously smooth regulation over entire range of resistance strip, free from friction and almost totally without wear, due to roller contact arm. No jerks—no jumps—no dead spots—no sudden increases or decreases in volume. Just stepless, perfect regulation. Has Bakelite shell and cover, and engraved Bakelite pointer knob. Adopted as standard by leading set manufacturers, and countless thousands are in use in home built sets. Supplied in two or three terminal type, in wide range of resistances from 2,000 to 500,000 ohms, and with or without switch. 2 or 3 Terminal Type, less switch, \$1.75. 2 or 3 Terminal Type, with switch, \$2.10.

HERBERT H. FROST, INC.  
Main Offices and Factory  
Elkhart, Ind.





## A New A C Transformer with terminals for use with all types of Wiring Harnesses

Here is the latest A C success in the Dongan Approved A C line No. 6570, built into a crystalized lacquered case, is equipped with terminals for use with the new wiring harnesses. Designed to operate with 4 UX 226, 1 UY 227 and 1 UX 171 power amplifier tubes. Also equipped with lamp cord and plug outlet for Beliminitor as well as tap for control switch. Price \$6.50.

## A Complete Line of Approved A C and Output Transformers By-Pass and Filter Type Condensers

for Set Manufacturers  
and Custom Set Builders

The reason you can expect real engineering help as well as par in modern design and construction is due to the fact that Dongan's entire radio business always has been devoted exclusively to the interest of the set manufacturer.

Ask for information and prices, on any desired type, direct from Dongan to you.

See the Dongan Parts Exhibit at the R. M. A. Show

**DONGAN ELECTRIC MFG. CO.**

2991-3001 Franklin St. Detroit, Michigan

TRANSFORMERS of MERIT for FIFTEEN YEARS

## Jenkins & Adair Condenser Transmitter



For Broadcasting, Phonograph  
Recording, and  
Power Speaker Systems

THIS transmitter is a small condenser which varies its capacity at voice frequency, and is coupled direct into a single stage of amplification, contained in the cast aluminum case. The output, reduced to 200 ohms, couples to the usual input amplifier. The complete transmitter may be mounted on the regulation microphone stand. It operates on 180 v. B and 6 or 12 v. A battery.

This transmitter contains no carbon, and is entirely free from background noise. Its yearly upkeep is practically nothing. It is extremely rugged, and will withstand hard usage.

Price, complete with 20 ft. shielded cable, \$225.00 F.O.B. Chicago.

J. E. JENKINS & S. E. ADAIR, Engineers  
1500 N. Dearborn Parkway,  
Chicago, U. S. A.

Send for our bulletins on Broadcasting  
Equipment

No. 198

RADIO BROADCAST Laboratory Information Sheet

June, 1928

## The Screen-Grid Tube as an R. F. Amplifier

CALCULATING GAIN

**PROBLEM:**—Suppose that we have a radio-frequency amplifier connected as indicated in the figure and that a screen-grid tube is used. How can we calculate the amplification that can be obtained?

**SOLUTION:**—To solve the problem we must make use of the tube constant known as the mutual conductance, which, for the screen-grid tube, has a value of about 350 micromhos or 0.000350 mhos. The mutual conductance  $G_m$  by definition,

$$G_m = \frac{I_{ac}}{E_g} \quad (1)$$

where  $G_m$  is the mutual conductance in mhos;  $I_{ac}$  is the alternating current flowing in the plate circuit;  $E_g$  is the alternating voltage impressed in the grid; transposing this equation we get

$$I_{ac} = G_m \times E_g \quad (2)$$

The voltage  $E_t$  across the tuned circuit is equal to the impedance of the circuit  $Z$  times the current through it

$$E_t = I_{ac} \times Z \quad (3)$$

and therefore

$$E_t = G_m \times E_g \times Z \quad (4)$$

The amplification of the circuit is equal to the voltage across the output  $E_t$  divided by the voltage

across the input  $E_g$ . Transposing equation (4) to get this ratio we obtain

$$\frac{E_t}{E_g} = G_m \times Z \quad (5)$$

This equation shows that the gain of this circuit using a screen-grid tube is simply equal to the mutual conductance of the tube in mhos, times the effective impedance of the tuned circuit.

Therefore, if we know the impedance into which the tube is working, we can, by multiplying the impedance by  $G_m$ , obtain the amplification. If the tuned circuit at resonance has an effective impedance of 100,000 ohms then the amplification would be

$$\text{Amplification} = 0.000350 \times 100,000 = 35$$

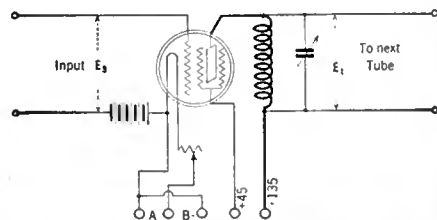

No. 199

RADIO BROADCAST Laboratory Information Sheet

June, 1928

## Current

ITS DIRECTION OF FLOW

THE direction of flow of current around a simple circuit consisting of a battery and a resistance is generally considered to be as indicated by the solid arrows in sketch A on this sheet. As indicated, the current is thought of as flowing out of the positive terminal of the battery, through the resistance and into the negative terminal of the battery.

Now let us look at the circuit of a vacuum tube, as indicated in sketch B. In this circuit we would assume that the current would flow as indicated by the solid arrow,  $i, e.,$  out of the positive terminal through the tube and into the negative terminal just as it did in circuit A. However, we know that the filament of the tube is the electron-emitting substance and that the electron flow is from the filament to the plate. Apparently we have two currents flowing in the circuit, and this has led some experimenters to believe that there were two distinct currents flowing in the circuit, one the battery current and the other the electron current. This is not so and there is only one current flowing in the circuit, the electron circuit.

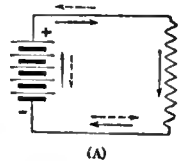

The idea that the electric current flows from the positive to the negative originated before anything was known about electrons. This direction of flow has since been proved to be wrong. It is now realized that an electric current is actually a flow of electrons and that electrons, being negatively charged, flow toward the point of positive potential. Therefore the actual flow of current in the tube circuit B and the battery circuit A is as indicated by the dotted arrows.

Fortunately the incorrect assumption that was made years ago for the direction of the flow of current is not important in the solution of electrical problems so long as we remain consistent regarding the direction in which the current is assumed to flow.

Many meters used in electricity are marked with plus and negative signs and the winding of the meter is arranged so that the pointer on the meter will deflect in the right direction when the positive terminal of the meter is connected to the more positive part of the circuit.

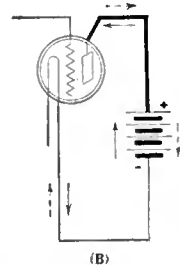

No. 200

RADIO BROADCAST Laboratory Information Sheet

June, 1928

## Resistors

DETERMINING WHAT SIZE TO USE

IN CHOOSING a resistance for any particular purpose it is necessary to determine the value required, the current it must carry and then from these two facts determine the wattage rating required. The chart published on this sheet will prove useful to determine:

- (a) the wattage rating a resistor must have to carry a given current
- (b) the current a resistor, of given wattage rating, will carry

The curve is plotted to cover resistors up to 10,000 ohms and wattage ratings up to 5 watts.

**EXAMPLE:** A resistor is to be used to supply C-bias to a 171-A type tube. The plate current of the tube (which must flow through the resistor) is 20 milliamperes. The required C-bias voltage is 40 volts. What value of resistance and what wattage rating should the resistor have?

To calculate the required value of resistance we use Ohm's law.

$$\begin{aligned} \text{Resistance} &= \frac{\text{Voltage}}{\text{Current in amperes}} \\ &= \frac{40}{0.020} \\ &= 2000 \text{ ohms} \end{aligned}$$

Referring to the chart below, we find that the vertical line corresponding to 2000 ohms crosses the horizontal line corresponding to 0.020 amperes (20 milliamperes) at the point indicated between the curves of 1.0 and 0.25 watt resistors. In such a case we must, of course, always use the larger size and therefore in this case we should use the 1.0-watt resistor.

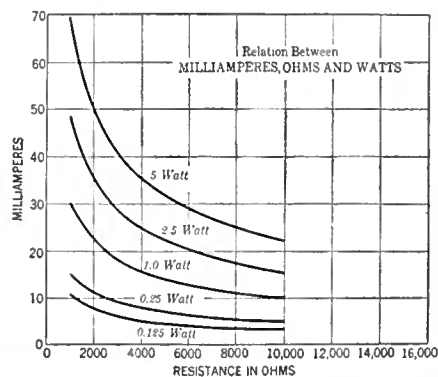



STATEMENT OF THE OWNERSHIP, MANAGEMENT, CIRCULATION, ETC., required by the Act of Congress of August 24, 1912, of RADIO BROADCAST, published monthly at Garden City, New York for April 1, 1928. State of New York, County of Nassau.

Before me, a Notary Public in and for the State and County aforesaid, personally appeared John J. Hessian, who, having been duly sworn according to law, deposes and says that he is the treasurer of Doubleday, Doran & Co., Inc., owners of Radio Broadcast and that the following is, to the best of his knowledge and belief, a true statement of the ownership, management (and if a daily paper, the circulation), etc., of the aforesaid publication for the date shown in the above caption, required by the Act of August 24, 1912, embodied in section 411, Postal Laws and Regulations, printed on the reverse of this form, to wit:

1. That the names and addresses of the publisher, editor, managing editor, and business managers are: *Publisher*, Doubleday, Doran & Co., Inc., Garden City, N. Y.; *Editor*, Willis Wing, Garden City, N. Y.; *Business Managers*, Doubleday, Doran & Co., Inc., Garden City, N. Y.

2. That the owner is: (If owned by a corporation, its name and address must be stated and also immediately thereunder the names and addresses of stockholders owning or holding one per cent. or more of total amount of stock. If not owned by a corporation, the names and addresses of the individual owners must be given. If owned by a firm, company, or other unincorporated concern, its name and address, as well as those of each individual member, must be given.) F. N. Doubleday, Garden City, N. Y.; Nelson Doubleday, Garden City, N. Y.; S. A. Everitt, Garden City, N. Y.; Russell Doubleday, Garden City, N. Y.; George H. Doran, 244 Madison Avenue, N. Y. C.; George H. Doran, Trustee for M. N. Doran, 244 Madison Avenue, N. Y. C.; John J. Hessian, Garden City, N. Y.; Dorothy D. Babcock, Oyster Bay, N. Y.; Alice De Graff, Oyster Bay, N. Y.; Florence Van Wyck Doubleday, Oyster Bay, N. Y.; F. N. Doubleday or Russell Doubleday, Trustee for Florence Doubleday, Garden City, N. Y.; Janet Doubleday, Glen Cove, N. Y.; W. Herbert Eaton, Garden City, N. Y.; S. A. Everitt or John J. Hessian, Trustee for Josephine Everitt, Garden City, N. Y.; William I. Neal, Garden City, N. Y.; Daniel W. Nye, Garden City, N. Y.; E. French Strother, Garden City, N. Y.; Henry L. Jones, 244 Madison Ave., N. Y. C.; W. F. Etherington, 50 East 42nd St., N. Y. C.; Stanley M. Rinehart, Jr., 1192 Park Ave., N. Y. C.

3. That the known bondholders, mortgagees, and other security holders owning or holding 1 per cent. or more of total amount of bonds, mortgages, or other securities are: (If there are none, so state.) NONE.

4. That the two paragraphs next above, giving the names of the owners, stockholders, and security holders, if any, contain not only the list of stockholders and security holders as they appear upon the books of the company but also, in cases where the stockholder or security holder appears upon the books of the company as trustee or in any other fiduciary relation, the name of the person or corporation for whom such trustee is acting, is given; also that the said two paragraphs contain statements embracing affiant's full knowledge and belief as to the circumstances and conditions under which stockholders and security holders who do not appear upon the books of the company as trustees, hold stock and securities in a capacity other than that of a bona fide owner; and this affiant has no reason to believe that any other person, association, or corporation has any interest direct or indirect in the said stock, bonds, or other securities than as so stated by him.

5. That the average number of copies of each issue of this publication sold or distributed, through the mails or otherwise, to paid subscribers during the six months preceding the date shown above is: . . . . (This information is required from daily publications only.)

(Signed) DOUBLEDAY, DORAN & COMPANY, Inc.  
By John J. Hessian, *Treasurer*.

Sworn to and subscribed before me this 15th day of March, 1928.

[SEAL] (Signed) Frank O'Sullivan  
(My commission expires March 30, 1928.)

Why not subscribe to *Radio Broadcast*? By the year only \$4.00; or two years \$6.00, saving \$2.40. Send direct to Doubleday, Doran & Company, Garden City, New York.



## RADIO INVENTIONS WANTED

The world needs radio inventions. One idea may make you rich. A new book by Raymond F. Tate contains a list of 99 needed Radio Inventions. Don't spend time and effort on worthless inventions. Concentrate on the NEEDED inventions, described in this book.

### 101 OTHER NEEDED INVENTIONS

are also described, including Automotive, Electrical, Auto, Mechanical, Chemical. Over 100 pages, durably bound. Send no money. Cut out this advertisement and send it to us with your name and address plainly written, and your copy of this remarkable book will be sent immediately. Pay the postage only \$1.25 plus postage on arrival. Money back after 10 days' examination if desired. Limited edition. Write NOW. (Outside U. S. \$1.50 each with order.) BUREAU OF INVENTIVE SCIENCE, Dept. 466, Rochester, N. Y.



## Do You Buy Satisfaction?

After all, it is the satisfaction you expect to derive from it that causes you to buy any product. It may be satisfaction obtained from the use of the device, or satisfaction from pride of ownership.

Owners of the Jewell Pattern No. 139 high resistance voltmeter for the set owner find satisfaction both from use and pride of ownership, for the use of this instrument brings

assurance of accurate results and its appearance will be an attractive addition to any radio set.

Pattern No. 139 is of the D'Arsonval moving coil type with high internal resistance requiring little current draw, with results much more accurate than obtained with the ordinary type of voltmeter. The range is 0-300 volts. Movement parts are all silvered, and the scale is silver etched with black characters.

Description and price of this instrument are given in a special circular No. 1103. Write for a copy.



Pattern No. 139  
High Resistance Voltmeter—For the Set Owner

### Jewell Electrical Instrument Company

1650 Walnut Street, Chicago

"28 Years Making Good Instruments"

### Follow the Radio Leaders!

Those who know the value of micrometric resistance—precisely matched to radio conditions—always specify not merely variable resistance but—

## CLAROSTAT

Reg. U. S.

Pat. Office

### ROBERT S. KRUSE

Consultant and Technical Writer

103 Mesdowbrook Road, West Hartford, Conn.

Telephone Hartford 45327

This is a good time to subscribe for

### RADIO BROADCAST

Through your dealer or direct, by the year only \$4.00



## Play Safe with PARVOLTS

Bypass and Filter Condensers in all MFD capacities and standard working voltages. At all good dealers. The ACME WIRE CO., New Haven, Conn.

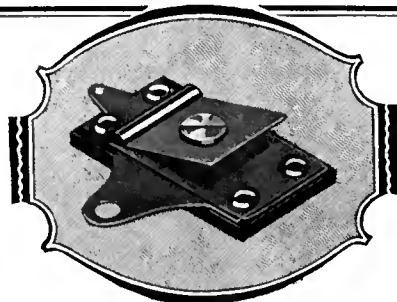
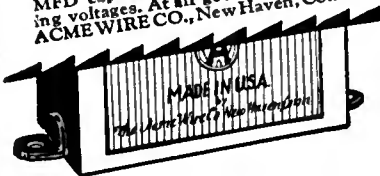

### The Improved

## HAMMARLUND Equalizing Condenser

Greatly simplified, more compact and more sturdily constructed than the previous model.

The fixed plate of brass, the mica dielectric and the movable phosphor-bronze spring plate are firmly riveted to the Bakelite base and cannot short. The adjusting screw gives a wide capacity variation.

## Always Improving!

EVER seeking ways to better its products and to reduce their cost—that is the Hammarlund purpose.

But *quality first* is the Hammarlund ideal, steadfastly maintained for 18 years.

Whatever radio parts you may need—condensers, coils, chokes, dials or shields, ask for Hammarlund first.

It is the safe way to insure satisfaction.

Interested in low-wave reception? Write for special folder.

HAMMARLUND MFG. CO.  
424-438 West 33rd Street New York



## New Aero Circuits for Either Battery or A. C. Operation

Proper constants for A. C. operation of the Improved Aero-Dyne 6 and the Aero Seven have been studied out, and these excellent circuits are now adaptable to either A. C. or battery operation. A. C. blue prints are packed in foundation units. They may also be obtained by sending 25c for each direct to the factory.



### Aero Universal Tuned Radio Frequency Kit

Especially designed for the Improved Aero-Dyne 6. Kit consists of 4 twice-matched units. Adaptable to 201-A, 199, 112, and the new 230 and A. C. Tubes. Tuning range below 200 to above 550 meters.

Code No. U-16 (for .0005 Cond.) ..... \$15.00  
Code No. U-163 (for .00035 Cond.) ..... 15.00



### Aero Seven Tuned Radio Frequency Kit

Especially designed for the Aero 7. Kit consists of 3 twice-matched units. Coils are wound on Bakelite skeleton forms, assuring a 95 per cent. air dielectric. Tuning range from below 200 to above 550 meters. Adaptable to 210-A, 199, 112, and the new 210 and A. C. Tubes.

Code No. U-12 (for .0005 Cond.) ..... \$12.00  
Code No. U-123 (for .00035 Cond.) ..... 12.00

*You should be able to get any of the above Aero Coils and parts from your dealer. If he should be out of stock order direct from the factory.*

**AERO PRODUCTS, INC.**

1772 Wilson Ave. Dept. 109 Chicago, Ill.

## YAXLEY APPROVED RADIO PRODUCTS



### Radio Convenience Outlets

Wire your home for radio. These outlets fit any standard switch box. Full instructions with each outlet.

No. 135—For Loud Speaker . . . \$1.00  
No. 137—For Battery Connections 2.50  
No. 136—For Aerial and Ground 1.00

#### With Bakelite Plates

Now furnished with a rich satin brown Bakelite plate, with beautiful markings to harmonize, at 25 cents extra. See illustration.

At Your Dealers

**Yaxley Mfg. Company**  
Dept. B, 9 So. Clinton St.  
Chicago, Ill.

## TOBE

### A-FILTER

Here is a new kind of DRY and HUM-LESS A-FILTER, ready to hook onto any 6 volt charger, to convert your filament supply to A. C. No harnesses, no new tubes required. Clip this ad. and send with your name and address today for pamphlet B-5.



**TOBE DEUTSCHMANN CO.**  
CAMBRIDGE, MASS.

# The Haven of a Sea-Going Audion

By **RAYMOND TRAVERS**

**L**IFE on Teraina (Washington Island) was one of complete detachment from all the rest of the world. After a thrilling ride through the surf and a safe landing on the beach, a strange sense of having been abandoned comes over you. This is followed, after a few days by a feeling of emancipation. At last life is freed from its great complications, and the mad existence of the cities is but a hazy thing of the past. Living is simplified to the fundamentals. Sleep is not only a matter of the nights but is indulged in during the hot noon-day. Food comes from cans without fuss or garnish. Eating is a necessity—not a habit. Everyone has work to perform and in so doing is called upon to exercise feats of ingenuity beyond belief. There isn't any assistance around the corner. Further and further into the background of the mind fades the worlds beyond the horizon, and greater becomes the content with the life at hand.

The steamer from Honolulu arrived about every four months (once it was nine!) and brought mail, excitement, and grief, most times. For the few days the little ship lay off the island, unloaded its cargo of food and supplies, and took aboard the tons of copra we had laboriously gathered, conditions ashore were in a state of crazy confusion. The mail had to be sorted for matters of great importance requiring immediate reply; the supplies to be checked and examined, some to be returned or complained about; sometimes distinguished guests to be entertained, when every minute was so vital to personal affairs. At last the sailing hour arrives, the ship disappears, and the last surf boat is hauled ashore. There are weary sighs, some cursing, a few drinks of gin and coconut, and a prayer that the blooming ship will never return!

Tabueran (Fanning Island) and Teraina (Washington Island), are British possessions, situated one thousand miles directly south of Honolulu, about three degrees north of the Equator, and five thousand miles west of Panama. The finest copra in the world is natted here, but never in large quantities, because the major parts of both islands are wild, prohibiting maximum crops and efficient collection. In 1917 an Englishman was sent from London to place Washington Island on a more modern operating basis and increase production.

At Fanning is located the relay station on the

**O**N THE sands behind the coral reefs of Washington Island, in the Pacific South Seas, a thousand miles south of Honolulu and five thousand miles west of Panama, an audion bulb was picked up some years ago. There was a radio telegraph station at Washington Island, and R. A. Travers was the operator. He saw the audion bulb, recognized the handiwork of the inventor, and that night put the bulb in the mail, with the following letter:

WASHINGTON ISLAND.  
VIA HONOLULU AND FANNING ISLAND  
December 1, 1919.

Dr. Lee DeForest,  
New York City.

Dear Doctor DeForest:

I am sending you by parcel post an interesting valve I believe to be one of you pre-war types. . . . This valve traveled many miles through the Pacific ocean, bobbed over a coral reef, and came to rest on the sands of this island. . . . Washington island is a wee spot in the wide Pacific, having less than a dozen miles of coast. . . . From wreckage picked up from time to time, it appears drifting objects come from the eastward. . . . I believe this valve will be of interest in your collection.

R. A. TRAVERS.

The foregoing paragraphs appeared in an article in the November, 1925, RADIO BROADCAST as introduction to part of the history of Dr. Lee DeForest. Mr. Travers here writes his side of the story and gives an interesting description and more details of this "wee spot in the wide Pacific" where the "lost audion" was found.



WASHINGTON ISLAND IN THE SOUTH PACIFIC

Here the author found the audion which had drifted thousands of miles—from where?

Pacific Cable Board's Canadian-Australian lines. The cable from Fanning to Bamfield, British Columbia, is the longest in the world, running from the warm waters of the tropics into the slate gray, choppy and cold shallows of the north—five thousand miles! All important communications between England and the Colonies were routed over this cable, and so we find one of the notorious German raiders terrorizing the South Pacific, slipping ashore at Fanning, and with some well placed dynamite, enlarging the area covered by the cable buildings. Off-shore the cable was cut. This may have had

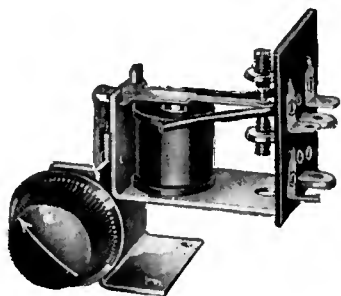

**BRACH  
RAYFOTO  
RELAY**

*Used Exclusively  
in the*

**COOLEY  
Rayfoto Receiver**

*Approved by*  
**A. G. COOLEY**

*For Further Information Address*  
**L. S. BRACH  
MFG. CORP.**  
ENGINEERS AND MANUFACTURERS  
NEWARK N. J. U. S. A. TORONTO, CAN.

**THE HAVEN OF A SEA-GOING  
AUDION**

*(continued from page 116)*

something to do with the fact that in May, 1917, I left San Francisco with two 3 kw. wireless sets for the islands. A naval operator came from Sydney Navy Yard to take over Fanning and I proceeded to Washington. The grief and struggle of construction is another tale.

A manager, bookkeeper, doctor, surveyor, two half-caste overseers, myself, and about two-hundred natives set about building a settlement and at the same time gathering copra. The replacing of thatched huts by modern cottages occupied many months of labor. Every Sunday morning at about eleven o'clock, the Staff assembled and in a very dignified manner made an inspection of all work and of the native quarters. To the manager this was a serious affair executed with military severity, but to the others it was a joke, and much playing took place behind his back. A match on the floor or under a native's house was sufficient to have the offender arrested and brought before "Court" Sunday evening. Many amusing situations developed in "Court" and often the stern manager-judge "lost face". There was the case of Kabuta who refused to clean his house unless he was paid overtime for so doing. He contended that, as the house belonged to "The Company" he should be paid for keeping it clean. This brought about an impasse, and he was arbitrarily ordered to polish it up if he expected to live in it. The following morning native police reported Kabuta had not slept in his house and was absent from camp. This violated two more rules. Kabuta stated he had spent the night sleeping on boxes of dynamite in a lean-to, about a mile up the beach, where cleaning wasn't necessary.

DISCOVERING THE AUDION

ON THE morning of September 16, 1917, I experienced the same sensation as the man who saw the giraffe for the first time and exclaimed, "There isn't any such animal!" The usual inspection was in progress, and the average number of arrests being made, when my attention was attracted to a little glass ball suspended from the rafters in a native's room. Wrinkling my nose in native fashion point, I asked of the fellow squatting on the floor, "Terrah?" He shrugged his shoulders up around his ears and with a puzzled expression on his chocolate features replied, "Ungcome!" I extended my hand for the thing and he passed it to me. Imagine my astonishment to find that it was a DeForest Audion, the first I had ever seen, but recognized from pictures. I wanted to know where the native had found it and he said, "Ay naka may en tardy," ("It came here from the sea.") He had picked it up while walking along the beach and thought it a pretty bauble.

There is a native custom which forces one to give up an object if the other party desiring it merely begs for it saying, "Now! Ye pacheco." In this manner I became the owner of the tube, one of the strangest and most fragile bits ever cast ashore by the pounding seas.

Remember that this was in 1917 and I doubt if there was a handful of these tubes in the entire territory contiguous to the Pacific Ocean. Some tubular shaped Audiotrons, made in Berkeley, California, were being used. I had a dozen myself.

The question as to where this Audion could have come from was a difficult one to answer. Teraina was 900 miles from the Australian sealanes and 1800 miles from the courses to Tahiti. Honolulu was the nearest port and that was a

*(continued on page 118)*



**RADIO  
DEALERS**

Send for our catalog illustrating the products of over 100 radio manufacturers.

**WHOLESALE ONLY!**

**F. D. PITTS COMPANY**  
219-223 Columbus Ave.  
BOSTON, MASS., U. S. A.  
*Established 1919*

**Don't Gamble on RESISTANCE**

Poor radio results are generally due to incorrect resistance values or defective resistances. If you would avoid gambling, just remember—

**CLAROSTAT**

Reg. U. S.

Pat. Office

**Read Radio Broadcast**

every month. You can't afford to miss an issue. Order your copy from your Newsdealer or Radio Store. If you wish to subscribe direct send \$4.00 for one year or \$6.00 for two years.

**DOUBLEDAY, DORAN & COMPANY, Inc.**  
Garden City, N. Y.

**Big, New  
Summer Radio  
Catalog**

*Dealers — Set Builders — Agents*

Write for this Catalog. New Summer and Fall Book. Save money on newest hookups, sets, kits, parts, accessories at lowest prices.

*The "Big, Friendly Radio House"*

**WESTERN RADIO MFG.  
COMPANY**

126 W. Lake St. Dept. 46 Chicago, Ill.

**AMERTRAN  
DE LUXE**

First Stage turn ratio 3 } \$10.00  
Second Stage turn ratio 4 } Each

**Standard of Excellence in  
Audio Amplification**

AmerTran De Luxe Transformers are but two of more than 30 quality Radio Products bearing the name AmerTran, including power transformers, choke coils, push-pull systems and allied products. Each AmerTran device is designed for a specific use. Full and authoritative information will be given on any audio or power problem.

**AMERICAN TRANSFORMER COMPANY**  
*Transformer Manufacturers for 28 Years*  
121 Emmet St., Newark, N. J.

Model  
537

Makes  
every  
required  
test

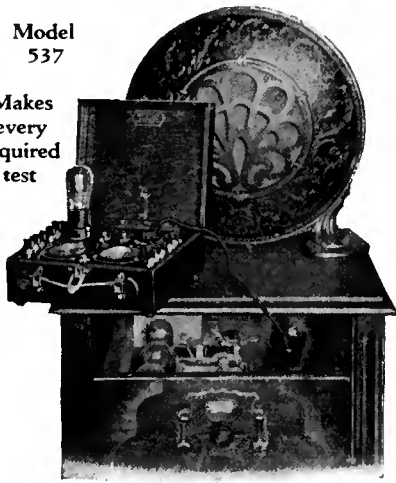

## A. C. and D. C. Set Tester

This "Universal" self-contained outfit is all the service man needs for testing every kind of receiver made. No other equipment necessary. The outfit consists of two 3-1/4" special instruments giving all the required A. C. and D. C. readings under actual operating conditions.

WESTON ELECTRICAL INSTRUMENT CORP.  
604 Feelinghuysen Avenue, Newark, N. J.

# WESTON RADIO INSTRUMENTS

Order your copy of *Radio Broadcast* from your news dealer or radio store. Make sure that he reserves a copy for you each month. If your favorite radio store does not stock the magazine write us giving name of radio dealer and address.

## Resistance for Every Need!

Volume Control, Grid Leak, Standard (Universal Range), Power, Table Type, Duplex—there is one for every radio purpose when you use

# CLAROSTAT

Reg. U. S.

Pat. Office

## AERO Corona Coil Used in New Cooley "Rayfoto"

Of course the new Cooley "Rayfoto" uses an AERO Inductance Coil. This special coil is designed to meet the exact specifications of A. G. Cooley, whose "Rayfoto" receiver so many experimenters will build. For every inductance requirement AERO Coils are proved best—by experts and amateurs as well. Always specify AERO Coils if you want the finest in radio performance.

AERO PRODUCTS, Inc.  
1722 Wilson Avenue Chicago, Ill.

## Convenient and Reliable

The convenience of variable or adjustable resistance has never been questioned. It has been a matter of reliability and noiseless operation. You get both in the

# CLAROSTAT

Reg. U. S.

Pat. Office

## THE HAVEN OF A SEA-GOING AUDION

(continued from page 117)

thousand miles to the north'ard. Allowing a drift of but a few miles a day, many months must have passed and miles unwound from the point of departure until riding the surf, this tiny glass bulb found rest on the sands at Teraina. Study of other drift material offered the only opportunity for conjecture.

Cocoanuts are supposed to have come from Central America and vegetated throughout the South Pacific. While digging an irrigation canal on Washington Island, an old Manahikian canoe was found. It was quite a distance inland from the present shore of the lake and buried in gravel, which undoubtedly was the old lagoon beach, before the present lake was formed by the lagoon's closing. The bow is in good condition and now occupies a prominent position in the Bishop Museum, Honolulu. There are legends told by the old men of Manahiki, about travels to Teraina in great canoes. One tale recites how the King of Manahiki, angered at some of his people who refused to return from Teraina, cursed them and cried for a tidal wave to wipe out the rebel village. The canoe is pointed out as evidence of Manahikian occupation and the closed lagoon as the fulfillment of the curse.

Of more recent date is a load of lumber consigned to A. P. McDonald, Tahiti. This must have been washed overboard from some schooner and found its way to Fanning and Washington. Fanning is 75 miles to the southeast of Washington. The lighter pieces came ashore at Washington while all the great, heavy beams piled up on Fanning, without exception. The British Commissioner at Fanning seized the lumber for his new house, quoting a law some hundreds of years old, which claims everything from the sea for the Crown.

Standard Oil Barge No. 95 almost foundered off the coast of lower California. Everything on deck was swept away. A year and a half later, one of her steel lifeboats, buoyed by the airtight compartments in bow and stern, majestically floated past our island. An object resembling a human head was visible, silhouetted against the bright noon-day sky. Dave Greig, the overseer, and I were the only ones at the settlement, except the cooks and store boys. Greig launched a small fishing boat and started to run down the visitor. What suspense as I stood on the beach and watched him overtake the lifeboat! Then he gave me the prearranged signal that there wasn't any one aboard. After quite a struggle against the strong current, Greig succeeded in bringing the boat ashore. We were surprised to find it nearly full of water and with a great many fish of all sizes swimming about. The bottom was filled with fish bones, who had perhaps served as food for later comers. Many of the bones were from large sharks. This craft must have come at least 5000 miles, and as it is highly improbable that it traveled anything like a straight course, the distance must have been many times that.

All of this drift has been from the eastward and in each case, except the audion, a point of origin is known. It is possible that the DeForest wanderer started somewhere in the Atlantic, bobbed through the Canal, crossed the Pacific, and came to rest, at last, on the beach at Teraina. This is not any more difficult to believe, than the mere fact that it came out of the sea, over a rocky reef, to the beach—a beach whose entire length is but eleven miles, situated in mid-Pacific where distances are measured in thousands of miles!

The cocoanuts, the canoe, the lumber, the lifeboat, and the DeForest Audion—symbols of an age, and slender threads from other worlds—to peaceful, detached Teraina!

## MICROPHONE



THIS SIZE \$1.00

Many Radio Sets are now out of date because they do not include the latest improvements. To meet the popular demand and bring a fair price every radio receiver should be made with a microphone transmitter through which to talk, sing, play the piano, violin, phonograph, band, orchestra or any musical instrument by the loud speaker, in the room, or any distance away.

No additional coils, magnets, or batteries are needed to make a player radio receiver, or change one that is already made into a player radio, they are already there, and it is only necessary to connect a phone cord to the screw eye on each side of the Baby Mike Transmitter and plug it into the detector circuit as shown in the plain printed directions with each microphone and sent by sealed letter for \$1.00. With cord, \$1.25. With cord and plug, \$1.50. Special socket adapter 50c. extra. Interesting circular free. DON'T buy a radio until you hear from us.

The ELECTRIC Specialty Co.  
309 Phillips St. Box 244 Helena, Ark.

This is a good time to subscribe for

RADIO BROADCAST

Through your dealer or direct, by the year only \$4.00

DOUBLEDAY, DORAN & CO., INC. GARDEN CITY, N. Y.

## Build for Permanence — Cardwell FOR Condensers

CARDWELL TAPER PLATE CONDENSERS (unbelievably rigid—best for short waves) and other receiving condensers in many capacities.—TRANSMITTING CONDENSERS for Amateur, broadcasting and commercial use—AIR DIELECTRIC FIXED CONDENSERS—ULTRA HIGH VOLTAGE TRANSMITTING CONDENSERS—Standard or built to fit your exact requirements.

WRITE FOR LITERATURE OR  
STATE YOUR REQUIREMENTS

The Allen D. Cardwell Mfg. Corp.  
81 Prospect Street Dept. B Brooklyn, N. Y.

## SHIELD GRID BOOSTER

This little device will inject almost undreamed of pep into almost any receiver and is ready for instant attachment. Price assembled \$25. Essential parts \$17.

Write for information on the entire Browning-Drake line, now complete with sets, kit parts, and a wonderful loud speaker.

Browning-Drake Corp.  
CAMBRIDGE, MASS.



# FROST RADIO



**FROST-RADIO**

## Frost Variable High Resistances

Think of a variable high resistance with a marvelously smooth regulation over entire range of resistance strip, free from friction and almost totally without wear, due to roller contact arm. No jerks—no jumps—no dead spots—no sudden increases or decreases in volume. Just stepless, perfect regulation. Has Bakelite shell and cover, and engraved Bakelite pointer knob. Adopted as standard by leading set manufacturers, and countless thousands are in use in home built sets. Supplied in two or three terminal type, in wide range of resistances from 2,000 to 500,000 ohms, and with or without switch. 2 or 3 Terminal Type, less switch, \$1.75. 2 or 3 Terminal Type, with switch, \$2.10.

**HERBERT H. FROST, INC.**  
Main Offices and Factory  
Elkhart, Ind.

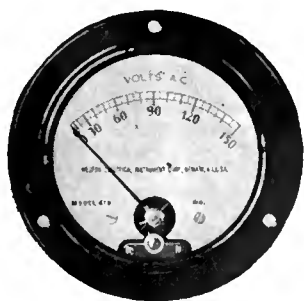

## The Greatest Money Value in Matched Instruments

Electrical units of measurement are not subject to change. But electrical quantities can, and do, vary widely when measured with unreliable instruments.

Why gamble with inferior products when Weston instruments insure life-time accuracy at a very moderate cost?

Moreover, the use of *bargain* instruments sooner or later results in ruined equipment and big repair bills.

Think before you buy, and then buy *dependability*. Write for Circular J on Weston Radio Instruments.

Weston Electrical Instrument Corp.  
604 Frelinghuysen Ave., Newark, N. J.

# WESTON RADIO INSTRUMENTS

# A New and Better SHORT WAVE RECEIVER

## The Aero International Four

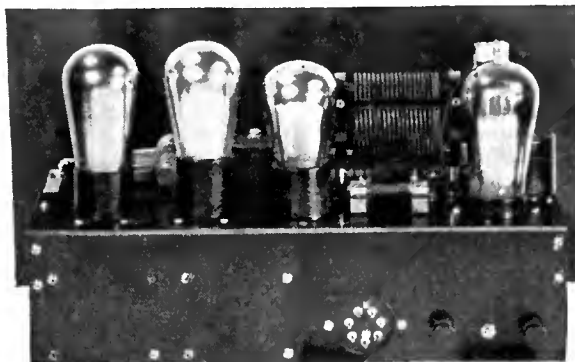

(Rear Panel View)

### NOTICE

We can furnish all parts for this new receiver, including foundation unit, direct from factory. Write for information and complete kit price list.

These are the new Aero L. W. T. Coils used in the Aero International Four. Read about them below—then plan to build this superlative set at once!

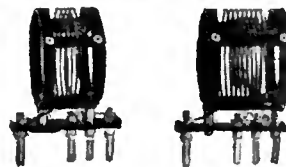

**T**HE new Aero "International Four" Receiver marks a distinct milestone in radio progress.

For the first time, radio frequency amplification on short waves has become a possibility. Sensitivity has been increased, control has been made far easier and receiver noises have been reduced considerably below their former level by development in the design of this receiver.

Newly designed parts have been incorporated throughout. The tuning condenset has no metal-on-metal bearing, so that the hissing noises formed by the variation in contact has been eliminated. New coils of a smaller diameter, having a much smaller external field, a better shape factor and improved efficiency are employed. The foundation unit with holes drilled for mounting every part, simplifies the construction of the set, and assures proper placement of the parts. The isolation of the antenna from the tuned stage means that swinging of the antenna will have no effect on tuning and variations in antenna lengths have little effect on the operation of the set.

The Aero "International Four" is to our knowledge the first short wave receiver of any kind designed peculiarly for reception of musical broadcast rather than code reception, and as such fills its place far better than the best of all-purpose outfits, although due to its ease of control and great sensitivity, it is superior to most all perfect short wave sets in any field.

### Uses The Aero Coil L. W. T. 10 Kit

The new kit of coils illustrated above is the L. W. T. 10, price \$10.50. This kit is designed to go with special drilled and engraved foundation unit, in which mounting base is provided in drilled sub-panel. If you desire to furnish your own foundation unit, order the L.W.T. 11 Kit, price \$11.50. This kit includes mounting base.

### The New Aero L. W. T. 12 Coils

This is the new Aero L. W. T. 12 kit. Consists of 3 new small diameter Aero Interchangeable Coils and base mounting with primary coil. A pronounced improvement, even superior to our last season's coils. You should own this kit if you're interested in securing the best in short wave reception performance.



Code No. L. W. T. 12—Price \$12.50

### All Parts Can Be Purchased Direct

We have made arrangements to supply a complete kit of all parts of the Aero International Four direct from our factory. Write us today for descriptive literature, list of parts, and special price list. You'll want to build and own this dandy receiver. Send for complete information at once!

## AERO PRODUCTS, Inc.

Dept. 109 1772 Wilson Ave. Chicago, Ill.