

PUBLIC LIBRARY  
KANSAS CITY

# RADIO BROADCAST

VOLUME XIII

MAY, 1928, to OCTOBER, 1928



GARDEN CITY NEW YORK

DOUBLEDAY, DORAN & COMPANY, INC.

1928

# INDEX

(\*Illustrated Articles. Editorials in Italics)

PAGE	PAGE
* <b>A</b> -B-C Power Unit and One-Stage Amplifier, An Interesting (J. George Uzzmann).....	145
*A-Power Unit from Your Battery Charger, Making an (Robert Burnham).....	137
*Adapter for Long-Wave Reception. An (W. H. Wenstrom).....	275
*Adding Regeneration to Any Set (Herbert Grove).....	210
*All About Loud Speakers (Joseph Morgan).....	188
<i>Allocation, The Engineers' Plan of</i> .....	132
*A. C. Receiver, A Dual Control (Robert Burnham).....	192
*A. C. Screen-Grid Receiver, An.....	37
*A. C. Screen-Grid Tuner, A Two-Tube (James Millen).....	349
*A. C. Super-Heterodyne, A Flexible (Dana Adams).....	39
<i>Amateur Bands, Keep Commercialism Out of the</i> .....	254
<i>Amateurs in the Ten-Meter Band</i> .....	197
*Amplifier and B Supply, A Space-Charge (H. P. Manly).....	163
*Amplifier and Power Supply, A Resistance-Coupled (J. George Uzzmann).....	257
*Amplifier Power Unit for the 250, A Good (Howard Barclay).....	141
*Amplifier, The 222 Tube as an R. F. (Glenn H. Browning).....	252
<i>Annual Report of the R. C. A.</i> .....	11
<i>Another Non-Radio Man for the Commission</i> .....	131
Apparatus, New... 35, 85, 139, 227, 284,	372
*As the Broadcaster Sees It (Carl Dreher).....	42, 102, 161, 219, 267, 352
*Audio Combination, The Right (L. W. Hatry).....	23
*Audio Distortion, Checking Up on (G. F. Lampkin).....	290
*Audio Transformer Design, A New Principle in (Kendall Clough).....	133
*Automatic Tuning for the Radio Receiver (Leroy S. Hubbell).....	72
<i>Aviation Must Come to the Use of Radio</i>	129
*Aviation, What Radio Has Done for (An English Radio Engineer).....	288
* <b>B</b> SUPPLY, A D. C. Power Amplifier and (Victor L. Osgood).....	18
*B Supply, A Space-Charge Amplifier (H. P. Manly).....	163
<i>Baird Television Apparatus on Sale</i> .....	11
*Beat-Frequency Oscillator, How to Build a (G. F. Lampkin).....	156
Book Reviews:	
<i>Bible Dramas</i> , by William Ford Manley (Carl Dreher).....	304
<i>Drake's Radio Cyclopeda</i> , by Harold P. Manly (Carl Dreher).....	302
<i>Elements of Radio-Communication, The</i> , by O. F. Brown (Carl Dreher).....	306
<i>Experimental Electrical Engineering</i> , by V. Karapetoff (Carl Dreher).....	280
<i>Lefax Radio Handbook</i> (Carl Dreher).....	76
<i>Popular Guide to Radio, A</i> , by B. Francis Dashiell (Carl Dreher).....	76
<i>Practical Radio Telegraphy</i> , by Arthur R. Nilson and J. L. Hornung (Carl Dreher).....	56
<i>Radio Engineering Principles</i> , by Henri Lauer and Harry L. Brown (Carl Dreher).....	76
<i>Radio Theory and Operating</i> , by Mary Texana Loomis (Edgar H. Felix).....	56
<i>What Use Broadcasting?</i> by William G. Shepherd in <i>Mirrors of the Year</i> (Carl Dreher).....	274
<i>Wireless Direction Finding and Directional Reception</i> , by R. Keen (Carl Dreher).....	360
<i>British Imperial Radio System, Struggles of the</i> .....	195
<i>British Skeptical of Baird Television Accomplishments</i> .....	69
<i>Broadcast Regulation at a Standstill</i> .....	130
Broadcast Station Calls with a Past (William Fenwick).....	150
<i>Broadcast Stations, Present Distribution of</i> .....	69
*Broadcasting, How to Improve (John Wallace).....	31
*Broadcasting Is Accomplished, How Chain (C. E. Dean).....	65
<i>Broadcasting, More High Power</i> .....	69
<i>Broadcasting Needs Capable Leadership</i> .....	68
*Building and Operating the A. C. "R. B. Lab." Receiver (Hugh S. Knowles).....	93
*Building the D. C. Lab Receiver (Keith Henney).....	199
<i>CALDWELL Hits Straight from the Shoulder</i> .....	196
*Can We Multiply Our Radio Channels? (Albert F. Murray).....	245
*Chain Broadcasting Is Accomplished, How (C. E. Dean).....	65
*Checking Up on Audio Distortion (G. F. Lampkin).....	290
*Coast Survey, Radio Helps in the (D. L. Parkhurst).....	374
<i>Commission Announces Its Short-Wave Policy, The</i> .....	196
<i>Commission, Another Non-Radio Man for the</i> .....	131
<i>Commission Eliminates Its First Station, The</i> .....	132
*Compact and Inexpensive "Trouble Shooter." A (Emil Reisman).....	273
<i>Congress Dabbles with the Radio Situation</i>	10
*"Cornet" Multiwave Receiver, The (W. H. Wenstrom).....	77
"Cornet" Receiver, Notes on the (W.H. Wenstrom).....	302
*Coupling Methods for the R. F. Amplifier (Bert Smith).....	361
*Crystal Receiver for the Beginner, A Good (Keith Henney).....	97
* <b>D</b> . C. Lab Receiver, Building the (Keith Henney).....	199
*D. C. Power Amplifier and B Supply,	
A (Victor L. Osgood).....	18
Direct Selling by Radio (Francis St. Austell).....	58
Directory of Vacuum Tubes, "Radio Broadcast's".....	107, 300
*Distortion, Checking Up on Audio (G. F. Lampkin).....	290
*Dual Control A. C. Receiver, A (Robert Burnham).....	192
<i>EMPTY Pool, The</i> .....	255
<i>Engineers in Quantity Production of Standards</i> .....	255
<i>Engineers' Plan of Allocation, The</i> .....	132
<i>"Equalization," The Inequalities of</i> .....	131
*Extra R. F. Stage for Any Receiver, An (The Laboratory Staff).....	217
* <b>F</b> INE Program You Will Never Hear, A (John Wallace).....	165
*5-Meter Band? What About the (Robert S. Kruse).....	212
*5-Meter Hints, Practical (Robert S. Kruse).....	371
*5 Meters, Working on (Robert S. Kruse).....	263
*Five-Tube Screen-Grid Receiver, A (James Millen).....	20
*Flexible A. C. Super-Heterodyne, A (Dana Adams).....	39
*From Milliammeter to Multi-Meter (G. F. Lampkin).....	80
* <b>G</b> OOD Amplifier-Power Unit for the 250 Tube, A (Howard Barclay).....	141
*Good Crystal Receiver for the Beginner, A (Keith Henney).....	97
<i>Guggenheim Fund Shows the Way to "Frisco"</i> .....	253
<i>HARRISBURG, Ill. Needs a 500-watt Station</i> .....	254
*Haven of a Sea-Going Audion, The (Raymond Travers).....	116
<i>Here and There</i> ..... 12, 70, 197, 255,	339
*"Hi-Q 29." The—A Receiver with a Band-pass R. F. Amplifier (D. K. Oram).....	341
<i>High-Frequency Spectrum, The</i> .....	132
<i>High Power Broadcasting, More</i> .....	69
*Home Study Sheets, "Radio Broadcast's":	
Alternating Current.....	357
Determining the Capacity and Inductance of a Radio Circuit.....	136
Measuring the Amplification Factor of Tubes.....	261
Nature of Radio and Electricity, The.....	135
Ohm's Law.....	206
Testing Vacuum Tubes.....	205
Vacuum Tube Characteristics.....	262
*How Can Good Radio Programs Be Created? (John Wallace).....	104
*How Chain Broadcasting Is Accomplished (C. E. Dean).....	65
*How to Build a Beat-Frequency Oscillator (G. F. Lampkin).....	156
How to Improve Broadcasting (John Wallace).....	31

INDEX—Continued

	PAGE		PAGE		PAGE
<b>I</b> NEQUALITIES of "Equalization," The.....	131	Flux for Nichrome Wire, A.....	144	More High Power Broadcasting.....	69
*Interesting A-B-C Power Unit and One-Stage Amplifier, An (J. George Uzmann).....	145	From a Lab Circuit Fan.....	144	Monopoly? Why the Persistent Cry of.....	9
*Is the Highbrow Entitled to a Program of His Own? (John Wallace).....	223	High Powered Press Releases. Keeping R. F. Current Out of the Audio.....	83	*Month's New Phonograph Records, The.....	25, 106
<b>K</b> EEP Commercialism Out of the Amateur Bands.....	254	Line Voltage Variations.....	201	<b>N</b> EMA Convention, At the.....	253
*LABORATORY Information Sheets, "Radio Broadcast's":		Loud Speaker Tests.....	202	*National Screen-Grid Five, Oper- ating the (James Millen).....	225
A. C. "Universal" Receiver, The.....	50	Loud Speakers.....	30	Naval Stations, Press, Weather and Time Signal Transmissions of.....	52
Amplification Constant.....	112	Making D. C. Sets Comfort- able.....	202	*New Apparatus..... 35, 85, 139, 227, 284,	372
Audio Transformer, The.....	380	May Standard Frequency Sig- nals.....	84	*New Principle in Audio Transformer Design, A (Kendall Clough).....	133
Calculating Grid Bias for A. C. Tubes.....	378	More Radio Hoaxes.....	259	*New Transmitting Methods be the Remedy? Will (Edgar H. Felix).....	5
Circuit Diagram, A. C. "Uni- versal" Receiver.....	51	Mortality Among the A. C. Tubes.....	347	*Newest Power Tube, The (Howard E. Rhodes).....	74
Circuit of a Resistance-Cou- pled Screen-Grid Amplifier.....	112	New Crystal Control.....	143	*Nine-Tube Screen-Grid Super, A (Robert Burnham).....	334
Circuit of the Roberts Four- Tube A. C. Receiver.....	298	Output Transformer Charac- teristics.....	83	No Innovations or Revolutions for 1928.....	130
Circuits of the Hi-Q Six, The.....	234	Present Compression-Type Re- sistors.....	144	*Non-Radiating Short-Wave Tuner, A (James Millen).....	286
Current.....	114	Present Interesting Trends in Radio.....	143	Notes on the "Cornet" Receiver (W. H. Wenstrom).....	302
Dynamic Loud Speakers, The.....	380	Prices of British "Compo- nents".....	143	*"ONE-SPOT" Screen-Grid Super, A (W. H. Hollister).....	249
Electrical Measuring Instru- ments.....	176	Publications Worthy of Note Radio as a Scapegoat.....	144	*Operating the National Screen-Grid Five (James Millen).....	225
Equalizers.....	232	Radio School Scholarships.....	84	*Our Readers Suggest.....	33, 89, 151, 215, 271, 364
Equalizing Wire Lines for Broadcasting.....	178	Radio Gossip.....	143	<b>P</b> ATENT Situation, The.....	12
Farm Lighting Systems.....	174	Real Power from Two 112's.....	29	*Phonograph Records, The Month's New.....	25, 106
Filters.....	382	Recent Articles of Interest.....	202	*Photo Broadcasting in England (Wil- liam J. Brittain).....	384
Frequency Characteristic of a Seven-Mile Cable.....	232	Recent Interesting Contem- porary Articles.....	84	*"Pick-Up" Shall I Buy? What (David Grimes).....	207
Grid Bias.....	50	Recent Interesting Technical Articles.....	144	Picture Broadcasting Must Contain No "Ads".....	11
Grid Bias Circuits for A. C. Tubes.....	378	Remler A. F. Amplifying Sys- tem, The.....	348	Picture Transmission, Regulations for Television and.....	338
Grid Bias Measurements.....	50	Screen-Grid and Automatic Receivers.....	259	*Power Amplifier and B Supply, A. D. C. (Victor L. Osgood).....	18
Hi-Q Six, The.....	234	Screen-Grid Mystery, A.....	347	*Power Supply, A Resistance-Coupled Amplifier and (J. George Uzmann).....	257
Impedance-Coupled Amplifiers Index, August 1927-May 1928.....	51	Screen-Grid Tube, The: Selec- tivity.....	30	*Power Tube, The Newest (Howard E. Rhodes).....	74
Line Voltage Variations.....	176	Short-Wave Adapter, A.....	29	*Practical 5-Meter Hints (Robert S. Kruse).....	371
Measuring Instruments..... 234,	296	Short-Wave Broadcasting.....	29	Present Distribution of Broadcast Sta- tions.....	69
"Motorboating".....	110	Short-Wave Market, The.....	201	Press, Weather and Time Signal Trans- missions of Naval Stations.....	52
Power Values in Radio Receiv- ing Antennas.....	178	Short-Wave Notes.....	84	*"R. B. LAB." Receiver, Building and Operating the (Hugh S. Knowles).....	93
Protecting the Rectifier Tube.....	230	Short-Wave Reception.....	348	*"R. B. Lab." Receiver, A Short-Wave Adapter for the (Hugh S. Knowles).....	153
Push-Pull Amplifiers.....	110	"Sink or Swim" Tube Testing "Skim Milk Masquerades as Cream".....	201	"Radio Broadcast's" Directory of Vacu- um Tubes.....	107, 300
Radio Transmission.....	296	Some Coil Measurements.....	144	*"Radio Broadcast's" Home Study Sheets (See Home)..... 135, 205, 261,	357
Resistance-Coupled Amplifier With Screen-Grid Tubes, A.....	112	"Strays" from other Labora- tories.....	202	*"Radio Broadcast's" Laboratory In- formation Sheets (See Laboratory) 48, 110, 174, 230, 294, 378	
Resistors.....	114	Technical Smoke Screen.....	144	*"Radio Broadcast's" Service Data Sheets on Manufactured Receivers (See Service)..... 91, 159, 221, 277,	369
Roberts Four-Tube A. C. Re- ceiver, The.....	298	Tested Products.....	29	*Radio Channels? Can We Multiplex Our (Albert F. Murray).....	245
Screen-Grid Resistance-Cou- pled Amplifier, A.....	178	Testing for Soft Tubes.....	348	*R. F. Amplifier, Coupling Methods for the (Bert E. Smith).....	361
Screen-Grid Tube as an R. F. Amplifier, The.....	114	Trailing "Power Leak" Inter- ference.....	259	*R. F. Amplifier, The 222 Tube as an (Glenn H. Browning).....	252, 359
Selectivity.....	230	Two Interesting Patents.....	347	*R. F. Stage for Any Receiver, An Extra (The Laboratory Staff).....	217
Servicing Radio Receivers.....	294	Who Our Readers Are.....	144	*Radio Helps in the Coast Survey (D. L. Parkhurst).....	374
Size of Tap and Clearance Drills.....	298	<i>Laboratories Grapple with Aircraft Radio, The.....</i>	253	Radio Laughs at Wired Wireless.....	10
Soldering Irons.....	232	Letters from Readers..... 179, 231, 308,	386	*Receiver for Short-Wave Broadcast Reception (Bert E. Smith).....	167
Telephone Transmission Unit, The.....	380	*Lighting Lines Safe for A. C. Tubes, Make Your (Kasson Howe).....	269	Recent Radio Events.....	132
Text Books on Radio.....	296	List of Short-Wave Stations Throughout the World, A.....	44	Regulations for Television and Picture Transmission.....	338
Tube Life.....	174	*Listeners' Point of View, The (John Wallace)..... 31, 104, 165,	223	*Resistance-Coupled Amplifier and Power Supply, A (J. George Uzmann)	257
Tube Overloading.....	48	Long Waves Needed in Transoceanic Ser- vice.....	255	*Right Audio Combination, The (L. W. Hatry).....	23
Tuned Circuits.....	176	*Loud Speakers, All About (Joseph Morgan).....	188		
ux-250 and cx-350, The.....	48	Low-Power Stations Plead Their Case, The.....	337		
Using a Milliammeter as a Voltmeter.....	294	<b>M</b> ACKAY-R. C. A. Struggle, The.....	195		
Voltmeter, The.....	382	*Make Your Lighting Lines Safe for A. C. Tubes (Kasson Howe).....	269		
*Laboratory, "Strays" from the (Keith Henney):		*Making an A-Power Unit from Your Battery Charger (Robert Burnham).....	137		
A. C. Screen-Grid Tubes.....	202	Manufacturers' Booklets.....	25, 108, 170, 228, 282,		
A. C. Troubles.....	83	*Manufactured Receivers, "Radio Broadcast's" Service Data Sheets on (See Service)..... 91, 159, 221, 277,	369		
Another Patent Muddle.....	260	*March of Radio, The (E. H. F.).....	9, 68, 129, 195, 253,		
Another Useful Publication.....	84	Mergers in the Radio Industry.....	69		
At Last—A Line Voltage Regulator.....	259	*Milliammeter to Multi-Meter, From (G. F. Lampkin).....	80		
Coil Dimensions, An Error in.....	30				
Detector Distortion.....	29				
Engineers as Salesmen.....	347				
"Equamatic" System in Eng- land, The.....	29				
Finding Ore by Radio.....	29				

INDEX—Continued

	PAGE		PAGE		PAGE
*Roberts Receiver, A Three-Tube A. C. Operated (Elmer G. Hery) . . . . .	99	*What Can We See By Radio? (R. P. Clarkson) . . . . .	185	Hatry, L. W. . . . .	23
*SARGENT-RAYMENT Seven Receiver, The (Howard Barclay) . . . . .	354	*What Hope for Real Television? (R. P. Clarkson) . . . . .	125	Henny, Keith . . . . .	29, 97, 143, 199, 259, 347
*Screen-Grid Booster for Any Receiver, A (Glenn H. Browning) . . . . .	87	<i>Ten-Meter Band. Amateurs in the</i> . . . . .	197	Hery, Elmer G. . . . .	99
*Screen-Grid Receiver, A Five-Tube (James Millen) . . . . .	20	*Tester, A Universal Set and Tube (D. A. R. Messenger) . . . . .	148	Hollister, W. H. . . . .	249
*Screen-Grid Receiver, An A. C. . . . .	37	*Three-Tube A. C. Operated Roberts Receiver, A (Elmer G. Hery) . . . . .	99	Howe, Kasson . . . . .	269
*Screen-Grid Short-Wave Receiver, A (Howard Barclay) . . . . .	203	*Transmitting Methods be the Remedy? Will New (Edgar H. Felix) . . . . .	5	Hubbell, Leroy S. . . . .	72
*Screen-Grid Tube in Popular Circuits, Using the (Laboratory Staff) . . . . .	96	<i>Transoceanic Service, Long Waves Needed in</i> . . . . .	255	Knowles, Hugh S. . . . .	93, 153
*Screen-Grid Tuner, A Two-Tube (Glenn H. Browning) . . . . .	27	*"Trouble Shooter," A Compact and Inexpensive (Emil Reisman) . . . . .	273	Kruse, Robert S. . . . .	212, 267, 344, 371
*Screen-Grid Tuner, A Two-Tube A. C. (James Millen) . . . . .	349	*Tuning for the Radio Receiver, Automatic (Leroy S. Hubbell) . . . . .	72	Lampkin, G. F. . . . .	80, 156, 290
*Service Data Sheets on Manufactured Receivers, "Radio Broadcast's":		*Two-Tube A. C. Screen-Grid Tuner, A (James Millen) . . . . .	349	Manly, H. P. . . . .	163
Amrad, A. C. 7, The . . . . .	91	*Two-Tube Screen-Grid Tuner, A (Glenn H. Browning) . . . . .	27	Messenger, D. A. R. . . . .	148
Bosch Model 28 Receiver, The . . . . .	369	*222 Tube as an R. F. Amplifier, The (Glenn H. Browning) . . . . .	252, 359	Millen, James . . . . .	20, 225, 286, 349
Federal Ortho-sonic Seven-Tube Receiver, The . . . . .	222	*UNIVERSAL Set and Tube Tester, A (D. A. R. Messenger) . . . . .	148	Morgan, Joseph . . . . .	188
Grebe A. C. Six, The . . . . .	159	*Universal Short-Wave Receiver, A (Lloyd T. Goldsmith) . . . . .	13	Murray, Albert F. . . . .	245
Kolster 6K A. C., The . . . . .	160	*Using the Screen-Grid Tube in Popular Circuits (Laboratory Staff) . . . . .	96	Oram, D. K. . . . .	341
Marconiphone Model 61 Receiver, The . . . . .	278	VACUUM Tubes, "Radio Broadcast's" Directory of . . . . .	107, 300	Osgood, Victor L. . . . .	18
Pfansteihl A. C. 34 and 50, The . . . . .	92	*"Vivitone 29" Receiver, The (R. F. Goodwin) . . . . .	366	Parkhurst, D. L. . . . .	374
Splitdorf "Inherently Electric" Receiver, The . . . . .	370	<i>WAR on the Short Waves, The</i> . . . . .	195	Reisman, Emil . . . . .	273
Stromberg-Carlson Receivers Nos. 635 and 636 . . . . .	277	*"What About the 5-Meter Band? (R. S. Kruse) . . . . .	212	Rhodes, Howard E. . . . .	74, 331
*Short-Wave Adapter for the R. B. Lab. Receiver, A (Hugh S. Knowles) . . . . .	153	*What Can We See by Radio? (R. P. Clarkson) . . . . .	185	St. Austell, Francis . . . . .	58
*Short-Wave Broadcast Reception, A Receiver for (Bert Smith) . . . . .	167	*What Hope for Real Television? (R. P. Clarkson) . . . . .	125	Shea, R. F. . . . .	279
*Short-Wave Code Signals, A Super-Heterodyne for (Lloyd T. Goldsmith) . . . . .	15	*What "Pick-Up" Shall I Buy? (David Grimes) . . . . .	207	Silver, McMurdo . . . . .	281
<i>Short-Wave Policy, The Commission Announces Its</i> . . . . .	196	<i>Why the Persistent Cry of Monopoly?</i> . . . . .	9	Smith, Bert . . . . .	167, 361
*Short-Wave Receiver, A Universal (Lloyd T. Goldsmith) . . . . .	13	*Will New Transmitting Methods Be the Remedy? (Edgar H. Felix) . . . . .	5	Travers, Raymond . . . . .	116
Short-Wave Stations Throughout the World, A List of . . . . .	44	*Working on 5 Meters (Robert S. Kruse) . . . . .	263	Uzmann, J. George . . . . .	145, 257
*Short-Wave Transmitter for 1929, A (Robert S. Kruse) . . . . .	344			Wallace, John . . . . .	31, 104, 223
*Short-Wave Tuner, A Non-Radiating (James Millen) . . . . .	286			Wenstrom, W. H. . . . .	77, 275, 302
*Simple Unit for Measuring Impedances A (F. J. Fox and R. F. Shea) . . . . .	279				
*Six-Tube Screen-Grid Receiver, A (McMurdo Silver) . . . . .	281				
*Space-Charge Amplifier and B Supply, A (H. P. Manly) . . . . .	163				
*"Strays" from the Laboratory (Keith Henney) (See Laboratory) . . . . .	29, 83, 143, 201, 261, 347				
<i>Struggles of the British Imperial System</i> . . . . .	195				
*Super, A Nine-Tube, Screen-Grid (Robert Burnham) . . . . .	334				
*Super-Heterodyne, A Flexible (Dana Adams) . . . . .	39				
*Super-Heterodyne for Short-Wave Code Signals, A (Lloyd T. Goldsmith) . . . . .	13				
<b>T</b> ELEVISION:					
<i>Baird Television Apparatus on Sale</i> . . . . .	11				
<i>Television and Picture Transmission, Regulations for</i> . . . . .	338				
*Television—Its Progress Today (Howard E. Rhodes) . . . . .	331				

PORTRAITS  
(\*Portraits in "The March of Radio")

# NATIONAL

## Single Dial Tuning-Unit - Type 222

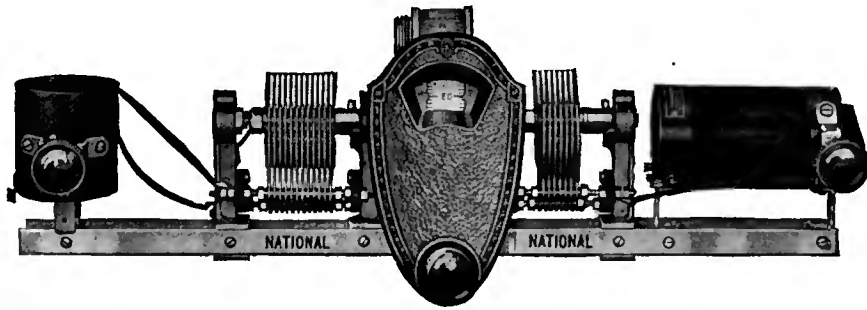

Made expressly for experimentation with the new 4 electrode UX 222 tube. The newly designed transformer and variable induction antenna coil, NATIONAL Equitune Condensers and New NATIONAL Velvet Vernier Type F Single Drum Dial are mounted on rigid light aluminum girders that preserve the alignment. The unit is very easy to install and to use.

Volney D. Hurd, of the Christian Science Monitor, reports that on a test of this Type 222 Tuning Unit, at Malden, Mass., *Chicago stations came in like locals on a 5-foot antenna.* This means a DX-getting rating, under favorable conditions, of 200 miles per foot of antenna.

List Price, Type 222, \$25.00

Two other types available. Send for Bulletin 121-B.

NATIONAL TUNING UNITS STANDARD WITH THE EXPERIMENTOR SINCE 1924

NATIONAL COMPANY INC. · W · A · READY · PRES · SHERMAN · ABBOT · JACKSON STS · MALDEN · MASS ·

## RESISTANCE and BRAKES CLAROSTAT

Reg. U. S. Pat. Off.

RESISTANCE is to a radio circuit what brakes are to your car. You need good brakes. You vary them according to conditions. You apply them as required

Do the same with resistance. Use good reliable resistance. Vary your resistance according to requirements—circuit, components, voltage, signal, tubes, tube life and so on.

All of which spells Clarostat—a unique resistance adjustable to meet all conditions, and fixed when conditions have been met.

There is a Clarostat for every purpose—the tiny Volume Control for receiving circuits, Standard type for B-Power voltage control, Power type for heavy-duty units and electrified receivers, and Table type for use as an accessory with any set.

Ask your radio dealer to show you the complete line of Clarostats, and to give you informative literature on how to improve your radio. Or write us direct.

American Mechanical Laboratories Incorporated  
Specialists in Variable Resistors  
285-7 N. Sixth St., Brooklyn, N. Y.



## Learn Radio for Bigger Pay

GET into this new big-pay live-wire field. Its rapid, enormous growth has astounded the world. A flood of gold is pouring into this new business. Big and little fortunes are coming out of Radio every year. Trained men are needed. Opportunities in twenty different branches—Radio manufacturing, selling, servicing sets, in business for yourself, travelling all over the world without expense as an operator on board ship, operator in a broadcasting station, commercial land station operator and many other wonderful positions are explained in my 64-page book "Rich Rewards in Radio." Get a copy—clip the coupon—it's FREE. There's no obligation. Investigate!

Many Make \$50 to \$250 a Week

Why be satisfied with the \$20, \$25, or \$35 a week when the good Radio jobs pay \$50 and all the way up to \$250 a week and offer practically unlimited opportunities for quick financial progress. Study Radio now and in a short time land yourself a real job with a real future.

Easy to Learn at Home This Practical Way

Stay home. I'll train you in your spare time. My practical method, with six big outfits of Radio parts, makes learning at home in spare time easy, fascinating. You can build and experiment with practically every type of receiving set known. No other method can equal it. This course has put thousands of dollars in other fellows' pockets. High School education unnecessary. Boys 16, men up to 65 have mastered Radio this way. Your Money back if not satisfied upon completion.

You can build 100 circuits with 6 big outfits of Radio parts I give you



HERE ARE THREE YOU BUILD

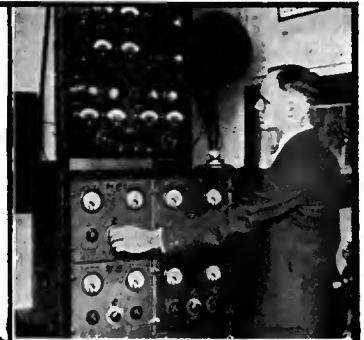

\$10 to \$30 a week in spare time while learning

That's what many of my students are making. Pay your tuition out of spare time earnings. This is the famous course that pays for itself. I show you how you can begin earning money almost the day you enroll. G. W. Page, 1807 21st Ave., Nashville, Tenn., writes: "I picked up \$935, in my spare time while studying." K. W. Griffith, 2320 Maple St., Little Rock, Ark., made \$394.

64-Page Book FREE

Send for it. Clip the coupon. It won't cost you a penny. It has pointed out the way to success to hundreds of fellows. See what Radio has to offer you and how my Employment Department helps graduates get good jobs. There's no obligation. Mail the coupon right now. Address: J. E. Smith, Pres., Dept. 5-D, National Radio Institute, Washington, D. C.

MAIL THIS COUPON

J. E. SMITH, President  
Dept. 5-D, National Radio Institute  
Washington, D. C.  
Dear Mr. Smith: Without obligating me in any way, send me "Rich Rewards in Radio" giving facts and information on money-making opportunities in Radio and explaining your practical, fascinating way of teaching with Six Big Outfits of Radio Parts.  
Name..... Ago.....  
Address.....  
Occupation.....

# RADIO BROADCAST

WILLIS KINGSLEY WING, Editor

KEITH HENNEY  
Director of the Laboratory

EDGAR H. FELIX  
Contributing Editor

Vol. XIII. No. 1

MAY, 1928

## CONTENTS

Cover Design . . . . .	From a Design by Harvey Hopkins Dunn	
Frontispiece . . . . .	Radio Service in a Philadelphia Hotel	4
Will New Transmitting Methods Be the Remedy? . . . . .	Edgar H. Felix	5
The March of Radio . . . . .	An Editorial Interpretation	9
Why the Persistent Cry of Monopoly? Radio Laughs at Wired Wireless Congress Dabbles With the Radio Situation Baird Television Apparatus on Sale	Picture Broadcasting Must Contain No "Ads" Annual Report of the R. C. A. Here and There The Patent Situation	
A Universal Short-Wave Receiver . . . . .	Lloyd T. Goldsmith	13
A Super-Heterodyne for Short-Wave Code Signals	Lloyd T. Goldsmith	15
A D.C. Power Amplifier and B Supply . . . . .	Victor L. Osgood	18
A Five-Tube Screen-Grid Receiver . . . . .	James Millen	20
The Right Audio Combination . . . . .	L. W. Hatry	23
The Month's New Phonograph Records . . . . .		25
A Two-tube Screen-Grid Tuner . . . . .	Glenn H. Browning	27
"Strays" from the Laboratory . . . . .	Keith Henney	29
Detector Distortion A Short-Wave Adapter Short-Wave Broadcasting The "Equamatic" System in England Finding Ore by Radio Real Power from two 112's	Tested Products The Screen-Grid Tube: Selectivity Loud Speakers An Error in Coil Dimensions The A. C. "Lab" Receiver	
How to Improve Broadcasting . . . . .	John Wallace	31
The Listeners' Point of View		
Our Readers Suggest . . . . .		33
Remote Volume Control Improving Your B Device Plate Detection	Adjusting Cone Loud Speakers Selectivity With A. C. Tubes	
New Apparatus . . . . .		35
An A.C. Screen-Grid Receiver . . . . .		37
A Flexible A.C. Super-heterodyne . . . . .	Dana Adams	39
As the Broadcaster Sees It . . . . .	Carl Dreher	42
Design and Operation of Broadcasting Stations: 19, Frequency Runs	Radio Folk You Should Know: No. 5 E. B. Pillsbury	
A List of Short-Wave Stations Throughout the World . . . . .		44
"Radio Broadcast's" Laboratory Information Sheets . . . . .		48
No. 185 Tube Overloading No. 186 The UX-250 and CX-350 No. 187 Grid Bias No. 188 Grid Bias Measurements No. 189 The A. C. "Universal" Receiver	No. 190 Circuit Diagram, A. C. "Universal" Receiver No. 191 Index, August 1927—May 1928 No. 192 Index, August 1927—May 1928	
Press, Weather and Time Signal Transmissions of Naval Stations . . . . .		52
Manufacturers' Booklets Available . . . . .		54
Book Reviews . . . . .		56
(1). <i>Radio Theory and Operating</i> , Loomis (2). <i>Practical Radio Telegraphy</i> , Nilson and Hornung		
Direct Selling by Radio . . . . .	Francis St. Austell	58

The contents of this magazine is indexed in *The Readers' Guide to Periodical Literature*, which is on file at all public libraries.

## TO OUR READERS

BECAUSE we value very highly the confidence of our readers, we present here a few words about the editorial policy of this magazine as it affects the problem of editorial ethics. The readers of RADIO BROADCAST are much like the readers of a magazine devoted to book reviews. In the latter, editorial articles must deal, perforce, with the same subjects as found in the advertising pages. In RADIO BROADCAST our text pages must very often contain articles describing the use of units featured in the advertising pages. But how long would you read a book review publication if all reference to publisher, price and author were omitted? And how long would you read such a magazine if you felt there were collusion between editorial and advertising content?

ALL of the articles in this magazine—constructional ones, especially—are chosen for one reason, only, because we think they are interesting and useful to our readers. We are frank about mentioning parts employed because we believe our readers want to know that information. We have in the past and will continue to indicate in the future the possibilities of substitution of parts, leaving the actual construction to the judgment of the reader. The reader has a right to know just how any circuit we describe was built, what it costs, and whose parts are used. In RADIO BROADCAST, all this essential information is in the article. You will not have to write us for additional circuit diagrams, a list of parts or other essential information which should be in the article in the first place. Our duty to the reader is to give him articles which are interesting, useful, and complete. If he encounter difficulties, our Technical Information Service will help him by mail, and the editor will always be pleased to hear of the results he achieves.

THE technical accuracy of every statement made in this magazine is carefully checked by Radio Broadcast Laboratory, manned by radio engineers all of whom have technical university training. Their vigilance fortifies every article. Articles from the staff present material not available elsewhere, some of it constructional, some more general, but all with the definite purpose to be as sound and accurate as we know how. These requirements invariably apply to all our articles, whatever their source. Our Laboratory will continue to originate useful circuits of all sorts; contributions from independent radio workers are constantly sought and will regularly appear. Articles, constructional or otherwise, originating in manufacturers' laboratories will be published with their origin made quite clear, only when the articles meet our rigid requirements. This is and has been our practical conception of responsibility to the reader.

THE news of radio developments, no matter where they originate, is important, so, naturally, the activities of radio manufacturers will be reported in these pages, but no such articles have appeared or will appear merely because of their advertising potentialities. The reader need not fear that this magazine will overflow with articles thinly masking manufacturers' publicity. Is it good? Is it useful? Is it important?—those questions must be satisfactorily answered before the article appears in our pages, whether or not the article originates with a manufacturer. It is only natural if readers respect our text pages that the advertiser should find our advertising pages valuable, and it is obvious that no publication can long exist without high standards in both editorial and advertising content.

—WILLIS KINGSLEY WING.

## DOUBLEDAY, DORAN & COMPANY, INC., Garden City, New York

### MAGAZINES

### BOOK SHOPS (Books of all Publishers)

### OFFICES

### OFFICERS

COUNTRY LIFE  
WORLD'S WORK  
GARDEN & HOME BUILDER  
RADIO BROADCAST  
SHORT STORIES  
EDUCATIONAL REVIEW  
LE PETIT JOURNAL  
EL ECO  
FRONTIER STORIES  
WEST  
THE AMERICAN SKETCH

NEW YORK: LORD & TAYLOR; JAMES MCCREERY & COMPANY  
PENNSYLVANIA TERMINAL AND 166 WEST 32ND ST.  
848 MADISON AVE. AND 51 EAST 44TH STREET  
420 AND 526 AND 810 LEXINGTON AVENUE  
GRAND CENTRAL TERMINAL AND 38 WALL STREET  
CHICAGO: 75 EAST ADAMS STREET  
ST. LOUIS: 223 N. 8TH ST. AND 4014 MARYLAND AVE.  
KANSAS CITY: 920 GRAND AVE. AND 206 WEST 47TH ST.  
CLEVELAND: HIGREE COMPANY  
SPRINGFIELD, MASS: MEEKINS, PACKARD & WHEAT

GARDEN CITY, N. Y.  
NEW YORK: 244 MADISON AVENUE  
BOSTON: PARK SQUARE BUILDING  
CHICAGO: PEOPLES GAS BUILDING  
SANTA BARBARA, CAL.  
LONDON: WM. HEINEMANN, LTD.  
TORONTO: OXFORD UNIVERSITY PRESS

F. N. DOUBLEDAY, Chairman of the Board  
NELSON DOUBLEDAY, President  
GEORGE H. DORAN, Vice-President  
S. A. EVERITT, Vice-President  
RUSSELL DOUBLEDAY, Secretary  
JOHN J. HESSIAN, TREASURER  
LILLIAN A. COMSTOCK, Ass't Secretary  
L. J. McNAUGHTON, Ass't Treasurer



VITROHM RESISTORS . IN EVERY INDUSTRY . IN EVERY LAND

*Radio in the Home*

Vitrohm Resistor 508-2 is employed by the Thordarson Electric Mfg. Co. in their R210 Power Compact. The Resistor has a total resistance of 13,000 ohms in steps of 2000, 2000, 2000 and 7000 ohms. It is priced at \$2.65.

*Vitrohm Resistors*  
for radio

¶ Vitrohm Resistors are made by winding a special resistance wire upon a refractory tube and protecting both the wire and terminal contacts with fused-on vitreous enamel. This process has been used by Ward Leonard Electric Co. for more than 36 years.

¶ *Circular 507*, describing Vitrohm Radio Resistors, and "*Vitrohm News*" will be sent you without charge upon request.

... Equipped with  
**VITROHM RESISTORS**

**T**ODAY'S electric radio receiver is a highly complex instrument placed at your service by the throw of a switch and turn of a dial.

The intricacies of circuit and mechanical design probably do not interest you; it is enough that the receiver operates to your satisfaction each time it is turned "on".

One criterion of probable receiver life is the quality of component parts. The resistors, for example, limit current and voltage in almost every part making up the receiver. Their failure frequently means damage to other parts.

Vitrohm Resistors are most frequently chosen by those radio manufacturers who make certain that their product will serve you long and well.

Vitrohm Resistors are chosen by every industry where the accurate control of current and voltage over an indefinite life is of importance. Make certain that the power supply unit in your next electric radio receiver employs them.

**WARD LEONARD ELECTRIC CO.**

MOUNT VERNON, N.Y.



*Radio Service in a Philadelphia Hotel*

**T**HE Hotel Robert Morris in Philadelphia, in common with many other hotels in the United States, has provided its guests with a compelling reason to stay in their rooms in the evening. The Robert Morris was equipped in March, 1925, and the unusual feature of the arrangement is that the widest possible program choice is offered to the listener. A plug with three jacks is provided in every room and the three jacks provide the program at the moment being transmitted over the Blue or Red

Networks of the National Broadcasting Company or the Columbia chain. The radio control room is located on the top floor of the hotel and the equipment, in the main office on the first floor, is operated by remote control. Constant volume level throughout the hotel is maintained by using compensating and repeating coils. By grouping the jacks in the various rooms in parallel series it is possible to maintain reception in every room in the hotel even though trouble develop in the outlet in one or more rooms.



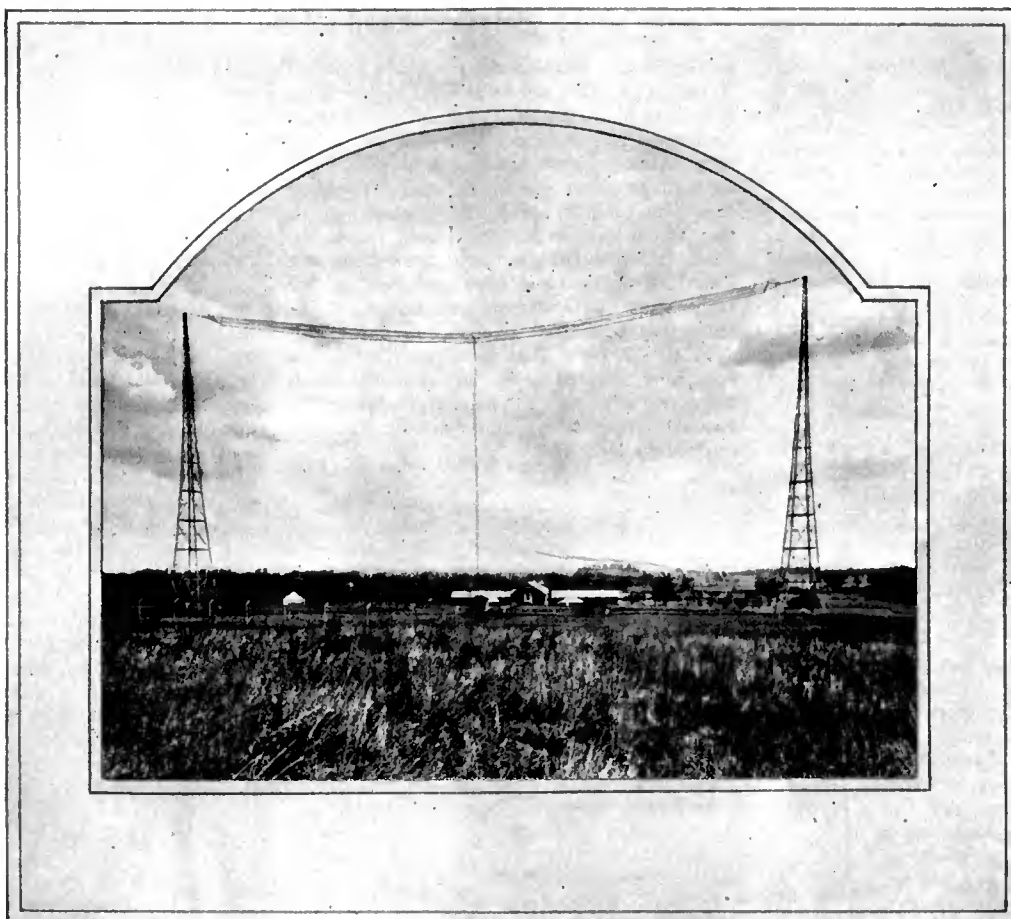

WHIPPANY

# Will New Transmitting Methods Be the Remedy?

By Edgar H. Felix

**T**HE acuteness of the broadcasting congestion problem focusses public attention upon any method suggested to increase the capacity of the broadcasting band. Many proposals have been made, some of which hold promise and others which, if put into practice, would only increase the existing confusion. Since the regulation of broadcasting has become a political matter, the great danger exists that the statements of pseudo-scientists may be accepted and untried plans for station synchronization will be forced into practice before they have been fully developed.

There are only two possible ways of reducing congestion in the broadcast band: (1), large numbers of stations must be eliminated, reduced to part time, or curtailed in power, or (2), the number of stations of a given power, successfully occupying the same channel, must be increased. Time division is already practiced to such an extent that further relief cannot be expected from this source without too much restriction of the service and earning power of existing stations. Power reduction will only lessen the value of better stations; the tendency is toward increased power because it means better program service for greater numbers. Legal and political considerations make it impossible to ex-

pect wholesale station elimination as a source of the radical improvement necessary for good broadcasting service in every section of the country.

Consequently, the only measure of relief which can be effective is the development of

some means of increasing the number of stations of present powers operating on the same channel without interference. Many schemes to effect this result have been offered. They fall into three classifications:

- (1) The elimination of the carrier whistle by accurate control of the carrier frequency of stations occupying the same channel, permitting service range rather than carrier range to determine the necessary spacing between stations on the same channel;
- (2) The synchronization of both carrier and program, popularly referred to as placing chain stations on a single channel;
- (3) The limitation of the carrier range to the service range of the station by the application of new principles of transmission.

Before considering in detail the actual methods for each of these general systems, what are the requirements for a plan which will increase the capacity of the broadcasting band? Four major qualifications must be met and failure to meet any one of them condemns any suggestion as useless. They are:

- (1) The system must be of unflinching reliability in operation. The adoption of closer spacing among stations on the same channel, the objective of most of the systems,

## Service Range and Interference Range

THE following table shows how the power radiated by a broadcasting station affects, (a) the "service range," which is that distance over which good reception will be possible independent of static, day and night, rain or shine; and (b) the "interference range," which is that distance over which the carrier wave of a broadcasting station can mar reception by generating a heterodyne whistle with the carrier wave of another station:

ANTENNA POWER IN WATTS	MILES		
	SATISFACTORY SERVICE	HIGH-GRADE SERVICE	CARRIER INTERFERENCE RANGE
5	10	1	100
50	22.5	3	250
500	65	10	625
5000	160	30	1500
50,000	350	90	3000

If we divide the interference range by the high-grade service range we get the following figures:

ANTENNA POWER IN WATTS	INTERFERENCE RANGE DIVIDED BY HIGH-GRADE SERVICE RANGE
5	100
50	83
500	62.5
5000	50
50,000	33

The figures in the right-hand column show clearly that high-power stations approach closer to the ideal condition as the ratio of the interference range to the service range is decreased.

means that their temporary or permanent failure will bring heterodyne whistles of much greater intensity than are experienced under present conditions.

- (2) The system must not demand an order of operating skill beyond that obtainable by average broadcasting station staffs.
- (3) The first cost of equipment required and its maintenance expense must not be so high as to place it beyond the financial capacity of average broadcasting stations.
- (4) The adoption of the system must not require any substantial alteration in transmitting and receiving equipment and must entail no sacrifice in quality of reproduction.

We will examine each proposal in the light of these four qualifications. The first general class of methods concerns those intended to eliminate the carrier heterodyne or whistling interference with which all listeners are now painfully familiar. The pitch of the carrier whistle depends upon the difference in frequency between the two or more carriers simultaneously actuating the receiving set. Suppose we have two stations assigned to a million cycles, or 300 meters, one precisely on the assigned frequency; the other one half of one per cent. above it, or on 1,005,000 cycles. The resultant effect will be to impose a 5000-cycle note upon the programs of both stations. If one station deviates a hundredth of 1 per cent. from the assigned frequency, the resultant heterodyne will be a hundred cycles. Accuracy of one part in a hundred thousand is therefore essential if the carrier heterodyne is to be reduced to a point below audibility. In that case, the maximum heterodyne note would be 20 cycles, assuming that both stations have deviated in opposite directions from the assigned frequency. Note the extraordinary stability necessary to permit two carriers to overlap without heterodyne.

The intensity of the whistle heard at a receiving point is dependent upon the carrier energy received from the more distant station. The degree to which it mars reception depends somewhat upon the ratio of the carrier whistle to the amount of modulation received from the nearer station. An understanding of these two statements will reveal why carrier synchronization will effect real relief under present conditions. You have frequently heard a heterodyne of considerable intensity and waited for the local station to sign off, in the hope that you could identify the distant station causing the whistle. But you find it impossible to hear the slightest sound from the distant station. This is due to the fact that the carrier spreads from thirty to forty times the distance that a high-grade program signal is heard and also, because of the square law operation of the detector tube, the carrier is subject to much greater amplification than the audio-frequency modulation impressed on it.

#### WHY STATIONS ARE SPACED

**I**N PRACTICE, this condition accounts for the great spacing required between stations of moderate power, if the service area of each of them is to enjoy undisturbed reception. The

maximum high-grade service range of a 500-watt station is 30 miles, but its average carrier range is at least 1000 miles and often over 2000 miles. Under average conditions, it delivers a distinguishable program signal to sensitive receivers for perhaps 350 or 400 miles. If two stations on the same channel are perfectly synchronized, they would have to be spaced only 400 to 500 miles apart, without suffering audio-frequency distortion within their respective local service ranges. But, under present conditions, 1500-mile separation is necessary to reduce carrier heterodyne to the point that local reception is not noticeably affected and complaints are often registered with respect to heterodynes caused by 500-watt stations 2000 miles distant from the receiving point.



#### "SERVICE AREA" AND "INTERFERENCE RANGE"

The circles show the relative areas of high-grade service range, satisfactory service range, and interference range, of a 50,000-watt broadcasting station. Note how large the interference range is in comparison to the service range. The actual service area of this station does not extend beyond the area enclosed by circle No. 2, for at greater distances, static and fading will interfere with good reception. The much larger area of circle No. 3 extends far beyond the area of fair reception. Within this large area the station can create interference by generating a heterodyne with the carrier wave of another station, supposedly operating on the same frequency, but actually transmitting on a frequency slightly higher or lower. Accurate stabilization of the carrier frequencies of stations operating on similar frequencies—perhaps by the quartz crystal method—will prevent heterodyne interference but will not prevent interference arising from the clashing of sidebands.

Four methods have been suggested for stabilizing the carriers of broadcasting stations so as to eliminate the possibility of carrier whistle:

- (1) Stable precision crystal oscillators;
- (2) Remote manual control of carrier frequency;
- (3) Radio transmission of a reference frequency; and
- (4) Wire synchronization of carriers.

The zero-beat method, employing crystal control oscillators, is now widely used. The station operator wears a headphone through which courses the output of the crystal oscillator and also the station's radiated carrier frequency. The frequency of the station is adjusted until the two are in exact synchronism so that no heterodyne whistle is heard.

In preparing to write this article, the author maintained a broadcasting station on its frequency by the zero-beat method for several programs. When utilizing a crystal oscillator, installed at the station, the comparison signal is constant and powerful. The amount of skill required and the cost of maintenance of the equipment needed are within the reach of any broadcasting station.

Independent crystal control, however, has been described as too inaccurate and too unstable to permit the perfect synchronization of two carriers. As a matter of fact, there is no inherent fault in the crystal oscillator which cannot be corrected. What are needed are perfected means of supplying crystal oscillators with absolutely constant voltages and means of maintaining the crystal at an absolutely constant temperature.

A change of one degree centigrade varies the frequency of a crystal oscillator by sixty to a hundred cycles. The crystal oscillator is usually installed in a penthouse on the roof of a building where the transmitter is installed. Heat supply is often uncertain in such exposed locations and temperature variations of twenty degrees, during operating hours, are not uncommon. Such a change is sufficient to cause a 2000-cycle variation in the frequency of a crystal oscillator.

Crystals have been submitted to laboratories by broadcasting station owners with a view to finding out why they do not hold the station to its assigned frequency. Among these are ordinary quartz lenses, crudely scratched and insecurely mounted in contacting clamps. These worse-than-useless crystals have been sold to broadcasting stations with the expectation that they will stabilize carrier frequencies. The fact that a station uses crystal control is no guarantee whatever that it will remain accurately on its frequency any more than providing an aviator with a compass assures that he will arrive safely at a distant destination.

Proponents of the crystal oscillator method have sometimes proved their case by setting up two such oscillators in the laboratory, both using a slab from the same quartz crystal. Such demonstrations, however, prove nothing because both oscillators are then working under exactly the same conditions. When one of the oscillators is shipped to a distant station to control its carrier, varying temperature conditions cause sufficient deviation to produce annoying heterodynes. With equipment now commercially available, the crystal oscillator does not possess sufficient stability to eliminate the heterodyne whistle between two stations operating on the same channel. Nevertheless, development of precision oscillators, with accurate temperature control, is a most promising line of research.

#### MANUAL CONTROL OF FREQUENCY

**A** NUMBER of enthusiasts have loudly heralded their success in synchronizing their station's carrier with a single interfering station by checking the heterodyne with a receiving set remote from the broadcasting station. This is the second method listed. By means of a wire connection with the station, the carrier frequency is varied until the observed heterodyne

disappears. Because, in isolated instances, two stations have employed this method successfully, it has been hailed as a panacea. In those cases where two stations, assigned to the same channel, cause a heterodyne sufficiently loud to permit of easy elimination by the zero-beat method, they both suffer audio-frequency distortion, due to the interaction of their programs, even within their immediate service areas.

Although the heterodyne whistle may be eliminated, the system does not permit of accurate synchronization unless the receivers used respond to frequencies below sixty cycles. Furthermore, the scheme merely accomplishes approximate synchronization between two stations and affords no assurance that either station is on its assigned frequency. Should any number of stations on the same channel use this plan, that frequency would become a raving bedlam, each station trying to follow the others, each not knowing what changes to expect in the frequency of the others. The difficulties of manual frequency control can best be appreciated by setting up three or four regenerative receivers in neighboring houses, adjusting them all in an oscillating condition upon a predetermined broadcasting station, and maintaining them there without permitting an audible whistle.

The third plan listed is theoretically most attractive. A short-wave station is to radiate a national synchronizing signal, to be used as a reference frequency by all broadcasting stations. This is accomplished by radiating a 10,000-cycle note, impressed by modulation on a short-wave carrier. A receiving set, installed at each broadcasting station, would pick up this signal, supply it to a harmonic producer which multiplies the received note to the assigned frequency of the station. The station's carrier would then be adjusted until it zero-beat with the output frequency of the harmonic producer. The transmitted synchronizing signal cannot be higher than 10,000 cycles because it must be a multiple of every frequency used as a broadcast carrier.

The manual control of a broadcasting station's frequency is difficult enough when a local crystal oscillator at the station itself furnishes the reference frequency. But to use for this purpose a weak and varying national synchronizing signal, transmitted in most cases more than a third of the way across the country, is like trying to balance an egg on your nose. The carrier frequency of a broadcasting station is constantly subject to slight variations, due to changing temperatures of vacuum tubes, voltage changes in the main power supply, and the effect of modulation peaks. Each of these variations must be compensated by readjustment of the carrier frequency. The source of the reference or comparison frequency must therefore be perfectly stable.

A NATIONAL SYNCHRONIZING SIGNAL?

THE principal difficulty with the national synchronizing signal plan is that the entire country cannot be successfully blanketed by the output of a single short-wave station at all hours of the day and night. The received signal must be sufficiently strong and stable to actuate a harmonic producer and produce a steady reference frequency for every broadcasting station in the United States. The system does not meet the requirement of reliability. The cost of maintaining a national synchronizing station in continuous operation, even if divided among 700 broadcasters, and the rather elaborate receiving equipment needed at each station is a serious, though by no means insurmountable, barrier to the plan.

The fourth method is the employment of wire lines for synchronizing stations. In the case of

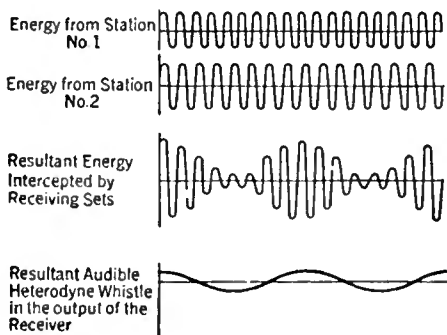

WHEN TWO STATIONS INTERFERE

Station 1 may be operating on its correct frequency, but Station 2, which we will assume should be on the same frequency, may be slightly off its assigned frequency. A receiver tuned to Station 1 also receives energy from Station 2. The third curve shows what happens in the detector circuit: the two waves combine and in the loud speaker there is a heterodyne whistle, constant in pitch, indicated by the fourth curve. If the whistle is loud enough, it will completely ruin reception. Accurate stabilization of the carrier frequencies of all broadcasting stations within an accuracy of at least .05 per cent. is absolutely essential if reception is to be free of heterodyne interference due to this cause

chain broadcasters, it might be possible to use the order wire circuit interconnecting chains, but, since chain circuits are set up for only an hour or two each evening, the contribution to stability which this would afford is quite negligible. There are not enough telephone wire facilities to spread a national synchronizing signal to every city where a station exists. The cost of interconnecting hundreds of stations would run into several million dollars annually. The economic burden which wire synchronization on a national scale would impose is entirely beyond the capacity of the broadcasting industry to bear.

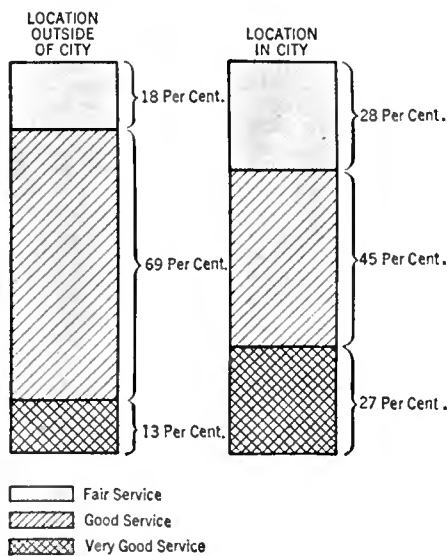

STATIONS SHOULD BE OUTSIDE CITIES

The drawings show the relative effectiveness of two transmitters of equal power, one located in a city and the other outside. As many listeners as possible should be included within the good service area of a station, which is possible by locating the station outside of a city. Under such conditions, 69 per cent. are located in the area of good service compared with 45 per cent. in the previous city location. Locating a station outside of a city distributes more evenly the field strength of the signals because the absorption effect of steel buildings is removed. (Data from *Bell System Technical Journal*, Jan. 1927)

With respect to the second problem, the synchronization of both program and carriers on the part of chain stations, many of the considerations already discussed apply. The outstanding example of carrier and program synchronization has been the successful simultaneous operation of WBZ in Springfield, Massachusetts, and WBZA in Boston. A special channel is utilized to transmit a synchronizing signal so that both stations take their carrier frequency from the same frequency source. Both stations invariably broadcast the same program. The results of this experiment have been satisfactory and the question is often asked why all the stations of the Red Network, for instance, do not synchronize their carrier frequencies in the same way so that, instead of occupying ten or twelve channels, they would use but one.

The task of carrier and program synchronization of WEAf and WLW, for example, as compared with the synchronization of WBZ and WBZA, presents some curious problems, the importance of which is not generally realized. In the first place, WBZ and WBZA are separated by only seventy miles, while WEAf and WLW are 570 miles apart. This eight-folds the wire leasing costs for synchronizing the latter two stations, making a truly imposing financial burden. Secondly, the two stations do not continuously and invariably radiate the same program. Were they to radiate two different programs, audio-frequency distortion of both programs would be sufficient to cripple the entertainment value of both stations, even well within their local service areas. Third, since large areas receive signals from both WEAf and WLW in appreciable amounts, the received signals in such areas would cause phase distortion. The reason that phase distortion is not experienced more generally in the WBZ-WBZA combination is that, because of an inexplicable ether wall, there are few points where an appreciable signal is received from both stations.

Considering that radio waves travel 186,000 miles a second, it is hard to conceive appreciable lag in the reception of the same program radiated simultaneously from two different stations at varying distances from a receiving point. But, even in the hypothetical case of WEAf and WLW this lag may cause serious distortion. A listener at Staunton, Virginia, where both WEAf and WLW are received with good volume, is approximately 272 miles from Cincinnati and 365 miles from Bellmore. The distance from Bellmore is 93 miles greater than the distance from Cincinnati and therefore, theoretically at least, the program from Bellmore would lag  $\frac{93}{186,000}$  of a second behind that from Cincinnati. This would cause serious distortion. Some frequencies in the musical scale would be exaggerated and others reduced in intensity.

Experience with the reception of several signals from the same station, through the effect of reflection and the influence of bodies of water resulting in phase differences, offers valuable evidence, tending to confirm the distorting effect of synchronized chain broadcasting where the receiver responds appreciably to signals from more than one broadcasting station.

Ordinarily, the reception of two or three signals from the same station does not seriously affect quality because one of the signal sources usually predominates over the others sufficiently to make their influence negligible. But there are many known cases where phase distortion accounts for the poor quality with which high-grade stations are heard in some areas. When WEAf broadcast from Walker Street, several years ago, listeners in Pelham, New York, but 16 miles airline distance from the transmitter, complained that, even with the best of receivers,

only a weak and distorted signal could be received. A thorough investigation with loop receivers and field strength measuring equipment revealed that two signals from WEAf, apparently coming in from two different directions and, at some points, exactly 180 degrees out of phase, tended to cancel each other. Similar effects would be experienced when two stations radiate identical programs on the same channel.

If a chain of twenty stations were synchronized, the resultant reception, at all points beyond the high-grade service range of the synchronizing stations, would at least lack that clearness and purity of tone which characterizes modern broadcasting and might be sufficiently confused to be almost unrecognizable. Because of this consideration, desirable synchronization of chain programs is limited to stations widely separated geographically so that no listener is within the practical range of more than one synchronized station.

#### CHAIN STATION SYNCHRONISM

THE practical application of synchronization of chains is thereby limited to the establishment of two or three groupings per chain rather than placing all the members of a chain on a single channel. This would not effect radical saving of cleared channels, a maximum of four or five for each chain being possible.

A further barrier to extended chain synchronization is the fact that it can conserve channels only if the stations involved broadcast chain programs exclusively. Since most of the subscribing stations use chain programs only occasionally, an hour or two each evening at the most, permanent assignments to synchronized channels is now impossible. The cost of wire lines and chain features is altogether too high to require subscribers to chain programs to utilize only chain programs. Yet, only under those conditions, would chain synchronization effect any economy of channels. Most chain stations broadcast local programs and perform local services during a majority of their broadcasting time. These services would have to be discontinued or transferred to minor stations under any plan of widespread chain program synchronization.

Considering that the problem is to find comfortable room for nearly 700 stations in a band of 89 channels, reliance upon the single measure of chain station synchronization does not offer any promise of real relief, even if the difficulties cited could be overcome immediately.

A trend of development which holds some promise is improvement in the permissible percentage of modulation without resultant distortion. This is the third general measure of relief given at the beginning of this article. Its effect is to increase the percentage of the high-grade service area to the total carrier interference range area. The experimental fifty-kilowatt transmitter at Whippany, maintained by the Bell Laboratories, utilizes a new method of combining carrier with program signal, said to effect one hundred per cent. modulation. While the results, so far as increased service range for a given carrier power is concerned, are not startling, they are, nevertheless, appreciable. The engineering ideal to be attained in this direction is that the carrier shall cease to radiate at the edge of the station's high-grade service area. The problem of setting up an intense wave motion of any kind and making it cease abruptly at the limit of its usefulness is a tremendous challenge to engineering ingenuity. In radio transmission, there is room for so much improvement in reducing the ratio of carrier spread to useful service range that some progress in this direction may be hoped for. But that this development will have material bearing in the present situation is not within

the expectation of the most sanguine workers in this field of research.

Considering the immediate possibilities of all the proposed measures of relief, none holds greater promise than the development of high-precision crystal oscillators with accurate temperature control. Realizing the value of a source of constant-frequency oscillation, many laboratories have been concentrating on this problem during the last few months. The writer has seen, in the development stage, a new type of quartz crystal precision oscillator for broadcasting stations which will probably be marketed by the R. C. A. This device will consist of two accurately ground and matched quartz crystals mounted in a constant temperature chamber. The temperature is kept constant by means of a thermostat and maintained at a given setting

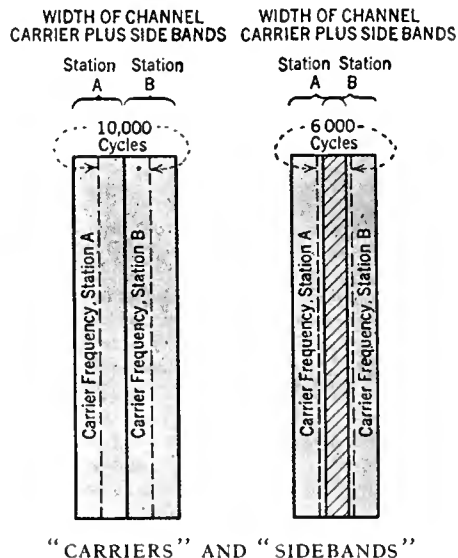

"CARRIERS" AND "SIDE BANDS"

Stations assigned to adjacent broadcasting channels transmit on carrier frequencies differing by 10,000 cycles. When programs are transmitted, two sidebands are produced which introduce into the transmitted wave, frequencies up to 5000 cycles above and 5000 cycles below the carrier frequency; the station therefore uses a band of frequencies 10,000 cycles wide. The left sketch shows the frequency bands used by two adjoining stations. The two carrier frequencies differ by 10,000 cycles; the sidebands meet each other but do not overlap. This holds true when two adjacent stations hold exactly to their assigned frequency. If either station varies, the condition shown at the right obtains, where we have assumed that one station has wandered from its frequency to the extent of 4000 cycles (4 kc.) deviation. This leaves the carrier separation between the two only 6000 cycles (6 kc.). Then, in the receiver output, we would hear a 6000-cycle note, which may be loud enough to ruin reception. Interaction between the two sidebands of the stations—shown on the shaded portion of the diagram—also occurs

by means of this thermostat, checked by a thermometer. A suitable heating coil is also mounted in the constant temperature chamber. The two crystals, supplied with this oscillator, may be ground to any one frequency in the band of from 550 to 1500 kilocycles. A small selector switch is arranged to select either of the two crystals. Should one of the crystals fail during the operation of a broadcasting station, it is only necessary to throw this selector switch which removes the defective crystal and cuts in the spare crystal, which will be at the right temperature to start operation immediately.

The oscillator circuit will consist of a vacuum tube and coil system, the electrical constants of

which have been very carefully determined with a view to being suitable to work with the quartz crystals. A monitoring receiver, comprising a suitable detector and two stages of audio-frequency amplification, in a separate box, has also been designed for use in connection with the quartz crystal precision oscillator. When these two boxes (the quartz crystal oscillator and the monitoring receiver) are used in conjunction, a loud speaker may be connected to the output of the last stage of audio-frequency amplification and the quartz crystal frequency beat against the carrier of the broadcasting station. Special precautions will be taken to emphasize the low frequencies so that the zero-beat note will be heard at its greatest efficiency.

No definite claims have yet been made as to the stability of this device, but there is no question that two stations, operating on the same channel, both employing the device, will not heterodyne each other seriously. It should eliminate the high pitched squeal and that, alone, will justify its installation. It is not unreasonable to expect that, with continued improvement and experience with precision quartz crystal oscillators, complete carrier synchronization will ultimately be made possible.

#### NEW METHODS OF TRANSMISSION

THIS summary would be incomplete if mention were not made of several proposed new methods of transmission, claimed to reduce the width of the channel required by a broadcasting station. These methods are frequently mentioned in public statements, issued as possible measures of relief by persons who must know the objections to their adoption in the broadcast band. One is single side-band transmission, accomplished by suppression of the carrier and one side-band, as utilized in practice in the transatlantic telephone. It has the vital objection that its adoption is predicated upon scrapping every transmitting and receiving equipment in the country. The broadcast receiver necessary to pick up single side-band transmission is expensive and delicate. One of its elements is an oscillator which must be adjusted to within ten or fifteen cycles of the assigned frequency of the station to be received, in order to supply the missing suppressed carrier. To reëquip every broadcast listener with a suitable receiver under this system would cost the public not less than half a billion dollars.

Another suggestion along these lines is the adoption of a new system of frequency modulation. For this has been claimed the extraordinary virtue of accommodating simultaneously between one and two thousand broadcasting stations in the present band. The basic principle of the system is that the carrier frequency is shifted up and down according to the desired audio signal to be transmitted. The receiving set is tuned with extreme sharpness so that the shifting carrier causes varying energy to actuate the receiving set by reason of the detuning effect. This system would also require the scrapping of all receiving sets, unless the carrier is shifted over so wide a scale that no economy of channels is effected. The contention is also raised that a shifting carrier sets up numerous harmonics so that the theoretically narrow band occupied by the frequency modulated carrier would prove to be in practice no narrower than that used by broadcasting stations operating under the present simple methods of modulation.

A most exhaustive study of the entire subject will lead inevitably to the conclusion that progress in increasing the capacity of the broadcasting band will be steady but that no radical developments, sufficient to offer a complete solution to the present problem, are in sight.



# THE MARCH OF RADIO

## NEWS AND INTERPRETATION OF CURRENT RADIO EVENTS

### Why the Persistent Cry of Monopoly?

**T**HE struggle now shaking the foundations of the radio industry has long been brewing. On one hand is assembled a group of militant independent manufacturers, vigorously attacking an alleged monopoly whose grasping tentacles reach into every branch of the radio field; on the other hand, the radio mouthpiece of vast electrical interests, claiming, with injured innocence, that it was born out of patriotic motives and possesses its imperialistic power over the radio industry by virtue of its widespread and proper patent rights. Drawn into this conflict are the Federal Courts, the Federal Trade Commission, Congress, and the Federal Radio Commission.

The consequences of this struggle may be far-reaching. So great is the patent strength of the combination that little reliance is placed upon upsetting the validity of enough patents which it holds to free the industry of its domination. Nor is there any vast sum being spent in research to develop non-infringing vacuum tubes and associated circuits. Instead, attack has been made upon the methods used in taking advantage of its patent position and upon the fundamentals of the patent itself.

Several bills before Congress propose drastic revision in the powers conferred upon all patent holders; one, for example, seeks to make revocation of patents the penalty for violation of anti-trust laws so that companies conducting research and promoting progress will suffer more severely than those which simply copy designs and infringe patents. Another bill proposes that patents applying to vacuum tubes shall not confer upon their holders the same rights which apply to all other articles, a plain discrimination against one industry.

Another line of attack is through the Federal Radio Commission. The commission is severely criticized by Congress, to which it reports, and by hostile station owners, for the privileges extended to the chain stations, partly owned by the combination. Bills proposing equal geographic distribution of broadcast transmitters are being written, requiring the destruction or curtailment of useful and popular broadcasting services. The operation of such a law would inevitably require power reductions on the part of WEA, WJZ, WGY, and KDKA, all N. B. C. stations. No avenue is being overlooked to injure, directly or indirectly, any and every activity of the combination.

Let us view the situation sanely. A wave of resentment has arisen against the power of the Radio Corporation of America and the huge electrical interests backing it. This power is based upon the ownership of patents, in themselves a legal monopoly. The restrictions imposed by patent holders are escaped either by abandoning the field, paying royalties, or devising new methods which do not infringe. Many companies in the radio industry have elected to pay royalties. There is no indication that any of the unlicensed independents are making any real effort to devise non-infringing designs. They elect to follow none of the three customary alternatives.

Politics have further clouded matters in a fog of flaming oratory. Bills are proposed, with the

intention of injuring the Radio Corporation of America, which, if passed, will accomplish that objective, but will also mutilate both the present broadcasting structure and the entire patent structure upon which American industry has been built. The Radio Corporation of America should be punished for any crimes of which it is guilty, but it would be unfortunate if unwise legislation were enacted in the current anxiety to inflict punishment.

The foundations for the present situation were laid shortly after the war. American communications had been greatly hampered, both during and after the period of neutrality, by foreign censorship and foreign ownership of cables and long-distance radio communications. Naval officials desired the establishment of an American owned transoceanic network and an American radio industry so that channels of communication and sources of supply for war needs would always be available. No one company had access to a sufficient number of patents to enable it to conduct a profitable transoceanic radio service or even to manufacture modern vacuum-tube transmitting and receiving apparatus.

With the encouragement of high naval officials, the Radio Corporation of America was formed in 1919. It was given rights, in a patent pool comprising the principal radio patent holders, to conduct transoceanic services and marine communication and also to sell transmitting and receiving apparatus to the handful of amateurs then operating. The pool consisted of the American Telephone & Telegraph Company and its subsidiary, the Western Electric Company, the General Electric Company, the Westinghouse



#### RADIOMARINE CORPORATION ORGANIZED

The ship-to-shore marine radio communications of the Radio Corporation of America were transferred to a new subsidiary, the Radiomarine Corporation with which was combined the Independent Wireless Company. Charles J. Pannill, former president of the Independent, is now vice-president and general manager of Radiomarine and J. P. Duffy, for years superintendent of the New York division of RCA marine, has been appointed superintendent of operations. Mr. Duffy is shown above

Electric & Manufacturing Company, and the Wireless Specialty Apparatus Company. Each company threw their radio patents into the pool and received license under *all* the patents, each for use in a particular and limited field of activity. The fundamental objective of the combination sought by the Navy was promptly accomplished. The world-wide communication system came into being. Had this been the only result of this pooling arrangement, there would be no conflict to-day.

Radio broadcasting came in an avalanche of public enthusiasm in 1920 and 1921. It is obvious to anyone who has read the original agreement, upon which the patent pool is based, that broadcasting was not contemplated when the pool was formed. But the patent structure which was thus built up has established an almost impregnable domination of the radio industry. Considering the immense research facilities of the group and the important patents which its various members have purchased, it is in a position to maintain that hold, unless its patent rights are abridged or modified.

At the beginning of the radio boom seven years ago, few of the group's radio patents had been adjudicated. An independent industry grew up and flourished in total disregard of these patents. A few gestures were made by the group to make known its patent holdings, such as sending infringement warnings to manufacturers by registered mail regarding the Pickard crystal patents, but no effort was made to make the public conscious of the importance of the pool, its research facilities, and the patents which it held. Suits were filed which are only now being finally settled.

With recent adjudications, all of the large producers, representing about three fourths of the industry's volume, have become licensees of the group. The remainder have been unable or unwilling to meet the license terms, with their minimum annual royalty guarantee of \$100,000. The independent vacuum-tube industry has been virtually destroyed by the effects of one of the clauses of the license contract which requires that all licensed radio sets be equipped with tubes sold by the R. C. A. or Cunningham, a subsidiary. This clause has been adjudged as a case of restraint of trade under the Clayton Act. The R. C. A.'s justification might be among other things, that no one can make tubes without infringing their patents (adjudicated and unadjudicated), and hence there is no legal competition.

This, briefly, and stripped of many ramifications, is the background of the situation. The combination was formed with a useful and patriotic purpose which has been successfully accomplished. Its existence was also instrumental in initiating the first permanent broadcasting and, more recently, in making possible a source of a comprehensive license to manufacture radio receiving sets without infringement of any but a few patents held outside of the group. Several members of the combination are responsible for vitally important research work, contributing to the modern standard of radio reproduction.

Strong companies and dominant groups exist in

every important field of industry. But in none is the dominant group so generally disliked and so freely criticized. Mention of the General Motors car wholesaler does not have the effect of ruining his digestion or moving him to profanity. Why all this resentment against the radio combination?

The Radio Corporation of America is singularly devoid of public relations sense. It has never effectively set itself to the task of winning public goodwill. Only when under attack does it offer belated explanations. It conducts its affairs in a dictatorial manner, deciding for itself what is good for it and what is good for the entire industry. It regards the interests, but apparently not the opinion, of the public. The severest penalties are imposed by the court of public opinion.

We must distinguish between publicity and public relations. Publicity is a matter of releasing information to the press. In this respect the R. C. A. is highly efficient. It issues publicity material copiously. Public relations involve every relationship with those outside a company's personnel, not merely relations with the press. The building up of satisfactory public relations requires that every act, however small, be considered in the light of public understanding and interpretation.

It may be legal to collect royalties based on the gross business of a licensee, but how will the public react to the knowledge that one manufacturer, making a cheap table model radio set, pays three or four dollars royalty on each set he makes, while another, using the same patents in the same way, pays fifteen or twenty dollars because his set is of high quality and is housed in a piece of fine furniture? How will the public feel when it learns that R. C. A. patent royalties have been sufficiently large to add greatly to the cost of producing radio sets and to make the operations of some of the most successful independent companies almost profitless?

An early adjustment of the present situation must be effected, lest it cause the passage of legislation detrimental to all patent holders. Any law which makes a patent less valuable and offers less protection to the owner of a patent will

discourage scientific research and rob the independent inventor of his incentive to devote himself to progress. Unless considerable forbearance and cool judgment is displayed by all the parties involved in the present controversy, the only possible outcome is legislation which will permanently weaken our patent structure. Aroused public opinion may exact too great a penalty, unless the patent holding group be guided by more of the spirit of live and let live.

*Radio Laughs at Wired Wireless*

OUR contemporary, *Radio Retailing*, leads off, in a recent issue, with a stirring editorial to the effect that the radio industry can no longer "laugh off" the approach of wired wireless. It states that the program services, which the electric companies will soon pour into American homes via the power lines, will be superior in quality to "space" broadcasting and hints that radio will have difficulty in competing with them. The publication solemnly warns the radio industry to prepare for the competition of wired wireless.

Because of the well-earned reputation of our contemporary, these editorial remarks have created some uneasiness in the radio trade. It is our view, however, that we can "laugh off" wired wireless competition for many a year. In fact, we very gravely doubt that the future of wired wireless is as rosy as *Radio Retailing* believes it to be.

If the electric power companies can find better symphony orchestras than the Philharmonic and the New York Symphony, more important prizefights than the Dempsey-Tunney, better bands than the Marine Band and the Goldman, greater artists than Jeritza, Mary Garden, Galli Curci, John McCormack, Gigli—oh well, what's the use of continuing—anything they can unearth will quickly be recruited to the broadcasting field. The power companies will require as elaborate and as expensive transmission equipment as do broadcasting stations serving an equal area. There is no reason to believe that the wired wireless company can secure talent at a lower cost than can broadcasting companies. They

cannot claim better transmission quality because power lines also have their share of atmospheric noises and, in addition, current surges and disturbances which are fully as great, if not greater, than those with which radio contends. They cannot claim more faithful reproduction because radio now encompasses practically all the frequencies heard by the human ear. Wired wireless has no advantage over radio in cost of program and technical operations or in reproduced result.

The most important claim, made by the supporters of wired wireless, is that it will not put forth publicity programs. Wire broadcasting will derive its revenue, not from transmission, but from reception. The consumer will pay directly at a rate probably ranging between three and ten or twelve dollars a month, depending upon whether he is content to use headphones or wishes high-grade loud speaker reception. We hazard the prediction that the electric power companies will, sooner or later (and probably sooner), yield to the temptation of making occasional remarks about electrical appliances, good lighting and a few other things which will promote the sale of electrical apparatus and increase current consumption. The monthly wire broadcasting toll will be a much more serious obstacle to spreading wired wireless than is the publicity accompanying commercial radio programs to the growth of the broadcasting audience.

The American public is not accustomed to paying for something which it can secure without direct payment. The monthly payment feature of wired wireless will confine its market very largely to public places, such as restaurants, hotel lobbies, and railroad station waiting rooms. That element of the consuming public which considers programs coming over an electrical circuit so superior to radio reception that it is waiting for the coming of wired wireless is not, and never has been, a prospect for radio sets.

We believe our contemporary has considerably exaggerated the possibilities of wired wireless. The radio industry has little or nothing to fear from its competition. Wired wireless will serve a field peculiar to itself and has a valuable mission to perform but, in so doing, it will not be a serious or dangerous competitor to the radio industry.

*Congress Dabbles with the Radio Situation*

CONGRESS has been intensely busy tinkering with the radio situation during the last few months. The House Committee on Marine and Fisheries, the Senate Committee on Interstate Commerce, and the Senate Patent Committee have been the scene of endless hearings, inquiring into every phase of broadcasting and radio manufacturing. The result, at the time of writing, has been to paralyze the Federal Radio Commission into almost complete inactivity and to confuse the entire situation with a riot of rabid opinions.

It is likely that some form of legislation will be passed by the time this editorial appears, presumably extending the life of the Radio Commission for another year. The opposition to this course is based largely on a desire to embarrass Secretary Hoover with the radio situation by the automatic operation of the unamended Radio Act of 1927. If the situation does revert to his jurisdiction, he must make some progress with it and, in so doing, will incur the enmity of politicians in the areas affected. Thus Congress, unable to help the radio situation by intelligent legislation, proceeds to use it to its own political advantage.

Nothing of particular novelty has been revealed in any hearings and only one statement of importance has been made. A bill has been pro-

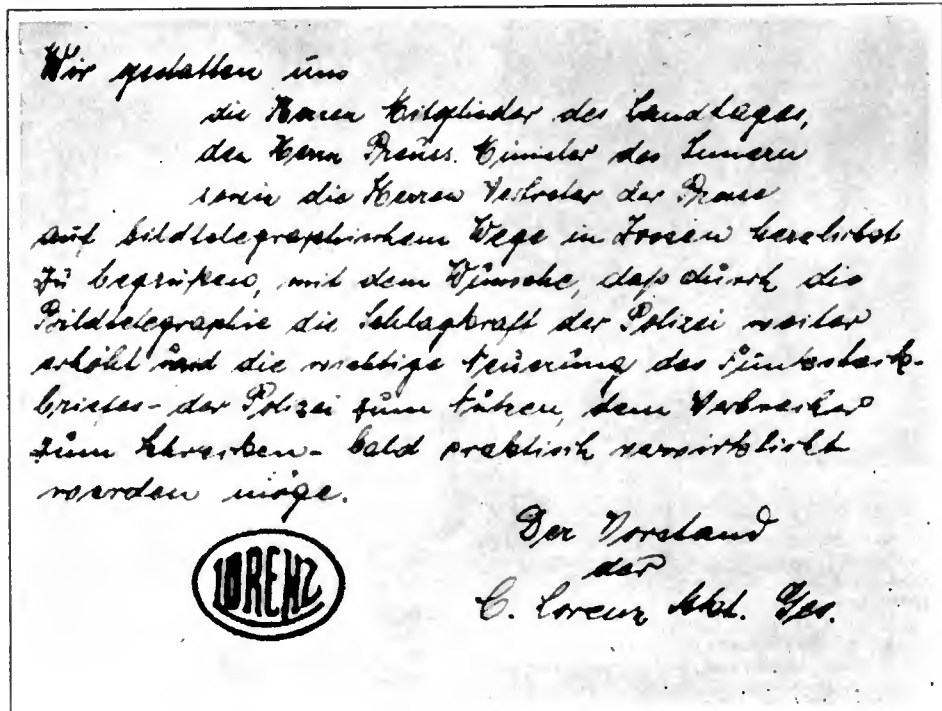

A SAMPLE OF FACSIMILE TRANSMISSION BY THE KORN SYSTEM



posed to clarify the equitable distribution of broadcasting service clause of the Radio Act of 1927. The total wattage of broadcasting stations in the southern district is less than that of the largest single station in the northeastern district. The Federal Radio Commission is being blamed for this situation and is charged with discrimination against the south. To bring about a modification, the bill proposes that the total wattage of the five districts shall be equalized.

Commissioner Caldwell responded to this destructive suggestion by pointing out that the principal program sources of the entire country would, by the operation of such a provision, be required to suffer substantial power cuts, depriving immense rural populations of their favorite program services. There are neither stations nor frequency space sufficient to bring up the total wattage in the less progressive areas (speaking only from the broadcast transmission standpoint), and, consequently, the only possible way in which to observe the proposed law would be to reduce the power of every station in the New York district by eighty per cent., or eliminate a large number of medium and high-power stations. Many of the politicians were highly irritated by Commissioner Caldwell's succinct exposition of the situation but, so forceful was his logic that the only answer, so far made, has consisted of pointed and—it seems to us—unjustified insinuations about the Commissioner's susceptibility to the influence of the great broadcasters.

Commissioner Caldwell is to be commended for stating the facts so plainly and having the courage, at this time, to stick to the truth even though it be favorable to the viewpoint of the N. B. C. Political wisdom dictates a different attitude but he is swayed only by a desire to serve the listener.

The only other activity of the Commission has been the issuance of a formidable list of frequency and power changes by Commissioner LaFount, affecting stations on the Pacific Coast. These changes promise to clear up many existing heterodynes. It seems quite apparent, at this writing, that congressional hungling will prolong the present unsatisfactory radio situation for another year.

BAIRD TELEVISION APPARATUS ON SALE

PRESS dispatches from London announce that Selfridge's is selling Baird television outfits at a price of thirty-two dollars per set. Investigation reveals, however, that this equipment consists only of the parts for building a shadowgraph transmitting outfit. The amateur transmitting enthusiast can send, at his home, a moving hand or a shadow made by a cardboard figure held before the outfit. The cost of the receiver parts, to be marketed later, will be approximately the same. The shadowgraph offers a field for entertaining home experiments and it should promote interest in the problems of television.

As to the commercialization of television in the United States, a statement made by David Sarnoff of the Radio Corporation of America, before the New York Electrical League, is significant. He is quoted in the press as saying: "We will hear much more about these developments within the next year. My guess is that, within five years, they (television receivers) will be as much a part of our life as sound broadcasting is now."

An unnamed representative of the R. C. A. is quoted in the New York Times, when questioned as to how soon the Alexanderson still picture transmission apparatus will be placed on the market, as follows: "Oh, it will be a long



GERMAN POLICE USE THE KORN PICTURE SYSTEM

In recent months, the Korn picture transmitting system has been adopted for regular use by the German police. The illustration shows a sample of the received picture. Average transmitting time for a picture is said to be 2½ minutes

time. Look at the apparatus. It is too cumbersome. It is only in experimental form."

Considering the great number of years that photo transmission has been the subject of experiment both here and abroad and the success obtained by such pioneers as Korn, Jenkins and Baird, and the recent successes of the Bell Laboratories and Alexanderson, it is surprising that picture broadcasting is so slow in becoming a supplement to tone broadcasting.

PICTURE BROADCASTING MUST CONTAIN NO "ADS"

MR. DAVID CASEM, Radio Editor of the New York Telegram, pointed out editorially recently that numerous commercial broadcasters are already considering ways and means in which they can use picture broadcasting. He points out that, if picture transmission is used to distribute miniature billboards in the home, its growth will be stifled at the outset. The public is not going to buy picture receiving apparatus in order to have itself exploited by advertisers.

Mr. Casem's point is well taken. Picture broadcasting must adhere to the highest stand-

ards of education and entertainment, if it is to be popularized. We have interviewed many broadcasting station managements on this subject, and have found that this fact is generally appreciated. Program managers have apparently learned that the first and most important factor to be considered in any radio presentation is that it shall please the radio audience. To this rule, picture broadcasting is no exception.

ANNUAL REPORT OF THE R. C. A.

THE annual report of the Directors of the Radio Corporation of America to stockholders, for 1927, indicates a substantial improvement in the corporation's financial position. The net income transferred to surplus amounts to \$8,478,320, as compared with \$4,661,397 for the previous year. About seven per cent. of its gross business is the result of its transoceanic services, the need for which inspired certain naval officials to encourage the company's original formation. Its combined transoceanic and marine business is but nine per cent. of its total business. It collected, during 1927, \$3,310,722 for royalties, of which about one and a third million cover past damages. An interesting item among its assets is nearly ten and a half million dollars in accounts receivable. It is not generally considered that this is largely inventory and it may be mostly uncollected royalties. Although more than three million dollars were collected as patent royalties, a good part of the surplus has been devoted to reducing the value of the patents credited in the balance sheet. They are now down to a little over five and a half million.

THOSE interested in studying sales and distribution figures will find the report compiled by the Electrical Equipment Division of the Bureau of Foreign and Domestic Commerce, aided by N. E. M. A., on stocks of radio equipment in the hands of radio dealers, very illuminating. This is the second of a series of quarterly reports to be issued. A little over 30,000 dealers contributed to the information. On October 1, the dealers had 65,921 battery sets in stock and,

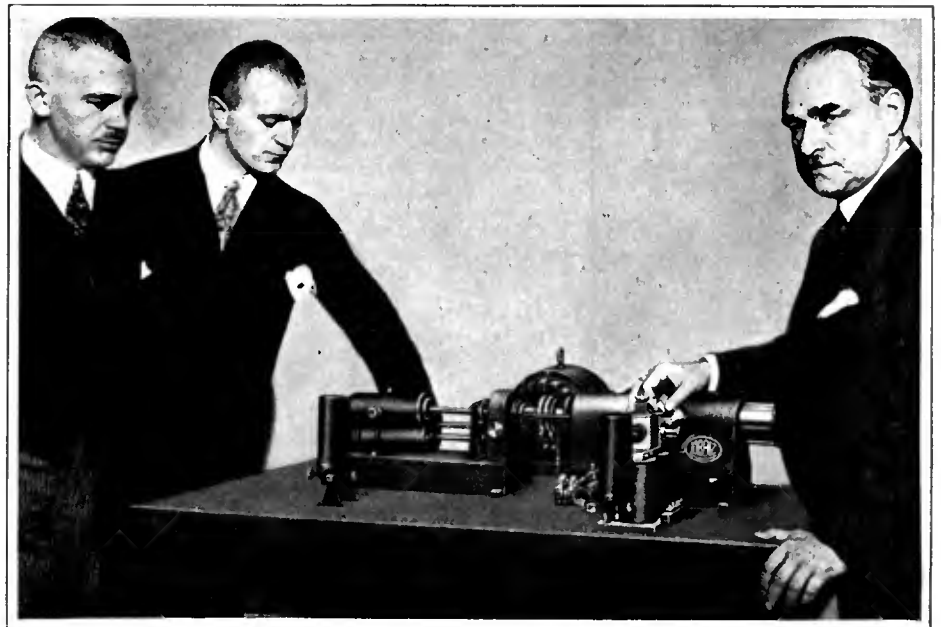

THE KORN SYSTEM OF RADIO PICTURE TRANSMISSION

Doctor Korn (extreme right) demonstrating his latest transmitter to German police officials. Synchronism is achieved by synchronous motors and the received picture is made on light-sensitized paper revolving on a drum in a light-proof chamber. It is said that the armies of Italy and Japan use the Korn "telautograph" which enables aeroplane observers to draw simple maps and then radio them direct to their bases

on January 1, the number had fallen to 62,778. The total stock on hand averages but two per dealer, a number insufficient to cause uneasiness.

*Here and There*

THE Association of National Advertisers has appointed a committee to make a survey of broadcasting as an advertising medium. They will endeavor to ascertain the average audience listening to a radio program. Their task is equivalent to determining the number of crickets chirping at any given instant, in a swamp, on a foggy summer evening.

LIEUTENANT Commander Craven has been assigned to the Federal Radio Commission by the Navy Department to grapple with the short-wave problem.

ALTHOUGH it is definitely known that both the N. B. C. and the Columbia chains will have microphones at the political conventions, just how these events will be handled is not yet made clear. Both chains have commitments to commercial broadcasters and any alterations to their schedules are made at the price of commercial income. Mr. Aylesworth of the N. B. C. has pointed out these difficulties and issued a general hint through the press that the entire convention proceedings might be sponsored by one commercial broadcaster. It appears that there was no great rush of volunteers as a result.

STATION WOAI, San Antonio, Texas, recently joined the N. B. C. network. It had been one of the few independent stations assigned a cleared channel by the Federal Radio Commission. The Commission has no control over the programs radiated by a station and is

not in a position to require that an independent, assigned to a cleared channel, shall not use chain programs after receiving such an assignment.

ASST. Secretary of Commerce for Aeronautics William C. McCracken, Jr., announced that approval had been obtained for the erection of a radio control station at Key West to be operated by the Airways Division of the Light-house Service. It will provide and exchange weather information between terminal airports, radio communication to aircraft in flight, and a radio direction service.

THE transatlantic telephone service has been subjected to a forty per cent. cut in rates, reducing the basic rate from New York to London to \$45 for three minutes and \$15 for each succeeding minute. The hours of service have been extended to from 7:30 A. M. to 8 P. M. Eastern Standard Time, corresponding to 12:30 P. M. to 1 A. M. in Great Britain. The service to Berlin, Hamburg, and Frankfort was inaugurated on February 10, and to Sweden on the 20th.

THE Department of Agriculture is extending its broadcasting service through NAA, Arlington, by issuing weather reports on several frequencies, both in telegraph and voice. The new schedule will benefit aviation and agriculture in particular.

OFFICIAL reports of American exports of radio apparatus in November indicate their aggregate value to be about one and a quarter million dollars, with Canada, Argentine, Australia, and Uruguay the largest purchasers. A CHINESE broadcasting organization has been formed which will rent time from a radio telephone plant at Shanghai. A subscription of ten dollars a year is to be charged each

member to meet the cost of providing programs and employing announcers. THE MUNICIPAL authorities of Buenos Aires are planning to extend the service of their station, LOS, in the Colon Theatre, which has so far been used exclusively for broadcasting operas and concerts from the stage of the theatre. THE NUMBER of licenses in the Australian broadcasting system has now reached 300,000. One high-power station has been erected in each capital city, and in Melbourne and Sidney there are two. Telephone lines for interchange of programs are frequently used. A CONTROVERSY rages as to radio concessions extended by various Chinese administrations. Japan has an agreement, negotiated by the Chinese Ministry of the Navy, which gives it a monopoly for thirty years. In 1921, the Federal Telegraph Company made a contract with the Chinese Ministry of Communications for five stations to be operated by the American company for twenty years. The British also obtained contracts on behalf of the Marconi Wireless Telegraph Company. Apparently an exclusive license in China is non-exclusive. IN EUROPE, the International Radiophone Union regulates the frequencies and time assignments of broadcasting stations. The Hungarian Government has been barred from admission to this organization at the plea of Czecho-Slovakian delegates. The Hungarians have been accused of using their stations to spread propaganda, attacking the Treaty of Trianon, thereby, endangering the integrity of Czecho-Slovakia. ALL EXISTING telegraph records were broken during the Christmas season in England when the inter-empire beam radio telegraph system transmitted no less than 31,694 Christmas greetings from Great Britain to the dominions at a speed of 400 words per minute, without a single repetition being required. GERMAN POLICE systems have adopted the Korn system of picture transmission which is built along lines which have become conventional. Korn is a pioneer in the field, having, as early as 1907, transmitted newspaper photographs between Paris and London. Synchronous motors and neon lights are used.

THE PATENT SITUATION

IN A decision released February 18, the District Court for Delaware held that Clause IX of the Radio Corporation of America license agreement with radio set manufacturers constituted an unfair method of competition in violation of the Clayton Act. Clause IX of the license agreement required that each set made under license be equipped with a complete complement of R. C. A. tubes, sufficient to make them initially operative. A suit for \$10,000,000 damages was subsequently brought by a group of independent tube manufacturers who avowed that the operation of this clause virtually paralyzed their business. Section III of the Clayton Act specifically provides that its provisions shall apply whether the article, in behalf of which unfair methods are employed, is patented or not.

In a suit brought by the Westinghouse Company, under the Armstrong patent, against the Tri-City Radio Company, the effect of continued acquiescence and acceptance of royalties on certain regenerative sets sold prevented the collection of damages. The Tri-City was a licensee under the Armstrong patent prior to its acquisition by the Westinghouse Company. It appointed a sub-manufacturer to make the goods for it, although the original license did not permit such sub-manufacture

*Estimated Number of Radio Receivers in Use*

*United States, January 1, 1928*

THROUGH the courtesy of the radio division, National Electrical Manufacturers' Association, the figures showing the number of radio sets now in use are presented. New York, California, and Illinois, are the leaders in order, according to this survey. Note the number of estimated sets in the southern states, figures which are interesting, in view of the efforts of some Congressmen, especially from southern states, to have an "equitable station-power distribution" clause made a part of the present radio act.

STATE	TOTAL SETS	STATE	TOTAL SETS
Alabama . . . . .	45,000	Nebraska . . . . .	118,000
Arizona . . . . .	25,000	Nevada . . . . .	15,000
Arkansas . . . . .	42,000	New Hampshire . . . . .	25,000
California . . . . .	704,000	New Jersey . . . . .	209,000
Colorado . . . . .	89,000	New Mexico . . . . .	18,000
Connecticut . . . . .	125,000	New York . . . . .	876,000
Delaware . . . . .	15,000	North Carolina . . . . .	48,000
District of Columbia . . . . .	44,000	North Dakota . . . . .	35,000
Florida . . . . .	73,000	Ohio . . . . .	464,000
Georgia . . . . .	64,000	Oklahoma . . . . .	104,000
Idaho . . . . .	26,000	Oregon . . . . .	121,000
Illinois . . . . .	539,000	Pennsylvania . . . . .	501,000
Indiana . . . . .	184,000	Rhode Island . . . . .	53,000
Iowa . . . . .	176,000	South Carolina . . . . .	22,000
Kansas . . . . .	104,000	South Dakota . . . . .	41,000
Kentucky . . . . .	46,000	Tennessee . . . . .	52,000
Louisiana . . . . .	74,000	Texas . . . . .	188,000
Maine . . . . .	39,000	Utah . . . . .	33,000
Maryland . . . . .	56,000	Vermont . . . . .	19,000
Massachusetts . . . . .	328,000	Virginia . . . . .	56,000
Michigan . . . . .	336,000	Washington . . . . .	217,000
Minnesota . . . . .	129,000	West Virginia . . . . .	50,000
Mississippi . . . . .	28,000	Wisconsin . . . . .	169,000
Missouri . . . . .	227,000	Wyoming . . . . .	20,000
Montana . . . . .	29,000	TOTAL . . . . .	7,000,000

# A Universal Short-Wave Receiver

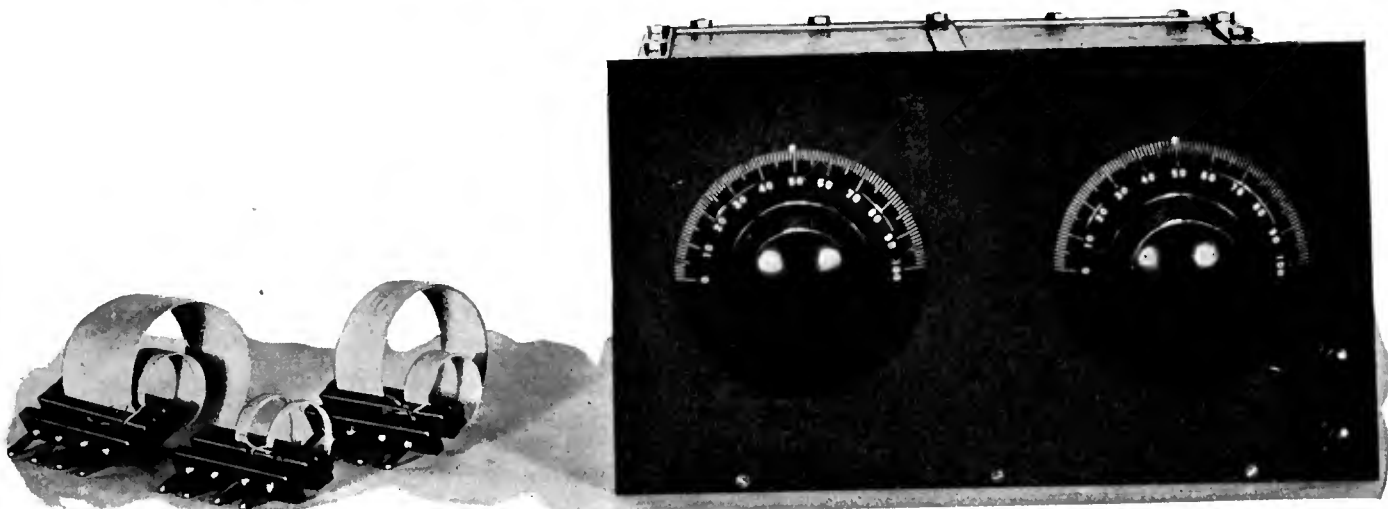

A SHORT-WAVE RECEIVER FOR 11.2 TO 219 METERS

Its construction is fully described in the article below, data for making the coils also being given. The three coils shown by the side of the receiver are for the 175, 80, and 20 meter ranges. A table on page 14 gives the number of turns for various frequency bands

By Lloyd T. Goldsmith

Col. E. H. Green Radio Research

## A "Super" for Code Work

*THE short-wave receiver described in this article has been designed for use with any ordinary audio amplifier, and when so used, will be found extremely sensitive, especially for code reception. The main purpose for its design, however, is its adaptation to the super-heterodyne unit described on the pages following those devoted to the present article. The super-heterodyne combination will not be satisfactory for short-wave phone reception due to the peaked characteristics of the intermediate-frequency amplifier. It will, on the other hand, be wonderfully sensitive for code reception.*

—THE EDITOR.

mmfd. capacity of the straight frequency-line type. The regeneration condenser,  $C_2$ , is a National of 250-mmfd. capacity. The latter two condensers are mounted directly on the copper box and bakelite panel. Each is provided with a 4" National Velvet vernier dial.

The grid condenser,  $C_4$ , is a 100-mmfd. Sangamo across which is a Tobe 8-megohm grid leak,  $R_1$ . The detector tube is a UX-201-A and fits in a General Radio UX type socket mounted on a General Radio rubber cushion to absorb shocks and reduce noises. The leads to the socket are of flexible rubber-covered wire. The radio-frequency plate choke,  $L_3$ , is a Samson No. 85 of 85 mh. inductance. The audio-frequency choke,  $L_4$ , in the positive B-battery lead is a Samson No. 3 of 3 henrys inductance. The audio-

**T**HIS article describes the construction of a single-tube receiver and coils to go with it to cover the frequency band between 1.37 and 26.7 megacycles (11.2 to 219 meters approximately). The receiver may be used with any audio amplifier system.

It is completely shielded in a copper box 10 $\frac{1}{4}$ " wide, 9 $\frac{3}{4}$ " deep, and 6" high. The copper sheet from which the box is made is  $\frac{1}{32}$ " thick. All joints are soldered and the top opening of the box is reinforced with  $\frac{1}{2}$ " by  $\frac{1}{2}$ " by  $\frac{1}{16}$ " angle brass which is soldered to the copper. Holes are drilled in the angle brass for  $\frac{3}{8}$ " 8-32 machine screws with which to fasten on the cover. The screws are soldered into the angle brass. The cover is of sheet copper reinforced at the edges and center with a strip of brass  $\frac{1}{2}$ " wide by  $\frac{1}{8}$ " thick. Holes are drilled in the strip around the edge of the cover to allow the cover to fit down on the angle brass where it is tightly held by hexagonal nuts. Although it takes a few moments to remove and replace the cover when changing coils, this method of shielding has been found to be very complete and mechanically strong.

The copper box is screwed to a 10" by 11 $\frac{1}{2}$ " by  $\frac{5}{8}$ " wood baseboard to which is also fastened by three wood screws the 7" by 12" bakelite panel. The only objects on the panel are the tuning and regeneration controls and the output binding posts. Note that the copper box is not centered behind the baseboard but is set in  $\frac{1}{4}$ " from the left-hand edge of the panel in order to allow room for the output binding posts at the right.

At the rear of the set there is a bakelite strip on which are mounted four binding posts for connections to the antenna, A battery, and to the detector positive terminal of the B battery. The three battery wires go into the copper box through one hole and the antenna lead through another. Most of the parts are mounted on an inside baseboard 10 $\frac{1}{4}$ " by 8 $\frac{1}{2}$ " by  $\frac{1}{8}$ " thick.

As will be seen by reference to Fig. 1, the antenna is coupled to the antenna coil through a General Radio midjet variable condenser of 15-mmfd. capacity,  $C_1$ . A General Radio coil mounting holds the plug-in coils and is spaced a generous distance from the sides of the box. The tuning condenser,  $C_3$ , is a Cardwell of 50-

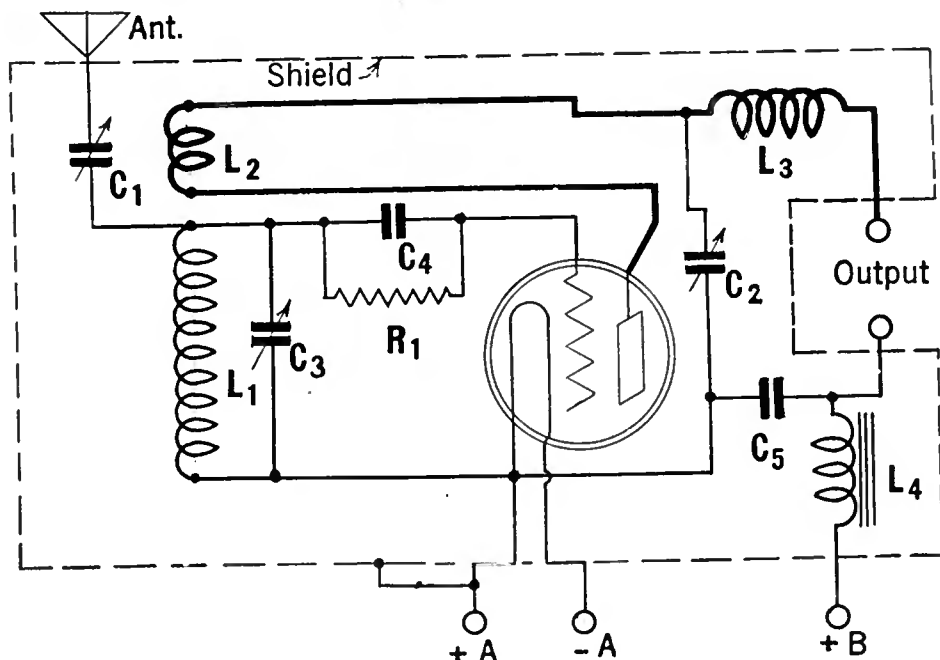

FIG. 1

Circuit diagram of the short-wave receiver described in this article

frequency current is bypassed to filament through a 1-mfd. Tohe condenser, C<sub>6</sub>, which in the photograph can be seen mounted on the baseboard beneath the regeneration condenser. The copper box is grounded to the positive A binding post.

No rheostat, filament switch, or voltmeter is provided on the receiver because it is designed primarily to be used with the screen-grid tube super-heterodyne described in the article following this one in this same issue, and common A and B batteries are used, the A battery connections for the receiver being taken off the filament terminals of the second detector socket of the super-heterodyne. In this way the filament switch on the super-heterodyne controls the filaments of all the tubes, and the voltmeter reads their filament voltage, which is adjusted by the master rheostat.

The plug-in coils are mounted between ½" bakelite strips provided with General Radio type 274-R plugs. The socket, or base, into which the coils are inserted, is a General Radio 274-B base, which retails complete for \$1.00. The plugs on the coils must be so spaced that they will plug into this standard base. The tickler is mounted next to the antenna coil when it is of the same diameter as the latter, but in the larger coils, to save space, it is mounted within the secondary coil. In any case, the tickler should be at the filament end of the secondary coil.

The coils are wound on a bakelite tube which has been cut in half diametrically and held together by

SECONDARY COIL			TICKLER COIL			BANDS	
No. of Turns	Diameter (Inches)	Size of Wire (D.C.C.)	No. of Turns	Diameter (Inches)	Size of Wire (D.C.C.)	Frequency (Megacycles)	Wavelength (Meters-Approx.)
4	1½	18	3	1½	22	16.7-26.7	18-11.2
7	1½	18	4	1½	22	11.5-18	26.1-16.7
11	1½	18	6	1½	22	8.3-13.3	36.2-22.6
0	2½	18	10	1½	22	6.0-9.4	50-31.9
14	2½	18	13	1½	22	4.2-6.52	71.4-46
23	2½	18	16	1½	22	2.87-4.6	104.5-65.2
37	2½	18	10	1½	22	2.1-3.43	143-90
54	2½	22	22	1½	22	1.37-2.17	210-138

A TABLE OF COIL SIZES

Complete details of the number of turns for the secondary coil, L<sub>1</sub>, and the tickler coil, L<sub>2</sub>, for various frequencies are incorporated in this table

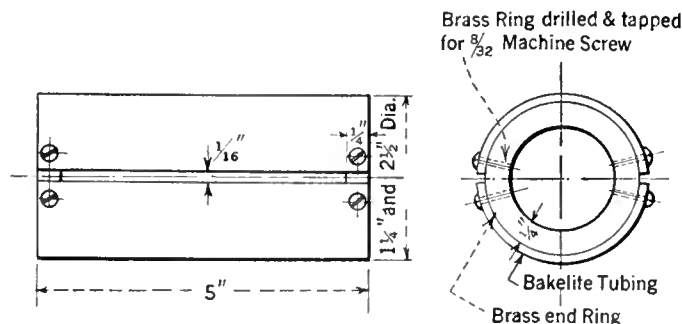

FIG. 2

Constructional details for the coil form

brass end rings. Fig. 2 shows the construction of the coil form. The desired number of turns is wound on the form and given two light coats of collodion. When the coil is dry the screws are removed from the end rings, the latter are slipped out, and the bakelite form is pushed together so that the coil can be slipped off. The inside of the coil is then given a coat of collodion to add to its mechanical strength.

The accompanying table gives data on the number of turns, size of wire, diameter of the coil, and the frequency band covered with the tuning condenser used. In the front view of the receiver are shown the 175-meter coil, the 80-meter coil, and the 20-meter coil, while the interior view of the set shows the 40-meter coil in place.

Elaborate constructional details have not been given in this article for it is felt that those interested will be sufficiently versed in the art of amateur set construction to build the receiver from those data presented. The layout of apparatus can be distinctly followed by reference to the photographs, and the circuit diagram is so simple as not to require an elaborate explanation.

The receiver as described is complete and ready for operation with any audio amplifier. It was primarily designed, however, for code reception, and particularly to be used in conjunction with the super-heterodyne unit described in the article beginning on the next page.

The following parts are required for the single-tube receiver described:

LIST OF PARTS

- C<sub>1</sub>—General Radio 15-Mmfd. Midget Variable Condenser
- C<sub>3</sub>—Cardwell 50-Mmfd. Variable Condenser
- C<sub>2</sub>—National 250-Mmfd. Variable Condenser
- C<sub>4</sub>—Sangamo 100-Mmfd. Fixed Condenser
- C<sub>5</sub>—Tohe 1-Mfd. Fixed Condenser
- R<sub>1</sub>—Tohe 8-Megohm Grid Leak
- L<sub>1</sub>, L<sub>2</sub>—Plug-in Coils (Specifications in Text)
- L<sub>3</sub>—Samson No. 85 Choke
- L<sub>4</sub>—Samson No. 3 Choke
- General Radio ux Tube Socket
- Six Eby Engraved Binding Posts
- General Radio No. 274-B Coil Mount
- General Radio Rubber Socket Cushion
- Two 4" National Velvet Vernier Dials
- 7" x 12" x 3/16" Bakelite Panel
- 10" x 11 1/2" x 1/8" Wood Baseboard
- 10 1/2" x 8 1/2" x 1/8" Wood Baseboard
- 3/2" Copper Box with Cover 10 3/4" x 9 3/4" x 6"
- Brass Angle, Brass Strip, Angles, etc.

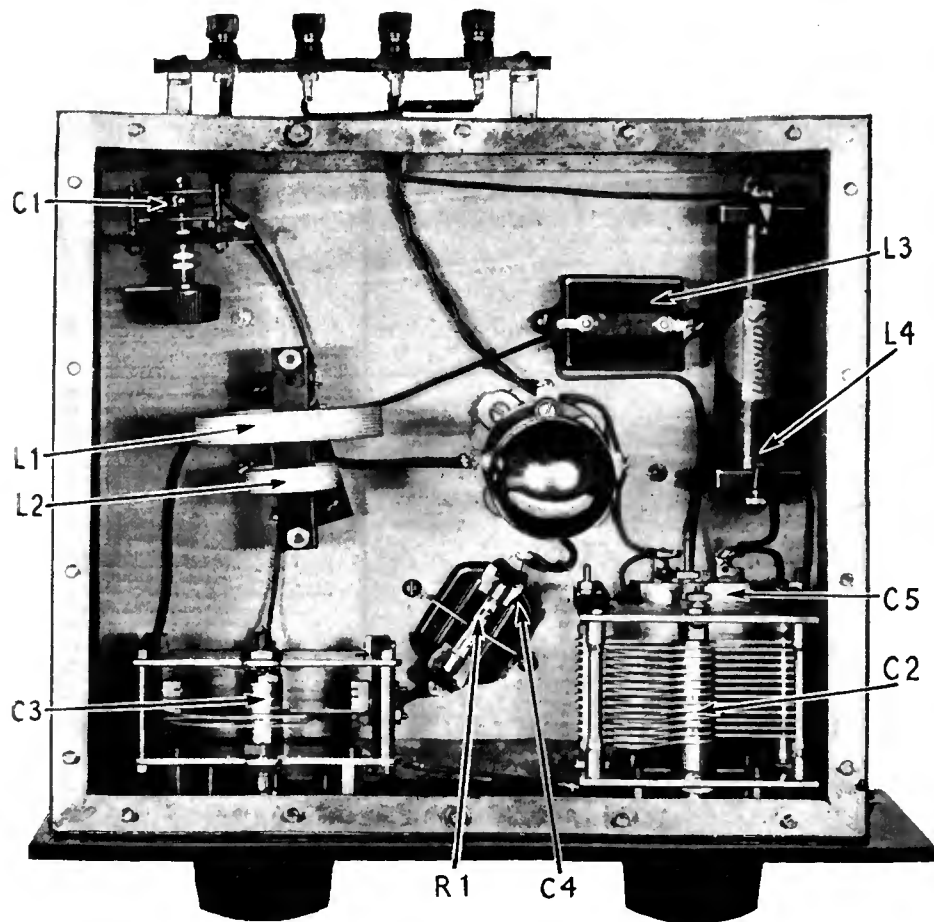

AN INTERIOR VIEW OF THE RECEIVER

The parts are numbered for cross reference to the list of parts in the column immediately to the right

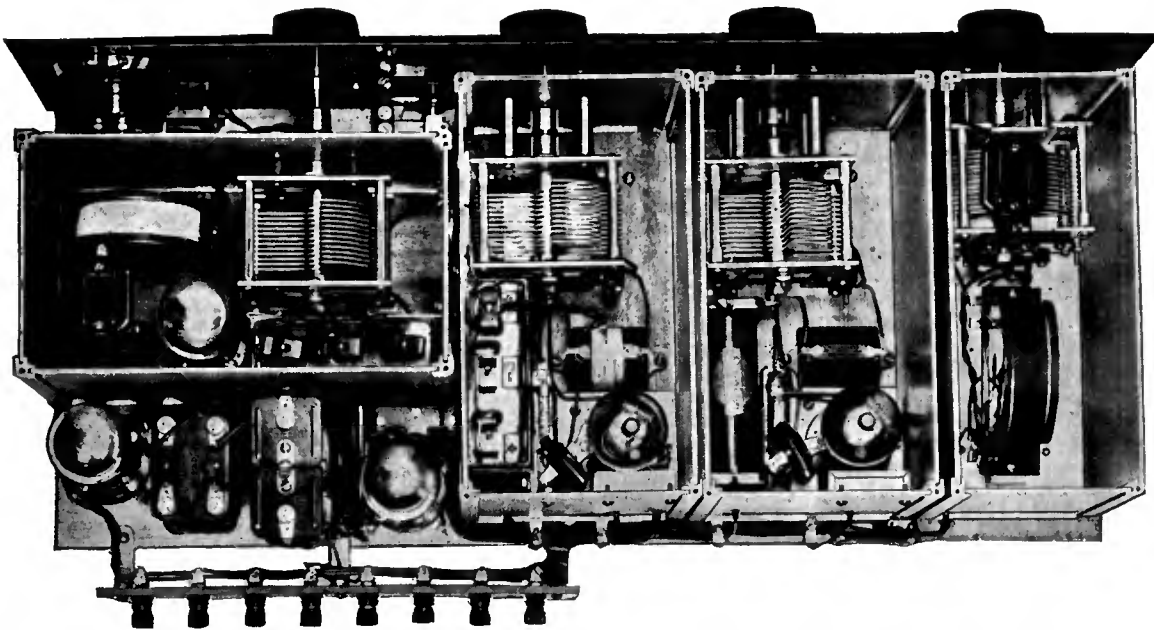

TWO SCREEN-GRID TUBES ARE USED IN THE INTERMEDIATE AMPLIFIER OF THIS SUPER-HETERODYNE UNIT

The unit has been devised for use with an existing short-wave receiver (such as that described in the previous article), converting it into a remarkably efficient short-wave super-heterodyne, especially suited for code signals

# A Super-Heterodyne for Short-Wave Code Signals

By Lloyd T. Goldsmith

THE standard receiver used for short-wave code reception usually consists of a detector (such as that described in the preceding two pages) and one stage of audio-frequency amplification, although sometimes a second audio stage is used in an effort to secure more volume. In the latter case, unless a selective amplifier is used, the noise level is amplified in about the same proportion as the received signal, which is undesirable, as the real aim is to amplify the signal and not the noise. This difficulty suggests that the signal be amplified at a radio frequency rather than at an audio frequency in an effort to amplify it more than the noise background. Radio-frequency amplification at very high radio frequencies has not been found very satisfactory but if the signal be changed to a radio frequency of the order of 20 to 100 kilocycles, amplification is not only satisfactory for the signal gain alone but from the point of view of increasing the signal-to-noise ratio. This is what is done in the super-heterodyne. In addition, if the radio-frequency amplifier stages are sharply tuned, the selectivity of the receiving apparatus as a whole is very materially increased.

With the increase in the number of transmitting stations operating on the shorter waves the need is becoming greater for a receiver giving all possible practical selectivity. In an attempt to realize these requirements the super-heterodyne described in this article was built.

Super-heterodyne receivers using 201-A type tubes with impedance-coupled and tuned transformer-coupled intermediate-frequency amplifiers built and tested at the Massachusetts Institute of Technology have been found very much worth while in the reception of long-distance short-wave telegraph signals. Upon obtaining the new screen-grid tubes, a super-heterodyne was constructed at the Institute using these tubes as the intermediate-frequency amplifiers. The construction of this receiver is described here.

The arrangement, as will be seen by referring to Fig. 1, consists of two stages of intermediate-frequency amplification using screen-grid tubes, a beat frequency oscillator, a detector, and one stage of audio amplification, using 201-A tubes. The unit as a whole is intended to follow any short-wave receiver, using the latter's detector tube as an autodyne frequency converter, and changing the signal frequency to 50 kilocycles. The super-heterodyne unit is particularly adaptable to the short-wave circuit described on the previous two pages.

The first intermediate-frequency stage has a tuned transformer input circuit. The transformer, T, has an air core and is a spool made of  $\frac{3}{4}$ " diameter bakelite having a winding space  $\frac{3}{4}$ " wide by  $\frac{3}{8}$ " deep. The secondary winding consists of 1000 turns of No. 28 d.c.c. wire. Over this are placed a few layers of paper to prevent possible grounding of the two windings. Over the paper the primary is placed, consisting of 250 turns of the same wire. The secondary can be tuned to an intermediate frequency of 50 kilocycles by means of a 500-mmfd. variable condenser or to 30 kilocycles if an additional fixed capacity of 1000 mmfd. is shunted across the variable condenser.

With a given plate voltage the voltage amplification of the screen-grid tube is directly proportional to the effective impedance which can be built up in its plate circuit. (See "Characteristics of shielded-grid Plotrons," by A. W. Hull and N. H. Williams, and "Measurements of High-Frequency Amplification with Shielded-Grid Plotrons," by A. W. Hull. Both of these papers appeared in the *Physical Review*, April, 1926, Vol. 27.) This fact should be kept in mind when choosing values of inductance and capacitance to be used as a coupling impedance. In this case the coils, L, are No. 85 Samson choke coils which can be tuned from 20 to 50 kilocycles by a 500-mmfd. variable condenser. Honeycomb coils

were tried as coupling impedances and slightly greater amplification was obtained, but because of the ease of mounting and compactness of the Samson choke coils, they were used in the final receiver. These chokes are helical wound and although their direct-current resistance is higher than that of a honeycomb coil having the same inductance, their effective resistance at radio frequencies is much less.

The variable condensers are provided with insulating shafts to keep the radio-frequency circuits as far away from the panel as possible and all except the first are mounted on the shields with insulating pillars. The interstage coupling condensers, C<sub>1</sub>, are of 2000-mmfd. capacity and the grid leak, R<sub>1</sub>, is of 100,000 ohms. The B-battery voltage is 135 volts and the screen-grid voltage is 67.5 volts.

The filament voltage is reduced to 5 volts by means of a 2-ohm master rheostat in the positive A-battery lead and the filament voltage of the screen-grid tube is further reduced to 3.3 volts by 15-ohm fixed resistances, R, placed in each of their negative filament leads. The grid returns are brought to the battery sides of these resistances giving a grid bias, equal to the drop in the resistance R, of approximately 1.7 volts negative.

For grid detection in the second detector the grid condenser is of 2000-mmfd. capacity and the leak can be from 4 to 8 megohms where the plate voltage is 45 volts. Provision is made for a C battery if plate detection is used.

A small amount of regeneration or resistance neutralization is introduced into the plate coupling impedance of the second intermediate-frequency stage to secure increased amplification in that stage. The effective shunt impedance of the parallel circuit, consisting of the plate coil and condenser, is limited by the resistance of the circuit. The introduction of regeneration reduces this effective resistance, giving a greater effective impedance in the plate circuit, with



correspondingly increased amplification. (See "Complete Suppression of a Single Frequency by Means of Resonant Circuits and Regeneration," by J. A. Stratton. *Journal Optical Society of America*. Vol. 13, No. 1, July 1926.) Regeneration is accomplished by means of a small tickler,  $L_2$ , in the detector plate circuit of 25 turns wound directly on the plate coil of the second intermediate-frequency stage. The tickler can be cut in or out as desired by means of a switch, K, mounted on the front panel. The receiver was not designed for broadcast reception and with air condensers to tune the intermediate-frequency stages, the tuning is too sharp for quality reception. If, however, fixed condensers of the proper capacity are used to tune the intermediate stages, it is probable that the response curve would include a band 10 kc. wide. The amplification would probably be reduced accordingly. With a 50-mmfd. tuning condenser across the secondary of the short-wave detector out of

voltage is then necessary as when receiving unmodulated signals.

The oscillator is a "shunt feed" Hartley type the frequency of which is regulated by a variable condenser of 500-mmfd. capacity in shunt with a fixed condenser,  $C_2$ , of 1000-mmfd. capacity for 30-kilocycle operation, or 750-mmfd. capacity for 50-kilocycle operation. The oscillator coil,  $L_3$ , consists of 1500 turns of No. 28 wire wound on the same kind of spool as is used for the input transformer, T, the filament tap being made one third of the way from the grid end of the coil.

Some difficulties were encountered in adding a stage of audio-frequency amplification as the separation between a 50-kilocycle radio-frequency signal and an audio-frequency signal of approximately 2 kilocycles is relatively small. To keep the 50-kc. component out of the audio-frequency circuit a single-section filter having a cut-off at approximately 5 kc. is used in the detector plate circuit of the detector. The filter is

stage coupling through the B-battery leads. All battery binding posts, as well as the output posts, are mounted on a bakelite terminal strip at the rear of the set.

The aluminum shields are 5" by 6" by 9" except the first which was cut down to 4" by 6" by 9". The first shield contains the input transformer, with its secondary fixed, and variable condensers. The second and third shields contain the first and second stages of intermediate-frequency respectively, along with their associated coils, condensers, etc. The 15-ohm fixed resistance in the filament circuit of the first screen-grid tube is within its aluminum shield while the fixed resistance in the filament circuit of the second screen-grid tube is mounted at the rear of the baseboard behind the shields.

The input lead to the first stage is brought out through the top of the first shield and connects directly to the control grid cap of the first screen-grid tube, which projects through a hole in the

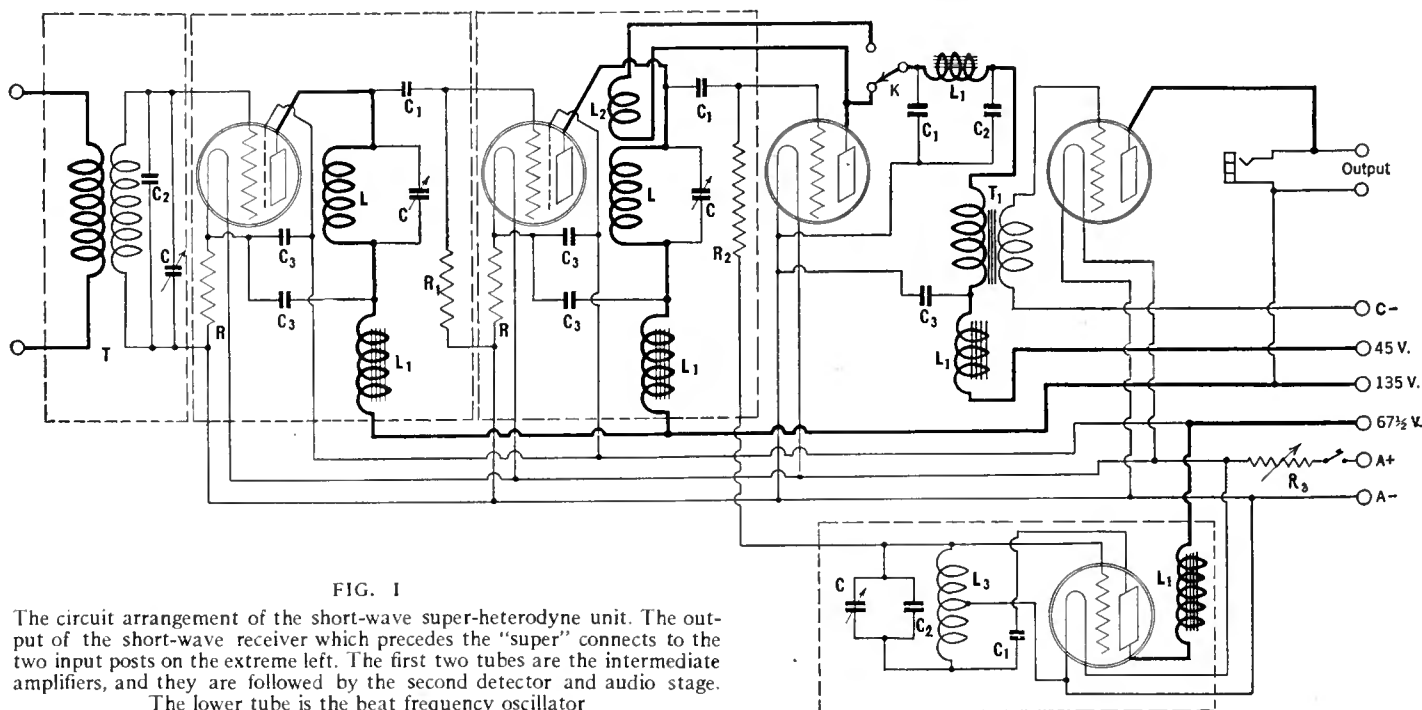

FIG. 1

The circuit arrangement of the short-wave super-heterodyne unit. The output of the short-wave receiver which precedes the "super" connects to the two input posts on the extreme left. The first two tubes are the intermediate amplifiers, and they are followed by the second detector and audio stage. The lower tube is the beat frequency oscillator

which this amplifier works, the outfit is as selective as one dares make it. An a.c. note appears and disappears in one half a division on the 100 division scale of the condenser when working in the 3- to 4-megacycle (75-100 meter) band.

In the ordinary short-wave receiver employing a simple oscillating tube as a detector of c.w. signals, the detector is made to oscillate at a frequency differing one or two kilocycles from the incoming signal and the resulting audible beat is heard in the telephone receivers. In tuning the detector when followed by the intermediate-frequency amplifier described here, the beat frequency is made an inaudible frequency of 50 kilocycles, instead of the usual one or two kilocycles. To reduce this to an audible frequency an oscillator whose frequency can be varied is made to beat with the 50-kilocycle intermediate frequency and give a difference frequency of one or two kilocycles as desired. The beating oscillator voltage is fed to the grid circuit of the second detector tube through the grid leak resistor. The audible beat frequency produced in the second detector is then amplified by the stage of audio amplification. For phone reception the oscillator tube is removed from its socket as no beating

a simple "pi" section consisting of a 3-henry choke in the detector plate lead preceded and followed by 2000-mmfd. and 1000-mmfd. fixed condensers respectively. The choke is a Samson No. 3 which has a small open iron core.

There is nothing unusual about the stage of audio amplification. The transformer is a Samson with a 6 to 1 ratio and there is provided a pair of output binding posts as well as the usual output jack. The B-battery voltage is 135 volts and the grid battery is 4.5 volts.

The baseboard is  $23\frac{1}{2}$ " by  $10$ " by  $\frac{1}{4}$ ". The front panel is of bakelite and is  $24$ " by  $7$ " by  $\frac{3}{16}$ ". The first three dials tune the intermediate-frequency stages while the fourth controls the frequency of the beating oscillator. All the dials are 4" National Velvet Vernier dials. At the right there is provided a Weston double-range voltmeter to read plate and filament voltages while below it are the 2-ohm master rheostat, filament switch, and output jack. The regeneration switch is between the third and fourth dials and is a Yaxley jack switch of the single-pole double-throw type. The two input binding posts are at the extreme left of the panel. Plate-voltage leads are provided with Samson 3-henry chokes and 1-mfd. bypass condensers to prevent inter-

top of the shield. The output lead of the first amplifier stage is brought out through a hole in the top of the second shield and connects with the grid cap of the second shield grid tube, which projects through a hole in the third shield. To prevent pick-up by these leads they are wrapped in copper foil which in turn is grounded. This aids in the prevention of oscillation in the stages and helps materially in securing stable operation. The tube sockets are raised on blocks of wood in order that the control grid may project as far as possible through the hole in the top of the shield. The grid terminal is insulated where it is likely to come into contact with the edge of the hole and the grid lead is wound into a spiral spring which makes a tight connection to the grid terminal.

The last shield, placed at right angles to the first three, contains the audio beating oscillator. All the shields are connected together and brought to a binding post at the rear of the set marked "Ground." In this way effects of grounding the shields individually or collectively, the negative A alone, or shields and battery together, may be noted. Behind the oscillator shield there is the detector, filter, and the stage of audio amplification.



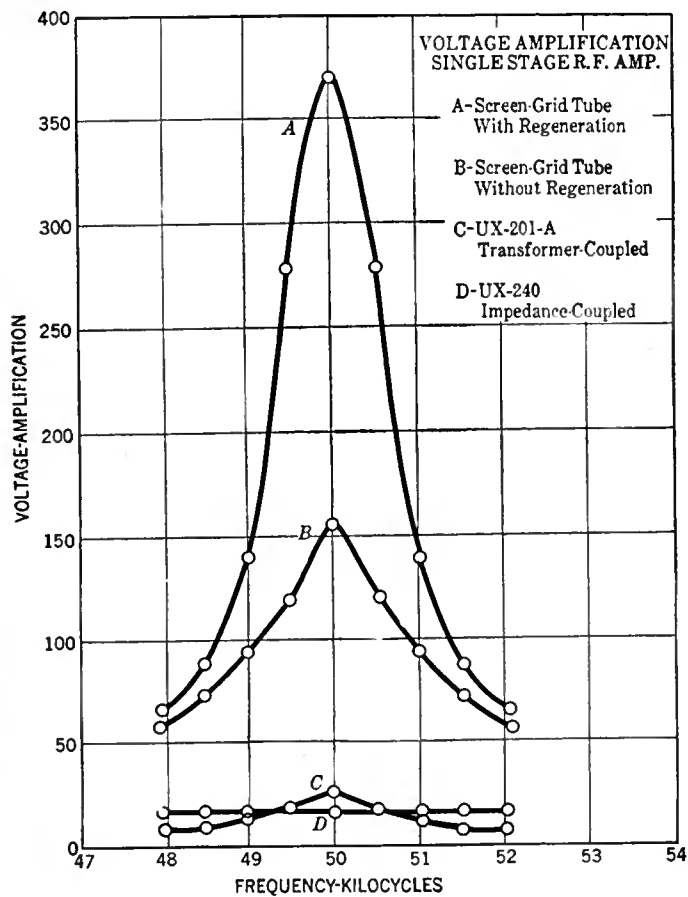

FIG. 2

Showing the voltage amplification for a single r.f. stage with or without regeneration and for different tubes and forms of coupling

## EXAMINING THE CURVES

AN EXAMINATION of the amplification curves of Fig. 2 shows that at 50 kilocycles the maximum amplification obtained in one stage with the plate impedance used is 155 without regeneration and 370 with regeneration. By amplification is meant the ratio of the voltage appearing across the plate impedance to the voltage impressed on the grid. The curves also indicate the sharpness of tuning of a single stage. The amplification obtained in both stages of intermediate frequency is rather difficult to measure accurately because it is so great but is in the order of 25,000 with regeneration. The amplification obtained in the stages of intermediate frequency of other super-heterodynes built at Massachusetts Institute of Technology using UX-201-A tubes has been (see Fig. 2) in the order of 25 for one tuned amplifier stage and 16 for one stage of impedance-coupled amplification with high- $\mu$  tubes. (These data were presented in an unpublished report of Green Radio Research, Massachusetts Institute of Technology).

A compromise had to be made between greater amplification secured by increased regeneration, and sharpness of tuning. In the present arrangement the amplifier is not well adapted to the reception of voice and music as the width of the band of frequencies passed in a single stage is not more than 1400 cycles.

Too much stress cannot be laid upon the need of proper shielding when using the screen-grid tube. The grid leads from the tubes *must* be shielded from all the plate circuit apparatus of the same tube. The covers of the shields would be much better flanged to eliminate cracks after the cover is put on. The holes for the wires

should be as few as possible and no larger than necessary. All radio-frequency circuits should be kept within the shields, by the use of chokes and large bypass condensers in the plate circuits particularly.

The amplification curves were obtained by the substitution method using a vacuum-tube volt-meter. A 50-kilocycle voltage from an oscillator is impressed by means of a calibrated resistance on the input of the single stage and a reading is taken on the vacuum-tube voltmeter connected in the plate circuit of the detector. Then the stage is cut out and a second voltage is impressed upon the input terminals of the detector of such a value as will give the same reading on the voltmeter. This input voltage will be larger than when the stage of amplification is used and if the current through the variable resistances is kept the same in both cases, the voltage impressed will be directly proportional to the corresponding values of resistance. The ratio of

the value of resistance used without the stage of amplification to the value of resistance used with the stage of amplification gives the voltage amplification of the stage. All measurements are made with the oscillator tube removed from its socket and a resistance of 10,000 ohms is placed in series with the test leads from the calibrated resistance to represent the plate resistance of the first detector which is normally shunted across the primary of the input transformer.

As has been mentioned, the amplifier is for code reception with any autodyne receiver and it may either be connected in place of the primary of the audio-frequency transformer of the receiver, or more simply by connecting its input terminals in series with the positive detector B-battery lead of the receiver.

The operation of the complete receiver is no more complicated than the operation of the

usual two-control short-wave outfit. The first three dials of the amplifier are set at about the same values and a station tuned-in on the receiver while the oscillator dial is varied to give the desired note. The first three dials are readjusted carefully for maximum volume. Now the entire amplifier can be left untouched, all the tuning being done with the tuning and regeneration controls of the short-wave receiver. The regeneration switch on the amplifier can be used as a rough volume and selectivity control.

If the receiver described by the author on pages 13 and 14 is to be operated with the screen-grid super-heterodyne unit, the following statements hold. Because of the fact that the variable condenser across the secondary of the input transformer of the super-heterodyne unit is mounted directly on the aluminum shield, the ground post of the shields of the super-heterodyne cannot be directly grounded to the positive A battery but can be done so through a 1-mfd. fixed condenser. This is necessary because the copper shield of the receiver is necessarily grounded to the positive side of the A battery while the first aluminum shield of the "super" has been connected to the negative side of the battery. When using the two sets together, then, the positive side of the A battery is grounded and the shields of the "super" are connected to the positive A binding post through the large condenser.

The following parts were used in the construction of the super-heterodyne unit:

## LIST OF PARTS

- T—Special Input Transformer (See Text)
- T<sub>1</sub>—Samson Audio Transformer, 6-1 Ratio
- L—Two Samson No. 85 Choke Coils
- L<sub>1</sub>—Five Samson No. 3 Choke Coils
- L<sub>2</sub>—25-Turn Tickler Coil (See Text)
- L<sub>3</sub>—Special Oscillator Coil (See Text)
- C—Four 500-mmfd. National Variable Condensers
- C<sub>1</sub>—Four 2000-mmfd. Sangamo Fixed Condensers
- C<sub>2</sub>—Three 1000-Mmfd. Sangamo Fixed Condensers
- C<sub>3</sub>—Five 1-mfd. Dubilier Fixed Condensers
- R—Two 15-Ohm Carter Fixed Resistances
- R<sub>1</sub>—100,000-ohm Tobe Resistor with Mounting
- R<sub>2</sub>—4-Megohm Durham Grid Leak with Mounting
- R<sub>3</sub>—2-Ohm General Radio Rheostat
- Five General Radio Sockets
- Yaxley Filament Switch
- K—Yaxley S.P.D.T. Jack Switch
- Carter Midget Open-Circuit Jack
- Ten Eby Engraved Binding Posts
- Four 4" National Velvet Vernier Dials
- White Pine Baseboard 23½" by 10" by ½"
- Bakelite Panel 24" by 7" by ¾"
- Aluminum Shields, Extension Shafts, Insulating Pillars, Angles, Wood Screws, Etc

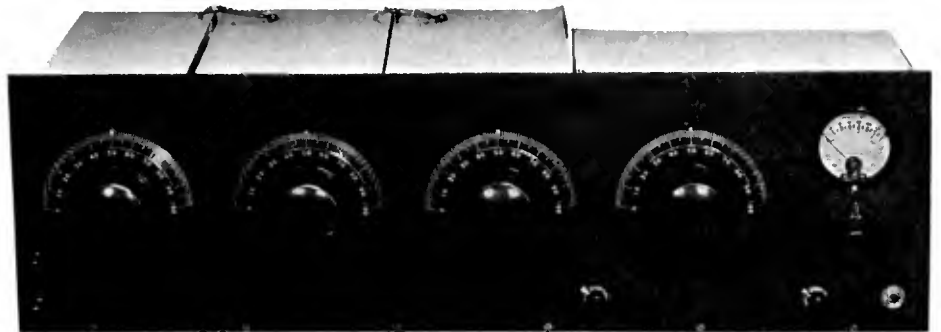

A PANEL VIEW OF THE SHORT-WAVE "SUPER" UNIT

Despite the number of dials on the panel, the receiver is no more difficult to tune than the ordinary two-control short-wave receiver. After the dials on the super-heterodyne unit have once been set, all the tuning is done by means of the controls of the short-wave receiver which precedes the "super"

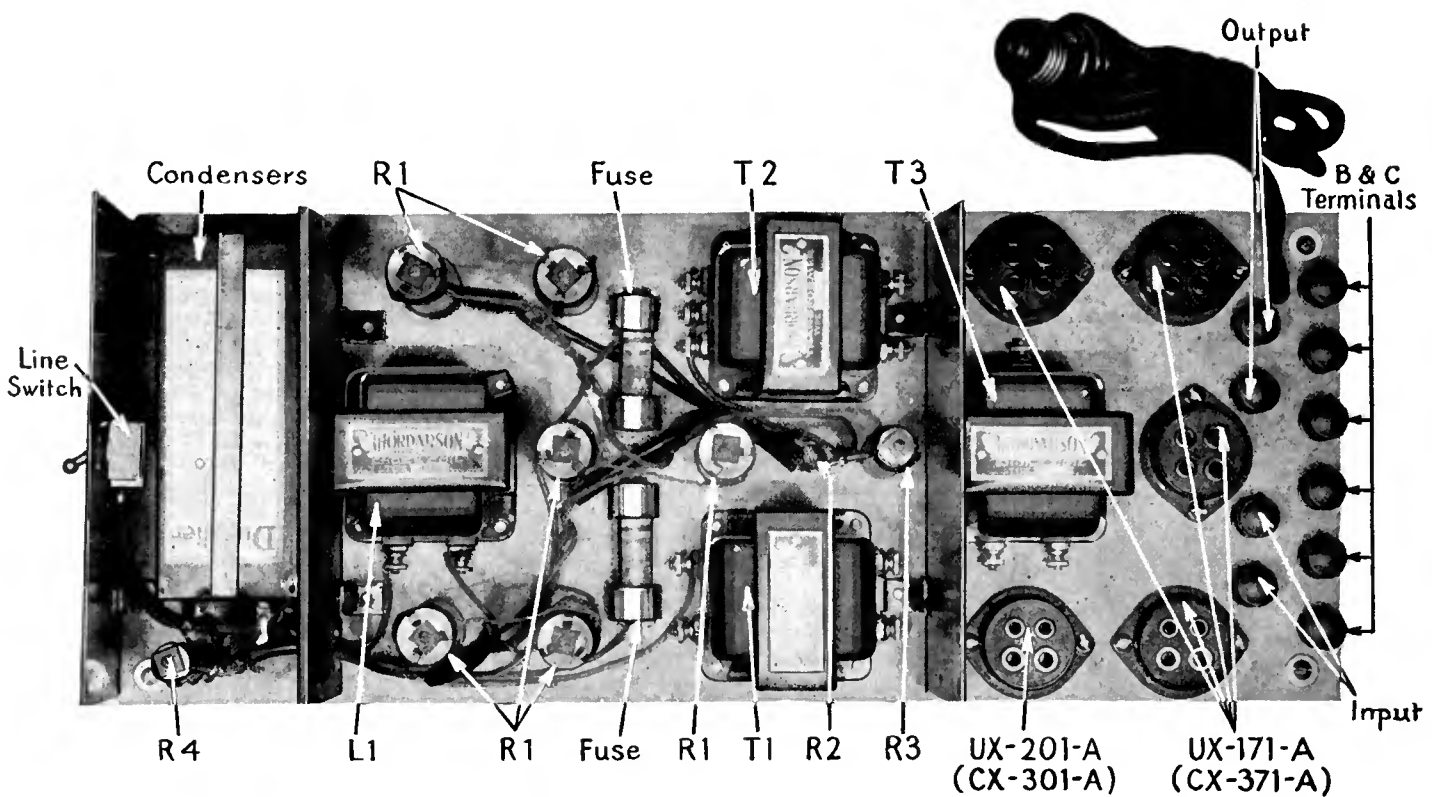

THE SIMPLICITY OF THE D.C. AMPLIFIER IS EVIDENT FROM THIS PHOTOGRAPH

# A D.C. Power Amplifier and B Supply

By Victor L. Osgood

**T**HE problem of getting really fine tone quality, power, and volume from an amplifier entirely electrically operated from a 115-volt direct-current supply is one that has frequently stumped the fan who does not live in a district where a.c. is available. Many still believe that it is not possible to do away with B batteries where the supply is d.c. in nature, and still get good quality and volume.

The problem for a time was a baffling one, but the introduction of power tubes, especially those of the 171-A type, has made possible the design of a power amplifier that has won the approval of all those who have heard it.

The solution lies in combining a stage of transformer-coupled amplification with a second stage of push-pull, using two tubes in parallel on each side of the push-pull system. Ninety volts are placed on the plate of the first tube (a UX-201-A

## About the Amplifier—

*THE majority of self-contained electrically-operated receivers now on the market are designed to function by plugging into an alternating-current source. While there are some manufactured receivers now available for use where the supply is d.c., these are few and far between. Constructional articles on d.c. equipment have been equally scarce, mainly due to the fact that the districts where d.c. is supplied are considerably in a minority. The combined power amplifier and power-supply unit described in this article is especially for the much-neglected constructor whose house supply is d.c. It will handle as much undistorted output as will a single 171 type tube with 180 volts on the plate and 40.5 volts on the grid—sufficient for ordinary home purposes.*

—THE EDITOR

or a CX-301-A) with a grid bias of 4.5 volts, and power tubes of the 171-A type are employed in the push-pull system with a plate potential of 105 to 110 volts and a grid bias of 22.5 volts. The input connection to the amplifier may be made directly to the plate of the detector tube in the receiver itself. Four UX-171-A (CX-371-A) tubes are used in the push-pull system, as shown in the schematic diagram, Fig. 1, and they can supply an output of 700 milliwatts to the loud speaker. This will be found ample to give excellent tone quality and volume. A push-pull amplifier sometimes has a tendency to oscillate and for this reason a 25,000-ohm resistance, R<sub>3</sub>, is connected in the center tap lead of the input push-pull transformer which would otherwise tend to make the amplifier oscillate. The filaments of the 171-A type tubes in the power amplifier are lighted with power obtained from the 115-volt line after the voltage has been reduced by resistance R<sub>1</sub>.

The circuit is arranged so that plate potential for the radio-frequency amplifying tubes and the detector is available; thus the necessity for B batteries is altogether eliminated.

Even though the supply is d.c. some filtering is necessary to eliminate the commutator ripple in the voltage. The filter circuit used here, however, is very simple, consisting of one choke coil, L<sub>1</sub>, and a 4-mfd. filter condenser, C<sub>1</sub>. Two 1-mfd. bypass condensers, C<sub>2</sub> and C<sub>3</sub>, are also necessary across the two intermediate voltage taps. The d.c. voltage rating of these condensers need not be more than 160 volts. Either 67 or 90 volts are available for the plate circuits of the r.f. amplifiers, the choice of voltage depending upon the individual set and the owner's preference.

Biasing voltages are supplied by dry batteries. Were we to take the required 22.5 volts C bias from the power line, we would, of course, have to deduct just that much from the total voltage

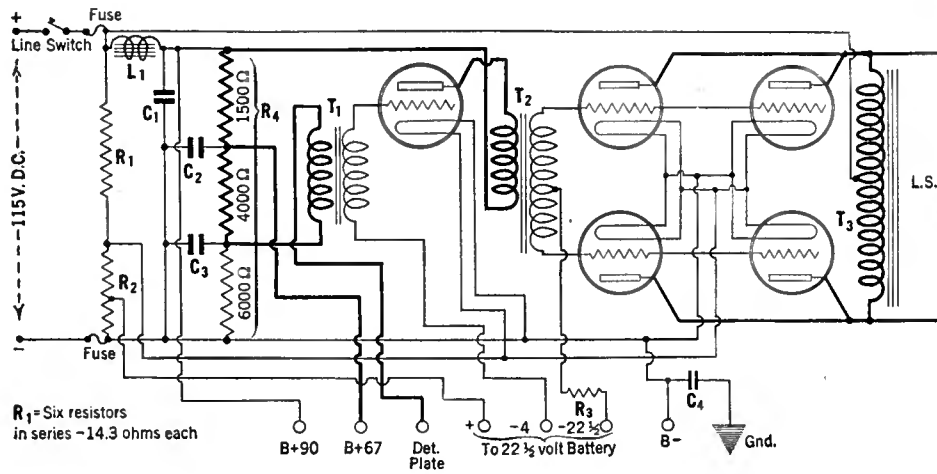
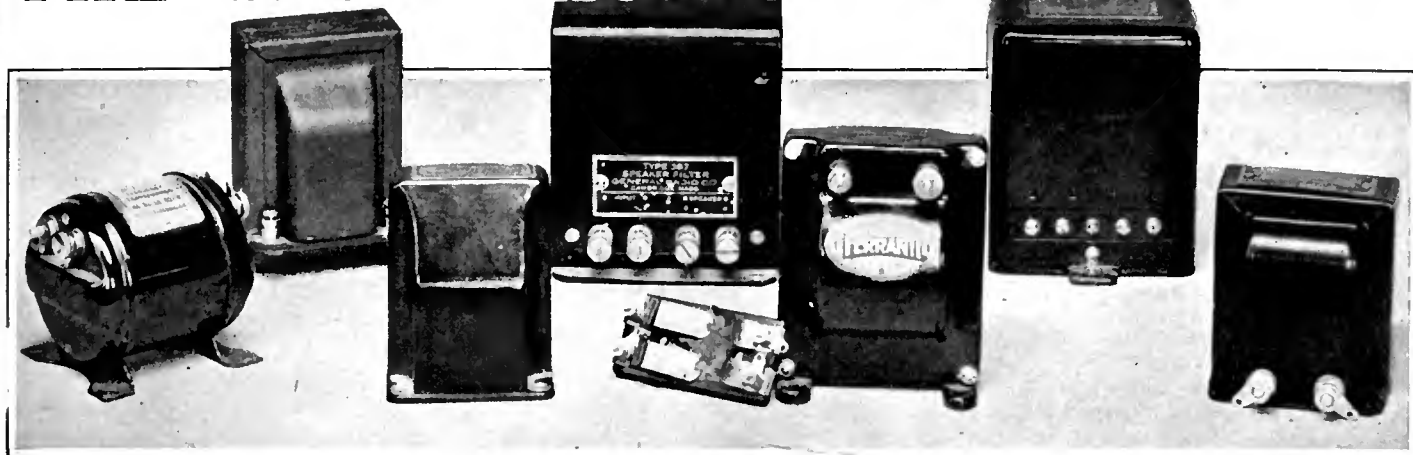

FIG. 1

# THE RIGHT AUDIO COMBINATION



By L. W. Hatry

MANY set builders have searched for the ideal form of amplification by plodding their way through combinations of resistance, impedance, and transformer coupling, attempting to effect a compromise between the supposed quality of one system and the well-known high step-up ability of another. Or, at times, the search for perfection may have been tintured with the desire for a combination which made use of apparatus already on hand.

Whatever the reasons for such combinations, they should be made only with some appreciation of the apparatus and its limitations. Many persons, for instance, wonder where in an a.f. system to place the audio transformer if only one is used. The answer to such questions can always be found. The method is simple.

Consider that the voltage step-up:

- (1.)—in a 201-A is 8.
- (2.)—in a 199 is 6.
- (3.)—through a resistor-coupler is 1.
- (4.)—through an impedance-coupler is 1.
- (5.)—through a transformer is 2, 3, 3½, 5, or 6, according to the step-up ratio of the windings.
- (6.)—through a high-mu tube (240 type) is about 20, or through any tube in a resistance- or impedance-coupled stage ought to be about two-thirds of the tube's mu (we have taken the effective step-up to be six in the case of a 201-A type tube).

This information is available in magazines, in catalogues, in tube instruction sheets, and in textbooks. It allows one to engineer his a.f. amplifier with the employment of something akin to intelligence and the enjoyment of a feeling near that of competence.

As a preliminary to this engineering feat, choose some audio system you know to be functioning in a way that satisfies. As an example, let us use a two-stage amplifier with 3 to 1 and 6 to 1 audio transformers, a 201-A in the first

## Read This Box First

THE signal voltage handling capacity of a tube used as an audio amplifier is governed by the amount of bias placed on that tube's grid. Thus, a 201-A type tube, with 4.5 volts bias (and the corresponding plate voltage of 90) will be overloaded and distort if called upon to handle more than 4.5 peak volts. The following table of C and B battery voltages for various tubes used as amplifiers will serve to make the author's article more complete:

TUBE TYPE	B VOLTS	C VOLTS	MU
201-A	45	1.5	8.4
	67	3	8.4
	90	4.5	8.5
	135	9	8.5
112	90	6	7.9
	135	9	8.2
	157	10.5	8.2
171	90	16.5	3
	135	27	2.9
	180	40.5	2.9
210	90	4.5	7.5
	135	9	7.5
	180	10	7.5
222	180	1.5	60

stage, and a 171 in the second stage, as shown in Fig. 1. The power tube is getting a B voltage of 180 and is properly biased so it is important to remember that its grid-swing limit is about 40 volts peak. To load the power tube, the second a.f. transformer must supply this 40 volts. We shall now determine the characteristics of an

amplifier which will fulfill this requirement. For the second or the final audio transformer to give 40 volts, the grid of the tube in the first stage must be getting a voltage equal to 40 divided by the turns ratio of the transformer and the mu of the tube. The overall gain of the amplifier in Fig. 1 will be:

$$\frac{T}{3} \times \frac{V_t}{8} = \frac{201-A}{8} \times \frac{T}{6} = 144$$

Thus the requisite voltage at the output of the detector must be:

$$\frac{40}{144} = 0.28 \text{ VOLTS}$$

For sake of argument we shall accept this value of 0.28 volts as being average in future calculations. It has been the writer's observation, however, that many signals overload the 171 with an amplifier of this type, which would indicate that the output voltage of the detector sometimes exceeds 0.28 volts. This holds true for a set in Hartford, Connecticut, which, of course, is comparatively surrounded with high-powered broadcasters. If the detector will put out 0.56 volts, twice that calculated above, we can use a 3 to 1 transformer instead of the 6 to 1 transformer in Fig. 1 with somewhat better frequency characteristics.

Presuming that the a.f. amplifier will be satisfactory if up to the grid of the power tube it has a voltage multiplying ability of 144, the business of figuring equivalent combinations of resistance or other couplings is easy. For instance, in a three-stage resistance-coupled amplifier, such as is shown in Fig. 2, using 201-A tubes, the gain up to the grid of the power tube will be (bearing in mind that a resistor-coupler has a gain of 1 and that the actual amplification through the tube is about two-thirds of its mu):

$$\frac{R_c}{1} \times \frac{V_t}{6} = \frac{201-A}{6} \times \frac{R_c}{1} \times \frac{V_t}{6} = \frac{201-A}{6} \times \frac{R_c}{1} \times \frac{V_t}{6} = 36$$

If the second tube has a grid bias of 4.5 volts

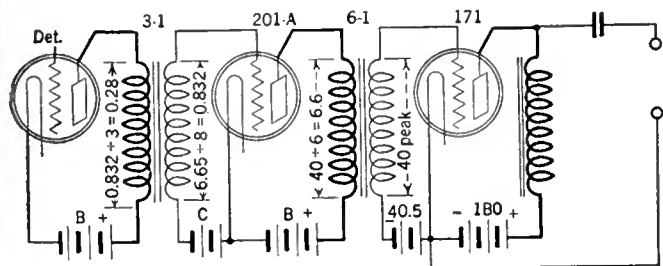

FIG. 1

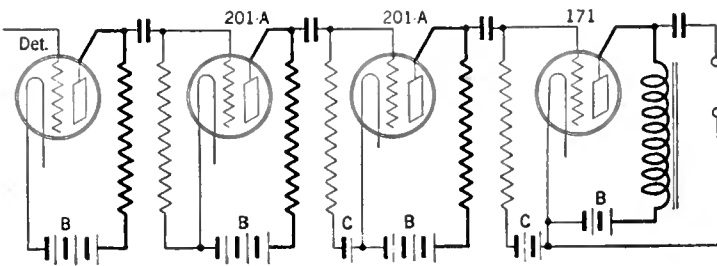

FIG. 2

and the correspondingly correct B voltage (in which case it should not be called upon to handle more than 4.5 volts signal voltage), it would be overloaded when required to handle the six volts which would deliver 36 a.f. volts to the grid of the final tube. This latter figure is not even enough to load up a 171 fully. The bias on the second tube could be increased, with correspondingly greater handling capacity, but this in turn would necessitate a higher B-battery voltage. It will be seen, therefore, that the second 201-A audio tube would be nicely loaded with a 4-volt grid-swing, in which case it would be able to supply the final tube with 24 grid volts. A 171 type tube with only 135 B volts and a C bias of 27 will be adequate to handle these 24 volts. With this amplifier the detector must output 0.67 volt ( $24 \div 36$ ) to load the 171, which is quite a lot, if for no other reason than that local stations are likely to be necessary for so high a voltage. It will be agreed, then, that the usual resistance coupled amplifier with 201-A type tubes is not very satisfactory.

But suppose we use 240 type high-mu tubes with a working mu of 20. Here are the figures:

$$\frac{R_c}{1} \times \frac{V_t = 240}{20} \times \frac{R_c}{1} \times \frac{V_t = 240}{20} \times \frac{R_c}{1} = 400$$

The 240 will take a grid-swing of 3 (with 180 volts B, 3 volts C). It can overload a 171 on 180 volts if it gets more than 2 grid volts because 2 multiplied by 20 (the gain in the tube) is equal to 40, the maximum handling capacity of the 171. Hence, if three resistance-coupled stages are used, and since we have already decided that an amplification of 144 will satisfy for average conditions of detector output, the use of 240 type tubes is probably foolish. By dropping the plate resistor of the first tube to 100,000 ohms, the latter's step-up can be reduced to about 12. That would give an overall step-up of 240 to the grid of the last tube. A 201-A type tube in the first stage, with a step-up of only 6, will reduce the overall gain to 120, which begins to fit better with the desirable figure.

Now let us consider a single resistance-coupled stage. There has been a lot said about it in some of the more active sections of the press:

$$\frac{R_c}{1} \times \frac{V_t = 240}{20} \times \frac{R_c}{1} = 20$$

That is obviously no good. Why? The detector would have to output 2 volts in order to put 40 volts on the grid of the power tube. What about one resistance-coupled and one transformer coupled stage, such as that shown in Fig. 3?

$$\frac{T}{3} \times \frac{V_t = 240}{6} \times \frac{R_c}{1} = 60$$

It will be seen that the gain is insufficient in such a combination, too great a detector output being necessary. If, however, the transformer were a high-grade 6 to 1 unit instead of a 3 to 1 unit, the overall gain would be 120, which is much better.

Now let us consider the following three-stage a.f. amplifiers, shown in Figs. 4 and 5, in which

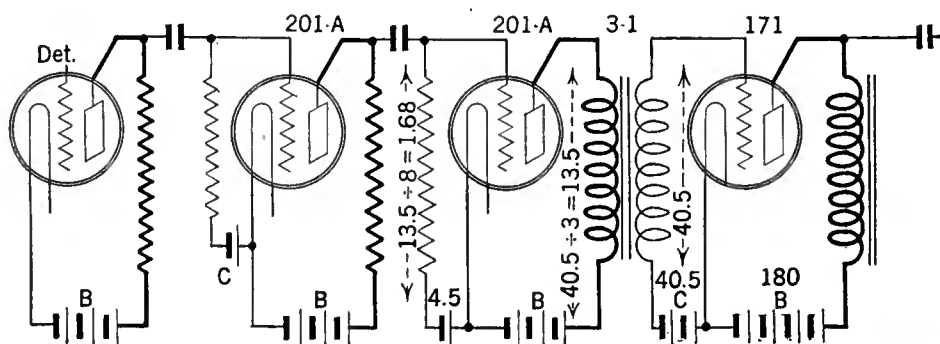

FIG. 5

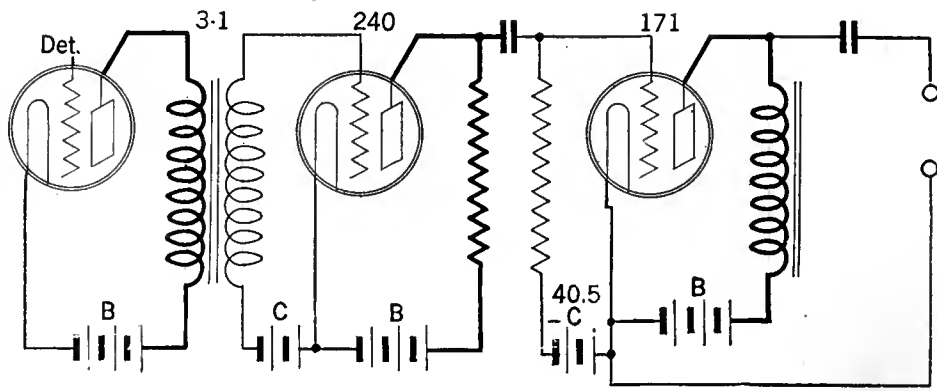

FIG. 3

the second audio tubes will handle about 4.5 volts grid voltage (since they are biased accordingly):

$$\frac{T}{3} \times \frac{V_t = 201-A}{6} \times \frac{R_c}{1} \times \frac{V_t = 201-A}{6} \times \frac{R_c}{1} = 108$$

$$\frac{R_c}{1} \times \frac{V_t = 201-A}{6} \times \frac{R_c}{1} \times \frac{V_t = 201-A}{8} \times \frac{T}{3} = 144$$

In the first case the next-to-the-last tube will be badly overloaded if the signal is strong enough to load a 171 to its maximum handling capacity of 40 grid volts. In practice, of course, the volume control on the receiver would be turned down as soon as overloading of the 201-A, manifest as distortion, became apparent, and thus the 171 would be working uneconomically. To deliver 40.5 volts to the 171 the next-to-the-last tube

the gain of the amplifier, the smaller the detector output voltage necessary to load up the power tube. Various three-stage combinations, with their overall amplification, are listed below. The necessary C voltage for the tubes may be determined by reference to the table on page 23.

$\frac{R_c}{1} \times \frac{V_t = 240}{20} \times \frac{R_c}{1} \times \frac{V_t = 240}{20} \times \frac{R_c}{1} = 400$
$\frac{R_c}{1} \times \frac{V_t = 201-A}{8} \times \frac{T}{3} \times \frac{V_t = 201-A}{8} \times \frac{T}{3} = 576$
$\frac{R_c}{1} \times \frac{V_t = 201-A}{8} \times \frac{T}{2} \times \frac{V_t = 201-A}{8} \times \frac{T}{2} = 256$
$\frac{R_c}{1} \times \frac{V_t = 201-A}{8} \times \frac{T}{2} \times \frac{V_t = 201-A}{8} \times \frac{T}{3} = 384$
$\frac{R_c}{1} \times \frac{V_t = 240}{20} \times \frac{R_c}{1} \times \frac{V_t = 201-A}{8} \times \frac{T}{3} = 480$

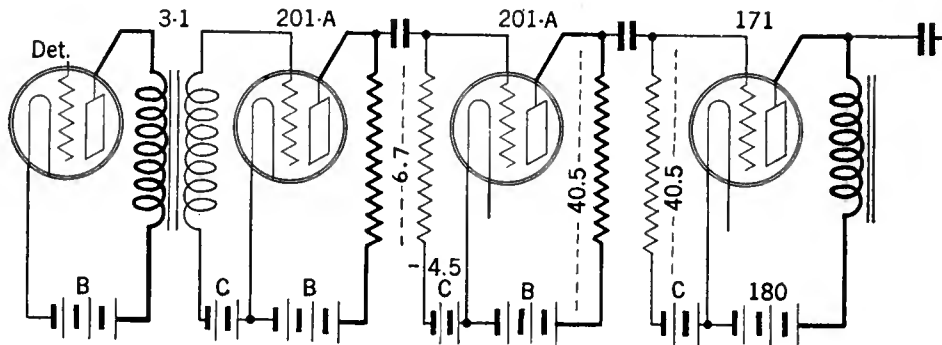

FIG. 4

has to handle 6.75 volts on the grid. If this tube were given a raise in bias to 9 volts with 135 plate volts, it would be capable of handling this voltage without overloading. Merely moving the a.f. transformer to the third coupling position, as in Fig. 5, requires that the second audio tube have a grid-voltage of only 1.68 to produce 40.5 volts on the grid of the power tube.

Judging from the fact that many set owners find two high-mu tubes highly desirable in a resistance—or impedance-coupled amplifier, the opinion that an amplifier step-up of 400 is sometimes useful, seems logical. Of course the higher

From all of the foregoing come a few useful rules, which may be outlined as follows:

(1.) In a combination of transformer-coupling with any other type of audio-frequency amplification the transformers should be in the last stages, and the transformer with the greatest step-up should be in the last one.

(2.) Always make certain that the tube before the power tube will not be overloaded before the power tube is fully loaded. To find this out is merely a matter of simple division or multiplication.

(3.) When judging the performance of two amplification systems, calculate what the overall step-up for each is before deciding what has happened.

There are other simple rules that it is good practice to heed. They may be stated as follows:

(a.) It is always best to require least of the detector. This is possible when the a.f. step-up is high.

(b.) High a.f. step-up is no help to the detector if the volume control follows the detector, and the less the step-up in the audio end the more this is true.

(c.) A detector gives greater undistorted output with increased B voltage, within limits. Operate it according to the needs of your set.



A \$10,000 PHONOGRAPH-RADIO COMBINATION

The phonograph equipment is housed at the left and the radio at the right. The panel in the center contains a distortion meter (reading up to 150 mils.) and special circuit arrangements make it possible to control the amplitude of the sound by the top knob in this panel, while the control directly below it regulates overtones. The installation uses a four-stage balanced amplifier rated at 50 watts. Individual expression in the rendition of phonograph records or radio is said to be achieved through circuits arranged to vary both musical pitch and overtones without, at the same time, altering quality.

This installation was especially built for La Salle & Koch, of Toledo, Ohio

TO THE great American query, "What's new?" we are forced to reply this month, "Not much." It may be merely an off-season for records. There were all too few likely looking titles in the advance lists. Perhaps the phonograph industry, like book publishing, blooms in full glory but twice a year and in-between-times puts out only a few pale buds. No, it isn't quite as bad as that because we did find nine records of such exceptional merit that they quite make up for the mediocrity of the rest. Among the classical output are several prize-winners: two duets by Gigli and De Luca, who can always be counted on to be worth while; two beautiful songs by Sigrid Onegin; choral work of outstanding quality by the Metropolitan Opera Chorus; and two instrumental numbers by the Columbia Symphony Orchestra. Of the popular stuff there are five better-than-average records. Ohman and Arden performing Gershwin music; Johnny Johnson and His Statler Pennsylvanians offering another Gershwin number and on the reverse one of the best songs from the Connecticut Yankee; a Paul Whitman masterpiece; two good numbers from the orchestra directed by the Maestro, known to the trade as Ben Bernie; and, lastly, a couple of unusual waltzes by the South Sea Islanders. The rest are so-so.

*'S Wonderful* and *Funny Face* by Victor Arden and Phil Ohman and Their Orchestra (Victor). Superb Gershwin music mixed well with Ohman-and-Arden piano magic and flavored with a bit of Johnny Marvin's best singing.

*Thou Swell* and *My One and Only* by Johnny Johnson and His Statler Pennsylvanians (Victor). Tuneful antidotes for that poisonous late-winter boredom.

*Mary* and *Changes* by Paul Whiteman and His Orchestra (Victor). Whiteman continues to glorify American jazz.

*The Man I Love* and *Dream Kisses* by Ben Bernie and His Hotel Roosevelt Orchestra (Brunswick). This record deserves a great big gold star.

*I've Been Looking for a Girl Like You* and *Everywhere You Go* by Paul Ash and His Orchestra (Columbia). For those who crave their jazz red hot.

*Changes* and *Let's Misbehave* by Ben Bernie and His Hotel Roosevelt Orchestra (Brunswick). Keeping up with the Bernie tradition of bigger, better dance music, with the emphasis on dance.

*We'll have a New Home* and *When You're With Somebody Else* by Ben Selvin and His Orchestra (Columbia). Standard fox trots of the snappy variety dressed up with fancy orchestration.

*Tomorrow* and *I'm Making Believe That I Don't Care* by the Colonial Club Orchestra (Brunswick). Just like countless other plaintive waltzes.

*Girl of My Dreams I Love You* and *Sugar Babe, I'm Leavin'* by Blue Steele and His Orchestra (Victor). One more waltz and a noisy foxtrot with a raucous vocal chorus.

*The Man I Love* by Fred Rich and His Hotel Astor Orchestra (Columbia) A good song handled with no particular merit. *For My Baby* by Leo Resiman and His Orchestra. If your doctor has tactfully suggested that you do more exercising, get this record. You can't sit still to this number.

*I Ain't Got Nobody* and *Weary Blues* by Ray Miller and His Hotel Gibson Orchestra (Brunswick). Right you are! The first is an old number and what's more it is played in the old fashioned way with lots of brass and much pep. Of the second—the only thing that's weary must be the orchestra after it finishes.

*When the Robert E. Lee Comes to Town* and *I Scream, You Scream, We All Scream for Ice Cream* by Harry Reser's Syncopators (Columbia). If you haven't heard the words to the latter song the record is worth listening to—once.

*Dawn* and *We Two* by The Troubadours (Victor). Lewis James and Ed Smalle who manipulate the vocal refrains and the Troubadours have between them made a grand record out of two fairly good musical comedy numbers.

*Among My Souvenirs* and *Keep Sweeping the Cobwebs Off the Moon* by Abe Lyman's Califor-

## The Month's New Phonograph Records

nia Orchestra. (Brunswick). The treatment of the first is perfectly orthodox which means good. The second leaves us cold.

*Away Down South in Heaven* and *There's a Rickety Rickety Shack* by Frank Black and His Orchestra (Brunswick). (a) Even if this were good we wouldn't like it. Not with that vocal chorus! (b) Something else again; it's good!

*That's What the Lei Said to Me* and *The Call of Aloha* by the South Sea Islanders (Columbia). Waltzes that are waltzes.

*Poor Lizzie* and *I Love to Catch Brass Rings on a Merry-Go-Round* by Billy Jones and Ernest Hare (Columbia). a. The Happiness Boys sing out the old and sing in the new (Ford). b. Not very good nonsense.

### More or Less Classical

*Pescatore Di Perle—Del Tempio Al Limitar* (Pearl Fishers—In the Depths of the Temple) (Bizet) and *Gioconda—Enzo Grimaldo, Principe Di Santafior* (Enzo Grimaldo, Prince of Santafior) (Ponchielli). Sung by Beniamino Gigli and Giuseppe De Luca (Victor). Week-day words are inadequate to describe the exquisite beauty of

### Recommended New Records

*Pescatore Di Perle—Del Tempio Al Limitar* (Bizet) and *Gioconda—Enzo Grimaldo, Principe Di Santafior* (Ponchielli) sung by Beniamino Gigli and Giuseppe De Luca (Victor).

*The Blind Ploughman* and *The Fairy Pipers* sung by Sigrid Onegin (Brunswick).

*Die Zauberflote—O Isis Und Osiris* (Mozart) and *Chorus of Courtiers—on Mischief Bent* (Verdi), sung by the Metropolitan Opera Chorus (Victor).

*Bridal Procession* (Grieg) and *March of the Bojaren* (Halvorsen) played by the Columbia Symphony Orchestra. (Columbia).

*'S Wonderful* and *Funny Face* by Victor Arden and Phil Ohman and Their Orchestra (Victor).

*Thou Swell* and *My One and Only* by Johnny Johnson and His Statler Pennsylvanians (Victor).

*Mary* and *Changes* by Paul Whiteman and His Orchestra (Victor).

*The Man I Love* and *Dream Kisses* by Ben Bernie and His Hotel Roosevelt Orchestra (Brunswick).

*Jupiter Symphony* (No. 41, Op. 551) (Mozart) by the State Opera Orchestra of Berlin, conducted by Richard Strauss. (Brunswick).



these duets as sung by this baritone and tenor from the Metropolitan Opera Company.

*The Blind Ploughman* (Radclyffe-Hall-Clarke) and *The Fairy Piper* (Weatherly-Brewer) sung by Sigrd Onegin (Brunswick). An organ accompanies this rich contralto voice in the first selection and reflects the seriousness of the song. In the second selection the tinkling notes of a piano and a flute illustrate the fairy music of which Miss Onegin sings delightfully as well as capably.

*Lucia: Sextet—Chi raffrena il mio furore (Why do I my arm restrain?)* (Donizetti) Sung by M. Gentile, D. Borgioli, G. Vanelil, S. Baccaloni, G. Nessi, I. Mannarini and chorus. (Columbia). This imported recording does not do full justice to the famous musical race in which the soprano is foreordained to win. The volume is, for one thing, too great. On the reverse is *Somnambula: D'un Pensiero (No Thought but for thee)* by M. Gentile, D. Borgioli, I. Mannarini, G. Pedroni and chorus, which is excellent except for the thinness of the soprano voice.

*Die Zauberflöte—O Isis Und Osiris (The Magic Flute—Chorus of Priests)* (Mozart). Sung by the Metropolitan Opera Chorus with the Metropolitan Opera House Orchestra under the direction of Giulio Setti. (Victor). This splendid organization presents a very plausible chorus of priests who are evidently all superior musicians. And the very next moment (on the reverse of the record) they are equally convincing as a *Chorus of Courtiers—On Mischief Bent (Scorrendo Uniti Remota Via)* from Verdi's *Rigoletto*.

*My Message and Nocturne* by John Charles Thomas (Brunswick). The same glorious baritone—and you may like the ballads.

*Quartet in G Minor Second and Fourth Movements* (Debussy). Played by the New York String Quartet (Brunswick). All the tricks of the string trade are herein utilized to demonstrate the beautiful and varied effects obtainable by two violins, a viola and a cello.

*Bridal Procession* (Grieg; Op. 19, No. 2) and *March of the Bojaren* (Halvorsen). Played by the Columbia Symphony Orchestra under the direction of Robert Hood Bowers (Columbia). This delightfully gay and lighthearted bridal chorus must have been written for a fairy wedding;

mortals take their weddings more tearfully. And here is a march that is not impressed with its own importance but is quite willing to be exuberant and even humorous. But then a march scored for strings, and woodwinds as well as for brasses can present these characteristics more easily than can the fife and drum brigade. The Columbia Symphony handles both these numbers with ability.

### All Hail the Record Albums

IT IS just another miscarriage of justice that somewhere in these United States there walks a man, unheralded and unsung. The man in question is the inventor of the album set. Until he sold his idea to the phonograph companies (we *hope* he sold it; if he can't have fame he should at least have royalties) our record library contained only *selections* from operas, *gems* from operettas, arias, ballads, folk songs, bits of this, and bits of that. No extended work could be had in its entirety because, alas, it could not be fitted on to the limited space afforded by a rubber disc, and it had never occurred to the phonographers to distribute one work of art over several discs, selling them as one unit. Now, however, we have whole symphonies, tone poems, and concertos, complete from the first note to the last. They come on several records, neatly stowed away in good looking albums, and accompanied by explanatory booklets which invariably are excellent and useful. These musical works are recorded by the best talent available in this country and in Europe and the technical work of putting the notes on the wax is done so expertly that no iota of tone is missing, no shading is lost.

In the March RADIO BROADCAST appeared a partial list of the music available in album form. The list is growing daily.

### Mozart's "Jupiter" Symphony

WE HAVE already reviewed one album set, the *Scheherazade Symphonic Suite* by Rimsky-Korsakov, played by the Philadelphia Orchestra under the direction of Leopold Stokowsky, and recorded by Victor. This month we

praise another symphony, equally beautiful in an entirely different way, the *Jupiter Symphony* (No. 41, Op. 551) of Mozart, played by the State Opera Orchestra of Berlin, conducted by Richard Strauss, recorded in Europe for Brunswick. It covers two sides of three records and one side of a fourth, the remaining surface being given over to the *Turkish March* (Mozart-Cerne) played by Vasa Pihoda. The Rimsky symphony is full of color, warmth, and emotion. It conjures up pictures of the Orient with its glowing colors, shimmering light, sinuous maidens, swaying camels, dancing fakirs, and the spicy smells of the market place—all the kaleidoscopic romance of the East. Mozart's symphony, on the other hand, brings forth no pictures. It lacks the warm humanity of the Russian music, lacks its emotion, lacks its color. But it has something which takes the place of these qualities, a precise musical style. It is music as pure, unsullied, and crystal clear as water bubbling from a spring on a mountain side. It is melodious from start to finish for Mozart was an expert harmonist. He lived his short life (1756-1791) at a time when emphasis was placed on form and harmony. The symphony was a fairly recent development. It had evolved gradually from the overture, the instrumental introduction to an opera, and had been given a more or less standard form by Haydn who was born twenty-four years before Mozart. This form consisted of three or four movements, generally four. The first and fourth were the longer and more essential, and were brisk in tempo. The second was slower and eminently lyrical, and the third usually a sprightly minuet. This is the form used by Mozart in the *Jupiter Symphony*. The orchestra for which he scored the symphony consisted of one flute, two oboes, two bassoons, two horns, two trumpets, kettledrums, and strings, and for the second movement he reduced it by the omission of trumpets and drums. This is a much smaller organization than the symphony orchestra of to-day.

It is particularly in the fourth movement, the loveliest of them all, that Mozart displays his technical skill, but not ostentatiously. The beauty and spontaneity of the music conceal the learning which is its foundation. The design of the movement is a combination of the sonata form and the fugue. The sonata form is that used for first movements of symphonies and consists of three parts, the Exposition which sets forth the themes; the Development which embroiders the themes; and the Recapitulation which restates the themes. In this movement Mozart uses four distinct musical ideas. The first is given out at once by the violins, its four opening notes being an ecclesiastical melody of which Mozart made frequent use. A second, and gayer, phrase follows this; the subject is then repeated *forte* by the full orchestra and at the end of the passage the second idea is introduced by woodwind and strings. There are sixteen measures of this, filled with exuberant tone. Next there is a return to the church theme treated in the orthodox fugal manner. At length this same theme is taken up *forte* by the full orchestra and at the fourth measure of it there is heard, in the first violins, the third idea. After a repetition of the second idea, the fourth idea—the second real theme—appears in the strings.

From this brief analysis of the last movement of the symphony you can perhaps derive some idea of the intricacy of the framework on which Mozart weaves his beautiful melodies. You will love these melodies whether or not you understand the construction, but if you follow the mechanics of the symphony you will arrive at a more complete understanding and consequent appreciation of the composition.

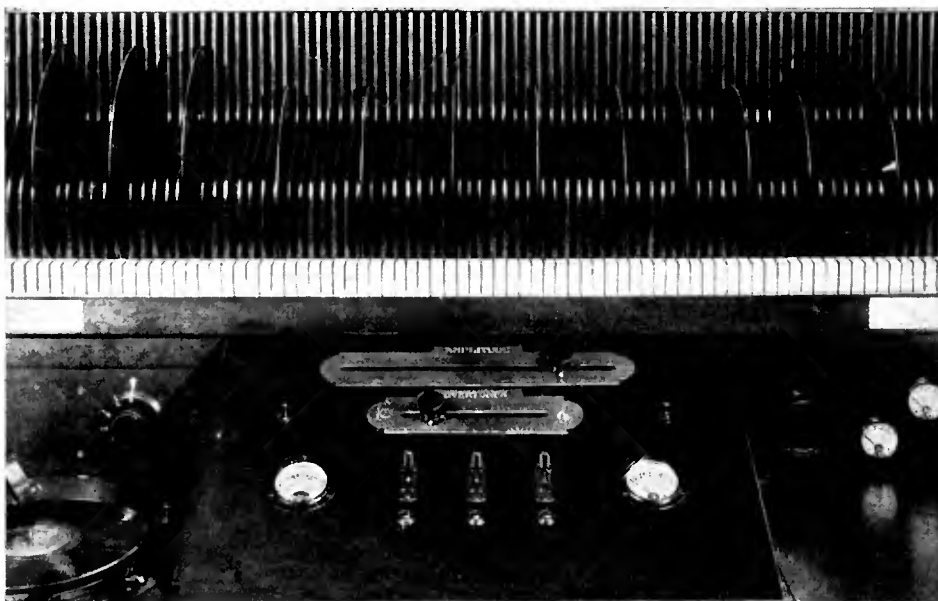

A CLOSE-UP OF THE CONTROL PANEL

A bank of three loud speakers is used with this phonograph-radio combination. Each loud speaker circuit has its own distortion meter, with controls permitting each circuit to be operated at its own regulated volume. Circuits and apparatus are provided so that the operator can announce the selection to be played through the entire loud speaker system



**Detector Distortion**

MANY TIMES we have read about radio receivers so engineered that the detector did

not overload, or receivers in which the detector did overload, or some other reference to distortion due to detector overloading. This leads us to ask such questions as: When does a detector overload? What does the output sound like when such overloading occurs? Is it true that a C bias detector will handle much larger input voltages without overloading? If so, how much? The answers to some of these questions are being sought in the Laboratory, and as fast as the material is ready it will be presented in these columns.

In the meantime, one of our friends has determined, empirically, that the average detector begins to overload when the detector delivers about 15 TU below 1.0 milliwatt. What does all this mean, you will ask?

Let us suppose that a detector has an output impedance of 30,000 ohms and that it works into a load of this impedance, say a resistance or a transformer of proper characteristics. Fifteen TU below 1.0 milliwatt is equal to about 0.03 milliwatts, or about 30 microwatts. What voltage across 30,000 ohms will deliver this amount of power? This is the useful voltage, for it is what the amplifier boosts in value so that the final power tube in the system will deliver its rated output. This voltage may be found by extracting the square root of the product of the power by the resistance. Or.

$$E = \sqrt{W_o \times R} = \sqrt{0.03 \times 10^{-3} \times 30,000} = 1 \text{ volt (approximately)}$$

Therefore, a detector which will deliver 30 microwatts to 30,000 ohms without overloading will produce 1.0 volt across the input to the amplifier. It now remains to prove under what conditions the detector will fulfill these expectations, and when overloaded, how the average experimenter can tell it by the sound of the output.

Has any reader experience in this matter?

**A Short-Wave Adapter**

THE FOLLOWING letter appropos of short-wave experimental broadcasting and its reception is interesting: It comes from C. R. Strange, of Sydney, Australia. "On the page 'Our Readers Suggest' in the December RADIO BROADCAST, there is described 'A Short-Wave Converter for any Radio Receiver' by Perry S. Graffam.

"It will be of interest to your readers to know that out here in Australia we appreciate your journal and that several days ago I built this adapter to plug into my Grebe Synchronphase which was presented to me by the A. H. Grebe Company of Richmond Hill, New York, following my reception of their station, WAHG, on 31.4.5 meters.

"An hour after I had finished Graffam's adapter I was listening to the transmission from 2 LO (London) through the short-wave station 5 sw Chelmsford England, on 24 meters, using the two audio valves of the Synchronphase receiver and my model-100 loud speaker. On the 25th (January) I listened wonderfully to this station for 55 minutes, the volume being audible some 15 feet from the speaker. Also on the 25th and last night I listened also with wonderful success; here, some 13,000 miles away, it is rather thrilling to listen to London broadcasting at

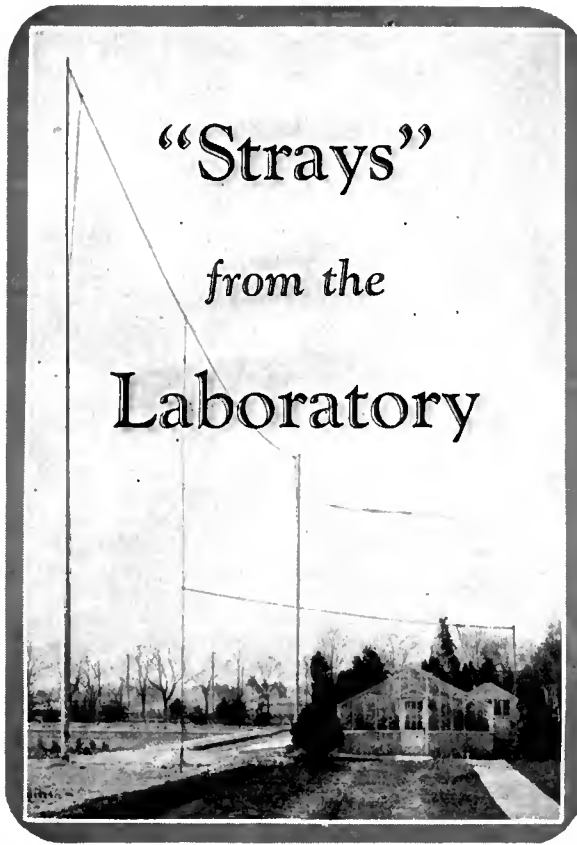

midday such items as selections from Cavalleria Rusticana, Percy Grainger's pianoforte arrangements, Carmen, and a fine tenor voice singing 'The Sargent Major's on Parade.'

"We surely are in a wonderful age. Television will be the next thing for Australia."

**Short-Wave Broadcasting**

THERE HAVE been numerous attempts to convince the public and, we imagine, the Radio Commission as well, that broadcasting should take place on the high-frequency (short-wavelength) bands. Let us look only at the problem of keeping a station on its assigned frequency which, for sake of argument we shall assume to be 10,000 kc., or ten million cycles. Many broadcasters are having difficulty in keeping their present transmitters within one-half kc. of their assigned frequency. What would be their troubles if they worked at 30 meters? Five-hundred cycles in 10,000,000 represents an accuracy of one part in 20,000, or five-thousandth of one per cent. At the present time, a station operating on 1000 kc. must keep its assigned frequency to within 500 cycles in one million which represents one part in 2000 or five-hundredths of one per cent. In other words, it would be about ten times as difficult to keep a station on its frequency at 30 meters as it now is at 300 meters.

We understand the Navy builds short-wave equipment that must be accurate to within 100 cycles at 30,000 kc. That is, they build a transmitter to this specification, and a receiver to go with it and the sum of their percentage inaccuracies must not be over 200 cycles in 10 million, or 100 cycles for the individual unit. This represents an accuracy of one part in one hundred thousand, or one ten thousandth of one per cent., an accuracy 50 times as great as that required of stations now operating within the broadcast band. These Navy units, it should be noted, are designed for code transmission and reception.

**The "Equamatic" System in England**

RADIO BROADCAST takes pride in quoting part of a letter from Louis G. King, whose

system of tuning, known as the Equamatic System, was first described in this magazine. Mr. King has just returned from Europe and that his trip was successful may be surmised from this part of his letter: "Recently we have entered into an agreement with Graham Amplion, Ltd., for the production of the Equamatic System in the British Isles. After carefully testing radio receivers produced by the leading manufacturers in all parts of the world, Graham Amplion, Ltd., adopted the Equamatic System." The system has, in this country, been most closely associated with receivers designed by the Karas Electric Company.

**Finding Ore by Radio**

MANY TIMES in the past year or so, the editors have been asked to forward information on devices useful in finding ore or hidden treasure by radio.

Up to the present time it has been impossible to give any authentic information regarding such apparatus, and therefore, we are appealing to the readers of the magazine. What is wanted is information on methods and apparatus used, whether using radio or other electrical apparatus, results secured, and articles published whether in this country or abroad. This will enable us to help prospective treasure hunters toward a financially successful jaunt.

**Real Power from two 112's**

RADIO LISTENERS in communities where there is no a.c. power available need not feel that it is impossible to

secure sufficient power to operate their loud speakers properly just because they cannot tap the house lighting system and get high voltages and considerable plate current therefrom. For example, two 112-A tubes will deliver considerable power without excessive plate voltage or current—which means that the farmer who has no power equipment may secure good quality and plenty of loud speaker power from B batteries, and do it economically. The table below shows the relative power output and necessary grid a.c. voltage to deliver this power from a single 171 or two 112's in parallel. Note that two 112's in parallel with 157 volts on the plate require 16 milliamperes from the B batteries and deliver 400 milliwatts of power to a loud speaker on only 10.5 input grid volts while a 171, taking the same current from 135 volts, requires a grid voltage of 27 to produce 350 milliwatts. Two 112's in parallel will have an output impedance of about 2500 ohms which will work very well into the average loud speaker:

TUBE	EP	EC	IP	WATTS OUTPUT
171	90	16.5	11	.12
	135	27	16	.35
	157	33	18	.50
	180	40.5	20	.65
2—112's	90	4.5	8.0	.08
	135	9.0	11.6	.240
	157	10.5	16.0	.400

**Tested Products**

SOME TUBES from Sylvania Products Co., have been measured in the Laboratory recently. The values given below are the average of six of each type of tube:

TYPE	IP	μ	RP	GM	EP	EG
201-A	2.2	9.2	12330	750	90	-4.5
112-A	7.0	7.5	5160	1450	135	-9.0
171	19.0	2.9	2240	1300	135	-27.0

### The Screen-Grid Tube: Selectivity

EXPERIMENTERS who have installed a single screen-grid tube ahead of a detector, regenerative or not, have been disappointed at the apparent loss in selectivity of the system, although the gain increases. Let us suppose that the resonance curve of a single-stage of r.f. amplification using a 201-A tube is as shown in Fig. 1. Now let us use a screen-grid tube in which the gain may be twice as great. In other words every point of the resonance curve of Fig. 1 is boosted twice as high with the result as shown in B. In any local area, stations are separated by 50 kc., so that on Curve A the incoming signals from a station 50 kc. off resonance are below the line which represents the arbitrarily chosen signal magnitude beyond which interference occurs. Now look at Curve B. Here the 50-kc. signal is up out of the area in which no interference occurs, and is heard in the background of the station to which the receiver is tuned.

Let us call the absolute selectivity factor, the ratio between the height of the curve at resonance to the height at 50 kc. off resonance. This factor for curve A is  $50 \div 2.4$ , or 2.1, and for the curve B is  $100 \div 4.8$ , or 2.1 exactly the same. Then, if the apparent selectivity is defined as the number of kilocycles off resonance a signal must be before it is reduced to the non-interfering region, we see that for the 201-A example it is 50 kc. while for the Curve B where the gain is twice as great the frequency is 70 kc. These figures depend, of course, upon the shape of the resonance curve.

Each additional stage of 201-A r.f. amplification increases the gain of the receiver and increases the selectivity, but as Professor Hazeltine has shown in his recent patent, No. 1, 648, 808—(Nov. 8, 1927)—by properly designing the inter-stage transformers in such amplifiers, an increase in selectivity of 50 per cent. can be obtained at a loss of only 20 per cent. in amplification. In other words, in a system using successive tuned stages, relying upon resonance curves for selectivity, there must always be a compromise between gain and selectivity. Increasing the gain without increasing the absolute selectivity at the same time, reduces the apparent selectivity. Although the signal to which the system is tuned will be louder, so will the background produced by other stations.

Adding a single stage of screen-grid tube r.f. amplification under conditions which produce maximum gain from that tube, decreases the apparent selectivity too much. Adding an extra stage, from which we secure maximum amplification, will boost the sensitivity faster than the selectivity is increased, and we are no better off than before.

In other words, if three stages of 201-A amplification are needed to secure sufficient selectivity, more than three stages will be necessary when using screen-grid tubes. This seems to indicate that these tubes will not decrease the number of effective tubes in a receiver, but will actually increase that number—so long as we use the t.r.f. system of tuning.

The answer, if this reasoning is correct, is to use a different system of tuning. The super-heterodyne is one solution; perhaps the Vreeland system described recently in the I.R.E. *Proceedings* is another. This is a system designed with the avowed intention of making a response curve of a receiver flat on top and very steep on the sides. It is done by using two closely coupled circuits so that the resonance hump is not a single sharp peak, but is composed of two peaks with a dip between. The Laboratory hopes to present some quantitative data on this system

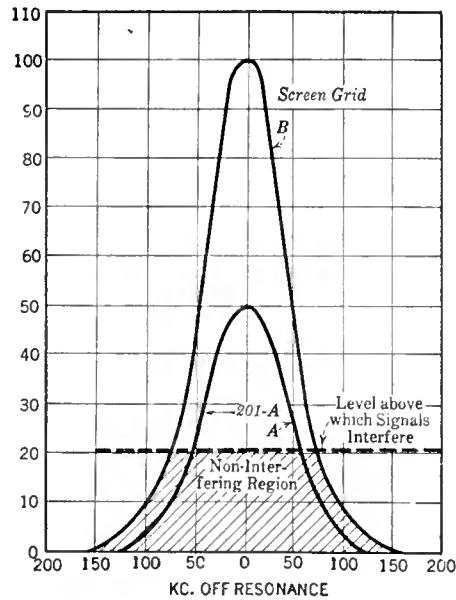

FIG. 1

soon, and in the meantime welcomes comments on the problem outlined above.

### Loud Speakers

MANY TIMES per month we hear about some high official in this or that radio company who indulges in a bit of forecasting, usually about the future of radio. Among other trends, to believe these officials, is that toward greater power which will be handled in the future radio's amplifier, one executive going so far as to state that our sets of the future would have amplifiers turning into our loud speakers at least ten times as much energy as they do at the present time. Judging from what has happened during the past few years, one cannot doubt it, for in the good old days we were satisfied with the output of a 199, then we needed a 201-A to deliver sufficient power, then the 112, then the 171 and 210 tubes, and now the 250 type. Each of these tubes delivers considerably more power than its predecessor, and to jump from a 5-watt tube to a 50 watt represents ten times as much power output, that is, 10 ru difference.

We are not convinced. Several years ago we listened to a pretty fair program coming from a speaker that was 10 ru better than any speaker now generally available. That is, it required 10 ru less power to get a good healthy sound from it. This represents the difference between a power output of 600 milliwatts (171-A), and 60 milli-

watts (201-A). In other words, when loud speaker manufacturers are able to build a loud speaker with a good characteristic that is 10 ru better than our present loud speakers, we can all go back to our old 201-A tube, our B batteries, and start all over again.

What are the prospects? We have heard that the Western Electric Company builds a loud speaker much more efficient than the 540-AW, for sale in England only. It does not have the same tonal range as the 540-AW and is cited only as an example of an efficient loud speaker.

Incidentally, present trends in loud speaker design are toward moving-coil affairs, electrodynamic units, such as the Magnavox and the Jensen cones, and the Vitaphone, which is a moving-coil unit, coupled acoustically to an exponential horn. All of these have very fine frequency characteristics, with honors at this writing in favor of the Jensen. The Jensen is made in California and is now generally available, we understand. We have seen curves, above reproach, which show the Jensen to have a quite flat response curve from about 60 to 6000 cycles. With a large baffle-board, such as obtained by inserting the loud speaker in the walls of a home, the lower limit of response can be pushed down to about 35 cycles. A six-foot square baffle about one and a half inch thick, is however, very satisfactory.

If this Jensen unit, for example, could be made 10 ru more efficient, that is to say, deliver the same output with one-tenth the input, the result would be distinctly worth achieving. It should not be forgotten, however, that aside from the question of overall "audio" efficiency in this unit, we must supply the coil with 60 mils. at 100 volts—6 watts of power.

The Magnavox, too, is a fine product, but seems to suffer from excess filters which appear to be necessary to prevent too much a.c. hum from getting into it, to cut down the high-pitched heterodyne whistles, and other noises. In other words, a Magnavox loud speaker unit without the removable devices now employed to make up for our present poorly filtered a.c. receivers, or the present unfortunate situation in the ether, is a fine unit.

We understand from an unimpeachable authority that the Stromberg-Carlson engineers built into stock receiver models a few years ago, audio amplifiers so good that nearly all of them came back. Criticism arose from the fact that these receivers seemed more noisy than sets of other manufacturers; more static came in, and "whistles" were more evident. It was a simple matter at the factory to put filters in the amplifier system, cutting down on the two ends of the frequency spectrum. Then the receivers stayed sold. It is a fact that many hundreds of these receivers have been sold to Bell Laboratories engineers and their friends. As soon as they are received out comes the soldering iron, off comes the filters, and out of the loud speaker come the low and high frequencies that are so essential to good quality.

### An Error in Coil Dimensions

IN THE article on the four-tube "Lab" receiver in the April RADIO BROADCAST, specifications were given in Fig. 2 for coil dimensions. Coils L<sub>1</sub> and L<sub>2</sub> were shown to consist of 90 turns, No. 24 s.c.c., on a form 2.5" in diameter. The correct designation should have been 90 turns No. 24 s.c.c. on a 2.0" diameter form. If the reader already has a 2.5" coil form, he may use 66 turns of No. 24 s.c.c. wire to cover the same range.

—KEITH HENNEY.

### Watch for the A. C. "Lab" Receiver

HUGH KNOWLES' article describing the construction of the popular R. B. "Lab" circuit for a.c. operation will appear in RADIO BROADCAST for June. The completed receiver has been thoroughly tested in RADIO BROADCAST Laboratory and has proved very satisfactory indeed. Readers will recall the complete experimental article in our April number describing tests in the Laboratory on the design of this circuit. The June article describes completely the construction of an a.c. four-tube "Lab" circuit receiver. Some of its interesting features are: Excellent efficiency for four tubes; a.c. operation, an extra socket and control switch enabling quick transfer of the audio system to phonograph pick-up or short-wave tuner unit, and an interesting volume control.

—THE EDITOR

# HOW TO IMPROVE BROADCASTING

By JOHN WALLACE

IN THE January number we unburdened our soul of some ingrowing and irate convictions in an article, "Are Radio Programs Going in the Wrong Direction?" They were, we said, and the general tenor of our hymn of complaint may be recalled by quoting: "Whatever roseate promises radio may have seemed to have held in the past, we are at present thoroughly convinced that things have reached a sorry pass, and that radio is standing still—smug, self-satisfied, and unutterably banal. . . . In fact standstill is putting it mildly; the state of affairs is more exactly a retrogression. All the money, all the ingenuity, all the labor that is being devoted to the designing of programs is being diligently devoted to efforts in the wrong direction—with the result that radio is going to the dogs at a break-neck speed, so rapidly, in fact, that to check it will require no little effort."

During the four months which have elapsed since publishing this diatribe we have had an unusual number of communications, ranging all the way from heartiest endorsement to bitterest denunciation.

One commentator says: "The writer is one of those humans who inordinately admires a 'kicker' if, and when, said kicker registers his kick with some accuracy and a lot of éclat. That is preparatory to a 100 per cent. endorsement of your kick in the January RADIO BROADCAST—"Are Radio Programs Going in the Wrong Direction?" Every word in this article is pregnant with common sense and as true as Gospel." (Such perspicuity! J. W.)

Another correspondent states: "You are just like all the rest of the tribe of critics—'smug and self-satisfied.' What good do you expect to effect by such destructive criticism as is contained in your article in the January RADIO BROADCAST? Here thousands of people throughout the country have been putting in eight hours a day for the last five years to make radio what it is today and then you come along and in an article that couldn't have taken two hours to write, presume to set at naught all this accomplishment." (O my, O my, it sometimes takes us twenty hours to write one of these! J. W.)

Such was the run of lay comment. We quote two other replies, both from members of "the profession." These retorts were not addressed directly to us but were forwarded to "Pioneer" of the New York *Herald-Tribune* who quoted our unkind remarks in his column. One is from the president of two small stations and the other from the president of the National Broadcasting Company. Mr. Donald Flamm, president of stations WMCA and WPCH, in a lengthy open letter said, among other things:

"It is to answer Mr. Wallace, as well as the radio critic through whose courtesy Mr. Wallace's remarks were presented, that this is written. I don't propose to speak for all the broadcasters. I am simply giving my own opinion, based upon three years of association with the radio industry and particularly with the broadcasting end of the business. . . . I, too, have come to the realization that radio is at a standstill and . . . it is not within the province of the radio impresario to do very much about it. And, furthermore, it is going to remain at a standstill unless some very remarkable change occurs in the very art of radio broadcasting itself—a

change that is entirely beyond our control. . . . Let us consider . . . the plight of the broadcaster.

"He can appeal to his audience only through sound—nothing else. . . . There is nothing in the world he can add to his 'tools' with which to accomplish so-called showmanship. There is another angle that we cannot overlook . . . the fact that the broadcaster is constantly doing something different. In writing a play, the author takes weeks and sometimes months . . . the stage director continues the job and shapes and changes the play . . . until it is finally ready for a long, or perhaps a short, run on Broadway. The same play is repeated performance after performance without the slightest variation of a line or a movement. The author's job is done, the director's job is done, the producer's job is done. How different is the task of the broadcaster! Every program must be different. And as in the case of WMCA, which goes on the air at 9 o'clock each morning and continues broadcasting right through the day and evening until sometimes as late as 2 A. M., what opportunity have we for observing these rules of 'showmanship'?"

"After all, what is there that we can present to the public that will display good 'showmanship' and 'intelligence'? Radio impresarios have presented almost every great living artist available. There is not a musical organization in the country whose services have not been utilized at some time or other. During the course of the year we have also presented hundreds of orchestras, numerous celebrities from all walks of life, interesting and informative talks by competent authorities, vaudeville programs, short programs and long programs; in short, we have availed ourselves of every possible form of entertainment. We have not left a stone unturned in our effort to bring to our audience the complete range of program material. Beyond that we can do no more."

Mr. M. H. Aylesworth, president of the National Broadcasting Company said, in part:

"I have read with considerable interest the various criticisms of broadcasting programs . . . which you recently quoted in your interesting column. It has occurred to me that a short résumé of the talent which has been made available through the system of the National Broadcasting Company and associated stations by American industries who are sponsoring national programs, as well as those produced by the National Broadcasting Company, and associated stations in the last sixty days (January and December), shows something of the vast undertaking in arrangement and finance to make possible the feasible reception of these speakers and artists by the American radio public." The résumé, which is entitled "A Partial List of Outstanding Broadcasts by the National Broadcasting Company," is given herewith:

*Artists, actors, and actresses*—Ernest Hutcheson, Percy Grainger, Ohman and Arden, Irene Scharrer, Ethel Leginska, Robert Armbruster, Ignace Friedmann, Herbert Carrick, George Gershwin, Josef Lhevinne, Adam Carroll, Richard Rodgers, J. Milton Del Camp, Richard Buhlig, Benno Moiseiwitsch, and Mme. Wanda Landowska, pianists; Mischa Weisbord, Paul

Kochanski, and Arcadie Birkenholz, violinists; Ethel Hayden, Van and Schenck, Katherine Meisle, Editha Fleischer, Reinald Werrenrath, Maria Kurenko, Marie Tiffany, Elsie Baker, Arthur Hacket-Granville, William Simmons, Mary Lewis, Armand Tokatyan, Ann Mack, Mary Garden, Al Jolson, John Charles Thomas, Emilio de Gorgoza, Merle Alcock, Mario Chamlee, Duncan Sisters, Tita Ruffo, Fanny Brice, Claudia Muzio, Cliff Edwards, Rosa Ponselle, Giovanni Martinelli, Ezio Pinza, Richard Crooks, and Sophie Braslau, singers; "Chick" Sale, Joe Cook, Dr. Rockwell, Fred and Dorothy Stone, Leo Carilla, Weber and Fields, and Cornelia Otis Skinner, actors.

*Orchestras and orchestra leaders*—Walter Damrosch, conducting the New York Symphony Orchestra; Fritz Busch, guest conductor; Roderic Graham, conducting G. M. Symphony Orchestra; Patrick Conway and band, Edwin Franko Goldman and band, Paul Whiteman and orchestra, Vincent Lopez and orchestra, and Ben Bernie and orchestra.

*Authors and explorers*—Robert Benchley, Will Rogers, Irvin S. Cobb, Ford Madox Ford, Louis Golding, Glenway Westcott, Louis Bromfield, Commander George Dyott, Fannie Hurst, Helen Hull, Elmer Davis, Cosmo Hamilton, S. S. Van Dine, Dr. Ralph Sockman, John B. Kennedy, Homer Croy, Grantland Rice, and Bruce Barton.

## ARGUMENTS FOR THE DEFENSE

IN VIEW of the foregoing we have a defense of our January remarks, and an enlargement of them.

To those who objected that our stand was destructive, our retort is: It wasn't. We claim, constructively, that serious instrumental music should be the backbone of radio entertainment. We offered no constructive suggestions as to what should make up the balance of programs, not because we had no ideas on the subject but simply because of lack of space. Specific ideas along those lines follow.

As for Mr. Aylesworth's reply—sorry, but we're going to quote again from the January squawk: "What is the right direction for program making to take? Program makers are too embroiled in their business to glance at the guideposts, too pressed by the strenuous and unceasing job of making programs to take a moment or two off for a little rational reflection on what their job is all about. They persist in refusing to take account of the fact that radio is a new medium, a unique medium and, like any other medium, endowed with its peculiar limitations and peculiar possibilities. Pig-headedly, they persist in attempting to reconcile with their duties the traditions of the drama, the opera, the music hall, and the vaudeville stage."

In view of these remarks Mr. Aylesworth's rebuttal is seen to contain its own refutation. All the individuals he mentions are recruited from "the drama, the opera, the music hall, and the concert stage." However, we will not gloat over Mr. Aylesworth's self-confounding; our victory is merely a dialectic one. For the fact is that the programs he mentions are the very best that are at present discoverable on the air.

But it is unfortunate that this is true for such programs represent not progress, but stand-

still. They are good in their way, but they remain a makeshift, a borrowing. Multiplying them to the *n*'th degree would still be doing nothing to serve the ultimate ends of radio as a permanent institution. Radio must develop its own artists, actors, actresses, and orchestras. These may also do work in the other field but they must be first of all radio performers. What Mr. Aylesworth lists is not *radio performers* but names names, names.

Mr. Flamm, quoted above, agrees with us—but—we do not agree with him. Our version of the predicament was not pessimistic. His is. We claimed that nothing was being done to get radio out of its rut. He claims that nothing can be done.

#### THE BROADCASTER CAN'T IMPROVE BROADCASTING

HERE the broadcaster—if Mr. Flamm can be taken as representative—lays all his cards on the table and discloses himself for what he is—an unimaginative soul who isn't fitted to guide his own destinies. He laments that the broadcaster can appeal only through sound. He should rejoice. Sound. There is his medium—plainly and unmistakably identified. There are half a million sounds in existence awaiting his use of them. Obdurately he ignores them. The conclusion toward which we have been laboring should by now have made itself manifest: *the broadcaster can't improve broadcasting.*

If broadcasting is to be extricated from the rut of dull routine in which it finds itself, it is evident that the help must come from without.

Why? The reason is plain enough. The broadcaster is first of all a business man—an impresario. If he transcends that he may, in some instances, be also an interpretative artist. But by no stretching of the imagination can he be regarded as a creative artist. Nor are the gents on his staff of continuity writers likely to be creative artists. Creative artists are rare birds and not likely to be found among the hirelings of a big industry. The result is that nothing is being created for radio; without creation no art can come into being—including radio art.

True, there are program makers who go through some of the motions of creating. But they haven't got the goods in them and what finally results is merely a banal, or at best "tricky" arrangement of a lot of old stuff.

The broadcasters, however, have no occasion to resent this indictment of their artistry. We wouldn't have them artists! Imagine what would happen to the National Broadcasting Company if a crew of long haired birds should try to run it. It would go out of business in three days. The broadcasters are marvels of efficiency in their own field. They have effected the most rapid growth that any industry has ever known. All honor is due them. The only trouble is that they are trying to extend their field outside of its legitimate limits. Impresarios, well and good; but creators—phooey!

Now the truth of the matter is that there is an Art of Broadcasting. The only trouble is that it hasn't been discovered yet. There have been inklings and foreshadowings of what it is to be. But these foreshadowings, though they're as obvious as the nose on your face, have been practically ignored. To mention a couple of these harbingers, one was the Eveready Hour's "Galapagos" and the other was that same organization's "Show Boat."

These two programs came at least nearer than any others to demonstrating what the new radio art form will be like. But excellent as they were they only faintly suggest the unexplored possibilities of what we hereby dub "Sound Drama."

We don't propose to write you a "Sound Drama." In the first place that's not what

we're hired to do, and in the second place we haven't the necessary talents to do it. But it is within our rights and powers to prophesy what the so far unwritten "Sound Drama" will be like. It will be a little like the Stage Drama. It will be a little like the Opera. It will be a little like the Symphony. It will be a little like Literature. It will be a little like the Oratorio. And it will be exactly like no one of these. What it will be is the perfect synthesis of all the modes we have mentioned. Which also means it will be quite a chore in the making! No ordinary ham is going to be able to take all these art forms and weld them into a whole which will be not merely a conglomeration but a unity, an art form in itself. It is a task for a creative artist of the highest ability and originality. The artist who does it will have to be Playwright, Composer, and Poet all at once—in other words such a man as was Richard Wagner. He need not be technically equipped in each one of these fields of art. But his taste, at least, must direct the efforts of collaborators to a unified end. (It is needless to add that he must also familiarize himself with the mechanical limitations of radio transmission and adapt his music and all else he offers to these requirements.)

The time is now ripe for the new art to appear, for the radio lords have brought radio up to the point where it is susceptible of being made an art. To their credit it must be said that radio is miles ahead of the writing that is being done for it. Radio technicians have done astounding things. They have developed their apparatus and their knowledge of transmission to the point where they can do wonders. But there are no wonders to be done. Most of the truck that is on the air is an insult to the excellence of the apparatus that transmits it.

Radio play directors have made exhaustive researches in the realm of noises. They have learned how properly to imitate hundreds of noises in nature. But so far they have been unable to put these noises to any artistic use.

The radio engineers and the studio staffs have done their share. They have set the stage. What they need now is something worth while to put on that stage. And they ought to realize that *they* can't produce it. They must call for outside help. Their position is much like that of an expert violin maker who has put in months of loving craftsmanship in the making of a perfect instrument. This same craftsman doesn't attempt to perform on the fiddle when it is finished. He leaves that to the artist.

So the radio program makers must sooner or later summon the aid of the artist. An artist is attracted to a new medium by four different factors: 1. The artistic possibilities of the new medium. 2. The possibilities of reaching an appreciative audience through that medium. 3. The permanence of the medium. And, 4. The rewards available in that medium.

That radio has artistic possibilities we are firmly convinced. That radio has a large and sympathetic audience is an obvious fact. That the medium is at present a most ephemeral one happens also to be a fact, but one of no permanent importance. Now, a program is given once and forgotten sixty minutes later. Which is generally what it deserves. But there is no reason why a radio creation of sufficient merit and meaty content could not be given again and again and find a permanent place on the repertoires of stations throughout the world.

As to the rewards available for creative radio program designing, that brings us up against the practical. At present there is no financial inducement for any one to worry his head over the future of radio—unless he be a paid "continuity" writer, in which case he does just enough

worrying to earn his salary. Many millions of dollars are spent in this country every year on radio programs. It is our conjecture that of these many millions of dollars less than a tenth of one per cent, goes to paying for the writing of broadcast programs. Much of it is wasted on paying the extravagant bills of opera singers and other overpaid interpretative artists.

If less money were lavished on the individuals who interpret things, and more money spent in getting them something to interpret, matters would be vastly improved.

As a practical suggestion of a method to start the ball rolling, we propose the following:

Let some station or syndicate of stations post a prize of \$5000 for the best specially composed program of sixty minutes duration submitted in manuscript by October 1, 1928. The privilege of purchasing other compositions at more ordinary rates could be reserved by the station offering the prize. Certain copyright stipulations would also have to be arranged.

What will this winning composition be like? We will suggest its make-up. It will be a collaboration between a modern composer—a Honneger, say—and a writer or poet. The announcer will introduce it with not more than two or three minutes of explanatory foreword. He will not intrude again. This imagined program will open, say, with a vague rumble of distant noises. They will steadily grow louder and presently organize themselves out of the chaos into recognizable sounds. They will be the noises of nature, perhaps the beating of surf, the noise of a street, or the buzzing of insects. They will constitute the setting. But these noises will be craftily selected, manipulated, minimized, or exaggerated. Some may be amplified to a high degree—as they would sound, for instance, to the keen ears of a wild animal. They will suggest the mood of the entire piece.

Imperceptibly they will melt into music, the music of the symphony orchestra, which will continue to build up the mood. Then the music will grow quieter, a modulation will change its key and its tempo until presently it will merge, without any break, into the human voice. Not your ordinary human voice, but the voice of an artist actor which can convey the slightest nuance of emotion. And the words will not merely be words, but just the right words. They will be as informative as the words in any stage play, but at the same time they will be prose poetry. They will further clarify the situation, or plot, which will of necessity be an elemental and emotional one. The speaker's words may at any time change into song and perhaps back again. Presently the noises will be heard again, or the orchestra, or perhaps a chorus of voices—observers commenting on what transpires. And so on, all these various sound sources will be manipulated and shuttled about until the comedy or the melodrama, the tragedy or fantasy, whatever it is, has come to a close.

In thus briefly setting down our ideas of the possible trend of such a Sound Drama, we have perhaps made the thing seem simply curious and "tricky." Perhaps we have made it seem "highbrow." If it is properly composed and executed it will be none of these. It will be a gripping emotional thing that will completely carry us away. It will not be something vague and disjointed that we will forget immediately it is over, but something rememberable and pleasurable. And it will have accomplished its end, not through visible means, nor verbal description, but through an appeal to that much neglected organ of ours—the ear.

And still the broadcaster laments that he "can appeal to his audience only through sound—nothing else!"



# "Our Readers Suggest—"

*"Our Readers Suggest..." is a regular feature of RADIO BROADCAST, made up of contributions from our readers dealing with their experiences in the use of radio apparatus. Little "kinks," the result of experience, which give improved operation, will be described here. Regular space rates will be paid for contributions accepted, and these should be addressed to "Our Readers Suggest Editor," RADIO BROADCAST, Garden City, New York.*

—THE EDITOR

## Remote Volume Control

THE operation of a receiver by remote control is an interesting possibility, and one that has intrigued many engineering minds. The mechanical and electrical complications of existing systems are such, however, as to preclude their general use. It is, nevertheless, a relatively simple matter to control the volume of a receiver from your easy chair, which, though only partially solving the problem, is really a great convenience. The radio fan is, I think, inherently a lazy individual. Writing from personal experience I may say that there is nothing more annoying than finding it necessary to rise from a comfortable chair or sofa to tone down or bring up volume on a receiver that a few minutes before was apparently correctly adjusted.

Fans indisposed to labor have undoubtedly noted that the volume of a receiver is anything but constant. An original adjustment made when the broadcaster was using the soft pedal, proves entirely off on a fortissimo passage. Also, in congested radio districts, the intensity of signals, I have found, varies considerably with the number of receivers tuned to the same program in the immediate neighborhood. This is not due to an absorption effect upon the field strength, but rather to a parallel wave trap effect. Regardless of the reason, the condition exists and can be made more tolerable by providing a means of volume control from wherever the indolent listener may be reclining.

The writer uses a variable zero to five-thousand ohm resistor connected between the antenna and ground posts of the receiver by means of a long flexible telephone cord. This is employed as an auxiliary volume control to the adjustment provided on the receiver itself. The original volume control is set for a degree of

volume quite a bit in excess of comfortable listening, and is toned down by the external control.

I have found that practically any variable resistor, covering a range of from five to at least five-hundred ohms, is satisfactory for the purpose described. It is apparently immaterial whether or not the resistor is inductive.

JAMES MONTAGUE,  
Newark, New Jersey.

## STAFF COMMENT

ELECTRAD, Clarostat, Yaxley and others are manufacturing remote volume controls of the type described by our contributor. Their use in the antenna circuit, where, of course, signal



A NEW CLAROSTAT

It is the remote volume control type. Electrad Yaxley and others have similar controls

intensity is reduced before the signal is impressed on the audio-frequency circuits, precludes the possibility of overloading, with resulting distortion.

Devices of this nature can be made to serve a utilitarian purpose other than Mr. Montague's commendable moral support to laziness. Such a volume control installed near the telephone is a logical arrangement of genuine utility, and will be greatly appreciated by persons who have endeavored to converse over the 'phone in competition with the radio.

## Improving Your B Device

SEVERAL articles have appeared in "Our Readers Suggest" department on the improvement of socket power devices. These

articles have considered, singly, the stabilizing possibility of the glow tube, the use of additional resistors to obtain desired plate potentials, and the use of C biasing resistors. It is the purpose of this article to describe a simple arrangement which takes care in one unit of these various desirable possibilities.

The starting point in improving the existing B device is in the rectifier tube. In this connection it is necessary first to clarify a misunderstanding which has gained ground of late, namely, that a rectifier tube, when renewed, must be replaced by one of identically the same type.

With virtually any good Raytheon B socket power outfit heretofore provided with the Raytheon B type rectifier, an increase in voltage output may be obtained by substituting the present Raytheon type BH tube for the old B type. The voltage, providing it was adequate for the requirements of the output tube used before this substitution, now is of sufficient value to take care of the grid biasing requirements of the power tube as well as its plate supply demands.

Other improvements for B devices have taken the form of better voltage regulation at the output end. Reliable potentiometer resistances, together with a voltage regulator tube, will maintain fixed voltages across two or more terminals.

The photographs on page 34 present an adapter which may be connected to many of the better quality B power units so as to incorporate the advantages of a potentiometer resistance network and a regulator tube, while increased voltage output is obtained for use as grid bias by replacing the B type with the BH type Raytheon, as mentioned above. It will be noted from Fig. 2 that the adapter comprises a tapped potentiometer resistance, two bypass condensers, a socket for the R (regulator) tube, and a special current-limiting resistor for use in the third element circuit of the regulator tube. These few parts, along with the necessary binding posts, may be mounted in almost any desirable manner.

Fig. 1 shows a typical B unit circuit, with the original resistors supplying the potential requirements of last year's receivers. Fig. 2 shows a wiring diagram of the additional unit described by the author. Point "A" is connected to point "A" in Fig. 1 and point "B" to point "B" in Fig. 1. The center choke tap runs through the

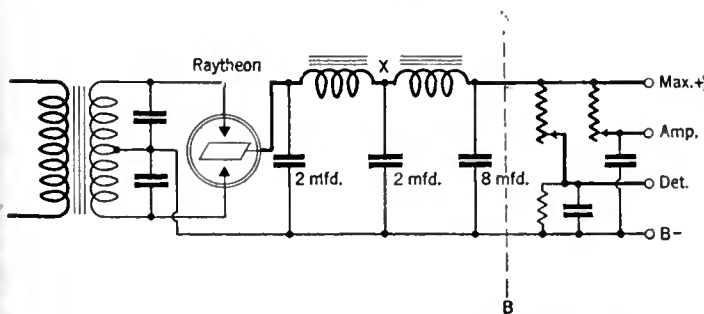

FIG. 1

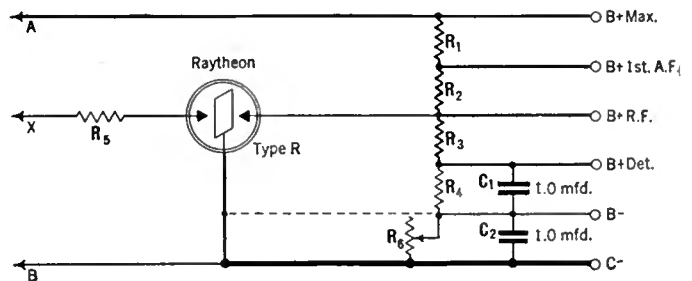

FIG. 2

9000-ohm resistor to the metallic base of the regulator tube from "X" in Fig. 21 to "X" in Fig. 1.

The following table shows the value of the resistors designated in Fig. 2:

- R<sub>1</sub> 1000 ohms, 5 watts
- R<sub>2</sub> 2000 ohms, 5 watts
- R<sub>3</sub> 50000 ohms, 2 watts
- R<sub>4</sub> 20000 ohms, 2 watts
- R<sub>5</sub> 9000 ohms, 5 watts
- R<sub>6</sub> 2000 ohms, (double potentiometer, such as the Amsco "duostat")

The constructor should find no difficulty in following the layout of parts by reference to the photographs.

D. E. REPLOGLE,  
Cambridge, Massachusetts.

STAFF COMMENT

THE arrangement shown in Fig. 2 may be used with practically any socket power device. As was pointed out in previous articles of this nature in "Our Readers Suggest" Department, however, the C bias arrangement should be employed only with a socket power unit capable of delivering a total voltage output under load equalling the sum of the maximum plate and grid voltage required. The grid bias feature may be eliminated by the omission of C<sub>2</sub> and R<sub>6</sub> and by the connection of the bottom of R<sub>4</sub> to the regulator tube and to "B" on the regular B device. This connection is indicated in dotted lines, the heavy line being, of course, left out

Plate Detection

THE advantages of using a C battery for bias in the detector circuit may be retained without the use of an extra battery by a simple change in the wiring of any circuit. In the writer's case a resistance-coupled audio amplifier is used for the first stage. The detector grid condenser and leak are no longer used, and are "shorted" out of the circuit.

Connect the detector rheostat in the A minus filament line and connect the grid return as shown in Fig. 3, which arrangement utilizes the negative bias obtained by the drop across the filament rheostat. A definite value of resistance in the detector plate circuit will be found to work best with each value of C bias. In this case a one-megohm leak was found to be right when ninety volts was used with a 201-A type tube.

This arrangement was found to be practically as sensitive as the usual circuit having a grid leak and condenser, and at the same time had

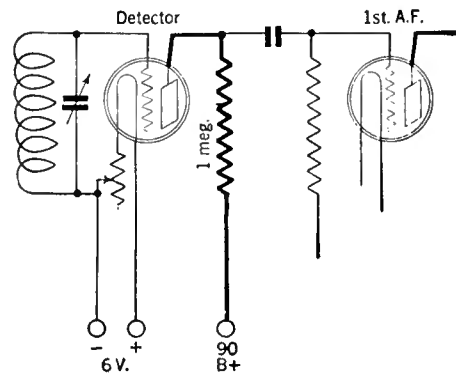
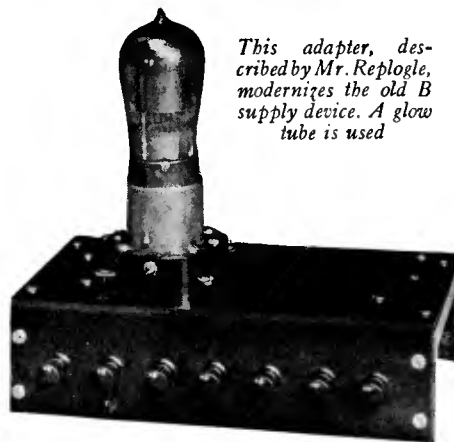

FIG. 3

A useful circuit for plate detection



This adapter, described by Mr. Replogle, modernizes the old B supply device. A glow tube is used

the selectivity and tone qualities gained by employing plate detection.

KARL V. NYQUIST,  
Stromsbing, Nebraska.

STAFF COMMENT

DETECTING on the lower bend of the plate-current grid potential characteristic curve, like most justifiable variations from an average procedure, is characterized both by advantages and disadvantages. The possibility of distortion due to overloading of the detector circuit is reduced in the so-called plate method of

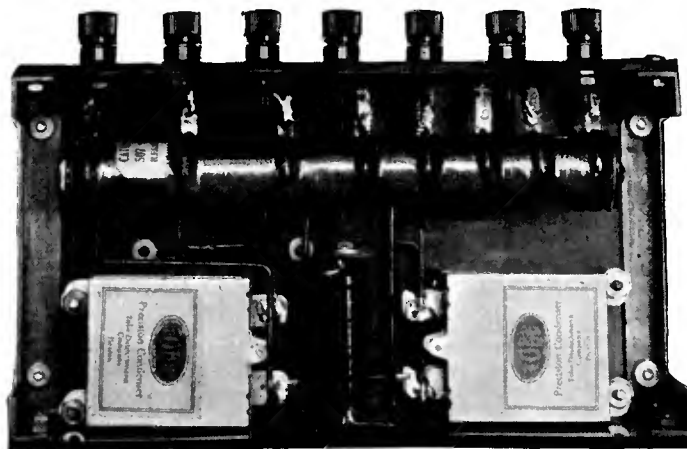

AN UNDER VIEW OF THE DEVICE DESCRIBED BY MR. REPLOGLE

detection. The sensitivity of the detecting circuit is, however, generally lessened. In the case under consideration, the loss in signal strength is probably negligible due to the fact that the relatively low plate potential is secured by increasing the resistance in the plate circuit of the detector tube to approximately ten times the value employed in the grid current detecting system. Increasing the value of the external plate resistor in a resistance-coupled amplifier, while still maintaining the applied plate voltage at an optimum value for detection, increases the input to the amplifier, which in this instance, partially compensates the loss in detecting efficiency.

Adjusting Cone Loud Speakers

FOR THE proper adjustment of a cone loud speaker, it is essential that the pin be exactly centered in the collar at the apex. It often happens that in the rough handling of transportation the movement of the loud speaker is shifted slightly from dead center with the result that there is a strong tension on the pin. This limits the amount of power the loud

speaker can handle without distortion. The correct adjustment can be easily made with the aid of such simple apparatus as is generally found in the radio equipped home.

A 110-volt lamp of indiscriminate wattage, a house current plug, and a 1000-ohm resistor are required to make the adjustment. This apparatus is placed in series with 110 volts a. c. and the loud speaker. The set screw on the loud speaker collar is loosened and the circuit shown in Fig. 4 is closed. A 120-cycle hum will be distinctly heard in the loud speaker. The screws holding the frame should be loosened slightly and the actuating mechanism moved from side to side and up and down until the sound is at a minimum. With the set screw loosened the loud speaker will rattle freely at this adjustment. The current is turned off and the set screw is tightened down upon the pin.

HARRY WIRTH,  
New York City.

Selectivity with A. C. Tubes

HAVING had occasion to alter a half dozen or so battery receivers for a. c. operation, with both the R. C. A. and Arcturus types of tube, I have noticed that the selectivity of the battery receiver has been, in every case, noticeably superior to that of the rewired job. In the course of my experiments, however, I found that the selectivity of the a. c. set could be improved until it was quite on a par with the original 201-A job, by increasing the negative bias on the r. f. tubes.

WALTER BENNETT,  
New York City.

STAFF COMMENT

WITH coils designed for tubes having the characteristics of the 201-A type tube, the substitution of alternating-current tubes of a lower input impedance will necessarily result in the loss of selectivity, generally accompanied with an increase in sensitivity. These effects can be compensated, as suggested by Mr. Bennett,

by increasing the grid bias applied to the radio-frequency tubes. It will be found that, at the point at which the selectivity is equal to that of the d. c. set, the sensitivity will also have been readjusted to the same degree characterizing the original battery receiver.

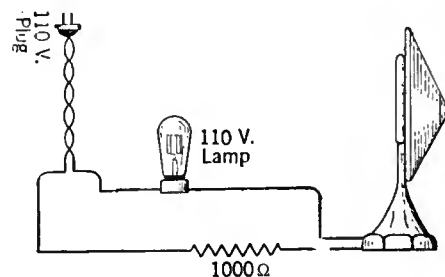

FIG. 4

A simple arrangement for the adjusting of cone loud speakers. Unless properly adjusted, the cone loud speaker will not give its maximum undistorted volume



# New Apparatus

## Complete A. C. Push-Pull Amplifier

X22

Device: Samson Power Audio Amplifier, Types PAM-16 and PAM-17 for use with radio receivers or phonograph pick-ups. Both types are exactly the same except that the type PAM-17 is equipped to supply 40 milliamperes at 120 volts to the field winding of a Magnavox, or similar dynamic type loud speaker. The amplifier is a two-stage transformer-coupled unit and consists of an input transformer followed by a

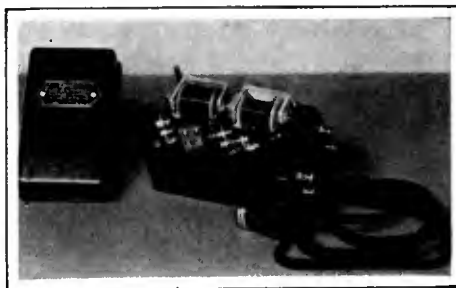

YAXLEY'S POWER CONTROL

Manufactured by the SAMSON ELECTRIC MANUFACTURING COMPANY. Price: \$125.00.

Application: This amplifier can be connected to the output of the detector tube in a radio receiver, being used therefore instead of the amplifier in the set, or it may be used in conjunction with a phonograph pick-up to reproduce phonograph records. At a recent R. M. A. meeting, Mr. Cotton of the Samson Company demonstrated the amplifier to two of the staff of RADIO BROADCAST Laboratory and the reproduction from phonograph records was excellent. There was absolutely no hum audible in the Western Electric 540 AW cone used. The unit is beautifully finished and is very well arranged mechanically and electrically. Complete data, blue prints, etc., are available from the Samson Company.

## A Complete A. C. Adapter Unit

X21

Device: Marathon A. C. Harness equipment. Consists of a cable conductor, a transformer, supplying the correct voltage for Marathon tubes, type AC 608, and a volume control. The Marathon a. c. tube is of the heater type and is rated at 6 volts and 1 ampere. Manufactured by the Northern Manufacturing Company. Price: \$30.00 (5 or 6-tube kit); seven and eight-tube units available.

Application: In order to make the conversion of a d. c. set to a. c. operation a simple matter using Marathon tubes, this company is supplying the accessory apparatus (transformer, cable, and volume control) required. It should be understood that this apparatus is made especially for use with Marathon tubes; the transformer voltage is incorrect for other types of a. c. tubes. The Marathon a. c. tube is equipped with two

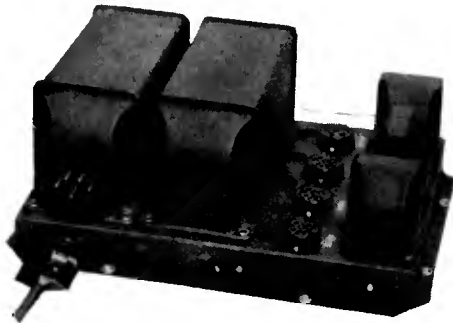

SAMSON PHONOGRAPH OR RADIO AMPLIFIER

type 227 a. c. tube which in turn feeds into the primary of a push-pull transformer. Two 210 type tubes are used in the push-pull stage. The filaments of the 210 type tubes are operated on a. c. and plate power for them is obtained from a rectifier-filter system using a type 281 tube. As indicated in the circuit diagram one of the input leads is shielded. This lead connects the input of the amplifier to the output of the detector in the radio receiver (or output of a phonograph pickup if one is used). Electrically the device has been arranged to conform with the underwriters' specifications, all the wiring being entirely enclosed. The terminals of the audio transformers project down through the base of the transformers into the sub-base, and are therefore unexposed.

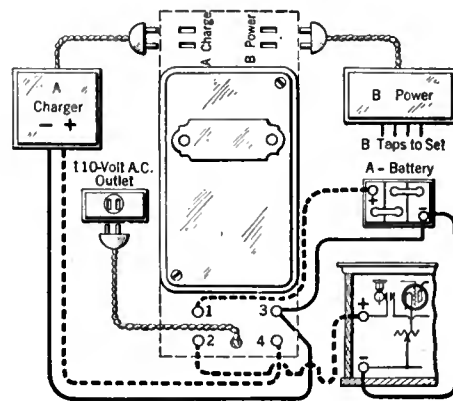

HOW TO USE THE YAXLEY POWER CONTROL



THE MARATHON A. C. KIT

## At Last—Automatic Power Control

X23

Device: Yaxley Full Automatic Power Control. For the automatic control of the power units used with a radio receiver. Manufactured by YAXLEY MANUFACTURING COMPANY. Price: \$7.50.

Application: This device, designed automatically to control a receiver installation operated from a B supply and a trickle-charger storage battery combination, functions (a) to turn on the B power unit when the set is turned off, (b) turn off the trickle charger and turn on the B power unit when the set is turned on and, (c) cut out the trickle charger when the battery is fully charged. All of

extra terminals on the side of the tube base and the filament transformer terminals need merely be connected to these convenient terminals using the harness supplied for the purpose in this kit, and the tubes plugged into the regular sockets in the receiver. No adapters are required. This is a distinct advantage when space is limited for these tubes, when installed, will project no higher than the storage battery type tubes used formerly in the set. When 226 and 227 type tubes are used with the necessary adapters the overall height of the tube and adapter is greater than that of a storage battery tube and this fact will, in some a. c. conversion jobs, give some difficulty and necessitate rearrangement of some apparatus.

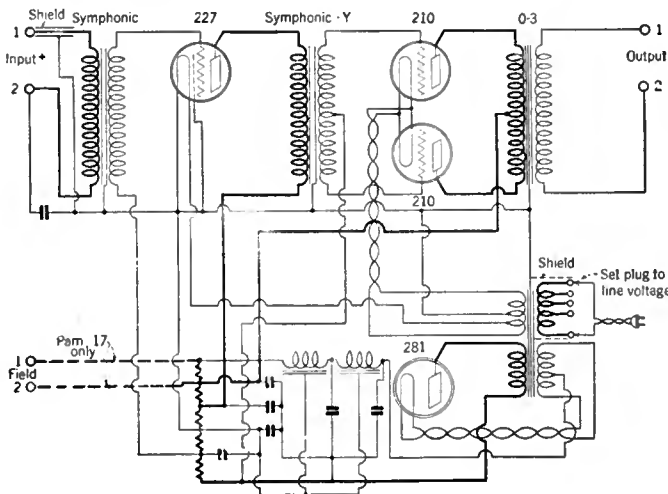

CIRCUIT OF SAMSON AMPLIFIER

this is accomplished automatically by merely turning the filament switch on the receiver off and on. It is evident from the description above that the functioning of this device differs from that of an ordinary power control device in that a relay in this unit is adjusted to cut out the trickle charger when the battery is fully charged so that there is no possibility of overcharging the battery. The device will function with sets having any number of tubes.

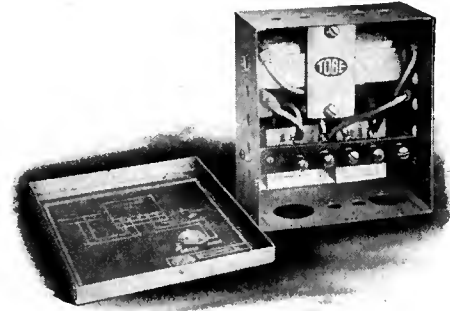

TOBE'S INTERFERENCE FILTER

### Heavy-Duty Interference Filter

X24

*Device:* Interference Filter No. 2. Consists of a combination of filter choke coils and filter condensers, all assembled in a single case. Manufactured by the TOBE DEUTSCHMANN COMPANY. *Price:* \$15.00.

*Application:* This filter is designed for use in conjunction with small motors and other devices which are acting as sources of radio interference. This filter may be used with motors rated up to 5 horsepower; for smaller motors, interference filter No. 1 may be used. The filter is connected in series with the power line, close to the piece of apparatus producing the interference. The Tobe Deutschmann Company will supply any special filter that may be necessary for unusual cases.

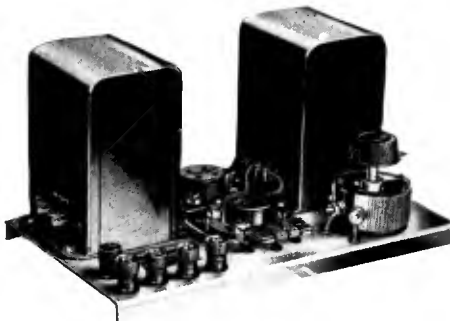

GENERAL RADIO PUSH-PULL AMPLIFIER

### A. C. or D. C. Push-Pull Amplifier Complete

X25

*Device:* Push-pull Power Amplifier Type 441. The filament wiring is arranged so that the filaments may be lighted from either a. c. or d. c. The input impedance of this amplifier is 30 henries and the turns ratio of the input transformer to the entire secondary is 4.5. The output transformer has a step-down ratio in voltage of 3.5 to 1, to adapt the tube to the loud speaker impedance. This gives a good ratio for 112 and 226 type tubes. If 171 type tubes are used it will be better to connect the loud speaker between one plate terminal and the B Plus terminal of

the output transformer. Completely assembled. Manufactured by the GENERAL RADIO COMPANY. *Price:* \$20.00.

*Application:* For use as a last stage amplifier in conjunction with any standard receiver. Any type of tube may be used in the amplifier, the choice depending on the amount of voltage available for driving the unit and upon the amount of power output that is desired. This push-pull amplifier might be used with 112 or 120 type tubes where moderate amounts of power are desired and with 171 type tubes when greater power is required. An amplifier of this type, in use in RADIO BROADCAST Laboratory for some time, has been giving very satisfactory results.

### Volume Control Unit

X26

*Device:* Table Type Clarostat. Consists of a Clarostat variable resistance, mounted in a small metal case, and supplied with extension cords so that it may easily be connected between the receiver and the loud speaker. Manufactured by the AMERICAN MECHANICAL LABORATORIES. *Price:* \$2.50.

*Application:* A convenient accessory, readily attached to any radio receiver, to control the volume of signal from the loud speaker. And as the advertisements say, it will control the volume from a "whisper to a roar."

Although the device is primarily intended for use as a volume control in the loud speaker circuit, there is no reason why it can't be put to any of the other uses for which a Clarostat is suited, such as controlling oscillations in the r. f. amplifier, by connecting it in series with the B+ lead to the radio frequency tubes. This device might also be used as a volume control when connected in parallel across the antenna and ground of a receiving set installation.

### Filament Transformer for A. C. Tubes

X27

*Device:* A. C. Filament Lighting Transformer Model T-1. Supplies following voltages:

1½ volts—Capacity for seven type 226 tubes

2½ volts—Capacity for four type 227 tubes

5 volts—Capacity for two type 112 or 171 tubes

The transformer is arranged with a flexible lead to be plugged into one of three possible jacks which permit the transformer to be operated on line voltage from 80 to 125 volts. Condensers and center-topped resistors necessary for a. c. tubes contained in transformer case. Manufacturer: HAROLD J. POWER, INC. *Price:* \$10.00.

*Application:* May be used to supply filament current to a. c. tubes in a radio receiver. The flexible lead by which different line voltages can be compensated is an excellent feature for a. c. tubes, especially the 227 heater type, which have a very short life if supplied with excessive filament voltage. Wiring diagrams of various standard receivers revised for a. c. operation may be obtained by writing the manufacturers of this device.

### Drum Dial and Adjustable Gang Condenser

X28

*Device:* Gang Condenser and Drum Dial. The apparatus contains the following features:

1. All of the condensers are mounted on a single shaft and the condensers may be adjusted to any desired spacing between them by merely loosening two set screws and slid-

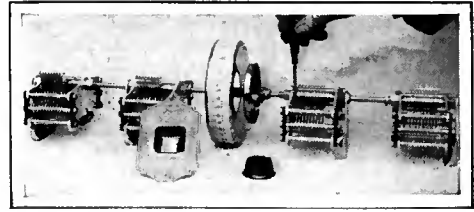

PRECISE DIAL AND GANG CONDENSER

ing the condenser along the shaft to the desired position.

2. Each condenser is equipped with an adjustment for slightly altering its capacity, so that accurate tuning of each circuit in a single-control set can be accomplished. The photograph illustrates such an adjustment being made, a procedure which is only necessary when the set is placed in operation for the first time.

3. The spacing between the condenser plates is quite large so that the capacity of the condenser will not be affected to any considerable extent by variation in the thickness of the plates.

4. Any number of condensers may be used in the assembly. Each condenser has a capacity of 0.00035 mfd. The drum dial is equipped for a dial light and reads from 0. to 100, the scale being also approximately calibrated in wavelengths. Manufactured by the PRECISE MANUFACTURING COMPANY. *Price:* (drum dial assembly, \$5.00; variable condensers, 0.00035 mfd., \$6.00). *Application:* May be used in constructing a single-control receiver.

### Loud Speaker

X29

*Device:* Rola Table Type Loud Speaker, Model 20. Finished in hand-rubbed walnut. 11½ inches high, 11¼ inches wide and 6¾ inches deep. Frequency range, according to the manufacturers, is approximately 70 to 5000 cycles. The loud speaker is equipped with a filter to suppress the higher frequencies. The armature of the unit is laminated, evidently to obtain higher efficiency. Manufactured by the ROLA COMPANY. *Price:* \$35.00.

*Application:* This loud speaker may, of course, be used with any standard radio receiver. The manufacturers recommend the speaker especially for use with a. c. sets, because of its "tendency to suppress and minimize the residual hum characteristic of most a. c. sets."



NEW ROLA CONE

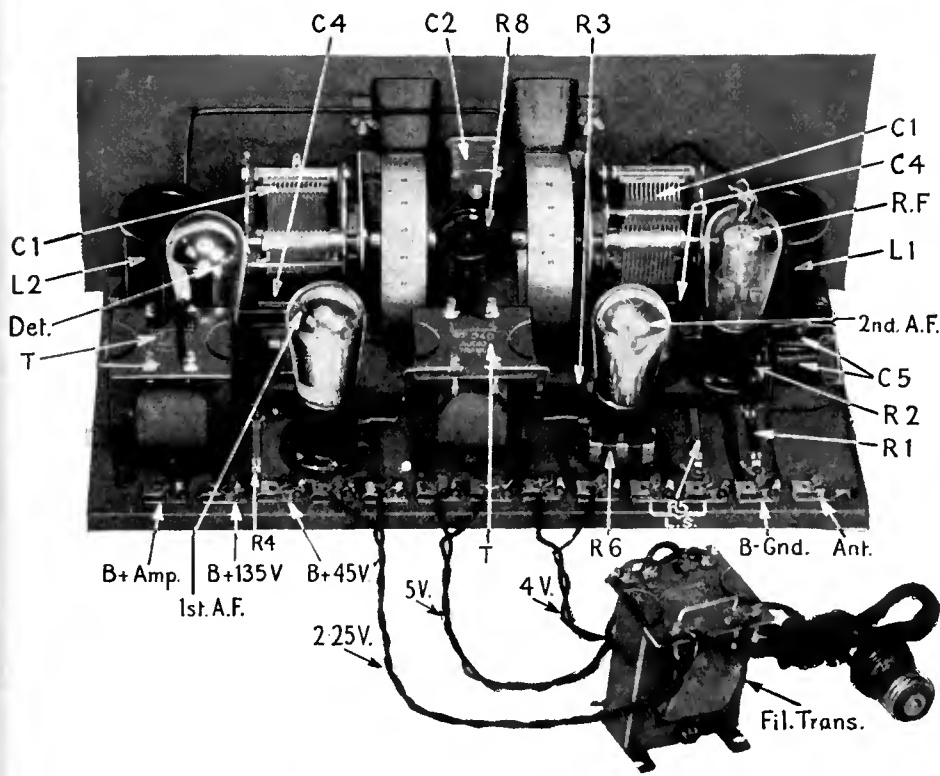

## An A.C. Screen-Grid Receiver

ALTERNATING-current operation of screen-grid tubes has been in the minds of many experimenters, judging from the amount of correspondence received by RADIO BROADCAST, and by the number of visitors to the Laboratory who have broached this subject. The receiver described here is the first that has come into the Laboratory which shows how this may be accomplished. After all the speculation regarding the possibilities of a. c. operation of this new tube, the trick of how to do it seems to be no trick at all; all one needs is a source of a. c. voltage of the proper value—3.3 volts.

The receiver, originally designed for d. c.

operation, was described in the March RADIO BROADCAST. It covers, with plug-in coils, all frequencies between 100 and 10,000 kc., and consists simply of a stage of radio-frequency amplification using the screen grid-tube, a regenerative detector, and two stages of audio-frequency amplification, transformer-coupled. All tubes in the present adaptation of this receiver operate from a. c., the voltage for the screen-grid tube being obtained by connecting in series the 1.5- and the 2.5-volt windings of a standard filament transformer, and then dropping the resultant 4 volts to the proper value, 3.3, by means of a 4-ohm resistance. The output

tube is a 112-A and the detector and first audio amplifier are heater type C-327 or UX-227 tubes. In the proper places in the circuit are bias resistances so that not even C batteries are necessary for the receiver's operation.

In the Laboratory the use of a. c. on the screen-grid tube's filament contributed no a. c. hum to the output from the loud speaker. When listening with a pair of phones across the output, the hum which is audible is no greater than that of any two-stage audio amplifier and detector operating entirely from a. c.

The difference in circuit between the original d. c. receiver and the present one can be determined by reference to the accompanying diagrams, Figs. 1 and 2. Aside from the a. c. wiring, and the addition of C bias resistors in their proper places, another change is that the grid leak is placed across the grid condenser instead of from grid to plus filament. This is because the heater type of tube has no filament proper, and all grid and plate returns are connected to the fifth or cathode post of the tube.

Reference to the diagram of the a. c. model, Fig. 2, shows the following resistances which are not in the d. c. set: R<sub>1</sub>, 1500 ohms, to furnish C bias for the screen-grid tube; R<sub>2</sub>, 64 ohms, center-tapped, across the filament of this tube, the center point connecting to ground through the bias resistance; R<sub>3</sub>, 4 ohms, to drop the output voltage of the transformer to 3.3 volts for the filament of the screen-grid tube; R<sub>4</sub>, 1500 ohms, in the grid return lead of the first audio tube to supply C bias to this tube; R<sub>5</sub>, 2000 ohms, to furnish C bias to the last tube; and R<sub>6</sub>, another 64-ohm center-tapped resistance for the last tube, the center connecting through the bias resistance to ground. There are also two 0.1-mfd. condensers across the center-tapped and bias resistances on the screen-grid tube to act as radio-frequency bypasses, and there is a 500,000-ohm potentiometer across the secondary of the first audio transformer to act as a volume control. A 1-mfd. condenser across the C bias resistor of the final tube is optional. Its inclusion will provide better bass note reproduction. Naturally, ux sockets must be used in place of standard sockets, for the two heater type tubes now used in the detector and first audio stages. Otherwise the present receiver is exactly like the one described in March. It covers the same frequency ranges,

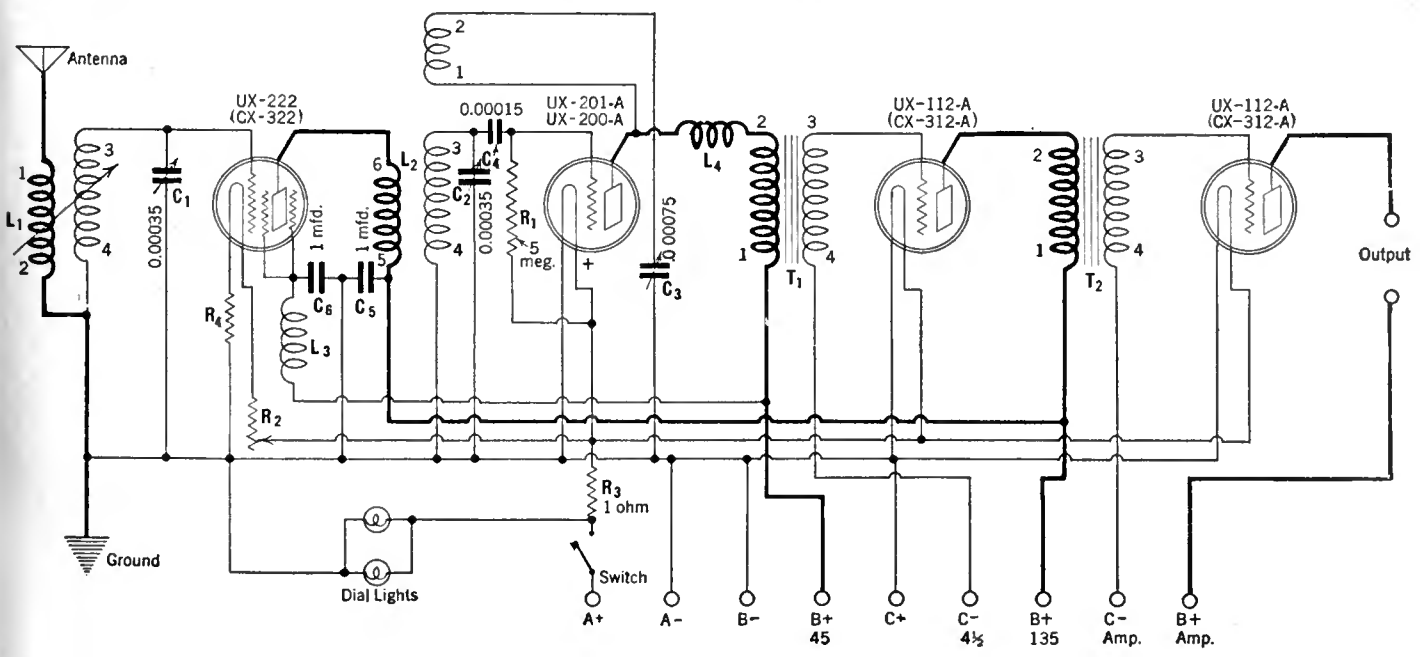

FIG. 1

A schematic diagram of the four-tube receiver as originally designed for d.c. operation

uses the same parts, is laid out on the panel and baseboard similarly, and its operation differs not at all.

As stated before, to get 3.3 volts for the first tube's filament it is necessary to connect in series the 2.5-volt and the 1.5-volt windings of the standard filament transformer. If these windings are not connected together properly, the screen-grid tube will not light. No harm can be done, however, by such a connection, and, therefore, the builder can easily determine which connection is proper.

The voltage on the filament of the screen-grid tube is not critical as to hum; the variation in voltages occurring in practice, due to line fluctuations etc., are not great enough to cause hum.

While the arrangement used for the operation of the 222 tube in the four-tube set has not been tried with two or three r. f. stages yet, there appears no reason why it should not function satisfactorily, and the application of a. c. operation to two- and three-stage screen-grid r. f. amplifiers should prove a most fertile field of experiment.

The parts used for constructing the four-tube a. c. screen-grid receiver are listed below. While the parts specified are recommended, the experimenter may substitute other makes of parts electrically equivalent with safety:

L <sub>1</sub> —S-M 111A Antenna Coil.....	\$ 2.50
L <sub>2</sub> —S-M 114SG R. F. Coil.....	2.50
Two S-M 515 Universal Interchangeable Coil Sockets.....	2.00
L <sub>3</sub> —Two S-M 275 R. F. Chokes.....	1.80
T—Two S-M 240 Audio Transformers.....	12.00
C <sub>1</sub> —Two S-M 320 0.00035-Mfd. Variable Condensers.....	6.50
C <sub>2</sub> —S-M 342 0.000075-Mfd. Midget Condenser.....	1.50
C <sub>3</sub> —Sangamo 0.00015-Mfd. Condenser with Leak Clips.....	.50
C <sub>4</sub> —Two Fast 1-Mfd. Condensers.....	1.80
C <sub>5</sub> —Two Sprague 0.1-Mfd. Bypass Condensers.....	1.70
R <sub>1</sub> , R <sub>4</sub> —Yaxley 1500-Ohm Grid Resistors.....	1.00
R <sub>2</sub> , R <sub>6</sub> —Two Frost FT64 Balancing Resistors.....	1.00
R <sub>3</sub> —Carter 4-Ohm Resistor.....	.25

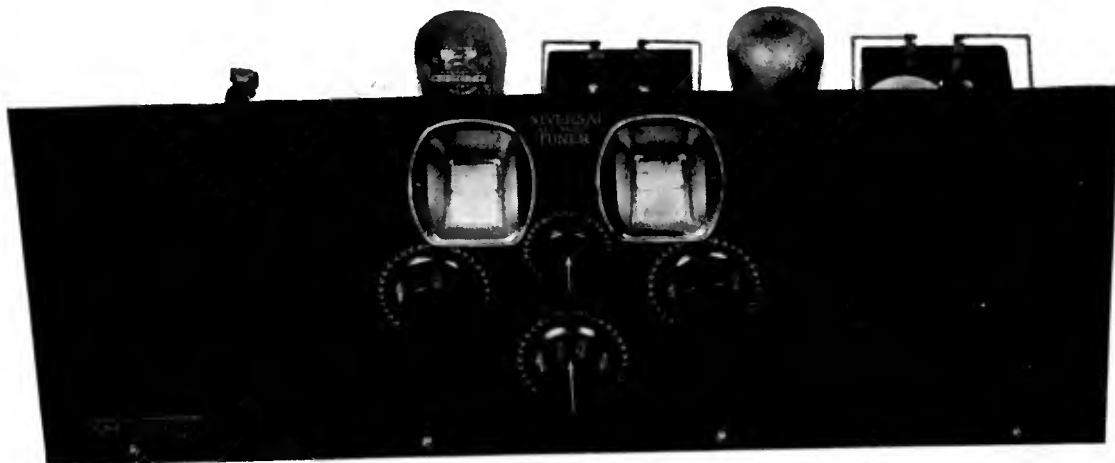

THE CONTROLS ARE GROUPED CLOSELY TOGETHER ON THE FRONT PANEL

R <sub>5</sub> —Yaxley 2000-Ohm Grid Resistor....	.50
R <sub>7</sub> —Durham 5-Megohm Grid Leak....	.25
R <sub>8</sub> —Carter 500,000-Ohm Volume Control Potentiometer.....	2.00
Thirteen Fahnestock Connection Clips.....	.65
Two S-M 511 Tube Sockets.....	1.00
Two S-M 512 Tube Sockets.....	1.50
Two S-M 805 Vernier Drum Dials....	6.00
7x17x $\frac{1}{2}$ " Wood Baseboard, with Hardware.....	1.50
1 Van Doorn 7x18" Decorated Metal Panel.....	3.00

AND THE FOLLOWING ACCESSORIES

UX-112-A (CX-312-A) Power Tube
UX-222 (CX-322) Screened Grid Tube
Two UX-227 (C-327) Heater Tubes
Cone Loud Speaker
Filament-Lighting Transformer with 1 $\frac{1}{2}$ -, 2 $\frac{1}{2}$ - and 5-Volt Secondaries, such as the S-M 247 Illustrated.
Three 45-Volt Heavy-Duty B Batteries, or Any Standard Socket Power Unit Capable of Accurate Voltage Adjustment.

The coils listed above are suitable to cover the broadcasting frequencies. Other coils from the same manufacturer make the receiver truly universal insofar as wavelength range is concerned.

To hook this set up, it is simply necessary to connect the B batteries (or the socket power supply), loud speaker, antenna and ground, to the clips marked in the illustration, and to insert the tubes. The filament transformer must be

connected to its appropriate clips by means of carefully twisted wires. Preferably, it should be situated a foot or so from the audio transformers in the receiver.

The receiver operates exactly as any other set of its type, the two station selector dials serving to tune-in the different stations in the broadcast band of 200 to 550 meters, the midget regeneration condenser controlling sensitivity (regenerative amplification) and the volume knob controlling loud speaker volume. No "On-Off" switch has been provided in the set for it is assumed that the socket-power unit or filament transformer used will be provided with a switch either in the instrument itself, or in the connecting cord, or if in neither, the set may easily be turned on or off at the lamp socket to which the power unit supply cord is attached. Using the standard 111-A and 114-SG coils the set tunes from 200 to 550 meters, while by dropping the r. f. stage and connecting the antenna to point 3 of the detector coil socket through a small 0.000025-mfd. midget condenser the set will cover the shorter wavelength ranges from 30 to 75 meters with 114-C coil, or 70 to 210 meters with a 114-B coil. Waves above 550 meters may be received with a 111-D and 114-D coils (500 to 1500 meters) or a 111-E and 114-E coil (1400 to 3000 meters). Although there are no American broadcasting stations operating above 550 meters there is great sport for those who know the code on these lower frequency bands: Ships at sea, compass stations, air-mail stations, time signals, and navy vessels—all have wavelengths covered by this receiver. It will be necessary to shunt the regeneration condenser with a fixed capacity of 0.0001-mfd. to get good oscillation control when the D and E range coils are used.

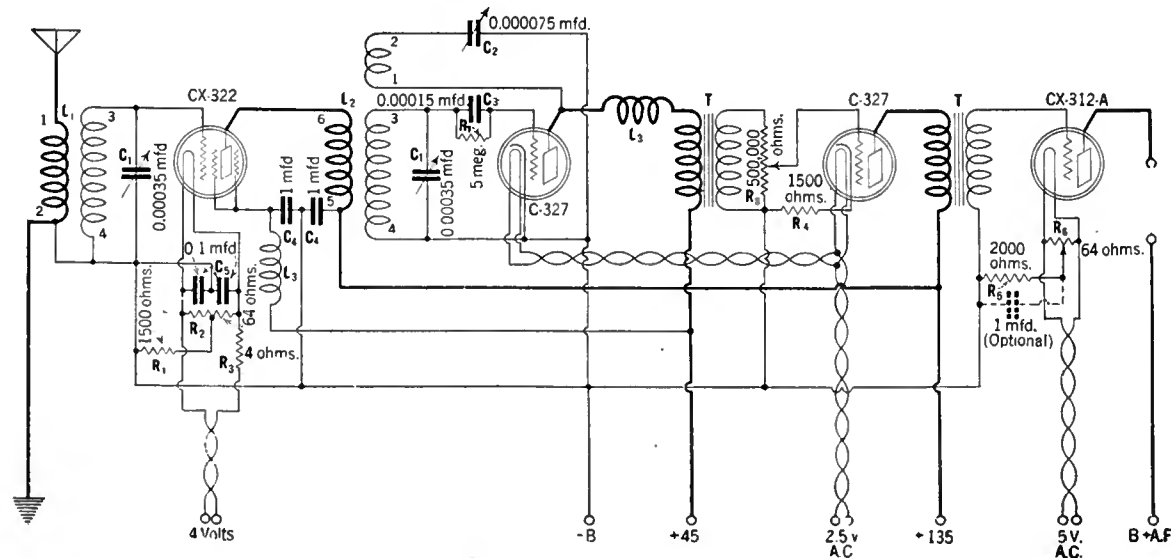

FIG. 2  
Circuit diagram of the a. c. screen grid receiver

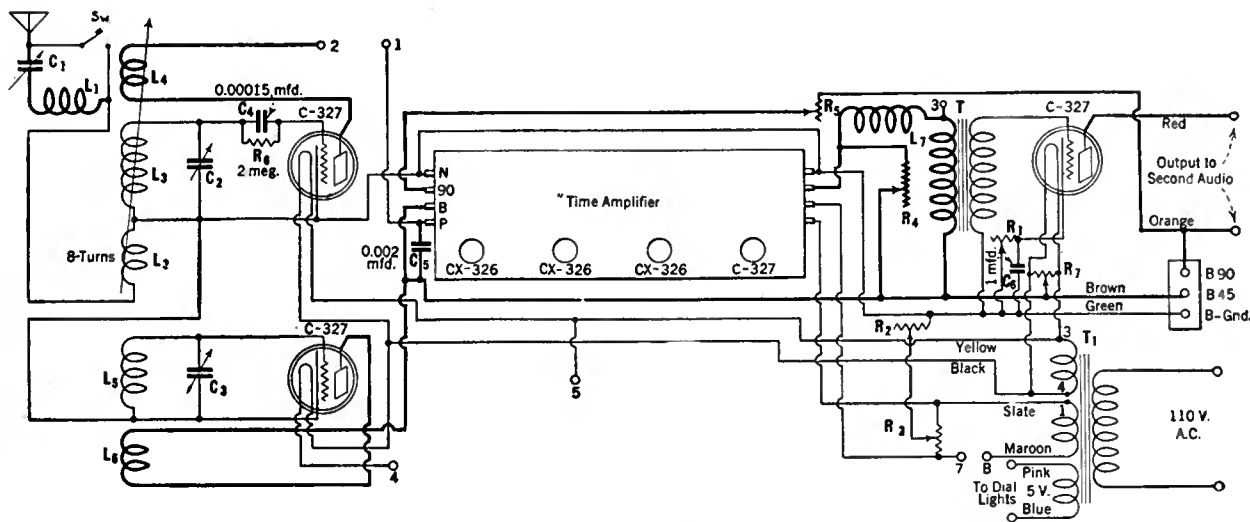

FIG. 1

Switching provides for the use of this circuit either as a super-heterodyne or as a single-circuit receiver

## A Flexible A.C. Super-Heterodyne

By Dana Adams

**T**HE receiver described in this article has several unique points of interest which distinguish it from the commonplace. In the first case, it is a.c. operated, a feature which is becoming more and more popular. The most interesting feature of the receiver, however, is the fact that, by the mere flip of a switch, the degree of selectivity and sensitivity of the system may be augmented or decreased, depending upon the requirements of the operator and his geographical location with respect to the station he wishes to hear. The circuit, in its most sensitive form, is a super-heterodyne employing a three-stage intermediate-frequency amplifier. The switching, which controls the selectivity and sensitivity, provides for three circuit arrangements as follows:

1st Position: The receiver is converted into a single-circuit receiver with one tuning control and one volume control, the output of the detector tube inputting directly to the audio amplifier.

2nd Position: Same as 1st Position with the exception that a series condenser in the antenna circuit is switched in by means of a Yaxley No. 10 antenna switch, thus adding a further tuning control, but at the same time improving sensitivity.

3rd Position: The complete super-heterodyne receiver is thrown into operation, a third main tuning control being added. The antenna tuning condenser need not necessarily be switched into circuit in this case.

The switch used for switching from single-circuit receiver to super-heterodyne receiver is a Yaxley No. 63 triple-pole switch. In Fig. 1 (the complete circuit diagram up to the output of a single-stage audio amplifier), various connections to this switch are indicated by number but are not grouped. The numbers for the switch terminals are determined by counting from right to left from a rear view of the switch.

Fig. 1 shows a coil and the condenser in series with the antenna. Variation of this condenser tunes the antenna to any desired frequency in the same manner that the grid circuit of a tube is tuned, with a consequent increase in signal strength. At the same time, the strength of sig-

nals flowing in the antenna circuit at other than the resonant frequency is reduced, following the law of all series-tuned circuits. Laboratory measurements show this gain at the resonant frequency to be equal to that of one radio-frequency stage. Coupling to the detector circuit is obtained through a small variable coil,  $L_2$ , which is a part of the Samson No. 31 coupler (which comprises  $L_2$ ,  $L_3$ , and  $L_4$ ). This coupling coil, particularly when the antenna tuning is used, is generally set very near the minimum coupling point, with a consequent increase in selectivity.

Having made the antenna circuit and the coupling method as efficient as possible we turn next to the first detector. This tube is regenerative with the sensitive grid leak and condenser method of detection and at this point the circuit departs from the ordinary. The Yaxley No. 63 triple-pole switch is used here to cut out the oscillator and intermediate stages of the receiver, at the same time transferring the first detector plate lead from the intermediate amplifier input to that of the audio amplifier. The result is a highly efficient regenerative receiver with an

audio amplifier. The middle dial may be used alone in tuning-in the local programs with the antenna coupling acting as a volume control. If additional efficiency is required, a flip of the antenna switch makes the antenna tuning feature immediately available.

A change of position of the three-pole switch returns the detector plate to its normal connection in the super-heterodyne circuit, at the same time lighting the oscillator and intermediate-amplifier tubes, which gives us a two- or three-dial super-heterodyne receiver. Instead of the ordinary coupling coil method of introducing the heterodyne frequency to the detector grid circuit this is done by placing the oscillator coil itself in inductive relation to the detector coil. This eliminates the losses of signal strength frequently caused by a tightly coupled coil which is, in most cases, at ground potential. The oscillator circuit is thus made entirely independent of the receiver except for its power supply. The oscillator circuit is the familiar modified Hartley circuit, grounded rotor plates preventing any hand-capacity while tuning.

The beat note set up by the oscillator and first

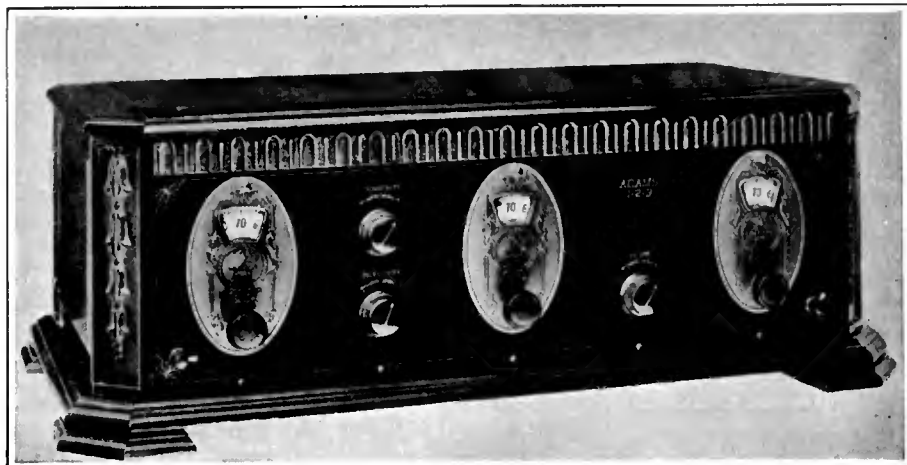

A FRONT VIEW OF THE COMPLETE RECEIVER



detector is impressed on the first intermediate-frequency amplifier tube grid. The reader will no doubt recognize the intermediate amplifier as the well-known Silver-Marshall "Jeweller's Time-Signal Amplifier" unit. The high amplification, the sharp cut off of its accurately tuned air-core transformers, and the consistently excellent results obtained with a considerable number of these units, are the reasons for its selection for this receiver.

After the second detector, the audio component of the signal is amplified by one stage of audio amplification. A choke coil together with the bypass condenser included in the amplifier, combine in bypassing the radio-frequency component of the signal to ground, thereby keeping it out of the audio amplifier. The output of this stage is fed to the second audio stage, which has been omitted in the circuit diagram.

To combine the various ideas described above in a receiver employing battery-operated tubes is an easy matter. Fig. 2 shows such an arrangement. True electric operation, however, is convenient and obtained in simplest, cheapest, and least troublesome form with the tubes lighted from an alternating-current source of supply. Tube life when a.c. tubes are used is an important consideration. The writer's experience indicates that excessive filament voltage is the cause of complaints of short life of the a. c. tubes. An almost total lack of measuring instruments is responsible for this condition which time and an increase in knowledge will undoubtedly correct. As all tubes in this receiver are worked at a point well under the rated voltage, uniform and highly satisfactory results are to be expected, the voltage adjustments being extremely easy to make.

#### GENERAL CONSIDERATIONS

THE omission of a number of details from the review of the receiver, while enabling the reader to obtain a clearer idea of the main features, has no doubt set up a number of questions. The numbers for the switch terminals are determined by counting from right to left from a rear view, as explained previously. The first detector and oscillator circuits may be easily traced with this information at hand. These tubes in these two circuits are of the cathode type in order that the beat note, tremendously amplified in the intermediate stages, will be absolutely free from hum. The CX-326 (UX-226) type tube is used in the three intermediate stages, the 20-ohm potentiometer,  $R_3$ , across the filament circuit, providing a mid-tap

for the grid returns. The 1000-ohm potentiometer,  $R_2$ , biases the grids of these tubes to prevent oscillation and hum, the usual method of running the grids positive being impossible where alternating current is employed. The method of securing the bias voltage will be recognized as that used in biasing the last audio stage in the modern power amplifier. A 50,000-ohm variable resistor,  $R_4$ , is shunted across the primary of the audio transformer in order to provide an additional means of reducing the volume when the super-heterodyne is employed. The remaining resistor, the 3000-ohm potentiometer,  $R_1$ , provides a common bias voltage for the second detector and first audio stages.

The adapter which is necessary in order that the cathode type tube may be employed in the standard socket in the "Time-Signal Amplifier" is omitted from the diagram for the sake of simplicity. It is referred to in the list of parts. A detailed account of this device will be found later, in the wiring instructions. The various colored leads, ten in number, noted in the diagram, are provided in a single Jones ten-wire cable. This enables the user to disconnect the power from the receiver in a second or so. A Silver-Marshall filament transformer is used to supply the two filament voltages for the a. c. tubes and the voltage for the dial lights. Three of the cable wires provide B voltage to the receiver while a fourth connects the plate of the first audio tube to the primary of the second transformer.

#### ASSEMBLY

WITH a grasp of the main facts and an idea of the principles employed, the construction of this receiver becomes an extremely simple matter. The first step is that of assembly. All of the apparatus, with the exception of the "Time Amplifier," is put in the positions noted in Fig. 3. The pointers listed below have been gathered from the experiences of a number of builders, and if followed carefully, will insure perfect results.

After mounting the panels and dials the first point to be noted in the assembly is the method of mounting the condensers. The slotted bars provided with the dials are removed and a one-inch machine screw is slipped into the slot in the dial frame. The three collars or bushings furnished with each dial are slipped over the screws. The condensers are then held in the position shown in the photograph and the screws are threaded into the holes provided in the condenser frames. An extremely solid mounting is the result. The tube sockets, audio transformer,

switches, bypass condenser, choke-coil, the 50,000-ohm resistor on the panel, and the antenna coil require no special description. The remaining resistors are mounted on the resistor strip which is raised two inches above the baseboard by brackets, in the following order: In No. 1 position place the 3000-ohm potentiometer; No. 2, the 1000-ohm potentiometer; No. 3, the 20-ohm potentiometer; No. 4, the 50,000-ohm resistor.

The double rotor coupler (consisting of  $L_2$ ,  $L_3$ ,  $L_4$ ) used in the first detector circuit to secure variable antenna coupling and regeneration requires altering before mounting. All but eight turns are removed from the antenna coupling rotor,  $L_2$ , which is controlled by the lower of the two knobs. The oscillator coil also requires alteration before mounting. Eight turns are removed from the outside end of the large or grid winding of the coil,  $L_5$ . This is done so that the detector and oscillator control settings will match although tuned 112 kc. apart. The wire removed from this coil should be added to the plate coil,  $L_6$ , at the bottom, insuring sufficient feedback to cause oscillation. This coil is then mounted three eighths of an inch from the coupler, as shown in the photograph, to insure proper coupling.

The wiring of the first detector, audio stage, and oscillator circuits is the next step. A twisted pair from the pink and blue terminals of the cable to each pair of dial light terminals eliminates these from further calculation. From the yellow and black terminals another twisted pair is connected to the contacts of the mid-tap resistor mounted on the filament posts of the audio tube socket. From this point the pair is continued to the detector socket and from there one wire goes to the oscillator tube socket while the other connects to Contact No. 5 on the triple-pole switch. A wire from No. 4 contact on the switch to the remaining filament post completes the wiring of the heater circuits. The remaining wiring to these three tubes may be easily traced from the diagram.

All filament, cathode, and B battery wiring should be formed along the main cable, as shown in the photograph, wherever possible. The leads from the plate of the detector to the switch, from the antenna coil to the coupling coil, and other leads at a high potential from a radio-frequency standpoint, should be formed in a secondary cable close to the panel. Avoid right-angle bends on grid and plate connections; the shorter they are, the better. In wiring the oscillator circuit be sure that the grid and plate connect to the outside ends of their respective coils, or the tube will not oscillate. Pin-jacks may be mounted at the ends of the resistor strip so that a phonograph pick-up or one of the "home-broadcasting" microphones may be employed. One pin-jack should be connected to B minus and the other to the plate terminal of the audio transformer.

The drilling instructions for the resistor strip are shown in Fig. 3. Only two of the three connections on the 1000- and 3000-ohm potentiometers are employed as their function is that of a variable resistor rather than a bridge resistance in this circuit.

The "Time-Signal Amplifier" should be put in position next. The filament wiring should be twisted together and the remaining leads running the length of the receiver should be formed into the main cable. The B minus, plus 45 volt, and plus 90 volt connections should be picked up at the nearest point in the wiring of the other tubes and connected to the proper posts on the amplifier.

The adapter for the second detector tube, referred to previously, is provided with a pair

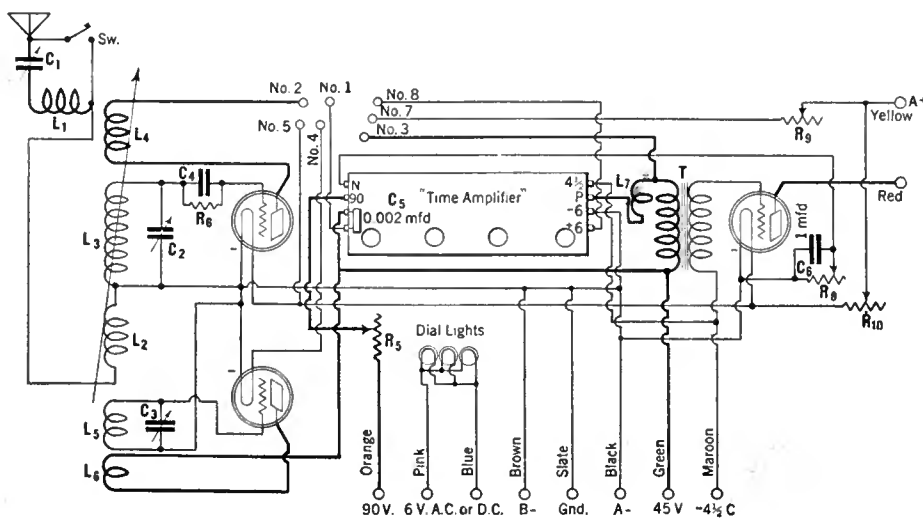
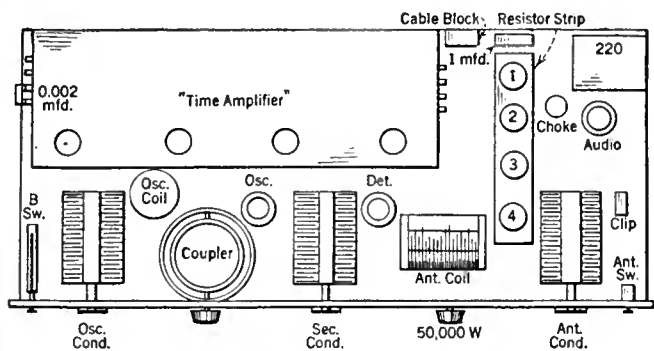
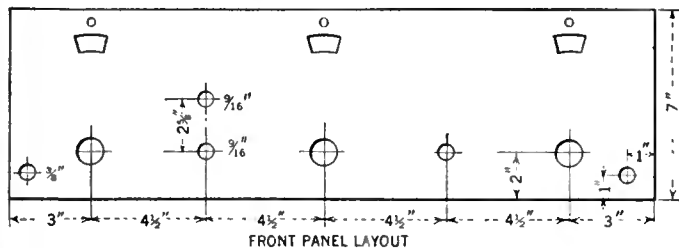

FIG. 2  
Circuit arrangement for battery operation



LAYOUT OF PARTS



FRONT PANEL LAYOUT

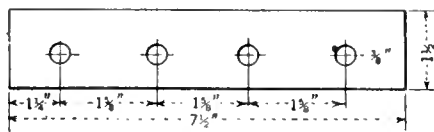

RESISTOR STRIP

FIG. 3

of filament leads, the pins that normally would supply filament power being dummies. These leads are twisted together and connected to the filament terminals of the oscillator tube socket, the detector then turning on or off with the rest of the intermediate tubes. The grid and plate make the normal connections to the circuit through the adapter pins while the cathode is brought to the pin normally used for negative filament. The wire connecting to the corresponding post on the socket inside the can should be unsoldered and a new wire run out of the shield from this post and connected to the cathode post of the audio amplifier tube socket. The removal of this connection, which is merely a connection to the shield, does not disturb the circuit in any way. The bypass shown across the B and P terminals of the amplifier is most important, as well as the radio-frequency choke in the output lead of this amplifier.

The receiver is now ready for test. To do this properly the power unit that is to be used must be at hand. A few suggestions anent this unit will undoubtedly assist those who are not familiar with this adjunct to quality reception. The combination of a full-wave rectifier, a good filter circuit, and a voltage regulator tube provide the best possible B voltage supply. As the unit is also used to secure C bias, its freedom from ripple is important. Naturally a push-pull cx-310 (ux-210) stage represents the last word for a tremendous amount of undistorted output although a cx-371 a (ux-171) stage will be found sufficient in the average home.

The first step in testing is to throw the switch to the single-circuit receiver position. A minute should elapse before the receiver starts functioning. The 3000-ohm resistor should be set at the halfway position. Failure to operate may be readily traced in this simple two-tube set. Hum audible over a foot from the loud speaker indicates either oscillation, in which case the tickler should be adjusted, or an open circuit. A check of the B voltage at the plate and a test for open grid circuits is sure to locate the trouble. The panel resistor should be turned

functioning of the oscillator. A check up on the connection and the continuity of the grid and plate circuits will readily correct any trouble.

The third step in the testing is that of the intermediate amplifier. The 1000-ohm resistor should be set at a quarter turn from the zero bias point, the 15-ohm potentiometer at the midpoint, and the B resistor slightly below the full-voltage position. A turn of the switch and a few moments wait should see the super-heterodyne in operation. A rapid succession of "birdies" when the oscillator is tuned indicates oscillation in the intermediate stages. This is the only trouble that will be encountered if the wiring has been done in the correct manner. It is readily corrected by reducing the filament voltage. An 0.5-ohm rheostat, which should be located at the filament transformer end of the cable, is the remedy. A slight readjustment of the bias and B-voltage resistor will also be of assistance. It should be borne in mind that the amplifier should be adjusted so that maximum amplification is obtained at all times. The input is controlled by the antenna coupling while the resistor across the transformer primary may be used as an auxiliary means of reducing the tremendous volume that may be obtained, to a reasonable level. While the rheostat takes care of the voltage applied to the cx-326 (ux-226) tubes in excellent fashion, care should be taken that the cathode tubes are not run at an excessive voltage.

If the receiver is to be operated from an A battery and is to derive

to the left to obtain greatest volume. After tuning up and down the dial a few times the antenna tuning should be tested by opening the switch. Its effect will be noticed more readily on the weaker stations. The dial setting may be matched within a few divisions of the detector dial by putting a few turns of wire in series with the antenna. This will be necessary only where a short antenna is employed. Up to 150 feet may be used without fear of broad tuning, assuring a stronger signal from distant stations.

The oscillator is tested by tuning-in a station in the middle or lower portion of the wave band and temporarily short-circuiting contacts Nos. 4 and 5 of the switch. After the tube has warmed up the dial should be rotated. A loud heterodyne squeal on the incoming signal indicates the proper

its plate voltage from either batteries or power-supply unit, various changes must be made. Three S-M No. 511 sockets will be required in place of the three No. 512 ones indicated in the list of parts. Two Carter IR-6 6-ohm rheostats, R<sub>9</sub> and R<sub>10</sub>, are also necessary. A Carter M-400-S potentiometer-filament control switch, R<sub>8</sub>, is also wired in the circuit. The list of parts for the a.c. receiver:

LIST OF PARTS

C <sub>1</sub> , C <sub>2</sub> , C <sub>3</sub> —Samson No. 65 0.0005-Mfd. Condensers	\$22.50
L <sub>1</sub> —Samson No. 71 Antenna Coil	2.75
L <sub>2</sub> , L <sub>3</sub> , L <sub>4</sub> —Samson No. 31 Coupler	7.50
L <sub>5</sub> , L <sub>6</sub> —Samson No. 41 Oscillator Coil	2.85
Three Marco No. 421 Illuminated Controls	10.50
S-M No. 440 Time Amplifier (Includes Three Intermediate Stages and 2nd Detector)	35.00
T—S-M No. 220 Audio Transformer	8.00
L <sub>7</sub> —S-M No. 276 Choke Coil	1.00
Three S-M No. 512 Tube Sockets	2.25
Sw—Yaxley No. 10 Antenna Switch	.50
One Yaxley No. 63 Triple-Pole Switch	1.60
R <sub>1</sub> —Carter MW-3000 3000-Ohm Potentiometer	1.25
R <sub>2</sub> —Carter MW-1000 1000-Ohm Potentiometer	1.25
R <sub>3</sub> —Carter MP-20 20-Ohm Potentiometer	.75
R <sub>4</sub> , R <sub>5</sub> —Carter Type L 50,000-Ohm "Hi-Ohm"	4.00
Carter Cathode Tube Adapter	1.10
R <sub>6</sub> —Durham 2-Megohm Leak	.50
R <sub>7</sub> —Frost FT-64 Mid-Tap Resistor	.50
C <sub>4</sub> —Carter 0.00015-Mfd. Grid Condenser, with Clips	.40
C <sub>5</sub> —Carter 0.002-Mfd. Condenser	.50
C <sub>6</sub> —Carter No. 210 1-Mfd. Bypass Condenser	1.25
Jones No. BM 410 Ten-Wire Cable	3.25
Cortlandt Panel 7" x 24" x 3/8" Drilled and Engraved	7.50
Resistor Mounting Strip 1 1/2" x 7 1/2" x 3/8" Drilled	.50
Baseboard 12" x 23" x 1/2", Plywood Preferred	.75
Two Rolls of "Braidite" Wire, Two Colors	.60
One Fahnestock Clip and Assorted Screws	.70
<b>Total</b>	<b>\$118.25</b>

The following additional equipment is partly necessary to operate the receiver. A choice in several instances may be made by the constructor.

Four c-327 Tubes	\$24.00
Three cx-326 Tubes	0.00
T <sub>1</sub> —SM 325 Filament Transformer	8.00
One S-M 660-210 Power Pack or—	83.50
One S-M 660 171 Power Pack	66.50
One Fritts Cabinet 7" x 24" x 12"	23.50

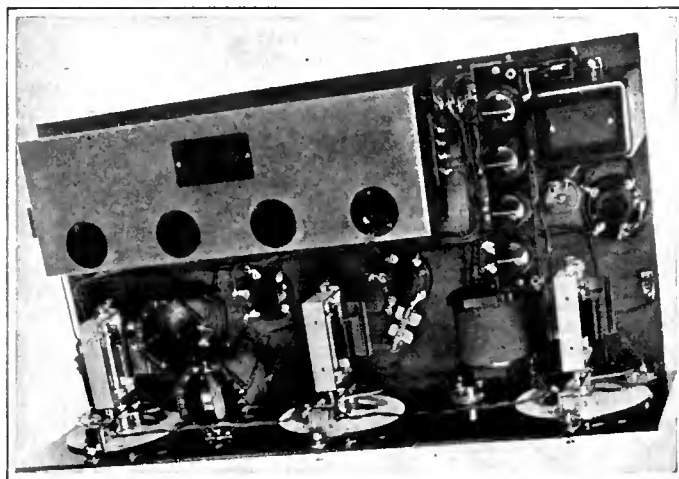

HOW THE PARTS ARE LAID OUT

The coil units to the left comprise L<sub>2</sub>, L<sub>3</sub>, L<sub>4</sub>, L<sub>5</sub>, and L<sub>6</sub>, while L<sub>1</sub> is to the right

# AS THE BROADCASTER SEES IT

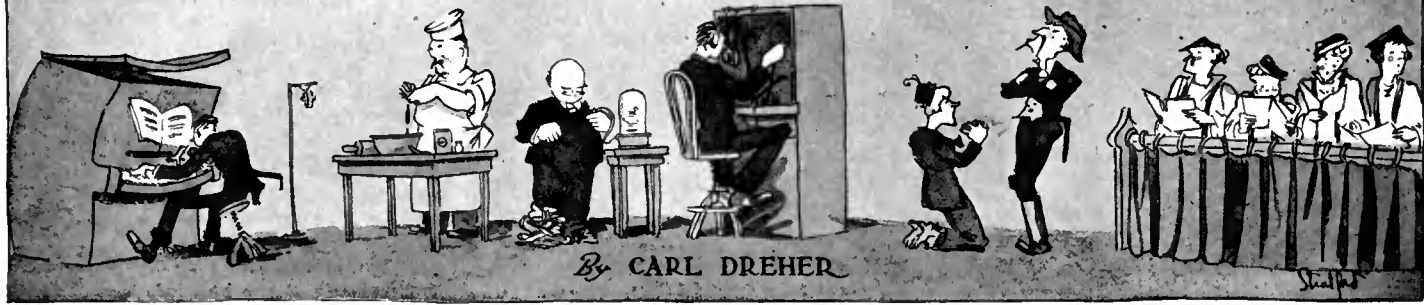

## Design and Operation of Broadcasting Stations

### 19. Frequency Runs

THE various elements of the circuits used in broadcasting exhibit effects which depend, among other factors, on the frequency of the potentials applied to them. A line, for example, tends to attenuate voice currents of high frequency more than currents of lower frequency, because of the shunting effect of the distributed capacity, which varies with the frequency. More specifically, we may say that every piece of apparatus has a definite transmission characteristic with frequency, which it is necessary to know if organizations of apparatus are to be brought about for given objects, for example, impartial or "flat" reproduction of sounds of different pitches. Such a curve of amplitude against frequency is secured by means of a frequency run. In broadcasting the most common frequency runs are made within the audio band, say between 50 and 10,000 cycles per second, and typical circuit

amplitude of  $\frac{1}{2}$ -per cent. is allowable, but the proportion must not be greater. The power output of the oscillator should be reasonably constant over the range of frequency, and it is not difficult to design an oscillator which will meet this requirement within 5 per cent. output voltage variation over a 50 to 10,000-cycle band. The oscillator may be one of several types. One form consists of audio tuned circuits, generally employing fixed condensers and obtaining the frequency variation by means of taps on an iron core coil of suitable inductance. The inductance and capacitance together tune to the audio frequency directly. Another type of audio oscillator utilizes the heterodyne principle. Two radio-frequency oscillators have their outputs combined, rectified, and, if necessary, amplified at audio frequency. Generally one of the component oscillators has its frequency fixed; the other radio frequency is varied, and the beats may be made to cover the whole audible range. Precautions must be taken to avoid too much fre-

tory training in measurements will do better if they buy such instruments as audio oscillators. Such apparatus is sold by the General Radio Company, Graybar Electric Company, and other concerns. Oscillators covering a range of from 10 to 50,000 cycles, or higher, with definitely known output characteristics, are obtainable. One form covers from 15 to 9000 cycles, continuously variable through a single control; the price is a little more than \$200.

Returning now to Fig. 1, we note that the receiving instrument is a "volume indicator" of the vacuum-tube type. The circuits of a typical form are shown in Fig. 2. The action will not be taken up in great detail, as a previous article in this series ("Volume Indicators," RADIO BROADCAST, May, 1927) dealt with the general theory. In the form shown the negative grid bias is adjusted until the d.c. galvanometer in the plate circuit of the tube reads 5 scale divisions out of a total of 60 full-scale. Then the tap on the secondary of the input transformer is set to give peak readings, with modulation, of, say, 30 scale divisions. The level of the circuit across which the instrument is bridged may then be read on a scale attached to the transformer tap switch. High levels, obviously, correspond to settings in which only a small portion of the total transformer voltage is utilized, whereas when the telephonic level is low, more of the winding must be included by means of the tap switch in order to get the requisite galvanometer swing. Obviously the readings of such an instrument are the resultant of many factors, such as the wave form of the alternating currents under measurement, the ballistic characteristics of the galvanometer, the size of the galvanometer shunt, the smoothing characteristics of the inductance-capacitance filter in the plate circuit, the type of vacuum tube employed, and other details, but it is possible to design such level indicators to read in telephonic transmission units with sufficient accuracy for the usual purposes of broadcast transmission or measurement. The prototype is the Western Electric 518-B type, which, in its lowest range, from minus 10 to plus 10 TU, is constructed as shown in Fig. 2, but extends the range of measurable levels to as high as plus 40 TU by the addition of a potentiometer arrangement across the secondary of the input transformer.

Obviously a level indicator must always be a bridging instrument, a circuit element, that is, with a relatively high input impedance, intended for connection across circuits of low impedance without drawing enough energy from the low-impedance circuit to affect conditions therein.

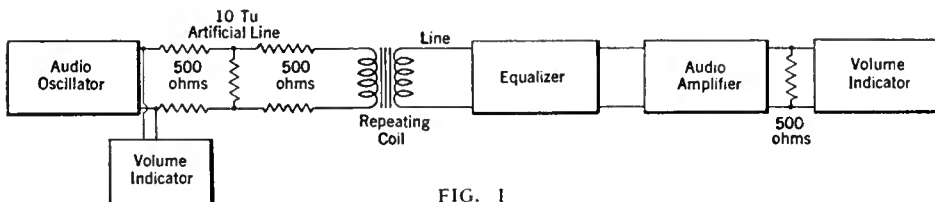

FIG. 1

elements which require this sort of investigation are telephone lines and the audio circuits of transmitters. Representative methods of making such tests will be briefly described in this article.

Fig. 1 is a diagram showing how a frequency run may be made on a wire line, using an audio oscillator at the transmitting end and vacuum-tube voltmeters for the indicating instruments. The audio oscillator in all such work must fulfill several requirements. It must cover the frequency range over which the circuit is to be equalized. For ordinary line work, by present standards, this would be from 100 to 5000 cycles, hence the oscillator of Fig. 1 will have to more than cover this band—a 50 to 6000-cycle oscillator would be suitable. The output must be substantially free from harmonics. Obviously since the instrument is to be used in determining frequency characteristics one must be able to secure oscillations of any frequency in the range without the admixture of other frequencies. If, for example, the behavior of the line is to be studied at 200 cycles, the harmonics (400, 600, 800 . . . cycles) must be suppressed. Usually a harmonic

quency drift, owing to varying voltages, and there is also a tendency for the two radio oscillators to pull into synchronism at the lower beat frequencies. Some information on the construction of audio beat oscillators for laboratory testing is contained in several 1927 papers in the *Proceedings of the Institute of Radio Engineers* (Wolff and Ringel: "Loud Speaker Testing Methods," May, 1927; Dickey: "Notes on the Testing of Audio-Frequency Amplifiers," August, 1927; Diamond and Webb: "Testing of Audio-Frequency Transformers," September, 1927). In general, broadcasters who lack labora-

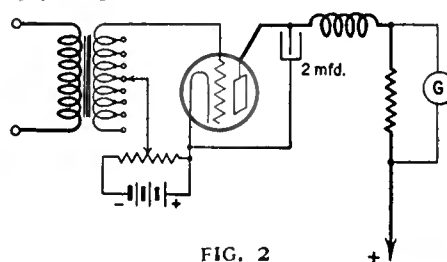

FIG. 2

The volume indicator described above has an input impedance of about 12,000 ohms and it must be used across a 500- or 600-ohm circuit if its calibration is to hold. It is so connected in the set-up for a line frequency run shown in Fig. 1. The output of the oscillator is of 500 ohms impedance. This feeds a 10-TU artificial line which presents an impedance of 500 ohms in each direction. The usual repeating coil is inserted ahead of the line. The line is assumed to have an impedance of about 500 ohms also. At the other end of the line there is an equalizer (See article on "Types of Equalizers," RADIO BROADCAST, June, 1926) followed by a two-stage amplifier, with an output impedance of 500 ohms. This amplifier must be terminated with a resistance of this magnitude, therefore, before the level readings of a volume indicator bridged across it will be valid.

Since the equalizer is at the far end of the line, the latter will not present a strictly constant impedance at the transmitting end, and this would affect the output of the oscillator if instrument were connected directly to the line. The artificial line acts as a buffer, in that it provides a more constant impedance for the oscillator to feed into; in some cases the artificial line network also permits measurement at more convenient levels without excessive input to the telephone line.

The procedure for a frequency run is obvious from this point on. The oscillator is set at various frequencies, the outgoing level checked with the volume indicator across it, and similar readings taken at the receiving end. A curve of received level against frequency may thus be secured for a given setting of the equalizer. If the equalizer is omitted, and the transmitted level remains constant, such a curve will show the line attenuation characteristic, which is a curve descending with frequency. The object of the equalizer being to correct this loss of the higher frequencies, a number of frequency runs may be taken, until a horizontal curve of received level is secured. The line is then equalized. Communication between the two terminals may be maintained over the line by telephone or telegraph in the intervals between readings, or over a separate pair. Of course before an attempt is made to take a frequency characteristic of a line, or to set the equalizer for a flat characteristic, the usual d.c. wire chief's tests are made for defects like open circuits or grounds. Nothing in the way of audio-frequency testing can be accomplished until such faults have been eliminated.

HOW NOT TO DO IT

FIG. 3 shows a method of taking line frequency runs which is illegitimate. I have seen it used, and so mention it here with the caution that results so secured will usually be misleading. The oscillator, with the volume indicator bridged across it, is connected across a 500-ohm resistance and the level is read. The output of the oscillator is then switched to a line, the equalizer being at the other end. In this way a frequency run is made and the line is thought to be equalized. Actually, as the impedance of the line varies with the frequency, the output of the oscillator will also vary with frequency and the result of the experiment will merely be to show how the oscillator behaves with a variable impedance connected across its terminals.

Sometimes it is convenient to send out tone on a line using the regular broadcast amplifier set-up. For example, in chain operation it is a sound precaution to transmit tones at a number of important frequencies before a program. The network stations take level readings at the various frequencies transmitted, which may be

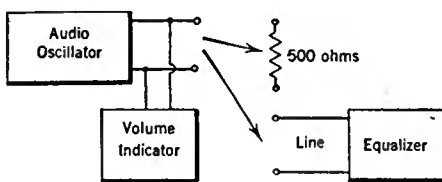

FIG. 3

100, 1000, and 5000 cycles, and telegraph them back as a check on the condition of the lines. Any irregularity will show up in these readings and necessary changes in routing of circuits, adjustment of terminal apparatus, etc., may be made before the program begins. Fig. 4, from the input of the three-stage amplifier, is the usual set-up for broadcasting. The input to the first amplifier would normally be a microphone. For the microphone there has been substituted the audio oscillator, a repeating coil, and a variable attenuation network, which can be adjusted to any loss up to 30 TU. By means of this pad the level of the outgoing tone may be made the same as that normally used during broadcasting—usually around zero level (12 milliwatts on peaks, or about 5 milliamperes into a 500-ohm circuit).

In the December, 1924, issue of the *Proceedings of the Institute of Radio Engineers*, Mr. Julius Weinberger showed a means of taking the audio-frequency characteristic of the modulation system of a radio station. The diagram is reproduced, with some slight modifications, in Fig. 5 herewith. The audio oscillator in this case

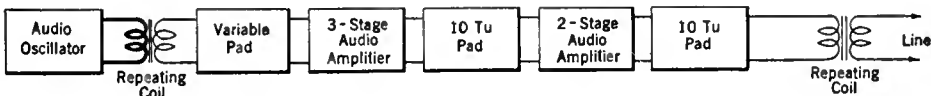

FIG. 4

feeds into a 500-ohm resistance, matching its normal output impedance. A thermo-galvanometer in series measures the a.c. emitted by the oscillator. A portion of the voltage across the 500-ohm resistor is fed into the line amplifier of the station with enough added resistance on either side to maintain the 500-ohm impedance. The tone passes through the entire audio-frequency system and the level is measured at the output of the modulators. A fixed condenser of 1/2-mfd. capacity blocks the direct plate voltage and allows only the audio component to affect the measurement circuits. The lower terminal of the condenser is connected to ground through a resistance of the order of 20,000 ohms, which is so high that the characteristics of the transmitter will be unaffected by the addition of the measuring circuit. A relatively small portion of the audio voltage across the resistor is tapped off for the thermo-galvanometer. A radio-frequency trap is usually required to keep r.f. out of the galvanometer circuit. The current readings of the input and output galvanometers will now give the transmission characteristics of the modulation system at any frequency within the compass of the oscillator. The curve may be drawn with ordinates of percentage of

amplitude compared with the transmission of the mean speech frequency (1000 cycles), or in TU, the horizontal axis representing frequency.

The thermo-galvanometers in such a set-up as that shown in Fig. 5 must necessarily have the right full-scale reading for the circuits under measurement. The required capacity can readily be calculated, since the output of the oscillator, the amplification of the audio system, and therefore the alternating voltage developed by the modulators, will all be approximately known. Where there is any doubt a large instrument is first used, until one of the right sensitiveness and current-carrying capacity is found. As the output measurements are made across the full plate voltage the engineer who works on this end must take the usual precautions against accidental contact with the high-tension portions of the equipment.

RADIO FOLK YOU SHOULD KNOW

4. E. B. Pillsbury

IF THERE is a communication man in the United States it is Edward Butler Pillsbury, the Vice President and General Manager, as well as a Director, of the Radio Real Estate Corporation of America, the holding company for the realty properties of the R. C. A. Mr. Pillsbury has spent his entire career in telegraphy, starting as a messenger, working ten years as a Western Union operator, followed by many years in the service of the Postal Telegraph-Cable Company, first as Chief Operator in Bos-

ton, then advancing to the grades of local Manager in that city, Assistant Superintendent, District Superintendent for New England, and finally General Superintendent of the Eastern Division of the company, with jurisdiction over the lines and offices in thirteen states from his headquarters in New York. This position Mr. Pillsbury held for six years, until he resigned to take up radio work as General Superintendent of the Transoceanic Division of the Marconi Wireless Telegraph Company of America, and later for the Radio Corporation. In 1922 he was elected to his present office.

While serving as an operator Mr. Pillsbury was renowned as an expert Morse man. He was among the first chief operators to adopt the practice of using the Wheatstone bridge method of locating faults on telegraph lines.

Anyone else who has seen all he has of the communication business and of life would be writing his memoirs. But when Mr. Pillsbury was asked to supply information for this biographical sketch he replied plaintively. "I regret to say that no interesting anecdotes or experiences have come my way." Press agents should thank God that the country is not crowded with Edward Butler Pillsburys.

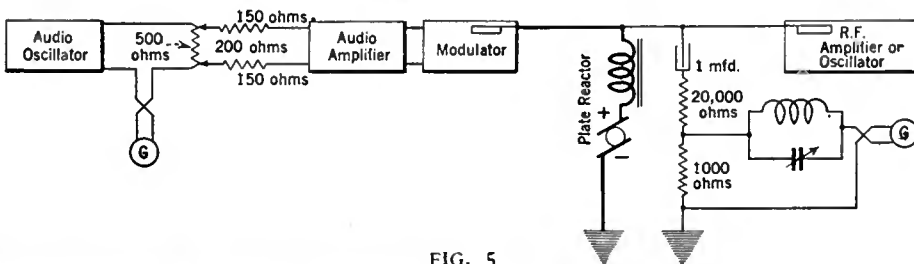

FIG. 5

# SHORT-WAVE TRANSMISSIONS

## Stations Throughout the World Working Below 100 Meters

THE following list is reprinted from *Wireless World*, London, England, and comprises the stations which transmit fairly regularly on wavelengths below 100 meters. As a result of the recent Radio-telegraphic Conference it is possible that several of these wavelengths may be altered. We shall, therefore, welcome any authoritative information correcting or supplementing that given below.

The stations are arranged alphabetically according to their call-signs, as we believe this will be found the most acceptable method for easy identification. The editors of *Wireless World* have, in the case of experimental stations, omitted the usual continental prefix, but retained that indicating the country (e.g., U 2XAD and not NU 2XAD, and A 2FC not OA 2FC). Where transmissions are sent out at regular times these are in many cases indicated in brackets following the usual wavelength. The list cannot be guaranteed free from inaccuracies since the constant changing of schedules makes it impossible to get up a list which is as correct at the time of its publication as it was at the time of its compilation.

All the times, it will be noted, are given in Greenwich Mean Time (G.M.T.). Greenwich time is five hours ahead of Eastern Standard Time. Thus five o'clock in the evening London time is midday New York time eleven o'clock a.m. Chicago time, ten o'clock a.m. Denver time, or nine o'clock a.m. San Francisco time. G. M. T. runs from 01.00 to 24.00, 01.00 being 1 a.m. and 24.00 being midnight. Thus 13.07 G. M. T. (the same as seven minutes after one o'clock p.m. G. M. T.) is the equivalent of seven minutes after eight o'clock a.m. E. S. T. While this conflicts with the table supplied by the U. S. Navy Department printed on page 53, it is obvious from a study of some of the known schedules below that it jibes with what was intended by the compiler.

CALL-SIGN	STATION	WAVELENGTHS AND REMARKS	CALL-SIGN	STATION	WAVELENGTHS AND REMARKS	CALL-SIGN	STATION	WAVELENGTHS AND REMARKS
AFI	Königswinterhausen	26.3	CF	Drummondville, Montreal (Beam Station)	32.0 (Temporary)	GFR	Winchester (R.A.F. School)	20.0
AFJ	Königswinterhausen	53.5	CG	Drummondville, Montreal	16.501, 32.128	GFY	Royal Air Force, Henlow	76.0
AFU	Königswinterhausen	39.7	CH	Quilicura, Chile	15-20	GLG	Royal Air Force, Henlow	15.740, 15.707
AGA	Nauen	14.9, 12.25, 13.5, 14.25, 16.0, 26.0	CRHA	Lourenco Marques, Portuguese East Africa	18.360	GLH	Dorchester (Beam Station)	22.091 (American Circuit)
AGB	Nauen	25.5, 26.6, 27.0	CRHB	Fraia, Cape Verde Islands	18.094	GLQ	Ongar (for communication with New York, Buenos Aires, and Rio de Janeiro)	24.5
AGC	Nauen	17.2, 26.0, 39.8, 40.2 (Phone occasionally)	CRHC	Loanda, Angola	18.182	GLS	Ongar	15.0
AGJ	Nauen	56.7 (Phone occasionally after 1800 G. M. T.)				GLSQ	SS, <i>Olympic</i>	20.0
AGK	Nauen	11.0, 20.0 (2 hrs.)	D			-SLW	Dorchester (Beam Station, South American Circuit)	15.707
AIN	Casablanca, Ain Bordja	51.0 (Weather reports, 0830 and 1930 G. M. T.)	DPC	SS, <i>Cap Palatin</i> (German)	25.0, 34.0	GLYX	Dorchester (Beam Station, South American Circuit)	37.0
AKA	German Naval Vessel, M.81	54.0	DNSC	Royal Danish Dockyard, Copenhagen	47.0	G 2BR	SS, <i>Derbyshire</i>	15.0, 17.0
AKB	German Naval Vessel, M.82	54.0	DS	H. M. S. <i>Renown</i>	36.0	G 2NM	Chelmsford	32.5 (Phone Tues., Thurs., Sat., Sun., 0600-0700, and Sun., 1600-1800 G. M. T.)
AKC	Tiltilin, Java	26.2, 40.2 (Code)	E			G 2YT	Poldhu	25.0, 32.0, 60.0, 92.0, 94.0
AKD	Tiltilin, Java	18.8, 28.8, 37.5 (Code)	FAM	Madrid	30.7	G 5DH	Dollis Hill (P. O. Station)	21.7, 27.6, 35.3, 47.0
ANDR	Malabar, Java (Military Aerodrome)	38.5				G 5SW	Chelmsford (B.B.C. Exp.)	24.0 (Phone 1330, 1430, and 1930 onwards)
ANE	Bandoeng, Java	17.4 (Code and Phone)	FAMJ	French SS, <i>Jeanne d'Arc</i> (French Navy)	26-60	HBC	Berne, Switzerland	34.2
ANF	Tiltilin, Java	20.3, 36.5 (Code)	FL	Eiffel Tower	32.0, 75.0	HIG	Bogotá, Colombia	32.0
ANH	Malabar, Java	17.4, 27.0 (Code and Phone, Phone on Saturday, 1200-1700 G. M. T., and at other times as then advanced)	FTJ	SS, <i>Jacques Cartier</i> (France)	75.0	HVA	Hanoi, Tonkin	22.0
ANK	Malabar, Java	19.4, 30.20 (Exp. Tests)	FW	St. Assise, Cie. Radio, France	14.28, 23.25, 25.0, 41.95, 43.0	HZA	Salgon	25.0
AOE	SS, <i>Sir James Clark Ross</i>	33.5	FUA	Bizerta-Sidi-Abdallah, Tunis	42.7 (Phone with Buenos Aires)	H 90C	Telegraphic and Radio Service, Cas. No. 63, Poste Transfr. Berne	32.0 (Relays Berne, Mon., Thurs., and Sat., 2000-2100)
ARCX	Nilegian Whaler <i>Nilsen</i>	33.5	FUE	Mengam, France	38.5	H 9XD	Radio Club of Zurich	32.0, 85.0
ARDI	SS, C. A. <i>Larsen</i>	30.5 (After 0700 G. M. T.)	FUL	Beyrouth-Djeddah, Lebanon	27.0-80.0			
AYC	Guayra, Venezuela	32.0	FUM	Montebourg (Air Station)	37.0			
A 2FC	Sydney, N. S. W.	31.8	FUT	Toulon-Mourillon, France	36.5			
A 2ME	Sydney, Australia	28.50 (Phone Sun., 1830-2000 G. M. T.)	F 8GA	St. Assise, Paris (S.F.R.)	75.0 (S.F.R. Bulletins)			
A 3LO	Melbourne	29.8, 32 or 36 (Phone Sun., 1830-2030 G. M. T.)	F 8G3	Radio LL, Paris	60.0 (Phone)			
			F 8GC					
BAM	Tahiti	40.0	GBH	Grimsby (Beam Station)	25.906	ICC	Coltano	18.0
BVI	R. N. College, Dartmouth	46.0	GBI	Grimsby (Beam, Indian Circuit)	16.216, 34.168	ICD	Rome (Conto Celle)	63.0
BWV	Gibraltar, North Front (Naval Station)	35.0	GBJ	Bodmin (Beam, S. Africa Circuit)	16.146, 34.013	ICF	Messina, Sicily	49.0
BXY	Selekar, Singapore (Naval)	35.0	GBK	Bodmin (Beam Station)	16.574, 32.397	ICK	Bengasi, Cyrenaica	26.0, 53.0
BXY	Succutere, Island, Hong Kong	35.0	GBL	Leafield (P. O. Station)	17.5, 21.5, 24.0, 30.0, 56.0	ICL	Tripoli	45.0
BYB	Whitell, P. C. (Naval)	35.0	GBM	Leafield (P. O. Station)	17.5, 21.5, 24.0, 30.0, 56.0	ICU	Derna, Cyrenaica	54.0
BYC	Honza (Naval)	35.0	GBO	SS, <i>Dorsetshire</i>	24.0, 41.7	ICV	Tobrük, Cyrenaica	54.0
BYZ	Rinella, Malta (Naval)	35.0	GDB	Air Ministry, London		ICX	Massawa	47.0
BZC	Portsmouth Signal School	35.5	GFA			IDO	Rome, San Paulo	33.0-37.5
BZE	Madara, Ceylon (Naval)	35.0				IDX	Amara, Erythrea	32.5, 64.0
BZE	Aden (Naval)	35.0				IHF	Catania, Italy	53.5
BZQ	Uccle, Belgium	40.0				IST	Chisimailo, U. Somaliland	38.0
						I LAX	Rome, Via Savoia 80	45.0 (Phone occasionally)
						I 1FC	Royal Frederico Cesi School, Rome	33.0, 34.0
						I 1MA	Rome, Via Bramante 3	43 (Saturdays, G. M. T.)
						I 1RC	Rome, Via Bramante 3	10.0, 18.0, 35.0, 65.0



CALL-SIGN	STATION	WAVELENGTHS AND REMARKS	CALL-SIGN	STATION	WAVELENGTHS AND REMARKS	CALL-SIGN	STATION	WAVELENGTHS AND REMARKS
JB	Johannesburg	32.0 (Phone)	KVR	Las Vegas, Nevada (Western Air-Express Inc.)	49.5	OCTN	Mourillon, Toulon	20.0 (Series of "a" from 1530-1540 G.M.T.), 33.0 (Series of "b" from 1545-1555 G.M.T.), 57.0 (Series of "c" from 1600-1610 G.M.T. daily, except Sundays).
JBK	Kagoshima, Japan	30.0, 40.5, 70.0	KWE	Bolinas, Calif. (R.C.A.)	14.08, 28.15	OCTU	The Military Station of Nogent-le-Rotrou	48.0, 50.0
JEL	Osaka, Japan	24-41	KWJ	Portland, Oregon	53.54 (1kw)	OHK	Tunis la Casbah	39.5, 40.6
JEP	Osaka, Japan	24-41	KWT	Palo Alto, Calif. (Fed. Telegraphic Co.)	34.86, 48.05, 49.97, 58.10	DLQ	Vienne, SS, <i>Stamiat</i>	19.0, 22.5, 37.0
JFAB	Hiroshima, Japan	39.5 (0.900 G.M.T.)	KWV	Bakersfield (Pacific Air Transport)	66.48	—	Paris, Radio I.L.	61.0 (Phone Wed., Fri., Sun., 2100-2245 G.M.T.)
JFU	Karlsruhe, Germany	32.0, 58.0, 74.0	—	Lyois, Radio Lyon	39.5 (Phone 1700-1800 G.M.T., except Sundays)	—	Paris, Radio Vitus	37.0 (Phone Wed., Fri., Sun., 2100-2245 G.M.T.)
JGV	Karlsruhe, Germany	37.5 (Temporary)	—	—	—	—	—	—
JKZB	Osaka, Japan	24.0	LA LF	Meteorological Hnt. Bergen	43.0	PCA	Amsterdam	33.33
JPC	Osaka, Japan	18.0, 37.0	LA LM	Meteorological Inst., Oslo	45.0	PGG	Malabar, Java	17.0
JPE	Osaka, Japan	29.0, 38.0, 60.0	LCHO	Telegraph Administration, Oslo	33.0	PGH	Scheveningen Port	20.0, 20.6, 20.69, 21.127, 28.800, 29.226, 29.283
JPS	Osaka, Japan	16.0, 37.0	LPI	Buenos Aires	31.0	PGJ	Hilversum, Holland (Philips Lamp Works)	30.2 (Phone)
JVZ	Tokyo, Japan	16.0, 37.0	LEZ	Buenos Aires	36.0, 75.0	PCLL	Kootwijk, Holland	46.0, 32.0, 18.0 (Wed., 1400-1600 G.M.T. and occasionally on Mon. and Fri.) and other wavelengths below 60 meters (40kw)
JVA	Iwatsuki, Japan	40.5	LY	Bordeaux, Lafayette	32.0	PCMM	Ministry of Posts and Telegraphs, Kootwijk	25.0, 27.5, 36.0 and other wavelengths below 60 meters
JLPP	Tokyo	20.0, 21.5, 35.0	—	Matagora (Spain), Cie. Transatl. Espagnola	70.0	PCPP	Kootwijk, Holland	27.0 and other wavelengths below 60 meters
KAV	Norddeich	39.0, 68.0	N	Washington, Illinois	24.9, 37.4, 74.7	PCRR	Kootwijk, Holland	20.0, 25.0, 37.0 and other wavelengths below 60 meters
KDKA	East Pittsburgh, Pa. (Westinghouse E. & M. Co.)	26.3, 42.95, 62.5 (Phone from 2300 G.M.T.)	NAL	Navy Yard, Washington, D. C.	40.0, 76.0, 34.0	PCTT	Kootwijk, Holland	21.0, 29.5 and other wavelengths below 60 meters (10 kw)
KDO	SS, <i>Esperia</i> (United Fruit Co. U. S. A.)	33.0	NBA	Pensacola, Florida	20.0, 30.6	FCUU	Dutch Colonial Ministry, The Hague	31.0
KDZ	Point Barrow, Alaska	21.4, 42.08, 74.77	NEL	Balboa, Canal Zone	40.0	FKD	Koeping	32.0
KEB	Oakland, Calif. (G. E. Co.)	18.62, 21.8	NEFO	Lakhurst, N. J.	80.0	FKH	Ambona	24.0
KEG	Vancouver, Washington (Pacific Air Transport)	45.0	NERM	U. S. S. <i>Relief</i>	20.0	FKJ	Soerabaja, Java (D. E. Indies)	23.0
KEL	Bolinas, Calif. (R.C.A.)	14.1, 29.3, 95.0	NFV	U. S. S. <i>Los Angeles</i>	70.0-84.5	FKK	Medan	21.5, 31.5
KEMM	Bolinas, Calif. (R.C.A.)	14.29, 28.58	NIRX	U. S. S. <i>Conopsis</i>	77.4, 77.5	POF	Java	27.0, 32.0
KESS	Bolinas, Calif. (R.C.A.)	14.40, 28.80	NKF	Naval Lab., Bellevue, Antarctica	75.0	POI	Nauen	13.5, 18.0
KET	Bolinas, Calif. (R.C.A.)	99.0	NKL	Arlington	41.3, 54.4, 61.0, 71.3, 81.5	POJ	Nauen	25.0
KFU	Los Angeles, Calif. (Pacific Air Transport)	45.02	NKLN	U. S. Submarine Base, Coco Solo, Panama	37.0	POK	Nauen	20.0
KEUN	Bolinas, Calif. (R.C.A.)	14.08, 38.38	NKLN	U. S. Submarine Base, Coco Solo, Panama	37.0	POQ	Nauen	20.0
KEWE	Bolinas, Calif. (R.C.A.)	14.08, 28.15	NKLN	U. S. Submarine Base, Coco Solo, Panama	37.0	POZ	Nauen	20.0
KFD	Denver, Colorado (G.E. Co.)	17.7, 24.3	NKLN	U. S. Submarine Base, Coco Solo, Panama	37.0	POZ	Nauen	20.0
KFW	Sy. <i>Poinsettia</i>	40.0	NKLN	U. S. Submarine Base, Coco Solo, Panama	37.0	POW	Nauen	20.0
KFQU	Holy City, Calif.	31.0, 53.0, 63.0	NKLN	U. S. Submarine Base, Coco Solo, Panama	37.0	PTQ	Nauen	20.0
KFVM	SS, <i>Italia</i>	17.0, 37.0, 74.0	NKLN	U. S. Submarine Base, Coco Solo, Panama	37.0	PVC	Nauen	20.0
KFWB	Los Angeles, Calif.	68.4	NKLN	U. S. Submarine Base, Coco Solo, Panama	37.0	—	—	—
KFY	Poncaiana, Florida	40.0	NKLN	U. S. Submarine Base, Coco Solo, Panama	37.0	—	—	—
KFZG	Port Barrow	45.32, 69.25	NKLN	U. S. Submarine Base, Coco Solo, Panama	37.0	—	—	—
KFZH	Fairbanks, Alaska	44.71, 68.32	NKLN	U. S. Submarine Base, Coco Solo, Panama	37.0	—	—	—
KFZO	SS, <i>Robador</i>	37.5	NKLN	U. S. Submarine Base, Coco Solo, Panama	37.0	—	—	—
KGBR	U. S. S. <i>Ungava</i> (R. B. Met-calf)	22.0, 37.0	NKLN	U. S. Submarine Base, Coco Solo, Panama	37.0	—	—	—
KGDU	SS, <i>Four Winds</i>	35.03	NKLN	U. S. Submarine Base, Coco Solo, Panama	37.0	—	—	—
KGE	Medford, Oregon (Pacific Air Transport)	46.06	NKLN	U. S. Submarine Base, Coco Solo, Panama	37.0	—	—	—
KGFT	Portable Station, Texas	50.0	NKLN	U. S. Submarine Base, Coco Solo, Panama	37.0	—	—	—
KGH	Hillsboro, Oregon (Fed. Telegraphic Co.)	36.52, 46.99	NKLN	U. S. Submarine Base, Coco Solo, Panama	37.0	—	—	—
KGT	Fresno, Calif. (Pacific Air Transport)	46.06	NKLN	U. S. Submarine Base, Coco Solo, Panama	37.0	—	—	—
KIO	Kahuku, Hawaii (R.C.A.)	90.04	NKLN	U. S. Submarine Base, Coco Solo, Panama	37.0	—	—	—
KKC	Palo Alto, Calif. (Fed. Telegraphic Co.)	17.0, 27.5	NKLN	U. S. Submarine Base, Coco Solo, Panama	37.0	—	—	—
KLL	Bolinas, Calif. (R.C.A.)	21.85	NKLN	U. S. Submarine Base, Coco Solo, Panama	37.0	—	—	—
KMM	Bolinas, Calif. (R.C.A.)	14.29, 28.58	NKLN	U. S. Submarine Base, Coco Solo, Panama	37.0	—	—	—
KMV	Bandini, Calif. (Western Air Express Inc., Morse)	49.5	NKLN	U. S. Submarine Base, Coco Solo, Panama	37.0	—	—	—
KNN	Honolulu (Mackay, R. & T. Co.)	17.2, 23.0, 23.7, 28.0, 34.4, 46.0, 47.4, 56.0	NKLN	U. S. Submarine Base, Coco Solo, Panama	37.0	—	—	—
KNR	Clearwater, Calif. (Fed. Telegraphic Co.)	29.5, 49.15	NKLN	U. S. Submarine Base, Coco Solo, Panama	37.0	—	—	—
KNW	Palo Alto, Calif. (Mackay, R. & T. Co.)	16.7, 17.0, 24.0, 33.4, 34.0, 48.0, 51.0	NKLN	U. S. Submarine Base, Coco Solo, Panama	37.0	—	—	—
KOS	Lone Pine, Calif. (City of Los Angeles)	45.77	NKLN	U. S. Submarine Base, Coco Solo, Panama	37.0	—	—	—
KOT	Los Angeles, Calif. (City of Los Angeles)	45.77	NKLN	U. S. Submarine Base, Coco Solo, Panama	37.0	—	—	—
KRP	Salt Lake City, Utah (Western Air Express Inc.)	14.40, 28.80	NKLN	U. S. Submarine Base, Coco Solo, Panama	37.0	—	—	—
KSS	Bolinas, Calif. (R.C.A.)	48.05	NKLN	U. S. Submarine Base, Coco Solo, Panama	37.0	—	—	—
KSZ	McCamey, Texas	18.0, 21.8, 22.0, 23.5, 36.0	NKLN	U. S. Submarine Base, Coco Solo, Panama	37.0	—	—	—
KTA	Guam (Mackay R. & T. Co.)	43.6, 44.0, 47.0	NKLN	U. S. Submarine Base, Coco Solo, Panama	37.0	—	—	—
KTF	Midway Island (Mackay R. & T. Co.)	21.6, 33.2, 43.2, 66.4	NKLN	U. S. Submarine Base, Coco Solo, Panama	37.0	—	—	—
KUN	Bolinas, Calif. (R.C.A.)	16.93, 33.88	NKLN	U. S. Submarine Base, Coco Solo, Panama	37.0	—	—	—
KUY	Bear Creek, Alaska	82.0	NKLN	U. S. Submarine Base, Coco Solo, Panama	37.0	—	—	—
KVA	Norddeich	39.0, 68.0	NKLN	U. S. Submarine Base, Coco Solo, Panama	37.0	—	—	—
KDKA	East Pittsburgh, Pa. (Westinghouse E. & M. Co.)	26.3, 42.95, 62.5 (Phone from 2300 G.M.T.)	NKLN	U. S. Submarine Base, Coco Solo, Panama	37.0	—	—	—
KDO	SS, <i>Esperia</i> (United Fruit Co. U. S. A.)	33.0	NKLN	U. S. Submarine Base, Coco Solo, Panama	37.0	—	—	—
KDZ	Point Barrow, Alaska	21.4, 42.08, 74.77	NKLN	U. S. Submarine Base, Coco Solo, Panama	37.0	—	—	—
KEB	Oakland, Calif. (G. E. Co.)	18.62, 21.8	NKLN	U. S. Submarine Base, Coco Solo, Panama	37.0	—	—	—
KEG	Vancouver, Washington (Pacific Air Transport)	45.0	NKLN	U. S. Submarine Base, Coco Solo, Panama	37.0	—	—	—
KEL	Bolinas, Calif. (R.C.A.)	14.1, 29.3, 95.0	NKLN	U. S. Submarine Base, Coco Solo, Panama	37.0	—	—	—
KEMM	Bolinas, Calif. (R.C.A.)	14.29, 28.58	NKLN	U. S. Submarine Base, Coco Solo, Panama	37.0	—	—	—
KESS	Bolinas, Calif. (R.C.A.)	14.40, 28.80	NKLN	U. S. Submarine Base, Coco Solo, Panama	37.0	—	—	—
KET	Bolinas, Calif. (R.C.A.)	99.0	NKLN	U. S. Submarine Base, Coco Solo, Panama	37.0	—	—	—
KFU	Los Angeles, Calif. (Pacific Air Transport)	45.02	NKLN	U. S. Submarine Base, Coco Solo, Panama	37.0	—	—	—
KEUN	Bolinas, Calif. (R.C.A.)	14.08, 38.38	NKLN	U. S. Submarine Base, Coco Solo, Panama	37.0	—	—	—
KEWE	Bolinas, Calif. (R.C.A.)	14.08, 28.15	NKLN	U. S. Submarine Base, Coco Solo, Panama	37.0	—	—	—
KFD	Denver, Colorado (G.E. Co.)	17.7, 24.3	NKLN	U. S. Submarine Base, Coco Solo, Panama	37.0	—	—	—
KFW	Sy. <i>Poinsettia</i>	40.0	NKLN	U. S. Submarine Base, Coco Solo, Panama	37.0	—	—	—
KFQU	Holy City, Calif.	31.0, 53.0, 63.0	NKLN	U. S. Submarine Base, Coco Solo, Panama	37.0	—	—	—
KFVM	SS, <i>Italia</i>	17.0, 37.0, 74.0	NKLN	U. S. Submarine Base, Coco Solo, Panama	37.0	—	—	—
KFWB	Los Angeles, Calif.	68.4	NKLN	U. S. Submarine Base, Coco Solo, Panama	37.0	—	—	—
KFY	Poncaiana, Florida	40.0	NKLN	U. S. Submarine Base, Coco Solo, Panama	37.0	—	—	—
KFZG	Port Barrow	45.32, 69.25	NKLN	U. S. Submarine Base, Coco Solo, Panama	37.0	—	—	—
KFZH	Fairbanks, Alaska	44.71, 68.32	NKLN	U. S. Submarine Base, Coco Solo, Panama	37.0	—	—	—
KFZO	SS, <i>Robador</i>	37.5	NKLN	U. S. Submarine Base, Coco Solo, Panama	37.0	—	—	—
KGBR	U. S. S. <i>Ungava</i> (R. B. Met-calf)	22.0, 37.0	NKLN	U. S. Submarine Base, Coco Solo, Panama	37.0	—	—	—
KGDU	SS, <i>Four Winds</i>	35.03	NKLN	U. S. Submarine Base, Coco Solo, Panama	37.0	—	—	—
KGE	Medford, Oregon (Pacific Air Transport)	46.06	NKLN	U. S. Submarine Base, Coco Solo, Panama	37.0	—	—	—
KGFT	Portable Station, Texas	50.0	NKLN	U. S. Submarine Base, Coco Solo, Panama	37.0	—	—	—
KGH	Hillsboro, Oregon (Fed. Telegraphic Co.)	36.52, 46.99	NKLN	U. S. Submarine Base, Coco Solo, Panama	37.0	—	—	—
KGT	Fresno, Calif. (Pacific Air Transport)	46.06	NKLN	U. S. Submarine Base, Coco Solo, Panama	37.0	—	—	—
KIO	Kahuku, Hawaii (R.C.A.)	90.04	NKLN	U. S. Submarine Base, Coco Solo, Panama	37.0	—	—	—
KKC	Palo Alto, Calif. (Fed. Telegraphic Co.)	17.0, 27.5	NKLN	U. S. Submarine Base, Coco Solo, Panama	37.0	—	—	—
KLL	Bolinas, Calif. (R.C.A.)	21.85	NKLN	U. S. Submarine Base, Coco Solo, Panama	37.0	—	—	—
KMM	Bolinas, Calif. (R.C.A.)	14.29, 28.58	NKLN	U. S. Submarine Base, Coco Solo, Panama	37.0	—	—	—
KMV	Bandini, Calif. (Western Air Express Inc., Morse)	49.5	NKLN	U. S. Submarine Base, Coco Solo, Panama	37.0	—	—	—
KNN	Honolulu (Mackay, R. & T. Co.)	17.2, 23.0, 23.7, 28.0, 34.4, 46.0, 47.4, 56.0	NKLN	U. S. Submarine Base, Coco Solo, Panama	37.0	—	—	—
KNR	Clearwater, Calif. (Fed. Telegraphic Co.)	29.5, 49.15	NKLN	U. S. Submarine Base, Coco Solo, Panama	37.0	—	—	—
KNW	Palo Alto, Calif. (Mackay, R. & T. Co.)	16.7, 17.0, 24.0, 33.4, 34.0, 48.0, 51.0	NKLN	U. S. Submarine Base, Coco Solo, Panama	37.0	—	—	—
KOS	Lone Pine, Calif. (City of Los Angeles)	45.77	NKLN	U. S. Submarine Base, Coco Solo, Panama	37.0	—	—	—
KOT	Los Angeles, Calif. (City of Los Angeles)	45.77	NKLN	U. S. Submarine Base, Coco Solo, Panama	37.0	—	—	—
KRP	Salt Lake City, Utah (Western Air Express Inc.)	14.40, 28.80	NKLN	U. S. Submarine Base, Coco Solo, Panama	37.0	—	—	—
KSS	Bolinas, Calif. (R.C.A.)	48.05	NKLN	U. S. Submarine Base, Coco Solo, Panama	37.0	—	—	—
KSZ	McCamey, Texas	18.0, 21.8, 22.0, 23.5, 36.0	NKLN	U. S. Submarine Base, Coco Solo, Panama	37.0	—	—	—
KTA	Guam (Mackay R. & T. Co.)	43.6, 44.0, 47.0	NKLN	U. S. Submarine Base, Coco Solo, Panama	37.0	—	—	—
KTF	Midway Island (Mackay R. & T. Co.)	21.6, 33.2, 43.2, 66.4	NKLN	U. S. Submarine Base, Coco Solo, Panama	37.0	—	—	—
KUN	Bolinas, Calif. (R.C.A.)	16.93, 33.88	NKLN	U. S. Submarine Base, Coco Solo, Panama	37.0	—	—	—
KUY	Bear Creek, Alaska	82.0	NKLN	U. S. Submarine Base, Coco Solo, Panama	37.0	—	—	—
KVA	Norddeich	39.0, 68.0	NKLN	U. S. Submarine Base, Coco Solo, Panama	37.0	—	—	—
KDKA	East Pittsburgh, Pa. (Westinghouse E. & M. Co.)	26.3, 42.95, 62.5 (Phone from 2300 G.M.T.)	NKLN	U. S. Submarine Base, Coco Solo, Panama	37.0	—	—	—
KDO	SS, <i>Esperia</i> (United Fruit Co. U. S. A.)	33.0	NKLN	U. S. Submarine Base, Coco Solo, Panama	37.0	—	—	—
KDZ	Point Barrow, Alaska	21.4, 42.08, 74.77	NKLN	U. S. Submarine Base, Coco Solo, Panama	37.0	—	—	—
KEB	Oakland, Calif. (G. E. Co.)	18.62, 21.8	NKLN	U. S. Submarine Base, Coco Solo, Panama	37.0	—	—	—
KEG	Vancouver, Washington (Pacific Air Transport)	45.0	NKLN	U. S. Submarine Base, Coco Solo, Panama	37.0	—	—	—
KEL	Bolinas, Calif. (R.C.A.)	14.1, 29.3, 95.0	NKLN	U. S. Submarine Base, Coco Solo, Panama	37.0	—	—	—
KEMM	Bolinas, Calif. (R.C.A.)	14.29, 28.58	NKLN	U. S. Submarine Base, Coco Solo, Panama</				

Stations Throughout the World Working Below 100 Meters

(Continued)

CALL-SIGN	STATION	WAVELENGTHS AND REMARKS	STATION	WAVELENGTHS AND REMARKS	CALL-SIGN	STATION	WAVELENGTHS AND REMARKS	CALL-SIGN	STATION	WAVELENGTHS AND REMARKS
SKB	Motorship <i>Griffshalm</i>	37.5	San Francisco, California	33.00 (Phone 2400 G.M.T. onwards)	U 6XAR	San Francisco, California	33.00 (Phone 2400 G.M.T. onwards)	WGY	Schenectady, N. Y. (G. E. Co.)	35.0
SMHA	Stockholm	41.0	Bolinas, California	29.3	U 6XI	Bolinas, California	29.3	WHD	Sharon, Pa. (Westinghouse Co.)	49.0
SOJ	Brazilian SS. <i>Jaquarao</i>	100.0	Kahului, Hawaii	50.0	U 6XO	Kahului, Hawaii	50.0	WHK	Cleveland, Ohio	66.04 (4 kw.)
SOK	Moskwa Sokolenski Radio	37.0	Columbus, Ohio	54.02	U 8XK	East Pittsburg, Pa.	26.8 (Mon. and Fri. 1900-2100 G.M.T.)	WHR	Rocky Point, N. Y. (R.C.A.)	13.93, 31.96
SFM	Radio Laboratory, Ministry of Posts, Helsingfors	47.0	East Pittsburg, Pa.	67.0, 96.0	U 8XS	East Pittsburg, Pa.	67.0, 96.0	WHW	Highland Park, Ill. (Wireless Telegraph & Communication Co.)	45.02
SFR	Sepetha, Rio de Janeiro, Brazil	22.180 (Meteorological reports, 1530 local time)	East Pittsburg, Pa.	61.06 (Phone)	U 9XU	East Pittsburg, Pa.	61.06 (Phone)	WIK	New Brunswick, N. J. (R.C.A.)	21.48, 21.5
SFU	Santa Cruz (Beam)	15.576	Council Bluffs, Iowa	61.06 (Phone)				WIR	New Brunswick, N. J. (R.C.A.)	74.0 (20 kw.)
SFX	Rio de Janeiro	29.3						WIZ	New Brunswick, N. J. (R.C.A.)	43.35 (Phone occasionally from 2300 G.M.T.)
SFW	Rio de Janeiro	40.5						WJZ	New York International News Service	37.01
SF1	Rio de Janeiro	17.0, 44.5, 47.0						WKC	Bountbrook, N. J. (R. C. A.)	18.17
SUC 2	Abuzabal (Cairo)	47.0						WKK	Newark, N. J. (Fed. Electr. Co.)	17.5, 27.9
TFA	Reykjavik Iceland	42.5, 49.5						WKL	Cuba, Porto Rico (Bureau of Insular Telegraphs)	52.0
TSE	Norwegian SS. <i>Helder</i>	46.5, 51.0						WLV	Rocky Point, N. Y. (R.C.A.)	16.57
TUK	Tomsk Siberia	20.0						WNB	Cincinnati, Ohio (Crosley Radio Corporation)	52.02 (2200-0400 G.M.T. except Fri.)
TVE	SS. <i>Solderijf</i>	31.0						WND	Elgin, Illinois	33.5 (Special Time Signals)
U 1XAO	Belfast, Maine	40.0, 56.0, 60.0, 70.0						WNU	Ocean Township, N. J. (American Telephone & Telegraph Co.)	13.88, 16.35, 22.38, 32.69, 46.48
U 1XAB	Portland, Maine (Congress Square Hotel Co.)	63.79 (250 Watts)						WOB	New Orleans, Louisiana	26.0, 40.0 (Press Reports)
U 1XR	Manila, Philippine Islands	20.0						WOBV	U. S. S. <i>Nippokoniu</i>	37.0, 43.74, 77.0
U 2XAA	Houlton, Maine	22.99 (Phone after 2300 G.M.T.)						WOP	Fort Wayne, Indiana (Main Auto Supply Co.)	36.2, 72.4, 21.57, 43.14
U 2XAC	G. E. Co., Schenectady, N. Y.	50.0						WPE	Rocky Point, N. Y. (R.C.A.)	22.80 (1 kw.) (Phone after 2300 G.M.T.)
U 2XAD	G. E. Co., Schenectady, N. Y.	21.96 (Phone Mon., Wed., Fri., 2400; Sat., 1900-2200 G. M. T.)						WQA	Rocky Point, N. Y. (R.C.A.)	21.63, 43.14
U 2XAF	G. E. Co., Schenectady, N. Y. transmitting program from WGY	32.7 (Phone Tues., Thurs. and Sat., 2300 G. M. T.)						WQB	Rocky Point, N. Y. (R.C.A.)	14.13, 28.26
2XAI	Newark, N. J. (Westinghouse Electric Co.)	43.0						WQC	Rocky Point, N. Y. (R.C.A.)	16.71, 33.42
2XAL	New York, short-wave transmitter (Publ. Co.)	30.91						WQN	Rocky Point, N. Y. (R.C.A.)	16.78, 33.57
U 2XAO	Belfast, Maine	40.0, 56.0, 60.0, 70.0						WQQ	Rocky Point, N. Y. (R.C.A.)	51.5, 54.5, 57.0
U 2XAP	G. E. Co., Schenectady, N. Y.	18.3, 18.7, 36.6, 37.5						WQQ	Rocky Point, N. Y. (R.C.A.)	35.03, 44.0
U 2XAW	Newark, N. J. (Short-wave Station of WAAM)	3.0-20.0, 15.0						WQX	Rocky Point, N. Y. (R.C.A.)	14.8
U 2XBA	New York (R. C. A.)	65.18 (Phone Mon., Wed., Fri., 2355-0500 G. M. T.)						WQY	Rocky Point, N. Y. (R.C.A.)	14.85, 29.71
U 2XBB	Rocky Point, N. Y. (R.C.A.)	1-5 (1kw.)						WRB	Miami, Florida (Radio Florida News)	14.91, 29.83
U 2XBC	Rocky Point, N. Y. (R.C.A.)	14.09 and 5.35-18.74						WRNY	Coteyville, N. J. ("Radio News")	70.74
U 2XBI	Rocky Point, N. Y. (R.C.A.)	1-15 (10 kw.)						WSS	Rocky Point, N. Y. (R.C.A.)	30.91 (Phone Mon., Wed., Fri., 1930-2215 G.M.T.; other days, 2355-0500)
U 2XE	Richmond Hill, N. Y. (Short-wave of WABC)	22.1 (Phone after 2300 G.M.T.)						WTT	Rocky Point, N. Y. (R.C.A.)	16.0, 20.0, 16.02
U 2XG	Rocky Point, N. J. (Western Electric Co.)	16.02 (Phone Mon. and Fri. after 1700 G.M.T.)						XDA	Mexico City, Mexico	31.0 (Press Reports, 0500 G.M.T.)
U 2XH	Schenectady, N. Y.	50.0						XEK 4AP	German Aeroplane	42.5
U 2XI	Schenectady, N. Y.	30.0, 35.0, 38.0						YZ	Fort d'Issy, France	45-47
U 2XK	South Schenectady, N. Y. (General Electric Co.)	65.5						ZWT	Bremerhaven	53.0
U 2XN	Rocky Point (R.C.A.)	5-80 (150 Watts)						ZZ	Fort d'Issy (Portable)	45-47
U 2XS	Rocky Point (R. C. A.)	14.93 (80kw.)								
U 2XT	Rocky Point, N. Y. (R.C.A.)	16.17 (80 kw.)								
U 3XL	Mount Brook, N. J.	60.0 (30 kw.)								
U 3XQ	Mountain Lakes, N. J.	37.95, 75.9								
U 4XK	San Juan, Porto Rico (Bull Insular Line)	18.3, 18.7, 36.6, 37.5								
U 5XH	New Orleans (Tropical Radio Telegraphic Co.)	42.0								
U 6XAI	Inglewood, California	66.04 (Phone 2400 G.M.T. onwards)								

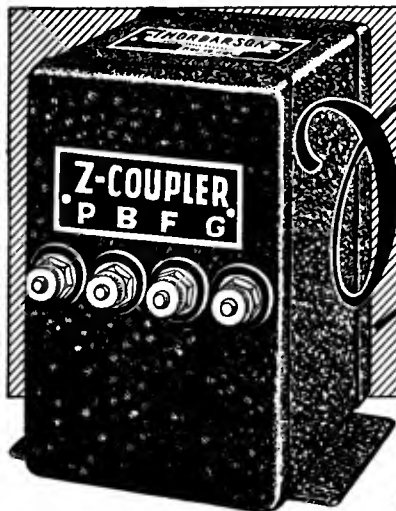

*The Thordarson Z-Coupler, a special audio impedance coupler for use with screen grid tubes; price each, \$12.*

# *New!* SCREEN-GRID Audio Amplification

Screen grid audio amplification, most revolutionary development in audio systems since the introduction of the power tube, is now an established fact.

The Thordarson Z-Coupler is a special audio coupling device designed for use with the screen grid tube UX-222. With the remarkable amplification thus obtained a mere whisper from the detector is stepped up to a point that gives the power tube all it can handle in the way of signal voltage. In fact, one stage Z-Coupled audio has the amplification equivalent of two, or even three, stages of ordinary coupling. Signals barely audible before may now be heard at normal room volume.

In tone quality, too, the Z-Coupler is unexcelled. Despite the high amplification the tonal reproduction is as nearly perfect as any audio amplifier yet developed. Both high and low notes come through with the same volume increase. Even at 60 cycles the amplification is over 95% of maximum.

Regardless of the type of your receiver you can vastly improve its performance by including this new system of amplification. The Z-Coupler replaces the second audio transformer, with very few changes in the wiring. The screen grid tube is used in the first audio stage. No shielding is required.

## THORDARSON Z-COUPLER

THORDARSON ELECTRIC MANUFACTURING CO.

*Transformer Specialists Since 1895*  
 WORLD'S OLDEST AND LARGEST EXCLUSIVE TRANSFORMER MAKERS  
 Huron and Kingsbury Streets - Chicago, Ill. U.S.A.

### Write To-Day for Complete Information

THORDARSON ELECTRIC MFG. CO.  
 Huron and Kingsbury Sts., Chicago, Ill.  
 Gentlemen:

Without obligation on my part, please send me complete information on screen grid audio amplifiers using your new Z-Coupler. (3578-J)

Name.....

Street and No.....

Town..... State.....



Don't use old  
or Inferior Tubes  
with New ones  
Use new  
**Cunningham**  
RADIO TUBES

throughout  
and enjoy  
modern radio  
reception at  
its best

E. T. CUNNINGHAM, Inc.  
New York Chicago  
San Francisco

# The Radio Broadcast

## LABORATORY INFORMATION SHEETS

THE RADIO BROADCAST Laboratory Information Sheets are a regular feature of this magazine and have appeared since our June, 1926, issue. They cover a wide range of information of value to the experimenter and to the technical radio man. It is not our purpose always to include new information but to present concise and accurate facts in the most convenient form. The sheets are arranged so that they may be cut from the magazine and preserved for constant reference, and we suggest that each sheet be cut out with a razor blade and pasted on 4" x 6" filing cards, or in a notebook. The cards should be arranged in numerical order. In July, 1927, an index to all Sheets appearing up to that time was printed. This month we print an index covering the sheets published from August, 1927, to May, 1928, inclusive.

All of the 1926 issues of RADIO BROADCAST are out of print. A complete set of Sheets, Nos. 1 to 88, can be secured from the Circulation Department, Doubleday, Doran & Company, Inc., Garden City, New York, for \$1.00. Some readers have asked what provision is made to rectify possible errors in these Sheets. In the unfortunate event that any serious errors do occur, a new Laboratory Sheet with the old number will appear

—THE EDITOR.

No. 185

RADIO BROADCAST Laboratory Information Sheet

May, 1928

### Tube Overloading

#### EFFECT OF INCORRECT VOLTAGES

DURING recent years many familiar types of radio tubes have played the rôle of "Jack of all trades," and as a result have frequently been placed in service under conditions never intended or contemplated by the manufacturer.

What constitutes "overload" on a tube, resulting in shortened life? It might be imagined that the last tube in a receiver tuned-in on a strong local station, and with the volume turned up beyond the point where the music sounds clear, would fall under this classification, but this is not the case. This is a form of overloading, but one which only results in distorted music, and in general the tube is not affected at all. A severe overload permanently affecting the tube occurs, however, when the manufacturer's specifications as regards filament, plate, and grid voltages are disregarded and higher voltages are used.

One of the popular tube types affords a good illustration of this condition. The voltages recommended for type 201-A tubes are a filament voltage of 5.0

volts, and plate voltages of 90 to 135 volts, with the grid bias specified as -4.5 and -9.0 volts respectively. If the grid bias of 4.5 volts recommended at 90 volts is omitted it is equivalent to adding about 35 volts to the plate voltage, or in other words, is equivalent to operation of the tube at 125 volts with -4.5 volts bias. The overload is, of course, correspondingly more severe if the plate voltage is raised. This is clearly shown in the table below:

PLATE VOLTS	GRID VOLTS	CURRENT M. A.	EXTENT OF OVERLOAD
90	4.5	2.0	Below maximum
135	9.0	2.5	Normal
90	0	6.0	58%
120	0	9.8	240%
135	0	12.0	380%

The 201-A type tube is capable of withstanding some overload more successfully than other types of tubes, but as a general rule it is always advisable to follow the manufacturer's ratings regarding tube voltage.

No. 186

RADIO BROADCAST Laboratory Information Sheet

May, 1928

### The UX-250 and CX-350

#### A NEW POWER AMPLIFIER

THE ux-250 (cx-350) is the latest tube designed for use as a power amplifier to supply large amounts of undistorted power for the operation of loud speakers. The large output obtainable from this tube prevents any possibility of overloading of the last stage of an audio amplifier.

The filament rating is 7.5 volts, 1.25 amperes. The material used in the filament is the rugged coated ribbon form, similar to that used in the UX-280 (cx-380) rectifier, the filament operating at a dull red. The filament current may be supplied from the 7.5-volt winding of a power transformer. The low operating temperature and the increased size

of this type of filament results in minimum ripple voltage or "hum."

It should be noted that, although the filament and plate voltages are the same as those for the UX-210 (cx-310) tube, the plate current is 55 milliamperes at a plate voltage of 400 volts whereas under similar conditions, the plate current of the UX-210 (cx-310) is only 18 milliamperes. The grid voltages for these two tubes, at a plate voltage of 400 volts, are respectively -70 and -31.5, the larger voltage being necessary on the ux-250 (cx-350) tube. Because of the higher plate current and grid bias required by this new tube it cannot always be used to replace the ux-210 (cx-310) tube without changing the circuit.

Plate Voltage	RECOMMENDED				MAXIMUM
	250	300	350	400	
Negative Grid Bias	45	54	63	70	450 Volts
Plate Current	28	35	45	55	84 Volt
Plate Resistance (a.c.)	2100	2000	1900	1800	55 Milliamp.
Mutual Conductance	1800	1900	2000	2100	1800 Ohms
Voltage Amplification Factor	3.8	3.8	3.8	3.8	2100 Micromhos
Max. Undistorted Power Output	900	1500	2350	3250	3.8
Filament	7.5 Volts 1.25 Amperes				4650 Milliwatts
Max. Overall Height	6 1/2" Diameter 2 1/4"				
Base:	Large Standard ux (cx)				

# BENJAMIN

## Cle-Ra-Tone Sockets

**Red Top**

For Standard UX Type Tubes. For quick and easy finding of the correct position of the tube and the prongs.

**Green Top**

A new Five Prong Socket for A. C. Detector Tubes. Especially designed for heavy current-carrying capacity for these new tubes.

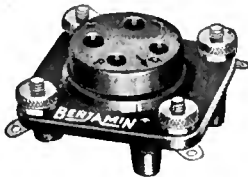

You can tell immediately into what socket each tube should go. No more mistakes, hesitation or confusion. Improves the appearance of the set.

Cle-Ra-Tone Sockets are spring supported to absorb the shocks that distort tonal qualities. The tube "floats" on four finely tempered springs, which absorb shocks and jars from slamming doors, passing traffic and other disturbances caused by outside vibrations. One-piece terminal to tube connection. Positive contacts. Knurled nuts for binding post connections or handy lugs for soldering.

Cle-Ra-Tone Sockets have been chosen for practically every prominent circuit for several years.

At All Radio Jobbers and Dealers

**Benjamin Electric Mfg. Co.**

120-128 So. Sangamon St., Chicago  
247 W. 17th St. New York  
448 Bryant St. San Francisco

# ARBORPHONE RADIO



A.C.  
Lamp Socket  
Operation

### Loftin-White Circuit and Other Exclusive Features

For those in whom the pride of ownership is strong, for those who instinctively choose the best, the Model 35 AC Arborphone Radio is a revelation. Q A revelation in exact reproduction of broadcast programs, in the depth and range of tone that produce such fidelity, in engineering design and conscientious workmanship. Q It is available in a variety of cabinet and console styles. Q The famous Loftin-White circuit as perfected in the new Arborphone is described in a 24-page booklet. It is yours upon request.

- SEVEN TUBES
- SINGLE DIAL CONTROL
- NO BATTERIES
- NO ACIDS
- NO LIQUIDS

CONSOLIDATED RADIO CORPORATION

Arborphone Division

ANN ARBOR, MICHIGAN

Licensed under R C A and Loftin-White patents

## More POWER

### From Your Eliminator



If your Raytheon eliminator will not hold its voltage when supplying one or two 171 or 371 tubes, you can probably bring it back to full voltage by the addition of an Aerovox Condenser as shown. Here is the circuit. The Condenser is a 4 Mfd. type 402.

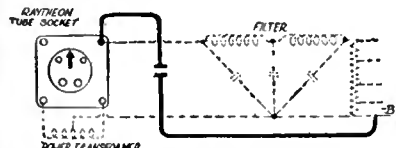

The Aerovox "Research Worker" contains much useful and interesting information. A postcard will put your name on the mailing list.

**AEROVOX**  
78 WASHINGTON ST.  
BROOKLYN, N. Y.

Why not subscribe to *Radio Broadcast*? By the year only \$4.00; or two years \$6.00, saving \$2.00. Send direct to Doubleday, Doran & Co., Inc., Garden City, New York.

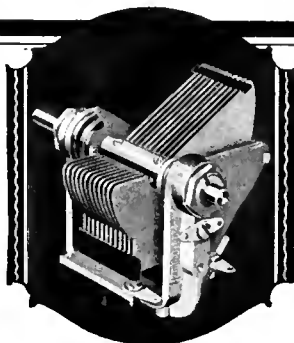

### HAMMARLUND "Midline" CONDENSER

Soldered brass plates with tie-bars; warless aluminum alloy frame; ball bearings; bronze clock-spring pigtail; full-floating, removable rotor shaft permits direct tandem coupling to other condensers. Made in all standard capacities and accurately matched.

Write for Folder

HAMMARLUND MFG. CO.  
424-438 W. 33rd St. New York

### Whatever Your Favorite Circuit Use

## HAMMARLUND PARTS

The "Midline" is but one of many Hammarlund models, designed to fit your exact condenser requirements.

Single (in all standard capacities for long and short waves); multiple; double-spaced models for transmitting; the famous "Hammarlund Jr." Midget; and the tiny equalizing condenser—not much larger than a postage stamp, but Hammarlund quality clear through.

The designers of most of the season's featured circuits officially specify one or more Hammarlund products. You, too, should take a tip from the experts and use—

For Better Radio  
**Hammarlund**  
PRECISION  
PRODUCTS



Adds the  
Final Touch

# TABLE TYPE CLAROSTAT

Reg. U. S. Pat. Off.

THE ideal control for volume and tone of your loud-speaker, from soft, soothing background for conversation, reading, dining, resting, 'phoning or dozing, to loud, crisp, snappy entertainment for center of interest. And it's always at your finger tips—on the end table, easy-chair arm, dining table, davenport, sick-room table, telephone stand—anywhere for remote control of radio entertainment.

Handsomely finished in statuary bronze and nickel. Felt bottom to protect finest furniture. Bakelite knob. Two cordswith tips and connector block for applying to battery or socket-power set, without tools, skill, time or trouble. Learn the new joys of controlled radio! And all for \$2.50!!

Ask your radio dealer to show you the Table Type Clarostat and give you copy of "Radio Etiquette". Or write us direct for interesting data on improving your radio.

American Mechanical Laboratories  
Incorporated  
Specialists in Variable Resistors  
285-7 N. Sixth St., Brooklyn, N. Y.

MEMBER  
**RMA**

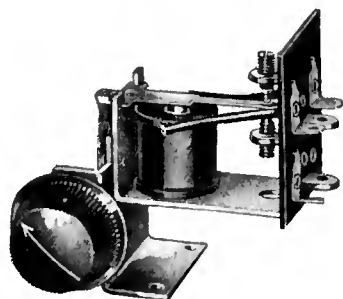

## BRACH RAYFOTO RELAY

Used Exclusively  
in the

## COOLEY Rayfoto Receiver

Approved by  
A.G. COOLEY

For Further Information Address

## L.S. BRACH MFG. CORP.

ENGINEERS AND MANUFACTURERS  
NEWARK N. J. U.S.A. TORONTO, CAN.

No. 187

RADIO BROADCAST Laboratory Information Sheet

May, 1928

### Grid Bias

#### HOW TO CALCULATE BIAS

THIS Laboratory Information Sheet gives some information regarding grid bias and how it depends upon the voltage of the grid battery and the manner in which the filament circuit of the tube is wired.

The bias voltage on the grid of a tube is always specified with respect to the negative end of the filament. In drawing A of the diagram on Sheet No. 188, the grid voltage is zero.

In drawing B, the filament resistance  $R$  has been placed in the negative leg of the filament, and since the drop across this resistance is 1.0 volt, the grid bias is also -1.0 volt.

In drawing C, a 4½-volt battery has been introduced in the circuit so that the grid bias is now equal to the voltage of this battery plus the voltage drop

across the resistance  $R$ . The bias is therefore -4½ plus -1.0 or -5½ volts.

A positive grid bias of +6.0 volts is obtained if the resistance  $R$  is connected in the positive leg of the filament and the grid return is connected to the +A terminal of the battery. See sketch D. If the grid return was connected to the other leg of the resistance, the grid bias would be equal to the voltage drop in the filament or +5.0 volts.

A variable grid bias from -1.0 to +5.0 volts can be obtained by means of the potentiometer  $P$  in drawing E. With the potentiometer at the extreme left-hand position, the bias is -1.0 volt (due to the voltage drop in  $R$ ) and with the arm moved over to the extreme right-hand position the bias is +5.0 volts.

From the information given in this Sheet it should be possible to determine the grid bias with any circuit arrangement.

No. 188

RADIO BROADCAST Laboratory Information Sheet

May, 1928

### Grid Bias Calculations

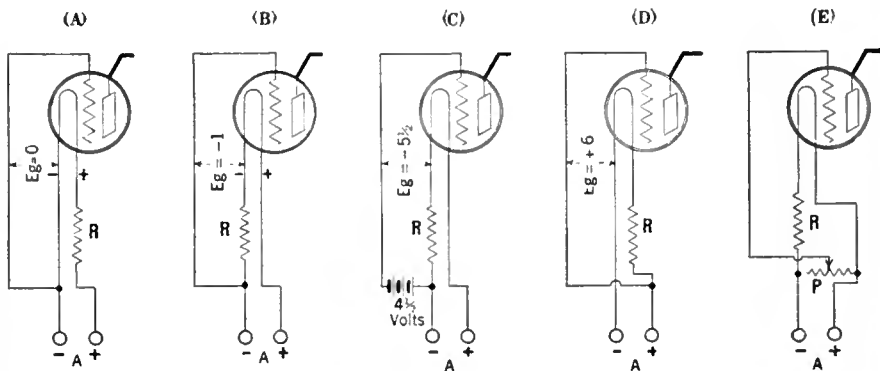

Laboratory Sheet No. 187 explains these five circuit arrangements. Determination of the grid bias of any circuit arrangement is a simple matter once the information contained on these sheets is mastered

No. 189

RADIO BROADCAST Laboratory Information Sheet

May, 1928

### The A. C. "Universal" Receiver

#### PARTS REQUIRED

LABORATORY Sheet No. 190 gives the circuit of the "Universal" receiver wired for a.c. operation. The d.c. receiver was described in the December, 1926, RADIO BROADCAST and the circuit of the d.c. receiver was also given on Laboratory Sheet No. 100, June, 1927. The a.c. circuit is published in response to many requests from readers.

$L_1$ —Antenna coil consisting of 13 turns of No. 26 d.s.c. wire wound at one end of a 2½-inch tube.

$L_2$ —Secondary coil consisting of 50 turns of No. 26 d.s.c. wire wound on the same tube as  $L_1$ . The separation between  $L_1$  and  $L_2$  should be ¼ inch.

$L_3$ —Primary of interstage coil constructed in same manner as  $L_1$  and tapped at the exact center.

$L_4$ —Secondary winding constructed in same manner as  $L_2$  and tapped at point A, the 15th turn from that end as  $L_4$  which is nearest to  $L_3$ .

$C_1, C_2$ —Two 0.0005-mfd. variable condensers.

$C_3$ —Neutralizing condenser, variable, 0.00015 mfd.

$C_4$ —Regeneration condenser, 0.00005 mfd.

$L_5$ —R.F. choke coil, made by winding 400 turns of No. 28 wire on 1" dowel.

$T_1, T_2$ —Two audio-frequency transformers.

$R_1$ —Fixed resistance, 1000 ohms.

$R_2, R_3, R_4$ —Center-tapped resistances for a.c. tubes.

$R_5$ —Fixed resistance, 2000 ohms.

$R_6$ —Grid leak, 2 megohms.

$C_5, C_6$ —Bypass condensers, 1-mfd.

$C_7$ —Grid condenser, 0.00025-mfd.

$C_8$ —Output condenser, 200 volts, 4-mfd.

$L_6$ —Output choke, 60 henries.

$VT_1, VT_2$ —226 type a.c. tubes.

$VT_3$ —227 type a.c. tube.

$VT_4$ —171 type tube.

Three standard four-prong sockets.

One five-prong socket.

Binding posts.

C bias for the tubes is obtained from resistances  $R_1$  and  $R_3$ .

The 227 type detector tube requires about 30 seconds to heat up and begin functioning and therefore about this length of time must lapse between the time the power is turned on and the set begins to operate. The receiver must, of course, be carefully neutralized.

No. 190

RADIO BROADCAST Laboratory Information Sheet

May, 1928

A revised arrangement of the well-known "Universal" circuit which provides for the use of a.c. tubes. It is fully described on Laboratory Sheet No. 189

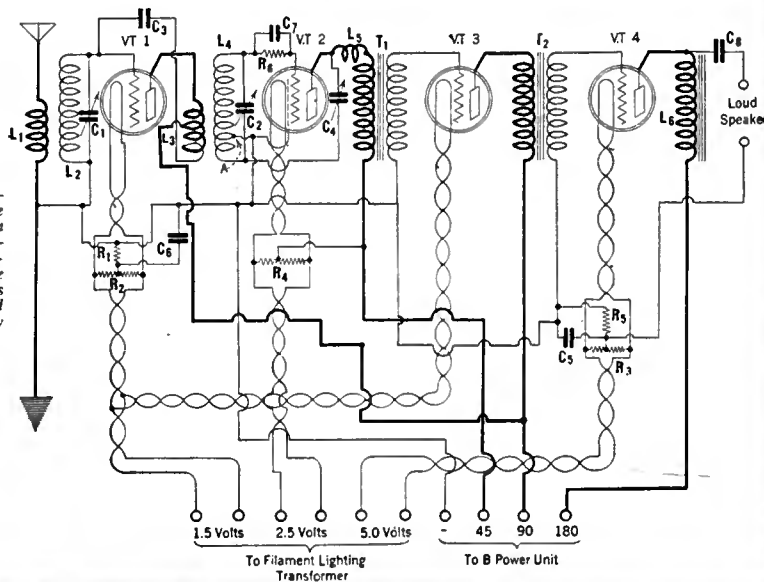

No. 191

RADIO BROADCAST Laboratory Information Sheet

May, 1928

Index

August, 1927, to May, 1928

SHEET NUMBER MONTH		SHEET NUMBER MONTH	
Acoustics	166 February	Glow Tubes:	
A Battery Chargers	120 August	How they function	129 October
Audio Amplifier:		Why they are used	173 March
A.C. Operated	148,149 December	Grid Bias	
Frequency and load characteristic	118 August	Calculating Its Value	187 May
General considerations	165 February	Why It Is Used	174 March
Resistance-Coupled	131,132 October	Hertz Antenna	121 September
Transformer Ratio, Effect of	179 April	Honeycomb Coils, Data on	130 October
Capacity, The Unit of	138 November	Inductive Reactance	139,140 November
Carrier Telephony	136 October	Loud Speakers:	
Chargers, A Battery	120 August	Exponential Type	134 October
Choke Coils, Radio-Frequency	119 August	General Considerations	145 December
Condenser Reactance	126,127 September	Modulated Oscillator	164 February
Constant Frequency Stations	153 January	Morse Code	125 September
Coupled Circuits	135 October	Oscillation Control	150 December
Ear, Characteristics of the	168 February	Output Devices	113 August
Exponential Horn, The	178 April	Overloading, Effect on Tube	185 May
Fading	160 January	Power Supply Devices:	
Filter Choke Coils	175 March	Calculation of various voltages	142 November
Filter Condensers	182 April	Care of	133 October
Gain, R. F. Amplifiers	147 December	Characteristics at various voltages	146 December
		Desirable Characteristics	128 September
		Transformer Voltages, Effect of	180 April

No. 192

RADIO BROADCAST Laboratory Information Sheet

May, 1928

Index (Continued)

August, 1927, to May, 1928

SHEET NUMBER MONTH		SHEET NUMBER MONTH	
Radio-Frequency Choke Coils	119 August	Tubes:	
R. F. vs. A. F. Amplification	181 April	Alternating-Current Types	141 November
Receivers, Testing of	122 September	Comparison of 112 and 171	171 March
Resonant Circuits	163 February	Comparison of 112, 171, and 210	161,162 February
Roberts Reflex, The	158,159 January	Effect of plate circuit on grid circuit	176 March
Selectivity	170 March	Parallel Operation	137 November
Sensitivity	170 March	171	123,124 September
Single-Control Receiver, Boosting Sensitivity of	151 December	112-A	154 January
Solenoid Coil Data	143 November	171-A	154 January
Speech:		222	169 March
Articulation	177 April	280 and 281	183 April
Sources of Information on	152 December	250	186 May
Standard Frequency Stations	153 January	Tuning, Effect of Distributed Capacity on	184 April
Static	116 August	"Universal" Receiver, A. C. Operation of	189,190 May
Super-heterodyne, The	117 August	Wavelength-Frequency Conversion	156,157 January
Transmission Unit, The	114 August	Wavemeter, A Simple	172 March
	145 December	Wave Traps	155 January
			115 August



# Announcing Dongan By-Pass and Filter Type Condensers

With the acquisition of the business and equipment of the Electrical Specialties Mfg. Company, Inc., Dongan now offers the manufacturers of radio receivers a line of fixed condensers comparable in quality and ingenuity of design to Dongan Radio Transformers.

Mr. C. Ringwald, an authority on condenser design and construction, will direct the condenser division of the Dongan radio line.

Just as Dongan has pioneered in transformer development, so will the Dongan laboratories strive to maintain front rank in fixed condenser design.

Thus the radio industry is assured additional permanency in the approved parts field.

*Dongan will continue its policy as an exclusive source to set manufacturers*

### —another Transformer Success

To meet the increased capacity of the new UX 250 power amplifier tube, Dongan engineers have perfected two new Output Transformers. No. 1176 is Push Pull type, No. 1177 a straight power amplifier type.

### A Popular A C Transformer

No. 6512



This is one of the best-liked A C transformers on the market. It is designed to operate with 4 UX 226, 1 UX 227 and 1 UX 171 power amplifier tubes. Mounted substantially in crystallized lacquered case, equipped with lamp cord and plug outlet for B-eliminator, also tap for control switch. \$5.75.

Set Manufacturers and Custom Set Builders will be furnished with any desired information and engineering data on request

DONGAN ELECTRIC MFG. CO.  
2991-3001 Franklin St., Detroit, Michigan

Model 528



### Three Ranges 150/8/4 Volts for Testing A. C. Receivers

For checking up supply and tube voltages—a small, compact and portable instrument of highest quality and electrical performance, yet moderate in price. Open scales, responsive and excellently damped. At all dealers or write to:—

WESTON ELECTRICAL INSTRUMENT CORP.  
604 Frothinguysen Ave. Newark, N. J.

# WESTON RADIO INSTRUMENTS

## Jenkins & Adair Condenser Transmitter

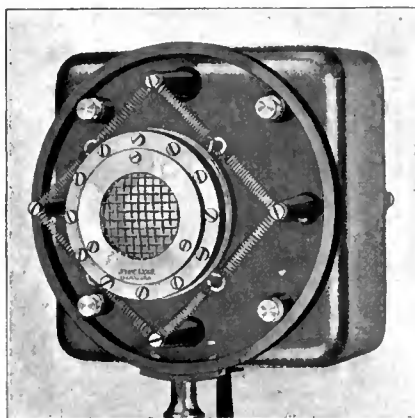

### For Broadcasting, Phonograph Recording, and Power Speaking Systems

THIS transmitter is a small condenser which varies its capacity at voice frequency, and is coupled direct into a single stage of amplification, contained in the cast aluminum case. The output, reduced to 200 ohms, couples to the usual input amplifier. The complete transmitter may be mounted on the regulation microphone stand. It operates on 180 v. B and 6 or 12 v. A battery.

This transmitter contains no carbon, and is entirely free from background noise. Its yearly upkeep is practically nothing. It is extremely rugged, and will withstand hard usage.

Price, complete with 20 ft. shielded cable, \$225.00 F.O.B. Chicago.

J. E. JENKINS & S. E. ADAIR, Engineers  
1500 N. Dearborn Parkway,  
Chicago, U. S. A.

Send for our bulletins on Broadcasting Equipment

## PRESS, WEATHER, AND TIME SIGNALS

THE list below has just been released by the Navy Department, radio service, to RADIO BROADCAST. It includes the press, weather hydrographic, and time signals transmitted by United States Naval Stations throughout the world. This list supersedes that appearing on page 514 of this magazine for March, 1927. The material in columns three and four below is of especial interest. The abbreviations employed and their meaning follows: "i.c.w." interrupted continuous wave; "c.w.," continuous wave; "a.c.w.," raw a.c. These trans-

missions are of vital importance to all marine and shore station operators. Other readers who are interested in listening to these signals should employ a simple regenerative circuit with a long antenna. A satisfactory receiver for this purpose was described on RADIO BROADCAST Laboratory Information Sheet No. 19, August 1926. Also, the article, "A Portable Long-Wave Receiver," page 166, RADIO BROADCAST, July 1927, describes a receiver especially designed for long-wave reception.

TIME (GREENWICH CIVIL)	STATION	CALL SIGN	FREQUENCY IN KC/S AND TYPE OF EMISSION	MATERIAL BROADCAST
0000	Brownsville, Tex.	NAY	132 i. c. w.	Weather.
0015	San Juan, P. R.	NAU	48 c.w.	Weather (1 July to 15 November).
0100	Norfolk, Va. Puget Sound, Wash.	NAM NPC	122 i.c.w. 118 c.w.	Weather Weather.
0115	Arlington, Va.	NAA	4015 i.c.w.	Aviation weather and upper air reports.
0130	Eureka, Calif. Norfolk, Va.	NPW NAM	104 i.c.w. 122 i.c.w.	Weather, hydrographic. Weather.
0200	Cavite, P. I. Guantanamo Bay, Cuba. San Juan, P. R.	NPO NAW NAU	56 c.w. & 112 i.c.w. 118 i.c.w. 106 i.c.w.	Press. Weather (1 June to 15 November). Weather (1 July to 15 November).
0255 to 0300	Arlington, Va.	NAA	112 i.c.w. 690 i.c.w. 4015 i.c.w. 8030 i.c.w. 12045 i.c.w.	Time Signals.
	Annapolis, Md. Cavite, P. I.	NSS NPO	17.6 c.w. 56 c.w. 112 i.c.w.	Time Signals. Time Signals.
0300	Arlington, Va.  Cavite, P. I. Key West, Fla. Puget Sound, Wash.	NAA  NPO NAR NPC	36 c.w. 112 i.c.w.  56 c.w. 112 i.c.w. 102 i.c.w. 118 c.w.	Marine Weather followed by Navigational Warnings and ice reports (in season). Weather, hydrographic. Weather, hydrographic. Hydrographic.
0305	Navy Yard, Wash. D. C.	NAA	690 voice	Weather.
0330	San Francisco, Calif. Tutuila, Samoa	NPG NPU	42.8 c.w. 108 i.c.w. 66 c.w.	Weather, hydrographic. Hydrographic.
0355 to 0400	Balboa, C. Z. Colon, C. Z.	NBA NAX	46 c.w. 132 i.c.w.	Time Signals. Time Signals.
0400	Arlington, Va. Great Lakes, Ill. Puget Sound, Wash. San Juan, P. R.	NAA NAJ NPC NAU	4015 i.c.w. 132 i.c.w. 118 c.w. 48 c.w.	Weather broadcast to Europe. Weather, hydrographic. Weather. Weather.
0430	Astoria, Oreg. San Diego, Calif.	NPE NPL	112 i.c.w. 102 i.c.w.	Hydrographic. Weather.
0500	Brownsville, Tex.	NAY	132 i.c.w.	Weather.
0555 to 0600	San Francisco, Calif.	NPG	42.8 c.w. 62 c.w. 108 i.c.w.	Time Signals.
0600	San Francisco, Calif.	NPG	108 i.c.w.	Weather, hydrographic.
0630	Honolulu, T. H.	NPM	54 a.c.w.	Weather, hydrographic.
0700	Annapolis, Md. Arlington, Va.	NSS NAA	17.6 c.w. 112 i.c.w.	Press. Press.
0730	Tutuila, Samoa	NPU	66 c.w.	Hydrographic.
1000	Balboa, C. Z. Balboa, C. Z. Colon, C. Z. San Diego, Calif.	NBA NBA NAX NPL	46 c.w. 118 c.w. 132 i.c.w. 30.6 c.w.	Press and hydrographic. Press. Hydrographic. Press.
1300	Puget Sound, Wash.	NPC	118 c.w.	Weather.
1315	Arlington, Va.	NAA	4015 i.c.w. 8030 i.c.w. 12045 i.c.w.	Aviation weather and upper air reports.
1330	Norfolk, Va.	NAM	122 i.c.w.	Weather.
1355 to 1400	Cavite, P. I.	NPO	56 c.w. 112 i.c.w.	Time Signals.
1400	Cavite, P. I.	NPO	56 c.w. 112 i.c.w.	Weather, hydrographic.
1500	Arlington, Va.	NAA	112 i.c.w. 16060 i.c.w.	Marine weather followed by ice reports (in season).
1505	Arlington, Va.	NAA	690 voice	Weather.

PRESS, WEATHER, AND TIME SIGNALS

(Continued)

TIME (GREENWICH CIVIL)	STATION	CALL SIGN	FREQUENCY IN KC/S AND TYPE OF EMISSION	MATERIAL BROADCAST
1530	New York, N. Y. Charleston, S. C.	NAH NAO	108 i.c.w. 122 i.c.w.	Weather, hydrographic. Weather, hydrographic.
1545	Philadelphia, Pa. Great Lakes, Ill. Norfolk, Va.	NAI NAJ NAM	101 i.c.w. 132 i.c.w. 122 i.c.w.	Weather, hydrographic. Weather, hydrographic. Weather, hydrographic.
1600	Boston, Mass. Newport, R. I. Arlington, Va.  New Orleans, La. San Juan, P. R. Savannah, Ga.	NAD NAF NAA  NAT NAU NEV	102 i.c.w. 118 i.c.w. 12045 i.c.w.  106 c.w. 48 c.w. 132 i.c.w.	Weather, hydrographic. Weather, hydrographic. Weather broadcast to Europe. Weather, hydrographic. Weather. Weather.
1630	Jupiter, Fla. San Diego, Calif. St. Augustine, Fla.	NAQ NPL NAP	132 i.c.w. 102 i.c.w. 128 spark	Weather. Weather. Weather.
1645	Pensacola, Fla.	NAS	112 i.c.w.	Weather.
1655 to 1700	Arlington, Va.  Annapolis, Md. Great Lakes, Ill. Key West, Fla. New Orleans, La. San Diego, Calif.	NAA  NSS NAJ NAR NAT NPL	112 i.c.w. 690 i.c.w. 4015 i.c.w. 8030 i.c.w. 12045 i.c.w. 17.6 c.w. 132 i.c.w. 102 i.c.w. 106 c.w. 30.6 c.w. 102 i.c.w.	Time Signals.  Time Signals. Time Signals. Time Signals. Time Signals. Time Signals.
1700	Arlington, Va. Brownsville, Tex. Eureka, Calif. Key West, Fla. Puget Sound, Wash. San Francisco, Calif.	NAA NAY NPW NAR NPC NPG	112 i.c.w. 132 i.c.w. 101 i.c.w. 102 i.c.w. 118 c.w. 42.8 c.w.	Navigational warnings. Weather. Weather, hydrographic. Weather, hydrographic. Weather, hydrographic. Weather, hydrographic.
1755 to 1800	Balboa, C. Z. Colon, C. Z.	NBA NAX	46 c.w. 132 spark	Time Signals. Time Signals.
1800	Balboa, C. Z.	NBA	46 c.w.	Hydrographic.
1830	Honolulu, T. H.	NPM	54 a.c.w.	Weather, hydrographic.
1930	Tutuila, Samoa	NPU	66 c.w.	Hydrographic.
1955 to 2000	Astoria, Oreg. Eureka, Calif. San Francisco, Calif.	NPE NPW NPG	112 i.c.w. 101 i.c.w. 42.8 c.w. 62 c.w. 108 c.w.	Time Signals. Time Signals. Time Signals.
2045	Arlington, Va.	NAA	690 voice	Weather.
2100	Norfolk, Va. Puget Sound, Wash.	NAM NPC	122 i.c.w. 118 c.w.	Weather, hydrographic. Weather, hydrographic.
2130	Astoria, Oreg.	NPE	112 i.c.w.	Hydrographic.
2200	Boston, Mass. Newport, R. I. New York, N. Y. Phila, Pa. Annapolis, Md. Eureka, Calif. Great Lakes, Ill. New Orleans, La. San Diego, Calif.	NAD NAF NAH NAI NSS NPW NAJ NAT NPL	102 i.c.w. 118 i.c.w. 108 i.c.w. 101 i.c.w. 17.6 c.w. 104 i.c.w. 132 i.c.w. 106 c.w. 102 i.c.w.	Weather, hydrographic. Weather, hydrographic. Weather, hydrographic. Weather, hydrographic. Ice reports (in season). Weather, hydrographic. Hydrographic. Weather, hydrographic. Weather.
2230	Honolulu, T. H.	NPM	54 a.c.w.	Weather, hydrographic.
2300	Charleston, S. C. Jupiter, Fla. Pensacola, Fla. Savannah, Ga.	NAO NAQ NAS NEV	122 i.c.w. 132 a.c.w. 112 i.c.w. 132 i.c.w.	Weather, hydrographic. Weather. Weather. Weather.
2330	Tutuila, Samoa	NPU	66 c.w.	Hydrographic.
2355 to 2400	Honolulu, T. H.	NPM	26. i.c.w. 106 i.c.w.	Time signals.

A TIME CONVERSION TABLE

GREENWICH Mean Time was adopted by the recent International Radio Telegraph Convention in Washington for use in the Convention and regulations drawn up by it. Greenwich Civil Time is used in the Navy for navigation and that time is employed in naval almanacs. The conversion table below indicates the relation between G.C.T., G.M.T., and 75th Meridian Time. The latter is "Eastern Standard" Time and those living in other

time belts can easily calculate the time to listen for these transmissions in their own locality.

G.C.T. (Hours)	G.M.T. (Hours)	75TH MERIDIAN
0	12	7.00 p.m.
6	18	1.00 p.m.
12	0	7.00 p.m.
14	2	9.00 p.m.
18	6	1.00 p.m.
22	10	5.00 p.m.
24	12	7.00 p.m.

Electrify Your Set  
WITH THE  
**MARATHON**  
*A-C KIT*  
SIMPLE AS A-B-C

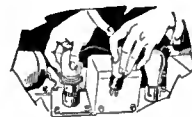

Replace your old Tubes with Marathon A-C Tubes

Marathon AC Tubes have the standard 4 prong UX bases. No adaptors or center tap resistors.

The Marathon harness is universal, and can be used in any set. The "spades" slip over the projections on the tube — no thumb screws.

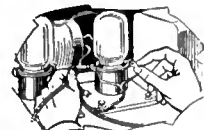

Connect the harness

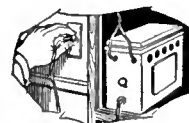

One end of the harness connects with the Marathon Transformer. All tubes operate on one voltage — 6 volts — so there are no taps. Simply plug the transformer into the light socket.

Plug in the light socket — that's all there is to do

YOU CAN'T MAKE IT COMPLICATED



Satisfaction

Guaranteed

No need to wonder if the Marathon AC Kit will operate on your set — we guarantee it. If you have a 5, 6, 7 or 8 tube set using UX sockets and are now employing an "A" Battery (either dry cell or storage) you can use the Marathon AC Kit — perfectly. Marathon AC Tubes are guaranteed for a year. If your dealer cannot supply you use the coupon below.



The Marathon AC Kit

is Complete

Nothing else to buy — everything is complete. For example the six tube kit includes 6 Marathon AC Tubes — a universal harness — a 6 volt Transformer — a volume control — and an instruction sheet. Anyone, no matter how ignorant of radio can change his set from DC to AC.

Jobbers — Dealers

Write or wire for our sales proposition. You can absolutely guarantee the operation of the Marathon AC Kit.

**NORTHERN MFG. CO.**  
NEWARK, NEW JERSEY

Northern Manufacturing Co.,  
376 Ogden St., Newark, N. J.

Send me complete information on the Marathon AC Kit.

Jobber..... Dealer.....  
Professional Builder..... User.....  
(Please check your classification)

Name.....  
Address.....

## New Aero Circuits

for Either Battery or A. C. Operation

Proper constants for A. C. operation of the Improved Aero-Dyne 6 and the Aero Seven have been studied out, and these excellent circuits are now adaptable to either A. C. or battery operation. A. C. blue prints are packed in foundation units. They may also be obtained by sending 25c for each direct to the factory.



### Aero Universal Tuned Radio Frequency Kit

Especially designed for the Improved Aero-Dyne 6. Kit consists of 4 twice-matched units. Adaptable to 201-A, 199, 112, and the new 240 and A. C. Tubes. Tuning range below 200 to above 550 meters.

Code No. U-16 (for .0005 Cond.) ..... \$15.00  
Code No. U-163 (for .00035 Cond.) ..... 15.00



### Aero Seven Tuned Radio Frequency Kit

Especially designed for the Aero 7. Kit consists of 3 twice-matched units. Coils are wound on Bakelite skeleton forms, assuring a 95 per cent. air dielectric. Tuning range from below 200 to above 550 meters. Adaptable to 210-A, 199, 112, and the new 240 and A. C. Tubes.

Code No. U-12 (for .0005 Cond.) ..... \$12.00  
Code No. U-123 (for .00035 Cond.) ..... 12.00

You should be able to get any of the above Aero Coils and parts from your dealer. If he should be out of stock order direct from the factory.

**AERO PRODUCTS, INC.**  
1772 Wilson Ave. Dept. 109 Chicago, Ill.

## Flexible A. C. Superheterodyne

An aristocrat of a famous family especially designed to meet the demands of that select circle of set builders who desire the finest in receiver construction with cost a secondary consideration.

Complete detailed blueprints on this unique combination of the best radio principles, \$1.00 postpaid. All specified parts supplied. Price list on request.

**DANA ADAMS**

222 East 52nd St. N. Y. City  
Western Office: 604 Davis St., Evanston, Ill.

## Manufacturers' Booklets

A Varied List of Books Pertaining to Radio and Allied Subjects Obtainable Free With the Accompanying Coupon

READERS may obtain any of the booklets listed below by using the coupon printed on page 57. Order by number only.

1. FILAMENT CONTROL—Problems of filament supply, voltage regulation, and effect on various circuits. RADIALL COMPANY.
2. HARD RUBBER PANELS—Characteristics and properties of hard rubber as used in radio, with suggestions on how to "work" it. B. F. GOODRICH RUBBER COMPANY.
3. TRANSFORMERS—A booklet giving data on input and output transformers. PACENT ELECTRIC COMPANY.
5. CARBORUNDUM IN RADIO—A book giving pertinent data on the crystal as used for detection, with hook-ups, and a section giving information on the use of resistors. THE CARBORUNDUM COMPANY.
7. TRANSFORMER AND CHOKE-COUPLED AMPLIFICATION—Circuit diagrams and discussion. ALL-AMERICAN RADIO CORPORATION.
9. VOLUME CONTROL—A leaflet showing circuits for distortionless control of volume. CENTRAL RADIO LABORATORIES.
10. VARIABLE RESISTANCE—As used in various circuits. CENTRAL RADIO LABORATORIES.
11. RESISTANCE COUPLING—Resistors and their application to audio amplification, with circuit diagrams. DEJUR PRODUCTS COMPANY.
12. DISTORTION AND WHAT CAUSES IT—Hook-ups of resistance-coupled amplifiers with standard circuits. ALLEN-BRADLEY COMPANY.
15. B-ELIMINATOR AND POWER AMPLIFIER—Instructions for assembly and operation using Raytheon tube. GENERAL RADIO COMPANY.
- 15a. B-ELIMINATOR AND POWER AMPLIFIER—Instructions for assembly and operation using an R. C. A. rectifier. GENERAL RADIO COMPANY.
16. VARIABLE CONDENSERS—A description of the functions and characteristics of variable condensers with curves and specifications for their application to complete receivers. ALLEN D. CARDWELL MANUFACTURING COMPANY.
17. BAKELITE—A description of various uses of bakelite in radio, its manufacture, and its properties. BAKELITE CORPORATION.
20. AUDIO AMPLIFICATION—A booklet containing data on audio amplification together with hints for the constructor. ALL-AMERICAN RADIO CORPORATION.
21. HIGH-FREQUENCY DRIVER AND SHORT-WAVE WAVE-METER—Constructional data and application. BURGESS BATTERY COMPANY.
46. AUDIO-FREQUENCY CHOKES—A pamphlet showing positions in the circuit where audio-frequency chokes may be used. SAMSON ELECTRIC COMPANY.
47. RADIO-FREQUENCY CHOKES—Circuit diagrams illustrating the use of chokes to keep out radio-frequency currents from definite points. SAMSON ELECTRIC COMPANY.
48. TRANSFORMER AND IMPEDANCE DATA—Tables giving the mechanical and electrical characteristics of transformers and impedances, together with a short description of their use in the circuit. SAMSON ELECTRIC COMPANY.
49. BYPASS CONDENSERS—A description of the manufacture of bypass and filter condensers. LESLIE F. MUTER COMPANY.
50. AUDIO MANUAL—Fifty questions which are often asked regarding audio amplification, and their answers. AMERTRAN SALES COMPANY, INCORPORATED.
51. SHORT-WAVE RECEIVER—Constructional data on a receiver which, by the substitution of various coils, may be made to tune from a frequency of 16,660 kc. (18 meters) to 1999 kc. (150 meters). SILVER-MARSHALL, INCORPORATED.
52. AUDIO QUALITY—A booklet dealing with audio-frequency amplification of various kinds and the application to well-known circuits. SILVER-MARSHALL, INCORPORATED.
56. VARIABLE CONDENSERS—A bulletin giving an analysis of various condensers together with their characteristics. GENERAL RADIO COMPANY.
57. FILTER DATA—Facts about the filtering of direct current supplied by means of motor-generator outfits used with transmitters. ELECTRIC SPECIALTY COMPANY.
59. RESISTANCE COUPLING—A booklet giving some general information on the subject of radio and the application of resistors to a circuit. DAVEN RADIO CORPORATION.
62. RADIO-FREQUENCY AMPLIFICATION—Constructional details of a five-tube receiver using a special design of radio-frequency transformer. CAMFIELD RADIO MFG. COMPANY.
63. FIVE-TUBE RECEIVER—Constructional data on building a receiver. AERO PRODUCTS, INCORPORATED.
66. SUPER-HETERODYNE—Constructional details of a seven-tube set. G. C. EVANS COMPANY.
70. IMPROVING THE AUDIO AMPLIFIER—Data on the characteristics of audio transformers, with a circuit diagram showing where chokes, resistors, and condensers can be used. AMERICAN TRANSFORMER COMPANY.
72. PLATE SUPPLY SYSTEM—A wiring diagram and layout plan for a plate supply system to be used with a power amplifier. Complete directions for wiring are given. AMERTRAN SALES COMPANY.
80. FIVE-TUBE RECEIVER—Data are given for the construction of a five-tube tuned radio-frequency receiver. Complete instructions, list of parts, circuit diagram, and template are given. ALL-AMERICAN RADIO CORPORATION.
81. BETTER TUNING—A booklet giving much general information on the subject of radio reception with specific illustrations. Primarily for the non-technical home constructor. BREMER-TULLY MANUFACTURING COMPANY.
82. SIX-TUBE RECEIVER—A booklet containing photographs, instructions, and diagrams for building a six-tube shielded receiver. SILVER-MARSHALL, INCORPORATED.
83. SOCKET POWER DEVICE—A list of parts, diagrams, and templates for the construction and assembly of socket power devices. JEFFERSON ELECTRIC MANUFACTURING COMPANY.
84. FIVE-TUBE EQUAMATIC—Panel layout, circuit diagrams, and instructions for building a five-tube receiver, together with data on the operation of tuned radio-frequency transformers of special design. KARAS ELECTRIC COMPANY.

85. FILTER—Data on a high-capacity electrolytic condenser used in filter circuits in connection with A socket power supply units, are given in a pamphlet. THE ABOX COMPANY.

86. SHORT-WAVE RECEIVER—A booklet containing data on a short-wave receiver as constructed for experimental purposes. THE ALLEN D. CAROWELL MANUFACTURING CORPORATION.

88. SUPER-HETERODYNE CONSTRUCTION—A booklet giving full instructions, together with a blue print and necessary data, for building an eight-tube receiver. THE GEORGE W. WALKER COMPANY.

89. SHORT-WAVE TRANSMITTER—Data and blue prints are given on the construction of a short-wave transmitter, together with operating instructions, methods of keying, and other pertinent data. RADIO ENGINEERING LABORATORIES.

90. IMPEDANCE AMPLIFICATION—The theory and practice of a special type of dual-impedance audio amplification are given. ALDEN MANUFACTURING COMPANY.

93. B-SOCKET POWER—A booklet giving constructional details of a socket-power device using either the BH or 313 type rectifier. NATIONAL COMPANY, INCORPORATED.

94. POWER AMPLIFIER—Constructional data and wiring diagrams of a power amplifier combined with a B-supply unit are given. NATIONAL COMPANY, INCORPORATED.

100. A, B, AND C SOCKET-POWER SUPPLY—A booklet giving data on the construction and operation of a socket power supply using the new high-current rectifier tube. THE Q. R. S. MUSIC COMPANY.

101. USING CHOKES—A folder with circuit diagrams of the more popular circuits showing where choke coils may be placed to produce better results. SAMSON ELECTRIC COMPANY.

22. A PRIMER OF ELECTRICITY—Fundamentals of electricity with special reference to the application of dry cells to radio and other uses. Constructional data on buzzers, automatic switches, alarms, etc. NATIONAL CARBON COMPANY.

23. AUTOMATIC RELAY CONNECTIONS—A data sheet showing how a relay may be used to control A and B circuits. YAKLEY MANUFACTURING COMPANY.

26. DRY CELLS FOR TRANSMITTERS—Actual tests given, well illustrated with curves showing exactly what may be expected of this type of B power. BURGESS BATTERY COMPANY.

27. DRY-CELL BATTERY CAPACITIES FOR RADIO TRANSMITTERS—Characteristic curves and data on discharge tests. BURGESS BATTERY COMPANY.

28. B BATTERY LIFE—Battery life curves with general curves on tube characteristics. BURGESS BATTERY COMPANY.

30. TUBE CHARACTERISTICS—A data sheet giving constants of tubes. C. E. MANUFACTURING COMPANY.

32. METERS FOR RADIO—A catalogue of meters used in radio, with diagrams. BURTON-ROGERS COMPANY.

33. SWITCHBOARD AND PORTABLE METERS—A booklet giving dimensions, specifications, and shunts used with various meters. BURTON-ROGERS COMPANY.

35. STORAGE BATTERY OPERATION—An illustrated booklet on the care and operation of the storage battery. GENERAL LEAD BATTERIES COMPANY.

36. CHARGING A AND B BATTERIES—Various ways of connecting up batteries for charging purposes. WESTINGHOUSE UNION BATTERY COMPANY.

37. WNY RADIO IS BETTER WITH BATTERY POWER—Advice on what dry cell battery to use; their application to radio, with wiring diagrams. NATIONAL CARBON COMPANY.

53. TUBE REACTIVATOR—Information on the care of vacuum tubes, with notes on how and when they should be reactivated. THE STERLING MANUFACTURING COMPANY.

69. VACUUM TUBES—A booklet giving the characteristics of the various tube types with a short description of where they may be used in the circuit. RADIO CORPORATION OF AMERICA.

77. TUBES—A booklet for the beginner who is interested in vacuum tubes. A non-technical consideration of the various elements in the tube as well as their position in the receiver. CLEARTRON VACUUM TUBE COMPANY.

87. TUBE TESTER—A complete description of how to build and how to operate a tube tester. BURTON-ROGERS COMPANY.

91. VACUUM TUBES—A booklet giving the characteristics and uses of various types of tubes. This booklet may be obtained in English, Spanish, or Portuguese. DEFORREST RADIO COMPANY.

92. RESISTORS FOR A. C. OPERATED RECEIVERS—A booklet giving circuit suggestions for building a. c. operated receivers, together with a diagram of the circuit used with the new 400-milliamperer rectifier tube. CARTER RADIO COMPANY.

102. RADIO POWER BULLETINS—Circuit diagrams, theory constants, and trouble-shooting hints for units employing the BH or B rectifier tubes. RAYTHEON MANUFACTURING COMPANY.

103. A. C. TUBES—The design and operating characteristics of a new a. c. tube. Five circuit diagrams show how to convert well-known circuits. SOVEREIGN ELECTRIC & MANUFACTURING COMPANY.

41. BABY RADIO TRANSMITTER OF 9XH-9EK—Description and circuit diagrams of dry-cell operated transmitter. BURGESS BATTERY COMPANY.

42. ARCTIC RADIO EQUIPMENT—Description and circuit details of short-wave receiver and transmitter used in Arctic exploration. BURGESS BATTERY COMPANY.

58. HOW TO SELECT A RECEIVER—A commonsense booklet describing what a radio set is, and what you should expect from it, in language that any one can understand. DAY-FAN ELECTRIC COMPANY.

67. WEATHER FOR RADIO—A very interesting booklet on the relationship between weather and radio reception, with maps and data on forecasting the probable results. TAYLOR INSTRUMENT COMPANIES.

(Continued on page 55)

# YAXLEY

APPROVED RADIO PRODUCTS



## Radio Convenience Outlets

Wire your home for radio. These outlets fit any standard switch box. Full instructions with each outlet.

No. 135—For Loud Speaker ..... \$1.00  
No. 137—For Battery Connections 2.50  
No. 136—For Aerial and Ground 1.00

### With Bakelite Plates

Now furnished with a rich satin brown Bakelite plate, with beautiful markings to harmonize, at 25 cents extra. See Illustration.

At Your Dealers

**Yaxley Mfg. Company**  
Dept. B, 9 So. Clinton St.  
Chicago, Ill.



- 73. RADIO SIMPLIFIED—A non-technical booklet giving pertinent data on various radio subjects. Of especial interest to the beginner and set owner. CROSLY RADIO CORPORATION.
- 76. RADIO INSTRUMENTS—A description of various meters used in radio and electrical circuits together with a short discussion of their uses. JEWELL ELECTRICAL INSTRUMENT COMPANY.
- 78. ELECTRICAL TROUBLES—A pamphlet describing the use of electrical testing instruments in automotive work combined with a description of the cadmium test for storage batteries. Of interest to the owner of storage batteries. BURTON ROGERS COMPANY.
- 95. RESISTANCE DATA—Successive bulletins regarding the use of resistors in various parts of the radio circuit. INTERNATIONAL RESISTANCE COMPANY.
- 96. VACUUM TUBE TESTING—A booklet giving pertinent data on how to test vacuum tubes with special reference to a tube testing unit. JEWELL ELECTRICAL INSTRUMENT COMPANY.
- 98. COPPER SHIELDING—A booklet giving information on the use of shielding in radio receivers, with notes and diagrams showing how it may be applied practically. Of special interest to the home constructor. THE COPPER AND BRASS RESEARCH ASSOCIATION.
- 99. RADIO CONVENIENCE OUTLETS—A folder giving diagrams and specifications for installing loud speakers in various locations at some distance from the receiving set. YAXLEY MANUFACTURING COMPANY.
- 105. COILS—Excellent data on a radio-frequency coil with constructional information on six broadcast receivers, two short-wave receivers, and several transmitting circuits. AERO PRODUCTS COMPANY.
- 106. AUDIO TRANSFORMER—Data on a high-quality audio transformer with circuits for use. Also useful data on detector and amplifier tubes. SANGAMO ELECTRIC COMPANY.
- 107. VACUUM TUBES—Data on vacuum tubes with facts about each. KEN-RAD COMPANY.
- 108. VACUUM TUBES—Operating characteristics of an a.c. tube with curves and circuit diagram for connection in converting various receivers to a.c. operation with a four-prong a.c. tube. ARCTURUS RADIO COMPANY.
- 109. RECEIVER CONSTRUCTION—Constructional data on a six-tube receiver using restricted field coils. BODINE ELECTRIC COMPANY.
- 110. RECEIVER CONSTRUCTION—Circuit diagram and constructional information for building a five-tube set using restricted field coils. BODINE ELECTRIC COMPANY.
- 111. STORAGE BATTERY CARE—Booklet describing the care and operation of the storage battery in the home. MARKO STORAGE BATTERY COMPANY.
- 112. HEAVY-DUTY RESISTORS—Circuit calculations and data on receiving and transmitting resistances for a variety of uses, diagrams for popular power supply circuits, d.c. resistors for battery charging use. WARD LEONARD ELECTRIC COMPANY.
- 113. CONE LOUD SPEAKERS—Technical and practical information on electro-dynamic and permanent magnet type cone loud speakers. THE MAGNAVOX COMPANY.
- 114. TUBE ADAPTERS—Concise information concerning simplified methods of including various power tubes in existing receivers. ALDEN MANUFACTURING COMPANY.
- 115. WHAT SET SHALL I BUILD?—Descriptive matter, with illustrations, of fourteen popular receivers for the home constructor. HERBERT H. FROST, INCORPORATED.
- 104. OSCILLATION CONTROL WITH THE "PHASATROL"—Circuit diagrams, details for connection in circuit, and specific operating suggestions for using the "Phasatrol" as a balancing device to control oscillation. ELECTRAD, INCORPORATED.
- 116. USING A B POWER UNIT—A comprehensive booklet detailing the use of a B power unit. Tables of voltages—both B and C—are shown. There is a chapter on troubleshooting. MODERN ELECTRIC MFG. CO.
- 117. BEST RESULTS FROM RADIO TUBES—The chapters are entitled: "Radio Tubes," "Power Tubes," "Super Detector Tubes," "A. C. Tubes," "Rectifier Tubes," and "Installation." GOLD SEAL ELECTRIC CO.
- 118. RADIO INSTRUMENTS, CIRCULAR "J"—A descriptive manual on the use of measuring instruments for every radio circuit requirement. A complete listing of models for transmitters, receivers, set servicing, and power unit control. WESTON ELECTRICAL INSTRUMENT CORPORATION.
- 119. THE NEW LOFTIN WHITE CIRCUIT—A twenty-four page booklet explaining the principles and application of this popular circuit. CONSOLIDATED RADIO CORPORATION.
- 120. THE RESEARCH WORKER—A monthly bulletin of interest to the home constructor. A typical feature article describes the construction of a special audio amplifier—AEROVOX WIRELESS CORPORATION.
- 121. FILTER CONDENSERS—Some practical points on the manufacture and use of filter condensers. The difference between inductive and non-inductive condensers. Polymert Mfg. Corp.
- 122. RADIO TUBES—Specifications and operating characteristics of vacuum tubes. Twenty-four pages. E. T. CUNNINGHAM, INC.
- 123. B SUPPLY DEVICES—Circuit diagrams, characteristics, and list of parts for nationally known power supply units. ELECTRAD, INC.
- 124. POWER AMPLIFIER AND B SUPPLY—A booklet giving several circuit arrangements and constructional information and a combined B supply and push-pull audio amplifier, the latter using 210 type tubes. THORDARSON ELECTRIC MFG. CO.
- 125. A. C. TUBE OPERATION—A small but complete booklet describing a method of filament supply for a.c. tubes. THORDARSON ELECTRIC MFG. CO.
- 126. MICROMETRIC RESISTANCE—How to use resistances for: Sensitivity control; oscillation control; volume control; regeneration control; tone control; detector plate voltage control; resistance and impedance coupling; loud speaker control, etc. AMERICAN MECHANICAL LABORATORIES.

# Samson "Pam" Amplifier

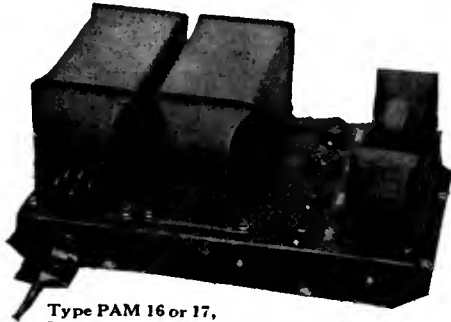

Type PAM 16 is for all ordinary types of loud speakers,

Type PAM 17 is for and supplies field current to dynamic type speakers.

Type PAM 16 or 17, List Price \$125.00 for 110 Volt, 50-60 Cycle A. C.

A COMPACT, self-contained, rugged, all electric, two stage audio amplifier for radio console or table. Designed to meet Underwriters' and A. I. E. E. standards. Compensation is made for line voltage variation. Approximate undistorted power output 7 watts.

Due to the high standard of parts used in its manufacture, the question of service ends with its installation. Immediate deliveries can be made by your jobber or dealer, or direct from us.

With the use of superlatives in radio advertising all too prevalent the best guarantee of excellence in performance is the fact that Samson products have been standard in the quality field since 1882.



General Offices: Canton, Mass. Factories, Canton and Watertown, Mass. Manufacturers since 1882

## ALL THE LATEST KITS and PARTS

Send for 1928 WHOLESALE DEALERS' CATALOG

Greatest Discounts on All Standard Parts, Kits, Accessories and Equipment

Dealers, set builders, and agents, send for this catalog. You will find complete parts and equipment for the latest circuits featured in Radio Broadcast and other magazines—and at the lowest prices.

### LATEST SHIELDED GRID and A. C. CIRCUITS

Complete stocks for the latest kits are always on hand. We are the largest exclusive Radio house and the largest distributors for nationally popular radio parts. The following kits and hundreds of other circuits are featured in our catalog and ready for instant shipment.

- Silver-Marshall Shielded Grid Six
- Silver-Marshall Screen Grid Laboratory Super
- Silver-Marshall Hi-Volt
- Silver-Marshall Unipacs and Pushpull Amplifiers
- Remler Infradyne
- Remler Best Screen Grid Super
- World's Record Super
- Karas A-C Equamatic
- New Bremer-Tully Power Six

- New Bremer-Tully Short Wave
- Latest Browning-Drake
- Tyrman Amplimax Seven
- Completa Stock Aero Parts
- Hammarlund Hi-Q
- Magnaformer A-C
- Latest Thordarson Pushpull Amplifier
- Silver-Marshall A-C Laboratory Super

### THOUSANDS OF RADIO BARGAINS

Most complete stock of all parts—A-B Eliminators, Power units and loud speakers. All the latest developments in six, seven, and eight tube sets for A-C and D-C operation. We stock genuine A-C sets, using 226 and 227 A-C tubes. You will be amazed at our wonderful selection of consoles and cabinets.

## HAMILTON-CARR CORPORATION

711 WEST LAKE STREET, CHICAGO, ILLINOIS

#### QUICK SERVICE—PROMPT SHIPMENT

You can rely upon us to fill your orders promptly. We have the very latest parts and complete stocks always on hand. You can tie up with us for anything in radio that you may need at any time.

#### SEND FOR FREE CATALOG NOW

You can have this complete, up-to-the-minute radio guide with no obligation to you. It is a complete, up-to-the-minute radio reference and a real money-saver. Just mail the coupon and a complete copy will be sent you.

Hamilton-Carr Corporation  
711 W. Lake St., Chicago, Ill., Dept. 403  
Please send at once your Free 1928 Wholesale Dealers' Catalog.

Name.....  
Address.....  
City..... State.....





## RADIO DEALERS

Send for our catalog illustrating the products of over 100 radio manufacturers.

**WHOLESALE ONLY!**

F. D. PITTS COMPANY  
219-223 Columbus Ave.  
BOSTON, MASS., U. S. A.  
Established 1919

# TOBE

## A-FILTER

Here is a new kind of DRY and HUM-LESS A-FILTER, ready to hook onto any 6 volt charger, to convert your filament supply to A. C.

No harnesses, no new tubes required. Clip this ad. and send with your name and address today for pamphlet B-5.

TOBE DEUTSCHMANN CO.  
CAMBRIDGE, MASS.

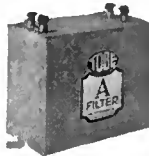

# ELKAY

## SUPPRESSOR

### Controls the Squeals

Fits grid circuit of any tuned R. F. set. Stops tendency to "boil over" and squeal. 75c each; \$1 mounted. Satisfaction or money back. Describe set when ordering. Longbein-Kuulman Radio Co., Dept. R, 92 Franklin St., New Haven Conn.



## Book Reviews

**RADIO THEORY AND OPERATING.** By Mary Texanna Loomis. Chapters, 44. Pages, 886. Illustrations 632. Loomis Publishing Company, Washington, D. C. Price, \$3.50.

**R**ADIO Theory and Operating" is one of the most comprehensive volumes so far published in its field, covering not only radio theory and circuits but also the necessary electrical engineering required in the operation of radio telegraph and radio telephone transmitters and receivers.

The book is obviously a product of most extensive and painstaking research and reading, and familiarity with the work of the best authorities on radio subjects. It is now issued, recently revised, in its third edition.

There are two possible treatments of comprehensive works on radio subjects. A book may be designed to appeal to the radio enthusiast who desires to understand thoroughly the theory and operation of radio. It may also be planned for the professional radio man who studies the subject as a member of a class conducted by an expert teacher. Miss Loomis's book is decidedly in the latter classification. Her treatment of the subject is in a matter of fact and unromantic style. This is not written in the spirit of condemnation, but merely to define the author's point of view.

The work is divided into four parts. The first, of twenty-five chapters, discusses the principles of transmitting. There are seventeen chapters dealing with the principles of electricity and magnetism, generators, condensers, transformers, and the essential parts of the radio transmitter before we come to Chapter XVIII, dealing with oscillating currents. Thus the groundwork is thoroughly laid before radio circuit principles are considered. The second part deals with receiving circuits, in eleven chapters; the third, devoted to vacuum tubes and continuous waves, comprises six chapters; the fourth, entitled "The Practical Radio Operator," covers that subject with eight chapters.

To substantiate my point that the book is based more on reading and research than upon practical experience in the handling of radio equipment (not that the author is without extensive practical experience), this last section quotes liberally and thoroughly digests the Government regulations applying to radio, abbreviations used in practice, message forms, traffic regulations, and the forms used in practical ship-to-shore operating, all material obtainable by research and consultation of authorities. On the other hand, when the author deals with troubles which may be encountered in the operation of transmitters and receivers, that clearness and completeness which otherwise characterizes the book is somewhat lacking. For example, the operation of crystal control in broadcasting stations is disposed of in the following paragraph:

"When crystal control is used, too high a voltage must not be placed on the crystal, as this may break it. From 300 to 400 volts appears to be the limit that the crystal can stand. Crystals are a great help in keeping the oscillation frequency constant and, by eliminating wastes due to wild oscillations, the radiation is increased. However, the crystals are not imperishable. They need care and have to be replaced occasionally."

The same characteristic of treatment may be observed in the discussion of possible troubles with receiving sets:

"If upon sitting down to listen, on what appears to be a correctly wired receiving set, nothing is heard, aside from the possibility of an error in the circuit, this may be caused by something very simple. The trick is to find the

simple cause. Perhaps the most common cause of this is a short-circuited fixed condenser, either shunted across the telephone circuit or the first amplifying transformer. This may be caused by the use of a hot soldering iron as a condenser composed of copper or tin foil and waxed paper, is not intended to withstand heat. Where fixed condensers are soldered into a circuit, this must be done very cautiously. Probably the next most important cause for silence in a receiving set is a poor contact between the prongs on the base of the tubes and the springs in the socket. Springs should press tightly against the prongs," etc., etc.,

Considering that the volume is entitled "Radio Theory and Operating" and not merely "Radio Theory," possibly a better balanced book would have been produced by more complete and systematic arrangement of possible troubles encountered in the operation of transmitting and receiving apparatus.

Another peculiarity of the book is the meticulous care observed in giving credit to independent inventors whose work antedated those generally given credit for radio's important inventions. Unquestionably this attitude arises out of the fact that Miss Loomis's father is Dr. Mahlon Loomis, who demonstrated radio transmission and reception in 1872, in Virginia. His pioneer work is not generally recognized. A patent was issued him on July 30, 1872, and his demonstrations, a matter of public record, establish his priority over Marconi. But history invariably credits the man who first puts over a new idea or system commercially, whether he is the first inventor or not.

Doctor Loomis bears the same position in radio that Dr. Samuel Langley holds in aeronautics. The Wright brothers are credited with the invention of the airplane because they were the first to demonstrate it to the general public so that, through their influence, it has won recognition as a practical device. Glenn H. Curtis, substituting a modern motor for the steam engine originally installed as motive power in 1897, made Langley's plane fly successfully. But even this vindication of Langley has not deprived the Wright brothers of their position as the acknowledged inventors of the airplane.

Miss Loomis's book is to be recommended particularly to commercial wireless telegraph operators. The chapters dealing with the care of storage batteries, the functioning and care of motor generators and power equipment, and the regulations applying to commercial practice are thorough and complete. An extensive series of questions at the back of the book are helpful in preparing for Government examinations. Standard ship and commercial installations are quite thoroughly dealt with. The volume is well indexed and well arranged.

—EDGAR H. FELIX.

### Another Text for Operators

PRACTICAL RADIO TELEGRAPHY, by Arthur R. Nilson and J. L. Hornung, McGraw-Hill Book Co., Inc., 380 pages, \$3.00.

**T**HE preface to this book states that it is written for radio students preparing to become radio operators. Its scope is therefore marine radio telegraphy, and does not include broadcasting. At first it may seem that enough books have been written to aid aspiring young electricians to survive the terrors of the government license examination, but this book really does the job extraordinarily well; better, I believe, than any previous work on the subject. The art has changed, and most of the earlier treatments

**BOOK REVIEWS**

(Continued from page 56)

*Practical Radio Telegraphy*—Nilson and Hornung

are out of date. This fact, as well as the long experience of the authors in the training of radio operators, justifies the appearance of the present volume.

The treatment begins with the physical fundamentals of the art, the first seven chapters being devoted to such topics as magnetism, motors and armatures, and characteristics of alternating current circuits. The treatment is nowhere skimpy; in the chapter on armatures, for example, the elements of armature winding are fully described. Wherever physical principles are expressed the atomic theory is used. Occasionally the phraseology is a little dubious, as in the discussion of dielectric breakdown on page 107, where the authors tell us that "a ruptured insulator might be defined as a material in which the electrons have been extended beyond their limit, or, in other words, the electrons have been strained beyond the elastic limit of the atomic structure. . . ." A strained electron might tax the conceptual powers of greater intellects than those of average young men studying to become brass pounders on the high seas. But the explanations are in the main clear and scientific; the one which has been quoted is not a fair example.

Photographs and practical illustrations of apparatus have been secured from manufacturers and communication companies. Spark, vacuum tube, and arc transmitters for marine use, commercial receivers, and the radio compass, are thoroughly described. Questions at the end of each chapter may be used by the student to test his knowledge. Most of the chapters are written to the length of a normal assignment in a radio school. The printing is first-rate, with the exception of a comical error in the running head of Chapter XXI. The book includes an index. It is written for readers who lack preparation in elementary electricity, mathematics, and chemistry, gives them what they need of such prerequisites, carries them through the technique of radio marine telegraphy, and fills the need for a reference book for finished operators.

—CARL DREHER.

In sending the coupon below, make sure that your name and address are included and are plainly written.

USE THIS BOOKLET COUPON

RADIO BROADCAST SERVICE DEPARTMENT  
RADIO BROADCAST, Garden City, N. Y.

Please send me (at no expense) the following booklets indicated by numbers in the published list above:

.....

.....

.....

.....

.....

.....

Name.....

Address..... (Number) (Street)

..... (City) (State)

ORDER BY NUMBER ONLY  
This coupon must accompany every request. RB 5-28

**THREE TIMES!**



Type 587-A Power Speaker Filter

This instrument thoroughly insulates the speaker from the high voltage and current of the last stage tube. It is equipped with a heavy duty choke that will pass 100 milliamperes without undue saturation and suitable condensers. Price, \$10.00.

The new UX 250 Power Amplifier Tube is capable of supplying the speaker three times the undistorted energy as that of a UX 210 tube. Results—great volume with unsurpassed quality. This tube, however, requires equipment especially designed for it. The General Radio Company have developed a complete line of transformers and filters particularly adapted for use with this tube. Folders describing amplifier units and component apparatus will be sent on request.

**GENERAL RADIO**

30 State St., Cambridge, Mass.

274 Brannan St., San Francisco, Calif.

**LYNCH**

Resistors for receiving, transmitting, and power supply work.

ARTHUR H. LYNCH, Inc., 1775 Broadway, N. Y. C.

**Master the Code**

Wireless or Morse—at home with the Teleplex Automatic Code Instructor. No better method for self-instruction exists. Quick—Easy—Thorough. Endorsed by U. S. Navy. The only instrument that reproduces actual reading—messages, radiograms, etc. Any speed. Complete course furnished. Thirty times as many words as any other instrument. Avail yourself of the Teleplex for a quick mastery of the code. Write for booklet BR. TELEPLEX CO., 76 Carlstadt St., New York.



**200,000 Ohms**



Pattern No. 116 High Resistance Voltmeter

Two hundred thousand ohms is quite a lot of resistance in wire wound form and of a type unaffected by temperature changes to build into a voltmeter. Still, that is the actual amount used in the Jewell high resistance B-eliminator voltmeter, to establish a high resistance of 800 ohms per volt.

For the set owner who demands the best from his receiver, this instrument will provide the maximum flexibility in home testing. Besides its adaptability for making B-eliminator voltage adjustments, the Pattern No. 116 may be used for general test purposes as well.

The movement of Pattern No. 116 is a sensitive, D'Arsonval moving coil type, having silvered movement parts. The scale is silver etched with plain black characters and the pointer is provided with a zero adjuster.

Ask your dealer about it or write us for descriptive circular No. 1103.

**Jewell Electrical Instrument Company**  
1650 Walnut Street, Chicago  
"28 Years Making Good Instruments"



## Is Your Set a 60 Percenter?

**T**OO many sets are delivering only 60% of the tones broadcast by the studio. Most of the audio systems choke off or distort the very tones which give that fullness and roundness which makes the difference between ordinary and Natural Reproduction.

Link up your Tuner to Natural Reproduction with the companion units, The AmerTran Push-Pull Power Amplifier and the AmerTran ABC Hi-Power Box.

You must hear it to appreciate it. Even your imagination will not exaggerate the difference. Write for full information or ask us to arrange a demonstration at your dealer's store, no obligation of course.

**AMERICAN TRANSFORMER CO.**  
120 Emmet St., Newark, N. J.

*Transformer Manufacturers for 28 years*

**AMERTRAN**  
TRADE MARK BEHOLD THE PAT. OFF.

## AERO Corona Coil Used in New Cooley "Rayfoto"

Of course the new Cooley "Rayfoto" uses an AERO Inductance Coil. This special coil is designed to meet the exact specifications of A. G. Cooley, whose "Rayfoto" receiver so many experimenters will build. For every inductance requirement AERO Coils are proved best—by experts and amateurs as well. Always specify AERO Coils if you want the finest in radio performance.

**AERO PRODUCTS, Inc.**  
1722 Wilson Avenue Chicago, Ill.

## COMPLETE PARTS FOR REMLER 45 Kc. AC SUPERHET.

**G**ET prompt, efficient service and lowest prices from Western. Our catalog lists a complete line of kits, parts, sets and accessories.

Dealers—Write for Catalog  
**WESTERN RADIO MFG. CO.**  
134 W. Lake St. Dept 45, Chicago

# DIRECT SELLING BY RADIO

## Is It a Menace to the Retail Business Structure?

By Francis St. Austell

*President, Iowa Radio Listeners' League*

**O**UT in Iowa, the haunt of direct selling by radio, all arguments for and against "Direct Advertising" and "Indirect Advertising" have been abandoned in favor of a heated controversy on the subject of direct selling by radio. Advertising, direct and indirect, has in the case of some radio stations, given place to urgent, persistent, forceful and vociferous clamoring for orders for all kinds of commodities.

The three terms, indirect advertising, direct advertising and direct selling have been defined as follows: Indirect advertising is the type of publicity sent out by a great number of stations including those on the networks. It consists of the name of the advertiser who sponsors the entertainment, with a mention of products in a manner calculated to create good will and also help all who are concerned in the merchandising of those products. Direct advertising consists of the broadcasting of requests for orders, with or without price quotations sent out by a station which has sold time to an advertiser for the purpose of selling goods by radio. Direct selling consists of the solicitation of orders by a station which sells goods direct to the consumer for its own account and for its own profit.

The center of the controversy is quite naturally Iowa, because the principal direct selling stations are located in that state. The writer is not familiar with the situation in other states, but is certainly very familiar with the Iowa station which is probably unique or ought to be.

A half-hour period usually called the "Letter Basket" has just been brought to a close by the owner and operator of KFNF Shenandoah. This station was the first to adopt the plan of selling directly to consumers and is still the chief exponent of the art. During the period referred to, the public was begged to send orders for tires, dishes, peaches, coffee, Chinese baskets, pencils, fountain pens (guaranteed for life) suits, overcoats, paint, canned corn and nursery stock, not forgetting prunes. Before the advent of radio, the owner and operator of KFNF was in the seed and nursery business. The other lines have apparently been added since the issue of a license to broadcast.

KFNF, Shenandoah, is now self-announced as the "merchandise center of the middle west"—"the pioneer trading station" and somewhat vaguely as "the world's largest." In a few short years a business primarily devoted to seeds and nursery stock, with an annual turnover of probably about three hundred or four hundred thousand dollars, has grown with the aid of radio into a business with a volume of more than three million dollars.

The entertainment furnished by KFNF is not of a high class nature. It is what is called common music for common people or simply old-fashioned music for plain folk. While the response from the public to the efforts at entertainment is meager, the response to the talks broadcast from that station is enormous. These talks are really clever and deal with agriculture, horticulture, household hints and many other subjects. KFNF has a following which numbers many hundreds of thousands and every one of them will fight if his favorite station is criticized. There is probably no station in the country that has such a loyal following and some extra bitter opponents of direct selling say that no other station wants such a following. The opponents

of direct selling are divided into two classes. One class wants direct selling stations to be put off the air entirely. The other would be content if direct selling were abolished and would demand nothing more.

Henry Field of KFNF, just plain "Henry" to his friends, has a magnetic personality which reaches out and grips his audience. His description of a cup of his famous coffee is tantalizing and his vivid picturization of a cooked slice of his wonderful ham just makes one's mouth water. His coats are the best ever heard of, his overalls are works of art, his tires make motoring a joy forever, his canned peaches bring to our table the sunshine of California. It is a bad day when his sales talks do not bring a few thousands of dollars to the merchandise center.

### THE FINE ART OF RADIO SELLING

**H**ENRY FIELD has developed salesmanship by radio into a very fine art—so fine an art in fact that many claim that if his example were followed by others fortunate enough to own a radio station, the whole retail business structure of the country might be endangered. The selling of merchandise by radio is so profitable that it is surprising to find so few radio stations engaged in the pastime.

Those who oppose direct selling as unfair competition ask: "If one broadcaster is allowed to use the greater part of his time on the air for the purpose of soliciting orders, why should not every broadcaster do it? Why should not every man be given the right to erect and operate a radio station, provided he expresses the willingness or desire to sell prunes, peaches, tires, overalls and other commodities?"

At present, the local dealer who has no broadcasting station is in an unfortunate position. He is open to attack, direct, indirect, by accusation and by innuendo. Not having a radio station from which to shout, he is naturally at a loss for a reply. He gets sore and thinks of all kinds of smart "come backs," but he has to remain silent.

It is not unusual to hear over the air remarks to the effect that "your local merchant would charge you at least twelve dollars—but by buying from this station, you get it for seven dollars." The purchaser by radio also has the extra and exquisite pleasure of hearing his name "read out." The price comparison, according to reports from dealers, is not always fair or absolutely correct, but who can contradict it?

KFNF sometimes issues statements to the effect that the station does not undersell competitors and claims "quality" as the keynote of its business policy. At another time, the station claims to have forced down prices on many commodities and to have saved the farmer vast sums of money. Whether or not they save money or get better quality the loyal followers of Henry send their cash to his station and demand that he be allowed to do as he likes with his radio station.

It has been stated that the direct selling stations of Iowa can produce five hundred thousand signatures to support their claims to popularity. This is no doubt a very low estimate. But it may be asked whether the popularity of a station is sufficient excuse for what many regard as the evils of direct selling. On this subject a correspondent remarks "popularity has nothing to do with



## THE OFFICIAL Browning-Drake Kit

THE world-wide fame of Browning-Drake radio apparatus has been built upon a firm foundation of wonderful results.

The Official single-control Kit, introduced last fall, is the heart of any Browning-Drake receiver and may be used in shield grid, A. C. or D. C. assemblies. Foundation Units and other parts matched to this Kit may be secured if desired.

A new loud speaker has taken its place as a Browning-Drake product and its fame is spreading rapidly.

Your inquiry will bring full information on factory-built receivers, Kit apparatus and loud speakers.

**Browning-Drake Corporation**  
110 Brookline St. Cambridge, Mass.

# BROWNING DRAKE

## DIRECT RADIO SELLING

by Francis St. Austell

(continued from page 58)

it. Saloons were popular once, but where are they now?" Correspondence comes from all over the country, from Rhode Island to California, from Maine to New Mexico, and it is a very noteworthy fact that most letters from opponents of the principles of direct selling are on excellent paper and represent a highly educated class, while those from supporters of the direct seller are for the most part, extremely hard to read, are not noted for cleanliness and usually avoid reference to the real subject of debate. The popularity of KFNF is based on its talks, its gospel hymns, religious services and its old-fashioned music. The opponents of direct selling do not necessarily criticize these features, but the loyal followers of KFNF see in an attack on direct selling, a camouflaged attack on the gospel. They want Henry or "Henery" and resent any suggestion of criticism, even of the station presided over by their idol. The owner and operator of KFNF recently broadcast a statement to the effect that those who did not like his station were writing to the Federal Radio Commission, telling that body all about it. He also commented on the fact that these people were sending typewritten letters. The young lady who sorts my mail was discovered once making two piles of letters before opening them. One was a clean, neat pile, the other was quite different. When asked the reason for such a procedure, she remarked "The clean ones object to direct selling, the dirty letters support it." Quite simple, but also very significant. Of course there are some very clean and well written letters favoring direct selling but these are conspicuous in comparison.

### WHERE DIRECT SELLING IS POPULAR

AT A convention in Des Moines, held last year, a speaker attacked the principles of direct selling, without mentioning any stations by name. Mr. Field of KFNF requested that barriers be let down and that the matter be discussed openly, as he said he was quite aware the remarks referred to him. The way followers of Shenandoah rallied to his support was an eye opener to many. Women, who would ordinarily dread the ordeal of a public appearance, spoke fearlessly and eloquently, facing with real determination a crowded convention hall. Farmers and their wives told of what Henry had done for them, and they left not the slightest doubt as to the popularity of Henry Field among his immediate followers. To his opponents, he represents probably the most unpopular station in the world. Popularity is not the right word. This man, Henry Field, arouses a feeling among his followers that is akin to worship. He is becoming a cult. The reasonable opponents of direct selling do not hesitate to give him credit for all the good things he has done. They fight with him on the points only of direct selling and the methods employed in merchandising.

All the foregoing remarks can be applied to other stations, of course, as far as merchandising is concerned; but the magnetic personality of Henry Field makes him stand alone, a national figure, a creation of radio, a leader of hundreds of thousands, almost a prophet, a Moses of the common people.

It would seem that the direct selling stations sometimes act as agents for manufacturers and merchants, while certain commodities are bought outright and sold by the station which is in reality a mail order house, with a catalog and also the additional advantage of having a radio station from which to broadcast bargains. All

# FROST-RADIO



### A Good Little Rheostat

The Frost Gem Rheostat is built with the same care and of the same materials as our larger rheostats. Diameter: 1 1/2 in. Depth: 11-32 in. Bakelite pointer knob, smoothly working contact arm, flexible Bakelite foundation for resistance wire. Plain Gem Rheostats. 75c. With switch, Potentiometers, \$1.00.

### FROST-RADIO Velvety Smooth in Action

Frost De Luxe Variable High Resistances are velvety smooth in action, their roller bearing contact arm insuring perfect regulation of resistances. Polished Bakelite case. Bakelite white arrow pointer knob, single hole mounting, 2 or 3 terminals. 2,000, 10,000, 25,000, 50,000, 100,000, 200,000, and 500,000 ohms. Plain, \$1.75. With switch, \$2.10.

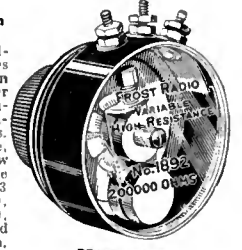

FROST-RADIO

### Mail Coupon for Two Free Books

"What Set Shall I Build?" and "For Better Reception," our two valuable books every set builder should have, will be sent you free, if you will fill out and mail coupon below.

**HERBERT H. FROST, Inc.**  
New York ELKHART, IND. Chicago  
HERBERT H. FROST, Inc.  
160 North La Salle Street, Chicago

Send me your two free books as advertised in Radio Broadcast for May.

Name .....  
Address .....  
City ..... State .....

## RADIO PANELS

BAKELITE—HARD RUBBER

Cut, drilled and engraved to order. Send rough sketch for estimate. Our complete Catalog on Panels, Tubes and Rods—all of genuine Bakelite or Hard Rubber—mailed on request.

STARRETT MFG. CO.

521 S. Green Street Chicago, Ill.

# LYNCH

Resistors for every requirement of the radio fan, builder and engineer.

ARTHUR W. LYNCH, Inc., 1775 Broadway, N. Y. C.

## What. Filament Control

Good tube performance demands perfect filament control. AMPERITE alone gives it, automatically. Eliminates hand rheostats, guessing and tube damage. Simplifies wiring and panel design. Backed by 6 years of perfect service. There is no alternative. Insist on AMPERITE. \$1.10 mounted (in U.S.A.). All dealers sell it.

**RADIALL CO.**  
50 Franklin St. New York



# AMPERITE

REG. U.S. PAT. OFF.

The "SELF-ADJUSTING" Rheostat

**FREE**  
Write for "Amperite Book" of best circuits and latest construction data to Dept. RL-5

## electrify your set the easy practical Knapp way....

The Kit completely assembled with metal cover in place. Operates on 105-110 volts AC, 50 to 60 cycles.



No expensive short lived AC Tubes, no troublesome re-wiring, no annoying hum. Increase instead of decrease the efficiency of your set, no waiting... the

### Knapp "A" POWER KIT

gives you music instantly at the snap of a switch.

#### Absolutely Dry

There is not a drop of moisture in this absolutely dry unit. The condensers are baked so that not a drop of moisture remains. The unique, fully patented, solid full-wave rectifier is absolutely dry. No water... no acid... no alkali... no tubes... no electrolytic action. Nothing to get out of order. Nothing that needs attention.

#### Assemble in Half an Hour

Everything supplied, even to the screws, wire, drilled base-board and metal cover. "B" Eliminator may be operated from the same switch.

#### Big Profits for Set Builders

Our President, Mr. David W. Knapp, is offering the act builders of America, for a limited time only, a money-saving plan which is unique in the annals of radio. Send the coupon today, before it is too late.

**KNAPP ELECTRIC CORPORATION**  
Port Chester, N. Y.

MR. DAVID W. KNAPP, Pres., Knapp Electric Corporation  
233 Fox Island Road,  
Port Chester, N. Y.

Send me complete information regarding the Knapp "A" Power Kit and your special discount to set Builders.

Name.....  
Address.....



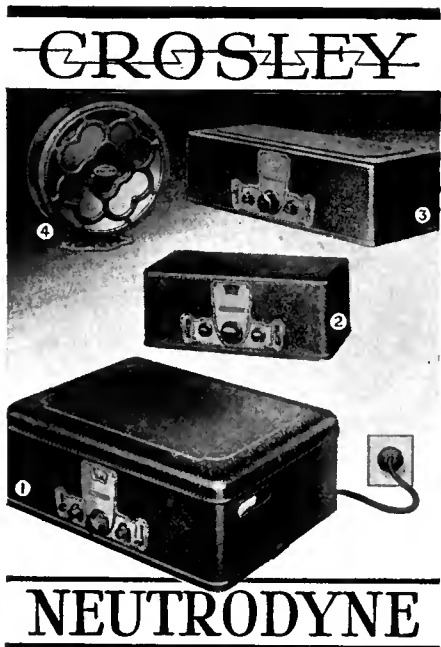

1. Single Unit AC Jewelbox, \$65. Genuine neutrodyne fully shielded—selective.
2. Dry cell operated Bandbox Junior, \$35. Loud speaker volume—most economical.
3. Bandbox 601, \$55. Operates from batteries or power supply units.
4. New Type-D Musicone, \$15, finished with gold highlights to match the Jewelbox.

Crosley radios are adaptable to any type of console installation. Write Dept. 20 for descriptive information.

**THE CROSLEY RADIO CORPORATION**  
 Powell Crosley, Jr., Pres. Cincinnati, Ohio

Licensed only for Radio Amateur, Experimental and Broadcast Reception. Prices slightly higher in far Western states

# NEUTRODYNE

## Send for Latest RADIO CATALOG and GUIDE

### Parts for New Adams Circuit

We supply all parts for the Adams circuit as well as all popular circuits. Send us your orders for quick service.

### Free 1928 Radio Guide

The big Barawik Radio Guide book is used by hundreds of thousands of radio enthusiasts. It's the handiest and most reliable radio reference guide, and a big money-saver. Keep up to date by utilizing Barawik service.

It shows pages replete with reliable information about the newest and most advanced ideas in A C radio development, describes and illustrates the latest improvements. It will keep you posted on what's up to date.

### Standard Discounts to Dealers, Set Builders, Agents.

It will pay you to get our prices for complete parts for the popular circuits featured in radio magazines. Whenever a new circuit appears for which you want complete parts, write or wire us and they'll be on their way to you quickly. We know what parts to send you. Simply give name of circuit and we'll take care of the rest. We guarantee you a big saving on every order.



**Send for Free Copy Now!**  
 Get our new radio catalog to-day before you spend another cent. Mail the coupon and free copy will be sent you.

**BARAWIK CO.**

Dept. 835  
 Chicago, U. S. A.

Mail This Coupon Now! For Free Copy

Name .....

Address .....

.....

.....

## DIRECT RADIO SELLING

by Francis St. Austell

(continued from page 59)

goods are sold with a money back guarantee. Even the hams can be cooked, partly consumed and the remainder sent back if not satisfactory.

As an indication of the volume of business done figures recently broadcast from one of the so-called "farm stations" are given here. They indicate sales since February, 1927.

55 carloads of tires—400,000 pounds of coffee—100,000 overalls and jackets, 30,000 work and dress shirts, 70,000 dress patterns of 3½ yards each—10,000 ready made dresses—24 carloads of prunes—60,000 pairs of silk stockings—50,000 radio tubes—3000 suits and overcoats since October 1927; that represents only a part of the business of one radio station. To the writer, the figures do not appear in any way exaggerated.

Retail merchants are becoming alarmed, followers of the farm stations are elated. The so-called farm stations claim the support of farmers as a class. One farmer writes and states plainly that it is a damned lie to say that all farmers are in favor of direct selling. Another is equally positive that farmers are all for it.

That broadcasters themselves are not entirely united on the subject of direct selling is indicated by the following quotation from a letter addressed to the writer by the secretary of the Berry Seed Company, which owns and operates station KSO, Clarinda, Iowa. This station was engaged in the direct radio sale of seeds and kindred lines. The letter says, in part:

"The question of direct selling or the quotation of prices over the radio is one that is receiving much discussion not only in Iowa but in many other sections of the United States. . . . We cannot help but come to the conclusion, after considering the matter from all angles, that it does give such firms an undue advantage over competitors who have no radio station or access to one over which their prices may be quoted. This might readily be termed an unfair advantage and perhaps for that reason alone should be eliminated. . . . To return to our former statement, we would welcome an order to desist from quoting prices. We welcome a mutual agreement that would eliminate it, and if neither of these occur, we shall perhaps cease anyhow."

An ardent supporter of direct selling principles was asked by the writer if he could produce one logical argument in favor of it, merely said: "The broadcaster was lucky and he found a gold mine in a radio station. There is no law against using a gold mine."

There is no law to prevent a man from being lucky enough to find and use a gold mine, but unfortunately, there is a law which prevents a lot of people from founding a broadcasting station. One station of the direct selling kind, according to its own report, annually sends out catalogues to the number of a million and a half. The follow-up to these catalogues consists of direct selling talks by radio. Catalogues from other firms must be followed up by mail. It looks a bit one-sided, doesn't it?

The Radio Commission announces that it has not been given the power to dictate to a broadcaster whether or not he should sell and puts the matter up to the public.

Let the public decide—as quickly as possible.

# CARTER

## NEW Adapter Harness

Makes possible the using of new A. C. tubes in present set without any structural alteration. Change can be made in ten minutes. Eliminates "A" batteries. Use your present "B" and "C" supply. Complete with auxiliary volume control. \$7.50 to \$9.50 according to number of tubes.

Write for illustrated folder

MEMBER RMA  
**Carter Radio Co.**  
 CHICAGO

# LYNCH

Resistors are accurate, permanent, noiseless.

ARTHUR N. LYNCH, Inc., 1775 Broadway, N. Y. C.

## How Does Your Receiver Work?

## What Antenna is Best?

## How Radio Tubes Function?

These questions and many others are answered in Walter Van B. Roberts' book, "How Radio Receivers Work."

Today—send one dollar, for your copy, to the Radio Broadcast Booklet Dept., Garden City, N. Y.

# DRAKE'S RADIO CYCLOPEDIA

1928 Edition, complete, up-to-date. Full information on A. C. and Screen Grid Tubes. Over 900 pages, 1025 illustrations. For Service and Repair Men, Dealers, Salesmen, Experimenters and Designers. At dealers or by mail, \$6.00.

FREDERICK J. DRAKE & CO.  
 PUBLISHERS  
 10135 Michigan Ave. Chicago

**SM**

*New!*

**5-Prong S-M Plug-In Coils**

**Economy — Efficiency**



For the popular "tube base" short wave receiver Silver-Marshall will have ready on June 1st, new types of moulded Bakelite coil forms and wound coils designed to fit any standard 5-prong tube socket, such as S-M 512. These forms have ample winding space for all short wave or broadcast band coils, and a tickler slot at the base. Their small size particularly adapts them to short wave sets to provide the smooth regeneration necessary to telephone or rebroadcast reception, and their cost is as low as their efficiency and flexibility is high. Type 130 blank forms can be had with smooth winding space  $1\frac{1}{2}$ " in diameter and  $1\frac{1}{2}$ " long, with tickler slot and pins at .50 each, or with threaded winding space (.95 threads) if preferred. A variety of types wound for different purposes can be had at \$1.25 each list. Type 512 socket which fits these coils is priced at 75c. Why pay \$3.00 to \$12.00 for a set of short wave coils when four 130 forms and a 512 socket costing \$2.75 altogether, plus less than a pound of wire and an hour's fun will give you as pretty a little set of coils, tuning from 17 to over 200 meters, as you'd ever want to see.

**The Famous S-M 240 Audio Transformer**

At \$6.00 S-M 240 Audio transformers, containing more actual material than competitive \$8.00 transformers, give such fine performance that they are being increasingly chosen in preference to other makes. The Peridyno used them, the LC 28 Unipac was built around them, the Universal Tuners rely on 240's for the fine tone that has made them so popular. Radio Broadcast Laboratory has reported most favorably on them. Small, compact, rugged and above all possessed of the qualities that have made S-M leader in the audio field in two short years, they are your guarantee of fine tone quality in any set you buy or build. Price, 240 audio, 3:1 ratio, \$6.00; 241 output, \$5.00.



**A B C and B Power Units to Fit in Your Set Cabinet**

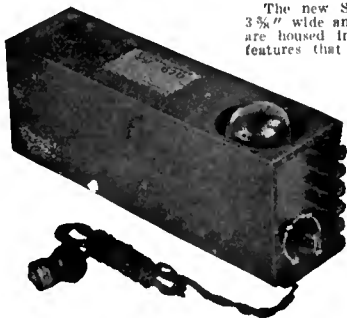

The new S-M "670" Reservoir Power Units are but 13" long, 3 3/4" wide and 6 1/2" high over the 230 rectifier tube they use. Both are housed in attractive brown crystalline steel cases, and have the features that made the older 652 and 656 Reservoir B's the most popular kits of their type. The Clough selective filter and a new voltage divider system provide unusually quietness and freedom from motor-boating on any set of one to ten tubes. 670B supplies fixed voltages of 22 1/2, 90, 135 and 180 to 200 volts, with a variable tap giving from 22 1/2 to 90 volts. 670ABC supplies the same B power and A and C power to any AC tube set—1.5 volts, 2.25 and 5.0 volts A for up to seven tubes, with the necessary C bias for the tubes used obtained by suitable resistors in the set. 670B is priced at \$35.50 wired, ready to use, or \$33.00 in kit form, with cabinet, ready to assemble. 670ABC is priced at \$38.50 wired, or \$35.00 for the complete kit with all instructions.

**New Unipacs for 250 Tubes**

Two Unipacs taking full advantage of the new 250 type tube are ready, one a single stage light socket power amplifier and B supply, and the second a two stage amplifier for radio or phonograph. Each uses one UX-250 amplifier tube to furnish 4650 milliwatts of undistorted power output, which means just about the sweetest, fullest tone you've ever heard—just a shade better than you can get with the next best.

Both Unipacs are peers in their fields, operate from 105 to 120 volt 60 cycle alternating current, and deliver 450 volts B and 84 volts C to the self contained 250 tube which develops more undistorted power output than two 210's in push pull. 681-250 is the single stage model using one 250 tube, two 281 rectifiers and one 874 voltage regulator. Besides a stage of 250 amplification for any radio set, it also furnishes 45, 90 and 135 volts of B power. Price wired \$88.25, or in kit form ready to assemble, \$83.25. 682-250 is the single stage model with a 220 first stage tube added. It supplies two stages of power A, F, amplification—enough for dance hall volume using the output of a record pick-up or radio set detector tube. It gives 45, 90 and 135 volts of B and 1.5 and 2.25 volts of A for receiver operation. Price wired, \$107.75, or as a kit, ready to assemble \$92.75.

**SILVER-MARSHALL, Inc.**

**838 West Jackson Blvd., Chicago, Illinois**

SILVER-MARSHALL, Inc., 838 West Jackson Blvd., Chicago, Ill.

- ....I enclose 10c for which please send me full information on the S-M audio transformers, power supply units, unipacs, and the S-M receivers.
- ....I enclose 25c for instructions for building the S-M unipacs.
- ....I enclose 25c for instructions and blueprints for building the Shielded Grid Sixes.
- ....I enclose 25c for instructions and blueprints for building the S-M wave tuners.

Name .....

Address .....

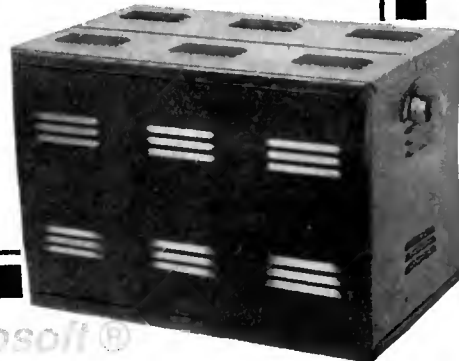

Digitized by Microsoft®