

Desk

RADIO BROADCAST



CONTENTS

An Experimental Screen-Grid Tuner
Converting Receivers for A.C. Operation
How to Build a Short-Wave Telephone Transmitter
A Non-Motorboating Resistance-Coupled Amplifier
A New Rectifier Tube for B-Supply Units
How Phonograph Records Are Made



"I have used ACME PARVOLT Condensers for many years and have never had one break down."

S.W. Corbrey

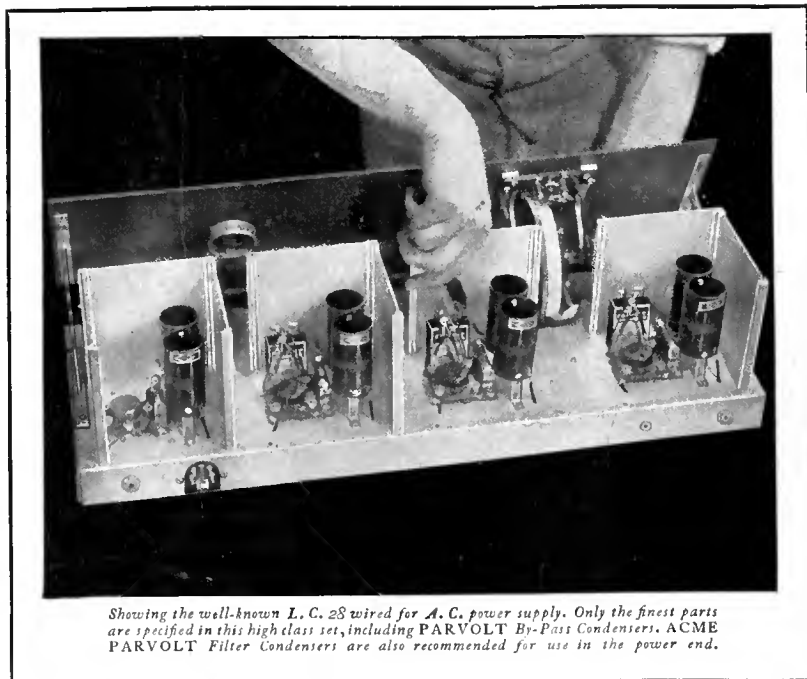

Showing the well-known L. C. 28 wired for A. C. power supply. Only the finest parts are specified in this high class set, including PARVOLT By-Pass Condensers. ACME PARVOLT Filter Condensers are also recommended for use in the power end.

Whether You Buy or Build

a Power Supply Unit for Your Radio

PLAY SAFE WITH PARVOLTS!

WHEN you buy an electrified radio or power supply unit for your receiver, look for ACME PARVOLT Condensers; they are your guide to quality in all other parts. They cost the manufacturer a trifle more, but they are both his and your guarantee against costly condenser break-down.

Should you build your own power supply, be sure to use ACME PARVOLT Condensers and be safeguarded against the possibility of break down. Remember that poor filter condensers have caused untold thousands of dollars worth of loss in the past year or two, for blown out condensers mean blown tubes, burned out transformers and frequently the ruination of speaker units.

Just as PARVOLT By-Pass Condensers have been used for years in high grade

receivers, so are PARVOLT Filter Condensers rapidly replacing ordinary condensers in electrified radio. These condensers are wound with the very finest insulating papers combined with highest grade foils. Every detail produced in one of America's most modern plants and under the supervision of experts in condenser design and manufacture.

Uniformity of capacity and uniformity of sizes are two big features. Accuracy of all ratings, based upon the R.M.A. standards, is another guarantee of uninterrupted service. Play safe with PARVOLTS!

Made by THE ACME WIRE CO., New Haven, Conn., manufacturers of magnet and enameled wire, varnished insulations, coil windings, insulated tubing and radio cables.

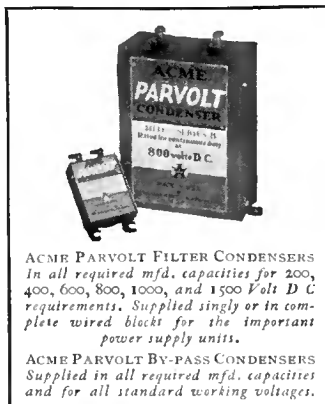

ACME PARVOLT FILTER CONDENSERS In all required mfd. capacities for 200, 400, 600, 800, 1000, and 1500 Volt D C requirements. Supplied singly or in complete wired blocks for the important power supply units.

ACME PARVOLT BY-PASS CONDENSERS Supplied in all required mfd. capacities and for all standard working voltages.

ACME PARVOLT CONDENSERS

Made by the Manufacturers of

ACME CELATSITE WIRE

ENAMELED AERIAL WIRE

Enameled copper wire in both stranded and solid types. Also Acme Leads, Battery Cables, Indoor and Loop Aerial Wire

CELATSITE FLEXIBLE and SOLID

For all types of radio wiring. High insulation value; non-inflammable. 10 colors.

ACME SPAGHETTI

A superior cambric tubing for all practical radio and other electrical requirements. Supplied in 10 colors.



I Will Train You at Home to Fill a Big-Pay Radio Job



Here's the PROOF



Made \$185 in Three Weeks' Spare Time

I have met with continued success. For instance, recently I realized a profit of \$185 in three weeks for spare time work. I charge \$1.50 an hour. Right now I am making more money in my spare time than I am making in my regular job. I have been making good money almost from the time I enrolled. I am going to give up my present position and open a Radio shop. The N. R. I. has put me on the solid road to success.—Peter J. Dunn, 907 W. Monroe St., Baltimore, Md.

Made \$588 in One Month



The training I received from you has done me a world of good. Some time ago, during one of our busy months, I made \$588. I am servicing all makes of Radio receiving sets. I haven't found anything so far that I could not handle alone. My boss is highly pleased with my work since I have been able to handle our entire output of sets here alone.—Herbert Reese, 2215 South E Street, Elwood, Indiana.



Earns Price of Course in One Week's Spare Time

I have been so busy with Radio work that I have not had time to study. The other week, in spare time, I earned enough to pay for my course. I have more work than I can do. Recently I made enough money in one month's spare time to pay for a \$375 beautiful console all-electric Radio. When I enrolled I did not know the difference between a rheostat and a coil. Now I am making all kinds of money.—Earle Cummings, 18 Webster Street, Haverhill, Mass.

If you are earning a penny less than \$50 a week, send for my book of information on the opportunities in Radio. It's FREE. Clip the coupon NOW. A flood of gold is pouring into this new business, creating hundreds of big pay jobs. Why go along at \$25, \$30 or \$45 a week when the good jobs in Radio pay \$50, \$75, and up to \$250 a week. My book "Rich Rewards in Radio," gives full information on these big jobs and explains how you can quickly become a Radio Expert through my easy, practical, home-study training.

SALARIES OF \$50 TO \$250 A WEEK NOT UNUSUAL

Get into this live-wire profession of quick success. Radio needs trained men. The amazing growth of the Radio business has astounded the world. In a few short years three hundred thousand jobs have been created. And the biggest growth of Radio is still to come. That's why salaries of \$50 to \$250 a week are not unusual. Radio simply hasn't got nearly the number of thoroughly trained men it needs. Study Radio and after only a short time land yourself a REAL job with a REAL future.

YOU CAN LEARN QUICKLY AND EASILY IN SPARE TIME

Hundreds of N. R. I. trained men are today making big money—holding down big jobs—in the Radio field. Men just like you—their only advantage is training. You, too, can become a Radio Expert just as they did by our new practical methods. Our tested, clear training, makes it easy for you to learn. You can stay home, hold your job, and learn quickly in your spare time. Lack of education or experience are no drawbacks. You can read and write. That's enough.

MANY EARN \$15, \$20, \$30 WEEKLY ON THE SIDE WHILE LEARNING

My Radio course is the famous course "that pays for itself." I teach you to begin making money almost the day you enroll.

My new practical method makes this possible. I give you SIX BIG OUTFITS of Radio parts with my course. You are taught to build practically every type of receiving set known. M. E. Sullivan, 412 73rd Street, Brooklyn, N. Y., writes, "I made \$720 while studying." Earle Cummings, 18 Webster Street, Haverhill, Mass.: "I made \$375 in one month." G. W. Page, 1807 21st Ave., Nashville, Tenn.: "I picked up \$935 in my spare time while studying."

YOUR MONEY BACK IF NOT SATISFIED

I'll give you just the training you need to get into the Radio business. My course fits you for all lines—manufacturing, selling, servicing sets, in business for yourself, operating on board ship or in a broadcasting station—and many others. I back up my training with a signed agreement to refund every penny of your money if, after completion, you are not satisfied with the course I give you.

ACT NOW—

64-Page Book is FREE

Send for this big book of Radio information. It won't cost you a penny. It has put hundreds of fellows on the road to bigger pay and success. Get it. Investigate. See what Radio has to offer you, and how my Employment Department helps you get into Radio after you graduate. Clip or tear out the coupon and mail it RIGHT NOW.

J. R. SMITH, President

Dept. 4-O

National Radio Institute
Washington, D. C.

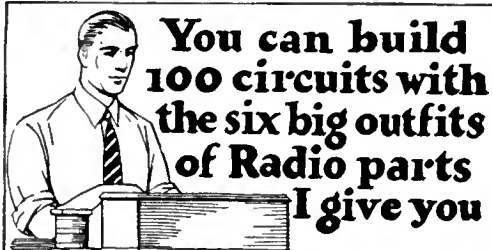

3 of the 100 you can build

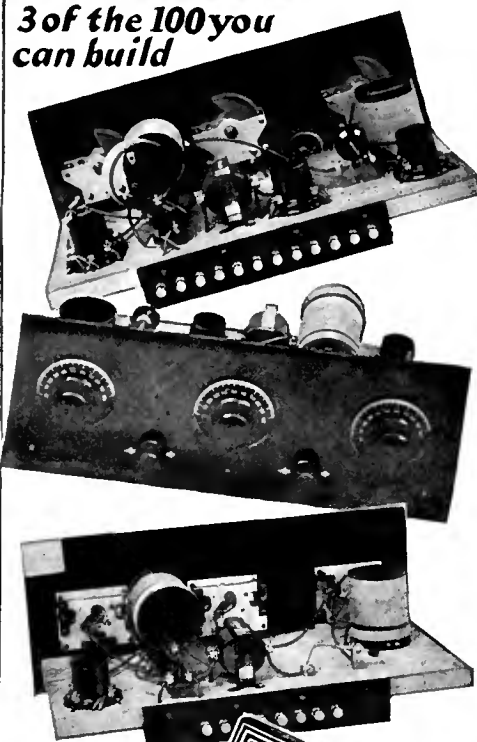

Find out quick about this practical way to big pay



Mail This FREE COUPON Today

J. E. SMITH, President
Dept. 4-O, National Radio Institute
Washington, D. C.

Dear Mr. Smith: Kindly send me your big book "Rich Rewards in Radio," giving information on the big-money opportunities in Radio and your practical method of teaching with six big outfits. I understand this book is free, and that this places me under no obligation whatever.

Name _____
Address _____
City _____ State _____

Employment Service to all Graduates

Originators of Radio Home Study Training

RADIO BROADCAST

WILLIS KINGSLEY WING, Editor

KEITH HENNEY
Director of the Laboratory

EDGAR H. FELIX
Contributing Editor

Vol. XII, No. 6

APRIL, 1928

CONTENTS

Cover Design	From a Design by Harvey Hopkins Dunn	
Frontispiece	Francis Gow Smith	402
Thanks to WGY—!	Francis Gow Smith	403
The March of Radio	An Editorial Interpretation	406
Picture Broadcasting Becomes a Practical Reality	The Commission Retreats	
Possibilities of Still Picture Broadcasting	The Blue Laws of Radio	
The Shrinking Short-Wave Spectrum	Here and There	
A Short-Wave Phone and C. W. Transmitter	Kendall Clough	410
Electrification Without A. C. Tubes	Lewis B. Hagerman	413
How Radio Developments Have Improved Recording and Reproducing	Sylvan Harris	414
Electrifying Your Present Set	Zeh Bouck	416
The Listeners' Point of View	John Wallace	419
Radio Must Be Made a Necessity		
"Our Readers Suggest—"		421
Testing an Audio Amplifier	Phonograph Pick-up Switch	
Sources of Power-Supply Hum	Stabilizing with High-Mu Tubes	
An R. F. Volume Control	Another Output Arrangement	
Eliminating A. C. Hum		
The Four-Tube "Lab" Receiver	Keith Henney	423
"Strays" from the Laboratory		427
Music from the Ether	Interesting Technical Literature	
A. C. Tube Troubles	Meters for Research Workers	
"Gross Exaggeration"	Short-Wave Notes	
As the Broadcaster Sees It	Carl Dreher	429
R. F. in Vaudeville	Studio Slang	
Rosa Ponsella before the Microphone	When Orchestra Leaders Sing	
Among the Broadcasters: WAAM-WOC-3 LO, Melbourne—Sydney, Australia.	An Engineer's Embarrassment	
Studio Scandal	Radio Inspectors—Fine Fellows	
	Commercial Publications	
No "Motor-Boating"	H. O. Ward	433
An Experimental Screen-Grid Receiver	Charles Thomas	434
Electrifying the "Hi-Q"	F. N. Brock	436
An A. C. Loftin-White Receiver	John F. Rider	438
Radio Folk You Should Know		440
(3). Lester Jones	Drawing by Franklyn P. Stratford	
The Month's New Phonograph Records		441
Testing A and B Power Units	Howard E. Rhodes	443
"Radio Broadcast's" Laboratory Information Sheets		446
No. 177. Characteristics of Speech	No. 181. R. F. vs. A. F. Amplification	
No. 178. The Exponential Horn	No. 182. Filter Condensers	
No. 179. A Problem in Audio Amplification	No. 183. The Type 280 and 281 Tubes	
No. 180. B Power Unit Characteristics	No. 184. Tuning	

The contents of this magazine is indexed in *The Readers' Guide to Periodical Literature*, which is on file at all public libraries.

AMONG OTHER THINGS. . .

THE issue before you contains a variety of articles appealing to all tastes. For the short-wave enthusiast there is the constructional article on the code and telephone transmitter on page 410. For experimenters, we offer many articles, such as those on a two-tube, screen-grid receiver, measurements on the "Lab" circuit receiver, the circuit and description of a non-motor-boating resistance amplifier, the technical editorials, "Strays from the Laboratory," descriptions of tests on B-power units for hum characteristics, how to operate the Hammarlund-Roberts "Hi-Q" set on a.c., and the story on how to convert many standard receivers for a.c. operation. Of more general interest, there are the reviews of new phonograph records, "The Listeners' Point of View," the editorial section, "The March of Radio," the invaluable "As the Broadcaster Sees It," the article by Sylvan Harris describing modern methods of phonograph record making, and many others.

OWING to causes which were beyond our control, we are unable at the last moment to present the article on a new tube for B-supply units, promised in the announcement on our cover. This article will appear as soon as it is finally released by the manufacturer.

THE May RADIO BROADCAST will be full of features which will make it one of the most important issues we have had in many months. Lloyd T. Goldsmith of M. I. T. has written a description of a short-wave receiver, and an intermediate-frequency amplifier using the screen-grid tube. This receiver, especially when used for code reception, provides efficiency heretofore impossible before the advent of the screen-grid tube. There will also appear in the May issue a most accurate list of international short-wave stations. Many readers have asked for a description of a power supply circuit for use in direct-current districts and an article describing a practical circuit for this purpose will appear in May.

THE problems of synchronizing broadcasting stations and, in general, of accurate frequency control for radio stations, has assumed great importance in the past year. Edgar H. Felix has prepared an accurate report of what has been accomplished to date and an analysis of the immediate possibilities in an interesting article scheduled for the May number. For radio constructors, Hugh S. Knowles is writing a description of an a.c. operated "Lab" circuit receiver which has many interesting features, besides its efficiency and flexibility of use, to commend it. This story is also scheduled for May.

SEVERAL additional regular features are being planned for the coming numbers of RADIO BROADCAST and it is hoped to start the first of them with the May issue. Each of these features will appear in a very practical way to a large number of the radio fraternity. . . . Those interested in information about the Cooley Rayfoto system of picture reception who desire to be placed in touch with the manufacturers may address their letters to the undersigned who will forward them.

—WILLIS KINGSLEY WING.

DOUBLEDAY, DORAN & COMPANY, INC., Garden City, New York

MAGAZINES

COUNTRY LIFE
WORLD'S WORK
GARDEN & HOME BUILDER
RADIO BROADCAST
SHORT STORIES
EDUCATIONAL REVIEW
LE PETIT JOURNAL
EL ECO
FRONTIER STORIES
WEST
THE AMERICAN SKETCH

BOOK SHOPS (Books of all Publishers)

NEW YORK: { LORD & TAYLOR; JAMES MCCREERY & COMPANY
PENNSYLVANIA TERMINAL AND 166 WEST 32ND ST.
848 MADISON AVE. AND 51 EAST 44TH STREET
420 AND 526 AND 819 LEXINGTON AVENUE
GRAND CENTRAL TERMINAL AND 38 WALL STREET

CHICAGO: 75 EAST ADAMS STREET
ST. LOUIS: 223 N. 8TH ST. AND 4914 MARYLAND AVE.
KANSAS CITY: 920 GRAND AVE. AND 206 WEST 47TH ST.
CLEVELAND: HIGBEE COMPANY
SPRINGFIELD, MASS: MEEKINS, PACKARD & WHEAT

OFFICES

GARDEN CITY, N. Y.
NEW YORK: 244 MADISON AVENUE
BOSTON: PARK SQUARE BUILDING
CHICAGO: PEOPLES GAS BUILDING
SANTA BARBARA, CAL.
LONDON: WM. HEINEMANN, LTD.
TORONTO: OXFORD UNIVERSITY PRESS

OFFICERS

F. N. DOUBLEDAY, Chairman of the Board
NELSON DOUBLEDAY, President
GEORGE H. DORAN, Vice-President
S. A. EVERITT, Vice-President
RUSSELL DOUBLEDAY, Secretary
JOHN J. HESSIAN, Treasurer
LILLIAN A. COMSTOCK, Ass't Secretary
L. J. McNAUGHTON, Ass't Treasurer

Copyright, 1928, in the United States, Newfoundland, Great Britain, Canada, and other countries by Doubleday, Doran & Company, Inc. All rights reserved.
TERMS: \$4.00 a year; single copies 35 cents.

VITROHM RESISTORS . IN EVERY INDUSTRY . IN EVERY LAND

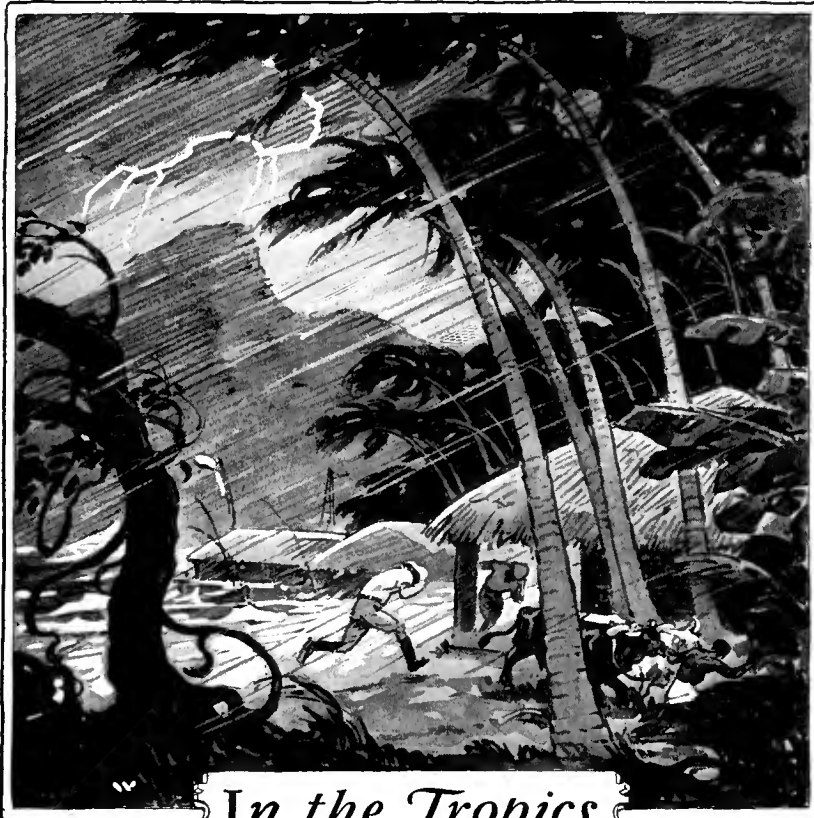

In the Tropics



Vitrohm Resistors are made in a large number of sizes and resistances. Type "S", illustrated, is 4" x 9/16". It is regularly available in resistances up to 25,000 ohms.

Vitrohm Resistors for radio

¶ Vitrohm Resistors are made by winding a special resistance wire upon a refractory tube and protecting both the wire and terminal contacts with fused-on vitreous enamel. This process has been used by Ward Leonard Electric Co. for more than 36 years.

¶ *Circular 507*, describing Vitrohm Radio Resistors, and "*Vitrohm News*" will be sent you without charge upon request.

*"Changing weather ...
from driving rain to beating sun ...
does not affect them ..."*

DOWN around the equator, great commercial companies are engaged in developing the resources of a dozen tropical lands. The countries are new. Normal communication by mail, train, and even road is difficult, and often impossible.

Radio is relied upon to maintain vital contact between district offices, ports and ships.

An engineer was sent to investigate the permanency of radio apparatus operating under the adverse conditions found in tropical countries.

His report, made to one of the largest operators, is typical: "... Vitrohm Resistors and Rheostats are ideal for use under difficult conditions ... changing weather, varying from driving rain to beating sun in a few hours, does not affect them."

You will find sturdy, permanent Vitrohm Resistors and Rheostats in every industry, in every land—always making good.

WARD LEONARD ELECTRIC CO.

MOUNT VERNON, N.Y.



© Julius Kirschner

Francis Gow Smith

THE INTREPID explorer whose recent expedition to the jungles of the Brazilian hinterland was facilitated by the use of short-wave radio equipment carried by the party. Twice weekly time signals were sent out on one of WCY's short-wave channels to aid Mr. Gow Smith in his map making. The special microphone used for the purpose is still known up at Schenectady as the Gow Smith "mike." The story beginning on the next page relates the amusing adventures of the explorer in the smaller towns on his route leading to the heart of the dark continent. Listening-in was a pastime never before indulged in by the inhabitants of many of these towns, and the explorer, who otherwise might have been received coldly, was acclaimed wherever he went, and was embarrassed by the great number of invitations to social functions which he received



MOUNTED BRAVADOS IN A MATTO GROSSO TOWN

The author frequently encountered mounted groups of nomadic ex-convicts whose thirst for amusement seemed to be satisfied only by plundering. Sometimes they will lay waste a whole settlement, murdering and robbing the inhabitants

Thanks to WGY—!

By Francis Gow Smith

THIS is WGY calling Francis Gow Smith, on the Upper Paraguay River, Matto Grosso: The discovery made in the use of your set without antenna or ground while you were on the steamship *Pan America* this last March is expected to have important results in the further development of radio."

This message, broadcast for me by the General Electric Company from Schenectady, and reaching me one spring night in the tiny frontier town of São Luiz de Cáceres, forty-five hundred miles south of New York, finally convinced my Brazilian friends that I was not a magician or a faker or a spy but a *bona fide* explorer.

And whatever value there may have been to radio in the experimental short-wave broadcasting that I received during my latest and most adventurous trip into the wilderness of Brazil, there is no doubt in my own mind that these experiments helped greatly to build goodwill for the United States in a backwoods region where North Americans have hitherto been looked upon with suspicion.

Incidentally, I owe my safe return from that expedition very largely to the radio set I carried.

It was a neat, portable two-tube affair, specially built for me by RADIO BROADCAST. When I sailed with it for Rio, aboard the *Pan America*, I appreciated it rather as a possible source of recreation during the long months I would be isolated from civilization. I had no inkling of its future utility in making my expedition a success.

Indeed, I was very much disappointed, the first few nights out, when I strung the antenna around my cabin expecting to get news reports and actually getting nothing in the phones but dead silence. Finally one night I turned it over to the radio operators to experiment with.

"What's the matter with the darn thing?" I asked.

"Give it a chance," said they. "Bring it up on deck."

And then one of them, with the headphones rumpling his hair and a delighted grin on his face, remarked:

"What's the matter with the blamed thing? Listen to this! I'm getting New York without antenna or ground. We're close to seventeen hundred miles out."

Every night thereafter we used the set on deck and got code signals from Germany, England, and Japan. The sensitivity of the set

amazed the radio boys, and was the occasion for that later message from Schenectady, which I received at São Luiz de Cáceres.

In Brazil to-day, radio is barely emerging from its infancy. There are two broadcasting stations in Rio and one in São Paulo, while the General Electric Company is erecting another. Entertainment programs and lessons in English are on the air constantly; but outside of the cities and a few prosperous ranches, there is nobody in Brazil equipped to hear the programs.

Here's a nation bigger than the continental United States, with a population of more than thirty million, and increasingly prosperous economic conditions. Some day soon it is bound to be a profitable market for American radio products. And when American radio programs are being received by American radio sets throughout Brazil, a greater influence will have come into being for Pan American goodwill and commercial development than all the spectacular goodwill flights and conferences that we can organize.

For radio will break down among the common people that suspicion which at present is fed by local propagandists to the detriment both of political amity and friendly trade.

I'm positive of this, because I've seen how it works out. When I reached Corumba, on the upper Paraguay River, I was just another of those Yankees, regarded with vague suspicion. I had a few acquaintances there, from previous trips, but no friends to speak of and no entrée into the intimate social life of the town. I put up at the hotel, and asked the proprietor's permission to install my radio.

He looked at me blankly. Corumba has water supply, electric lights, and telephones. But radio? Huh! There was no use trying to persuade the hotel man that the little wooden box I carried could perform any of the radio miracles he had indefinitely heard about. Still, he skeptically authorized me to put up an antenna on his roof.

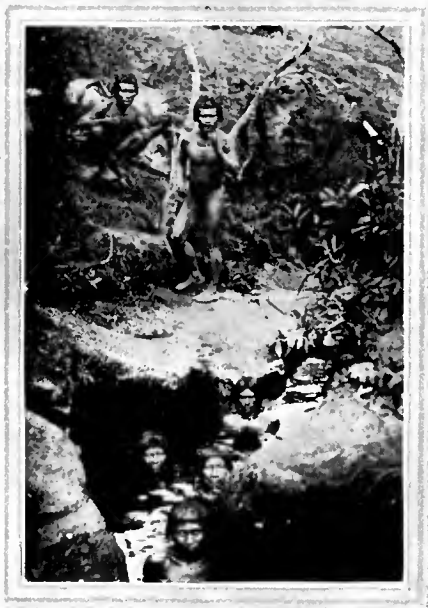

SATURDAY NIGHT!

A community bathing "crevice" makes unnecessary the "hot and cold water" clause in the South American Indians' lease

My opening act was unfortunate. One of the poles slipped while I was erecting it, fell through the red tile roof of the house next door and just missed hitting on the head one of the society leaders of the town. She came storming outdoors and gave me frankly a piece of her mind. Soon it was all over town that this crazy Yankee was destroying property with something he called a radio.

But that night I invited the hotel proprietor to bring a few friends into my room. They stood around rather abashed. What was the sense of all this fuss over a box with some wires and two oddly shaped electric light bulbs in it?

And then, singing sweetly in the phones, came from Schenectady a musical program given experimentally on short waves for a man in Johannesburg!

My guests were thrilled as they had never been in their lives. They were almost incoherent in their enthusiasm. The news spread like wildfire through the town. The leading citizens flocked into my room, uninvited; the crowd jammed the corridor outside. Men waited hours for their few minutes' turn with the phones; many went away disappointed and came back night after night until they had heard for themselves this miracle. The lady next door was placated—she wouldn't even let me pay for the damage to her roof. While the hotel proprietor was in the Seventh Heaven of bliss. His bar had never done such a flourishing business.

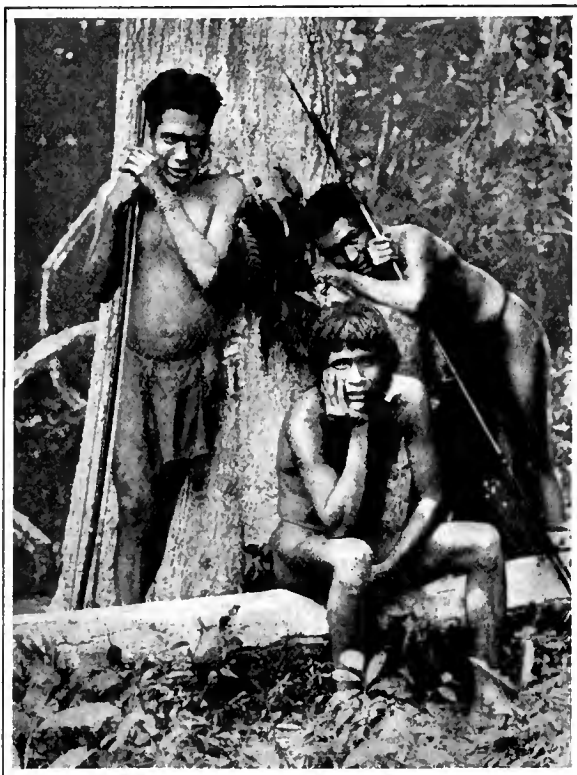

SOME FRIENDLY INDIANS OF MATTO GROSSO
While these were only too willing to pose for their photographs, there are others who could not be approached with safety

For eighteen days, while waiting for the little stern wheeler that would take me up to São Luiz de Caceres, I had the set working. There was considerable fading at times, but it worked, better after nine at night. Soon I had become the personal friend of the most important business men and politicians in Corumba. They heard dance music from the Waldorf and music from Aeolian Hall; they heard Chauncey Depew speak; they listened to plays and to operas from the Eastman Theatre in Rochester; they got the news of Amundsen's flight over the North Pole, and of one of the attacks on Mussolini.

I translated the news every night for the local newspaper. Corumba had never before been so intimately in touch with the outside world. The community became pro-American. Nobody could do enough for me; they wanted me to settle down and stay with them; they all said they were going to learn English; and I could have sold the set a hundred times over at any price I asked.

When I left, the leading citizen of the town pressed on me a letter of introduction to an influential friend of his in Cuyaba, the frontier capital of the state of Matto Grosso. I wasn't going anywhere near Cuyaba, but he wanted me to make a special trip there anyhow. His letter read:

"This is to introduce to you my good friend Mr. Francis Gow Smith, who is coming to you with a most marvelous machine called the *radio telephonia*, which has proved in experiments here to be a very amazing thing indeed and I want you to have the privilege of listening to this truly magical instrument."

SÃO LUIZ

WARNED by my experience in Corumba, I rented a big twelve-room house when I reached São Luiz de Caceres. I knew that no hotel room would hold the crowds that would come. And besides, São Luiz boasts no hotel worthy of the name. It's the jumping-off place on the Brazilian frontier—a town of five thousand population, at the edge of the jungle. To the northward beyond it are scattered ranches, a few hamlets of rubber and ipecac gatherers, and then unexplored wilderness, several hundred thousand square miles in extent, peopled sparsely with naked savages.

In São Luiz I was received with greater suspicion than in Corumba. Many of the common people thought I was some sort of gringo spy. Why did I have a camera, if it wasn't to take photographs of sites for future forts, when the dreaded "Colossus of the North" should begin the process of gobbling up Brazil? The people misunderstand the United States completely. They have been filled up with such fantastic bugaboo stories about us that they extend toward us a hazy mixture of dread and dislike such as a child feels toward imaginary giants and dragons.

The inhabitants are practically cut off from the world. They have a weekly four-page newspaper, but it publishes only items concerning local society events—marriages and birthday festivals, and perhaps a sprinkling of political news. Besides, most of the people can't read.

The streets are unpaved; there is no electric light, telephone, or water supply. Water from the river is peddled in barrels about the streets. On the edge of the barren plaza, fronting the river, there stands an unfinished stone church,

FORM 78

INDEPENDENT WIRELESS TELEGRAPH Co., INC.
67 WALL STREET, NEW YORK

RADIO LOG Page 2
Sheet No. 2

Station *W9Y + KDKA*

DATE	TIME	STATION CALLED	CALLED BY	REMARKS
4/14/28	7:50 AM	W9Y	32.79	Eastern Orchestra & two Operas at Rochester. Base Ball scores, & current events. Reception intense most of the time. Night very cool, with mist part of the time. Reception best up to date.
4/15/28				Heard unknown station not plain enough. B. A.
4/16/28		W9Y		broadcasting on wave length of 327.5 meters. First time I heard Plain 4 to 10° - night clear and cool.
4/17/28		W9Y	32.79	on wave length of 327.5 meters. Reception very clear with vertical + horizontal Antenna as well as with vertical + clear. Prominent citizens listening in. Programme from Aeolian Hall especially good.

PART OF A LOG KEPT BY MR. GOW SMITH IN BRAZIL

The expedition came to an untimely end owing to the fact that the party was robbed of all its belongings by a gang of bandits. This fragment was saved because Mr. Gow Smith covered it with his foot while he was being searched

and the piles of building stones beside it are alive with snakes, lizards, and rats.

Naturally, in this isolated community, I was looked upon with disfavor by the uneducated. My radio set in its mysterious box with the iron handles was set down in their minds with my camera as evidence that I had some mysteriously unfriendly intentions. They couldn't believe I was using the town merely as a jumping-off place for exploration. Why should anybody in his senses penetrate the jungles beyond and get himself shot at with poisoned arrows? No; obviously I had come for no good purpose, doubtless as a secret agent of the United States, either to survey gun emplacements or to detect hidden mineral wealth.

What a change in their attitude my radio worked!

There wasn't a stick of furniture in the house I had rented, except an old table. I set up the radio on that table, and slung my hammock in one of the bare rooms. I hired a boy to help me, went into the jungle and cut down two fifty-foot bamboos, which we erected as antenna masts in the *quintal*, or back garden, of my house.

The villagers watched these proceedings with growing suspicion. Many of them had never even heard of radio. Then I invited the mayor and a few prominent citizens to come and hear the set work. To give a touch of festivity to the occasion, I had hung Eveready electric flashlights around the walls, and softened them with bits of colored paper. The evening was a phenomenal success. Three sets of phones were working all the time. Sometimes a listener, after hearing ecstatically a few bars of music, would drop the phones and scurry out of the house, to round up his wife and children and friends.

Soon I was mobbed, as I had been in Corumba. Every citizen prosperous enough to wear shoes felt himself privileged to come in; the barefoot families humbly congregated about the doors and windows and stared in, imagining some queer sort of magic was going on.

So, within a few nights I was welcomed into the center of the town's social life, invited to all the most elite weddings, birthdays, and funerals, and offered banquets in every home. The bare rooms of my rented house began to fill up with furniture—chairs, tables, wine glasses, and even that rare and valued treasure, a bed! All contributed by the citizens to their distinguished guest—who had done nothing to distinguish himself but bring a radio set into their midst.

But suspicion still smoldered among the poor and illiterate, and I was advised to allay it by having a barefoot soiree, when the unshod portion of the populace could hear the radio work for themselves. Many of them heard it, but were still unconvinced. They'd go out into the back yard and stare up at the aerial; they poked about in the rose bushes, and surreptitiously investigated the empty rooms of the house. Somewhere, they were sure, I had a confederate hidden, to play on a musical instrument.

Then came the three special programs, broadcast by the General Electric Company for my benefit from Schenectady. The dentist in São Luiz understood English, and when the rest of the guests heard him translate the messages addressed to me, the last bit of skepticism vanished. But my reputation was enormously enhanced. Everybody called me affectionately "Mister," or "Mister Yank," and it was said that I was a great and influential millionaire.

Certainly nobody but a millionaire could have a wonderful radio set and receive special news and musical programs sent through the air, forty-five hundred miles over sea and jungle, just so that his evenings on the frontier might not be lonely!



AT CORUMBA

Listening-in with the short-wave receiver built for the expedition by RADIO BROADCAST

The girls of the town could never quite get over the notion, however, that I was some sort of magician as well. Some of them asked me to tell their fortunes with cards, and when I did so, invariably predicting a forthcoming marriage, the town's regular and previously prosperous fortune teller was deserted. She couldn't compete with the authentic forecasts that I had to offer—for didn't I get them straight out of the air, wearing my headset and listening wisely while I read the cards?

The guests came to these radio soirées clad in the strangest mixture of costumes. Some of the men wore evening dress; others came in homespun. There were cowboys wearing sombreros, gaudy neckerchiefs, and sidearms; there were

ranchers in khaki shirts and big boots. But many of the women, with their bobbed hair, low cut evening gowns and sparkling diamonds, might have just stepped out of a Broadway night club.

I understand that this experimental short-wave broadcasting was of some interest to the General Electric Company. However that may be, it certainly put a backwoods community of Brazil into a turmoil of excitement. The old suspicions of the United States vanished, and the town became a focal point of boosting for Uncle Sam. Every inhabitant wanted a radio, and they all insisted that nowhere else in the world could it be so great a blessing as it will soon be in these backwoods regions where there are only the most meager entertainments and no contact at all with outside events.

When finally my batteries gave out, it was considered a disaster. I left the set in São Luiz, and carried out my expedition into the wilderness, the entire services of the town being put at my disposal while I was making ready. Months later, having been waylaid by bandits, robbed of all my equipment and left fever-stricken and starving in the jungle, I was rescued by a boat coming up the Sipotuba River from São Luiz. They brought me down to the village too weak to walk, put me up in a private home, nursed me back to health, and lavished attentions upon me.

All this in the town that I had entered first amid such an atmosphere of suspicion. And when I was strong enough to leave I was escorted down to the little river steamer by practically the entire populace. Knowing that I had been robbed and left penniless, they thrust handfuls of currency at me; and I even discovered that some of them had secretly stuffed money into my pockets.

Believe me, a radio receiving set will be an essential part of my equipment on my next exploration trip. I don't mind the isolation in the jungles myself, and I dislike to increase the weight of my equipment; but a radio works wonders in building goodwill for the stranger along the frontier. I might not have survived the illness of my last trip but for the friendly attentions which RADIO BROADCAST'S portable set had won for me. And I think that, when it comes to the touchy job of dealing with hostile Indians in the wilderness, a radio would be even more valuable in winning friendship and esteem.

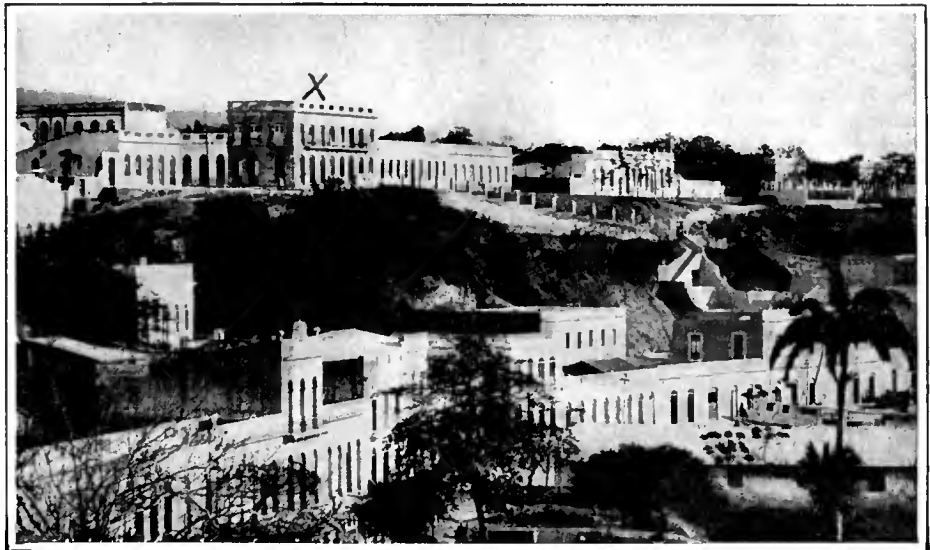

THE CROSS MARKS THE HOTEL "GALILEO," CORUMBA

It was here that Mr. Gow Smith unfortunately permitted one of his antenna masts to crash through the roof of a local society leader's house

The March of Radio

News and Interpretation of Current Radio Events

Picture Broadcasting Becomes a Practical Reality

HARDLY a day passes without some news of progress in radio picture transmission. On November 6, WOR broadcast its first complete radio picture, using the Cooley system. On January 13, Dr. E. F. W. Alexanderson publicly demonstrated his television device in Schenectady. On January 26, WEAF broadcast its first picture, utilizing equipment also developed by Doctor Alexanderson. On January 31, WOR began the regular broadcasting of Cooley radio pictures three times a week. Each event is significant and brings nearer the day when the radio reception of pictures becomes an integral part of the broadcasting art.

The transmissions from WOR have been continued since the initial experiment in November, at first occasionally and then on a regular basis. A group of twenty or thirty enthusiasts have installed Cooley Rayfoto receivers and the number increases as rapidly as the equipment is manufactured. These experimenters are typical set builders rather than specially trained professional engineers. Phonograph recordings of actual pictures have also been made successfully which make possible experiments with Cooley apparatus at any time, regardless of the availability of broadcasting. The sponsors of the Cooley system advise that, within two or three months, their equipment will be available in quantity and a rapid growth of the picture reception audience may be expected.

We witnessed a confidential demonstration of Doctor Alexanderson's apparatus at Schenectady some months ago. Several radio channels are required to transmit television images and consequently the system is now restricted to short-wave transmission. The conventional broadcast receiver cannot be utilized, therefore, in the reception of television by this system. The Alexanderson television outfit, which

uses Daniel Moore's improved neon tube, is infinitely simpler than the elephantine apparatus demonstrated by the Bell Laboratories a year ago. The picture, with the Alexanderson system, is scanned eighteen times a second. The received picture is in the form of a pinkish glow, covering an area of three by three inches. It is not rich in detail. Presumably three to five years of development are necessary before this apparatus is capable of reproducing sufficiently good moving pictures at a reasonable cost to the average user.

The picture receiver, demonstrated at WEAF, employs the neon tube and requires about ninety seconds for the reception of a picture. It utilizes high-grade synchronous motors to keep transmitting and receiving

drums in step. The transmitted signal was a high-pitched audio note, similar to that used in sending Cooley pictures. No statement has been made as to when the equipment necessary to build these picture receivers will be on the market. Since the synchronizing equipment is somewhat more expensive than the "stop-start" system used with the Cooley apparatus, its cost may be fairly high. It is capable of excellent detail and possesses considerable reliability.

The adoption of a regular picture broadcasting schedule by WOR, the fourth significant event, is an indication that that station has already established a picture receiving audience and is preparing to extend it. That this audience will grow rapidly as soon as the apparatus is available in quantity is foreshadowed by the fact that the Cooley equipment is no more expensive than the parts for a good broadcast receiver.

At the same time that these various news events occurred in the field of radio vision, a representative of the Baird system, *en route* to the United States, announced that television between London and New York had been definitely established. One demonstration for the press was held some weeks ago and the first transatlantic television transmission is claimed by Baird's representative in New York.

Possibilities of Still Picture Broadcasting

TELEVISION, or radio vision, naturally has a much greater appeal to the public imagination than the transmission of still pictures. Because of the tremendous number of images which must be broadcast at an extremely high rate of speed, the perfection of radio vision is a problem a thousandfold more complex than radio photography. It is unlikely that television will ever be possible in



ANOTHER RADIO PICTURE RECEIVER

Readers of this magazine are familiar with the Cooley Rayfoto picture system demonstrated at the New York radio show last September and which was first heard over WOR on November 6, 1927. On January 26, 1928, Dr. E. F. W. Alexanderson of the General Electric Company demonstrated one of his systems of radio picture transmission and reception through WEAF. The illustration shows Doctor Alexanderson and the receiver. The rectifier and amplifier unit is in the box near the wall and the mechanical element with paper on the receiving drum is in the foreground. Pictures are received in 90 seconds and are excellent in quality

the present broadcasting band, since it requires a number of channels used simultaneously to transmit all the necessary images. In its present development, the subject of television transmission must stand within a few inches of the scanning device and, as a consequence, only the bust of a single individual can be broadcast. Any rapid motion is blurred. Under the circumstances, present-day television has few, if any, advantages over the transmission and reception of still photographs.

All of the defects in television will, of course, be remedied gradually and the present state of the art is sufficiently advanced to make clear and entertaining radio moving pictures a prospect of the next few years. In the meanwhile, does radio picture reception offer sufficient fascination to promise rapid extension in the homes of broadcast listeners?

The existing systems of radio picture transmission and reception have many practical advantages. The pictures may be radiated from an ordinary broadcasting station and received with the aid of any good broadcast receiver. High-grade reproduction of pictures in the home is quite possible with apparatus now available. Broadcasting of pictures by remote control, with the aid of wire lines, is feasible with all existing systems. A news photographer can take a picture at a broadcasting studio, or at a remote point connected with the studio by wire, and put it on the air within two or three minutes. Radio picture broadcasting serves the same useful purpose that illustrations do in a book, magazine, or newspaper and enhances a radio program to an equal degree. The broadcasting of sporting and news pictures, photographs of prominent artists, and technical diagrams and data accompanying educational lectures is entirely possible and adequately useful or entertaining. Whatever the camera records, so long as the subject is not entirely too fine in detail or lacking in contrast, is suitable material for radio picture transmission.

It is not unreasonable to expect, in radio picture broadcasting, a new field destined to rapid growth. Those who have the foresight to participate in early experiments will reap their reward in the manufacture, marketing, and servicing of picture sets.

Foreseeing these possibilities, RADIO BROADCAST has been diligent in presenting all available information. So far, constructional information has been limited to the Cooley system but, as rapidly as information regarding other systems is available, we will present it in these pages, so that our readers may keep abreast of progress in the art.

The Shrinking Short-Wave Spectrum

FORESEEING the international complications which would result from the indiscriminate assignment of the higher frequencies to the numerous applicants therefor, we have persistently urged conservation of these frequencies.

Not until the hearings in Washington, however, did we realize that the Federal Radio Commission's problem in the short-wave spectrum is already more complex than that existing in the broadcasting field. Competent engineering authorities, with a long background of experience in short-wave transmission, pointed out that a short-wave radio telegraph station requires a channel having a width of 0.2 of one per cent. of the assigned frequency. Thus, immediately below the broadcasting band, a radio telegraph channel must be 3 kc. wide, while, at 30,000 kc., or ten meters, frequency variation is so great that the channel must be 60 kc. wide.

Assuming this separation, or channel width, to be necessary, there are only 1316 channels between 1500 and 30,000 kc. A part of these has been assigned to mobile, amateur, and broadcasting purposes, leaving only 666 channels available to the entire world for point to point short-wave communication. Inasmuch as, even with the most insignificant powers, a radio telegraph transmitter, assigned to these wavelengths, is likely to cause interference in all parts of the world, duplication of station assignments, for operating continuously is quite impossible.

Furthermore, to maintain continuous service over long distances, the varying transmission qualities of these frequencies at different hours of the day and night make it necessary to use two, three, and four channels. Consequently, instead of a host of channels, sufficient to meet the needs of all communication interests, the Army and the Navy, and the considerable

number of private concerns which desire channels, there is only a very limited number of channels to be divided among the numerous applicants. Assuming that the United States is entitled to twenty per cent. of the channels available to all the nations of the world, there are only approximately 126 channels to be considered after discounting those assigned for broadcasting, amateur, and experimental purposes.

The Radio Corporation of America has already established a number of short-wave, transoceanic services. It desires to extend these services greatly and, were all its prospective requirements considered exclusively, there would be no room on the air for any but Radio Corporation stations and the stations of the Army and the Navy. The Mackay interests propose to enter the radio telegraph field and have made demands for channels in numbers sufficient to absorb any reasonable allotment to the needs of the United States.

How the demands of brokerage houses, department stores, newspapers, oil companies, railroads, bus transportation services, and the thousand-and-one other interests can be met with this meager allotment of frequencies is not apparent until considerable technical progress is made in maintaining frequency stability. As soon as we learn how to hold stations within a few hundred cycles of their assigned frequencies, the capacity of the short-wave bands will be increased a hundredfold.

The Commission has announced that it will require two months of study before it can make any decisions. It is hoped that it

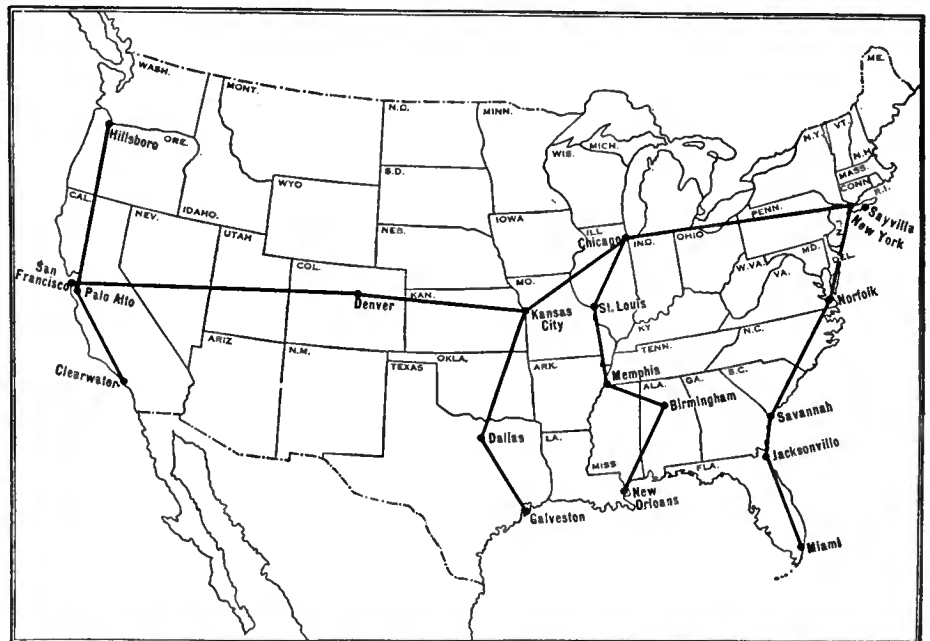

THE PRESENT AND PROPOSED MACKAY RADIO SYSTEM

Recently the Mackay Company entered the radio field and took over the Pacific Coast stations of the Federal Telegraph Company. These stations are at Hillsboro, Oregon, and Palo Alto and Clearwater, California. The points shown on the outline map are the basis of a short-wave system to furnish communication which will supplement the present Postal Telegraph wire system. The proposed channels will connect points most subject to storms and other interruptions to wire service. In addition to this land radio system, the old Sayville station on Long Island has been purchased and will shortly be opened for marine communication with ships on the Atlantic. The Mackay system now holds 42 wavelengths in the short-wave spectrum, of which 34 are for a chain of stations for transpacific communication

will establish a definite policy and stick to it. In the broadcasting spectrum, expediency, rather than an established set of principles, has ruled. In view of the complexity of the short-wave problem, it is most urgent that definite principles be enunciated, lest the Commission be later charged with favoritism or discrimination.

The first obvious principle is that there is no short-wave channel available for any service which can be conducted by wire. The Mackay interests, as one of their plans desire to establish an emergency network so that, should wires break down, they may use short-wave radio transmission. There is every reason why a duplicate emergency radio service should be available in national emergencies but, should such a system be established, permission to utilize the radio network should be restricted to grave emergencies.

The requirement that wire services be used where available is complicated by certain economic factors. A chain of department stores, for example, can erect short-wave transmitters and maintain communication at a much lower cost than entailed in using public service wire telegraph channels. The application of this principle requires, therefore, discrimination against private interests in favor of the wire companies. In view of the needs of transoceanic services and the value of an independent American communication service, this discrimination against private interests appears entirely necessary. Furthermore, it is utterly impossible to serve all private interests with the limited facilities available. Only a selected few could be accommodated, were short-wave radio telegraph channels assigned to private interests.

This suggests a second principle which may be established as a policy of the Commission. No short-wave channels shall be assigned for any service unless such service be opened to the general public upon an equitable basis of charges without discrimination.

It is unfortunate that the wire interests, which are so well entrenched and established in the United States, should seek to enter the radio field and compete with existing radio communication companies and that radio communication interests, on the other hand, should seek to compete with the wire interests. For example, application was made for the right to conduct a New York to Montreal service by a radio communications company. These cities are already well linked by wire telegraphy and telephony. Possibly there might be some simplification of the situation if the radio companies decide not to establish radio communication networks where wire services exist and the wire companies, in turn, stay out of the radio field and stick to their well established and profitable wire business.

The stifling of competition is clearly un-American in principle and carrying out this suggestion would obviously tend to stifle competition. But what alternative exists?

We do not grant street railway franchises for routes along the same avenue to two or three rival companies in order to establish competition. If radio channels are limited, they must be regarded as a franchise and be distributed in such a manner as to assure the greatest possible public service.

A further embarrassment in the situation exists in the fact that long-distance radio communication is dominated by a single interest. Whatever the means used to gain this acknowledged ascendancy, the fact remains that it exists. In almost every important line of industry there is a dominant company which has established its acknowledged leadership in the field. This company is always the object of vilification by politicians but, because of sheer strength and competence, merrily goes on occupying its position. Under the circumstances, the Federal Radio Commission is bound to be criticized as the tool of monopoly and its activities will always offer subject matter for spellbinding politicians because the dominating company, if fairly treated, will have a preponderance of assigned channels. For this situation, there is no practical and fair remedy other than the uneconomic proposal of government ownership.

The demands of the press for short-wave channels, although clothed in high-sounding phrases regarding public service and freedom of the press, are really an effort to reduce its wire costs. Signals travel through the ether no faster than they do over wire circuits. The demands of the press for special radio channels are in the same category as all other requests of private interests, excepting in those few instances that wire services are not available. The press already receives preferred consideration from the wire services which carry most of its communications at or below cost.

The Commission Retreats

THE Federal Radio Commission has issued new application blanks, requiring the submission of considerable information on the part of broadcasting stations concerning their technical equipment, their program hours, the proportion of time devoted to commercial broadcasting and facts regarding chain affiliations. The Commission should have gathered this information immediately on its accession, to authority last March.

Congressman Wallace H. White has expressed again and in greater detail his disappointment in the functioning of the Federal Radio Commission. He has urged, as we have in these columns for many months, that the future appointees be possessed of sufficient technical qualifications so that they may perform their duties efficiently.

The members of the Commission have been testifying before the House Merchant Marine Committee and they have hardly had a pleasant time of it. Judge Sykes admitted that a much larger proportion of channels had been assigned to New York and Chicago than those cities deserved, an abuse which we have frequently stressed in these columns for more than a year. The favorable position of chain stations which, the testimony brought out, occupy twenty-one

out of the twenty-five cleared channels, does not please members of the Congressional committee.

The saddest news which we have heard from the Commission so far is the announcement by Acting Chairman Sykes that the 300 stations which were to be scheduled for elimination on March 1 will have their licenses extended. This move, he says, is made because three of the four members of the Commission are not confirmed by the Senate. Naturally, each of these three hundred stations is the pet of some congressman or senator and the unconfirmed members of the Commission could not hope for a confirmation if they took the necessary and drastic action of eliminating such stations. Politics now rule radio, confirming our predictions made when a commission control of radio was first proposed before the Radio Act of 1927 was passed.

Representative White has presented a bill extending the powers of the Commission for another year and including, in addition, some provisions aimed at the Radio Corporation of America and the National Broadcasting Company. An amendment to Section 10 of the Radio Act, which he proposes, is to permit the Commission to refuse a license to a station intended for international commercial communication, if the company operating that station has entered, or intends to enter, into exclusive rights with a foreign country. We understand that the Radio Corporation has made several such agreements. The Commission, however, may grant such a license if the company will maintain just and reasonable rates and will secure and maintain equality of right and opportunity for other American citizens to engage in competitive services.

Other proposed changes in the Act are the strengthening of the powers of the Commission to revoke licenses for false statements in applications, or for failure to observe any of the terms, restrictions, and conditions of the Act or regulations issued by the licensing authority. To the powers of the Commission, Representative White proposes to add that it may fix the hours during which chain broadcasting may be carried on, designate the stations and limit the numbers participating therein, and that it may prohibit commercial broadcasting through chain stations and, in fact, may make any rules and regulations in the public interest, applying to chain broadcasting.

The crowning touch of Representative White's bill is a proposed provision to be included in the Radio Act that it shall be unlawful for any firm to import or ship in interstate commerce any vacuum tube, whether patented or unpatented, which shall have any restrictions of the use to which such tube may be put or which shall have the effect of fixing the price at which the tube may be sold. It is doubtful whether this unusual curtailment of patent rights of a single group is constitutional. This proposal is really an amendment to the patent law and is not properly a part of the act regulating radio communication.

If the fundamental theory of our patent law must be changed, why does not Congress undertake its thorough study and pass a new patent law instead of singling out vacuum-tube manufacture as a special case? High-grade vacuum tubes, suited to all purposes, are available to the public and sold without exorbitant profit. If the R. C. A. is indulging in unfair practices, there are adequate measures which can be taken without depriving it of the benefits of normal patent protection. If the patent monopoly, established by patent law, confers too great powers on the patent holder, then the patent law should be modified. A possibility worth considering is the compulsory issuance of licenses upon an equita-

ble basis to all who apply, thereby assuring patent holders of adequate reward, but preventing the use of patents to establish monopolies or embarrass competition. The principle of singling out a particular patent situation for special legislation is contrary to the principle of equal rights to all.

The Blue Laws of Radio

FAIRFIELD, IOWA, has passed an ordinance prohibiting the use of electrical equipment which causes interference with radio reception between noon and midnight. Interpreted literally, not only do vacuum cleaners, washing machines, electric toasters and flatirons fall within the ban, but also electrical incinerators, elevators, refrigerators, cash registers, fire alarm signals, and railroad block signals. Violations are punishable by a fine of one hundred dollars or thirty days imprisonment or both.

There is nothing reasonable about this ordinance. It is doubtful whether this practical confiscation of property is legal. Electrical interference problems should be solved by aiming at the cause rather than the effect. A modern cash register, for example, should be designed so that it cannot cause electrical interference, although even the best of them do so. Any electrical device can be equipped with suitable interference preventors which will eliminate the possibility of interference with radio reception.

In Providence, Rhode Island, they have invoked an old blue law to embarrass a radiodealer. The ordinance prohibits any person to ring a bell or to use any other instrument or means for the purpose of giving notice of any public sale or auction of any article. This has been interpreted by the police to embrace the use of radio loud speakers in stores, although it is doubtful whether the writers of the blue laws had radio in mind. To be really fair in the matter, the police ought to be prohibited from using whistles.

Here and There

AN APPEAL has been filed by the Westinghouse Electric and Manufacturing Company for a review of the decision of the Circuit Court of Appeals which upheld DeForest against Armstrong in the invention of the feedback circuit. ¶ ¶ ¶ THE HAZELTINE Corporation has filed against the Charles Freshman Company and the Stewart-Warner Speedometer Corporation in the Southern District, citing U. S. Patent No. 1,648,808. ¶ ¶ ¶ THE ORIGINAL decision of the examiner, rejecting claims 1 to 6 inclusive, 8, 9, 11, 12, 15, 19, 21, and 22 as unpatentable over prior art, was affirmed in the case of re-issue patent 16834, issued to Lloyd N. Knoll on December 27, 1927. The references cited were Bellini, Kolster, and a scientific paper issued by the Bureau of Standards. ¶ ¶ ¶ A SUCCESSFUL appeal from the decision of the primary examiner, denying the patentability of several claims of patent 1,654,285, issued to Charles Fortescu, describing a modulation system for quickly absorbing residual energy stored in the antenna system after signal impress has been completed, has been announced by the Board of Appeals. ¶ ¶ ¶ CORNELIUS D. EHRET, counsel for the applicant, Frederick A. Kolster, in Patent 1,637,615, called our attention to the fact that our item in the December issue, citing the substance of the opinion of Second Assistant Commissioner of Patents M. J. Moore, implies that the claims referred to were rejected after the patent was issued. While we fail to see how

this conclusion was reached from our item, we are pleased to state, in deference to Mr. Ehret's wishes, that no claims were declared invalid after the patent was issued.

THE FIELD FOR GOOD RADIO SETS

ARTHUR SMITH, radio dealer of Tampa, Florida, sends us a most lucid letter explaining the position of the radio dealer in locations where high-grade local broadcasting is not available. He complains that radio manufacturers concentrate their advertising almost exclusively upon the cheaper models and fail to point out the advantages to the user of the high-grade, super-power, radio receivers, really necessary in such areas. As a consequence, the dealer is compelled to demonstrate the cheaper type of receivers which do not give satisfactory results when remote from good broadcasting. He states as his opinion that less than one per cent. of the listeners in his area are utilizing receiving sets with 210 power output tubes and that most of them are still using the cheapest type of set which has been so forcibly heralded in the advertising columns. He urges that set manufacturers devote more advertising space to high-quality radio sets because the public, once appreciating their capabilities, is quite willing to spend the necessary money for better models.

E. T. CUNNINGHAM announces the introduction of the CX-371-A tube which has the characteristic of the 371 and 171 type except that it has an oxide-coated filament. This reduces the filament current required to a quarter of an ampere, effecting an economy of filament current. The oxide coated filament also gives uniform emission throughout its life instead of gradually falling emission which is characteristic of the thoriated filament.

JUDGE HUGH BOYCE in the Federal Court at Wilmington, Delaware, dismissed the suit of the General Electric Company, charging the DeForest Radio Company with infringement of Langmuir's high-vacuum tube patent. If this decision is sustained in higher courts, to which it will undoubtedly be appealed, one of the most important reliances of the R. C. A. in its hold on the tube situation is destroyed.

THE Federal Trade Commission proposes to broaden the scope of its investigation of the radio combination, amending its formal com-

plaint against the radio group by adding the following charge:

The defendants have: "8. Substantially lessened competition and tended to create a monopoly in the sale in commerce of unpatented parts of chassis, and of unpatented consoles and cabinets, and of other unpatented parts of radio devices," etc. etc.

THE Mackay interests have acquired the famous transatlantic station at Sayville, Long Island, which they will use in ship-to-shore service. Another station for the same purpose is planned somewhere near Norfolk. The system is already operating stations in San Francisco, Los Angeles, and Portland on the Pacific Coast and expects by next summer to have transpacific service to Honolulu and the far east.

THE National Better Business Bureau collected advertising literature at the Radio Show in New York last September and analyzed the inaccuracies and violations of their standard code of radio ethics and advertising practice. They found 232 inaccuracies, of which 39 per cent. were violations of their Rule 4 which calls for the accurate naming of cabinet woods. Twenty-six per cent. violated Rule 2-B, which provides that price quotations state clearly whether the offer includes accessories or not. Sixteen per cent. disregarded Rule 8 which holds that superlative claims lack selling force. The fact that only 58 complaints were investigated during the year 1927, as against 123 in 1925, is taken as an indication of the cooperation which has been extended by the radio industry in the work of the Bureau.

THE International Radio Telegraph Conference has adopted a new schedule of "Q" signals and, in addition, has recognized a number of one-, two- and three-letter combinations, some of which have been widely used but did not heretofore have the stamp of official approval. Prominent among these is the adoption of CQ as the general calling signal, replacing the three-letter combination QST. Some changes were made in the assignments of alphabetical groupings to the various nations from which each assigns call letters to the radio stations under its jurisdiction. The United States, hereafter, will have the entire letter K combinations at its disposal, instead of only a part, as well as the entire range of N and W calls.

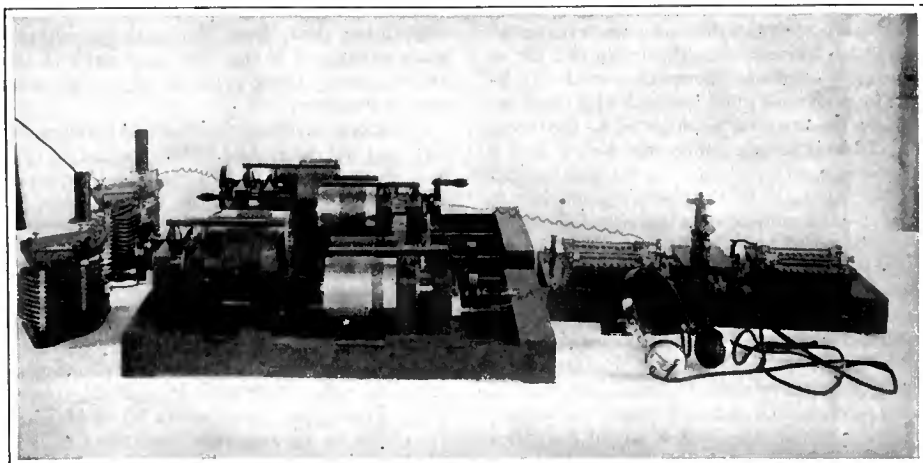

—Courtesy J. V. L. Hogan

AN EARLY FESSENDEN RADIO RECEIVER

It was "wireless" in those days, however. The antenna and ground circuits enter on the left, through the variable air condensers; the four drums, wound with wire, and each with its handle, illustrate the ingenious method of continuously varying the inductance of the closed circuit; the crystal detector and headset are on the extreme right

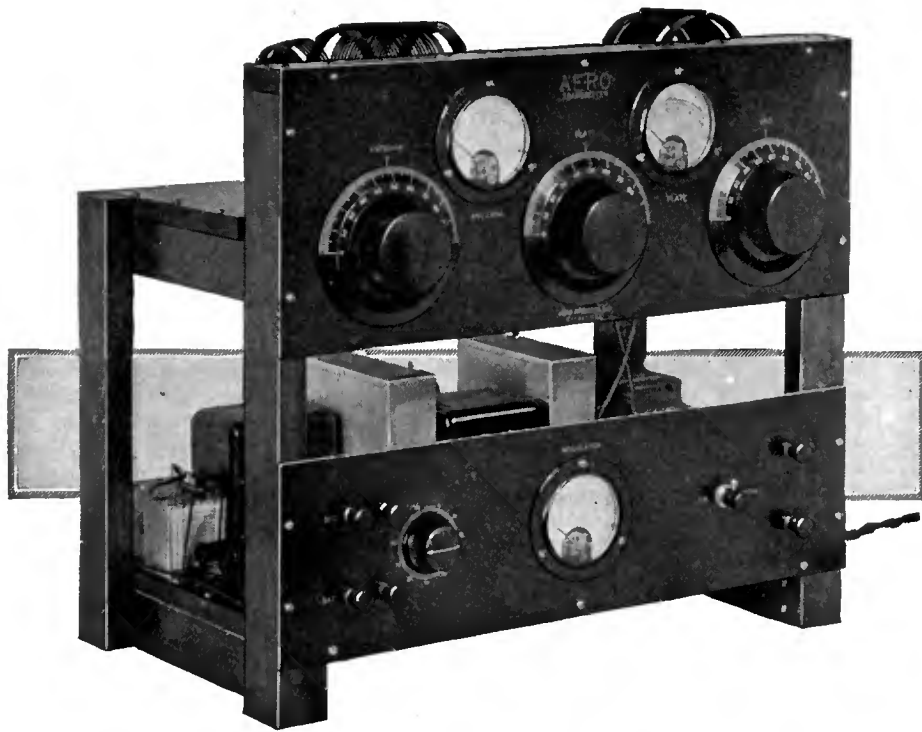

THE TRANSMITTER IN ITS FINAL FORM

By the mere throwing of a switch, it may be used for either c.w. or phone signals. It has covered a thousand miles with phone signals during its tests, although this figure is somewhat high to expect for regular work

A Short-Wave Phone and C. W. Transmitter

By Kendall Clough

WITH appetites whetted by the remarkable expanse of their eavesdropping, consummated with the simplest of equipment, the broadcast listener who became interested in short-wave reception, satisfied his curiosity, and listened half way round the globe, is now ready for new fields to conquer. The logical outlet for his enthusiasm lies in the construction of a transmitter, for it is provoking to hear a fellow a thousand miles away pounding out a crystal-clear message, terminating such with a remark to the effect that "I'm using a single 201-A, OM," and not to be able to answer him back, and report a better "watts-per-mile" record.

To supply the demand created by this growing enthusiasm, several well-known parts manufacturers have cooperated in the design of a short-wave radio telephone transmitter which can be built for about the same cost and with the same ease as a good receiver constructed for the reception of broadcasting. While this design is of a low-power type transmitter, it has been repeatedly demonstrated that the power is sufficient to carry on conversations over surprising distances. It will be noted from the photographs that the manner of construction permits the isolation of all the parts carrying radio-frequency currents on the upper "deck," or shelf, while all the circuits associated with the power or voice currents are on the lower "deck." This form of construction insures that the masses of metal contained in power devices, such as transformers, condensers, etc., will not be in the fields of any of the radio-frequency coils, since this would introduce losses therein. Corresponding to the arrangement of the circuits in decks, the front controls are also grouped. Thus, on the upper panel we have the controls for the tuning condensers, the antenna-current meter, and the plate-current meter for

the oscillator tube. On the lower panel we have the plate-current meter for the modulator tubes, the modulator C bias control, the switch for changing from telegraphy to telephony, and the necessary binding posts for the key, microphone, and battery. The circuit diagram of the transmitter is shown in Fig. 1. That portion of the circuit shown on the upper "deck" is the justly famous tuned-grid, tuned-plate circuit, which has been in use for several years. This circuit employs a series feed for the plate voltage to the oscillator rather than the shunt feed ordinarily used. In this way an already efficient oscillator circuit has been improved by eliminating those losses in the choke coil that are bound to occur when using shunt feed. Naturally enough any losses eliminated in the choke coil result in additional energy being available for actual transmitting purposes.

Considerable voltage is developed between the plate coil and the ground by this method, so that it is necessary to use two condensers in series (C_3 in Fig. 1) as an r.f. bypass. An r.f. choke, L_4 , serves to keep the radio-frequency currents from finding their way down to the lower "deck."

The power supply consists of a Silver-Marshall 328 transformer, T_1 , which supplies the plate current as well as lights the filaments of the oscillator and modulator tubes. In order to secure direct current, which is necessary for phone operation, the high voltage of T_1 is rectified by means of a gas tube, and filtered with a Silver-Marshall 331 Unichoke, L_6 , and Tobe condensers, C_6 , and C_7 . It will be noted that two modulator tubes, V_2 and V_3 , are used in conjunction with one oscillator, V_1 , of the same type. This is in accordance with the best practice and while the set is perfectly operable with only one modulator, it is recommended that two be used where the

best quality of transmission is desired. The modulator tubes and the oscillator tube are all of the CX-310 (UX-210) type.

In order to operate the modulator tubes at maximum capacity, it is necessary to amplify the output of the microphone transformer to bring the speech to the proper volume level. This amplification is accomplished by means of a CX-312 (UX-112) tube, V_4 , and a Silver-Marshall 240 transformer, T_2 . The proper C and B voltages for the CX-312 are secured from the power supply by means of the resistors R_4 , R_5 , and R_6 , the latter supplying the C voltage for this tube. During the preliminary experimental work a CX-326 (UX-226) was used in place of the CX-312 and was lighted from the power transformer. In view of the fact that a 6-volt battery was necessary for the operation of the microphone, however, the same battery was finally used to light a CX-312 instead of the a. c. tube, since a quieter signal from the transmitter resulted.

DETAILS OF ASSEMBLY

THE construction of the transmitter may well commence with the lower "deck" as this unit must be assembled and wired before the work is started on the upper structure, otherwise the latter will hinder the wiring. The lower deck is shown separately in an accompanying illustration. The board for this assembly is screwed to the cleats below, and the screw holes for the equipment are located with the aid of the full-size template supplied with the foundation unit specified in the list of parts.

After screwing down the parts for the lower "deck" and wiring them in accordance with the circuit diagram, the lower front panel and the equipment on it should be screwed in place as

shown, after which the wiring of the lower "deck" may be completed. This unit may be tested separately before proceeding with the work. In order to do this the unit is connected, as it would be in operation, with the microphone, storage battery, etc., and the switch on the panel is thrown to the "Phone" position. Most of the resistance, R_8 , should be in circuit. The tubes should all light properly and the needle of the modulation meter, M_3 , should jump up when the microphone is spoken into. Now, to check the quality, a loud speaker should be connected across the modulation choke, L_6 , by means of a long cord leading into another room. It may be necessary to shut the door between the rooms in order to keep the loud speaker from transmitting acoustical energy to the microphone and setting up a continuous howling noise. When the equipment on the lower deck is operating properly, the microphone speech input as heard by another observer at the loud speaker, should be very clear and distinct. The resistance, R_8 , should be adjusted during the test until speech is at its clearest point, at which time the modulation meter will indicate from 20 to 30 milliamperes.

The equipment on the upper "deck" should now be assembled from the template and diagram in the same manner as the lower "deck" was, after which the whole frame (supplied with the foundation kit) may be put together with wood screws. The upper panel, with its equipment, should be attached last. The wiring is next completed in accordance with Fig. 1.

LIST OF PARTS

M_1 Weston Model 425 Thermoammeter, 0-1 Amp.	\$13.50
M_2 Weston Model 301 Milliammeter, 0-100 Mils.	8.00
M_3 Weston Model 301 Milliammeter, 0-50 Mils.	8.00
L_1, L_2, L_3 Aero Short-Wave Transmitting Coil Kit (2040K, 4080K, or 9018K)	12.00
L_4 Aero 248 Radio-Frequency Choke (Included with Above)	—
L_5, L_6 S-M 331 Unichokes	16.00
C_1 Cardwell 0.0005-Mfd. Condensers	15.00
C_2 Polymet 0.002-Mfd. Moulded Condensers	.80
C_3 Polymet 0.0005-Mfd. Moulded Condensers	.70
C_4 Polymet 0.00025-Mfd. Moulded Condenser	.35
C_5 Tobe 2-Mfd. 300-Volt Condensers	2.50
C_6 Tobe 2-Mfd. 1000-Volt Condenser	3.50
C_7 Tobe 4-Mfd. 1000-Volt Condenser	6.00
C_8 Tobe 1-Mfd. Condenser	.80
R_1 Yaxley 810-Type 10-Ohm Resistors	.60
R_2 Polymet 10,000-Ohm 10-Watt Resistor	.75
R_3 Yaxley 2000-Ohm Potentiometer, No. 2000	1.75
R_4 Polymet 25,000-Ohm 10-Watt Resistor	1.25
R_5 Polymet 15,000-Ohm 10-Watt Resistor	1.00

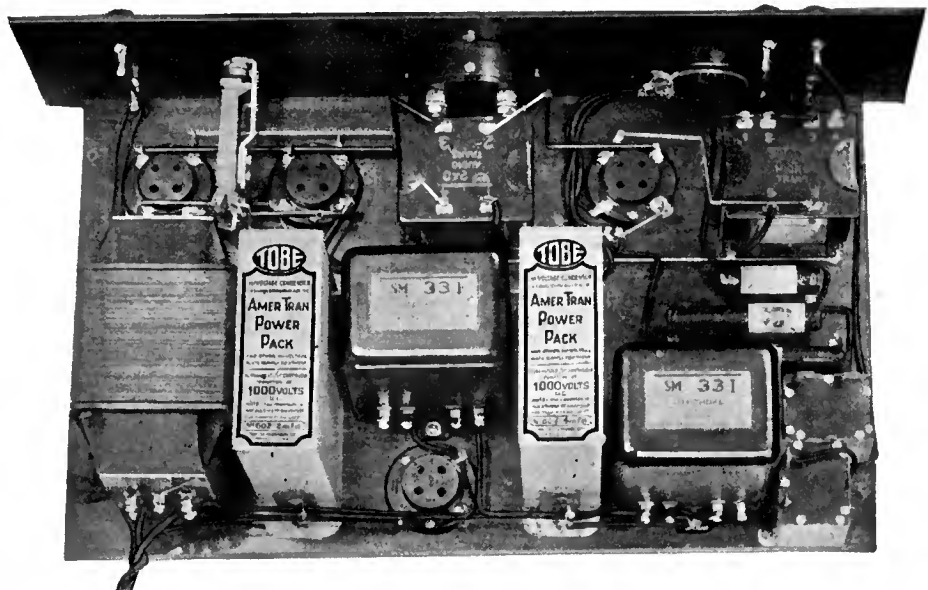

THE LOWER DECK ARRANGEMENT

The circuits associated with the power or voice currents are located on this deck. The two-deck arrangement prevents losses which would otherwise occur

R_6 Polymet 750-Ohm 10-Watt Resistor	.75
R_7 Yaxley 1.5-Ohm Resistor, No. 2L	.15
R_8 Yaxley 100-Ohm Resistance, No. 8100	.25
T_1 S-M No. 328 Transformer	18.00
T_2 S-M No. 240 Transformer	6.00
T_3 S-M No. 242 Transformer	7.00
S_1, S_2, S_3 Yaxley 2-Pole Switch, No. 63	1.60
Five S-M No. 511 Tube Sockets	2.50
Aero Transmitter Foundation Unit (Consists of drilled and engraved Westinghouse Micarta upper front panel, 7 x 18 x 1/4 inches, drilled and engraved lower front panel, 5 x 18 x 1/4 inches, seasoned walnut lacquered frame kit cut to size for making a stand 16 x 18 x 10 1/2 inches, with all screw holes drilled that are necessary to put framework together, wiring diagram, and layout sheet.)	27.00
No. 159 Frost Desk Microphone	8.75
TOTAL	\$164.50

ACCESSORIES

V_1, V_2, V_3 CX-310 (UX-210) Tubes	\$ 27.00
V_4 CX-312 (UX-112) Tube	3.50
V_5 Manhattan No. 2721 Gas Rectifier	7.00
Transmitting Key	1.50
Three Four-Inch Bakelite Dials	1.50
Six Binding Posts	.60
TOTAL	\$41.40

Since the accompanying photographs were taken, a "key click" filter, consisting of a 1-mfd. Tobe condenser, C_8 , in series with a 100-ohm Yaxley resistor, R_8 , has been connected across the key terminals as shown in the circuit diagram. Space is available for these items on the baseboard just behind the key binding posts. Its use will be appreciated by near-by broadcast listeners, who otherwise would hear the key clicks in their receivers.

The set should be tested to insure that it oscillates properly. The plug is inserted in the 110-volt 60-cycle light socket and the switch is thrown to the c.w. side. This should leave only the oscillator tube lighted and, on shorting the "key" binding posts, current will be indicated in the plate meter. Probably this current will cause almost a full-scale deflection but by varying the plate or grid condensers it will snap back to 20

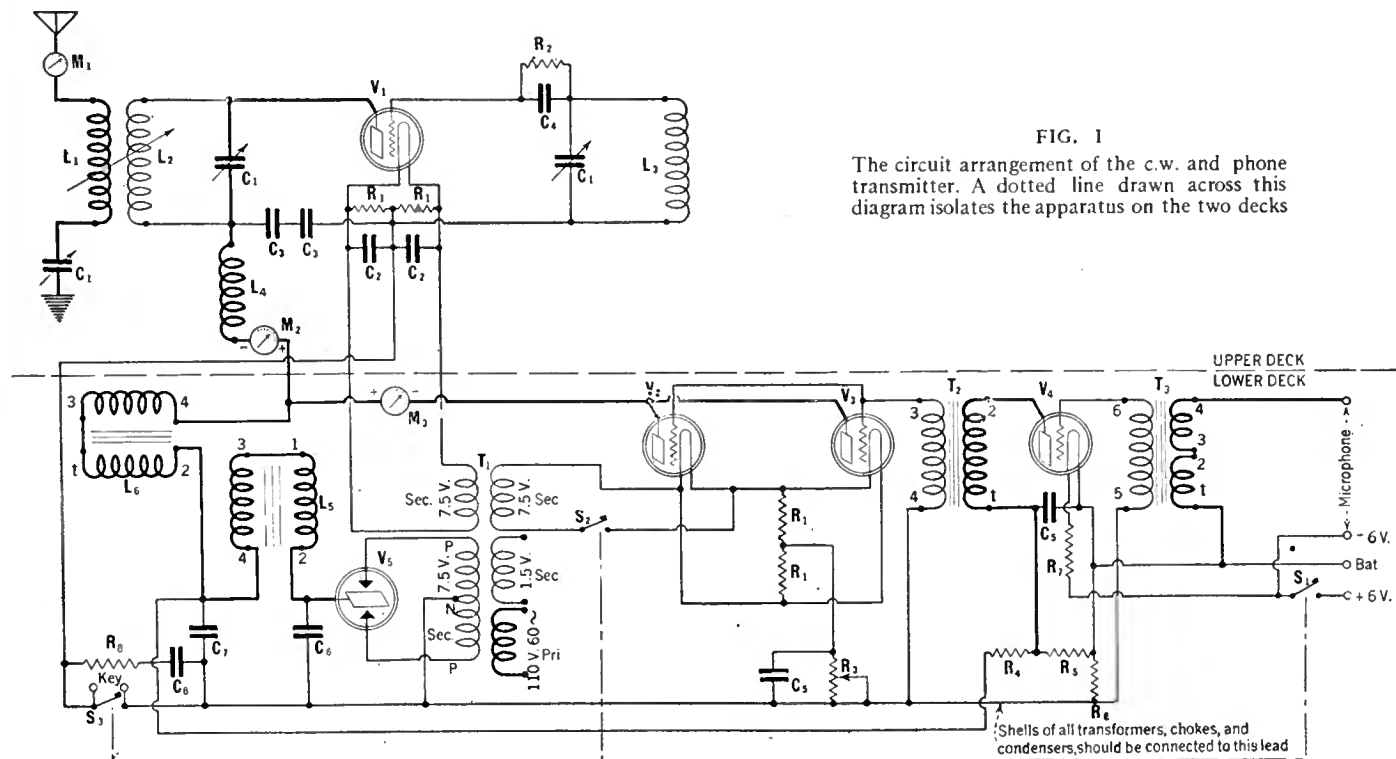

FIG. 1

The circuit arrangement of the c.w. and phone transmitter. A dotted line drawn across this diagram isolates the apparatus on the two decks

or 30 milliamperes at a certain point, indicating that the tube is oscillating. On connecting an antenna and ground, and tuning the antenna condenser, this reading will be increased when resonance is obtained, and at the same time some antenna current will be noted. If the coupling is too close the tuning of the antenna will tend to throw the tube out of oscillation and it will be necessary to loosen somewhat the coupling between the hinged primary coil and the plate coil (L_1 and L_2).

Final tuning should always be done with a wavemeter in order that transmission may be within one of the bands licensed by the Government. One of the features of the transmitter is, however, that due to the interchangeable coil feature, the set may be tuned to any wave between 18 and 180 meters so that it is not rendered unserviceable by any slight changes in wavelengths granted by the Government. The transmitter may not be used, of course, unless the operator has a license which permits him to do so.

Space does not permit us to go into the antenna construction, operating methods, etc., at this time, and the reader is referred to *The Radio Amateurs' Handbook*, published by the American Radio Relay League, Hartford, Connecticut, for excellent information along this line. This transmitter is now in operation at 2 GY, the RADIO BROADCAST station at Garden City, New York, and there is also a similar one now working at the Aero Products station located at Chicago and the results that have been obtained in a limited time are very gratifying. With c.w., on the 40-meter band, all U. S. districts have been worked from Chicago as well as NC 5ZZ in Vancouver, British Columbia. Twenty-meter phone work has been unusually successful. The following stations have been worked on 20-meter phone with reports varying from R-5 to R-7: 1 BMM, Harwich, Massachusetts; 1 ASF, Medford, Massachusetts; 1 SW, Andover, Massachusetts; 2 BSC, Glen Head, New York; 3 ARS, Phila-

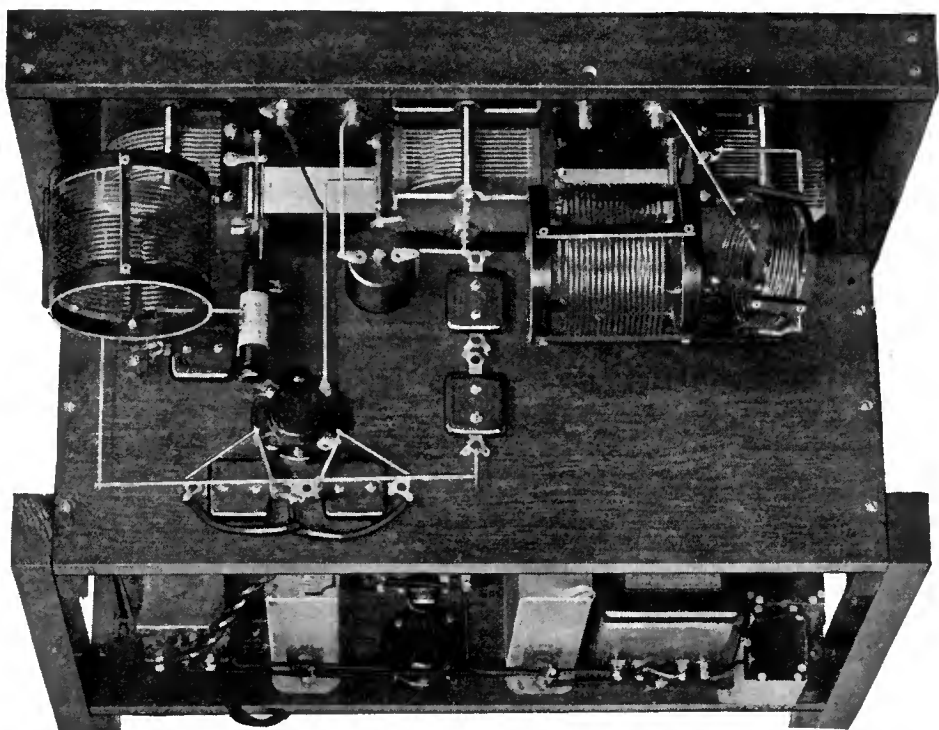

A PHOTOGRAPH OF THE UPPER DECK

All the equipment carrying radio-frequency currents is mounted on this deck. Fig. 1 will clearly show just what equipment is placed on this deck

delphia; 4 MI, Asheville, North Carolina; and 8 CVJ, Auburn, New York. In all cases where the transmission has been on phone, the quality of the speech has been reported to be very fine. Even greater distances have been worked on code with the transmitter located at Garden City.

FOR CODE WORK ONLY

MANY amateurs are interested in c.w. transmission to the exclusion of phone. In such cases the transmitter may be constructed for that purpose only at a substantial saving in parts. The conversion requires simply the omission of the parts that are necessary for phone operation since the transmitter described here is an ideal c.w. transmitter in itself.

The circuit diagram of the outfit wired for c.w. only is shown in Fig. 2.

The values of the parts shown in Fig. 2 are exactly the same as those of the parts in Fig. 1. The only addition is the inclusion of R_8 in the second diagram. This is a 50,000-ohm Polymet resistor of 10 watts carrying capacity. It lists at \$1.50, and is used to prevent the voltage on the final filter condenser from rising to an unsafe value when the key is up.

As it will be noted in the above list of parts, there are three distinct sets of Aero coils available for transmitting purposes. The most popular kit is the 4080K, which covers a wavelength range of 36 to 90 meters (8330 to 3330 kc.). The 2040K kit covers the band between 18 and 52 meters (18750 and 5770 kc.). The No. 9018K kit is suitable for the band between 90 and 180 meters (3330 and 1670 kc.).

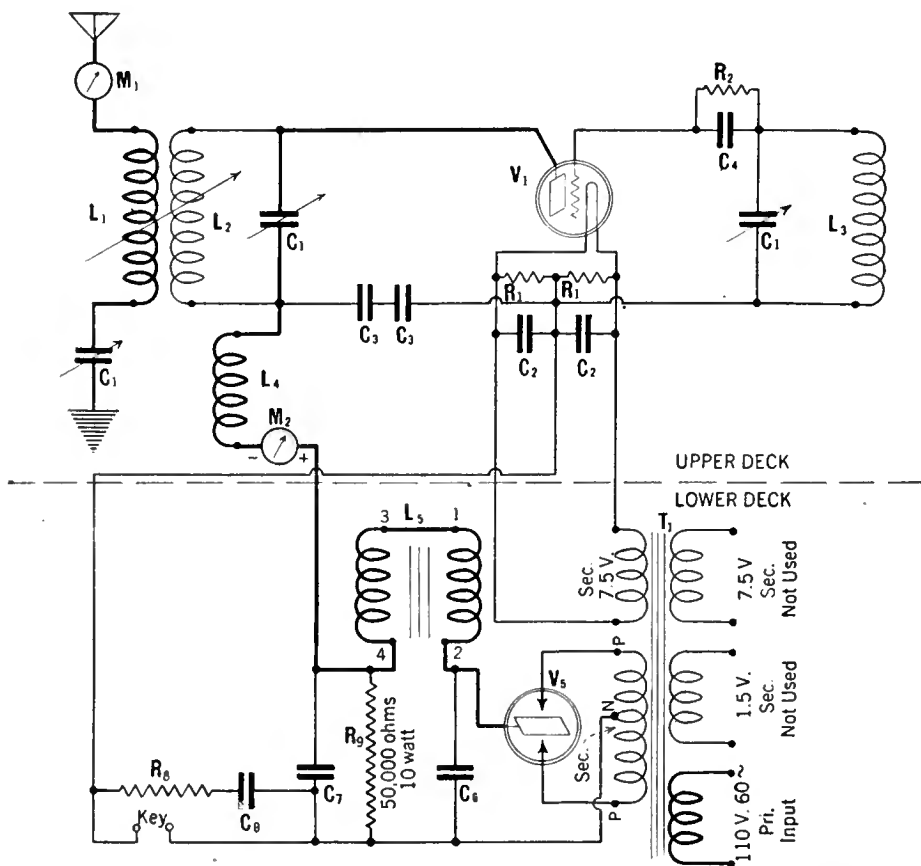

FIG. 2

Here is the transmitter circuit diagram for the experimenter who wishes only to transmit c.w. signals. The upper and lower deck feature, it will be seen, is still maintained

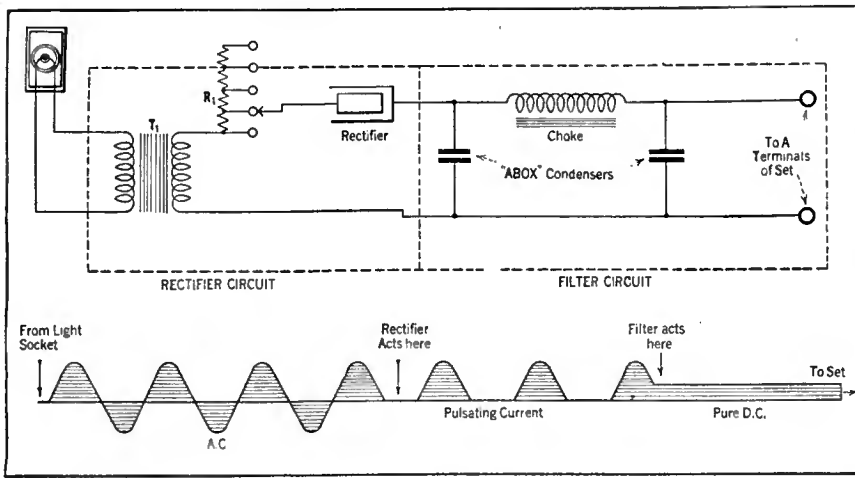
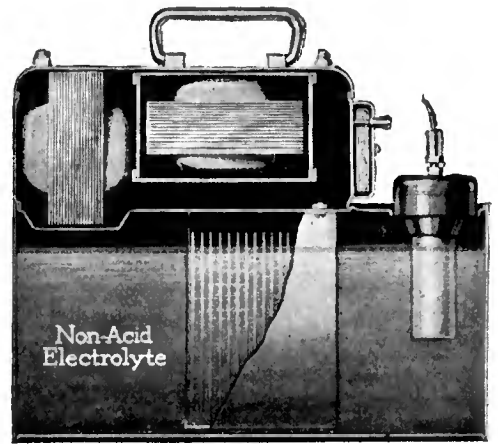

FIG. 1: THE CIRCUIT OF THE "ABOX" UNIT



A SECTIONAL VIEW OF THE "ABOX"
Its circuit arrangement is given in Fig. 1

Electrification Without A. C. Tubes

By Lewis B. Hagerman

JUST push the plug into the light socket," is the answer most radio set users would like to give to the query: "How do you turn on your radio receiver?" In this classification, so many believe, are included only those receivers using a.c. tubes, and so when they go out to buy an "electric" receiver, they examine it to be sure that it uses a.c. tubes. Also, when they consider converting their battery-operated sets for a.c. operation the problem to most of them becomes one of adapting the set to use a c. tubes. It is possible, however, to electrify a receiver in another way which is frequently much easier to accomplish and generally just as satisfactory. We refer to the use of accessories in conjunction with a receiver originally intended for battery operation so that the equivalent of light socket operation is obtained without the substitution of new tubes.

Electrically there is practically no difference in the operation of a receiver from a.c. tubes or from storage battery type tubes in conjunction with an external A power unit connected to an a.c. source. With a.c. tubes we supply a.c. power either directly or indirectly to the electron emitting surface which then emits electrons. With d.c. tubes we supply a.c. power first of all to a rectifier which in turn supplies power to the filaments, and these become hot and their surfaces then emit electrons. In neither case does the current in the filament enter directly into the operation of the tube; it is merely the agent which causes the electron emitting surface to become hot. Socket power operation is a means of eliminating the problems associated with the storing of electric power for the operation of the receiver, such as by means of a storage battery, and any method which enables us to do this implies direct operation of the receiver from the power mains. If you want to electrify your receiver, you can do it by using a good B power unit and a reliable A power unit, such as the "Abox."

Many of RADIO BROADCAST'S readers are at present obtaining plate voltage for the operation of their receivers from a B power unit and, therefore, a socket power A unit will complete the electrification of the receiver. When the plus and minus terminals on the "Abox" unit are connected to the corresponding A terminals on the receiver and the power lead is plugged into the light socket, there will be available, from the "Abox" unit, a source of filament current, and from the B power unit, a source of plate

voltage, both obtained directly from the light socket.

Electrically, the problems associated with the design of a satisfactory A power unit are similar to those connected with the design of a B power unit. In both cases the problem is to take alternating current power from the light socket and rectify and filter it so that it will be satisfactory for the operation of the receiver. The problem in the design of an A power unit is that it must deliver large amounts of current, which necessitates a great difference in the values of the constants incorporated in a proper rectifier and filter unit, as opposed to those of a B power device.

An A supply unit must deliver at least two amperes to be universally adaptable to most receivers and this value of current is approximately one hundred times the output in amperes of a low power B device. As the current to be handled increases, the capacity of the filter condensers must also be increased in direct proportion, which will be about 100 times, and it is only recently that large capacity condensers of reasonably small physical dimensions have been commercially available at a low price.

Then we have the voltage factor. A given condenser stores more power the greater the voltage; at one hundred and fifty volts, therefore, it will store much more energy than at six volts. To compensate this, the capacity of the filter condenser must be increased in proportion to the difference in voltage, or another twenty-five times. Since the A device delivers current to the filament circuit, any hum will tend to effect the grid bias and be amplified by the tube. The capacity of the filter condensers must be increased about seven times to offset this effect.

Thus it will readily be understood that the filter condenser of an A power-supply device must be one hundred times twenty-five times seven times, or 17,500 times, as great as that used in a B device. The capacity of a B filter condenser is about 4 microfarads; the capacity required for an A power unit is, therefore, in the neighborhood of 70,000 microfarads.

To obtain this the "Abox" Company developed a condenser consisting of a number of nickel and iron plates immersed in a caustic potassium solution, which is not an acid. This solution causes thin films of oxygen and hydrogen

to form on the surface of the plates, and these films constitute the dielectric of the condenser. The caustic solution is one side of the condenser while the plates form the other.

Since the capacity of a condenser increases as the thickness and amount of dielectric decreases, this infinitesimally thin gas film is responsible in part for the tremendous capacity obtained.

This film has several advantageous features. Should an excess voltage be impressed on the condenser, the film immediately breaks down and bypasses the excess energy. When the output returns to normal, the film forms again, and the condenser is as good as new. The bugaboo of burnt-out condensers is thereby done away with.

The capacity of the condenser is far in excess of that required; it has been estimated that its capacity is in excess of 200,000 microfarads. When used with the "Abox" rectifier, it reduces the alternating component of the input pulsating d.c. to less than 3000th of its original value.

Both the rectifier and condenser work in the same solution. The addition of distilled water every six months or so is the only maintenance needed. The condenser plates are never affected by use or disuse, and the rectifier electrode has a life of several years and can be replaced in a few seconds at a very low cost. The tapped resistance, R₁, which compensates for the number of tubes used is adjustable from the front of the unit.

Fig. 1 shows the circuit of the complete eliminator. The alternating current from the house lighting circuit is stepped-down from 110 volts to the proper low voltage by the transformer, T₁. The current then flows through the rectifying valve which will pass current in one direction only, thereby eliminating one phase of the alternating current and creating a pulsating direct current. It is next passed through the filter circuit, where it is smoothed, and all variations and pulsations in current are removed. The drawings at the lower part of this diagram show the effect of the rectifier and filter on the alternating current. The rectifier changes the alternating current to pulsating direct current by eliminating one phase of the a.c. wave, and the filter then smooths out the pulsating current, producing practically pure direct current. When this A power unit is used in connection with the average receiver, it will not cause any hum.



A "HUDDLE" IN ONE OF THE VICTOR TALKING MACHINE COMPANY'S STUDIOS FOR RECORDING, OLD STYLE

How Radio Developments Have Improved

THE electromagnetic phonograph reproducer, also often simply called the "unit" or "pick-up," is acquiring great popularity nowadays on account of the tie-up it creates between the radio receiver and the phonograph. When static is bad, or when radio programs are not to one's taste, it becomes a simple matter to change over to the phonograph and enjoy the best or the worst in musical art, according to the choice of the person who purchases the records.

On the other hand, since most of us are able to afford only a limited number of phonograph records, and must play them many more times than once in order to realize on our investment, such repetition occasionally palls, as it were, and we turn to the "air" to supply us with programs new to our ears.

Although there are a great many "pick-ups" already on the market, and more are coming on every day, their commercial exploitation is relatively new. The development of a new device requires the simultaneous development of a technic particularly suitable to it. At this early stage of the development, it is not to be expected that all those who design reproducers know everything about them, and it must also be remembered that many of those who are working on the problem are radio engineers, and are not versed in the phonographic art.

On the other hand, although the electric reproducer is new to the radio public, it is not by any means new to engineers. The writer remembers a demonstration of a piezo-electric reproducer which he witnessed in New York as far back as 1921, and the engineer who developed this reproducer had been working on it for a period of several years before. Electromagnetic pick-ups are likewise fairly old in the art, as also is the capacity type of pick-up, but the advent of these devices for practical and commercial application had to await the development of suitable amplifiers and loud speakers.

There are quite a few phases of the art to consider. These may be listed as follows:

Recording

Method of sound pick-up (horn, microphones of various types).

Method of actuating cutting head.

Amplification

Reproducing

Type of pick-up (capacity, piezo-electric, carbon, electromagnetic).

Amplification.

Conversion into sound (type of loudspeaker)

This list outlines the complete process from beginning to end, which we will describe briefly in the next few paragraphs.

At the recording studio we have a band, orchestra, singers, or other artists furnishing the original music. The sound waves of this music are collected by a horn, in the old "air-line" method of recording, or by a microphone in the newer system of "electrical" recording.

In the "air-line" method, the sound waves, entering the collector horn, were concentrated in it, so that sufficient energy could be obtained for actuating a diaphragm, to which was rigidly fastened a "cutting-head." Under this cutting-head traveled the wax disk known as the "matrix," on which the cutter engraved waves corresponding to the sounds entering the horn. Naturally, the power available for driving or actuating the diaphragm which carried the cutter was limited to that which could be collected from the original sounds in the studio.

In order to obtain sufficient power for cutting the record, it was necessary to use a resonant diaphragm, so that at the outset we have two inherent difficulties in the air-line system of recording; in the first place the horn which collected or concentrated the sound waves was a cause of distortion, due to its "resonance" at various frequencies, and, secondly, the same was true of the diaphragm, which was made resonant in order to operate the cutter satisfactorily.

These difficulties are avoided in the electrical system of recording, in which the sound waves operate directly on the diaphragm of a micro-

phone. The energy pick-up of this microphone is, of course, exceedingly small—much smaller than that picked up by the collector horn in the old system—but the advantage lies in the fact that since the microphone converts the energy of the sound waves into corresponding waves of electric current, it is possible to amplify them to any degree we might desire. On this account distortion need not be permitted at the outset, *i. e.*, as in a horn or resonant diaphragm. On the other hand, we run into the difficulty of distortion in the amplifier or in the microphone.

This is what we referred to previously when we stated that the development of electrical recording and reproducing had to await the development of the amplifier. To-day we can build amplifiers having negligible distortion, and the microphone, collecting such a small amount of power and having no extended surfaces, is inherently far superior to the collector horn of the old system. The main advantage of the "air-line" system of recording and the old method of reproducing, is simplicity. The new electrical systems show to greatest advantage in the recording, for it must be understood that very good quality is obtainable in reproducing by the old system when slowly expanding exponential horns are used in which the resonances have been reduced and the range of response has been extended to include the lower tones. But good reproduction by the old method requires that the recording be done properly, so it is here that the electrical system is especially valuable.

VOLUME CONTROL

ANOTHER feature of the electrical system which is of great importance is the ability to control the volume of reproduction. The phonograph record is a form of mechanical power amplifier, deriving its power to amplify from the motion of the turntable which carries the record. We can understand how this is by considering the old "air-line" system. The acoustic power con-



HOW A VICTOR RECORD IS MADE NOWADAYS. FOOTBALL TACTICS HAVE BEEN FORGOTTEN, AND BETTER RECORDS RESULT

Recording and Reproducing—By Sylvan Harris

centrated in the collecting horn and which actuates the diaphragm to which the cutter is attached is very small. After the record is made and is being run on the turntable under the needle of the pick-up, it is the motion of this needle, caused by the rotation of the disk, which furnishes the sounds which come out of the horn. In other words, the power which drives the disk causes the needle to vibrate in the grooves of the record. The waves themselves, in the grooves of the record, furnish no power. It is only the motion of the record which furnishes the power.

We have a very analogous situation in an amplifier; a voltage is impressed on the grid of the amplifier tube, but this voltage is not power. It is only due to the influence of this voltage on the power furnished by the B supply that an amplified reproduction of it occurs in the plate circuit. The alternating grid voltage is similar to the waves on the record; the power of the B supply is analogous to the power in the mechanism which drives the record.

In spite of the inherent amplification in the phonograph record, this amplification is not always sufficient when there are wide ranges of volume in the original music. It is also difficult to obtain all the volume that one might desire for ordinary purposes without introducing considerable distortion, unless electrical amplification supplements the mechanical amplification of the record. First we must amplify the weak output of the microphone, because the microphone pick-up is so small. Yet we must not amplify too much, for we run into other difficulties of recording, as, for instance, where the cutter cuts through from one groove to the next, or where distortion arises in the cutting apparatus.

This brings us to the next phase of the subject—the cutter. This is a specially ground amethyst set into the end of a rigid rod or bar, which, in the old system, was attached to the middle of the diaphragm at the throat of the collector horn. When the diaphragm was set into vibration by the sound waves in the studio, this bar and the

jewel at its end were likewise set into vibration. The jewel, cutting a groove into a heavy wax disk (the matrix), at the same time cuts waves in either the walls of this groove or at its bottom, depending upon the particular construction of the cutting-head, as it is called.

There are two methods of cutting—the “hill-and-dale” cut and the “lateral” cut. In the hill-and-dale method, the cutter vibrates up and down in the groove, so that there are “hills” and “dales” at the bottom of the groove. This was the original method used in the phonographic art, and is hardly ever used nowadays. It has been superseded by “lateral” cutting, in which the cutter is made to vibrate “laterally,” or from side to side. The result is that the groove cut in the wax, while circular around the center of the disk, is at the same time wavy. We will not discuss the advantages and disadvantages of the two methods here; they are mentioned merely to acquaint the reader with the general ideas involved.

In either case the vibrating bar of the cutting-head is connected (generally through a system of levers) to an armature (in the electrical system) which is actuated by an electromagnet. This electromagnet obtains its power from the amplifier, the input of which is connected to the microphone. The principle of the cutter is the same as that of a loud speaker, excepting that instead of having a cone for the load on the armature, we have the jewel cutting into the wax.

So, in the electrical system of recording we have first the microphone, which may be any one of several types, next, the amplifier, which may also be any one of several types, and finally, the cutting-head, which includes an electromagnet for actuating the armature to which is attached the cutter. There is no standard design of cutting-head, the type used often being the arbitrary choice of the man who does the recording, and the design often being his own. The design of the cutting-head is, however, extremely important, the success of the whole system de-

pending to a very great extent upon it, not so much perhaps, upon the electrical part of it as upon the mechanical arrangement of the levers, the damping of the movable parts, the shape of the cutting point, the depth of the cut, etc.

We will now skip over the actual making of the records for this is a mechanical process; in this article we are considering only the electrical features. Suffice it to say that from the large, thick wax disk (the matrix) upon which the cutting is done, a “master” is made, and from this master any number of impressions can be made, resulting in the records as they reach the music store.

In the old system of reproduction the vibration of the needle in the grooves of the record actuated a diaphragm of mica or other material, which directly communicated the energy of vibration to the air column of a horn of one type or another. In the newer electrical method power is communicated to the needle by the rotation of the turntable in the usual manner, but now, instead of driving a diaphragm, the needle drives an armature located in the magnetic circuit of a permanent magnet. A coil is also connected in the circuit so that the variations of the magnetic flux caused by the vibration of the armature induce fluctuating voltages in this coil, and these can be impressed on the input of an audio amplifier, the output of which is connected to a high-grade loud speaker.

So we have a means of amplifying the “pick-up” from the record, and of controlling the volume, neither of which could be done by the older method of reproduction.

The main feature of the electrical system of recording and reproducing is the fine quality that can be obtained. Music obtained from old-style records by old-style methods of reproducing is greatly lacking in the bass notes, and sounds thin and hollow. Very fine quality can, on the other hand, be obtained by the new methods. The tie-up between the radio and the phonograph has turned out to be very successful indeed.

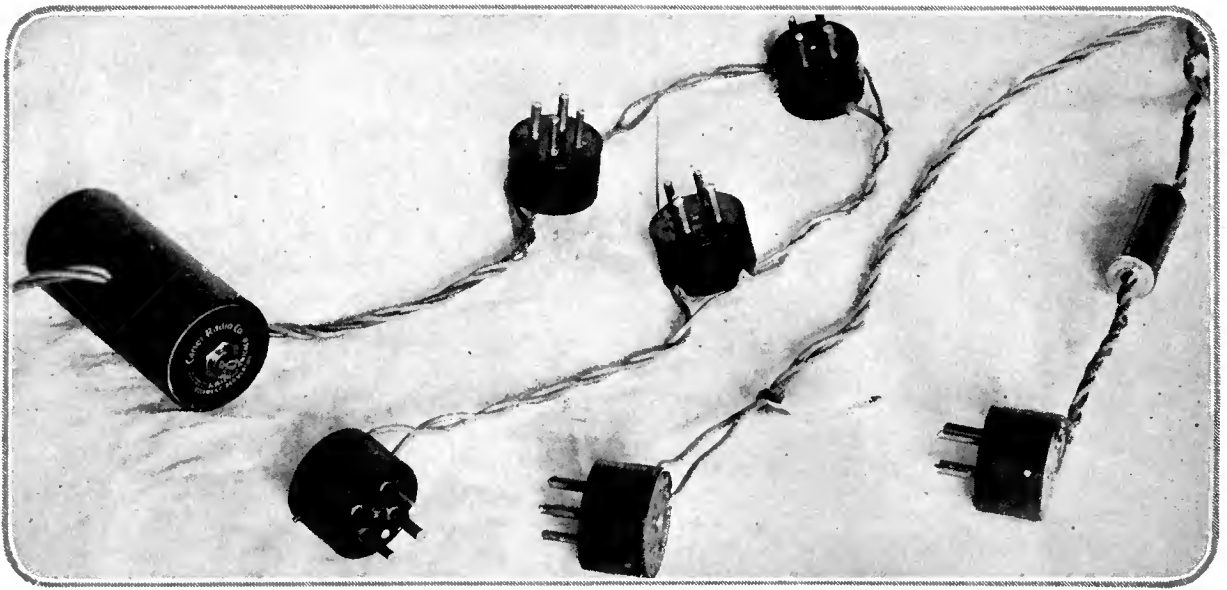

SIMPLE EQUIPMENT FOR UTILIZING A. C. TUBES WITH AN EXISTING RECEIVER
The photograph shows the various components—adaptors, C bias resistors, and cables—of the Carter a. c. harness

Electrifying Your Present Set

By Zeh Bouck

THE introduction of the alternating-current tube has stimulated something in the nature of a mild radio revolution. The advantages of a.c. operation—reliability and economy—in the majority of possible installations, are immediately obvious. This presents the problem of what is to be done with several-hundred thousand receivers of general efficiency, the only deficiency of which is their inability to be operated directly from an alternating-current source of a hundred and ten volts.

From an engineering standpoint this, of course, is merely a mechanical problem. Its solution was a simultaneous by-product of the a. c. tube itself. Any receiver in the world can be rewired for the use of a.c. tubes. In the majority of cases the changes are relatively few and simple. But the actual alteration of a radio receiver, particularly a commercial job, is repugnant to the average fan, and it was up to the manufacturers to provide

on the socket and at the same time provide two new filament or heater leads, and it was such adaptors that appeared on the market concurrently with the production of a.c. tubes. Fig. 1 indicates the familiar battery arrangement, while Fig. 2 suggests the electrical change effected by a simple adaptor. New filament leads have been provided for, while the former negative A post, to which the lower side of the grid coil or secondary is returned, remains open for biasing purposes.

The manner in which a typical adaptor fits between tube and socket is shown in the photograph, Fig. 3. The use of adaptors necessarily

increases the effective height of the tubes which in some cases makes it necessary to slightly gouge out the covers of the receivers, before they can be closed, or with suspended tubes as in the Atwater-Kent Model 35, the receiver must be raised on short legs. In consideration of this occasional inconvenience, the Arcturus a. c. tube, designed for cable or "harness" use, obviates the necessity for the use of adaptors by means of two small screws, one on each side of the base, to which the heater leads are connected. The manner in which the Arcturus a. c. tubes and a. c. cable are mounted in the average receiver is shown in Fig. 4.

"HARNES" OUTFITS

THE use of adaptors alone solves only half the rewiring problem. The adaptors themselves have to be wired, so the majority of manufacturers producing adaptors are also providing

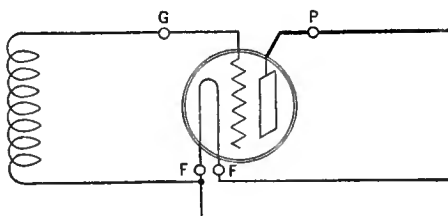

FIG. 1

FOR the convenience of our readers we have collected together here the names of the manufacturers of apparatus for use in converting a receiver for a. c. operation. Many of these names are also mentioned in the text of the article although those of the manufacturers of filament-lighting transformers are an exception for they are not given specific mention in the article. Readers should realize that, to light the filaments of a. c. tubes, a step-down filament transformer is necessary, besides the adaptors and harnesses mentioned in the article. A source of plate potential, and the necessary grid voltage are of course, also, required.

Manufacturers of A. C. Tubes:

Cunningham, R. C. A., Ceco, Arcturus, Sovereign, Televocal.

Manufacturers of Harnesses:

Arcturus, Carter, Eby, Naald, Cornish Wire, Harold Power, and Radio Receptor. The latter two companies sell combined A, B, and C power units and harnesses, as explained in the text.

Manufacturers of Filament Transformers:

Amertran, Dongan, General Radio, Karas, National, Samson, Silver-Marshall, Thordarson, and Ives.

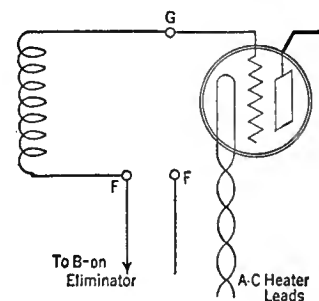

FIG. 2

suitable devices for the conversion of battery receivers with little or no alteration of the receiver itself. Almost simultaneously with the production of a.c. tubes—the Cunningham and R.C.A. 226 and 227 types, the Arcturus line, and a host of others—these desired devices appeared upon the market in numerous quantities.

By referring to Figs. 1 and 2 it is obvious that the mechanical and electrical requirements of the new tubes, in reference to receivers originally designed for battery use, can be satisfied by means of a simple adaptor, which will insulate the tube from the original filament terminals

connecting cables, usually referred to as "harnesses," in the form of braid-covered leads permanently connected to the adaptors. Other manufacturers sell the "harness" complete with an A, B, C power supply unit. Such devices are made in special and general types, prominent among which are those of the Radio Receptor company and Harold J. Power, Inc.

Radio Receptor makes three types of "Power-

the r.f. amplifying tubes respectively. A resistor connected between the center filament tap of any a.c. tube and B negative, will bias the grid of the tube negatively, providing the grid of the tube is returned (through a secondary or leak) to B negative.

Fig. 6 shows the adaptors and tubes mounted in the Atwater-Kent 35 receiver, and Fig. 7 shows the "Powerizer" itself. The rheostat panel on the Atwater-Kent was removed and a special volume control, supplied by Receptrad, was mounted in its place. An external form of volume control could have been employed.

The following are the steps taken in installing the "Powerizer," along with the time consumed for each operation:

Demounting the Receiver . . .	10 Minutes
Installing Volume Control . . .	30 Minutes
Installation of Adaptors and Tubes . . .	5 Minutes
Reassembly of Receiver . . .	12 Minutes
Connection of "Powerizer" . . .	2 Minutes
TOTAL TIME	59 Minutes

This time would be reduced to 34 minutes by using the external form of volume control.

The result is a thoroughly up-to-date receiver, capable of delivering remarkable volume with fine quality, with a reliability of operation achieved only by complete "electrification."

Fig. 8 shows a Radiola 28 superheterodyne in which a somewhat similar installation has been made with the Receptrad type 28 "Powerizer."

SPECIAL STABILIZATION

WITH some receivers, special devices (generally resistors in the grid circuits) must be employed, aside from the volume control, to achieve a satisfactory degree of stabilization. The following list considers various receivers that have been successfully adapted for a.c. operation, employing the Receptrad type of "Powerizer" and harness, with notes on special requirements:

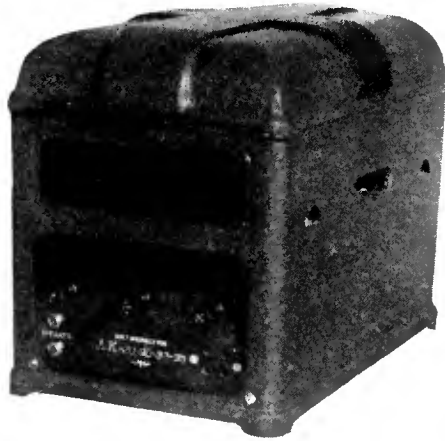

FIG. 7

A neat unit—the "Powerizer"

ATWATER-KENT, Models 20, 30, 32, 33, 35: For external control no change is needed.

BOSCH "CRUISER:" Regular harness. Requires re-neutralization. Uses external volume control.

BOSCH, Model 46: Simply plug in adaptors. No volume control necessary.

BOSCH, Models 66 or 76: Requires 400 ohms in grid circuits of r.f. tubes. Also requires re-neutralization. No volume control necessary.

BREMER-TULLY "COUNTERPHASE" 6-37: Requires standard harness. May need re-neutralization or grid resistors. External type volume control.

BREMER-TULLY "COUNTERPHASE" 8: Requires standard type of harness with special distances between adaptors. May require re-neutralization or the use of grid resistors. External volume

control. A high resistance of 50,000 or 100,000 ohms should be shunted across the secondary of the 2nd audio transformer.

CROSLEY "BANDBOX:" Simply plug in standard harness. Control may be had by "accumulators" or external. In some cases re-neutralization is necessary.

DAY-FAN 6 JR: Plug in standard harness. External volume control.

FADA SPECIAL 6, 265 A. R. P. 65: Standard harness. External Volume control.

FADA 7 — 475 A-S.F. 45/75: Remove tube housing. This is held in place by 6 or 8 screws. Put in standard harness for seven-tube set with distances between adaptors slightly longer. External control.

FADA 8—480 B-S.F. 50/80 B: Requires the use of 1600-ohm resistors in the grids of all of the r.f. tubes. Standard harness for eight-tube set with special distances between the adaptors. A high resistance of the order of 50,000 or 100,000 ohms should be shunted across the secondary of the 2nd audio transformer. External type of volume control.

FRESHMAN, Three Dial Type: 1600 ohms in r.f. grid circuits. Special uv harness. External control.

GREBE M11-1 (5): 700 ohms in grids. Standard harness. Requires re-neutralization. External type control.

GREBE 7: Special distance harness. External type control.

KOLSTER, Model 6D: 700 ohms in grids of r.f. tubes. Standard type harness. No control needed. Sensitivity control on set O.K. Must have very good ground.

PFANSTIEHL 32: Standard harness. External type control which may replace old switch volume control. Connections to switch joined together and leads to old volume control soldered together separately from switch connections. Accomplished by connecting 50,000 ohms between grid and old filament wiring.

RADIOLA 16: Plug in standard harness. External control.

RADIOLA 20: For external control no change is needed.

SILVER-COCKADAY: Requires 3200 ohms in grid of r.f. stage. Standard harness.

SPLITDORF 6: 400-ohm resistors in grids of r.f. tubes. Special distances between adaptors. External control.

STEWART-WARNER 525: Standard Harness. No changes. No volume control other than one in set needed.

STEWART WARNER 705: Special distances. No control needed.

STROMBERG-CARLSON 501-A: Special distances. Re-neutralization required in some cases. External control.

THERMIODYNE T.F. 5: Special uv adaptors. External type control.

ZENITH, Models 7, 8, 9: Special uv adaptors, 400-ohm grid resistors. No volume control needed. All C batteries must be removed and gaps shorted.

ZENITH 11 or 14: Special length harness. External control.

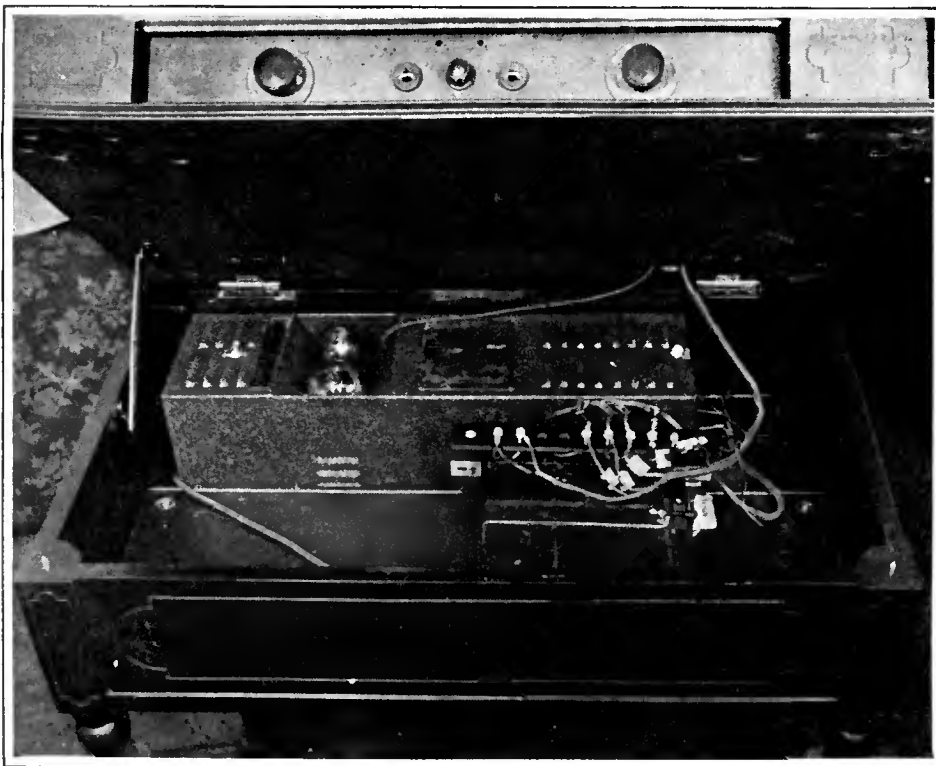

FIG 8

A "Radiola" Model 28 super-heterodyne with a "Powerizer" mounted in the battery compartment. This installation uses a 210 type power tube, doubly modernizing the receiver. It takes about forty-five minutes to make the revision

RADIO MUST BE MADE A NECESSITY

By JOHN WALLACE

MR. H. A. BELLOWS, manager of wcco and former member of the Federal Radio Commission, can generally be counted upon to say something pertinent when he speaks about radio. In a talk before the National Electrical Manufacturers' Association last winter he made several suggestions. One of the most important was that if radio is to be a stable institution it must become a necessary institution. This idea seems to us basic. He says:

"Improvement in broadcasting must follow two distinct lines, one of them being better presentation of musical programs. The other is, I think, still more important. Look for a moment at the history of the automobile. For years the automobile was a luxury, and its market was limited to those who felt they could afford luxuries of a rather costly nature. The thing that has made the automobile business what it is to-day is the conversion of a luxury into a necessity. People who would never own a single car as a luxury now own two or three because they regard them as absolute necessities, since our entire mode of living has readjusted itself to this new type of transportation.

"The real future of radio reception lies in a similar conversion of broadcasting service from a luxury into a necessity. This can never be done by programs of musical entertainment alone. You can never persuade the mass of the people that they *must* be able to hear the New York Symphony Orchestra once a week. You can come nearer it with reports of baseball and football games and of boxing matches. The stations in the farm belt of the Middle West have done it admirably, for a part of their audience, with their market reports. For the people in the cities this service feature of radio—this creation of a new necessity—is still largely in the embryonic stage.

"Of course I like to get letters praising our musical programs—we all do—but what I really value is the letter which tells me that thanks to our market service some farmer up in North Dakota has saved two hundred dollars on a shipment of wheat, or the letter saying that some family in Minneapolis has come to find our morning comment on the day's news just as essential a part of the day's routine as the morning newspaper.

"Can we develop some form of centralized teaching so that radio will establish itself in all our schools? Can we cooperate with the great news agencies so that, without competing with the newspapers, radio can be made a dependable and instantaneous means for sending out news flashes? Can we make broadcasting a legitimate agency for communicating between our governing bodies—national, state, and municipal—and the people who pay the taxes? What, in a word, can we do to make radio a necessity?

"Once again, let me cite an illustration. You all know the horrible tedium of civic association annual banquets—the indigestible food, the entertainment half drowned out by clattering waiters, and the dreary reports. We are trying the experiment of holding such an annual meeting by radio. The members of the civic association in question are being cordially invited to dine at home, to listen to reports carefully boiled down, and to do the necessary voting at the close of the meeting by mail.

"Radio must be a necessity, not a luxury.' This I believe, is the solution of the future of

the radio industry, and it is for you to play a large and active part in bringing it about. Constantly improving network service will help, but it will not be enough. The broadcasting stations must vastly strengthen their local programs, above all in the matter of the type of local



OSKAR SHUMSKY AT WBAL

Here is your chance to say you heard him "way back when"—provided he turns out to have the kind of future his press agent promises him. At any rate, Oskar Shumsky, whose playing and composition ability have already been praised by none other than Fritz Kreisler, will be heard from WBAL Sunday evening, March 18, at 8, eastern time

service which carries radio out of the field of mere entertainment and into that of household necessity."

Mr. Bellows remarks were aimed primarily at the radio manufacturer. He said earlier in his

speech: "I do not need to remind you gentlemen that you are all engaged in manufacturing a commodity which of itself is entirely worthless. The finest receiving set in the world is no better than the broadcasting which comes within its range. You do not have to be told what would happen to the radio manufacturing industry if the public should ever become really bored with broadcast programs."

This must have sent the cold chills coursing through the veins of his hearers, all of them with their entire capital and future prosperity inextricably tied up in radio. Particularly since the situation, if not probable, is at least conceivable. The public is notoriously fickle, and if it decided to become bored with broadcasting, all the king's horses and all the king's men couldn't change its whim. Where are the petticoat manufacturers and ostrich plume vendors of yesteryear? How can the man who invests in radio stock to-day be certain that by 1938 the public will not have capriciously shifted over to some other mode of entertainment, that the broadcasting stations will not be abandoned crumbling ruins even as—alas—are the breweries to-day!

Certainly if the radio manufacturers are to have any feeling of security they must see to it that radio becomes a utilitarian device as well as the entertainment device that it now is. If it can be made an indispensable utility like the telephone its longevity is practically assured. But while it remains in the luxury class, like the phonograph, its future is a gamble. The talking machine business, as is well known, almost went on the rocks a little while years back; the new fad which threatened its existence was radio itself.

Mr. Bellows mentions four ways in which radio can be practically utilized: Service to farmers; dissemination of news; agency of communication between governing bodies and the public; and centralized teaching for the schools.

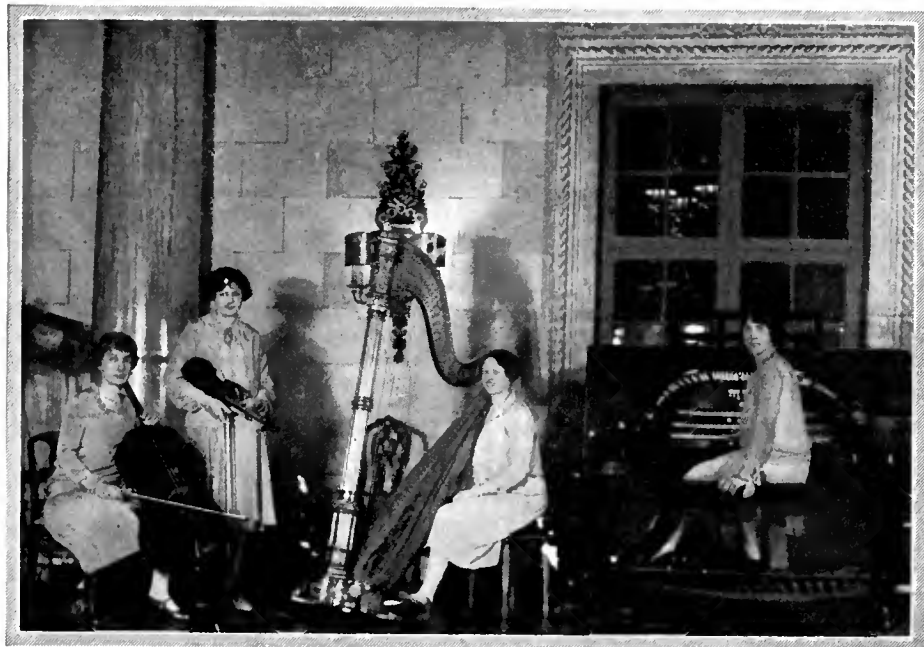

A REGULAR FEATURE AT WGR, BUFFALO

The Hotel Statler Concert Ensemble, which is heard daily from WGR in a program of luncheon music

The first mentioned, service to farmers, is already a tried and proved function of radio. A survey recently conducted by WLS shows that the value of radio as a means of entertainment has been equalled and exceeded by its economic utility as a daily aid in the production and marketing operations of the farmer. It has taken its certain place as an instrument of farm education and has proved its dollars and cents value many times over in the transmission of market news, weather forecasts, and other items of immediate importance to the farmer. "If you had to give up either music or talks on the radio which would you prefer to retain?" was a question put up to a number of farmers by the United States Department of Agriculture. "We will keep the talks," answered 2358, while 1538 answered "music." The most recent government estimates place the number of radios on farms at 1,250,000. The number is now doubtless more than a million and a half. The radio farm and market service has already done much in solving the venerable problem of market gluts, with their resulting demoralization of prices and wrecking of values. Tens of thousands of farmers or their wives hear and tabulate the market returns every day on the particular product in which they are interested, and plan their marketing accordingly.

Anent the second mentioned method, Mr. Bellows asks: "Can we cooperate with the great news agencies so that, without competing with the newspapers, radio can be made a dependable and instantaneous means for sending out news flashes?" The answer is probably no, not without competing with the newspapers. But why should that consideration enter into it? If there is some sort of lively instantaneous news which radio can put over better than the newspapers and in which dissemination it is fore-ordained to supplant the newspaper, let the supplanting start at once. Conservative maneuvers on the part of the news agencies, and on the part of the newspapers, can only succeed in postponing the inevitable, not in suppressing it.

Concerning the third suggested method of giving radio a permanent utilitarian function we can say very little. Our knowledge of the workings of municipal, state, and national administrative bodies is too sketchy to be revealed here in its nakedness. But we see no reason to believe that radio will not some day be an official mouthpiece for governing bodies. And by official we mean Official—that is, there will be certain prescribed governmental broadcasting hours during which time certain prescribed individuals or bodies of individuals will be expected, by duty of their office, to listen-in and make prescribed findings. (Which is about as near as we can get to the jargon of law making.) Anyway we venture to prophesy that before ten years have passed radio will be in some way, if only in a minor way, tied up with governmental administration.

It is in the fourth suggested means of stabilizing radio that we are most interested. The propounder of the idea asks: "Can we develop some form of centralized teaching so that radio will establish itself in all our schools?" The answer is yes; the opportunity is now upon us.

We have made disparaging remarks about radio education in the past and lest we should seem to contradict ourself (not that we object to contradictions; our opinion happens to be still the same) let us reassert that as an "educating" medium radio is the bunk. It is next to useless as far as teaching such stuff as economics, horse-shoeing, sociology, or play-writing goes. But we have always believed that radio is peculiarly well adapted to teaching music appreciation and still think so.

Its possibilities in this field have long been

recognized and from time to time during the past couple of years rumors have become current that something was going to be done about it. Mr. Walter Damrosch has been particularly active in keeping the idea before the public. It is one of his pet hobbies. And now, as the result of much scheming and labor on his part, he has carried the idea through to the point where it becomes a live issue.

His plan, as you doubtless already know, is to broadcast a series of his music appreciation lectures next winter over a network of stations during some daytime hour, the talks to be illustrated by his own piano playing and by an orchestra, probably the New York Symphony. So much, in brief, for his end of the arrangement. The other end is where the difficulties come in. Each one of the many thousands of schools throughout the country would have a first-rate receiving set, in perfect operating condition, available in its assembly hall or in one of the larger class rooms. Into this room, at the scheduled hour, would be herded all those pupils who had "Music Appreciation" on their program of courses. They would be provided with advance

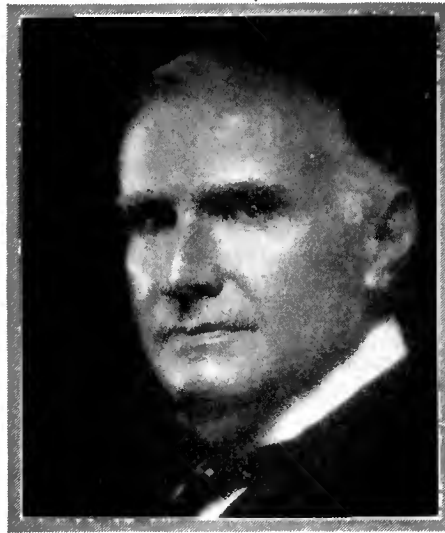

MR. WALTER DAMROSCH

Who for very many years was leader of the New York Symphony Orchestra and now frequently conducts that organization in the capacity of guest conductor. His experiments in broadcasting musical appreciation courses to schools has caused considerable favorable comment

notes on the lecture, sent to their teachers through the mail by Mr. Damrosch, and each lecture-concert would be followed by a written "quizz," also furnished from the central headquarters of the "course."

There is no especial practical difficulty in the way of carrying out this end of the scheme. The rearranging of the schedules to embrace this new hour of school work once every two weeks, or perhaps once a week, could be done with little trouble. Someone on the premises with sufficient intelligence to supervise the upkeep and proper operation of the receiving set could easily be found. Furthermore, receivers and loud speakers of adequate quality to reproduce the lectures satisfactorily are available.

The obstacle to be met with is the difficulty in arousing nation-wide interest in the idea to the point where boards of education and school trustees will undertake the red tape involved in officially adopting the course and appropriating funds for the necessary equipment.

Of course the obvious way to "sell" the idea

to the school masters throughout the country would be by a campaign of publicity and propaganda. But this would involve an enormous expenditure of money. And where is it to come from? All Mr. Damrosch has to offer is the idea and his own time and effort. Who is going to sponsor it?

By way of giving the idea some publicity Mr. Damrosch, with the cooperation of the Radio Corporation of America and the National Broadcasting Company, has already broadcast experimental programs. We think they proved conclusively that Mr. Damrosch will be able to carry off satisfactorily his part of the arrangement if the plan is ever put through. The first program was as follows:

PART I

- For Children of the Grammar Schools*
- (1.) Allegretto from Symphony No. 8..... Beethoven
 - (2.) Entrance of the Little Fauns....Pierne
 - (3.) Scherzo from Symphony in B flat..... Glazounow

PART II

For Students in the High Schools and Colleges

- (1.) Overture to "A Midsummer Night's Dream"..... Mendelssohn
- (2.) Andante from Symphony No. 5..... Beethoven

Before each of the numbers Mr. Damrosch gave an introductory talk and called attention to certain things to be watched for in the music, much in his familiar manner, except that he modified his material in accordance with the age of the prospective youthful listeners.

You may not be thoroughly in accord with Mr. Damrosch's method of explaining music (we, for instance, think he lays a misleading emphasis on the "story" content of non-program music) but nevertheless he has had some forty years' experience in giving such lectures and ought to know what he's about. Besides we can think off-hand of no one better fitted for the job; no one who combines, as he does, the qualities of authority on the subject, wide and popular renown, distinctive and intriguing personality. We opine that it will be radio's distinct loss if it finds itself unable to take advantage of these rare qualifications while they are available. Pedantry over the radio simply will not work. The pedant needs the help of bodily presence, and often too the help of school regulations, such as the one forbidding sleeping in class, to keep his audience attentive. A radio course in music will succeed or fail according to the personality of its spokesman. If Mr. Damrosch's eminently suitable personality is not made use of it may be a long time before another such personality turns up.

We have said nothing here about the desirability, in theory, of such a course, mostly because we are confident that its desirability is already granted. Heaven knows, the young hopeful is having enough stuff drummed into him during his school years to "fit him for later life." In this age of educational progress he is given opportunity to take most anything in "extra" courses from carpentry and cooking to tire repairing and dentistry. These vocational extras are useful. They make for remunerative work hours after he leaves school. But lamentably little attention is paid to equipping him to enjoy his non-working hours in later life. Out of every ten children exposed to eight years or so of such musical training, at least one would discover that he actually liked the stuff. And that, it seems to us, would justify the whole business.

“Our Readers Suggest—”

OUR Readers Suggest... is a regular feature of RADIO BROADCAST, made up of contributions from our readers dealing with their experiences in the use of manufactured radio apparatus. Little “kinks,” the result of experience, which give improved operation, will be described here. Regular space rates will be paid for contributions accepted, and these should be addressed to “The Complete Set Editor,” RADIO BROADCAST, Garden City, New York. A special award of \$10 will be paid each month for the best contribution published. The prize this month goes to William C. Duer, Denver, Colorado, for his suggestion entitled “Eliminating A.C. Hum.”

—THE EDITOR.



Testing an Audio Amplifier

I HAVE used the following method for localizing trouble in audio-frequency amplifiers with considerable success.

The average manufactured receiver, as well as most home-built sets, make no provision for outputting the detector circuit to telephone receivers. Thus it is difficult to locate definitely a fault in either the radio- or audio-frequency channels. The system I am recommending will indicate immediately in just which section of the receiver the trouble exists.

Secure a hand microphone. If one is not available, a transmitter button may be used with equally good results if it is backed to a diaphragm so that vibration will actuate the button moderately well. Connect this microphone, through a push-button, in series with the primary of a 25 to 1 induction coil, such as is available from any junked telephone set, and a six-volt battery. The regular filament battery of the set may be used. The secondary of the induction coil has two leads, with clips, soldered to it for convenience in setting up. The following is the method of operation:

Disconnect the detector plate-voltage lead from the B battery or power-supply device, and attach one of the clips mentioned to the detector plus post on the set. Connect the other clip to the point on the battery or power-supply device on which the lead to the set was formerly connected (22.5 or 45 volts), as shown in Fig. 1. Now push the button in the microphone circuit and speak into the microphone. Speaking into the microphone causes a varying current to pass

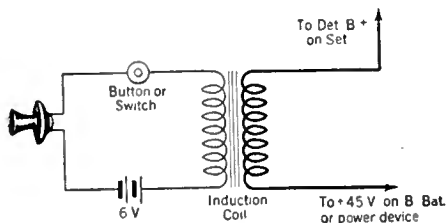

FIG. 1

An interesting circuit arrangement which may be used for testing an audio amplifier

through the primary of the induction coil. This induces current variations in the induction coil secondary, which, being in series with the detector plate lead through the primary of the first audio transformer, in turn affects the battery current in this winding, producing a variation in the balance of the audio-frequency circuit. Speech will be reproduced in the loud speaker as the microphone is spoken into. If the audio circuit is not functioning properly, no speech, or at most, a distorted voice, will issue from the loud speaker, thus indicating the trouble to be in this part of the set.

W. J. MORROW,
Macon, Georgia.

STAFF COMMENT

THE method suggested by Mr. Morrow provides a convenient means of testing the audio-frequency channel of a receiver. For experimental and entertainment purposes a greater response can generally be secured to voice variations by inputting the secondary of the modulation transformer or induction coil to the grid circuit of the detector tube. This is easily accomplished by connecting the secondary terminals across the grid leak, which is generally an accessible portion of the receiver.

Sources of Power-supply Hum

THE output of many receivers taking some of their power from the mains is marred by an excessive 60-cycle hum.

Investigation in many instances reveals the trouble to be due to sources often unsuspected. In the case the writer has in mind, a non-technically trained friend bought a socket-power kit about a year ago, and assembled and wired the device himself. It was less satisfactory than battery power because of the intensity of the hum, which defied all efforts made to eliminate it. He asked the writer to look the outfit over.

Upon opening the output circuit it was found that only part of the hum came from the loud speaker. The laminations in the power transformer were so loose that the resulting vibrations could be heard ten or twelve feet away in a quiet room.

Further examination disclosed that the voltage-divider section consisted of a number of adjustable resistors of the carbon-pile type. Operating the equipment with the power transformer removed from the socket-power baseboard confirmed the belief that a portion of the hum was due to the microphonic action of the carbon-pile resistors brought about by the vibration transmitted from the transformer through the baseboard.

The transformer case was opened and, after the transformer had been warmed up cautiously to about 100° C., was filled with molten battery compound. The primary was energized while the compound was still liquid so that the latter could penetrate between the vibrating laminations.

The hum soon fell to a slight murmur, inaudible six inches from the transformer.

As an additional precaution, the carbon-pile resistors were replaced by the wire-wound type which are now generally available.

HERBERT J. HARRIES,
Pittsburgh, Pennsylvania

STAFF COMMENT

THE microphonic effect caused by loose carbon-pile resistors is unusually interesting. The department editor has run across several such cases in his own experience. Microphonic hum will generally be eliminated when the adjustment of the carbon-pile resistors is tightened.

An R. F. Volume Control

OWNERS of three-dial five-tube radio receivers who live near one or more powerful local stations often find that they have such strong reception that the last audio tube, or even the detector, is overloaded. Even where there is no overloading there is often too much volume for ordinary use, or control, by the usual methods.

This difficulty may be remedied and at the same time more economical operation secured by the addition of a switch so connected in the circuit that the first radio-frequency stage of the set may be laid aside, so to speak, at the desire of the operator. When the first stage is not being used, one tube will be automatically turned out and it will become unnecessary to adjust the first tuning dial. The switch can be installed in any commercial or home-made receiver, and its use will result in no loss of stability or efficiency.

The author recommends a Yaxley radio jack switch No. 60 for this purpose, but any compact double-pole double-throw switch may be used with complete success. The switch may be mounted securely at any convenient place on

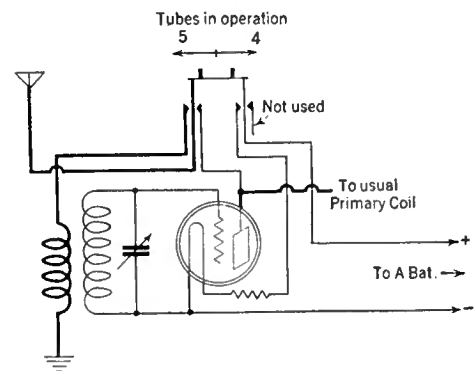

FIG. 2

A simple method of cutting out one radio-frequency stage for local reception. In addition to its economy this method of volume control is conducive to high-quality reproduction from near-by stations

the panel, preferably near the first tuning dial. If a separate rheostat or ballast resistance is not used in connection with the first tube of the receiver, it will be well to obtain a resistance of the proper value for the type of tube in the first stage.

Connect the switch as shown in the diagram, Fig. 2. In one position, all five tubes should light and the first tuning dial should be in operation. In the other position, the first tube should not be lighted, and the first tuning dial should be out of operation. For local work, and when extreme selectivity is not desired, the latter position will be found ideal, since it simplifies operation and prevents the unnecessary use of one tube with resultant extra load on the batteries. This switch will be found to be a very effective, though rough, volume control. Instead of tending to cause distortion, as some volume controls do, it helps to prevent distortion, by preventing tube overloading.

ALBERT R. HODGES,
Clinton, N. Y.

STAFF COMMENT

IN SOME cases a similar degree of volume control can be obtained merely by turning off the filament of the first tube, a switch being provided for this purpose. In some receivers, merely removing this tube from the socket will effect the desired control, sufficient energy being fed through various inductive and capacitive channels to supply an adequate signal on local stations.

Eliminating A.C. Hum

IN SPITE of the many improvements incorporated in the modern socket power device, a.c. hum has not been eliminated in many receiver-power combinations in use to-day.

After trying various methods of getting rid of this nuisance and achieving no real results, I hit upon the hook-up shown in Fig. 3, which really eliminated that a.c. hum.

The filter used was an output device designed to keep the high d.c. current out of the loud speaker windings. It was rated at 30 henries.

By hooking up the 2-mfd. condenser as a shunt across one side and using three of the four posts of the filter, the desired result was obtained. Many of these "tone filters" already contain condensers integral with the choke, which further simplifies the hook-up. Fig. 3 shows the condenser as part of the filter, and is self-explanatory.

WILLIAM C. DUER,
Denver, Colorado.

STAFF COMMENT

THERE seems to be no end of the possible uses of the output device. Here we have an interesting and logical use distinct from the original purpose of the unit. Mr. Duer's sugges-

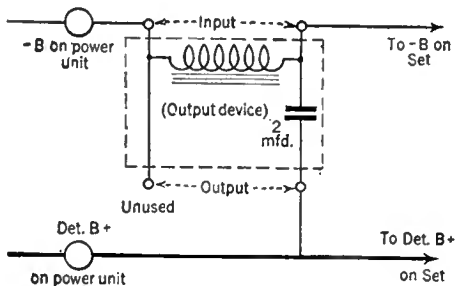

FIG. 3

An arrangement of apparatus which has been successfully applied in the elimination of a.c. hum

tion recommends the use of a filter circuit in addition to that already provided as a part of the power-supply device, which, as our correspondent suggests, is occasionally inadequate.

Phonograph Pick-up Switch

I AM using an electrical pick-up in conjunction with my phonograph and radio receiver. The pick-up is of usual design calling for the removal of the detector tube from its socket and the substitution of a four-prong plug. This arrangement is rather clumsy mechanically so I devised the simple switching arrangement shown in Fig. 4, using a Yaxley No. 60 switch, which is mounted on the panel of the receiver. An extra socket is placed in the receiver into which the pick-up plug is inserted. The switch throws the input to the amplifier from the detector circuit to the pick-up circuit.

FRANKLYN F. STRATFORD,
Jersey City, New Jersey

STAFF COMMENT

ASIDE from the convenience of Mr. Stratford's arrangement, the switch short-circuits the output of the detector when the phonograph is being used, and vice versa, of course, so that there is no danger of "cross talk"

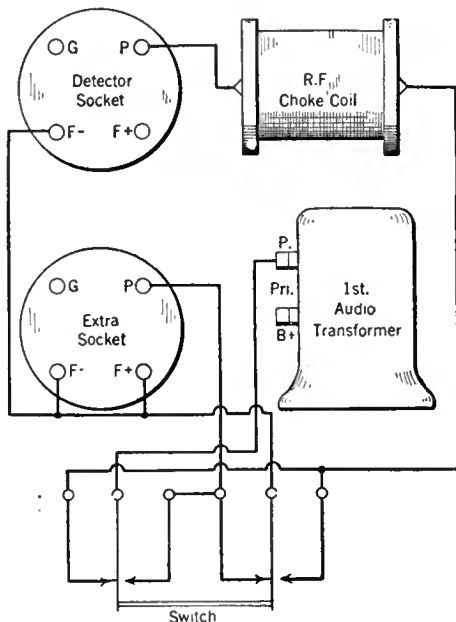

FIG. 4

A convenient switching arrangement for controlling phonograph and radio pick-ups

between two audio circuits. This is particularly desirable when the receiver is powered from the lighting socket, since leaving the detector output open, or suddenly throwing the amplifier to it, may cause oscillations.

Stabilizing With High-Mu Tubes

I HAVE been building and experimenting with a Browning-Drake receiver, and after trying a "Phasatrol" and different neutralizing condensers, I find that a CX-340 (UX-240) tube in the r.f. stage, with ninety volts on the plate, will neutralize easily. A small balancing condenser should be used. Considerable volume, with no sacrifice in efficiency of the set, will result.

MILTON HICKS,
Rockville Centre, Long Island.

STAFF COMMENT

IT IS possible to stabilize many radio-frequency circuits in this manner. The fact that the high-mu tubes have a higher plate impedance than those generally employed in radio-frequency circuits in many cases more than counteracts the increased regenerative effect due to higher amplification constant of the tube, with the result that the circuit into which they are plugged is relatively stable. Also, in the cases of two or more tuned radio-frequency stages, the use of a single high-mu tube, preferably in the radio-frequency stage preceding the detector tube, will have a slight detuning effect upon the tandem circuits due to the introduction of a capacity discrepancy. In other words, one circuit will be slightly off tune, with the usual stabilizing effect.

It is always a good idea to switch the tubes around in an oscillating circuit in an endeavor to arrive at a combination giving the best results.

Another Output Arrangement

SEEING an article on output devices in a recent issue of RADIO BROADCAST, I have decided to send you a diagram of one which I have used for three years. I tumbled on it in fooling around with a choke output and find it particularly satisfactory as it provides for a headset without changing the loud speaker circuit.

It requires an amplifying transformer, two condensers (of 2-mfd. and 0.5-mfd.), and two open-circuit jacks.

It will be noted, from the wiring diagram, Fig. 5, that the output of the set is fed through the secondary of the transformer and that the 2-mfd. condenser and loud speaker (in series) are shunted in the usual manner. The variation from the conventional circuit lies in the primary side where you will note that a "jumper" is attached to only one side of the B circuit. This gives plenty of power for the headset without depriving the loud-speaker circuit of enough energy to decrease volume.

Another advantage peculiar to this output device is the fact that the total load on a power-supply device remains constant when the loud-speaker is removed from the circuit, thereby leaving all voltages on tubes the same, regardless of whether phones or loud speaker is employed.

I have made four of these in the past three years using different audio transformers and find that results are equally good; a relatively cheap transformer I found to be as satisfactory as an expensive one.

F. W. WOOLWAY,
Newton Centre, Massachusetts.

STAFF COMMENT

THE average audio transformer secondary has a rather high d.c. resistance so that the voltage actually on the last tube plate will be quite a little below the terminal voltage of the B voltage supply. Experimenters can try reversing the transformer windings, i.e., keeping the primary in the plate circuit and the phones across the secondary.

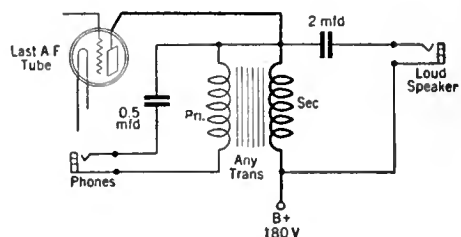
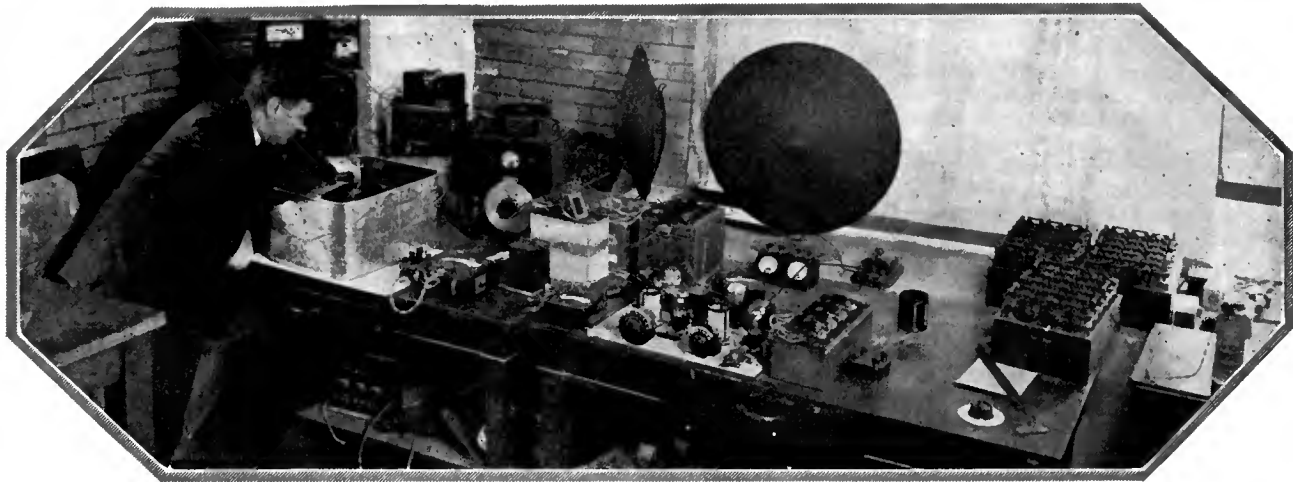

FIG. 5

A flexible output circuit



A SET-UP OF APPARATUS IN ONE OF THE "RADIO BROADCAST" LABORATORIES
 The measurements which are outlined in the article were made with this equipment. Note the radio frequency oscillator at the extreme left. It is housed in a large tin wash boiler. The large loud speaker is the new Western Electric 560AW cone

The Four-Tube "Lab" Receiver

By Keith Henney
Director of the Laboratory

ALTHOUGH many receivers have come and gone since June, 1926, when the R. B. "Lab" circuit was first described in RADIO BROADCAST, the latter still represents the criterion by which all other receivers are compared in the Radio Broadcast Laboratory, and the measure by which all four-tube receivers are judged. There are several reasons for the continued popularity of the "Lab" receiver; the most important lies in the fact that, with good component parts and a good layout of apparatus, four tubes in this circuit seem to require a minimum amount of energy from the ether to deliver any required loud speaker power.

The "Lab" circuit receiver is a member of that famous family which includes the Roberts and the Browning-Drake, to mention but two, and it employs, therefore, a single stage of neutralized radio-frequency amplification followed by a regenerative detector and the usual audio amplifier. Since June, 1926, few startling inventions or discoveries to do with circuits have appeared in the field of radio, so the circuit itself has changed but little. Experience has taught, however, just where the inductances and their related parts, condensers and tubes, should be placed behind the panel for most efficient operation, and this alone might be considered quite a big step forward so far as efficient design is concerned. A bad layout of apparatus can mean all the difference between poor and good reception.

The following article, which is preliminary to the publication of a constructional article on the "Lab" receiver, gives some useful information on how receivers are designed, how the component parts are measured, or what the voltage amplification of the detector or the amplifier may be. The information is available as a result of exhaustive tests conducted in the RADIO BROADCAST Laboratory, and although the measurements were made with the

prototype of the "Lab" receiver scheduled for description next month, they should appeal to anybody interested in radio receiver design and measurements generally.

A certain amount of engineering data can be collected at home; to gather other data a laboratory equipped with instruments is necessary. A typical "armchair" investigation was described in the March RADIO BROADCAST. It told how one could calculate the voltages appearing at various points in an audio amplifier if one knew the electrical dimensions of his apparatus and the amount of power he desired from his output tube. The data presented below result from a definite series of laboratory experiments designed to learn what is going on between the detector output circuit and the antenna of a receiver; in other words, their purpose is to take up where the armchair engineer left off. As the investigation tells a great deal about the "Lab" circuit it should be interesting to those who already own such receivers, or those who are being introduced to it for the first time.

In the "Armchair Engineer," which was the title of the March article, we showed what voltages were necessary in an audio amplifier when a maximum of 700 milliwatts of undistorted audio power was to be delivered to a loud speaker of 4000 ohms impedance, which

conditions obtain when a 171 type tube is in use, delivering its maximum quota of undistorted power. We have chosen 4000 ohms for the impedance of the loud speaker as representing the best value (twice that of the tube) for maximum undistorted power output. Seven hundred milliwatts of power is small compared to that taken by a 40-watt incandescent lamp with which we are all familiar, smaller compared to the 500 watts required by that common home apparatus, the electric iron, but is greatly in excess of the power that can be collected from one's antenna from a distant broadcasting station. In other words, between the antenna and the loud speaker, there must be considerable power amplification. How great is this amplification, how can it be measured? These are questions that a laboratory investigation can answer, and these figures enable a laboratory to form some kind of an opinion on the overall efficiency of a receiver.

In Fig. 1 is a two-stage audio amplifier which includes two transformers whose turn ratios, secondary to primary, are about 3 to 1 at 1000 cycles, a tube the amplification factor of which is 8 (about 7 of which can be realized), and a power tube with an amplification factor of 3. The voltages at several points in this system are given on the diagram, showing that about 0.42 volts must appear across the primary winding of the first audio transformer if a value of 700 milliwatts is to be delivered to 4000 ohms.

It will be noted that the voltage across any point is found by multiplying together the voltages appearing on the grids of tubes in the circuit, the amplification constants of these tubes, and the turn ratios of the audio transformers. Thus the voltage across the output of the second audio tube (note that its effective μ is 7 and not 8) will be approximately:

$$0.42 \times 3 \times 1.26 \times 7 = 8.8$$

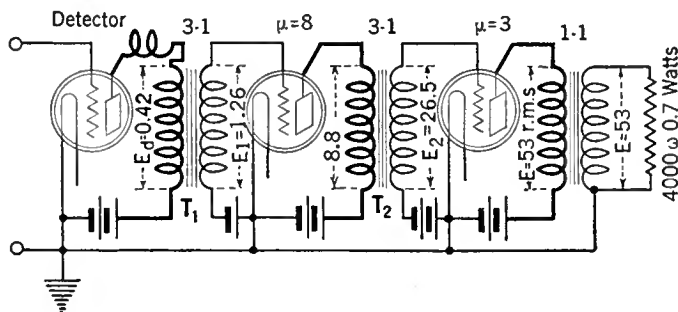

FIG. 1

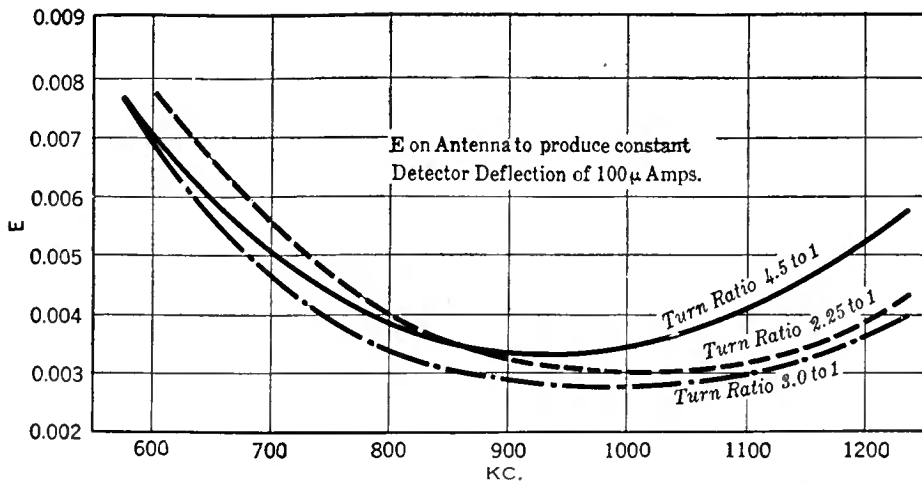

FIG. 5

deflections against input r. f. voltages and percentage modulation, and the change in detector plate current—which we shall call detector deflections—against r. f. voltages.

The set-up used is shown in the photograph at the head of this article, and in Fig. 2. It comprised an audio-frequency oscillator, a General Radio push-pull amplifier, and a radio-frequency oscillator, the latter housed in a tin wash boiler with a tight fitting lid. Across the output of the audio amplifier is a 40-milliamper thermocouple in series with 1000 ohms to act as a voltmeter for the 1000-cycle modulating energy. Across the output of the radio-frequency generator is a variable resistance in series with a thermocouple which measures the current through this resistance. The voltage drop, at radio frequencies, across this resistance, is utilized to drive our receiver under test. This voltage can be varied by changing the value of resistance used, or by changing the current through it. Large changes in voltage are produced by the former method, small changes by the latter.

These are crude methods of measuring voltage gain compared to the ultra refinements employed in the Crosley Laboratory for example, where an accuracy of better than 2 per cent. is possible, or in the General Electric Laboratory, but they are effective, as the following data will show.

Measuring the plate voltage of the oscillator we find that it is 69 volts, and noting that the current in its tuned circuit varies directly with the plate voltage we assume that the ratio between the fixed plate voltage and the low-frequency voltages from the amplifier fed into the plate circuit of the r. f. generator is a measure of the percentage modulation. The 1000-cycle voltages obtainable are from about 18 to about 35 r. m. s., which give us modulation percentages of from 36 to 71 approximately.

If the modulation is changed while a constant r. f. voltage is applied to the receiver in series with its artificial, or "dummy," antenna, and secondly, if the modulation is held constant while the r. f. voltage is changed, the following facts are noted: the detector deflections are independent of percentage modulation, the a. f. voltages appearing across the secondary of the first audio transformer vary almost directly as the modulation and as the r. f. voltage applied, and the detector deflections vary approximately as the square of the input r. f. voltages.

We learn that a 660-kc. wave modulated 54 per cent. and producing a change in detector plate current of 100 microamperes produces an audio voltage of 1.67 across the secondary of the transformer. If this is a 3 x 1 turn ratio unit, the

voltage across its primary will be 0.56, which will furnish ample power to the loud speaker from a two-stage transformer-coupled amplifier of the type shown in the photograph of the receiver upon which these measurements were taken.

So far we have established several important points. We have determined the relation between detector deflections and detector output audio voltages; we have found out the relation between audio voltages and radio input voltages; and we have decided that to get about 0.5 volts across the input to the audio amplifier we need a radio signal, 54 per cent. modulated, which will cause a detector deflection of about 100 microamperes. We may now neglect the audio amplifier, and deal only with the part of the circuit between the antenna and the detector plate circuit. What we now desire is to get this 100-microampere deflection with the least input r. f. voltage to the antenna, the greatest amount of selectivity, and the best characteristic, that is, the most even amplification over the broadcasting band.

There are several variables that need in-

vestigating; for example, the number of turns included in the r. f. tube plate circuit must be determined. Let us start by placing various voltages at 660 kc. on the detector input directly, *i. e.*, without going through the tuned circuits or the first tube. Then we shall apply voltages to the grid of the r. f. amplifier, and finally to the artificial antenna. The result is shown in Fig. 3, and was obtained by applying the voltage drop across 20 ohms to the detector, that across 3.3 ohms to the grid of the r. f. tube, and that across 0.191 ohms to the antenna.

To get our 100-microampere detector deflection required about 0.5 volts when applied to the detector input, about 0.085 volts when applied to the r. f. grid, and only 0.005-volts when impressed across the artificial antenna. It is difficult to translate these differences in voltages into "gain," but it is interesting to note that a ratio of about 6 to 1 in voltage appeared by removing the driving r. f. voltage from the detector grid and placing it across the r. f. grid, and that an input voltage of five millivolts produced 100 microamperes detector deflection, and, therefore, if modulated about 54 per cent. produced our required 700 milliwatts of audio power.

Now let us vary the frequency of the impressed voltages and see what happens. The detector input has essentially a flat characteristic over the broadcasting band. Applying voltages to the r. f. grid gives the result shown in Fig. 4, in which various turn ratios between detector input and r. f. tube output are given. At a turn ratio of 2.25 to 1, where nearly one half of the detector coil is in the plate circuit of the previous tube, the curve is flat, and as the turns ratio is increased more input voltage is necessary at high frequencies to deliver the same detector deflection.

When voltages are impressed upon the "dummy" antenna, the characteristic changes, and becomes peaked, with maximum amplification near the middle of the broadcasting band, the ratio between the lowest and highest point in the curve being about two to one. This curve, Fig 5, gives the input voltage required to give a

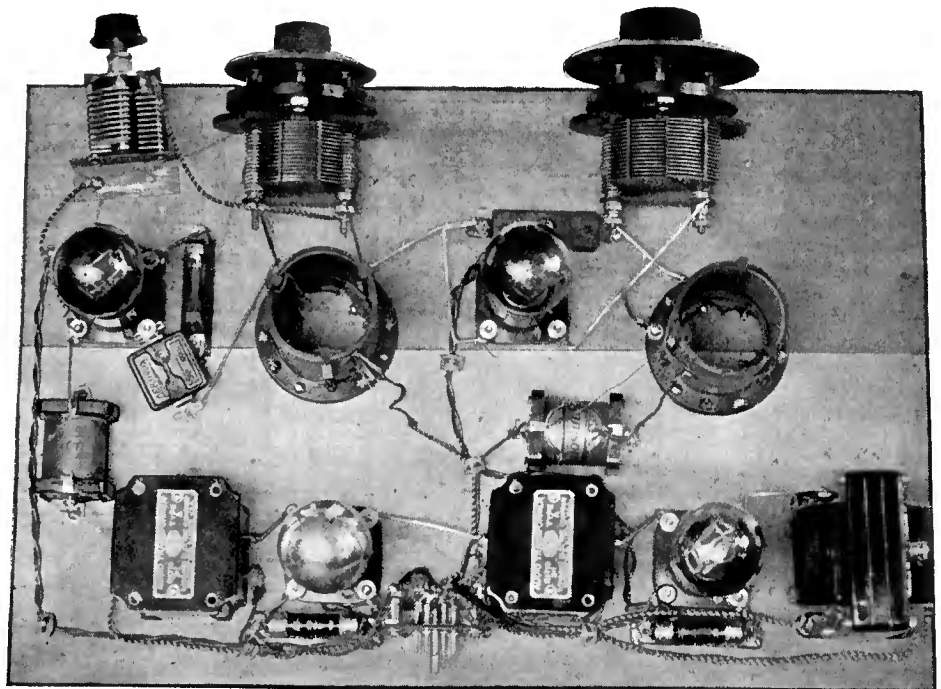

A FOUR-TUBE "LAB" RECEIVER

An experimental breadboard layout of the "Lab" receiver which will be described constructionally next month. The measurements outlined in this article were made with the layout shown here

constant deflection of 100 microamperes, and when turned upside-down, gives an idea of the overall amplification characteristic.

Investigation of the artificial antenna and coupling coil, consisting of ten turns wound about the center of the r. f. input coil, shows that it resonates at about 900 kc. which accounts for part of the humped characteristic. Part of it is accounted for by the rising characteristic toward the higher frequencies noted in Fig. 5 and part by the looser coupling between antenna and r. f. input coil at the lower frequencies.

Placing a coil and variable condenser in series with the antenna, so that the entire system may be resonated to the frequency desired, will bring up the overall amplification of the receiver as well as improve the characteristic. It necessitates an additional tuning control, and has the unfortunate habit of making necessary readjustment of the r. f. tuning condenser whenever any change is made in the setting of the antenna series condenser. For these reasons, and because a 2 to 1 characteristic such as shown in Fig. 5 is not bad enough to worry about, the antenna series resonant system has not been added to the "Lab" circuit. A further study of antenna coupling systems is under way and it is hoped that the result can be given to interested experimenters soon. The turn ratio of any good coil should be 3 to 1 since greatest amplification results thereby.

SELECTIVITY

ONE thing remains to be investigated—the selectivity of the two tuned circuits and that of the receiver as a whole. A small condenser of 0.0005-mfd. capacity bridged across the main tuning condensers and varied through the point which resonates the circuit will give an idea of the selectivity. Fig. 6 shows both the selectivity curve on the r. f. circuit and the overall curve.

A word about the practical result of all this investigation may be interesting. In Garden City, 8 miles from WEAF, it is possible to receive wjz 50 kc. away without interference. It has been easily possible to receive wjz when wjz was on the air, a difference of 20 kc., and on the higher frequencies many stations outside of Manhattan, 15 miles distant with perhaps 30 local stations in operation, have been received regularly. In an Ohio town, 100 miles from

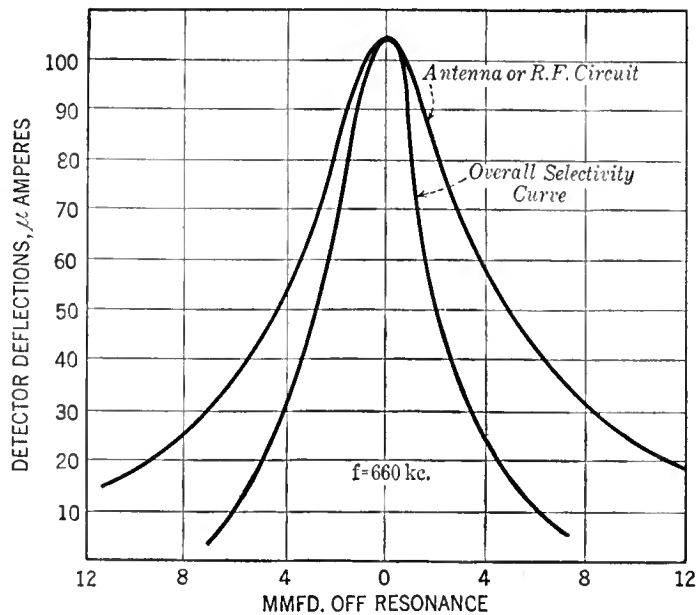

FIG. 6

a broadcasting station, a similar receiver has a choice of over 40 stations without appreciable interference.

In none of these experiments has regeneration been added to the detector, which, in fact, has been operating at poor efficiency, since it has a high-impedance plate circuit at high frequencies. As soon as the regeneration condenser is connected, partially bypassing some of the r. f. load, the detecting efficiency goes up, and adding regeneration increases the overall gain and selectivity at all frequencies, and improves the characteristic. Figs. 2 and 7 give all electrical constants for the two-tube "Lab" circuit. Owing to the superior gain produced by the 112 type of tube, we recommend it in both the r.f. amplifier and detector sockets.

As in all similar tuning systems, the efficiency of the circuit as a whole depends solely upon the quality of the apparatus (especially the coil) put into it, and their relative location behind the

panel. Coil resistance is especially to be avoided in the antenna stage for here the losses in amplification and selectivity are directly proportional to the resistance in the tuned circuit.

Coils of small diameter may be placed as close together as shown in the photograph on page 425, although it will not be possible to neutralize the amplifier at one extreme of the broadcasting band and have it remain neutralized at the other. If neutralization is carried out in the middle of the band, it will be fairly complete at other frequencies and will not oscillate at any frequency. The parts used in the four-tube "Lab" receiver on which the above tests were made, are as follows:

LIST OF PARTS

- 2—0.0005-Mfd. Remler Condensers
- 1—0.000055-Mfd. Precise Condenser
- 1—Type N X-L Condenser
- 1—0.0001 Mfd. Averovox Condenser
- 1—0.001-Mfd. Aerovox Condenser
- 2—Aero Inductances
- 2—Samson 85-Mh. Chokes
- 4—Benjamin Sockets
- 2—Sangamo Type A Transformers
- 1—Ferranti Output Transformer
- 2—Amperites, 0.5-Ampere
- 1—Lynch Resistor Mount
- 1—1.5-Meg. Aerovox Resistor
- 1—Yaxley 7-Wire Cable
- 2—CX-312-A (UX-112-A) Tubes
- 1—CX-371-A (UX-371-A) Tube
- 1—CX-301-A (UX-201-A) Tube

If the receiver is to be operated in a location where there are many stations, it will be well to shield at least the r. f. stage. In the layout shown in the photograph care has been taken to keep all amplifier apparatus to one side of a middle line, and all detector equipment on the other side of that line. This facilitates the introduction of a shield between the two circuits.

If the approximate layout shown in the photograph is followed, constructors should have no difficulty in making the receiver operate. Any good apparatus may be used; coil dimensions are included in Fig. 2 and commercial inductances from General Radio, Aero Products, Silver-Marshall, and Hammarlund have been used with complete success. An article scheduled for the next issue of RADIO BROADCAST will describe the construction of a four-tube "Lab" receiver in detail.

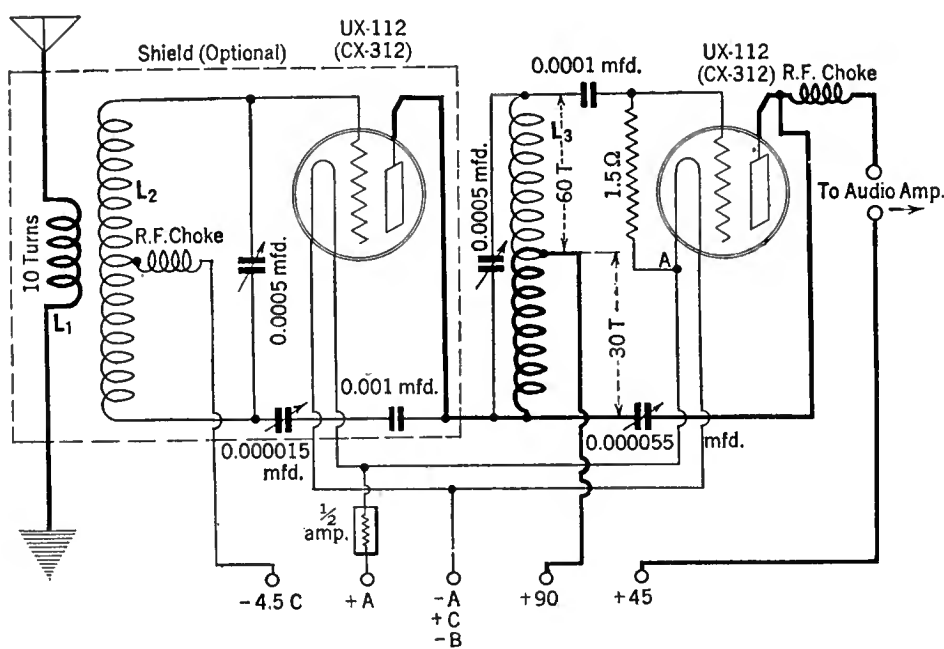

FIG. 7

This is the circuit diagram of the two-tube "Lab" receiver. As will be noted, the 112 type tube is used in both r.f. and detector stages and the gain will be greater than that possible were 201-A type tubes employed.

IT IS with considerable difficulty and some reluctance that we report the first public demonstration in America of Professor Léon Théremin's "Music from the Ether" on January 31st, 1927. We sat in the passing glory of the Metropolitan Opera House surrounded by a typical opera audience, all in evening dress, and watched and heard Professor Théremin and his associate, Dr. J. Goldberg, extract violin-like notes from two beating radio-frequency oscillators, and our emotions, we must admit, were mixed. Musically the demonstration was not good, but one cannot criticize an amateur who makes no effort to set himself up as a musician; as a scientific demonstration before a S. R. O. audience in no less a place than the Metropolitan, it was grand. The audience was enthusiastic, it applauded, and roared "bravo" and "heroïque" and begged for more all because they had watched two men without any visible connection with the instrument they were playing, wave their hands before a slender rod standing vertically in the air, and heard the tremolo notes of "Ave Maria," "Song of India," and other old favorites.

We must admit that we were more interested in the audience than in the music or the musicians; we wondered how they would take it—those trembling notes, often off key; we wondered who they were, whether music critics, scientists, or merely curious people, amazed in any sleight-of-hand performances, or demonstrations of forces unseen. We were interested, too, in the electrical mechanism, which is so well known to all workers in radio frequencies, in the loud speakers, great triangular green boxes standing high above the stage and showing off very well against a black velvet drop.

Electrically, Professor Théremin's apparatus is simple. It consists, according to *La T. S. F. Pour Tous*, for December, 1927, of a crystal-controlled generator oscillating at a frequency, let's say, of 100,000 cycles per second, and another oscillator whose frequency may be varied continuously so that the beat note between these two generators, when fed into a detector and amplifier, will cover the entire audio range of tones. Because there is always an attempt on the part of two such generators to "pull together" when their frequency difference is small, some difficulty is noted in securing low or bass notes. An ingenious trick, also well known to radio experimenters, is used here in an attempt to avoid such trouble; the second harmonic of one oscillator is made to beat with the third of the other. In this way Professor Théremin got down pretty low in the frequency scale, but because his loud speakers began to rattle at these frequencies or because he was still bothered by his oscillators "pulling together," these notes were not good.

The loss in audio-frequency output occasioned by using harmonics instead of the fundamentals is not serious; the volume can always be brought up by proper amplification. In fact the audience seemed astonished at the volume produced by these beating generators of radio-frequency waves, for at times it was "sufficient to fill the Metropolitan." Of course the audience did not know, as our readers do, that volume much in excess of this could have been produced if needed; all that was necessary was additional amplification.

In Professor Théremin's cabinets, then, were two generators, one fixed in frequency, the other

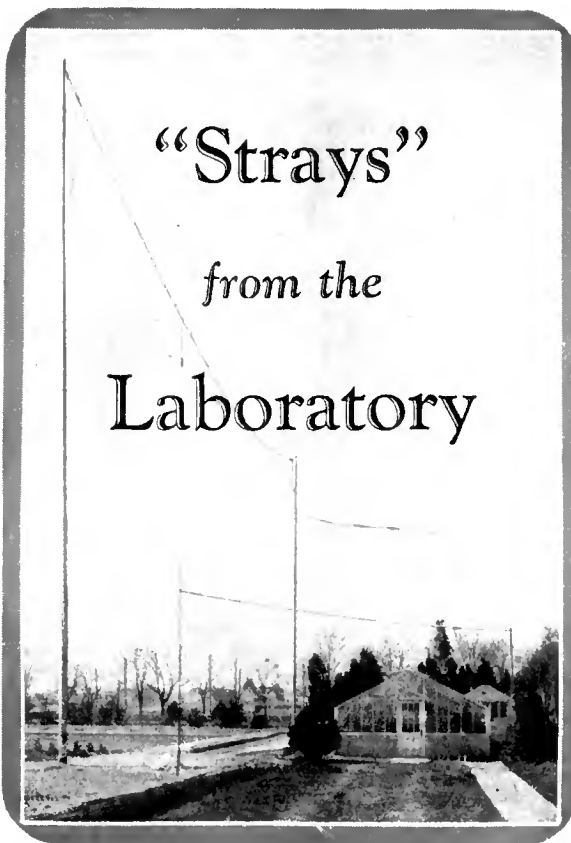

variable. Tunes are played by bringing the hand near a metal rod which is attached to the tuned circuit of the variable oscillator, the hand, which is connected to ground through the performer's body, serving to change the capacity of the tuning condenser—"body capacity," nothing less, the bane of all radio experimenters of a few years ago.

Volume is controlled by another conductor at right angles to the tone control and placed so that it can be approached by the other hand of the performer. It is a single loop of wire and constitutes part of the tuned circuit of the crystal-controlled oscillator. As is well known, when the tuned circuit of such an oscillator is properly adjusted, maximum power is produced, and at any adjustment different from this condition, less power is generated. Thus, bringing the hand near this loop detunes the closed circuit and reduces the power generated in the fixed oscillator, but because of the crystal, its frequency does not change appreciably.

The device is extremely simple to "play," there is no complicated fingering or bowing, as of a violin, and there is no labor on the part of the musician to get fortissimo passages, but in this very simplicity

there are disadvantages. The violin gets its timbre because of the complex manner in which its strings vibrate; its notes are not pure, *i. e.*, good sine waves, but they are more or less complex at the will or skill of the musician. The violin, the tone of which the "Théreminox" most nearly approaches, can be bowed on more than one string at a time, thereby producing a still more complex wave form, while the electrical instrument can hit but one note at a time, and that note ordinarily is quite pure, like that of a child's voice. By throwing a switch or two, the operator, or player, can bias grids differently and put into the output of one or both oscillators various harmonics, which results in a change of timbre.

The "Théreminox" glides smoothly from one frequency to another; it cannot, in its present form, jump from one note to another an octave, more or less, distant. It cannot produce staccato effects, or those of plucked strings, nor can it produce any of the effects of percussion instruments.

Let us not be too harsh on Professor Théremin of the Institute Physico-Technique of Leningrad. He is not a musician. He is a physicist and has several inventions to his credit, inventions on such things as methods of measuring weak field strengths, and as early as 1926 made contributions to what has come to be called television. According to a Paris interview published in *La T. S. F. Pour Tous* he stated of his latest development:

This is not at all a plaything for me. It is much more a concrete proof, an incontestable demonstration, of my conception of the arts and the sciences. The two are but one to me. I have always been disturbed by the disdain with which followers of art treat questions of science and of engineering. And conversely, how many times have these savants claimed that art was a word



PROFESSOR LÉON THÉREMIN "PLAYS" HIS "THÉREMINVOX"

devoid of all meaning. To prove to the one that science can render the greatest services in the development of the arts, to demonstrate to the other the fertility of an intimate collaboration of the arts and sciences, is my aim.

Perhaps the orchestra of the future will consist of many of these oscillators and many men before them waving their hands. Certainly there will be plenty of engineers who can put all the harmonics into the tones the musicians desire, and perhaps then the timbre will be more pleasant to musicians.

It is reported that Rachmaninoff turned to a member of the private audience which first witnessed the demonstration of the apparatus, and said, when she shouted "Bravo!" "Madame, you exaggerate!"

A. C. Tube Troubles

FROM various sources comes the rumor that set engineers are more pleased with the heater type of tube, the 227 type, from the standpoint of lack of hum and of general operating characteristics, than they are with the straight a. c. filament tube. It is said that set manufacturers would like to use this type only and to forget the low-voltage, high-current tube. How we run in circles, we radio engineers. Three years ago a heater type of tube, the McCullough, appeared on the market after many demands from those (notably Professor Morecroft in RADIO BROADCAST) who knew the possibilities of a unipotential cathode tube. In Canada this tube became very popular; in this country the manufacturers sold a comfortable lot of tubes. But in general the tube people, independent and "corporate," have taken a "high hat" attitude about it. And now, perhaps, it will become the preferred tube after all.

Several readers have noted a strange periodic increase and decrease in filament current in a. c. tubes. These fluctuations are reflected, naturally, in signal strength. On one occasion a reader remarked about the fading he noted on his new a. c. set while his neighbors were not so afflicted. What is the reason? Perhaps it is the following:

If an a. c. tube has an open filament or heater, it frequently happens that the broken ends actually make contact so that when the tube is turned on current passes through the filament or heater, causing it to expand in such fashion that the ends are pulled apart. Thereupon the signals disappear and a cooling of the filament or heater takes place. After the cooling process is completed the ends may again come together and signals will be received until expansion causes the ends to part once more. It may happen, too, in some localities, that a severe over-voltage is applied to the heater or filament terminals, due to line fluctuations. The heater tube may get so hot that it refuses to operate. When the voltage goes down the tube cools off and it returns to normal functioning.

The a. c. tube presents a more severe problem than does that of combined B and C voltage supply units. Line fluctuations may cause such changes in the filament, or heater, terminal voltages that the life of the tube is decreased, while in a plate power outfit the increase in plate voltage is balanced by a corresponding increase in C bias and thus the tubes will not be impaired.

Incidentally, the Samson Electric Company take great pride in the production of a power transformer which has a regulation of 5 per cent. That is, the voltage across the secondary at no load is only five per cent. higher than at full load. We understand some transformers have regulations as poor as 50 per cent., which may

explain why filter condensers in power supply units are prone to end their useful purpose at odd intervals.

Another peculiar case of "fading," which has nothing to do with a. c. tubes but is mentioned here as an interesting case of possible incorrect diagnosis, has been reported by A. H. Grebe and Company. An owner of a Grebe "Synchrophase" in Atlanta, Georgia, reported severe fading from wsb about two miles distant. A. Gilette Clark, the Grebe engineer who investigated the phenomenon, found that the fading took place in regular intervals, that the maximum signal did not increase beyond a certain value which was normal for a station of wsb's power and distance, but abnormal for a case of ordinary fading in which the peak values of signal strength might be somewhat high, and finally, after a little time, it was discovered that the fading coincided with the passing of a trolley car, starting as the car approached and continuing for some time after the car had passed. This gave a clue upon which to work.

"The most logical explanation that occurred to us," says Mr. Clark, "was that the trolley line, coming so close to the transmitter and receiver, acted as a conductor for 'carrier,' or wired-wireless, propagation of the wsb signals. Instead of coming in a direct line, the signals received by this set probably followed the wires. Now, in technical parlance, we find that if 'standing' waves were present on the trolley wire and track, in the fashion of Lecher wires, the trolley cars might act as sliders along the two parallel wires, reducing the volume delivered to the set as they passed through points of high potential and not affecting it when at the nodes.

"Further investigation with regard to the trolley car clue revealed that the lines of this car service ran directly parallel with the wsb antenna system in Atlanta and almost parallel to the set owner's antenna system, although the course altered slightly at about half way between the station and the point of reception. Since the nodes are one half a wavelength apart and the station's wavelength is 476 meters, the action should take place every time the car moves 238 meters, or about 785 feet."

"Gross Exaggerations"

ANOTHER wonderful new invention has come to the attention of the Laboratory. It costs but \$4 and anyone wanting a good job can make from \$150 to \$300 a week selling the gadget to gullible radio listeners! It will:

- (1) Eliminate 50 to 90 per cent. of static
- (2) Increase volume
- (3) Save 30 to 40 per cent. on batteries
- (4) Separate short-wavelength stations
- (5) Bring in distant stations
- (6) Tune-out powerful local stations
- (7) Add a stage of amplification to your set

We suspect it is a wave trap, consisting of less than a dime's worth of wire, a cheap variable condenser, a box, and two binding posts.

Interesting Technical Literature

THREE booklets have arrived in the Laboratory recently. One is a handsomely bound treatise on Cunningham tubes. It contains, in eighty-four large-size pages, data on all tubes made by this well-known tube manufacturer; characteristic curves, as well as a considerable amount of information that will appeal to all who have read the tube articles appearing from time to time in RADIO BROADCAST, are also given. The book sells for \$2.50.

"The Absorption of Sound by Materials" is the title of Bulletin No. 172 of the Engineering Experiment Station of the University of Illinois. In the Bulletin, Professor Watson describes methods of determining the absorption coefficients of many substances. The bulletin costs twenty cents and should be useful and interesting to studio designers and builders. The "Bureau of Standards Circular No. 300" describes similar data. This latter circular was issued in February, 1926, and can be obtained from the Government Printing Office for five cents.

Meters for Research Workers

EVERY laboratory worker takes delight in handling beautiful instruments, be they meters for measuring millionths of amperes or Curie balances for weighing radium. A catalogue from the Sensitive Research Instrument Corporation has come to the Laboratory. We regret that we have not known this maker of precision meters before, and are glad to be able to recommend the Sensitive Corporation to readers who are engaged in research requiring microammeters, vacuum thermo-couples, radio frequency-voltmeters, resistances, etc. All direct-current meters from this corporation, even down to the very sensitive meter reading four microamperes at full-scale deflection, are protected by a specially developed fuse wire so that it is impossible to burn out the moving coil system. We feel sure that the makers of Sensitive Research meters will be glad to furnish readers with information regarding their products.

Short-Wave Notes

DURING the last few months we have listened to short-wave broadcasting from PCJJ, Eindhoven, Holland, and from the experimental station 5 sw at Chelmsford, England, as well as to occasional programs from American short-wave broadcasters. We must admit we are not enthusiastic. The quality is invariably poor, the fading severe, and the whole affair strongly reminiscent of the early days of broadcasting, when any signal was worth getting, so long as it was from a long distance. The quality from Europe may be due to the poor transmission, but more probably is due to what happens between transmitter and receiver, and under the best conditions is not worth listening to except as a stunt.

Ben B. Skeete, radio operator of the S. S. Samuel O. Brown, in a letter dated at Balboa, Canal Zone, December 30, remarks upon the short-wave broadcasting from American stations and brings up one interesting point. This is the fact that fading does not seem to ruin reception of music, while it makes reception of sport events highly unsatisfactory. Perhaps it is because the ear supplies the missing measures of music, while no stretch of imagination will tell one what is happening in the final round of a closely fought boxing contest.

Mr. Skeete states that best reception is had from WGY's experimental transmission on 32.77 and 21.96 meters, that KDKA on 26 meters seems to tune so sharply that it is difficult to get the modulation, that the latter's 62-meter wave is strong but the modulation badly garbled, and that WLW can be heard better on the Pacific coast than in the eastern waters and that it is difficult to get the modulation although the carrier is strong. Perhaps WLW is not modulating the carrier to a very great degree? Station KDKA on 62 meters is heard with great strength and clarity in Garden City. The distance is about 300 miles.

AS THE BROADCASTER SEES IT

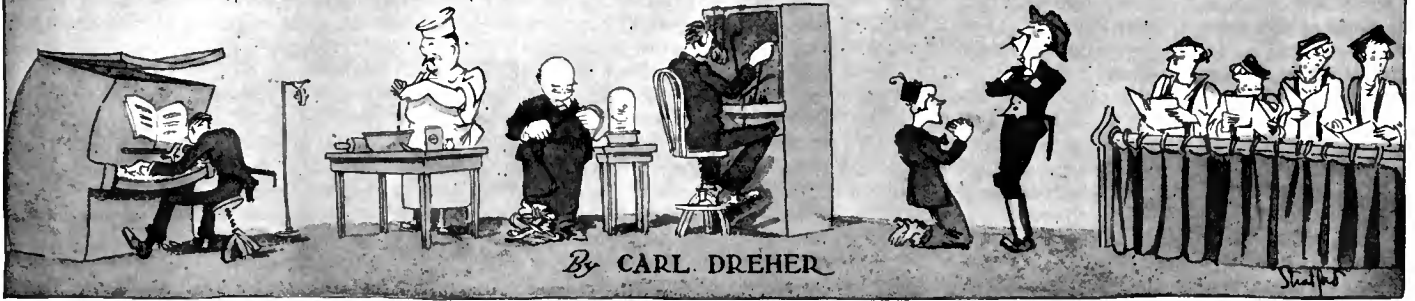

R. F. In Vaudeville

SOME twenty years ago, when most of the great figures in the radio world of to-day were still in the pants business, or sending comments to each other in Morse across the barren acres of West Farms in New York regarding the excellence or otherwise of their "sparks," a popular type of vaudeville act was evolved from the work of Nikola Tesla on high-frequency currents. The Tesla coil consisted of two windings, with non-ferric coupling; the primary was part of a closed oscillating circuit, with a condenser and spark gap. The condenser was charged by a spark coil or high-tension transformer. The secondary of the Tesla coil usually led to a spark gap. The arrangement was no more or less than a wireless transmitter with the open, radiating circuit replaced by another spark gap. In the larger sizes the Tesla coil proper had to be immersed in oil, to control the corona. Very high voltages could be secured at radio frequency. Since the currents passed over the surface of conductors, including the human body, a man could allow potentials of a few million volts to leap to a metal ball held in his hand, without hurting himself, but scaring the wits out of anyone who did not know what he was up to. Hence the vaudeville application. I did it myself on a small scale, with a Tesla coil fed from a quarter-inch spark coil. I proudly published an article on this marvel which, I asserted without fear of contradiction, was the smallest Tesla coil in the world. The secondary was wound on a test tube, and protected by several layers of empire cloth from the primary, which consisted of a few turns of heavy rubber-covered wire. In its full glory the apparatus threw a half-inch spark which stung slightly when taken on the bare skin, but produced no sensation at all if allowed to jump to metal in contact with the body. I astounded my family and the neighborhood with it, at the age of twelve, while various "professors" were profiting by the same stunt at the sublimated nickelodeons, using much larger coils, of course. Incidentally, Doctor Tesla, at that time an electrical investigator of the highest renown, and in his productive period, was something of an amateur vaudeville actor himself, and once sent Sarah Bernhardt into hysterics by sticking his head into a ball of high-frequency fire generated in his laboratory. Bernhardt was harmed more than he was.

But to return to the vaudeville aspect. It sank into partial oblivion for a decade or two, apparently. It is now being revived. In *Variety*, the theatrical magazine, a review appeared a while ago under the following caption: "Bernays

Johnson (4), Electrical Novelty, 18 Mins.; One and Full Stage, Hippodrome (V-P)." The review was by the talented "Abel." He put the seal of his approval on the act, devoting a full column to the task, and ending with this sentence: "Johnson is a natural for thrill exploitation." The grounds for this verdict are worth recounting.

After speaking of the stunt as a "dignified ballyhoo act," Abel pays tribute to Johnson as a "corking showman without being 'professional' or show-wise in his manner of speech or presentation," which begins with a "scientific" exposition before the curtain. Then follow some high-frequency demonstrations, such as the lighting of a lamp without wires, the frying of an egg ditto, and the transmission of the mysterious energy through a bowl of goldfish and the human body, "employing a comely woman for this demonstration." A beautiful girl will help sell anything, as the hosiery manufacturers know. There is also a "defiance-of-gravity" experiment, the idea of which, as explained by Mr. Johnson, is to improve transportation by allowing the traveler to get up into the air quite a way, whereupon the earth obligingly revolves beneath him, until he lets himself down where he wants to go. Jules Verne stuff.

But this is only the introduction. "The big punch in Johnson's act," Abel tells us, "is his billing as 'the man who defies the electric chair.'" The chair is stated to cost \$6000. "Johnson announces that he will receive 350 amperes of current through his body, thrice the quantity necessary to electrocute a human being. Johnson states that it is fear which paralyzes an electrocuted person and not the actual juice that kills him, inferring that possibly the ensuing autopsy has something to do with the physical destruction of a condemned murderer. Johnson contends that by keeping cool and dry (perhaps a trying condition for the average death-house victim), one can withstand the shock. On that theory, Johnson presents its demonstration. To further prove that the juice is actually passing through his body, a bar of metal is burnt to white heat from a wire on his person, the dismembered piece is caught in a pan by a 'nurse.' Two male attendants in regulation prisoner's uniform complete the cast."

Of course if even an ampere of honest-to-goodness d.c. or low frequency a.c. passed through Bernays' bones his soul would fly to heaven with the speed of light (300,000 kilometers a second), and his body would fall, a veracious carcass, on the Hippodrome stage. But as he is working well

up in the kilo- or megacycles he gets away with his fustian, and no doubt provides good entertainment for the customers. He doesn't let it get under his skin, to use the phrase literally. I am told, however, that he is unable to follow his own advice to the death-house inmates to keep cool and dry. At least, one close-up witness to Brother Johnson's demonstration told me that he (Johnson) was sweating copiously and looked uncomfortably scared while working his magic at the last radio show in New York. He may have been thinking of what would happen to him if his Tesla transformer broke down. Such misgivings would not be irrational. I wish Bernays luck, but, in my capacity as a consulting engineer, bestow on him gratis the advice that he had better filter and dry the oil in the said transformer frequently.

Rosa Ponselle Before the Microphone

I CAN see where singing before the microphone must be simpler in some ways for, say, an opera singer, than performing before an audience. Not as much voice need be used, and acting becomes unimportant. But if any one thinks that, on the whole, singing for the radio is less complicated than doing it on the stage, he should watch Miss Rosa Ponselle modulate her way through a Victor hour, as I did recently. Lately I have become interested in how great artists get their effects, as far as one can judge outwardly, and wherein they differ from the amiable but depressing amateurs who helped us out in 1923.

Miss Ponselle is a handsome and robustly built young woman, who looks the prima donna and would get a seat in the subway, even in this unchivalrous age, if she ever rode in it. She does not appear at all nervous as she faces the microphone, although there is some tension in her attitude—mainly energy and determination. She stands about three feet from the microphone and not much farther from the conductor, who is one of the regular maestri from the Metropolitan. The orchestra of about thirty-five is behind her, and a mixed chorus of about the same number in back and to one side, fully thirty feet from the transmitters; but they come through very well. Miss Ponselle, when she is in action, does five things; she sings, acts the rôle in a modified way, varies her distance from the microphone, follows the conductor, and watches her own monitor or coach who signals to her from the control booth. Talk about coordination! The last

stunt is accomplished as follows: The singer faces a side of the studio in which there is a large window through which she can see the group in the monitoring booth, consisting of a few engineers and program people, maybe a vice-president or two, and Miss Ponselle's assistant. The window is double glass, with an air space intervening, and those on the booth side hear only through a loud speaker. Miss Ponselle weaves back and forth as she sings, varying her distance from the microphone according to the loudness of the passages. During piano portions she advances to a point where her mouth is about eighteen inches from the transmitters, while when she wants to hit a note hard she may get as far away as four feet. By this device she sings the aria so that it sounds natural to her, and at the same time she compresses her volume range, as far as input to the microphones is concerned, for the best results on the air. The control operators have little to worry about, but Miss Ponselle has enough, because, after all, she does not hear the results of her divagations in a loud speaker. Her assistant supplies the loud speaker ear for her. When he considers that she is getting too close he moves his hands apart with the familiar "So big!" gesture of the fisherman; when she is

an ordinary artist is one of character as much as physical equipment, which is no doubt true, especially as no one can say where the one begins and the other ends, nor precisely how they interact.

Miss Ponselle does five things when she broadcasts. But those are only the main heads. Each one of them includes a multitude of minor coordinations. The singing itself, for example—breathing and voice production and diction and all the rest of it. The acting, as I remarked, is somewhat mechanical in a broadcast rendition, but the fact that the artist retains it even when her audience cannot see her shows how intricately such habit-formations are organized. She evidently feels that, if she dropped it altogether, her vocal expression might suffer. As one watches the headliners one realizes, if it was not plain before, that this business of singing and playing is a hard game, if one wants to excel in it. So many things must be done at once, and all timed to a split second. For myself, I return thanks that my feet were never set on that path. I should as soon think of walking a tight-rope stretched over Niagara Falls and at the same time demonstrating Green's theorem in mathematical physics to the newly-weds on the shore.

leading to the station, either through a transformer or by means of a loud speaker placed before a microphone. I should imagine that the transformer coupling would be preferable. A number of outdoor antennas are available. The procedure of listening and re-broadcasting is quite intricately systematized, there being a scouting operator who catches stations for Mr. Godley, the latter exercising his fine hand only on valuable prospects, such as West Coast broadcasting stations. Mr. Godley listens to the signals as they sound on the air after re-broadcasting, by means of a monitoring receiver tuned to WAAM. Special attention was paid to eliminating electrical noise in the neighborhood of the listening post, so that man-made static has been reduced to a minimum. The DX re-broadcast is said to be a popular feature on WAAM's programs.

WOC

THE well and favorably known Davenport, Iowa station stays on its assigned frequency by means of a beat frequency indicator developed by the Washington Radio Laboratories, of Washington, D. C. This device mixes the output of a crystal oscillator, calibrated by the

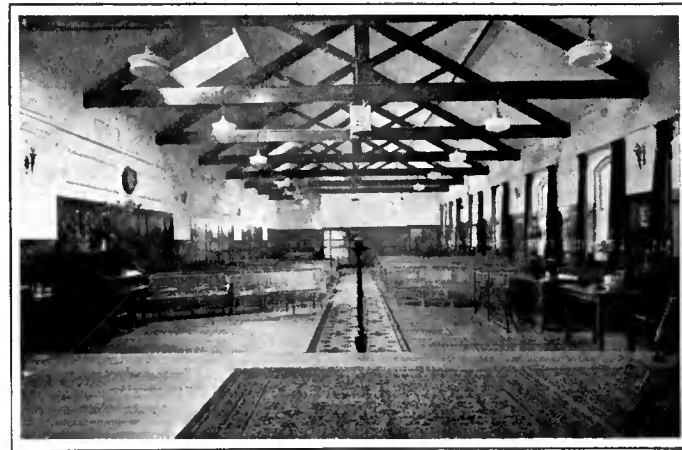

TWO OF THE 3 LO STUDIOS AT THE MELBOURNE STATION

The illustration on the right shows the main studio of the station. The studio is only partially acoustically treated and the presence of spectators in the wicker benches helps to deaden the room. In both these studios the use of an illuminated device for communicating with the performers while they are before the microphone is shown. This signal system has gradually been abandoned in the United States with the increase in the number of professional microphone performers

too far from the pick-up he advances the parallel palms of his hands to within a few inches of each other, and when she is hitting it right the coach signals with a short vertical gesture, palms down, quite like an umpire saying "Safe!" to a runner who has just slid into a base. He also nods his head, to reassure the diva still more. Almost all the time she is right, but no doubt she gets considerable comfort from the signalled affirmations to that effect. It is very comical, as she goes more or less mechanically through the actions natural to the aria—clapping her hands on her chest and so on—to see her glancing constantly, with the hundred-thousand candle power eyes which are part of her operatic equipment, now filled with mute appeal quite apart from the beauty of the notes, to see whether she is treating the microphone properly. It is also impressive. Genius, it has been said, is an infinite capacity for taking pains. It is that, partially, and in a broadcast studio as much as anywhere. Maybe one of the obscure girls in the chorus started with a voice as good as Ponselle's, but was too easy-going to get very far with it. All that amounts to saying, of course, is that the difference between a successful opera singer and

Among the Broadcasters

WAAM

WAAM of Newark, around this time of the year, is just getting through with its winter DX re-transmissions. The transmitter, situated in Newark, New Jersey, is fed for this purpose from a battery of receiving sets in a more rural location at Cedar Grove, presided over by no less a distance shark than Paul F. Godley. It was Paul Godley, as no good radio man has forgotten, who first received American amateur signals in Europe, something like six years ago. He sat in a tent on a beach in Scotland, and picked up the signals of U. S. hams on a Beverage wave antenna. The phones kept his ears from freezing. Now he listens in a sort of dug-out underneath a house—what might be called a radio cellar—and probably keeps more comfortable. The DX re-broadcasting starts at about 1 A. M. Several receivers are used, the main one being an eight-tube loop outfit using a.c. tubes, affording four stages of radio amplification, a detector, and three stages of double-impedance audio amplification. The receiver is coupled to the land line

Bureau of Standards, with radio-frequency from the broadcast transmitter. The latter voltage is picked up by means of a small antenna. The two radio-frequency voltages are mixed in a compartment which is shielded from the standard oscillation generator. A beat frequency is produced in the output of a rectifier tube. This beat frequency indicates its presence in two ways. When it is sufficiently high it produces an audible note through a loud speaker. Below about forty cycles per second the indication is visual. A relay capable of following fluctuations up to forty per second lights a green light when the broadcast transmitter is radiating the same frequency as that generated by the standard oscillator. When the transmitter frequency deviates a red light glows, or the red and green lights flicker in alternation. If this frequency is above fifteen per second both lights appear to be lit continuously, owing to the well-known phenomenon of persistence of vision. The operator of course endeavors to keep the transmitter frequency so close to his standard that the green light glows alone, or the two lights alternate very slowly, corresponding to a beat note of only a few cycles per second.

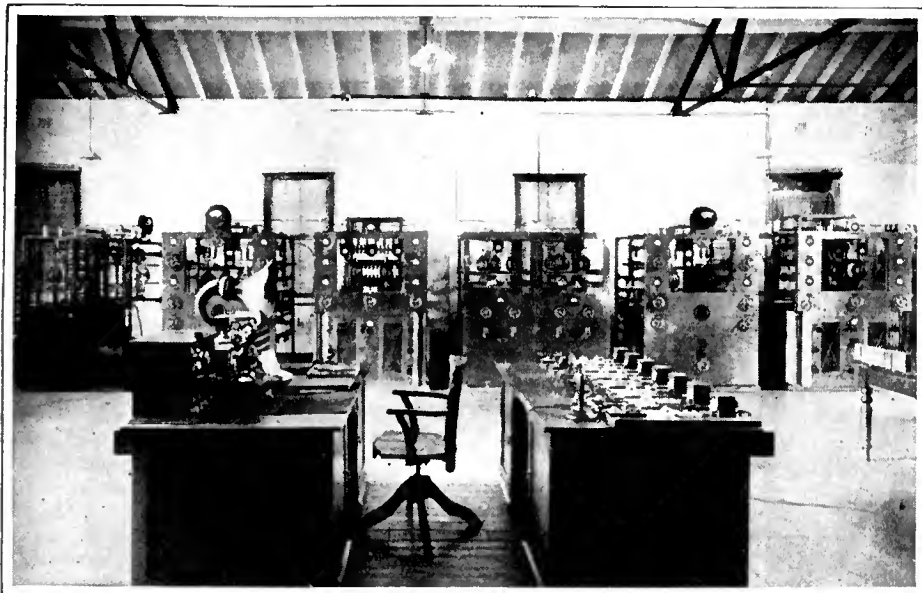

AT PENNANT HILLS, SYDNEY, AUSTRALIA

The transmitting room whence broadcasting programs received in England, Canada, and the United States have issued. In addition to the broadcasting transmitters, there is a marine transmitter at the extreme left, while the other panels form the short-wave set

The device operates on batteries, the voltage of which must naturally be kept constant. Meters are provided for checking. The highest voltage required is 100. Storage batteries are recommended as a source. Like other piezo-electric controls, this indicator must be kept in a constant temperature box if its indications are to be relied upon.

3 LO, Melbourne

WE PRESENT photographs of the studios and control equipment at the Australian station, 3LO. The main studio, it will be noted, contains plenty of wicker settees, for visitors. There is room for two hundred in the studio, which is therefore as much an auditorium as a broadcasting studio, and spectators are not merely welcome, but necessary. Every one adds a definite amount to the total absorption of the room, and when the place is filled the period of reverberation is markedly reduced. The platform for the performers is partly covered with carpet, as the picture shows, and the wall nearest the camera is draped. The absorption of this end of the studio is fixed, therefore, and with an audience in the body of the room the period is about right for broadcasting, there being enough reverberation to produce a lively effect, and not enough to set up standing waves and disturbing rattles.

The announcer, it would appear from the picture of the main broadcasting hall, sits at the table on the right and talks into his own microphone. The concert microphone is stage center. Each microphone box is surmounted with a signal lamp. There is also an illuminated device for communicating with the performers during a number; it may be seen hanging from one of the rafters, over the center aisle. This scheme was formerly used at some United States stations—WGY, for example—but with the advent of professional performers it is no longer very serviceable. At most of the large stations many of the artists are on the air several times a week, and they know precisely where to stand and what to do for given effects.

The photograph of the control room shows a good-sized PBX, and an amplifier panel not unlike the American layouts. The boxes on the table may be portable amplifiers.

Sydney, Australia

ANOTHER accompanying photograph gives one a good idea of the transmitting room at the Pennant Hills station whence broadcast programs received in England, Canada, and the United States, have issued. The control table with a monitoring receiver and apparently a small telephone switchboard is in the foreground, with a telegraph table to the right. The transmitter panels stand along the rear wall. The marine transmitter is at the extreme left; the other panels comprise the short-wave set. The design is a combination of panel-and pipe-rack construction probably all right if the place doesn't catch fire.

Studio Scandal

MOST tenors start rehearsals with nicely starched collars and cute neckties, only to tear off both before they get halfway through.

Few male singers appear in evening dress. The headliners, with occasional exceptions, dress very informally. Soft collars, in blue or some other fairly bright color, are the rule. When WJZ had its studio on Forty-Second Street in New York City one Italian tenor got down to his undershirt on a warm night. He wouldn't sing in his shirt, so what could the studio staff do? But ultra-modern studios are artificially ventilated, so that the air remains at sixty-eight degrees Fahrenheit, winter and summer, while the humidity is kept at the optimum figure of fifty. Thus the artists remain comfortable, although dressed. They are right, however, in taking off whatever incommodes them. The late Victor Herbert, in the year when he conducted the Stadium concerts during the summer in New York, used to rehearse the men clad in his white flannels from the waist down and only B.V.D.'s from the waist up, on hot mornings. He was a fine old Berserker, and looked better with his chest bared to the zephyrs than when he appeared, starched performance, before the *haute monde* in the evening.

Studio Slang

THE operators used to yell, "You're on the air!" when handing the program over to studio or to the field forces. This phrase has changed. "Take it away!" is now *de rigueur*. "It" refers to the program, of course. This phrase seems very picturesque to me and I get a certain kick out of hearing it. The NBC slang for "field" or "outside" annoys me, on the contrary. It is "Nemo" and was originally adopted for purposes of camouflage in some obscure and forgotten contractual tangle. But now that it has become a habit it cannot be eradicated and I expect to hear it for the next forty years, unless broadcasting kills me earlier.

When Orchestra Leaders Sing

THE best conductors seem to have the worst voices, and when they sing a bar to show the musicians what they want even the page boys around the studio snicker behind their handkerchiefs (when they have any). Mr. Setti, the brilliant maestro of the Metropolitan Opera Company who frequently broadcasts incognito, should be excepted. He has a good voice and sometimes sings right through a selection, accompanying the orchestra. He may have been



CONTROL ROOM OF 3 LO, MELBOURNE

an opera singer himself once, before he started conducting for them. Now and then he goes flat, but it does not bother him, for after all his singing is supererogatory. He annoys the control operators, who maintain that his singing interferes with their getting a balance during the rehearsal. But none of them has ever had the nerve to go out and tell him so. They are right; but if a man wants to sing it is generally dangerous to interfere with him. He will let you criticize his wife, his children, and the shape of his head before he will let you stop him from singing when the spirit moves him.

An Engineer's Embarrassment

IT IS true that the more a man is educated, soundly, the less he is surprised at anything. And conversely, if he knows little, he is frequently astonished at perfectly rational behavior which happens to be beyond his comprehension. In the last few months I have had occasion, quite often, to venture into unfinished studios where painters were at work, there to warble various notes or to clap my hands to get some idea of the reverberation. The results have been almost as dreadful as when Mr. Hanson and I invaded a church for a similar purpose, as recounted in these columns a while ago. Some of the painters have nearly fallen off their scaffolds, causing me no small amount of anxiety lest I should give rise to a damage suit against my company. Others have apprehended that I was mocking them, and the looks they directed toward me said as much as that they were ready to paste me in the eye or to go on strike. In most cases I have slunk out after banging my hands together much fewer times than I had intended. Then the painters would glance at each other, and I knew as soon as the sound-proof door closed they would say, "The poor nut!" Well, they may be right, but not on the grounds they thought. What I was doing was just as rational as painting.

Radio Inspectors—Fine Fellows

WITHOUT doubt there is something magical about radio. Have you ever considered the remarkable infrequency of bureaucrats among the government employees in the business? The fact that where I have my office now no transmitting apparatus exists, so that the radio inspectors do not visit the place, has made me think of them. The men in the U. S. Supervisors' offices are a fine lot of fellows. It is rarely that an operator is high-hatted by one of them. On the contrary, the inspectors and their assistants frequently go out of their way in order to help some boy in difficulty about his ticket. They form a marked contrast to the poisonous snobs in the naturalization offices, for instance. Maybe part of the difference is due to radio; I like to think so, anyway.

Commercial Publications

THE Daven Radio Corporation, of 158 Summit Street, Newark, New Jersey announces "Super-Daven" resistance units, wire wound, available in values from 10,000 to 3,000,000 ohms, and accurate to within one per cent. The inductance is given as "practically negligible,"

with the distributed capacity likewise minimized. The temperature coefficient is 0.0001. At a slight additional cost, resistors are furnished with a closer tolerance than one per cent. and with zero temperature coefficient. These units mount in clip holders. The line is offered for use as laboratory standard resistors, voltmeter multipliers, plate and grid resistors, high-voltage regulators, and in telephone and telephoto work. No doubt broadcasters will find uses for them.

J. E. JENKINS & S. E. Adair, of 1500 North Dearborn Parkway, Chicago, describe in their Bulletin No. 5 a wire-wound gain control, Type GL 35. This instrument contains 11 separate resistance units, each wound non-inductively with enameled Nichrome wire. The total resistance is 350,000 ohms, arranged in logarithmic steps, resulting in a straight-line TU variation. The resistance values are good to less than one per cent. The housing is an aluminum shield, the end pieces being three inches square; a depth of $4\frac{3}{4}$ inches is required behind the panel.

IN MARCH we started a review of the pamphlet entitled *Samson Broadcast Amplifier Units*, issued for limited distribution by the Samson Electric Company of Canton, Massachu-

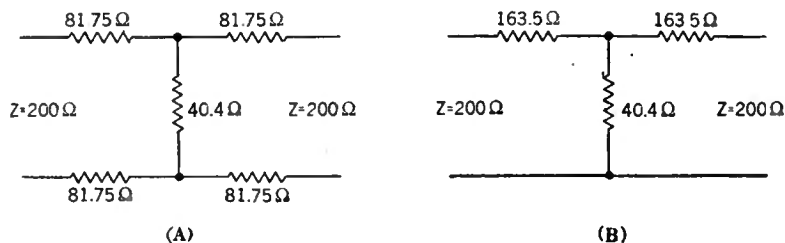

FIG. 1

setts. This detailed review will now be continued. On Page 18 we find a discussion of the design of a volume control arranged in 2-TU steps, with a maximum resistance of 100,000 ohms. The 2-TU drops may be secured by tapping off 79 per cent. of the voltage each time, or 79 per cent. of the resistance, as long as the voltage is proportional to the resistance. The first tap would therefore be at 79,000 ohms. The description is not entirely clear in the pamphlet, and there is an error in that the first tap is given as 59,000 ohms. On Page 19 there is further discussion of gain controls, and the design of one covering a range of 10 TU in 1-TU steps is given. This starts with a minimum, or first tap value, of 161,000 ohms, and continues in progressively increasing steps until the whole 10 TU have been covered. Another potentiometer affords a range of 50 TU in 10 steps of 5 TU each. The total resistance of each device is 500,000 ohms. One of these may be used across the grid and filament of one tube of an amplifier and the other across the input of a succeeding tube, thus providing fine and coarse regulation of gain as required.

The material presented under "Pad Design" will prove extremely useful to many broadcasters although there is no attempt to derive the formulas given nor to adhere to a conspicuously logical sequence in the discussion. The relationship between the impedance on either side of a conventional resistive T- or H-network, the impedances of the legs, and the TU loss introduced, are given at length and worked out to a practical conclusion in the form of a table (Table III). From this tabulation, knowing the TU drop

desired, one may read the value of Z_1 and Z_2 for Z equals 200 ohms and Z equals 600 ohms. Z is the impedance on either side of the pad (only bilaterally symmetrical pads are discussed); Z_1 is the total value of the series or X-legs; Z_2 is the value of the shunt or Y-member. For example, if one requires a 20 TU pad presenting 200 ohms each way, one finds from the table that Z_1 must be 327 ohms, while Z_2 is 40.4 ohms. The result, for an H-network, would be the pad of Fig. 1-A, while if a T-network with the same electrical characteristics is chosen the arrangement will be that of Fig. 1-B. Numerically the difference is simply one of splitting Z_1 into four parts or into two parts, for the corresponding number of legs, depending on whether a balanced network is required or not.

On Page 21 there is apparently an error, L_1 and L_2 having been printed for Z_1 and Z_2 , respectively. The article as a whole seems to have been written by an engineer who knew what he was about but had no unusual skill in presenting the subject for the education of others. This defect is not extremely important, inasmuch as most of the people who consult the pamphlet will be more interested in the results than in the procedure required to reach them. In some ways the treatment is more extensive than that

given in the article devoted to the same subject in this department for September, 1927, particularly in the working out of the table, but in other respects it is less thorough than the latter, and readers who are much interested in pad design might go back to the September, 1927, RADIO BROADCAST article after reading the Samson pamphlet, and also to the discussion of the General Radio write-up on pads in the January, 1928, RADIO BROADCAST.

The limits within which all these pad designs hold good are well stated in the Samson booklet, which broadcasters may secure by writing for it on their letter-heads; this portion is well worth quoting:

"It is assumed that the transformer is ideal, that is, that it has a negligible resistance in its windings, and an infinite input impedance with the output windings open-circuited, and vice-versa. It is also assumed that the line or other circuit element into which the transformer is working has pure resistance of the impedance value given as the impedance which the transformer is designed to match. It is also assumed that the transformer has no leakage reactance, that is, that all magnetic flux which links one winding links the other. In order that all these different things may hold, it is necessary that the consideration be based on a certain range over which the transformer practically meets all these conditions, and where those not depending on the transformer hold. Of course, as the frequency is reduced more and more, or as it is increased more and more, below and above this range respectively, these assumptions must fall down. Therefore, it must not be thought that a 'pad is a pad' over all ranges of frequencies. However, over the range that the circuit element is designed to work, these ideas hold very closely, and the simple addition of the attenuation of individual pads to obtain the total attenuation gives the desired working result, and that is the justification for its wide use in communication circles."

No "Motor-Boating"

A Quality Audio Amplifier Which Will Not "Motor-Boat"

By H. O. Ward

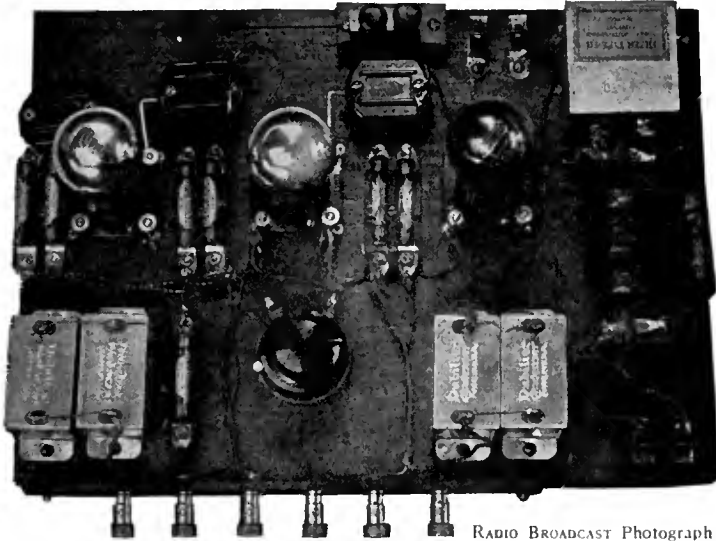

A HIGH-QUALITY RESISTANCE-COUPLED AMPLIFIER

The two condensers and the resistance in the lower left-hand corner prevent the amplifier from "motor-boating." The loud speaker connects to the two Fahnestock clips alongside of the output condenser; the two similar clips in the lower right-hand corner are used to read the plate current of the last tube

SEVERAL years ago the resistance-coupled amplifier was much in vogue, and justly so, for it is an excellent type of audio amplifier and is capable of giving practically equal response over the entire audio-frequency range. Its popularity at that time was comparatively short-lived—just why, it is hard to say. Since the introduction of the 240 type tube some time ago, however, there have been indications that the resistance amplifier will stage a comeback.

The amplifier described in this article has a flat frequency response curve from 60 cycles up to about 6000 cycles, it will not "motor-boat" when operated from any ordinary B power unit, and it has a voltage amplification of about 400 from the input of the amplifier to the grid of the power tube. A curve showing the frequency response curve of the amplifier is given in Fig. 1. In Fig. 2 is given the circuit diagram of the amplifier. There is nothing unusual about this amplifier with the exception of the anti "motor-boating" circuit which we have indicated by enclosing it in dotted lines. This anti "motor-boating" circuit originated in the engineering department of the E. T. Cunningham Company a short while ago, and the circuit, tested in RADIO BROADCAST LABORATORY, has proved very satisfactory. It should be noted that the circuit is arranged so that the plate current of the detector and first audio tubes must pass through resistance R_1 .

To test the circuit the amplifier was connected to a B power unit and with the resistance R_1 short-circuited the amplifier immediately began to "motor-boating." As soon as the short-circuit was removed the "motor-boating" stopped. It was found that the value of R_1 , necessary to produce stable operation of the amplifier, varies with different B power units. With some power units a resistance of 20,000 ohms is sufficient, while with other power units

a resistance of 100,000 ohms is necessary. Since the latter size resistance seems to be effective in all cases, it is suggested that those who construct the amplifier use this value of resistance. As the plate current of the first tubes in the

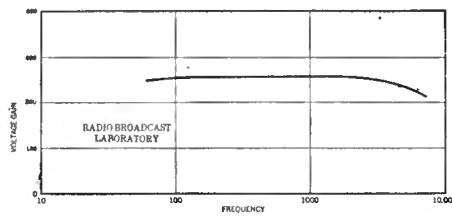

FIG. 1

amplifier and the detector tube must flow through this resistance, it might be thought that there would be an excessive loss in voltage across it. Such is not the case, however, as the following data will show.

For this test the amplifier was set up with a detector circuit connected ahead of it. The detector tube used was also a 240 type tube and the same voltage was applied to the detector tube as was applied to the first and second audio tubes in the amplifier.

This table indicates the voltage actually at the plates of the detector and first audio tubes for two different values of applied voltage. A difference of 10 or 20 volts at the plate of a tube will not change the characteristics of the amplifier and since the loss in voltage due to the resistance R_1 is of this order, it is evident that the amplifier will not be affected.

The following data were obtained:

APPLIED VOLTAGE	R_1 OHMS	VOLTAGE AT PLATE: DETECTOR	FIRST AUDIO
135	0	45	83
135	100,000	40	95
190	0	55	115
190	100,000	43	93

The reason that the detector plate voltage is lower than that of the first audio stage for the same values of resistance is because the current drawn by the latter is less than that drawn by the detector.

The recommended values of plate and grid resistances and coupling condensers are as indicated in Fig. 2 and the frequency response curve shows that the values specified give the desired flat characteristic. If larger values of resistances are used the gain of the amplifier will fall off at the high-frequency end. Larger values of coupling condensers tend to better the response at low frequencies but since the response is satisfactory with the values given, it is a waste of money to use any larger condensers unless you have them on hand.

The correct voltages to use on the grids and plates of the three tubes of the amplifier are given below. The letters B_1 , C_1 and B_2 , C_2 in the table below refer to similar notation in Fig. 2.

1ST AND 2ND AUDIO Tubes

Grid Voltage C_1	Plate Voltage B_1
1.0 TO 1.5	135
1.5	157
3.0	180

POWER TUBE

112 TYPE		171 TYPE	
Grid Voltage C_2	Plate Voltage B_2	Grid Voltage C_2	Plate Voltage B_2
6	90	16.5	90
9	135	27	137
10.5	157	33	157
		40.5	180

The following parts were used in the amplifier:

- 1—Durham 0.1-Megohm Resistor
- 3—Durham 0.25-Megohm Resistors
- 3—Durham 2. 0-Megohm Resistors
- 3—Sangamo 0.006-Mfd. Fixed Condensers
- 6—X-L Binding Posts
- 3—Benjamin Sockets
- 1—4-mfd. Tobe Condenser
- 1—Amertran Choke Coil, Type 854
- 5—Fahnestock Clips
- 1—6-Ohm Pacent Rheostat
- 4—1 Mfd. Dubilier Bypass Condensers
- 3—Lynch Double Resistor Mounts
- 1—Lynch Single Resistor Mount

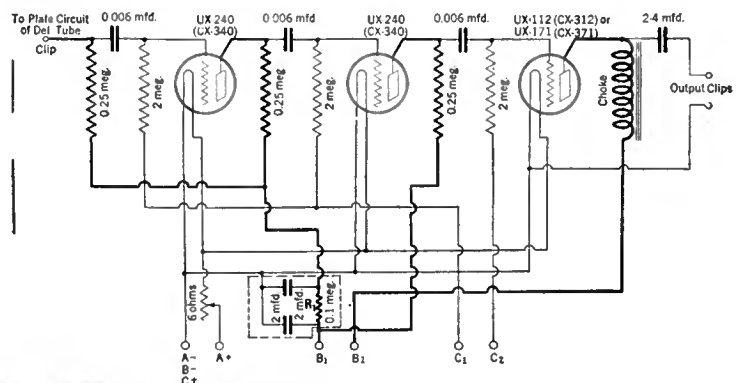
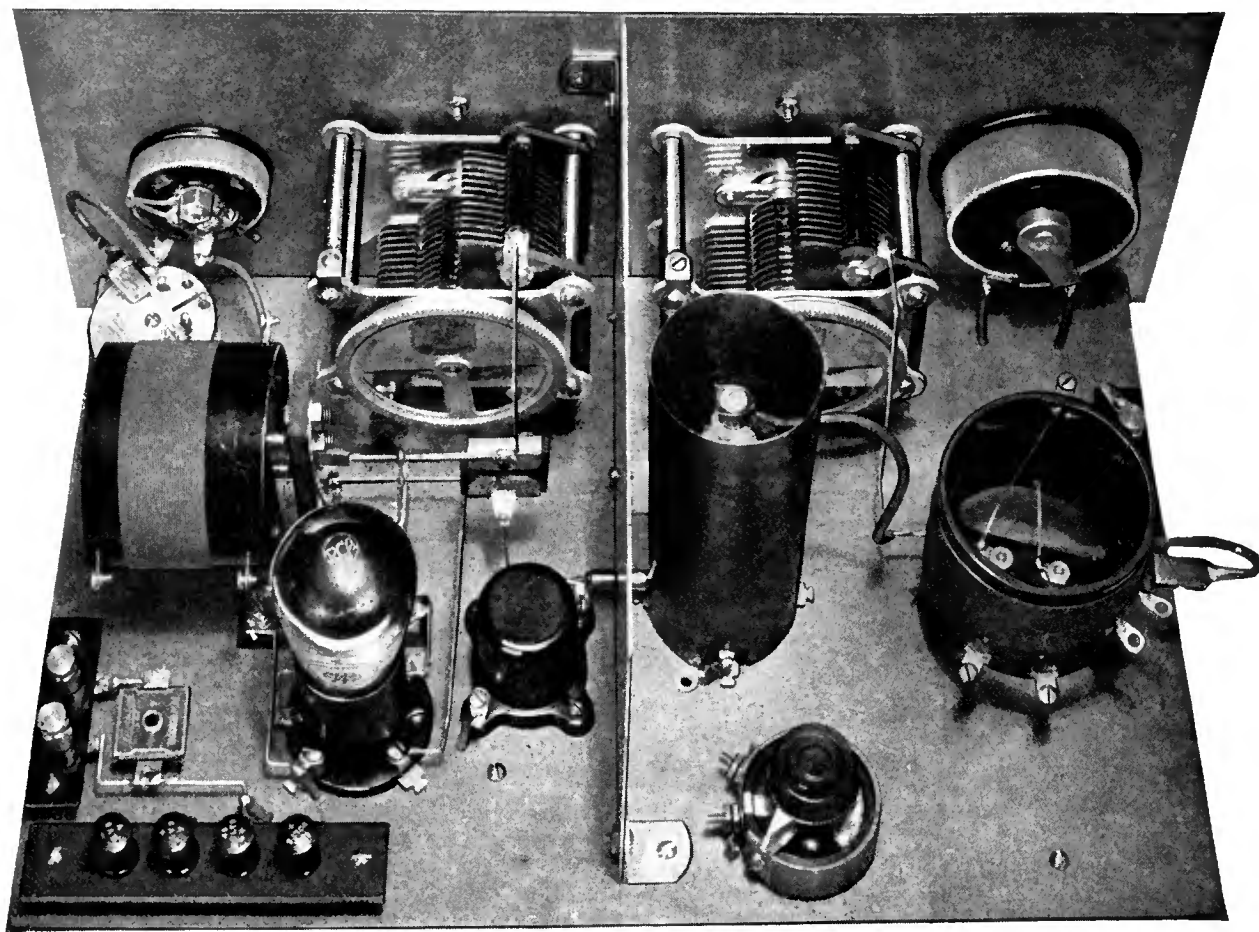

FIG. 2



A TWO-TUBE SCREEN-GRID RECEIVER

Maximum efficiency is obtained by using metal front and sub-panels while there is also a metal plate between the r.f. and detector tube circuits. The active parts used in this receiver are listed on page 435, and the circuit diagram is also given there. A copper cylinder is used to shield the tube

An Experimental Screen-Grid Receiver

Charles Thomas

THE introduction of the screen-grid tube is most opportune for that section of the radio world which is constantly in search of a new plaything. The UX-222 (CX-322), or screen-grid tube, offers the advantage of an extremely high gain per stage when used with the inside grid as control grid and with a steady polarizing voltage impressed on the screen. As is to be expected, the high amplification factor is accompanied by a very high plate impedance, necessitating a high impedance in the coupling unit if the advantage of the high amplification factor is to be realized to its fullest extent. While the screened-grid tube requires no neutralization, careful shielding is necessary, particularly if several stages are used.

Elaborate shielding is not required if only a single stage is used. For this reason, a single-stage amplifier adapts itself to preliminary experiments with the new tube. The set described here is purely experimental and no claims are made as to the results obtainable. Tests have shown that it is stable, and results in operation approach those obtained with three tuned circuits and fixed input in a three-stage amplifier using standard tubes. The selectivity without regeneration is comparable to that obtained in a normal two-circuit system but the figure of merit of both circuits is somewhat reduced because the

first circuit is coupled to the antenna and the second feeds the detector. Two-circuit selectivity is insufficient for broadcasting reception in this country, hence the detector is made regenerative. Regeneration more than compensates the losses

WITHOUT a doubt the screen-grid tube is attracting the attention of every serious experimenter and engineer in the radio field. Readers of RADIO BROADCAST are by this time familiar with the theory of this tube, and something of its operation and application has already been included in the contents of this magazine. The following brief description of a two-tube tuning unit, to which may be added any audio amplifier, is the forerunner of a construction article telling exactly how to build the receiver. This article, and the completed receiver, which is being thoroughly engineered, are products of a well-known engineer, whose real name, unfortunately must be hidden with a pseudonym. Articles on the new screen-grid tube appeared in RADIO BROADCAST as follows: "Applications of the Four-Electrode Tube" December, 1927; "The Screened-grid Tube" January, 1928; "A Screened-grid Tube" February, 1928; "A Four-Tube Screened-grid Receiver" March, 1928

—THE EDITOR.

in the tuning unit feeding the detector and improves both selectivity and sensitivity.

The shielding required, as shown in the photograph, is not very elaborate. Brass panel and baseboard are used, and a brass partition between the two stages is also advisable. The screen-grid tube is enclosed in a copper cylinder which fits closely around the tube and extends about half an inch above it. It is also necessary to shield the short lead between the plate of the screen-grid tube and the detector. In general, shielding is required between all parts of the plate circuit and all parts of the control grid circuit.

The circuit of the experimental set, which includes only detector and radio-frequency amplifier, follows conventional lines. The antenna is coupled through a tapped coil to the control grid of the screen-grid tube. The position of the tap controls to a certain extent the gain and selectivity of the set. Its position must be determined experimentally. The plate of the radio-frequency amplifier is coupled to a tuned impedance. Parallel coupling is used, the d. c. plate circuit going through a radio-frequency choke to the plate supply.

The method of regeneration control is somewhat unusual. The regeneration coil L_4 is not appreciably coupled to the grid circuit. Re-

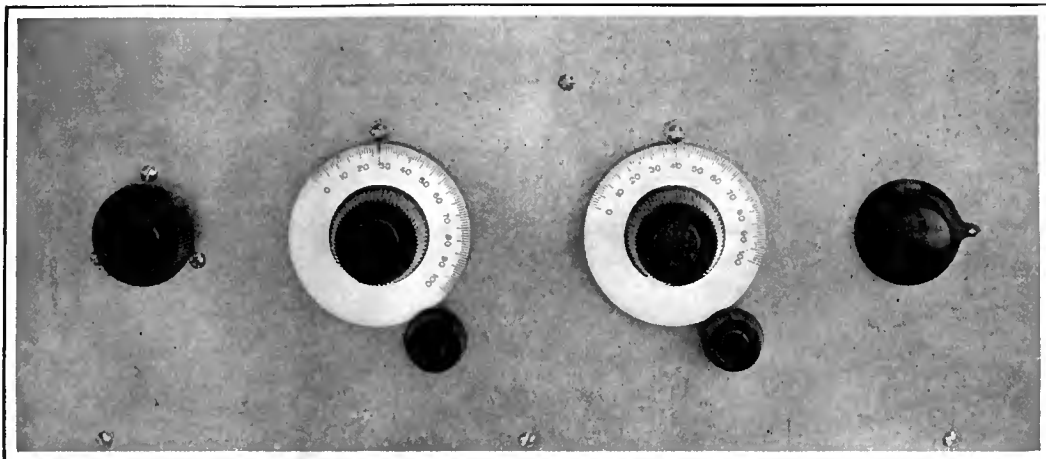

THE FRONT PANEL OF THE TWO-TUBE SET

The two variable condenser dials are made by General Radio and they come with the condensers. The smaller knobs provide for vernier tuning. The panel is of aluminum and is 7 x 14 inches in size.

in the accompanying photographs are as follows:

LIST OF PARTS

- L₁ L₂—45 Turns No. 26 D. S. C. 2 3/4" Diameter
- L₃—General Radio No. 37 Choke of 60 Millihenries
- L₄—Regeneration Coil (Constructional Data Below)
- C₁, C₂—General Radio Type 334 or 247 500-Mmfd. Variable Condensers
- C₃, C₄—1-Mfd. Bypass Condensers
- C₅—0.005-Mfd. Fixed Condenser
- C₆—0.00025-Mfd. Fixed Condenser
- C₇—0.001-Mfd. Fixed Condenser
- R₁—Carter 5000 Ohms, Variable
- R₂—3-Carter Megohm Resistor
- R₃—4-Ohm Fixed Resistor
- R₄—General Radio Type 214 50-Ohm Variable Resistor
- R₅—General Radio Type 301 30-Ohm Variable Resistor
- Two Sockets
- Eight Binding Posts
- One Copper Shield for Tube, 2" Inside Diameter and 5 1/2" High

- One UX-222 (CX-322)
- One UX-201-A (CX-301-A)
- One Aluminum Front Panel, 7" x 14"
- One Aluminum Sub-Panel, 13" x 9"
- Hardware, Etc.

generation is controlled by varying the effective inductance of the plate circuit. The effective value of L₄, shunted by the resistance, is varied by changing R₁. In this type of plate circuit the effective inductance increases with increasing wavelength, which tends to minimize the range

of adjustment of the regeneration control as the tuning is varied. So far as sensitivity and selectivity are concerned a plain variometer might be used in the detector plate circuit, or a fixed inductance with a small variable condenser coupling back to the detector grid.

As shown, the circuit is wired for use with a 6-volt battery and 201-A. type detector tube. Satisfactory operation using the method of obtaining regeneration described was not obtained with a 199 type tube as detector. The UX-227 (C-327) a. c. type tube may be used as a detector if a transformer of proper voltage is used to feed the heater. This tuning and detector unit should be satisfactory for use with alternating-current screened-grid tubes when, as available. The parts used in the receiver shown

The construction of the regeneration coil, L₄, is shown in Fig. 1. The coil form is a wooden spool with an inside winding diameter of 1/2" and a groove 1/8" wide. An outside diameter of 1 3/4" provides sufficient winding space. A coil wound with 93-95 turns of No. 30 d. c. c. will be found sufficient for the general run of 201-A tubes. Coils L₁ and L₂ may be General Radio coils type 277c with 10 turns removed.

If loud speaker operation is desired, any standard d. c. audio amplifier or a. c. power audio amplifier may be used with this unit.

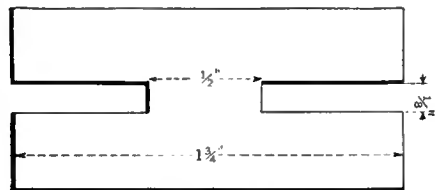

L₄, 93-95 Turns No. 30 D.C.C.

FIG. 1

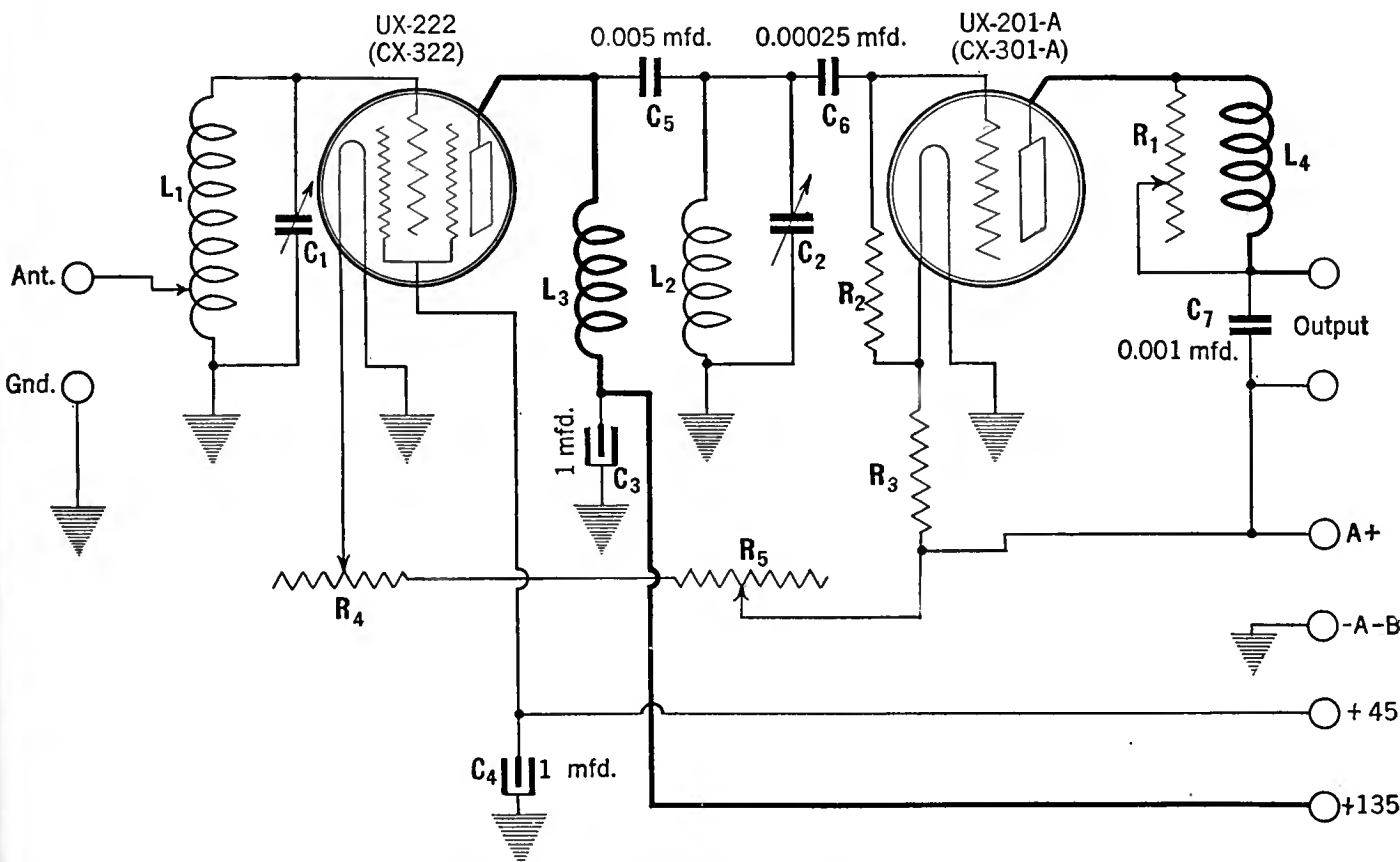

A SCHEMATIC DIAGRAM OF THE TWO-TUBE SCREEN-GRID RECEIVER

Electrifying the "Hi-Q"

By F. N. Brock

THE Roberts receiver, of which the Hammarlund "Hi-Q" is a semi-commercial model, was first introduced to the radio public by RADIO BROADCAST so many years ago that the author has neither the ambition nor time to go through his files to determine just when Dr. Roberts presented his first article. This momentary reminiscence perhaps has little in common with the point to be discussed in the present writing, but there is significance somewhere in the thought that this is the only circuit, of the many hundreds introduced in broadcasting's nebulous days, that has remained standard and popular to the present time. Simple efficiency is responsible for this consistent popularity.

The 1927-1928 Hammarlund Roberts "Hi-Q," described in RADIO BROADCAST for October, 1927, departed somewhat from previous models in mechanical and electrical design, though the ultimate effects are consistently in line with previous designs. The last two models of the "Hi-Q" receiver have incorporated variable coupling between the radio-frequency primary and secondary circuits. The possibilities of such an arrangement were pointed out by Zeh Bouck in an article appearing in the September, 1926, issue of this magazine, entitled "Higher Efficiencies in R. F. Amplifiers." The argument, in brief, is as follows:

At every frequency or wavelength there exists an optimum value of coupling between primary and secondary circuits—a value of coupling which provides the maximum signal intensity compatible with quality and stability. This optimum degree of coupling varies, however, with the frequency. To maintain optimum conditions over the entire tuning range, therefore, it is desirable that the coupling be varied with the wavelength. This is accomplished automatically in the Hammarlund-Roberts receiver.

The general characteristics of the Hammarlund "Hi-Q" receiver remain unaltered in the adaptation of this receiver for the use of a. c. tubes, as comparison of the circuits shown in Figs. 1 and 2 with the direct-current arrangement illustrated in the October, 1927, RADIO BROADCAST, will indicate.

The changes effected have merely been in the nature of the substitution of heater type a. c. tubes for the d. c. ones, accompanied by slight alterations in the constants of the circuit to compensate changes in tube characteristics.

The receiver has been redesigned for the use of two different makes of a. c. tubes, the R. C. A. 227 (Cunningham 327) type and the Arcturus a. c. amplifier, detector, and power tubes. The selection of two types of tubes has been suggested by motives of general convenience.

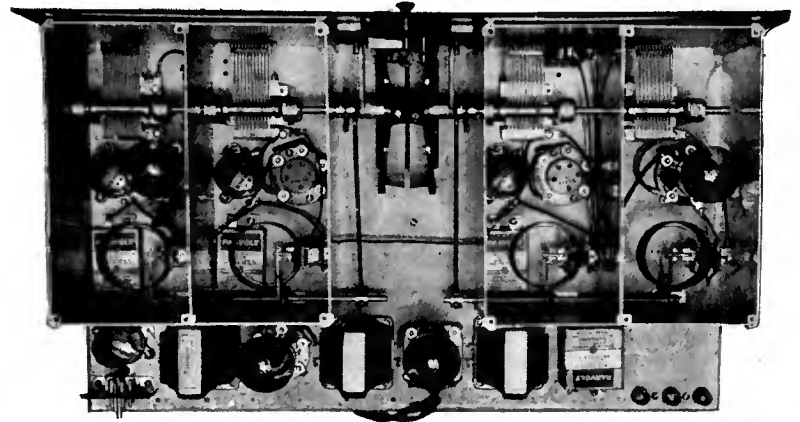

THE "HI-Q" WIRED FOR CUNNINGHAM OR R.C.A. A.C. TUBES

The use of the R. C. A. tube in the "Hi-Q" receiver will be first considered.

The following is a list of the essential parts employed in the construction of the receivers:

- 1 Samson "Symphonic" Transformer
- 1 Samson Type HW-A3 Transformer (3-1 Ratio)
- 4 Hammarlund 0.0005-mfd. Midline Condensers
- 4 Hammarlund "Hi-Q" Six Auto-Coupled Coils
- 4 Hammarlund type RFC-85 R. F. Chokes
- 1 Hammarlund Illuminated Drum Dial
- 1 Sangamo 0.00025-Mfd. Mica Fixed Condenser
- 1 Sangamo 0.0001-Mfd. Mica Fixed Condenser
- 1 Pair Sangamo Grid Leak Clips
- 1 Durham Metalized Resistor, 2 Megohms
- 3 Parvolt 0.5-Mfd. Series A Condensers
- 6 Benjamin No. 9040 Sockets
- 3 Eby Engraved Binding Posts
- 1 Yaxley No. 660 Cable Connector and Cable
- 1 Hammarlund Roberts "Hi-Q" Six Foundation Unit

(Containing drilled and engraved Westinghouse Bakelite Micarta panel, completely finished Van Doorn steel chassis, four complete heavy aluminum shields, extension shafts, screws, cams, rocker arms, wire, nuts, and all special hardware required to complete receiver.)

For the construction of or adaptation of an existing "Hi-Q" receiver to one employing the 227 type tube the following additional parts were used in the adaptation:

- 5 Benjamin Green Top A. C. 5-Prong Sockets
- 1 Thordarson Type 2504 Filament Transformer (or Karas AC Former)

- 1 T200 Electrad Variable Resistance to Permit Temperature Regulation
- 1 0.5-Mfd. "Parvolt" Series A Condenser
- 1 200-Ohm "Truvolt" Grid Resistance (Electrad)
- 1 Samson 30-Henry Choke or a Samson Type O Output Impedance
- 1 2- or 4-Mfd. Series A "Parvolt" Condenser
- 1 Electrad Type J Resistance for Volume Control
- 5 R. C. A. UV-227 or Cunningham C-327 Tubes
- 1 UX-171-A or CX-371-A power tube.

CONSTRUCTIONAL DETAILS

THE construction of the receiver remains practically identical with that of the direct-current models. The general layout of the parts and the mechanical mountings have been described in detail in articles on the d. c. set and in the Hammarlund Roberts "Hi-Q" Six Manual.

The five-prong sockets are mounted in the same places and with the same screws as the old sockets. An extra hole for the cathode lead must, however, be drilled just under the K or cathode terminal. In the a. c. models of the Hammarlund "Hi-Q" the right-hand control (the rheostat in the battery-type receiver) may be used to control a 110-volt line switch, such as the Carter "Imp" type 115.

The similarity of the a. c. and the d. c. mechanical layouts is evidenced by comparing the accompanying photographs with those of the d. c. models which have frequently appeared.

The circuit of the Hammarlund Roberts "Hi-Q" Six receiver employing type 227 tubes is shown in Fig. 1, in reference to which the following points are worthy of mention:

All filament or heater wiring should be made with a twisted conductor. It is desirable that consistency be observed in the socket connections with these power leads. In other words, it is preferable that the same heater terminal on each socket be connected to the same heater lead. This is most readily accomplished by employing a twisted pair of two colors. Corwico flexible red and black Braidite is a convenient recommendation.

The red and green leads on the Yaxley cable are not used.

Heater tubes are employed throughout the circuit (with the exception of the output amplifying stage) due to the simplicity and consist-

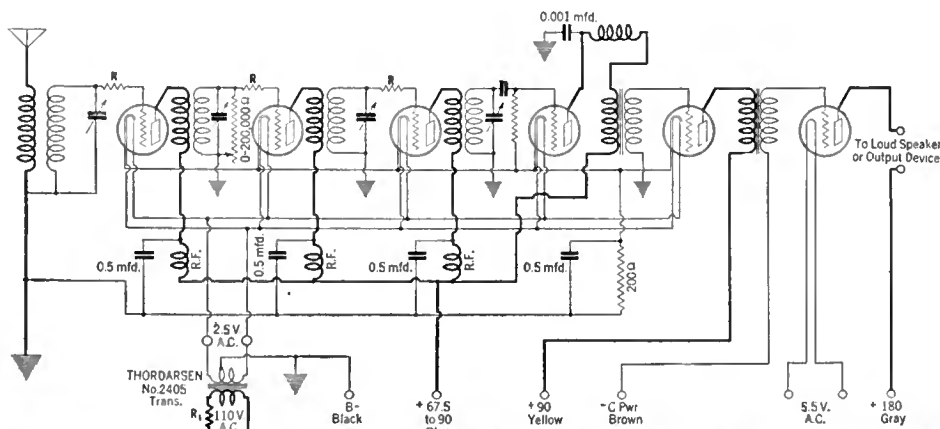

FIG. 1

ency of the circuit arrangement and the low hum characteristics of these tubes.

The Electrad T200 variable resistor is wired in series with the primary of the filament lighting transformer to provide a desirable amount of regulation of the secondary potential. The heaters of the 227 tubes should be operated at as low a temperature as will insure satisfactory reception. With the proper adjustment of the primary resistor it will take about 55 seconds for the tubes to reach an efficient operating temperature after the current is turned on. The life of the tubes will be considerably abbreviated if more than the rated operating filament potential is applied.

The bias to the radio-frequency and first audio transformer tubes is supplied through the drop across the Electrad 200-ohm grid bias resistor.

The pilot light is connected in parallel with the 171-A tube filament.

One side of the 0.5-mfd. bypass condenser across the grid biasing 200-ohm resistor is grounded to the chassis.

Sensitivity and selectivity may be controlled, in the usual manner, by varying the mechanical adjustment controlling the height of the primaries, particularly in the case of the last r. f. stage and the detector stage. Selectivity will also be considerably affected by the tightness of the antenna coupling. In order to attain satisfactory sensitivity and selectivity on the higher frequencies it will occasionally be desirable to use lower values of grid suppressor resistors than those recommended in the d. c. circuit, due to the alteration in the radio-frequency characteristics occasioned by the lower input impedance of the heater cathode type tube. The sensitivity of the receiver may also be increased by employing a higher resistance grid leak. The value of this resistor should, however, be increased cautiously with the possibility of overload on local stations in mind. In the case of a rewired d. c. receiver, originally operating with a radio-frequency plate potential of 67.5 volts from a B supply device, it is desirable to raise the voltage to about 80 to compensate the increased drain. The type J 200,000-ohm resistor is used for a volume control. This is mounted in the left-hand panel hole in the place of the filament switch employed in the battery set. The last three or four turns on the volume control (on the clockwise end, that is) should be clipped in order to give an "open" or maximum volume position.

The potentials, other than the a. c. voltage for the heaters of the tubes, indicated in Fig. 1, may be supplied either from B batteries or from an adequate B supply device, such as the Hammarlund Roberts "Hi-Q" Six power supply described in the Hammarlund Manual. The Thordarson 2504 filament transformer and this power unit will take care of all A, B, and C potentials.

USING ARCTURUS TUBES

FROM an electrical point of view the "Hi-Q" receiver rewired for the use of Arcturus a. c. tubes is practically identical with the 227 type tube design. Mechanically, the Arcturus system offers certain advantages which particularly recommend it for the adaptation of existing battery receivers. Arcturus a. c. tubes are of the four-prong heater type and they plug into the standard ux sockets without the use of adaptors and which, therefore, necessitate neither the use of special sockets nor a comparatively elaborate mechanical rearrangement.

In addition to the essential "Hi-Q" apparatus listed earlier in this article, the following extra

components will be required in the adaption or construction of the Arcturus model:

- 1 Electrad Royalty Type J Variable Resistor
- 4 Arcturus Type A. C. 28 Amplifier Tubes
- 1 Arcturus Type A. C. 26 Detector Tube
- 1 Arcturus Type A. C. 30 Power Tube
- 1 Step-Down Transformer, Having a 15-Volt Secondary, Such as the Ives Type 204, or the Thordarson TY-121.

A receiver employing Arcturus tubes is illustrated diagrammatically in Fig. 2 and in the accompanying photograph. Referring to Fig. 2, it will be noted that the following alterations have been made on the original d. c. circuit:

The three fixed and one variable filament resistors are eliminated. Similarly all connections between grid returns and filament circuits are broken. The connection between ground and A minus is likewise removed. These changes are best made by completely rewiring the filament or heater circuits with flexible Braidite—red and black wires—twisted into a single pair. Connect the red wire consistently to the positive filament terminals on the sockets. These two leads are wired to the filament lugs on the Yaxley cable post, the red wire being soldered to the plus terminal (polarity, however, being meaningless at this point). Another pair can be led to the switch on the "Hi-Q" which later is connected in series with the primary (or 110-volt lead) of the filament lighting transformer for turning on and off the tubes. The switch must not be wired in the conventional manner, *i. e.*, in series with the tubes themselves.

A fifteen-volt pilot light bulb can be secured from any store dealing in electric trains, and should be screwed into the socket provided for this purpose, and wired parallel to the tube circuit.

The grid returns from the radio-frequency amplifier, detector, and first audio-frequency secondaries are brought down to a common lead connected to ground, and this post should also be designated as "C Minus 1.5 volts." The 0.5-mfd. bypass condensers connected from the lower side of the radio-frequency primaries to the filament circuit in the original arrangement should be returned to the plus filament or cathode posts of the respective sockets.

The detector grid leak is disconnected from the A plus terminal of the socket and is brought down to a separate lead or post to be designated

as "D Plus 4.5 Volts." The detector r. f. grid return, *i. e.*, the low-potential end of the secondary coil, is wired, as already indicated, to the common radio-frequency grid return

The grid return from the first audio-frequency amplifier is rewired as described, to the post marked "C Minus 1.5 Volts," which is grounded on the receiver. No change is made in the power tube socket.

A separate wire is led to the plus filament or cathode terminal of the detector tube, designated as "B Minus, C Plus, and D Minus."

The zero to 200,000 ohms Electrad Royalty or any other satisfactory variable resistor is connected across the secondary inputting to radio-frequency tube number two, and mounted in place of the rheostat.

Arcturus type a. c. 28 tubes are used in the first, second, and third r. f. stages and in the first a. f. stage. A detector tube, type a. c. 26, is plugged in the detector socket, and a power tube, type a. c. 30, into the power stage, which feeds the loud speaker.

OPERATION

THE operation of the a. c. "Hi-Q" receiver is practically identical with that of the d. c. model. The indicated connections to batteries and transformer should be made.

A. C. heater type tubes do not function efficiently as soon as the heater current is turned on. With the correct voltage (15 volts) applied to the heater terminals of the Arcturus tubes, it requires just 30 seconds for the tubes to heat to the proper operating point. The filament potential should be adjusted by means of the taps on the transformer until satisfactory operation is obtained. It is needless to say that the heaters must be given three to four minutes to cool before making additional adjustments of this nature. It is desirable, wherever possible, to utilize an a. c. voltmeter for the adjustment of the heater potential.

Any efficient B and C socket power device may be substituted for the indicated battery potentials. Briggs and Stratton are marketing an efficient A, B, and C power unit supplying all the necessary potentials for the operation of Arcturus tubes.

The various points mentioned in the recommended adjustments effecting selectivity and sensitivity in the 227 type tube receiver apply equally as well to the Arcturus arrangement.

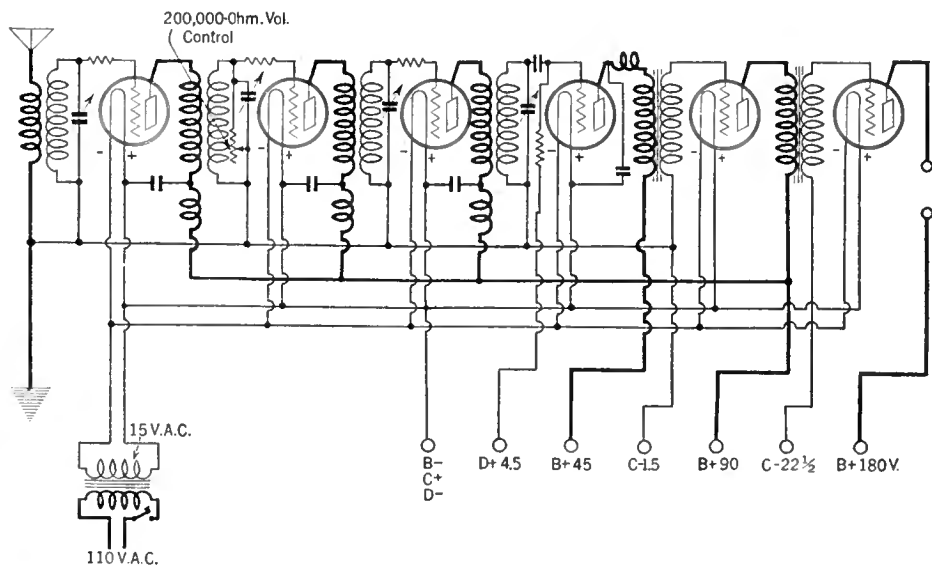
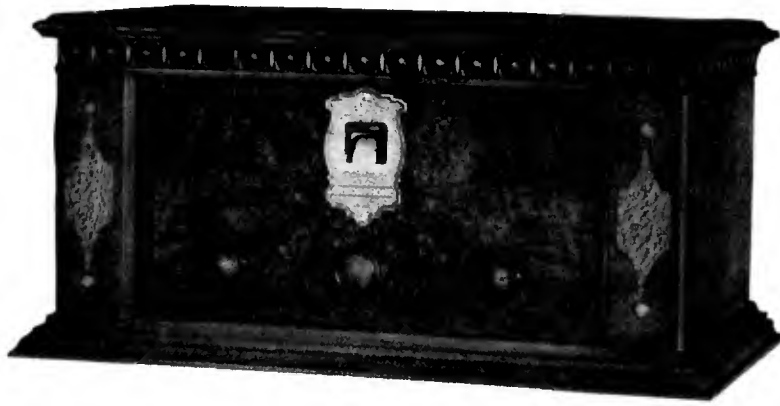

FIG. 2



A COMMERCIALY AVAILABLE LOFTIN-WHITE RECEIVER

The Arborphone 37-AC set employs 3 r.f. stages, detector, and two audio stages. The output audio stage is a push-pull one

An A. C. Loftin-White Receiver

By John F. Rider

PROMPTED by the great interest which hinged on the announcement of the Loftin-White circuit several months ago, the writer has endeavored in this article to describe in brief the outstanding features of a commercial receiver which makes use of this interesting circuit. The receiver in question has much to commend it, not the least important of its features being the fact that it is designed to use the new a.c. tubes.

The Arborphone 37-AC set, for that is its name, comprises three stages of tuned radio-frequency amplification, a non-regenerative detector, and two audio-frequency stages. The last audio stage, as will be seen by reference to the accompanying circuit diagram, is a push-pull one, making use of two parallel 171 type power tubes.

The radio-frequency stages use tuned transformers and a stabilizing system developed as a result of the combined efforts of Messrs. Edward H. Loftin, former Lieutenant-Commander, United States Navy, and S. Young White, a well-known radio engineer. The arrangement used in this receiver is really a modified version of the original, but in its function, is very similar.

This radio-frequency amplifying system accomplishes two things. In the first case it stabilizes the circuit, or the individual stages, whichever way we wish to view it, and secondly, it affords a certain uniformity of response over the tuning frequency spectrum.

A glance at the wiring diagram of the receiver shows the plate supply of the r.f. tubes being fed to the tube through a choke, and the plate coupling coil coupled to the plate through a variable condenser, C. This condenser, because of

its function, is greatly responsible for the stabilization of the stage. Its purpose is to change the phase of the alternating potential in the plate circuit due to the a.c. signal impressed upon the grid of that tube, so that it will not combine with the a.c. signal in the grid circuit. The maximum capacity of the phase-shifting condenser employed in such systems is approximately 0.0005 mfd., and it is usually adjusted to a point where the phase shift is such that the stage operates with a definite amount of feedback, or regeneration, which amount, however, is less than that required to cause a continued state of oscillation. The inductance value of the plate feed choke is of such proportion that, when resonated by its distributed capacity, its fundamental is above the longest wavelength which can be tuned-in with the receiver.

Referring to the method of obtaining what is called "constant coupling" between the plate and grid circuits of subsequent tubes, we find the system used differing somewhat from the original Loftin-White arrangement. An idea of the operating principle of the system can be gleaned from a study of the wiring diagram.

The plate and grid coils of the r.f. stages being inductively coupled, a certain amount of mutual inductance exists between the two coils. This mutual inductance is the path of energy transfer between the two coils, but the magnitude of energy transfer varies with the frequency of the signal. The higher the frequency (the shorter the wavelength) the greater the amount of energy transferred. The lower the frequency (the longer the wavelength) the less the energy transferred. But the coupling between the plate and grid circuits is not obtained solely through the mutual

inductance between the two coils. The fixed condensers in series with the grid circuits also function as coupling capacities, but their coupling value is governed by the ratio between their own capacity and the capacity of the variable tuning condensers in the grid circuits. Now mutual capacity behaves in a manner opposite to that of inductance, being more effective on the longer wavelengths and less effective on the shorter wavelengths. As the capacity of the tuning condenser is increased when tuning for the longer wavelengths, the effect of the fixed condenser is increased. The converse is true when the receiver is tuned to the shorter wavelengths and the value of the variable condenser is decreased. A graphical representation of the energy transfer by means of mutual inductance and mutual capacity for a single stage is shown in Fig. 1. An idea of the overall energy transfer as a result of the combined coupling mediums is also shown in Fig. 1. The response curve of one stage with the combined coupling mediums is not a perfectly straight line, but has a depression around 300 meters and slightly higher response on the lower end of the broadcast spectrum than on the higher end. These data were obtained after several measurements of different installations which employed the Loftin-White system. The greater amplification on the shorter wavelengths is probably due to inherent regeneration. The complete response curve, however, is of very good formation. The usual capacity of the variable condensers is 0.0005 mfd. and that of the fixed coupling condensers is 0.004 mfd.

The use of a push-pull audio output stage affords certain advantages not obtained when only one tube is employed in the output. First,

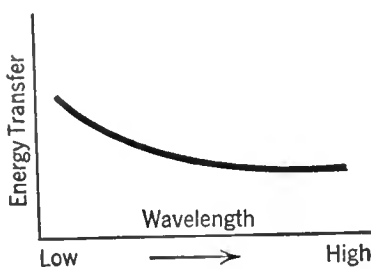

MUTUAL INDUCTANCE

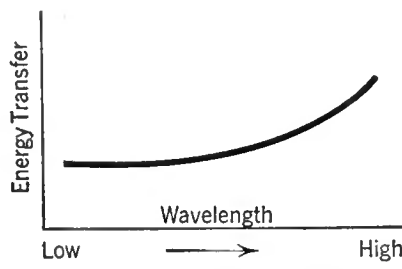

MUTUAL CAPACITY

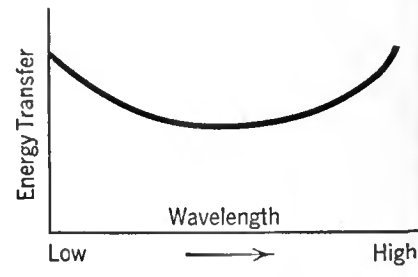

COMBINED COUPLING

FIG. 1

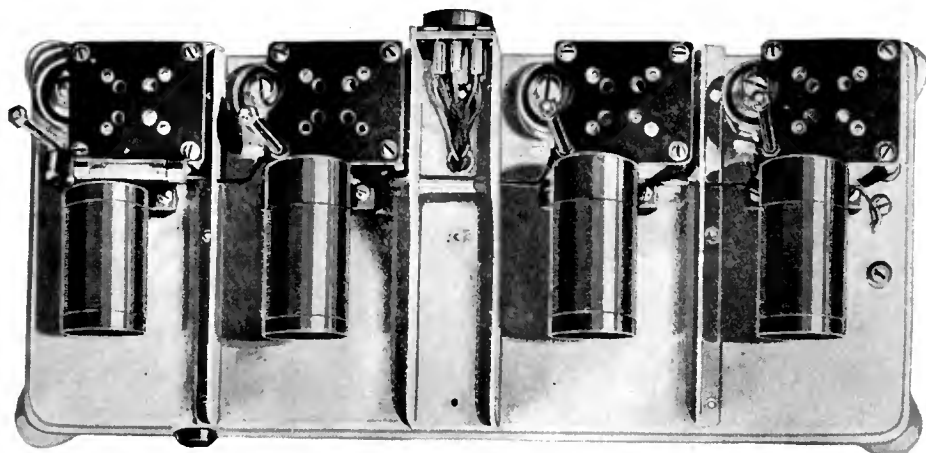

THE SHIELDED STAGES OF THE RECEIVER

it affords a greater signal output with much less distortion. Secondly, the increase in signal output is greater than the proportion of 1 to 2 tubes because somewhat greater input voltage can be tolerated without overloading or distortion. Thirdly, a push-pull output stage minimizes "hum" due to the use of a.c. on the filaments.

The receiver utilizes 226 type tubes for three radio-frequency amplifiers and the first stage of audio. The detector tube is a 227 and the push-pull output tubes are 171's.

Physically, the receiver is an interesting unit. In the first place the radio-frequency and detector systems are completely isolated from the audio and B power supply units. Each tuning stage is individually shielded, the whole forming one large can. The audio and power supply systems combine to form another shielded unit, thus precluding reaction between the two amplifying systems and minimizing radio-frequency reaction between the power unit and the radio-frequency amplifier. The shielding material is $\frac{3}{8}$ " aluminum of high conductivity and low mass resistance; there is a double thickness between stages. The chassis of the radio-frequency system forms one part of the can and is grounded.

Each can contains the chokes, plate and grid coils, the necessary phase shifting and coupling condenser, and the tube socket. Single-layer solenoids are used for the radio-frequency transformers and are placed parallel to each other. Reaction between these inductances is eliminated by means of the shielding. The phase shifting condenser and its associated radio-frequency choke are located adjacent to the socket connected thereto. The adjustment of the capacity of the phase shifting condenser is accomplished by means of a protruding screw head.

The inductances are wound on bakelite tubes and the turns are spaced 0.002" by means of a machine, as the coil is wound. A layer of collodion sprayed upon the turns keeps them in place. The inductance value of these coils is such that, with the condensers used, the wavelength range is from 200 to 550 meters (1500 to 545 kc.)

The plug located between the two inner sockets and in the groove reserved for the drum dial, carries the connections for the plate and filaments of the tubes in the radio-frequency and detector portion of this receiver. The female portion of this plug is located in the container housing the audio amplifier and the power supply, and the power is fed to the r.f. system by means of this plug.

Rigid sockets are utilized for all tubes, thus showing that very little concern is placed upon the necessity of cushion sockets in the modern receiver. It seems as if we have very little to worry about microphonic tubes. A rigid socket appears satisfactory for the detector tube.

Four tuning condensers are used, one for each stage of radio-frequency amplification. All four are simultaneously controlled from one point and are actuated by means of a small knob attached to a drum dial. The four condensers are divided into two groups of two each, the rotors of each group being on one shaft. The two groups are then coupled together by means of a steel coupling unit. The condenser which tunes the input stage is so arranged that its rotor operates in conjunction with the other rotors, but its stator is located on a rocker arm, which can be actuated by means of a small knob located on the receiver panel. In this way it is possible to make easy adjustment to compensate antenna variations.

The condensers are of the straight wavelength-

line type and are very accurately and rigidly made. The bearings are of fabricated bakelite on steel. The condenser plates are wedged into grooves in the side spacers. All grooves are simultaneously milled with a gang cutter, hence the spaces are uniform. Supplementing this design, in the effort to obtain accuracy, short, stubby plates are used in place of long, thin ones. Bakelite end plates are used on the condensers and this material is used for insulating the rotor from the stator.

The method of testing the variable condensers and the inductances is novel and precise. Two radio-frequency oscillators are adjusted for beat note resonance. One unit is maintained as the standard. The condenser to be tested is applied to the other. Perfect uniformity would mean a zero beat. The tolerance value is a 200-cycle beat note.

The B supply comprises a full-wave rectifier employing a 280 tube. One transformer carries the windings necessary to supply the filament voltages for all the tubes used in the receiver. One winding supplies the 1.5 volts required for the 226's; another winding supplies the 2.5 volts for the 227; a third supplies the 5 volts necessary for the 171's; a fourth supplies the filament voltage for the 280 tube; a fifth supplies the plate voltage for the rectifier tube.

The primary winding of the power transformer is tapped for 110-, 120-, and 130-volt supply. A short-circuiting plug shorts a portion of the winding when the line supply is 110 volts. The entire winding is used for 130-volt systems. All filament windings, with the exception of the 226 winding, are mid-tapped right in the transformer, thus eliminating necessity for mid-tap resistances and adjustments. The 226 winding is equipped with a potentiometer shunt, whereby the correct electrical center can be obtained.

The B supply utilizes a two-section filter, incorporating two chokes and three reservoir condensers. The plate current for the 171's is caused to flow through only one choke, the filtering action of this one section being sufficient for the push-pull tube plates. The voltage reducing resistance is, therefore, a single mid-tapped unit arranged as a potentiometer across the power-unit output. The high end of this resistance supplies the 90 volts required for the plates of the first audio stage and the three radio-frequency amplifiers. This tap is fixed in the process of manufacture. The mid-tap of this resistance supplies the 45 volts for the detector tube plate.

All C bias voltages are obtained directly from the B unit. Because of the heavy plate current drain of the two 171's (approximately 38 to 40 mls.), it is necessary to isolate the loud-speaker winding. This is accomplished by means of an output transformer.

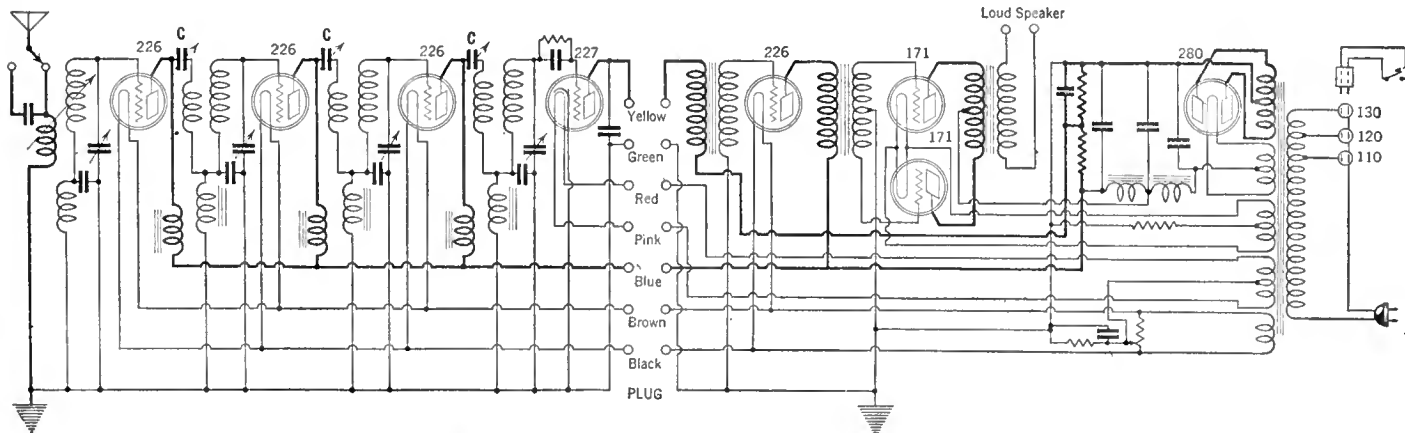

THE CIRCUIT DIAGRAM OF THE LOFTIN-WHITE RECEIVER DESCRIBED IN THIS ARTICLE



Radio Folk You Should Know

3. Lester L. Jones

AS PRESIDENT of the Technidyne Corporation in New York, Lester L. Jones plays an important rôle in radio research and laboratory investigation. His academic training as an engineer was received at the College of the City of New York, which, during the years when Alfred N. Goldsmith was a professor there, probably ranked as the foremost scholastic source of radio engineering personnel in the country. Mr. Jones graduated in 1913 with the degree of Bachelor of Science, *cum laude*. During the summer following his graduation he pursued special work at the College laboratories in various problems of radio engineering, including determination of the action of underground antenna systems, studies of the heterodyne system, using a Poulsen arc, and investigation of the characteristics of the then modern German quenched spark transmitters. The heterodyne tests were conducted in part with the Bush Terminal station of the National Electric Signaling Company, and presumably Mr. John V. L. Hogan was present at the Brooklyn end of the circuit.

In the winter of 1913 Mr. Jones was engaged as a civilian inspector of electrical and radio materials at the Brooklyn Navy Yard. He was responsible for the testing of all the radio transmitting and receiving equipment purchased by the Navy Department and delivered to the New York yard. In about a year this work led to Mr. Jones's promotion to the position of Expert Radio Aide, which included not only the former inspection responsibilities, but also the planning and testing of complete radio installations on battleships, destroyers, and submarines. While he was engaged in these specialized tasks Mr. Jones did not neglect the other branches of radio engineering, and the early issues of the "Proceedings of the Institute of Radio Engineers" frequently contain his name as a participant in the discussions, which were recorded at that time by the devastatingly charming Miss Nan Malkind, the only skilled and accurate radio stenographer who has ever appeared in the

art. In the 1914 "Proceedings," for example, there appeared a learned discussion by Mr. Jones on the subject of why the audion bulb causes a click in the receiving telephones when the filament current is shut off. Dr. Lee De Forest, the author of the paper that evening, observed laconically, "This is probably the correct explanation," a remark which must have been pleasing to the younger engineer, and which has been preserved for posterity in the "Proceedings," together with many words of contrasting asperity.

As an Expert Radio Aide Mr. Jones was not confined to the New York Navy Yard. At various times his duties carried him to outlying land stations of the Navy Department, such as the post at Guantanamo, Cuba, to suggest improvements and to supervise installations of new apparatus. The position also included design of transmitting equipment for the special conditions of naval radio communication, supervision of manufacture, installation, and testing of models, and the preparation of specifications under which contracts were let for the furnishing of sets in quantity by commercial manufacturers.

The New York yard was primarily a transmitter-developing base. In 1917 Mr. Jones was transferred to the Washington yard, which specialized in naval receiver design and investigation. During the year and a quarter Mr. Jones spent at Washington, he was the civilian in charge of development of naval receiving equipment for use on battleships, submarines, and airplanes, including the well-known two-stage audio amplifier with non-ferric transformer coupling, which became the despair of many a graduate of the Harvard Radio School, although it was probably the best thing in its line at that period. The Washington Yard, incidentally, has some claim to rank with Brant Rock, the Aldene factory of the Marconi Company, and the G. E. test shop at Schenectady, as a nursery of famous radio men. Besides Mr. Jones, at various times during the war period Professor Hazeltine, William H. Priess, Joseph D. R. Freed, and

others worked there on the SE line of naval receivers and auxiliary apparatus.

In addition to these more or less orthodox radio duties, Mr. Jones was charged with investigation of war-time devices offered to the government by inventors confident that the offspring of their brains was required to beat the Germans. Machines for detecting submarines and killing the magnetos of aeroplanes were among them. Some of the ideas were insane and others offered practical possibilities. Only scientific analysis could separate the chaff from the wheat. But Mr. Jones did not spend all his time on radio development and related investigations at the Washington yard. At intervals he made observation trips in naval craft, in connection with submarine signaling, search-light communication, and other special problems.

Mr. Jones left the service of the Navy Department in the spring of 1918 and spent a short time in the employ of commercial radio companies which were supplying apparatus to the Army and Navy. In 1919 he established himself as a consulting engineer specializing in radio. Among his clients (in 1920-21) were the Mackay interests, then contemplating establishing their own transatlantic radio circuits on behalf of the Postal Telegraph-Commercial Cable system. The developments considered at that time have only recently been projected anew in the announcement of the Postal Company that long- and short-wave radio channels are to be operated as adjuncts to the cable circuits of the company.

Mr. Jones has patented numerous radio inventions at home and abroad. In December, 1925, he was elected a Fellow of the Institute of Radio Engineers. His career is an illustration of the value of broad technical training and experience in the radio engineering field. For every prominent radio man in the technical end who entered the business when broadcasting began to agitate the ether in 1920, there are ten who spent years in developing radio telegraph communication, while wireless telephony was still a poet's dream.



The Month's New Phonograph Records

Pagliacci—*No Pagliacci Non Son!* (Leoncavallo). By Giovanni Martinelli (Victor). Martinelli's powerful tenor voice combined with his dramatic ability fit him eminently to sing the emotional Leoncavallo music. He handles these two glorious selections magnificently.

Andrea Chenier Improvviso—*Come un bel di*, Parts 1 and 2 (Giordano). By Arnoldo Lindi (Columbia). An imported recording of a fine Italian tenor who just misses being better than that.

Mazurka in B Minor (Chopin) and *La Campanella* (Liszt-Busoni). By Ignaz Friedman (Columbia). We would like to enthuse over this record because the Columbia Company has done an excellent job of recording Mr. Friedman's fine display of piano technique in *La Campanella*, but how can one enthuse over passionless music?

Dubinuschka and (a) *Old Forgotten Waltz* and (b) *Bouran* by the A. & P. Gypsies (Brunswick). If there is aught of the spirit of Terpsichore in you these gypsyish rhythms will make you yearn to express yourself in dance. Meaning: our grading of this offering—50 per cent.

Traumerei (Schuman) and *Mazurka in A Minor* (Chopin-Kreisler). By Max Rosen (Brunswick). Adequate violin solos unemotionally delivered.

Don't Miss These New Records

Andante Cantabile (Tschaikowsky) and *Theme and Variations* (Haydn) played by the Elman String Quartet (Victor).

Pagliacci—*Vesti la Giubba* and *Pagliacci*—*No Pagliacci Non Son!* (Leoncavallo) sung by Giovanni Martinelli (Victor).

Cradle Song (Brahms-Grainger) and *Molly on the Shore* (Grainger) played by Percy Grainger (Columbia).

Voices of Spring and Enjoy Your Life (Strauss) played by Johann Strauss and Symphony Orchestra (Columbia).

Dubinuschka and (a) *Old Forgotten Waltz* and (b) *Bouran* by the A. & P. Gypsies (Brunswick).

'S Wonderful and *My One and Only* (Gershwin) by the Ipana Troubadours and Clicquot Club Eskimos respectively. (Columbia).

My Heart Stood Still and *I Feel at Home With You* by George Olsen (Victor).

I Live, I Die For You and *Eyes That Love* by the Troubadours (Victor).

Beautiful Ohio and *Missouri Waltz* by Paul Whiteman and His Orchestra (Victor).

A Shady Tree and *Dancing Tambourine* by Paul Whiteman and His Orchestra (Victor).

WE ARE beginning to comprehend vaguely the extent of the phonograph industry. That we had not done so before is due to the fact that we never could visualize figures. Units, tens, and hundreds we can manage very well but when the thousand mark has been passed our brain reels, and the very numbers jump before our eyes. And so, although we knew that some sixteen hundred recordings were made annually by the Victor, Brunswick, and Columbia companies, we were not impressed because the figure was meaningless. Now we have a dim idea. An average of thirty-four records a month have been reviewed in this department for the last four months. Our statistical department reports that this totals one hundred and thirty-six records. These records occupy a considerable portion of our apartment, to be exact, a couch, a large mahogany office desk, one stool, and three chairs, not to mention the overflow on the floor. Walking has become dangerous and sitting is well nigh impossible. In another four months the records will have reached the kitchen and we will be forced to take our meals out. If we ever review all the records each month we will move into Carnegie Hall. Nice little industry!

Many of these we could lose without a tear. Then again there are those we will cherish forever. Already we have formed a permanent attachment for some of this month's supply: two

selections from *Il Pagliacci* sung by Giovanni Martinelli, a Percy Grainger record, two delightful numbers by the Elman String Quartet, two old and one new waltz from the Whiteman organization, and several better-than-usual dance numbers by the usual dance orchestras. These have gone into our library. Into the ash can we would like to put a Ted Lewis record and an Al Jolson song. The rest are chiefly dance records which will provide good entertainment for the moment.

We welcome the appearance of eight waltz numbers. We hope that means that the waltz is coming back but there have been so many false alarms already that we refuse to send out searching parties for our old waltz partners, yet. In the meantime we waltz alone in the privacy of our home.

More or Less Classic

Andante Cantabile (from String Quartet, Op. 11, by Tschaikowsky) and *Theme and Variations* (from *The Emperor Quartet* by Haydn). By the Elman String Quartet (Victor). Delicate chamber music exquisitely played by Mischa Elman, Edward Bachmann, William Schubert and Horace Britt. Both performances are richly colored by the beautiful tone of the Elman violin.

Pagliacci—*Vesti la Giubba* (Leoncavallo) and

Cradle Song (Brahms—Grainger) and *Molly on the Shore* (Grainger). By Percy Grainger (Columbia). To realize how thrillingly alive piano music can be one should hear the vibrant beauty of Grainger's rendition of *The Cradle Song*. *Molly on the Shore* is the familiar Irish reel, jovially played by its composer.

La Bobeme: Musetta's Waltz Song (Puccini) and *Mignon: Connais-tu le Pays?* (Thomas). By Maria Kurenko (Columbia). One moment we like this soprano voice exceedingly and the next it develops a harsh pinched nasal quality which is most unpleasant. In spite of this shortcoming we liked *Mignon*.

Voices of Spring and *Enjoy Your Life* (Strauss). By Johann Strauss and Symphony Orchestra (Columbia). Strauss waltzes beautifully played. Need we say more?

Do You Call That Religion and *Honey* by the Utica Institute Jubilee Singers (Victor). Two of the best songs in the repertory of this Negro quartet, sung with the subtle harmony which only Negro voices can achieve.

“Popular” and Such

'S Wonderful by the Ipana Troubadours and *My One and Only* by the Clicquot Club Eskimos (Columbia). *'S Wonderful* now holds first place in our own personal Best Number of the Year Contest. It is a swell Gershwin song and the Troubadours have done it full justice. The Eskimos were not quite as successful with the other Gershwin number but it is worth honorable mention.

My Heart Stood Still and *I Feel at Home With You* by George Olsen (Victor). The A side is runner-up in our contest but the B is a come-down.

(Note: If you want to be a social success you can't afford to be without both the above-mentioned records.)

Together, We Two and *Give Me a Night in June* by Johnny Johnson and His Statler Pennsylvanians (Victor). Despite their age these two numbers remain vigorous, due to the excellent Johnson rejuvenation.

A Shady Tree and *Dancing Tambourine* by Paul Whiteman and His Orchestra (Victor). Your neighbors will cry for, not at, this record. The waltz with its haunting melody is our favorite.

Beautiful Ohio and *Missouri Waltz* by Paul Whiteman and His Orchestra (Victor). Beautiful revivals of the fittest.

I Live, I Die For You and *Eyes That Love* by the Troubadours (Victor). Both these numbers from “The Love Call” have good tunes as backgrounds. Vocal refrains by Lewis James help put them across.

There's One Little Girl Who Loves Me by the Ipana Troubadours and *What'll You Do?* by Leo Reisman and His Orchestra (Columbia). Two melodious dance numbers with a good chorus by Scrappy Lambert in the first.

'S Wonderful and *Funny Face* by Bernie Cummins and His Orchestra (Brunswick). This orchestra unfortunately misses most of the Gershwin subtlety and messes up the Gershwin time, but they can't completely ruin either of the songs.

I'm in Heaven When I See You Smile—Diane and *Worryin'* by the Regent Club Orchestra. (Brunswick). Two good languorous waltzes with old fashioned whistling effects.

The Hours I Spent With You and *An Old Guitar and An Old Refrain* by Roger Wolfe Kahn and His Orchestra with vocal refrains by Franklyn Baur (Victor). The first is a fair waltz. The second is called a fox trot but it cries out to be tangoed to!

Up in the Clouds and *Thinking of You* by Nat Shilkret and the Victor Orchestra (Victor). Hot and snappy in the usual Shilkret manner.

There's a Cradle in Caroline by Nat Shilkret (Victor). Why didn't Mrs. Victor let Shilkret show the rest of them how to do it at the beginning? *The Song is Ended* by George Olsen and His Music. A good interpretation of a good waltz with a vocal chorus that's terrible!

Down the Old Church Aisle and *Is Everybody Happy Now?* by Ted Lewis and His Band (Columbia). The first number stirs unpleasant memories. Has Ted Lewis been robbing the song cemetery? If so, he'd better replace the corpse. And, oh, Mister Lewis! lay the second number beside the first, while you're at it.

From Saturday Night Till Monday Morning and *She'll Never Find a Fellow Like Me* by Ted Weems and His Orchestra (Victor). At last, a new idea in lyrics! And a catchy tune well played. We refer, of course, to the first number; the second is just a really good song on the old, old idea.

Dear, On a Night Like This by Cass Hagan and His Park Central Hotel Orchestra and *I'll Think of You* by Al Lentz and His Orchestra (Columbia). Two smooth, gliding fox trots, if you know what we mean.

Thinking of You and *Up in the Clouds* by Harry Archer and His Orchestra (Brunswick). Direction without enthusiasm.

Where Is My Meyer? by Nat Shilkret and the Victor Orchestra and *Blue Baby* by George Olsen and His Music (Victor). Fast-moving numbers handled by experts.

Make My Cot Where The Cot-Cot-Cotton Grows and *Sugar* by Red Nichols' Stompers (Victor). Why, this orchestra must have been up all night! Or, how do you explain the monotony?

Wherever You Are and *Headin' For Harlem* by Nat Shilkret and the Victor Orchestra (Victor). Franklyn Baur helps the orchestra make the best of two fair numbers.

Worryin' by Don Voorhees and His Orchestra and *Where in the World* by The Cavaliers (Columbia). If they got rid of their worries they might play better, or perhaps it's the song. The other number is not much better.

The Song Is Ended by the Columbians (Columbia). “But the melody lingers on.” And why not? It's a good one and well treated by the Columbians. *There Must Be Somebody Else* by the Radiolites. Nice orchestration and a good vocal chorus by Scrappy Lambert, formerly one half of the Trade and Mark combination.

Mother of Mine, I Still Have You and *Blue River* by Al Jolson and William F. Wirges and His Orchestra (Brunswick). Just your mother's boy, aren't you, Al?

Two Black Crows, Parts 5 and 6, by Moran and Mack (Columbia). More an' more Moran and Mack.

Good Records of Operas You Have Heard

DURING the current radio season, parts of many great and popular operas have been heard in the Balkite Hour, relayed from Chicago with the Chicago Civic Opera Company. And on the N. B. C. Networks, many well-liked operas have been done in tabloid form by the National Grand Opera Company. New electrical recordings of some of the most popular operas are offered by the leading phonograph companies. Some of these listed below are new, some not so new, but all are excellent and worth adding to one's collection.

<i>Aida</i> (Verdi)		
<i>Celeste Aida</i>	Giovanni Martinelli	Victor
<i>Celeste Aida</i>	Ulysses Lappas	Columbia
<i>Rilorna vincitor</i> }	Elisabeth Rethberg	Brunswick
<i>O patria mia</i> }		
<i>La fatal pietra</i> }	Ponselle-Martinelli	Victor
<i>Morir! si pura e bella!</i> }		
<i>Grand March</i>	Columbia Symphony Orchestra	Columbia
<i>Nel fiero anelito</i> }	G. Arangi-Lombardi and	Columbia
<i>O terra addio</i> }	Francesco Merli	
<i>Faust</i> (Gounod)		
<i>Air des Bijoux</i>	Edith Mason	Brunswick
<i>Le Roi de Thule</i>	Florence Easton	Brunswick
<i>Parlate d'amore</i>	Margarete Matzenauer	Victor
<i>Ballet music</i> (four parts on two records)	Sir H. J. Wood and the New Queen's Hall Orchestra	Columbia
<i>Soldiers' Chorus</i>	Victor Male Chorus	Victor
<i>Serenade Mephistopheles</i>	Marcel Journet	Victor
<i>Duet from Garden Scene</i>	Vessella's Italian Band	Brunswick
<i>Il Pagliacci</i> (Leoncavallo)		
<i>Prologo, Si puo</i> }	Lawrence Tibbett	Victor
<i>Prologo, Un nido di memorie</i> }		
<i>Seleclions</i>	Creatore's Band	Victor
<i>Ballatella—"Cbe volo d'augelli"</i>	Florence Easton	Brunswick
<i>No Pagliacci non son!</i> }	Giovanni Martinelli	Victor
<i>Vesti la Giubba</i> }		
<i>La Traviata</i> (Verdi)		
<i>Di Provenza il mar</i>	Giuseppe Danise	Brunswick
<i>Prelude</i>	Capitol Grand Orchestra (Mendoza conducting)	Brunswick

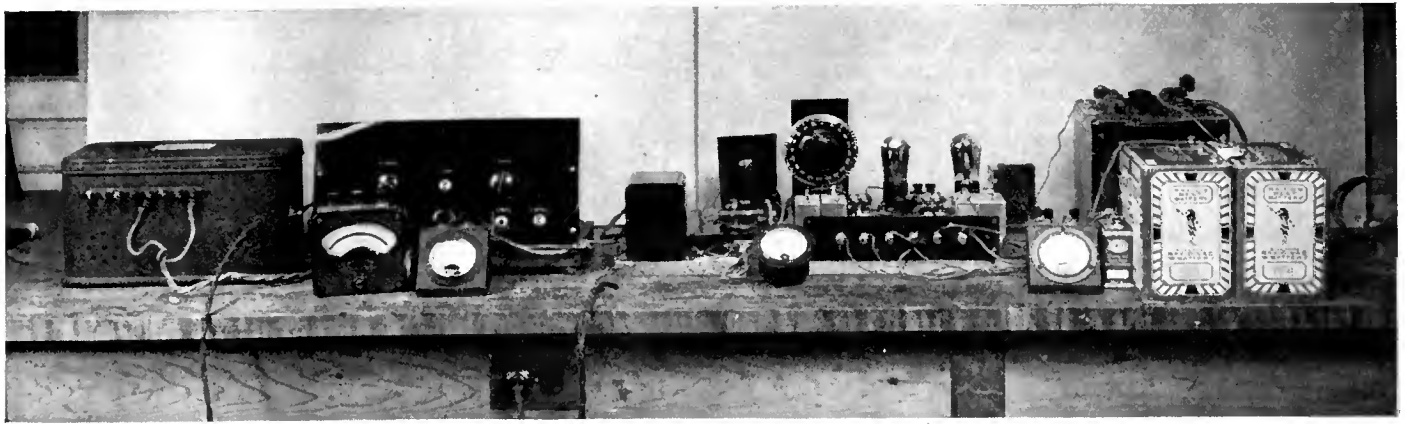

RADIO BROADCAST Photograph

A SET-UP OF APPARATUS FOR MEASURING CHARACTERISTICS OF A AND B UNITS
 It is not a difficult matter to measure the voltage output of A and B devices at different loads—This article explains. More complicated equipment is necessary, however, to determine the amount of hum in the output

Testing A and B Power Units

By Howard E. Rhodes

Laboratory Staff

THE testing of radio power-supply devices sent to RADIO BROADCAST by manufacturers has, for some time, been an important part of the Laboratory's work. What these tests are, how they are conducted, and what apparatus is used to make them, should be of general interest to our readers, and it is the purpose of this article to explain the procedure adopted for these tests. The information given here will also be helpful to manufacturers who, perhaps, contemplate sending power units to our Laboratory and are therefore interested to know to what tests their devices will be subjected. The tests described are applicable to either A power or B power units and the apparatus used in the tests is illustrated in the photograph at the head of this article.

It was the desire of the Laboratory staff to make the tests such that the data obtained would be most useful from the standpoint of the user of the device. With this point in mind the following tests were decided upon:

- (a.) Determination of the maximum output of the device at various current drains.
- (b.) Determination of the amount of hum in the output at various current drains.
- (c.) Determination of the cost of operating the unit.

With this information available we can determine whether a device is capable of supplying sufficient current at the correct voltage for the operation of any particular receiver, whether or not the device has a good filter system in it (determined by the amount of hum in the output), and how much it will cost to operate any receiver from a particular power unit. In the following paragraphs we will explain how these tests are made. Although they will be explained separately, all the tests are made at the same time in the Laboratory.

DETERMINING THE OUTPUT

THE circuit used in determining the output of a unit at various current drains is given in Fig. 1. If the unit under test is an A unit, then the resistance R consists of a heavy-duty Carter rheostat with a maximum resistance of 6

ohms so that with the resistance all in the load of the unit will be about 1.0 ampere, which will be indicated in the ammeter A. The voltmeter, V, used to measure the output voltage, may be a Weston Model 301 meter with a maximum reading of 10 volts. By moving the arm on the rheostat the load may be varied so that the A unit is placed under actual working conditions, the load (read on the ammeter) corresponding

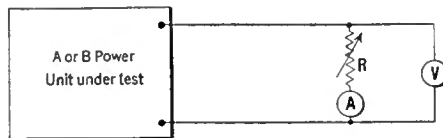

FIG. 1

to what would be drawn by the tube filaments were the A unit to be actually connected to the A posts of a set. At each setting of the resistance R, the voltage control knob on the A unit under test should be so adjusted that the voltage on V reads six, which is the value that the unit will be called upon to deliver under actual conditions of operation. At a certain reading of the ammeter it will be found that the voltage shown by the voltmeter is not as high as six, indicating that the A device is being overloaded. The maximum current output of an A device at rated voltage, which is six, can therefore be determined by setting the voltage control knob on the device at maximum (which will boost up the voltage to a figure above six at low values of current) and adjusting the resistance R until the voltmeter reads just six. The ammeter reading then represents the maximum permissible drain of the unit. When the A device is being used in con-

junction with a receiver consuming less than this maximum current output, the voltage control on the device is of course turned to a lower tap, otherwise the voltage output will be excessively high. Data of this kind obtained on three A power units recently tested in the Laboratory are given in the second and third columns of Table 1.

From these data we are able to determine whether an A power unit is capable of supplying filament current to any particular receiver, provided we know the filament current drain of the receiver. Since this merely depends upon the number and type of tubes used in the set, it is easily determined.

If the unit being tested is a B power device, the same circuit is used but instead of the rheostat there is used a variable high resistance—a power Clarostat. The meter M becomes a 0-100 milliammeter and the voltmeter is generally a Westinghouse high-resistance meter with a maximum reading of 250 volts and a resistance of 1000 ohms per volt. Some sample data on four B power units are given in the columns of Table 2.

If we know the total plate-current drain of a receiver we can easily determine from the figures given in Table 2 the maximum voltage the various units will supply at this load. For example if a receiver uses a 171 type tube in the output, on the plate of which we desire to place 180 volts

UNIT No.	LOAD IN AMPERES	VOLTS OUTPUT	WATTS INPUT	HUM VOLTAGE	PER CENT. HUM
1	0	7.3	20	Too small to Measure	
	0.5	6.0	23		
	1.0	6.0	26		
	2.0	4.3	40		
	3.0	4.2	54		
2	0	8	18	0.015	0.187
	1	6	28	0.015	0.25
	2	6	44	0.015	0.25
	3	6	62	0.015	0.25
3	1	6	60	0.007	0.12
	2	6	71	0.007	0.12
	2.7	6	101	0.017	0.17
	3	5.2	100	0.065	1.1
	3.5	2.8	100	0.45	7.5

TABLE 1

and the total plate current drawn by the receiver is 50 milliamperes, then unit No. 3, supplying only 120 volts at this current drain, would not be satisfactory. Units Nos. 1 and 2 would be more satisfactory as they deliver considerably higher voltage at the current drain specified. Although they do not supply quite as much as 180 volts, a matter of 20 or 30 volts less than 180 on the plate of the power tube does not make a difference sufficient to be noticeable in the output of the loud speaker.

These data also give us the "regulation" of the unit, which is generally specified as the voltage drop per milliampere of load. For example, taking the following data from unit No. 1, Table 2:

LOAD MA.	VOLTAGE
10	216
40	182

Difference 30 34

and dividing the difference in the voltages by the difference in the loads, we obtain a value of 1.13, which is the voltage drop per milliampere load. This is quite a good value for the regulation. Compare it with the value obtained from unit No. 3, which figures out to be 4.3. Power units with good regulation have the advantage that the voltage they deliver will be more nearly constant at all loads.

HUM

IT IS the function of the filter system in an A or B power unit to filter the output of the rectifier so that the output at the end of the filter system will be as free as possible of any hum or "ripple." Even from a comparatively poorly designed power unit the hum is too small to measure directly. Consequently, it was necessary to construct an amplifier for this test so that the hum voltage could be amplified sufficiently so as to be readily measured. A three-stage resistance-coupled amplifier is being used in the Laboratory for this purpose. Two 240 type tubes are used in the first and second stages and a 201-A type tube is used in the last stage. The circuit diagram is given in Fig. 2.

When an A or B power unit is to be tested for hum the input of the amplifier is connected to the power unit under test, and switch S₁ is thrown to point A. This causes the hum voltage from the power unit to be impressed across the input of the amplifier (note that the d.c. voltage is blocked by the 0.01-mfd. condenser). The amplified hum causes the plate current of the last tube in the amplifier to increase and this increase is indicated by the meter M in the plate circuit. The gain control (a 0.5-megohm po-

tentiometer across the input of the amplifier) is then adjusted so that the meter M gives a deflection that is easy to read. The switch is then thrown to the B position which connects the input of the amplifier to a source of known 60-cycle a.c. voltage the value of which is variable, as will be explained below. The 60-cycle voltage is so adjusted that the reading of the meter in the plate circuit of the output tube is the same as it was when the amplifier was connected to the power unit, and in which case this value of 60-cycle voltage is then equal to the hum voltage impressed upon the input of the amplifier.

Using this method (of connecting to the input of the amplifier a known voltage equal in value to the unknown voltage) makes unnecessary the calibration of the amplifier. It is necessary, however, to have available a source of 60-cycle voltage from which voltages can be obtained comparable in value to the hum voltages ordinarily obtained from radio power units. These voltages, which are around 0.01 volt in the case of a poor unit, can be obtained using the circuit indicated in Fig. 2 as: "Source of known voltage."

The transformer T in this circuit is an ordinary one designed to supply voltages to a.c. tubes. The 1.5-volt winding is used and across its terminals is connected a 6-ohm rheostat with an additional connection soldered to the free end of the resistance wire so that the rheostat might be used as a potentiometer. The voltage across the voltmeter can be adjusted to any value, between 0 and 1.5 volts, by means of the sliding contact on the rheostat. Across the voltmeter are connected, in series, a 4-ohm and two 2-ohm resistances, these resistances constituting a voltage divider the effect of which is to extend the voltmeter range downwards. Connections from these resistances are brought out to four pin jacks marked 1, 1/2, 1/3, and 0, indicating the portion of the voltage associated with the particular pin jack. Thus, if P is connected to the jack marked 1/2, the actual voltage impressed across X-Y is only one half of that indicated by the meter, etc. To the pin P is connected one end of a 400-ohm calibrated potentiometer, the purpose of which is to subdivide the voltmeter readings to even smaller fractions than is possible with the other resistances. By means of these adjustable units it is possible to impress across the input of the amplifier any voltage from 1.5 volts down to about 0.005 volts with an accuracy of not less than about 90 per cent., which is sufficiently accurate for measurements of this type.

Some examples of measurements of this sort are given in columns 5 and 6 of Tables 1 and 2. Column 5 gives the value of 60-cycle voltage that is equal to the hum voltage. Column 6 gives the per-

UNIT No.	LOAD IN MILLIAMPERES	VOLTS OUTPUT	WATTS INPUT	HUM VOLTAGE	PER CENT. HUM
1	0	245	9	0.01	0.004
	10	216	11	0.03	0.014
	20	205	14	0.03	0.01
	30	193	16	0.02	0.01
	40	182	19	0.05	0.027
	50	170	22	0.05	0.03
2	0	215	34	0.075	0.035
	10	204	35	0.067	0.033
	20	195	37	0.067	0.034
	40	170	40	0.067	0.039
	50	164	44	0.067	0.041
	3	0	270	88	0.27
10		250	91	0.26	0.105
20		210	92	0.25	0.12
40		150	96	0.315	0.21
50		120	98	0.165	0.14
4		0	240	17	0.14
	10	220	18	0.15	0.068
	20	195	20	0.17	0.087
	40	150	24	0.23	0.153
	50	135	26	0.28	0.210

TABLE 2

centage hum in terms of the d.c. voltage output of the device. Power unit No. 1 (Table 1) shows the smallest amount of hum in the output but it could not deliver more than one ampere at 6 volts. Unit No. 3 has more hum voltage than unit No. 1, but is capable of supplying up to 2.7 amperes at 6 volts.

The hum voltage measurements given in Table 2 give some idea of the magnitude of hum voltage obtained from some present-day B power units. It is possible to make some interesting mathematical calculations regarding the hum in B power units to indicate the effect in the loud speaker of various values of hum voltage, and this subject will be discussed in an early issue of RADIO BROADCAST. There is room here only to point out briefly the salient points regarding the matter. It can be shown that with a given audio amplifier, capable of amplifying down to 60 cycles, the permissible amount of hum in the output of a B power unit decreases:

(a.) as the amount of audio amplification in the receiver is increased and (b.) as the voltages on the various tubes, especially the detector tube, is increased.

Just how much hum is permissible is, of course, a function of the amount of amplification the audio amplifier gives at the hum frequency and how well the loud speaker will respond to these frequencies and their harmonics.

COST OF OPERATION

THE cost of operation per hour of an A or B power unit is found by first determining the amount of power the device consumes in watts when supplying the receiver, multiplying this power by the cost of power per kilowatt hour, and dividing by 1000. The cost of operation per month can, of course, be found by multiplying the cost per hour by the number of hours the set is in use per month. An example will make the whole calculation clearer. Suppose that a receiver drawing 40 milliamperes of plate current is operated from B power unit No. 4, Table 2, and that the set is in operation on an average of three hours a day. What will be the cost of operation per month, if the cost of power is \$0.10 per kilowatt hour? From Table 2 we know that this particular B power unit draws 24 watts of power when supplying 40 milliamperes. Following the information given at the beginning of this paragraph, we multiply 24 by 0.10 and then divide by 1000. This gives \$0.0024 as the cost of operation per hour. Since the set is in use 90 hours per month, then the cost per month is \$0.21 1/2. Other examples can be worked out in the same manner.

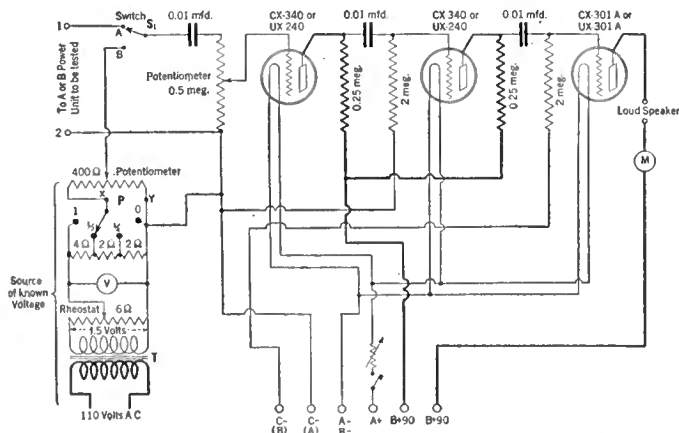

FIG. 2

New Aero Circuits for Either Battery or A. C. Operation

Proper constants for A. C. operation of the Improved Aero-Dyne 6 and the Aero Seven have been studied out, and these excellent circuits are now adaptable to either A. C. or battery operation. A. C. blue prints are packed in foundation units. They may also be obtained by sending 25c for each direct to the factory.



Aero Universal Tuned Radio Frequency Kit

Especially designed for the Improved Aero-Dyne 6. Kit consists of 4 twice-matched units. Adaptable to 201-A, 199, 112, and the new 240 and A. C. Tubes. Tuning range below 200 to above 550 meters.

Code No. U-16 (for .0005 Cond.) \$15.00
Code No. U-163 (for .00035 Cond.) 15.00



Aero Seven Tuned Radio Frequency Kit

Especially designed for the Aero 7. Kit consists of 3 twice-matched units. Coils are wound on Bakelite skeleton forms, assuring a 95 per cent. air dielectric. Tuning range from below 200 to above 550 meters. Adaptable to 210-A, 199, 112, and the new 240 and A. C. Tubes.

Code No. U-12 (for .0005 Cond.) \$12.00
Code No. U-123 (for .00035 Cond.) 12.00

You should be able to get any of the above Aero Coils and parts from your dealer. If he should be out of stock order direct from the factory.

AERO PRODUCTS, INC.
1772 Wilson Ave. Dept. 109 Chicago, Ill.

for improved musical performance

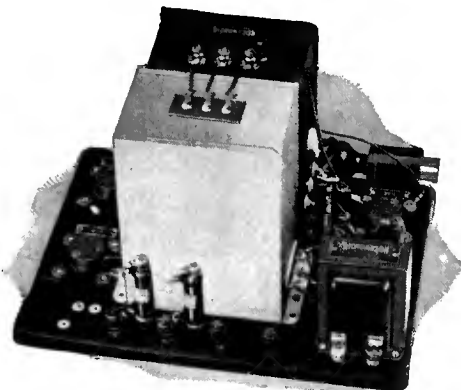

THORDARSON

210 Power Amplifier and Plate Supply

Easy to build — Simple to install — Economical to operate — Quiet in performance

FULL rich tonal reproduction with a generous supply of power for the heavier tones. You can bring your receiver up to these present standards of reception by building this Thordarson 210 Power Amplifier and B Supply.

Easy to build. Every effort has been made to make assembly as simple as possible. The metal baseboard is equipped with all sockets and binding posts mounted. All necessary screws, nuts and hook-up wire are furnished complete; simple pictorial diagrams are supplied. You can assemble this unit in an hour.

Simple to install. No changes in receiver wiring are necessary. This amplifier can be attached to set in a moment.

Economical to operate. Highly efficient and cool in operation. Consumes less current than a common 50 watt lamp.

Quiet in performance. The reliability of Thordarson engineering assures you of unquestionable performance and quietness in operation.

FOR SALE AT ALL GOOD PARTS DEALERS

Write for this free booklet

POWERIZER

Does more than make every set an A. C. Electric — it makes it a power amplified DeLuxe receiver

Powerizer is the same tone and power plant used in \$800 and \$1,000 phonographs and radios. It greatly improves the tone quality of every set—uses the UX-210 radiotrons — Rolls Royce of tone tubes.

General model for all standard sets \$60.00. Radiola "20" model \$59.00. Radiola "25" and "28" special Powerizer Power Pack \$84.00.

Radio Receptor Co.
106 7th Avenue, New York City

Licensed by Radio Corporation of America and Associated Companies



THORDARSON ELECTRIC MFG. CO.
500 W. Huron St., Chicago

GENTLEMEN: Please send me, free of charge, your booklet describing your 210 power amplifier on the metal baseboard.

Name

Street and No.

Town State

"Stand by" — for WESTON Announcement

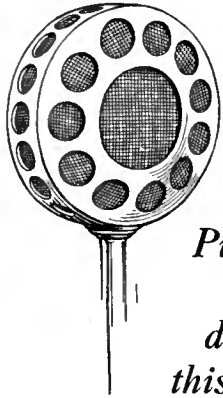

to Builders
of
Trans-
mitting
Sets — and
Purchasers of
Kits
described in
this publication

Here is a complete line of
Panel Instruments with
flush style cases, matched
in size and appearance

THESE instruments are designed for A. C. and D. C. service and are also furnished in Thermo-Couple types to meet every radio transmitting requirement. Their unusual characteristics and construction for instruments of such small size, are the talk of the scientific world. They are of exquisite design and workmanship—yet moderately priced.

Where and How to Purchase

Prompt instrument deliveries can be made from points near your city. The telephone books of all principal cities will give you the address of your nearest Weston representative. Write or wire to this address for your nearest local source of supply.

Write for the new Weston booklet which lists all radio instruments together with descriptive information and prices.

WESTON ELECTRICAL INSTRUMENT CORP.

604 Frelinghuysen Ave. Newark, N. J.

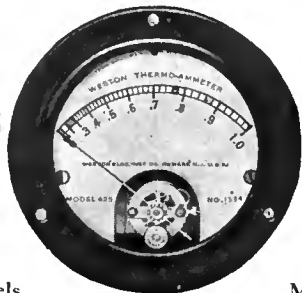

2"
Models

3 1/4"
Models

WESTON RADIO INSTRUMENTS

The Radio Broadcast LABORATORY INFORMATION SHEETS

THE RADIO BROADCAST Laboratory Information Sheets are a regular feature of this magazine and have appeared since our June, 1926, issue. They cover a wide range of information of value to the experimenter and to the technical radio man. It is not our purpose always to include new information but to present concise and accurate facts in the most convenient form. The sheets are arranged so that they may be cut from the magazine and preserved for constant reference, and we suggest that each sheet be cut out with a razor blade and pasted on 4" x 6" filing cards, or in a notebook. The cards should be arranged in numerical order. In July, 1927, an index to all Sheets appearing up to that time was printed.

All of the 1926 issues of RADIO BROADCAST are out of print. A complete set of Sheets, Nos. 1 to 88, can be secured from the Circulation Department, Doubleday, Doran & Company, Inc., Garden City, New York, for \$1.00. Some readers have asked what provision is made to rectify possible errors in these Sheets. In the unfortunate event that any serious errors do occur, a new Laboratory Sheet with the old number will appear.

—THE EDITOR.

No. 177

RADIO BROADCAST Laboratory Information Sheet

April, 1928

Characteristics of Speech

ARTICULATION

CLEAR speech is only possible when the person speaking uses careful articulation. Articulation is especially important in radio for if we do not understand something, we cannot have it repeated. In analyzing speech sounds a clear understanding of how the various sounds are produced is essential.

The human voice consists of sustained and transient notes and noises. The sounds which are ordinarily difficult to recognize (and which therefore require careful articulation), are the transients such as are associated with the sounds "t" and "d" or "p" and "b." These sounds are hard to reproduce accurately for they contain many of the highest frequencies found in sounds of speech.

If we examine the manner in which the sounds "p" and "b," for example, are produced, they will be found to have much in common. They are both produced by first compressing the lips together and then rapidly opening them. To pronounce the word "pa," we first produce the "p" sound by suddenly opening the lips and permitting the air to rush through them and then the vocal chords are set in motion to produce the vowel sound "a." The syllable "ba," is produced with a very similar motion of the lips but the vocal chords are set into motion and the lips open at the same instant and also there is only a slight rush of air from between the lips. The "pa" sound is characterized by an initial sound of high intensity; the "ba" sound does not have this feature. If the radio loud speaker cannot reproduce accurately the strong portion of the former sound, "pa," it will sound very much like "ba."

Some of the sounds most difficult to reproduce accurately are noises such as the dropping of a book on a table, for these sounds contain frequency components extending throughout the entire range of audible sounds.

The study of how words are formed is very interesting and can best be done with the aid of an oscillograph, which is an instrument with which we can obtain photographic records of the wave form associated with any sound. An analysis of these records, which are sometimes termed "audiograms," is helpful in determining the range of frequencies which must be handled by a radio broadcasting system if the reproduction is to sound natural.

No. 178

RADIO BROADCAST Laboratory Information Sheet

April, 1928

The Exponential Horn

THE CUT-OFF FREQUENCY

THE LOWEST frequency transmitted by a horn of the exponential type is determined by the rate of expansion of the cross sectional area of the horn, and to eliminate reflection the diameter of the mouth of the horn (if it is round) must be made equal to one-quarter of the wavelength corresponding to the lowest frequency to be transmitted.

The velocity of sound in air is 1120 feet per second and, therefore, the wavelength (in feet) corresponding to any particular frequency may be found by dividing 1120 by the frequency. The diameter of the mouth of the horn in feet must then be equal to this wavelength divided by 4.

The accompanying curve shows graphically the relation between the diameter of the mouth of a round horn and the cut-off frequency. It should be realized that the diameter of the mouth is not the only factor determining the lowest frequency that the horn will satisfactorily transmit and that the size of the mouth is an indicator of this frequency only if the remainder of the horn has been correctly designed. As shown by the curve, to transmit frequencies down to 64 cycles, for example, it is necessary that the horn's mouth have a diameter of about 4.5 feet.

If the horn is square rather than round, it will be satisfactory to make the area of the mouth equal to that of the equivalent round horn.

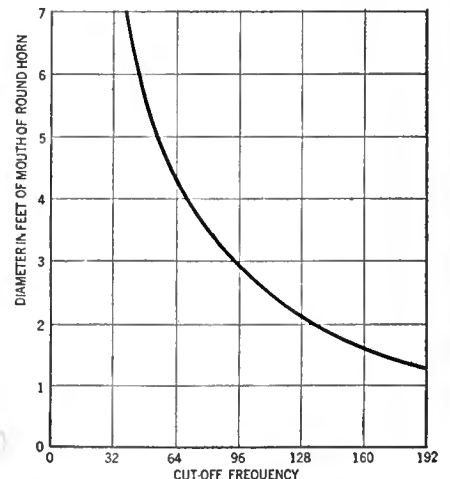

FROST-RADIO

Frost Gem Rheostats and Potentiometers

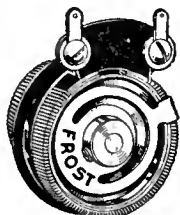

The Frost Gem Rheostat is a mighty good small rheostat. It is supplied in plain or switch type, in 7 convenient resistances from 3 to 30 ohms, and a potentiometer of the same size is made in 200 and 400 ohms. Built with the same care and of the same fine materials as our larger rheostats, the Gem offers you much in small dimensions. Diameter only 1½ in. depth ½ in. Has Bakelite pointer knob, smoothly working contact arm, and resistance element is wound on flexible Bakelite strip. For best results in small space use Gem Rheostats and Potentiometers.

Series 1900 (Plain) Gem Rheostats.....\$0.75
 Series S 1900 (With Switch)..... 1.00
 Gem Potentiometers, 200 and 400 ohm.... 1.00

HERBERT H. FROST, Inc.
 Main Office and Factory
 ELKHART, IND.

ELECTRIFY YOUR SET WITH THE MARATHON A-C KIT SIMPLE AS A-B-C

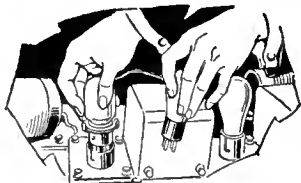

MARATHON AC Tubes have the standard 4 prong UX bases. No adaptors or center top resistors.

Replace your old Tubes with Marathon A-C Tubes

THE Marathon harness is universal, and can be used in any set. The "spades" slip over the projections on the tubes—no thumbscrews.

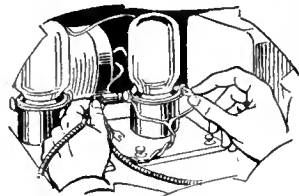

Connect the harness

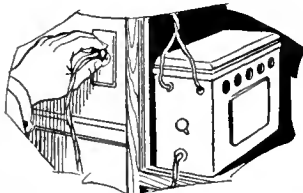

ONE end of the harness connects with the Marathon Transformer. All tubes operate on one voltage—6 volts—so there are no taps. Simply plug the transformer into the light socket.

Plug in the light socket
-that's all there is to do

**YOU CAN'T MAKE IT
 COMPLICATED**

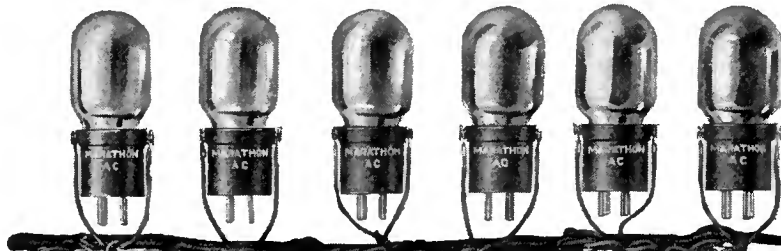

Satisfaction Guaranteed

No need to wonder if the Marathon AC Kit will operate on your set—we guarantee it. If you have a 5, 6, 7 or 8 tube set using UX sockets and are not employing an "A" Battery (either dry cell or storage) you can use the Marathon AC Kit—perfectly. Marathon AC Tubes are guaranteed for a year. If your dealer cannot supply you use the coupon below.

The Marathon AC Kit is Complete

Nothing else to buy—everything is complete. For example the six tube kit includes 6 Marathon AC Tubes—a universal harness—a 6 volt Transformer—a volume control—and an instruction sheet. Anyone, no matter how ignorant of radio can change his set from DC to AC.

Jobbers — Dealers

Write or wire for our sales proposition. You can absolutely guarantee the operation of the Marathon AC Kit.



NORTHERN MFG. CO.
 NEWARK, NEW JERSEY

NORTHERN MANUFACTURING CO.
 375 Ogden St., Newark, N. J.

Send me complete information on the Marathon AC Kit.

JOBBER DEALER PROFESSIONAL BUILDER USER
 (Please check your classification)

Name.....

Address.....

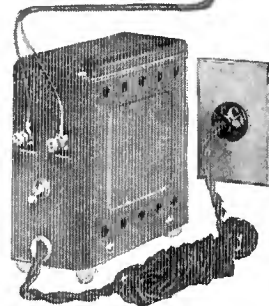

Master the Code



Wireless or Morse—at home with the Teleplex Automatic Code Instructor. No better method for self-instruction exists. Quick—Easy—Thorough. Endorsed by U. S. Navy. The only instrument that Reproduces actual sending—messages, Radiograms, etc. Any speed. Complete Course furnished. Thirty times as many words as any other instrument. Avail yourself of the Teleplex for a quick mastery of the code. Write for booklet BR. TELEPLEX CO., 70 Cortland St., New York.

self o. the Teleplex for a quick mastery of the code. Write for booklet BR. TELEPLEX CO., 70 Cortland St., New York.

LYNCH

Book on how to improve your radio 25c.
 ARTHUR H. LYNCH, Inc.
 1775 Broadway New York City

DRAKE'S RADIO CYCLOPEDIA

1928 Edition, complete, up-to-date. Full information on A. C. and Screen Grid Tubes. Over 900 pages, 1025 illustrations. For Service and Repair Men, Dealers, Salesmen, Experimenters and Designers. At dealers or by mail, \$6.00.

FREDERICK J. DRAKE & CO.
 PUBLISHERS
 10735 Michigan Ave. Chicago.

electrify your set the *easy practical* Knapp way....

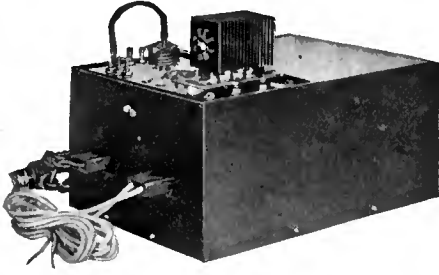

The Kit completely assembled with metal cover in place. Operates on 105-120 volts AC, 50 to 60 cycles.

Knapp "A" POWER KIT

No expensive short lived AC Tubes, no troublesome re-wiring, no annoying hum. Increase instead of decrease the efficiency of your set, no waiting... the Knapp "A" Power gives you music *instantly* at the snap of a switch.

This absolutely dry "A" Power is not in any way a battery combination... not something to add to your battery... it is the most efficient "A" Battery Eliminator ever designed. It supplies unflinching "A" current to any set using 201-A or 6 volt tubes.

Magic Silence

So silent is Knapp "A" Power, that you can place a pair of head phones directly across the output and not be able to detect a hum. This is made possible by the efficient Knapp filter system, consisting of 2 over sized chokes and 2 condensers of 1500 microfarads each. A new discovery makes these amazing capacities possible in the small space of 2x2x8 inches!

Absolutely Dry

There is not a drop of moisture in this absolutely dry unit. The condensers are baked so that not a drop of moisture remains. The unique, fully patented, solid, full-wave rectifier is absolutely dry. No water... no acid... no alkali... no tubes... no electrolytic action. Nothing to get out of order. Nothing that needs attention.

Assemble in Half an Hour

The Knapp "A" Power Kit is so easily assembled, that within half an hour after you receive it, you can have it in operation. The parts seem to fall in place. No drilling and very little soldering. Everything supplied, even to the screws, wire, drilled base-board and metal cover. It is so complete, that even a plug is supplied so that a "B" Eliminator may be operated from the same switch. We have never seen such simple instructions.

Big Profits for Set Builders

Our president, Mr. David W. Knapp, is offering the set builders of America, for a limited time only, a money-saving, profit-making plan which is unique in the annals of radio. Send the coupon today, before it is too late.



Knapp Electric Corporation Port Chester, N. Y.

MR. DAVID W. KNAPP, Pres.
Knapp Electric Corporation
332 Fox Island Road,
Port Chester, N. Y.

Send me complete information regarding the Knapp "A" Power Kit and your special discount to Set Builders.

Name.....

Address.....

.....

.....

No. 179

RADIO BROADCAST Laboratory Information Sheet

April, 1928

A Problem in Audio Amplification

THE EFFECT OF TRANSFORMER RATIO

PROBLEM:—The audio amplifier in a receiver comprises a 3:1 transformer in the detector circuit, followed by a 201-A type tube in the first audio stage, a 4:1 audio transformer for the second stage, and a power output tube. What will be the effect on the amount of signal voltage supplied to the grid of the power tube of substituting a 6:1 transformer for the 4:1 transformer?

ANSWER:—Let us first calculate the gain of the original amplifier. The total amplification to the grid of the power tube will be equal to the turns ratio of the first transformer multiplied by the effective amplification of the tube times the turns ratio of the second transformer. The effective amplification of a tube in a properly designed transformer-coupled audio amplifier can be taken as about 80 per cent. of the amplification constant of the tube; for a 201-A type tube, therefore, we take 80 per cent. of 8, which is 6.4. The total gain of the amplifier is, therefore:

$$3 \times 6.4 \times 4 = 76.8$$

Similarly the amplification with the 6:1 transformer substituted for the 4:1 will be:

$$3 \times 6.4 \times 6 = 115.2$$

The substitution of the 6:1 transformer, therefore, has increased the voltage gain by 50 per cent.; this represents a gain of 3.6 TU.

Now, the power into the loud speaker is proportional to the square of the signal voltage on the grid of the power tube feeding the loud speaker. When the voltage gain is increased 50 per cent., therefore, the power into the loud speaker is increased 125 per cent. This corresponds to a power gain of 3.5 TU which, while not very great, is appreciable. (The minimum gain audible to the ear is 1 TU.)

If the power tube is a 171 type with 40 volts on the grid, then using the original amplifier, approximately 0.5 volts (40 divided by 76.8) are required out of the detector tube in order to place 40 volts signal voltage on the grid of the 171. When the 6:1 transformer is used, only 0.3 volts (40 divided by 115.2) are required from the detector in order to "load up" the power tube.

No. 180

RADIO BROADCAST Laboratory Information Sheet

April, 1928

B Power Unit Characteristics

EFFECT OF TRANSFORMER VOLTAGE

THE CURVES published herewith were made by the Raytheon Manufacturing Company using one of their BH type tubes with an ordinary filter, as indicated in the accompanying circuit diagram. The curves show the relation between the voltage, E_t , across the secondary of the transformer and the input voltage, E_o . The output load in milliamperes as measured by the meter I is plotted along the horizontal axis and along the vertical axis has been plotted the difference between the effective value of the transformer voltage E_t and the average value of the voltage E_o into the filter system. The line marked +20, for example, indicates the voltage E_t to be 20 volts greater than E_o ; the line marked -20 indicates the converse.

These curves show that (to take an example) with a transformer voltage of 300 volts per anode, the average value of the voltage into the filter is 27 volts higher than the transformer voltage when the load is 10 milliamperes. At a load of 28 milliamperes the voltages are equal and at a load of 60 milliamperes the input voltage to the filter has dropped to a value 25 volts below the transformer voltage. During these tests the transformer voltage, E_t , was held constant.

Other data showing the effect of various trans-

former voltages, obtained with the same circuit used here, were given on Laboratory Sheet No. 146, published in the December, 1927, RADIO BROADCAST.

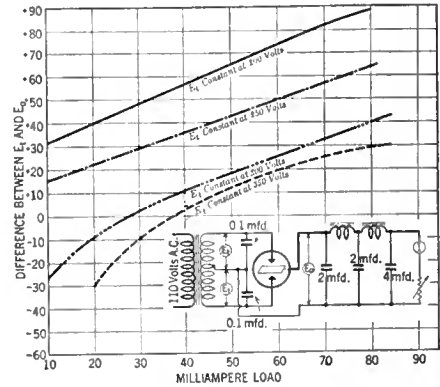

No. 181

RADIO BROADCAST Laboratory Information Sheet

April, 1928

R. F. vs. A. F. Amplification

A COMPARISON

THE SIGNAL output from a radio receiver may be increased by augmenting either the audio-frequency or radio-frequency amplification or by boosting the detecting efficiency. On this Laboratory Sheet we give briefly the comparative merits of audio-frequency and radio-frequency amplification. In the accompanying table is shown the effect on the power into the loud speaker of increasing the a. f. or r. f. amplification. The first column gives the increase in amplification and the second column the increase in power into the loud speaker if this extra amplification is introduced in the audio amplifier. The third column shows the increase in power into the loud speaker if the extra amplification is placed in the r. f. amplifier.

This table is based on the fact, first, that the power into the loud speaker is proportional to the square of the voltage on the grid of the power tube

and, secondly, that the output of the detector is proportional to the square of the voltage on its grid. When the audio-frequency amplification is multiplied by 10, for example, the power into the loud speaker is 100 times greater. When the radio-frequency amplification is multiplied by 10, however, the output of the detector is 100 times greater and the power into the loud speaker is 10,000 times greater. It is evident from these figures, therefore, that increases in r. f. gain are much more effective in producing greater signal than increases in audio-frequency gain.

Added Amplification	Increase in Power into Loud Speaker	
	A. F.	R. F.
2	4	16
5	25	625
10	100	10,000
20	400	160,000
50	2500	6,250,000



RADIO DEALERS

Send for our catalog illustrating the products of over 100 radio manufacturers.

WHOLESALE ONLY!

F. D. PITTS COMPANY
219-223 Columbus Ave.
BOSTON, MASS., U. S. A.
Established 1919

Announcing the TABLE TYPE CLAROSTAT

And now you can have micrometric resistance in the form of a convenient accessory. No need for tools. No need connecting time and effort. Just connect TABLE TYPE CLAROSTAT in circuit by means of handy connection cords and connection block, and you have micrometric resistance at work improving your radio results.

Imagine controlling loud-speaker volume with a knob at your finger tips. Instantly you can fit radio to the occasion. Instantly incidental music for background of conversation, to full volume when the program changes to a speech or other feature of prime interest. And that is but one of many applications covered in booklet "Radio Exquisites" which is yours for the asking.

The TABLE TYPE CLAROSTAT is a hand-some addition to any set. Finished in stationary bronze and nickel, with attractive bakelite knob. Bottom provided with felt to protect surface of fine furniture. Two connection cords and tin connection block permit of insertion in any circuit, or through connection to loudspeaker. Ample resistance range. Sufficient current-handling capacity. Resistance covered in several turns of knob. Noiseless. Holds resistance setting. Foolproof. Durable. In brief, a genuine Clarostat in a new dress.

You can make no better investment in radio than the \$2.50 you invest in the TABLE TYPE CLAROSTAT.

American Mechanical Laboratories
Incorporated
Specialists in Variable Resistors
285-7 North 6th St. Brooklyn, N. Y.

Ask your dealer to show you the new Table Type Clarostat, as well as the Volume Control, Standard and Power Types. And don't hesitate to ask for descriptive and practical literature, either from him or from us.



Be Sure to Use the KARAS AC FORMER To Convert Your Hammarlund Hi-Q Set To A C Operation

The Karas A-C-Former will deliver the correct voltage for the new AC tubes as follows: X-226 or CX 326, and Y-227 and CX 327. It does not permit the excessive voltage fluctuations which are ruinous to AC tubes—thus protecting them and insuring their long life. The A-C-Former needs no separate device for centertap. It has a convenient extra loop of wire for connection to the panel switch, and plug-in connection for "B" Eliminator.

Type 12 **\$8⁷⁵**

Supplies filament potential for 12 tubes as follows: 8-1½ volt, type 226 or 326 tubes, 2-2½ volt, type 227 or 327 tubes, and 2-5 volt type 171 tubes.

Write for details to

KARAS ELECTRIC CO.
4033-C N. Rockwell St. Chicago

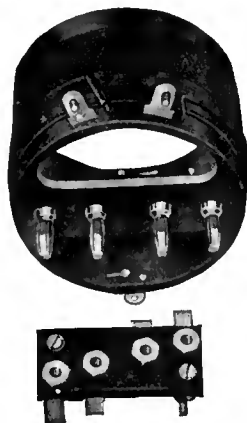

Low Loss Coils

The General Radio type 277 Coils are interchangeable thus making them adaptable to both short and long wave reception. They are so shaped in ratio of diameter to length and the construction is such that they have very low losses. Priced from \$1.25 to \$1.50 according to range. Type 274-B Coil mounting base as illustrated \$1.00. Described in bulletin 929.

GENERAL RADIO CO.

Parts and Accessories

30 STATE ST.

CAMBRIDGE, MASS.



They make
\$6,000
a year

The facts prove that
YOU can achieve
Success in Radio!

Radio News writes us:

"In looking over the dealer mail received in the last three months we find that the average income of all dealers who gave us their income figures, 38 in number, averages more than \$6,000 a year."

{Signed} C. W. EMERSON
RADIO NEWS

Why don't you think this over and say to yourself, "These dealers are no smarter than I am. If I knew radio thoroughly, I could make that much and more. I know that the Radio Institute of America is America's oldest radio school—that it gives the finest radio instruction obtainable anywhere, and the finest and fullest radio equipment.

"I know that RIA is conducted by the Radio Corporation of America and is backed by General Electric and Westinghouse—that their course in radio is complete and entirely covers every phase of radio, including operating, broadcasting, in fact *everything* in radio. I know that I can make progress because everything is told so clearly. I can get this instruction at home, and prepare for success in radio without giving up my present job. I can study when I please and as long as I please. With the tremendous opportunities opening up in radio today, I certainly can't pass up this opportunity to learn more about the RIA course. Here's one coupon I will clip. I want the full facts."



Tear out the coupon and mail it now.

RADIO INSTITUTE OF AMERICA
Dept. E-4 326 Broadway, New York City

RADIO INSTITUTE OF AMERICA, Dept. E-4
326 Broadway, New York City
Dear Mr. Duncan:

Please send me your new catalog. I want to know more about your new radio course.

Name.....
Address.....

No. 182

RADIO BROADCAST Laboratory Information Sheet

April, 1928

Filter Condensers

HOW TO CONNECT THEM IN SERIES

IF WE desire to place a filter condenser across, for example, a 1000-volt source of direct current and we have available two large-capacity 500-volt condensers, it is ordinarily not possible to connect them in series across the 1000-volt leads with safety. Why this is so will be explained on this Laboratory Sheet.

At A in the diagram is shown the connection of two condensers, C₁ and C₂, in series across the 1000-volt source. Now, a condenser has a definite d.c. resistance, which is generally very high but nevertheless finite, and this resistance is represented as R₁ and R₂ in B as external resistances across each condenser. A small amount of current will flow through these resistances and the voltage drop across the two resistances will be in direct proportion to the resistances. The resistances of condensers vary widely and therefore it is extremely unlikely that we would have two condensers with the same d.c. resistance. For example, condenser C₁ might have a d.c. resistance of 100 megohms while the d.c. resistance of condenser C₂ might be 900 megohms. The d.c. voltage drops across the two condensers being proportional to the resistances there would then be 100 volts across C₁ and 900 volts across C₂. If the two condensers were both rated at 500 volts, the obvious result would be that condenser C₂ would

have a very short life because of the overload being placed on it. The solution for this difficulty is to connect external resistances R₁ and R₂ across each condenser as indicated at C with a sufficiently low value in comparison with the internal resistance of the condenser (which is always very high) so that the voltage drops will be determined by the external resistances rather than by the internal resistances

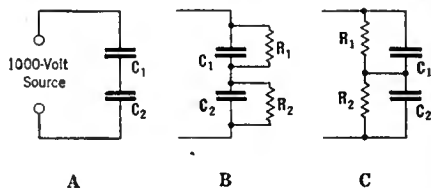

of the condensers. If we have two 500-volt condensers connected to a 1000-volt source, we might equalize the voltage across them by connecting two 100,000-ohm resistances in series across the source, as indicated at C. There would be 500 volts drop across each resistance and, therefore, 500 volts across each condenser, and the latter would then be satisfactory in operation and have normal life.

No. 183

RADIO BROADCAST Laboratory Information Sheet

April, 1928

The Type 280 and 281 Tubes

THEIR CHARACTERISTICS

THE characteristics of the type 280 and 281 rectifier tubes are given below. These tubes are for use as rectifiers in B power units, the 280 in circuits designed for full-wave rectification and the 281 in half-wave circuits. Two 281 tubes may be used, if desired, to give full-wave rectification:

TYPE 280 FULL-WAVE RECTIFIER

Filament Voltage	5 Volts
Filament Current	2 Amperes
A.C. Plate Voltage (Max. Per Plate)	300 Volts
Max. D.C. Output Current	125 Milliamperes
Max. D.C. Output Voltage	260 Volts
Height of Tube	5 3/8 Inches
Diameter of Tube	2 3/8 Inches

TYPE 281 HALF-WAVE RECTIFIER

Filament Voltage	7.5 Volts
Filament Current	1.25 Amperes
A.C. Plate Voltage (Max.)	750 Volts

A.C. Plate Voltage (Recommended)	650 Volts
D.C. Output current (Recommended)	65 Milliamperes
D.C. Output Current (Max.)	110 Milliamperes
D.C. Output Voltage (Max.)	620 Volts
D.C. Output Voltage (Recommended)	620 Volts

The type 280 tube may be used in circuits designed especially for it or may be used in circuits designed for the type 213 tube. The characteristics of these two tubes are similar with the exception that the former tube is capable of somewhat greater output than the 213. If a 280 tube is used in place of a 213, the 280 will be operating at less than full load and will consequently have a very long life. These facts are also true with regard to the 281, which may be used satisfactorily in place of a 216-B type tube.

If more than about 65 milliamperes at 600 volts is necessary to operate a radio installation, it will be a good idea to use two type 281 tubes in a full-wave circuit with about 650 or 700 volts a.c. on the plate of each tube. With this arrangement an output in excess of 100 milliamperes at 600 volts will be available.

No. 184

RADIO BROADCAST Laboratory Information Sheet

April, 1928

Tuning

THE EFFECT OF DISTRIBUTED CAPACITY

A RADIO receiver to cover the broadcasting band must be able to tune-in signals from 550 kc. to 1500 kc., a ratio of 2.73 to 1 in frequency. It can be shown mathematically that, in order to obtain this range, the ratio of the maximum to minimum of the capacity across a tuning coil must be 8.6 to 1 approximately. If we use a tuning condenser with a maximum capacity of 0.0005 mfd. then the minimum capacity across the coil must theoretically be (if the desired tuning range is to be obtained) 0.0005 divided by 8.6, or 0.000058 mfd. An ordinary condenser might have a minimum capacity of about 0.000025 mfd. and, therefore, it

appears that we should be able to cover the broadcasting band very easily. In the circuit, however, there is another capacity across the coil which has an important effect. This additional capacity is the effective input (grid-to-filament) capacity of the tube, indicated as C_i in the diagram, and this capacity varies with the amount of amplification the tube is producing in the circuit. This capacity, C_i, is in parallel with C, the tuning condenser, and its effect must therefore be added to that of C. The result is that the actual minimum capacity of the circuit is greater than that of the minimum capacity of C, and this will tend to restrict the tuning range of the receiver unless the precaution is taken that a variable condenser with a low minimum capacity is used to tune the circuit, that the coil itself does not have much distributed capacity, and that long leads in the circuit do not introduce objectional capacity.

If a station transmitting on the lowest frequency (longest wavelength) used in the broadcasting band tunes-in on the set with the condenser plates all in (as they should be) but it is found impossible to tune-in a station operating on the highest frequency (shortest wavelength), it is possible that the cause may be due to a tuning condenser with a large minimum capacity or excessively long leads connecting the coil with the condenser.

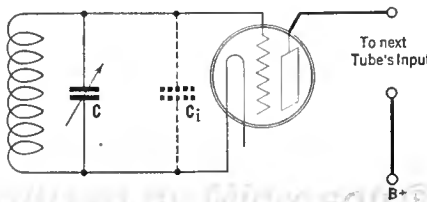



Custom Set Builders

Building, as you do, a receiving set for the buyer who insists upon the best in radio, you naturally seek the very latest in design and finest construction in parts—at a price that permits a profit. Just as Dongan has always devoted its entire facilities to the manufacturers of sets, now Dongan recognizes the Custom Set Builder as a distinct factor in the radio industry.

Establish a Direct Source on Fine Parts

You can avail yourself of special discounts on audio transformers, B-Eliminator transformers, chokes and units, A C transformers and units, power amplifier transformers, etc.,—all approved parts designed in one of the world's finest radio parts laboratories and manufactured in one of the most modern and well-equipped plants.

For converting DC sets to A C—or for building new sets—write for our Custom Builder's proposition. Your source is direct and satisfaction guaranteed.

Find out about this at once. You can improve the quality of your work and receive added profit.

Transformer Headquarters for Set Manufacturers

In designing your new set, take advantage of the research work on power transformers developed in the Dongan laboratories. Every feature of approved design available.

DONGAN ELECTRIC MFG. CO.
2991-3001 Franklin St., Detroit, Michigan

TRANSFORMERS OF MERIT for FIFTEEN YEARS

Send for Latest RADIO CATALOG and GUIDE

Set Builders!

Free 1928 Radio Guide

The big Barawik Radio Guide book is used by hundreds of thousands of radio enthusiasts. It's the handiest and most reliable radio reference guide, and a big money-saver. Keep up to date by utilizing Barawik service.

4000 Radio Bargains

It shows pages replete with reliable information about the newest and most advanced ideas in A.C. radio developments. It will keep you posted on what's up to date.

Lowest Prices on Parts

Standard Discounts to Dealers, Set Builders, Agents.

It will pay you to get our prices for complete parts for the popular circuits featured in Radio Broadcast and other magazines. Whenever a new circuit appears for which you want complete parts, write or wire us and they'll be on their way to you quickly. We know what parts to send you. Simply give name of circuit and we'll take care of the rest. We guarantee you a big saving on every order.

Send for Free Copy Now!

Get our new radio catalog to-day before you spend another cent on radio. Just mail the coupon and free copy will be sent you.



BARAWIK CO.

Dept. 834
Chicago, U. S. A.

Mail This Coupon Now! For Free Copy

Name

Address

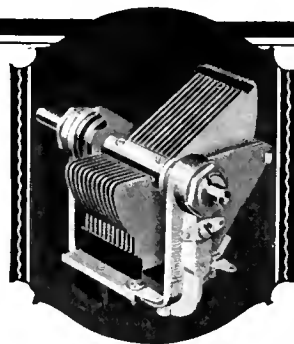

HAMMARLUND "Midline" CONDENSER

Soldered brass plates with tie-bars; warpless aluminum alloy frame; ball bearings; bronze clock-spring pigtail; full-floating, removable rotor shaft permits direct tandem coupling to other condensers. Made in all standard capacities and accurately matched.

Write for Folder

HAMMARLUND MFG. CO.
424-438 W. 33rd St. New York

The Remarkable HAMMARLUND-ROBERTS Hi Q SIX RECEIVER

(Both A. C. and Battery Models)

Is Equipped with This Famous Condenser

Take a tip from the experts and place your reliance in the Condenser they all respect—the condenser that most of them specify for their newest circuits.

The Hammarlund "Midline" embodies the best Condenser thought and engineering skill in the history of radio.

If Your Dealer Can't Supply You Write Direct to Us

For Better Radio
Hammarlund
PRECISION PRODUCTS



NEW NATIONAL DRUM DIAL

Type F

Velvet Vernier Quality and Tuning. Beautiful Hammered Silver Finish. Quick and Easy to Install.

List Price \$4.00

Type 28 Illuminator 50c



NATIONAL COMPANY, Inc., Malden, Mass.

YAXLEY

APPROVED RADIO PRODUCTS

Radio Convenience Outlets



Wire your home for radio. These outlets fit any standard switch box. Full instructions with each outlet.

No. 135—For Loud Speaker. . . . \$1.00
No. 137—For Battery Connections 2.50
No. 136—For Aerial and Ground 1.00

With Bakelite Plates

Now furnished with a rich satin brown Bakelite plate, with beautiful markings to harmonize, at 25 cents extra. See Illustration.

At Your Dealers

Yaxley Mfg. Company
Dept. B, 9 So. Clinton St.
Chicago, Ill.



You Can't Control Lightning

WHEN lightning goes on a rampage no one can tell just what is going to happen. When it strikes it generally takes the shortest electrical path to ground. When an outdoor antenna is used that path may be through the radio set if the set is not protected by a reliable lightning arrester.



Jewell Lightning Arrester

The Jewell Lightning Arrester is the best protection available for radio sets against Lightning. As an indication of its reliability, it is listed as Standard by Underwriters' Laboratories, who give it regular periodic tests for performance. It consists essentially of an accurately calibrated air gap enclosed and sealed within a glazed brown porcelain case suitable equally for indoor or outdoor installation.

Radio dealers everywhere carry Jewell Lightning Arresters in stock. Ask your dealer to show you one or write us directly for descriptive information.

Jewell Electrical Instrument Company
1650 Walnut Street, Chicago

"28 Years Making Good Instruments"

AT LAST!

A Real Radiophone Transmitter

—at a reasonable price!

Employs
Low Power

Surprisingly
Long Range

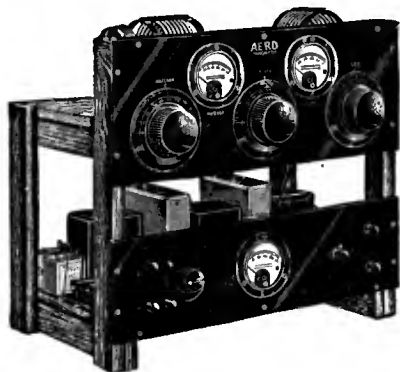

The Aero Radiophone Transmitter—
Ready to Plug into Electric Light Socket

Easy to Build

Easy to Operate

For All Low
Wave Work

Here is a low power radiophone transmitter that every true radio fan will want to own. An extremely efficient circuit, designed by some of the best known parts manufacturers, that is producing wonderful records on the government licensed low wave bands.

Simple to operate, easy to build, its cost is no more than that of a good broadcast receiver!

500 to 1000 Miles on Phone — Several Thousand Miles on Code

The New Aero Radiophone is a thoroughly tried and proved transmitter. As installed at station 9DBM, Chicago, the results on 20 meters have been remarkably good. Reports varying from R-5 to R-7 have been regularly received from these typical stations: 1BBM, North Harwich, Mass.; 1ASF, Medford, Mass.; 1SW, Andover, Mass.; 2BSC, Glen Head, N. Y.; 3AKS, Philadelphia, 3CE, Baltimore; 4MI, Asheville, N. C.; and 8CVJ, Auburn, N. Y. In every instance the quality of speech has been reported to be very fine.

Adapted to code work, the Aero Radiophone Transmitter has produced outstanding results. From a location not of the best, all U. S. districts have been worked with CW on the 40 meter band, as well as NC5ZZ, Vancouver, B. C.

Outstanding Performance Assured By Carefully Selected Parts

Only the best quality parts have been incorporated into the Aero Radiophone Transmitter. Products of the following manufacturers—all with a national reputation—are specified exclusively!

Aero Products, Inc.
Chicago, Ill.

Allen D. Cardwell Co.
Brooklyn, N. Y.

Herbert H. Frost, Inc.
Elkhart, Ind.

Polymet Mfg. Co.
New York, N. Y.

Silver-Marshall, Inc.
Chicago, Ill.

Tobe Deutschmann Co.
Cambridge, Mass.

Yaxley Mfg. Co.
Chicago, Ill.

Westinghouse-Micarta
Chicago, Ill.

INVESTIGATE NOW — Write for FREE BOOKLET

The Aero Radiophone Transmitter is worthy of your careful investigation. Send your name and address at once for complete illustrated descriptive literature showing schematics, and listing parts, prices, etc. Simply ask for Supplement A. Do it today, and learn how easily you can get into the fascinating field of radiophone transmission. Address

AERO PRODUCTS, Inc.

Dept. 109-R, 1772 Wilson Ave.

Chicago, Ill.

NOTE: The parts for the Aero Radiophone Transmitter are standard parts and are available at all dealers — when completed is ready to plug into your electric light socket. All have been carefully chosen to give the maximum in transmitter performance. Complete drilled and engraved foundation units are also available.

CROSLLEY

BANDBOX

1. Single Unit AC Bandbox 704, \$95. Genuine neodyne fully shielded—selective.
2. Dry cell operated Bandbox Junior, \$35. Loud speaker volume—most economical.
3. Bandbox 601, \$55. Operates from batteries or power supply units.
4. Double Unit AC Bandbox, \$90 for console installation. Adaptable to any installation.
5. New Type—D Musicone, \$15. Loud speaker leadership in popular price field since 1925.

Write Dept. 20 for descriptive information.

THE CROSLLEY RADIO CORPORATION
Powel Crosley, Jr., Pres. Cincinnati, O.
Crosley is licensed only for Radio Amateur, Experimental and Broadcast Reception. Prices slightly higher in far Western states.

RADIO

TOBE

CONDENSERS
B-BLOCKS
VERITAS RESISTORS

Universally accepted as standard for the construction of Radio Receiving Sets, Resistance and Power Supply Amplifiers and Power Supply Units. Send 25¢ for new Power Supply Handbook

Tobe Deutschmann Co.
Cambridge, Mass.

ACME WIRE CO.

CELATSITE

for RADIO WIRING

Flexible stranded Celatsite is composed of fine, tinned copper wires with non-inflammable Celatsite covering in 9 bright colors. Strips clean, solders readily. Sold only in 25' coils, in cartons colored to match contents. Solid Celatsite has same colored covering, but over bus bar wire.

ACME SOLID CELATSITE is a tinned copper bus bar hook-up wire with non-inflammable Celatsite insulation, in nine colors. Sizes, 14, 16, 18, 19, 30" lengths. Write for folder. The Acme Wire Co., Dept. B, New Haven, Conn.



A BRAND that is STANDARD in QUALITY

Thirteen years of concentrated effort on a single product has brought such uniform perfection that confidence in these tubes and the name they bear is almost universal among radio enthusiasts.

E. T. CUNNINGHAM, Inc.
New York Chicago San Francisco

**SINCE 1915
STANDARD
For all sets**

**Cunningham
RADIO TUBES**

**WHATEVER COMES TO YOUR SET
YOU GET IT CRYSTAL CLEAR**

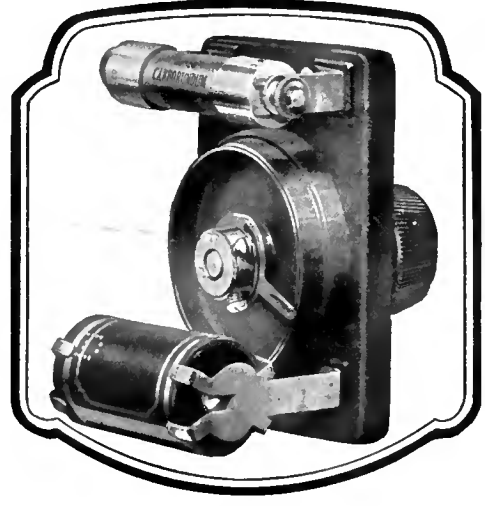

with a
**CARBORUNDUM STABILIZING
DETECTOR UNIT**

ALL the volume you need and selectivity too, when you attach this unit—but, best of all, you get clear, undistorted tones—natural, true, and crystal clear. Can be used on nearly all sets.

Carborundum is the Registered Trade Name used by The Carborundum Company for Silicon Carbide. This Trade Mark is the exclusive property of the Carborundum Company.

The Complete Unit No. 32 for **\$3.50**
The Detector alone No. 30 is **\$1.50**

Buy from your dealer, or we will send direct.

Use coupon to get our Hook-Up Book, sent free.

THE CARBORUNDUM COMPANY, NIAGARA FALLS, N. Y.
CANADIAN CARBORUNDUM CO., LTD., NIAGARA FALLS, ONT.

The Carborundum Company
Niagara Falls, N. Y.
Please send free Hook-Up Book D-2

Name
Street
City
State

**COMPLETE PARTS FOR
REMLER
45 Kc.
AC SUPERHET.**

GET prompt, efficient service and lowest prices from Western. Our catalog lists a complete line of kits, parts, sets and accessories.

Dealers—Write for Catalog
WESTERN RADIO MFG. CO.
134 W. Lake St. Dept 44, Chicago

ELKAY
TRADE MARK REG.

SUPPRESSOR

Controls the Squeals

Fits grid circuit of any tuned R. F. set. Stops tendency to "boil over" and squeal. 75c each; \$1 mounted. Satisfaction or money back. Describe set when ordering. Langbein-Kaufman Radio Co., Dept. B, 62 Franklin St., New Haven Conn.



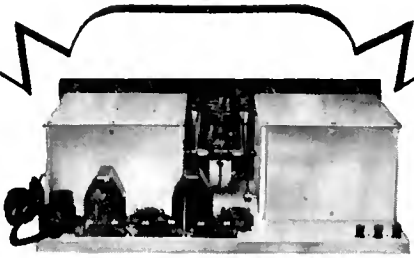

The Hammarlund "Hi-Q" Receiving Set which uses box shields of Alcoa Aluminum Sheet and special corner post moulding.

NOW— Finer Reception for Amateurs

ALUMINUM BOX SHIELDS will help you to get *greater distance, better selectivity—closer tuning*. Their use eliminates or greatly reduces interference. *They are ideal for shielding circuits using the new shielded grid tubes.*

The superiority of Aluminum is recognized by Hammarlund in the design of the "Hi-Q" receiver (above). Two special Hammarlund Box Shields made of Alcoa Aluminum Sheet are used.

Aluminum Company of America's standard box shields, designed especially for amateur sets, are made of heavy Alcoa Aluminum with satin-dip finish, size 5 in. x 9 in. x 6 in. high. They are easily adapted to smaller sizes. They require no soldering. They embody the ideal combination of high electrical efficiency, mechanical strength, lightness, fine appearance and long life.

Be sure to use Aluminum Box Shields, for *finer* results. If your dealer cannot supply you, send us your order and we will have an authorized dealer ship promptly at \$3.50 each (standard size). You simply pay the postman.

ALUMINUM COMPANY
OF AMERICA

2464 Oliver Bldg., Pittsburgh, Pa.

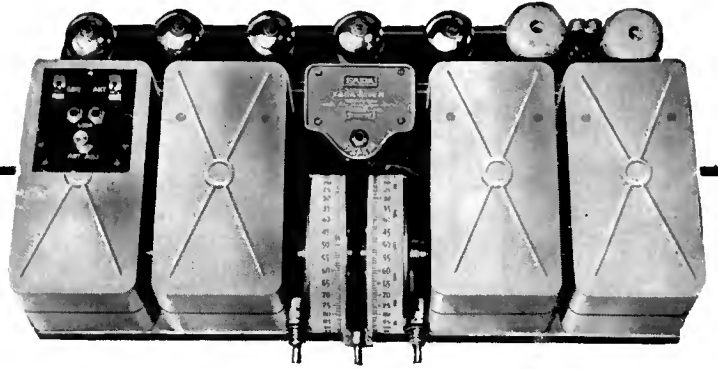

F. A. D. Andrea, Inc., uses Alcoa Aluminum for Shielding and other parts of "Fada" receiving sets.

Expect Better Results When You See This Metal in Radio

WHEN you look at radio receivers using aluminum shielding or condenser blades; aluminum castings, front panels, chasses or sub-panels you will know that the manufacturer has chosen the *one* metal that most efficiently meets *all* the widely differing conditions encountered in radio design.

MR. L. M. CLEMENT
Chief Engineer of
F. A. D. Andrea, Inc.,
commenting on shielding
says, "In a radio receiver
aluminum, because of its
electrical conductivity,
makes a more efficient
shield than any other of
equal weight. The material
can be easily drawn into
the desired shape and its
finish is permanent and
pleasing to the eye."

Such famous makers as Atwater Kent, Crosley, Fada, Freed-Eisemann, Grebe, Howard, R-C-A, Stewart-Warner, Stromberg - Carlson, Zenith and a host of oth-

ers employ parts of Alcoa Aluminum so that the purchasers of their receivers may enjoy the *best of radio reception*.

These makers recognize the superiority of Alcoa Aluminum. They appreciate its ideal combination of high electrical conductivity, lightness, strength, and beauty. Look for Aluminum in the set you buy—

when you find it you may expect the *best* results that the *best* radio engineers have yet achieved. Send for a copy of our new booklet, "Aluminum for Radio." It is free.

ALUMINUM COMPANY OF AMERICA

2464 Oliver Building

Pittsburgh, Pa.

ALUMINUM

The mark of Quality in Radio