

RADIO BROADCAST



CONTENTS

How to Build an A-Power Unit
Inside the Manufactured Receiver
Radio Picture Transmission In Canada
How Colleges Teach Radio Engineering
Is Broadcasting Now a Monopoly?
A Two-Tube Tuner Unit

35 Cents

Doubleday, Doran & Company, Inc.
Garden City, New York

MARCH 1928



Get Your Share of the BIG MONEY

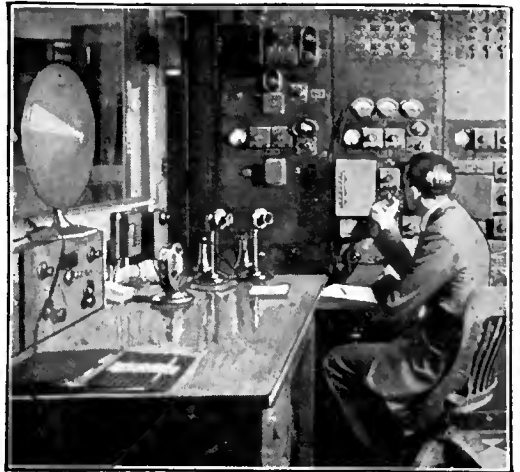

Read What Big Money these N.R.I. men are making



High As \$78 A Week

"I am only about half way through the course but I have made as high as \$78 in one week in a retail radio store. I estimate my total income, as the result of my knowledge of Radio, around \$3,000 to date. I know I could not have picked a better course." Frank Reese, 304 Walnut St., Coatsville, Pa.



\$70 In One Day

"I am in business for myself and recently made \$70 in one day. I estimate that the Radio training I received from you will be worth tens of thousands of dollars to me in the future." T. M. Wilcox, Belle Island, Newfoundland.

Learn Radio the Practical Fascinating Way



You can build 100 circuits with the 6 big outfits of Radio Parts I give you

3 of the 100 you can build

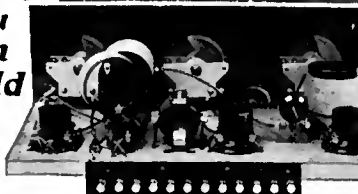
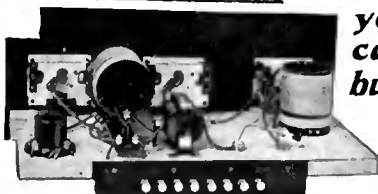

WHY be satisfied with \$25, \$30, or \$45 a week when the good jobs in Radio pay \$50, \$75, and all the way up to \$250 a week. The astounding growth of Radio has already created three hundred thousand jobs in a few short years. Small and large fortunes are coming out of this new business every year. Twenty different branches offer you work that's almost romance with practically no limit to the money you can make. Manufacturing, selling, repairing, servicing, assembling, installing sets, operating on board ship which gives you world-wide travel without expense, operating a broadcasting station, and many other lines of work are fully explained in "Rich Rewards in Radio," my 64-page FREE book. Send for it to-day.

Learn At Home In Spare Minutes

No need to leave home. Hold your job, I'll bring your training to you. You can learn during your spare time. My easy-to-learn, practical course has put hundreds of fellows who had only a few minutes a day to study into big pay jobs. You don't have to be a college or high school graduate to become a Radio Expert. Many of my students and graduates now making big money didn't even finish the grades.

You Get Six Big Outfits Without Extra Charge

I teach Radio the right way—the practical way. I give you six big outfits of Radio parts (not toys) and show you how to build approximately 100 different circuits, locate, repair, and remedy all receiving set troubles. Three outfits you build are shown on this page. You build practically every type of receiving set known to-day. Thus you learn the "why" and the "how"—get a complete, thorough, rounded-out knowledge that shows its worth in your pay envelope. Full details in my big book.

Earn \$15, \$20, \$30 a Week Extra While Learning

Deloss Brown, South St., Foxboro, Mass., made \$1,000 from spare time jobs before he even finished his course. Frank Toomey, Jr., Piermont, New York, made \$833, G. W. Pare, 1807 21st Ave., Nashville, Tenn., says the course brought him \$935 spare time profits. No need to scrimp, save, and deny yourself good things to pay for this course. It's the world-famous course that pays for itself.

Your Money Back If Not Satisfied

That's the agreement I make with you when you enroll. It's my way of showing you that I'll give you the training and service you need and want. You are the only judge.

64-Page Book FREE For the Asking

I will gladly send you my 64-page book of information on N. R. I. training and the money-making opportunities in Radio without a penny's cost to you. Send for it NOW. Clip or tear out the coupon to-day. Find out what Radio offers you and how my Employment Department helps you get into Radio after you graduate.

J. E. SMITH, President
Dept. 3-O, National Radio Institute
WASHINGTON, D. C.

RADIO
I'll Show you how MANY MEN are MAKING \$50 to \$250 A WEEK in this New Business

Send for FREE 64 Page Book giving facts on this new opportunity Act Today



Mail This FREE COUPON NOW

J. E. SMITH, President
Dept. 3-O, National Radio Institute
Washington, D. C.

Dear Mr. Smith:

Without obligating me in any way please send me your Free book, "Rich Rewards in Radio," with information on your practical Home Study Radio Course.

Name..... Age.....
Address.....
City..... State.....
Occupation.....

Employment Service to all Graduates

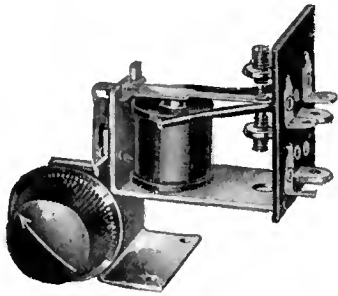

**BRACH
RAYFOTO
RELAY**

*Used Exclusively
in the*

**COOLEY
Rayfoto Receiver**

Approved by
A.G. COOLEY

For Further Information Address

**L.S. BRACH
MFG. CORP.**
ENGINEERS AND MANUFACTURERS
NEWARK, N. J. U.S.A. TORONTO, CAN.

**FROST-
RADIO**

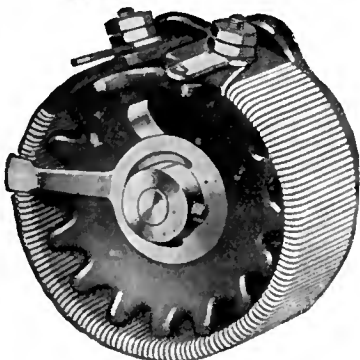

**FROST-RADIO
DE LUXE POTENTIOMETERS**

HERBERT H. FROST, Inc.
Main Office and Factory
ELKHART, IND.

Mail Coupon for Two Valuable
Frost-Radio Booklets

If you will fill out and mail coupon below we will send you FREE our two new booklets: "What Set Shall I Build," and "For Better Reception." Write for these today.

HERBERT H. FROST, Inc.
160 No. La Salle Street, Chicago, Ill.

Send me your two free books, as advertised in Radio Broadcast for March.

Name
Address
City State

*for improved
musical performance*

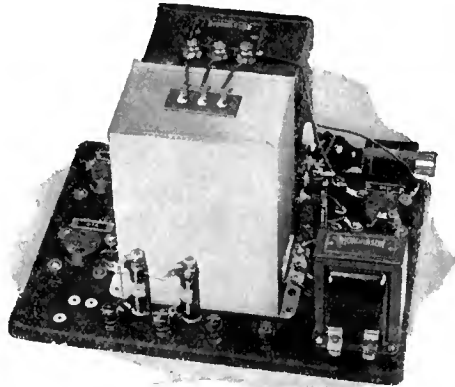

THORDARSON

**210 Power Amplifier
and Plate Supply**

*Easy to build — Simple to install — Economical
to operate — Quiet in performance*

FULL rich tonal reproduction with a generous supply of power for the heavier tones. You can bring your receiver up to these present standards of reception by building this Thordarson 210 Power Amplifier and B Supply.

Easy to build. Every effort has been made to make assembly as simple as possible. The metal baseboard is equipped with all sockets and binding posts mounted. All necessary screws, nuts and hook-up wire are furnished complete; simple pictorial diagrams are supplied. You can assemble this unit in an hour.

Simple to install. No changes in receiver wiring are necessary. This amplifier can be attached to set in a moment.

Economical to operate. Highly efficient and cool in operation. Consumes less current than a common 50 watt lamp.

Quiet in performance. The reliability of Thordarson engineering assures you of unquestionable performance and quietness in operation.

FOR SALE AT ALL GOOD PARTS DEALERS

Write for this free booklet

THORDARSON ELECTRIC MFG. CO.
500 W. Huron St., Chicago

GENTLEMEN: Please send me, free of charge, your booklet describing your 210 power amplifier on the metal baseboard.

Name

Street and No.

Town State

RADIO BROADCAST

MARCH, 1928

WILLIS KINGSLEY WING, Editor
 KEITH HENNEY
 Director of the Laboratory
 EDGAR H. FELIX
 Contributing Editor

Vol. XII, No. 5

CONTENTS

Cover Design	From a Design by Harvey Hopkins Dunn	
Frontispiece	A Short-Wave Transmitter for Imperial Broadcasting	338
University Offerings in Radio Education	Carl Dreher	339
An A.C. Browning-Drake Receiver	Glenn H. Browning	343
The March of Radio	An Editorial Interpretation	346
What Is the True Broadcasting Situation? Does Monopoly Rule the Commission? The Growing Political Pressure on the Commission Limitations to the Use of High-Frequency Channels	The First Rayfoto Transmission Two Stations Cannot Occupy the Same Ether Space Will the Radio Industry Do It Again? The Month in Radio	
A New A Power Unit	Ralph Barclay	350
"Strays" from the Laboratory		351
Poorly-Designed Amplifiers Quartz Transmitting Tubes Quiet A.C. Sets	Into What Impedance Should the Tube Work? Audio Transformer Measurements	
An Interview with J. V. L. Hogan	Edgar H. Felix	353
A Four-Tube Screened-Grid Receiver	McMurdo Silver	355
Some New Loud Speakers and Sets		358
The Armchair Engineer	Keith Henney	360
CJRM, Pioneer Picture Broadcasting Station	Edgar H. Felix	362
"Our Readers Suggest—"		363
A Distortion Indicator "Motor-boating"	A.C. Tube Operation Without Rewiring	
The Listeners' Point of View	John Wallace	365
If You Like Good Music, Listen This Way	For Program Directors Only	
As the Broadcaster Sees It	Carl Dreher	367
How a Famous Artist Broadcasts Note for Lexicographers	Speech Constants Catalogs and Commercial Publications	
The A. C. "Bandbox"	John F. Rider	369
Loud Speakers and Power Equipment		373
Designing an R.F. Amplifier	Sylvan Harris	376
Suppressing Radio Interference	A. T. Lawton	379
"Radio Broadcast's" Laboratory Information Sheets		384
No. 169 Data on the UX-222 (CX-322) No. 170 Selectivity and Sensitivity No. 171 The CX-312 (UX-112) and CX-371 (UX-171) No. 172 A Simple Wavemeter	No. 173 The Regulator Tube No. 174 Grid Bias No. 175 Filter Choke Coils No. 176 How the Plate Circuit Affects the Grid Circuit	
"Radio Broadcast's" Directory of Manufactured Receivers		388
Manufacturer's Booklets Available		392
What Kit Shall I Buy		393
Book Review:	Carl Dreher	394
Principles of Radio Communication: J. H. Morecroft		

The contents of this magazine is indexed in *The Readers' Guide to Periodical Literature*, which is on file at all public libraries.

AMONG OTHER THINGS.

THE many radio experimenters who are looking forward to a college course to lead them farther in their chosen field will find this month's leading article, by Carl Dreher, of considerable value. Mr. Dreher's story on radio instruction in colleges and universities is not exhaustive and there are many other colleges which have courses of value to the student who plans eventually to go into radio work. The article does, however, answer many of the general questions most frequently asked us in correspondence.

THIS issue contains a great deal of interesting material for the experimenter and home constructor as well as some pages of especial importance to the many who are connected with the business of selling radio apparatus. The description of the Crosley "Bandbox" receiver is one example; Sylvan Harris' article describing the Stewart Warner receiver is another. The interesting illustrations in the full pages of radio set and accessory pictures form a useful guide to interesting new products. The description of the a.c. Browning-Drake set shows this popular tuning unit combined with an excellent amplifier unit working on the push-pull principle. Thus far, we have described the Samson push-pull amplifier and B-supply, the Thordarson push-pull amplifier and B-supply, and in this issue reference is made to the AmerTran push-pull amplifier. Each of these devices will give the user excellent audio quality when combined with a good loud speaker. The Knapp A-Power unit, described on page 350, should appeal to many home-constructors because of its performance and price. And on page 355 and following, a remarkably inexpensive screened-grid receiver is discussed.

FOR those who like to discuss the design and performance of amplifiers, the leading article in our technical editorial section, "Strays from the Laboratory," will provide plenty of material for discussion. Keith Henney, who writes this department, will be pleased to hear from those of our readers who have ideas on the matter. On page 352, the average characteristics of the 226 and 227 type tubes are presented.

READERS who are interested in receiving additional information from the makers of the Cooley Rayfoto apparatus may send their names to the undersigned who will forward them. The April RADIO BROADCAST will contain a long-awaited article on the RADIO BROADCAST "Lab" circuit, a description of an interesting short-wave phone and code transmitter, and a wealth of other interesting constructional material.

THE Laboratory Data Sheets, which have been one of the most popular features of RADIO BROADCAST since they first appeared in our June, 1926, issue, are the work of Howard E. Rhodes of the technical staff of RADIO BROADCAST Laboratory. Of necessity they cannot be signed, but so many have written us in complimentary terms of them that we feel that the many readers who have expressed interest in this regular feature should know to whom they are due. The first eighty eight Data Sheets, by the way, are available in bound form from the Circulation Department of Doubleday, Doran and Company, Inc., and sell for one dollar.

—WILLIS KINGSLEY WING.

Doubleday, Doran & Company, Inc.
MAGAZINES

COUNTRY LIFE
 WORLD'S WORK
 GARDEN & HOME BUILDER
 RADIO BROADCAST
 SHORT STORIES
 EDUCATIONAL REVIEW
 LE PETIT JOURNAL
 EL ECO
 FRONTIER STORIES
 WEST WEEKLY
 THE AMERICAN SKETCH

Doubleday, Doran & Company, Inc.
BOOK SHOPS

(Books of all Publishers)
 NEW YORK: { LORD & TAYLOR BOOK SHOP
 PENNSYLVANIA TERMINAL (2 Shops)
 GRAND CENTRAL TERMINAL
 38 WALL ST. and 526 LEXINGTON AVE.
 848 MADISON AVE. and 166 WEST 32ND ST.
 ST. LOUIS: 223 N. 8TH ST. and 4914 MARYLAND AVE.
 KANSAS CITY: 920 GRAND AVE. and 206 W. 47TH ST.
 CLEVELAND: HIGBEE CO.
 SPRINGFIELD, MASS.: MEEKINS, PACKARD & WHEAT

Doubleday, Doran & Company, Inc.
OFFICES

GARDEN CITY, N. Y.
 NEW YORK: 244 MADISON AVENUE
 BOSTON: PARK SQUARE BUILDING
 CHICAGO: PEOPLES GAS BUILDING
 SANTA BARBARA, CAL.
 LONDON: WM. HEINEMANN LTD.
 TORONTO: OXFORD UNIVERSITY PRESS

Doubleday, Doran & Company, Inc.
OFFICERS

F. N. DOUBLEDAY, Chairman of the Board
 NELSON DOUBLEDAY, President
 GEORGE H. DORAN, Vice-President
 S. A. EVERITT, Vice-President
 RUSSELL DOUBLEDAY, Secretary
 JOHN J. HESSIAN, Treasurer
 LILLIAN A. COMSTOCK, Asst. Secretary
 L. J. McNAUGHTON, Asst. Treasurer

DOUBLEDAY, DORAN & COMPANY, INC., Garden City, New York

Copyright, 1928, in the United States, Newfoundland, Great Britain, Canada, and other countries by Doubleday, Doran & Company, Inc. All rights reserved.
 TERMS: \$4.00 a year; single copies 35 cents.

VITROHM RESISTORS.....IN EVERY INDUSTRY.....IN EVERY LAND

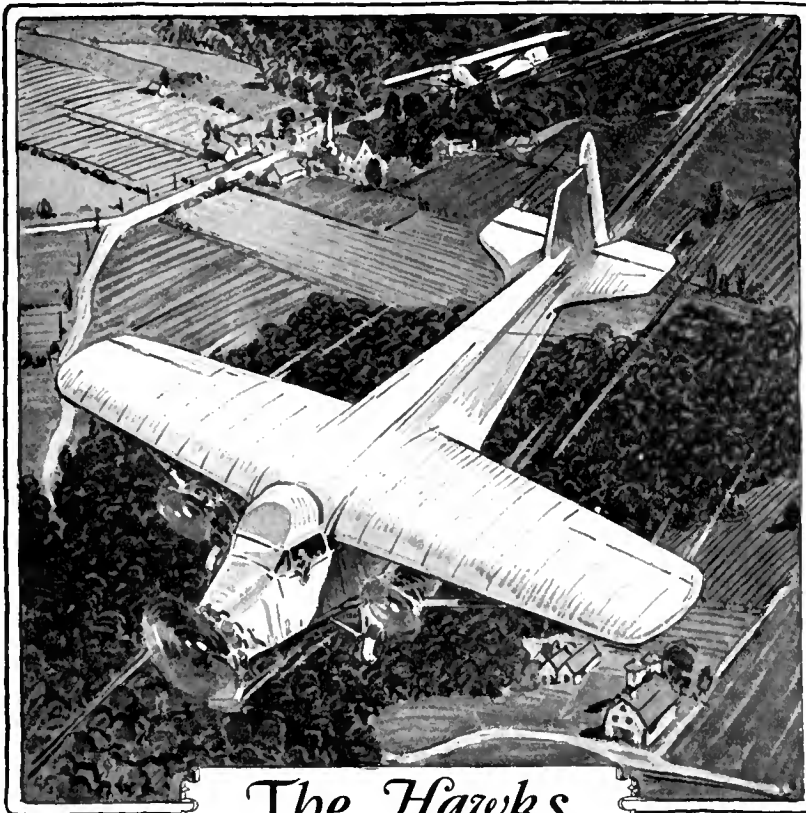

The Hawks



5000 ohm, tapped center, Vitrohm grid leak for transmitting circuits of 1000 watts or less. This resistor is used frequently in airplane transmitters. It is priced at \$2.80.

*Vitrohm Resistors
for radio*

¶ Vitrohm Resistors are made by winding a special resistance wire upon a refractory tube and protecting both the wire and terminal contacts with fused-on vitreous enamel. This process has been used by Ward Leonard Electric Co. for more than 36 years.

¶ Circular 507, describing Vitrohm Radio Resistors, and "Vitrohm News" will be sent you without charge upon request.

"....switch on, sir...."

WITH the drop of his arm, the pilot signifies that he is ready to take his ship of the air to her own element. A few years ago, that roar of motor and short dash across the field meant the loss of all contact with the ground, until the flight was ended.

Today, radio maintains constant communication between airplane and ground. The pilot, or navigator, receives and gives instructions; learns of changing conditions, and is able to protect better airplane and cargo.

It is interesting to know that Vitrohm Resistors are specified most frequently by the designers of airplane radio transmitters.

In the air, on and under the sea, at the poles, in every industry, in every land you will find sturdy, permanently accurate Vitrohm Resistors—always making good.

WARD LEONARD ELECTRIC CO.

Mount Vernon, N.Y.

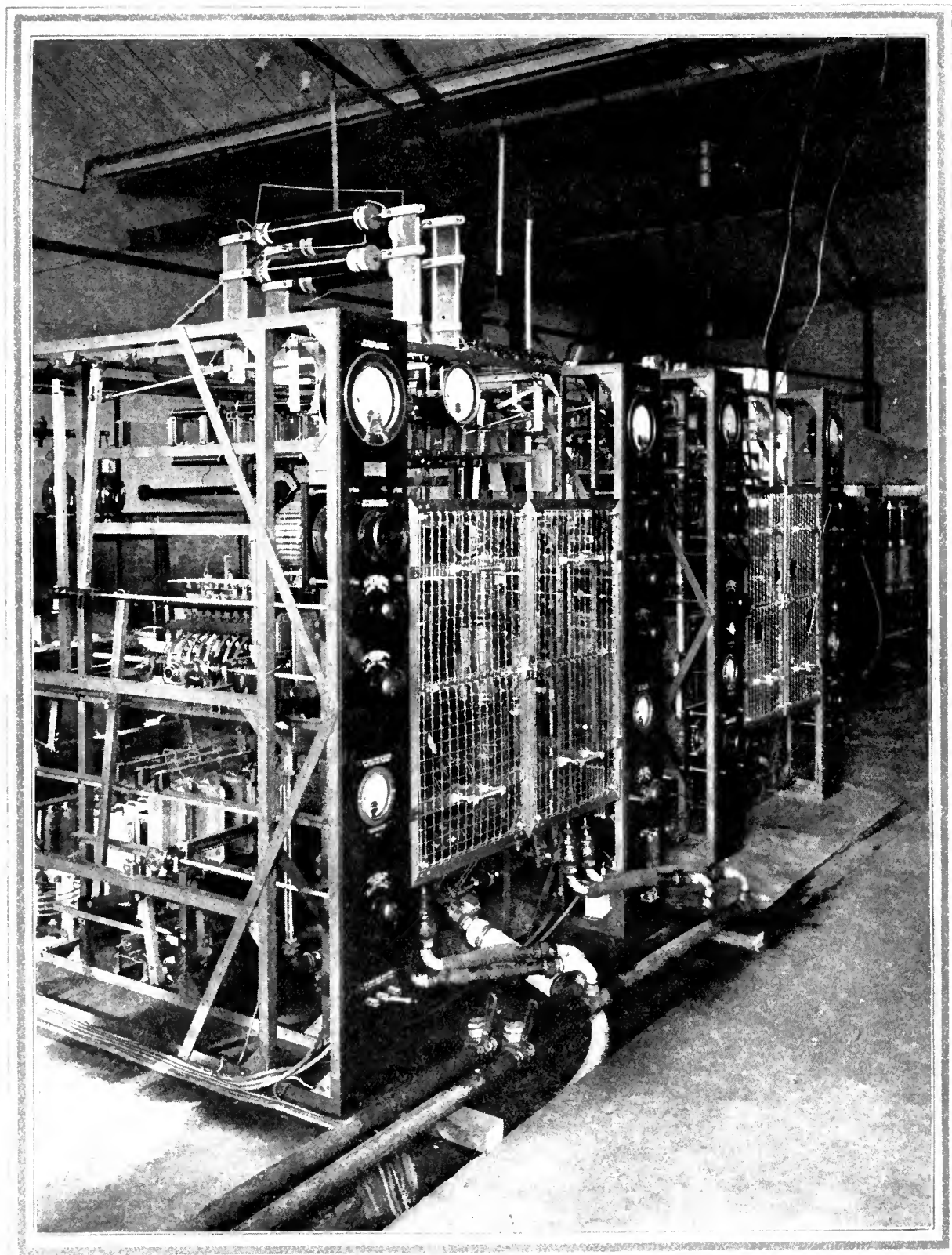

A Short-Wave Transmitter for Imperial Broadcasting

ANIMATED by the success of other European countries in this field, the British Broadcasting Corporation finally permitted itself to fall victim to short-wave broadcasting. The purpose of 5 SW is to unite the radio audiences of the far-flung corners of the British Empire, and reports so far received would indicate that quite a large degree of success is being met with in this effort. The wavelength of 5 SW is 21 meters (12,500 kc.) and it may be heard well in this country. With the exception of Saturdays and Sundays (when the schedule

is irregular), 5 SW broadcasts daily from 7:30 to 8:30 a. m. E. S. T., and from 2:00 to 7:00 p. m. E. S. T. The power is 20 kw. The transmitter is at present erected in the experimental laboratories of the Marconi Company at Chelmsford, some thirty miles from London. The apparatus consists of two panels of a Marconi short-wave beam transmitter (shown in the foreground) with the addition of three modulating panels, which may be discerned faintly in the background

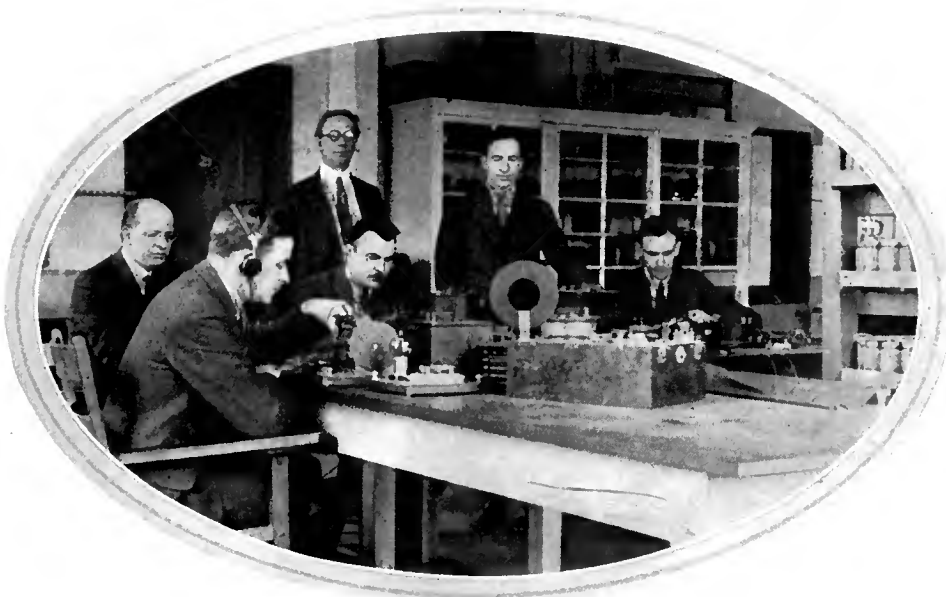

WHERE ELECTRIC COMMUNICATION ENGINEERING MAY BE STUDIED

Students at work in the Cruft Memorial Laboratory, Harvard University. Professor G. W. Pierce is Rumford professor of physics there. In the article below he tells what courses are available at Harvard for the radio man

University Offerings in Radio Education

By Carl Dreher

NOT infrequently readers address this magazine with questions regarding university training in radio. They are interested in such matters as entrance requirements at various institutions, courses offered, prerequisites, and the practical value of the training available. As a rule the questions come, not from the usual group from which college students are drawn, but from young men who feel the need for adding to their knowledge but lack formal preparation. Secondary school graduates, and those who have been fortunate in securing college preparatory education at the usual age, generally are familiar with the educational system beyond this point, but many others have only the vaguest ideas about the procedure of technical study in institutions. They imagine, in some cases, that all universities admit students to certain courses of interest to them, regardless of aptitude or previous training on the part of the student. Actually there is a wide range of flexibility among technical colleges, some offering a wealth of extension courses, with little scrutiny of the applicant's credentials, while others have rigid entrance qualifications, no extension courses, and, in a number of instances, no electives and no variations in the curriculum. The relation of radio engineering to the more fundamental divisions of technology is also frequently misapprehended, the importance of radio being naturally exaggerated in the minds of some of its devotees. All this has made it appear worth while to conduct an inquiry into the subject of university training in radio communication, with a view to supplying information regarding conditions in representative institutions, and also to make clear the relation of university training in radio to other forms of study of the subject.

Letters were written to the professors of Electrical Engineering at ten institutions, with requests for answers to the following questions:

(1.) What communication and radio engineering courses are given as required or elective studies in the electrical engineering division?

(2.) Does your institution offer any extension courses in communication or radio engineering, and, if so, what are the entrance requirements for such specialized work?

Nine out of the ten institutions addressed replied, giving the information sought. Of course a choice of ten universities and technical schools, among several hundred, is not sufficient for com-

prehensive conclusions, but it does serve to show the general trend of higher education in radio. Colleges known to be interested in the radio field were rather favored, although not exclusively, and there was some attempt at territorial distribution.

The answer of Prof. J. H. Morecroft at Columbia University is well worth quoting, inasmuch as it represents one reasoned policy in higher technical education:

"Both Professor Slichter and I have always felt that it is extremely foolish for a young man to specialize on a specific branch of engineering work before he is well aware of his aptitude and of the opportunities awaiting him in any special field, and naturally the courses at Columbia are laid out in accordance with this idea.

"The very large companies which are always ready to take any men whom we regard as well fitted for research work have this same idea with regard to specialization. Our largest communication company, for example, does not desire to have men trained in specialized communication theory and practice. Their representatives have always expressed to me their desire for men who are trained rather in the general fields of science and engineering than those who have attempted to specialize in some certain phase of the work.

"Whereas the fundamental principles of communication, including radio, are given to all of our electrical engineering students, there is no special arrangement of courses for those who might desire to specialize in radio. In the senior year the electrical engineering students at Columbia are allowed to take more than half of their work from a list of elective subjects and at this time of course a man desiring to do so can pick out most of his work in the communication field.

"I myself do not recognize radio engineering as being apart from telephone engineering or other similar types and do not recommend that



© Bachrach

J. H. MORECROFT

Professor of Electrical Engineering, Columbia University, New York City: "I do not recommend that a man specialize too much while he is at college"

a man specialize too much while he is at college. When he starts to work he will have to specialize to earn his living and will get but little opportunity to carry on studies outside of those required by his daily tasks, so that it seems foolish for him to give up the opportunity for broad training while at college."

These views of Professor Morecroft's are an authoritative statement of what might be called the broad-training policy in engineering education, which in my own opinion, is the best thing for those who fortunately have the time and money to take advantage of it. Columbia does, however, offer an extension course, "Electrical Engineering 99-10-Radio Communication," which "is not intended for those who are already familiar with radio theory and practice but rather for those who have had no training in this particular field, and is so designed that anyone who has had the equivalent of an ordinary high school course will be able to do the work satisfactorily." The class meets twice a week for an aggregate of three hours. The admission requirements for Columbia University Extension students are very elastic. For "mature students whose chief interest lies outside the University and who have leisure to pursue only a few courses in the late afternoon or at night . . . the sole condition is that they show their ability to pursue the work with profit." In practice this amounts to satisfying the instructor or a supervising professor that one has some background in the subject and an earnest desire to learn more of it. In past years Columbia has given some excellent advanced extension courses in vacuum-tube theory and other branches.

Professor Morecroft is one of the most prominent of American radio engineers, and a past president of the Institute of Radio Engineers. Dr. G. W. Pierce likewise ranks among the highest radio technicians, and is similarly a past president of the Institute. Nevertheless Harvard University, where Professor Pierce is Rumford Professor of Physics and Director of the Cruft Memorial Laboratory, pursues a policy differing from that of Columbia, in that Harvard offers a "Programme of Study in Electric Communication Engineering," and confers the degree of "Bachelor of Science in Communication Engi-



AT HARVARD UNIVERSITY
The Cruft Memorial Laboratory

neering" upon candidates who complete the four-year course satisfactorily. The course is substantially one in electrical engineering, with specialization beginning in the third year. Of the eight courses listed in that year four are radio, or, broadly, communication subjects ("Electric Oscillations and Their Application to Radiotelegraphy and Radiotelephony; Electric Oscillations, Electric Waves, and Radio-Frequency Measurements; Electron Tubes—Amplifiers, Detectors, and Oscillators; Electron

Tubes, Advanced Course"). The other courses in the third year are in electrical engineering and mathematics. In the fourth year there are five communication subjects and four courses in electrical engineering.

Harvard University also offers work in communication engineering to graduate students and on occasion confers the degrees of "Master of Science" and "Doctor of Science in Communication Engineering." The admission requirements in all cases are high. In the case of the four-year course leading to the bachelor's degree the entrance requirements are the same as for admittance to the Freshman Class of Harvard College, the academic elements being substantially those provided by a first-class high school or preparatory training.

The Massachusetts Institute of Technology answered the questionnaire through Prof. Edward L. Bowles. In the regular electrical engineering course intended for students who seek training in electrical power engineering, two optional one-term courses, "Principles of Radio Communication" and "Principles of Wire Communication," are available. Students who desire to specialize in electrical communication, after taking the regular E. E. course for two years, may register for the "Electrical Communication Option" at the beginning of the junior year. This option "embraces work covering wire telephony, carrier telephony and radio telephony, also wire telegraphy, carrier telegraphy, and radio telegraphy. The properties and engineering applications of electron tubes are also included." During the third year only one specific communication course, "Electrical Communications, Principles," appears, but there are other modifications in the work, such as the addition of a course in vector analysis, the omission of a course in heat engineering which appears in the regular E. E. outline, etc. In the fourth year there is marked specialization in communication and electro-magnetic theory. Incidentally, a one-term Senior course in "Sound, Speech, and Audition" is included. The degree is that of "Bachelor of Science." M. I. T. also offers a number of limited-attendance five-year "co-operative courses in electrical engineering" which, for the first two years, are the same as the regular E. E. course, while for the last three years, the student's time is equally divided between instruction at the Institute and work in industrial plants. "Option 3," in Communications, is arranged in co-operation with the Bell Telephone Laboratories in New York City. These co-operative courses lead to the degree of "Bachelor of Science" after four years, and "Master of Science" after five years. Admission to the Institute is by examination. There are no extension courses.

At Stevens Institute, Hoboken, N. J., where the Department of Electrical Engineering is headed by Prof. Frank C. Stockwell, succeeding no less a radio man than L. A. Hazeltine, no special attention is paid to communication training. Stevens offers only a single course, leading to the degree of "Mechanical Engineer," and has no electives in any engineering subject. Extension courses are unknown, nor does Stevens accommodate special students. However, as part of the regular work in electrical engineering, a certain amount of radio engineering is prescribed for all students, including laboratory exercises and class room practice.

Undergraduate students at Rensselaer Polytechnic Institute, working for their E. E. degrees, after the usual grounding in mathematics and physics, followed by general electrical engineering courses, receive a communication engineering course in the last seven weeks of the senior year. The following subjects are presented

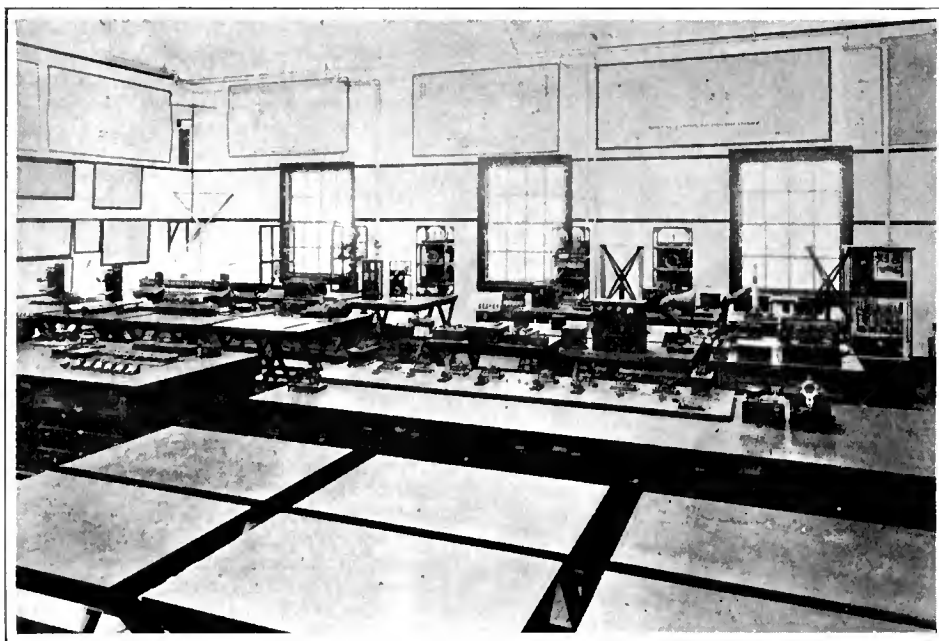

A WELL-EQUIPPED LABORATORY

A view of the electrical-engineering laboratory of the Rensselaer Polytechnic Institute, Troy, New York. R. P. I. offers special and graduate work in communication to qualified students

in the order named: "Telephone transmitters; telephone receivers; transformation of medium-frequency alternating currents and electromotive forces; resistance, inductance, and capacitance in medium-frequency alternating-current circuits; distribution of current and electromotive force over telephone lines; electrical filters, transmission line impedance, and equivalent networks; fundamental telephone and telegraph circuits; telephone transmission and its measurement; telephone and telegraph systems and telephone service; vacuum tubes and their application; telephone repeaters and public address systems; multiplex or carrier current telephony; radio telephony and telegraphy; interference and cross-talk."

Rensselaer men seeking the B. S. in Physics are required to take a general course in electrical engineering covering the production, transmission, and utilization of electrical energy for light, power, and communication purposes. In the junior year these students have a seven-week course in radio communication. The topics are as follows: "Underlying electrical theory; properties of oscillatory circuits; antenna systems and radiation; damped and undamped wave radio telegraphy; general properties of the three-electrode vacuum tube; the three-electrode vacuum tube as detector, amplifier, oscillator, and modulator; radio telephony."

R. P. I. offers special and graduate work in communication engineering to qualified students. Applicants who have acquired the physics and mathematics covered in the first and second years at Rensselaer, or in equivalent courses elsewhere, may be admitted to a special course in radio communication whereby practically the entire third year is devoted to laboratory and theoretical study of radio. "We do not advise students to take this special course unless they know positively that they are going to enter some branch of the radio industry at the completion of their course," writes Prof. W. J. Williams, who supplied all the information regarding communication training at R. P. I. It would appear that this special course is in the line of definitely vocational training in radio engineering for men who have the requisite grounding in the general engineering field, including, necessarily, considerable mathematics and physics. Two one-year graduate communication courses are also given in alternate years. One covers wire communication and general electric circuit theory. The other is in radio communication and advanced electromagnetic theory. About twelve hours of work a week are required. The content of these courses is variable, the effort being to keep the subject matter up to date. This work is necessarily limited to students who have the E. E. or B. S. in Physics from Rensselaer, or equivalent degrees from some other institution.

At the Polytechnic Institute of Brooklyn, on the basis of Prof. Erich Hausmann's reply, four subjects are given as required studies in the curriculum leading to the degree of Electrical Engineer. These are "Telegraphy" (two hours per week of class work in the second semester of the Junior year); "Telephony" (two hours per week of class work in the first semester of the Senior year); "Radio Communication" (two hours per week of class work in the second semester of the Senior year); "Communication Laboratory" (three hours per week of laboratory work in the second semester of the Senior year). The course in radio communication is described as "A practical and theoretical course on the generation of radio oscillations of the sustained and decadent types, damping of wave trains, resonance of single and coupled circuits, plotting of reactance diagrams and resonance curves

reception of electric waves, the use of vacuum tubes as amplifiers, detectors and oscillators, the forms of antennas, and the design of commercial forms of radio telegraphic and telephonic apparatus. Prerequisite, Alternating Current Circuits." The "Communications Laboratory" work covers operation of telephone, telegraph, and fire alarm installations, tests of characteristics of spark, arc, and tube oscillation generators, measurements of such quantities as coupling coefficient and decrement, etc.

The four courses outlined above are also given in the Evening Session of the Polytechnic, the first three during one year and the fourth during the following year, alternating. The prerequisites are "Electricity and Magnetism," "Direct-Current Machines," and "Calculus." For "Telephony," "Alternating Current Circuits" is an additional prerequisite, and the three classroom courses must precede the "Communication Laboratory" course. "A few years ago," writes Professor Hausmann, "an elementary evening course in radio was given which did not require a knowledge of calculus: while this course has not been offered for several years, there is no reason why it should not be given

ate students who have completed the fourth year electrical courses, as well as to other students with similar qualifications.

(3.) *A combination lecture and laboratory course on the theory of transmission circuits*, intended to occupy about one third of the student's working time for ten weeks. The subject matter includes the theory of long-distance power and telephone circuits, waves on transmission lines, theory and design of simple and composite wave filters. Probably half of this course applies directly to telephone communication problems. It is open to electrical engineering graduate students in full standing.

(4.) *Another graduate course with the same prerequisites is about fifty per cent. concerned with communication problems*, such as skin effect, transient oscillations, theory of telephone receivers and loud speakers, and harmonics, the treatment being of an advanced mathematical nature. There are two lectures a week for ten weeks.

All these courses are given by Professor Terman, who is in charge of communication and analytical work at Stanford University.

The University of Wisconsin, with its College of Electrical Engineering located at Madison,

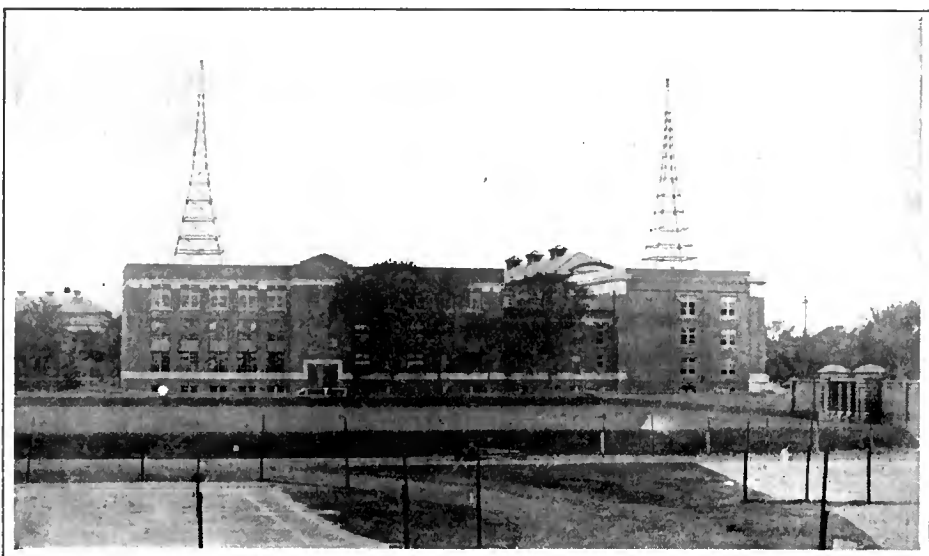

ELECTRICAL ENGINEERING BUILDING, UNIVERSITY OF MINNESOTA

The communication laboratories of this fine building occupy the third floor. The University has an experimental radio station and, like R. P. I., operates a broadcasting station

again. What do you think of the demand for such a brief course, say of 15 lectures?" The best way to gauge the demand is to propound the question and to invite any readers who are interested to communicate with Professor Hausmann. The writer believes that there is a sufficient demand for such a course to warrant offering it again.

Stanford University in California, while offering no extension work of any kind, lists four communication engineering courses described by Prof. Frederick Emmons Terman as follows:

(1.) *Lecture course in principles of radio communication*. Three lectures a week for ten weeks, open to seniors who have taken the regular electrical course, and to graduate students.

(2.) *Laboratory course in radio measurements*. Two lectures and one afternoon in laboratory per week for ten weeks. Reports are required. The experiments consist of bridge measurement of vacuum-tube amplification factors, dynamic plate resistance, etc.; radio-frequency resistance; resonance curves; detectors; audio-frequency transformer characteristics; adjustment of vacuum-tube oscillators, etc. This course is open to gradu-

cannot be said to neglect the field of communication engineering. Four resident elective courses in "Radio Telegraphy"; "Electric Amplifiers and Oscillators"; "Radio Circuit Analysis and Design"; and "Telephony and Telegraphy," are provided. The first is substantially the "application of alternating-current theory to radio problems and measurements," accompanied by laboratory work. The second includes "analytical study of the properties of amplifier and oscillator circuits and of the characteristics of tri-electrode thermionic amplifiers," likewise with laboratory sessions. "Radio Circuit Analysis and Design" is described as "a continuation of the above courses, treating such topics as amplifiers and their design, operation of oscillators in parallel, design of oscillators, modulation and demodulation, and analysis and design of radio transmitting and receiving sets." The theory of instruments and lines is treated under "Telephony and Telegraphy," laboratory work being included. The above are all one-semester courses. Other courses bearing on communication problems are also available for graduate students, such as "Advanced Theory of Electric

Circuits" and "Seminar in Electric Circuit Theory." The content of both of these courses is largely in the field of transient and high-frequency phenomena, behavior of networks, etc.

A number of correspondence courses in communication work are included in the bulletin "Courses in Electrical Engineering" issued by the University Extension Division of the University of Wisconsin. Course 318, "Principles of the Telephone" is given in three parts: "Subscriber's Apparatus," "Central Office Equipment," "Aerial and Underground Construction." The instruction fee for the first part is \$6, with ten assignments in this portion. "This course," according to the catalogue, "includes study of the laws underlying speech, transmission, of the instruments, switchboards, and other apparatus in an exchange, and of the laying, testing, and maintaining in good condition of the circuits outside the exchange."

Course 329, "Principles of Radiotelegraphy" treats the standard topics in twenty assignments, for an instruction fee of \$12. An understanding of trigonometry is stated to be essential. An evening course on "Theory of Radio Circuits" is also being given in Milwaukee under the auspices of the Extension Division. This is an engineering course, open to "graduates of scientific courses of college grade or men of equivalent training," and may carry credit for degrees. It provides "a quantitative treatment of radio circuit theory" and aims to demonstrate "the dependence of radio circuit theory upon fundamental electric theory." The fee is \$10 for the course of eighteen sittings. Four other radio courses are given by the Extension Division in Milwaukee, these being designed for amateurs, so that the treatment is more popular and elementary.

The Professor of Electrical Engineering at the University of Wisconsin, Edward Bennett, is a well-known radio engineer and has con-

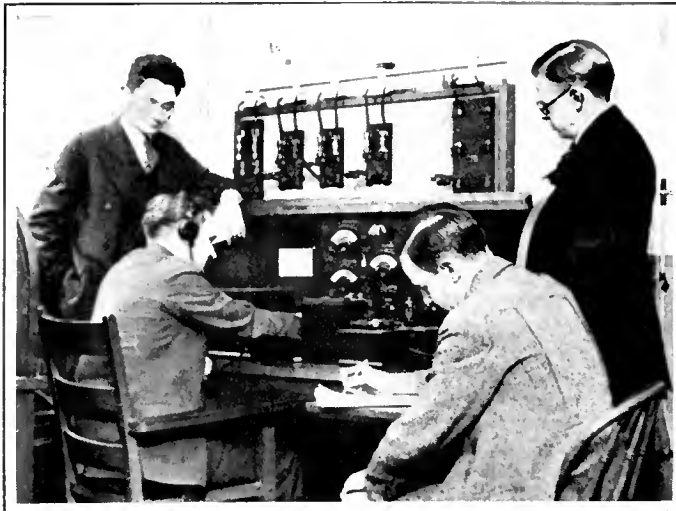

© Harvard Crimson

IN THE CRUFT MEMORIAL LABORATORY, HARVARD UNIVERSITY

The picture shows a group of students making measurements during one of the courses

tributed extensively to the literature of the subject.

For the University of Minnesota, C. M. Jansky, Jr., Associate Professor, Radio Engineering, writes as follows, after referring to his paper, "Collegiate Training for the Radio Engineering Field" in *The Proceedings of the Institute of Radio Engineers* for August, 1926:

"Collegiate work in the field of radio engineering is given in the Department of Electrical Engineering of the University of Minnesota. Students desiring to specialize in communication engineering in general, or radio engineering in particular, take their work in this department. Upon completing the four years' work they receive the degree of 'Bachelor of Science in Electrical Engineering,' and upon completing an additional year of graduate work they receive the degree of 'Master of Science in Electrical Engineering.' The student gets his first course in the communication field in his junior year. He gets a year's course in radio engineering

in the senior year. Where men are specializing in radio, I select such elective courses as will be of particular value to them, such as 'Transient Electrical Phenomena' and 'Differential Equations.'

"This year the Electrical Department has approximately 80 senior students, about 40 of whom are registered in radio engineering. Not all of these 40 will, however, become radio engineers, as many of them will go into other fields of electrical engineering.

"We are obtaining an increasing number of post-graduate students who are specializing in radio communication. These students, in addition to advanced courses in electrical engineering, take advanced courses in physics and mathematics. Where possible, I recommend the fifth year.

"I believe our building and equipment excel that of the majority of institutions. We have approximately 7000 square feet of floor space devoted to communication laboratories and research rooms. In addition, we operate an experimental radio station and a broadcasting station."

The above summaries of communication engineering training which is offered at nine centers of higher learning afford a view of some of the main trends in the field. At some institutions there is little interest in communication engineering except as a part of general electrical engineering. The philosophy underlying this attitude is that industry is so highly specialized that it is hopeless to give a man more than the broad fundamentals at school, and that if this is accomplished, he will make his way after he gets into business by the addition of his common sense and the training provided by the job itself. Some of the large communication concerns, in fact, set up schools of their own for the engineers on the staff, evidently with the thought that the technological content of their particular jobs cannot be secured in any outside school. Many colleges, on the other hand, teach the theory and some of the practice of telegraphy and telephony, by wire and radio, to qualified students of junior and senior grade. Still others go further and, in addition to such studies, offer popular extension courses, correspondence study, and the like. If there is a demand for vocational study, for example, in a neighborhood, the local university is probably better qualified to fill the need than some primarily commercial institution. Study, even if it is not of the most scholarly sort, is not apt to do anyone harm, and it may do good, as long as it is not allowed to interfere with the rigorous and inexorably thorough training which makes a real engineer. Again, it may be argued that communication engineering courses deal with fundamentals just as much as the older power engineering subjects, that nowadays a vacuum tube is as important a machine as a dynamo. Different courses are for different people, we may conclude. If a man has the intellectual equipment, the money, and the time required for a thorough study of the subject he intends to make his lifework, by all means let him spend four or six years preparing himself. Let him specialize only after he has mastered the fundamentals. But if at some time a man wants to learn something special in a superficial way, no harm is done, provided he knows what he is getting, and does not take it for more than what it is.

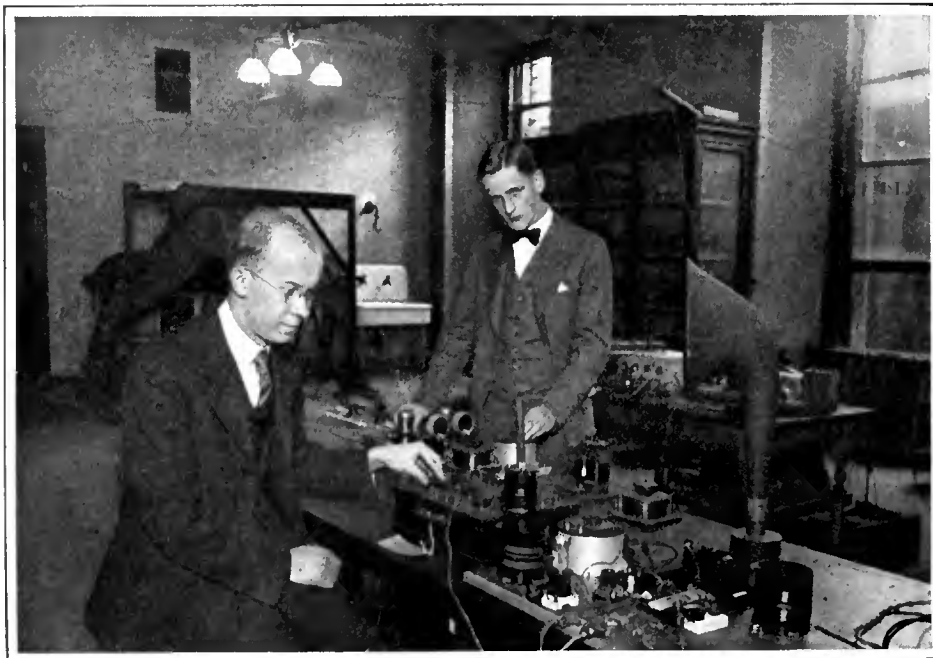

A CORNER OF ONE OF THE COLUMBIA UNIVERSITY LABORATORIES
Making measurements on a resistance-coupled audio amplifier in the Hartley Laboratory

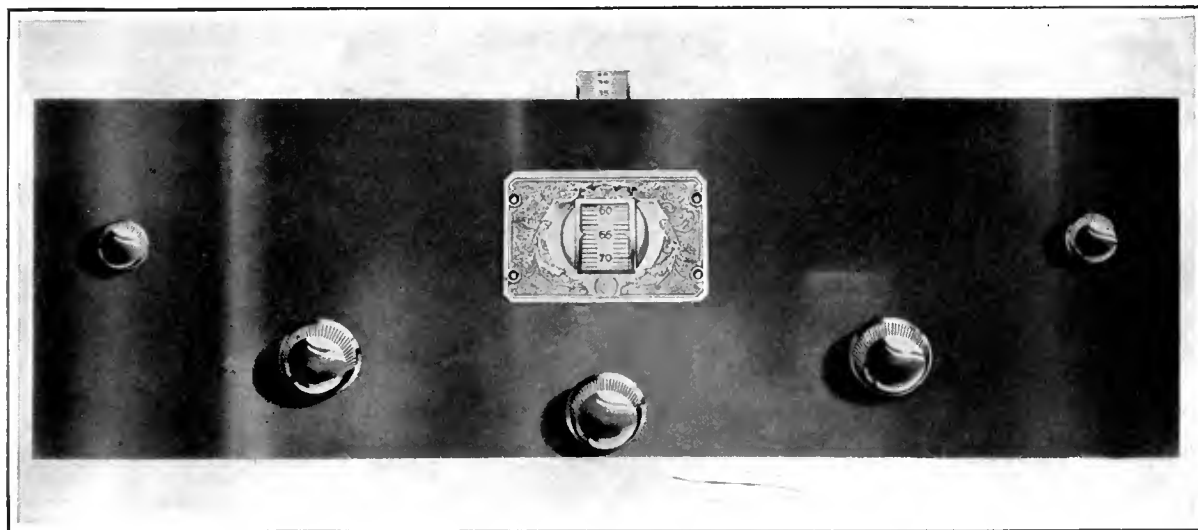

HOW THE COMPLETED TWO-TUBE TUNER LOOKS
The five knobs, from left to right, are: "On-Off" switch, trimmer condenser (C_3), main tuning control, volume control, regeneration control

An A. C. Browning-Drake Receiver

By Glenn H. Browning

THE Browning-Drake circuit has been popular for a number of years, due, probably, to the fact that the set is very easy to build and operate, sufficiently sensitive to receive most distant stations which are above the noise level, and selective enough to cope with present broadcasting conditions, except when located in extremely congested regions. The sensitivity of the set is primarily due to the tuned r.f. transformer which Dr. Drake and the writer developed a number of years ago at Cruft Laboratory, Harvard University. Also, the antenna tuning system, which is a conductively coupled one, gives more signal strength than any the writer has tested so far. This is especially true when operating the set with a short antenna.

The electrical engineering in the Browning-Drake receiver has been changed very little during the last three years, though minor improvements have been incorporated from time to time. With the introduction of a.c. tubes and the popularity of so-called single control receivers, however, it seems particularly advisable at the present time to change the mechanical layout of the receiver and add any refinements in the electrical design which constant work on the circuit have indicated as worthy of recommendation.

As most radio constructors know, the Browning-Drake circuit consists of one stage of tuned r.f. amplification with some type of neutralization, coupled to a regenerative detector. Any form of audio amplification may be used with this tuning arrangement, but, of course, the audio amplifier determines to a large extent the quality of the received signals.

This article deals essentially with the new two-tube receiver unit, employing a.c. tubes and making use of single control, and we will not go into detail about the audio channel. In passing, it might, however, be mentioned that the Browning-Drake Corporation supplies a foundation kit for a five-tube receiver, which includes the necessary sub-panel for the mounting of whatever audio equipment is used, and a larger

base panel than that used in the two-tube tuner unit described here.

After experimenting for some time with a.c. tubes two CX-327 (UX-227) tubes were chosen for the tuner unit. With a tuner constructed according to the instructions in this article, and used with a three-stage amplifier also wired for a.c. tubes, there is very little audible 60-cycle hum in the loud speaker. Sometimes it is necessary to experiment with the voltages used and also with the tubes in order to get the best combination, otherwise there may be some hum in the loud speaker, and the quality would be impaired.

The nucleus of the Browning-Drake set described here is what might be called a single drum control unit; it consists of a single illuminated drum type dial driving two variable condensers. The necessary coils for the two-tube

tuner are also an integral part of the drum unit. As antennas differ a great deal, it is advisable to put a small condenser in parallel with the first tuning condenser in such fashion that it may be controlled from the front panel, and variations in antenna length thus compensated. In actual tuning, this condenser is used as a minor control. In Fig. 1, the diagram of the complete tuner unit, this condenser is indicated as C_3 .

As will be noted, a slightly different system of neutralization than has heretofore been used is employed; also parallel plate-voltage feed for the r.f. tube is featured. The parallel feed, which consists of an r.f. choke coil in series with the r.f. B-battery lead, together with a 0.5-mfd. condenser, keeps all r.f. current from entering the B supply, and forces this current to go through

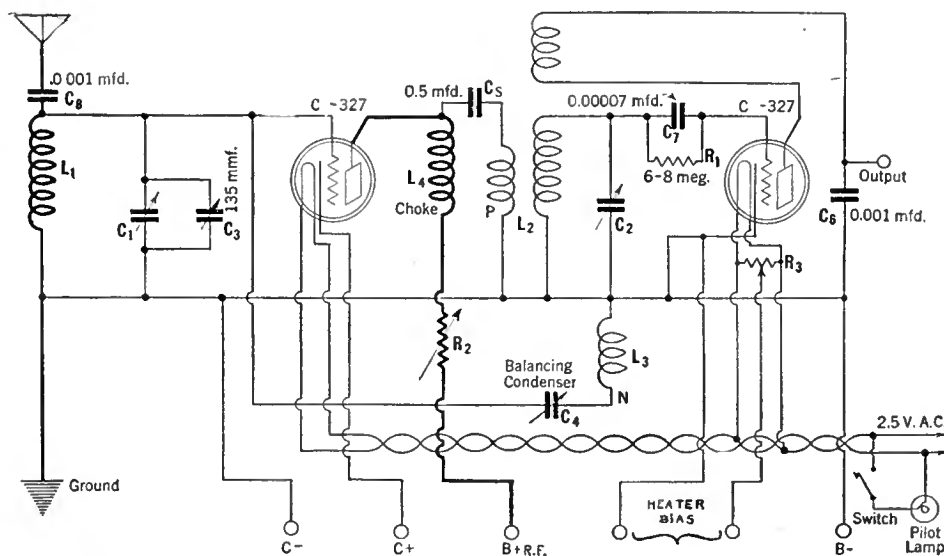
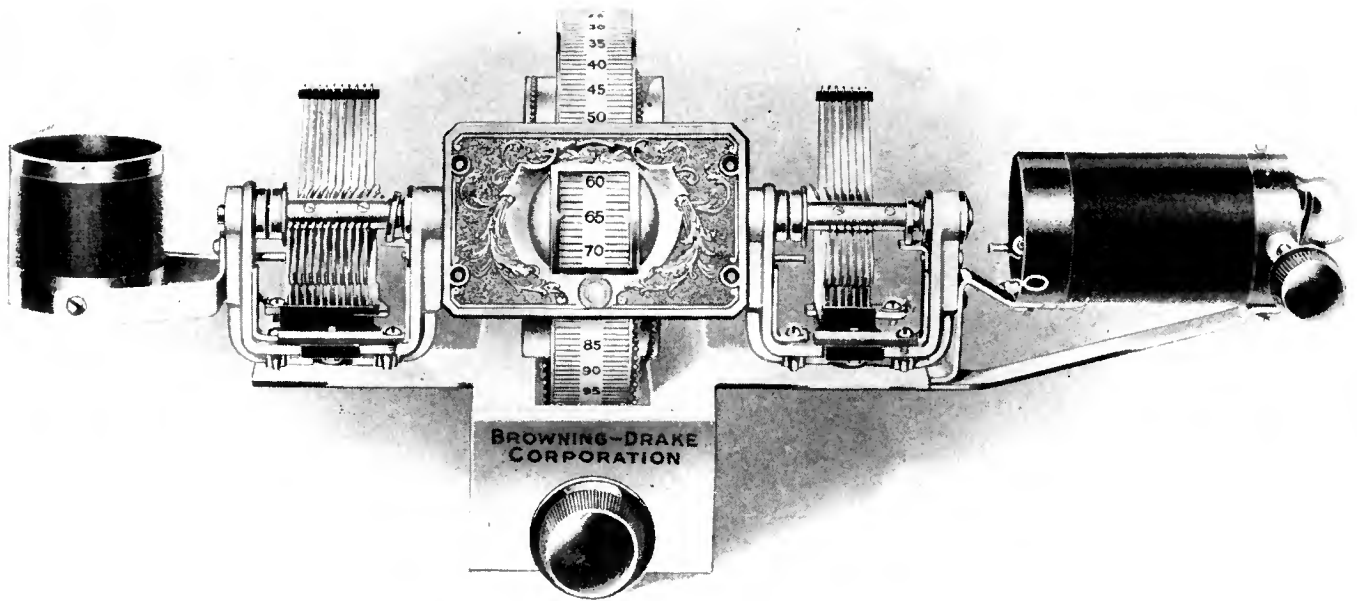

FIG. 1

This diagram gives the complete connections for the two-tube tuner unit. Manufacturers of a.c. tubes of the heater type state that less hum will be evidenced if the heater is biased with respect to the cathode. This bias may be plus or minus, depending upon which gives the better results.



THE NUCLEUS OF THE BROWNING-DRAKE A. C. TUNER

It is known as the single drum control, and comprises (refer to fig. 1, page 343) C₁, C₂, L₁, L₂, L, regeneration coil, and the receptacle for the pilot light

the 0.5 mfd. condenser and the primary of the r.f. transformer. Neutralization is then accomplished by means of a few extra turns, L₃, on the r.f. transformer, the end of which is connected through a neutralizing condenser, C₄, to the grid of the tube. In practice, it is necessary to have the stator plates of the neutralizing condenser connected to the grid of the first tube rather than the rotor plates. It is found that a tube with a much larger capacity between grid and plate can be tolerated by the use of the above-mentioned system of neutralization.

When the set builder is located in a very congested region and there are a number of local broadcasting stations within a radius of three or four miles from the receiver, shielding is to be recommended, and a complete shield for the Browning-Drake receiver will probably be commercially available soon. Such shielding eliminates all pick-up by coils and the wiring of

the set, and adds materially to the selectivity of the receiver when it is used under the above conditions. Where the set builder is located in the country or suburbs, shielding is unnecessary.

The parts necessary for the construction of the single-control a.c. Browning-Drake tuner unit are listed below:

LIST OF PARTS

Official Browning-Drake Single Drum Control Kit comprising C₁, C₂, L₁, L₂, L₃, the regeneration coil and pilot light socket \$26.00
 Official Browning-Drake Type T-2 Foundation Unit consisting of Westinghouse Micarta drilled and engraved front panel, base panel complete with mounting hardware. Also miscellaneous machine screws, nuts, and wire 13.50

L ₁ Browning-Drake Radio-Frequency Choke	2.00
C ₃ Browning-Drake 135-Mmfd. Trimmer Condenser	2.50
C ₄ Browning-Drake 30-Mmfd. Neutralizing Condenser	1.75
Yaxley Filament Switch No. 10 B-D	.60
C ₅ Tobe 0.5-Mfd. Moulded Condenser	.90
R ₁ Tobe 8-Meg. Grid Leak	.75
C ₆ , C ₇ "Tinytobe" Condensers (0.001 and 0.0007 Mfd.)	.80
C ₈ Mica Fixed Condenser (0.0001 Mfd.)	.75
Five Eby Binding Posts (Ant., Gnd., B + Amp., B + Det., B-)	.75
One Set of Shields (Optional)	8.00
R, Clarostat	2.25
R ₃ Browning-Drake Center-Tapped Resistor	.60
Two Benjamin Five Contact A-C Sockets	2.40
One Flashlight Lamp (2.5 Volt)	.10
TOTAL	\$63.65

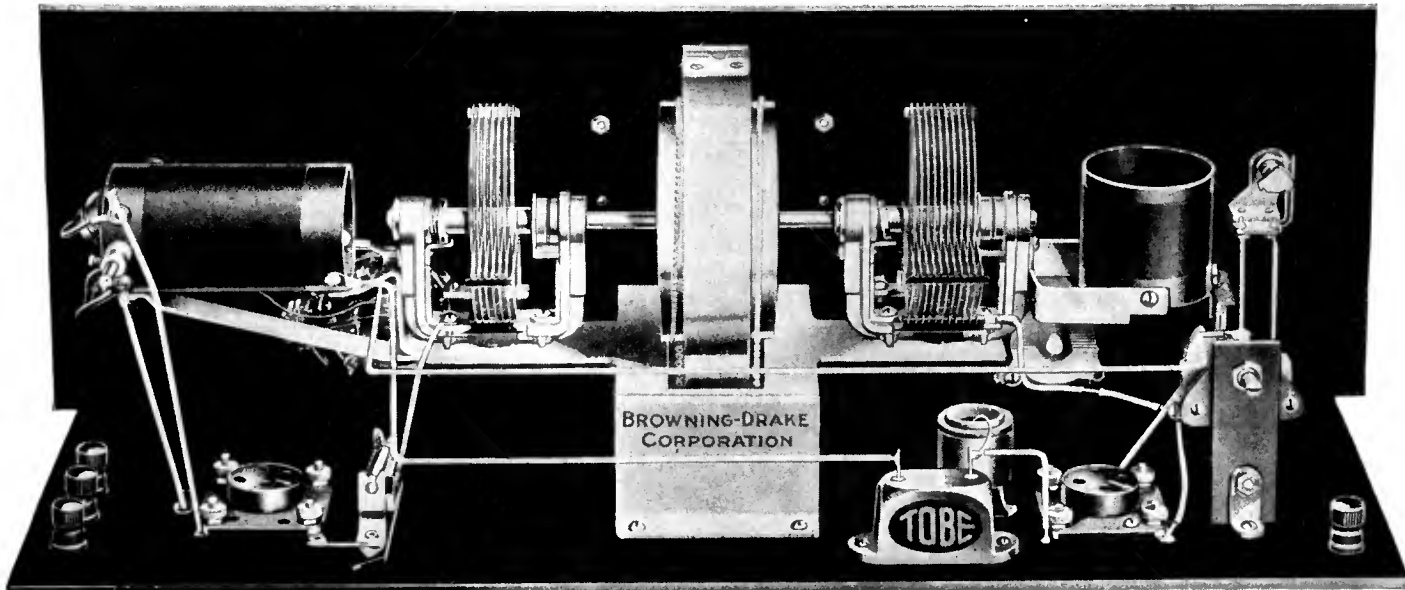

A REAR VIEW OF THE COMPLETE TWO-TUBE UNIT FOR D. C. OPERATION

After the parts are mounted on the drilled and engraved panel it is a simple matter to complete the wiring. The use of the single drum control unit greatly helps matters. This layout is similar to that employed in the a. c. model

CONSTRUCTION OF THE RECEIVER

THE receiver is very easy to build and for most set builders detailed constructional information is unnecessary. The leads running to the B supply and filament supply for the a.c. tubes are placed underneath the sub-panel, while the high-potential leads, which carry r.f. current, are placed above the sub-panel. These high-potential leads comprise:

The connection from the stator plate of the first tuning condenser to the grid of the first tube; the plate of the first tube through the 0.5-mfd. condenser, and from the 0.5-mfd. condenser to the primary of the r.f. transformer; the neutralizing lead, which comes from one end of the secondary of the r.f. transformer to the rotor plates of the neutralizing condenser. Of course, the connections between the grid leak, grid condenser, and the grid itself, should be as short as possible. These are the most important connections in the set, and they should be run as directly as possible and kept away from other connections

In connecting the A supply of the tubes, twisted pairs must be run from the power supply to their filaments. This is extremely important for if the wires are not carefully twisted together, a.c. hum may be noticeable. Also, the power apparatus, which should consist of a good B supply device and the necessary transformer for lighting the filaments of the tubes (the latter being either incorporated as a part of the B supply or as a separate transformer), must be kept several feet away from the receiver; otherwise there might be some 60-cycle voltage induced in the audio circuit of the radio set.

As will be noted in Fig. 1, a Clarostat inserted in the B plus lead of the r.f. tube is used for volume control. This the writer has found quite satisfactory as long as the parallel feed shown in the diagram is used. Some experimenting will be necessary on the C battery bias for the r.f. tube, as the voltage may vary between $1\frac{1}{2}$ and $4\frac{1}{2}$, according to the individual characteristics of the tube used.

BALANCING AND OPERATION OF THE RECEIVER

WHEN the set has been connected up according to the instructions given, and attached to the power supply (note: the filaments of the C-327 [UY-227] tubes take about 45 seconds to a minute to heat up sufficiently for satisfactory operation), it is ready to balance. Turning the tickler coil in one direction or the other should throw the second circuit into oscillation. This condition may be determined by placing the finger on the stator plates of the second tuning condenser, whereupon a distinct "click" or "plop" will be heard in the loud speaker. Then turn back the tickler coil until the circuit just goes out of oscillation. If the set is improperly balanced, turning the trimmer condenser slightly will throw the circuit into oscillation again, which state can be determined as before. The neutralizing condenser then can be varied by means of a wooden or bakelite screwdriver until turning the antenna trimmer has no effect whatever on oscillations produced in the second circuit.

There is another method which will give almost the exact point of neutralization. Tune-in a local station, remove one of the leads going to the C battery of the r.f. tube and, by careful re-tuning, the local station can in all probabilities be heard. Set the neutralizing condenser so that a minimum amount of signal is heard. This point

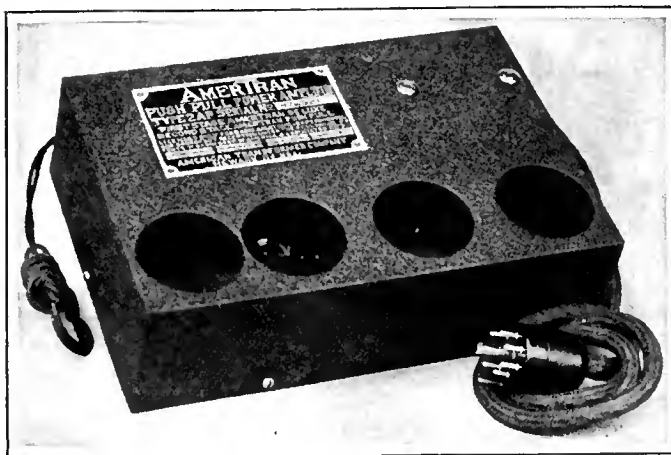

AN AMERTRAN PUSH-PULL AMPLIFIER

As mentioned on this page, it is a two-stage push-pull affair, provision being made for the use of either a 201-A type tube or an a. c. type tube in the first audio stage

on the neutralizing condenser is almost the correct one, and the test given above can then be applied for the exact point. It will be found that neutralization is quite critical. Of course, when neutralizing, the Clarostat should be turned up as far as it will easily go (in a clock-wise direction.)

In operation, the a.c. Browning-Drake is exactly like previous models. The tickler coil may be turned up to a point where the set is just oscillating and the dial rotated, whereupon a station will be indicated by a whistle. Set the dial where the whistle is lowest in pitch and turn back the tickler coil and adjust the antenna trimmer condenser until the signal is plainly heard. Readjustments of the drum dial will then probably be advantageous.

AUDIO-AMPLIFIER SUGGESTIONS

AS HAS already been mentioned, the choice of an audio amplifier is left entirely to the constructor. There are several amplifier units and plate supply units now on the market which have very good characteristics, and it is believed that the combination of such apparatus with the two-tube tuner unit described here will pro-

vide the user with as simple and as effective a receiver as he may need.

As an example of the type of audio-frequency amplifier and power supply that can be constructed and which will work very satisfactorily with the two-tube tuner, there is shown in Fig. 2 the circuit diagram of a combined push-pull amplifier and power unit which may be made from Amertran parts.

The amplifier is a two-stage transformer-coupled affair, designed to use in the first stage a C-327 (UY-227) type a.c. tube. The other two sockets in the amplifier are for the power tubes. Tubes of the CX-371 (UX-171) or CX-310 (UX-210) may be used in conjunction with either a type 271 (for 171 tubes) or a type 152 (for 210 tubes) Amertran push-pull output transformer. With a push-pull amplifier similar to that shown here, the comparatively large amount of undistorted power necessary for high-quality reproduction, can be obtained.

Completely assembled power amplifiers and A, B, C supply units can also be obtained from the Amertran Company. The amplifiers, when combined with the power units, result in a circuit differing slightly from that given in Fig. 2, in that they are designed to use either a CX-301-A (UX-201-A) or a C-327 (UY-227) type tube in the first stage, and CX-371 (UX-171) or CX-310 (UX-210) type tubes in the push-pull stage.

The type 2AP-10 amplifier is designed for CX-310 (UX-210) type output tubes while the type 2AP-71 is for CX-371 (UX-171) type tubes. Both of these amplifiers are the same in external appearance. The necessary Amertran power unit will furnish complete A, B, and C power to the push-pull amplifier and to all the other a.c. tubes used in the receiver proper.

The complete type 2AP amplifier (either type) lists at \$60, without tubes. A set of Amertran push-pull transformers, which might be used in the home-construction of a power amplifier, can be purchased for \$30. The Amertran power supply (the A, B, C Hi-Power Box) lists at \$55.00.

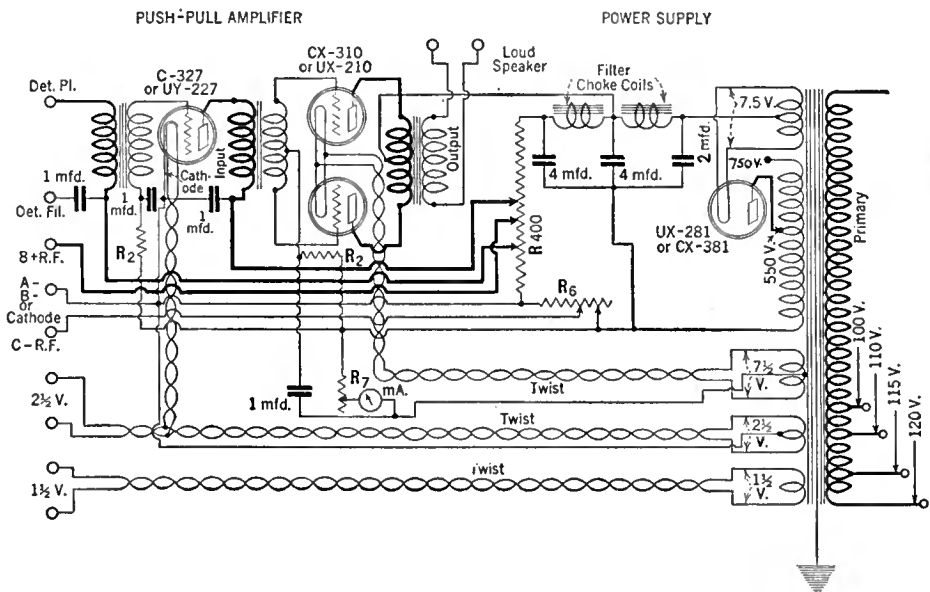

FIG. 2

The circuit diagram of an amplifier which may be used with the two-tube tuner unit. It is made with Amertran parts

THE MARCH OF RADIO

NEWS AND INTERPRETATION OF CURRENT RADIO EVENTS

What Is the True Broadcasting Situation?

WHENEVER we see the name of Senator Howell of Nebraska in print, our eyes blaze, because we consider him to be the man who, single handed, did more to obstruct the proper administration of radio during the last nine months than any other Senator. During the closing days of the last session of Congress, his was the only dissenting vote raised to a unanimous consent agreement to vote an appropriation for the maintenance of the Federal Radio Commission.

Thereby deprived of an appropriation, the Federal Radio Commission has been most seriously embarrassed in its labors. Its effectiveness has been crippled because a petulant Senator chose to throw a monkey wrench at the radio listeners of America. The Commission can issue orders to broadcasting stations, but has no means whatever of finding out whether those orders are complied with. When its members travel, they advance the money out of their own pockets.

Instead of a staff of expert observers with high-grade measuring instruments, the Commission has had nothing to guide it but the reports of the public, the complaints of station owners and the protests of politicians, advancing the fatuous claims of every broadcasting station represented in their particular constituencies, regardless of the public interest. The Commission has not been able to employ consulting experts in order to evaluate the numerous panaceas offered it in the direction of frequency stabilization, synchronization of stations, and to determine quantitatively the exact minimum spacing which may prevail among stations of various power combinations without heterodyning within their service areas.

Consequently, when we saw Senator Howell's name in a dispatch from Washington, we expected bad news for radio. The Senator, we find, is now engaged in a war with the ghost of monopoly, which he finds skulking behind every microphone radiating chain programs. He wants a Congressional investigation, perhaps as a vehicle of publicity, perhaps for some other purpose. He may suspect that Mr. Aylesworth, president of the N. B. C., once bought a lunch for a Federal Radio Commissioner or that George McClelland, vice-president of the same company, sent a basket of apples from his Queens fruit ranch to Sam Pickard. Whatever he finds will be sensational and well phrased for newspaper publication. To save time, we offer the proposed Committee's findings even before the hearings are arranged:

Does Monopoly Rule the Commission?

THE Federal Radio Commission, at this writing, has cleared twenty-five channels and picked the best stations in the country to utilize them. Naturally, these stations, since they have been well selected, are the ones which offer the greatest variety and the best type of program. Such programs are not available in every hamlet from which a Congressman comes, but are centered at the musical and artistic centers of the United States. From such centers, a company, the odious and monopolistic National Broadcasting Company, has offered a wire service to which independently owned broadcasting stations have subscribed, making superior programs available to them. This service has been conducted at a tremendous loss, met out of the treasuries of receiving set and accessory manufacturers so that their customers would derive pleasing entertainment as a result of their purchases and therefore continue to patronize them.

Utilizing the chain programs has made the subscribing stations superior in program value to those which must rely for their programs on the Squeedunk church choir and the piano-playing professor at a roadside speakeasy. And so, by selecting good stations for good channels, the Federal Radio Commission has become guilty of inflicting the Red, Blue, and Columbia chain programs upon practically all the

channels in the cleared band. This is the situation which Senator Howell will uncover, perhaps by spending a few hundred thousand dollars of the Government's money to do so.

We recognize, without the aid of a Congressional investigation, that this situation is not an ideal one. It would be much more desirable if only four or five leading stations on each chain, widely separated at such points as New York, Chicago, Denver, and New Orleans, for example, should be given clear channels so that long-distance listeners who are not within the service range of other stations on the chain can secure them via a cleared route.

The rest of the chain stations should also have good channels so that they can be heard throughout their service area without an annoying heterodyne. This requirement, however, does not call for a nationally clear channel, but merely one which is free of excessive congestion. The claimed service range of chain stations, as expressed in their prospectuses, on the basis of which they sell radio advertising, clearly indicates that nationally clear channels are not contemplated by them nor is national service attempted by all or any of their stations.

But certainly such stations as wjz, WEAf, WOR, WGY, and WGN are worthy of a nationally clear channel. Allowing five clear channels to each of the three chains would account for only fifteen of the twenty-five clear channels. The remainder should be reserved for some of the better stations, offering high grade programs from local sources, for example, WPG, Atlantic City, WBBM, Chicago, WCCO, Minneapolis, and WHAM, Rochester. These latter two do use chain programs but the excellence of their local programs ranks them high indeed.

We understand that WCCO, recognizing that chain programs are available from so many points and are therefore needed only locally, has decided to distribute its chain programs through a smaller Minneapolis station, which covers only the local Minneapolis-St. Paul area. The programs of WCCO will be almost entirely from local program sources, such as their famous symphony orchestra and other individual and distinctive programs, thus contributing to the variety of programs offered listeners near and far. This policy should be encouraged by offering such stations clear channels, thereby increasing program variety.

The long-distance listener, remote from the local service area of any broadcasting

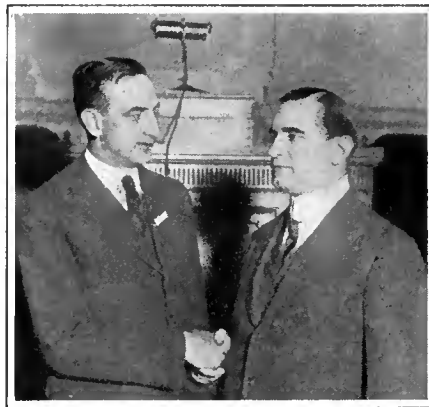

AT THE INSTITUTE OF RADIO ENGINEERS
The old president and the new. On the left, Ralph Bown, president for 1927, greets Dr. Alfred N. Goldsmith who has been chosen to lead the Institute for 1928. Doctor Bown is a radio engineer for the American Telephone & Telegraph Company and Doctor Goldsmith is chief broadcasting engineer of the Radio Corporation of America as well as one of the board of consulting engineers of the National Broadcasting Company

station, and that includes sixty or seventy per cent. of the radio audience, is not served if, with twenty-five cleared channels, he can hear but three different programs. Under those circumstances, there is no necessity for clearing such a large number of channels. Each clear channel means that three or four higher frequency channels must be more seriously congested. If greater program variety for the rural listener is not gained by additional channel clearing, it will soon cease. But, if there are sufficient independent stations, originating their own high-grade programs, or more chains, then the clearing process can continue even to the point where we have only clear channels with either independent or chain stations serving them and local channels for low- and medium-power stations.

At the present time, there is a monopoly of good program service, attained by subscription to the three chain programs—the Columbia and the Red and Blue Networks of the National Broadcasting system. This monopoly has been won by good service and by public tolerance. It is hard to name ten or fifteen independent stations truly worthy of cleared channels; the writer confesses he knows of but four, WPG, WCCO, WHAM, and WBBM, the latter more because of its good carrying qualities than because of any especially good programs. Of these, two use chain programs, but to a limited extent. The Commission would not for a moment hesitate to assign clear channels to good independent stations, but most broadcasting stations are hopelessly mediocre. The broadcasting band is much larger than is required to accommodate the good stations of the country. Southern politicians cry discrimination, but they cannot name five stations having program standards sufficiently high to attract consistent audiences outside their local service areas.

The Growing Political Pressure on the Commission

IN CONGRESS, the evaluation of a station is measured by the amount of pressure which the station owner can bring upon his particular Senator and Congressman. A Congressman can readily be induced to raise a large howl about the most puny, insignificant, puerile, useless, annoying, broadcasting station on earth. He can wax eloquent before the Federal Radio Commission and praise alleged services which he has never heard of except from the owners of the stations claiming to render them, an eloquence usually entirely unwarranted. Never would such an alleged statesman ask a local station owner to modify his demands for increased power or a clearer channel in the slightest iota in deference to the national situation and to aid in securing uniformly good broadcasting conditions all over the country.

We visited one of the most annoying and obnoxious stations in New Jersey which spreads a blanket of odoriferous advertising throughout the northern part of the

state. This station owner was able to show us a pile of letters which he had obtained by solicitation from his Senators and Congressmen, commending its service, although they had probably never listened to it voluntarily. These legislators urge the Federal Radio Commission to give that station special consideration over other stations in the metropolitan area of New York, simply because it means political support next time elections come around.

Our prophecy, made before the Radio Act was written, that placing broadcasting regulation in the hands of a Commission at the mercy of Congress would simply make political lobbying the criterion by which broadcasting rights are distributed, may, unfortunately, be fulfilled. The Commission has done its best to educate or to disregard the politicians, but both courses have their difficulties. If the Commission does not heed the politicians and their local needs and impossible requests, it is bound to suffer chastisement by failure to secure confirmation of its members, by curtailing of its appropriations or by special legislation requiring recognition of principles incompatible with good allocation but favoring station owners above the listening public.

Limitations to the Use of High-Frequency Channels

WE HAVE already mentioned the problem of selective fading on short-wave channels, which causes varying audio-frequency distortion, but there are a number of other points, equally potent, which must be considered when appraising the value of the short-wave region for broadcasting purposes. If the number of broadcasting stations on high-frequency

channels continues to increase, the short-wave DX audience will show continued growth. Any great increase in the number of radio receivers working on the short waves will render these waves useless for radio telephone reception because only a radiating regenerative receiver can be made to work on these waves. No sets have yet been built successfully which do not oscillate at the high frequencies, although the new UX-222 tube promises to make short-wave neutrodyne and super-heterodyne practical. With the receivers now available, however, tuning is so critical that the most skilful operator cannot avoid radiating whistles when tuning-in a station. Consequently, wide-spread listening will make the short waves even more disturbing than the broadcasting channels were during the oscillating receiver days of 1922 and 1923.

A channel utilized on short waves is international in scope, almost regardless of the amount of power used. Even a fifty-watt station, broadcasting on short waves, requires an internationally exclusive channel. Therefore, there are a maximum of 2700 channels in the entire world between 10 and 200 meters (30,000 and 1500 kc.), of which the United States might justly claim perhaps 250 for all purposes. Already the band between 25 and 50 meters (12,000 and 6000 kc.), is completely filled with stations and there are few blank spots in the remaining channels. Hence, instead of a vast unused ether territory, as those suggesting a broadcasting band seem to consider it, the high-frequency territory will soon have a congestion problem of its own.

The needs of broadcasting and the needs of the radio listener can be adequately met by a well allocated layout of broadcasting stations confined to the present broadcast-

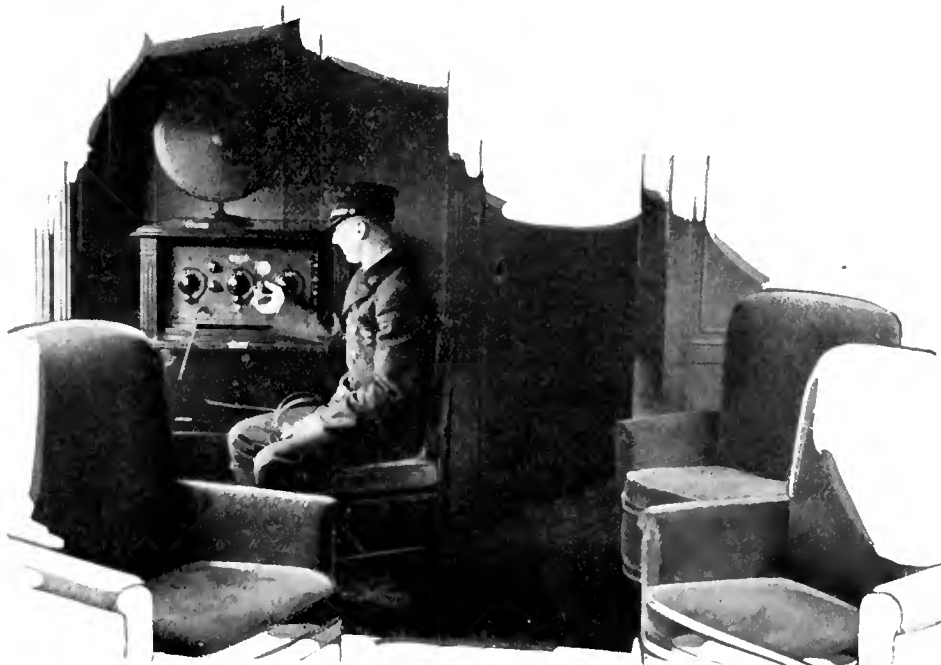

RADIO ON CANADIAN TRAINS

Many of the crack trains of the Canadian National Railways are equipped with radio receivers to entertain passengers on long daylight runs. The sets were especially designed for this service. Loop operation is not used, every set receiving its energy from a low antenna on the car

ing band. Such an allocation can provide ample program choice, equitable service for all parts of the country, and sufficient long-distance reception to meet the needs of the public for years to come. The present band is the only one ideally suited to broadcast transmission and reception. Stable, non-radiating receivers which can select stations ten kc. apart are easily made. Neither of these features can now be embodied in sets working on the high-frequency band. Below 25 meters (12,000 kc.) channels for radio telephony must be separated by 75 to 100 kc. because we do not yet know how to avoid cross talk with closer spacing.

A further difficulty is introduced by varying hour to hour transmission qualities of the high frequencies, which requires changing of the frequency of a station every few hours if it is to give reliable service between any two points. Short-wave, transatlantic telegraph communication stations need three and four channels in order to maintain satisfactory twenty-four hour service between two points on opposite sides of the Atlantic.

More important than any of these objections to the use of high frequencies for general broadcasting, however, are the needs of the world for short-wave, radio telegraph communication networks. The high frequencies are extremely prolific in telegraph channels. For speech and music, a frequency space ten kc. wide is required but, in a band of this width, fifty short wave transmitters could be accommodated.

This is assuming, of course, that means of establishing perfect frequency stability has been discovered so that a high-frequency station might stay exactly on its channel. While there would be a maximum of 2700 broadcasting channels in the ether space from 30,000,000 to 1,500,000 kc. or 200 down to 10 meters, there are actually about 275,000 potential telegraph channels.

The needs for these channels are literally enormous. Already they are extensively used in high-frequency beam transmission across oceans and even to the opposite side of the earth. They are needed for transmitting news to large numbers of newspapers by syndicate news services. They will be needed for the tens of thousands of aircraft transmitters which will fill the skies within a decade or so and which will depend upon radio for weather information and for the safety of the lives of the passengers. Navigation companies, railroads, bus systems, police and fire systems, and forest and water patrols, will require these channels in increasing numbers. Then there are a host of private communication systems in contemplation where the use of high-frequency radio service will effect tremendous economies and savings which will be reflected in the cost of goods purchased by the public. Department store chains, businesses having factory branches at widely distributed points, ranch owners who have to communicate with employees fifty and

a hundred miles away, lumber operators, packers and shippers, and numerous other services can use short waves and use them effectively.

There is need for ship beacons, fire and signal systems, aircraft service, aircraft beacons, landing field radio beacons, and a host of other services which dwarf radio broadcasting into insignificance so far as social and economic importance is concerned.

As radio listeners and as those participating in a large and prosperous radio industry, we are inclined to exaggerate the importance of broadcasting. The most important service which radio renders is in promoting the safety of the lives of those at sea. Radio has saved thousands of lives annually by bringing aid to ships in distress. The ships of the air are not as staunch as ships at sea, and radio is much more vital to their safety. Ether congestion will add material problems to the expansion of aerial navigation.

The clamor for short-wave communication in order to soothe the feelings of broadcasting station owners must cease. We have learned the lesson of conservation of forests and now go to great effort to replenish the trees which have been so ruthlessly cut. Once they are assigned to a service, there is no way of planting new ether channels. The mistakes of to-day are not easily rectified to-morrow.

The broadcasting stations, which go on short waves for any reason other than serious research or to effect the rebroadcasting of special international events, are doing so in order that they may claim to advertisers that they cover the civilized world. Without doubt, going down on short waves will bring responses from foreign countries. If all the letters received by all the short-wave broadcasters were put in a heap, it would be found that there are three men in South Africa, about ten in Argentina, and about thirty in Australia and New Zealand who are the sources of seventy-five per cent. of all of these letters. These short-wave transmitting outfits, for which so much publicity value is claimed, are serving audiences of very small numbers.

Broadcasting on the regular channels, it may be claimed, started in the same modest way, serving only small numbers. But it had the opportunity to grow because the medium was suited to good transmission and reception. That consideration does not apply to high-frequency broadcasting. It has dx fascination but not esthetic value. As a means of distributing goodwill programs, the short waves are useless because the musical reproduction is not sufficiently good to please the listener. Those who listen to radio for the entertainment will prefer the stabler low-frequency broadcasting band.

May the publicity-seeking gentlemen who solve the broadcasting problem by newspaper interviews cease misleading the public about the possibilities of short-wave broadcasting!

The First Rayfoto Transmission

THE backers of Austin G. Cooley are exhibiting pleasing conservatism in going forward with their Cooley Rayfoto transmissions. Instead of accepting the numerous offers to broadcast through every station which invites them to the microphone, they are still quietly conducting tests with the aid of qualified experimenters. Some twenty picture recorders are in the hands of experienced set builders and they are making radio pictures, sent occasionally during the early morning hours through WOR, of L. Bamberger & Co. Newark, New Jersey. If these twenty experimenters are successful in securing reliable and satisfactory pictures without special instruction or experience with the Cooley Rayfoto apparatus, more recorders will be distributed until the reliability of the apparatus is fully established. The equipment will not be offered to the general public until it has been fully tested by typical users to their entire satisfaction.

Mr. Cooley's representatives are being flooded with inquiries both from broadcasting stations and from experimenters who desire to purchase the apparatus. Phonograph records for transmission and testing, and the complete equipment, will be distributed as soon as existing receivers have been fully tested. The recorder at RADIO BROADCAST Laboratory has been very satisfactory.

Two Stations Cannot Occupy the Same Ether Space

A NEW YORK *Times* headline proclaims that Dr. Lee DeForest has discovered a covered room for 500,000 broadcasting stations. It is most irritating to read such misleading statements because they afford an excuse for not dealing with broadcasting conditions as they exist in the present. The remedies of to-morrow do not alleviate the problem of to-day.

Scrutiny of Doctor DeForest's remarks shows that the usually accurate *Times* misinterpreted what he said. He merely stated that there are some 6000 channels, with 10-kc. separation, between 200 and 10 meters (1500 and 30,000 kc.) and that perhaps 500,000 radio-telegraph stations could be disposed upon these frequencies if the double-heterodyne method of transmission, requiring the use of low-frequency super-audible, master oscillators, were employed.

Doctor DeForest also suggests that the same system might be utilized in the broadcasting band. Such a course would necessitate the complete scrapping of all transmitting and receiving equipment and add a delicate manipulation somewhat beyond the skill of the average listener, to the tuning process. The remedy would cost a billion dollars—or what you will—and would not even accommodate all our present stations.

Between 10 and 200 meters—considered a radio utopia by experts in publicity and politics, there are 27,500,000 cycles, or 27,500 kilocycles, of frequency space. At 10-kc. separation, which is necessary for ordinary radio telephony, there are 2750 broadcasting channels for distribution among all the nations of the world. Some twenty of these are already used by stations broadcasting on this band as well as their regular longer-wave channels some of which boast that they are broadcasting "to the civilized world" through their short-wave stations.

This is a misconception because the only persons who listen to broadcasting on the short waves now are dx cranks. No civilized person would seek musical entertainment on these short waves because of the existing audio-frequency

distortion for which no one has found a cure. Programs are quite distinguishable at enormous distances but they appeal to musical tastes about as much as a five-legged calf appeals to a stock breeder. To suggest relief from broadcasting congestion by pointing to the numerous high frequencies is as practical as offering the vast Arctic spaces to the overcrowded populations of India.

The problems of the broadcasting situation are extremely complicated. Experts have no easy remedies to offer. With the unwearied persistence of Cato, we repeat that excess broadcasting stations must be eliminated. The rights of the listener and the property rights of the broadcaster are in conflict. No one, not even the broadcasting station owner, at least when speaking for publication, denies that the listeners' rights are paramount. Therefore, the question centers on how great are the rights of the broadcasting stations involved because the broadcasting station owner must make sacrifices so that the listener may hear undisturbed programs.

The National Association of Broadcasters estimates that the total investment in broadcasting stations, as computed on March 1, 1927, is \$19,283,000. These figures were probably obtained in answer to a questionnaire and are therefore the broadcasters' own valuation of themselves. We are inclined to regard the figure as a good guess. The one hundred leading stations are probably the larger part of this investment. That leaves only about ten million dollars of disputed rights involved, of which only half need be confiscated to bring good broadcasting. If that problem is too great for the master minds in Congress to solve, we had better employ some foreign broadcasting experts.

Will the Radio Industry Do It Again?

WITH great secrecy, a score of manufacturers are designing new radio sets to utilize the experimental UX-222 (CX-322) tube. This tube is virtually a laboratory product, the much heralded double-grid type tube, having four elements. Everything points to a repetition of the radio industry's annual suicide because undoubtedly one manufacturer or another will soon startle the world with the statement that he has a set using this great tube which will make all rivals and predecessors obsolete. Then will follow the usual race and a score of manufacturers will announce new UX-222 sets, and all their previous models, some of them hardly perfected by experience, will go into the discard. In this way, the radio industry forces itself into a seasonal state and adopts new methods and types before the old ones are hardly introduced. The way in which the a.c. set was heralded completely ruined the business in battery sets. Everything points to a repetition of precedents, that the a.c. sets will be rendered obsolescent by the new UX-222 tube.

There is no sense whatever in this procedure. There is no reason for stopping the manufacture of touring cars and sedans because the roadster is popular. On the contrary, development should be pursued on all types because all have their particular and distinctive fields of service.

The annual destruction of last season's stocks by the vainglorious announcements of next season's improvements has forced the radio industry to concentrate its production during only four months of the year and to maintain its factories in virtual idleness during the remaining eight months of the year. Manufacturers do not dare to accumulate stock in excess of the immediate demands and the result of hand to mouth manufacture has been to re-

duce the quality and grade of workmen who can be attracted to the industry. Look at the advertising now current, and observe that the a.c. set has in no way reduced the simplicity, the tonal quality, or the usefulness of the battery-powered set.

The first radio set manufacturer who promises the public a revolution in radio next year by his UX-222 tube set should be squelched by the radio trade. He is paving the way to wreck the values of existing stocks of a.c. sets. The industry should determine, from now on, to make its announcements of new styles and types modest and in true perspective with the facts, and leave revolutions to Mexican bandits.

The Month In Radio

THE Secretary of the Navy's annual report states that 119,337 vessels were furnished 267,486 bearings by the Navy Radio Compass Service. The savings to other government departments by the use of the naval radio communications service amounted to about a million dollars.

IN A report on beam and directional short-wave radio telegraphy, issued by the Transportation Division of the Department of Commerce, V. Stanley Shute points out the advantage of the American beam system over the British. The American beam antenna requires only ordinary telegraph poles while the Marconi system uses expensive and complex steel masts. Another feature of the American antenna system is that provision is made for the melting of ice, overcoming serious difficulties in winter transmission. This feature is impossible with the Marconi beam. Other advantages, common to both systems of beam transmission, is the possibility of high-speed transmission, economy of power, and stability of the received signal.

Mr. Merlin Aylesworth, in his New Year statement, informs us that the Red, Blue, and

Pacific Coast networks, during 1927, spent approximately six million dollars in program presentation, of which over two million was for talent on sponsored programs, presented by some fifty American concerns. The Company itself spent a half a million dollars for its own sustaining programs. Wire cost, involving 10,270 miles of regularly used circuits, was in excess of \$1,350,000. † † † Our attention is frequently called to the verbose claims made by Norman Baker, operating direct-advertising station KTNB. He writes listeners that "his is the only station in America that is dedicated to the farm, labor, and general public's problems, which we will always fight for against powerful interests. Do you realize that advertising by radio, cuts overhead expenses so low, that merchandise can be sold at prices meaning from twenty-five to fifty per cent. saving to you?"

We have examined some of these prices, for example, the claim that Mr. Baker is selling "tires, far below others, in fact we sell 12,000 miles guaranteed tires as low as others ask for 8000 miles tires." Specifically, the 30 x 3 3/4 over-size cord, clincher tire, guaranteed for 12,000 miles, sells for \$7.70 through KTNB's radio emporium. The corresponding Sears, Roebuck, tire sells for \$7.75, making the possible saving less than one per cent. Can this be called a substantial saving?

There is no law protecting the listener against untruthful statements in radio advertising, although firms, subjected to unfair competition, may invoke the aid of legal protection on that ground. † † † Station 3 LO of Melbourne, Australia, has begun to transmit on 36 meters, and has been reported in many parts of the world. The station's organization has made application to install a number of relay stations with a view to making its programs available to all parts of the Australian continent. † † † The Mackay interests will erect a short-wave transatlantic radio station on Long Island to supplement their Commercial Cable Company's submarine cable service. The progress which has been made in short-wave radio telegraph communication makes it unlikely that any more cables will be laid in the ocean.

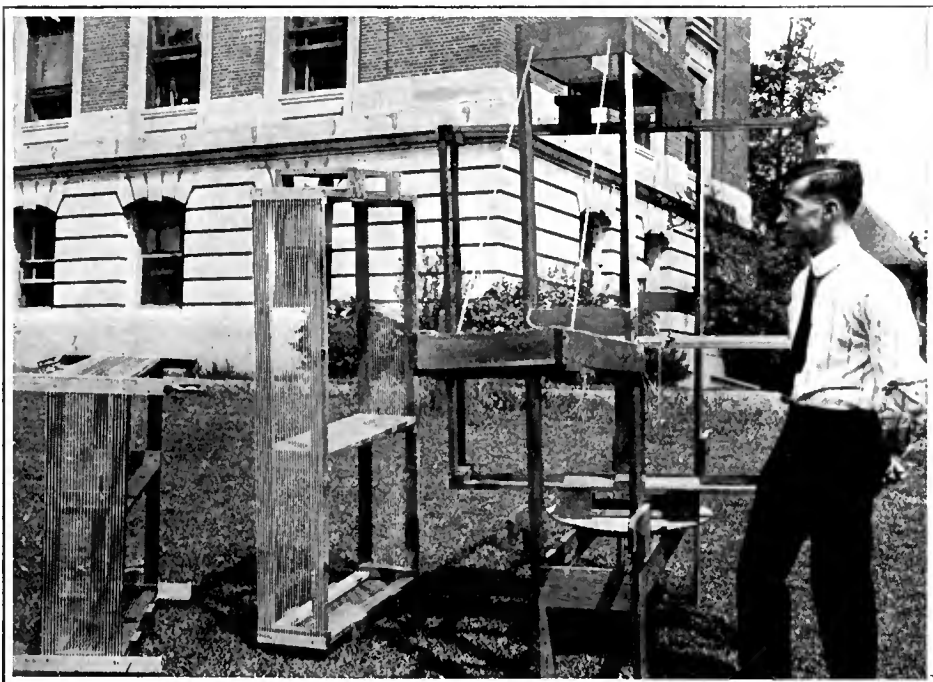

AT THE BUREAU OF STANDARDS

The illustration shows a field set-up for comparing "coil antennas," more familiarly known as loops

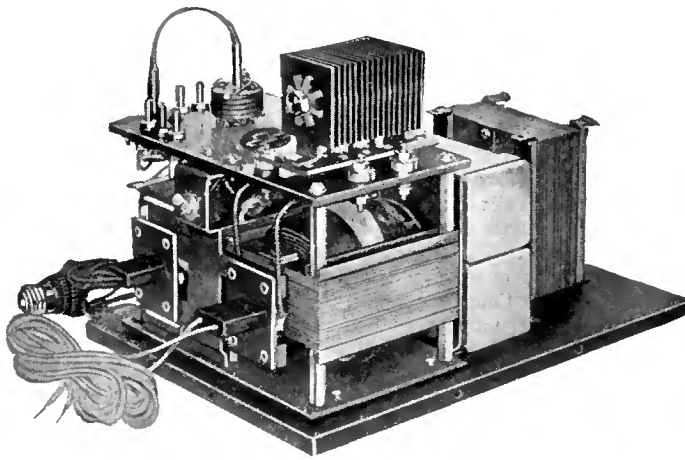

A HOME-CONSTRUCTED A SUPPLY
A view of the A power unit described in this article.
It is here shown with the metal cover removed

A New A Power Unit

By Ralph Barclay

THE convenience and desirability of a radio receiver that requires no attention other than to turn it on and off, is obvious, and to produce such a receiver has been the aim of set designers for the last few years. The problem has now been more less surmounted and it is possible to-day to purchase many receivers which are completely a.c. operated.

The design of apparatus for use in conjunction with existing battery-operated receivers to obtain socket power operation has also been satisfactorily solved, and preceding articles in RADIO BROADCAST have described many B power units and A power units which will give socket power operation of a receiver designed originally for use with batteries. These preceding articles have, however, described completely manufactured units, while it is the purpose of the present article to give the characteristics of the Knapp A power unit, parts for which can be obtained for home assembly.

The characteristics of the Knapp A power unit are as follows:

(a.) It can be used to supply A power directly from the light socket, to any receiver using up to about ten 201-A type tubes or combination of tubes drawing an equivalent amount of filament current. No changes at all are necessary in the receiver, the two leads from the unit merely being connected to the A plus and A minus terminals on the set.

(b.) The hum audible in the loud speaker when the tube filaments in the receiver are supplied from the power unit is so low as not to interfere at all with reception.

(c.) The cost of operation is very low—about 25 cents per month if the receiver is an ordinary five-tube set, in use an average of four hours a day.

(d.) The cost of a complete kit of parts from which the A power unit may be constructed is \$22.50.

(e.) The device requires no maintenance attention other than to turn it on and off.

The circuit diagram of the device is given in Fig. 1. The transformer, T, steps down the line

voltage to the correct value, the various taps on the secondary being used to adjust the output voltage. The taps are all numbered and the movable contact should be clipped onto a low-numbered tap if the receiver is a small one; if the receiver contains a large number of tubes, the clip should be placed on a high-numbered tap. The two condensers, C_1 and C_2 designed especially for use in this A power unit, and the filter choke coils, L_1 and L_2 , combine to make the final output of the unit free from hum. C_1 has a capacity of about 1000 to 1500 mfd. and C_2 has a capacity of between 1500 and 2000 mfd. It is the design of these condensers, in which compactness combined with high capacity is embodied, that makes possible the A device described here. The choke coils each have an inductance of about 0.1 henry, a resistance of 3 ohms, and a current-carrying capacity of approximately 3 amps. The rectifier, R, is a dry metallic one and the particular unit used in this power unit contains sixteen pairs of electrodes arranged in a bridge circuit to give full-wave rectification. At times, when the power is first turned on, the rectifier will spark over but this does not injure it in any way for the device is self-healing, a characteristic not found generally in rectifiers of this type. The rectifier has a life, according to its manufacturers, generally in excess of 1000 hours. It is held in place by several clamping screws and can easily be re-

placed when necessary. A new rectifier can be obtained for \$6.00.

A complete kit from which the power unit can be constructed should contain the following parts:

- T—Transformer Rectifier Unit
- C_1, C_2 —Special High-Capacity Condensers
- L_1, L_2 —Choke Coils
- Drilled Base Plate (Copper-Plated Steel)
- Drilled Top Plate (Brown Bakelite with Studs in Place)
- Contact Plate (With Mounting Bracket)
- H & H Toggle Switch
- Drilled Baseboard
- Metal Cover
- A. C. Line Attachment Cord with Plugs
- Output Cord for Connecting to Set with Polarized Plug
- Complete Instructions for Assembly and Operation
- Necessary Nuts, Screws, Clamps, etc.

The constructional data supplied with the kit of parts are very complete and with their aid, the building of the unit may easily be accomplished in an hour or two. The baseboard is all drilled and the first job is to fasten all the parts to it. The unit may next be wired with any ordinary kind of rubber-covered wire.

In order that it may operate most satisfactorily, it is essential that either the A plus or A minus be grounded. In most receivers one side of the filament circuit is grounded but in those cases where this is not true, it will be necessary to connect a ground between the A minus, preferably, and the regular ground post on the receiver.

Light socket operation of a radio receiver is, therefore, a simple matter using a Knapp A power unit and good B power unit. The Knapp A power unit is supplied with an extra plug into which the supply lead for the B power circuit may be connected, and the entire installation is then controlled from the single power lead on the A power unit, and turning on your receiver becomes a matter of merely pushing a plug in a light socket receptacle.

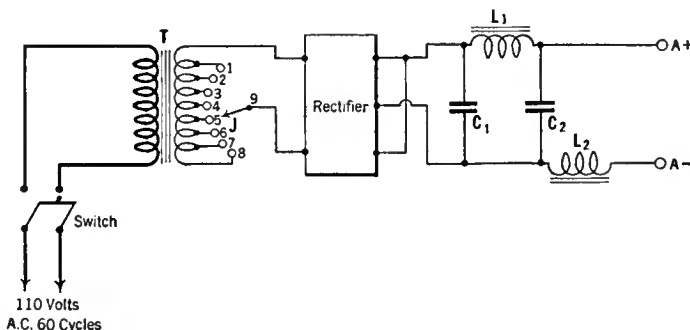

FIG. 1
A circuit diagram of the home-constructed A supply

Poorly-Designed Amplifiers

IN THE Laboratory at the present moment is an a.c. receiver with a well-known name

which uses a three-stage audio amplifier, two stages being resistance-coupled and one transformer-coupled. Although the power tube, a 171 type, draws no measurable grid current, and although the plate current of this tube is constant as measured by a d.c. meter, the quality is bad; something seems to overload. What is wrong?

The transformer couples the detector to the amplifier while resistance-capacity units connect together the remaining amplifier stages. There is no C bias on either of the resistance-coupled tubes (this seems to be standard practice, although one has difficulty in understanding why). To load up the final tube, 40 volts are required on its grid. Since the next-to-the-last tube is coupled to this power tube by a resistance-capacity unit, there is no voltage gain except that due to the tube. In other words, the next-to-the-last tube must have 40 volts a.c. in its plate circuit, necessitating about 5 volts a.c. on its grid, if the amplification factor of the tube is 8, which is correct for a 226 type tube. Five volts a.c. on the grid of a tube which has no C bias will cause severe overloading, and when a voltmeter is placed from the plate of this tube to the negative filament, the needle jumps violently. The voltage between negative filament and the plate battery side of the resistor shows a voltage which is found constant at 175 volts.

When the next-to-the-last tube overloads, considerable d.c. plate current is generated. This plate current generated in the tube, due to overloading, is opposite in direction to the no-signal plate current and the voltage drop across the coupling resistor due to this decrease in plate current reduces the voltage drop across the resistor due to the no-signal current. This allows more plate voltage to be impressed on the tube, so that the plate voltage varies from a steady no-signal value of 25 to 50 on the modulation peaks.

Now let us suppose that the transformer is used to couple the second stage of the amplifier to the power tube, which still requires 40 volts a.c. on its grid. The turn ratio is 3 so that across its primary are required $40 \div 3$, or 13.3 volts which, divided by 8, the μ of the tube, gives 1.67, which is the grid a.c. voltage which the next-to-the-last tube requires. If no C bias is used, much less severe overloading will occur than if 5 volts appear here, and in a fair loud speaker it is true to say that no loss in quality will be noticeable.

The answer is naturally to use C bias on all tubes, but if this cannot be done, the transformer should be used last in the chain. This is a better plan for another reason—that of using as high an impedance as possible in the plate circuit of the detector.

The plate resistors are each of 100,000 ohms value, and for a transformer to have that impedance at 60 cycles—which is as low a frequency as anyone need worry about—its primary must have 160 henries inductance!

This amplifier is clearly a case of poor engineering, and a small amount of pencil and slide rule work would have shown the designers of this receiver what could have been expected before they had even built one up and put it on the laboratory bench and tested it with expensive instruments.

"Strays" from the Laboratory

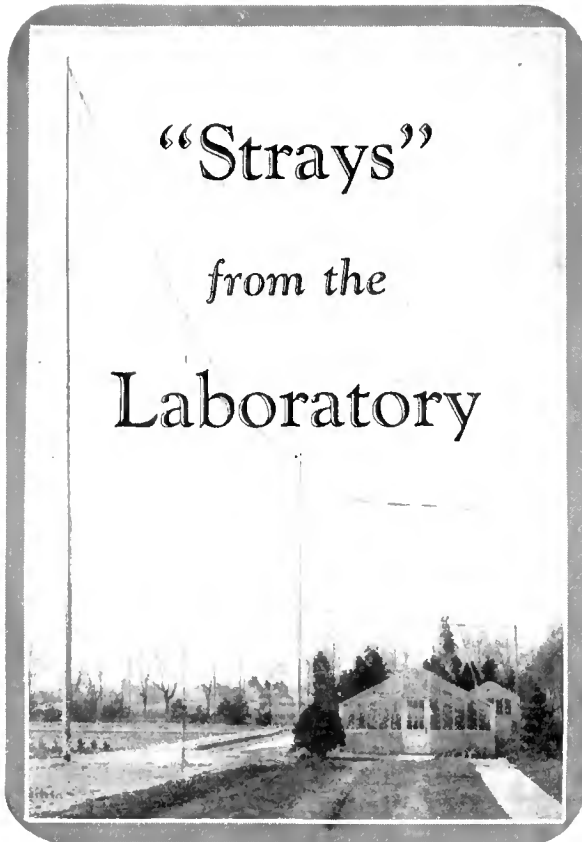

Quartz Transmitting Tubes

FROM time to time we read and are mildly amused, about the new glass substitutes which admit ultra violet into our homes—even in large cities where there is practically no ultra violet because of smoke. During the early development of the General Electric's fused quartz, which transmits 92 per cent. of all radiation, from ultra violet to heat,

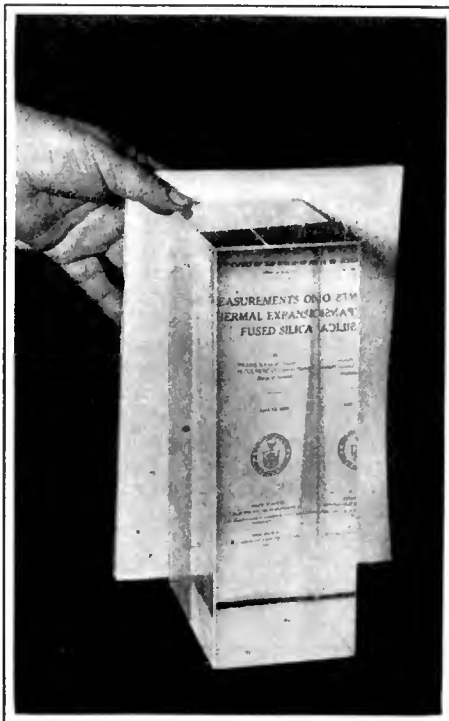

General Elec. Co.

A SLAB OF FUSED QUARTZ

The writing would not be legible through a piece of ordinary glass of equal thickness

we had the pleasure of working with Dr. Berry of the General Electric Company and the Harvard Cancer Commission, on some uses of this beautifully transparent glass.

Fused quartz has another important quality in addition to its transparency to ultra violet. This is its coefficient of expansion which is so low that it is possible to grind telescope lenses of quartz without the many hours of slow work necessary when our best lens glass is used. Under the heat produced by the grinding process the quartz expands so little that there is no danger of cracking, and it is possible to grind the lens to the desired dimensions with less regard to internal mechanical stress.

One of the great difficulties with high-power transmitting tubes lies in the heat generated, which must be dissipated without danger to the glassware. Water-cooled tubes mark one step in the development of safe high-power tubes; another may be the use of fused quartz, as is being done experimentally in England.

We remember a demonstration in a motion picture projection room where glass condensing lenses are used which get very hot and which occasionally crack because of the severe mechanical stress in the glass. A pair of lenses had been made—large pieces of convex quartz carefully ground and polished—and were taken to the motion picture house for test. They worked beautifully, of course, and after the show it was necessary to remove the lenses and take them back to the laboratory.

This would have meant a delay of appreciable time for them to cool if they had been made from glass, but despite the operator's disclaiming any responsibility (the quartz lenses were worth their weight in gold) the lenses were removed, thrown into a pail of water, and within a very few moments they were sufficiently cool to be removed to the laboratory.

While there is no prospect that there will be any need to cool a 100-kw. tube as quickly as this, or that anyone would want to carry such a tube around, hot or cold, a tube that is impervious to temperature changes will relieve engineers from one worry at least.

Fused quartz is wonderfully transparent; one can read a paper through a yard of it; it expands but little under application of heat and, as a matter of fact, is difficult to heat because the radiation passes through it without being absorbed. It has another characteristic—it is frightfully expensive.

Quiet A. C. Sets

SOME interesting tests have been made by the manufacturers of Kuprox, one of the dry rectifiers, on using a combination of rectifier and a.c. tubes. In every case the audibility of hum emanating from the receiver was decreased by the use of partially filtered a.c. on the filaments.

One receiver was a standard five-tube set using McCullough a.c. tubes. With d.c. throughout, the audibility of hum—the origin of which was unknown—was 2; with a.c. on the heaters of these tubes, the hum rose to 250 audibility units, and dropped to 46 when the Kuprox rectifier and a single choke coil was used to rectify and partially filter the a.c. Another receiver was a well-known product requiring no batteries. With d.c. on the filaments and a socket power device for supplying the plate current, the hum was from 120 to 150 units as measured on a General

Radio audibility meter. When the special a.c. converter supplied by the manufacturer furnished power for the filaments, the hum increased to 1000 units, but dropped to from 90 to 120 when the Kuprox was added.

While we do not agree with the manufacturers that Kuprox is "the most important discovery in radio since the first three-element vacuum tube was successfully used", and cannot agree with advertising writers of a.c. sets who state that there is absolutely no hum from their sets, if a Kuprox unit, or other rectifier, and a choke coil, will enable one to use a.c. tubes without appreciable hum, we are willing to advise our friends to go in for a.c. receivers.

At the present moment it is difficult to subscribe wholeheartedly to the apparent craze for a.c. sets. Without a doubt the ultimate receiver will require no attention, will be fool-proof, and will operate from any lamp socket, but at the present moment we are not convinced that we should junk our storage battery and charger outfit, which is perfectly quiet and which requires an expenditure of about eight minutes a week to put on and take off the charger, for a new-fangled receiver that can be neglected as soon as it is plugged into a socket.

While on the question of a.c. operation, we might give the following data on Radio Corporation of America a.c. tubes, which come from the Technical and Test Department of that concern, and are average data of a great many measurements:

MEASUREMENTS MADE WITH D.C. FILAMENT SUPPLY

UX-226

$E_f = 1.5$ v.; $E_c = -9.0$ v.; $E_p = 135$ v.

Plate Impedance	8000 Ohms
Amplification Factor	8.2
Mutual Conductance	1050 Micromhos
Filament Current	1.05 Amperes
Plate Current	5.2 mA.

UY-227

$E_f = 2.5$ v.; $E_c = -6.0$ v.; $E_p = 90$ v.

Plate Impedance	9810 Ohms
Amplification Factor	8.9
Mutual Conductance	907 Micromhos
Filament Current	1.75 Amperes
Plate Current	3.1 mA.

Into What Impedance Should the Tube Work?

CONSIDERABLE uncertainty seems to exist in the minds of popular writers as to whether the impedance

into which a tube works should be equal to that of the tube or several times greater. The answer is that it all depends.

If any source supplies power to a load, the

maximum output of power will be absorbed when the effective resistances of the source and the load are equal and when the reactances are equal but opposite in sign. Under these conditions the power absorbed will be the voltage squared divided by four times the effective resistance of the source.

In other words, to supply power the numerical value of the impedances must be equal—to use the usual semi-technical language.

If a tube is to be used as a voltage multiplier, say in a resistance-coupled amplifier, greater amplification will result if the load resistance is several times that of the tube resistance. In a transformer-coupled amplifier, the impedance which the tube looks into—the effective imped-

tube and a 10,000-ohm load. Since greatest amplification will result if the load has, say 30,000 ohms impedance, shall we add 20,000 ohms to the plate circuit? The answer is no, unless the voltage across the entire 30,000 ohms is made use of, and not that across the 10,000-ohm load alone. If the additional 20,000 ohms can be included in the load, somewhat greater voltage amplification will result.

Audio Transformer Measurements

THE LABORATORY has recently had the pleasure of measuring, according to the N. E. M. A. standard method already described in these columns, the voltage appearing across the secondary of the new Sangamo Type A audio transformer when a constant d.c. current flowed through the primary, and when a constant a.c. voltage was impressed upon the primary in series with 11,000 ohms. The circuit is given on this page as well as a curve representing the result of the measurement, which should be interesting to all pursuers of fidelity in reproduction.

As mentioned before, we do not believe measurements, such as this, on single transformers without accessory tubes and common impedance which always exist in a standard two-stage amplifier, mean a great deal, because we have

found in practice that the curve obtained by measuring the voltage across an output resistance of a two-stage amplifier may differ altogether from what one obtains by measuring a single stage only. This should not be taken to indicate that a two-stage amplifier using Sangamo Type A transformers would not be as good as is indicated in our curve—it might be better. It all depends upon the care taken in the construction and the amount and kind of feedback existing in the circuits.

A single Silver-Marshall type 220 audio transformer falls off badly above 3000 cycles when measured singly, while a two-stage amplifier using these transformers is perfectly good up to 5000 cycles, the additional amplification at these higher audio tones being due to regeneration. Many two-stage amplifiers will howl or sing at the higher audio frequencies if sufficient impedance exists in the common negative plate-battery lead. This difficulty is easy to remedy, usually, and necessitates the use of a 2-mfd. condenser across the B batteries, or socket power device. The transformers used in such amplifiers usually have a rising characteristic when measured singly, as was done in the Laboratory to measure the Sangamo transformer.

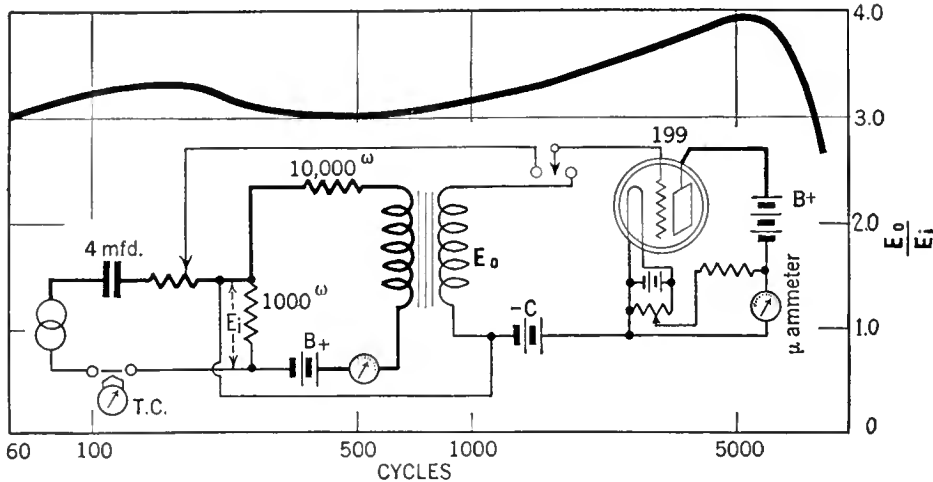

A CIRCUIT USED FOR TRANSFORMER MEASUREMENTS

In the Laboratory the voltage appearing across the secondary of a new type A Sangamo audio transformer was measured with this set up with a constant d.c. flowing through the primary and a constant a.c. voltage impressed upon the primary. The resultant curve is also shown here

ance of the primary of the transformer,—should be several times the impedance of the tube at the lowest audio frequency which it is desirable to transmit. At the higher frequencies a combination of effects takes place to maintain the amplification more or less flat. With a good transformer, that is, one which has a very high primary impedance, and a high impedance tube, the amplification will still be peaked. This is the price one pays for amplification—loss in fidelity. If it were possible to make a tube whose impedance would be low and still have a high amplification factor, it would be possible to use good transformers and have high amplification and a high degree of fidelity. Or, if it were possible to build 10:1 ratio audio transformers which would not "go resonant" and otherwise cause trouble at audio frequencies, we should have high gain and high fidelity—but here again we are in difficult water.

This impedance matching problem prompts one reader to ask if it is wise to add resistance to a tube plate circuit in case we desire the tube to work into a resistance several times the internal impedance of the tube and if the load impedance is not this great. A concrete example will illustrate the question. Suppose we have a 10,000-ohm



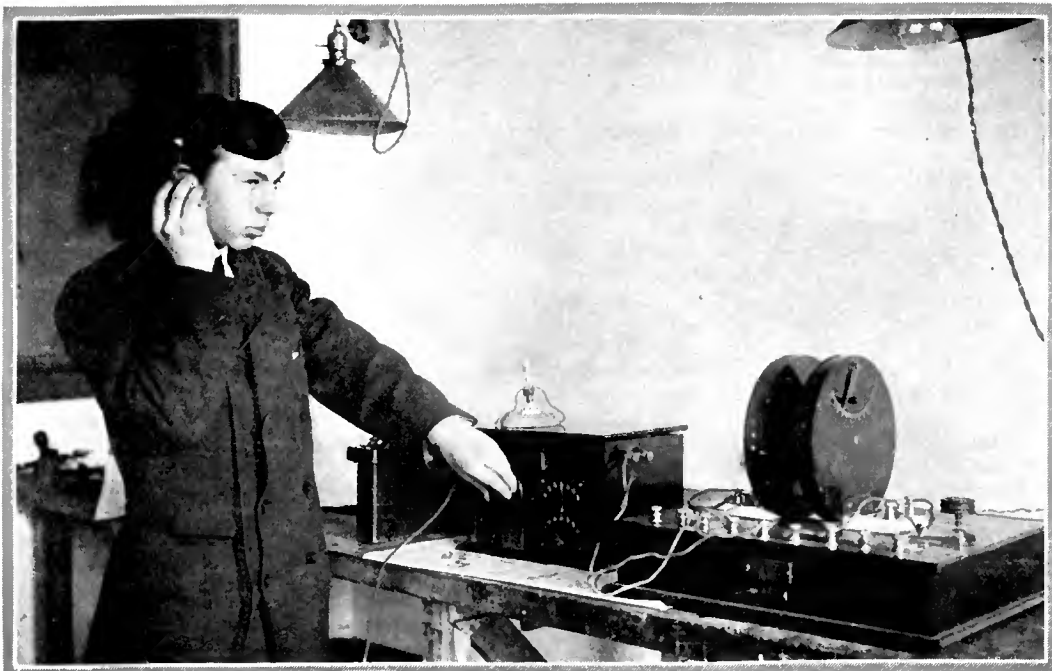

AN EARLY PICTURE OF MR. HOGAN

He is here shown using the first audion ever made, at which time he was DeForest's Laboratory assistant

An Interview With J. V. L. Hogan

By Edgar H. Felix

NO INDUSTRY is more clearly the product of inventive ingenuity than radio. If necessity is the mother of invention, radio must take after its paternal parent—creative imagination. It has grown to its imposing importance, not by virtue of necessity, but by discovering for itself a new field—the bringing of entertainment into the home.

"It is my belief" says John V. L. Hogan, pioneer radio engineer and technical authority, "that a vital and fundamental change has taken place in the spirit of the industry. Instead of a competition of ingenuity, the majority of manufacturers are now content to copy the designs of a few leaders who shape the trend from season to season."

Mr. Hogan is qualified to speak of the spirit of the radio industry because he has been intimately associated with the progress of that industry for more than twenty years. Shortly after Marconi had sent his famous first signal across the Atlantic in 1901, Hogan, then a boy in his teens, witnessed a demonstration of wireless telegraphy at the University of Wisconsin. Two years later, he spent a summer at San Juan, Porto Rico, most of it within the four walls of the radio station there. As it has with so many after him, radio made short work of its victim, imbuing him with its incurable fascination. From then on, radio has been his principal interest in life. He did not lose time in associating himself with the best minds in the art.

During 1906 and 1907, Hogan worked as DeForest's laboratory assistant and, in that capacity, used the first audion ever made. After his association with DeForest, he continued his studies at Yale University, specializing in mathematics and physics. But, before his work was completed, Reginald Fessenden, recognizing his natural ability for conducting experimental

work, employed him to assist with his experiments at Brant Rock, Massachusetts. Here, in 1909, the Arlington Naval Station transmitter was designed, assembled, and tested. Mr. Hogan's association with Fessenden extended over a period of many years.

After completion of the Arlington transmitter and its acceptance by the United States Government, Fessenden and his National Electric Signalling Company transferred their activities to Bush Terminal in Brooklyn. Hogan became chief research engineer and later manager of the company.

In the laboratory, operated under his direction, the basic principles for continuous-wave transmission were formulated by Fessenden. The first successful, high-frequency alternator was built for Fessenden at the General Electric Laboratories. E. F. W. Alexanderson, already distin-

guished by his achievements in electric railway locomotive design, was assigned to the problem and successfully built and later perfected the high-frequency alternator. These were fruitful periods of research, both in transmission and reception. Hogan is credited with many inventions, perhaps the most important of which is the detector heterodyne which he described in the Proceedings of the Institute of Radio Engineers in 1913. He was a founder and later became president of that body.

Fessenden is the inventor of the heterodyne principle. In its original reduction to practice, two windings in the telephone receiver were used, one to carry the incoming detector signal and the other to superimpose the local high-frequency oscillations. Hogan's invention is the method of combining the incoming signal with the local heterodyne signal before detection by an electrical rectifier. Owing to the square law action of the detector, enormous increases in sensitiveness are attained, accounting largely for the effectiveness of the regenerative and super-heterodyne systems. He was also the first to disclose the advantages of single control, so widely applied in broadcast reception, even before the various tuning circuits of receiving sets followed any law of regular and equalized progression.

Identified so closely with the early growth of radio, Hogan is now recognized as a leader in the patent and engineering fields. His views on the patent situation of to-day and the causes underlying its complexity are founded on the best possible authority.

"Contrasting with the early tendency toward extraordinary ingenuity," said Mr. Hogan, in answer to the writers' request that he amplify the statement which opened the interview, "the radio industry has largely adopted the habit and practice of copying the designs developed by



J. V. L. HOGAN

the leaders of the industry. For example, the most widely used modern radio receiver, almost a standard design for the entire radio industry, is the alternating-current, tuned radio-frequency set, employing no batteries, self-contained with all the necessary power supply, and using a single-control tuning system.

"Following so closely the same design principles, practically all makers use the same inventions, covered by the same patents. With such a formidable array of patents, some adjudicated and some not, the decisions of the courts are bound to have salutary results upon the economic situation in the radio industry. As an example of the effect of only a single patent, the recent adjudication of the Alexanderson tuned radio-frequency patent was sufficient incentive to more than twenty of the leading manufacturers of the industry to obtain licenses from the Radio Corporation of America, which holds the right to issue licenses under this patent. If future adjudications continue favorable to the Radio Corporation, these licensees will not suffer any great changes in their status. But suppose that the Latour, the later Hazeltine, the Lowell and Dunmore patents, and some of the other patents whose scope and validity are not yet tested in the courts, should be adjudicated in favor of their holders, there may be another set of substantial royalties to pay. The holders of patents applying to vacuum tubes, such as the thoriated filament, pure electron discharge, and the magnesium keeper, may collect large penalties from independent tube manufacturers who have so far disregarded them.

"The radio industry has problems still ahead of it," continued Mr. Hogan, "although there is no doubt that they do not mean its destruction or its paralysis. Their existence is due to a very fundamental weakness in the present conduct of most manufacturers in the field, namely, the tendency to stereotype and imitate.

"The radio industry has not always been prone to follow the designs of its pioneers, but showed independent inventiveness on the part of many

individuals. Marconi, in the early days, held a patent on the insulated, grounded antenna. Instead of waiting for the adjudication of that patent, or entirely disregarding it, rival inventors worked out means so that they would not have to use the Marconi antenna system, by devising the loop type of aerial for instance.

"In the field of detectors, after the coherer and the magnetic detectors had been invented, the manufacturers in the field simply developed other forms of detector. The electrolytic of Fessenden, the crystal detector, and the three-element vacuum tube of DeForest, each a valuable contribution to the industry, were invented to improve service and, at the same time, their manufacturers and users were practically cleared of infringement of existing patents. Thus patents, instead of serving as a constricting and restraining influence, were the stimulus to making some of the most important inventions in the radio art.

"Only three sensible courses are open to those who find patents apparently covering devices which they desire to make or actually do make," said Mr. Hogan. "They are either pay, or fight, or don't use. The second of these is often hazardous. Many members of the radio industry elect a still more hazardous course—to use without paying until patents are adjudicated. Naturally, these are likely to have to pay dearly in the end. Many of those who fight do so in the spirit that patents are a danger and a menace, to be fought and destroyed, though this is obviously not a sound position. When forced to do so, they pay reluctantly because there is no other course open to them, rather than encouraging inventions and utilizing them legitimately and without restriction. The alternative of developing new means so as to avoid infringement is the one least used, although it is the course that would contribute most to the progress of radio."

Mr. Hogan cited specific instances of unadjudicated patents which are almost universally used by the industry and which manufacturers are seemingly making no effort to circumvent by

developing substitute or improved means. He even showed how, in the field of broadcast transmission, the tendency is to endeavor to make the best of conditions as they are instead of attempting seriously to develop and put into use new means and methods.

Mr. Hogan has had exceptional opportunities in studying transmission phenomena. Fessenden was one of the first to build a successful radio telephone transmitter, having established a record of several hundred miles' range as early as 1906. When the Arlington transmitter was still installed at Brant Rock, prior to its acceptance by the Navy, a most comprehensive series of tests, the first extensive study of radio transmission phenomena, were made with its aid. Data as to attainable range, with various powers, at all hours, were collected aboard the U. S. S. *Birmingham*. Out of this mass of data, the historic and useful Austin-Cohen formula was worked out. Hogan was intimately concerned with these tests, being in entire charge of the Brant Rock end. With such pioneer study of transmission phenomena as a foundation and the many subsequent years of research and contact, his suggestions as to the most effective way to attack the present broadcasting problem are worthy of most profound consideration.

"The limitations of our ether channels are almost as definite and specific as familiar laws of physics," Mr. Hogan stated to the writer. "The number of solid bodies of a certain size that can be fitted into a room of certain dimensions is readily calculated and no one attempts to deny the operation of the law which determines it. In the available ether, likewise, there are just so many broadcasting channels, each of which can accommodate just so many stations of a certain power. There is no evading this law. If we squeeze more programs than fit in our ether space, the programs are certain to be damaged.

"The number of stations which can be accommodated in the broadcasting band is directly a factor of their power. Either we maintain many stations comfortably in the band by reducing their power, or we increase their power and reduce the number of stations. If we exceed the capacity of the ether, as we are doing at the moment, we have confusion. There is no successful evading of technical laws upon which the capacity of the ether is founded, unless we establish new laws by making new discoveries. As in patent tangles, so in ether tangles, inventions may cut the Gordian knot.

"To continue to increase the number and the power of stations on the air, we must attain such objectives as perfect synchronization of carriers and their modulation, limitation of carrier range to the area actually served by programs, or modulation of the carrier in a new way which narrows the band occupied by a fully modulated carrier. None of these things is impossible, but how much more energy is spent by broadcasters in clamoring to stay on the air than in developing the means which will make room for them on the air.

"Founded, as the radio industry is, upon ingenuity and invention, the work of the research laboratory is still its most valuable asset and is still the only really effective gateway to the solution of its problems. Mere imitation is fatal to its growth and to its economic future. To-day, for every dollar spent on research, hundreds of dollars are spent on imitation. The crying need of the industry is research and originality, the employment of engineering genius and continuous technical growth. With proper concentration on these factors, patent difficulties will be mitigated and the fullest potentialities of the industry and its field of service will be developed."

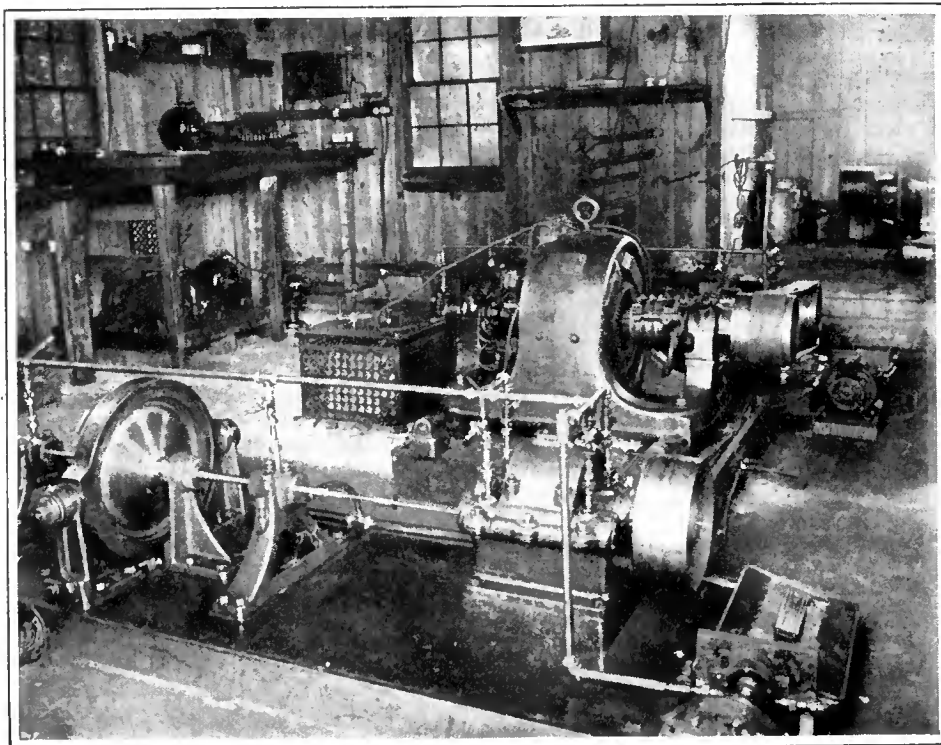

THE FIRST PRACTICAL HIGH-FREQUENCY ALTERNATOR

It was built for Fessenden at the General Electric Laboratories, by E. F. W. Alexanderson. The latter is now in the public eye on account of his television experiments



RADIO BROADCAST Photograph

THIS IS HOW THE COMPLETED RECEIVER LOOKS
It fits into any standard cabinet that will take a 7 x 18 inch panel

A Four-Tube Screened-Grid Receiver

By McMurdo Silver

THE four-tube all-wave receiver described herewith represents what is probably the most profitable application to a radio receiver of the new screened-grid tube, from a performance per dollar per tube standpoint.

The new screened-grid tubes, offered, as they have been, by the tube makers with little or no actual practical operating data, present most attractive possibilities to the experimentally inclined by virtue of the increased amplification that they theoretically make possible. The application of one of these tubes in the four-tube all-wave receiver described here provides a receiver of high sensitivity, selectivity, and general worth, and the methods of utilizing the UX-222 (CX-322) tube should be of considerable interest to the experimentally inclined in view of the dearth of practical operating information; a number of misconceptions concerning the UX-222 tubes have already arisen in the minds of many radio fans.

The receiver pictured in the accompanying illustrations employs one UX-222 tube in a tuned r.f. amplifier stage with conventional transformer coupling between this tube and the detector, despite popular belief that the UX-222 tube should work with tuned impedance coupling. The detector is made regenerative by the use of a fixed tickler winding, with regeneration controlled by a midget variable condenser. The two-stage audio amplifier, employing two large-core heavy 3:1 ratio transformers, provides a practically flat curve from below 100 cycles to over 5000 cycles. The measure of the receiver's

true worth is its performance compared against other sets. Operated in a steel building in Chicago with a forty-foot wire hanging out of a window for an antenna, a model set brought in stations within a range of 1000 to 1500 miles on the loud speaker, while KFI, in Los Angeles, was faintly heard on the loud speaker through local interference. A couple of popular one-dial factory sets on the same table refused to "step out" at all. The four-tube receiver was moved to a

THIS article describes a four-tube receiver which is notable chiefly because of its economy—all the parts listing for a total of \$46.75. This feature alone should attract many a home constructor and professional set builder. As the author states in the article, the use of the screened-grid tube increases the voltage to the detector, from a distant station, about twice compared to that delivered by a 201-A type tube. This gain is not all that the new shielded-grid tube is capable of producing, but is about all that is possible in a single stage and with the requisite degree of selectivity. This is a distinct gain, and is desirable, and is due to the new tube alone, but the home constructor should not expect a doubling of voltage before the detector to work miraculous results on extreme DX; it means, simply, that louder signals will be received without the bother of neutralizing apparatus or tricky adjustments. The receiver delivers excellent tone quality.

—THE EDITOR

Chicago suburb, where it brought in stations on the East and West coasts with ample loud speaker volume, pulling in some fifty stations in one evening on a fifty-foot antenna. Yet the parts for the whole set cost less than \$50.00.

In developing the set, experiments were started on the basis of individually shielded stages for the r.f. amplifier and detector, using tuned impedance coupling as recommended in the UX-222 data sheets. It was immediately found that, while quite high amplification could be obtained, varying from 20 per stage at 550 meters (545 kc.) to about 55 per stage at 200 meters (1500 kc.), the amplifier was far too broad for practical use. Using the optimum value of coupling between r.f. amplifier and detector, the selectivity was even worse, though the amplification increased. All this was previously predicted by mathematical analyses of the system, which experiments simply served to confirm. Tuned impedance coupling was then abandoned, and a standard tuned r.f. transformer employed, having a secondary coil equivalent to the coil previously employed in the tuned impedance amplifier circuit. This transformer was provided with adjustable values of primary coupling, and a series of amplification measurements were made at different wavelengths, the different primary sizes providing varying degrees of selectivity. Some representative amplification curves are reproduced in Fig. 1. The final transformer selected employs ninety turns of No. 20 plain enamelled wire wound on a threaded moulded bakelite form, with turns spaced to provide low

r.f. resistance, this coil being tuned by a 0.00035-mfd. variable condenser to cover the wavelength band from 200 to 550 meters (1500 to 545 kc.). The primary consists of 55 turns of No. 32 d.s.c. wire wound on a 1½-inch tube slipped inside the secondary form, the primary winding being at the filament end of the secondary. The actual amplification obtained with this coil and a UX-222 tube is shown on the accompanying curves, varying from 11 at 550 meters to 35 at 200 meters for the stage. This value is very low as compared to the mu of the UX-222 tube (about 250) but it is about all that can be realized without adversely affecting the selectivity. Actually, the figure of merit for the UX-222 tube is only about twice that of a UX-201-A, despite its misleadingly high amplification factor, so that it is entirely proper that the actual amplification obtained in practice from the UX-222 tube should only be about double that of a UX-201-A tube, at substantially equal values of selectivity. As stated, throwing selectivity to the winds, the gain could be almost redoubled—an impossible condition in practice.

At this point, conclusions arrived at on the laboratory bench were checked experimentally, and it was found that shielding was not necessary or even helpful in the four-tube circuit, providing the coils were spaced about twelve inches apart, as has been done in the final receiver layout. Precautions were taken to keep coupling between the r.f. amplifier and the detector circuits at a minimum by proper bypassing, but even with shielding it was found that "motor-boating" was experienced when the detector was adjusted for critical regeneration. An analysis of the UX-222 tube's action indicated that this was due to changes in screen grid current reacting on the detector, and vice versa, through the coupling of the B battery. This was eliminated by an r.f. choke in the screen grid lead. The operation then became entirely stable, and the results obtained in tests were quite gratifying.

The physical aspects of the set are well illustrated in the photographs. On the attractively decorated walnut-finished metal front panel are mounted the vernier drum dials controlling the two 0.00035-mfd. tuning condensers, which are of the modified straight frequency-line—straight wavelength-line—type. These drums read nearly alike in operation, log definitely for any station

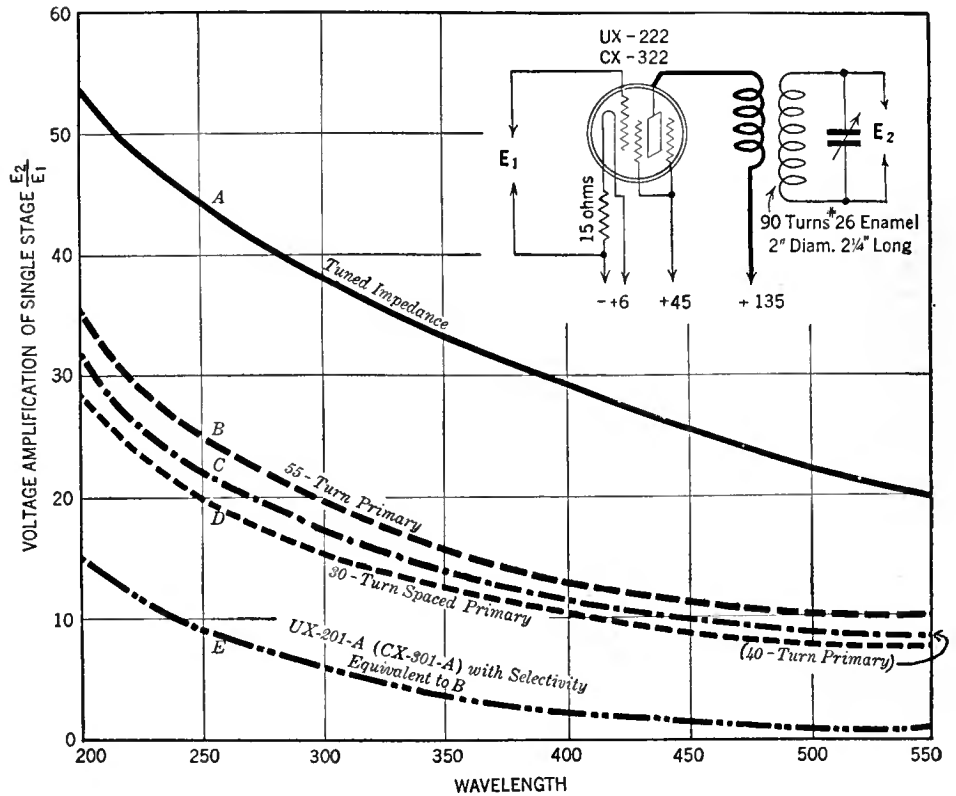

FIG. 1

heard, and are provided with small lamp brackets for illumination. Between them is the 0.00075-mfd. midget condenser controlling regeneration, and below it the 50-ohm rheostat controlling the filament voltage of the UX-222 tube to regulate volume. Attached to the rheostat is an automatic "On-Off" switch turning the set on or off at will.

The a.f. amplifier is unusual in that it employs UX-112-A (CX-312-A) type tubes in both the first and second stages. The first stage operates at 135 volts plate potential, with 4½ volts C bias. These values insure good handling capacity and a low plate impedance, favoring good bass-note reproduction. The second stage should have from

135 to 180 volts of B battery with 9 to 12 volts of C bias. At the higher value, the undistorted power output is nearly 300 milliwatts, a respectable value. Of course, a UX-171 (CX-371) tube could be used with greater undistorted power output, but in this case an output device should be used. The total current consumption of the whole set is about 15 milliamperes, a very low value even for battery operation.

The simplicity of the front panel is in keeping with the general design of the receiver, which is simple in the extreme. All parts not on the panel are mounted on the wood sub-base. The antenna coil and coil socket are at the left end, and the r.f. transformer and its socket at the right end

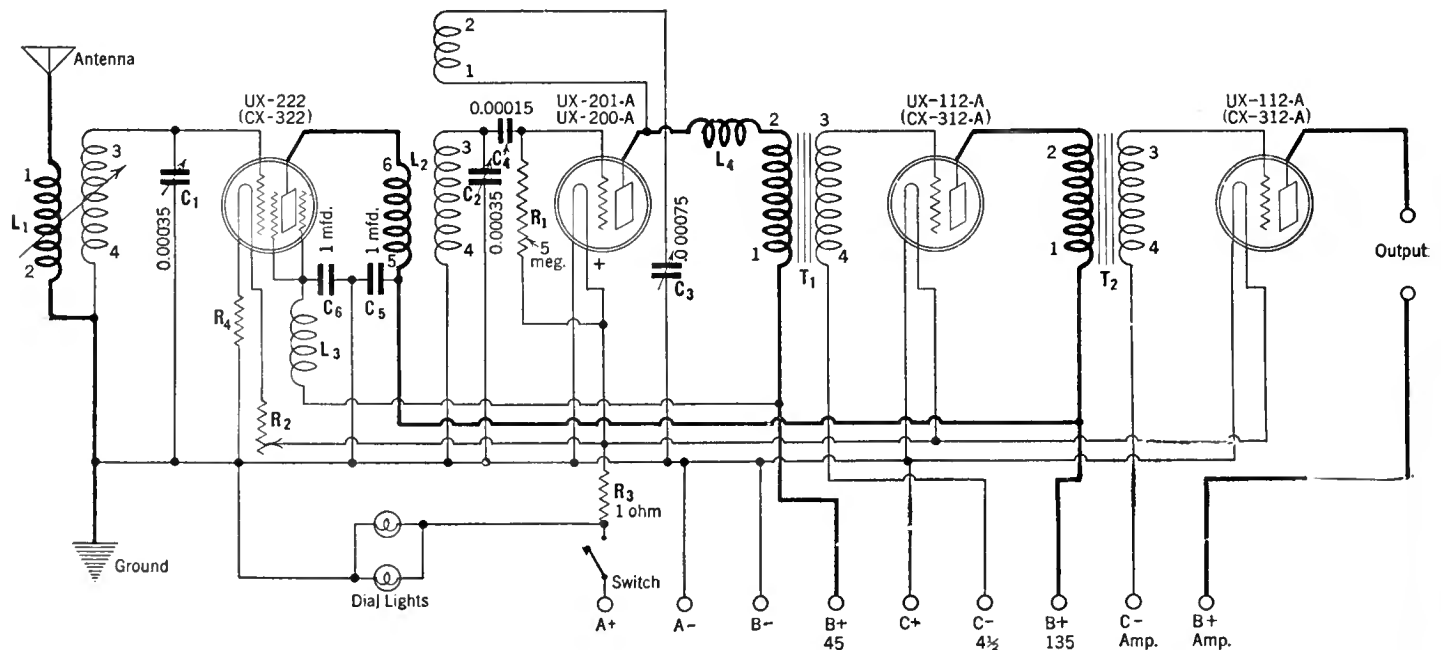
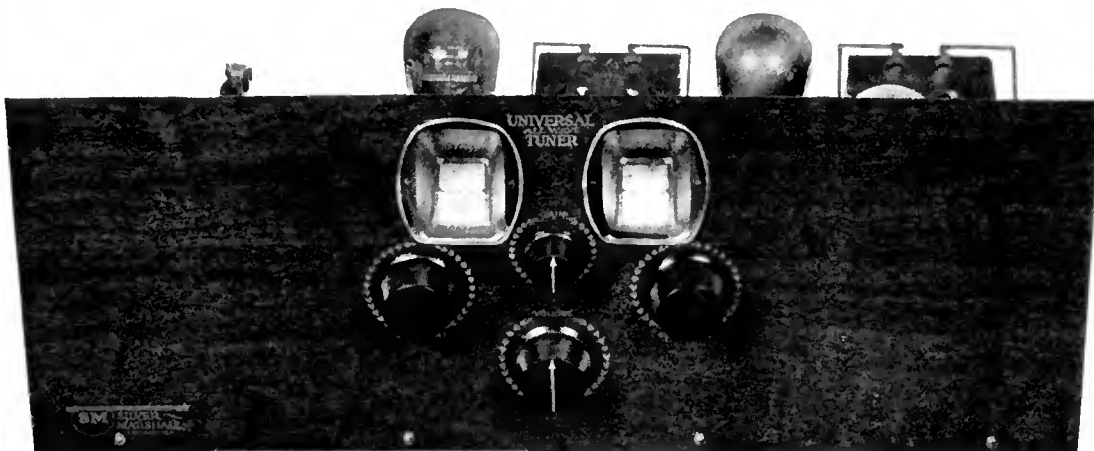

FIG. 2

The schematic diagram of the four-tube receiver which uses a screened-grid r.f. tube



A CLOSE-UP OF THE FRONT PANEL

of the base. On the baseboard beneath the variable condensers are fastened the 1.0-mfd. bypass condensers. The positions of all other parts is clearly illustrated in the photographs.

The actual parts used in the set are listed below, and due to the possible complexities that might arise on account of the UX-222 tube, it would be well not to substitute other parts for those specified, particularly as the wavelength ranges might also be affected were parts of the oscillating circuits changed in any way.

LIST OF PARTS

L ₁ —S-M 111A 190-550 Meter Antenna Coil	\$ 2.50
L ₂ —S-M 114SG 190-550 Meter R.F. Transformer	2.50
Two S-M 515 Universal Interchangeable Coil Sockets	2.00
L ₃ , L ₄ —S-M 275 Chokes	1.80
T ₁ , T ₂ —S-M 240 Audio Transformers	12.00
C ₁ , C ₂ —S-M 320 0.00075-Mfd. Variable Condensers	6.50
C ₃ —S-M 342 0.000075-Mfd. Midget Condenser	1.50
C ₄ —Sangamo 0.00015-Mfd. Condenser	.40
C ₅ , C ₆ —Fast 1-Mfd. Condensers	1.80
R ₁ —Polymet 5-Megohm Grid Leak	.25
R ₂ —Carter IR50-S 50-Ohm Switch Rheostat	1.50
R ₃ —Carter H1 1-Ohm Resistance	.25
R ₄ —Carter H15 15-Ohm Resistance	.25
Polymet Grid Leak Mount	.50
Ten Fahnestock Connection Clips	.50
Four S-M 511 Tube Sockets	2.00
Two S-M 805 Illuminated Vernier Drum Dials	6.00
7 x 17 x 1/2 Inch Wood Baseboard with Hardware	1.50
Van Doorn 7 x 18 Inch Decorated Metal Panel	3.00
TOTAL	\$46.75

The assembly of the set is very simple. The condensers are first mounted on the dial brackets, the drums attached, and the brackets fastened on behind the front panel, which also carries the dial windows and the small dial lamp brackets. The rear of the panel should be scraped to insure good contact between the panel and dial brackets and the same precaution should be observed in mounting the midget condenser so that its shaft bushing makes good contact with the panel. The switch rheostat should be thoroughly insulated from the metal panel by means of two extruded fibre washers.

All parts mounted on the base are screwed down as shown, taking care that terminal 3 of the antenna coil socket is to the right, and post 3 of the detector coil socket (r.f. transformer) is to the left. The positions of these sockets, audio transformers, etc., should be exactly as

shown, all being screwed down using roundhead No. 6 wood screws from 3/8 inch to 1 1/8 inches (for the r.f. chokes) long.

The wiring is simple, and clearly illustrated in the schematic diagram, Fig. 2 in which all instruments represented by symbols, carry exactly the same numbers and markings in the diagram as they do physically. All grid and plate leads are of bus-bar, in spaghetti where necessary, while all low-potential battery wiring is grouped along the center of the base, and is of flexible hook-up wire. After all wiring is done, the central group is cabled, or laced, using waxed shoemaker's thread. The Fahnestock clips are used for battery connections.

Testing and operating the set is very easy, and involves the use of standard accessories as listed below:

- Two UX-112-A (CX-312-A) Tubes
- One UX-201-A (CX-301-A) Tube
- One UX-222 (CX-322) Screened-Grid Tube
- One Western Electric Cone Loud Speaker
- One 6-Volt A Battery
- Three (or Four) 45-Volt Heavy-Duty B Batteries
- Two 4 1/2-Volt C Batteries

With the batteries connected and tubes in place, the rheostat should be turned full on, which will give 3.3 volts to the UX-222 tube under average conditions. With the midget condenser all in, the right-hand tuning dial should be rotated until a squeal is heard (every squeal is a station). The squeal should be tuned-in loudest by proper adjustment of the left-hand and right-hand drums. If the midget condenser is then

turned out slowly, the squeal will disappear and the station program be heard. Volume may be controlled by the knob, adjusting R₂. In tuning for local stations, the regeneration condenser can be left set about one quarter in (far enough out so that no squeals are heard), but in tuning for distant stations it should always be turned in far enough to make the detector oscillate, and stations first picked up as a squeal, and then cleared up by turning the regeneration condenser out slowly to cut out the squeal and get the program. The set is most sensitive, the operator will find, with the regeneration condenser just

barely out of the squealing condition.

The rotor in the antenna coil may be adjusted with the fingers to give greatest sharpness of tuning on the left-hand tuning dial. When set at right angles to the coil form, greatest selectivity and least volume will be obtained.

By using a 111D antenna coil and a 114D r.f. transformer in the coil sockets, the set will tune from 500 to 1500 meters (600-200 kc.). A 111E and a 114E coil will go from 1400 to 3000 meters (215-100 kc.). To operate below 200 meters (1500 kc.), the screened-grid r.f. amplifier is cut out entirely and the antenna connected to post 3 of the detector coil socket through a 0.000025-mfd. variable midget coupling condenser, such as the S-M 340. With this connection, using the right-hand condenser dial only to tune the regenerative detector, the three-tube set will tune from 70 to 210 meters (4285-1430 kc.), with a 114B coil, from 30 to 75 meters (10,000 to 4000 kc.), with a 114C coil; and down to about 18 meters (16,660 kc.) if the stator winding of another S-M 114C coil is cut down to four turns. It is not desirable to use the UX-222 r.f. amplifier stage below 200 meters, the three-tube portion of the set being amply sensitive for all short-wave reception.

It will be necessary to shunt the regeneration condenser with a fixed capacity of about 0.0001 mfd. to cause oscillation at the frequencies below the broadcast band.

Of course, suitable A or B power devices may be used with the set, glow-tube equipped B units being most satisfactory.

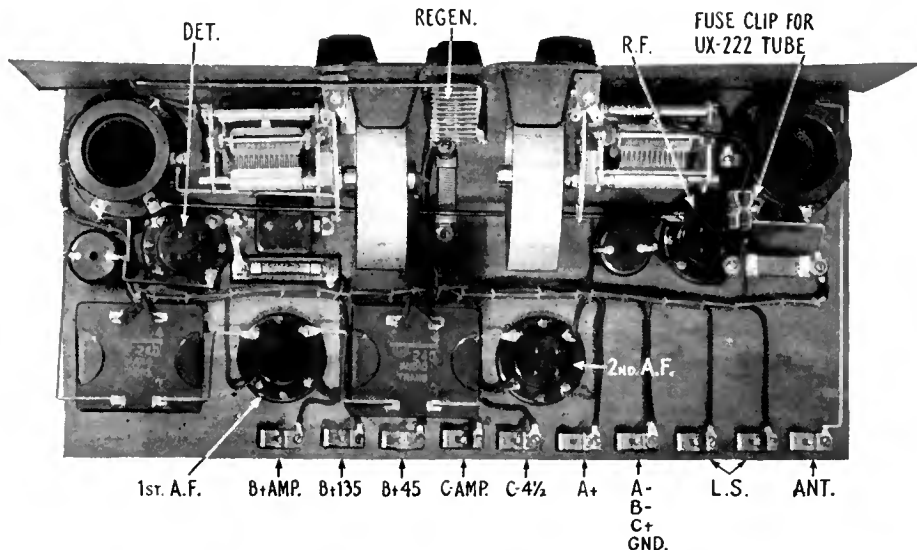

SHOWING THE ARRANGEMENT OF APPARATUS ON THE BASEBOARD

Some New Loud



THE richness of its selected woods instantly distinguishes this beautiful Bosch receiver (shown to the left) from the commonplace. The model 87 is a seven-tube table type receiver having four stages of balanced radio-frequency amplification, a detector, and two transformer-coupled audio stages. Exceptional selectivity is possible, while provision is made for very exact and gradual control of volume. Needless to say, there is but a single dial for station selecting, and this is graduated in kilocycles. Engineering features make the receiver adaptable for all forms of power supply, while there is a switch on the front panel which not only controls the power for the tubes, but automatically turns on or shuts off the battery charger, B supply device, and all other power equipment. The model 87 is priced at \$195.00

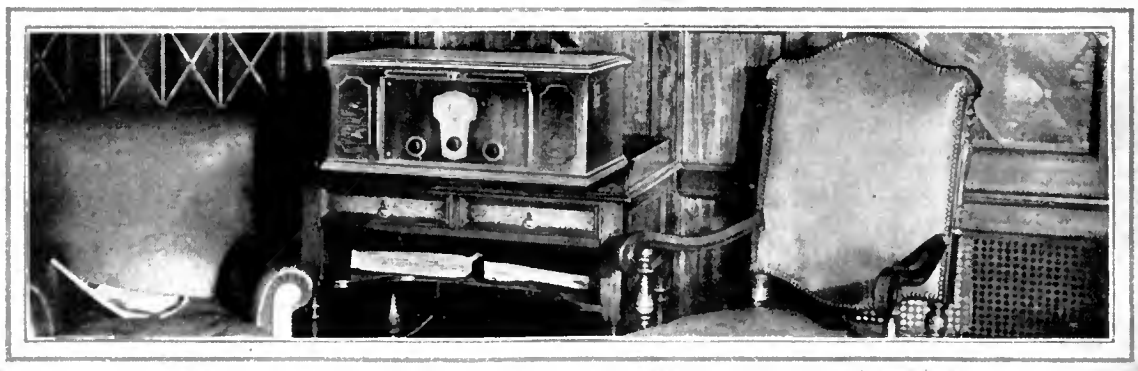

ANOTHER unique loud speaker by Amplion—the "Shield." The unusual lines and artistic appeal of the "Shield" lend charm to whatever surroundings it may be required to form a part of. The cabinet construction is entirely new in radio reproducer construction. The new-process embossed walnut panelling is attractively curved, and combines a grille front and back. The cone has a diameter of 16½ inches. Height, 22 inches. The Amplion "Shield" retails at \$67.50



A NEWCOMER to the ranks of the electric set is depicted above—in the form of the Kolster 6J table type receiver. The new a. c. tubes make possible the 6J, which is a six-tube receiver employing three r. f. stages, and having built-in power equipment. All that is necessary to start the set operating is to insert the tubes, connect a loud speaker, antenna, and ground (or loop), and plug in to a light socket. Tuning is accomplished by means of a single control. The 6J retails at \$250.00

Speakers and Sets

A BEAUTIFUL example of what Federal, Buffalo, is offering—the E45-60 "Ortho-sonic." While the price (\$160.00) of the model shown is a little high for the average man's purse, it is worth while to remember that Federal has an equally attractive five-tube table model for only \$100.00. The picture shows a completely a. c. operated six-tube receiver with a built-in loud speaker. Tuning is accomplished by means of a single knob, and the graduated scale is illuminated to facilitate tuning. Its remarkable selectivity is a feature claimed for the E45-60, but this is not obtained at the expense of tone quality. The height is 54½ inches, the depth is 17½ inches, and the width is 30½ inches. The cabinet is an original design in figured walnut with overlay of fiddle-back mahogany. The knobs and pendants are burnished.

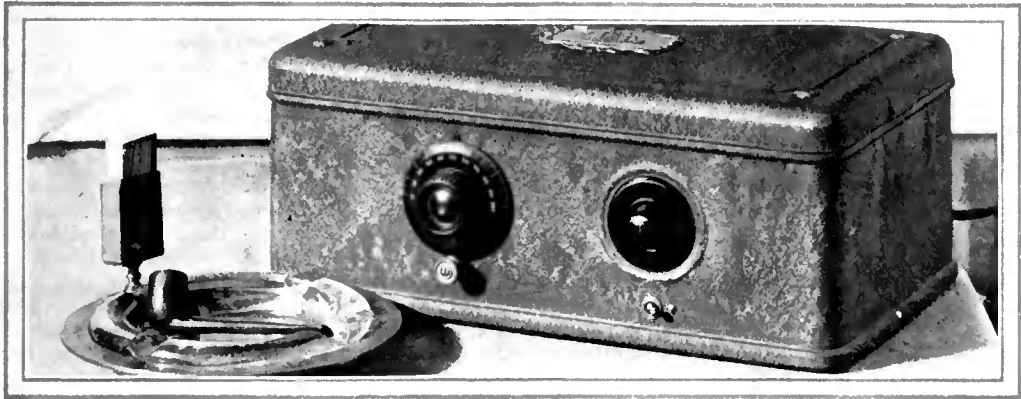

THE new Atwater Kent a. c. receiver is shown in the illustration above. It is indeed a remarkable piece of engineering—a complete radio installation, with the exception of the loud speaker—in a metal cabinet 7½ inches high and 17½ inches long. The apportioning of the six tubes is as follows: Three r. f. stages, detector, two transformer-coupled audio stages. Single control tuning is featured, and the built-in power unit is shielded from the rest of the receiver. Absolutely no batteries are necessary for operation. The price of the Model 37 Atwater Kent a. c. receiver is \$88.00

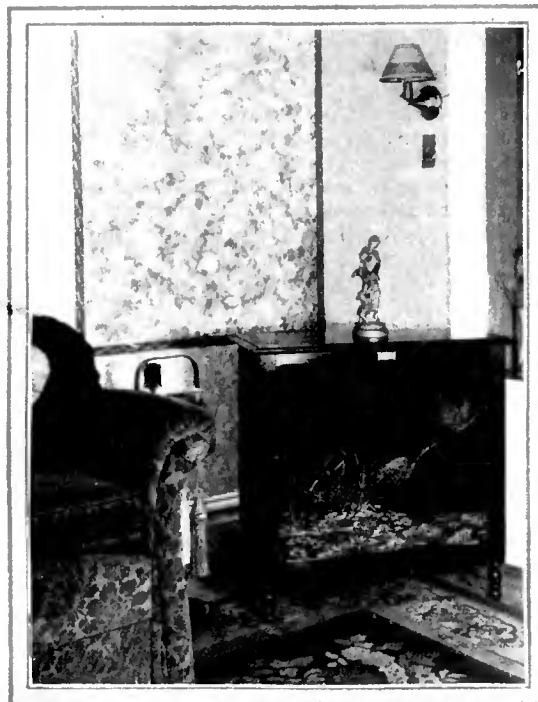

A WELCOME newcomer to the loud speaker field is pictured to the left. It is the "Air Chrome," a product of the Air-Chrome Studios, Irvington, New Jersey. Tests in RADIO BROADCAST Laboratory have shown this loud speaker to be capable of exceptional tone reproduction, while its efficiency is claimed by the manufacturers to exceed that of the best cones on the market. The "Air-Chrome" is not a cone loud speaker although in appearance it somewhat resembles one. The console model shown retails at \$65.00, there being a choice of design in so far as the tapestry front covering is concerned. The loud speaker without cabinet is priced at \$25.00

The Armchair Engineer

Keith Henney

Director of the Laboratory

TO THE RIGHT

This illustration shows a corner of the Radio Broadcast Laboratory. As the accompanying article explains, it is not necessary to have a laboratory or costly instruments at ones disposal to conduct interesting radio experiments. A piece of paper, a pencil, and a slide rule are sufficient to enable one to learn a lot about the design and operation of radio circuits, etc.

THERE are several interesting and perhaps instructive investigations of receiver design that one may explore without a laboratory full of expensive apparatus. A slide rule, a pencil, and some paper, are all that are necessary.

For example, let us consider a conventional two-stage transformer-coupled audio amplifier with an output device to protect the loud speaker from the d.c. plate current of the last tube. There are two methods of connecting the loud speaker to this amplifier, as shown in Figs. 1 and 2. The turn ratio of the first audio transformer let us suppose to be T_1 , and that of the second to be T_2 ; μ_1 and μ_2 are the amplification factors of the first and second tubes respectively. The detector of this set-up also secures its plate current from a common source, represented by the box at the left. In the first case the loud speaker is connected to the negative lead of the final amplifier tube. Now let us suppose that a 1000-cycle note comes into this system producing an a.c. voltage of 50 across the output choke, which, if it is very good indeed, will have an inductance of 40 henries, or an impedance at 1000 cycles of about 250,000 ohms. If the loud speaker has an impedance of only 4000 ohms at this frequency, most of the a.c. current will flow through the loud speaker, as is desired. This 50 volts across the choke is arbitrarily chosen, and the absolute value does not matter for our present discussion. Fifty volts is probably higher than is encountered in practice.

Fifty volts across the 250,000 ohms impedance of the choke will send through it a current of about 0.2 milliamperes which, to return to the filament of the last tube, must go through the B battery leads, through the 2-mfd. condenser across the plate supply unit, and thence to the filament. The 2-mfd. bypass con-

denser has an impedance of about 80 ohms at 1000 cycles (this may be found by reference to laboratory sheet No. 127, in the September, 1927, RADIO BROADCAST) and the voltage across it, obtained by multiplying the impedance by the current, is roughly 0.016 volts, most of which is impressed across the primary winding of the first audio transformer because of its high impedance compared to the plate impedance of the tube. This tone will go through the amplifier, and will be amplified accordingly, and if there are an odd number of stages securing plate voltage from this common source, say a detector and two audio stages, and if the transformer primaries are "poled" correctly, the final voltage appearing across the output choke will not only be amplified but will be in phase with the original voltage.

The problem is to find out how strong this voltage becomes by going through the amplifier. If the transformers are 3:1 each and the first tube has an amplification factor of 8, and the final tube (an UX-171 or CX-371) an amplification factor of 3, the maximum amplification will be the product of these factors, or $3 \times 3 \times 8 \times 3$, or roughly 200. In the plate circuit this voltage will divide, part being lost on the 2000-ohm plate impedance of the output tube and part appearing across the 4000-ohm output impedance (choke and loud speaker). As a matter of fact two-thirds of the voltage will appear across the choke so

that the voltage finally appearing there will be $0.016 \times 200 \times \frac{2}{3}$, or about 2.1. In other words, the original 50 volts which appeared across the output choke have returned in phase but have been decreased to 2.1 volts.

Now let us consider Fig. 2. Here all a.c. components in the plate circuit of the last tube must go through the plate supply before they can return to the filament of the power tube. The impedance of the choke is lowered by the shunt impedance of the loud speaker, say to 4000 ohms, and if the same 50 volts appears across this load impedance the a.c. current through it will be $50/4000$ or 12.5 milliamperes, which will produce a voltage of 1.0 across the 2-mfd. condenser, and this finally appears as $1.0 \times 200 \times \frac{2}{3}$, or 135, volts. Since this "feedback" voltage is greater than the original voltage, and may be in phase with it, an endless chain results and the amplifier turns itself into an excellent oscillator, singing at some frequency determined by the constants of the circuit, usually at the point where the maximum amplification of the audio transformers takes place, say about 5000 cycles.

This is exactly what happens in an oscillator; part of the output is fed back to the input so that it is amplified through the tube and again impressed across the output.

In the amplifier under discussion the feed-back is caused by the impedance of the plate supply unit which is common to all of the amplifier stages. If the bypass condenser is increased (which decreases the total impedance) the tendency to oscillate becomes less, since the feedback voltage impressed upon the input to the amplifier decreases with decrease in common impedance. In the Laboratory, a high-quality two-stage transformer-coupled amplifier with detector getting its plate supply from the same source as the amplifier sang terrifically when a resistance of 37 ohms was inserted in the negative B battery lead when the loud speaker was connected directly across the output choke-condenser combination. With one side of the loud speaker connected to the filament, a total of 670 ohms in the negative B lead could be tolerated before the amplifier sang.

Bypassing the common resistance with a 2-mfd. capacity, the tolerance in common impedance was increased, so that with the loud speaker across the output choke, 200 ohms did



RADIO BROADCAST Photograph

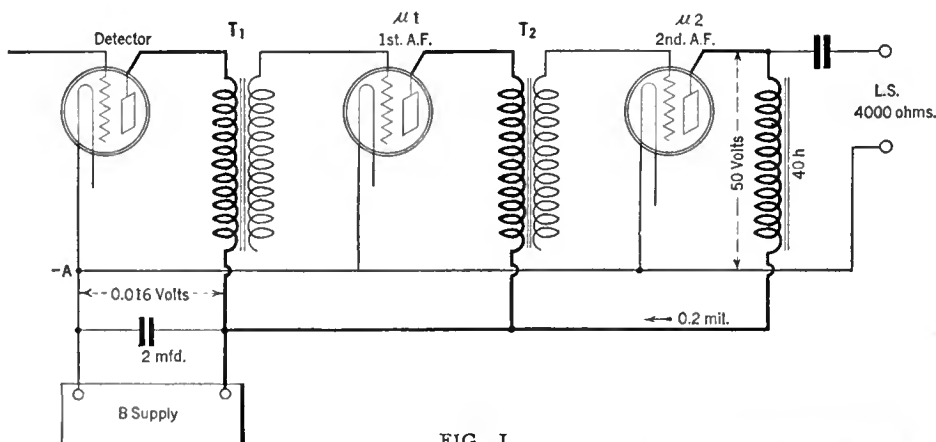

FIG. I

not cause singing, and in the other case 2000 ohms could be tolerated.

This investigation indicates that, when a condenser-choke output device is used, the loud speaker should connect directly to the negative A, or to the filament center tap if a.c. operated, of the last tube. When an output transformer is used, corresponding to the case where the loud speaker is connected across the output device, and all of the a.c. components of the plate circuit must go through the plate supply, a large bypass capacity should be used. This is necessary when B batteries or plate-supply units are used, for the latter have a rather large a.c. impedance at all times, and the former have considerable a.c. impedance when they have been used for some time.

Now continuing our investigation, let us look at this two-stage amplifier again. Let us suppose that at some frequency the loud speaker represents a load to the last tube which takes as much power as a pure resistance equal to twice the impedance of the tube. This is an assumption easily satisfied, and since tube experts in England, and of the General Electric Company in America, have shown that the maximum undistorted output will be attained under these conditions, we shall start off on the right foot at least.

If the loud speaker impedance is twice that of the tube, $\frac{2}{3}$ of the total a.c. voltage appearing in the plate circuit will be impressed across it.

Now the maximum voltage amplification of the amplifier, which we shall call A, is as follows, when T represents the turn ratio of the transformers and μ the amplification factor of the tubes:

$$A = T_1 \times \mu_1 \times T_2 \times \mu_2$$

and since two-thirds of this appears across the loud speaker, the voltage across the latter is:

$$E_{l.s.} = \frac{2}{3} \times A \times E_d$$

where E_d is the a.c. voltage available across the primary of the first audio transformer.

Actually the loud speaker voltage will be less than this figure, since the full transformer ratio, and amplification factor of the tube, cannot be realized, but good design will make it possible to approach this maximum voltage amplification.

Now, looking at a booklet on tubes, we note the maximum undistorted power output of a 171 type tube is 700 milliwatts, that the amplification factor is 3, and that the plate impedance is 2000 ohms. Then at the frequency chosen, the loud speaker impedance will look like 4000 ohms resistance to the tube, and since the power, W_o , into it is:

$$W_o = I^2 Z = \frac{(E_{l.s.})^2}{Z}$$

$$\text{or } E_{l.s.} = \sqrt{W_o \times Z} = \sqrt{0.7 \times 4000} = 53 \text{ volts r.m.s.}$$

where Z = loud speaker impedance, $E_{l.s.}$ = voltage across loud speaker, and I = current through loud speaker, we see that there must be 53 volts r.m.s. across the loud speaker to put 0.7 watts into it, and since this is but two-thirds of the total a.c. voltage in the plate circuit of the last tube, the total is $\frac{3}{2} \times 53$, or 79.5 volts.

Since the amplification factor of this tube is 3, $79.5 \div 3 = 26.5$ r.m.s. or 37.4 peak volts (since peak volts equals 1.41 times r.m.s. volts) which must appear on the grid of the power tube, so that when the booklet states that the grid bias should be 40.5 it shows that our calculations are not far wrong.

Now let us use a UX-201-A (CX-301-A) type tube as the first amplifier and two 3:1 transformers and calculate:

$$A = 3 \times 8 \times 3 \times 3 = 216$$

which shows that the maximum voltage am-

plification of the amplifier, from input to the first transformer to the plate circuit of the final tube, will be 216, and since we need 79.5 volts in the output tube plate circuit the voltage necessary across the primary of the first audio transformer will be:

$$79.5 \div 216 = 0.368 = E_d$$

This, then, is the voltage which the detector must supply to the input of the audio amplifier.

Now in place of the low-mu low-impedance tube in the output or power stage let us use a UX-210 (CX-310), which has a mu of 8 and an impedance of 5000 ohms, or a UX-112 (CX-312) which has the same characteristics. In this case we must use a step-down output transformer of 1.58 turns ratio ($\sqrt{10,000 \div 4000}$) so that our 4000-ohm loud speaker will look like 10,000 ohms to the power tube. Of course the same voltage will be necessary across the loud speaker to deliver 700 milliwatts to it, i.e., 79.5, which, multiplied by 1.58, the turn ratio of the output transformer, gives 125 as the voltage which must appear in the plate circuit of the final tube.

In this case, however, the voltage amplification of the amplifier is increased to:

$$3 \times 8 \times 3 \times 8 = 576$$

and the detector output must be:

$$125 \div 576, \text{ or } 0.218$$

and the input peak volts to the last tube must be:

$$125 \div 8 = 22, \text{ approximately}$$

This calculation shows that the detector must deliver only 0.218 volts compared to 0.368 when

(CX-310) tube is substituted for a UX-171 (CX-371).

There is one more point which our computation may bring out—the reason why such high voltages are necessary for the plates of UX-210 (CX-310) type tubes. If 40 volts C bias is used on a UX-171 (CX-371) type tube, 180 plate volts are needed. This figure may be calculated by multiplying 40 by 3, the mu of the tube, and by what we may call a factor of safety of 1.5, or $40 \times 3 \times 1.5 = 180$. Now, when we use a UX-210 (CX-310) tube with a C bias of 22 the calculations say $22 \times 8 \times 1.5 = 263$ volts. If, however, the detector delivers 0.368 volts the C bias on the last tube must be 37.5 volts which, in turn, demands a plate voltage of $8 \times 37.5 \times 1.5 = 450$, and there you are.

Our little investigation into amplifier problems has not taken us from our armchair, and all we have needed to determine several interesting facts is a pencil, some paper, and if we possess one, a slide rule. We have learned that output devices, if choke-condenser affairs, should be so connected that the a.c. plate currents return directly to the filament of the last tube, and that if we use an output transformer, or if the a.c. currents do not return directly to the filament, we must bypass as heavily as we can afford the common impedance of the plate supply.

We have learned that we can estimate the maximum voltage amplification of an amplifier by multiplying the turn ratios of the transformers and the amplification constants of the tubes together, and that for distortionless amplification the loud speaker should have roughly twice the impedance of the tube. Under these conditions the voltage across the loud speaker is two-thirds of the total a.c. plate voltage in the plate circuit

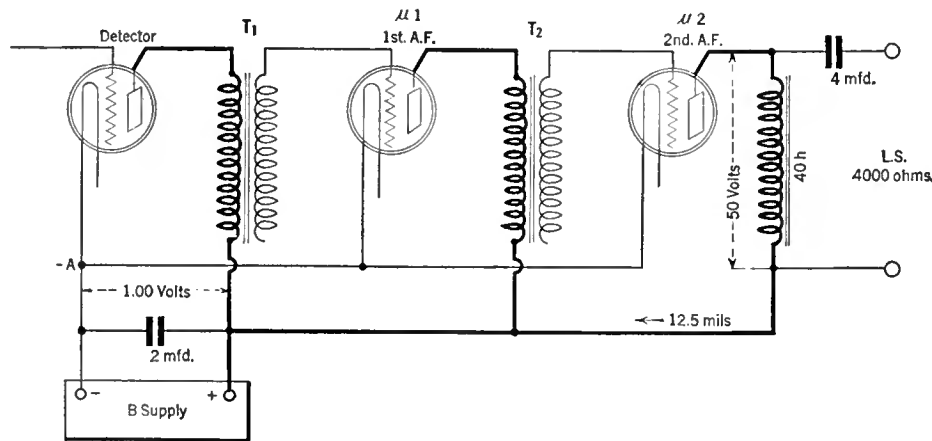

FIG. 2

a 171 type tube is used to furnish the same amount of power, 700 milliwatts, to the loud speaker. If, however, the detector can deliver to the input of the amplifier 0.368 volts without distortion, due to detector overloading, the power put into the loud speaker will be:

$$W_o = \frac{(E_d \times A \times \frac{2}{3})^2}{10,000} = 1.4 \text{ watts}$$

In other words the 210 type output tube will deliver exactly twice the power to the loud speaker as is obtained when a low-mu low-impedance tube is used. This difference is entirely due to the higher amplification factor of the tube.

The results of this simple comparison between output tubes are several. In the first place it means that the detector tube can be worked with lower input voltages, the r.f. amplifier need not be "geared up" so high, weaker stations may "load up" the amplifier, and it shows in some measure why more volume results when a UX-210

of the last tube, and the detector output required may be calculated by dividing the a.c. voltage in the last tube's plate circuit by the amplification of the amplifier.

We have learned that a high-mu tube in the final stage of an audio amplifier delivers considerably more power, and requires considerably smaller input voltages to deliver the same power, compared to a low-mu tube. We have learned why such high plate voltages are required on power amplifiers using tubes with high values of amplification factor. Throughout this armchair investigation we have had to make certain assumptions that will make a "hard-boiled" engineer smile. We know but little of how a loud speaker looks to a tube, we have not bothered with vector voltages, we have not tried to be mathematically exact. But we have shown that with a slide rule, a pencil, and some paper we can delve into the subject of receiver and amplifier design.

CJRM, Pioneer Picture Broadcasting Station

By Edgar H. Felix

TO THE RIGHT

The illustration shows Mr. D. R. P. Coates, manager of CJRM, with his picture transmitting apparatus



THE series of articles in RADIO BROADCAST describing the Cooley Rayfoto system, have brought to its editors a surprising number of letters from experimenters who have already worked with telephotography of one kind or another. These, together with the thousands of letters, from those who plan to build Cooley recorders, make it appear quite certain that there will soon be a definite new experimental field—the making of radio pictures in the home. Indeed, we know of quite a number of Cooley outfits already in operation, even though, as we write, broadcasting is only spasmodic.

Perhaps the most interesting broadcasting experiment which has come to light is that of CJRM, of Moose Jaw, Saskatchewan, of which Mr. D. R. P. Coates is manager. An active Radio Picture Club, formed under his leadership, is already in existence, and a group of ardent workers are busy improving their existing picture reception apparatus. The Radio Picture Club is installing a Cooley picture receiving system but, in the meanwhile, is working with a somewhat more crude, picture system.

The transmitting apparatus, built by Mr. Coates, is a remarkable example of resourcefulness, for the facilities available are very limited. The transmitter is made with a cylindrical record phonograph as its basis. A copper plate is mounted on the drum, taking the place of the conventional record. On the copper plate, the picture to be sent is pasted in silhouette or outline form. A stylus passes over the copper drum and completes the circuit for an audio-frequency "howler," the output of which is used to modulate the transmitting carrier. A synchronizing signal, using the stop-start system, also used in the Cooley receiver, serves to re-check the synchronization at the beginning of each revolution.

Reception is simply a reverse of the transmitting process. A stylus makes a continuous black line by pressing on carbon paper laid over a sheet of white paper, on a revolving cylinder. When the "howler" signal comes in, the stylus is lifted, thus

giving a positive silhouette. Nothing simpler than this system can be imagined, but Mr. Coates tells us it was widely used by the Germans during the War for transmitting military information.

Owing to the fluctuations in drum speed, the synchronization is not good. The difficulty lies in the fact that the phonograph motor is brought to a full stop by the synchronizing system and it does not always resume speed at the same rate when released by the synchronizing control.

Naturally, the Radio Picture Club looks forward to the receipt of its Cooley recorder equipment because that will overcome these difficulties. An ingenious clutch and locking arrangement makes good synchronization easy with the Cooley system, and it is independent of the operation of the phonograph motor. The Cooley stop-start system, and the mechanical unit which is a part of it, is so built that the load on the phonograph motor does not change when the light aluminum drum is stopped at the end of each revolution by the stop-start mechanism. A clutch allows the motor and the turntable to continue revolving, so that there is little or no speed variation.

A PREDICTION

IT IS pleasing to see such enterprise in far-away western Canada. A rather interesting point in Mr. Coates' letter is his point of view with regard to the broadcasting of pictures:

"The present position of the radio picture art reminds me very much of the position of radio seven or eight years ago. I believe that we shall find amateurs dabbling in it for a while and that this will gradually evolve until receiving apparatus is improved and popularized. If we are to follow the line that was taken by broadcasting, we must go ahead and put pictures on the air, no matter how simple and elementary, so that people will be encouraged to build apparatus for the purpose of reproducing the pictures. The fact that there is no one around here yet able to reproduce the pic-

tures does not deter me at all, because I remember broadcasting years ago when our audience was very limited indeed. If we had waited for a big audience before going ahead with broadcasting, we would not be very far advanced at the present time."

Not only do we find that American stations have a similar point of view, but inquiries have come from broadcasting systems, even as far distant as New Zealand, desiring to put Cooley pictures on the air so as to give experimenters an opportunity to develop the picture receiving art.

Mr. Coates is the originator of a system of broadcasting "pictures" of the constellations as an aid to the study of astronomy. He terms these "stellagraphs." The stellagraphs were broadcast by cooperation with a local newspaper which printed a graph paper suitably marked up so that any position on the paper could be given by two reference numbers. A third number in the code indicated the intensity of the star so that a lecturer on astronomy could enable his radio listener to illustrate and draw out the principal constellations of which he was speaking.

The precedent set by Mr. Coates, in suggesting the formation of a radio picture club, is one which should be encouraged. An individual experimenter may hesitate to spend a hundred or a hundred and fifty dollars to go into picture experimentation, but, if five or six club together, the individual cost is small and the experimenters have the benefit of their combined facilities and ingenuity. The Cooley system is sufficiently well developed that it can hardly be termed a hazardous experiment and the amount of special equipment required is not particularly great. We have been advised that a number of substantial prizes will soon be offered for the best Cooley picture reception, through the courtesy of a large radio manufacturer who believes in the future of picture transmission and reception. Naturally, the leaders and pioneers who have the greatest experience, are the most likely to be successful in such a contest.

“Our Readers Suggest—”

OUR Readers Suggest... is a regular feature of RADIO BROADCAST, made up of contributions from our readers dealing with their experiences in the use of manufactured radio apparatus. Little “kinks,” the result of experience, which give improved operation, will be described here. Regular space rates will be paid for contributions accepted, and these should be addressed to “The Complete Set Editor,” RADIO BROADCAST, Garden City, New York. A special award of \$10 will be paid each month for the best contribution published. The prize this month goes to Fred Madsen, Chicago, Illinois, for his suggestion entitled “A.C. Tube Operation Without Rewiring”

—THE EDITOR.

A Distortion Indicator

THE average loud speaker is blamed for a multitude of sins which really should be laid at the door of other parts of the receiving circuit. It is not generally understood that a rattle almost identical with the mechanical rattle of an overloaded loud speaker can be caused by a distorting amplifier. The sound of the strain, depending upon the extent of distortion, reproduces in a manner quite deceiving to other than experts, all the various forms of blasting experienced in faulty loud speakers.

If you are experiencing difficulties of this nature, it would be well to investigate the characteristics of your amplifier before discarding your loud speaker as defective. The procedure is simple, as the following illustrations indicate.

A milliammeter capable of carrying the current to the power tube (a zero-to-25 milliamperes meter is about right) can be inserted in the plate circuit of any tube, providing a fairly reliable indication as to whether or not that particular tube is introducing distortion. The circuit is shown in Fig. 1.

Any deflection on the meter scale with incoming signals is evidence that the tube in the plate circuit of which it is included is rectifying, *i. e.*, distorting. This distortion can be eliminated by proper biasing. If the needle kicks down, more C battery should be used. If the needle kicks up, the C potential should be lowered. If the C bias is correctly adjusted no movement whatever should be noticed in the needle when a signal of moderate strength is being received. Any movement, up or down, indicates distortion, and the C battery should be adjusted in an endeavor to stabilize the needle.

Quite naturally, every tube has a maximum distortionless output with a given plate voltage, and when this limit is exceeded by applying too powerful a signal to the grid, rectification and distortion will result, regardless of the grid bias. It will be at a minimum, however, if the grid battery is correctly adjusted. If more than a slight flicker of the needle is indicated at the desired volume, a higher plate voltage or a power tube of greater handling capacity should be employed.

The correct biasing of every tube in the

audio-frequency amplifier can be effected in this manner. As the grid swing applied to other than the last or power amplifier stage is relatively small, however, a rough adjustment (that is the application of approximately the bias recommended by the tube manufacturer for the plate voltage used) will be sufficient in these preceding stages.

PHILIP RILEY
Cincinnati, Ohio.

STAFF COMMENT

MR. RILEY'S distortion indicator is of particular utility when the plate voltage is obtained from a B power-supply device. The voltage supplied by such an arrangement varies with the load, and it is always more or less indeterminant. The correct bias changes with variations in plate potential, so an arbitrarily designated bias voltage rarely affords the maximum distortionless output.

Still more undistorted power can often be obtained from a given amplifier-loud speaker combination by the use of an output device

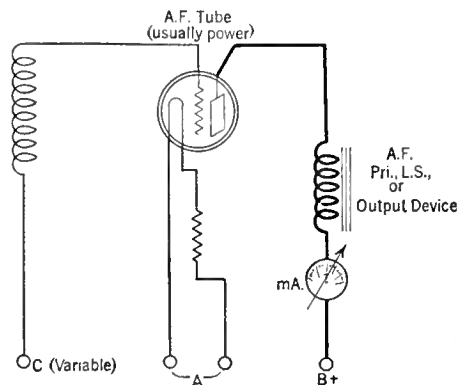

FIG. 1
A simple hook-up to indicate distortion

connected between the loud speaker and the power tube, because the relatively high d. c. resistance of the loud speaker lowers the actual voltage on the plate of the tube, and the use of an output device therefore results in a greater potential being applied to the plate. The loud speaker should never be placed directly in the plate circuit when there is a current of more than 10 mils. flowing. Aside from the relatively powerful current surges, which may damage the delicate windings, the steady direct current tends to draw the armature toward one of the pole pieces, causing the mechanism to hit and rattle on loud signals. There are several commercial output devices which may be instantly connected between loud speaker and power tube. Such filters are manufactured by the National Company, Silver-Marshall, Muter, Ferranti, General Radio, Samson, and Federal, etc.

“Motor-boating”

I HAVE a seven-tube set which employs one stage of resistance-coupled audio amplification and I have been trying for some time to find a B supply device that would not “motor-boat,” but without success. It was quite costly to operate the set with a 171 power tube with B batteries so I conceived the idea of using a combination of B battery and B device. It is well known that the r. f. stages and the power tube take most of the B current, so I use the B device on those taps and the battery on the resistance coupled tap. This arrangement is very satisfactory and is giving fine results. The drain on the B battery is small, hardly noticeable in fact, while the B device operates the tubes drawing the heavy current. Fig. 2 tells the story. The negative of both B supplies are common.

C. R. YARGER
Shenandoah, Iowa.

STAFF COMMENT

THE method suggested by Mr. Yarger hits directly at the very source of “motor-boating,” *i. e.*, a common B supply circuit through which coupling may be effected. The arrangement suggested by our correspondent will probably be effective in the most violent cases of “motor-boating.”

Unfortunately, the purpose of B battery elimination is more or less defeated in this scheme. The current drain on the B battery is, as Mr. Yarger points out, nevertheless very slight.

The connection of an Amrad Mershon electrolytic condenser across the high-voltage and negative terminals of the power supply of a motor-boating receiver, will, in the majority of cases, be equally effective in eliminating this disturbance.

A glow tube, connected according to the directions given in “Our Readers Suggest” for February 1928, is also effective.

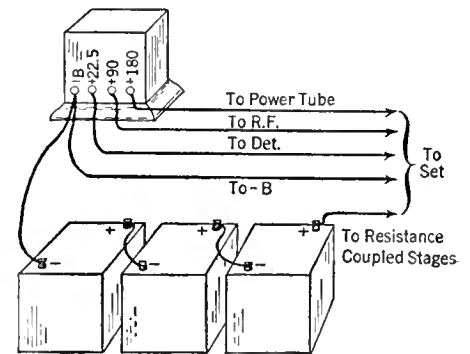

FIG. 2
A simple way of eliminating “motor-boating” in all circuits. The troublesome circuit is fed from a separate plate source

A. C. Tube Operation Without Rewiring

IN THE November, 1927, issue of RADIO BROADCAST, "Our Readers Suggest" department gave directions for the rewiring of a standard radio-frequency receiver and an Atwater Kent 35 for the use of Arcturus alternating-current tubes.

This rewiring necessitated changes in the filament and radio-frequency circuits of such nature that many comparatively experienced fans would hesitate to make. It is extremely difficult to gain access to the wiring of many commercial receivers, and some enthusiasts, adept with the soldering iron and pliers, are reluctant to tamper with a ready-made job.

I have an Atwater Kent 35 receiver which I desired to adapt for a. c. operation without touching the actual wiring of the receiver. I succeeded in doing this along the lines suggested in Fig. 3, and in the accompanying photograph. Arcturus a. c. tubes, which are of special construction, being used for the purpose. The arrangement, briefly, requires the sawing off of the two heater prongs from the a. c. tube bases and soldering lugs in their places, to which the heater connections are made.

The mechanical changes are clearly illustrated in the photograph. Though the prongs are sawed off at the bottom of the base, sufficient metal remains for firm soldering of the lugs. The prongs should be carefully tinned before the lugs are soldered to them in order to insure perfect connection with the heater leads. See that the leads from the elements within the tube are not sawn off when the prongs are removed. They should be firmly soldered to the remaining prong stubs.

The original sockets in the receiver hold the tubes with sufficient rigidity by means of the plate and grid prongs, which remain unchanged. Flexible Braidite is recommended for use in the rewiring of the heater circuits. This can be obtained in different colors facilitating consistent heater connections. The same side of every heater (as determined by their relationship to the pin on the tube base) should be connected together throughout the circuit.

Looking at the bottom of the base with the pin toward you, the left-hand prong is filament plus on a d. c. tube. On the Arcturus a. c. type tube it is a combined heater and cathode connection. It is good practice to wire these prongs with red Braidite, using black for the other heater leads. Both leads should be twisted, as shown in the photograph. A separate wire is brought out from the cathode of the detector tube to which B minus, C plus, and D minus

connected across the secondary of the first audio-frequency transformer where it functions as a volume control. This volume control is mounted externally. The only change actually made in the receiver itself was a slight alteration in the detector grid circuit. The grid leak was removed and a piece of heavy wrapping paper inserted in the prong toward the back of the receiver. A small piece of copper foil, to which a flexible lead was soldered, was laid on top of the wrapping paper so that no connection was made to the prong. The copper foil, however, makes contact with the cap of the grid leak when inserted. This lead was brought out along with the other wires and marked "D" plus 4.5 volts. This operation automatically opens the connection between the grid leak and the center of a resistance which exists across the filament of the detector in this model of the Atwater Kent receiver.

The tubes were placed in the sockets and the set was ready for operation.

Minus 1.5 volts of C battery were connected to the ground post and minus 22.5 volts of C battery were connected to the power tube. If it is possible to tap off between 4.5 to 9 volts on your first B battery or from the B supply device, the D plus lead from the detector grid leak may be lead directly to such a tap, otherwise it will be necessary to insert a 4.5-volt battery, plus to the grid leak and negative to the B minus.

A plate potential of 90 volts is applied to the plates of the radio-frequency and first audio tubes and 180 volts to the plate of the power tube. Arcturus type A-C 28 tubes are used in the first radio-frequency amplifier and in the first audio amplifier. An Arcturus detector type A-C 26 tube is employed in the detector socket and a power tube type A-C 30 in the power stage. The A plus and A minus leads from the original Atwater Kent receiver are short circuited. Fifteen volts a. c. is applied across the twisted heater wires. This is obtained from an Ives type 225 step-down transformer.

The arrangement as applied here can be adapted to practically any circuit with very few changes.

FRED MADSEN
Chicago, Illinois.

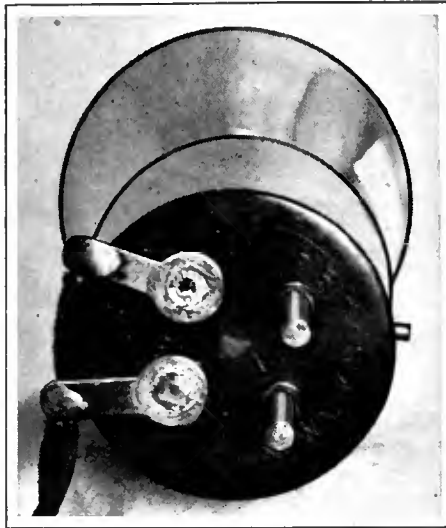

WITH HEATER PRONGS REMOVED

An accompanying contribution explains how the Atwater Kent model 35 receiver may be arranged for a.c. tube operation. The main mechanical change requires that the two heater prongs be sawed off and replaced with soldering lugs

are connected. The expression "D" refers to the special biasing battery necessary for the detector tube, the grid of which is made positive. The fundamental diagram is shown in Fig. 3.

An Electrad Royalty 200,000-ohm resistor, shown, in Fig. 3, in dotted lines, must be

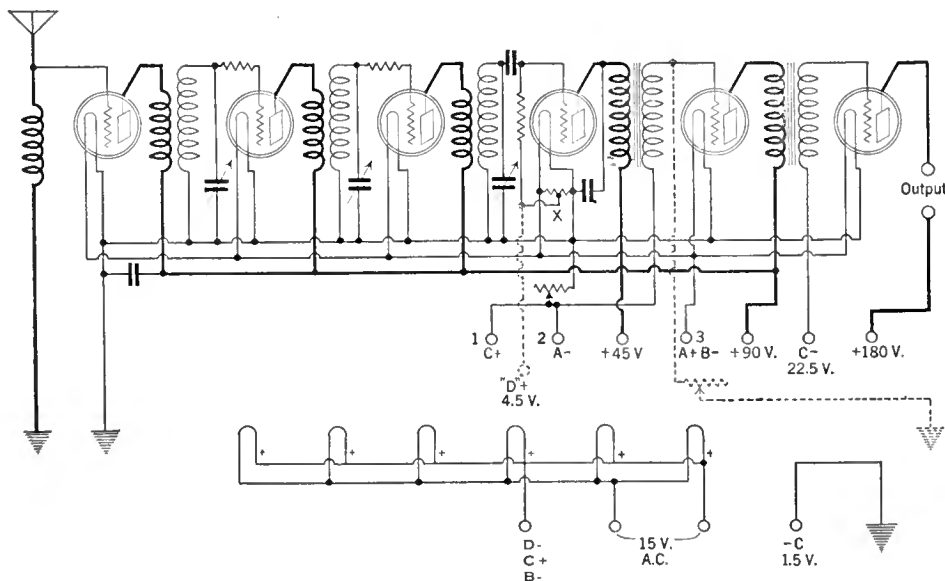

FIG. 3

Adapting the Atwater Kent Model 35 receiver for a. c. tube operation without making any major changes to the wiring of the receiver itself. The detector grid leak return is broken at X, and brought down, according to the dotted line, to the special "D" plus lead. Dotted lines also show the position of the volume control. The wiring below shows the external wiring to the heaters of the tubes.

Posts Nos. 1, 2, and 3 are short-circuited, and no connections whatever are made to them

STAFF COMMENT

THE arrangements suggested by Mr. Madsen are quite practical. As he suggests, there are doubtless many instances where the "harness" system is preferable to actual set changes. Commercial "harnesses," which are very similar to the arrangement described, are being placed upon the market to adapt various receivers to different types of a. c. tubes.

In some receivers the prongs of the tube are inserted in metal eyelet holes which protrude a fraction of an inch or more above the surface of the sub-panel. The presence of these eyelets, which are connected electrically to some part of the circuit, will make the receiver inoperative unless care is taken to see that the sawed off prongs or the soldering lugs do not touch them. This is easily accomplished by the use of a pasteboard disk cut to size and punched with two holes to pass the grid and plate prongs.

In some instances it will be more desirable to control volume by means of a zero to 500,000 ohm Electrad Royalty or Centralab resistor connected across the radio-frequency secondary preceding the detector tube. Not all variable resistors of the required ohmic value will work in this arrangement due to the relatively high capacity of several makes.

IF YOU LIKE GOOD MUSIC LISTEN THIS WAY

By JOHN WALLACE

WE HAVE utilized this department before, in fact as recently as last January, to make tearful entreaties to the radio lords to furnish more straight instrumental music. If we may be said to have any platform, that is its principal plank.

In one of these articles we advanced the point that listening to symphonic music via the radio has at least one distinct advantage over listening to the same in a symphony hall, namely: the orchestra cannot be seen. With none of the modesty proper to the father of an idea we aver that the point is an excellent one and well worth dragging out again.

The universal custom of lighting up concert halls with a dazzling effulgence of electric light has about as much to recommend it as would the equipping of art galleries with a fire siren and a ship's bell beside each picture. It is our occasional custom to attend the Friday afternoon concerts of the Chicago Symphony Orchestra, frequented presumably, by the very cream of Chicago's music lovers. Here, as elsewhere, the blaze of light system prevails. In the course of the concert, a surprisingly large proportion of the audience may be observed to be taking advantage of this lavish pyrotechnical display in any one of three ways: (a) reading their programs, (b) embroidering, (c) sitting on the edge of their chairs better to watch the conductor. Anyone who can thus disport himself before Brahms or Beethoven, or even Tschaiakowsky, and then later claim that he "heard" the music is either a physiological phenomenon or a prevaricator. To follow honestly the development of a piece of music requires so high a degree of concentration that it is absurd to imagine that an attention divided between the eye and the ear is sufficient. We have essayed the more or less successful subterfuge of slumping down in the seat with one or the other hand before the eyes, but this lays us open to the suspicion of our neighbors that we are (a) a silly fellow feigning intense absorption, (b) asleep. Extinguishing the lights would solve the problem, but this the persons who run concert halls will not do.

To attack the reading of program during a concert is a ticklish proposition. It is "done" by our very best people. Tell them they are demonstrating their ignorance of music by so doing and they will look at you aghast.

It is perfectly possible to look at, and enjoy, a picture without knowing a thing about the painter's life, in fact without even knowing who painted it. This is done constantly, even by connoisseurs. Music, a purer art than painting, is even more independent of its composer and he may be even more easily ignored.

Or it may be protested with still more vigor that "you have to watch the conductor really to 'feel' the music unfolding!" This likewise is pishposh. The gesticulations of the conductor, however graceful or dramatic they may be, have little to do with the music as music. They exist for the purely technical purpose of evoking the proper sounds at the proper time, and the technique of putting the thing across is no more your business than would be the trade name of the pigments your artist used in his painting.

Perhaps we seem to wax too wroth and to be making a mountain out of a mole hill in our vehemence against optical assimilation of music.

But our fury is aroused by the fact that the people who so insult good music in the concert halls are supposedly the very topmost strata of music lovers—the highbrows, no less! If the highbrows of the nation don't know how to listen to serious music what about the masses?

It would seem, perhaps, that the case we are making out for proper concert listening is no very happy one, and that we would place it on the same tedious and exacting plane as listening to a class-room lecture on philosophy or astronomy. This is not entirely true. Certainly we have to concentrate just as much—a symphony by Brahms has just as much meat in it as any four chapters from Kant's *Critique*—but the concentration can be entirely effortless.

Herein, as we have said before, lies the advantage of radio. Given a good receiver and a symphony orchestra properly "picked up" and transmitted and you are all set for a concert



EUNICE WYNN OF KFVB

Miss Wynn is a regular artist of the Hollywood station of Warner Brothers, KFVB. Cute songs, she sings, according to the station

which may nine times out of ten be more enjoyable than one in a mazda-equipped concert hall. You can don your slippers, turn off the lights and park in an easy chair—three separate counts wherein "second hand" radio has it over the first hand thing: With your own private stage thus set you are in an ideal position really to "hear" the music with a fullest possible realization of what it really has in it.

A popular delusion exists that music should caress the listener and lull him into a pleasant state of lethargy, and that he need do nothing but just "set" and let the vague tides of sound wash over him soothingly. The answer to this is age old: the artist can go only half way.

The reward for going half way is the surprising discovery that there are tasty bon-bons waiting at the half-way point whose existence was never even suspected.

Now our point is that it is easier for the neophyte to cultivate an understanding of serious music by listening to it on the radio than by going to concert halls—simply because he can do it with less distraction.

Devious and many are the ways suggested for learning "how to appreciate music." Most of

them involve too much work (they are the best ones). Others go in too much for the technical and intellectual, which after all is only half the content of music at most. We are going to suggest a short-cut method—one which requires no preparatory work at all.

HOW TO LISTEN TO GOOD MUSIC

DOUBTLESS this system of learning how to follow music has been suggested before—though we have not run across it. It may be objected to as an unscientific method, as an unintellectual method—in short as a too strictly emotional method. But it is, a practical method.

Sit yourself before the receiving set in the afore-mentioned slippers condition when there is some first rate symphonic orchestra program going on (we hope you can find one!). Turn off the lights and the oil burner and otherwise exclude all conceivable distractions and then concentrate on the sound issuing from the loud speaker as though you were entombed in a mine waiting for the faint ring of a distant pick ax. Or strain your ears as though you were trying at three in the morning for 210. Things will immediately begin to happen. Surprising things. A host of sounds will begin to emerge that were formerly just lost in the shuffle. Pick out one of the thinnest and feeblest of these sounds and follow it through the maze like a bloodhound pursuing little Eliza through the forest. Keep on its trail and see what it does—and what some of the big bullying noises do to it. Then for a change pick out some little transitory tune—perhaps only five notes long—wait for it like a cat before a mousehole. Presently it will appear again, perhaps in a different key or on a different instrument, or even disguised with false whiskers. But you will recognize it, and with a glee quite equal to that of the cat when the mouse finally emerges from its burrow.

Next try listening to two tunes—or two instruments—at once. Watch how the two tunes sneak along side by side, some times drawing together and shaking hands; other times running off on by-paths and making faces at each other. Watch them intertwine and overlap and disappear and emerge again with a new suit and their hair combed on the other side. Search out some little insignificant orchestral effect that seems to be buried obscurely away at the bottom of the heap of noises. Watch it while it pussy-foots around the corner and gets itself a drink. Watch it start to swell and swagger and toss its hat around. Presently the snifter does its stuff and it is strutting around bombastically. Before you know it, it is running the whole works, the other noises fleeing, terrified, to shelter.

In such wise, listening to the symphony orchestra becomes a grand game with yourself just as much a participant as the orchestra. It has much in common with football: there are long end-runs and fake plays and intercepted passes and trick formations; there is team work and tripping, signalling, and shifts, even "time out" where a rest occurs in the music. And both the football game and the symphony are divided into quarters.

The analogy to football is not quite complete. What happens in a football game is largely subject to chance (as we found out just before we swore off betting last season). But what happens

in a symphony, far from resulting from chance, results from perfect organization.

Herein our proposed method of learning how to listen fails. It will not reveal to you the organization of the music. That would be asking too much. However, the method we suggest will at least demonstrate to a listener that music is not simply a blur of sound, and will enable him to recognize the elements out of which music is organized.

This will be a first step. Furthermore it will be fun—which is the only excuse music has for existence anyway.

For Program Directors Only

WRITES Paul Hale Bruske, of Detroit: My friend Jimmie is blessed with one of those urbane baritone voices that pleasantly vibrate so many loud speakers in the sun rooms and front parlors of our broad land.

Yes! He's a radio announcer. More than that, he's also a program director. On his shoulders rests the responsibility of seeking, interviewing, choosing, auditioning, hiring, scheduling and rejecting various features of alleged entertainment and enlightenment. His station is a good one.

Jimmie does little if any seeking for talent. He does a microscopical amount of hiring. At interviewing he shines. His waiting room is usually full of folks who believe they have a Mission and a Message. Male and female—blondes and brunettes—old and young—artists and artistes—they are all grist for Jimmie's mill. Auditions occupy a good share of his day. He always takes the name, address and telephone number, and gives them a sweet promise to let them know.

One might think that, with all this wealth of willing workers on call, the programs from Jimmie's station would be replete with variety, and fertile in surprise, as the theatrical notices say. Such is not the result. Far from it. Tune-in on him any evening and here is what you are pretty sure to get:—

6:00—7:00—Dinner concert from the Herculaneum Room of a good hotel. Gwan to Bed dope for the kiddies.

7:00—8:00—News Bulletins, Hot Stuff for Farmers, Organ Recital from a Cinema Palace.

8:00—9:00 (Commercially Tainted Hour)—Somebody's Antiseptic Carolers in solos, duets and quartet numbers. Somebody's Real Estate Minstrels in comic songs and dialog.

9:00—10:00 P. M.—(Big Station Feature);—Baby Grand Philharmonic Orchestra in classical and semi-classical numbers, with guest artist soprano or tenor.

10:00 P. M. and on:—Jazz Bedlam from some cabaret or night club.

On Sundays, Jimmie broadcasts church services. In midsummers, he gives us band concerts from the parks. He occasionally hands us a sporting event. He has a weekly silent night. More so than seems usually the case, Jimmie enjoys quite a free hand. His boss is rich, a radio bug and has no personal propaganda to get over—not enough, at any rate, to make it obnoxious.

Some months ago I began to razz Jimmie a bit on the striking lack of originality in his programs. He insisted that he was every bit as good as his competition, and I had to admit it. With him, it was purely a matter of beating competition on one common ground. Jimmie's rut was too deep. He couldn't see over the top.

But one day I got a barb under his hide. Perhaps the boss had just asked about the applause letters. For Jimmie turned on me defiantly.

"What would you do if you were in my place?" he challenged.

That was surely a quick pass of the celebrated

buck but, after all my railery, I couldn't dodge.

"Well," I stalled, "I'd first try to analyze a bit. Here you are, competing for public attention with from four to forty other stations, depending on reception conditions. You want folks to be tuning you in and then letting the dials alone for a while. You want them to think of you when they think of radio—to talk about your station and your programs. You want more applause letters. You'd even prefer knocks to the present silence. You crave personal glory. You could endure a bigger check in your pay envelope."

"Yes! And how?"

"Shut up; I'm analyzing.

"The main offering of all radio stations is music. On that you've gone about the logical limit. Vocally, instrumentally and in combination, you fellows have probably tried about all the tricks there are. I doubt if there is any new musical dodge which would create more than a ripple of interest. And what we want is a tidal wave.

"But there are at least two channels of approach to your dear invisible audience. The one that isn't music is speech. Let us admit, therefore, that the method you will use in getting folks to talking about your station is the spoken word."

"No chance!" yelled Jimmie. "The dullest thing that comes over the air is a speech. The minute one starts here, I can just feel the people tuning-out. There are only three kinds of radio speeches. There's politics. There's platitudes. And there's propaganda. Each is worse than the other. I'd like to pass a rule that would absolutely prohibit all speeches from this station.

"Why you've no comprehension of the speechifiers we turn down right now," Jimmie continued. "There isn't a public official in town who doesn't think he'd be the hit of the season, if he could only get on the air. Every convention that comes here tries to get time for its Grand High Cockalorum. The ladies with pet charities can't understand why we don't put them on oftener. The boy scouts litter up the place with officers that have a message. Speeches? Take a swift jump into the lake!"

"Wait a minute Jimmie," I begged. "Don't get me as any friend of your three P's. They're even more terrible than you say. But there must be such a thing as interesting talk. The newspapers get it."

Jimmie picked a fresh edition from his desk. Clear across the front, in glaring 72-point, screamed the legend, "MRS. BANCROFT WEEPS ON STAND."

It was just the current divorce case and not much of a case at that—no shooting, no violence of any kind, hardly any real scandal. But both parties were socially prominent. The gentleman was rich. The lady alleged he was cruel and neglectful. The children also socially prominent, took sides. The case was good food for tea-table gossip, so the papers were playing it strong.

Jimmie and I looked at the headline. It seemed suggestive.

"She weeps, Jimmie," I said. "And the people read about it. Wouldn't it be better if they could really hear her weep?"

"If you could schedule her to weep into your mike to-night, would they tune-in?"

"You're whoopin' they would," admitted Jimmie.

"Then go get her," I insisted. "Tell her she's got a Mission. Explain that what's happened to her is only a sample of what's happening to thousands of other women. Get her to tell these others what to do. Let her put her case to the whole world, with her own voice and freed from any cross-examination or other rules of any kind. I'll bet she'd jump at the chance. Give those listeners of yours something worth listening to."

"Gosh!" commented Jimmie.

"Then next night, give the same privilege to Mr. Bancroft. Let him talk to the husbands. Have him tell what a real life partner should do. Let him say anything within reason about these wives who spend their days in clubs, and don't have time to cook a dinner for the family. Play him as the outraged American husband, and let him counsel others who feel bad with him. Then let the household arguments rage. Every time the case is mentioned, folks will think of your station and wonder what next."

"Well, that's a good question. What next?"

"Next will come the poor boob who's just been sentenced to life in the hoosegow for murder of his sweetie's friend husband. Give him a last chance to say farewell to the world. What a cinch it will be for you to write his speech! To-night, he's a man and has a name. To-morrow night, and until he dies, he's nothing but a number. And who's to blame? The woman, of course! And then the moral. All this in his own voice, with the handcuffs rattling every time he turns a page.

"Gruesome? Sure, but will they listen?"

"As for me, Jimmie, I've always had a longing to know just what happens at a hospital during a good, major operation on the human torso. I'd rather hear you describe such a thing than get your fresh-from-the-ringside word picture of a good prize fight. That's only a sample of what you can do when you once get your mind on really interesting topics. But let that pass.

"Watch the front pages. They're the best bet. Grab those features hot, give 'em a good, moral, uplifting line of talk, rehearse 'em, and turn 'em loose with their own voices to give us listeners honest-to-goodness heart throbs in the raw. If you're too busy to add this department's duties to those you carry now, hire Pat Montgomery, our old city editor, and put it up to him. Yellow up—and that only means make your stuff interesting."

Jimmie had been getting more pop-eyed with every word. Temporarily, at least, I had him sold. But he cooled off just as quickly. Eventually he admitted that there was something in this idea and promised he'd think it over.

"But no murderers! And no gory operations, either," he declared. "Something controversial, maybe. That's perhaps the secret of making speech interesting. And I may be able to do something with decent celebrities of the day."

A few days later, Jimmie's station announced the first controversial event. It was a debate. On one side was the mayor. Opposed was one of his appointees who had the courage to think for himself. The debate itself wasn't so much. But before it started, right in Jimmie's studio, the mayor fired the appointee, and the latter announced the fact in his address. Jimmie's station got a lot of good publicity, and he was greatly elated.

For several weeks thereafter I was out of touch with Jimmie and with radio. Back in town again I bumped into Jimmie.

"I'll bet I've been missing some hot stuff," I remarked. Jimmie looked blank. Actually I had to remind him of the big idea.

"Oh! We've got something a lot better than that," he boasted. "We've joined a big chain and get our programs right from New York." And then he went on to tell how much better his chain was, on every count, as compared to the others.

However, comma, there are other stations and other cities. Every city has a newspaper, and that newspaper must have a front page. Somewhere, I doggedly insist, there will bob up a program director with the necessary nerve to watch that front page and do what every successful newspaper does—get circulation by being interesting.

AS THE BROADCASTER SEES IT

BY CARL DREHER

How a Famous Artist Broadcasts

THE scene is in the large "B" studio of the National Broadcasting Company at the building on Fifth Avenue in New York City. The room, thirty-six by fifty-two feet, and two stories in height, holds an orchestra of sixty-five men recruited from the New York Philharmonic, with Fritz Busch conducting. The musicians are all in evening dress; their white shirt-fronts gleam in the light streaming down from six giant electrolights. It is a General Motors hour on a Monday night, a somewhat formal occasion, as broadcast features go. About a hundred spectators are grouped around the orchestra, most of the ladies seated, the men standing. I lean against the wall, an idle spectator for the moment, interested, even so, in the effect of the presence of this good-sized crowd on the acoustic characteristics of the room. A concert manager stands on one side of me, and a very famous baritone on the other. We are all looking toward Fritz Busch, who stands, with his baton upraised, in an attitude of commanding tenseness, and at another man who faces the microphones a few feet to one side of the conductor. This man is of a notably handsome and virile aspect; his body is that of an athlete; his features might be those of an intelligent and sensitive business man, but at the same time something of the actor and artist is easily discernible. His head is about three feet from one of the microphones of a double set-up. He stands with his legs well apart and his arms folded across a broad chest. This is John Charles Thomas, the tenor. He is about to sing an aria from Verdi's "The Masked Ball." Interested in the outward manifestations of his technique, I watch the artist carefully.

Fritz Busch now swings his arm downward with an emphatic gesture, and the orchestra begins to play the introductory bars. As the moment for his first note approaches, Thomas raises his left hand and cups it behind his ear. He does this in order better to hear the tones as they reach the microphone, for a man hears his own voice both through the air and through the bones of his head, while others hear him only through the air. His other arm the singer holds across his chest in a rather cramped position, which does not concern him, for he is singing with only moderate volume and does not, for the present, require the full capacity of his lungs. Nevertheless, he is ready for exertion, he has his coat off, and incidentally he is not, like most of the others in the room, in evening dress, but wears a business suit and a blue shirt with soft collar.

He rounds his lips carefully for the notes and sways a little in time with the music. His attitude is one of mingled nonchalance and the greatest circumspection. On the one hand you see a man with every natural advantage for his part, with a reputation made early and securely based on experience; and yet this same man realizes that to sing beautifully is never easy, and that it is only too easy to deviate from the pitch, if only a little, or to falter in the time, if only for a fraction of a second, or to mar a phrase with a breath that is only a little awkwardly drawn. So, seen in one aspect, John Charles Thomas sings effortlessly, and from another angle, he is working as hard as any man in any trade cares to work. The expression of his face changes, sometimes in consonance with the music, but at times, because he is singing more for the audience which cannot see him than for the hundred



Interesting Highlights this Month

—How John Charles Thomas Performs Behind the Microphone.

—Matters Which Make Life Hard for the Broadcaster.

—Where to Get New Information on Human Speech Constants.

—Sources of Helpful Printed Information from Manufacturers.



spectators, he seems frankly to use his facial muscles to aid his larynx. And again, when a note does not suit him precisely, he frowns critically, engrossed in his own private world of tonal creation. As Thomas maneuvers through a difficult succession of transitions, the concert manager nods approvingly, while the baritone on my right, when I glance at him, is watching the singer with critical professional admiration.

The aria is nearing its end. As he approaches the forte passage at the close, Mr. Thomas moves his right arm down from his chest and lets out something near his full volume. He is much too good a microphone performer to go all the way; it is interesting to see how nicely, without knowing a transmission unit from a kilocycle, he unconsciously compresses his volume range within approximately the 40-TU-width allowable in radio telephone transmission, leaving the control operator little to do. Having had considerable experience singing for the radio and phonograph, and, presumably, having heard the performances of others in the same mediums, this artist has adjusted his

technique, when he sings for the air, to the requirements of that particular machinery. Therein you see one of the reasons for his success. The difference between the artist who goes well over the air and the one who is a flop in the broadcast field is as often one of adaptive intelligence as a matter of voice characteristics. That adaptive intelligence may be intuitive rather than quantitative, but the results are the same, whether reached through the vocal feeling of the artist or the calculations of the engineer—better, in fact, when the artist does the editing himself. So, at his climax, Mr. Thomas roars formidably, but not so recklessly as to cause consternation at Bellmore, where the transmitter technicians are keeping an eye on the modulation peaks. Nor does he walk into the microphone; he gestures somewhat with his free right hand, but his feet remain rooted to the spot where he originally took up his position.

The last fine notes ring out, and for a second the artist stands, still in his part, looking somberly at the microphone, as if, behind its unrevealing diaphragm, he saw, across hill and plain and river, on farms and in cities, the several hundred thousand of his countrymen whom he has held entranced for those few minutes. Then, turning, he smiles broadly at the conductor, and, as the announcer speaks his lines, Thomas walks off-stage, or what amounts to off-stage in a broadcast studio, puts on his coat with a gesture curiously reminiscent of a football player struggling into his blanket as he retires to the sidelines, and looks over his next song before he is once more called before the transmitters.

Note for Lexicographers

IN THE December, 1927 issue, under the heading "Radio As An Electro-Medical Cure-All" we recounted the claims of a quack imbued with the conviction that he is curing the assorted ailments of the populace by saturating them with his own brand of radio waves. The word "stob" occurred several times in the healer's description of his paraphernalia, and, failing to find it in my Webster's Collegiate, a very good dictionary for its size, I was at a loss as to its meaning, except that the context indicated that it was some sort of metal ground stake. Mr. H. G. Reading of Franklin, Pennsylvania, clarifies the subject in the following communication:

"Thinking it queer that there could possibly be a word 'not in the (New Standard) Dictionary,' I looked for 'stob'

and find it having several meanings, one of which is 'a long steel wedge' used in coal mines. Doubtless the Doctor wielded the pick for a living at one time."

Mr. Reading's conjecture may possibly have hit the mark. If so, the electronic magic worker in question abandoned a socially laudable profession. We may hope that his adventures in the healing arts, having led him to the conclusion that he can remedy the lesions of a man a mile away by modulating the output of his battery-operated radio transmitter with the stutters of his "oscilloclast," will end by putting him to work with a pick again, although perhaps not in a coal mine.

Speech Constants

ON PAGES 753-754 of Morecroft's *Principles of Radio Communication* (Second Edition), published by John Wiley & Sons, Inc., there is a useful summary of the results of the research work on speech carried on in telephonic laboratories during the past decade. Most of the figures have already been given in this department in the past, but Morecroft adds one or two new ones gleaned from his reading.

(1) The frequencies encountered in human speech are within the range of 100 to 6000 complete vibrations per second.

(2) The energy contained in speech is carried almost completely by frequencies below 500 but the quality and intelligibility of speech is determined very largely by the frequencies higher than 500.

(3) The average power output of the average normal voice is about 75 ergs per second or 7.5 microwatts.

(4) The average male voice exerts a pressure of about 10 dynes per square centimeter at a distance 3 centimeters from the mouth of the speaker.

(5) The human ear can detect sounds, at a frequency of about 1000 cycles, if the sound pressure is as low as 0.001 dyne per square centimeter. If the pressure exceeds about 1000 dynes per square centimeter at this frequency, the ear is practically paralyzed in so far as sound is concerned and the sensation is one of feeling rather than hearing.

(6) The ratio of peak power in the voice (accented syllable) to average may be 200 to 1. Thus an average voice of 10 microwatts shows peaks of 2000 microwatts.

Professor Morecroft gives references to two articles in the *Bell System Technical Journal* which have not been specifically mentioned in this department. One is the article on "Speech, Power and Energy" in the October, 1925 issue of the *Journal*; the other is a paper on speech analysis by Harvey Fletcher in the July, 1925 issue of the same publication. Both discussions are of direct interest to broadcast technicians.

Catalogs and Commercial Publications

THE number of commercial publications of interest to broadcasters is increasing. Three may be mentioned this month. The Sales Department of the Radio Corporation of America (233 Broadway, New York City, with district offices in

Chicago and San Francisco) is distributing to its dealers a leaflet entitled *Average Characteristics of Receiving Radiotrons*. [This leaflet, listed as No. 69 in our "Manufacturers' Booklets Available List, appearing in the back pages of this magazine, may be secured by our readers by using the coupon indicated.—Editor.] Some of the tubes described, such as the UX-210 (7.5 watts oscillator rating) are used in the lower power stages of broadcast speech amplifiers, while others are commonly employed in field equipment. The tubes are classified as "Detectors and Amplifiers"; "Power Amplifiers"; "Rectifiers" and "Miscellaneous." The data given is, first, general physical and electrical information, such as the type of base, outside dimensions, special circuit requirements, possible filament supplies, voltages, and currents. For detection purposes the proper grid return, grid leak, "B" voltage, and plate current are specified. Under "Amplification," for various plate and corresponding bias voltages, the plate current, a.c. plate resistance, mutual conductance, voltage amplification factor, and maximum undistorted output in milliwatts, are included. The alternating current filament and a.c. heater type radiotrons are listed, and the whole list is a useful page to be added to the broadcast engineer's notebook.

J. E. Jenkins & S. E. Adair of 1500 North Dearborn Parkway, Chicago, have issued their *Bulletin No. 4*, dealing with a "Complete Input System" installed at the 1927 Chicago Radio Show. This equipment was used during the entire week of the show, feeding a network of some thirteen of the local broadcasting stations, and a public address system the output of which supplied 22 eighteen-inch cone speakers in the Coliseum. The "Broadcast Amplifier" portion of the apparatus was mounted on a frame 72 inches high by 25 inches wide, which supported the following units: meter panel; a monitor panel, employing a W. E. 205-E or R. C. A. UX-210 tube to feed a loud speaker; an output level indicator; a three-stage broadcast amplifier; a microphone mixing panel; and a telephone jack panel for the broadcast pairs and order wires. The amplifier was the "Type A" described in Jenkins & Adair's *Bulletin 1A*, comprising two stages of amplification using W. E. 102-E or R. C. A. UX-240 tubes, and an output stage for a 205-E or UX-210. A 350,000-ohm wire-wound gain control afforded 11 values of amplification, with equal TU-increments. The 500-ohm output of the amplifier was connected to the level indicator, the monitor amplifier, and the jacks for the outgoing broadcast pairs. The maximum undistorted output available is stated to be 0.8 watt, on a plate voltage of 135 for the small tubes and 350 for the output stage, secured from heavy-duty dry batteries.

The power amplifier portion of the equipment was mounted on a frame only 19 inches wide, but the same height as the broadcast frame (72"). Current was supplied from a generator capable of giving

150 milliamperes at 1200 volts and 10 amperes at 12 volts for the plates and filaments, respectively, of the power tubes, which consisted of two fifty-watters in a push-pull circuit. The actual plate potential was 1000 volts, and separate grid bias batteries enabled each tube to be adjusted to draw 60 milliamperes. Each tube also had a 0-100 millimeter in the plate circuit, and a quarter-ampere fuse. The push-pull amplifier was fed from a 5-watt stage, which in turn received part of the output of the three-stage broadcast amplifier previously described. A level indicator panel for the P. A. system was also included in this frame, the input being directly connected to the output of the large amplifier with a high resistance in series to reduce the voltage. This instrument gave a check on the volume of the loud speakers, incidentally showing up irregularities in the 3000 feet of line connecting up the loud speakers. The broadcast and P. A. frames, set up with a desk between them, made a neat lay-out. All the parts used in building the units with the exception of such items as tube sockets, etc., were manufactured by J. E. Jenkins & S. E. Adair.

A more elaborate publication is *Samson Broadcast Amplifier Units*, issued by the Samson Electric Company, of Canton, Mass. This is a pamphlet of 24 eight-and-one-half-by-ten pages describing Samson parts for broadcast amplifiers and associated equipment, and incidentally going quite deeply into design considerations. It is not intended for general distribution, but may be obtained free of charge by broadcasters writing for it on their letterheads. Microphone-to-tube transformers are first described, with some advice regarding connections and care of carbon microphones. There appears to be an error on page 5, where the d.c. of a 200-ohm microphone is given as 200 milliamperes per button, instead of 20. The difference is serious! Following there is a discussion of multiple microphone (mixer) operation, but the pamphlet argues that "this practice (using more than one transmitter for pick-up) should be avoided unless it is imperative." The point is highly debatable, but at any rate, as the Samson people sell mixer transformers, it is refreshing to see them state what they believe to be true, regardless of a little economic advantage. Tube-to-line and line-to-tube transformers, as well as other matching devices, interstage impedances and transformers are described in following pages. The discussion of impedance relations in audio circuits, direct current design considerations, and the use of center-tap connections, including devices for obtaining a center tap electrically where the actual winding midpoint is unavailable, is quite thorough. The last seven pages are devoted to "General Considerations"—Interference Level, Gain, Volume Control, Attenuation Networks or Pads, and Pad Design. The Samson Electric Company's engineers have turned out a valuable publication.



The A. C. "Bandbox"

By JOHN F. RIDER

A SHORT time ago, the writer had occasion to visit a friend who maintains a hunting lodge in the Berkshires—in the northwestern part of Connecticut. We spent the day in a virgin forest, chopping trees and hauling timber, for the stock of wood fuel required to heat the lodge had to be replenished. There were five of us at the camp and, at the day's end, after our evening meal, we would gather around the fire and listen to the radio.

Say what you will of the radio in the city, the welcome cheer which it imparted to us up in the woods created a deep impression in our minds. To the woodsman habitually isolated many miles from the city it must indeed be a blessing. Imagine the interior of a rough shack, snowflakes beating against the window panes which are almost hidden by sweeping drifts of snow, a merciless wind screaming through the tree tops, and a temperature of "three above" outside. The stillness within the shack is broken by the crackling of the blazing log fire, and by the deep breathing of the woodsman inhabitant, who sits deep in thought—a few well worn books his only companions. His nearest neighbor may be miles away; it would be useless to try and reach him during the several days the storm rages. And what a different state of affairs exists at this neighbor's. Outwardly there is little to choose between the two shacks. They are both lost in the depths of the snow. Each has its blazing open fire of logs, and in each lives a solitary woodsman. But there is also a radio in the second one, and what a transformation it has wrought. Were you to knock at the door for shelter, you might enter to the strains of a Strauss waltz, a Berlin melody, or perhaps even,

some politician may be monopolizing the attention of the blustering fellow who admits you. He'll discuss the Waldorf Astoria orchestra as if he were accustomed to dine there and listen to it almost every day, and will talk with you of Mr. Coolidge's choices almost before the President even chooses. Or he'll demonstrate how Gene got in the winning punch, compare Damrosch's rendition of Beethoven's "Fifth" with Mengelberg's, talk of the merits of the four-wheel brakes on Dodge Brothers "Fastest Four," and match the "Silver Slipper" orchestra with that of the "Twin Oaks." No, he's never been to New York. He was born up in the woods. Rarely sees an automobile. Yes, lots of the men now have radios up here. Don't need them in the summer. Too much to do outside, and plenty of people around, anyhow. No, neighbor Joe hasn't got one. He's an iconoclast (a word he picked up on the radio). Never knows what's going on in the big cities. He himself wouldn't be without a radio.

THE "BANDBOX"

THE receiver that we used at the lodge in the Berkshires was a Crosley "Bandbox." Reception was good, volume adequate, and the quality of reproduction, excellent. After listening to a concert from Springfield, we tuned-in wgy, with the usual result—periodical fading. This phenomenon provoked a discourse by one of the party—Jones, a medical man. He knew all about receivers, although medicine was his forte. His was an analytical mind, and he had grasped the fundamentals of radio. It was simple. He was an old timer. His interest dated back since the day wor commenced operations.

The discussion finally centred upon the receiver at hand. He was the radio authority. The receiver seemed to work well, but—. Yes, it was selective, but—. The volume was good, but—. Well, he had a ten-tube receiver at home, which he had constructed; it comprised five stages of tuned radio-frequency amplification, push-pull audio amplification, a variable grid leak, etc., etc. In sum and substance, it was a "wow." He hoped that some day we would have the opportunity to listen to his pet receiver!

At this point the writer timidly explained his connection with the radio industry. Fine—just the man he was looking for. Could I explain to him wherein the Crosley differed from any other receiver? Would I point out to him the engineering features of the "Bandbox?" How could this receiver be a scientific receiver, and still sell at its low price? As far as he could see, all manufactured receivers were alike; he would never buy a finished product anyhow. Would I tell him something about the new a. c. operated "Bandbox," which is fundamentally similar, so far as the circuit constants are concerned, to the battery-operated "Bandbox" we were using up in the Berkshires?

The fact that highly scientific design and highly scientific production were absolutely necessary to produce a successful inexpensive receiver never entered his mind. He overlooked the fact completely that an accurate study must be made before even the apportioning of the tubes is made, or before the engineering staff can decide upon how many stages of radio-frequency amplification should be employed. The fact that the receiver is sold at a low price

cannot influence the staff to make haphazard decisions. In this particular instance, I told him, the selection of three stages of radio-frequency amplification was a compromise of the sales division and the engineering staff to produce and sell a radio receiver at a reasonable cost for a given amount of radio-frequency amplification and stability. That is to say, calculations were made to determine how much radio-frequency amplification was necessary to provide a certain amount of sensitivity, with a reasonable stability factor. After a study of the sensitivity factor, selectivity was the next consideration. Would the three stages which afford sufficient sensitivity be selective enough? This could be determined mathematically, but it was also determined experimentally. This determination is extremely important in the design of a radio receiver. A low sales price and a high degree of efficiency will immediately "make" a receiver, but low sales price will not compensate deficiency in design.

In view of the demand for single-control receivers, there was much discussion as to what arrangement could be used in the "Bandbox" to permit efficient single tuning control. The receiver has but one major tuning control, and in order to accomplish this, it was necessary to incorporate into the design of the receiver, a circuit arrangement which provided for the different electrical characteristics of various antennas. This was essential in order that true single control be obtained, otherwise a vernier control would be necessary for the input circuit. Under normal conditions, different antennas, with different electrical constants of capacity and inductance, would alter the setting of the first tuning condenser. In the a. c. "Bandbox" the antenna stage has been left untuned. The remaining stages are tuned, and are isolated from the antenna stage. Hence the settings of the tuning condensers remain uniform regardless of the height or length of the antenna used. A radio-frequency choke is connected across the grid-filament circuit of the first tube. The antenna and ground are connected across the choke, and the action of this latter is to cause the radio-frequency signals induced in the antenna circuit to be impressed across the grid-filament circuit of the tube. The choke must be one with very

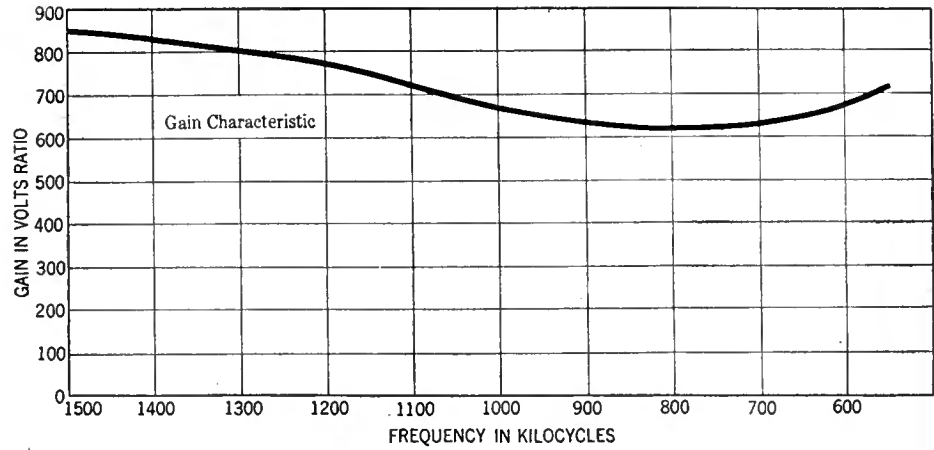

FIG. 1

little distributed capacity, since inherent capacity would afford an easy path for the radio-frequency signals to ground. By reducing the effect of the choke, the magnitude of the signal applied across the grid-filament circuit of the first radio-frequency tube can be reduced, hence the Crosley engineering department immediately visualized an excellent volume control. This is found in the variable resistance which shunts the radio-frequency choke in the antenna circuit. This resistance is non-inductive, free of capacity and, when varied, reduces the impedance of the choke. By reducing the impedance of the choke, its effect is reduced, and the signal input is decreased. Thus we have a volume control, which does not display any effect upon the selectivity of the receiver.

Receivers which oscillate and at the same time perhaps radiate an interfering signal, are not very popular, hence the radio-frequency stages are neutralized—by means of the Hazeltine system. The manner of neutralization gives the system an excellent radio-frequency amplifying characteristic, and helps overcome the usual falling characteristic on the longer wavelengths. Fig. 1 shows the radio-frequency response curve of the system. This graph is graduated from 200 meters (1500 kilocycles) to 545 meters (650 kilocycles). The maximum difference is about 25

per cent., and the minimum point of sensitivity is around 320 meters. The amplification rises on both sides of this point. The maximum gain is found at 200 meters, but even at this frequency, it is not a sharp peak. At no place on the curve is there a sharp peak or depression. Contrary to usual design, the amplification increases as the wavelength setting is increased above 320 meters (940 kc.), the low amplification point of the system. At 350 meters (545 kc.) the difference between its level and the maximum is approximately 16 per cent. These differences are small, and are not noticeable in actual operation. The radio-frequency transformers are single-layer solenoids with bifilar primary windings; that is to say, they have two primary windings. One winding is the regular primary and the other small winding is the inductance utilized in the neutralizing system. The inductance value of the secondary of these transformers is 190 microhenries and the capacity of the tuning condensers is approximately 430 micro-microfarads (0.00043 mfd.). The excellent radio-frequency response characteristic is attributable to a very large extent to the design of the primary winding of each radio-frequency transformer, its position with respect to the secondary winding, and to the coil utilized in the neutralizing system. A close study of the wiring diagram,

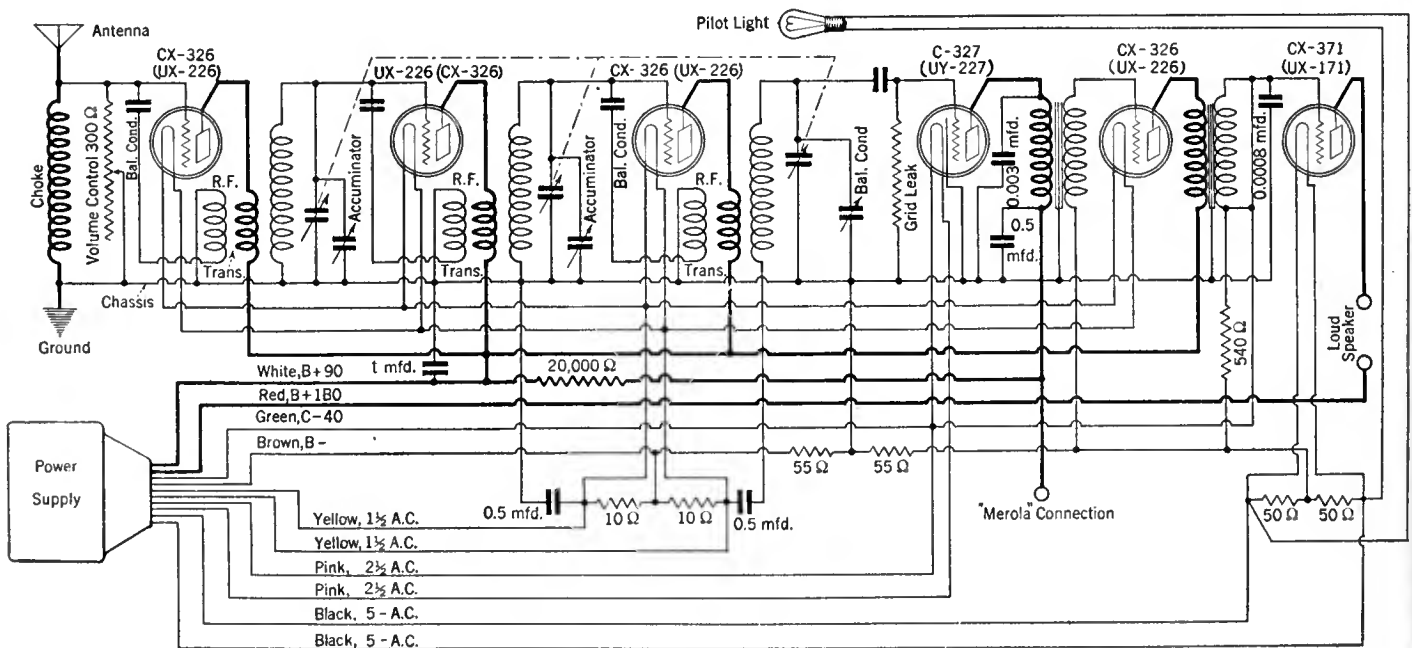

FIG. 2

The circuit diagram of the a. c. "Bandbox" showing the power unit connected for operation

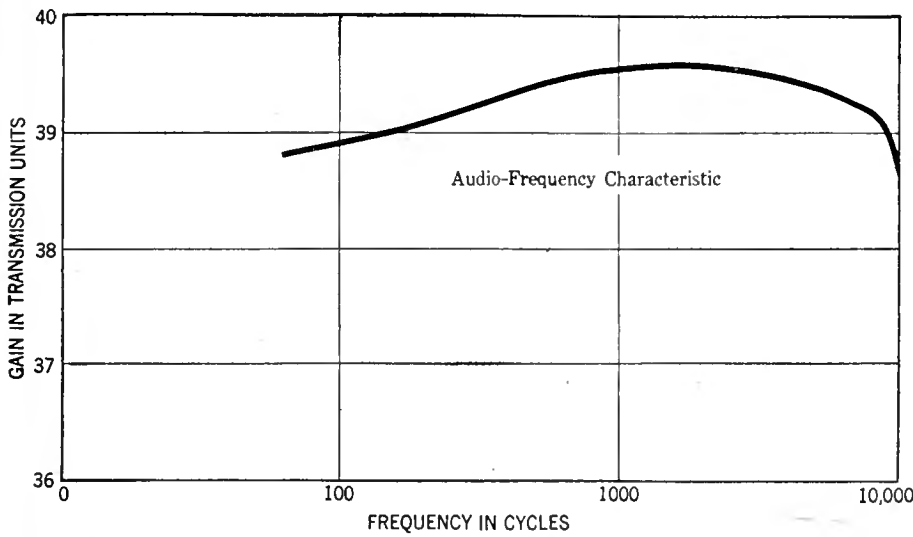

FIG. 3

Fig. 2, will bring to light the fact that this system is different from the conventional split-primary neutralizing arrangements. It is just these little differences which make for the variances in design, and necessitate extensive research, in order that the final result be meritorious and worthy of recognition.

An examination of the receiver shows thorough and complete shielding of all the units, including condensers, coils, and transformers. This is a sound piece of engineering, since it practically isolates the receiver from all external influences. Very often, a. c. operation with the power supply unit adjacent to a receiver utilizing unshielded transformers results in the induction of an interfering hum from the power equipment into the receiver audio-frequency transformers. Shielding the units eliminates all possibility of external interfering influences. Sheet iron, cadmium plated, is used as the shield for the condensers, of which shield the chassis also forms a part. Copper cans are used for the shielding of the radio-frequency transformers. These shields facilitate elimination of coil interaction and external influences, and also tend to increase stability. By selection of copper shields, the design of the coils, and placement of these latter with respect to the shields, the effect of the shield upon the radio-frequency transformer is kept at a very low value, so much so, that its detrimental effects are negligible so far as sensitivity and selectivity are concerned.

THE AUDIO SYSTEM

WITH respect to the audio system, two stages of transformer coupling are utilized and the operating curve is shown in Fig. 3. A study of the curve shows a variation of less than one half of a transmission unit through a frequency spectrum of from 60 to 10,000 cycles. At first glance, one is apt to imagine an operating characteristic very much akin to the majority of two-stage audio units. Upon closer observation, however, the small variation becomes apparent. The gain of the audio channel is low, but with the amplifying powers of the radio-frequency system, the combination affords a very satisfactory overall response. The absence of a definite peak on some audio frequency shows the result of careful study of the leakage reactance factor in transformer design.

A study of the curve shows an overall frequency range of from 60 to 10,000 cycles, with about equal amplification on 60 and 10,000 cycles. The curve rises between 60 and 900 cycles, is fairly flat between 900 and 3000 cycles,

falls gradually to 8000 cycles, and then drops abruptly between 8000 and 10,000 cycles.

OTHER FEATURES

BEING, at the time of my sojourn in the Berkshires, conversant with the features of the a. c. operated "Bandbox," the writer was able to communicate all the above information to



THE POWER UNIT

Its compactness is evidenced by the photograph on page 369

Jones, whose mind, strangely enough, was gradually allowing itself to be changed to look upon the manufactured receiver in more favorable light.

By this time the other members of the group had evinced interest. Some had read the advertisements describing the receiver, and commenced hurling questions: "What were the accumulators?" "Were there any other interesting features?" The appearance of the accumulator controls deceived the "expert." He was certain that they were resistances or potentiometers, by means of which the grid bias voltages were altered. He was much surprised to hear that they were small vernier condensers, one in shunt with the third radio-frequency stage input tuning condenser and the other in shunt with the detector tuning condenser. These are visible in the wiring diagram and their function is to permit more accurate tuning.

The chassis is of 1/8" iron and is grounded so that all ground connections of the receiver may be attached to it. The radio-frequency transformers used in the receiver are tested on radio-frequency bridges to within 2 per cent. and are matched with condensers which are also tested at radio frequencies. No coil or condenser combination of a set of three varies more than 1 per cent. from the rated values. In other words, the coils and condensers are sorted into groups and are matched so that the resonance points are identical in the various tuned stages. The grid returns for the untuned and tuned stages are at ground potential and obtain the various bias voltages through resistances, which carry the plate current. The voltage drop across these resistances is utilized as the grid bias.

The tubes in the three stages of radio-frequency amplification of the a. c. "Bandbox" are of the cx-326 (ux-226) type, and this tube is also used for the first audio stage. The detector is a c-327 (uy-227) and the output audio tube is a cx-371 (ux-171).

The electrical balance in the various filament circuits is obtained by means of mid-tapped resistances connected across the filaments, instead of resorting to the use of mid-tapped transformers. The plate voltage applied to the radio-frequency tubes and also the first audio tube is 90 volts. The 90-volt lead also connects to a 20,000-ohm resistance in the set, and is thus dropped to supply the required detector plate voltage. In other words, only two positive plate-voltage leads are available from the unit supplying the receiver. These are the 180-volt lead for the power tube and the 90-volt lead for the

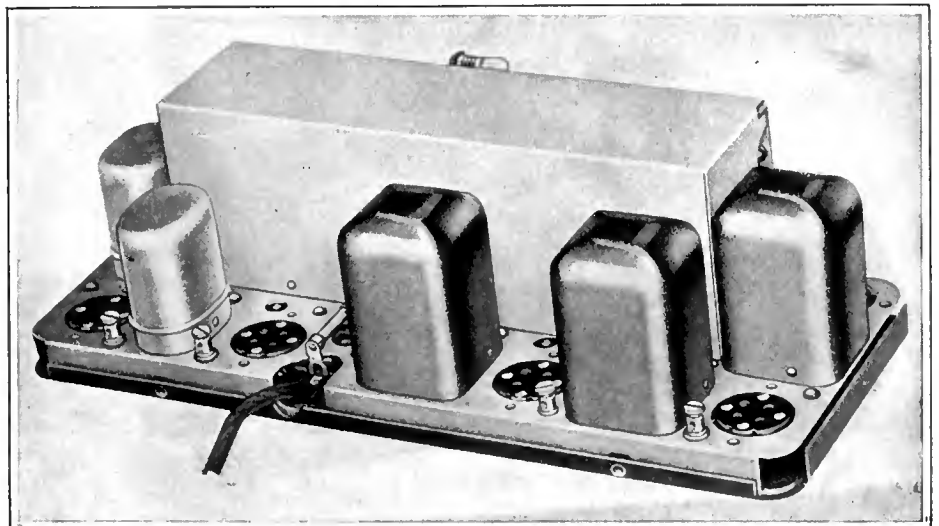

A REAR VIEW OF THE "BANDBOX" CHASSIS

other tubes. A separate 45-volt lead is not provided in the manner usually employed. The power unit also has a negative grid bias 40-volt lead, and the regular B minus lead. The resistances which supply the radio-frequency and detector tubes with grid bias are in series with the B minus.

All of the cx-326 type tubes are connected in parallel and are fed from individual low-voltage filament windings. The midpoint in the filament circuit is obtained by means of a 20-ohm mid-tapped resistance in shunt with this filament circuit. A mid-point is not required in the filament circuit of the c-327 tube since it is of the heater type. The mid-point for the 171 tube filament circuit is obtained by means of a 100-ohm mid-tapped resistance. The filament heating transformer in the power unit supplies three distinct voltages from three distinct windings. These are for the 1.5-volt tube, the 2.5-volt tube, and the 5-volt tube. The cx-326 tubes require 1.5 volts at 1.05 amperes for normal filament operation. The c-327 requires 2.5 volts at 1.05 amperes, and the cx-371 requires 5 volts at 0.5 ampere.

The "Merola" connection indicated on Fig. 2 is the contact point for a phonograph pick-up unit, should it be used. "Merola" is the trade name for a pick-up made by Crosley.

THE POWER UNIT

THE power unit differs in several respects from the conventional. It is obtainable in two forms, the first being suitable for a 60-cycle supply and the second for a 25-cycle supply. The latter may also be used for 60 cycles.

A ux-280 type full-wave rectifying tube is employed, as can be seen in Fig. 4. A well-designed two-section filter is employed and the chokes are of 10 henries inductance each, and have a high current rating. This is important, since filtration is improved when the choke is operating below the maximum current rating.

The condensers in the filter network are of 10-mfd. each, three being used in the form of a single Mershon condenser. The voltage reducing resistance has a total resistance of 5000 ohms, tapped at 1525 ohms. With 280 volts input across the two anodes of the rectifying tube, the total voltage across the output is 220 volts. The rectified voltage is, therefore, sufficient to supply the required negative bias of 40 volts. The transformer contained in the power unit has six individual windings. The primary is tapped for low and high line voltage. The rectifier tube filament voltage is obtained from one secondary

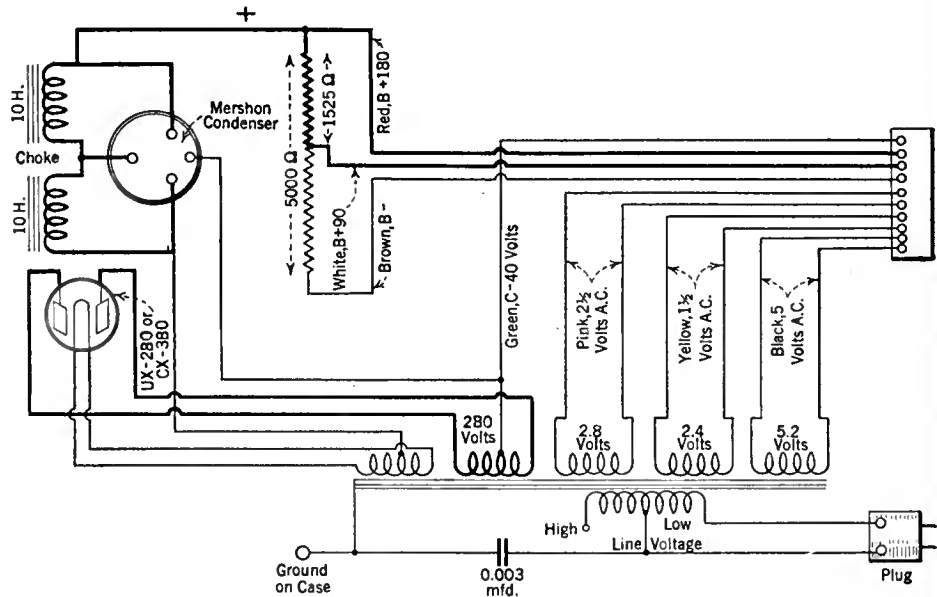

FIG. 4
The circuit diagram of the power supply unit of the a.c. "Bandbox"

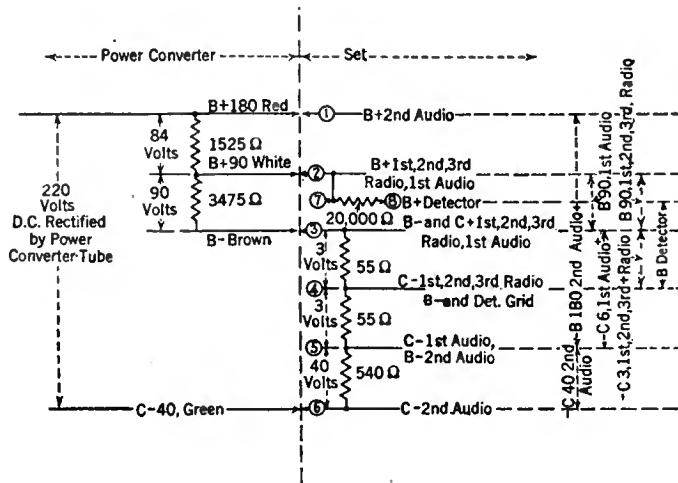

FIG. 5
This diagram shows how the grid voltages are obtained

winding, the rectifier plate voltage from another, while a winding of 2.8 volts is used to supply the 2.5-volt filament of the detector tube.

resistance in the feed line will cause an appreciable voltage drop.

The voltage output of the winding which supplies the 1.5-volt tubes is rated at 2.4 volts, and the voltage output of the winding which supplies the 5-volt power tube is 5.2 volts.

An idea of how the various grid bias voltages are obtained can be gleaned by a study of the wiring diagram of the receiver Fig. 2, and Fig. 5. The three resistances which produce the C bias voltages for the various tubes are shown in both drawings. The main wiring diagram shows the actual position of these resistances, as located in the receiver. The small wiring diagram, on the other hand, shows a much simpler arrangement, such as would be found were these resistances located in the power unit. The first 55-ohm resistance results in a voltage drop of 3 volts. This is the bias applied to the three radio-frequency amplifiers and to the detector grid. The next 55-ohm resistance, in series with the first, produces a voltage drop of 6 volts, which is applied to the grid of the first audio-frequency tube. The 540-ohm resistance produces the voltage drop of 40 volts required for the second audio tube, which, in this case, is a cx-371 (ux-171).

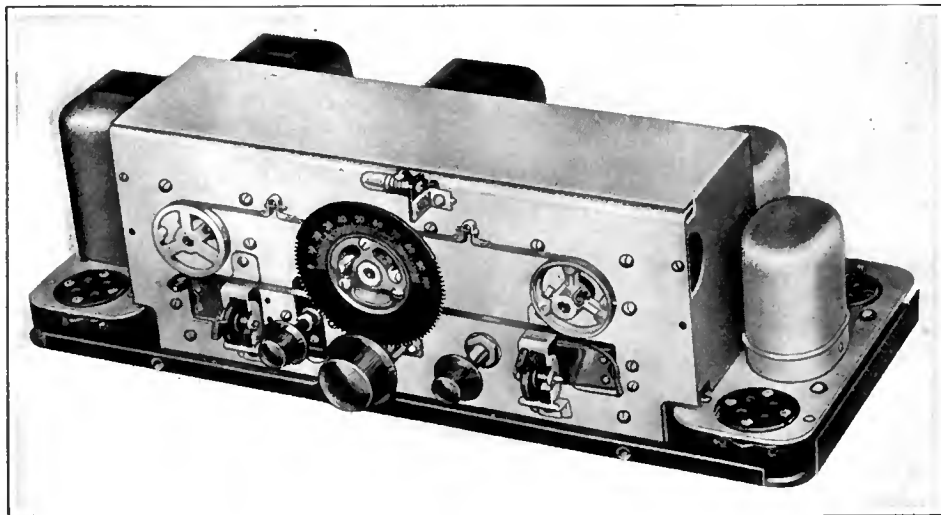

WHAT THE "BANDBOX" LOOKS LIKE WITH THE CABINET REMOVED

Interesting Loud Speakers and Power

Equipment

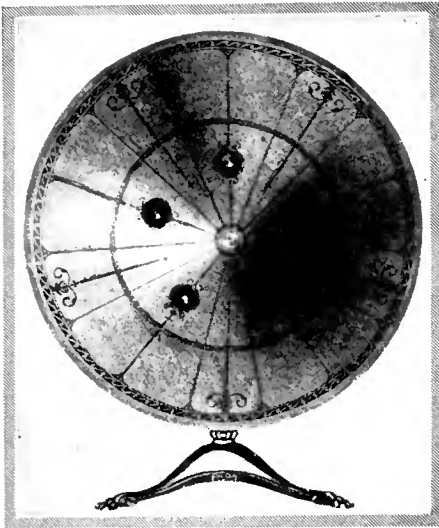

THE FADA 22" CONE

ALTHOUGH this picture illustrates only the table model, the 22" cone is obtainable also in pedestal form at \$50.00, and for hanging on the wall at \$25.00. The table model shown lists at \$35.00. Fada also has a 17" cone which retails (the table pattern) for \$25.00.

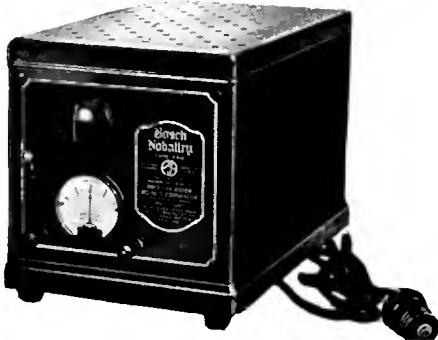

THE BOSCH A UNIT

WHICH has been designed to supply A current to a receiver employing from four to ten tubes. The unit makes use of a Tanager rectifier tube. The price of this A supply is \$58.00, and it is produced by the American Bosch Magneto Corporation, Springfield, Massachusetts.

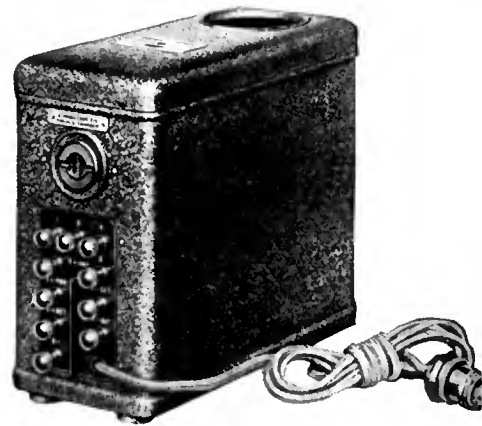

IF YOU HAVE AN ATWATER KENT RECEIVER

YOU will find this Atwater Kent B supply especially suitable for use in conjunction with it. The B supply may, however, be used with other receivers. It delivers up to 135 volts, and is for sets consuming not more than 40 mls. An automatic relay is incorporated within the unit, and there is a receptacle in the front for trickle charger plug. Price \$39.00.

A NEW DYNAMIC LOUD SPEAKER

THE movable coil principle is featured in this attractive new loud speaker, which retails at only \$65.00. Two of its connections go to the A battery, but a minimum of current is consumed. The loud speaker (with step-down transformer) without cabinet retails at \$17.50. Jensen Radio Manufacturing Company, Oakland, California.



TWO MAGNAVOX LOUD SPEAKERS

THE popular B-1 unit is shown to the left. It is a moving coil electro-dynamic loud speaker retailing for \$50.00. It should be used in conjunction with a baffleboard. The model to the right lists at \$120.00. In addition to being a loud speaker, it also combines a B supply unit and power amplifier. A 210 type tube is used for the latter, while a 216 type tube is employed as the rectifier.



A NEW WESTERN ELECTRIC CONE

THE Western Electric 540 AW cone loud speaker has been the standard of comparison for so long that considerable interest is bound to follow the announcement of a new cone by this company. The 560 AW, as this new instrument is known, is a 25" cone, and it lists at \$35.00. The decoration in red and dark brown, is more striking than that on the 540 AW.

New Records

Short Reviews of Recent Releases by
Victor, Brunswick, and Columbia—
A List of Some New Record Albums
—Rimsky-Korsakov's Scheherazade
Suite Obtainable in Complete Form



WE ARE celebrating the four-month birthday of this department by climbing out of our rompers and taking a big step. Henceforth we shall aim to be a guide to all the best phonograph records. You cannot read all the books published each year in order to choose the best volumes, so you consult book reviews and guides. Neither can you while away the hours in your favorite music store listening to the new—and old—offerings of the very active phonograph companies. When you buy records the chances are you act on the advice of the music salesman, or take the word of a friend, or if you happen to be on the mailing list of a music store, you check over the catalogue and select the most likely sounding titles. Any one of these methods is precarious and the element of chance is large in each.

When this department was mapped out in the editorial mind, the word went forth that these two pages were to be devoted to a general review of phonograph records which had been produced by artists who were familiar to listeners—in as broadcast performers. Now we will extend the field to include the records of all artists whether or not they play the dual rôle. Some of the recordings will be briefly reviewed, others will merely be mentioned, and each month there will be a list of records which we consider well worth hearing, and buying, if the spirit moveth.

WHAT HAVE WE HERE?

AFTER inspecting the current supply of records we find that it contains the following ingredients: The usual popular vocal numbers by the usual popular vocal artists; an array of good dance numbers with one outstanding success, *Dream Kisses*; several old favorites rendered superbly by such distinguished artists as Sophie Braslau, John Charles Thomas, Charles Hackett,

and Maria Kurenko; seven minutes of very beautiful choral singing by the Metropolitan Opera Chorus; and an album of Rimsky-Korsakov music, of which, more anon. These ingredients have been highly seasoned with the sentiment which, we are led to believe by song writers, song singers, and phonograph companies, the public cries for, and they have been expertly mixed, and sifted, spread on the discs by the new electrical recording method, and served hot to the public, for prices ranging from seventy-five cents to ten dollars. Taken as a whole there can be no question of the general excellence of the output. Our chief complaint is that it is too sweet for our taste. Is our taste

Don't Miss These

Scheherazade Suite (Rimsky-Korsakov) played by the Philadelphia Orchestra under Leopold Stokowski (Victor). *Cavalleria Rusticana—Gli Aranci Olegziano* and *Immezziamo Il Signor* (Mascagni) sung by the Metropolitan Opera Chorus, with Orchestra (Victor). *Rigoletto: La Donna E Mobile* (Verdi) and *Cavalleria Rusticana: Siciliana* (Mascagni) sung by Charles Hackett (Columbia). *Liebestraum* (Liszt) and *Sheep and Goat Walkin' To Pasture and Gigue* (Bach) played by Percy Grainger (Columbia). *Among My Souvenirs* and *Washboard Blues* played by Paul Whiteman and His Concert Orchestra (Victor). *Dream Kisses* and *Among My Souvenirs* played by the Ipana Troubadours and Bea Selvin respectively (Columbia). *My Lady and Two Loving Arms* played by Cass Hagan and His Park Central Orchestra and The Cavaliers respectively (Columbia). *A Shady Tree and There Ain't No Land Like Dixieland To Me* played by Ernie Golden and His Hotel McAlpin Orchestra (Brunswick). *Back Where the Daisies Grow and Lonely in a Crowd* played by the Park Lane Orchestra (Brunswick). *Lilise and Hanohano Hanalei* by the South Sea Islanders (Columbia).

peculiar or are there others who do not clamor for sentiment as the pervading flavor in their musical diet? Would they, too, like a little humor in their daily slice of song?

More or Less Classic

Cavalleria Rusticana—Gli Aranci Olegziano and *Cavalleria Rusticana—Innezziamo Il Signor*. By Metropolitan Opera Chorus with Orchestra. (Victor). An expert recording of two of the

most melodious of the choruses of Mascagni's opera, sung with great beauty and restraint.

(a) *Sheep and Goat Walkin' to the Pasture* (Guion), (b) *Gigue* from *First Partita* (Bach), and *Liebestraum* (Liszt). By Percy Grainger (Columbia). Here is variety itself: a humorous tale, a lively jig, and a romance all on the same record, and each feelingly interpreted by this master pianist.

Hungarian Dance No. 1 (Brahms-Joachim) and *Slavonic Dance No. 2*, in E minor, (Dvorak-Kreisler). By Toscha Seidel (Columbia). Two lusty dances played with too mechanical vehemence to suit us.

Lucrezia Borgia: Brindisi (Donizetti) and *Come to Me O Beloved!* (Bassani-Malipiero). By Sophie Braslau (Columbia). We prefer the rollicking joyousness of the drinking song to the heavy solemnity of the cantata but that is a matter of opinion. The rich contralto voice of this artist handles both expertly.

Love's Old Sweet Song (Molloy) and *The Sweetest Story Ever Told* (Stults). By Sophie Braslau (Columbia). Miss Braslau digs way down in the bag and brings up some of the old tricks. But she sings beautifully.

Rigoletto: La Donna e Mobile (Verdi) and *Cavalleria Rusticana: Siciliana* (Mascagni) by Charles Hackett (Columbia). So convincingly does this glorious tenor sing Verdi's surprise number that one is almost ready to agree that woman is fickle! Well, were it necessary, we would agree to anything for the privilege of listening to Hackett's singing.

Coq D'Or, Hymn to the Sun (Rimsky-Korsakov) and *Song of India* (Rimsky-Korsakov) By Maria Kurenko (Columbia). We would like the first selection better were it minus a few coloratura frills. As for the S. of I. we said what we had to say about that years ago. However, it is beautifully sung.

Smiling Eyes and *Roses of Picardy*. By John Charles Thomas (Brunswick). Why turn this fine baritone voice loose on such shop-worn ballads as these?

"Popular"

Among My Souvenirs and *Washboard Blues* by Paul Whiteman and his Concert Orchestra (Victor). Whiteman at his unique best. You can't dance to these but who wants to? It's music worth hearing.

Dream Kisses by the Ipana Troubadours (Columbia). At last we have something different in dance numbers! A soothing, insinuating rhythm built for dancing and played for dancing

Interesting Record Albums

Beethoven: <i>Symphony No. 9, in D minor (Choral)</i>	ALBERT COATES AND SYMPHONY ORCHESTRA	Victor
Beethoven: <i>Concerto in D major, Violin</i>	FRITZ KREISLER AND STATE OPERA ORCHESTRA, BERLIN	Victor
Brahms: <i>Symphony No. 1, in C minor</i>	LEOPOLD STOKOWSKI AND PHILADELPHIA ORCHESTRA	Victor
Schubert: <i>Symphony No. 8, in B minor (Unfinished)</i>	LEOPOLD STOKOWSKI AND PHILADELPHIA ORCHESTRA	Victor
Tschaikowsky: <i>Casse Noisette (Nutcracker Suite)</i>	LEOPOLD STOKOWSKI AND PHILADELPHIA ORCHESTRA	Victor
Chopin: <i>Sonata in B minor, for Pianoforte, Opus 58</i>	PERCY GRAINGER	Columbia
Brahms: <i>Sonata in A major, Opus 100, Violin and Piano</i>	TOSCHA SEIDEL AND ARTHUR LOESSER	Columbia
Ravel: <i>Ma Mère l'Oye (Mother Goose) Suite for Orchestra</i>	WALTER DAMROSCH AND NEW YORK SYMPHONY ORCHESTRA	Columbia
Dvorak: <i>Symphony No. 5, "From the New World"</i>	SIR HAMILTON HARTY AND HALLÉ ORCHESTRA	Columbia
Berlioz: <i>Symphonie Fantastique, Opus 14</i>	FELIX WEINGARTNER AND LONDON SYMPHONY ORCHESTRA	Columbia
Beethoven: <i>Symphony No. 5, in C minor</i>	WILHELM FURTWÄENGLER AND PHILHARMONIC ORCHESTRA, BERLIN	Brunswick
Beethoven: <i>Symphony No. 7, in A major</i>	RICHARD STRAUSS AND THE ORCHESTRA OF THE STATE OPERA, BERLIN	Brunswick
Handel: <i>Concerto for Organ and Orchestra No. 4 (Op. 4)</i>	WALTER FISCHER OF THE BERLIN CATHEDRAL WITH ORCHESTRA	Brunswick
Mozart: <i>Jupiter Symphony, No. 41 Opus 551</i>	RICHARD STRAUSS AND ORCHESTRA OF THE STATE OPERA, BERLIN	Brunswick
Richard Strauss: <i>Ein Heldenleben</i>	RICHARD STRAUSS AND THE ORCHESTRA OF THE STATE OPERA, BERLIN	Brunswick

The records in the above groups are to be had only in album form. The list is by no means complete but serves to indicate a few of the most interesting complete recordings which are available. The Rimsky-Korsakov *Scheherazade Suite* (Victor) is reviewed elsewhere on this page.

by S. C. Lanin's Toothpaste Boys. On the reverse is *Among My Souvenirs*. Ben Selvin makes as good a dance record out of this as Whiteman did a set piece.

A Shady Tree and There Ain't No Land Like Dixieland To Me by Ernie Golden and His Hotel McAlpin Orchestra (Brunswick). Two more hot numbers from the orchestra under the direction of the gent who has musical "it."

Yep! 'Long About June and Blue Baby by Ray Miller and His Hotel Gibson Orchestra (Brunswick). The first is a lively down-east-barn-dance sort of number that will make your feet very restless; the second, only another dance tune. Both smoothly played by this excellent Cincinnati orchestra.

Back Where the Daisies Grow and Lonely in a Crowd by the Park Lane Orchestra (Brunswick). After hearing these two numbers you will add the P. L. to your list of best orchestras.

Ooh! Maybe It's You and Shaking the Blues Away by Ben Selvin (Brunswick). Not quite up to the Selvin mark but you won't want to sit still to either number.

Barbara and There's a Cradle in Caroline by Ben Bernie and H. R. Orchestra (Brunswick). Just another disappointment.

Together We Two and What'll You Do by Isham Jones Orchestra (Brunswick). Isham has certainly been in seclusion long enough to have dug up better numbers than these for his return engagement.

My Lady by Cass Hagan and His Park Central Orchestra. Simply swell! *Two Loving Arms* by the Cavaliers. A grand waltz. (Columbia).

Are You Happy? and Kiss and Make Up by Vincent Lopez and His Casa Lopez Orchestra (Brunswick). Answering the question: No more so than if we'd never heard this record.

Together We Two by Fred Rich and His Hotel Astor Orchestra. (Columbia). Only moderate. *Baby Feet Go Pitter Patter* by Harry Reser's Syncopators. Won't you give just a little something for a decent funeral?

Where Is My Meyer? by Eddie Thomas' Collegians (Columbia). A good nonsense song from the *Chauce Souris* sung by Frank Harris with an orchestral background and a little yodeling for good measure. *Clementine* by Don Voorhees and His Orchestra is only fair.

A Lane in Spain and There Must Be Somebody Else by Van and Schenck (Columbia). A very good vocal duet aided by guitar and piano.

Watching the World Go By by Ford and Glenn

(Columbia). Why shouldn't it? This isn't enough to stop for. *Are You Thinking of Me To-night?* by Elliott Shaw. Insomnia must be prevalent among song writers.

There's a Cradle in Caroline and I'll Be Lonely by Frank Bessinger and Ed Smalle (Brunswick). Good sentimental singing.

I'm Coming, Virginia and Just a Memory by the Singing Sophomores (Columbia). Leaves us cold.

Twiddlin' My Thumbs and The Pal You Left At Home by the Whispering Pianist (Columbia). Good rubber wasted on tripe.

Liliue and Hanobano Hanalei by the South Sea Islanders (Columbia). Good Hawaiian music magnificently played.

My Blue Heaven and The Song is Ended by Jesse Crawford (Victor). If you know anyone who wields a better movie organ than the organist at the Paramount Palace we would like to hear of him. Jesse Crawford is at his very best on these records.

Are You Lonesome To-night? and *Under the Moon* by Lew White (Brunswick). But the Roxy organist isn't far behind.

Estrellita and Mi Viejo Amor by Godfrey Ludlow (Brunswick). Good violin solos by the well-known staff artist of the National Broadcasting Company.

A COMPLETE SYMPHONY

Scheherazade—Symphonic Suite (Rimsky-Korsakov). By Leopold Stokowski and the Philadelphia Orchestra. Complete on five double-faced Victor records.

When the Russian composer Rimsky-Korsakov called this music the *Scheherazade Suite* he did not mean to imply that he was telling, musical word for spoken word, the story of the Sultan Schahriar, who so distrusted women that he vowed to put each of his wives to death after the first nuptial night; and of Scheherazade, the Sultana, who caused him to forsake his vow by entertaining him with fascinating tales for one thousand and one nights, at the end of which time it is to be presumed that he had regained his faith in women. Rimsky-Korsakov merely used the title as a hint to his listeners that the suite was "an Oriental narrative of some numer-

ous and varied fairy tale wonders," told by some one person to her stern husband.

Take the hint of leave it. If you take it you can easily pick out the voice of the stern husband with which the first movement, *The Sea and the Vessel of Sinbad*, opens. It is a bold phrase played in unison by the trombone, the horn, woodwinds, and strings in their lower range. Then the sweet, timid voice of Scheherazade, in the high trembling notes of the violin, with the harp in the background. Then we hear the long roll of the sea translated into music by the violins. Now and then the lapping of the waves on the vessel. In the second movement, *The Tale of the Prince Kalender*, you can certainly identify the figure of the fakir prince in the now sad, now comic, notes of the bassoon; and there is no mistaking the wild violent dance of the Orient in which brasses, woodwinds, tuba, trombone, bassoon, and strings combine. The third movement tells a love story of *The Young Prince and the Young Princess*. The romance is plainly indicated in the simple tender melodies. And lastly there is *The Festival at Bagdad*, music full of the color and sinuous rhythm of the East. Queer minglings of sounds, seductive strains, call to mind beautiful veiled maidens, snake-charmers, swaying camels, spicy odors, perfumes of the Orient. Then suddenly we swing back again to the sea, this time not the calm, rolling sea of the first movement but a turbulent, treacherous sea, in which the vessel of Sinbad finally sinks, after a mighty crash on the rocks. And as the waters close over the ship the voice of the Sultan, now subdued, tells us that the tale is over and he is pleased, and the Sultana goes back to the opening theme of the strings for her finale.

Beautiful music, rich, colorful, varied—dealing with weird and wonderful events but always essentially human. Played by a master orchestra directed by a master hand—a feast to suit the palate of the most discriminating of music lovers.



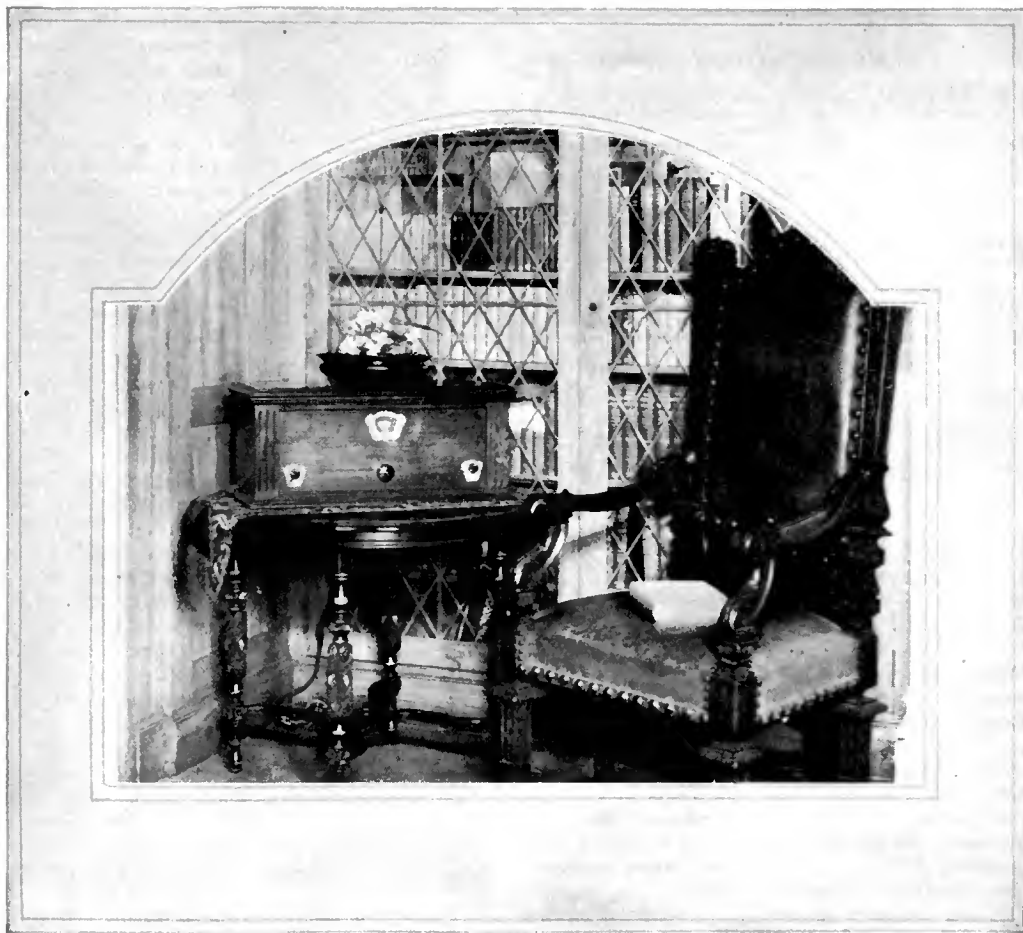

RADIO BROADCAST Photograph

A RECEIVER EMBODYING NEW R. F. PRINCIPLES

This six-tube Stewart-Warner receiver employs the features of r.f. design which are described in this article

Designing an R. F. Amplifier

By Sylvan Harris

PERHAPS the most important problem that remains in connection with the design of radio receivers is that of controlling regeneration and the tendency toward self-oscillation. The patent situation in the radio industry to-day accentuates the importance of this matter, but aside from this, and considering only the technical aspect of the problem, there are certain important points concerning which the layman's ignorance is appalling and on which many engineers are doubtful. The most important of these is, perhaps, the magnitude of the amplification which a radio-frequency amplifier can furnish under the most favorable conditions.

This problem will not be discussed here; it will suffice for the present to state that the greatest amplification that a radio-frequency amplifier, having regeneration, will furnish, is determined by the electrical characteristics of the circuits, and takes place when the decrease in amplitude of the feed-back current from stage to stage becomes less than equal to the natural amplification in the opposite direction. That is, a voltage established in the plate circuit of the last amplifier (r.f.) tube, is decreased in each stage looking in a direction toward the input of the amplifier.

In the opposite direction we have the signal voltage passing from stage to stage, but being amplified at each step. When the decrease in

amplitude in the direction of feed-back becomes small enough, oscillations are established, and it is at the instant that these oscillations are established that the greatest amplification is obtained.

The maximum possible amplification that can

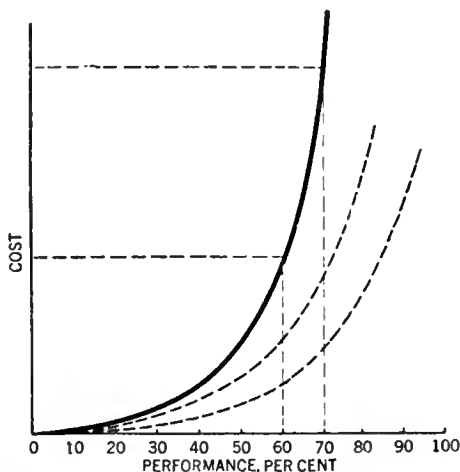

FIG. 1

be obtained from the system under given conditions can be computed. A method of making this computation was shown some time ago by Dr. A. W. Hull, in his paper on the shielded-grid tube in the *Physical Review*.

It can be shown that, using the usual tubes, and under the usual average circuit conditions, it is not possible to obtain a gain per stage of more than about 10 or thereabouts, in the broadcasting spectrum, assuming reasonable values for the circuit elements and the 201-A type tube characteristics. Furthermore, the amplification naturally drops off as the frequency increases because of several complicated tube and circuit factors. The amplification we are referring to is the *maximum* amplification obtainable, keeping the adjustments such that the system is always on the verge of oscillation.

This brings to our attention a particular phase of the problem, *viz.*, that of keeping the overall gain of the amplifier constant over the broadcasting frequency range. Since the amplification is naturally greater at lower frequencies than at higher, the only way in which to make it uniform is to operate very close to the point of oscillation at high frequencies, and not so close at low frequencies. On account of difficulties encountered due to the stabilizing elements (grid resistors, etc.), we have many sets which operate well at

300 meters but are "dead" at 500 meters, and many of which are rather "wild" below 300 meters.

On the other hand, due to absorption in metal panels, additional attenuation introduced by neutralizing condensers, etc., we often encounter the condition where the set is "dead" at the higher frequencies also. Of course, these terms are merely relative; it is clear that under any circumstances the design of the receiver, especially when it is intended for production in large quantities, must provide for sufficient tolerance in this matter of operating close to the oscillation point.

Another point which is of paramount importance, especially as regards the production of radio receivers in large quantities, is that of the relation between the performance of a receiver and its cost. Let us call the "performance" of our ideal receiver 100 per cent. and the performance of the receiver which will not work at all, 0 per cent. As regards the cost, let us say we can build a receiver whose performance is zero per cent. for practically nothing. On the other hand, as we improve the performance of our receiver in uniform steps, the cost mounts up and up at an ever-increasing rate, until it would cost an infinite amount to produce the ideal receiver operating at a performance of 100 per cent. The relation between the performance and the cost of a receiver is probably an exponential one, and may be something like the curve of Fig. 1. Thus, we can design and build a receiver having a "performance" of 60 per cent. at a reasonable cost, but when we attempt to improve the performance by 10 per cent. more, we drive the cost way up. Of course, the curve of Fig. 1 is purely qualitative; it is intended merely to illustrate the idea.

The receiver described in these articles has been designed with these ideas in mind; at the same time it must be remembered that there are certain circuit arrangements which are more flexible than others, making it possible to build a better receiver at the same cost, so that actually Fig. 1 should be a family of curves, each curve applying to a different type of receiver. As to the merits of the receiver to be described here, it will be well to leave these to the judgment of the reader rather than run the risk of laying oneself open to criticism.

It is well known that the presence of inductive reactance in the plate circuit of a radio-frequency amplifier tube results in regeneration. Furthermore, if that reactance exceeds a certain critical value, oscillations will be established in that stage, and further, the critical value varies with the frequency. Many different methods have been tried for keeping this reactance below the

critical value, such as varying the coupling in the resonance transformers simultaneously with the tuning condenser. The method used in this circuit is unusual as applied to r.f. amplifiers, although a similar arrangement has been used for controlling regenerative detectors.

Fig. 2 illustrates the fundamental idea of the

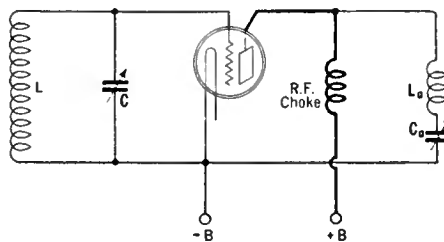

FIG. 2

circuit. The coil L and the condenser C constitute the tuned input circuit. In the plate circuit of the tube there is the usual primary coil of a resonance transformer, L_0 . This inductance L_0 is of such value that the circuits would ordinarily oscillate; in other words, L_0 is greater than the critical positive value.

In order to stop the oscillations the condenser C_0 is introduced in series with L_0 ; the condensive reactance furnished by C_0 is negative in sign, so that the net positive reactance in the plate circuit of the tube is reduced, depending upon the value of the capacity of C_0 .

It is clear that the net reactance can be made almost anything we desire by this means. We may so proportion L_0 and C_0 that X_0 may be positive and greater than the critical value, equal to or slightly less than the critical value, or, we may even make X_0 equal to zero, or make it negative. When X_0 is positive and greater than the critical value, the circuits will oscillate; under any other condition it will not oscillate. The special case where X_0 equals zero is known as the "zero reactance plate circuit," and will be discussed later on. The case where X_0 is negative (or capacitive) is not of interest here, for under such conditions the circuit becomes very inefficient, due to the absorption of power at the input of the tube. These conditions have been discussed by J. M. Miller in *Circular No. 351 Bureau of Standards*.

It would evidently be very cumbersome to operate two condensers in each stage of the radio-frequency amplifier, a three-stage amplifier requiring seven condensers, three "twins" and one "single." The obvious thing to do, therefore, is to operate them all together. The problem re-

mains then, to so proportion the inductance and capacity in the plate circuits so that when C_0 is varied at the same rate as C (the tuning condenser) the net plate circuit reactance will be slightly below the critical value at all frequencies.

The first problem in the design was, therefore, to determine whether C and C_0 could be varied at the same rate; this amounts to the same thing as determining whether the plates in the two condensers could have the same shape. In order to determine this, as well as to determine other things that were to follow, a system of measuring the amplification or "gain" per stage was set up, a description of which was presented by the writer in *The Proceedings of the I.R.E.*, July, 1927.

The complete circuit of the receiver is shown in Fig. 3. Each stage is completely shielded, originally in copper cans, but later in aluminum cans. A laboratory set-up was made, in conjunction with the measuring system mentioned above, "single" condensers being used in the receiver, with leads coming out of the cans to which separate plate condensers were connected. Each condenser was individually controlled.

With a constant-frequency signal impressed on the input of the receiver, the condensers in the plate circuits of the r.f. tubes were gradually and simultaneously increased from zero upwards, in steps, their capacities being always kept the same, and measurements of the gain were taken at each step.

At a high frequency, say 1500 kilocycles, a curve similar to that marked f_1 in Fig. 4 was obtained. At the upper limit of the curve the circuits broke into oscillation. Having completed this curve, a similar curve was obtained for a slightly lower frequency, say 1750 kilocycles, illustrated by curve f_2 of Fig. 4. So, a family of curves was obtained, each curve for a different frequency; sufficient curves were obtained so that the operation over the entire broadcasting range of frequency could be studied.

It will be noted that there is an inflection in each of these curves near the upper limit where oscillations begin. Above the point where the inflection begins the system is very critical, so it was evident that the greatest gain per stage that could be utilized with safety at any given frequency is at this point. In Fig. 4, therefore, the points a, b, c, d, represent the greatest amplification that can be obtained with the particular tubes, coils, etc. Through these points a curve can be drawn, marked AB, from which can be taken values to plot a curve of C_0 against the frequency, or against C, which is the information which was required. It was found that on plotting C_0 against C, the curve obtained was very nearly linear, indicating that it was per-

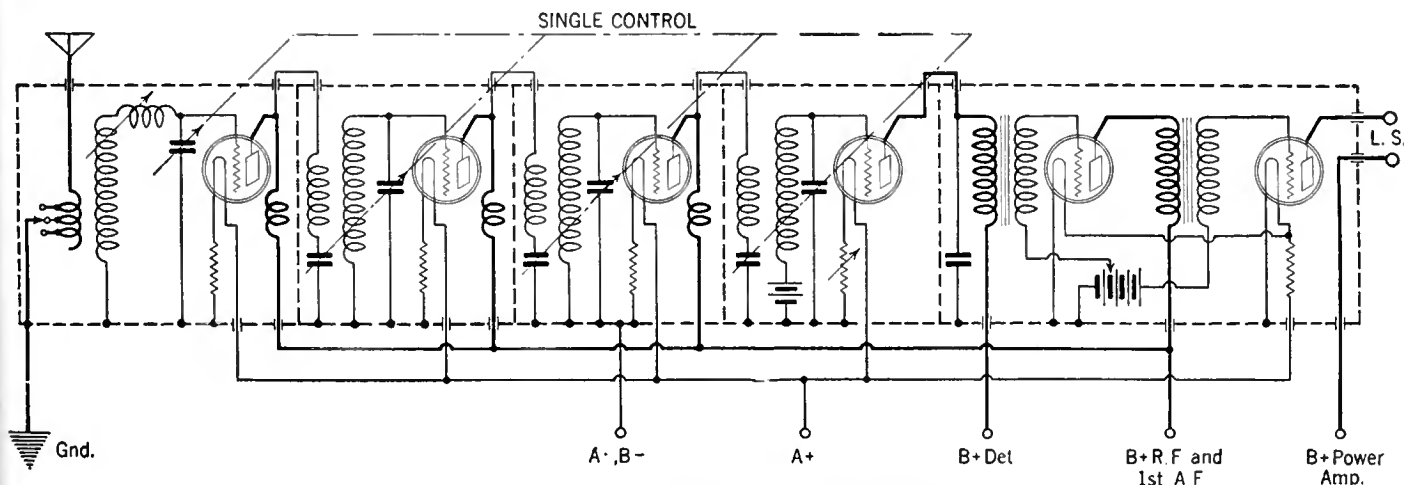

FIG. 3

fectly feasible to vary C_0 at the same rate as C , and that the two condensers may have plates of the same shape and may be driven by the same dial.

It is evidently desirable to have the same shape plates in the two condensers, in the interests of economy as well as simplicity. It was also found that with the given coils, the capacity required in the plate circuit (represented by the points a, b, c, d, of Fig. 4) at various frequencies was very

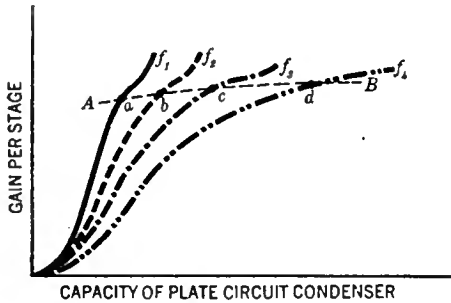

FIG. 4

close to that required in the tuning condenser C at each frequency. This relation can be adjusted at will, by simply changing the design of the resonance transformer; it was thought advisable, however, to keep both sections of the "twin" condenser the same, as this would facilitate factory inspection, permitting the inspection of both sections, by the same operator and on the same testing "jigs."

Upon setting up a model of the receiver, it was found, that, whereas the amplification was considerable at lower frequencies, it dropped off very rapidly as the higher frequencies were approached. This was very noticeable when the receiver was tried "on the air;" the ability of the receiver to "perform" at wavelengths shorter than about 350 meters was practically *nil*. The problem then remained to increase the sensitivity of the receiver at the shorter wavelengths, leaving the sensitivity at the longer wavelengths the same.

The means used for doing this is, as far as the writer is aware, a new one; it is new, not in the sense that it has never been used before, but in the sense that it has been done intentionally and with a definite purpose. There is plenty of coil capacity in plenty of receivers, but as far as the writer has been able to find out, no one has heretofore attempted to put this coil capacity to a good use.

Up to this point in the work the primary coils of the resonance transformer were wound in a single layer at one end of the secondary, separated from the secondary by about one-quarter of an inch. The idea occurred that by introducing a slight amount of capacity coupling in the resonance transformers, in addition to the magnetic coupling, the regeneration at the higher frequencies would be slightly increased, and the desired increase in amplification would be thereby attained.

Consequently, the primary coil of one of the resonance transformers (that preceding the detector) was wound on a short tube and slipped

inside the secondary. When tuned to a short wavelength (or high frequency), the response of the receiver would gradually increase as this primary is moved up into the secondary further and further, until oscillations begin. This point is located, and the primary coil is then fixed in place slightly below it. Besides the advantage gained by increasing the amplification at the higher frequencies and thus solving the greatest problem which was encountered, there is an additional and important advantage gained by making the primary adjustable at the factory. It is possible by this means to insure uniform production of receivers with regard to sensitivity.

The effect can be explained qualitatively by means of Fig. 5. The curve AB is supposed to represent the amplification curve of a stage of the r.f. amplifier before the coil capacity has been introduced. On introducing the coil capacity the curve rises at the right-hand side, resulting in the curve AC. On the first trial a considerable depression was found in the curve at a frequency of about 850 kilocycles. It was found, however, that by properly adjusting the self-inductance of the primary as well as its location within the secondary, this depression could be made to disappear almost, and the amplification was thus made practically uniform over the entire broadcasting spectrum.

The resulting receiver proved to be very sensitive and selective. No difficulty was experienced in separating the local broadcasting stations in either New York or Chicago, and it was possible in many cases to even tune-in stations between the locals.

There are several other additional features of this receiver which are worthy of mention. One of these is the location of a separate filament resistor in the negative lead of each tube filament of the r.f. amplifier.

By this means a negative bias is placed on each grid, with the result that the receiver is very economical with respect to the B supply. The maximum plate current is about 27 milliamperes, and on receiving local concerts, sufficient volume for ordinary sized homes is obtained with the volume control "just on," and the set drawing only about 10 milliamperes. This latter statement holds also when receiving some powerful stations at fair distances.

Another feature of the receiver is the C battery detector. This type of detector was used instead of the grid leak-grid condenser type on account of its ability to rectify more powerful signals before overloading occurs. It also cuts down the costs by eliminating the grid condenser and leak, and necessary inspection were they used. The difference in sensitivity between the two types of detectors is of secondary importance in this receiver on account of the great sensitivity of the r.f. amplifier.

The input stage of the amplifier is tuned by a "single" condenser, and, in addition to this, has a portion of the secondary winding of the antenna transformer variable. There are also three taps on the primary or antenna coil, so that by means of the taps and variable portion of the secondary, the input stage is made very efficient. The constants of this stage, however, are so chosen that no matter on which of the three points the switch

may be set, it is not possible to "pass over" any except the very weakest signals when varying the condensers.

Another feature of the receiver is the absence of bypass condensers in the r.f. amplifier. The only place where a bypass condenser is used is in shunting the primary of the first audio transformer. The general wiring of the receiver makes it unnecessary to use them, the only avenue of exit for the r.f. currents outside of the grid and

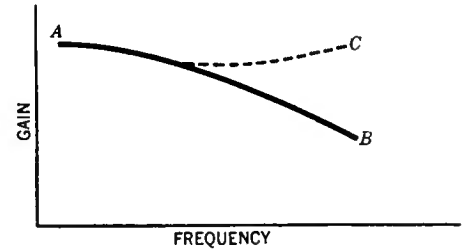

FIG. 5

plate leads being the B supply lead, which is blocked by an effective r.f. choke coil.

The greater part of the wiring is in the metal of the receiver—the aluminum cans and base. The ground accommodates the A minus, B minus, and C plus, making the entire wiring job a very simple one indeed. A "matched unit" construction is used, the four cans and their contents being identical in many respects. The first stage differs from the rest only in the coil and single condenser, and the fourth can (the detector stage) differs only in having an individual filament control. This was deemed necessary, or at least desirable, on account of the varying characteristics of electron tubes. But when once this rheostat is set for a particular tube, there is no further necessity of adjusting it.

The mechanical arrangement of the receiver is also novel. The separate cans are easily removable, for servicing purposes, by simply loosening the screws on the backs of the cans which hold the terminal lugs fastened on to the four or five leads connecting to the can. All the battery supply leads are cabled along the rear of the set outside the cans. Likewise the audio amplifier, of the transformer type, is removable as a unit, in the same manner. There are four "twin" condensers and one "single" condenser in the receiver, all of which are driven by the same mechanism. To facilitate the "matching" of condensers while the lids of the cans are in place, the front steel panel on which the condensers are mounted is slotted, so that the stators of the condensers can be rotated through a small angle and then clamped in place.

The great sensitivity of the receiver described here is due to several things; first the primary self-inductance is a little greater and the coupling is slightly closer than in the usual resonance transformer employed in r.f. amplifiers. Furthermore, it is possible to adjust, and to maintain the adjustment closer to the oscillation point than is usually the case. Next, there is the reduction of grid losses due to the grid bias on each r.f. amplifier tube, and finally there is the tuned input stage.

Suppressing Radio Interference

Some Recently Investigated Sources of Interference—Trouble from High-Tension Lines and Distribution Systems—General Hints on the Location of Sources, the Arrangement of a Patrol Car, and the Receiver to Use—Procedure in Patrol Work and the Many Misleading Clues

By A. T. Lawton

WHEN we consider that a little spark, say one-sixty-fourth of an inch long, can cause severe radio interference, it becomes obvious that almost any piece of electrical apparatus in ordinary commercial use is a potential source of trouble. This does not mean that all electrical accessories do actually give rise to disturbances. On the contrary; considering the expansion of the electrical industry and the universal use of electrical equipment, we may well marvel that the noise level of the average city is so low.

When looking around for the possible cause of interference, however, nothing in the electrical line should be overlooked. It may help a little if we detail some of the sources located recently in following up interference complaints:—

- (1.) Printing office linotype motor; normal operation, no fault. Cleared up by method (a) Fig. 1.
- (2.) Clippers in barber shop. Normal. Cleared up by method (a) Fig. 1
- (3.) Same source as above. Abnormal—commutator grooved. Used method (c) Fig. 1
- (4.) Cream tester in dairy plant. Normal. Used (a) Fig. 1
- (5.) Battery charger, vibrating reed type. A 1-mfd. condenser across contacts eliminated trouble.
- (6.) Same source as above—different manufacture. Required method (a) Fig. 1
- (7.) Refrigerator, home type artificial refrigeration. Used method (a) Fig. 1
- (8.) Battery Charger, rotary rectifier. Obstinate case. Used method (c) Fig. 1
- (9.) Woolen mill, static neutralizer. Defective plug connection. Repaired.
- (10.) Brass foundry, lighting wires crossed and sparking, concealed. Confusing, as corresponded with vibration of large motor which was shaking floor. Motor supply cut abruptly but radio interference died gradually with slowing down of motor giving clue to the trouble, which was located and fixed.
- (11.) Voltage regulator in a power station. Case still pending.
- (12.) Chattering circuit breaker in power plant operated by thermocouple. Breaker re-adjusted and interference disappeared.
- (13.) Washing machine motor, defective. Repaired.
- (14.) Thermostat, mounted on wall subject to abnormal vibration. Bad clicking radio interference. Changed location of thermostat to solid wall.
- (15.) Constant-current transformer in power station. Case pending.
- (16.) Noisy grid leak in complainant's radio set. Referred to service man.
- (17.) Elevator in apartment house. Under investigation.
- (18.) Bakery oven. Thermostats to regulate heat and operate gas lighting jump sparks. Case pending.

Many other cases of interference reported in the same period had their origin in apparatus already discussed in previous sections while an additional number arose from defects on power lines, all of which were located and rectified.

HIGH-TENSION LINES

IN THIS category we include primary distribution systems operating on from thirty thousand to one hundred and ten thousand volts a.c.

We must frankly admit that the data on interference from this source are far from complete. Difficulties of a practical nature are responsible. Thirty or more towns may be served by say, a

UNDER the title "Suppressing Radio Interference" the author has printed three previous articles in this series, all of which deal, in an enlightening and comprehensive fashion, with the different forms of interference with which the radio listener may have to cope. Each article in the series is complete in itself, and should be read by all radio men whether they are troubled by man-made static or not. Mr. Lawton's articles cover a period of two and a half years' research made in more than 130 different cities. The first article appeared in the September, 1927, RADIO BROADCAST, and dealt with interference caused by oil-burning furnaces, electro-medical therapeutic apparatus, X-Ray equipment, and dental motors. The November article dealt with interference from motion picture theatres, telephone exchanges, arc lamps, incandescent street lamps, flour mills, factory bells, electric warming pads, and precipitators. In the January, 1928, RADIO BROADCAST, the following sources of interference were dealt with: Farm lighting plants, railway signals, land line telegraph and stock tickers, radio receivers, and electric street railways. The present article is of especial interest to radio clubs and organizations contemplating the construction and operation of interference locating equipment.

—THE EDITOR.

110,000-volt three-phase system and to cut this line the required number of times for test purposes is out of the question since all towns depending on it for electric power would be interfered with to a prohibitive extent.

Also, when suspicion to any piece of apparatus in connection with such a line arises and arrange-

ments can be made to have it investigated at a close range, the line must, of course, be cut prior to detail inspection. Complications enter; foreign matter, deposited at such points as to be a possible cause of the trouble, is burned up by the surge produced on cutting the line. The investigator, not noting any apparent defect, and no spitting of current being possible for an audio check, often removes the source of the trouble unconsciously.

Where several possible sources are observed all must be rectified at once in order to get the line back in operation as quickly as possible, so even if elimination of interference is secured the exact source is not definitely established. Piece-meal elimination is a theoretical idea—desirable from a scientific standpoint but impractical.

It is probable that a slightly leaky insulator on a 110,000-volt line will cause radio interference though certain observations point to the contrary. For instance, a six-petticoat suspension insulator which was spitting vigorously over three petticoats caused absolutely no radio interference on a three-tube regenerative receiver located thirty feet distant. Possibly this caused a disturbance farther out on the line but other disturbances at the same points complicated the determinations.

If a high-tension conductor on a pin insulator is not fastened down securely, audible hissing is usually the result, but it gives rise to no radio interference. Two defective wall bushings on a 12,000-volt line showed considerable spitting, which gave an audible noise, but there was no indication of radio interference on a "patrol" receiver in the vicinity. Out on the line half a mile or so it was impossible to tell whether these constituted material sources or not; if anything, the "mushy" noise usually associated with high-tension lines was slightly augmented.

We must not assume that because a line, d.c. or a.c., produces audible noise, it necessarily gives a corresponding radio interference. Take the case of a d.c. line operated at 700 volts and carrying thirty thousand amperes. The "lines"

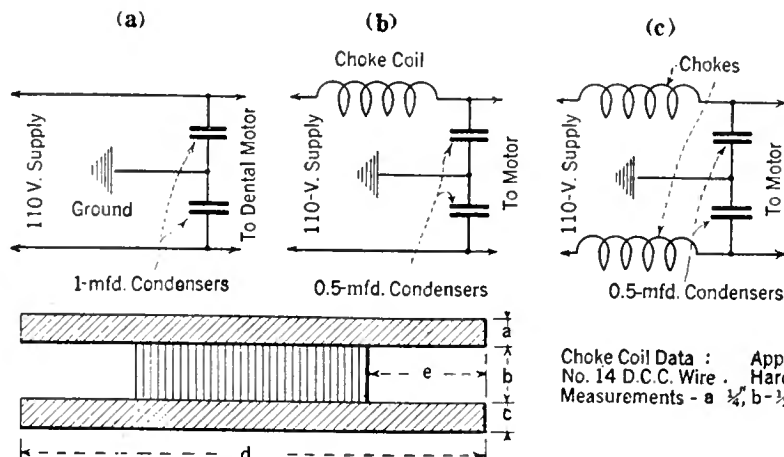

FIG. 1

in this case were composed of several hundreds of wires or, rather, rods, bound together at intervals and were mechanically noisy but variations of this heavy current caused no radio disturbance.

When two separate conductors are used as one on a high-tension line, running close together and attached to the same insulators, there will likely be audible hissing although the voltage at any given point is equal on both wires. Prevailing interference could not be definitely associated with lines of this nature.

It is worth noting that the smelting arcs fed by the thirty-thousand ampere d.c. line referred to above do not set up any serious disturbance beyond about one hundred yards. Even within this distance we are inclined to think that some of the interference noted on test had its origin in associated apparatus because in the near vicinity of three a.c. arcs, operating on 22,000 amperes, reception from station WGY, 300 miles distant, was possible with the receiver within 60 feet of the arcs.

The charging of h.t. lightning arresters sets up heavy interference. Charging is done twice daily as a rule, each operation requiring only a few seconds. Where there are many sub-stations in a restricted area it is usual to arrange to have the arresters charged at 2 A.M. and 2 P.M. instead of during the more significant broadcasting hours.

Thick snow falling between the horn gaps is pretty sure to cause considerable snapping and the interference, being vigorous, is propagated for miles.

Surprising as it may seem, the normal interference field of a 110,000-volt a.c. line has much in common with a 600-volt d.c. trolley feeder. Within fifty or sixty feet of either, reception is doubtful, but an abrupt cut occurs here, and a few feet farther away normal reception is possible, a condition which would seem to indicate magnetic coupling rather than a pick-up through direct radiation.

A.C. lines of fifty-thousand volts or so can, of course, set up currents of very high potential in parallel systems. We know that enough energy is transferred by induction to the overhead ground wire of a 100,000-volt line to supply lighting power to small communities, and advantage is taken of this in many localities for the purpose mentioned. It is obvious then, that where h.t. lines and part of the city distribution system run parallel at close range, any irregularity of the high-tension line will transfer a vigorous surge to the city system—a surge of sufficient initial amplitude to carry it all over the distribution and create widespread interference. The source in a case of this nature was recently located seventeen and a half miles from the town affected.

It has been noted in a few cases, that h.t. systems having telephone lines on the same poles or towers appear to be the greater offenders. Further research is required here and must be carried out with the full cooperation of the line engineers and their qualified assistants. All h.t. switches are not set with a cycle counter although they really should be, and any investigator who happens to be touching bare metal parts of the parallel line telephone installation when the h.t. line is cut will probably have good reason for remembering the incident.

In the case of noisy h.t. lines we do not know of one exception to the following: In sub-zero weather, interference is very bad; in mild weather, it is slight; in rainy weather, when all the insulators and cross arms are dripping wet, it is practically nil. Offhand, we are inclined to believe that this notorious trouble originates, not at any one specific point, but is the result of thousands of small brush discharges all over the

system. Incidentally, we hope that we are wrong; the outlook for elimination is indeed poor if our diagnosis happens to be correct.

DISTRIBUTION SYSTEMS

JUST what percentage of a city's total interference originates on the local distribution system is a difficult question. One thing is certain; any interference occurring here is serious because of its proximity to the broadcast listener and its wide range. One loose primary cutout on a 2200-volt line can propagate severe interference for two miles in one direction and every wire running parallel picks up the disturbance by induction and spreads it all over the district. Now there are two primary cutouts used in connection with every transformer, except in the case of banked units, and if there are three hundred transformers in the city we have roughly six hundred potential sources of trouble from this agency alone.

Primary cutout interference represents about seventy-five or eighty per cent. of the total trouble caused by power lines in any city at any time. We should remember that this means no material loss of energy to the power company; such faults will not necessarily affect power consumption or even cause the house lights to flicker. For the sake of the good will of the public, however, it is in the interest of the operating company to give this particular accessory careful attention.

Interference from this source takes the form of a hard buzzing. It may be steady or intermittent; gusts of wind shaking the pole may start or stop it and heavy trucks passing along the road will do the same thing. Several cutouts buzzing intermittently will give the effect of wireless telegraph transmission and is easily confused by persons unfamiliar with the code.

A systematic check with a radio receiver should be made of such sources at least twice yearly. In one city, 146 transformers were checked and 41 loose cutouts giving rise to radio interference, were found. In another city the relative figures were higher.

The next fault, in the order of frequency of occurrence, is that of primary leads (2200-volt) spitting to the transformer case, guy wires, or crossarm braces. Severe buzzing results in the first case—practically the same characteristics as primary cutout interference—and it doesn't matter whether the transformer is grounded or not. Spitting to an insulated guy wire gives rise to a heavy clicking interference rather than buzzing. Where the primary lead is scraping on a brace the disturbance is not unlike that produced by the home type violet-ray machine but may, under varying conditions, take a different form.

Tree grounds are next in order. The intermittent "zip" from this source is very annoying. Even a little green twig waving on a bare 2200-volt feeder can set up enough "chirping" to bother reception. Tree trimming is the obvious remedy here but property rights, etc., come up, and much difficulty is often experienced in getting action. It might be as well for tree owners to reflect on the fact that copper has a bad effect on tree growth and if a copper spike be driven in the base of a healthy tree the tree will perish. Chemical analysis of branches, grooved and burned by 2200-volt lines, showed a deposit of copper, not only at the point of contact, but also a short distance either way, just as though the sap were absorbing this fine deposit and spreading it through the tree system.

Interference from the next source, loose splices, is not common. When such faults are present they give rise to heavy clicking. Generally speaking, poor splices or connections are the result of

winter jobs, done in zero weather when the lineman's lot is no sinecure.

It is not usual to find cracked or leaky bushings in transformers. There are instances, of course—a few bad ones—but they are rare. Also, in a thousand odd transformers checked, only one had loose inside connections, and there were three of them in the one transformer. This particular source wiped out reception in two adjoining towns.

LOCATION OF SOURCES

WHILE access to a properly equipped radio patrol car is desirable, much good work in the location of sources of radio interference has been done with an ordinary loop receiver and standard automobile.

In order to get an idea of the area covered by any given interference, it is usual to telephone various radio fans throughout the city and find out if interference coinciding in time and character with your own case prevails at the distant points. The distant observer should bring his loud speaker near the house telephone so that you may be able to check the noise from his set and your own at the same time. Another method is for the various observers to keep a log of the characteristics and periods of activity of the trouble under investigation. Synchronized watches should be used here.

Knowing the general location, use is then made of a loop receiver carried around in an automobile. Any good super-heterodyne or radio-frequency receiver with a volume control is suitable.

Once in a great while some use may be made of the directional properties of the loop; for the present, disregard this feature for it is misleading.

Prop the loop in a fixed position, not too close to the side of the car, and drive around the affected district. At some point where the interference is strong, cut down the volume control so that the noise is just audible. Then repeat the patrol. It is probable that another point will be found where the noise comes up slightly; cut down the volume control further and keep lowering it at every increase in the intensity of the disturbance until there are only one or two points on the patrol route where the noise is audible.

An inspection is then made, watching out for garage battery chargers, transformer cutouts, chiropractors' offices, etc., etc. If the trouble seems to be in any way connected with the lighting or distribution system it should be referred to the power company for action.

The foregoing gives a general idea of the method followed in running down radio disturbances. In view, however, of the growing interest and activity along this line, it might be of help to those organizing patrols on a large scale if we go into a little more detail.

THE CAR

THE car should be a six-cylinder one; complicated interference requires that the receiver volume control be cut down until the disturbance is a mere whisper and any mechanical rumbling noise is a detriment to the patrol.

The car body, above the waist line anyway, should be of wood, facilitating inside loop reception. Metal bodies shield an inside loop and weaken the signals in addition to distorting the wave direction.

Measures are taken to prevent the ignition interference unduly affecting reception. No standard method, applicable to all cars, can be

recommended, but one of the following methods, or a combination of them, should be effective:

- (1.) A one-microfarad condenser across the battery circuit; attach one side to the ammeter terminal and the other under any convenient nut in contact with the chassis. Paint or enamel causing imperfect contact should be scraped away.
- (2.) Duplication of method (1.) except that connection is made at the coil primary instead of at the ammeter.
- (3.) Seventy-five turn choke coil, enclosed in a metal box, inserted in the lead from the dash switch to the coil primary.
- (4.) Complete box screen of fine mesh wire gauze over cylinder head clamped around engine block and covering spark plugs, distributor, and ignition cables. Removable side gate is fitted giving access to the enclosed parts.

Where trouble is experienced from the generator a one-half or one-microfarad condenser from the positive brush to the chassis will help, and if the tail light cable is carrying a surge another condenser will be required here.

All low-tension wiring should be of armored cable but copper braid over the high-tension leads, while it clears up the interference, is objectionable since it tends to founder the spark energy.

It is not desirable to wipe out the ignition click completely; leave a slight trace of it to act as a pilot signal for the receiver.

The layout of interior fittings, *i.e.*, desk, cupboards, etc., will depend on the size of the car and the scope of the patrol. Convenient racks for record books, etc., should be fitted; it is very necessary to have a place for everything and equally necessary that the interior of such a car be kept, at all times, in first-class order.

THE RECEIVER

FOR official patrols, a good stable superheterodyne receiver is desirable. We specify stable because so many "supers" burst into oscillation under the conditions of patrol—especially near high-tension lines. In this case the "mushy" note of oscillation and the normal h.t. interference are almost identical, and accurate determinations are not possible.

Any make of tube known to be microphonic should be ruled out without further consideration. It is not necessary to take the precaution of mounting the sockets on rubber. A volume control of some nature is essential but throwing the set out of tune to accomplish this is not recommended.

The loop is mounted on a swivel base, allowing at least ninety-degree rotation and the three leads to the set should be sewn in a flat strap leaving a distance of three-eighths or half an inch between each wire. A storage A battery and dry cell B batteries are connected to a receptacle which is fixed permanently at some convenient point on the desk front. The corresponding plug and cable is, of course, attached to the "super." A neat box containing spare A and B batteries should also be carried, and should be fitted with a receptacle similar to the desk one.

Where metal body cars are used the loop is mounted outside, on the car roof, the handle for rotation coming down through a special weather-proof fitting.

It is obvious that in the course of extended patrol the receiver will get some rough usage so it is important that very careful attention be paid to all connections and steps taken to make the equipment as rugged as possible. Nothing can be more exasperating than to have this gear fail at a critical moment when tests involving much prearrangement are being carried out.

Condenser bearings must be set up fairly tight so that vibration of the car does not alter the tuning. Mechanically unbalanced condensers, mounted in a vertical plane, which move ever so little through jolting of the car, can throw a patrol into complete chaos. Frequent observation of the filament ammeter is important; a slight drop in filament current after the first intensity observations have been made can cause considerable confusion.

Inclusion of a loud speaker in the equipment is not recommended since this instrument tends to suppress the finer characteristics, harmonics and overtones, of specific interferences, rendering determination of their origin more difficult. Headphones, exclusively, are used on standard patrols.

PATROL WORK

SUCCESSFUL patrol work is largely a matter of experience. Given a suitable car and the necessary receiving equipment, the beginner is apt to become discouraged at his failure to secure immediate results—a condition which will probably last until he learns some of the wiles of the elusive interference and knows the pitfalls to avoid.

In the first place, the directional properties of the loop are practically valueless in city work; its plane for maximum sensitivity will, in every case, be parallel to the adjacent street wiring and instead of pointing toward the source, may point in any direction away from it. There is just one circumstance in which a rotating loop can be of value and it is simply to cover this one condition that we recommend the swivel base.

If the patrol is parked at the corner of intersecting streets where distribution wiring runs, say, north and south on one street and east and west on the other, it is sometimes an advantage to know on which set of wires the interference is stronger. The loop may be turned through ninety degrees while the car is parked directly under the intersection of the wires and a determination arrived at. The system showing the greater disturbance is then followed up.

It is popularly supposed that, at its source, interference is very loud, and that its intensity tapers gradually to zero as we move away. This is only partly correct. As a matter of fact, one often finds that actually at the source, interference is much weaker than, say, fifty feet away. Suppose, however, we start patrol in the vicinity of a source where the noise is very loud. On moving away, say, 250 feet, the disturbance falls to zero; at 500 feet it is up again very strong. At 750 feet it has died again; at 1000 feet it comes up, and so on for a mile or more of straight patrol. We can see that this trouble is a case of forced oscillations creating standing waves on the distribution system and the varying intensities plotted out take the general form of a sine curve.

In contrast to the sine curve, however, successive "bumps" or peaks of intensity will be slightly weaker than the preceding one, that is, when we are moving away from the source. The reverse is true when we approach the source from a distance.

By cutting down the volume control to bare audibility in the vicinity of the heavy bumps it is possible to narrow down the trouble to a small area, since nothing will be heard where only a slight bump prevails. The audibility control should have a knob and pointer rather than a dial; it is desirable to be able to switch on to full volume at intervals but we must know, accurately, the original setting to which to revert. Failure to note this renders comparisons with previous observations inaccurate.

Now, in the course of this patrol, certain complications will probably enter. We are assuming that the disturbance is strongest near the source—if not directly at the source—and, naturally, are watchful for the strongest "bump." In ordinary reception, say, from some broadcasting station, a difference of half a mile or so in distance between the station and receiver makes very little difference in signal strength. A few feet, however, can make a big difference in the intensity of radio interference being guided by city wiring; simply moving the patrol set over to the other side of the street may make as much

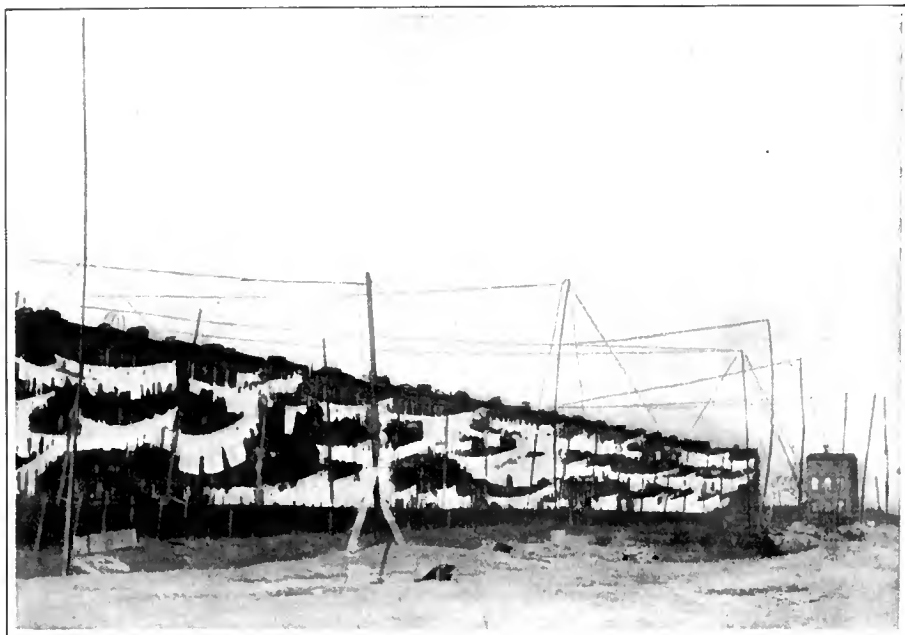

WHERE RADIO COMPETES WITH THE WASHING

The owner of these tenements in Long Island City, New York, does not permit construction of antennas on the roof, with the result that a forest of back yard poles at crazy angles support the necessary antennas. Interference from improperly operated receivers is frequently acute in such congested areas

as 40 per cent. reduction or increase as the case may be. For this reason it is desirable always to keep the same distance from the curb when patrolling, so far as this is possible, and occasional observations should be made to see that the line is still on the same side of the street being patrolled. If it has crossed over at an unobserved point and continued on, on the other side of the street, misleading checks may result.

Every wire, directly connected or not, in the vicinity of a vigorous source of radio interference, will pick up the disturbance and radiate it in different directions; trolley wires, being much nearer the loop than the power wires, will give a heavy indication even when the trouble is not in any way connected with the car system.

Service wires running low across the street will also produce a false peak and, incidentally, give a bogus direction if directional properties of the loop are being counted upon.

Pothead and pole ground wires are notorious misleaders of the unwary. At these points the overhead wiring is brought right down to us and we will get a heavy bump of the noise when passing the pothead or ground wire although the source may be half a mile or more away. The bump here may even be stronger, so far as effect on the receiver is concerned, than at its loudest point near the source.

In the affected area, nearly every street corner or intersection registers a number of confusing bumps. This is due to abrupt physical changes in the circuits, free radiation probably, since high-frequency surges dislike going around sharp corners.

A rise in the disturbance intensity will be noted at each transformer passed during patrol but when the car is running over an iron bridge with side supporting girders, interference will drop practically to zero although the source may be nearby. A peak will be registered at dead ends and circuit stops also, whether the wires are alive or not. Dead wiring is just as effective in propagating radio interference as live wiring and under certain circumstances the actual source may be on a system which is not energized except by induction from some other line. If a dead circuit having on it a partial ground, parallels a high-tension line, the voltage induced in the former is sufficient to cause a spit-over at the imperfect contact, resulting in severe disturbance.

Where complicated interference is being investigated on streets on which electric cars are run, much time will be saved by carrying out the work between the hours of 1 A.M. and 5 A.M. In fact, these are the best hours for radio patrol work up to the point of location to a given pole or residence. Daylight inspection is then necessary. During the early morning hours street car activity is at a minimum and traffic conditions are ideal for concentrated patrol.

One thing to be religiously avoided is any tendency to jump at hasty conclusions; an investigator cannot be too careful on this point. Literally hundreds of reasons, each with a story behind it, can be cited to show how very neces-

sary it is for the patrol man to attack his problem with a perfectly open mind. One example selected at random, may be of interest. Reception over a fairly wide area in a certain town was being spoiled by a strong buzzing interference. The "buzzes" came at one-second intervals and kept up for days at a time, stopping for a few hours or a day, as the case might be, and then starting off again. It was narrowed down to two buildings—a large factory and an electrical power plant. Generator interference close to the plant swamped the disturbance being investigated, but it was learned here that the "static ground detector" on the factory supply lines (2200 v.) showed an intermittent ground on one phase. The factory electrician had checked everything in detail and insisted there were no grounds on his end of the business; the power company did likewise. Service was not impaired in the least but still the radio interference corresponded exactly with the swinging of the ground indicator, and such a ground on the 2200-volt system would account for our trouble.

We might say that there was absolutely no reason whatever for suspecting this meter; it was a standard instrument made by a very reliable firm. Nevertheless one of the condensers in it had broken down and constituted the source from which our radio interference originated. The trouble was eliminated with despatch.

It must be obvious from what has been said that the location of the source of any given disturbance is not always an easy matter. The work is doubly difficult in the case of intermittent interference or that which periodically alters its intensity. Where several sources are active at the same time, the resultant confusion demands close concentration on the part of the investigator.

On all standard patrols a five- or six-pound sledge hammer is carried. If the characteristics of the interference indicate power line trouble, patrol is carried out until the source is confined to half a block or less on one street. Then the suspected poles are tapped with the sledge and any loose connection of any nature whatever will immediately show up on the patrol receiver, usually as a violent buzzing. Loose primary cutouts, defective lightning arresters, partial grounds, bad splices—all show up definitely and at once.

Care is taken not to hit the pole too hard; an inexperienced investigator can cause damage here. If looking for loose splices, the pole should be tapped in the plane of the overhead wiring since right-angle tapping does not always send the vibration along the wires. A moderate tap in the plane of the wiring will show up defective splices five poles distant.

Literally, thousands of transformer poles have been checked in this way and we know of only three instances in which the method failed. In these instances the cutouts were jammed mechanically solid and could not vibrate but at the same time they were making poor electrical connection. Such cases are extremely rare, the point

is worth noting however, in view of a possible recurrence.

Poles giving an indication of severe interference on the first tap are not jarred a second time, since the loose cutouts are liable to fall and disrupt the service.

When a lineman is setting up loose cutouts it is desirable to check with the sledge hammer and radio set, tapping the pole while the lineman is still aloft. A cutout in proper order for lighting or power purposes may, at the same time, be a source of radio interference because of some apparently insignificant internal sparking.

We might say, in passing, that a good many faults have been found in perfectly new line accessories and constructions; new installations are checked just as carefully as old constructions.

COMPLAINT RECORDS

THE method of handling complaints, adopted by public utility companies and other organizations engaged in radio interference elimination work, varies according to the services performed and the area covered. The questionnaire system finds favor in certain quarters. Its application, however, is limited, and where work is being carried out on a large scale the questionnaire is worse than useless.

Details of the recording system for taking care of nationwide patrols with which the author is associated would serve no useful purpose here; it may be remarked, however, that the central authority diagnoses every complaint, and, on the information given, endeavors to fix its source. If this can be done, appropriate remedial measures are recommended; if not, the nearest patrol car is ordered to the location and trained experts take over the case, reporting to the division headquarters on completion of the work.

Here, the information is classified and recorded together with other data relative to the particular location, *i.e.*, previous cases cleared up, specific sources, general noise level, local patrol facilities, radio clubs, etc., etc. In this way a fairly accurate check is kept on the general interference situation, which facilitates the laying out of future patrol work for the staffs engaged.

In reviewing the radio situation generally and from direct contact with thousands of broadcast listeners, we are forced to the conclusion that the greatest need in the radio game to-day is a concentrated and determined effort to rid every town and city of all preventable interference.

The suppression of every source is a practical impossibility, but it is obvious that the noise level of any given centre can be considerably reduced. Much work along this line has been done by different private corporations and various governments, and we hope that the day is not far distant when every city will have its specially equipped radio patrol car to run down interfering disturbances and give radio the chance that it deserves.



*Whether socket power or battery operated
you'll find Faradon in the better sets*

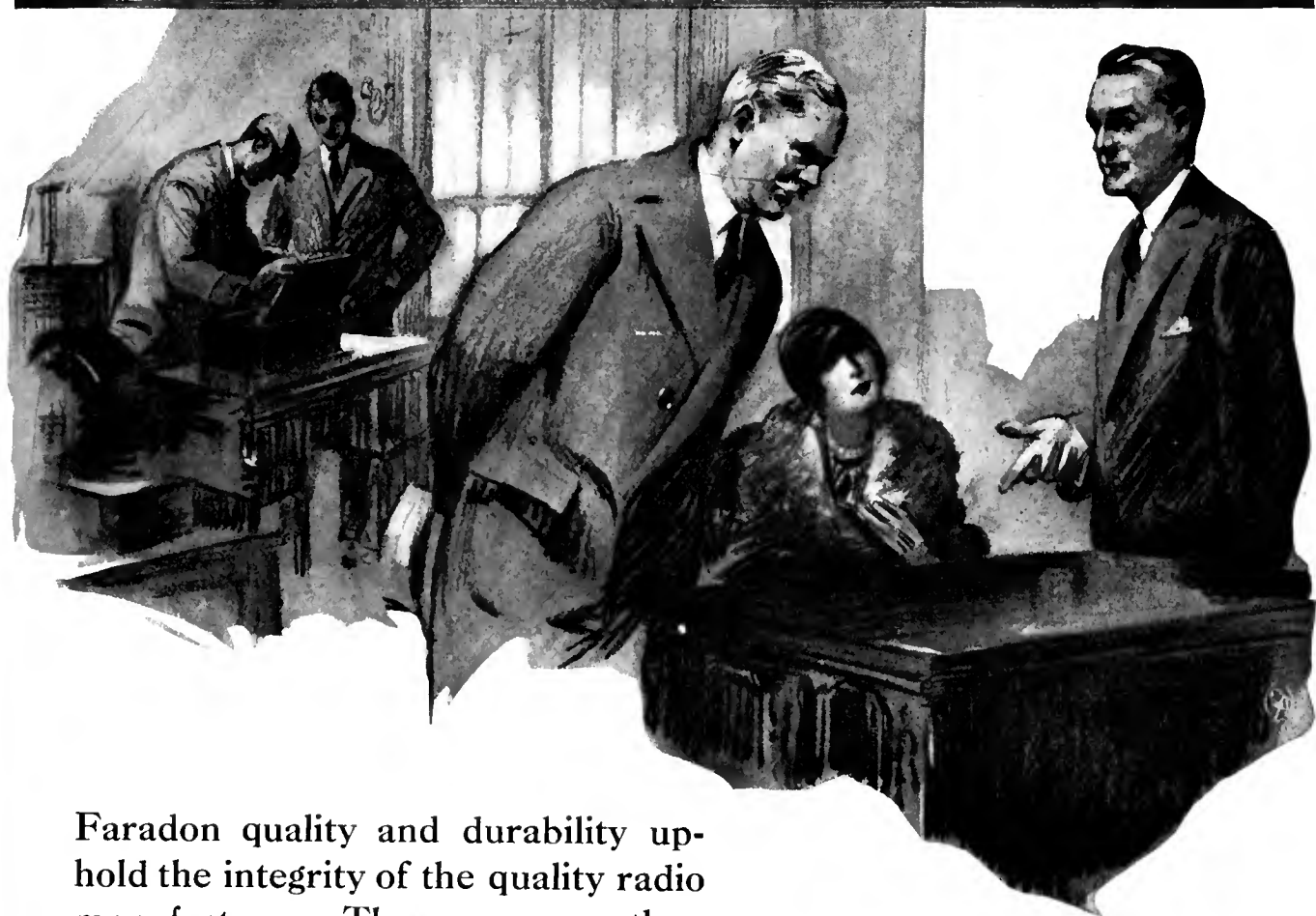

Faradon quality and durability uphold the integrity of the quality radio manufacturer. There are more than twenty years of production experience behind each unit.

When next you purchase a set, kit or replacement part, be sure to look for the blue and white Faradon label.

WIRELESS SPECIALTY APPARATUS
COMPANY

Jamaica Plain, Boston, Mass., U. S. A.

Established 1907

*Electrostatic
Condensers
for all
Purposes*

Faradon

MAGNAVOX



**R500 Unit
Dynamic Power
SPEAKER**

**and power amplifier
combination**

THE wonderful Magnavox Dynamic Speaker, with a matched power unit, self-contained on steel frame, is ready for installation in any radio set or phonograph cabinet having space available of 14 in. wide and 12 in. high.

Power unit for 105-125 volts 60-cycle A. C. supply. Requires one 316B type rectifying tube and one 310 or 210 type amplifying tube. Can replace last audio tube of set or use all tubes of the set. For use with phonograph electrical pickup head; two additional audio stages recommended between pickup and R500 unit.

Only the dynamic type of speaker can bring out the full qualities of reproduction demanded today. With this carefully matched power unit the combination is the highest grade of radio device. Price \$120 for complete unit less tubes. Write for speaker bulletin.



LOBOY MODEL

R500 Unit in handsome cabinet, finished in rich old English brown mahogany. \$165.00, less tubes.

The Magnavox Company
Oakland, California

The Radio Broadcast

LABORATORY INFORMATION SHEETS

THE RADIO BROADCAST Laboratory Information Sheets are a regular feature of this magazine and have appeared since our June, 1926, issue. They cover a wide range of information of value to the experimenter and to the technical radio man. It is not our purpose always to include new information but to present concise and accurate facts in the most convenient form. The sheets are arranged so that they may be cut from the magazine and preserved for constant reference, and we suggest that each sheet be cut out with a razor blade and pasted on 4" x 6" filing cards, or in a notebook. The cards should be arranged in numerical order. In July, 1927, an index to all Sheets appearing up to that time was printed.

All of the 1926 issues of RADIO BROADCAST are out of print. A complete set of Sheets, Nos. 1 to 88, can be secured from the Circulation Department, Doubleday, Doran & Company, Inc., Garden City, New York, for \$1.00. Some readers have asked what provision is made to rectify possible errors in these Sheets. In the unfortunate event that any such errors do occur, a new Laboratory Sheet with the old number will appear.

—THE EDITOR.

No. 169

RADIO BROADCAST Laboratory Information Sheet

March, 1928

Data on the UX-222 (CX-322)

CONSTRUCTION

THE new UX-222 (CX-322) screened-grid tube is designed especially for use as a radio-frequency amplifier and when used as such it is capable of giving greater amplification than can be obtained from other tubes. A receiver using these tubes does not have to be neutralized. This Laboratory Sheet gives details regarding its construction.

The arrangement of the elements as we look down on a UX-222 (CX-322) tube is indicated in the drawing on this Sheet. At the center is the filament, A, consisting of a single straight wire. Surrounding the filament is the control or signal grid, B. The plate, D, is located between C and E, which are two comparatively coarse "screen grids." The filament terminals, the plate terminal, and the extra grid terminal (grids C and E are connected together inside the tube), are brought down to a standard four-prong base. The signal grid, B, is connected to a small brass cap on top of the tube.

The amplification constant of this new tube is of the order of 200 to 300, the mutual conductance is about 300 micromhos, and its plate impedance is around one megohm. These values will vary widely, depending upon the voltages. The amplification of the tube in an r. f. circuit may average about three times that possible with a 201-A type tube. Three times as much amplification in the r. f. stage is equivalent to 81 times as much power in the loud speaker.

When a 201-A type tube is used as an r. f. amplifier there is a strong tendency for it to oscillate, due to feed-back through the grid-plate capacity. The plate of the UX-222 (CX-322) is shielded from the signal grid by the screen grid C-E, and the tendency toward oscillation due to feed-back through the tube is practically nullified.

The general characteristics of the tube, and the correct voltages to employ when it is used as an r. f. amplifier, are given below:

- Filament Volts 3.3
- Plate Voltage 90 to 135
- Screen-Grid Voltage +45
- Signal Grid Bias -1 to -1.5 volts

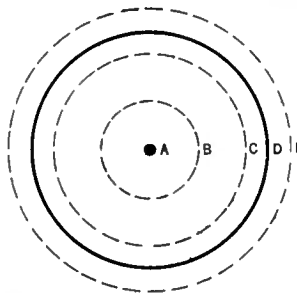

No. 170

RADIO BROADCAST Laboratory Information Sheet

March, 1928

Selectivity and Sensitivity

DESIRABLE CHARACTERISTICS

THE ideal receiver should be as selective as is possible; that is, it should receive a channel of frequencies 10,000 cycles wide (or only 5000 cycles wide in the case of single side-band transmission) equally well, but should not receive other frequencies at all. A receiver for reception of broadcast programs cannot be made any more selective than this without impairing the quality of reproduction. When a receiver is this selective, it will offer a barrier to all frequencies except those lying in the channel to which it is tuned.

The ideal receiver should not need to be any more sensitive than is necessary to amplify interfering noises to more than tolerable loudness under conditions of least interference. When the interference is greater, the sensitivity should be cut down to keep these noises from becoming objectionably loud. In summertime the interfering radio waves manufactured by nature are generally the strongest.

Assuming that an ideal radio receiver is available, there is only one way left (other than the invention

of a static eliminator or reducer) to reduce interference to any further extent and thereby increase the distance over which satisfactory reception is possible. This second method of reducing interference is through the use of increased power at the transmitting station. If the signal strength at any given location is increased, the ratio between the signal and the static is thereby increased and reception in this way made freer of interfering noises. Just as in the case of land wire telephony, however, we will probably never be able to put enough power into the ether to give good transmission across the continent in spite of bad interference.

In so far as sensitivity and selectivity are concerned, the super-heterodyne type of receiver is probably the most desirable. These characteristics in a receiver of this type depend, however, in large measure on the design of the intermediate-frequency amplifier. This amplifier can be designed only to amplify a very narrow band of frequencies (a good design for reception of code signals), or, by the use of band-pass filters, the equal amplification of a band of frequencies can be accomplished (a satisfactory design for the reception of ordinary broadcast signals).

Digitized by Microsoft

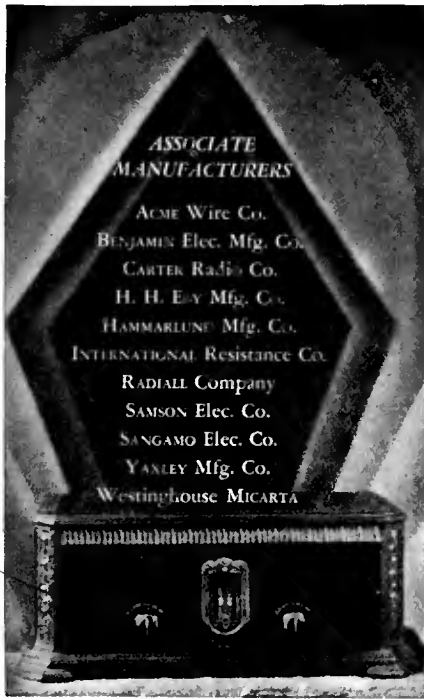

It Must Be Custom-Built!

The new improved Hammarlund-Roberts Hi-Q SIX Receiver has been designed by ten of America's foremost radio engineers entirely with an eye to finest possible reception. From the outset price was a secondary consideration.

Every modern constructional feature is included—the finest parts in America are used—perfect synchronization at last is realized and through such advanced features as four completely shielded stages of tuned frequency, Automatic Variable Coupling and Symphonic transformers—a truly deluxe quality of performance is achieved!

This wonderful instrument cannot be purchased ready-made. It must be CUSTOM-BUILT by yourself at home. Complete parts cost only \$95.80, whereas to market it completely built would mean a price of nearly \$300. Instruction book shows you how to build. Drilled foundation panels make construction a pleasure rather than a job. The finished instrument is accepted as the best in radio regardless of price. Ask your dealer for the "How to Build" Book or write direct. Price 25 cents.



HAMMARLUND-ROBERTS, Inc.
1182 Broadway, Dept. A, New York

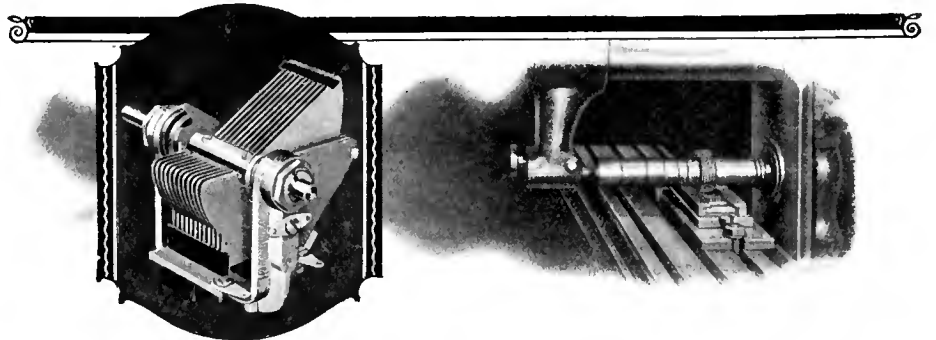

HAMMARLUND "Midline" CONDENSER

Soldered brass plates with tie-bars; warpless aluminum alloy frame; ball bearings; bronze clock-spring pigtail; full-floating, removable rotor shaft permits direct tandem coupling to other condensers. Made in all standard capacities and accurately matched.

If your dealer can't supply you write to us.

HAMMARLUND MFG. CO.
424-438 W. 33rd St. New York

Accurate Capacity Values Assured

Here is the machine, designed and built by Hammarlund, that cuts the slots in which Hammarlund Condenser plates are firmly soldered.

One operation cuts all slots, thus assuring uniform spacing as the first step toward accurate capacity values.

It is such precision methods that have given Hammarlund Condensers world leadership and that guarantee to you the quality performance for which all Hammarlund Products are famous. Write for folder.



*The Clearest
and Truest Electric Radio*
Is a standard Radio Set
equipped with

Balkite Electric "AB"

\$64.50 and \$74.50. Ask your dealer
Fansteel Products Co., Inc., North Chicago, Ill.

Balkite Radio Power Units

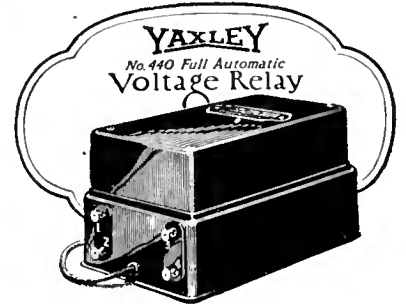

For automatically switching on and off your B Eliminator and Charger, or either, and in addition, automatically switching off your Charger when the battery is fully charged.

No. 440 \$7.50

YAXLEY MFG. CO.

Dept. B, 9 So. Clinton St. CHICAGO, ILL.



Keep Your Filaments Under Control

Better filament control means more uniform reception. The guess method of setting the filament rheostat doesn't tell you when the tubes are being burned too high or too low. Neither can a filament rheostat be set accurately by the brightness of the radio tube or by the volume of reception.

The Jewell pattern No. 135 Voltmeter is the ideal radio instrument for use in accurate filament control. It tells at a glance the exact voltage being applied to the filament at that time. The movement is of the D'Arsonval moving coil type with silvered parts and silver etched dial, and with a pointer equipped with a zero adjuster. The case is two inches in diameter and black enameled.

The instrument is easy to mount and is connected as shown in the diagram.

Write for description form No. 776.

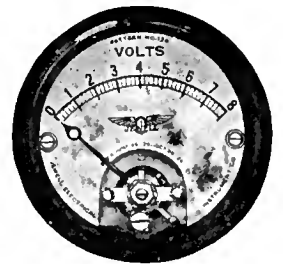

Pattern No. 135
Panel Mounting Voltmeter

Jewell Electrical Instrument Company

1650 Walnut Street, Chicago

"28 Years Making Good Instruments"

Proven Parts That Are Popular With Set Builders

Bradleyunit-A



provides the ideal resistance for B-eliminators requiring fixed resistors of permanent resistance value. Not affected by age, temperature or humidity. Will not deteriorate in service.

Bradleyohm-E

provides accurate plate voltage control for B-eliminators. Used extensively by B-eliminator manufacturers. Not affected by time or moisture.

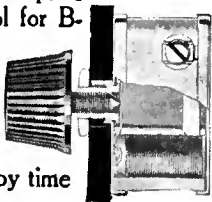

Bradleyleak

A variable grid leak that assures the ideal grid leak value. Easily installed on any set. Enables operator to get the best possible results with any tube.



Bradleystat

This pioneer in filament control of radio tubes is still mighty popular. Provides noiseless, stepless filament control for all tubes. Try a Bradleystat on your next set.



Allen-Bradley Co.

Electric Controlling Apparatus

MILWAUKEE, WISCONSIN



No. 171

RADIO BROADCAST Laboratory Information Sheet

March, 1928

The CX-312 (UX-112) and CX-371 (UX-171)

FURTHER COMPARISONS

THE two types of power tubes best adapted for medium B voltages are the CX-312 (UX-112) and the CX-371 (UX-171). The former tube, introduced first, came into immediate favor, and for a time was more popular than the CX-371 (UX-171). This initial preference was due to several factors, the most important ones being, first, the fact that the voltages required by this type were identical with those required by type CX-301-A (UX-201-A) tubes, and therefore, the tube could be substituted without battery changes. Secondly the horn type loud speaker, generally more sensitive than the cone loud speaker, was still popular, and there was less necessity for the greater power output given by the CX-371 (UX-171). A third factor was the misapprehension about battery voltages, many not realizing that although the CX-371 could be used to best advantage at the maximum voltage of 180 volts, the quality of reproduction was equally good at 135 volts, and the volume ample for average home service.

During the current season the standing of the two tubes is rapidly being reversed, the CX-371 (UX-

171) assuming the leadership, partly because of the large number of new receivers for which the tube is specified, and partly because of better facilities for using the tube to its best advantages. As improvements in audio amplification and in loud speaker design are made, the advantage of using this type of tube becomes increasingly apparent. The higher frequencies are usually reproduced satisfactorily by any type of output tube, but to secure full undistorted reproduction of low frequencies, or the bass notes, a tube having low internal resistance, such as the CX-371 (UX-171), is required.

In installing the CX-371 (UX-171), the first precaution with which the user has to become familiar is the use of a high grid biasing, or C, battery voltage—from 16½ to 40½ volts, depending upon the B voltage used. With general-purpose tubes, which the power tubes replaced, the use of a C battery was to a large extent optional with the user, although the fact that better quality was obtained with this battery was generally recognized.

Laboratory Sheets Nos. 161 and 162 gave some interesting data and curves on the type 112 and 171 tubes. The 210 type tube was also covered in these latter sheets.

No. 172

RADIO BROADCAST Laboratory Information Sheet

March, 1928

A Simple Wavemeter

CONSTRUCTION AND CALIBRATION

A WAVEMETER is a very useful asset to the laboratory of any radio experimenter. A coil of wire and a condenser, connected together properly, are all that is required to make this instrument.

The circuit diagram of a wavemeter is given on the curve published herewith. It is evident from the diagram that the coil is simply connected across the condenser. The coil should preferably be a solenoid wound on a piece of tubing so that it will be able to withstand some abuse without any alteration in its inductance, and should have sufficient number of turns to cover the frequency band it is to be used on.

The construction of the wavemeter presents no problems. The method of calibrating it and plotting a calibration curve may, however, require some explanation. The procedure is as follows:

- (1) Set the wavemeter at a distance of about two feet from your radio receiver.
- (2) Take the lead from the antenna and wrap one turn around the coil of the wavemeter and then run the antenna lead over to the regular antenna post on your receiver.
- (3) Turn on the receiver and tune-in the signals of some station. Now slowly revolve the dial on the wavemeter and at some point on the dial the signal output of the receiver will decrease. Note the reading on the wavemeter condenser dial which cuts out the signal most completely. Make the same test on some other stations.

(4) Now draw the curve, using the data obtained, in a manner similar to that indicated on this Laboratory Sheet. The wavelengths, or frequencies, on which the various stations are transmitting can, of course, be obtained from any list of broadcasting stations.

Such a wavemeter aids materially in the identification of stations heard on a receiver which is not calibrated.

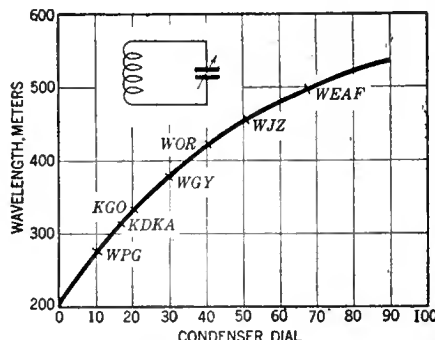

No. 173

RADIO BROADCAST Laboratory Information Sheet

March, 1928

The Regulator Tube

WHY IT IS USED

THE voltage regulator tube, or glow tube, as it is sometimes called, has found rather wide use in the design of B power units, making them capable of delivering a voltage output that is practically constant over a wide range of load. The output of a power unit not using a glow tube will, of course, vary with the load, although the magnitude of this variation may be held to comparatively low values by good design. A power unit supplying an output voltage that does not depend upon the load may be used with practically any receiver with a knowledge that the voltage actually delivered to the receiver will be correct. Constant voltage output is, however, only one of the advantages accruing from the use of a regulator tube.

The action of the tube in holding the voltage of the output circuit constant serves also to eliminate the small ripples which may be present as a result of incomplete filtering, and this action makes possible a reduction in the capacity, and therefore the expense, of the final filter condenser. In fact, the

tube, when in operation, has many properties in common with a large fixed condenser. One of these properties is extremely low a. c. impedance which, when combined with its instantaneous response as a voltage regulator, entirely eliminates the annoying "motor-boating" effect which generally results when an attempt is made to use one of the ordinary B power units with many forms of amplifiers.

The fact that the regulator tube keeps the output voltage constant also permits the safe use of condensers of a lower voltage rating than would be permissible if the tube were not used. The rating of the condensers used in an ordinary power circuit is fixed by the maximum values of voltage that they must handle. The voltage output of some units, at no load, rises to comparatively high values and the condensers must therefore have a rating sufficient to withstand these voltages. The output voltage of a power unit with a regulator tube is limited, even at no load, to values only slightly above rated voltage and, therefore, the condensers are not called upon to withstand voltages greater than the rated output of the unit.

No. 174

RADIO BROADCAST Laboratory Information Sheet

March, 1928

Grid Bias

WHY IT IS USED

THERE are apparently many, as indicated by letters to the Laboratory, who still feel that the major reason for using C bias on a tube is to reduce the plate current. Although negative bias on the grid of a tube does decrease the plate current, this is not really the most important reason for its use.

C bias is used primarily to reduce distortion and make the tube operate more efficiently. In an ordinary receiver, C bias is most important in the audio-frequency amplifier and we will, therefore, discuss on this Laboratory Sheet the effect of using various values of C bias on the grid of a tube.

The curves A, B, C, and D indicate the distortion of signals which results when too little or too much bias is used. Curve A represents the voltage on the grid of the tube. Curve B shows how the plate current of the tube varies if the bias on the tube is correct. It should be noted that the form of this curve is the same as curve A, indicating that there is no distortion being created by the tube. If too little bias is used, the positive halves of the input voltage wave will cause the grid to become positive when the grid draws current, and the positive peaks are then cut off as indicated at C. If the bias is too great the tube operates on the lower bend of its characteristic

and this causes the negative half of the signal to be flattened out, as shown in curve D. To prevent distortion, therefore, the proper C bias must be used.

It is especially important that the bias on the last tube be correct, for this tube must handle the greatest amount of signal current and will, therefore, overload and distort most easily. As a matter of information the correct bias for a 112 or 171 type tube is given below:

TUBE	PLATE VOLTS	C BIAS
112	{ 90	6.0
	{ 135	9.0
	{ 137	10.5
171	{ 90	16.5
	{ 135	27.0
	{ 180	40.5

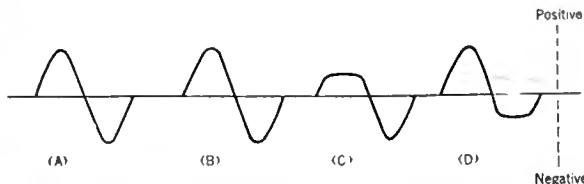

No. 175

RADIO BROADCAST Laboratory Information Sheet

March, 1928

Filter Choke Coils

EFFECT OF AIR GAP

IF THE filter circuit of a B power unit is to eliminate satisfactorily all hum, it is essential that the filter choke coils have sufficient inductance under actual operating conditions. The value of the inductance of a choke coil as measured without any direct current flowing through it will differ from the value obtained with direct current, so all measurements on choke coils should, therefore, be made with d. c. flowing in the winding.

When direct current flows through a filter coil it produces a certain amount of magnetic flux, or "lines of force," in the core. This flux tends to saturate the core of the choke and, when this occurs, the unit will no longer function satisfactorily in eliminating the hum.

Manufacturers are always willing to supply data on the maximum amount of d. c. current their filter choke coil can handle and this value should not be exceeded in practice.

When the filter coil is constructed, the core may be clamped tightly together or a small air-gap may be left. As the current capacity rating of the coil is increased, the air-gap should be increased also, and this tends to prevent magnetic saturation. The group of curves on this Sheet show this effect. The conditions under which they were obtained are given below:

- T—No air gap
- A—Average air gap
- B—Air gap at one end, 0.01 inches
- C—Air gap at both ends, 0.005 inches each

D—Air gap at both ends, 0.0075 inches each
E—Air gap at both ends, 0.01 inches each
If the d. c. current is to be 10 milliamperes, construction type T is best, while type C is best at a current of 30 milliamperes, or if the current through the choke is to be 55 milliamperes, type E should be used.

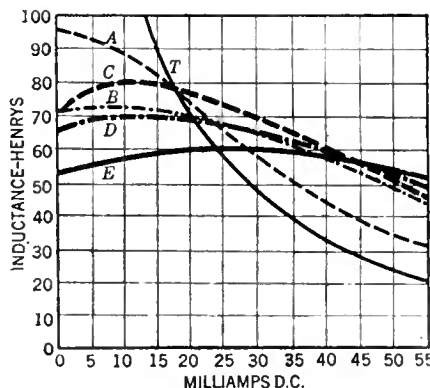

No. 176

RADIO BROADCAST Laboratory Information Sheet

March, 1928

How the Plate Circuit Affects the Grid Circuit

REVERSE ACTION

IN WORKING with tubes, we normally consider that the plate circuit is controlled by the grid and that there is no reverse action. This, however, is not strictly true, for the plate circuit does affect the grid circuit in two ways.

In the first place the plate acts as a grid with respect to the regular grid in the tube and large variations in plate voltage have the same effect with respect to the grid as has slightly varying the grid voltage. The reverse effect is generally not appreciable so long as the grid is held negative, as is the case in an amplifier. The reverse effect is important in oscillator circuits, however, where the grid is not always negative. In making an accurate analysis of the action of an oscillator, it would be necessary to consider this effect.

The second manner in which the grid is controlled by the plate is through the grid-plate capacity of the tube. At (A) in the diagram on this Sheet, we have indicated the circuit of an ordinary r. f. amplifier and at (B) is shown the equivalent circuit with the inter-electrode resistances and capacities indicated. R_g is the grid-filament resistance of the tube, C_g the grid-to-filament capacity, C_i the inter-electrode

capacity between the grid and the plate, R_p the plate filament resistance, C_p the plate-filament capacity, and L the load impedance. Probably the most important of the capacities shown is the grid-plate capacity, C_i , for it is this capacity which permits the grid circuit to be affected by what goes on in the plate circuit. In radio-frequency amplifiers it is this capacity which causes the tube to oscillate.

The diagram at (B) should give some idea of the complexity of the network represented by a tube, and the action of this network of resistances, condensers, and inductances must be understood if the action of a tube in any particular circuit is to be accurately foretold. J. M. Millen, in *Scientific Paper of the Bureau of Standards No. 351*, carefully and completely determined the dependence of the input circuit of a tube upon the output circuit.

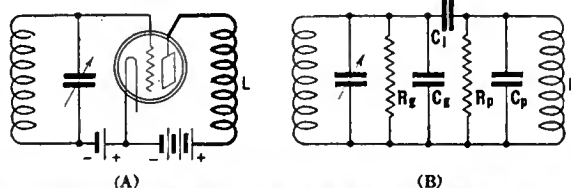

Whether it's battery or A-C Tubes --BE MASTER of Your Set!

RADIO can be a pleasure or a curse, depending upon whether you run your radio set or your radio set runs you. An uncontrolled radio set is like an automobile without steering wheel and throttle—except that the latter soon kills outright, whereas the former causes a slow, lingering, painful death to the owner and others.

YET nothing is simpler than the control of your set, whether equipped with A-C or battery tubes. In the case of either type of tubes, just connect a

VOLUME CONTROL CLAROSTAT



across antenna and ground binding posts of your set. Now you have distortionless control that gives you anything from full output to mere whisper—from dance music for shuffling feet to soft background for dinner conversation. All for \$1.50, and instantly applicable to any receiver.

Again you must control your power supply for A-C as well as battery type tubes. In the case of A-C tubes, you must compensate for line voltage fluctuations. This is essential for best results. Much of the hum with A-C tubes is due to improper operating voltage. In the case of all B-power supply devices, you must also compensate for line voltage changes. The solution here is a Power Clarostat (25-500 ohm range) connected in primary circuit of power transformer. You can instantly adjust A-C tube filaments or heaters, B and C voltages, all at one time. Applicable to any set or radio power unit. And all for \$3.50.



WRITE us for data on how to improve your radio, whether A-C or battery operated. And when you buy CLAROSTATS, be sure you get the genuine, distinguished by familiar green box and name Clarostat stamped on nickeled shell. Accept no substitutes!

AMERICAN MECHANICAL LABS. Inc.



Specialists in Variable Resistors

285 No. 6th St. Brooklyn, N. Y.

"RADIO BROADCASTS" DIRECTORY OF MANUFACTURED RECEIVERS

☐ A coupon will be found on page 395. All readers who desire additional information on the receivers listed below need only insert the proper numbers in the coupon, mail it to the Service Department of RADIO BROADCAST, and full details will be sent. New sets are listed in this space each month.

KEY TO TUBE ABBREVIATIONS

99—60-mA. filament (dry cell)
01-A—Storage battery 0.25 amps. filament
12—Power tube (Storage battery)
71—Power tube (Storage battery)
16-B—Half-wave rectifier tube
80—Full-wave, high current rectifier
81—Half-wave, high current rectifier
Hmu—High-Mu tube for resistance-coupled audio
20—Power tube (dry cell)
10—Power Tube (Storage battery)
00-A—Special detector
13—Full-wave rectifier tube
26—Low-voltage high-current a. c. tube
27—Heater type a. c. tube

DIRECT CURRENT RECEIVERS

NO. 424. COLONIAL 26

Six tubes; 2 t. r. f. (01-A), detector (12), 2 transformer audio (01-A and 71). Balanced t. r. f. One to three dials. Volume control: antenna switch and potentiometer across first audio. Watts required: 120. Console size: 34 x 38 inches. Headphone connections. The filaments are connected in a series parallel arrangement. Price \$250 including power unit.

NO. 425. SUPERPOWER

Five tubes: All 01-A tubes. Multiplex circuit. Two dials. Volume control: resistance in r. f. plate. Watts required: 30. Antenna: loop or outside. Cabinet sizes: table, 27 x 10 x 9 inches; console, 28 x 50 x 21. Prices: table, \$135 including power unit; console, \$390 including power unit and loud speaker.

A. C. OPERATED RECEIVERS

NO. 508. ALL-AMERICAN 77, 88, AND 99

Six tubes; 3 t. r. f. (26), detector (27), 2 transformer audio (26 and 71). Rice neutralized t. r. f. Single drum tuning. Volume control: potentiometer in r. f. plate. Cabinet sizes: No. 77, 21 x 10 x 8 inches; No. 88 Hiboy, 25 x 38 x 18 inches; No. 99 console, 27 x 43 x 20 inches. Shielded. Output device. The filaments are supplied by means of three small transformers. The plate supply employs a gas-filled rectifier tube. Voltmeter in a. c. supply line. Prices: No. 77, \$150, including power unit; No. 88, \$210 including power unit; No. 99, \$285 including power unit and loud speaker.

NO. 509. ALL-AMERICAN "DUET"; "SEXTET"

Six tubes; 2 t. r. f. (99), detector (99), 3 transformer audio (99 and 12). Rice neutralized t. r. f. Two dials. Volume control: resistance in r. f. plate. Cabinet sizes: "Duet," 23 x 56 x 16 inches; "Sextet," 22 x 13 x 15 inches. Shielded. Output device. The 99 filaments are connected in series and supplied with rectified a. c.; while 12 is supplied with raw a. c. The plate and filament supply uses gaseous rectifier tubes. Milliammeter on power unit. Prices: "Duet," \$160 including power unit; "Sextet," \$220 including power unit and loud speaker.

NO. 511. ALL-AMERICAN 80, 90, AND 115

Five tubes; 2 t. r. f. (99), detector (99), 2 transformer audio (99 and 12). Rice neutralized t. r. f. Two dials. Volume control: resistance in r. f. plate. Cabinet sizes: No. 80, 23 x 12 x 15 inches; No. 90, 37 x 12 x 12 inches; No. 115 Hiboy, 24 x 41 x 15 inches. Coils individually shielded. Output device. See No. 509 for power supply. Prices: No. 80, \$135 including power unit; No. 90, \$145 including power unit and compartment; No. 115, \$170 including power unit, compartment, and loud speaker.

NO. 510. ALL-AMERICAN 7

Seven tubes; 3 t. r. f. (26), 1 untuned r. f. (26), detector (27), 2 transformer audio (26 and 71). Rice neutralized t. r. f. One drum. Volume control: resistance in r. f. plate. Cabinet sizes: "Sovereign" console, 30 x 60 x 19 inches; "Lorraine" Hiboy, 25 x 53 x 17 inches; "Forte" cabinet, 25 x 13 x 17 inches. For filament and plate supply: See No. 508. Prices: "Sovereign" \$460; "Lorraine" \$360; "Forte" \$270. All prices include power unit. First two include loud speaker.

NO. 536. SOUTH BEND

Six tubes. One control. Sub-panel shielding. Binding Posts. Antenna: outdoor. Prices: table, \$130, Baby Grand Console, \$195.

NO. 537. WALBERT 26

Six tubes; five Kellogg a. c. tubes and one 71. Two controls. Volume control: variable plate resistance. Isofarad circuit. Output device. Battery cable. Semi-shielded. Antenna: 50 to 75 feet. Cabinet size: 10 x 29 x 16 inches. Prices: \$215; with tubes, \$250.

NO. 522. CASE, 62B AND 62C

McCullough a. c. tubes. Drum control. Volume control: variable high resistance in audio system. C-battery connections. Semi-shielded. Cable. Antenna: 100 feet. Panel size: 7 x 21 inches. Prices: Model 62B, complete with a. c. equipment, \$185; Model 62C, complete with a. c. equipment, \$235.

NO. 523. CASE, 92 A AND 92 C

McCullough a. c. tubes. Drum control. Inductive volume control. Technidney circuit. Shielded. Cable. C-battery connections. Model 92 C contains output device. Loop operated. Prices: Model 92 A, table, \$350; Model 92 C, console, \$475.

NO. 484. BOSWORTH, B5

Five tubes; 2 t. r. f. (26), detector (99), 2 transformer audio (special a. c. tubes). T. r. f. circuit. Two dials. Volume control: potentiometer. Cabinet size: 23 x 7 x 8 inches. Output device included. Price \$175.

NO. 406. CLEARSTONE 110

Five tubes; 2 t. r. f., detector, 2 transformer audio. All tubes a. c. heater type. One or two dials. Volume control: resistance in r. f. plate. Watts consumed: 40. Cabinet size varies. The plate supply is built in the receiver and requires one rectifier tube. Filament supply through step down transformers. Prices range from \$175 to \$375 which includes 5 a. c. tubes and one rectifier tube.

NO. 407. COLONIAL 25

Six tubes; 2 t. r. f. (01-A), detector (99), 2 resistance audio (99), 1 transformer audio (10). Balanced t. r. f. circuit. One or three dials. Volume control: Antenna switch and potentiometer on 1st audio. Watts consumed: 100. Console size: 34 x 38 x 18 inches. Output device. All tube filaments are operated on a. c. except the detector which is supplied with rectified a. c. from the plate supply. The rectifier employs two 16-b tubes. Price \$250 including built-in plate and filament supply.

NO. 507. CROSLBY 602 BANDBOX

Six tubes; 3 t. r. f. (26), detector (27), 2 transformer audio (26 and 71). Neutrodyne circuit. One dial. Cabinet size: 17 x 5 x 7 1/2 inches. The heaters for the a. c. tubes and the 71 filament are supplied by windings in B unit transformers available to operate either on 25 or 60 cycles. The plate current is supplied by means of rectifier tube. Price \$65 for set alone, power unit \$60.

NO. 408. DAY-FAN "DE LUXE"

Six tubes; 3 t. r. f., detector, 2 transformer audio. All 01-A tubes. One dial. Volume control: potentiometer across r. f. tubes. Watts consumed: 300. Console size: 30 x 40 x 20 inches. The filaments are connected in series and supplied with d. c. from a motor-generator set which also supplies B and C current. Output device. Price \$350 including power unit.

NO. 409. DAYCRAFT 5

Five tubes; 2 t. r. f., detector, 2 transformer audio. All a. c. heater tubes. Reflexed t. r. f. One dial. Volume control: potentiometers in r. f. plate and 1st audio. Watts consumed: 135. Console size: 34 x 36 x 14 inches. Output device. The heaters are supplied by means of a small transformer. A built-in rectifier supplies B and C voltages. Price \$170, less tubes. The following have one more r. f. stage and are not reflexed; Daycraft 6, \$195; Dayrole, 6, \$235; Dayfan 6, \$110. All prices less tubes.

NO. 469. FREED-EISEMANN NR11

Six tubes; 3 t. r. f. (01-A), detector (01-A), 2 transformer audio (01-A and 71). Neutrodyne. One dial. Volume control: potentiometer. Watts consumed: 150. Cabinet size: 19 x 10 x 10 inches. Shielded. Output device. A special power unit is included employing a rectifier tube. Price \$225 including NR-411 power unit.

NO. 487. FRESHMAN 7F-AC

Six tubes; 3 t. r. f. (26), detector (27), 2 transformer audio (26 and 71). Equaphase circuit. One dial. Volume control: potentiometer across 1st audio. Console size: 24 x 41 x 15 inches. Output device. The filaments and heaters and B supply are all supplied by one power unit. The plate supply requires one 80 rectifier tube. Price \$175 to \$350, complete.

NO. 421. SOVEREIGN 238

Seven tubes of the a. c. heater type. Balanced t. r. f. Two dials. Volume control: resistance across 2nd audio. Watts consumed: 45. Console size: 37 x 52 x 15 inches. The heaters are supplied by a small a. c. transformer, while the plate is supplied by means of rectified a. c. using a gaseous type rectifier. Price \$325, including power unit and tubes.

NO. 517. KELLOGG 510, 511, AND 512

Seven tubes; 4 t. r. f., detector, 2 transformer audio. All Kellogg a. c. tubes. One control and special zone switch. Balanced. Volume control: special. Output device. Shielded. Cable connection between power supply unit and receiver. Antenna: 25 to 100 feet. Panel 7 1/2 x 27 inches. Prices: Model 510 and 512, consoles, \$495 complete. Model 511, console, \$365 without loud speaker.

NO. 496. SLEEPER ELECTRIC

Five tubes; four 99 tubes and one 71. Two controls. Volume control: rheostat on r. f. Neutralized. Cable. Output device. Power supply uses two 16-B tubes. Antenna: 100 feet. Prices: Type 64, table, \$160; Type 65, table, with built-in loud speaker, \$175; Type 66, table, \$175; Type 67, console, \$235; Type 78, console, \$265.

NO. 538. NEUTROWOUND, MASTER ALLECTRIC

Six tubes; 2 t. r. f. (01-A), detector (01-A), 2 audio (01-A and two 71 in push-pull amplifier). The 01-A tubes are in series, and are supplied from a 400-mA. rectifier. Two drum controls. Volume control: variable plate resistance. Output device. Shielded. Antenna: 50 to 100 feet. Price: \$360.

NO. 413. MARTI

Six tubes: 2 t. r. f., detector, 3 resistance audio. All tubes a. c. heater type. Two dials. Volume control: resistance in r. f. plate. Watts consumed: 38. Panel size 7 x 21 inches. The built-in plate supply employs one 16-B rectifier. The filaments are supplied by a small transformer. Prices: table, \$235 including tubes and rectifier; console, \$275 including tubes and rectifier; console, \$325 including tubes, rectifier, and loud speaker.

NO. 417. RADIOLA 28

Eight tubes; five type 99 and one type 20. Drum control. Super-heterodyne circuit. C-battery connections. Battery cable. Headphone connection. Antenna: loop. Set may be operated from batteries or from the power mains when used in conjunction with the model 104 loud speaker. Prices: \$260 with tubes, battery operation; \$570 with model 104 loud speaker, a. c. operation.

NO. 540. RADIOLA 30-A

Receiver characteristics same as No. 417 except that type 71 power tube is used. This model is designed to operate on either a. c. or d. c. from the power mains. The combination rectifier—power—amplifier unit uses two type 81 tubes. Model 100-A loud speaker is contained in lower part of cabinet. Either a short indoor or long outside antenna may be used. Cabinet size: 42 x 29 x 17 1/2 inches. Price: \$495.

NO. 541. RADIOLA 32

This model combines receiver No. 417 with the model 104 loud speaker. The power unit uses two type 81 tubes and a type 10 power amplifier. Loop is completely enclosed and is revolved by means of a dial on the panel. Models for operation from a. c. or d. c. power mains. Cabinet size: 52 x 72 x 17 1/2 inches. Price: \$895.

NO. 539. RADIOLA 17

Six tubes; 3 t. r. f. (26), detector (27), 2 transformer audio (26 and 27). One control. Illuminated dial. Built-in power supply using type 80 rectifier. Antenna: 100 feet. Cabinet size: 25 1/2 x 7 1/2 x 8 1/2. Price: \$130 without accessories.

NO. 545. NEUTROWOUND, SUPER ALLECTRIC

Five tubes; 2 t. r. f. (99), detector (99), 2 audio (99 and 71). The 99 tubes are in series and are supplied from an 85-mA. rectifier. Two drum controls. Volume control: variable plate resistance. Output device. Antenna: 75 to 100 feet. Cabinet size: 9 x 24 x 11 inches. Price: \$150.

NO. 490. MOHAWK

Six tubes; 2 t. r. f., detector, 2 transformer audio. All tubes a. c. heater type except 71 in last stage. One dial. Volume control: rheostat on r. f. Watts consumed: 40. Panel size: 12 x 8 1/2 inches. Output device. The heaters for the a. c. tubes and the 71 filament are supplied by small transformers. The plate supply is of the built-in type using a rectifier tube. Prices range from \$65 to \$245.

NO. 411. HERBERT LECTRO 120

Five tubes; 2 t.r.f. (99), detector (99), 2 transformer audio (99 and 71). Three dials. Volume control: rheostat in primary of a.c. transformer. Watts required: 45. Cabinet size: 32 x 10 x 12 inches. The 99 filaments are connected in series, supplied with rectified a. c., while the 71 is run on raw a. c. The power unit uses a Q. R. S. rectifier tube. Price \$120.

NO. 412. HERBERT LECTRO 200

Six tubes; 2 t.r.f. (99), detector (99), 1 transformer audio (99), 1 push-pull audio (71). One dial. Volume control: rheostat in primary of a. c. transformer. Watts consumed: 60. Cabinet size: 20 x 12 x 12 inches. Filaments connected same as above. Completely shielded. Output device. Price \$200.

BATTERY OPERATED RECEIVERS

NO. 542. PFANSTIEHL JUNIOR SIX

Six tubes; 3 t. r. f. (01-A), detector (01-A), 2 audio. Pfanstiehl circuit. Volume control: variable resistance in r. f. plate circuit. One dial. Shielded. Battery cable. C-battery connections. Etched bronze panel. Antenna: outdoor. Cabinet size: 9 x 20 x 8 inches. Price: \$80, without accessories.

NO. 512. ALL-AMERICAN 44, 45, AND 66

Six tubes; 3 t. r. f. (01-A, detector) 01-A, 2 transformer audio (01-A and 71). Rice neutralized t. r. f. Drum control. Volume control: rheostat in r. f. Cabinet sizes: No. 44, 21 x 10 x 8 inches; No. 55, 25 x 38 x 18 inches; No. 66, 27 x 43 x 20 inches. C-battery connections. Battery cable. Antenna: 75 to 125 feet. Prices: No. 44, \$70; No. 55, \$125 including loud speaker; No. 66, \$200 including loud speaker.

NO. 410. LARCOFLEX 73

Seven tubes; 4 t.r.f. (01-A), detector (01-A), 2 transformer audio (01-A and 71). T.r.f. circuit. One dial. Volume control: resistance in r.f. plate. Console size 30 x 42 x 20 inches. Completely shielded. Built-in A, B and C supply. Price \$215.



—at Slight Cost
—in a Few Moments

Your Set can be A C-Operated

There is a Dongan A C Transformer designed specifically for each of the approved A C Tubes

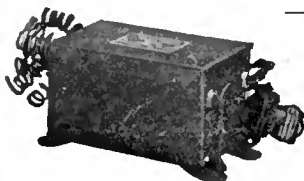

—for instance here is No. 6512

A remarkably well-designed and sturdy A C Transformer, mounted in a crystalized lacquered case, equipped with lamp cord and plug outlet for B-Eliminator, also tap for control switch. Operated with 4 UX 226, 1 UY 227 and 1 UX 171 R C A Tubes. \$5.75 list

Then you can have exactly the same transformer without plug outlet and control switch tap—No. 6515 for \$4.75 list

Ranging in price from \$3.50 to \$5.25, there are 10 other A C Transformers, operating with the approved A C Tubes.

Send check or money order if your dealer cannot supply you.

Custom Set Builders

Write for our special proposition to Custom Set Manufacturers

DONGAN ELECTRIC MFG. CO.

2991-3001 Franklin St. Detroit, Michigan

TRANSFORMERS of MERIT for FIFTEEN YEARS

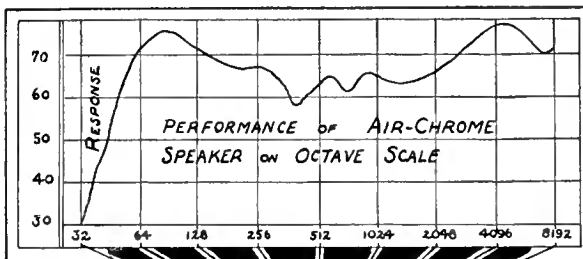

KEYBOARD of PIANO

The First of its Kind

YOUR receiver deserves an AIR-CHROME speaker. The "balanced tension" principle, governing the operation of this speaker, is a new engineering development . . . It means the full realization of the brilliance of broadcast selections. . . . ALL MUSICAL INSTRUMENTS ARE WITHIN ITS RANGE.

Speakers at \$15.00, \$20.00, \$25.00, and \$65.00

Order from us or your dealer. If your dealer cannot supply, send us his name. . . .

Write for descriptive literature

The Air-Chrome SPEAKER

168 Coit Street

Irvington, N. J.

LYNCH

Equalizers make rheostats unnecessary. A type for every tube and combination of tubes.

CARTER

READY?
OF COURSE!
CARTER
Adapter Harness
for converting battery sets to
A. C. Tube Operation

Without any structural or wiring change in the set. Change can be made in a few minutes. Complete, eliminates "C" batteries.

Write for illustrated folder giving full information.

MEMBER RMA
Carter Radio Co.
CHICAGO

New Aero Circuits

for Either Battery or A. C. Operation

Proper constants for A. C. operation of the Improved Aero-Dyne 6 and the Aero Seven have been studied out, and these excellent circuits are now adaptable to either A. C. or battery operation. A. C. blue prints are packed in foundation units. They may also be obtained by sending 25c for each direct to the factory.

Aero Universal Tuned Radio Frequency Kit
Especially designed for the Improved Aero-Dyne 6. Kit consists of 4 twice-matched units. Adaptable to 201-A, 199, 112, and the new 240 and A. C. Tubes. Tuning range below 200 to above 550 meters.
Code No. U-16 (for .0005 Cond.) \$15.00
Code No. U-163 (for .00035 Cond.) 15.00

Aero Seven Tuned Radio Frequency Kit
Especially designed for the Aero 7. Kit consists of 3 twice-matched units. Coils are wound on Bakelite skeleton forms, assuring a 95 per cent. air dielectric. Tuning range from below 200 to above 550 meters. Adaptable to 210-A, 199, 112, and the new 240 and A. C. Tubes.
Code No. U-12 (for .0005 Cond.) \$12.00
Code No. U-123 (for .00035 Cond.) 12.00

You should be able to get any of the above Aero Coils and parts from your dealer. If he should be out of stock order direct from the factory.

AERO PRODUCTS, INC.
1772 Wilson Ave. Dept. 109 Chicago, Ill.

Insuring Tube Efficiency

AMPERITE alone gives utmost life and performance from tubes. Because AMPERITE alone keeps the filament voltage, or temperature, constant, despite "A" battery variations. Particularly needed with Battery Eliminators. Simplifies wiring and panel design. Eliminates hand rheostats and guessing. Proved for 6 years. Entirely different from fixed filament resistors. There is no alternative. Insist on AMPERITE. Price \$1.10 with mounting (in U.S.A.). At all dealers.

Write for FREE "Amperite Book" of season's best circuits and latest construction data, to Dept. EB-8

Radiall Company
50 FRANKLIN ST., NEW YORK

AMPERITE

REG. U.S. PAT. OFF.

The "SELF-ADJUSTING" Rheostat

NO. 485. BOSWORTH B6

Five tubes; 2 t. r. f. (01-A), detector (01-A), 2 transformer audio (01-A and 71). Two dials. Volume control: variable grid resistances. Battery cable. C-battery connections. Antenna: 25 feet or longer. Cabinet size: 15 x 7 x 8 inches. Price \$75.

NO. 513. COUNTERPHASE SIX

Six tubes; 3 t. r. f. (01-A), detector (00-A), 2 transformer audio (01-A and 12). Counterphase t. r. f. Two dials. Plate current: 32 mA. Volume control: rheostat on 2nd and 3rd r. f. Coils shielded. Battery cable. C-battery connections. Antenna: 75 to 100 feet. Console size: 18½ x 40½ x 15½ inches. Prices: Model 35, table, \$110; Model 37, console, \$175.

NO. 514. COUNTERPHASE EIGHT

Eight tubes; 4 t. r. f. (01-A) detector (00-A), 2 transformer audio (01-A and 12). Counterphase t. r. f. One dial. Plate current: 40 mA. Volume control: rheostat in 1st r. f. Copper stage shielding. Battery cable. C-battery connections. Antenna: 75 to 100 feet. Cabinet size: 30 x 12½ x 16 inches. Prices: Model 12, table, \$225; Model 16, console, \$335; Model 18, console, \$365.

NO. 506. CROSLLEY 601 BANDBOX

Six tubes; 3 t. r. f., detector, 2 transformer audio. All 01-A tubes. Neurodyne. One dial. Plate current: 40 mA. Volume control: rheostat in r. f. Shielded. Battery cable. C-battery connections. Antenna: 75 to 150 feet. Cabinet size: 17½ x 5½ x 7½. Price, \$55.

NO. 434. DAY-FAN 6

Six tubes; 3 t. r. f. (01-A), detector (01-A), 2 transformer audio (01-A and 12 or 71). One dial. Plate current: 12 to 15 mA. Volume control: rheostat on r. f. Shielded. Battery cable. C-battery connections. Output device. Antenna: 50 to 120 feet. Cabinet sizes: Daycraft 6, 32 x 30 x 34 inches; Day-Fan Jr., 15 x 7 x 7. Prices: Day-Fan 6, \$110; Daycraft 6, \$145 including loud speaker; Day-Fan Jr. not available.

NO. 435. DAY-FAN 7

Seven tubes; 3 t. r. f. (01-A), detector (01-A), 1 resistance audio (01-A), 2 transformer audio (01-A and 12 or 71). Plate current: 15 mA. Antenna: outside. Same as No. 434. Price \$115.

NO. 503. FADA SPECIAL

Six tubes; 3 t. r. f. (01-A), detector (01-A), 2 transformer audio (01-A and 71). Neurodyne. Two drum control. Plate current: 20 to 24 mA. Volume control: rheostat on r. f. Coils shielded. Battery cable. C-battery connections. Headphone connection. Antenna: outdoor. Cabinet size: 20 x 13½ x 10½ inches. Price \$95.

NO. 504. FADA 7

Seven tubes; 4 t. r. f. (01-A), detector (01-A), 2 transformer audio (01-A and 71). Neurodyne. Two drum control. Plate current: 43 mA. Volume control: rheostat on r. f. Completely shielded. Battery cable. C-battery connections. Headphone connections. Output device. Antenna: outdoor or loop. Cabinet sizes: table, 25½ x 13½ x 11½ inches; console, 29 x 50 x 17 inches. Prices: table, \$185; console, \$285.

NO. 436. FEDERAL

Five tubes; 2 t. r. f. (01-A), detector (01-A), 2 transformer audio (01-A and 12 or 71). Balanced t. r. f. One dial. Plate current: 20.7 mA. Volume control: rheostat on r. f. Shielded. Battery cable. C-battery connections. Antenna: loop. Made in 6 models. Price varies from \$250 to \$1000 including loop.

NO. 505. FADA 8

Eight tubes. Same as No. 504 except for one extra stage of audio and different cabinet. Prices: table, \$300; console, \$400.

NO. 437. FERGUSON 10A

Seven tubes; 3 t. r. f. (01-A), detector (01-A), 3 audio (01-A and 12 or 71). One dial. Plate current: 18 to 25 mA. Volume control: rheostat on two r. f. Shielded. Battery cable. C-battery connections. Antenna: 100 feet. Cabinet size: 21½ x 12 x 15 inches. Price \$150.

NO. 438. FERGUSON 14

Ten tubes; 3 untuned r. f., 3 t. r. f. (01-A), detector (01-A), 3 audio (01-A and 12 or 71). Special balanced t. r. f. One dial. Plate current: 30 to 35 mA. Volume control: rheostat in three r. f. Shielded. Battery cable. C-battery connections. Antenna: loop. Cabinet size: 24 x 12 x 16 inches. Price \$235, including loop.

NO. 439. FERGUSON 12

Six tubes; 2 t. r. f. (01-A), detector (01-A), 1 transformer audio (01-A), 2 resistance audio (01-A and 12 or 71). Two dials. Plate current: 18 to 25 mA. Volume control: rheostat on two r. f. Partially shielded. Battery cable. C-battery connections. Antenna: 100 feet. Cabinet size: 22½ x 10 x 12 inches. Price \$85. Console \$145 including loud speaker.

NO. 440. FREED-EISEMANN NR-8 NR-9, AND NR-66

Six tubes; 3 t. r. f. (01-A), detector (01-A), 2 transformer audio (01-A and 71). Neurodyne. NR-8, two dials; others one dial. Plate current: 30 mA. Volume control: rheostat on r. f. NR-8 and 9; chassis type shielding. NR-66, individual stage shielding. Battery cable. C-battery connections. Antenna: 100 feet. Cabinet sizes: NR-8 and 9, 19½ x 10 x 10 inches; NR-66 20 x 10½ x 12 inches. Prices: NR-8, \$90; NR-9, \$100; NR-66, \$125.

NO. 501. KING "CHEVALIER"

Six tubes. Same as No. 500. Coils completely shielded. Panel size: 11 x 7 inches. Price, \$210 including loud speaker.

NO. 441. FREED-EISEMANN NR-77

Seven tubes; 4 t. r. f. (01-A), detector (01-A), 2 transformer audio (01-A and 71). Neurodyne. One dial. Plate current: 35 mA. Volume control: rheostat on r. f. Shielding. Battery cable. C-battery connections. Antenna: outside or loop. Cabinet size: 23 x 10½ x 13 inches. Price \$175.

NO. 442. FREED-EISEMANN 800 AND 850

Eight tubes; 4 t. r. f. (01-A), detector (01-A), 1 transformer (01-A), 1 parallel audio (01-A or 71). Neurodyne. One dial. Plate current: 35 mA. Volume control: rheostat on r. f. Shielded. Battery cable. C-battery connections. Output: two tubes in parallel or one power tube may be used. Antenna: outside or loop. Cabinet sizes: No. 800, 34 x 15½ x 13½ inches; No. 850, 36 x 65 x 17½. Prices not available.

NO. 444. GREBE MU-1

Five tubes; 2 t. r. f. (01-A), detector (01-A), 2 transformer audio (01-A and 12 or 71). Balanced t. r. f. One, two, or three dials (operate singly or together). Plate current: 30 mA. Volume control: rheostat on r. f. Binocular coils. Binding posts. C-battery connections. Antenna: 125 feet. Cabinet size: 22½ x 9½ x 13 inches. Prices range from \$95 to \$320.

NO. 426. HOMER

Seven tubes; 4 t. r. f. (01-A), detector (01-A or 00A); 2 audio (01-A and 12 or 71). One knob tuning control. Volume control: rotor control in antenna circuit. Plate current: 22 to 25 mA. "Technidyne" circuit. Completely enclosed in aluminum box. Battery cable. C-battery connections. Cabinet size, 8½ x 19½ x 9½ inches. Chassis size, 6½ x 17 x 8 inches. Prices: Chassis only, \$80. Table cabinet, \$95.

NO. 502. KENNEDY ROYAL 7. CONSOLETTTE

Seven tubes; 4 t. r. f. (01-A), detector (00-A), 2 transformer audio (01-A and 71). One dial. Plate current: 42 mA. Volume control: rheostat on two r. f. Special r. f. coils. Battery cable. C-battery connections. Headphone connection. Antenna: outside or loop. Console size: 36½ x 35½ x 19 inches. Price \$220.

NO. 498. KING "CRUSADER"

Six tubes; 2 t. r. f. (01-A), detector (00-A), 3 transformer audio (01-A and 71). Balanced t. r. f. One dial. Plate current: 20 mA. Volume control: rheostat on r. f. Coils shielded. Battery cable. C-battery connections. Antenna: outside. Panel: 11 x 7 inches. Price, \$115.

NO. 499. KING "COMMANDER"

Six tubes; 3 t. r. f. (01-A), detector (00-A), 2 transformer audio (01-A and 71). Balanced t. r. f. One dial. Plate current: 25 mA. Volume control: rheostat on r. f. Completely shielded. Battery cable. C-battery connections. Antenna: loop. Panel size: 12 x 8 inches. Price \$220 including loop.

NO. 429. KING COLE VII AND VIII

Seven tubes; 3 t. r. f., detector, 1 resistance audio, 2 transformer audio. All 01-A tubes. Model VIII has one more stage t. r. f. (eight tubes). Model VII, two dials. Model VIII, one dial. Plate current: 15 to 50 mA. Volume control: primary shunt in r. f. Steel shielding. Battery cable and binding posts. C-battery connections. Output devices on some consoles. Antenna: 10 to 100 feet. Cabinet size: varies. Prices: Model VII, \$80 to \$160; Model VIII, \$100 to \$300.

NO. 500. KING "BARONET" AND "VIKING"

Six tubes; 2 t. r. f. (01-A), detector (00-A), 3 transformer audio (01-A and 71). Balanced t. r. f. One dial. Plate current: 19 mA. Volume control: rheostat in r. f. Battery cable. C-battery connections. Antenna: outside. Panel size: 18 x 7 inches. Prices: "Baronet," \$70; "Viking," \$140 including loud speaker.

NO. 489. MOHAWK

Six tubes; 2 t. r. f. (01-A), detector (00-A), 3 audio (01-A and 71). One dial. Plate current: 40 mA. Volume control: rheostat on r. f. Battery cable. C-battery connections. Output device. Antenna: 60 feet. Panel size: 12½ x 8½ inches. Prices range from \$65 to \$245.

NO. 547. ATWATER KENT, MODEL 33

Six tubes; 3 t. r. f. (01-A), detector (01-A), 2 audio (01-A and 71 or 12). One dial. Volume control: r. f. filament rheostat. C-battery connections. Battery cable. Antenna: 100 feet. Steel panel. Cabinet size: 21½ x 6½ x 6½ inches. Price: \$75, without accessories.

NO. 544. ATWATER KENT, MODEL 50

Seven tubes; 4 t. r. f. (01-A), detector (01-A), 2 audio (01-A and 12 or 71). Volume control: r. f. filament rheostat. C-battery connections. Battery cable. Special bandpass filter circuit with an untuned amplifier. Cabinet size: 20½ x 13 x 7½ inches. Price: \$120.

NO. 452. ORIOLE 90

Five tubes; 2 t. r. f., detector, 2 transformer audio. All 01-A tubes. "Trinum" circuit. Two dials. Plate current: 18 mA. Volume control: rheostat on r. f. Battery cable. C-battery connections. Antenna: 50 to 100 feet. Cabinet size: 25½ x 11½ x 12½ inches. Price \$85. Another model has 8 tubes, one dial, and is shielded. Price, \$185.

NO. 453. PARAGON

Six tubes; 2 t. r. f. (01-A), detector (01-A), 3 double impedance audio (01-A and 71). One dial. Plate current: 40 mA. Volume control: resistance in r. f. plate. Shielded. Battery cable. C-battery connections. Output device. Antenna: 100 feet. Console size: 20 x 45 x 17 inches. Price not determined.

NO. 543. RADIOLA 20

Five tubes; 2 t. r. f. (99), detector (99), two transformer audio (99 and 20). Regenerative detector. Two drum controls. C-battery connections. Battery cable. Antenna: 100 feet. Price: \$78 without accessories.

NO. 480. PFANSTIEHL 30 AND 302

Six tubes; 3 t. r. f. (01-A), detector (01-2A), transformer audio (01-A and 71). One dial. Plate current: 23 to 32 mA. Volume control: resistance in r. f. plate. Shielded. Battery cable. C-battery connections. Antenna: outside. Panel size: 17½ x 8½ inches. Prices: No. 30 cabinet, \$105; No. 302 console, \$185 including loud speaker.

NO. 515. BROWNING-DRAKE 7-A

Seven tubes; 2 t. r. f. (01-A), detector (00-A), 3 audio (Hmu, two 01-A, and 71). Illuminated drum control. Volume control: rheostat on 1st r. f. Shielded. Neutralized. C-battery connections. Battery Cable. Metal panel. Output device. Antenna: 50-75 feet. Cabinet, 30 x 11 x 9 inches. Price, \$145.

NO. 516. BROWNING-DRAKE 6-A

Six tubes; 1 t. r. f. (99), detector (00-A), 3 audio (Hmu, two 01-A and 71). Drum control with auxiliary adjustment. Volume control: rheostat on r. f. Regenerative detector. Shielded. Neutralized. C-battery connections. Battery cable. Antenna: 50-100 feet. Cabinet, 25 x 11 x 9. Price \$105.

NO. 518. KELLOGG "WAVE MASTER," 504, 505, and 506.

Five tubes; 2 t. r. f., detector, 2 transformer audio. One control and special zone switch. Volume control: rheostat on r. f. C-battery connections. Binding posts. Plate current: 25 to 35 mA. Antenna: 100 feet. Panel: 7½ x 25½ inches. Prices: Model 504, table, \$75, less accessories. Model 505, table, \$125 with loud speaker. Model 506, console, \$135 with loud speaker.

NO. 519. KELLOGG, 507 AND 508

Six tubes, 3 t. r. f., detector, 2 transformer audio. One control and special zone switch. Volume control: rheostat on r. f. C-battery connections. Balanced. Shielded. Binding posts and battery cable. Antenna: 70 feet. Cabinet size: Model 507, table, 30 x 13½ x 14 inches. Model 508, console, 34 x 18 x 54 inches. Prices: Model 507, \$190 less accessories. Model 508, \$320 with loud speaker.

NO. 427. MURDOCK 7

Seven tubes; 3 t. r. f. (01-A), detector (01-A), 1 transformer and 2 resistance audio (two 01-A and 12 or 71). One control. Volume control: rheostat on r. f. Coils shielded. Neutralized. Battery cable. C-battery connections. Complete metal case. Antenna: 100 feet. Panel size: 9 x 23 inches. Price, not available.

NO. 520. BOSCH 57

Seven tubes; 4 t. r. f. (01-A), detector (01-A), 2 audio (01-A and 71). One control calibrated in kc. Volume control: rheostat on r. f. Shielded. Battery cable. C-battery connections. Balanced. Output device. Built-in loud speaker. Antenna: built-in loop or outside antenna, 100 feet. Cabinet size: 46 x 16 x 30 inches. Price: \$340 including enclosed loop and loud speaker.

NO. 521. BOSCH "CRUISER," 66 AND 76

Six tubes; 3 t. r. f. (01-A), detector (01-A), 2 audio (01-A and 71). One control. Volume control: rheostat on r. f. Shielded. C-battery connections. Balanced. Battery cable. Antenna: 20 to 100 feet. Prices: Model 66, table, \$99.50. Model 76, console, \$175; with loud speaker \$195.

NO. 524. CASE, 61 A AND 61 C

T. r. f. Semi-shielded. Battery cable. Drum control. Volume control: variable high resistance in audio system. Plate current: 35 mA. Antenna: 100 feet. Prices: Model 61A, \$85; Model 61 C, console, \$135.

NO. 525. CASE, 90 A AND 90 C

Drum control. Inductive volume control. Technidyne circuit. C-battery connections. Battery cable. Loop operated. Model 90-C equipped with output device. Prices: Model 90 A, table, \$225; Model 90 C, console, \$350.

NO. 526. ARBORPHONE 25

Six tubes; 3 t. r. f. (01-A), detector (01-A), 2 audio (01-A and 71). One control. Volume control: rheostat. Shielded. Battery cable. Output device. C-battery connections. Loftin-White circuit. Antenna: 75 feet. Panel: 7½ x 15 inches, metal. Prices: Model 25, table, \$125; Model 252, \$185; Model 253, \$250; Model 255, combination phonograph and radio, \$600.

NO. 527. ARBORPHONE 27

Five tubes; 2 t. r. f. (01-A), detector (01-A), 2 audio (01-A). Two controls. Volume control: rheostat. C-battery connections. Binding posts. Antenna: 75 feet. Prices: Model 27, \$65; Model 271, \$99.50; Model 272, \$125.

NO. 528. THE "CHIEF"

Seven tubes; six 01-A tubes and one power tube. One control. Volume control: rheostat. C-battery connection. Partial shielding. Binding posts. Antenna, outside. Cabinet size: 40 x 22 x 16 inches. Prices. Complete with A power supply, \$250; without accessories, \$150.

NO. 529. DIAMOND SPECIAL, SUPER SPECIAL, AND BABY GRAND CONSOLE

Six tubes; all 01-A type. One control. Partial shielding. C-battery connections. Volume control: rheostat. Binding posts. Antenna: outdoor. Prices: Diamond Special, \$75; Super Special, \$65; Baby Grand Console, \$110.



**Engineering Pamphlet on
B Power Supply
and Amplifier Design**

Here is a new 12-page book, 8½" by 11", containing blueprints of the circuits, photographs and full lists of parts for the construction of all of the newest and most modern Power Amplifiers and Power Supplies. The latest development of Samson, General Radio, Silver-Marshall, Thor-darson, National Co., Acme, etc., for high quality, high power audio reproduction. Invaluable for all set builders and home constructors of radio. Send for it today.



Price
25c

Tobe Deutschmann Co.
Cambridge, Mass.
Gentlemen: Please send me your new book, "TOBE B POWER SUPPLY and AMPLIFIER DESIGN." Enclosed please find 25c.

Name.....
Address.....

SANGAMO
MICA CONDENSERS
UNAFFECTED
by
MOISTURE



When the humidity hovers around 100, the components of your radio receiver are subjected to the equivalent of a water bath!

You can make certain, at least, that the fixed condensers in the circuit will not alter in capacity or efficiency under these conditions.

Use Sangamo Mica Condensers—they are permanently protected from all atmospheric action by a solid sheathing of pure bakelite!

SANGAMO ELECTRIC COMPANY
Springfield Illinois

DISTANCE
lends
ENCHANT-
MENT



WHEN you buy or build a radio set make sure that it has Copper Shielding. Where long distance reception is desired Copper Shielding is essential. It is a refinement to your set that will enable you to hear the programs of distant stations much more clearly.

Copper Shielded sets give:
BETTER RECEPTION
FINER SELECTIVITY
IMPROVED TONE QUALITY

By virtue of its easy working qualities and its high conductivity Copper Shielding is a decided improvement to any set.

COPPER & BRASS
RESEARCH ASSOCIATION
25 Broadway, New York



Write for your copy of this book. There is no cost nor obligation on your part.

LYNCH
Book on Resistance 25¢

Why not subscribe to *Radio Broadcast*? By the year only \$4.00; or two years, \$6.00, saving \$2.40. Send direct to Doubleday, Doran & Company, Inc., Garden City, New York.

ACME WIRE CO.
CELATSITE
for RADIO WIRING

Flexible stranded Celatsite is composed of fine, tinned copper wires with non-inflammable Celatsite covering in 9 bright colors. Strips clean, solders readily. Sold only in 25' coils, in cartons colored to match contents. Solid Celatsite has same colored covering, but over bus bar wire.

ACME SOLID CELATSITE is a tinned copper bus bar hook-up wire with non-inflammable Celatsite insulation, in nine colors. Sizes, 14, 16, 18, 19, 30' lengths. Write for folder. The Acme Wire Co., Dept. B, New Haven, Conn.

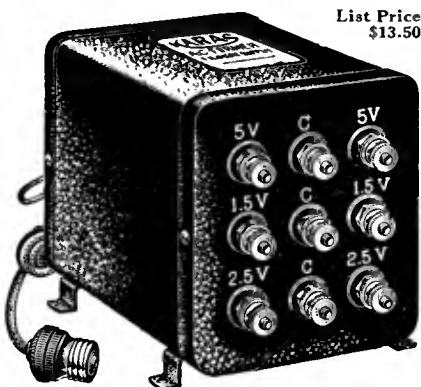

List Price
\$13.50

Convert your set to A. C. with the NEW Karas A-C-FORMER. Easy to do—No rewiring.

YOU now can have A. C. operation of your present battery-operated receiver by using the New Karas A-C-Former Filament Supply and the Carter Adapter Cable Harness now available. You can then use the new A. C. Tubes and enjoy the marvelous reception they afford—get distant stations with tremendous volume—be forever free from battery operation. Easy to convert your set. No rewiring. Simply remove present tubes, insert Carter Adapter Cable Harness, attach end of harness to Karas A-C-Former, and put in new A. C. Tubes. Anyone can do it in a few minutes. Mail coupon today for full information on how to convert your set.

KARAS ELECTRIC CO.
4032-C North Rockwell St. Chicago

KARAS ELECTRIC CO.
4032-C North Rockwell St., Chicago
Send me complete details on how I can convert my.....tube.....receiver to A. C.

Name.....
Address.....
City..... State.....

Achieve SUCCESS in Radio

New course gives finest instruction obtainable

You Can Learn at Home!



R.L. DUNCAN, Director, Radio Institute of America and author of several volumes in radio.

Good pay from the start, rapid advancement, and phenomenal success—a life profession of fascinating brain-work—that is what Radio holds for the man who knows his subject thoroughly. Since 1909 Radio Institute of America has trained thousands to become successful in the many branches of Radio. Are you going to plod along at a thirty-five dollar a week job when REAL MONEY is waiting for you in radio?

New Course Finest Ever

Prominent radio men have enthusiastically greeted RIA's new course as the most complete and up-to-date offered today. All this first-quality equipment is furnished FREE WITH THE COURSE—parts for making many practical radio circuits and the Peerless Signagraph for code instruction.

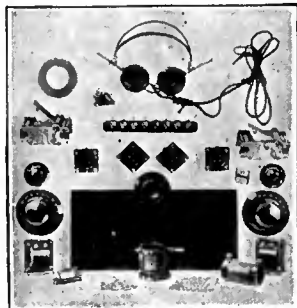

RIA backed by RCA, G-E and Westinghouse

You get all the benefits of instruction conducted by RCA and sponsored by RCA's associates, G-E and Westinghouse. Our employment department is at the service of graduates.

Study at Home!

Moreover you can STUDY AT HOME—when you please and as long as you please.

This new booklet describing the course is just off the press. If you want to learn more about the well paying positions in this fascinating profession send the coupon now for your copy.



RADIO INSTITUTE OF AMERICA
Dept. E-3 326 Broadway, New York City

RADIO INSTITUTE OF AMERICA, Dept. E-3
326 Broadway, New York City

Dear Mr. Duncan:

Please send me your new catalog. I want to know more about your new radio course.

Name.....
Address.....

Manufacturers' Booklets

A Varied List of Books Pertaining to Radio and Allied Subjects Obtainable Free With the Accompanying Coupon

READERS may obtain any of the booklets listed below by using the coupon printed on page 393. Order by number only.

1. FILAMENT CONTROL—Problems of filament supply, voltage regulation, and effect on various circuits. RADIALL COMPANY.
2. HARD RUBBER PANELS—Characteristics and properties of hard rubber as used in radio, with suggestions on how to "work" it. B. F. GOODRICH RUBBER COMPANY.
3. TRANSFORMERS—A booklet giving data on input and output transformers. PACENT ELECTRIC COMPANY.
5. CARBORUNDUM IN RADIO—A book giving pertinent data on the crystal as used for detection, with hook-ups, and a section giving information on the use of resistors. THE CARBORUNDUM COMPANY.
7. TRANSFORMER AND CHOKE-COUPLED AMPLIFICATION—Circuit diagrams and discussion. ALL-AMERICAN RADIO CORPORATION.
9. VOLUME CONTROL—A leaflet showing circuits for distortionless control of volume. CENTRAL RADIO LABORATORIES.
10. VARIABLE RESISTANCE—As used in various circuits. CENTRAL RADIO LABORATORIES.
11. RESISTANCE COUPLING—Resistors and their application to audio amplification, with circuit diagrams. DEJUR PRODUCTS COMPANY.
12. DISTORTION AND WHAT CAUSES IT—Hook-ups of resistance-coupled amplifiers with standard circuits. ALLEN-BRADLEY COMPANY.
15. B-ELIMINATOR AND POWER AMPLIFIER—Instructions for assembly and operation using Raytheon tube. GENERAL RADIO COMPANY.
- 15a. B-ELIMINATOR AND POWER AMPLIFIER—Instructions for assembly and operation using an R. C. A. rectifier. GENERAL RADIO COMPANY.
16. VARIABLE CONDENSERS—A description of the functions and characteristics of variable condensers with curves and specifications for their application to complete receivers. ALLEN D. CARDWELL MANUFACTURING COMPANY.
17. BAKELITE—A description of various uses of bakelite in radio, its manufacture, and its properties. BAKELITE CORPORATION.
19. POWER SUPPLY—A discussion on power supply with particular reference to lamp-socket operation. Theory and constructional data for building power supply devices. ACME APPARATUS COMPANY.
20. AUDIO AMPLIFICATION—A booklet containing data on audio amplification together with hints for the constructor. ALL AMERICAN RADIO CORPORATION.
21. HIGH-FREQUENCY DRIVER AND SHORT-WAVE WAVE-METER—Constructional data and application. BURGESS BATTERY COMPANY.
46. AUDIO-FREQUENCY CHOKES—A pamphlet showing positions in the circuit where audio-frequency chokes may be used. SAMSON ELECTRIC COMPANY.
47. RADIO-FREQUENCY CHOKES—Circuit diagrams illustrating the use of chokes to keep out radio-frequency currents from definite points. SAMSON ELECTRIC COMPANY.
48. TRANSFORMER AND IMPEDANCE DATA—Tables giving the mechanical and electrical characteristics of transformers and impedances, together with a short description of their use in the circuit. SAMSON ELECTRIC COMPANY.
49. BYPASS CONDENSERS—A description of the manufacture of bypass and filter condensers. LESLIE F. MUTER COMPANY.
50. AUDIO MANUAL—Fifty questions which are often asked regarding audio amplification, and their answers. AMERTRAN SALES COMPANY, INCORPORATED.
51. SHORT-WAVE RECEIVER—Constructional data on a receiver which, by the substitution of various coils, may be made to tune from a frequency of 16,660 kc. (18 meters) to 1999 kc. (150 meters). SILVER-MARSHALL, INCORPORATED.
52. AUDIO QUALITY—A booklet dealing with audio-frequency amplification of various kinds and the application to well-known circuits. SILVER-MARSHALL, INCORPORATED.
56. VARIABLE CONDENSERS—A bulletin giving an analysis of various condensers together with their characteristics. GENERAL RADIO COMPANY.
57. FILTER DATA—Facts about the filtering of direct current supplied by means of motor-generator outfits used with transmitters. ELECTRIC SPECIALTY COMPANY.
59. RESISTANCE COUPLING—A booklet giving some general information on the subject of radio and the application of resistors to a circuit. DAVEN RADIO CORPORATION.
62. RADIO-FREQUENCY AMPLIFICATION—Constructional details of a five-tube receiver using a special design of radio-frequency transformer. CAMFIELD RADIO MFG. COMPANY.
63. FIVE-TUBE RECEIVER—Constructional data on building a receiver. AERO PRODUCTS, INCORPORATED.
64. AMPLIFICATION WITHOUT DISTORTION—Data and curves illustrating the use of various methods of amplification. ACME APPARATUS COMPANY.
66. SUPER-HETERODYNE—Constructional details of a seven-tube set. G. C. EVANS COMPANY.
70. IMPROVING THE AUDIO AMPLIFIER—Data on the characteristics of audio transformers, with a circuit diagram showing where chokes, resistors, and condensers can be used. AMERICAN TRANSFORMER COMPANY.
72. PLATE SUPPLY SYSTEM—A wiring diagram and layout plan for a plate supply system to be used with a power amplifier. Complete directions for wiring are given. AMERTRAN SALES COMPANY.
80. FIVE-TUBE RECEIVER—Data are given for the construction of a five-tube tuned radio-frequency receiver. Complete instructions, list of parts, circuit diagram, and template are given. ALL-AMERICAN RADIO CORPORATION.
81. BETTER TUNING—A booklet giving much general information on the subject of radio reception with specific illustrations. Primarily for the non-technical home constructor. BREMER-TULLY MANUFACTURING COMPANY.
82. SIX-TUBE RECEIVER—A booklet containing photographs, instructions, and diagrams for building a six-tube shielded receiver. SILVER-MARSHALL, INCORPORATED.
83. SOCKET POWER DEVICE—A list of parts, diagrams,

and templates for the construction and assembly of socket power devices. JEFFERSON ELECTRIC MANUFACTURING COMPANY.

84. FIVE-TUBE EQUAMATIC—Panel layout, circuit diagrams, and instructions for building a five-tube receiver, together with data on the operation of tuned radio-frequency transformers of special design. KARAS ELECTRIC COMPANY.

85. FILTER—Data on a high-capacity electrolytic condenser used in filter circuits in connection with A socket power supply units, are given in a pamphlet. THE ABOX COMPANY.

86. SHORT-WAVE RECEIVER—A booklet containing data on a short-wave receiver as constructed for experimental purposes. THE ALLEN D. CARDWELL MANUFACTURING CORPORATION.

88. SUPER-HETERODYNE CONSTRUCTION—A booklet giving full instructions, together with a blue print and necessary data, for building an eight-tube receiver. THE GEORGE W. WALKER COMPANY.

89. SHORT-WAVE TRANSMITTER—Data and blue prints are given on the construction of a short-wave transmitter, together with operating instructions, methods of keying, and other pertinent data. RADIO ENGINEERING LABORATORIES.

90. IMPEDANCE AMPLIFICATION—The theory and practice of a special type of dual-impedance audio amplification are given. ALDEN MANUFACTURING COMPANY.

93. B-SOCKET POWER—A booklet giving constructional details of a socket-power device using either the BH or 313 type rectifier. NATIONAL COMPANY, INCORPORATED.

94. POWER AMPLIFIER—Constructional data and wiring diagrams of a power amplifier combined with a B-supply unit are given. NATIONAL COMPANY, INCORPORATED.

100. A, B, AND C SOCKET-POWER SUPPLY—A booklet giving data on the construction and operation of a socket power supply using the new high-current rectifier tube. THE Q. R. S. MUSIC COMPANY.

101. USING CHOKES—A folder with circuit diagrams of the more popular circuits showing where choke coils may be placed to produce better results. SAMSON ELECTRIC COMPANY.

22. A PRIMER OF ELECTRICITY—Fundamentals of electricity with special reference to the application of dry cells to radio and other uses. Constructional data on buzzers, automatic switches, alarms, etc. NATIONAL CARBON COMPANY.

23. AUTOMATIC RELAY CONNECTIONS—A data sheet showing how a relay may be used to control A and B circuits. YAXLEY MANUFACTURING COMPANY.

25. ELECTROLYTIC RECTIFIER—Technical data on a new type of rectifier, with operating curves. KODEL RADIO CORPORATION.

26. DRY CELLS FOR TRANSMITTERS—Actual tests given, well illustrated with curves showing exactly what may be expected of this type of B power. BURGESS BATTERY COMPANY.

27. DRY-CELL BATTERY CAPACITIES FOR RADIO TRANSMITTERS—Characteristic curves and data on discharge tests. BURGESS BATTERY COMPANY.

28. B BATTERY LIFE—Battery life curves with general curves on tube characteristics. BURGESS BATTERY COMPANY.

30. TUBE CHARACTERISTICS—A data sheet giving constants of tubes. C. E. MANUFACTURING COMPANY.

32. METERS FOR RADIO—A catalogue of meters used in radio, with diagrams. BURTON-ROGERS COMPANY.

33. SWITCHBOARD AND PORTABLE METERS—A booklet giving dimensions, specifications, and shunts used with various meters. BURTON-ROGERS COMPANY.

35. STORAGE BATTERY OPERATION—An illustrated booklet on the care and operation of the storage battery. GENERAL LEAD BATTERIES COMPANY.

36. CHARGING A AND B BATTERIES—Various ways of connecting up batteries for charging purposes. WESTINGHOUSE UNION BATTERY COMPANY.

37. WHY RADIO IS BETTER WITH BATTERY POWER—Advice on what dry cell battery to use; their application to radio, with wiring diagrams. NATIONAL CARBON COMPANY.

53. TUBE REACTIVATOR—Information on the care of vacuum tubes, with notes on how and when they should be reactivated. THE STERLING MANUFACTURING COMPANY.

60. VACUUM TUBES—A booklet giving the characteristics of the various tube types with a short description of where they may be used in the circuit. RADIO CORPORATION OF AMERICA.

77. TUBES—A booklet for the beginner who is interested in vacuum tubes. A non-technical consideration of the various elements in the tube as well as their position in the receiver. CLEARTRON VACUUM TUBE COMPANY.

87. TUBE TESTER—A complete description of how to build and how to operate a tube tester. BURTON-ROGERS COMPANY.

91. VACUUM TUBES—A booklet giving the characteristics and uses of various types of tubes. This booklet may be obtained in English, Spanish, or Portuguese. DEFEST RADIO COMPANY.

92. RESISTORS FOR A. C. OPERATED RECEIVERS—A booklet giving circuit suggestions for building a c. operated receivers, together with a diagram of the circuit used with the new 400-milliamperer rectifier tube. CARTER RADIO COMPANY.

97. HIGH-RESISTANCE VOLTMETERS—A folder giving information on how to use a high-resistance voltmeter, special consideration being given the voltage measurement of socket-power devices. WESTINGHOUSE ELECTRIC & MANUFACTURING COMPANY.

102. RADIO POWER BULLETINS—Circuit diagrams, theory constants, and trouble-shooting hints for units employing the BH or B rectifier tubes. RAYTHEON MANUFACTURING COMPANY.

103. A. C. TUBES—The design and operating characteristics of a new a. c. tube. Five circuit diagrams show how to convert well-known circuits. SOVEREIGN ELECTRIC & MANUFACTURING COMPANY.

(Continued on page 393)

- 41. BARY RADIO TRANSMITTER OF 9XH-9EK—Description and circuit diagrams of dry-cell operated transmitter. BURGESS BATTERY COMPANY.
- 42. ARCTIC RADIO EQUIPMENT—Description and circuit details of short-wave receiver and transmitter used in Arctic exploration. BURGESS BATTERY COMPANY.
- 58. HOW TO SELECT A RECEIVER—A commonsense booklet describing what a radio set is, and what you should expect from it, in language that any one can understand. DAY-FAN ELECTRIC COMPANY.
- 67. WEATHER FOR RADIO—A very interesting booklet on the relationship between weather and radio reception, with maps and data on forecasting the probable results. TAYLOR INSTRUMENT COMPANIES.
- 73. RADIO SIMPLIFIED—A non-technical booklet giving pertinent data on various radio subjects. Of especial interest to the beginner and set owner. CROSLY RADIO CORPORATION.
- 74. THE EXPERIMENTER—A monthly publication which gives technical facts, valuable tables, and pertinent information on various radio subjects. Interesting to the experimenter and to the technical radio man. GENERAL RADIO COMPANY.
- 76. RADIO INSTRUMENTS—A description of various meters used in radio and electrical circuits together with a short discussion of their uses. JEWELL ELECTRICAL INSTRUMENT COMPANY.
- 96. VACUUM TUBE TESTING—A booklet giving pertinent data on how to test vacuum tubes with special reference to a tube testing unit. JEWELL ELECTRICAL INSTRUMENT COMPANY.
- 98. COPPER SHIELDING—A booklet giving information on the use of shielding in radio receivers, with notes and diagrams showing how it may be applied practically. Of special interest to the home constructor. THE COPPER AND BRASS RESEARCH ASSOCIATION.
- 99. RADIO CONVENIENCE OUTLETS—A folder giving diagrams and specifications for installing loud speakers in various locations at some distance from the receiving set. YAKLEY MANUFACTURING COMPANY.
- 105. COILS—Excellent data on a radio-frequency coil with constructional information on six broadcast receivers, two short-wave receivers, and several transmitting circuits. AERO PRODUCTS COMPANY.
- 106. AUDIO TRANSFORMER—Data on a high-quality audio transformer with circuits for use. Also useful data on detector and amplifier tubes. SANGAMO ELECTRIC COMPANY.
- 107. VACUUM TUBES—Data on vacuum tubes with facts about each. KEN-RADIO COMPANY.
- 108. VACUUM TUBES—Operating characteristics of an a.c. tube with curves and circuit diagram for connection in converting various receivers to a.c. operation with a four-prong a.c. tube. ARCTURUS RADIO COMPANY.
- 109. RECEIVER CONSTRUCTION—Constructional data on a six-tube receiver using restricted field coils. BODINE ELECTRIC COMPANY.
- 110. RECEIVER CONSTRUCTION—Circuit diagram and constructional information for building a five-tube set using restricted field coils. BODINE ELECTRIC COMPANY.
- 111. STORAGE BATTERY CARE—Booklet describing the care and operation of the storage battery in the home. MARKO STORAGE BATTERY COMPANY.
- 112. HEAVY-DUTY RESISTORS—Circuit calculations and data on receiving and transmitting resistances for a variety of uses, diagrams for popular power supply circuits, d.c. resistors for battery charging use. WARD LEONARD ELECTRIC COMPANY.
- 113. CONE LOUD SPEAKERS—Technical and practical information on electro-dynamic and permanent magnet type cone loud speakers. THE MAGNAVOX COMPANY.
- 114. TUBE ADAPTERS—Concise information concerning simplified methods of including various power tubes in existing receivers. ALDEN MANUFACTURING COMPANY.
- 115. WHAT SET SHALL I BUILD?—Descriptive matter, with illustrations, of fourteen popular receivers for the home constructor. HERBERT H. FROST, INCORPORATED.
- 104. OSCILLATION CONTROL WITH THE "PHASATROL"—Circuit diagrams, details for connection in circuit, and specific operating suggestions for using the "Phasatrol" as a balancing device to control oscillation. ELECTRAD, INCORPORATED.
- 116. USING A B POWER UNIT—A comprehensive booklet detailing the use of a B power unit. Tables of voltages—both B and C—are shown. There is a chapter on trouble shooting. MODERN ELECTRIC MFG. CO.
- 117. BEST RESULTS FROM RADIO TUBES—The chapters are entitled: "Radio Tubes," "Power Tubes," "Super Detector Tubes," "A. C. Tubes," "Rectifier Tubes," and "Installation." GOLD SEAL ELECTRICAL CO.
- 118. RADIO INSTRUMENTS, CIRCULAR "J"—A descriptive manual on the use of measuring instruments for every radio circuit requirement. A complete listing of models for transmitters, receivers, set servicing, and power unit control. WESTON ELECTRICAL INSTRUMENT CORPORATION.
- 119. THE NEW LOFTIN WHITE CIRCUIT—A twenty-four page booklet explaining the principles and application of this popular circuit. CONSOLIDATED RADIO CORPORATION.
- 120. THE RESEARCH WORKER—A monthly bulletin of interest to the home constructor. A typical feature article describes the construction of a special audio amplifier—AEROVOX WIRELESS CORPORATION.

What Kit Shall I Buy?

THE list of kits herewith is printed as an extension of the scope of the Service Department of RADIO BROADCAST. It is our purpose to list here the technical data about kits on which information is available. In some cases, the kit can be purchased from your dealer complete; in others, the descriptive booklet is supplied for a small charge and the parts can be purchased as the buyer likes. The Service Department will not undertake to handle cash remittances for parts, but when the coupon on page 395 is filled out, all the information requested will be forwarded.



- 201. SC FOUR-TUBE RECEIVER—Single control. One stage of tuned radio frequency, regenerative detector, and two stages of transformer-coupled audio amplification. Regeneration control is accomplished by means of a variable resistor across the tickler coil. Standard parts; cost approximately \$58.85.
- 202. SC-II FIVE-TUBE RECEIVER—Two stages of tuned radio frequency, detector, and two stages of transformer-coupled audio. Two tuning controls. Volume control consists of potentiometer grid bias on r.f. tubes. Standard parts cost approximately \$60.35.
- 203. "HI-O" KIT—A five-tube tuned radio-frequency set having two radio stages, a detector, and two transformer-coupled audio stages. A special method of coupling in the r.f. stages tends to make the amplification more nearly equal over the entire band. Price \$63.05 without cabinet.
- 204. R. G. S. KIT—A four-tube inverse reflex circuit, having the equivalent of two tuned radio-frequency stages, detector, and three audio stages. Two controls. Price \$69.70 without cabinet.
- 205. PIERCE AIRO KIT—A six-tube single-dial receiver; two stages of radio-frequency amplification, detector, and three stages of resistance-coupled audio. Volume control accomplished by variation of filament brilliancy of r.f. tubes or by adjusting compensating condensers. Complete chassis assembled but not wired costs \$42.50.
- 206. H & H-T. R. F. ASSEMBLY—A five-tube set; three tuning dials, two steps of radio frequency, detector, and a transformer-coupled audio stages. Complete except for base-board, panel, screws, wires, and accessories. Price \$30.00.
- 207. PREMIER FIVE-TUBE ENSEMBLE—Two stages of tuned radio frequency, detector, and two steps of transformer-coupled audio. Three dials. Parts assembled but not wired. Price complete, except for cabinet, \$35.00.
- 208. "QUADRAFORMER VI"—A six-tube set with two tuning controls. Two stages of tuned radio frequency using specially designed shielded coils, a detector, one stage of transformer-coupled audio, and two stages of resistance-coupled audio. Gain control by means of tapped primaries on the r.f. transformers. Essential kit consists of three shielded double-range "Quadraformer" coils, a selectivity control, and an "Ampitrol," price \$17.50. Complete parts \$70.15.
- 209. GEN-RAL FIVE-TUBE SET—Two stages of tuned radio frequency, detector, and two transformer-coupled audio stages. Volume is controlled by a resistor in the plate circuit of the r.f. tubes. Uses a special r.f. coil ("Duo-Former") with figure eight winding. Parts mounted but not wired, price \$37.50.
- 210. BREMER-TULLY POWER-SIX—A six-tube, dual-control set; three stages of neutralized tuned radio frequency, detector, and two transformer-coupled audio stages. Resistances in the grid circuit together with a phase shifting arrangement are used to prevent oscillation. Volume control accomplished by variation of B potential on r.f. tube. Essential kit consists of four r.f. transformers, two dual condensers, three small condensers, three choke coils, one 500,000-ohm resistor, three 1500-ohm resistors, and a set of color charts and diagrams. Price \$41.50.
- 212. INFRADYNE AMPLIFIER—A three-tube intermediate-frequency amplifier for the super-heterodyne and other special receivers, tuned to 3490 kc. (86 meters). Price \$25.00.
- 213. RADIO BROADCAST "LAB" RECEIVER—A four-tube dual-control receiver with one stage of Rice neutralized tuned-radio frequency, regenerative detector (capacity controlled), and two stages of transformer-coupled audio. Approximate price, \$78.15.
- 214. LC-27—A five-tube set with two stages of tuned-radio frequency, a detector, and two stages of transformer-coupled audio. Special coils and special means of neutralizing are employed. Output device. Price \$85.20 without cabinet.
- 215. LOFTIN-WHITE—A five-tube set with two stages of radio frequency, especially designed to give equal amplification at all frequencies, a detector, and two stages of transformer-coupled audio. Two controls. Output device. Price \$85.10.
- 216. K.H.-27—A six-tube receiver with two stages of neutralized tuned radio frequency, a detector, three stages of choke-coupled audio, and an output device. Two controls. Price \$86.00 without cabinet.
- 217. AERO SHORT-WAVE KIT—Three plug-in coils designed to operate with a regenerative detector circuit and having a frequency range from 19,990 to 2306 kc. (15 to 130 meters). Coils and plug only, price \$12.50.
- 218. DIAMOND-OF-THE-AIR—A five-tube set having one stage of tuned-radio frequency, a regenerative detector, one stage of transformer-coupled audio, and two stages of resistance-coupled audio. Volume control through regeneration. Two tuning dials.
- 219. NORDEN-HAUCK IMPROVED SUPER 10—Ten tubes; five stages of tuned radio frequency, detector, and four stages of choke- and transformer-coupled audio frequency. Two controls. Price \$260.00.
- 220. BROWNING-DRAKE—Five tubes; one stage tuned radio frequency (Rice neutralization), regenerative detector (tickler control), three stages of audio (special combination of resistance- and impedance-coupled audio). Two controls

electrify your set the easy practical Knapp way....

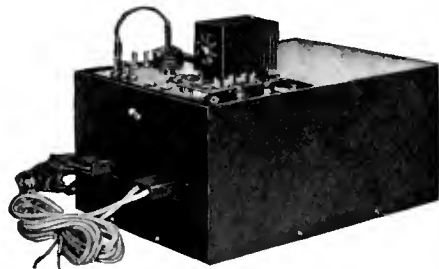

The Kit completely assembled with metal cover in place. Operates on 105-120 volts AC, 50 to 60 cycles.

Knapp "A" POWER KIT

No expensive short lived AC Tubes, no troublesome re-wiring, no annoying hum. Increase instead of decrease the efficiency of your set, no waiting... the Knapp "A" Power gives you music *instantly* at the snap of a switch.

This absolutely dry "A" Power is not in any way a battery combination... not something to add to your battery... it is the most efficient "A" Battery Eliminator ever designed. It supplies unflinching "A" current to any set using 201-A or 6 volt tubes.

Magic Silence

So silent is Knapp "A" Power, that you can place a pair of head phones directly across the output and not be able to detect a hum. This is made possible by the efficient Knapp filter system, consisting of 2 over sized chokes and 2 condensers of 1500 microfarads each. A new discovery makes these amazing capacities possible in the small space of 2x2x8 inches!

Absolutely Dry

There is not a drop of moisture in this absolutely dry unit. The condensers are baked so that not a drop of moisture remains. The unique, fully patented, solid, full-wave rectifier is absolutely dry. No water... no acid... no alkali... no tubes... no electrolytic action. Nothing to get out of order. Nothing that needs attention.

Assemble in Half an Hour

The Knapp "A" Power Kit is so easily assembled, that within half an hour after you receive it, you can have it in operation. The parts seem to fall in place. No drilling and very little soldering. Everything supplied, even to the screws, wire, drilled base-board and metal cover. It is so complete, that even a plug and metal cover. It is so complete, that even a plug and metal cover. It is so complete, that even a plug and metal cover. It is so complete, that even a plug and metal cover.

Big Profits for Set Builders

Our president, Mr. David W. Knapp, is offering the set builders of America, for a limited time only, a money-saving, profit-making plan which is unique in the annals of radio. Send the coupon today, before it is too late.



Knapp Electric Corporation
Port Chester, N. Y.

MR. DAVID W. KNAPP, Pres.
Knapp Electric Corporation
331 Fox Island Road,
Port Chester, N. Y.

Send me complete information regarding the Knapp "A" Power Kit and your special discount to Set Builders.

Name.....

Address.....

.....

.....

USE THIS BOOKLET COUPON
RADIO BROADCAST SERVICE DEPARTMENT
RADIO BROADCAST, Garden City, N. Y.
Please send me (at no expense) the following booklets indicated by numbers in the published list above:

.....

Name.....

Address.....

(Number) (Street)

(City) (State)

ORDER BY NUMBER ONLY
This coupon must accompany every request. RB 3-28



IN A HUDDLE?

Yes!—But it's not a Football Signal

They're looking at the
**NEW WESTON
TRIPLE-RANGE
A. C. VOLTMETER**

for measuring the A. C. supply and
tube voltages in connection with
A. C. RECEIVERS



Model 528
150/8/4 volts

THIS new A. C. portable voltmeter—the latest addition to the famous Weston line of Radio Instruments—has been eagerly awaited by the entire fraternity of radio interests, experimenter and set owner alike. With the advent of the new A. C. receivers, everywhere one heard the question—"What kind of an instrument do we need now?" And here it is, an exquisite design, typically Weston in construction and performance. The highest quality, yet moderately priced. See your dealer and place your order now. Get in ahead of that inevitable rush when Weston announces a new development.

WESTON ELECTRICAL INSTRUMENT CORPORATION
179 Frelinghuysen Ave. Newark, N. J.

WESTON RADIO INSTRUMENTS

Book Review

PRINCIPLES OF RADIO COMMUNICATION. By J. H. Morecroft. Second Edition. Published by John Wiley & Sons, Incorporated, New York. Pages, 1001. Illustrations, 831. Price, \$7.50.

MORECROFT has gone into a second edition. The revised volume calls for a supplementary review, for after the lapse of six years (the first edition was issued in 1921) much that was important is slipping into desuetude, and technological fancies have become engineering realities. The ordinary engineer, called on to review Morecroft's monumental work, is placed somewhat in the position of a parish priest ordered to review the Bible. It is safe, however, to quote Professor Morecroft himself in his outline of the changes made in the new edition:

The new material incorporated in this edition so increased the size that it was thought advisable to delete much of the first edition. A considerable part of the chapter on Spark Telegraphy has been taken out, therefore, and two chapters of the earlier edition have been deleted. The chapter on radio measurements, and that on experiments, have been omitted.

Notable additions to the older edition occur in Chapters II, IV, VIII, and X. In Chapter II many new data on coils and condensers at radio frequencies are given. In Chapter IV, dealing with the general features of radio transmission, new material on field strength measurements, reflection and absorption, fading, short-wave propagation, etc., has been introduced. In Chapter VIII (radio telephony) a great deal of material on voice analysis has been added; the performance of loud-speaking telephones, frequency control by crystals, etc., has been discussed. In Chapter X, dealing with amplifiers, the question of distortionless amplification has been thoroughly dealt with, some of the material being given for the first time. The questions of radio-frequency amplification, balanced circuits, push-pull arrangements, etc., have been explained.

Principles of Radio Communication is a comprehensive textbook of radio engineering. The author, a Professor of Electrical Engineering at Columbia University, and a Past President of the Institute of Radio Engineers, is one of the outstanding opponents of guesswork in radio technology. When the publishers in their circular describing the book refer to it as the "most complete, accurate, and authoritative book on radio available" they are simply telling the truth. But in justice to the author, who has put a considerable number of years into this job, it should be stated that when the publishers continue: "—for Designers, Engineers, Service Men, Distributors, Dealers, Salesmen, Teachers, Students, Operators, Set Owners," they talk like hashish addicts. I hope that Wiley sells as many copies of Morecroft as the publisher of Durant's *Story of Philosophy* has managed to dispose of, to his own and his client's enrichment, but I feel bound to warn Distributors, Dealers, Salesmen, and Set Owners that, with negligible exceptions in their ranks, the only portions of *Principles of Radio Communication* which they can hope to understand are the articles and prepositions. Not that it is an excessively abstruse work; any student of mathematics through the calculus can follow the demonstrations, and any student of radio engineering can read the whole thousand pages with vast profit. But it is a work in radio engineering. Its precise virtue is that dealers, salesmen, and the generality of set owners will not understand it.

How radio has grown! Here is a book of a thousand six-by-nine pages, and yet it is largely an outline of principles. If you consulted it for the actual design of a line equalizer or a to-TU

Send for Latest RADIO CATALOG and GUIDE

Set Builders!

Free 1928 Radio Guide

The big Barawik Radio Guide book is used by hundreds of thousands of radio enthusiasts. It's the handiest and most reliable radio reference guide, and a big money-saver. Keep up to date by utilizing Barawik service.

4000 Radio Bargains

It shows pages replete with reliable information about the newest and most advanced ideas in A-C radio developments. It will keep you posted on what's up to date.

Lowest Prices on Parts

Standard Discounts to Dealers, Set Builders, Agents.

It will pay you to get our prices for complete parts for the popular circuits featured in RADIO BROADCAST and other magazines. Whenever a new circuit appears for which you want complete parts, write or wire us and they'll be on their way to you quickly. We know what parts to send you. Simply give name of circuit and we'll take care of the rest. We guarantee you a big saving on every order.

Send for Free Copy Now!

Get our new radio catalog to-day before you spend another cent on radio. Just mail the coupon and free copy will be sent you.



BARAWIK CO.

Dept. 833
Chicago, U. S. A.

Mail This Coupon Now! For Free Copy

Name

Address

.....

.....

.....

.....

TO RADIO DEALERS!

The R. B. Laboratory Information Sheets have been appearing in RADIO BROADCAST since June, 1926. They are a regular feature in each issue and they cover a wide range of information of value to the radio experimenter and set builder. We have just reprinted Lab. Sheets Nos. 1-88 from the June, 1926, to April, 1927, issues of RADIO BROADCAST. They are arranged in numerical order and are bound with a suitable cover. They sell at retail for one dollar a set. Write for dealers' prices. Address your letter to

Circulation Dept.,
RADIO BROADCAST
Garden City, N. Y.

pad, you would not find either device even mentioned. The author makes no bones about this. "As in the previous edition," he writes in the new preface, "no pretense is made that the book is a treatise on radio practice; in general, only the principles involved in the operation of radio apparatus have received attention. Whatever radio apparatus is discussed is dealt with only to illustrate those principles the text is intended to elucidate." But those principles, by diagram, mathematical and physical analysis, oscillogram, and every other resource of technical instruction, it does clarify. The chapter on vacuum tubes alone runs to 240 pages, a book in itself, and after you have mastered it you know something about tubes. You may burn out the next one you put into a socket anyway, but at least you will not concoct any idiotic theories about it. If you believe that there is a dividing line between principles and practice, and that life is too short to include both, you will, of course, find no use for such a course as Morecroft offers. You had best go out and sell bonds, in that case. But if you are a radio engineer, or want to become one in the only genuine sense of the word, then Morecroft's textbook will be worth more than \$7.50 to you.

In a work of this size there are inevitably sections over which other engineers may disagree with the author. The treatment of "Elimination of Strays," pages 340-343, may be cited. In Fig. 16, "one of the early attempts to eliminate 'strays,'" ascribed to De Groot, is shown. This scheme is a neutralization system—one antenna tuned to the desired signal, the other aperiodic, etc. It will not work, which Professor Morecroft knows as well as anyone, but he does not tell the reader that the scheme is worthless, and why. The ingenious and useful wave antenna of Beverage, Rice, and Kellogg, which deserves mention in this section if anything does, is omitted without a word. Roy A. Weagant's name is twice misspelled. But such defects, which might be serious in a lesser work, are overshadowed by the high virtues of Morecroft's imposing contribution to radio science. CARL DREHER.



Type 440-A Transformer
Price \$10.00

A. C. OPERATION

The Type 440-A Transformer illustrated is designed for use on 105-125 V (50-60 cycle) A. C. and is rated at 65 watts. The following voltages and currents are available.

2 Volts.....	10 Amperes
3.5 ".....	5 "
5 ".....	2.5 "
7.5 ".....	2 "

The use of this transformer together with the new A. C. tubes and a dependable plate supply unit such as the General Radio type 445 Plate Supply and grid Bias unit makes the conversion of a battery operated receiver into one operated from the light socket very simple. If you do not care to undertake this change yourself go to your community set builder. He is well qualified to serve you.

GENERAL RADIO Co.

Manufacturers of Radio and Electrical Laboratory Apparatus
30 STATE STREET CAMBRIDGE, MASS.

USE THIS COUPON FOR KITS

RADIO BROADCAST SERVICE DEPARTMENT
Garden City, New York.

Please send me information about the following kits indicated by number:

.....

Name.....

Address..... (Number) (Street)

..... (City) (State)

ORDER BY NUMBER ONLY. This coupon must accompany each order. RB 3-28

USE THIS COUPON FOR COMPLETE SETS

RADIO BROADCAST SERVICE DEPARTMENT
RADIO BROADCAST, Garden City, New York.

Please send me information about the following manufactured receivers indicated by number:

.....

Name.....

Address..... (Number) (Street)

..... (City) (State)

ORDER BY NUMBER ONLY
This coupon must accompany each order. RB 3-28

Sovereign



HEATER TYPE

STANDARD SOCKET

A-C Reception Can Be Yours

A COMPLETE change to A-C power will make your set apparently 100 per cent more powerful. Be up to date—enjoy full, rich, clear toned reception brought in by Sovereign A-C Tubes. Only simple changes required in your set. Free yourself of all bother and cost of "A" Batteries — "A" Battery Eliminators — with Sovereign A-C Tubes on the job.

Just plug into any light socket. No hum. No noises or microphonics. Tubes will not paralyze when voltage changes.

A treatise on A-C reception is yours for the asking. Write for copy.

Sovereign Electric & Mfg. Co.
127 N. Sangamon St., Chicago, Ill.



RADIO DEALERS

Send for our catalog illustrating the products of over 100 radio manufacturers.

WHOLESALE ONLY!

F. D. PITTS COMPANY
219-223 Columbus Ave.
BOSTON, MASS., U. S. A.
Established 1919

The radio leadership of 1928

NOW
\$90



New
401 Dry Cell Type
BANDBOX JUNIOR
\$35

A new dry cell receiver with all the features of the Bandbox—selectivity, sensitivity, volume and appearance. For places where AC current or storage battery service is not available or desired.

180 volts on the output tube plate!
Gigantic UNDISTORTED volume from the Bandbox!

Power! Power! POWER! A feature of the Crosley AC Bandbox that lifts it head and shoulders above competition!

170 to 185 volts on the plate of the power output tube!

Comparative checkings of competitive radios show interesting figures. Under identical testing conditions the Bandbox shows a full 170 to 185 volts on the plate of the 171 power output tube. Other radios show from 100 to 110 and 130 to 140 volts on the plate of output tube. The 171 power tube should have around 180 volts. This better than 40% superiority in one case and 25% in the other is the difference between today's radio and yesterday's.



MUSICONE
Type D
\$15

Crosley Musicones are famous for their value. This new style is no exception. Its low price of \$15 is in keeping with Crosley traditions. It instantly demonstrated its soundness by immediate and enormous sales.

602 Double Unit AC **BANDBOX** Single Unit **704**

The Bandboxes are genuine Neutrodyne receivers. Totally and completely shielded, their acute sensitivity and sharp selectivity is amazing.

They have a single illuminated dial.

Contributing much to the success of this 1928 wonder radio is the Mershon Condenser in the power element of the set. Not being paper, the danger of its blowing out is entirely removed so that the desired heavy voltage can be used to produce the acoustic and volume results so greatly desired. **IT IS SELF HEALING.** It does not have to be replaced as is the case with paper condensers.

The capacity of smoothing condensers in Crosley power units is 30 mf. Other sets use only a fraction of that condenser capacity. Undersize condensers, transformers, etc., are used in order to build down to a price. Crosley builds up to a standard.

The AC Bandbox is purposely made in two models—the 602 in a double unit—the 704 self contained. This is to provide maximum adaptability in all sorts of surroundings and uses.

The 602 double unit provides console cabinet installation in ALL kinds of consoles.

The 704 is for those who want the entire set in one cabinet. The two sets are identical in element, design and performance. The physical difference is solely to meet the human differences of taste, necessity and price! The size of the 704 is 17 1/2 inches long by 12 1/4 inches wide and 6 1/2 inches high.

Battery Type Bandbox \$55

This celebrated model needs no picture, for in appearance it is identical to the 602 receiver pictured above. Its amazing performance has won the radio world this season and its value is as outstanding NOW as the day it was first presented.



SELF CONTAINED
\$95

Approved Console Cabinets manufactured by Showers Brothers Co., of Bloomington, Ind., and Wolf Mfg. Industries, Kokomo, Ind., are sold to Crosley dealers by H. T. Roberts Co., 1340 S. Michigan Ave., Chicago, Sales Representatives.



Crosley is licensed only for Radio Amateur, Experimental and Broadcast Reception.
THE CROSLEY RADIO CORPORATION
Powel Crosley, Jr., Pres. Cincinnati, Ohio
Montana, Wyoming, Colorado, New Mexico, and West, prices slightly higher
Write Dept. 20 for descriptive literature

"You're there with a Crosley"

CROSLEY

RADIO