

RADIO BROADCAST

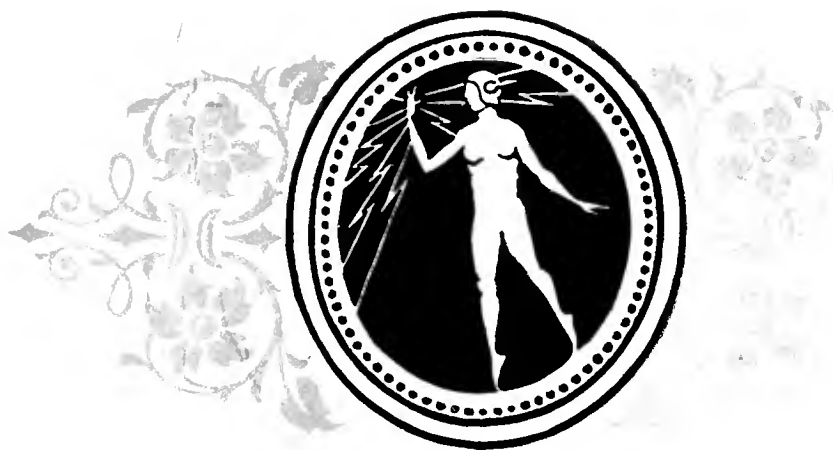

CONTENTS

How to Use the Screen-Grid Tube

A Directory of Manufactured Receivers

Hints on Operating Your Cooley Rayfoto Receiver

The Phonograph Joins the Radio Receiver

A Push-Pull Amplifier and B Supply

Inside the Complete Receiver

35 Cents

Doubleday, Page & Company
Garden City, New York

JAN · 1922

Cunningham RADIO TUBES

SINCE 1915

STANDARD FOR ALL SETS



Gifts

that bring happiness at
Christmas time and
throughout the year

Radio sets and radio equipment make immensely popular Christmas gifts.

To assure the utmost in Yule-tide Radio enchantment, see that Cunningham Radio Tubes are on duty in every socket. Every owner of a radio will be delighted to receive a set of new tubes.

Buy them in combination of five or more. Your dealer will tell you the correct types of Cunningham Radio Tubes for which any radio set is designed.

*Don't use old tubes with new ones.
Use new tubes throughout.*

E. T. CUNNINGHAM, Inc.
New York Chicago San Francisco

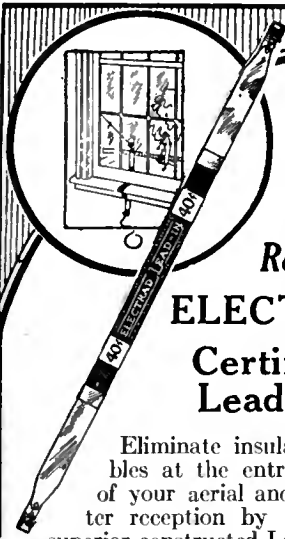

Improve Reception!
ELECTRAD Certified Lead-Ins

Eliminate insulation troubles at the entrance point of your aerial and have better reception by using this superior constructed Lead-In.

Bends any shape to fit around the corners and under locked doors or windows. Triple-ply insulation full 10 inches, covered with waterproof webbing. One piece copper strip heavily tinned to prevent corrosion.

Protect yourself by looking for the Electrad name. Price 40c each. At your dealers.

Write for Descriptive Circulars

Dept. 61B, 175 Varick St., New York, N. Y.

ELECTRAD

FROST-RADIO

OFFERS RADIO BROADCAST READERS TWO VALUABLE NEW BOOKLETS FREE!

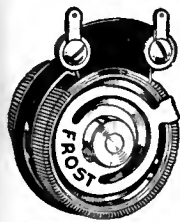

Write for Them

WE OFFER readers of Radio Broadcast two valuable new Frost-Radio publications free on request: "What Set Shall I Build?" the answer to a question which puzzles many set builders, and the new Frost booklet "For Better Reception," a complete and helpful manual of Frost Parts. Every set builder should have both of these booklets. They will be found check-full of useful information that is right up to the minute.

FROST-RADIO

What they Contain

"What Set Shall I Build?" tells much about the newest and most popular circuits. "For Better Reception" tells you proper size rheostat for multi-tube sets, has wiring diagrams for high resistance unit, and contains valuable facts about Frost-Radio Parts.



FROST-RADIO

Mail Coupon NOW

To secure these two booklets FREE fill out and mail coupon below, printing your name and address carefully. These books will amaze you with their completeness. Write for them to-day—NOW.

HERBERT H. FROST, Inc.
Elkhart, Indiana
Chicago New York

HERBERT H. FROST, Inc.
160 North La Salle Street, Chicago

Please send me free your two booklets, as advertised in Radio Broadcast for January.

Name

Street Address

City

State

Power^{and} Quality

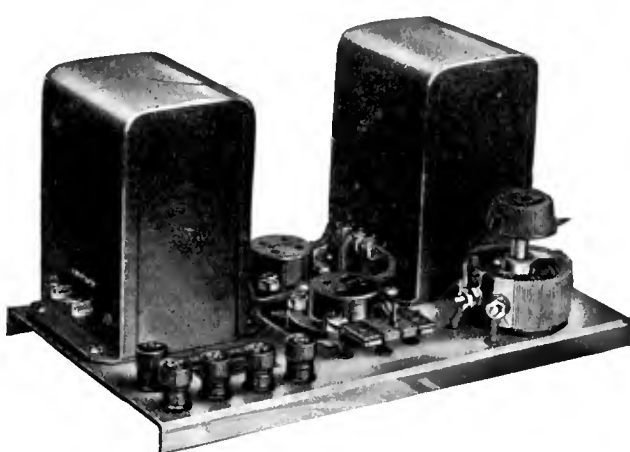

A PUSH-PULL amplifier in that last stage provides the speaker with ample power to sustain a high volume level without tube overloading, transmitting the full effects of large swings in intensity common in orchestra music.

This balanced type of amplifier draws no alternating current from the plate supply, a fact of great importance if socket power is used, as the impedance of the power unit does not affect the amplifier. This results in improved reproduction of sustained notes, particularly of low frequency.

Other advantages of the push-pull system are, a reduction in hum when alternating current is used for filament supply and for equal power outputs, a reduction in the plate voltage required.

- The amplifier is supplied completely wired.
- Type 441 amplifier
- For use with UX 226, CX 326, UX 171, CX 371, UX 210, or CX 310 tubes.
- Input inductance.....30 henries.
- Input turns ratio.....1:2.25.
- Output impedance ratio 12:1.
(whole primary to secondary)
- Price completely wired.....\$20.00.

Licensed by the Radio Corporation of America for radio amateur, experimental and broadcast reception only and under the terms of the R. C. A. license the unit may be sold only with tubes.

GENERAL RADIO

LABORATORY EQUIPMENT PARTS and ACCESSORIES

If we can be of help to you in supplying technical information, we welcome your correspondence. Write for our Series A of amplification booklets describing various amplifiers, circuits and units.

GENERAL RADIO CO. Cambridge, Mass.

RADIO BROADCAST

JANUARY, 1928

WILLIS KINGSLEY WING, Editor

KEITH HENNEY
Director of the Laboratory

EOGAR H. FELIX
Contributing Editor

Vol. XII, No. 3

CONTENTS

Cover Design	From a Design by Harvey Hopkins Dunn	
Frontispiece	In the Laboratory of a Tube Manufacturer	194
Radio Enlists the Helium Atom	Volney G. Mathison	195
The March of Radio	An Editorial Interpretation	198
Can the Serious Problem of Radio Patents Be Settled?	What Readers Say About Broadcasting Conditions	
The Prospects of a Patent Pool	Broadcasting Bands Changed	
The Commission Announces a New Policy	Broadcasting Notes	
The Commission Suggests Synchronization Schemes	News of the Patent Field Among the Manufacturers	
Push-Pull Amplification—Why?	Howard E. Rhodes	202
The Phonograph Joins the Radio Set		206
The Screened Grid Tube	Keith Henney	208
What Set Shall I Buy?	Edgar H. Felix	211
“Our Readers Suggest—”		213
Why I Installed a Cooley Picture Receiver	Edgar H. Felix	215
Suppressing Radio Interference	A. T. Lawton	217
Are Programs Going in the Wrong Direction?	John Wallace	219
The Listeners' Point of View		
A Vacuum-Tube Voltmeter	The Laboratory Staff	221
Radio Folk You Should Know		225
(1.) Ralph H. Langley	Drawing by Franklyn F. Stratford	
Some Fine Receivers and Their Chassis		226
“Strays” from the Laboratory		228
How Reliable are Short Waves?	High-Powered Bunk	
Mathematics of the Audio Transformer	New Apparatus	
Concomitants of Good Quality		230
How the “Synchrophase” Seven Was Developed	John F. Rider	232
As the Broadcaster Sees It	Carl Dreher	235
“Radio Broadcast's” Laboratory Information Sheets		238
No. 153. Standard- and Constant-Frequency Stations	No. 157. Table for Wavelength-Frequency Conversion	
No. 154. The 112-A and 171-A Type Tubes	No. 158. The Three-Tube Roberts Reflex	
No. 155. Wave Traps	No. 159. Diagram of Threecube Roberts Reflex	
No. 156. Wavelength-Frequency Conversion	No. 160. Fading	
Manufacturers Booklets Available		244
“Radio Broadcast's” Directory of Manufactured Receivers		246
A Key to Recent Radio Articles	E. G. Shalkhauser	255
What Kit Shall I Buy?		257

AMONG OTHER THINGS.

IT IS a sad duty to record the death of the Chairman of the Federal Radio Commission, Admiral W. H. G. Bullard, which occurred in Washington on Thanksgiving Day. Admiral Bullard, who served in the United States Navy for thirty-six years, for a very long time was close to the center of radio in almost all of its branches. His loss will be keenly felt, not only by those who knew him as a likable and able individual but especially by the Radio Commission itself. When the Radio Commission went to work on March 15, two of its members had a background of technical radio experience. These two men were Admiral Bullard and Colonel Dillon. Death has removed both. The Commission at this writing now consists of Acting-Chairman E. O. Sykes, O. H. Caldwell, Sam Pickard, and H. A. Lafount. Not one of these members has a technical radio background which would enable them to better struggle with the complicated problems which confront them.

THE reports of international conferences, on whatever subject, usually make rather dull reading for the general public and the Washington Radio Conference has been no exception to this rule. The proceedings may not be exciting, but the results are certainly important. There has been no revision of international agreement since the London conference of 1912, and radio progress has been so rapid since then that the articles of that Convention were hopelessly inadequate to meet present needs. There have been many rocks and shoals in the way of the present conference, which, at this writing, has just wound up its work, but through good management and a praiseworthy desire for general accord, the delegates have succeeded in drawing up a Convention which well meets the needs of radio today. Not the least important decision reached at Washington was that dealing with the international assignment of channels in the frequency spectrum. In that respect, we are glad to note, the future needs of short-wave communication, broadcasting, commercial, and amateur work were provided for. The amateurs had a hard fight, but room has been saved for them—a result of which the broad-minded directors of the American Radio Relay League may well be proud.

THE issue of RADIO BROADCAST before you contains some extremely interesting articles. The story by Howard Rhodes on the problems of push-pull amplification is distinctly helpful and should cast much light on a form of amplification which is again being revived after several years of comparative disuse. . . . Those who are anxious to know what the new screened-grid tube will do will find Keith Henney's article very valuable indeed. As soon as possible, RADIO BROADCAST will give its readers data on receiving circuits which can be used with the tube; the latter has just been released for general sale.

THOSE of our readers who would like to have their names forwarded to the manufacturers of the special apparatus necessary to construct a Rayfoto receiver may send letters to the undersigned, and printed matter containing detailed information will be sent them. . . . The next RADIO BROADCAST will contain an article describing a new super-heterodyne, entirely operated from a c., which has much to recommend it, both from the design and appearance point of view. There will also be many other articles of interest.

—WILLIS KINGSLEY WING.

Doubleday, Page & Co.
MAGAZINES
COUNTRY LIFE
WORLD'S WORK
GARDEN & HOME BUILDER
RADIO BROADCAST
SHORT STORIES
EDUCATIONAL REVIEW
LE PETIT JOURNAL
EL ECO
FRONTIER STORIES
WEST WEEKLY
THE AMERICAN SKETCH

Doubleday, Page & Co.
BOOK SHOPS
(Books of all Publishers)
NEW YORK: LORD & TAYLOR BOOK SHOP
PENNSYLVANIA TERMINAL (2 Shops)
GRAND CENTRAL TERMINAL
38 WALL ST. and 526 LEXINGTON AVE.
848 MADISON AVE. and 166 WEST 32ND ST.
ST. LOUIS: 223 N. 8TH ST. and 4914 MARYLAND AVE.
KANSAS CITY: 920 GRAND AVE. and 206 W. 47TH ST.
CLEVELAND: HIGBEE CO.
SPRINGFIELD, MASS.: MEEKINS, PACKARD & WHEAT

Doubleday, Page & Co.
OFFICES
GARDEN CITY, N. Y.
NEW YORK: 285 MADISON AVENUE
BOSTON: PARK SQUARE BUILDING
CHICAGO: PEOPLES GAS BUILDING
SANTA BARRARA, CAL.
LONDON: WM. HEINEMANN LTD.
TORONTO: OXFORD UNIVERSITY PRESS

Doubleday, Page & Co.
OFFICERS
F. N. DOUBLEDAY, President
NELSON DOUBLEDAY, Vice-President
S. A. EVERITT, Vice-President
RUSSELL DOUBLEDAY, Secretary
JOHN J. HESSIAN, Treasurer
LILLIAN A. COMSTOCK, Asst. Secretary
L. J. McNAUGHTON, Asst. Treasurer

DOUBLEDAY, PAGE & COMPANY, Garden City, New York

Copyright, 1927, in the United States, Newfoundland, Great Britain, Canada, and other countries by Doubleday, Page & Company. All rights reserved.
TERMS: \$4.00 a year; single copies 35 cents.

How's Your Old Audio Amplifier

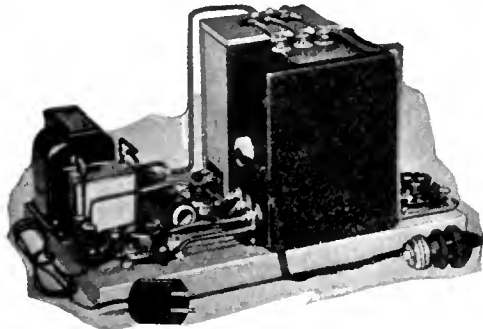

**THORDARSON 171 TYPE
POWER AMPLIFIER**

Built around the Thordarson Power Compact R-171, this power amplifier supplies "A," "B," and "C" current for one UX-171 power tube and B-voltage for the receiver. Employs Raytheon B. H. rectifier.

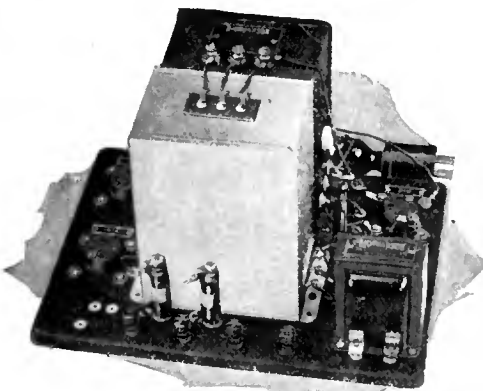

**THORDARSON 210 TYPE
POWER AMPLIFIER**

This amplifier, mounted on a special metal chassis, uses the Thordarson Power Compact R-210. Provides "A," "B," and "C" current for one UX-210 power tube and "B" voltage for the receiver. Employs one 226-B or 2S1 rectifier.

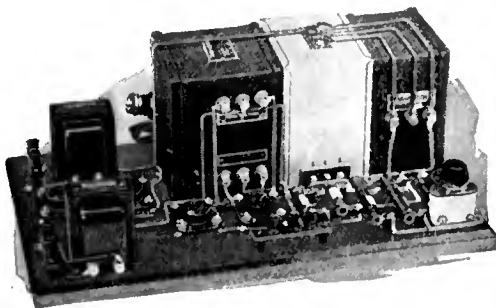

**THORDARSON 210 PUSH-PULL
POWER AMPLIFIER**

This heavy duty power amplifier operates two 210 power tubes in push-pull and has an ample reserve of power for "B" supply for the heaviest drain receivers. Built with Thordarson Power Transformer T-2098, and Double Choke Unit T-2099.

A Home Assembled Thordarson Power Amplifier Will Make Your Receiver A Real Musical Instrument

IMPROVEMENTS in the newer model receiving sets are all centered around the audio amplifier. There is no reason, however, why you cannot bring your present receiver up to 1928 standards of tone quality by building your own Thordarson Power Amplifier.

With a screw driver, a pair of pliers and a soldering iron you can build any Thordarson Power Amplifier in an evening's time in your own home. Complete, simple pictorial diagrams are furnished with every power transformer.

The fact that Thordarson power transformers are used by such leading manufacturers as Victor, Brunswick, Federal, Philco and Willard insures you of unquestionable quality and performance.

Give your radio set a chance to reproduce real music. Build a Thordarson Power Amplifier.

Write today for complete constructional booklets sent free on request.

THORDARSON

THORDARSON ELECTRIC MANUFACTURING CO.
Transformer Specialists Since 1895
WORLD'S OLDEST AND LARGEST EXCLUSIVE TRANSFORMER MAKERS
Ituron and Kingsbury Streets — Chicago, Ill. U.S.A.

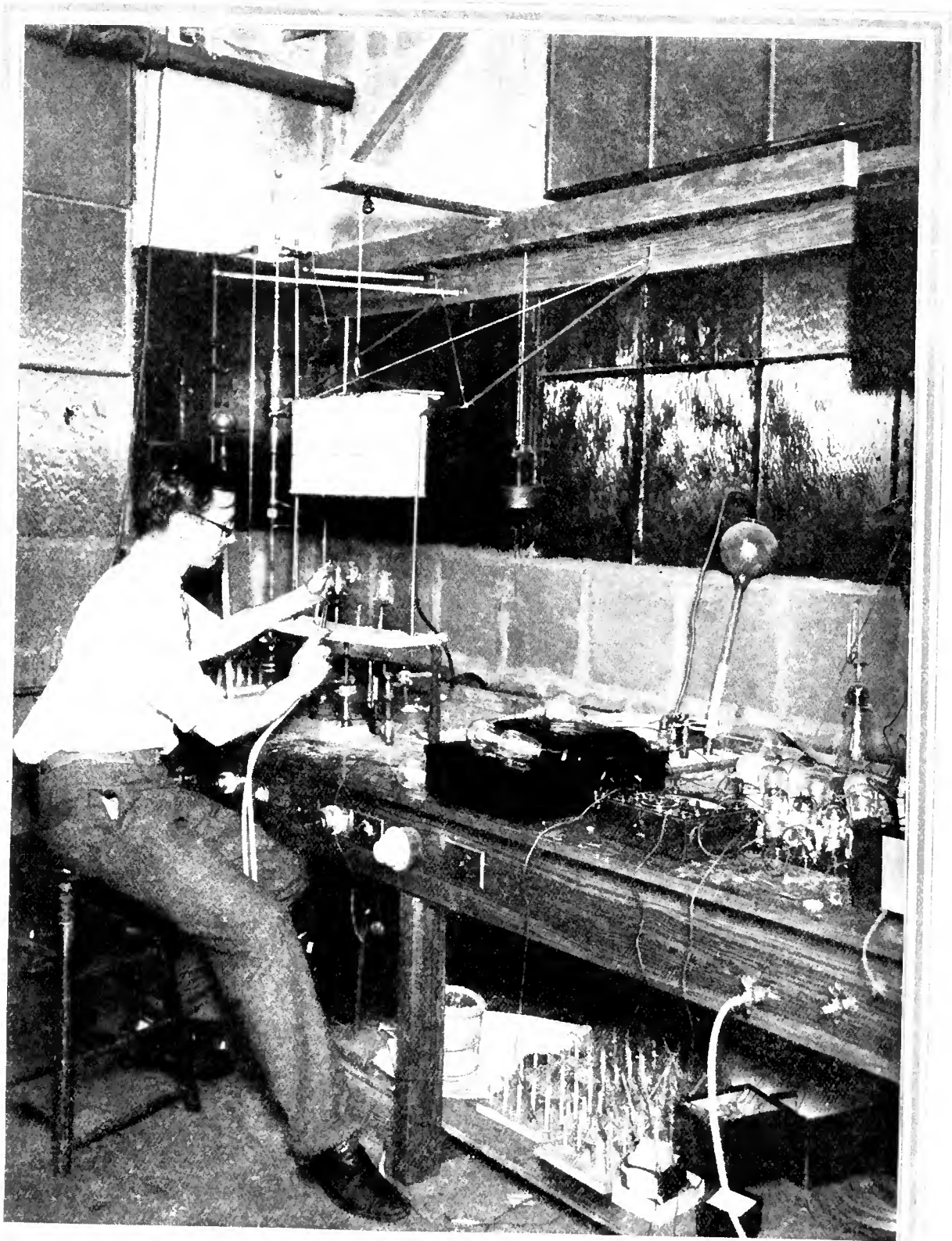

In the Laboratory of a Tube Manufacturer

Where diligent investigation precedes production of any new kind of tube. The particular laboratory here shown is given over to the study of rectifier tubes—the kind you are accustomed to use in your power-supply devices to rectify the a. c. of the house supply. This investigator is shown engaged in the construction of an experimental tube, which will afterwards be tested and, as

likely as not, discarded. It is said that about 99 per cent. of these hand-made experimental tubes are discarded without even being put into production. When we consider the expense of such tireless research, more and more do we recognize the logic of the statement, that it is only the larger and more "moneyed" manufacturers who are capable of producing dependable radio equipment

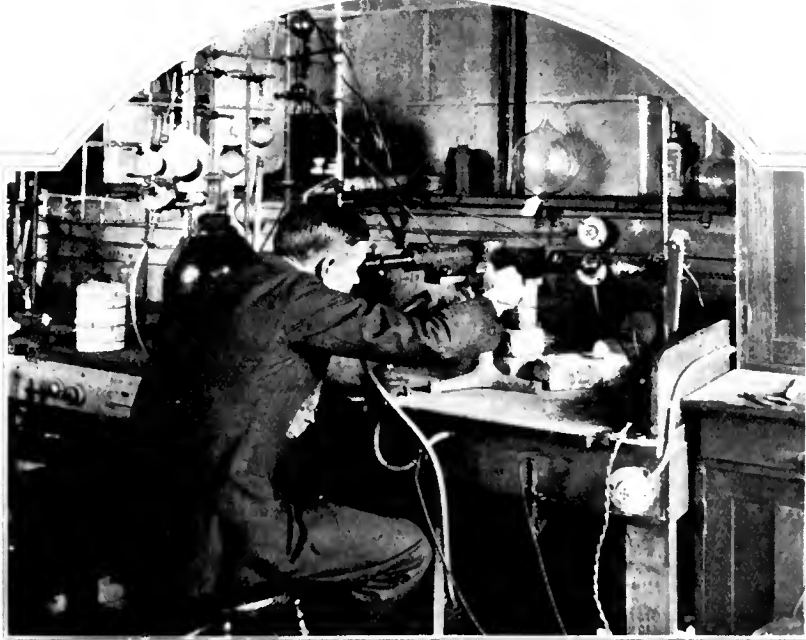

STUDYING GASES IN THE LABORATORY

Looking into the depths of ionized helium atoms with a spectroscope. Charles Grover Smith, who is shown in this picture, spends considerable of his time studying gases, especially helium

RADIO ENLISTS THE HELIUM ATOM

By VOLNEY G. MATHISON

IT'S all so useless, that's why I'm quitting," complained the young college graduate to the chief of the laboratory in which he had lately gotten a job. "What can ever come out of measuring the ohmic resistances of a cubic millimeter of about a million different substances under a couple of hundred different temperatures? That's the job you've given me—nothing but an endless measuring of ohms. If this is what you call scientific research—"

"It is," interrupted the electro-chemist. "It's the backbone of it—prolonged patience at tedious work."

"Seems tedious enough. But I could stand that if I could see some results ahead. I can't see any."

"Well, there may be no directly important outcome of what you're doing. You are simply adding to the stock of scientific knowledge in a prosy way, working on a huge book of temperature-resistance tables. You can't tell in advance what it may lead to. Take, for example, the helium-gas rectifier tube used in radio B-supply devices. It was never invented, it just grew out of a lot of laborious work like this. American factories are turning out about 20,000 of these tubes a day at present and the patent profit is close to a dollar and a half apiece. There's a return to pure research at the rate of something like \$30,000 a day. That soon pays for a lot of slow laboratory grinding, doesn't it?"

"Yes," reiterated the young graduate, "but that tube wasn't developed by any such work as I'm doing here—measuring the resistances of rust, rocks, roots, cocoanut shell, and the end years away. It's all so discouraging!"

As a matter of fact, the helium-gas tube for B-devices was the result of a great amount of purely scientific work of the tedious and rather unfocussed sort that this discouraged young chemist was assigned to, though, perhaps, the experiments involved were a good deal more technical. A few years ago we began studying the actions of electrons in gases. At that time nobody knew much about electrons—maybe we don't yet—and the experiments were entirely general in kind. The aim was to find out something, not to invent something. One young fellow had the job of finding out definitely whether or not electrons emitted from a cathode into a tube of gas passed through the gas without colliding with its atom centers.

An atom of any kind of substance, as nearly every one now is aware, consists of a group of protons and electrons surrounded by planetary electrons. The space in between seems to contain nothing but electric tension, though now late in 1927 we are about to believe that this tension consists of a flurry of particles called etherons that are so small they make an electron look like a balloon in comparison with an apple, and move almost twice as fast as light. Matter, even

solid steel, is nearly all emptiness, and it is the crudeness of our undeveloped physical senses that makes us think otherwise.

So this young man set about trailing a lot of wandering electrons through a wilderness of gases to find out what they did in there. He had a photographing outfit that would show the paths of the electrons. Many gases and pressures had to be tried. In one series of experiments each photograph showed the flight of 200,000 electrons, and that young man took 100,000 photographs separately, one after the other, before he got one collision of an electron with the middle of an atom of the gas under test. He kept on, and got a total of eight collisions in 400,000 photographs. Even when it is possible to use a fast automatic machine to take such photographs, they all have to be individually and laboriously examined.

The photographer found out something else. He found out that when an electron hit an atom of gas square in the middle, it blew the atom to pieces, producing a shower of unattached electrons, and unsmashable groups of electrons and protons that were named alpha particles. Alpha particles were identified with a spectroscope as being the same as a mysterious gas which had been seen by astronomers pouring over the sun, and which they had named helium—a "sun" word.

The alpha particles or helium atoms can be

quite easily robbed temporarily of one planetary electron, but they cannot be further broken up except with the most extreme difficulty. Helium gas was therefore recognized as a valuable electrical conducting medium that would tend to act at all times with unchanging properties and that would refuse to eat, corrode, or combine in any way with the metal tips of the electrodes by which electricity would be fed into the gas. No particular electrical use for this gas had yet been thought of, though it was proposed that metal-ended glass cartridges of helium might be valuable as ultra-stable resistors capable of withstanding enormous currents and pressures.

In photographing the flights of electrons through helium gas, it was observed that, when an electron struck an atom of helium, the electron ran off with one of the planetary electrons of the helium atom, carrying it to the anode.

A sketch of this performance would be almost inconceivably out of proportion since there would have to be represented the trillions times trillions of atoms in the tube, while electrodes about the size of the state of Georgia would be necessary to preserve the proper scale if the atoms were one half inch across. If the helium nucleus were drawn the size of a pea, the planetary electrons would properly be placed a quarter of a mile away. Such is the ghastly emptiness of matter—of even the "solid" walls of a glass tumbler from which we drink billions of electrons and protons in the peculiarly ordered state we call water; and of the stout iron bars upon which the jail-bird leans his head. But solidity, although physically an illusion, is nevertheless real because it is a manifestation of a powerful electrical condition.

To return now to the story of the doings in the helium tube under electrical pressure, we learn that the unfortunate gas atom that has lost an electron is said to be "ionized." This is all that ionization means, *i. e.*, a breaking away of electrons from gas atoms. It, the ionized atom, is over-positively charged and flies with terrific force toward the negative or cathode element, which it strikes violently and from which it extracts an electron from the inflowing stream in the wire leading to the cathode—the entrance element from the outside supply. The gas atom, now once more in a normal state, rebounds from the cathode and flies about jubilantly until it is again robbed of an electron, when it instantly goes through the performance just described all over again.

One remarkable thing about this action which is not yet understood is the fact that the bombardment of the cathode by ionized gas particles causes a liberal release of free electrons—of extra electrons beside those taken to balance the ionized atoms. In other words, by hammering a negative electrode with positively charged gas particles, we get a discharge of electrons. Perhaps the "yanking" out of the electron needed by the atom for itself is so violent that several extra electrons are hustled out along with it.

Some of these extra electrons in their flight to the positive or exit element collide with other gas molecules, and the action, the pounding of gas particles on the cathode and the emission of electrons, is continuous as long as electrical pressure is applied to the device. A current consequently

flows through the tube. In this manner electricity gets through a cold-electrode rectifier tube.

HOW A TUBE RECTIFIES

THE foregoing does not explain how current gets through the tube in only one direction. It would seem that, when the tube is put in an a. c. circuit, each element would become alternately an anode and a cathode, an exit and an entrance, and that the flow would be equally back and forth through the gas in the tube. But since the current flow depends upon hitting an electrode with gas particles, it becomes apparent that, by making one electrode big and the other one little, you can facilitate the hitting in one direction and minimize it in the other. When the larger electrode is negative, it will get thoroughly hammered with gas particles and will release many electrons; consequently, a large

electrode is treated with radioactive earths to encourage it to release electrons. Besides the difference in size of the bombarding areas of the two elements, the electric field produced by the smaller electrode is less attractive to the ionized gas particles than that of the larger one, with the result that it is hit less violently.

Both of the elements are made principally of nickel, which has been purified in a hydrogen furnace to remove all impurities.

The description so far has dealt with a tube in which there are only two elements. The usual helium-gas rectifier tube has three elements—a hat-shaped or tubular cathode and two anodes. This is simply two rectifier tubes in one, using a common cathode, and enables both halves of the a. c. wave to be used. The action here is exactly the same as that already described, except that the emission of electrons is alternately from the cathode to first one anode and then to the other—

to each one as it becomes positive in turn. And the cathode is almost continuously under bombardment, because it is always negative with respect to one anode or the other. At the same time that the flight of electrons takes place from the cathode to the positive anode, a "back-current" emission travels from the temporarily negative anode toward the cathode. Some electrons also fly between the two anodes, causing "leak" current. These "leak" and "back-currents," while not wanted, cannot be entirely eliminated, and as long as they are small, cause no serious trouble. In the factories, each tube is tested on a machine that measures the "back-current," and if excessive, the tube is discarded. Too much "back-current" through a tube will cause a B-device to hum.

It is worth pointing out that the popular conception of the movement of electricity through a B-device rectifier and filter system is erroneous. The general idea is that a "positive current" gets across the rectifier tube into the filter where it is tanked and choked into smoothness. But it should be remembered that current is purely electronic flow—it consists only of moving electrons in a conductor—and these electrons flow only from negative to positive. It is very con-

fusing to the novice and entirely unnecessary to say that the current flows one way and the electrons the other. There is no such current flowing against the movement of the electrons. It simply doesn't exist. In the early days of electrical science, long before any kind of a radio vacuum-tube had even been thought of, experimenters misunderstood some of the actions of electricity, and the positive-to-negative idea of current flow was one of the consequences of their lack of knowledge. In the business of science, there is no sensible reason for compromising with mistakes or twisting them around to meet new facts, as is being attempted all the time in religion; they should be simply left out of the story.

The electrons flowing in a B-device circuit enter the negative wires, pass direct to the filaments of the vacuum-tubes in the radio receiver, are emitted from the hot filaments to the plates, pass from the plates through the various circuits to the positive lead of the B device, thence through the chokes to the cathode element of the rectifier tube, and from this point they are

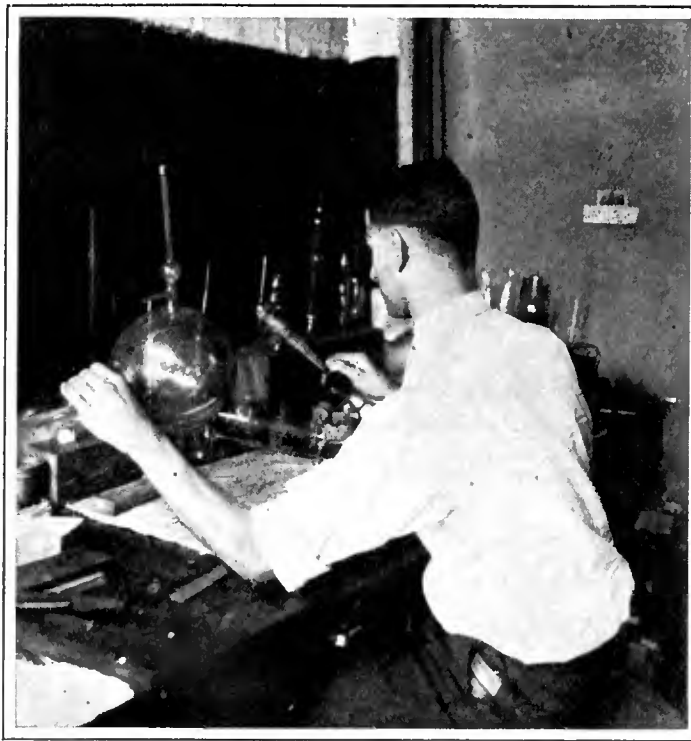

BEHIND THE SCENES IN THE LABORATORY

Preparing a globe of pure helium for research experiments. This kind of work never stops, and in every progressive tube concern, the laboratory is always ahead of the factory—is always working on "something better."

current will flow through the device. On the other hand, when the smaller electrode goes negative under the reversing a. c. current, it will not be battered so much by the flying gas particles as the other electrode was and therefore will not emit many electrons. A small current will, however, flow. The big electrode is a better emitter because it has more surface for the gas particles to "rip" electrons out of. When the big electrode is positive and the small electrode is negative, the ionized gas atoms do fly toward the small electrode but most of them miss it because it is comparatively hard to hit. Some particles strike the small element while it is negative and release electrons which fly across to the large electrode. This produces a "back-current" through the tube. All helium-gas rectifier tubes have this "back-current." The amount of it determines the efficiency of the rectifier and it usually is but a small percentage of the current in the other direction.

The "back-current" is reduced by making the anode small and hard, while the other large

sprayed alternately to the anode elements as these become positive in turn under the inductive action of the a. c. current in the primary power-supply windings. The filter chokes and tanks prevent a voltage and current fluctuation in the line during the intervals between the spraying or emission surges through the rectifier tube.

So deeply ingrown is the current-flow conception that in a recent issue of a well-known radio magazine there was a cut of a helium-gas tube with the hat-shaped cathode marked "anode" and the two anodes marked "cathodes." The accompanying text used the same terminology, which was wrong even in the light of the old theory. It should be clear that the positive side of a B-device filter is of negative potential compared to the ends of the secondary winding of the power transformer to which the rectifier-tube anodes are connected. The large cathode of a helium rectifier is equivalent to the incandescent filament of the filament type tube.

WHY A TUBE DETERIORATES

SINCE the helium-gas rectifier tube contains no heated filament emitter to burn out or become lifeless through deterioration, many users of the device feel that it ought to last almost forever—for years and years at any rate, and wonder why it sometimes has a short life.

As a matter of fact, the developers of the tube themselves thought at first that it would have a life of 10,000 hours or more of continuous use, but soon found that such was not the case. The principal thing that brings the life of a helium-gas rectifier tube to an end is the fact that the helium gas in the bulb disappears. Helium gas is inert, it will not combine with anything, so far as we know at present; it is genuinely strange, therefore, that it should disappear from a hermetically-sealed bulb. It seems that the ionized gas particles pound the cathode with such force that some of them are driven deep into the metal and stay there—become occluded or imprisoned.

After a certain length of time so many gas atoms are bound in the metal that the tube becomes very hard, the vacuum rises, and the bombardment of the cathode becomes meager, owing to the reduced number of molecules of gas to do the battering. The current output of the tube then falls off to such a point that it must be discarded.

The life of many a good helium-gas tube has been quickly brought to an end through the breaking down of condensers in filter circuits. Cheap inferior condensers in both home-made and factory-built power devices usually go to pieces after a few weeks or months of use, with the result that the rectifier tube is placed in a dead short-circuit. The heavy current flow quickly burns off the tips of the anodes in the tube. The helium gas itself cannot be injured by any current. Helium gas will carry currents so great that they will instantly explode copper conductors of the same cross-sectional area; but under such currents the gas particles quickly drive themselves deep into the negative electrodes and are as good as lost.

Some of the cheaper helium-gas tubes now on the market may be short-lived through the presence of impurities in the helium, which would destroy the electrodes. Extremely pure helium must be used. This gas is purified by passing it through copper tubes filled with cocoanut charcoal and maintained at the temperature of liquid air—more than 250° below zero, Fahrenheit; then to a steel reservoir; then to a second battery of tubes of charcoal surrounded with liquid air to remove oxygen or nitrogen which might come away from the walls of the reservoir. The helium is admitted until the charcoal is partly loaded with it; next it is pumped off with vacuum pumps and the impurities remain in the charcoal, which is itself purified and used over again.

It is interesting to consider that absolute purification of anything, liquid, gaseous, or solid, is almost impossible. Imagine for a moment that you could mark molecules in some such way that you could identify them when you saw them again. Assume that you took a glass of water with the molecules of water all thus marked and stirred it into the waters of the oceans of this earth, that you waited a couple of million years for thorough mixture, and that you then walked up to the nearest hydrant in your vicinity and casually drew a glass of water, you would find about 2000 of your marked molecules in it! Of course, we may be a few molecules out on this estimate, but that is roughly the correct mathematical number, because there are 2000 times as many molecules in a glass of water than there are glasses of water on the earth.

Again, molecules of air, if admitted into a

highly-evacuated 25-watt electric light bulb through a hole so small that they had to flow in single file, would take about 100,000,000 years to fill it to atmospheric pressure. A little reflection will show that "purity," like everything else, is probably only a relative condition. "Some of 'em is more pure, and some of 'em is less pure, but none of 'em is all pure," said the sour cynic, and while he wasn't speaking of gases, and was not a scientist for that matter, he was uttering profound truth.

THE TIN "HAT"

WHAT is the queer tin "hat" for in the modern gaseous rectifier tube? Nobody outside of the research laboratories seems to know. Even some of the "bootleggers" making these tubes don't know.

In the early experimental forms of the helium-gas tube, great trouble was met with owing to the disruption of the cathode element under the hammering of the ionized gas atoms. The earlier tubes had disk shaped cathodes, and the gas atoms pulled out electrons with such violence that tiny pieces of solid metal were often ripped loose from the electrode. These metal bits were thrown against the glass walls of the tube, blackening it, and resulting in the speedy destruction of the cathode.

For this reason the peculiar tin-hat form of cathode was evolved because, with this arrangement, the bombardment of the cathode and emission of electrons is entirely internal. The action all takes place inside of the electrode. If a bit of metal is torn from the cathode at any point, it is hurled across the inner chamber and thrown back onto the element somewhere else. There is no loss of metal because the cathode is continually built up as fast as it is torn down.

It seems that, if we, as human beings, could be temporarily reduced to the size of, say, an atom, together with a corresponding ability to see small objects, and were then placed upon the cathode of an operating helium-gas rectifier tube, we would have an impression of standing among ranges of heaving mountains of metal in a state of furious convulsion and uproar, bombarded with enormous meteors of helium and full of volcanic upheavals and earthquake-like shocks, while electrons would arise like clouds of steam on all sides, or spurt out like fiery sparks.



A VIEW OF THE LABORATORY IN WHICH THE HELIUM-GAS RECTIFIER TUBE WAS PERFECTED

THE MARCH OF RADIO

NEWS AND INTERPRETATION OF CURRENT RADIO EVENTS

Can The Serious Problem of Radio Patents Be Settled?

THE recent adjudication of several important patents, such as those of Hazeltine and Alexanderson, has forced upon the radio industry the long deferred day of reckoning with inventive genius. Conscientious and established manufacturers have proceeded promptly to obtain licenses under Radio Corporation patents which make available to them the work of some of the world's greatest laboratories. By assuming an annual royalty guarantee of one hundred thousand dollars a year, charged at the rate of $7\frac{1}{2}$ per cent. of the cost of radio receivers, they become licensed under R. C. A., A. T. & T., Western Electric, General Electric, Westinghouse and Wireless Specialty patents.

Having assumed this substantial burden, the licensees considered their patent difficulties disposed of. But some quickly found that licenses under Hazeltine and Latour patents are also necessary to freedom from patent difficulty and, probably quite reluctantly, signed the Hazeltine licenses with the additional burden of a $2\frac{1}{2}$ per cent. royalty and an annual guarantee of thirty thousand dollars a year. This duty performed, the manufacturer dismissed patent trouble and consecrated himself to the problem of selling newer and better radios.

And then came the independent inventor to disturb his peace of mind. Old patents were dug up, demanding recognition. New patents, just issued, added to the swarm. Some of these inventions are as worthy of recognition as those covered by the Radio Corporation license. Others may be worth-

less and which will not withstand the test of adjudication.

The weary manufacturer's answer to those demanding additional royalties is becoming less and less courteous. He is now paying all that the traffic will bear. Unless some remedy is offered, his answer to patent holders soon will be: "A plague upon your patents!"

The Prospects of a Patent Pool

SOME manufacturers have united in defensive groups to protect themselves against the swarm of inventions which now confronts them. They foresee the necessity for so great an increase in the price of radio receivers by reason of patent royalties that the public will no longer be able to afford them. Faced with the alternatives of excessive royalties or occasional injustice to the legitimate inventor, the manufacturers have, quite naturally, tended to the latter course.

No doubt, some of the inventors, whose claims for royalties are being disregarded or opposed, will eventually win adjudications, and triple damages, if they are sufficiently patient and prosperous to afford the protracted legal battle which must precede such a result. It is quite possible that combined resistance to the inventor may, in some cases, prove costly, because it is not reasonable to assume that Radio Corporation, Latour and Hazeltine patents are the only ones which will be favorably adjudicated.

Combined resistance, however, is the only

course open to the manufacturer because there are too many unadjudicated patents demanding attention. It would be suicidal to agree to a license under all of them; the cost of radio sets to the consumer would double and sales resistance would fourfold.

Most of the executives in the radio field wish to concentrate their attention on the design, manufacture and merchandising of radio equipment, but patent problems now require an alarming proportion of their time. Naturally, the leaders of the radio industry are nervous. At every trade convention and meeting, we hear talk of an all-inclusive patent pool.

Unfortunately, no patent pool can be successfully organized unless it has the unanimous support of all radio manufacturers and patent holders. To relieve the patent situation economically and painlessly, there must be a single, powerful, radio trade organization. Nevertheless, the N. E. M. A. and the R. M. A. still—to all outward appearances—indulge in shortsighted rivalry. An unofficial canvass of ninety per cent. of the membership of one of these organizations reveals that all but two were in favor of consolidation. To make a consolidation possible, one or two leaders in the R. M. A. must for a moment forget that their organization has the largest number of members and the youngest blood, and one or two members of the N. E. M. A. must forget some remarks made several years ago over matters long since settled. And both groups must cease suspecting each other.



CHANGES IN THE FEDERAL RADIO COMMISSION

Henry A. Bellows, Sam Pickard, and Carl H. Butman. Commissioner Bellows was appointed from the Minneapolis district where he had long ably managed wcco. His resignation, effective November 1st, left a vacancy which was filled by the President in appointing Sam Pickard who has been Secretary to the Commission since its appointment. Carl Butman is the new Secretary succeeding Mr. Pickard and has many years of experience in Washington as news correspondent, specializing in radio, to aid him in his new post. Mr. Butman has for some time been Washington correspondent for RADIO BROADCAST

© Henry Miller

The industry is headed for one of the most dangerous shoals in its career. Doubtless, it will weather it successfully. But how long the shoal will impede its progress depends upon how successful it is in placing the ship in the hands of one pilot, instead of two squabbling deck hands, to guide it past the patent whirlpool. It will require leadership of the highest order to establish a patent pool.

In the future, there will be a new and greater industry, much greater than we imagine to-day. The radio receiver is but a nucleus of a home entertainment device which will rival the automobile in usefulness and entertainment value and, in the end, its gross sales figures will be as large as those of the envied motor car industry. The radio receiver, the phonograph, the motion picture machine and the television receiver will, some day, be available in a single, compact, home-entertainment device. The public will pay as much for a versatile means of home entertainment as for an automobile to take them away from home. The more the leaders of the radio industry concentrate upon the development of radio and the establishment of its true market, the sooner they will have a five-billion-dollar industry. At present, the most vital aid in that objective would be turning over radio's patent problems to a patent pool. The alternatives are continued squabbles, continued patent fights, and a radio market still limited to about ten per cent. of the American public.

The Commission Announces a New Policy

THE Federal Radio Commission recently announced a long list of allocation changes which have been made with the purpose of improving the channels of a few of the leading stations of the country. The Commission it is rumored, will hereafter work on the theory that there are a few leading, national stations, which are the favorites of listeners all over the country and therefore deserve clear channels, entirely free of interference to the limit of their range. This is the basis upon which several years ago Secretary of Commerce Hoover worked out the plan of Class A and Class B broadcasting stations and urged on the commission in these columns for more than a year.

Following this plan, WHAZ, which shared time with WGY, was shifted to share time with WMAK, giving powerful and popular WGY a full channel. WJAR, Providence, was shifted from 620 kc. to 800, eliminating widespread heterodyning with WEAJ, ten kc. off, experienced throughout southern New England. WEEI, Boston, was shifted from 670 to 650 kc., avoiding a heterodyne imposed upon it by a Chicago station. WTRJ, a little station in Tilton, New Hampshire, formerly occupying a channel adjacent to WJZ, was shifted downward in order to eliminate a whistle which it thrust on WJZ's carrier in large parts of New England. WDWM of Asbury Park, New Jersey, was

shifted so as to eliminate conflict with WSAI's carrier. WNAC of Boston and WEAN of Providence, Columbia chain members, were made channel-sharing stations, probably in the interests of better management, and moved quite far into the unpopular higher frequency region. WCAU, a Philadelphia advertising station and now a member of the Columbia network and WKRC of the same chain were demoted from the lower frequency region. WOR now has won of Jefferson City, Missouri, as a channel neighbor instead of WSUT, Iowa City. We believe the Missouri station is more powerfully received in Newark and will therefore accentuate slightly the whistle which already mars WOR's programs.

Another station to benefit by the Commission's reallocation is KSD, St. Louis, which is given full time. KSD is one of the pioneers of broadcasting and is deserving of the consideration which the Commission has shown.

The conclusion that N. B. C. stations have fared better than Columbia chain stations is inescapable, but it must not be forgotten that the former do include most of the pioneer stations of the country which have served faithfully and well for years, while most of the latter have not yet won their spurs in public estimation. Clearing the channels of the N. B. C.'s leading stations cannot be criticized, but it might have been better policy to have concentrated less on Columbia stations when the demoting process was begun.

The Commission Suggests Synchronization Schemes

IN A speech before the American Institute of Electrical Engineers, Commissioner O. H. Caldwell made some remarks about the problems of maintaining a broadcasting station on its assigned frequency. He mentioned three methods of accomplishing this purpose, one well known and widely used, one successfully used experimentally but economically prohibitive, and a third which is a rather unfortunate suggestion. It is the Commissioner's idea that, if complete frequency stability could be secured and the heterodyne interference between stations now assigned to the same channels eliminated, more stations could safely occupy the same channel. While this is true, it must be realized that the audio-frequency components of two stations on the same channel also affect each other. When the distant station does not come in with sufficient volume to cause cross talk, it often causes irregular distortion.

Crystal control, the first method suggested for synchronizing carriers, is not sufficiently stable to solve the problem. Temperature and humidity changes affect the frequency of the crystal and, consequently, it does not give the absolute regulation necessary for successful occupancy of the same channel by two broadcasting stations whose carrier ranges overlap.

The second method suggested, the use of a wire circuit for the transmission of a con-

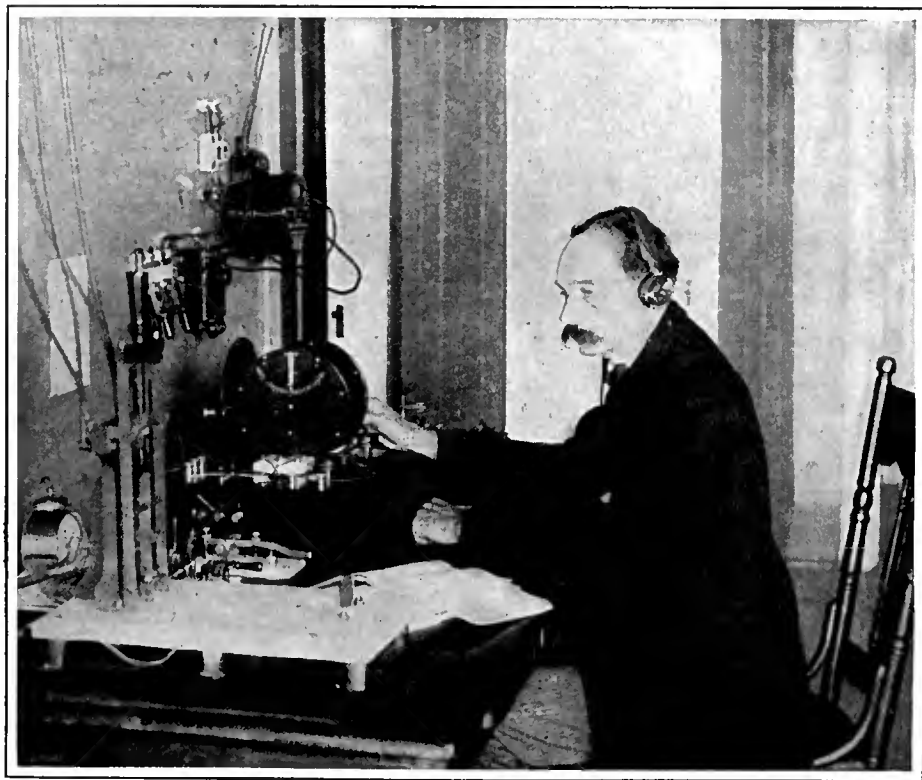

A WIRELESS STATION IN 1904

A 35-kw. spark transmitter was erected by the old De Forest Company for the Navy near San Juan, Porto Rico. The illustration shows the receiving installation with Mr. Irodell, operator for the De Forest Company using the receiving equipment which consisted of a "pancake" tuner and an electrolytic detector. It was not until 1906 that a carborundum detector was substituted for the electrolytic one. The call signal of this station, which may be recalled by old-timers, was SA.

trolling frequency, which has been successfully employed by WBZ and WBZA at Springfield and Boston, has the disadvantage of being prohibitively expensive. For example, if we attempted to eliminate the heterodyne whistle caused by WOS at Jefferson City by this method, it would probably cost some fifty thousand dollars a year. To stabilize the whole broadcasting structure would require perhaps five years to erect sufficient telephone channels for the purpose and an expenditure of perhaps twenty million dollars a year in maintenance.

The third suggestion made by the Commissioner was prompted by a suggestion from WDRG of New Haven, Connecticut, a 500-watt station. A heterodyne whistle, originating from the carrier of WAU, a 5000-watt station in Columbus, Ohio, about 500 miles distant, had been sufficiently annoying to require drastic measures. To solve this problem, a receiving station was installed five miles from New Haven, connected by wire lines with WDRG's transmitter. By tuning this receiving set carefully so that the heterodyne whistle is eliminated, WDRG's carrier is adjusted to coincide with that of WAU. So long as the operator is vigilant and skillful, there is no heterodyne whistle.

But, if the whole broadcasting structure depended for frequency stability upon manual control, it would become a sorry mess. One need but recall the days of the regenerative receiver, with its heterodyning carrier of but a tiny fraction of a watt. Then imagine manually controlled broadcast transmitters with hundreds and thousands of watts power, trying to establish zero beat with each other. The incident again emphasizes the fact that the Commission is sadly in need of technical assistance which will help the members to grapple more wisely with their problems. Any competent engineer could have pointed out the dangers of this ingenuous panacea.

What Readers Say About Broadcasting Conditions

THE following are quotations from readers of these editorials. George Madtes, Radio Editor of the *Youngstown Vindicator*, writes: "I have no doubt that the re-allocation of frequencies has materially helped stations in New York and Chicago, but it has not attained the Commission's apparent goal—an arrangement which would permit listeners everywhere to enjoy the stations nearest them. We are within fifty miles of stations in Cleveland, Pittsburgh and Akron and depend upon them for local service. Our four main stations in these cities, WTAM, KOKA, WCAE, and WADC are often heterodyned and WADC and WCAE are almost invariably useless at night."

W. W. Muir of Lockport, New York writes: "One cannot help but notice the difference between the stations which are operating in the few wave bands on which there is only one station and those operating on the frequencies on which there are more than one station. The stations which are operating on exclusive channels are usually free from distortion, the signal being strong and clear. The stations which are operating on wavelengths on which there are more than one station show a decided tendency to be mushy and weak, and have a wide variation in signal strength from moment to moment. . . . One cannot help speculating what is apt to take place in the future. We know that the American public have had lots of things put over on them without complaint. It is hard to believe that they will be willing to stand for the huge joke that it is possible to successfully operate more than one powerful broadcasting station on a single frequency without serious interference."

Another correspondent writes from Wyoming to the effect that KOA, Denver, is the principal reliance for summer and winter reception of the entire state. The Federal Radio Commission has ordered that station to cut its power in half after seven in the evening. Continuing, he writes: "Practically every strong station near the east coast is located on the same frequency as some powerful station on the west coast. While probably they do not interfere in their home territory, the heterodyne of the two completely ruins reception in the Rocky Mountain region. Before the recent changes, we could usually depend on WOC,

Davenport, and WCCO, St. Paul, for WEAJ programs, but have been unable to locate either for a long time."

Another correspondent writes from Ohio that he is located "forty-eight miles air line from WTAM, 102 miles from WW, and 95 miles from WAU. . . . WTAM fades so badly at night that it is worse than useless. WWJ is 'crowded to death' on both sides. There is not one station in this group, or any other station, that can be received here without heterodyning. Yet the Chairman of the Federal Radio Commission reports the district very much improved. It is all bunk. Some stations must be eliminated."

INTERNATIONAL CONFERENCE CHANGES BROADCASTING BANDS

THE International Radio Telegraph Conference at this writing is still in session in Washington. Very few of the articles of the new international agreement have yet been adopted. Some opposition has appeared to the American proposal that no more spark stations shall be licensed and that steps be taken to eliminate gradually those in existence with a view to their complete disappearance in 1935. The elimination of spark transmitters is proposed largely in the interests of the broadcast listener.

In the matter of frequency allocations, the amateurs, as usual, have defended their position with great heat. The Japanese delegation, in particular, was far from cordial in its attitude toward amateurs. The British, French and German governments sought lower frequency channels for broadcasting in the 1000-, 1300-, 1500- and 1800-meter regions, in addition to the usual bands in general use. It was finally decided to consolidate these requests for a longer wave broadcasting band of setting aside 1500 to 1550 meters (200 to 194 kc.) for the purpose, providing about two channels with ten-kc. separation. At this writing, this band is not yet officially approved, but is likely to stand.

The Committee on frequency allocation, while favorably inclined toward the recommendation of the American delegation for the broadcasting band, does not, at this writing, plan to devote the entire 500- to 1500-kc. region to broadcasting purposes. In the plan announced, it proposes to utilize the lower 200 kc. (i.e. from 1300 to 1500 kc. or 230 to 200 meters) for both broadcasting and ship stations. This does not mean that the 277 American broadcasting stations, now occupying that part of the band, will have to get off, but it is likely that ship interference will develop at this end of the broadcasting channels. This move on the part of the International Telegraph Conference will undoubtedly accentuate still further the need for curtailing the number of broadcasting stations on the air in the United States.

BROADCASTING NOTES

THE National Broadcasting Company and the British Broadcasting Company will cooperate in several short-wave international programs. In 1924, WJZ participated in the first attempt at international broadcasting by relay. A dance music program from the Savoy Hotel was radiated from England and intercepted at Houlton, Maine, and from there sent by wire to WJZ, in New York. The fading experienced on the 1600-meter wavelength, (187 kc.) upon which the program was relayed, was sufficient to discourage further attempts along these lines at that time. With the development of short-wave transmitters, however, more reliable results may be expected. ¶¶¶ In a statement of its policy on international broadcasting, the British Broadcasting Company lays considerable stress upon the failures of previous attempts along these

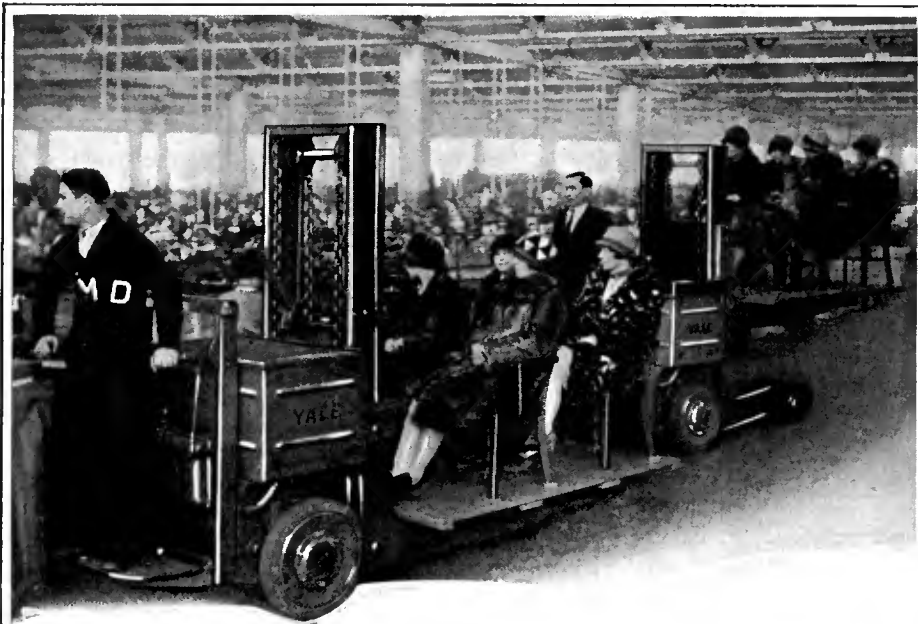

HOW VISITORS SEE THE ATWATER KENT FACTORY

lines. It describes an experimental relay of programs for Sidney as barely recognizable; a parallel attempt to relay Melbourne a few days later as a complete silence. It regrets that so much emphasis has been laid upon the possibilities of international broadcasting and points out that considerable development work is necessary before we can hope for regular and reliable international broadcasting. ¶ ¶ E. T. SOMERSET writes us from Sussex, England, that he enjoys WGY, WJZ, WLW, WEAJ and KOKA on their regular broadcasting channels, but American programs come in with much greater regularity on the high frequencies. 2XAZ, WGY's short-wave twin is the star performer, with KOKA on twenty-six meters and 2XAF following. He has also heard with great clarity, 2XAH, WRNY and WLW on its short wave, and ANH, Radio Malabar, Bendosng, Java, on 17.4 meters and last, but not least, 2ME, Sidney, Australia. It gave him a particular thrill, he writes, to hear the clock striking four A. M. in Sidney, when it was still seven P. M., British summer time, of the previous night. Mr. Somerset advises American fans to listen for 5 GB, Daventry, England, on a frequency of 610 kc. with 30 kw. output, and Langenberg, Germany, with a 25 kw. output on a frequency of 640 kc. ¶ ¶ SAM PICKARD, who first gained fame in radio circles as director of the Department of Agriculture Radio Service, has been made Federal Radio Commissioner to succeed Henry A. Bellows, recently resigned to resume the management of wcco. The Commission loses Mr. Bellows because the gentlemen of the Congress failed to confirm his appointment. He was a useful and hardworking Commissioner. Mr. Pickard is qualified to serve on the Commission because of his familiarity with its problems as its former secretary. Carl H. Butman now becomes Secretary of the Commission. He is well known to the newspaper fraternity and may be helpful to the Commission, not only as an efficient secretary, but in advising it how to handle its relations with the press and the public. ¶ ¶ "I HAVE come to the conclusion that it is not a practical or even a theoretical advantage to a broadcaster to sponsor a program through any small station. The companies that are marketing national products can use radio advertising to excellent advantage but for local companies to broadcast through a small local station is not good advertising, in my opinion. Their efforts are so mediocre in comparison with the programs sponsored by the big companies and transmitted through the high power of a well equipped, well operated station, that a bad impression is made and no benefit is derived." That is the statement, not of a newspaper publisher, but of Mr. Robert A. Fox, of Ashland, Ohio, who owned and operated station WLPC. Realizing that the small station serves little useful purpose, WLPC requested the Federal Radio Commission to cancel its license and its owner now states that he wishes "about two hundred more stations, now operating, would do the same." ¶ ¶ THE DEPARTMENT OF AGRICULTURE Farm Radio Service is being broadcast by eighty-nine radio stations in thirty-four states. Each of these stations will broadcast one or more of the eleven regular farm and household radio services prepared and released by the U. S. Department of Agriculture. Such services as these help to sell radio to the farmer.

NEWS OF THE PATENT FIELD

LEE DEFOREST won a victory over Edwin Armstrong in the United States Circuit Court of Appeals at Philadelphia, which decided that he is the inventor of the regenerative or feed-back circuit and the oscillating audion. Since the right to use both DeForest and Armstrong patents is included in the R. C. A. license, the decision does

not affect the R. C. A.'s licensees particularly. Certain companies, however, operated under licenses granted by Armstrong before his patent was acquired by the Westinghouse Company, appear, through this decision, to be liable for royalties under the DeForest patent. There is a possibility that this case may now reach the Supreme Court, although that body has the power to refuse to consider the matter. ¶ ¶ THE MACKAY interests announce that the DeForest victory places them on an equal footing with the Radio Corporation of America in the field of wireless communication. They will undertake immediate steps to establish short-wave wireless systems across the Pacific Ocean and throughout the United States. ¶ ¶ PATENT No. 1,639,042, recently issued to Wilford MacFadden of Philadelphia and assigned to the Atwater Kent Manufacturing Company, describes the use of a potentiometer for the stabilization of radio-frequency amplifiers. This system was used extensively before the neutrodyne system of stabilization was developed. ¶ ¶ THE DUBILIER Condenser Company has notified a number of manufacturers of the scope of patents 1,635,117, 1,606,212, and 1,455,141, describing plate-current supply devices and power amplifiers. Included among prospective defendants under these patents are various Radio Corporation licensees. One of these patents describes a power system comprising rectifiers, filter and choke circuits, using a. c. on the filaments; another, a two-stage power amplifier with alternating current on the filaments and a C battery used to obtain grid bias; plate potential is obtained from a thermionic rectifier.

AMONG THE MANUFACTURERS

THE Sonora Phonograph Company, manufacturers and distributors of phonographs and radio sets, the Bidhamson Company, a patent holding corporation, organized by John Hays Hammond, Jr., Lewis Kausman and others, and the Premier Laboratories, headed by Miller Reese Hutchinson, have recently merged to form a corporation devoted to the manufacture of acoustic devices. ¶ ¶ ARTHUR D. LORD, receiver in equity of the DeForest Radio Company, has filed a complaint with the Federal Trade Commission on Clause IX of the R. C. A. license contract. This clause specifically forbids R. C. A. licensees to equip and sell licensed radio sets without equipping them with R. C. A. or Cunningham tubes to make them initially operative. In his complaint, Mr. Lord claims that the consumer is penalized because he is forced to take a tube which otherwise might not be his choice. The clause is obviously aimed at independent tube manufacturers. He expresses the belief that this is an attempt at monopoly and restraint of trade, a direct violation of the Federal Trade Commission Act, the Clayton Act and the Sherman Anti Trust Law. ¶ ¶

IN FULL page newspaper advertisements in the principal newspapers of the country, Mr. A. Atwater Kent announced a price reduction of twenty per cent. in his receiving sets. This reduction, says the

announcement, is made possible by tremendous increase in production facilities. Particularly in the lower price classes, we may expect an era of intensive price competition with consequent advantages to the consumer. ¶ ¶ POWEL CROSLY, JR., has announced that his Bandbox model will probably not be changed for several years. This is the first time that a manufacturer has ventured such a prediction. ¶ ¶ THE STEWART WARNER Speedometer Corporation, which has long defied the R. C. A. in patent matters, is the most recent addition to the ranks of those committed to a 7½ per cent. royalty.

A STATEMENT by Dr. J. H. Dellinger, calls attention to a general current misunderstanding regarding short-wave beam communication. The international short-wave beam links confine the radiated energy to a thirty-degree arc which is indeed not concentration in a single narrow path. It represents merely, Doctor Dellinger points out, an economic advantage and not a secrecy system.

Science has been unable to affect a concentration of radiated wave energy, either light, sound, or heat, in a perfect single beam by the aid of any form of reflector, and there seems little ground for hope that we shall soon achieve it with radio telegraphy or telephony. The concept that we may reduce beam transmission to a concentration comparable to that obtainable by wire communication is now untenable.



THE NEW COAST GUARD SHORT-WAVE TRANSMITTER

B. J. Fadden, chief radioman aboard the U. S. C. G. *Modoc* in ice patrol duty is shown standing beside the 35.5-meter (8500-kc.) transmitter. The transmitter on this wave is used for direct communication between the *Modoc* while in the North Atlantic ice fields and headquarters in Washington



RADIO BROADCAST Photograph

MAKING FINAL ADJUSTMENTS ON THE PUSH-PULL AMPLIFIER DESCRIBED IN THIS ARTICLE
 Measurements of the grid bias voltage are being made. Note the electro-dynamic Magnavox loud speaker in the background. A circular baffle-board has been attached to it in the laboratory

PUSH-PULL AMPLIFICATION—WHY?

By HOWARD E. RHODES

THE essential prerequisites for faithful reproduction from a radio set are, first, a properly designed receiver capable of giving reasonably distortionless amplification and, secondly, a good loud speaker fed with power from a source able to supply the necessary energy without overloading. Much of the distortion in receivers is due to tube overloading, which usually occurs to the greatest extent in the last audio tube. The cure for this condition, obviously, is to use a tube, or combination of tubes, in the output circuit that has a high enough power rating so that overloading will not take place. As will be brought out in the following discussion, this requires that "power" tubes be used in the output circuit of the receiver, and at the end of the article some constructional details will be given regarding a push-pull amplifier employing 210 type tubes. Such an amplifier will deliver a large amount of power to a loud speaker without overloading.

Let us first determine approximately what requirements are necessary in the output of a receiver to prevent serious overloading. By the term "overloading," in this discussion, we mean that the input voltage on the grid of the tube is so great as to cause the grid to become positive at times so that current begins to flow in the grid circuit. In the operation of any ordinary amplifier, care must be taken that the signal input voltage is never great enough to cause grid current to flow for, when this does occur, the

input signal will be badly distorted. In determining the characteristics of an amplifier to prevent overloading, we must assume certain values, with the result that the final answer will not be exact, but should nevertheless give a good idea of what conditions must be met. Suppose, to take an average case, that an orchestra is broadcasting and that the ratio of power between the fortissimo and pianissimo passages as played by the orchestra, is a million to one, corresponding to a power ratio of 60 TU. Because of the characteristics of the amplifier

used to pick up this music, it is necessary to cut down this power ratio somewhat so as to keep the pianissimo passages above the noise level and to prevent the fortissimo passages from overloading the amplifier. In practice, this ratio is cut down in the control room at the broadcasting station by an operator in charge of the gain control. The power ratio is, after being cut down, generally about 40 TU into the amplifier system. This corresponds to a ratio of ten thousand to one. Let us assume that this ratio is maintained throughout the entire broadcasting and receiving system, a condition which will be true if there is no overloading at any point. Suppose that the energy in the pianissimo passages as they are reproduced by the loud speaker is 3 microwatts (0.000003 watts).

To get an idea of what this amount of energy represents, it may be compared to the average speech power delivered by a person speaking, which is about 10 microwatts. The energy associated with the fortissimo passages will be 10,000 times as great, or 0.03 watt. It is now necessary to assume a figure for the average efficiency of the loud speaker, but because the efficiency of a loud speaker varies considerably over the range of audio frequencies, it is hardly accurate to assume an average efficiency and have it mean very much. We will do so in this case, however, merely to get some idea of how much power is required. The efficiency of a loud speaker is very low, we will assume



RADIO BROADCAST Photograph

A CLOSEUP

Showing the plug which provides for variations in line voltage

it to be 3 per cent., which means that, in order to obtain a given amount of sound energy, we must supply the loud speaker with many times as much electrical energy. The amount of electrical energy required is found by dividing the sound energy output by the efficiency of the loud speaker; in this case we must divide 0.03 watt by 0.03 (3 per cent.) and the quotient, one watt, is the amount of energy the power tube in the receiver must be capable of delivering to the loud speaker during the fortissimo passages. Now let us see what tube or combination of tubes is capable of supplying this power.

The maximum amount of undistorted power that can be obtained from various tubes is given below.

TABLE NO. 1

TUBE TYPE	PLATE VOLTAGE	GRID VOLTAGE	UNDISTORTED OUTPUT WATTS
199	90	-4.5	0.007
120	135	-22.5	0.110
201-A	90	-9.0	0.055
112	157	-10.5	0.195
171	180	-40.5	0.700
210	450	-38	1.700

When two tubes are used in a push-pull arrangement the maximum power output of the combination is twice that of a single tube.

It is evident from the table that the only tubes delivering, in push-pull arrangement, more than 1 watt of power are the 171 and 210 combinations, and, therefore, these combinations are most satisfactory for supplying a loud speaker with the necessary amount of undistorted power. In practice it will be found that a push-pull amplifier can be overloaded, but this amount of overload is so small as to be negligible.

This treatment of the problem is not exact. It was necessary to assume an average value for the power associated with the pianissimo passages and this first assumption determines how much power will be required for the fortissimo passages. It is also true that a considerable amount of distortion can be present in the output of a loud speaker without being evident to most of us. The figures do, nevertheless, give an idea of why power tubes must be used, and show that present-day loud speakers cannot be supplied with sufficient undistorted power from tubes other than the 171 or 210 type. Marked improvement in the efficiency of loud speakers will some day make other tubes with a lower power output suitable for use in the last stage of a receiver, but until such an improvement is made, we must make certain that we have plenty of power handling capacity available in the receiver's output.

PUSH-PULL OR PARALLEL TUBES?

AT THIS point there might be some question regarding the relative merits of a push-pull amplifier with two 210 tubes and a parallel arrangement of the same tubes. Let us list the advantages and disadvantages of the two arrangements.

The italics indicate with which arrangement the advantage lies. Although point No. 4 was indicated as an advantage for the parallel arrangement, it is possible, by the use of a special push-pull output transformer, to compensate the higher plate impedance of the push-pull circuit, and the two arrangements will then be equal in this respect. Point No. 5 has not, as yet, been explained, but it is the most important reason for the existence of the push-pull arrangement:

PARALLEL ARRANGEMENT	PUSH-PULL ARRANGEMENT
(1) Requires only half as much input voltage from receiver to give same output as push-pull arrangement.	Requires twice as much input voltage from receiver to give same output power as parallel arrangement.
(2) Distortion due to overload quite noticeable.	Slight overload (about 25 per cent.) possible without noticeable distortion.
(3) Voltage gain somewhat higher.	Voltage gain is somewhat lower.
(4) Plate Impedance four times smaller than push-pull arrangement.	Plate impedance four times greater than parallel arrangement.
(5) Distortion due to curvature of tube characteristic not eliminated.	Distortion due to curvature of tube characteristic eliminated.
(6) Some hum may result if filaments are operated on a. c.	Any a. c. hum from filaments eliminated due to push-pull arrangement

We shall endeavor to explain now how the push-pull amplifier eliminates a certain type of distortion which exists in a simple single-tube amplifier. It is necessary to start the discussion by examining in some detail the characteristics of a CX-310 (UX-210) type tube (or, for that matter, any tube).

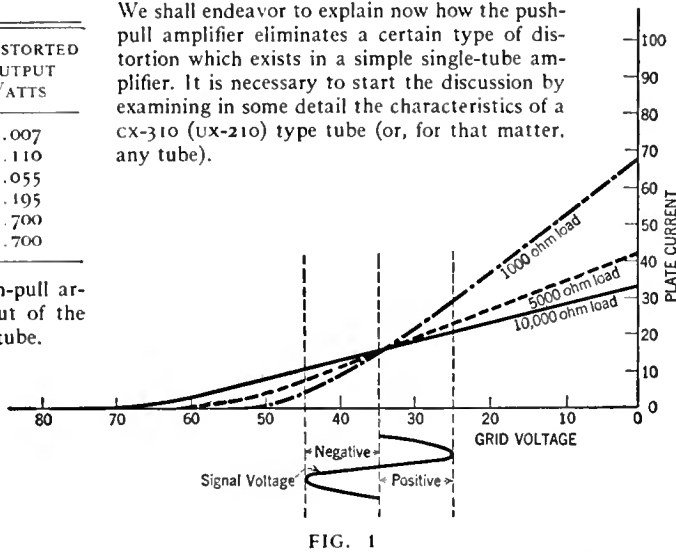

FIG. 1 Grid voltage - plate current curves of a 210 type tube

In Fig. 1 we have drawn several curves for a single tube of the 210 type with a plate voltage of 400 and a grid bias of -35 volts, and these curves show the relation between the plate current and the grid voltage with various load resistances in the plate circuit. The curve marked 1000 was made with a 1000-ohm resistance in the plate circuit and the curves marked 5000 and 10,000 were made with resistances of 5000 and 10,000 ohms respectively in the plate circuits. These curves are dynamic characteristics in the sense that they indicate how the plate current will vary with different loads in the plate circuit. If a signal having a value of, for example, 10 volts, is impressed on the grid of this tube, it will cause the grid voltage to vary 10 volts either side of its average value of 35 volts. Such a signal voltage is represented in Fig. 1 by the curve, marked "signal voltage," drawn below the grid voltage axis. If the change in plate current due to this voltage is determined on the 10,000-ohm curve by reading the values of plate current at each extremity, we find that, when the voltage is positive, the current rises to 21 milliamperes and that, when the voltage is negative, the current decreases to 11 milliamperes, a drop of 10 milliamperes.

The signal voltage of 10 volts has, therefore, caused the plate current to increase and decrease an equal amount with respect to the average value, the increase and decrease being 5-milliamperes in this case. If the same measurements are made on the 5000-ohm curve we find that the plate current increases 7 milliamperes above the average value but only decreases 6 milliamperes. On the 1000-ohm curve the increase is 14 milliamperes and the decrease is only 11 milliamperes. These values have been arranged in the form of a table:

TABLE NO. 2

OUTPUT RESISTANCE	INCREASE IN CURRENT	DECREASE IN CURRENT
10,000	5	5
5,000	7	6
1,000	14	11

This table indicates clearly that, as the resistance in the output circuit of the tube decreases, the increase and decrease in plate current due to a given signal become unequal. This represents distortion because it indicates that the positive side of the input voltage produces a relatively greater change in the plate current than does the negative side.

LOUD SPEAKER CONSIDERATIONS

AND now let us consider the loud speaker. The impedance of a loud speaker is a function of frequency and increases with increase in frequency. At low frequencies, therefore, the loud speaker will have a comparatively low impedance and the tube feeding the loud speaker will then operate on the characteristic corresponding to a low-resistance load in the plate circuit. This characteristic is indicated by the 1000-ohm curve in Fig. 1. At medium frequencies, where the loud speaker's impedance is higher, the tube will operate on a characteristic similar to the 5000-ohm curve, and at high frequencies the tube will operate on a characteristic similar to the 10,000-ohm curve. As indicated by the figures in table No. 2, the 10,000-ohm curve is quite straight and therefore produces

little distortion. A small amount of distortion is produced by the 5000-ohm curve, but much greater distortion occurs when the tube operates along the 1000-ohm curve. When a loud speaker is operated from a single 210 type tube, this distortion occurs and, if possible, it would evidently be of advantage to arrange the circuit so that no distortion of this type is produced. This leads us to consider push-pull amplification.

The circuit diagram of a push-pull amplifier is given in Fig. 2. In some push-pull arrangements the output choke, L, is replaced by a transformer, but the circuit will function with a simple choke coil as indicated. When a signal is induced in the secondary of the input transformer, T, the voltage relations are as indicated by the plus and minus signs on the diagram. It will be noted that the voltage at one end of the transformer is positive relative to the voltage at the other end, which is negative. The signal voltage impressed on either grid is one half the total voltage across the transformer. Since the two grids are at relatively opposite potential the plate current changes will also be opposite

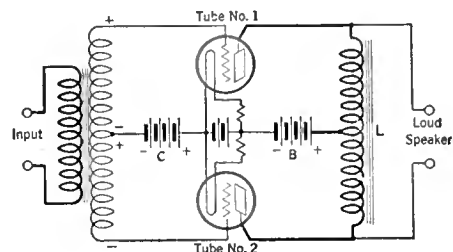

FIG. 2

The circuit connections for a push-pull amplifier

in nature. Referring to Fig. 1, this means that, during the time that the grid of tube No. 2 goes positive, the plate current will increase, and that the plate current of No. 2, as the grid goes negative, will decrease. In Fig. 3, we have represented at A the signal induced in the secondary of the input transformer, T, curve A-1 indicating how the voltage on the grid of tube No. 1 varies and curve A-2 indicating the variation of voltage on the grid of tube No. 2. It should be noted that the voltages are similar, that there is no distortion, and that the voltages are in opposite phase relation to each other (when one is positive the other is negative). Now these voltages cause changes in plate current in accordance with the curves given in Fig. 1, and if the particular signal being amplified is low in frequency, the loud speaker's impedance will be low and the tube's characteristic will have a form similar to the 1000-ohm curve. This curve will produce unequal changes in plate current (see table No. 2) and the curves at B-1 and B-2 in Fig. 3 indicate the change in plate current due to the voltages impressed on the grid. It should be noted that these two curves are distorted (the positive halves are larger than the negative halves) although the distortion of the two curves is similar in nature. These curves at B can be split into two parts, as indicated at C, C-1 and C-2 represent plate current variations exactly similar in form to the grid voltage variations and C-3 and C-4 represent additional plate current variations due to the curvature of the tube characteristic. The point of interest here is that, although the variations in plate current indicated by C-1 and C-2 are out of phase (as they should be) the distorted parts represented by C-3 and C-4 are in phase; that is, they are both positive or negative at the same time. In order to have current flow through the loud speaker, the a. c. voltage at one plate must be opposite in sign relative to the voltage at the other plate. We might consider that the plate whose voltage is negative tries to "pull" some current through the loud speaker while the plate whose voltage is positive tries to "push" some current through the loud speaker, and this gives us an idea of why such an amplifier is termed "push-pull." C-3 and C-4, indicating the distorted part of the plate cur-

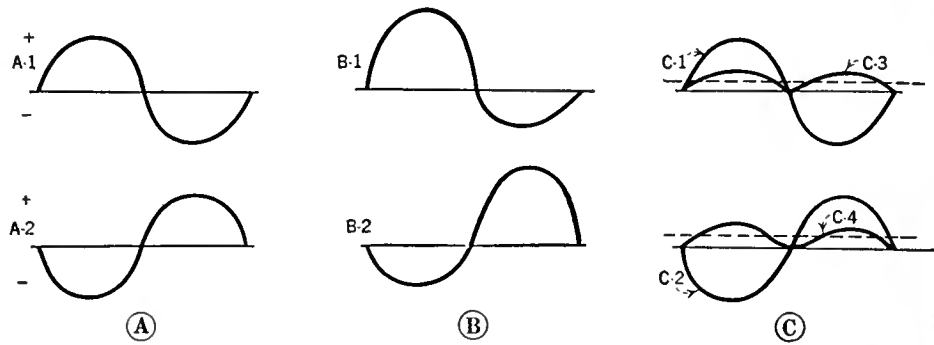

FIG. 3

These curves are used to explain how a push-pull amplifier operates

rent variation produced by the curvature of the tube characteristic, are such that both plates are relatively positive at the same time. These currents, therefore, cannot force any energy through the loud speaker. The only current flowing through the loud speaker is indicated by C-1 and C-2, and it is undistorted. In this way two tubes in a push-pull arrangement eliminate

a form of distortion present in a simple circuit using a single tube.

In Fig. 4 are given a group of curves obtained from some data on the Samson push-pull amplifier illustrated in this article. The three curves shown in solid lines were made using a single 210 type tube. Note how the gain begins to fall off when the voltage on the grid reaches about 18 volts and this point also corresponds approximately to the point at which grid current begins to flow. The power output also begins to flatten out after more than 18 volts is placed across the input. These three effects, a decrease in the gain, the presence of grid current, and a falling off in power output, are all definite indications of overloading. The dotted curve indicates the power output obtained from two 210's in a push-pull amplifier. This curve also begins to fall off slightly after about 18 volts has been placed on the input, but the change is not as rapid as in the case of a single tube. The power output of the push-pull amplifier at the point where grid current begins to flow is twice as great as that of a single tube.

The Samson push-pull amplifier illustrated in this article is an excellent example of a well-designed unit. The major characteristics of this amplifier are as follows:

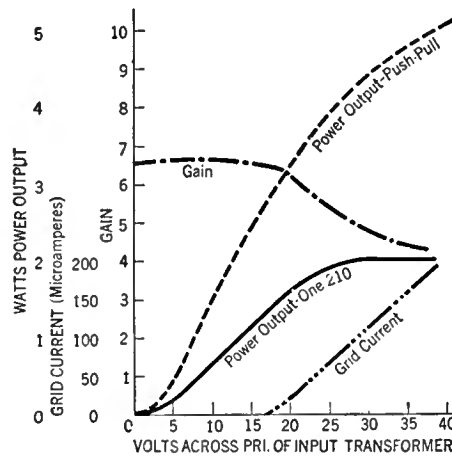
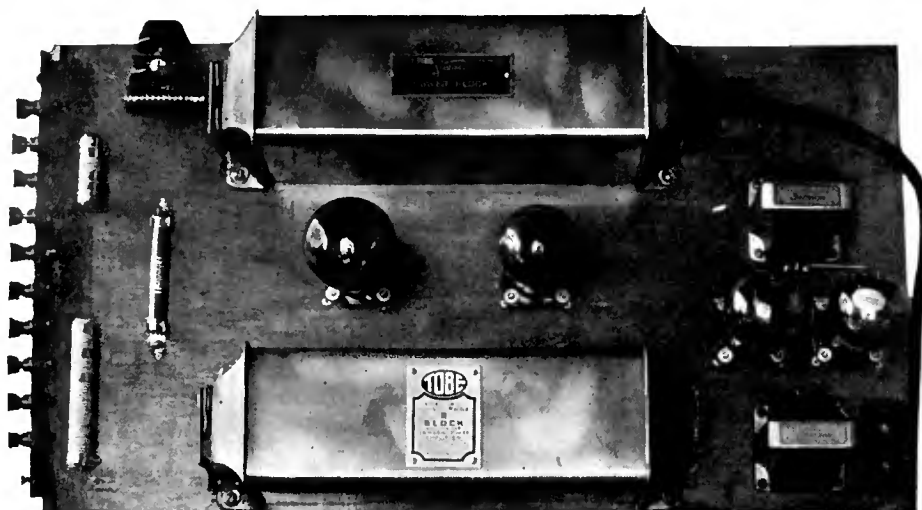

FIG. 4

What happens when an amplifier is overloaded can be determined from these curves. They are explained in the text, col. 3, page 204

- (1.) The unit consists of two 210 type tubes in a push-pull arrangement fed from an input push-pull transformer. The unit is designed to connect to the output of the first audio stage in a receiver, and thereby makes possible the attainment of better quality than can be obtained from the smaller tubes ordinarily used in a receiver.
- (2.) The power transformer and choke coils have been enclosed in a nicely finished metal case with the various leads brought out through a small terminal box at one end. At the other end of the transformer is a special plug, a Samson feature, which can be turned to different points to compensate differences in line voltage. The condenser bank is also enclosed in a metal case.
- (3.) The device will supply B power to a receiver. The circuit incorporates a glow tube which maintains the output voltages from the various terminals practically constant independent of load, and this makes it possible to use the device with almost any receiver with assurance that the voltages marked on the terminals will be equal to the actual voltages delivered by the device. The following voltages are available; 180, 135, 90, 67½, and a variable tap so that accurate adjustment of the detector voltage can be made. The 210 type tubes receive about 500 volts and the C bias is about 40 volts. The device also supplies C potentials as follows: -4.5, -9, and -43.



RADIO BROADCAST Photograph

THE LAYOUT OF THE PUSH-PULL AMPLIFIER FROM ABOVE

No d. c. plate current can flow through the loud speaker, and blocking condensers are therefore not necessary in this amplifier for this purpose. However, in the arrangement shown the loud speaker itself is at a potential of 500 volts above ground and a serious shock will be had if the loud speaker and a grounded object are touched at the same time. In order to make the installation entirely safe it is a good idea to connect a 4-mfd. high-voltage condenser in series with each lead to the loud speaker terminals

The circuit diagram of this power amplifier is given in Fig. 5. The following parts were used in the amplifier illustrated in this article.

LISTS OF PARTS

TL—Samson Power Block, Type 210, Containing Power Transformer and Two Filter Choke Coils	\$ 37.00
Tobe Condenser Block, for Samson Power Amplifier, Containing the Eleven Necessary Condensers	38.00
R ₁ —Electrad 7200-Ohm Type C "Tru-Volt" Resistance, 50 Watts	2.25
R ₂ —Electrad 420-Ohm Type C "Tru-Volt" Resistance, 25 Watts	1.50
R ₃ —Electrad 50,000-Ohm Variable Resistance, Type T-500	3.50
R ₄ —Tobe 10,000-Ohm Veritas Resistance	1.10
T—Samson Input Push-Pull Transformer, Type Y	19.50
L ₂ —Samson Output Push-Pull Choke, Type Z	
12—Eby Binding Posts	1.80
4—Benjamin Sockets	3.00
2—RCA UX-210 (Cunningham cx-310) Tubes	18.00

1—RCA UX-874 (Cunningham cx-376) Tube	5.50
1—RCA UX-281 (Cunningham cx-381) Tube	7.50
TOTAL	\$138.65

The circuit diagram has been marked with figures corresponding to the terminal markings on the power block and the condenser block. The arrangement of the apparatus on a single large baseboard makes it a simple matter to construct it and the circuit diagrams and photographs given herewith should supply all the necessary information.

All of the transformer cases, and also the case of the condenser block, should be connected to the negative B, as indicated in the schematic diagram, to prevent hum. This grounding can generally be most readily accomplished by running a lead from the negative B to the mounting screws of the various units. The wire can be fastened under these mounting screws. Remember that the voltages de-

livered by the transformer are very high and therefore care is necessary in making all of the connections. The 50,000-ohm resistance is the only variable control in the entire unit, and it is used to obtain accurate adjustment of the detector voltages.

When the construction has been completed, the special plug on the power input side of the Samson transformer may be inserted in the correct manner and connected to the a.c. light socket. When this is done, the tubes should light and the regulator tube should glow with a pinkish light.

In operation, the transformer block may become somewhat warm, but if it becomes so hot that the hand cannot be comfortably held on it, it indicates some error in the wiring. The input terminals of the device should be connected to the output of the first stage of the receiver and the loud speaker then be connected to the output of the amplifier.

If carefully constructed and properly operated, the unit will be found capable of giving excellent reproduction.

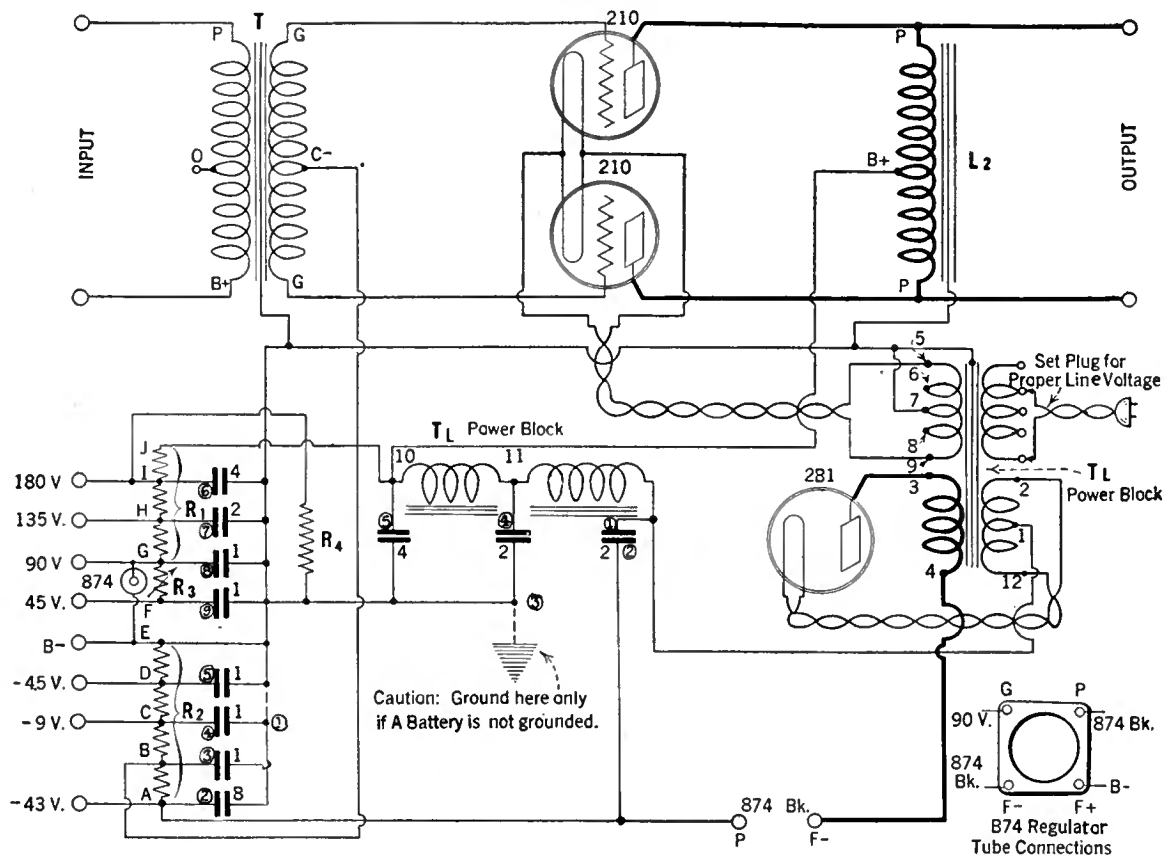
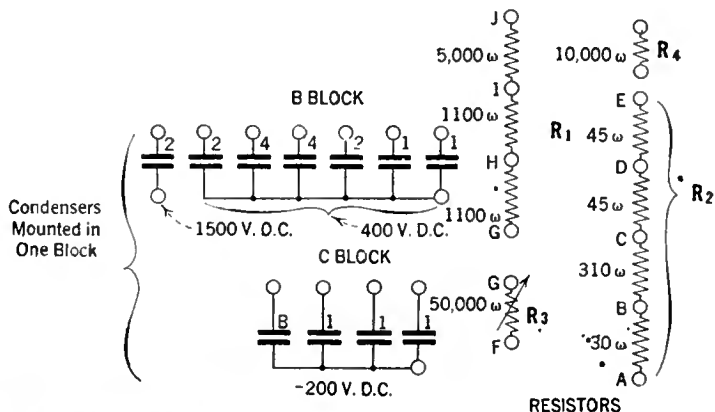

FIG. 5

This is a complete circuit diagram of the Samson push-pull power amplifier. The various numerals on the units correspond with the markings on the terminal blocks on the various parts; numbers in circles indicate terminals on the condenser block. This amplifier employs two 210 type tubes in the push-pull circuit, a type 281 tube as the rectifier, and an 874 type regulator tube. The connections to the socket holding the latter tube are indicated in the diagram. The P and F minus terminals on the socket are connected in the filter circuit as shown at the point marked "874 BK." on the diagram. The two corresponding contacts on the tube are short-circuited inside of the tube base during the process of manufacture and, therefore, if the regulator tube is removed from its socket while the power is on, the circuit is automatically opened and damage to the filter condensers thus prevented. The G post on the socket connects to the + 90 voltage tap and the F + terminal connects to B minus



TO JUDGE by the sale of radio-phonograph combination instruments and the popularity of the various electromagnetic pick-up units, the phonograph and the radio set in combination are climbing to high favor among radio users. If you have a good radio receiver and loud speaker, the purchase of a magnetic pick-up makes your old phonograph up to date and all the fine new electrical recordings then pour out of your loud speaker sounding as well as the best radio program. This magazine and others have contained descriptions on how to bring the old phonograph up to date using the electromagnetic pick-up. These pages on the entertainment that the radio-phonograph offers to the user are a regular feature of RADIO BROADCAST. It is not enough to know that the combination of the radio and phonograph provides a flexibility of home entertainment that is astounding—we feel our readers would also like to know what the disks actually offer. These columns discuss only the records made by artists well known to broadcasting.

—THE EDITOR.

A New Use for Records

IN THE days when life was simpler, we thought of the phonograph merely as an instrument for the diversion of the multitude of home-loving folk, who were enabled by it to listen to jazz or classical music without budging an inch from their Franklin stoves. Then someone realized that by preserving on its records the speeches, music and other audible accompaniments of events of national importance the phonograph could be made to have a definite historical importance. And now the phonograph has had another burden laid upon it, that of delivering speeches for important individuals at gatherings at which they cannot themselves be present. This was actually done at the opening of the fifth annual convention of the American Institute of Steel Construction in Pinehurst, North Carolina, on October 25. Secretary of Commerce Herbert Hoover was asked to deliver the speech of wel-

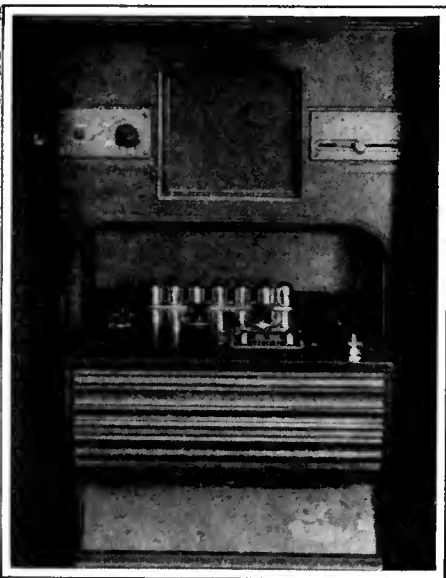

A CLOSE-UP OF VICTOR'S NO. 955
"ELECTROLA"

This illustration shows the radio panel of this elaborate combination radio phonograph model. The radio panel can be tipped for convenience in operation as shown here, or it can be tilted upright. Pilot lights make tuning easy. This instrument, completely electrically operated will play 12 records without stopping, contains built-in loop, power loud speaker (shown behind the grille above) and power supply. Price complete, \$1550

The PHONOGRAPH

come at this convention, but he could not take the time to make the trip there and back. The Institute, determined to have the speech, enlisted the services of the Victor Company, who made a record of a speech which Mr. Hoover delivered in his own office in Washington, and on October 25 this record was reproduced in Pinehurst before the convention. As Mr. Hoover himself remarked, one of the advantages of this method is that it puts a definite time limit on speeches. What a unique device for curtailing long-winded recitations! And what a splendid way to eliminate superfluous oratory, for as the Secretary also noted, and as all who have broadcast well know, a microphone is about as inspiring an audience as a bathroom door knob! We foresee a great future for this branch of phonograph service.

A Review of Recent Records

BUT though the phonograph now has a Mission it still continues to provide amusement and entertainment for those who want it. And, as far as we can see, the recent output of records is much the same as ever; there are many good records, a few poor ones, and a goodly supply of in-betweens. Of the latter the majority seem to be instrumental dance records. The orchestras which play for these are admirable and the recording of their playing is in most cases all it should be, but the selections on which they waste their talent are just about zero in musical worth. The result is like apple pie without the apple. Alas for more Gershwins and Berlins!

On the Victor, Columbia and Brunswick lists are many names familiar to those who sat at home turning the dials of their radio sets through the long winter evenings of 1926-27. They will recognize numerous regular performers and others who have made only a limited number of ethereal bows on such programs as Atwater Kent, Eveready, and Victor. New names are being added daily to this register of recording-broadcasters and now that Columbia has its aerial chain, we can expect even more.

Of the recent dance records, *Who Do You Love?* and *I'll Always Remember You* played by Paul Whiteman and His Orchestra (Victor) head the list. This famed outfit have taken two of the best songs now extant and by decorating them with a trick orchestration in the inimitable Whiteman manner have made an unusually good record out of them.

Is It Possible? and *Just Call On Me* played by Leo Reisman and his Orchestra (Columbia) is another grand record. If we hadn't always lived in the belief that Whiteman had no equal, we would say this was as good as the first record on our list. We will say it. Anyway, it is pretty smooth music and we defy you to keep your feet still when you listen to either number.

Gorgeous by Johnny Hamp's Kentucky Serenaders would be an asset to any collection of dance records and its companion on the opposite side, *There's a Trick in Pickin' a Chick-Chick-*

Chicken by Nat Shilkret and His Vic-Vic-Victor Orchestra is just as full of pep. (Victor).

Habitual listeners-in on Harold Leonard and his Waldorf Astoria Orchestra will want his latest Columbia product, *Just A Memory and Joy Bells*. You don't have to be told it is good.

Once Again and *No Wonder I'm Happy* as played by Ernie Golden and his Hotel McAlpin Orchestra will have the ring of familiarity to those who tune-in on station wmcA. They are good snappy numbers. (Brunswick.)

Having heard excellent reports of the new Broadway show "Good News" we were disappointed in the three numbers from it which have found their way onto the rubber discs. The title number, *Good News*, and *Lucky in Love* have been recorded for Columbia by Fred Rich and his Hotel Astor Orchestra, and Cass Hagan and his Park Central Hotel Orchestra have done *The Varsity Drag* (also Columbia). If you are one of those who raved over the show you may enjoy the records. You may also like *Dancing Tambourine* by the Radiolites on the reverse side of *The Varsity Drag*, though we can't enthuse over it.

If you stuff cotton in your ears during the seconds devoted to the vocal chorus in *Baby Feet Go Pitter Patter* you may agree with us that this record by Abe Lyman's California Orchestra (Brunswick) is one of the best that have appeared in many moons. In addition to an aversion to vocal choruses in general we detest the words to this particular song. It was an error on someone's part to attach such a silly lyric to such an excellent tune. However, it's short and the few seconds one sacrifices to get through it are a drop in the bucket and the rest of the record is fine. The other side carries *There's One Little Girl Who Loves Me*, also played by Abe Lyman, and also good.

Another of the better records slightly marred by a vocal chorus is *No Wonder I'm Happy* and *Sing Me a Baby Song* by the George H. Green Trio with Vaughn De Leath doing the vocalizing. (Columbia.)

The Ipana Troubadours, smile vendors under the direction of S. C. Lanin, have done a fine job with *Are You Happy?* and *A Night in June*, of which Frank Harris carols the chorus. (Columbia.)

Inhabitants of Mayor Thompson's Strictly American City will welcome a Columbia disk made by one of Chicago's Municipal Heroes, Paul Ash, and his Orchestra. *Just Once Again* is excellent and its vocal chorus by Franklin Baur makes us eat some of our words just uttered; we must admit it is an addition to the



THE UTICA JUBILEE SINGERS

There are those who are not especially impressed by negro spirituals. But if you like these interesting melodies and want to hear them sung as they should be sung, listen to this group on wjz and associated stations at 9:45 eastern time Sunday evenings. They have made one double-faced recording for Victor, one of the finest recordings of the kind we have heard

Joins the RADIO Set

record. In self-justification we insist that Franklin Baur is an exception. The reverse of the record *Love and Kisses*, is not quite up to the Paul Ash standard but that doesn't mean it is bad.

Several other records get only half a vote due to the fact that one face of record is good and the other not. *Stop, Go!* executed by Nat Shilkret and the Victor Orchestra has a unique rhythm, better than any other number on the list but *Something To Tell* is only moderate. *Me and My Shadow* by Phil Ohman and Victor Arden and their Orchestra is good; *Broken Hearted* is not. Even Paul Whiteman could not do much better with that last number but *Collette* on the reverse makes the record decidedly worth buying. (Victor). Don Voorhees tried something tricky with *Soliloquy* (which we are told belongs to the new school of music ushered in by the *Rhapsody in Blue*) and was not very successful, but his more orthodox *My Blue Heaven* is exceedingly good. *Just a Little Cuter* falls rather flat but *Marianette* is excellent dance music. Both come from the orchestra under the baton of Ben Selvin and are recorded by Brunswick.

We don't care much for *Cheerie Beerie Be* or *Waltzes of the Perkiomen* even though played by Leo Reisman and his Orchestra. *Roodles* and *I Ain't Got Nobody* are not as good as they ought to be coming as they do from Coon-Sanders Orchestra. And we were very much disappointed in *Who's That Pretty Baby?* and *Barbara* by Paul Specht and his Orchestra. The fault lies in each case not with the orchestras but with the stupid selections they play.

AND NOW FOR COMEDY

OF THE good humorous records recently issued by far the best is *Two Black Crows*, Parts 3 and 4. (Columbia). Of course we don't need to describe it. Everyone knows Moran and Mack and their riotously funny dialogues. What, you don't? Well, go right down to the corner music store and buy this record and their first one, *Two Black Crows, Parts 1 and 2*. You will remember us in your prayers.

Next in order of importance comes that grand song perpetrated by the Happiness Boys. Billy Jones and Ernest Hare, *Since Henry Ford Apologized To Me*. (Victor.) It is worth seventy-five cents just to hear this record once, which is fortunate, for we wouldn't give a nickel for the song on the reverse side, *I Walked Back From The Buggy Ride*, by Vaughn De Leath and Frank Harris.

Then the famous Sam and Henry combination (Correll and Gosden of wgn) offer two dialogues called *Sam's Big Night* and *The Morning After*. (Victor.) They are both labelled comic dialogues

but oh! the pathos of Sam's refrain, "Henry, Henry, I'se sick! My head's bout to kill me! . . . I b'lieve I'se gonna die!" It almost makes you want to sign the pledge.

Of the many popular vocal records we nominate for first place, a work of art by the Happiness Boys, *You Dont Like It—Not Much* and *Oh Ja Ja*. (Victor.) This is typical of what they offer to the audience of WEAf every Friday night and it's good! Personally we like them best of all the regular aerial performers, It's personality that does it—plus good voices.

Van and Schenck sing *Magnolia* and *Pasta-façoola* for you on a Columbia record. The Radio Franks present *No Wonder I'm Happy* and *When Day Is Done*. (Brunswick). And Johnny Marvin and Ed Smalle do a little duet with *Just Another Day Wasted Away* on a Victor. All of these are good. But on the back of the last mentioned disk is *Just Like a Butterfly* sung by Franklin Baur. Personally, as little Alice said in *Peggy Ann*, we'd rather have a baked apple. No matter how good the voice, the song is terrible! We feel just as strongly about *Baby Feet Go Pitter Patter* as we have hinted before, and when it is sung by Vaughn De Leath we see spots before our eyes. She could make *Turkey in the Straw* sound like a sentimental ditty and when she has something as mawkish as this to start with . . . words fail us. In case you are still interested in the record the opposite side bears another song by the same lady, *Sometimes I'm Happy* (Brunswick).

The Sunflower Girl of WBAP vocalizes *You Went Away Too Far* and *I Hold The World in The Palm of My Hand* on a Columbia disk. We cannot say she sings them because she has one of those rough and tumble shouts so often heard on the vaudeville stage. It is about as far from being musical as anything could be, but for that sort of thing, she will do.

We don't feel strongly one way or another about *Charmaine!* and *The Far-Away Bells* sung by Franklyn Baur (Columbia), *Ain't That a Grand and Glorious Feeling?* and *Magnolia*, sung by Harry Richman (Brunswick), or *Flutter By, Butterfly* and *I'd Walk a Million Miles* by Art Gillham and his Southland Syncopators (Columbia).

RED SEAL RECORDS AND SUCH

TURNING now to the sublime we find several red seal records made by operatic stars from the Metropolitan firmament, who twinkled before microphones upon occasion last winter. Lucrezia Bori, the beautiful Spanish soprano who is as lovely to look upon as she is to listen to (though you couldn't tell that when you heard her sing in the Victor radio concerts or in the Atwater Kent hour) presents us with the lovely old waltz song by Pestalozza, *Ciribiribin*, and *Il Bacio* by Ardit. (Victor).

Another soprano who was presented to the radio audience by Atwater Kent is Hulda Lashanska In company with Paul Reimers, tenor, she records for Victor two simple but extremely lovely old German folk songs, *Du, Du Liegst Mir Im Herzen* and *Ach, Wie Ist's Möglich Dann*. The harmony of the first selection is particularly notable.

ERNIE GOLDEN OF WMCA

He leads the Hotel McAlpin Orchestra, regularly heard through WMCA of New York. The Hotel McAlpin Orchestra has recorded many good dance numbers for Brunswick

It was a Victor hour that launched Emilio De Gogorza's baritone voice on the ether waves and it is a Victor record which presents his voice again for your permanent enjoyment. He sings two favorites, *O Sole Mio*, and *Santa Lucia*. We think it would be a grand idea for everybody to have this record in his home, if for no other reason than just so that whenever he hears the song murdered by a would-be artist he can play the record on the phonograph and reassure himself that the song is all right after all.

We presume it is rank heresy to say that we prefer to hear the Utica Jubilee Singers sing *Old Black Joe* than to hear Lawrence Tibbett. Tibbett's voice is marvelous, of course, and it is perfectly trained, but he cannot manage this negro melody as expressively as the Utica Jubilee Singers do. If this be treason. . . The reverse of the record is *Uncle Ned*. We have never heard the Jubileers sing this but we will wager our two cents that they could do it more to our satisfaction than the Metropolitan star has done. Both these songs are so worn out that they need all the expression that can be put into them.

The Utica Jubilee Singers have done a record for Victor, *Angels Watching Over Me and Climbin' Up the Mountain*. It's perfect! We can say no more. Incidentally it is interesting to note that these singers have just returned from a concert tour of Europe where they were greeted with great acclaim, so their popularity is no longer limited to this continent. They are now heard from WJZ and others on that chain Sunday nights at 9:45, eastern time.

Virginia Rea, staff artist for Eveready, has recorded a popular number which Victor thought good enough for a red seal record, *Indian Love Call* from Rose-Marie; and Lambert Murphy, whom you undoubtedly heard in an Atwater Kent hour, has recorded the title number from the same musical play on the reverse of the record. Though we saw this show at regular intervals through the winter of 1924-25 and heard these numbers on hand organs for the next two winters, we still like them.



AN ELECTRIC RADIO-PHONOGRAPH FROM FRESHMAN

This instrument, completely a. c. operated provides the usual Freshman receiver, electric turntable, electric pick-up, record space and loud speaker which serves for radio or phonograph music. Complete with a. c. tubes, \$350

UX-222 TUBES

Some idea of the construction of the new R. C. A. screened grid tube may be obtained from this illustration. The extra connection is made to the metal cap atop the tube. Eby new type sockets are shown.



THE SCREENED GRID TUBE

By KEITH HENNEY

Director of the Laboratory

STUDENTS of the characteristics and applications of the vacuum tube, and of circuits to do with it, may find themselves somewhat bewildered by the apparent complexity of the screened grid tube when they begin their researches into its idiosyncrasies. They will be impressed at once with the thought that this tube is no ordinary structure, and will appreciate more such names as Schottky of Germany and Hull of the United States—names actively associated in its development. Experimenters here have yet to become familiar with the new tube, which has already taken its share of space in English, French, and German radio periodicals, and it is certain that, with the Radio Corporation's announcement of the UX-222, not a

great length of time will elapse before it will be possible for anyone to obtain these interesting and useful screened grid tubes.

American writers, too, will have considerable to say about the double-grid tube, of which the screened grid tube is a type, as they become more familiar with its operation, and as its possibilities become more apparent.

Imagine a tube with an amplification factor of about 250, and such a small grid-to-plate capacity that it has little tendency to oscillate even though the plate circuit be made highly inductive in reactance. The nearest approach is the standard "high mu" tube with an amplification factor of about 30, but, unfortunately, with sufficient capacity to make oscillation inevitable if sufficient inductance is included in its plate circuit to transfer energy efficiently to a subsequent circuit. The screened grid tube, of which the UX-222 (CX-322) is the precursor, is a most unusual tube. What are its characteristics, its possibilities, its weak points?

Physically it is complicated by having a fourth element within the glass bulb. Picture a cylindrical construction with a 3.3-volt filament in the center, surrounded by a rather coarse grid, then, at some distance, another fine mesh grid, then a cylindrical plate, and the whole surrounded by another very fine grid of about forty spiral turns. The latter two grids, connected in parallel, form one electrode, thus constituting the extra element in the tube. It would be more accurate, for geometrical reasons, to call this tube a screened plate tube, but electrically, as we shall see, it is really the grid which is protected from alternating voltages impressed upon the plate.

The inner coarse grid is connected to a small metal cap which sits on top of the bulb, where the tip used to be, making the overall height about three quarters of an inch higher than standard tipless tubes. The screening grid connects to the usual grid terminal in the base so that the tube fits into the standard UX or UV socket.

As pointed out in the December, 1927, RADIO BROADCAST by Mr. T. H. Nakken, there are two types of double-grid tubes, those in which the inner grid is positive, known as the space-charge tube, and those in which the outer or protective grid is positive. The UX-222 may be used either

way. Let us consider first its action as a shielded-grid device. In this case the outer grid is positive.

We shall place 3.3 volts on the filament, make the inner grid negative, place about 45 volts on the shield, and read the plate current as the plate voltage is changed. The result is shown in Figs. 1 and 2.

When this is done there are unusual results: First, the plate current rises, as is customary with increase in plate voltage. Then the plate current begins to decrease, giving the tube a characteristic like that of the electric arc, *i.e.*, decreasing current with increased voltage; next, after a sharp minimum, the current rises almost per-

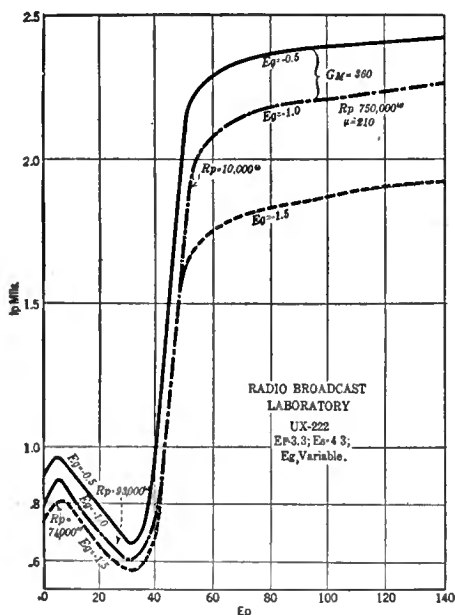

FIG. 1

The plate current of a screened grid tube varies in strange fashion, as these curves show. In these data the effect upon the plate current of changing the plate voltage, with several values of bias voltage, is given. The normal bias is about 1.5 volts, with 45 volts positive on the screen, and about 135 on the plate

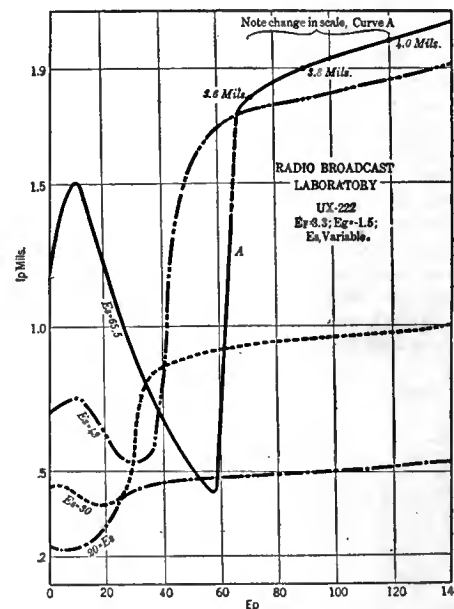

FIG. 2

If any reader of RADIO BROADCAST feels that he knows all there is to know about tubes, let him explain the sudden and extensive changes in plate current with change in plate voltage indicated in these graphs. With even greater screen voltages than are shown here, the plate current may be reduced to zero or even go negative (reverse its direction of flow) at some positive plate voltage

pendicularly and finally flattens out to become practically horizontal. All of this is contrary to what happens in standard tube practice and, to the student of physical phenomena, is extremely interesting.

The slope of this plate voltage-plate current curve represents the plate impedance and, if plotted, an extraordinarily large scale graph would be required owing to the extent to which it changes. For example, in Fig. 1 it is 74,000 ohms near the origin, then it suddenly goes negative to the extent of 100,000 ohms, then positive about 10,000 ohms, and finally becomes about three-quarters of a megohm in value! The tube has a negative resistance, or a dynatron effect, at low plate voltages.

These rapid and extensive changes in internal resistance are due to the varying proportions of current taken by the shield and the plate, both of which attract negative electrons, and to a certain amount of secondary emission which takes place within the tube. At the present moment, however, the detailed explanation of these effects must give way to the more practical information regarding the tube. We are more interested in this article in how the tube works than in "why." It is sufficient to state that the sum of the currents taken by the shield and the plate is constant, the plate current increasing when the shield takes fewer electrons, and vice versa. Under usual operating conditions, *i.e.*, high plate voltages, the shield takes very little current indeed.

Grid voltage-plate current curves appeared on page 111 of RADIO BROADCAST for December, 1927, and will not be repeated here. They conform to what one secures from other tubes of the general-purpose type. They indicate a mutual conductance of about 300 to 400 under average conditions, and an amplification factor of about 250 to 300, values which should be compared to those of standard tubes in Table 1. It is difficult to measure these factors on the ordinary bridge because of the extraordinarily high values of μ and plate impedance involved, and the better plan is to pick them from characteristic curves as we have done here.

MATHEMATICS OF THE TUBE

THE screened grid tube is designed primarily for radio-frequency amplification and, to understand its possibilities in amplifier circuits, we must examine somewhat more critically than usual the processes involved in the ordinary amplifier. Naturally we must have an input and output circuit, and for general analytical purposes we shall consider Fig. 3.

The purpose of the transformer in such circuits is not, as many would have us believe, to increase the voltage step-up from tube to tube, but to obtain a proper impedance for the amplifier plate circuit to look into. Mathematics will show that the maximum voltage amplification will be obtained when the effective primary impedance of the transformer is equal to the internal resistance of the tube, and that under these conditions this amplification is:

$$K_{max} = \frac{L \omega}{2\sqrt{R_p R_s}}$$

where R_p = tube impedance, L = secondary inductance, R_s = secondary resistance, and $\omega = 6.28 \times \text{frequency}$.

If the effective resistance of the tuned circuit at resonance is higher than that of the preceding tube impedance, a step-down transformer must be used. This effective resistance may be found mathematically by substituting the proper values in the following expression:

$$R_o = \frac{L^2 \omega^2}{R_s}$$

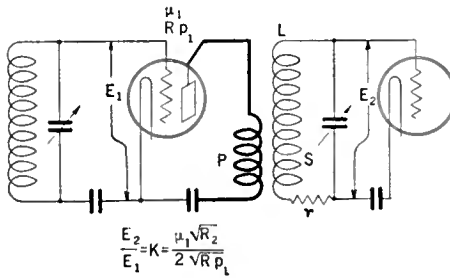

$$E_2 = K E_1 = \frac{\mu_1 \sqrt{R_p}}{2\sqrt{R_s}}$$

$$R_o = \frac{L^2 \omega^2}{R_s}$$

FIG. 3

A diagrammatic representation of the ordinary interstage radio-frequency amplifier, consisting of a transformer, tuned to the frequency desired, connecting two tubes. The voltage gain at resonance is given in the form of two equations

where L = inductance, R_s = high-frequency resistance, $W = 6.28 \times \text{frequency}$.

If we use an inductance of 250 microhenries having a resistance of 15 ohms at 1000 kc., this effective resistance will be:

$$R_o = \frac{(250 \times 10^{-6})^2 \times (6.28 \times 10^6)^2}{15} = 177,000 \text{ Ohms}$$

and if the previous tube is a 201-A with an impedance of 12,000 ohms we shall be compelled to use a step-down transformer to secure maximum amplification and to prevent short circuiting the secondary, to the impairment of the selectivity. Using a tube and coil of these

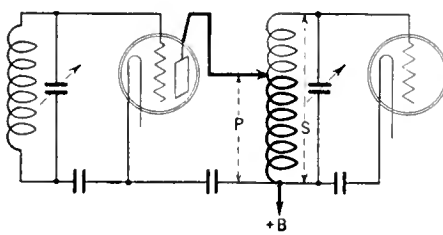

FIG. 4

For analytical purposes the two-winding transformer of Fig. 3 may be replaced by this auto transformer. The same conditions for maximum voltage amplification obtain

characteristics, and with the proper primary, the maximum amplification will be:

$$K_{max} = \frac{8}{2} \times \frac{250 \times 10^{-6} \times 6.28 \times 10^6}{\sqrt{12,000 \times 15}} = 15.0 \text{ (Approx.)}$$

When any receiver designer states that he gets a uniform amplification per stage of much over this, he has neither used his mathematics nor

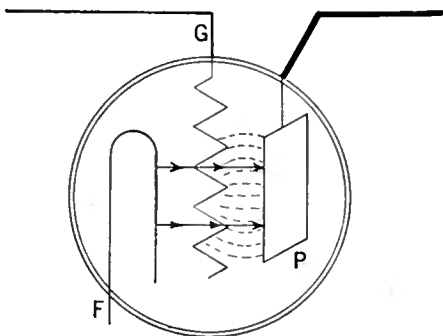

FIG. 5

In the ordinary tube, some electrostatic lines of force connect the plate and grid because they are at different potential. This means, simply, that some capacity exists between them and it is this capacity that causes trouble in the usual high-frequency amplifier

his vacuum-tube voltmeter to substantiate his statement.

This transformer, with its two windings, can be replaced by an auto transformer for all practical purposes, as shown in Fig. 4. An auto transformer, it will be remembered, is used in the "Universal" receiver previously described in this magazine and in the R. B. "Lab." Circuit, when the plate or primary coil is reversed. The impedance of the circuit, looked at from the preceding tube, must equal the impedance of that tube, and the position of the tap regulates the effective transformation ratio, so that this condition is realized, since the ratio of impedances across secondary and primary is equal to the square of the turns ratio.

If we use a special radio-frequency tube with a higher amplification factor and higher impedance, such as the Ceco Type K, we must move the tap higher toward the grid end, or use more primary turns if we use a transformer, while if a 112 type tube is used with its lower impedance, the tap can be brought further down. Table 1 gives essential data on existing tubes. The approximate turns ratio, in the auto transformer case, can be found by substituting the value of plate impedance in the following equation:

$$\text{Turns Ratio} = \frac{60000}{\sqrt{R_p}}$$

TABLE 1

TUBE	μ	R_p	G_m	TURNS RATIO
190	6.25	16,600	380	1.90
201-A	8.00	12,000	675	2.25
112	8.00	5,000	1,600	3.5
210	7.70	5,000	1,540	3.5
171	3.00	2,000	1,500	5.5
222	250.00	700,000	400	1.0
"K"	13.00	16,800	780	1.9

Now all of this sounds simple to carry out but, practically, there are difficulties ahead—most of them due to the fact that the tube does not act like a one-way street. Some traffic always goes in the opposite direction, because of the grid-plate capacity. As soon as we get the tap on our auto transformer moved high enough toward the grid end to secure maximum amplification, we include sufficient inductance in the plate circuit of the amplifier to make it oscillate, and trouble begins. Therefore we must do one of two things: we must either move the tap down, and lose amplification because our equal impedance condition is no longer satisfied, or we must play neutralization tricks on the amplifier to keep it from oscillating, with perhaps slight loss in amplification as the price of stability.

Here is where the screened grid comes in. Suppose, as in Fig. 5, we have the plate receiving electrons from the filament after passing through the grid in straight lines. Because of the fact that the grid and plate are at different potential there will be electrostatic lines between them, represented by the curved lines. In other words, there is some connection between the plate and the grid, other than that produced by the passage of negative electrons. Now if we surround the plate by a fine grid which is grounded, as shown in Fig. 6, these electrostatic lines do not reach the grid, and the latter is free to function only as a control on the flow of electrons. If, in addition, we make this shield positive with respect to the filament and grid, we neutralize some of the space charge which, in turn, boosts the amplification factor to a very high degree.

If the plate is completely screened, the tube will be a one-way repeater, there will be no tendency to oscillate in the familiar tuned grid-tuned plate circuit, and a little mathematics will

show that the amplification is a factor of the mutual conductance of the tube and the external impedance. This external impedance is the effective resistance of the tuned circuit, as already mentioned, and varies as shown below for average coils at usual frequencies. The possible voltage amplification may be easily calculated, with an assumed mutual conductance of 400 micromhos and an infinite plate impedance.

FREQUENCY, KILOCYCLES	$R_0 = \frac{L^2 \omega^2}{R_s}$ OHMS	AMPLIFICATION $G_m \times R_0$
100	400,000	200
1,000	100,000	40
10,000	10,000	4

These values of amplification are considerably greater than is possible with standard tubes such as we all use at the present time. At 1000 kc. (300 meters) the average gain in modern receivers may be as high as 10, and not many sets can do as well without some loss of stability.

Actually, however, these values in the table with the 222 tube will not be attained, since the assumptions on which they were calculated, infinite plate impedance, no grid-plate capacity, and an effective resistance in the plate circuit of 100,000 ohms, are not realized. Since the tube's internal impedance is of the order of a half megohm, or greater, which is considerably more than can be attained by average coils or by coils which will not cut side bands, there is no use in

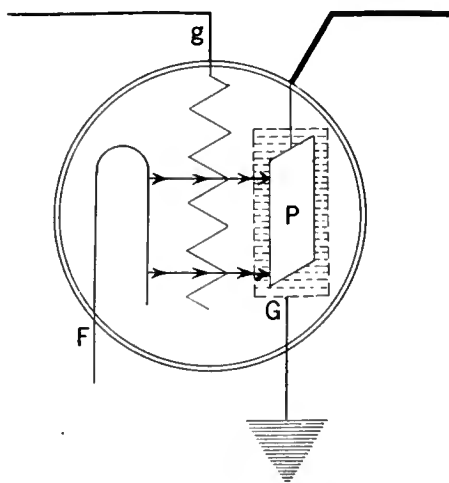

FIG. 6

If a grounded shield is placed around the plate, the lines of force from grid to plate will be interrupted, and fewer changes of plate voltage will affect the grid—in other words, the grid is shielded from the plate

above. If this resistance is equal to that of the tube, approximately one-half the mu of the tube may be realized. With 100,000 ohms in the plate circuit approximately one seventh of the amplification factor, or about 35 may be expected. For maximum voltage gain the effective resist-

amplifier, which had attached to its input a single wire antenna about 35 feet long, and a ground.

With the brass box containing a Rice neutralized amplifier, using a 201-A tube, and with the best position of the plate tap on the detector coil (see Fig. 8), the voltage upon the input to the detector was measured. Then the screened grid tube was used, the whole coil being used in its plate circuit, and the neutralization apparatus was done away with. The voltage was again measured with exactly the same input, and at the same frequency—500 kc. In this case the output voltage was a little over three times the best that could be obtained with the 201-A circuit. Resonance curves showed that the two circuits were about equally selective.

If the 201-A tube gave an amplification of ten, which is reasonable, the new tube had an indicated voltage gain of over 30, which seems to fit in with our calculations explained previously. Two stages would give a gain of 900 compared with 100 for two 201-A amplifiers, or approximately 20 TU, which has about the same effect as adding one stage of audio to existing receivers.

With the antenna described, and with but two tuning circuits, there was no difficulty in separating WEAf and WJZ, 50 kc. apart, when the former was 8 miles away with 50 kilowatts of power in the antenna and the latter was roughly 30 miles distant with somewhat less power. Measurements showed that, with the screened grid tube, WEAf delivered over 4.5 volts to the detector, sadly overloading it.

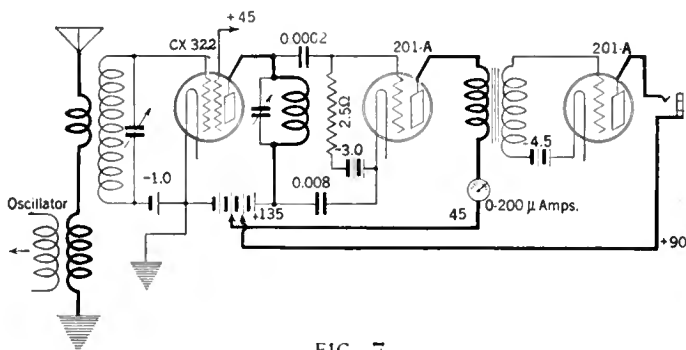

FIG. 7

In the Laboratory this arrangement of apparatus was used to discover the voltage delivered to a detector when the screened grid tube was used as an amplifier. The meter in the detector plate circuit read the change in plate current when a. c. voltages were applied to its grid. It was a calibrated detector, or vacuum-tube, voltmeter

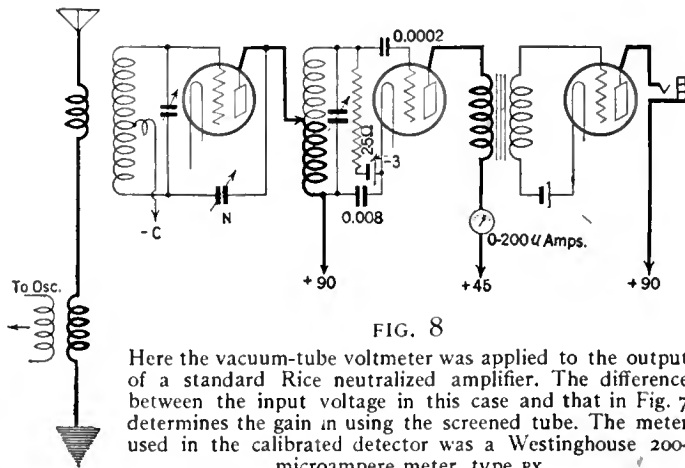

FIG. 8

Here the vacuum-tube voltmeter was applied to the output of a standard Rice neutralized amplifier. The difference between the input voltage in this case and that in Fig. 7 determines the gain in using the screened tube. The meter used in the calibrated detector was a Westinghouse 200-microampere meter, type PX

using a step-down transformer to couple the output of the tube to a succeeding stage, and the whole coil may be used without danger from oscillation.

With the entire coil in the plate circuit, as shown in Fig. 7, the amplification per stage may be figured by somewhat simpler mathematics. In this case we have a simple tuned impedance in the plate circuit of the tube, which at resonance has an effective resistance, as explained

ance must be high, that is, we must use exceptionally good coils of high inductance and low resistance with the probability that fidelity will suffer.

In the Laboratory a simple set-up was employed to examine the tube's behavior. The circuit is shown in Fig. 7 and, as may be seen, consisted of a single amplifier tube followed by a non-regenerative C bias detector which could be calibrated in volts input against change in d. c. plate current.

The shielded tube and its accessory input apparatus was carefully enclosed in a tight brass box, which was grounded. The audio amplifier was useful as a kind of monitoring stage to follow what was happening in the preceding circuits. It made it possible to insure against the amplifier oscillating, etc. A 100-cycle modulated signal was induced into the

The tube may also be used as a space charge grid affair, where the inner grid is positive with respect to the filament and the fine structure which ordinarily screens the plate is used as the signal grid. To test its capabilities the circuit shown in Fig. 9 was used. With an input voltage of 0.1, the gain was about 30, from 60 to 30,000 cycles, and then fell slowly. At the higher frequencies the tube capacities (in the space charge grid tube the capacities are much greater than in the screened grid connection) shunt the output resistance, with consequent loss of amplification.

Here, then, is a tube which must henceforth be carefully considered by all designers of radio equipment, for amplification of the very high frequencies, those of intermediate range such as are used in super-heterodyne receivers and broadcast frequencies, and again at the low audible tones. In all of these ranges it seems probable that greater amplification will be secured than has been possible with ordinary or high-mu tubes. In subsequent articles, we shall discuss the design problems at greater detail and have something to say about the problem of selectivity and fidelity of reproduction.

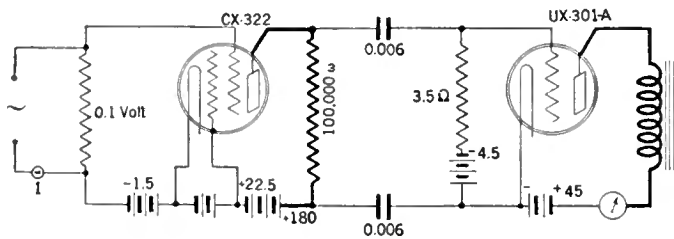

FIG. 9

When the grids of the UX-222 (CX-322) are reversed, i.e., the inner grid is made positive, the amplification factor and plate impedance fall to more usual values, and the tube can be used as an audio- or intermediate-frequency amplifier.

WHAT SET SHALL I BUY?

By
EDGAR H. FELIX



radio market for a long time to come. Magnetically controlled trickle chargers, which turn on automatically when the set switch is turned off, reduce the maintenance responsibility placed on the user of a storage battery to a minimum. Precautions against overcharging, and occasional filling of the cells with distilled water, are the only attentions required. Indeed, this type of storage battery receiver is often sold to the uninitiated buyer as the last word in socket power operation.

Large storage batteries, used almost exclusively with receiving sets four and five years ago, are likely to require replacement after two to five seasons, the period of service depending upon the care taken of the storage battery by its owner, and the quality of the battery itself. Bear in mind, when such replacement becomes necessary, that the reliability of many an old receiver would be greatly improved by the purchase of a trickle charger outfit, a suggestion which may be of value to many persons desiring to give a Christmas gift costing twenty to thirty dollars.

A device of interest to every storage-battery set owner is the "Abox," which may be substituted for the storage battery or trickle charger-storage battery combination. The "Abox" requires no maintenance attention and operates on an entirely different principle from the storage battery-trickle charger combination. Other manufacturers are marketing devices similar in principle to the "Abox." Balkite might be cited as an example.

A comprehensive article on A-power units, in which twenty or so A units were listed, and their characteristics noted, appeared in the November, 1927, RADIO BROADCAST, beginning on page 30 of that issue.

TUBE POWER UNITS

RECEIVING sets having A, B, and C power supplied from vacuum- or gas-tube rectifier units incorporated in the set, require no maintenance other than renewal of rectifier tubes. There is no periodic adding of distilled water to battery or chemical charger, nor is there any other maintenance problem in connection with

WITHOUT repeating the old arguments which earn for radio the title "the ideal Christmas gift," we are certain that more people select a new radio at this season than at any other. The fundamentals of good selection do not change from year to year, but the improvements which come with each new season always bring with them new factors to consider when purchasing. Indeed, the constant improvement of the radio receiver leads some to await new developments, expecting some sort of radio millennium.

Improvement will always continue in the radio art, and he who awaits perfection will neither purchase nor enjoy radio. Were the same policy followed with respect to the purchase of motor cars, some forty million people would still be walking because the ultimate automobile, after a quarter of a century has been devoted to development in this field, is not yet here.

The radio receiver of to-day is a product which, both from the musical and technical standpoint, is capable of many years of service. It will not be greatly outclassed in the musical quality of its output for a long time. In sensitiveness, selectivity, fidelity of reproduction, simplicity of control, and convenience of maintenance, it has reached high standards. In appearance, efficiency, compactness, simplicity of installation, and automatic operation, considerable progress may still be looked forward to, but none of these factors mean great changes in the fundamental output of the radio receiver, that is, reproduced musical programs. We have passed through the period of revolution and have come to the era of refinement in this radio world of ours. There is no longer any excuse for delay in

purchasing a high-grade manufactured receiver.

Maintenance convenience is the keynote of 1927's advances. The last word in installation instructions now is: "Plug the cord in the light socket, turn the set switch, and tune." This is indeed a contrast to the requirements of former years. There were antennas to install, batteries to connect with multi-colored cables, chargers to wire, power amplifiers to plug in, and loud speakers to attach. Between these two extremes, there are several stages of convenience, each of which is still represented in this year's products. The term "light socket operation," for example, is applied to power systems varying considerably in convenience, and is a very flexible term. It is advisable, therefore, to ascertain exactly what type of receiver and what degree of convenience you buy.

There are several ways of powering a receiving set "directly from the light mains." Filament power might be supplied from a storage battery-trickle charger unit and plate power from a rectifier unit operating directly from the power mains; or both filament and plate power may come directly from the mains through a rectifier unit; in another case the filament power may be delivered directly from the line to a set using alternating-current tubes, through a step-down transformer, and plate power obtained through a rectifier unit.

The field of usefulness for the storage battery receiver is far from exhausted. Its lower manufacturing costs give it a price advantage, at no sacrifice in attainable performance, over the alternating-current powered receiver. Because of lower cost, it is destined to remain in the

these sets. There are a large number of receivers of this type on the market. With skillful engineering and high-grade components, they offer care-free and high-quality reception. If carelessly designed, they may give a marred output because of excessive hum, and unreliability of service due to failures in vital parts. It should not be thought, however, that a set is necessarily good because it does not hum. If poor audio transformers are incorporated they may not be capable of amplifying the low-frequency hum produced by alternating current. The problem of the uninitiated in distinguishing between the inferior and the superior type is perplexing. The name and reputation of the manufacturer, the endorsement of men technically qualified to judge radio products, and the pages of high-grade publications, which censor and check the statements made in their advertising columns, are helpful sources of information and guidance.

Practical tests can be made by the technically untutored buyer, when a set is being demonstrated, which will protect him against the purchase of a power set of inferior design. The principal characteristic of a poorly designed receiver, deriving its A, B, and C potentials directly from the light mains, including both those employing rectifier systems and those using a. c. tubes, is the excessive hum experienced when the set is adjusted to sensitive reception.

A dealer, selling a radio set subject to hum, is likely to concentrate his demonstration upon the reception of strong, near-by stations. Ask him to tune-in a weak station, preferably one fifty or a hundred miles away, during the daytime, or one several hundred miles away at night, requiring that the sensitivity or volume control be turned up all the way to get the station comfortably. Then slightly detune the set. Without the covering effect of the music, you should then get a direct indication of how much the receiver hums under unfavorable conditions provided, of course, that a loud speaker is used which reproduces the very low notes. To be entirely satisfactory, the hum should be so weak that it cannot be heard in a quiet room ten feet from the loud speaker which the prospective purchaser will use.

It is quite possible to attain this standard but it costs money. A great discrepancy in price between two sets having the same sensitiveness, tone quality, and appearance, is often accounted for by the complete absence of hum in the more expensive receiver. The hum test is a simple one and should be made by every purchaser, regardless of his technical qualifications.

MEETING MODERN STANDARDS OF FIDELITY

IF THERE is one quality in radio receiving sets which has been appreciated by manufacturers, it is the ability to produce good tone. The judgment of a receiver's tone quality has already been fully discussed by the author in three recent issues of RADIO BROADCAST and hence it is unnecessary to repeat in great detail the factors applying to this most important requirement. Briefly, to obtain good tone quality requires that the set have: (1) Adequate power supplied the loud speaker by the use of a UX-171 (CX-371) type output tube, or even by the still more powerful UX-210 (CX-310) type tube; (2) an audio amplifying system which covers the tonal scale and (3) a loud speaker adequate to handle the volume and tonal range supplied it. To the non-technical reader, these requirements may seem difficult to appraise. But a simple test reveals a great deal about the tonal capacity of a receiver. Ask the dealer to tune-in a strong, near-by signal and bring it to full volume. Although the music is uncomfortably loud, using

the output tubes mentioned, it should not, even with very strong signals, be scratchy, stringy, or drummy. Music should be simply loud with tonal quality unaffected.

The second test is to listen critically with the set at moderate volume for the instruments producing low tones, like the 'cello, drums, or the organ. If these appear to be in their proper proportion, without being overshadowed by the treble, the receiver is capable of handling low tones.

There is much danger of selecting a set which exaggerates the low tones, a characteristic easily demonstrated in speech. A low, throaty, ringing effect, which makes words difficult to understand, is an indication of over amplification of low notes. A receiver omitting low notes, usually gives harsh, unsympathetic, but clear speech. Speech over the telephone is quite easily understood, but the rich, sympathetic quality of a good voice is lost because of absence of low tones in telephone transmission.

TESTING FOR SELECTIVITY

SELECTIVITY is necessary under modern receiving conditions, particularly in congested areas. Generally speaking, the more tubes a set has, the more likely it is to be selective, because each stage of radio-frequency amplification adds another filter circuit. It does not necessarily follow, however, that a great number of tubes means great selectivity any more than a great number of cylinders means great power in an automobile.

The pick-up system used is a valuable guide in determining the selectivity. Given an equal number of stages of radio-frequency amplification, an antenna set is likely to be less selective than one with a loop. A receiver lacking in selectivity, can often be improved by shortening the antenna.

Selectivity is simply tested but it is hardly possible to set down any definite procedure since local conditions play an important part; while a receiver may be perfectly satisfactory in one district, it might fail badly elsewhere, where the conditions and requirements are different.

There are some receiving sets so lacking in selectivity that the nearest station (we do *not* mean a so-called "super-power" station) can be heard over one-fourth to one-eighth of the entire dials' scales, while a few, high-grade receivers pick up the same station over only two or three degrees of the dial. The signal should tune-in fairly sharply without long fringes over which it is heard weakly above and below the point where it is heard at full volume. The selectivity with a weak and distant station is no indication of the receiver's performance under ordinary conditions.

EVALUATING SIMPLICITY OF CONTROL

THE third factor, and one of great importance, if the entire family is to use the receiver, is its simplicity. Only three controls are essential to the operation of the receiver: (1.) An "on-off" switch; (2.) a volume control and (3.) station selector. The "on-off" switch should take care of all power supply connections, such as those of the chargers and power supply units, as well as the filaments of the tubes themselves.

The volume control should enable you to bring the loudest, near-by station down to a whisper, without impairing its quality, while the station selector should give you the complete parade of broadcasting stations, up and down the scale, without requiring any other adjustment. Set the volume control to a weak station and turn

the dial from top to bottom and the stations should come in in the order of their frequency, this depending, of course, on their power and distance.

If, at the low end of the dial, the tone quality of the station cannot be cleared up without cutting down the volume control, the receiver is not properly balanced and probably radiates, and thus interferes with other receivers on the short wavelengths. The functioning of volume control and station selector should not be interdependent.

When two station selectors are used, which is frequently the case, one may be calibrated in frequencies, so that the dial may be set to a desired station accurately, and the other arbitrarily calibrated from 1 to 100, suiting it to antennas of different length. It is not inconvenient to operate a receiver with two station selectors, although the ideal arrangement provides but one.

Receivers having a single station selector and designed for antenna (as opposed to loop) operation, generally require an extra stage of radio-frequency amplification generally untuned. This extra stage only contributes little amplification and does not materially affect the selectivity. Because of this consideration, the fallacy of rating a receiver's capabilities by the number of tubes it possesses is obvious. Its sensitiveness and selectivity are dependent upon the number of stages of *tuned* radio-frequency amplification.

The buyer is often perplexed by the great number of receivers, apparently similar, but possessing a wide range of price. The factors of tone quality, selectivity, and volume capacity may be roughly tested upon demonstration, but unreliability develops only in service. Beware of the receiver that is too cheap, particularly one having power supply incorporated in it, because filter condensers may break down and mechanical difficulties may arise in service. It is true that very large quantity production decreases costs but, as with everything else, you do not get something for nothing. The extra cost of purchasing a set having back of it the name of a well-known manufacturer, is a protection against the hidden factor of unreliability. There is no reason for tolerating an unreliable receiver because the instrument which the buyer has at his command nowadays requires virtually no attention other than the periodic renewal of tubes.

The question is often asked, "How much does a good radio cost?" or "What is the best radio set for the money?" There are so many different requirements which must be met, dependent upon receiving conditions where the set is to be installed, and so wide a variation in the skill and temperament of the users, that such general questions cannot be answered.

The qualities every discriminating listener looks for are good tone, reliability, selectivity, convenience, and simplicity.

The prospective purchaser of a radio receiver should be fully cognizant of his requirements before setting forth to the radio store: He may also decide how far he will go in cost to secure the degree of maintenance convenience he desires, as already considered. He will confirm the quality of design of the power supply by listening for hum with the receiver set at maximum sensitiveness with no station tuned-in; its volume capacity and selectivity by tuning in the loudest near-by station to maximum volume; its tonal range by listening for low and high tones; and its simplicity by checking the exact number of operations required to tune-in a desired station. With the aid of these precautions, he will know just what he is buying and be able to compare intelligently one receiver with another.

“Our Readers Suggest—”

OUR Readers Suggest... is a regular feature of RADIO BROADCAST, made up of contributions from our readers dealing with their experiences in the use of manufactured radio apparatus. Little “kinks,” the result of experience, which give improved operation, will be described here. Regular space rates will be paid for contributions accepted, and these should be addressed to “The Complete Set Editor,” RADIO BROADCAST, Garden City, New York. A special award of \$10 will be paid each month for the best contribution published. The award for the December prize contribution “Antenna Compensation in a Single-Control Receiver” goes to Harold Boyd of Winchester, Virginia.

—THE EDITOR.

Eliminating the Loop

A FREQUENTLY suggested method of increasing the sensitivity of loop receivers is that of coupling the loop to a short antenna. This, of course, is a feasible proposition, but when coupling to any sort of an open antenna, why not eliminate the loop altogether?

The system generally advocated when a loop is used in conjunction with some kind of antenna is that of winding several extra turns of wire on the loop-frame and connecting the short antenna span and a ground lead to the two ends of these extra turns of wire. The combination of the loop with an extra winding thus constitutes a simple coupler, but one of rather extravagant dimensions. There is no reason why the size of the coupler cannot be reduced to more conventional dimensions, and an ordinary antenna coupler, such as an Aero or Bruno-Coil, substituted for it. The loop-antenna combination will be no more sensitive than the antenna-small coupler arrangement.

It requires no technical skill to effect the change. The coupler consists of two windings, a primary winding having relatively few turns—from six to twenty—and the secondary, having about fifty turns of wire. The primary should be connected between antenna and ground while the secondary should be substituted for the loop, as shown in Fig. 1.

It is desirable to obtain a coupler of the correct size for the tuning condenser. If the connections from the loop are traced, they will be found to lead to a variable condenser. In the majority of cases this condenser will have a capacity of 0.00035 mfd. The capacity of the condenser can almost always be determined by counting the plates. A condenser having approximately thirteen plates has a capacity of 0.0003 mfd.; one having about 17 plates is probably 0.00035 mfd.; with 23 plates, the capacity will be near 0.0005 mfd. In purchasing a coupler, specify the size condenser it is to be used with. In the few instances where it is difficult to determine the exact

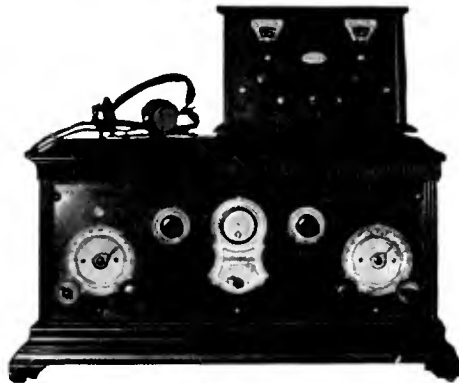

THE CROSLY “LOWAVE”

Used with a Stromberg Carlson “Treasure Chest.” See descriptive matter in the box below

capacity, obtain a coupler for a 0.0003-mfd. condenser. If you find that the receiver no longer responds to the shorter wavelengths, or that the longest desirable wave is attained with a considerable portion of the tuning condenser unused, a few turns can be taken from the secondary.

It is a simple matter to wind your own coupler. The following tables give the correct number of turns of wire:

CONDENSER	TUBING DIAMETER	WIRE D.C.C.	TURNS	
			PRI.	SEC.
13 Plates 0.0003 Mfd.	3-1/4"	No. 24	14	55
	3"	No. 24	16	64
	2-3/4"	No. 28	18	70
This Coil Has an Inductance of 282 Microhenries				
17 Plates 0.00035 Mfd.	3-1/4"	No. 24	12	49
	3"	No. 24	14	58
	2-3/4"	No. 28	16	64
This Coil Has an Inductance of 245 Microhenries				
23 Plates 0.0005 Mfd.	3-1/4"	No. 24	11	40
	3"	No. 24	12	40
	2-1/2"	No. 28	13	50
This Coil Has an Inductance of 175.6 Microhenries				

ARE YOU INTERESTED IN SHORT WAVES?

LAST month in this department we published the description of a simple home-made short-wave converter, an auxiliary attachment which makes it possible to receive wavelengths as short as 18 meters (16,700 kc.) on any receiver. RADIO BROADCAST Laboratory has recently received a commercial instrument, the Crosley “Lowave,” of somewhat similar design. Its adaptation to a Stromberg Carlson “Treasure Chest” receiver is shown in an accompanying photograph.

The Crosley “Lowave” is an especially designed circuit employing three tubes, and so arranged that the radio-frequency amplifier of the broadcast receiver is also utilized. The “Lowave” is connected to batteries according to directions, and one wire is led from it to the antenna post of the broadcast receiver. A small switch on the front of the panel throws the short wave attachment in or out of the circuit.

In tuning over the very high frequencies with such a converter, many broadcasting stations will be heard, but a great majority of them carry a badly distorted signal, which no amount of tuning will clear up. These are the harmonics of standard broadcasting stations, the frequency characteristics of which are invariably badly garbled. True short-wave broadcasting will be received as clearly as long-wave reception.

THE LABORATORY STAFF

I am using a simple electric light plug antenna made by Dubilier. The substitution for the loop was effected in this case not because of poor sensitivity, but merely for esthetic reasons—to do away with the unsightly loop. The successful use of this system is by no means confined to super-heterodynes and may be applied to any loop receiver.

A. J. HOWARD
New York City.

Combining Horn and Cone

CERTAIN of the cone type loud speakers now on the market are designed to compensate the failure of the usual two-stage transformer-coupled amplifier to satisfactorily amplify the very low audio frequencies. The customary audio amplifier feeding into such a loud speaker gives a very satisfactory overall characteristic. If, however, the audio amplifier itself is designed to give a slightly rising low-frequency characteristic, or even “straight-line” amplification, and it be used to feed into a cone of the type described, the bass is emphasized to such an extent that a sense of frequency distortion is introduced.

A three-stage audio amplifier was hooked up in conjunction with a Radio Corporation of America cone loud speaker, model 100 A. The resultant reproduction gave the effect of exaggerated bass. A very great improvement in the quality was accomplished in the following manner:

A Radiola horn type loud speaker was obtained and connected in series with the model 100A cone. The horn was shunted by a Centralab Modulator, variable from 0 to 50,000 ohms, as suggested in Fig. 2. Without this shunt, the proportion of the total load taken by the horn would have been excessive, on account of the higher impedance of its windings. With the shunt resistance set at about 25,000 ohms, the load seemed to be about equalized between the two loud speakers. Between 25,000 ohms and 50,000 ohms the effect of the horn was more pronounced, while from 25,000 down to zero, the cone predominated. At a setting of zero the horn was completely shunted from the circuit.

The particular cone used in this circuit gave excellent reproduction of the bass, while the horn brought out the treble clear and distinct. The reproduction resulting from this combination of

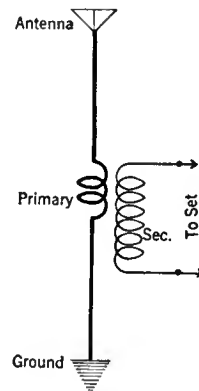

FIG. 1

about 20,000 ohms was the most pleasing the writer has ever listened to. By the turn of a single knob it was possible to bring out the bass or treble to any relative degree to suit the particular ear of the listener.

D. C. REDGRAVE
Norfolk, Virginia.

Another Cone and Horn Combination

LIKE many other radio fans I recently discarded my horn loud speaker for a cone. When listening attentively, I decided that the cone slighted the higher frequencies somewhat so I dug out the old horn, which rather favors the high notes, with the idea of using the two loud speakers in combination. But the impedance of the loud speakers were so poorly matched that some balancing arrangement had to be devised.

I evolved the scheme illustrated in Fig. 3, employing a half-megohm potentiometer, such as is often used for a volume control. As the slider is moved, one loud speaker is cut in and one eliminated.

I soon found, however, that I needed a better criterion than my ears to place the slider where it belonged, so I plugged a pair of good phones in the detector plate circuit

and adjusted the potentiometer until the loud speakers duplicated the pitch of the telephone receivers.

H. D. HATCH
Boston, Massachusetts

STAFF COMMENT

THE choice of the systems outlined above by our two readers rests pretty much on the convenience of what you have in the way of a variable resistor. Fig. 3 provides a greater variation in loud speaker selection than Fig. 2 but sufficient variation can be secured with the latter for the purpose of correct balance. In the arrangement shown in Fig. 2 the variable resistor should always be connected across the loud speaker having the higher impedance, i. e., the loud speaker that seems to produce the most sound when the resistor is disconnected.

Mr. Hatch's system for adjusting the relative intensities of the two loud speakers is worthy of special note. While a preference may exist for an emphasis of high or low notes (adjusting to suit individual tastes), this is not necessarily natural reproduction. The phone test method probably provides as correct a balance as can be achieved without elaborate equipment.

C Bias from B Socket Power Units

IN THIS department for November, 1927, an interesting item was published showing how a B socket power device could be changed to supply grid bias voltages as well as plate potentials. In effecting this change, it was necessary to "get inside" the device, break a connection, and make several additions. This method is quite practicable, but there is always a general disinclination to "monkey" with a commercial set-up.

It is possible to obtain the C bias potentials by application of external resistors—no change whatever being necessary in the device itself.

In so doing, several possible faults in the device can be corrected, such as break down of resistors, as may be evident in noisy reception and poor voltage regulation. It is also possible with the external arrangement to secure voltages other than those supplied by the original device for special sets or purposes.

The additional device takes the form of an entirely separate set of resistors, which is connected between the high-voltage and negative posts on the old power unit. The resistors are tapped to supply the desired B and C potentials and are mounted on a base-board.

The number of resistors required is determined by the number of voltage outlets. We shall need one Amsco "Duostat" to supply two variable "C" biases, while one resistor will be required between the negative tap and the lowest positive plate tap, and another resistor for each additional plate tap. The Amsco "Duostat" is equipped with two variable arms, making it possible to secure two variable C bias potentials with the one resistance unit.

The average arrangement is shown in Fig. 4, which requires three fixed resistors in addition to the "Duostat." The fixed resistors may be any satisfactory power resistor, such as those of Electrad, Amsco, Metaloid, Ward Leonard, Durham, Carter, etc.

The method of calculating the values of the resistors takes into consideration the probable plate current drain through each resistor, and is best illustrated by the example of Fig. 4.

An arbitrary value of ten milliamperes is chosen as the loss current—the current through the resistors over and above that drawn by the receiver. The presence of this loss current reduces the variations in voltage with slight differences in load. The higher the loss current the better the voltage regulation.

The output from the average power device receiver combination under load is about 200 volts. By an application of Ohm's Law, which tells us that the resistance is always equal to the voltage drop divided by the current in amperes, or one thousand times the voltage drop divided by the current in milliamperes, it is a simple matter to determine the total resistance necessary. The equation in this case is:

$$R = \frac{200 \times 1000}{10} = 20,000 \text{ Ohms}$$

So the total resistance of the "bridge" will be 20,000 ohms, 2000 of which is already apportioned to the "Duostat," R₄. It remains to calculate the values of R₁, R₂, and R₃. To do this, we must consider the probable plate currents through these resistors. A 201-A type tube, properly biased, draws the following currents: r. f. amplifier, 90 volts, 4 milliamperes; detector, 45 volts, 1.5 milliamperes; a. f. amplifier, 90 volts, 2 milliamperes.

We shall consider a receiver which comprises three r. f. tubes, detector, and two audio tubes, the last of which should be a power tube functioning directly from the highest voltage. So the first five tubes are all we have to consider now in designing the resistor bank.

Refer once more to Fig. 4. The current through R₁ is 10 milliamperes loss current, plus 12 milliamperes r. f. current, plus 1.5 milliamperes detector current, plus 2 milliamperes 1st audio current, or a total current of approximately 26 milliamperes. The voltage drop is 200 volts less 90 volts, or 110 volts. By Ohm's Law, the value of the resistor will be:

$$R_1 = \frac{110 \times 1000}{26} = 4200 \text{ Ohms}$$

R₂ carries a loss current of 10 milliamperes plus the detector plate current of 1.5 milliamperes. The voltage drop is from 90 volts to 45 volts. The calculation here is:

$$R_2 = \frac{45 \times 1000}{11.5} = 3900 \text{ Ohms}$$

Only the value of R₃ remains to be calculated. As the sum total of all the other resistors is 10,100 ohms, R₃ obviously should have a value of 9900 ohms—or, say, 10,000 ohms.

The resistors should always be capable of dissipating sufficient wattage. The wattage is equal to the voltage drop across any particular resistor times the current in milliamperes divided by 1000. The wattage in R₁ therefore is:

$$W_1 = \frac{110 \times 26}{1000} = 2.86$$

A five-watt resistor should be used, thus insuring perfect safety.

Similarly R₂ should be a 1- or 2-watt resistor, and R₃ the same.

In the majority of cases the reader will not have to make the calculations outlined above, for the resistor bank shown in Fig. 5 is well adaptable to the average B power device and receiver.

The resistor bank is merely connected to the old B power unit at the high-voltage and negative posts. No other posts on the B device are connected, the various voltages now being drawn from the new resistors.

JOHN J. WILLIS
Batavia, Illinois.

STAFF COMMENT

MR. WILLIS suggests a simple way of obtaining various B and C voltages from B power device other than those for which the device was originally designed. No changes whatever are made in the B unit itself. This arrangement, however, is practical only in the case of B device supplying voltages of 220 or more with a drain of 35 milliamperes, since the obtaining of C bias will reduce the voltage of the maximum B tap by an amount equal to that of C voltage. Thus, a device ordinarily capable of delivering 220 volts will still deliver sufficient voltage (180 v.) for best operation of a 171 type tube after a reduction of 40 volts is made to provide for C bias. The output of your present B device can be determined from the manufacturer's specifications accompanying it.

The resistor unit should be bypassed with 1-mfd. condensers, as indicated by the dotted lines in Fig. 4.

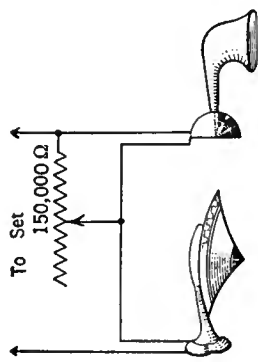

FIG. 2

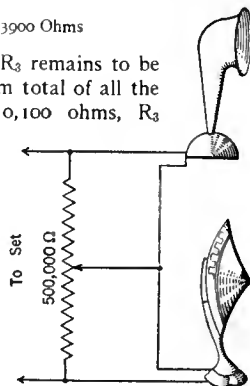

FIG. 3

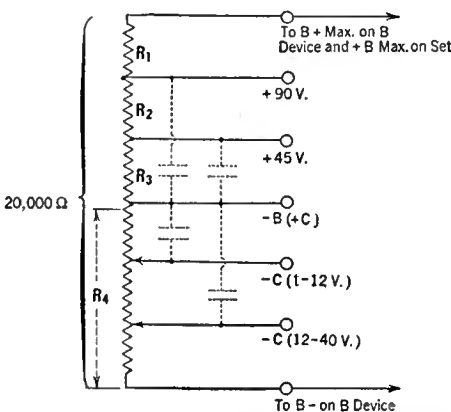
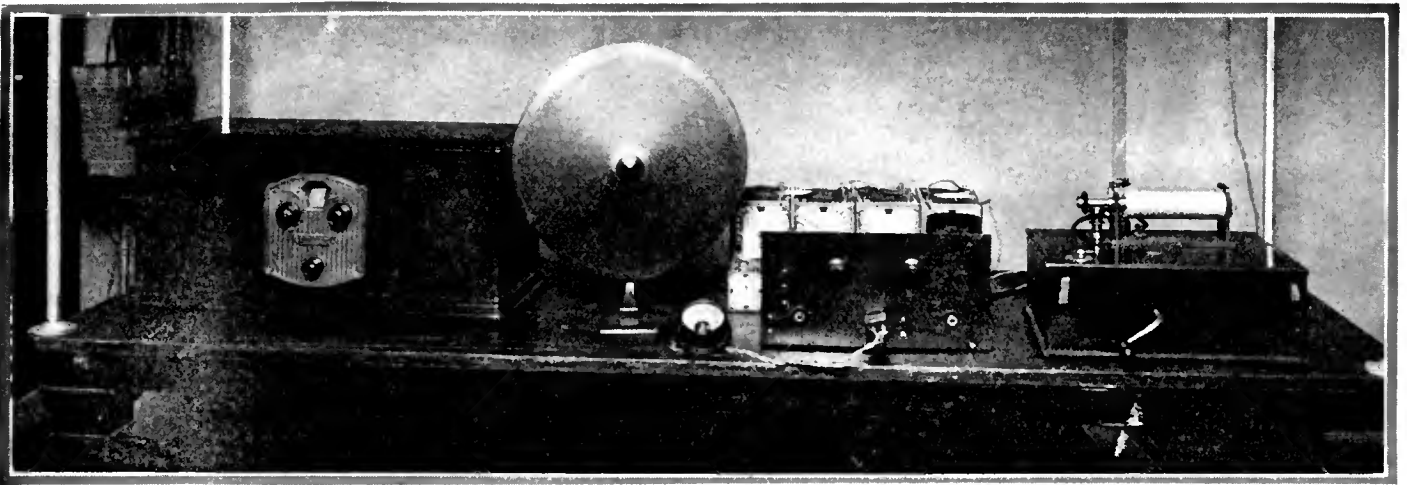

FIG. 4



L. Bamberger & Co. Photograph

A COMPLETE COOLEY RAYFOTO RECEIVING INSTALLATION

The incoming radio signals from a standard broadcasting station are received on a standard Freed-Eisemann broadcast receiver the audio output of which is connected to the printer unit and thence to the recorder at the extreme right. Station WOP, on November 5, 1927, transmitted the first series of radio pictures ever to be sent from a broadcasting station which were successfully received by an installation similar to this. This complete Cooley receiver was demonstrated early in November at a special radio show held at the Bamberger store in Newark. There are only two essential units to the Cooley Rayfoto receiving apparatus and they are shown on the table at the right of the loud speaker. Any good broadcast receiver can be used to pick up the Rayfoto signals. The recorder at the extreme right is not the type usually supplied, which is furnished without the spring phonograph motor. The commercial recorder may be attached to the turntable of any standard phonograph, thus decreasing the expense

WHY I INSTALLED A COOLEY PICTURE RECEIVER

By Edgar H. Felix

BEFORE me, as I write, is a photograph of a lady. I treasure it highly. Her face is rather indistinct; in fact, I doubt if I could recognize her from the photograph. Although the circumstances surrounding the acquisition of this photograph are highly romantic and thrilling, I neither hope, seek, nor expect to make her acquaintance. Yet her picture will always remain a treasured memento. It is the beginning of a beautiful friendship, a new addiction which will make my charming wife still more thoroughly a radio widow. My new absorbing interest is the radio reception of photographs and the valued curio is the first photograph ever received on a home-assembled radio picture receiver from any broadcasting station.

Not many months will pass before picture transmission will be a regular feature of broadcasting programs. I do not say this because I have inside information, but because picture reception is an inevitable step in the progress of broadcasting. The only hindrance so far has been the fact that no simple and inexpensive apparatus has been available, a problem which has been solved by the appearance of the Cooley Rayfoto System.

It is easy to speculate on the possibilities of picture reception. Most people think of it as a means of seeing broadcasting artists performing in the studio. Although such a use of picture transmission is quite feasible, it is only a minor application. Imagine a ringside description of a champion prize-fight coming through the loud speaker, while near-by your Rayfoto recorder is grinding out one picture after another of the high lights of each round. Or, imagine the ceremonies at the take-off of the first transatlantic air liner, accompanied by pictures of the immense bird taking on its cargo, taking off with its load, and finally disappearing in the distance.

The new medium has all the diverse possibilities of tonal broadcasting and it will add a new lure to radio reception. Perhaps my imagination runs away with me because I have just

made my first radio picture, but I firmly believe that it is only the first of hundreds, each of improved quality, which I shall pick out of the air.

On November 5, 1927, WOP, the broadcasting station of L. Bamberger & Co., Newark, New Jersey, put the first picture on the air from a public broadcasting station. It was only a preliminary test, to precede a public demonstration. So far as I know, my picture receiver was the only one, not installed at an experimental laboratory, capable of receiving the picture. But so great has been the interest manifested by set builders in picture reception that I am sure thousands of picture receivers will be in operation within a few weeks.

Picture transmission by wire and radio is not a



© Bachrach

AUSTIN G. COOLEY

new art. Pictures flash across the Atlantic by the Ranger system almost daily. The Jenkins system has been available to amateurs for years. The A. T. & T. has been transmitting high-quality pictures over wire lines to all parts of the country for some time. But most of these systems require either expensive receiving apparatus or more than one broadcasting channel, so that they are hardly suited to widespread use without considerable development.

THE COOLEY SYSTEM IS SIMPLE

THE Cooley Rayfoto system is rugged and inexpensive. It uses but a single radio telephone channel for transmission. The parts for a picture recorder cost no more than those required for a good six-tube home built receiver. The quality—and quality in picture reception means detail and accuracy in shading—is not below the standard of tonal reception quality which we had in 1921 and 1922, a quality sufficient to set the world on fire with a broadcasting boom. There is no reason to doubt that picture reception will improve as rapidly as did tone quality in a like period. In fact, all of the experience gained with tone broadcasting is directly applicable to the broadcasting of pictures.

The constructional details of the Cooley system have been given completely in this magazine. The radio element of the Cooley apparatus is no more difficult to assemble than a two-tube radio set. Essentially, it is a stage of audio-frequency amplification, coupled so as to modulate the output of an oscillator. It can be assembled and wired in two hours. The rest of the work is connecting power supply, setting the mechanical unit on the phonograph, and adjusting the relay, corona discharge, and phonograph motor speed. Mr. Cooley, in his articles, has described these matters in some detail; my only purpose in mentioning them here is to give you an idea of how easy it is to get the Cooley receiver in working order.

To receive this treasured picture of mine, we adjusted the Rayfoto relay by tuning-in a musical program. A few moments of tinkering with a screwdriver and the relay tripped at each loud modulation peak. Mr. J. L. Whittaker, who did most of the hard work while I looked on, had the relay working in two minutes.

Adjusting the corona offered no special difficulties. By tuning the variable condenser across the oscillator coil, the corona starts as soon as the oscillator starts going. There really isn't anything to it. To get the modulation current right, you plug in the meter to set the input at the correct value. It's only a matter of juggling the input volume control.

Synchronizing the phonograph motor when everything else is working properly is simple when you know how. The phonograph motor should revolve just rapidly enough so that the synchronizing signal releases the drum at each revolution. When it does so, the drum stops with a firm click and then resumes turning with hardly a perceptible stop. When it is working just right, the drum stop makes its click with perfect regularity, about as loud as that of a typewriter key against the platen. If the speed is decreased below this point, there is a drop in the intensity of the clicks and a few may skip entirely. That is the critical speed, when the drum is at "zero beat" with the transmitting drum. At that speed, the synchronizing signal is not utilized in releasing the drum; at a slightly faster speed, when the clicks are regular, it is in proper adjustment.

These three adjustments made, and you are ready to receive the picture. We got the first one quite well, but we did not get the second one. First the grid leak went wrong, dimming the corona. Then the phonograph needle slipped off the bushing. Then the relay stuck. And, finally, the A battery went down. Of course, we didn't get the second picture!

So, you see, there is plenty that may happen when you get your first picture with a Cooley receiver. You have reason to be proud of a successful result. Of course, when there are plenty

of pictures on the air, you won't have to meet all of your troubles in two short minutes. And, more important, is the advantage to be gained if you have a phonograph record of a Cooley picture transmission. I recorded the Cooley transmissions from wor

The author receiving pictures by means of a Cooley Rayfoto receiver

on a high-quality Dictaphone. By reproducing these records with an electric pick-up, every element of the picture receiver can be put in working order before transmission begins. Such records can probably be used for transmission purposes so that all the broadcasting station needs to put Cooley pictures on the air is a phonograph record and a phonograph.

THE GATEWAY TO TELEVISION

PICTURE transmission is the gateway to television and every red-blooded experimenter longs for the opportunity to become familiar with its problems by actual experience. The Cooley system sends the picture in one minute and to increase this speed of transmission sufficiently to get motion pictures requires a thousandfolding of this speed. Considering the magnitude of the improvement required, it seems impossible that the Cooley system can



ever be the basis for television. A fundamental and startling invention is necessary before so great an increase of speed can be hoped for. There have been demonstrations of television already, but all use electrical machinery so complex and expensive that the tests really proved that television is not yet a practical possibility with our present knowledge.

Someone will some day accomplish the essential invention to make television practical. Very probably the discoverer will be someone who has worked with picture transmission. And the man who does make television possible will go down as one of the world's greatest inventors.

Thousandfolding the speed of any process is a large order. But remember that only twenty-five years ago, when radio telegraphy made its appearance, the detector used was a glass tube filled with iron filings. Electromagnetic waves caused these iron filings to congeal or cohere so that the current from a local battery flowed through them. This operated a sounder. The iron filings were agitated by the clapper of a bell so that they would de-cohere or interrupt the battery current as soon as the radio wave ceased flowing through it. With this crude apparatus, transmission of two, three, four, and five words a minute was the maximum possible. Ranges were matters of a few miles.

Then came the invention of Marconi's magnetic detector. This greatly increased both speed and range. And then the really revolutionary vacuum tube. Now, with high-speed radio telegraphy, we send thousands of characters a minute. From many of the long-wave, transoceanic stations, you can hear the myriad of dots and dashes, so rapid that you cannot distinguish between them. The step from the coherer to radio telephone transmission and reception is no greater than that necessary from telephotography to television. Undoubtedly, someone will make that essential invention to make television possible and I hope it will be an American amateur experimenter, who has enough vision to see in the crude, simple, telephotographic apparatus available to him to-day the possibilities of the great new science and art of the future.



TWO PICTURES RECEIVED ON A RAYFOTO RECEIVER

The picture on the right shows the effect of improper adjustment of the oscillator in the Rayfoto printer unit. The white streaks are produced when the oscillator suddenly stops oscillating. The left-hand picture indicates the improvement in results after the oscillator has been adjusted. For best results the oscillator should not be tuned exactly to the point at which the maximum corona discharge is obtained since, when so adjusted, it is rather critical and easily stops oscillating. The variable condenser controlling the oscillator circuit should always be slightly detuned from that point at which maximum corona discharge is obtained

Suppressing Radio Interference

Every Conceivable Source of Radio Interference Is Considered, Remedial Suggestions Being Offered—Farm Lighting Plants, Railway Signals, Telegraph Lines, Stock Tickers, Street Railways, and Interference Originating in the Receiver Itself, Are Taken up in This Chapter

By A. T. LAWTON

THE studies made by the author in the elimination of interference have been so extensive that it would be hardly possible to combine the various chapters in one issue. An endeavor has been made, however, to eliminate cross references so that each article in the series may be complete in itself. The forms of interference covered in the two previous chapters, printed in the September and November, 1927, issues of RADIO BROADCAST, dealt with interference originating at the following sources: Oil-burning furnaces, X-ray equipment, dental motors, motion-picture theatres, telephone exchanges, arc lamps, incandescent street lamps, flour mills, factory belts, electric warming pads, and precipitators. The information printed results from a two-and-a-half-year study by the author in more than 132 cities. The first form of interference considered in the present chapter, is that originating in farm lighting plants.

FARM LIGHTING PLANTS

INTERFERENCE from this source is confined to rural districts. The characteristic click, click, corresponding to the ignition spark, reveals the source at once; rarely do we get trouble from the commutator.

This continuous clicking is very loud on nearby radio receivers and because of the large number of plants in operation in communities not served by electric power companies, the total interference is very annoying.

Complete elimination of the disturbance created is a relatively simple matter. Nearly all these plants, being bolted down to a wooden platform, are insulated from the ground and two 2-microfarad condensers in series, midpoint connected to the engine frame, and bridged across the outgoing d.c. feeders, will clear up the clicking. Ground connection of the series wire should not be made to a water pipe or earth rod in this case. Even 1-microfarad condensers will be found suitable for small plants.

If the engine bed is of concrete or the plant is grounded in some other way, complete elimination is not obtained by the above method although the reduction (about 80 per cent.) is material. The remaining interference is not likely to be serious. However, where it is desired to

clear this out also, choke coils should prove effective.

It is not uncommon to find the exhaust pipe of such plants carried to a muffler drum in the ground; such a connection to earth offsets the effect of the condensers and more satisfactory results will be obtained if this pipe is cut and a section of asbestos or other suitable piping inserted.

Further experimental work is required in the cases where Electrical Inspections call for the grounding of small lighting plants. Possibly a fine wire choke coil, say, of No. 26 wire, bridged by a standard lightning arrester, would be satisfactory, the coil preventing the accumulation of any static charge and the arrester taking care of any abnormal surge superimposed on the system from outside sources.

As a precaution, all leads around the plant proper, either high- or low-tension, should be cut as short as possible.

Where one or two of the storage cells are used to operate a radio set as well as light the residence, complete elimination of the trouble for that particular set becomes difficult.

Prior to arriving at suitable preventive measures in the various plants investigated, experiments were carried out directly on the ignition system but all methods tried proved of no avail. In the case of "make and break" type ignition, condensers applied directly to the ignition system stalled the engine, apparently neutralizing the effect of the inductance coil, but were quite effective on the outgoing lines and, of course, did not interfere with normal operation.

In all cases attachment of the condensers is made at the switchboard, under the same terminals to which the two lighting mains are connected.

RAILWAY SIGNALS

RAILWAY "wig-wag" signs and crossing bells give rise to heavy clicking radio interference. Fortunately, their periods of operation are limited, but where the trouble is material it can be cleared up by shunting the operating contacts with a resistance of about 350 ohms. This applies to low-voltage d.c. operated bells and signals.

For types operating on 400-600 volts it is necessary to bridge each individual set of contacts with a resistance of the above order.

The vibrating reed type battery charger used in conjunction with these signals is a real offender. Interference from this source has given rise to a large number of complaints but, generally speaking, railway companies are averse to tacking on any surge traps to this equipment and in the dozen or so cases cleared up, the operating company took the chargers out bodily and substituted a type which is silent so far as radio interference is concerned.

LAND LINE TELEGRAPH AND STOCK TICKERS

RAPID clicking interference from the above equipment is a serious matter in towns and smaller cities. Not that there is less telegraph activity in the larger centres, but in the places referred to a comparatively greater number of residences and radio dealers are located in the vicinity of the telegraph offices.

Normal operation of the keys and repeaters set up a vigorous highly damped wave which breaks in on practically any setting of the dials of the average radio set. The clicking from stock tickers is severe even where the wires are enclosed in lead-sheathed cable.

Since it is necessary to apply suppressive measures to each individual line, the factor of cost looms large when we consider the number of lines entering the average city office. Where only a few lines are concerned it is usual to place a 1-microfarad condenser across the key contacts inserting in each condenser lead a resistance of about 20 or 30 ohms.

Strictly speaking, only one resistance unit is required but it makes a very great difference which contact of the key this resistance lead is connected to. If the condenser alone is used, reduction of the interference may be noted but the resultant arcing at the contacts is prohibitive. It is ordinarily supposed that the condenser in this case should absorb the spark; rather, it turns the spark into an arc and resistance is required to overcome this.

We must remember that many variables enter here; at a given time, one leg of the key may be to ground and the other leg to line, positive or

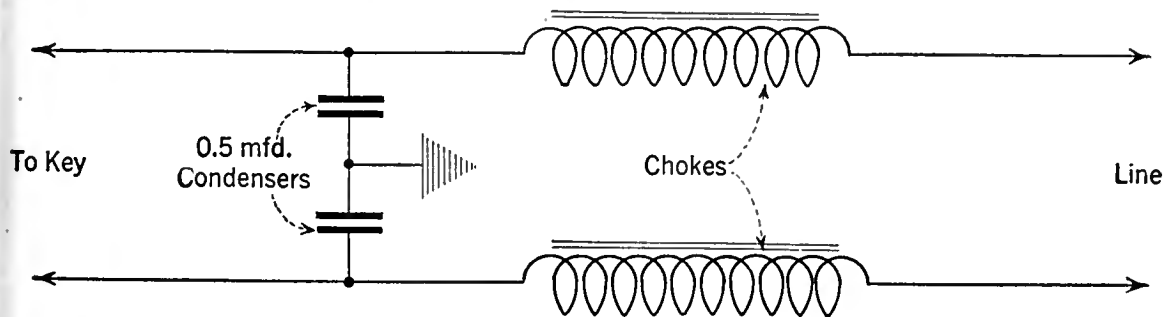

FIG. 1

The circuit employed to eliminate interference caused by key clicking. An obstinate case was eliminated by application of a surge trap, as shown in this diagram

Chokes- 130 turns No.26 D.C.C. wire on wooden core $1\frac{1}{4}$ diam.

negative. Again, the key may be cut in on a through line, positive or negative either way, and these conditions are likely to be reversed many times in the course of a day through jack plugging operations at the switch-board.

In most cases these clicks are unreadable; they occur at the break of the key, not on the closing of the circuit, but in the immediate vicinity of a telegraph office, radio interference may be noted from the local or sounder circuit. This is readable and can usually be eliminated by bridging the relay contacts of the local circuit with a one-half microfarad condenser without any series resistance.

Occasionally, complications enter into the situation, making necessary the use of full surge traps. An obstinate case of key clicking was cleared up only after applying the surge trap described in Fig. 1.

Another difficult case, in connection with a set of repeaters, required choke coils as described in Fig. 2 in each line and 0.5-mfd. condensers, series arrangement midpoint grounded, across the repeater contacts.

Duplex and quad circuits require individual treatment; much experimental work is required before standard eliminators can be recommended for these and the various types of stock tickers in daily operation.

RADIO RECEIVERS

MUCH of the so-called inductive interference has its origin in the broadcast listener's own set. It might be due to any one of the following causes:

- (1.) Loose antenna or ground connections will give rise to serious clicking noises when shaken by wind or other agency.
- (2.) Loose or corroded connections at the A battery will cause flickering of the tubes and consequent clicking.
- (3.) Internal defects in any one cell will cause harsh grating noises. This can be checked with a telephone transformer and pair of headphones, the secondary of the transformer being connected to the battery and primary to the phones.
- (4.) Defective B batteries cause a "chirping" or clicking interference. It doesn't follow that because a B battery registers full voltage, 22½ or 45, that it is in good condition. One high-resistance cell of the many incorporated in this battery can render the battery unfit for use although on open circuit it reads up to full strength.
- (5.) Oxidized contacts of the tube prongs or spring contacts of the sockets are fruitful sources of trouble. These should be scraped occasionally and the spring strips pulled up gently to insure that good contact is being made.
- (6.) Broken lead-in wires cause poor reception and clicking noises. Naturally, a lead-in wire must be insulated where it enters the building but the practice of using covered wire all the way down from the horizontal portion of the antenna is not to be recommended. From swinging in the wind, this wire often breaks inside the insulation but is held up by the fabric so it appears to be continuous whereas the wire itself is separated an eighth of an inch or more.
- (7.) Concealed house light wiring in the walls will cause humming noises if the radio set is installed close up to such partitions. This is especially noticeable in the case of single-circuit receivers.

In the case of abnormal humming it is probable that the main supply line (three-wire system) is badly out of balance or the wrong side of the house lighting system is grounded. This latter will not necessarily blow the fuses.

A and B supply devices designed for

sixty-cycle supply will also give some similar trouble when used on twenty-five cycle lines.

Various stray noises will, of course, result from defective tubes, shaky splices, poor construction, connections soldered with acid flux, etc. Before assuming that any given interference comes from the outside, broadcast listeners should disconnect the antenna and ground wires and note if the interference weakens or disappears. If it does, the source of the trouble is outside. If it remains the same and is not responsive to tuning, the trouble, nine times out of ten, is in the set itself.

Unshielded sets may pick up outside interference without the antenna or ground being attached, but a decided weakening will be observed when these are disconnected and this is sufficient proof that the disturbance is not internal.

As a test, the house lighting supply switch should be opened for a moment. If the interference disappears coincident with this, all lights and electrical apparatus in the residence should be checked over for possible faults. A lamp loose in its socket can cause quite a lot of trouble. Partial shorts in the interior wiring will cause trouble over a fairly wide area; such a case

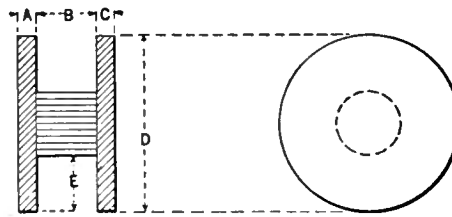

A-¼" B-¾" C-¼" D-2½" E-¾"
Hardwood Bobbin, approx. 300 turns No.22 (about 125 ft)

FIG. 2

occurred recently where a long nail driven in an attic floor brought a concealed power wire in contact with the grounded plumbing.

ELECTRIC STREET RAILWAYS

INTERFERENCE from this source presents a problem for which no really satisfactory solution has been found. Without question, many radio sets are unnecessarily interfered with by this agency and in such cases relief is possible.

The steady interference under a street-car line is violent; fifty feet either side of this it is almost negligible. Only when cars go by or some very abrupt alteration of the line energy values occurs do we get trouble at this distance.

The following actual test is interesting: On a radio set, the antenna of which ran parallel to a car line, broadcast programs were rendered valueless as mediums of entertainment but when this antenna was changed to run at right angles to the line, good reception became possible. The effect was decided.

If your antenna is at present installed at the front of the building, facing the car line, shift it to the rear as far as possible. If conditions permit, run it at right angles to the line of interference. It is surprising what a difference one or two feet variation in the plane will make here and we suggest when installing, permanently fixing one end of the horizontal portion and temporarily attaching the other end of the horizontal part to a pole which may be carried backward and forward on the roof to test out the exact position of minimum interference.

Relative intensity of the interference is noted at each setting and a permanent pole fixed at the

proper point. We must remember that lighting and power circuits nearer the residence than the trolley feeder are concerned in transferring this disturbance to the antenna, and distortion of direction is pretty sure to occur.

Sparks at the trolley wheel cause clicking interference; large arcs cause none. The bigger the flash, the less the interference. Cars going up grade on full power cause decidedly less interference than cars coasting with practically all power off, only the lights or heaters being in operation. Trolley shoes are no improvement over wheels. Catenary suspension makes no difference.

If the positive lead of the station generator goes direct to the trolley wire, interference will probably result. If this lead goes to the series field winding first, the free end of the series field going to the line, the choking effect of the coils tends to suppress any commutator interference.

In addition to checks on the usual 600-volt d. c. systems, observations were carried out on:

- (a.) Pantograph System, 6600 volts a.c. copper trolley wire.
- (b.) 1500-volt d.c. system using shoes. Copper trolley.
- (c.) 2400-volt d.c. pantograph. Copper trolley.
- (d.) 1500-volt system d.c. shoe contact. Entire system steel trolley wire.

A great many variable factors entered into the results and for scientific purposes the data obtained are not considered satisfactory. Much time and effort and expense have been devoted to the whole problem of interference from electric railways but, so far, results have not been very encouraging.

It must not be concluded, however, that the proposition is hopeless; greater efforts are being made in every city to keep the rail bonding in good shape and it is probable that more careful attention to car motors and equipment generally will tend to alleviate the situation.

Peculiar effects are often observed on radio sets installed in the vicinity of a car line. It is not uncommon to find that a passing car, even when causing little or no radio interference, will "take away," temporarily, the program being received. As soon as the car moves away a few hundred feet the program comes back, without any alteration of the set tuning whatever.

Again, in two widely separated instances, and some distance away from the car lines, the disturbance on residence radio receivers amounts to a continuous loud roar. Immediately outside both residences no interference can be picked up on a standard six-tube super-heterodyne receiver. Evidently this was a case of electrolysis since an exploring coil on the water piping indicates fluctuating current in the plumbing system. Concealed pipes and wiring in these residences carry the surge also and loop reception is practically no better although the ground wire to the water pipe is cut off.

One of the most curious and perplexing cases of radio interference that we know of had its origin in an electric street railway system. This particular noise affected only three residences, all fairly close together. All efforts to locate the trouble failed but the plumber solved the problem. It so happened that the drain pipe of the centre house became blocked; on digging this up it was found to be full of a fibrous growth and at a crack in the pipe a mass of roots had come through and grown out in the direction of the railway tracks, close up to the rails, in fact.

This offshoot evidently served as a conductor to electrify the plumbing fixtures of the three houses concerned and as the radio set grounds were attached to this, every variation in the railway line voltage set up a disturbance on the radio receivers. When the drain pipe was cleaned and replaced, all interference disappeared.

ARE PROGRAMS GOING IN THE WRONG DIRECTION?

By JOHN WALLACE

LET US LOOK AT THE GUIDE POSTS

SOMETIMES when we sit ourself down to pound out this monthly manifesto concerning matters radio, we attack the job with great gusto and enthusiasm. We are filled with a vast faith in radio's achievements and possibilities and garner a certain amount of personal satisfaction in making our small critical contribution to radio's great ends.

There are other times when we entertain grave misgivings as to whether the subject is actually worth the fifteen clean sheets of typewriter paper we employ to comment on it. Such doubts assail us this very minute. Probably when we are effusing enthusiastic utterances about radio entertainment we are writing romance, and to admit that it is pretty punk is simply to be realistic. Though if you be of the other turn of mind you may claim that it is the former that is realism and that the latter is rank pessimism—which suggests an appropriate variation of Cabell's ingenious epigram: The *optimist* thinks that radio has now reached the greatest heights of achievement. The *pessimist*, alas, is afraid that he's right!

Whatever roseate promises radio may have seemed to have held in the past we are at present thoroughly convinced that things have reached a sorry pass and that radio is standing still—smug, self-satisfied, and inutterably banal. One robin does not make a summer and the indubitably good program to which you may point here and there (only too infrequently!) isn't enough to raise radio to the standard it ought to be maintaining.

If two years ago someone had told us that by the end of 1927 programs would have only attained the level they now actually occupy we would have pooh-poohed him as a person incapable of reading the signs and portents. At the rate things were progressing in 1925 there was every indication that another two years would find us surfeited with high-class program material, of such high standard that we would be loath to absent ourselves from our receiving sets for two nights in a row.

As we look back several years, the greatest hope for improved programs then seemed to lie in the ever increasing number of sponsored programs. Great industries were going to start pouring their gold into the radio stations in payment for indirect advertising—more properly, radio publicity—and great things were going to result. Herein was the solution of all our difficulties: without government operation; without levying of taxes; without philanthropic financing, we were going to lead the world in program standards by utilizing our great American asset—Big Business.

Well the dismal fact of the matter is that none of these things has come about. And the ironical conclusion to which we are forced is that the rise of the sponsored program is responsible for the stand-still that radio has reached at the dawn of this year of grace 1928. In fact, stand-still is putting it mildly; the state of affairs is more exactly a retrogression. All the money, all the ingenuity, and all the labor that is being devoted to the designing of programs is being diligently devoted to efforts in the *wrong direction*—with the result that radio is going to the dogs at a breakneck speed, so rapidly in fact, that to check it will require no little effort.

WHAT is the right direction? It would seem that program makers are too embroiled in their business to glance at the guide posts, too pressed by the strenuous and unceasing job of making programs to take a moment or two off for a little rational reflection on what their job is all about. They persist in refusing to take account of the fact that radio is a new medium, a unique medium and, like any other medium, endowed with its peculiar limitations and peculiar possibilities. Pig-headedly they persist in attempting to reconcile with their duties the traditions of the drama, the opera, the music hall, and the vaudeville stage. This observation has



Radio Times, London

IGOR STRAVINSKY

The British Broadcasting Company, on a recent Sunday afternoon symphony program, presented the modernist composer, Igor Stravinsky, conducting a program of his own works. This is an event in radio annals. True, Stravinsky has been "outmodered" by a group of still younger composers but his compositions are still quite far in advance of the popular taste. It's likely that no American station would have, nor will have for many years, the temerity to present a program of such dubious popular appeal. This does not indicate that the Britisher is any more sophisticated in his tastes than the American; it is our guess that the B. B. C. is enabled to essay such a high-brow program simply because it is non-competitive. On Mr. Stravinsky's program appeared the Overture to Mavra, the Suite from the Fire Bird and a Concerto for Pianoforte with Accompaniment of Wind Instruments. The latter was a premier English performance. The above portrait is from a drawing by the famous French artist, Picasso.

been made often before. We are a trifle abashed at shouting the same tune again. But probably it will have to be stated many times more—and certainly by others than ourselves—before it sinks in.

Without annoying you by enumerating radios'

limitations, which you know as well as we (unless you happen to be a program designer, in which case you probably don't), we will proceed to the proposition that the one species of entertainment that radio is by its intrinsic nature best fitted to put across is instrumental music.

Music is the only existing mode of entertainment that can be assimilated solely by the unaided ear. The radio (together with the phonograph) is the only existing entertainment device which can reach nothing but the ear. Obviously they were made for each other! They should be joined in holy wedlock and wander hand in hand through the new mown hills, happily ever after.

Instrumental music should be the backbone of the radio program; it should predominate every program; it should be the *piece de resistance* with all the other little absurdities of broadcasting arranged around it like the potatoes around a roast beef. Plays, where you can't see the players, speeches where you can't see the speakers, comedy, where you can't see the comedians—all such like stuff is mere piccalilli and sauce.

So the business of broadcasting is music. And by music we mean music at its fullest realization, which is that of the instrumental ensemble—the symphony, the little symphony, or the chamber group.

In the field of the representative arts are many different mediums—water color, etching, caricature, wood cut, lithograph, miniature, pen drawing, fresco, and countless other specializations. But it is finally in the oil painting that graphic art finds its complete expression. Beside it all other artistic endeavors fall into comparative insignificance. It contains within itself the whole total of their qualities and infinite other ones of its own.

A perfect analogy exists in music. Vocal music is all right in its way, as are also organ recitals, piano gymnastics, jazz bands, and marimbaphones. But they are all dwarfed by the symphony orchestra. The orchestra not only can do all the things that they can do, but can do them better—and with its great musical resources can secure added effects that they can't possibly aspire to.

Of course it is always necessary to get back to the cold fact that, in America at least, the station manager's only business is to give the listeners what they want. But don't they want orchestral music? There has been much talk about how the taste of the listening public has been elevated by radio and much proclaiming that Mr. Average Citizen has reached a stage of enlightenment where he can actually enjoy serious musical compositions. We are inclined to believe that this is true. Moreover, there are thousands of people in the country who needed no "educating" but who already liked such music. It seems fair enough to deduce that genuine music is the "what-they-want" of a sizable section of listeners and potential listeners.

In view of the fact that orchestral music is the best thing that a station can put across, and the best thing that a listener could listen to, it seems fair enough further to deduce that there ought to be a certain amount of it in the air of an evening, available for such persons as wish to seek it out. But is it there?

THE HORRIBLE EVIDENCE

BY WAY of confirming our suspicion that there isn't, we sat ourself down at our receiver the other night and proceeded systematically to get a cross section of what was on the air. At 8:15 P. M. (Central time) we started at the top of the dial and worked our way patiently to the bottom, recording everything that was going on within our receiver's range. The stations encountered extended from Colorado to Texas to New England. At 9:35 P. M. (Central time) the chore was concluded, and if you entertain any delusions that there are a lot of fine things on the air awaiting the turn of a dial, gaze at the cold and cruel statistics we found on our tablet:

- 1 JAZZ PIANO, playing "Ain't She Sweet."
- 2 JAZZ ORCHESTRA, dance music.
- 3 COUPLE AT A PIANO, wise cracks, request numbers, ballads.
- 4 SENTIMENTAL SONGS, "Sweetheart of Sigma Chi," etc.
- 5 SOPRANO, singing the Brindisi from "Lucrezia Borgia."
- 6 BARITONE, singing unidentifiable ballad.
- 7 SERMON, of the vocal-cord-splitting variety.
- 8 TENOR, popular ballad, "I'll Forget You."
- 9 DANCE ORCHESTRA, playing "Rio Rita."
- 10 OLD TIME FIDDLE, with "swing your partners," etc., interpolations.
- 11 STRING TRIO, playing semi-popular airs.
- 12 CHORAL GROUP, in the finale of a light opera.
- 13 SOPRANO, singing the Shadow Song from "Dinorah."
- 14 SOPRANO, singing "Just a Wearyin' for You."
- 15 CHURCHILL SISTERS, singing "Say Au Revoir but Not Good-bye."
- 16 SOPRANO, singing some light ditties in French.
- 17 DRAMATIZATION, of Rip Van Winkle.
- 18 TENOR, solo.
- 19 STRING TRIO, playing Saint-Saëns' "Swan."
- 20 WEATHER REPORT.
- 21 DANCE ORCHESTRA.
- 22 NOVELTY SONG, with banjo.
- 23 HAWAIIAN GUITAR AND MANDOLIN, duet.
- 24 TRAVEL, talk on Starved Rock, Illinois.
- 25 FEMALE, reciting poetry.
- 26 MALE QUARTET, singing "Bye and Bye."
- 27 PRIZE FIGHT.
- 28 BRASS BAND, playing "Moonlight Wonderings."
- 29 JAZZ ORCHESTRA.
- 30 TENOR, singing Welsh folk songs.
- 31 TENOR, singing popular ballad, "Lonesome."
- 32 PIANOLOGUE.
- 33 TENOR, singing sentimental ballad.
- 34 VIOLINIST, playing Beethoven—Opus 12 Number 1.
- 35 TENOR. "A Robin Sings in the Apple Tree."
- 36 TRIO, playing semi-classics.
- 37 ORGAN, "Pale Hands I Loved," etc.
- 38 BASS, soloist.
- 39 DANCE orchestra, "On a Dew Dew Dewy Day."
- 40 FEMALE duet, sloppy ballad.
- 41 MALE CHORUS, college songs.

And there you are! Nowhere was the orchestral program we had set out in search of. Twenty of the forty-one programs were vocal, practically fifty per cent.! And this in spite of the fact that vocal transmission is one of the lesser effective things broadcasting is capable of. Only three of the programs encountered seemed to hold any promise of suiting our mood of the moment, numbers 5, 13, and 34. But a return to these dial positions found the stations already shifted to something trifling.

But perhaps, we reflected magnanimously, we

had picked out the wrong hour of the evening. So the following night we repeated the procedure, commencing at 7:15 P. M. Central time, and running through to 8:20. Behold our second log:

- 1 SOPRANO, singing Nevin's "Rosary."
- 2 DANCE ORCHESTRA, jazz.
- 3 BARITONE, solo "Young Tom o' Devon."
- 4 JAZZ ORCHESTRA.
- 5 DANCE ORCHESTRA.
- 6 DANCE ORCHESTRA.
- 7 DANCE ORCHESTRA—(what, another!).
- 8 ORGAN, Mendelssohn's A Major Organ Sonata.
- 9 MALE QUARTET, "Back Home Again in Indiana."
- 10 BANJO, solo with piano accompaniment.
- 11 TALK, on something or other.
- 12 PIANO, solo.
- 13 NEGRO SPIRITUAL, "I Heard From Heaven To-day."
- 14 PLAY, Julius Caesar.
- 15 SMALL ORCHESTRA, playing "Gypsy Sweetheart."
- 16 BAND, playing march tune.
- 17 VIOLIN, Schubert's "Ave Maria."
- 18 VOCAL DUET, semi-popular songs.
- 19 BIBLE READINGS.
- 20 TENOR, singing sloppy ballad.
- 21 TRIO, playing light stand-bys.
- 22 COUPLE, singing novelty songs about sweet mammas.
- 23 DANCE ORCHESTRA.
- 24 SPEECH, by some labor leader.
- 25 STRING QUINTET playing Handel's Water Music Suite—but, alas, even as we listened, this changed into a soprano solo!

Such was our clinic—sixty-six cases examined over a period of two hours and twenty minutes of the most favorable broadcasting time of the evening. It may be objected that we didn't examine all the programs of all the stations during that time period, but we see no argument to show that the cross section we observed was other than representative. Representative, for the most part, of a lot of inanities that only the veriest imbecile, with the meagerest amusement resources conceivable, could dignify with the name of worthwhile entertainment.

Of these sixty-six programs not a single one was orchestral. The few trios we ran across were simply doing their five or ten minute' turn on a well scrambled variety hour.

WE DON'T NEED SO MUCH VARIETY

THIS frantic search for variety is one of the silliest things in the whole radio broadcasting business. Variety has been set up on a pedestal as the one goal to be achieved. The means used to secure it are devious and dull. Variety is necessary, of course, but there are other sorts of variety than that of the vaudeville show. Program directors do not realize that music, real music, contains within itself all the variety that is necessary. If program arrangers only realized it, their job has already been done for them by the great composers.

Practically every hour of program furnished by the broadcasters to-day is a variety program. And where every program is a variety program would it not be a variety to introduce a program that is *not* a variety program?

We throw out the foregoing sound suggestion to whomsoever chooses to make use of it (fearing the while that no one will).

To the rising tide of sponsored programs is due the blame for the overwhelming number of variety programs which is rapidly reducing radio to the level of a gigantic and worthless vaudeville

show. In any schedule of entertainment it is the light frivolous item, introduced to break the monotony, that is the brightest thing on the program. This principle is borne in mind by the advertiser when he decides to produce a broadcast program of his own. He will make his program snappy and ever changing, he reasons, and thus make it stand out in high relief against all the others. Unfortunately every other advertiser goes through precisely the same sort of reasoning. The result is that sponsored programs are all as alike as peas in a pod, and no pea is any more novel or attention compelling than its neighbor on the left or on the right. All are dealing in olives and chilli sauce, nuts and caviar. None is willing to supply the meat of the repast. This meat must be orchestral music of solid musical worth.

If broadcasting, considering it as a whole, were maintaining a proper balance in its offerings—a thing it must eventually do or go out of business—it would be possible to find good music, played by competent orchestras, at at least ten places on the dial at any hour of the evening. Its present condition, that of having *no* respectable music to offer, is certainly not a healthy one.

Some stations used to maintain fair sized orchestras as a staff feature, but their number is rapidly diminishing—the very reverse of what should have happened. If radio had progressed in its proper channel we would now have some ten or twenty symphony orchestras throughout the country bearing as their titles the names of the stations which organized them, and being secondary in musical importance only to the old established symphonic societies. It is expensive, certainly, to maintain a large orchestra but when it comes to hiring dance bands or opera singers expense seems to be no important item to the broadcasting stations.

If expense is not the drawback it must be that there is still a lingering fear that not enough people will listen to a highbrow orchestral broadcast to make it worth while. This fear, as we have already stated thirteen different ways, is ungrounded. The Damrosch programs (an exception we advance in further proof of our point) seem successful enough. And witness the way the populace is clamoring for more sophisticated orchestration of its dance music. They go wild over Paul Whiteman's rendition of "When Day is Done." If they like this why wouldn't they enjoy the compositions of Stravinsky and others of the modern school. Katscher's piece is simply a shoddy and ineffectual mimicking of the works of these composers. There are tunes in the Beethoven symphonies as simply melodious as anything Victor Herbert ever wrote. No one who likes jazz effects could fail to be pleased by Casella, for instance, or Sowerby. We defy anyone but the stupidest moron to listen to the first movement of the César Franck symphony without craving to hear it repeated. Schelling's "Victory Ball" could sweep any Rotarian off his feet. The use of the human voice in Bloch's "Symphony Israel" is incomparable, but not incomprehensible. Ravel's "Waltz" makes those of the light operas tame indeed. Tchaikowsky's "Manfred" symphony, for those who would weep, is forty times more lugubrious than "Hearts and Flowers." The name of Bach could terrify no one who had heard Abert's arrangement of his Chorale and Fugue. Scriabin's Third Symphony is of such emotional ferocity that it could emotionally unstabilize a brass monkey. And as for soul satisfying harmony, better than any organ chords is the passacaglia that concludes Brahms' Fourth Symphony.

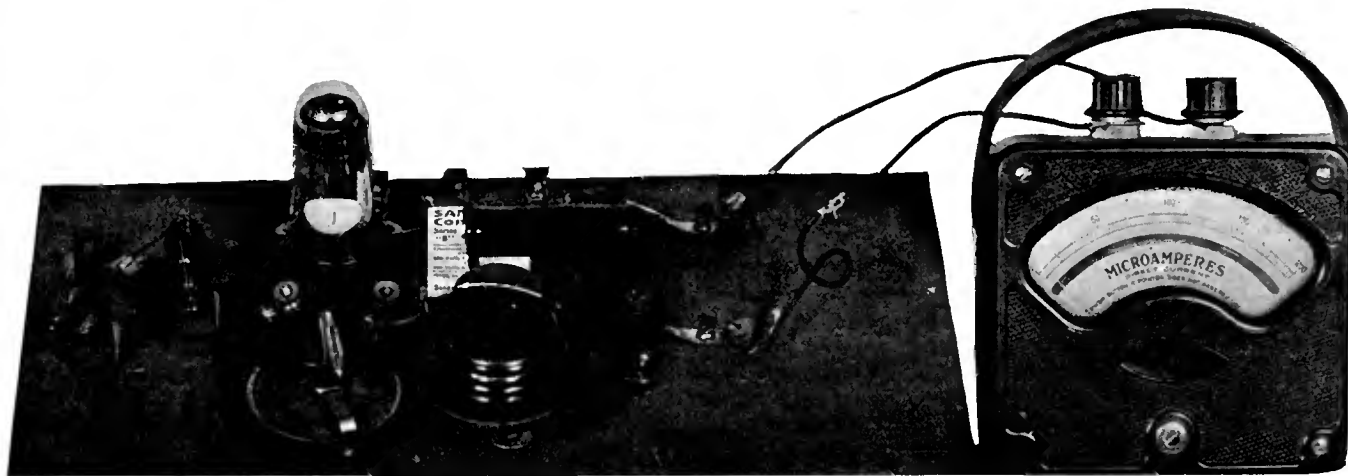

USED IN THE LABORATORY

RADIO BROADCAST Photograph

The photograph of the vacuum-tube voltmeter shown schematically in Fig. 2 indicates a simple breadboard layout. The equipment includes a Yaxley potentiometer, a Pacent rheostat, an Alden socket, Mountford and Crescent resistances, a Sangamo "Parvot" condenser, and several Fahnestock clips

A VACUUM-TUBE VOLTMETER

By THE LABORATORY STAFF

IN THE study of radio-frequency phenomena, experimenters have always been more or less handicapped by their lack of accurate measuring instruments. It is a simple matter, comparatively, to build a meter that will cover a considerable range when one works at 60 cycles, or at fairly high values of current and voltage, but let the research student attempt to measure currents at a million cycles and of a few microamperes, or voltages of a few microvolts, and his problem has increased in difficulty many fold.

The advent of the vacuum tube has made material progress possible in the realm of radio-frequency measurements, so much progress, in fact, that it is now possible to buy a hook that deals with nothing but measurements at frequencies far beyond those used for household purposes, and at values of current and voltage that are prefixed by the word "micro." Such a book, *Radio Frequency Measurements*, by E. B. Moullin, was reviewed in RADIO BROADCAST for October, 1926; no serious experimenter can afford to be without it.

In the present-day radio laboratory there will generally be found, on one hand, a vacuum tube generating currents and voltages of practically any frequency and any amplitude (the modulated oscillator described in the June, 1927, RADIO BROADCAST is an example), while on the other hand is another tube, perhaps exactly similar in type to the generator, the purpose of which is to measure the output of the first tube.

This latter tube, variously known as a "peak" voltmeter, or a vacuum-tube voltmeter, is the laboratory's most versatile and useful instrument. It can be used to measure voltages and currents of any amplitude and frequency, to measure the voltage or power amplification of audio- or radio-frequency amplifiers, the field strength of distant stations, the high-frequency resistance of a coil or condenser, as a level indicator in broadcasting stations or remote control stations—anywhere in fact where a meter is required which takes so little power from the circuit being measured that its presence causes no error in measurement. Briefly, the vacuum-tube voltmeter is a tube acting as a detector, or distorting device, so arranged that alternating potentials on the input may be read as direct current in the output. Unlike other translating mechanisms, the vacuum-tube voltmeter has no moving parts, there is little to wear

out, it has nothing in its construction that is not easily replaceable and, best of all, it can be made to consume almost no power from the source to which it is attached.

Why is such an instrument necessary, and what are its particular qualifications compared to voltmeters with which we are all familiar? Let us suppose, for example, that we wish to measure the voltage delivered by a dynamo which will light a hundred 40-watt lamps, that is, will deliver 4000 watts, or 4.0 kilowatts. Suppose our ordinary moving-coil voltmeter has a resistance of 10,000 ohms and that when placed across the terminals of the dynamo it registers 100 volts, how much current and power does it take from the generator?

Ohm's law, which states that the number of amperes flowing in a circuit is equal to the voltage of the circuit divided by its resistance, tells us that 0.01 amperes will flow, and when we multiply this value of current by the voltage across the meter we find that the product, 1.0 watt, is the actual power required by the meter to give the proper deflection. Now this one watt is a very small part of the power that can be delivered by the dynamo, one four-thousandth as a matter of fact. It will readily be seen that the error of reading of the meter, due to the current it consumes itself, will be so small in this case as to be negligible.

But suppose our dynamo still had a terminal voltage of 100, but was so small that it could supply only one watt of power? How can we measure its output? It is at once obvious that

we cannot use the same voltmeter for it would consume all the power the dynamo is capable of supplying.

The answer lies in making the resistance of the meter so high compared to the resistance of the source of power, the dynamo, that very little current flows through it, and consequently, very little power is drawn from the source, which, in turn, means that applying the meter to the tiny one-watt dynamo will not short-circuit it, as would be the case with a low-resistance voltmeter. This problem has resulted in the design of high-resistance voltmeters useful in measuring the output voltage of plate-voltage supply units.

The problem is even more complicated when we wish to measure alternating currents or voltages of very small magnitude, or at very high frequencies. There is a very definite need for a voltmeter or an ammeter that will measure any values of current, or voltage, at any reasonable frequency, and without taking appreciable power to operate it.

The vacuum-tube voltmeter is such a device. Its input resistance can be made so high that it consumes practically no current from the source being measured, and aside from a small input capacity which may require slight retuning when working with tuned circuits, it has so little effect on the circuit that its presence may be neglected.

C-BATTERY METER

THERE are several types of vacuum-tube voltmeters, the C-battery detector type being the simplest and perhaps the most generally useful. The one described in this article has been designed for reading small values of a.c. voltage although it may be adapted for reading any desired maximum value.

The circuit diagram of a C-battery type of voltmeter is shown in Fig. 1. As can be seen, it is quite simple, consisting only of the tube and its necessary batteries, and a direct-current meter which, for all ordinary measurements, should read not over 500 microamperes.

The question, "how can a direct-current meter in the plate circuit of a detector be made to measure alternating voltages placed on the grid-filament circuit of the tube?" naturally arises.

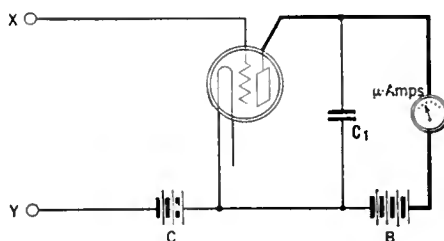

FIG. 1

A C-battery detector and a direct-current meter are the principal parts of a vacuum-tube voltmeter

Builders of plate-supply units, and owners of power amplifiers, who have placed a milliammeter in the plate circuit of the power tube, and watched its deflections under strong signals, have possessed the essential part of a vacuum-tube voltmeter—an overloaded tube. Whenever a signal came along which was greater than the C bias could handle, the average plate current changed and caused variations of the milliammeter needle.

But why does the needle wobble?

The normal plate current, as indicated by the milliammeter, is fixed with a fixed value of grid bias and a given plate voltage. When small a.c. voltages (the incoming signals) are placed on the grid circuit, the C bias is changed accordingly and in the plate circuit appears a magnified replica of these input voltages. In other words, the actual voltage on the plate of the tube varies with the input grid-filament voltage and naturally the plate current changes accordingly. If these changes are rapid and symmetrical, so that an increase in current is followed by an equal decrease, the average value of the plate current will remain the same and the milliammeter needle does not move. It is these a.c. plate currents which are amplified and which produce signals; the d.c. current is only a necessary and not directly useful part of the process.

If the changes in plate current are not symmetrical with respect to the value when no a.c. input is applied, the average value of plate current is different, and the plate milliammeter needle jumps about if this average value changes rapidly. The relative amount of plate current change, and whether it decreases or increases from the steady d.c. value with no input, depends upon the fixed C bias, so that we can make the complete unit, tube and meter, into a sensitive indicator of small a.c. voltages if we choose the plate and grid voltages correctly.

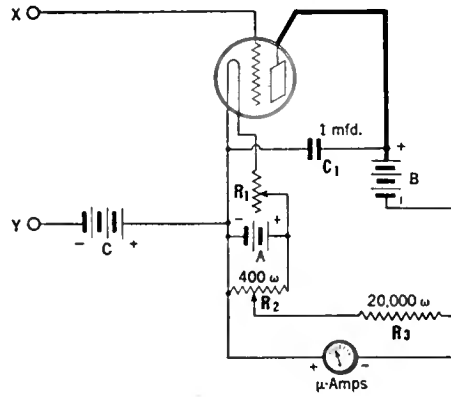

FIG. 2

Here is the circuit diagram of the vacuum-tube voltmeter described in this article. The additional apparatus not shown in Fig. 1 constitutes a bucking-voltage device to keep the normal plate current out of the microammeter and, of course, the filament battery and rheostat

The vacuum-tube voltmeter, then, consists of a tube so biased that input a.c. voltages cause large changes in average d.c. plate current. To make it into a calibrated meter, one merely places known a.c. voltages on the input, reads the plate current change, and plots a curve (typical curves are shown in Fig. 4). The purpose of the bypass condenser, C_1 , shown in Fig. 1, is to improve the rectifying or distorting property of the tube.

To prevent the device taking power from the source being measured, the C bias must be great enough that input peak voltages do not make the grid go positive at any time. In practice the bias is such that the normal d.c. plate current is very near zero; this near-zero current is prevented from going through the microammeter by a

"bucking" voltage secured from a battery or a potentiometer across the A battery, as shown in Fig. 2. The high resistance prevents shunting the meter with the potentiometer. The reason for preventing the normal d.c. plate current going through the meter is so that the latter's range will not be limited by having to register both the normal current and the current produced in the process of measurement.

Any type of tube may be used. For convenience, the small 199 type tubes are used in the Laboratory, and should be used with the voltages specified here.

One simple form of vacuum-tube voltmeter used in the Laboratory is shown in the photograph on page 221 and another type, housed in a Ware radio cabinet, on page 223. The microammeter in the first picture (that at the top of page 221) is a Westinghouse instrument Model PX and has a maximum range of 200 microamperes. It is also possible to obtain this model with a full-scale deflection of 500 microamperes. These are particularly good instruments for this work, since the scale length of four inches makes it easy to read accurately, and the little button at the left, when pushed, removes a shunt which protects the meter from overload. In other words, the meter is always protected until one pushes the button, and in a vacuum-tube voltmeter of the type described here, this is a very valuable feature.

The two Westinghouse meters list at about \$35. Weston makes a model 301 meter in two ranges which are suitable for tube voltmeters, one with a full-scale deflection at 200 microamperes listing at \$33 and another, a 1-milliamperere (1000 microamperes) meter at \$12. Jewell makes similar instruments at about the same prices. In the photograph on page 223 a Weston 1.5-milliamperere (1500 microamperes) meter is shown.

CONSTRUCTION OF THE VOLTMETER

THE photograph on page 221 shows how simple the vacuum-tube voltmeter may be. The small single-pole double-throw switch at the left is used to short the input by connecting the grid directly to the negative post of the C battery when circuits to be measured are being set up. There is no need to place the apparatus in such a small space as shown in this photograph, although the grid lead between voltmeter and external apparatus under test must be as short as possible, and well protected from other leads carrying a.c. voltages.

A list of the apparatus used in the voltmeter shown in Fig. 2 follows. Any of these parts may be substituted by others that are well made, and none of the values of resistance, etc., are critical.

- One Tube Socket.
- R_1 —30-Ohm Rheostat.
- R_2 —400-Ohm Potentiometer.
- R_3 —20,000-Ohm Resistance.
- C_1 —1-Mfd. Bypass Condenser.
- One S.P.S.T. Switch.
- 7—Clips (or Binding Posts).
- One Binding Post, Insulated from the Baseboard.
- Microammeter.

The experimenter who builds such an a.c. voltmeter for the first time must remember that he has in the circuit a very sensitive and, therefore, expensive meter, namely, the plate current reading device. If the grid circuit of the tube is left open, or if any one of several accidents happen, the meter will be blown up, and all experiments will terminate in an abrupt and disheartening manner. Every step in the construction, calibration, adjustment, and operation must be watched with great caution, and adjustments should be

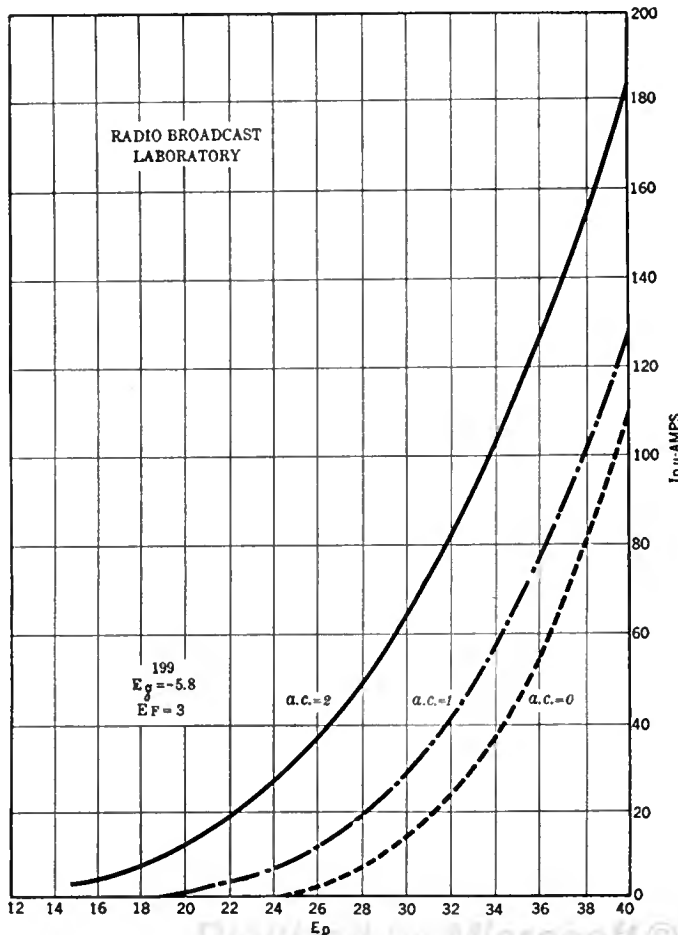

FIG. 3

Some calibration curves. Each curve was made with a different a.c. voltage input. Note how rapidly the plate current increases with small increases of plate voltage

made only after due deliberation of what will happen once the proposed adjustment is carried out. After the experimenter becomes familiar with his apparatus, he will be able to proceed rapidly from calibration to operation, and to have such a feeling for his instrument that he can predict what each change in voltage, etc., will produce.

CALIBRATION

THE first job after the assembly of the vacuum-tube voltmeter is the calibration process. This is a fairly simple operation and need not be balked at by the experimenter with average experience in handling measuring instruments. Before starting, bear in mind that too much current in the plate circuit of the tube will ruin the meter; so every step should be proceeded with gradually and with the utmost care.

But before the actual calibration is started, we must decide upon the voltage of the C and B batteries in the voltmeter circuit itself (the A voltage is, of course, that recommended by the manufacturer of the tube used). We are assuming in these experiments that a 199 type tube will be used. The microammeter should not be connected in circuit until the potentiometer switch arm is thrown as far as possible towards the negative end or, preferably, a small piece of paper should be slipped under the movable contact to insulate it from the wire beneath. This prevents any of the voltage across the potentiometer, due to the filament battery, flowing through the microammeter until needed. Since this current is backwards with respect to the meter, it may damage it until some plate current flows. Now adjust the filament rheostat until the voltage is normal.

Before proceeding further, we will test the circuit to see that everything is satisfactory (the actual calibration has not yet begun). We short-circuit the input to the tube by connecting together points X and Y, Fig. 2. Assuming that the microammeter has been connected in circuit and that the B and C batteries are of satisfactory value, a current will flow in the plate circuit and will be indicated by a deflection of the meter needle. The value of this current is dependent upon the voltages of the B and C batteries. Thus it will be seen that the value of these batteries is all important for if they are of such value as to give a larger plate voltage than the microammeter can indicate, it will be at this point that the abrupt and disheartening termination of experiments will occur. Do not, therefore, play about with different values of plate and grid voltages unless you know just what you are doing.

With a 199 type tube, we recommend that the B voltage be 45 and the C voltage be 9 to start with. Under these conditions a reading of 6 microamperes was obtained in experiments in the Laboratory. Fig. 3 shows some typical curves which were obtained in the Laboratory. They were obtained with a 199 type tube using a grid bias (E_g) of 5.8 volts and a filament voltage (E_f) of 3. Of the several curves shown, only that marked A.C.=0 interests us at the moment. The term A.C.=0 indicates that there is no alternating-current input to the vacuum-tube voltmeter (in other words, X and Y are shorted. See Fig. 2). We note in the curve A.C.=0 how rapidly the plate current increases with small increases in plate voltage. At 40 volts plate potential (F_p), for example the plate current (I_p) is 110 microamperes (μ Amps.). If with, say, forty volts plate potential, we increased the grid voltage, the plate current would decrease. The other curves in Fig. 3, incidentally, show the effect of placing an a.c. input across the terminals X and Y; in other words, they represent microammeter

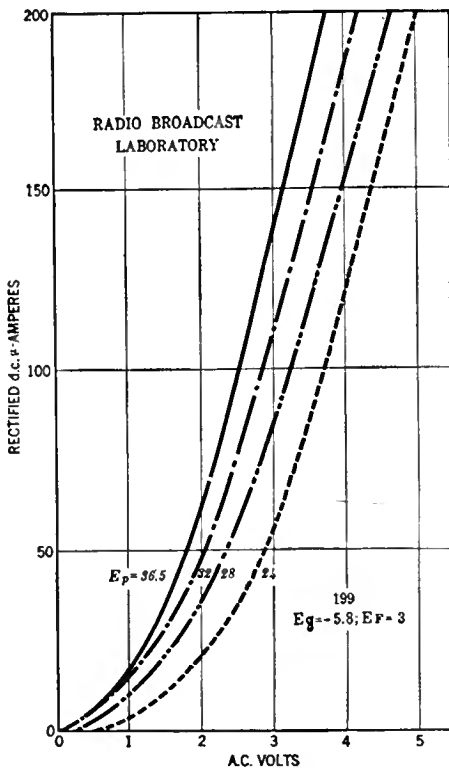

FIG. 4

Here are some typical calibration curves. The deflections of the microammeter needle caused by various a.c. input voltages are plotted, together with the effect of increasing the plate voltage (E_p) for a given value of C bias (E_g)

deflections due to the sum of the normal plate current and the current caused by input a.c. voltage.

We have digressed a little to go into a brief explanation of the curves in Fig. 3. We had previously arrived at that point where it was recommended that the experimenter use 45 volts B

battery and 9 volts C battery. Under these conditions, it was stated, a plate current of 6 microamperes was obtained in the Laboratory. Do not expect, however, to get a similar reading. Every tube will vary. It is quite possible that you will get no reading whatsoever. Perhaps the reading will be higher than 6 microamperes. Should there be no reading on the microammeter, slightly reduce the C voltage until a reading of a few microamperes is apparent. It is quite possible that a C battery quite a little smaller than a 9-volt one will ultimately be used, but the large value is recommended for safety's sake. The larger the C battery the smaller the plate current and, therefore, the greater the margin of safety.

Suppose that we have adjusted our batteries and have obtained a reading of 10 microamperes. We are satisfied that everything is working as it should, and take the next step, which is to balance out this 10-microampere reading. If we do not balance it out it will always be present when we are measuring a.c. voltages applied across X and Y and, therefore, the microammeter will not be used to its full advantage. That is to say, if the meter is always indicating 10 microamperes with no input across X and Y, its range will be reduced when an a.c. voltage is applied. True indeed, with a 200-microampere meter this 10 microamperes only represents one fiftieth of the whole scale, but possibly the combination of B and C voltages used will give a greater plate reading, perhaps 50 microamperes (such a high value would not be probable with a 199 tube and 45 volts B and 9 volts C), which certainly should be balanced out. The balancing out is accomplished by removing the piece of paper which we previously slipped underneath the potentiometer arm and adjusting the latter—slowly—until the needle on the meter reads zero. Some experimenters prefer their meters to indicate a few microamperes current when there is no a.c. input across X and Y so that any possible back deflection of the needle will not harm the meter.

The actual calibration of the instrument is our next job, and it is not an extremely difficult

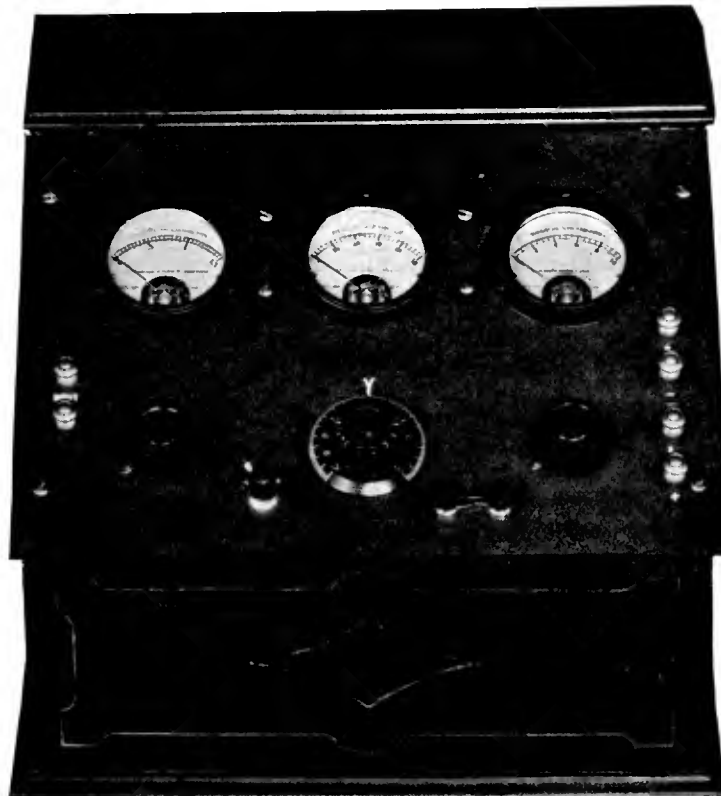

A VERY COMPLETE VACUUM-TUBE VOLTMETER

The complete instrument may be dressed up to look like this if you do not care for the breadboard layout shown in the photograph on page 221. Voltmeters to read the B and C potentials are included

one. Fig. 4 shows four typical calibration curves made with different values of plate potential. After one has become familiar with the vacuum-tube voltmeter described here, the voltages may be adjusted and all kinds of different curves obtained.

For the process of calibration, some known source of a.c. is necessary.

A fairly accurate calibration may be made by using one of the many step-down transformers that are now being used to supply filament voltage to a.c. tubes. With the primary connected to the 110-volt a.c. house supply the secondary voltage from one of these units will give several points on a perfectly good calibration curve. For example, a transformer which supplies filament power to a receiver using 226, 227, and a power tube, has the following voltage taps available: 5, 2.5, 1.5, 0.75. These voltages can be added to or subtracted from each other by connecting the windings to aid or to buck each other. Fig. 5 shows the complete vacuum-tube voltmeter with the accessory equipment for calibrating it. If, during calibration, but before the maximum known voltage to be applied across X and Y has actually been applied, the microammeter needle is dangerously near the maximum deflection point, it will be necessary to increase the C bias and commence the calibration again.

Vacuum-tube voltmeters can be calibrated by any Laboratory at small cost and it is probable that the constructor can procure such a calibration near-by. The reader should remember that the tube which is to be used should be sent with the instrument and that the whole unit should be very well packed.

The calibration of the instrument is practically independent of frequency, so that the experimenter can compare voltages in circuits operating at audio, intermediate, or broadcast frequencies. He can measure the voltage step-up in an audio transformer or amplifier, or the output of two radio-frequency amplifiers, or plot the resonance curve of an intermediate frequency stage.

It will be noted that the input of the tube looks directly into the device whose terminal voltage is being measured. If d.c. flows through this device, it will be impressed across the input to the voltmeter and ruin either the calibration or the plate meter, or both. Some means, such as that shown in Fig. 6, must be provided for isolating the voltmeter from d.c. potentials existing in the circuit under measurement, when, for example, the output voltage of a resistance-coupled amplifier tube is being measured. With

this arrangement the short-circuiting switch shown in the photograph on page 221 may be omitted, since the grid is always at a safe d.c. potential with respect to the filament. Frequencies in the same range, that is, all audio tones, or all frequencies in the broadcast band, will give similar calibration curves.

If the experimenter has no means of calibrating his instrument, he is not so unfortunate as might be supposed. He may make use of the fact that the deflections of the microammeter are roughly proportional to the input a.c. voltages squared. Thus he may get two deflections representing the gain, say, of two amplifiers. He need not know the actual voltages provided he knows roughly how much greater one is compared to the other. All he needs to do is to divide one

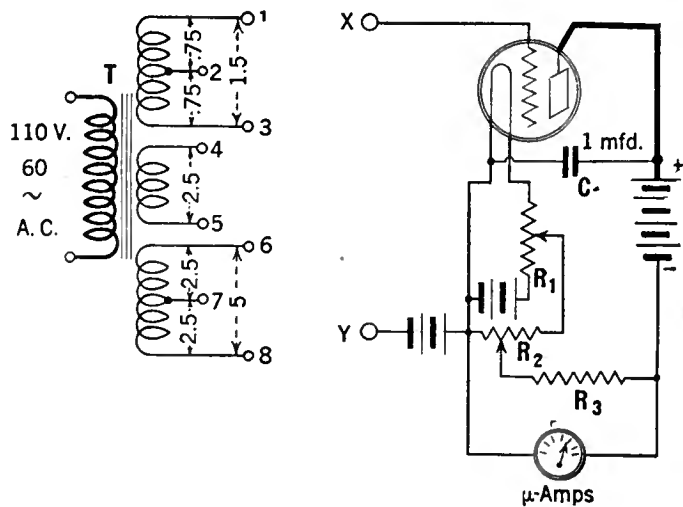

FIG. 5

A suitable set-up for calibrating the vacuum-tube voltmeter. T is a transformer which is used with a.c. tubes and, therefore, has several taps on the secondary. Thus several known voltages may be obtained, and these plotted as a graph, similar to Fig. 4

deflection by the other and extract the square root. This will be the ratio of the voltages.

The home constructor should be warned again to carefully watch every step when experimenting with the vacuum-tube meter and to be very careful of the microammeter. One mistake and the meter is gone. Always, at the conclusion of an experiment, remove the meter from the circuit first.

Those who wish to read further about the vacuum-tube voltmeter will find a most interesting and instructive series of articles in the English paper, *Wireless Experimenter and Wireless Engineer*, for October and November, 1926. Part of this material was republished in this country in *Lefax* leaflets in February, 1927, and forms the best background for the serious student of this instrument. It is possible to purchase from the Cambridge Instrument Company, of Ossining-on-Hudson, New York, a vacuum-tube voltmeter calibrated and "ready to go." It is a beautiful instrument, although somewhat expensive. The owner, however, may rest assured that he has the best possible apparatus for measuring small a.c. voltages, radio-frequency currents, the gain of his amplifiers, both audio and radio, and for the performance of a hundred valuable experiments.

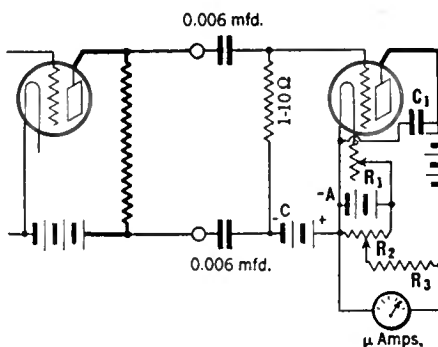
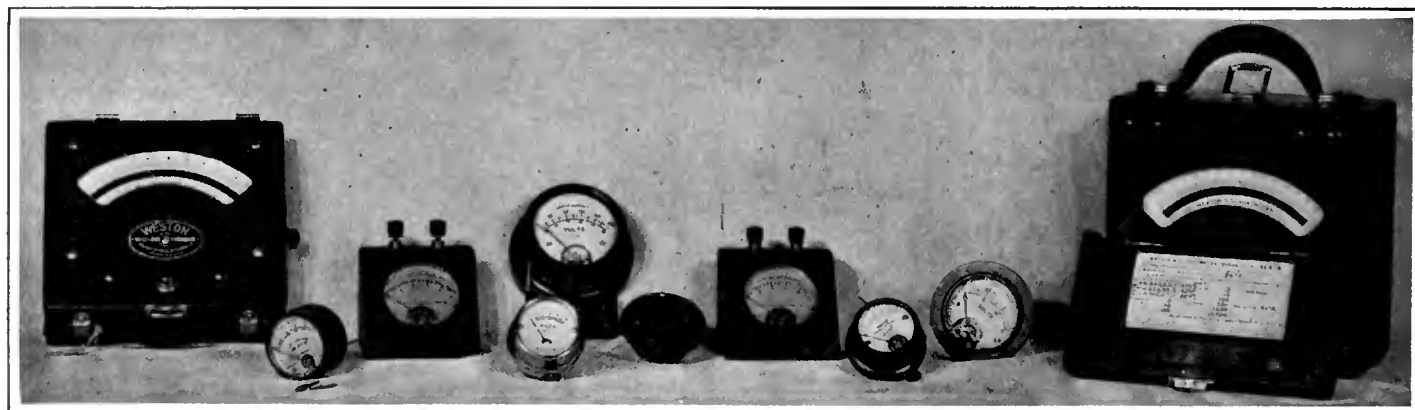

FIG. 6

When the vacuum-tube voltmeter is used to measure an a.c. voltage across the terminals of which is also a direct-current voltage, some means must be employed to prevent this d.c. from getting on the grid of the tube. Condensers as shown here will accomplish this. The diagram shows measurements being made on a resistance-coupled amplifier



SOME METERS USED IN THE LABORATORY

RADIO BROADCAST Photograph

The vacuum-tube voltmeter, although an invaluable asset to the RADIO BROADCAST Laboratory, by no means holds a monopoly in usefulness. Here are just a few of the dozens of meters always in use in the laboratory. Included are instruments by Weston, Sterling, Jewell, Dongan, and Hoyt

RADIO FOLK YOU SHOULD KNOW

I. RALPH H. LANGLEY

Drawing by Franklyn F. Stratford

RALPH H. LANGLEY, Assistant to the President of the Crosley Radio Corporation, and, in that capacity, manager of most of the operations carried on by the Crosley interests, was born in New York City on January 5, 1889. As this article goes into print he is, therefore, still two years short of the forty mark. By training, and probably by primary inclination, he is an engineer, but his vision has never been limited to screw-heads and tuning knobs; of late years he has become increasingly an executive figure. An administrator of thirty-eight would be considered very young in most lines of business, but in the radio industry there are a number of them. The fact is that no one can have more than thirty years or so of radio experience, and only a handful of men can point to anything like that. The twenty-year candidates, even, are few. In the case of all such veterans, the early years of experience have a value which is mostly sentimental, for the modern structure of the industry, with its complexities of mass production and public relations sprang up suddenly after the war. Mr. Langley's years of contact with the radio art amount to about nineteen, or half his age, which is quite enough in a field where the race is to the swift rather than the old.

Mr. Langley was born in New York City and lived there until 1916. His boyhood residence was near Morningside Park, under the hill on which the buildings of Columbia University were being erected. Young Langley, gazing at the newly created campus, formed an ambition to drink of knowledge at that fountain, but, as yet, he did not see how the project was to be financed. After finishing his elementary school course, however, he went to De Witt Clinton High School, 1904-1908, and towards the end of his secondary school course succeeded in winning a scholarship which enabled him to enter Columbia.

During the following winter, Mr. Langley's father died, and the son gave up college to take a position with the New York and Queens Electric Light and Power Company. But at Columbia, in the college "Wireless Club," the radio virus had already got into him, and in May, 1910, at the invitation of Emil J. Simon, he turned from electric power to work in Dr. Lee DeForest's laboratory at Park Avenue and 41st Street, where many strange wonders were being performed. Here he met Frederick A. Kolster and other men now prominent in the radio industry of to-day, which had its feeble and often abortive beginnings in just such laboratories. In those early days the courage of the workers made up for the scarcity of good milliammeters. A half year in DeForest's laboratory probably did Langley good, but a school teacher friend, James F. Berry, who had advised him before, now convinced the young man that he would be heavily handicapped in his later career if he did not complete his university course while there was still time. Mr. Langley took the advice and went back to college in the fall of 1910, repeating the sophomore year. But he did not give up radio. The summer of 1911 he spent working with E. J. Simon once more, this time for the International Wireless Telegraph Company (wasn't it the National Electric Signaling Com-

pany then?) at Bush Terminal in Brooklyn. Here he met S. M. Kintner, now in charge of the research activities of the Westinghouse Company. The summer of 1912 found him with the Wireless Improvement Company.

Mr. Langley graduated from Columbia University as an Electrical Engineer in 1913. Edwin H. Armstrong was one of his classmates, and



RALPH H. LANGLEY

Michael I. Pupin one of his professors. Professor Arendt, another of Langley's preceptors, had a poor opinion of the wireless game, and advised the young engineer to stay out of it, but Langley promptly joined the Wireless Improvement Company once more.

During the three years Mr. Langley put in with the Wireless Improvement Company, then under the guidance of Colonel John Firth, most of his work was with various types of 500-cycle quenched spark transmitters. The $\frac{1}{2}$ kw. submarine transmitter was one of his early design jobs. Mr. Langley's interests were not, however, confined to commercial matters. He had joined the Institute of Radio Engineers as an Associate in 1912, and in 1914 served as Assistant Secretary. In 1916 he was advanced to the grade of Member of the Institute. In that same year, at the invitation of David Sarnoff, he joined the engineering staff of the Marconi Company, and went to work at the Aldene factory, of which Adam Stein, Jr., was Works Manager. Roy A. Weagant was Chief Engineer of the Marconi Company during the period of Mr. Langley's connection with the firm. The Marconi Company was handling war-time orders, principally for the armed forces of the United States. In 1917 the plant was greatly enlarged, and, running on three shifts twenty-four hours a day, must have employed in the neighborhood of one thousand men. New types of quenched spark transmitters were designed for submarine and aircraft use. In the meantime the manufacture of the standard Marconi marine transmitters and receivers, with auxiliary apparatus, such as Leyden jar condensers, had to be continued, and in the shops one would see standing side by side models of Naval receivers of the SE Types,

with their heavily-varnished bank-wound coils, the older Type 106 tuners in their black cases, and cheap little cargo receivers which looked as if they had just come out of the five-and-ten cent store. But Mr. Langley's concern at this time was with the transmitters, so much so that, in 1918, one of them almost ended his career. This distinction would have gone to the 250-watt aircraft transmitter, equipped with the General Electric pliotrons of the same rating. During one of the tests of the transmitter, Langley, having shut off the filaments of the tubes, reached in and grasped a plate terminal, forgetting that the 1500-volt supply was still on. "That particular set never worked again," states Mr. Langley laconically. "and it was some time before I did." There was evidently nothing wrong with his heart. After the completion of the development work on the sets, he made test flights with them from the air base at Norfolk, Virginia. "But none of these sets was ever used in France," the designer adds, somewhat sadly. The answer to that is that few of the airplanes ever got to France either.

In 1920, the Radio Corporation of America having been formed, the radio engineering and manufacturing activities of the Aldene factory were transferred to the General Electric Company's plant at Schenectady. Adam Stein Jr. became Managing Engineer of the Radio Department there, and Langley was assigned to the Receiver Section, later to become the Engineer-in-Charge thereof. Practically all the broadcast receivers turned out by the General Electric Company have contained one or several of Langley's inventions and design features. Working with Messrs. Carpenter and Carlson, Mr. Langley was responsible for the production of the first Radiola super-heterodyne models, incorporating the sealed "catacomb" construction and the divided cabinet. He spent seven years at Schenectady, leaving for his present executive position with the Crosley Company on February 1, 1927.

During the last three years, Mr. Langley has been much interested in the work of the radio manufacturers' associations. He was vice-chairman of the Radio Section of the Associated Manufacturers of Electrical Supplies, and later, when that body was merged with the National Electrical Manufacturers Association, became Chairman of the Committee on Section Activities in the Radio Division. He also served, in 1926, on the Standardization Committee of the Institute of Radio Engineers.

With his years of experience in radio manufacturing and organization, and his wide acquaintance among radio men, Mr. Langley believes that the next two years will witness remarkable progress in the industry. He points out that many lines of progress have been almost completely blocked until the present season. With patent difficulties largely resolved, notable progress in standardization, adequate Federal control of broadcasting, and the development of exact methods of measurement and quantity production, the economic stability of the industry should approach that of more settled branches of business. Mr. Langley has contributed more than his share in the progress of radio toward that goal.

Some Fine RECEIVERS



THE "HIAWATHA"

An attractive six-tube receiver by Mohawk, Chicago. As the chassis picture shows, there are six tubes. The three tuned stages are adjusted by means of a single tuning knob. The chassis depicted is standard in several Mohawk receivers, which range in price from \$67.50 to \$275.00 for battery operation. For a. c. operation, add \$110.00 to the above prices. The retail price of the "Hiawatha" is \$165.00. It has a built-in pyramid form loud speaker, for which very excellent reproducing qualities are claimed.

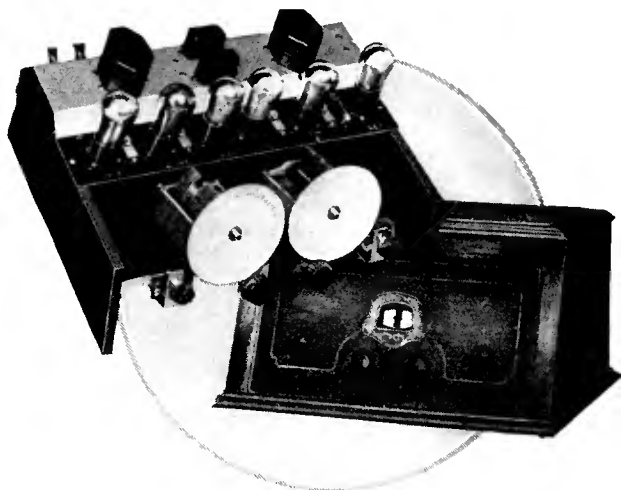
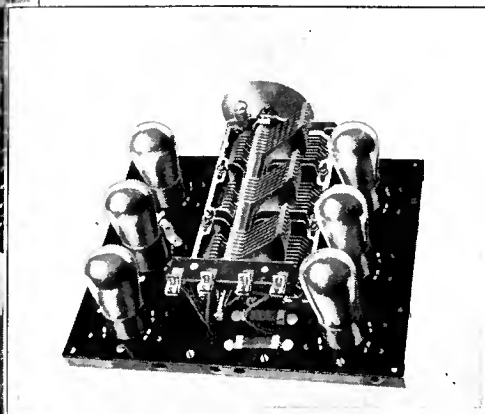

FOUR TUNED STAGES

Are incorporated in this six-tube receiver by Bremer-Tully. The "Counterphase" 6-35, to give the receiver its exact name, will delight the advocates of two-dial tuning, for the condensers are arranged in two units of two, and are, therefore, controlled by two knobs on the front panel. There are separate controls for sharp tuning and volume. This new "Counterphase" retails at \$110.00. A console model sells for \$165.00.

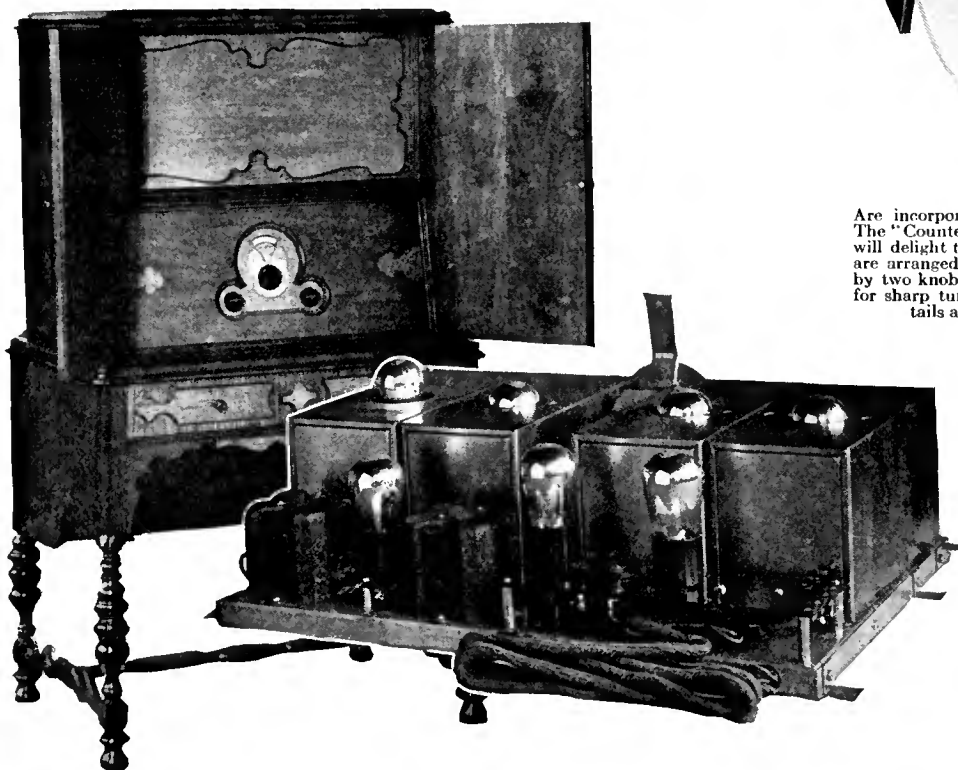

"GRANADA" CONSOLE

By Electrical Research Laboratories ("Erla"), of Chicago. The finish is of dark antique walnut combined with birdseye maple. The drawer front is of satinwood with maple overlay. The chassis comprises the equipment for four r.f. stages (three of which are tuned), detector, and two transformer-coupled audio stages. Tuning is accomplished by means of a single dial, and there is a built-in loud speaker. Price \$295.00. Furnished with an a. c. converter system, all tubes, and an output filter, price \$395.00.

and Their CHASSIS

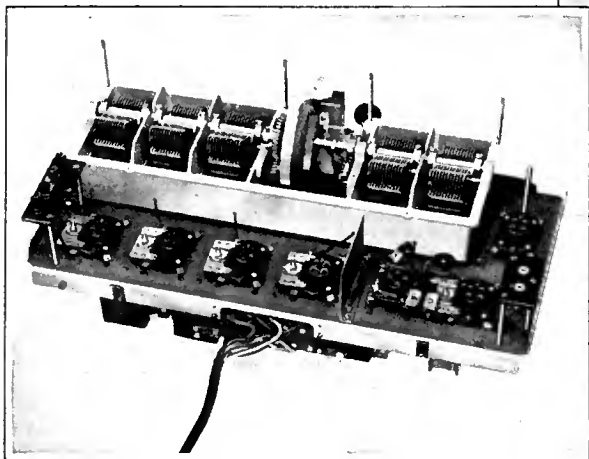

BOSCH, MODEL 57

Here is an interesting receiver typical of the progress of recent years—an example of the modern self-contained installation. The price, \$410.00, is not excessive when we consider that the receiver is designed for socket-power operation, has a built-in loop, and also includes a loud speaker of advanced design. This price is reduced to \$310.00 if the socket power feature is not desired. The single station selector, which adjusts five separate variable capacities, is graduated in kilocycles

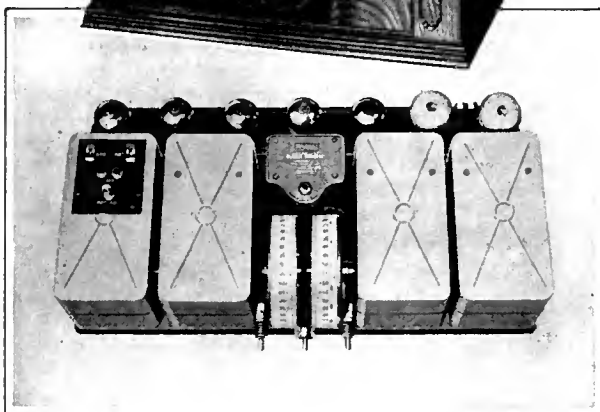
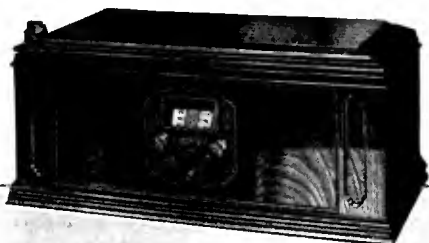

THE FADA 7

Another receiver employing four stages of r.f., but two tuning controls are used with this model. A loop is supplied with the Fada 7 although an outside antenna may be used successfully. The loop fits into a special clamp on the side of the cabinet. The two audio stages are transformer-coupled. A special arrangement in the detector circuit reduces the possibilities of overloading. Price, \$185.00

AMRAD'S THE "BERWICK"

A popular six-tube neutrodyne type circuit, employing four tuned stages and single-control tuning. As the chassis illustration shows, complete shielding is featured. A cone loud speaker is built into the "Berwick," which, partly due to the special Amrad tone filter, gives remarkably good quality of reproduction. The price is \$195.00

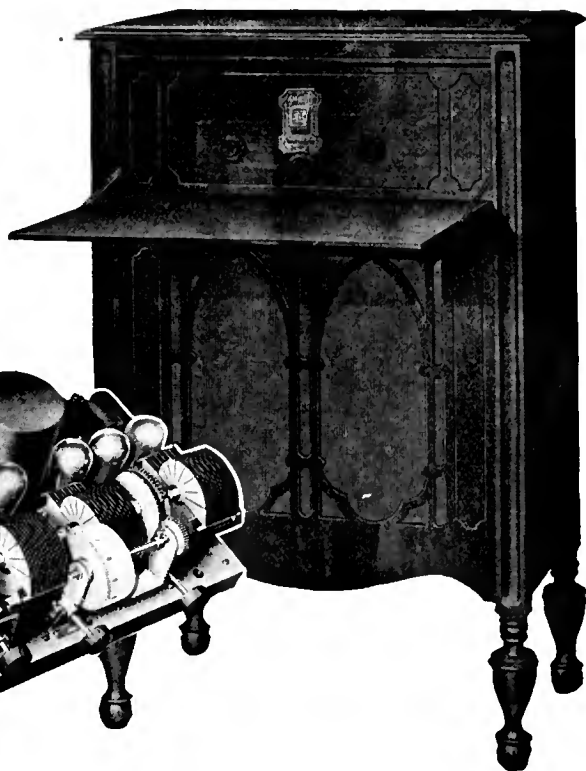
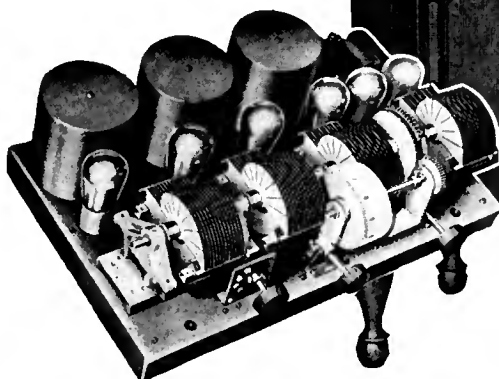

**How Reliable
Are Short
Waves?**

RECENT EXPERIMENTS of the General Electric Company, of engineers from other companies,

and of those interested in private research, have resulted in an explanation of many of the mysteries that have surrounded the short waves. Everyone marvels at the ease with which amateurs communicate with fellow enthusiasts over great distances with small input powers. We have done it ourselves—communicated and marveled both—and great is the “kick” thereof. It is undeniably thrilling to take from one’s lamp socket 60-cycle power of less than one fifth that required to heat the average electric iron, and to feed it into a comparatively simple system of apparatus from which it emerges as radio-frequency energy with which we actually ask a man in South Africa how the weather is there, all the time sitting quietly in our den surrounded by unimposing gear. When it is winter in New York it is summer in South Africa, when day here, it is night there, and so on. It is one of the marvels of our time that two people in the security of their homes but separated by 7000 miles can transfer their thoughts instantaneously and economically.

Just how good are these short waves? How reliable is communication? How many hours of the day, how many days of the year, can we send messages via short waves from New York to South Africa?

The results of several investigations point to the following facts which seem fairly well established. Ten meters (30,000 kc.) is probably the shortest useful wavelength. Below about 20 meters (15,000 kc.) the waves prefer to travel in the daylight, and above that wavelength, night time is the best. Below about 45 meters (6660 kc.) curious “skip distances” occur, resulting in regions beyond which signals are heard but within which they are inaudible. For example, on 15 meters (20,000 kc.) during daylight, transmission is not practicable within a distance of 900 miles, which increases to about 1000 miles at night, although it is possible to transmit signals for reception at points more distant than these figures indicate. At 27 meters (11,000 kc.) the daytime skip distance has been reported as 1000 miles and 450 miles at night, these distances being about the same at 33 meters (9086 kc.).

The General Electric experiments show that the 32.79-meter wave is no good at all for short distances. A power output of 500 watts on 65.16 meters (4500 kc.) will, however, transmit commercial daytime signals up to 100 miles.

Short waves seem necessary for extremely long-distance communication. During daytime, waves of the order of 20 meters should be used; waves below about 45 meters are not much good for short-distance work.

Night after night we have heard NAA on 37.5 meters pound away at a terrific rate, we have listened to the Marconi beam stations on 26

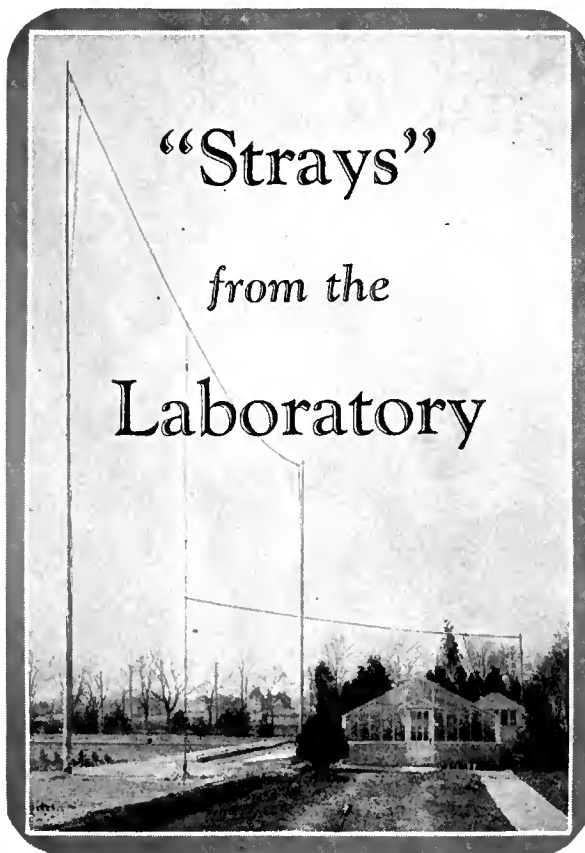

meters, AGA at Nauen, Germany, FW in Paris, and others, all bent on getting somewhere in a hurry, and we wonder how soon it will be before the band between 25 and 45 meters is as busy as the long-wave channels. Amateurs in this country who have a channel 1000 kilocycles wide around 40 meters have been blessed with an excellent assignment which at the time it was doled out was thought to be more or less worthless. More and more amateurs are going to 20 meters and with low powers are accomplishing unheard of records in broad daylight. They have not as yet the feeling for this band and for conditions existing there that they had for the 40-meter band, but it will come when they gain the wealth of experience they have amassed on the longer wavelength band.

Mathematics of the Audio Transformer

IN MOST radio work the mathematics is fairly simple; the difficulty comes when it is necessary to put the mathematical theory into practice. For example, the following mathematics is that underlying the theory of the input transformer for audio-frequency amplifiers. The circuit about which this theory is built up is given in Fig. 1, and its equivalent is shown in Fig. 2. In this mathematics, N is the turn ratio of the transformer.

$$E_s = NE_p = I_g R_g$$

$$E_p = \mu E_g - I_p R_p$$

$$E_s = N (\mu E_g - N I_g R_p)$$

$$I_g R_g = N (\mu E_g - N I_g R_p)$$

$$I_g = \frac{N \mu E_g}{R_g + N^2 R_p}$$

$$\text{Whence } E_s = \frac{R_g N \mu E_g}{R_g + N^2 R_p}$$

$$= \frac{N \mu E_g}{1 + N^2 \frac{R_p}{R_g}}$$

Differentiating this equation with respect to N and solving for a maximum, it is found that:

$$N^2 = R_g / R_p$$

and substituting this into the equation above for Es:

$$E_s = \frac{\mu E_g N}{2}$$

All of this assumes that the transformer is perfect, i.e., no d.c. resistance, no magnetic leakage, infinite primary and secondary reactance. It shows that under these conditions the voltage delivered to the input of the tube is one half that delivered to the previous tube multiplied by the turns ratio of the transformer and by the amplification factor of the previous tube.

If the input impedance is one megohm, 1,000,000 ohms, and the plate impedance of the previous tube is 12,000 ohms, the turn ratio will be equal to the square root of the ratio between these two quantities, viz:

$$N = \sqrt{\frac{1,000,000}{12,000}} = 3 \text{ approximately}$$

In order that a large percentage of the a.c. voltage developed in the plate circuit of the previous tube be available across the primary of the input transformer, the impedance of this transformer must be high. If we want to amplify well at 100 cycles, the input impedance should be not less than 30,000 ohms which means that the primary should have no less than 50 henries inductance—which in turn explains why transformers, good ones, cost money, and why a skinny little affair with a

few sheets of iron in the core and a little wire on the primary makes radio music sound “something fierce.”

Furthermore, if the turn ratio is three, and the inductance of a winding varies as the square of the turn ratio, the secondary inductance must be about 450 henries—and when anyone states that the secondary of an audio transformer makes a good output choke he neglects the fact that one cannot wind up an inductance of 450 henries without adding enough d.c. resistance to prevent the last tube from getting any plate voltage at all.

MATHEMATICS OF THE OUTPUT TRANSFORMER

THE mathematics of an output transformer design is no more difficult than that of the input transformer—and the answer is the same, as the following rigamarole proves. The symbols used in this discussion are the same as for the input transformer. N is the turn ratio of the transformer, and instead of Rg we use Rs.

$$I_s = \frac{E_s}{R_s} = \frac{NE_p}{R_s}$$

$$E_p = \mu E_g - I_p R_p$$

$$I_p = \frac{\mu E_g}{R_p + R_s}$$

$$\text{Whence } I_s = \frac{N}{R_s} \left(\mu E_g - \frac{\mu E_g R_p N^2}{N^2 R_p + R_s} \right)$$

$$= \frac{N \mu E_g}{N^2 R_p + R_s} = \frac{N \mu E_g}{\sqrt{2} (R_p N^2 + R_s)}$$

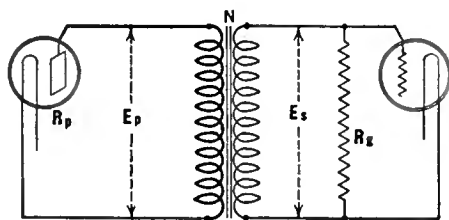

FIG. 1

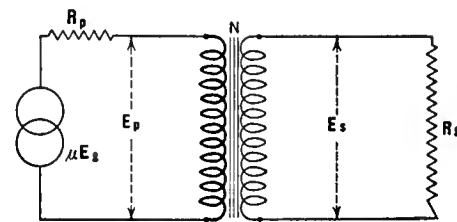

FIG. 2

Differentiating this expression with respect to N and solving for a maximum,

$$N^2 = \frac{R_s}{R_p}$$

$$\text{And } I_s = \frac{\mu E_g}{2V R_p R_s}$$

$$\begin{aligned} \text{whence power in } R_s &= I_s^2 R_s \\ &= \frac{\mu^2 E_g^2}{8 R_p} \end{aligned}$$

If the speaker R_s is in the plate circuit of the power tube without the output transformer, and if the impedance R_s equals R_p the power will be as indicated above, showing that the transformer is indeed an impedance adjusting device and that it is possible to secure maximum power in a load impedance which is not equal to the tube impedance provided the output transformer has the proper turn ratio.

A little consideration will show that if the primary impedance of this transformer is equal to the tube impedance and if the secondary impedance is equal to—"matches," is the usual word—the load impedance one half the voltage existing in the plate circuit will be expended in heating the plate. It is obvious, then, that the primary impedance again should be several times that of the tube impedance, but since the final tube has a low impedance, the UX-171 (CX-371) type for example has an impedance of 2000 ohms, a manufacturer of transformers needs to put nothing like the impedance in his output transformer primary that he puts into an input transformer. Likewise the secondary impedance must be high compared with the load, or speaker. As long as the turns ratio is proper, energy will be transferred from the tube to the speaker with a minimum loss, and for all practical purposes the output transformer may be neglected in calculations.

SOME OF RADIO BROADCAST'S

**High-Powered
Bunk**

readers are technically inclined, and must enjoy the monthly battle of wits among

radio advertising writers whose "eulogies" appear in many radio publications. We saw recently a new loud speaker advertised which consisted of a "tone column of new design; by means of a scientifically designed tone distributing chamber a forced crossing of sound waves is accomplished, and a divisional tone chamber of unique design segregates high and low tones, reproducing both with equal facility." Bell Laboratories engineers should take notice of this new scheme for attaining perfect fidelity, and should forget all about loud speakers which will look like a pure resistance to a power tube at all frequencies. All that is necessary is to segregate the low voice from the high one and then re-combine them. Presto!

There is also a new antenna that promises much, for, according to a widely circulated advertisement, it meets the need of radio users, whether for small or large sets. It has been thoroughly tested for over two years under all kinds of conditions and on many kinds of sets. In every set, it has proved its many advantages:

1. Easy to put up or take down.
2. Picks up waves in any direction because it is round.
3. Proven more selective.
4. Greater volume.
5. Greater distance.
6. Helps eliminate static.
7. Small and compact.
8. Neat in appearance.
9. Low in cost—only \$7.50.

What more could anyone want?

This kind of bunk is not only confined to the advertising pages of the media in question, sadly to recount. The following passages are quoted from a recent article describing a new and revolutionary receiver that anyone can build for about twice as much as he would have to pay for a well known and thoroughly engineered set.

"Its volume is due to the high amplification in the audio end of the circuit and to the fact that two 71 tubes in push-pull are used in the last stage."

Off hand this seems reasonable until one considers that there are three audio tubes—which furnish most of the amplification—and that there are eight tubes which precede them! It reminds us of the early days of radio when the Laboratory had its hands full weeding out the good apparatus from the poor. A receiver came to Garden City equipped with thirteen tubes, guaranteed to pick up any signal in any part of the world at any time. The total plate current of this super-receiver, including a power tube, was nine milliamperes. It seemed incredible—and was, until we discovered that eight of the thirteen tubes had no plate voltage on them. But let us continue with this totally new receiver.

"With all that amplification and power handling capacity there will be undistorted volume enough to make the welkin ring. But all of this would be merely potential volume were it not for the almost incomprehensible amplification in the intermediate amplifier. It is here where the weak signals from the remote stations are pulled from infinitesimal levels and placed on the plane of the signals from local stations. Both the amplification and selectivity could be expressed in numbers but they would be so large as to be meaningless to the human intelligence."

There you are, and five more columns of it for good measure!

**New
Apparatus**

DURING recent months, the Laboratory has received for test the following apparatus: Power units from Kellogg, Wise McClung, Valley, Universal, Briggs and Stratton, Boutin Electric Co., Sterling Mfg. Co., and Grigsby Grunow; tubes from the following tube plants, Arcturus, R. C. A., Cunningham, Supertron, CeCo, Manhattan Electric Supply Co., Conneway Laboratories, Zetka, Cable Supply Co., Televocal, Van Horne, DeForest, and Supercraft; audio transformers from Modern, Silver-Marshall, Samson, Tyrman, Sangamo, Amertran, G. W. Walker; the new Eby sockets, a Muter double-impedance amplifier, a Pacent Phonovox electrical pick-up unit, the excellent looking Abbey receiver manufactured by Splittdorf and already illustrated in RADIO BROADCAST, a useful floor cord made by Belden which enables one to place wires under a rug without danger of tripping or of impairing the appearance of the room—the wires may carry house lighting current for a lamp, or loud speaker wires; a complete assortment of Acme Wire Co. Parvot condensers; rheostats, etc. from Carter; a complete push-pull amplifier and B supply units from Samson, Thordarson, and General Radio; resistances for stabilizing grid circuits, for plate supply circuits, for center taps on a.c. tube circuits, etc., from General Radio, Electrad, Frost, Daven, AmSCO, Gardner and Hepburn, Aerovox; and coils from Precision Coil Co.

Many other interesting pieces of apparatus have been received, previous mention of which has been precluded pending test and on account of space limitations. Among the larger items are Silver-Marshall's interesting Time Receiver, a huge and much involved horn loud speaker from Newcomb-Hawley, using a Baldwin Unit, and known as a Console Grand Reproducer, a Peerless loud speaker from the United Radio Corporation of Rochester, and a Holmes Piano loud speaker from the International Radio Corporation, of Los Angeles. The Newcomb-Hawley loud speaker has a very long air column secured by giving the neck several convolutions about the wide opening. The Peerless is an attractive loud speaker with an excellent element. Both loud speakers cover wide frequency ranges and go down particularly well.

The Laboratory was especially interested to receive one of the "tuned" impedance amplifiers about which so much is heard, this one delivered by Mr. Kenneth Harkness in person, giving us the opportunity of meeting him for the first time. Frequency curves are being prepared on this amplifier, and will be ready soon.

Transformers for the new a.c. tubes were received from Amertran, General Radio, Mayolian, and Northern Manufacturing Company. New rheostats came in from Frost, Centralab, and Carter. Some large heavy-duty resistors from the Electro-Motive Engineering Corporation also made their appearance. Among the other items are new Samson apparatus, loud speaker units from the Balsa Wood Corporation, Engineers Service Company, Baldwin, Vitalitone, and Magnaphon Company, a series of new and probably very efficient inductances made by the Precision Coil Company, a "Subantenna" (is there any way of testing this antenna without digging up the garden?), two sheets of beautifully burnished copper for shielding, from C. G. Hussey & Company, of Pittsburgh, condensers from X-L Radio Laboratories, Electrad apparatus and a fine looking White socket power unit from Sioux City, Iowa.



THE NEW SCREENED GRID TUBE

The bulb of a "dead" UX-222 tube was broken so that this photograph of the interior construction might be taken. The RADIO BROADCAST Laboratory is expending considerable time experimenting with these tubes so that the information contained in articles in these pages might be backed up with actual experience. We can promise readers some particularly fine articles along such lines in the very near future

Concomitants

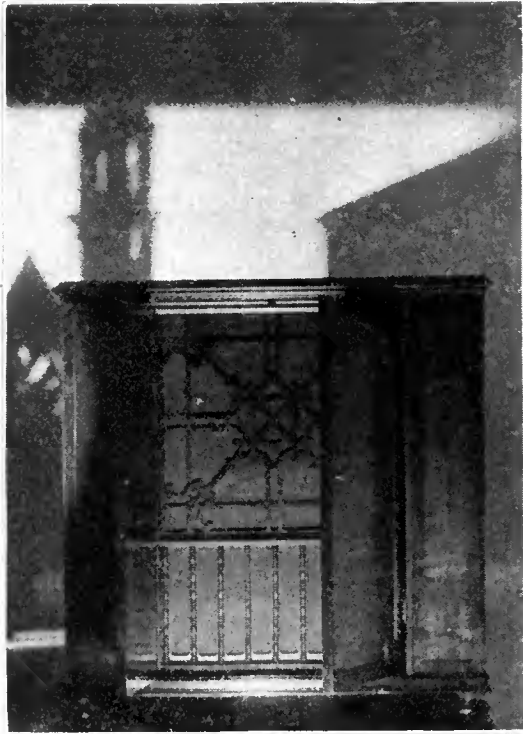

THE AMPLION "GRAND"

AS PLEASING to the eye as to the ear is this magnificent loud speaking device by Amplion. Contrary to what one might justly suppose upon first glance, the "Grand" does not use a horn inconceivably magnificent in inches, but employs a combination cone and sound board. The "Grand" lists at \$145.00. It is supplied with a 20-foot cord. The walnut cabinet measures 34" x 33" x 18"

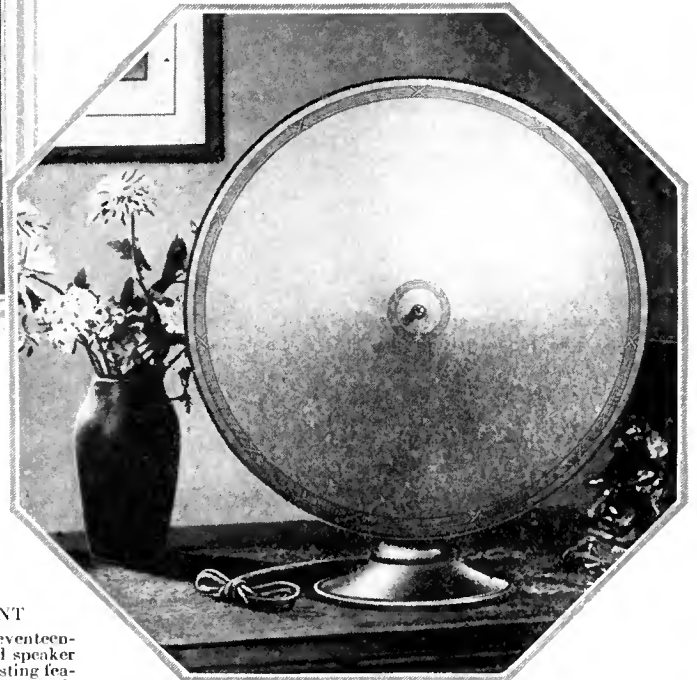

BY PACENT

HERE is a seventeen-inch cone loud speaker with several interesting features. Its extreme ruggedness and responsiveness to weak signals are features. The manufacturer claims that this cone has a thirty per cent. greater frequency coverage and sensitivity than most of the popular model cones on the market. Price, \$22.50

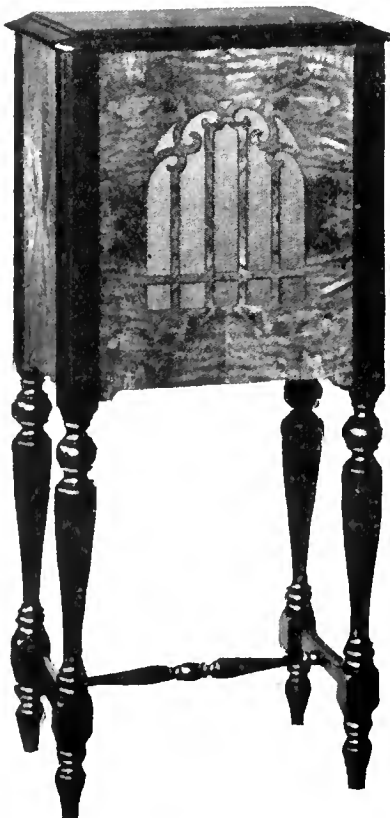

THE MAGNAVOX "ARISTOCRAT"

TO THE LEFT

IS A new power cone loud speaker employing electrodynamic principles. Due to its unique construction, great volume may be handled without any possibility of rattling. An external source of direct current is necessary for operating this instrument. Either the storage battery or the electric light mains may be employed for this, depending upon which type of loud speaker is used. If the storage battery is employed, the current drain will not exceed that usually drawn by a 171 type tube. The price of the "Aristocrat" is \$85.00 for storage battery operation or \$90.00 for 110-volt d. c. operation

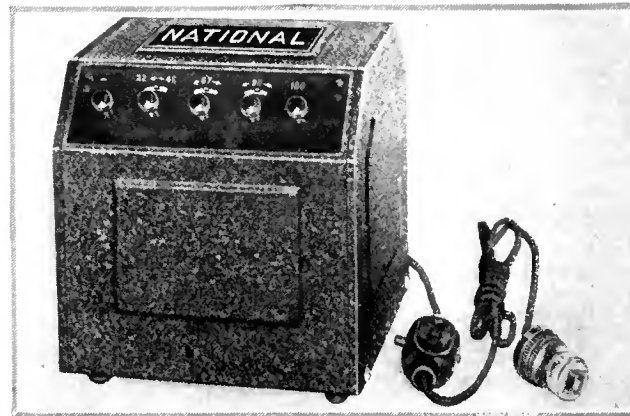

DESIGNED FOR HEAVY-DUTY WORK

THERE are four voltage taps on this new B supply device by National, three of which are adjustable. The detector voltage is from 22 to 45; the r.f. voltage, from 50-75; and the a.f. voltage from 90-135. The power-tube voltage tap delivers 180 volts. Price, with cord, switch, and plug, \$40.00. Rectifier tube, \$5.00

of Good Quality

EXPONENTIAL HORNS

A GOOD exponential horn is capable of very excellent results so far as quality reproduction is concerned, and is exceptionally efficient. The Temple Console to the right employs a 75-inch exponential air column, and is priced at \$65.00. The Temple Drum below also has an exponential air column and comes in two models, using 54-inch and 75-inch air columns, priced at \$29.00 and \$48.50 respectively

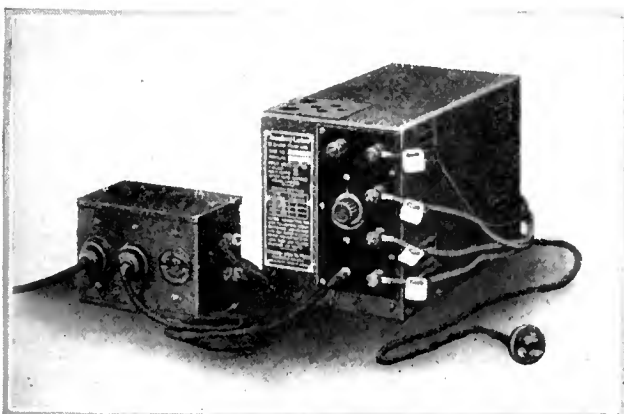
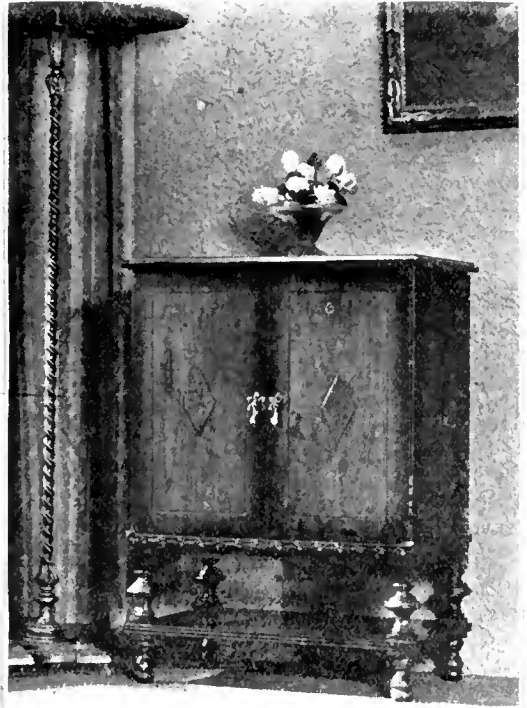

A NEW SOCKET-POWER DEVICE

TOGETHER with a relay which automatically switches the house electric light supply to the B device illustrated, or to a trickle charger, depending upon whether the set is in use or not. These devices are by Stromberg-Carlson, of Rochester, and retail at: B device, \$63.00 (with tube); relay, \$11.00

FOR THE PHONO-RADIO COMBINATION

THE Platter Cabinet Company, North Vernon, Indiana, is responsible for this attractive cabinet of walnut plywood, in which space is provided for a complete radio installation and a phonograph. The price of the cabinet is \$72.00. The same manufacturer will supply turntable, motor (electrical or mechanical), radio receiver, electrical pick-up device, and loud speakers of many patterns to fit into the cabinet, if desired

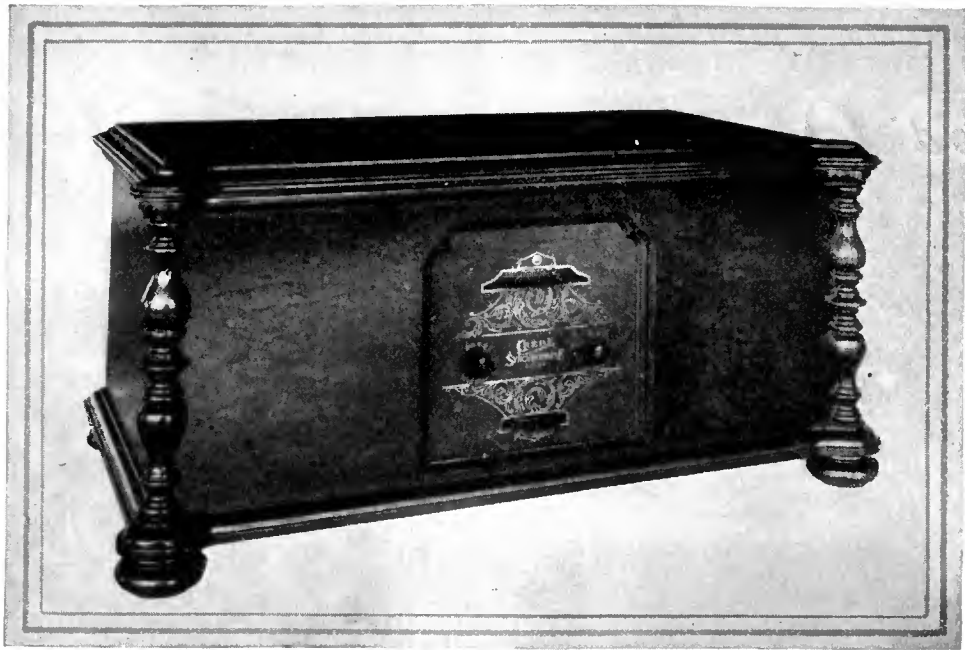

THE GREBE "SYNCHROPHASE" SEVEN
The circuit diagram of this receiver is shown on the next page

How the "Synchronphase" Seven Was Developed

By John F. Rider

WE REQUIRE a seven-tube receiver with single tuning control to be sold at a retail price of \$135.00. Produce it."

Such, in effect, might have been the wording of a memorandum from the board of directors of A. H. Grebe to the engineers responsible for the design of the "Synchronphase" Seven. Thereupon, a tedious process of laboratory and mathematical experiment sets in, for the "cut and try" methods of "mediæval" radio days are forgotten, since present broadcasting conditions would make such procedure impracticable.

Being familiar with the congestion among stations, the transmitting characteristics of the broadcasting stations, and the power used by the stations, the radio engineering department was able to select the number of tubes to be used as radio-frequency amplifiers, decide upon the detector system, and arrive at a decision concerning the number of stages of audio-frequency amplification necessary to produce a satisfactory receiver output signal. They were aware of the operating channels used by broadcasting stations in various localities, hence they could judge if their tuning system would be capable of separating the stations and of providing radio reception without a background of interference from other stations.

This was, however, not all a matter of guess work. Such perfectly engineered radio receivers are first produced on paper, with the aid of mathematics and the "slip stick" (a nick-name for the slide rule). The amount of time put into the design of radio receivers of modern times is almost inconceivable when compared to that of six or seven years ago.

After due deliberation, the decision of the Grebe engineers was to employ four stages of tuned radio-frequency amplification, a non-regenerative detector, and two stages of transformer-coupled audio-frequency amplification. The question then arose relative to the design

of the radio-frequency system. Should it be shielded or unshielded? Development carried out prior to this time resulted in the birth of a new type of fieldless inductance—an inductance which could be used in a multi-stage tuned radio-frequency receiver without fear of coil interaction. This coil, known as the "binocular" inductance, was the brain child of P. D. Lowell, and is the evolutionary development of the toroidal winding. Since this coil is fieldless, inter-stage shielding was unnecessary; two, three, or four stages of unshielded tuned radio-frequency amplification may, therefore, be used without worrying about excessive regeneration. Eliminate the coil fields and shielding is unnecessary, since coil interaction will not take place. The elimination of shielding means economy without any sacrifice.

The function of shielding is also to preclude direct coil pickup, but since the fieldless coil will not pick up any energy, shielding is unnecessary on this account. The binocular coil, therefore, solved several problems in the design of the "Synchronphase" Seven. The coil itself consists of two solenoidal windings mounted closely together with their axes parallel and with the two windings connected in such a manner that their electromagnetic fields are opposing each other. This means that, if one coil starts to radiate a magnetic field, the other coil simultaneously radiates a magnetic field of equal intensity but of opposite phase or direction, and the two fields combine and counterbalance each other. The result of the combined fields is zero. Hence, no reaction between the tuned transformers is evident.

The same phenomenon applies to the pickup of waves by the transformers. A voltage introduced in one coil is reacted upon by the voltage introduced in the other coil by that passing wave. The two induced voltages react upon each other and the resulting induced voltage is zero.

Hence pickup of energy is not apparent. The fact that these coils are fieldless permits of a layout different from that possible when the coils used have strong fields. Interaction of fields is the greatest objection to the single-layer solenoid. It is a very efficient winding out possesses a very strong field, and total shielding is imperative in a receiver employing a number of single-layer solenoid radio-frequency transformers.

The next problem was the actual design of the binocular inductances. The mere selection of a form of winding does not complete the design problems of the tuned radio-frequency transformers. Solid wire is conventional for the average tuned radio-frequency transformer. Is it best for these coils? Does the form factor of the average coil apply to this type of winding? Can some other wire be used to greater advantage? Here is room for research and experiment.

The first binocular coils were wound with solid wire. Further experiments and calculations by the engineering department proved conclusively that "litz" wire improved the inductance-resistance ratio to a large extent and as far as practical results were concerned, coils wound with "litz" wire could be made to have a more uniform amplification curve over the broadcast frequency spectrum, in addition to improving the selectivity of the tuned circuit. Here again we find a deviation from the conventional path. "Litz" wire has frequently been frowned upon as unsuited for high-frequency work. The designers of the "Synchronphase" have overcome the difficulties and are utilizing "litz" to good advantage.

The occasion next arose for the development of an original system to overcome a frequently occurring fault with conventional tuned radio-frequency amplifiers. It is of paramount importance that the frequency response curve of the radio-frequency system be substantially flat. Furthermore it is desirable that the effects of the

grid-filament capacity within the tube be so nullified that the purchaser can use whatever tubes he may choose without fear of upsetting the tuned circuit balance obtained in the factory when the receiver was first tested. With many receivers the neutralizing condenser (or condensers) has to be readjusted whenever any changes in the tubes are made. The frequency response curve of the average tuned radio-frequency amplifier shows maximum response on some short wavelength (high frequency) with a falling characteristic as the wavelength is increased (frequency lowered). The system represented in Fig. 1 by the variable condenser C_1 and the two resistances, R_1 and R_2 , was developed and incorporated to attain the two objectives mentioned at the beginning of this paragraph. The action of these units is twofold. First, they eliminate the effect of the grid-filament tube capacity upon the tuned circuit, particularly on the low settings of the tuning condensers, in such manner that tubes may be changed without affecting the original resonance setting. Second, they control the voltage being

give sufficient sensitivity and selectivity. Furthermore, the sideband suppression characteristics of the radio-frequency system are known and the introduction of a variable constant, which would be encountered with a variable regenerative detector, would upset the balance between the radio and audio amplifying systems.

THE AUDIO CHANNEL

THE audio amplifying system is closely associated with the radio-frequency system; in fact, it must be, for the reason that the frequency characteristics of the audio-frequency amplifying transformers are governed by the sideband characteristics of the radio-frequency system. If the sideband suppression of the upper audio register is great in the radio-frequency amplifier, the audio system must possess a certain rising characteristic. The slope of the rise is governed by the degree of suppression in the radio-frequency amplifier. Hence the two systems are closely associated. Being familiar with the sideband suppression in the radio-frequency

in the inclusion of a device which permits tonal flexibility. The problem arose during the process of development when the sales staff mentioned the fact that the aural fancy of the listener-in was apt to vary over a wide range. Could not some device be incorporated which would permit variation of the tone of received speech or music, so as to satisfy the individual tastes of the multitude? Some fans prefer a preponderance of low tones, while others are not so anxious about these low frequencies. The engineers decided that the best location for such a unit would be in the audio amplifying system, but a continuously variable change in the physical structure of the audio-frequency transformers to produce different response was impractical. Hence the "tone color" unit, consisting of a number of fixed capacities which can be shunted across the secondary of the second-stage audio-frequency transformer to change its operating characteristic, was originated. The "tone color" is controlled by a knob on the front of the panel and, by its manipulation, the listener is able to adjust the tone to suit his own taste. The capacities in the "tone color" vary from 0.0008 mfd. downwards.

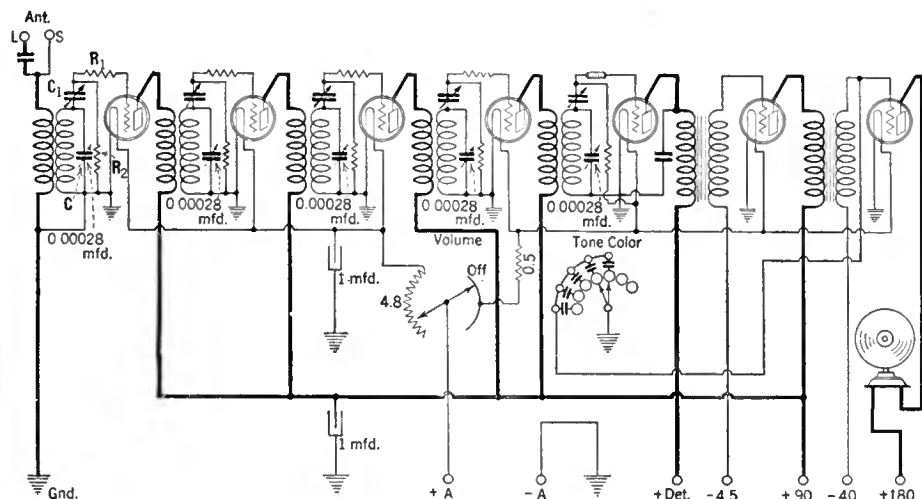

FIG. 1
Circuit diagram of the "Synchrophase" Seven

fed into the grid-filament circuit of the amplifying tube, so that the radio-frequency voltage fed into the tube is practically uniform over the complete tuning scale and the frequency response curve of the tuned system is sufficiently flat. With this arrangement, and the inherent lack of regeneration in the system, a high degree of stability and amplification is afforded.

The four stages provide ample selectivity and sensitivity and are designed to possess sideband characteristics with minimized suppression above 1000 cycles. This consideration is very important, and the presence of excessive regeneration would tend to nullify all the effects of scientific design. But the properties of the fieldless coil guard against this detrimental effect. With sufficient spacing between the inductances, the very small amount of external field, which cannot be eliminated completely, does no harm. Hence the regeneration present is uniform over the scale and is at no time sufficient to cause uncontrollable oscillation.

The detector system is the grid leak-condenser arrangement, affording maximum signal sensitivity and intensity. The compensating system utilized in the radio-frequency stages, is also resorted to in the detector input circuit, thus permitting the use of any detector tube without unbalancing the tuning system. A non-regenerative detector was decided upon because the four stages of tuned radio-frequency amplification

system, two audio stages are decided upon after a study of the amplifying powers of the system; these two stages possess sufficient magnifying power to afford a satisfactory output. The overall response curve of the audio system is shown in Fig. 2. The gain in transmission units is shown on the ordinate and the frequencies are shown on the abscissa. The curve is plotted on a logarithmic scale.

Particular consideration was given to the feminine speaking voice, the frequencies of which are difficult to amplify, and to the overtones of the high-frequency producing musical instruments. The result is that the transformers were designed to function satisfactorily on audio frequencies above 8000 cycles. This is easier said than done. A great deal of work was entailed before suitable transformers were produced. In order to realize satisfactory amplification on the upper audio register it was important to reduce the distributed capacitance of the secondary winding. This was accomplished by the use of three layers of insulation between each layer of winding. The distributed capacity of the secondary winding is approximately 18 micro-microfarads. The importance of a low distributed capacity can be appreciated when one realizes that the higher it is, the more limited will be the frequency range of the amplifying unit.

An example of vision, and a knowledge of the buying public's whims and fancies, is displayed

THE PROCESS OF TESTING

ENGINEERING and originality has made possible the manufacture of all the necessary equipment, exclusive of the cabinets, in the Grebe plant, at Richmond Hill, Long Island.

The manufacture and testing of the tuned radio-frequency inductances is of especial interest. The winding is spaced yet the winding form is not grooved. This is made possible by means of a grooved slider which carries the wire as it is wound on the winding form. The grooves on the slider space the wire, and the turns are kept in place by means of a layer of clear lacquer which is sprayed upon the coil before assembly. Ingenuity in testing now manifests itself. The wire, as mentioned before, is "litz," and it is extremely important that all the turns remain intact. If a single strand is broken it will result in a steep rise in the radio-frequency resistance of the wire, with consequent increase in losses, and lower selectivity. The condition of the finished coils is tested on a d.c. bridge, accurate enough to show one broken strand. The total resistance of all the strands is balanced against a known resistance. One broken strand in the "litz" cable will deflect the meter in the bridge, in which case the coil is rejected. The satisfactory coils' radio-frequency resistances are then measured. The inductance value of a completed coil should be 310 microhenries.

The condensers are matched on a capacity bridge, each one being individually tested against a standard. The condensers are then grouped according to their respective capacities. A control is arranged which shows a variation of 7 micro-microfarads for the complete scale, and extremely small variations are, therefore, detectable. By means of this control it is also possible to determine increased effective resistance of the condenser under test. The bridge is fed from

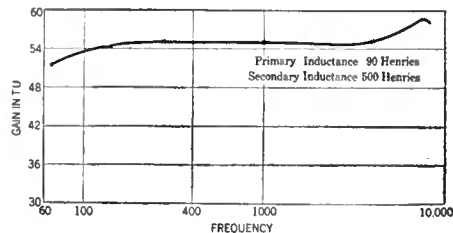

FIG. 2

The overall response curve of the "Synchrophase" Seven audio channel

a 1000-cycle source and the output of the bridge is connected to a single-stage audio amplifier, thus increasing the sensitivity of the system. The operator uses the headphone method of adjusting for capacitance by finding the minimum sound intensity. When the sound is minimum the capacity of the unknown is exactly that of the standard. A condenser with high losses does not permit of complete silence in the phones, and is rejected.

The audio-frequency transformers are also tested in an interesting manner. It is highly important to know the response of the transformers to be placed in the receiver, but it would be a tedious procedure to plot a response curve for each individual unit, hence each transformer is compared with a standard on certain frequencies. A tube oscillator, generating a 500-cycle note and a 6000-cycle note, is connected to a standard amplifier. The output of this amplifier is connected to the transformer to be tested, and the output of the transformer under test is connected to a vacuum-tube voltmeter, the output circuit meter of which gives visual deflections indicative of the response of the transformer under test. The circuit is so arranged that, by means of an anti-capacity switch, the transformer under test can be replaced by the standard and the deflections compared. By means of a switch, the oscillator can be adjusted to generate either the 500- or the 6000-cycle signal. This signal is free of harmonics and is constant at all times. The deflections with the standard transformer are therefore constant.

The complete receiver undergoes several tests, and the method of testing is also original and novel. A buzzer-modulated master oscillator, tuned to 200, 400, and 530 meters (1500, 750, and 566 kc.) feeds a master antenna. The buzzer modulation is accomplished by breaking the plate voltage supply with the interruptions of the buzzer. The operator testing the receiver (several operators are testing at one time) has his own antenna of standard inductance and capacitance value. He first adjusts the receiver at 200 meters by tuning it to resonance with the 200-meter oscillator signal. The receiver output is then noted by means of a tube voltmeter connected to the output circuit of the receiver. After the receiver is adjusted on 200 meters, adjustments are made on 400 and 530 meters, and the second harmonic of 530, which is 265 meters (1130 kc.). In this way each receiver is tested on four wave-



THE GREBE CONE LOUD SPEAKER

lengths. This is indeed a comprehensive test, for it will bring to light any defects in design upon any of the wavelengths within the range employed for broadcasting purposes. If the tube voltmeter does not show standard output on all four waves, the receiver is rejected for a re-examination.

The problem of conductive coupling in the receiver to adjacent leads was overcome by the use of the chassis as the negative filament lead, thus eliminating numerous long leads. The filament wiring in the receiver consists of only the positive polarity wires. The negative lead is formed by the chassis. The condensers are all grounded upon the chassis.

The mechanical alignment is facilitated by punching the complete chassis in one piece. It is made out of aluminum and stamped out on a 60-ton press. The chassis, after the stamping, carries all the mounting holes and brackets, thus assuring correct alignment. The receiver, from start to finish, is carried from one operation to another by means of a conveyer system approximately 1000 feet in length. This conveyer consists of a belt or a roller as the occasion demands,

and the partially assembled receiver moves from one operation to another until it finally reaches the final department.

THE GREBE CONE

THE electrical development of the Grebe loud speaker is also of interest, particularly because this field of endeavor requires highly trained engineering. The development of a loud-speaker does not consist of the mere selection of steel, iron, wire, and a paper cone. Let us consider for a moment an important consideration which the fan generally passes over very lightly. This is the angle of the apex of the cone, and the size of the cone. The information relative to the size of the cone will doubtless be of interest to constructively inclined radio fans. According to the engineer in charge of cone construction, their experiments showed that a 20" cone was the best compromise and that increases above this diameter did not justify the additional space required. Experiments showed that very little is gained by using a cone of larger diameter. Reduction in size, however, showed a material loss.

As to the angle of the apex, 20 degrees is also the best compromise for efficiency and quality. The greater the angle, the greater the efficiency but the poorer the quality of reproduction. The 20-degree angle was considered the best for quality and efficiency. Many articles published in this and other periodicals have stressed the importance of a large value of inductance for loud speaker windings in order to produce satisfactory response on the low frequencies. With this in mind, a value of 1.7 henries was selected as the loud speaker coil inductance. The shape of the armature is also an important consideration, and by using an armature that is wide and short, the lowest moment of inertia is obtained. The selection of the material for the armature also requires care and silicon steel was chosen instead of Swedish iron, because the losses of silicon steel are less on the higher audio register. The difference between Swedish steel, iron, and silicon steel is not appreciable on the lower audio register but it approaches an appreciable value on the higher audio frequencies.

The elimination of harmonics in the average loud speaker is a paramount item because their presence will not permit true reproduction. To attain this result it is necessary to minimize magnetic saturation.

The testing of the loud speaker is carried out by first subjecting it to a series of audio frequencies obtained from a beat note oscillator. This beat note oscillator consists of two radio-frequency oscillators adjusted in a manner which permits the generation of a beat note; this note is passed through several stages of audio-frequency amplification and then into the loud speaker. One of the radio-frequency oscillators, is variable in tuning and the frequency of the beat note is variable between 50 and, approximately, 20,000 cycles. This test will bring to light any defects in the loud speaker mechanism which would result in a rasping sound or a rattle when it is placed into operation. Another test consists of the reproduction of an organ record played upon a talking machine and fed into the loud speaker by means of an electric pick-up and amplifier combination. The organ selection has a wealth of low notes, and these are particularly desired for testing purposes, since the amplitude of these low frequencies is high. This test will bring to light any defects in the placement of the armature. Another test consists of the application of the plate current of a 171 tube through the windings of the loud speaker, first in one direction and then in the other, to test for magnetic saturation when it is in operation.

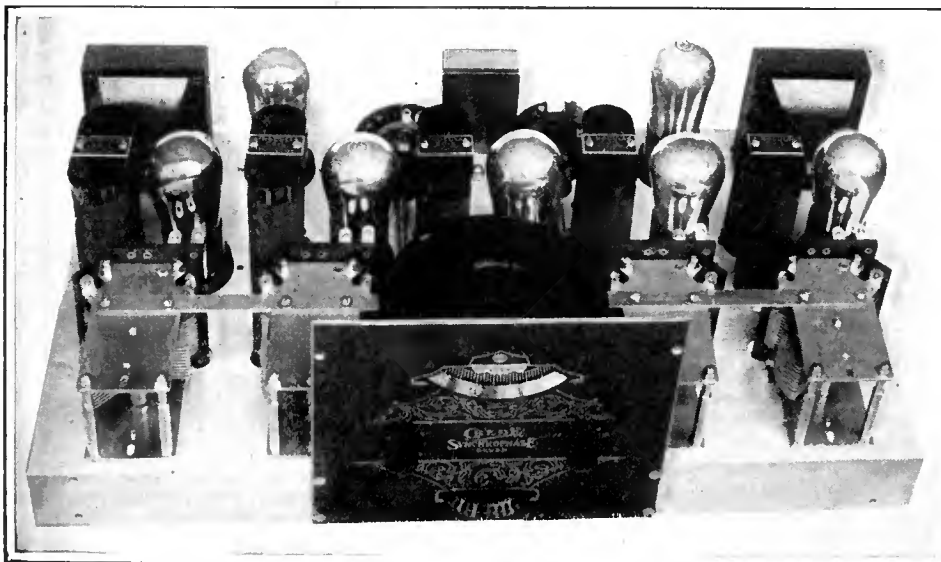

AN INTERIOR VIEW OF THE "SYNCHROPHASE" SEVEN

AS THE BROADCASTER SEES IT

BY CARL DREHER

Technical Problems for Broadcasters and Others

TECHNICAL problems presented in this section in the past have consisted of numerical problems requiring more or less lengthy solutions, so that only one question could be allowed to an issue. We shall vary these occasionally by a series of questions requiring only brief answers, like those below. The subjects, while not strictly confined to the design and operation of broadcast transmitters and associated apparatus, will have some connection with those considerations of quality in reproduction which are of most interest to the professional broadcast technician.

QUESTION 1. Why does sharp tuning tend to drop out of the high audio frequencies associated with a carrier?

Answer. The audio energy of speech or music exists in the side bands accompanying the carrier in question. If, for example, the carrier is of the order of 600 kilocycles, a frequency within the broadcast band, and the audio note being transmitted is 5 kilocycles, the side bands will have a frequency of 595 and 605 kilocycles. A sharply tuned circuit resonant to 600 kilocycles will include perhaps one kilocycle on either side, and will discriminate to a greater and greater degree against the higher audio frequencies, which lie further out from the central or carrier frequency. Hence the 595- and 605-kilocycle currents, in the present example, may be lost altogether, and with them the 5-kilocycle audio note which they would yield on demodulation. By this mechanism, called "side band cutting," the higher musical frequencies are likely to be lost.

QUESTION 2. Why does slight detuning of a sharply resonant circuit, with reference to the carrier frequency, tend to reinforce the higher notes contained in the modulation?

Answer. See Fig. 4, which has reference to the same example used to illustrate the answer to Question 1. Now, however, the circuit has been tuned so that the peak of the resonance curve occurs at 602.5 kilocycles instead of at the carrier frequency of 600.0 kilocycles. As a result, the peak of receptivity, after demodulation, has been shifted from currents of frequencies in the neighborhood of zero cycles to currents in the neighborhood of 2500 cycles per second. If, owing to the steepness of the resonance curve, the cut-off characteristic of the circuit becomes serious one kilocycle to either side of the peak, as assumed in the answer to Question 1 above, with the peak set at 602.5 kilocycles the audio frequencies up to 3.5 kilocycles are nevertheless included in the received band. It will be seen that through this mechanism a sharply tuned radio frequency circuit may be used to some degree as an equalizing or frequency correcting device in reception. This observation may be checked in practice. A similar phenomenon is found in some super-heterodyne receivers.

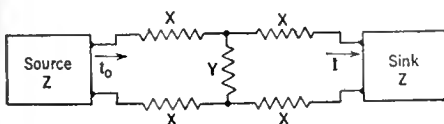

FIG. 1

QUESTION 3. What change in loudness is normally noticeable by the human ear?

Answer. A change of 3 TU is usually observed in speech or music even by listeners who are not expecting it. This corresponds to a change in energy of 2:1. A practiced listener looking for a change may detect differences of the order of 1 TU in a sustained note, without much difficulty. This is equivalent to an energy change of about 25 per cent.

QUESTION 4. What size steps, in TU, would you allow in a smooth gain control?

Answer. Since, according to the answer to Question 3 above, a change of 3 TU is noticeable, the maximum allowable step in a smooth gain control is 2 TU.

QUESTION 5. What error do non-technical observers invariably make in estimating relative loudness of sounds?

Answer. They underestimate radically. As is well known, the human ear follows a logarithmic response characteristic, which is as much as to say that a large increase or decrease in the stimulating energy results in a slight change in the loudness subjectively perceived. Or, more definitely, multiplying the energy by a fixed ratio results only in adding to the loudness an increment proportional to the logarithm of the energy ratio. This is expressed mathematically in the formula for the telephonic transmission unit, which is a measure of subjective loudness:

$$TU = 10 \log P_1/P_2$$

where P_1 and P_2 are the powers corresponding to the two telephone currents under comparison. Non-technical listeners, being unaware that hearing is a logarithmic process, usually apply to sounds the standards of measurement and estimating to which they are accustomed in dealing with distances, for example. A broadcast listener, comparing reception from two stations, one of which is a stage of audio amplification above the other, will say that the first station is "fifty per cent. louder," or "one hundred per cent. louder." Actually one a. f. stage may correspond to 20 TU, or a sound energy ratio of 100. In other words, a non-technical listener is apt to speak of an energy ratio of the order of 2:1 where the actual figure is of the order of 100:1.

Commercial Technical Publications

AMONG catalogs and technical publications received we must mention the September, 1927 issue of the General Radio *Experimenter*, a four-page paper sent out monthly to concerns and individuals on the mailing list of the General Radio Company of Cambridge, Massachusetts. [This publication may be secured by our readers by filling out the "Manufacturers' Booklet" coupon appearing in the advertising section in this and other issues. Booklet number 74.—*Editor.*] This firm, as is well known, specializes in communication laboratory and measuring apparatus, such as standards of inductance, resistance, and capacitance, oscillators, oscillographs, audibility meters, bridges, artificial telephone lines, etc. Its engineers have played no small part in reducing radio designing to a respectably exact

science. The September, 1927 issue of the *Experimenter* is of special interest to broadcasters in that it contains an article on "Design and Use of Attenuation Networks," by Horatio W. Lamson. The subject was discussed, it may be remembered, in this department for September, 1927 (Pages 293-294). Mr. Lamson's paper covers the same ground, in part, with the addition of a number of formulae and a detailed description of the General Radio Company's variable attenuation networks. Given, as in Fig. 1, a source of impedance Z and an absorbing circuit or "sink" of the same impedance, joined by an H-network as shown, with currents I_0 and I leaving the source and entering the sink, respectively, for a definite number of transmission units of attenuation N we may calculate the arms X and Y from

$$X = \frac{Z}{2} \left(\frac{k-1}{k+1} \right) \quad (1)$$

$$Y = 2Z \left(\frac{k}{k^2-1} \right) \quad (2)$$

$$\text{where } k = \frac{10}{1} \times n \quad (3)$$

$$\text{or, in TU} \\ k = 10^{n/20} = \text{Antilog } n/20 \quad (4)$$

If, as shown in Fig. 2, we make all five branches of the H-network adjustable by steps, moving five switch arms in unison to the proper switch points through a single control, the characteristic impedance Z of the network may be maintained constant to match the impedances to either side, while the attenuation is varied in steps. This is the principle of the Type 239 Variable Attenuation Network supplied by the General Radio Company. The box is equipped with two multiple switches. In the size which affords a total attenuation of 55 TU, one decade is calibrated in steps of 5 TU, and the other in steps of 0.5 TU. Another size goes up to a total of 22 TU, and in this case the steps are 2TU and 0.2 TU. Characteristic impedances of 600 and 6000 ohms are carried in stock or built to order. Some types are provided with a center tap for the Y-branch, where a ground may be applied.

A somewhat older type of variable pad supplied by the same manufacturer is adjusted by the addition or subtraction of fixed sections, which are cut in or out by means of four-pole double-throw switches, as shown in Fig. 3. This is known as the Type 249. The manipulation of this form is necessarily somewhat less convenient, but in many cases it serves the same purpose and the cost is about half of the rotary switch form. There are eight-section boxes affording a total attenuation of 110 TU in steps of 1 TU, and six-section boxes with a total of 63

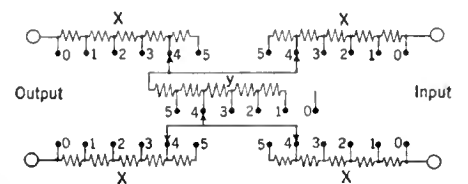

FIG. 2

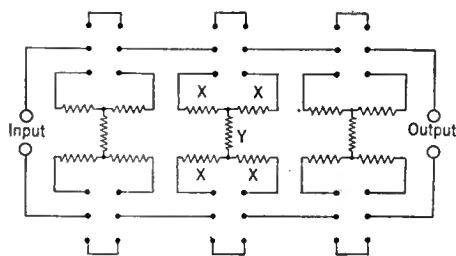

FIG. 3

TU in the same steps. The same characteristic impedances, 600 and 6000 ohms, are available. As explained in the September, 1927, RADIO BROADCAST discussion, the simpler T-networks may be used in place of the H-type where a balanced circuit is not essential. The General Radio Company also supplies the sectional networks in the T-connection, at a somewhat lower price, inasmuch as the number of coil-taps and switch-arms required is less.

The Portrait of the Author

MR. FRANKLYN F. STRATFORD, who embellishes these articles with clever pictures, sometimes sketches my likeness for the customers, so that they may not shoot the wrong man when they take offense at my sooth-sayings. In so doing Mr. Stratford has perpetrated a libel on me. I ask that interested readers turn to the illustration in the November, 1927 issue, over the quotation, "Let the ghost call at my office." The picture includes the ghost, myself, and part of the office. About the ghost I say nothing; Mr. Stratford's idea of a ghost is no doubt as good as anyone's. And my own likeness is not bad. It is true that my nose is depicted as about the size of Cyrano de Bergerac's, and not as well-shaped, but so God made me. My head has a contour not unlike that of a truncated cone, in Mr. Stratford's sketch, but such geometrical outlines are not lacking in esthetic value, and it would be worst if the cone were upside down. What I object to is the office furniture, and particularly the desk. The desk depicted seems about four feet wide. I wish the world to know that my office boy sits

at such a desk. My own desk was made to order in Circassian walnut, and cost \$3000. The top is a solid piece of Florentine marble, 150 square feet in area. Nymphs and satyrs are painted on the sides. When next Mr. Stratford draws my desk let him take an extra column and do justice to his subject.

Linguistic Observation

THE vilest French and German I have ever heard—in the sense of execrable accent, not of content, be it said—is on radio broadcast programs, and I refer to many large stations as well as small ones, if you please. The radio announcers, with a trifling number of exceptions, pronounce foreign languages like so many high school freshmen. The better vaudeville circuits are vastly superior in this detail. When a girl like Kitty Doner spills some French before the assembled intelligentsia at the New York Keith's 81st Street, it is Parisian French as you might hear it on the boulevards. But the announcers drive any half-way educated listener to thoughts of homicide whenever they have occasion to pronounce a simple phrase like *Danse Russe* or *Wiener Blut*. What ails the announcers and their bosses? Don't they know any better? Then let them go back to school. Or don't they care? Then let them seek some business in which they don't have to appear before the public.

Memoirs of a Radio Engineer: XXI

INSTEAD of going forward a few more months in the recital of these memories, at this point I wish to regress briefly in order to include an incident which was omitted in its proper place. It returns to my recollection when I hear of some broadcast listener ending his mortal existence by throwing a length of antenna wire across a high tension line, or through a fall from a roof. Such fatalities are too infrequent to deserve mention, perhaps, in a country which takes no account of some 100,000 deaths in four or five years through automobile accidents, but the victims are just as dead, although not killed in a popular manner. I might have joined their number, thus

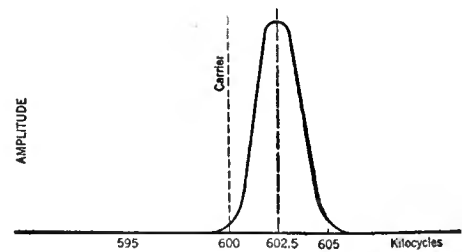

FIG. 4

swelling the total slightly, but for luck. The time was about 1914, when I was feeding a crystal receiving set from a one-wire antenna about four hundred feet long. So long was it, in fact, that it crossed a city street. After some months of fine reception, during which I was able to boast to the other amateurs about the great distances from the phones at which signals might be heard at my house, the antenna yielded to the elements one night, and in the morning it was down. On the street which it crossed there was an electric power line, the cross arms carrying six or nine heavy rubber covered wires. My copper strand now lay across these conductors. I went to the house at the end of the block and looked up at the transmission line. It did not appear dangerous, and I decided that it must be a 110-volt circuit, and that nothing much could happen. However, I decided to be very prudent, so I went below for a bamboo trout rod, made a cast for my antenna wire, hooked it, and lifted it off the transmission line. It fell back, however, and I grasped it impatiently in my bare hands and swung it clear. Nothing happened. What could happen even if a boy radio operator got his antenna tangled up with a 110-volt line covered with an eighth of an inch of rubber? But the other day I passed along that block, and, thirteen years older, looked up at the transmission line, which was unchanged in equipment and fittings, as far as I could judge. It is not a 110-volt line, and probably never was one. It may be carrying its load at a tension of 2200 volts, or perhaps 4400. Either would have been enough. Some people have luck. The insulation on the wires was not frayed.

The Radioman's "Britannica"

DRAKE'S RADIO CYCLOPEDIA. By Harold P. Manly. Published by Frederick J. Drake and Company, Chicago. Price \$6.00. Pages, about 800. Illustrations, 950.

MR. MANLY'S "Cyclopedia" is a comprehensive compilation of all the conceivable information which a set builder and designer needs for ready reference. The reviewer could not, of course, read the entire work in detail because that would require several weeks, but many pages were critically examined. The first impression gained is the completeness with which the author covers his subject.

As an example of the wealth of detail on a particular subject, under the heading of "Receiver, Audio Amplifier for," constructor's circuit diagrams, showing the arrangement of parts, wiring, outstanding performance qualities, and specifications of components, are given for fifteen types of audio amplifier systems, including three-stage choke-coupled, three-stage transformer-coupled, one transformer and two choke-coupled, three-stage double impedance, one transformer and one push-pull stage, two push-pull stages, three resistance-coupled stages, one transformer and three resistance stages with output choke, two transformer stages with output transformer,

two transformer stages with parallel output tubes, two transformer stages with potentiometer control.

In the matter of receiving circuits, the following types are described: Browning-Drake, crystal, four-circuit, long-wave, loop, "N" circuit, neutrodyne, one-tube, regenerative, Rice, Roberts, short-wave, single-circuit, single-control, super-heterodyne (13 pages), super-regenerative, and tuned radio-frequency.

A table, "Coil Design, Advantages and Disadvantages of Types of Coils," is an example of the practical kind of information collected in a manner suited to easy reference. This table lists various elements of coil design, such as type of winding, shape of winding, proportion of winding, wire insulation, wire size, material of winding form, design of winding form, fastening of winding, material of supports and connections to winding, and gives under each of these headings three to six different practices which may be followed. For example, under "Material of Form," paraffined paper or cardboard, fibre and "mud" dielectrics, dry paraffined wood, hard rubber, phenol, bakelite, and glass are listed. Under each of these design possibilities, the characteristics of each type is given in the simplest terms, "poor, fair, good, and best," for the following factors: Durability, most in-

ductance, least resistance, little distributed capacity in small field. Thus, "type of winding, (1) cylindrical, single wire, close wound," is declared the "best" from the standpoint of durability, most inductance, and least resistance, but "poor" from the standpoint of less distributed capacity and small field. Honeycombs, on the other hand, are good from the standpoint of durability, inductance, less distributed capacity, and small field, but only fair from the resistance standpoint. By the aid of the table, the designer may select the type of winding form which best suits his purpose.

In addition to covering constructional information, due space is given to practical operation, general theory, and design. Power supply for A, B, and C potential, design of receivers with alternating-current supply for filament lighting, single-control, shielding, are some of the subjects fully treated, indicating the volume to be up to the minute.

One mysterious feature of the whole work is that hardly a single line of credit is given for sources of information and assistance. Not a page in this book is numbered. The reviewer does not believe, however, that a more satisfactory addition to the experimenter's library, in any one volume, can be made.

—E. H. F.

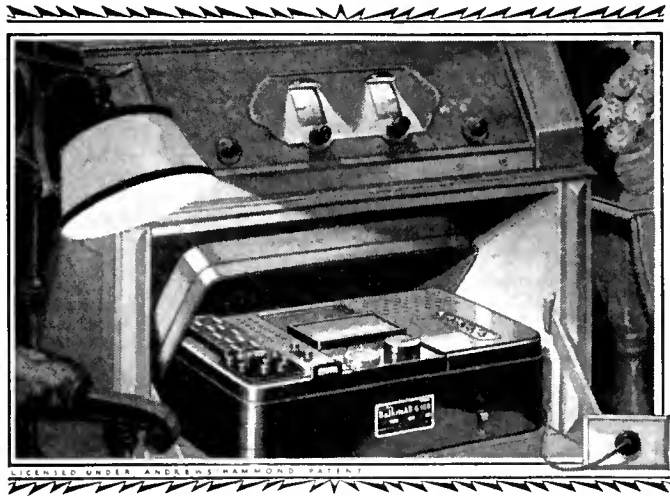

Now AC Electric Radio



Licensed under Andrews-Hammond patent

To owners of a "B" eliminator:

Balkite "A" is like Balkite "AB" but for the "A" circuit only. It enables you to make an electric installation at very low cost. \$35.



Balkite "B"

The accepted, tried and proved light socket "B" supply. One of the longest lived devices in radio. Three models, \$22.50, \$35, \$42.50.



Balkite Chargers

Standard for "A" batteries. Noiseless. Can be used during reception. High rate or trickle. Three models, \$17.50, \$9.50, \$7.50.

There are special models for 25-40 cycle current at slightly higher prices. Prices are higher West of the Rockies and in Canada.

**Without
the uncertainty of
untried apparatus
And without any
sacrifice in quality
of reception**

Of course you want an AC electric receiver. For its convenience. Now you can have it, without the uncertainty of untried apparatus and without sacrificing quality of reception.

Simply by adding Balkite *Electric* "AB" to your present radio set. Balkite *Electric* "AB" replaces both "A" and "B" batteries and supplies radio power from the light socket. It contains no battery in any form. It operates only during reception. It makes any receiver an electric set.

This method makes possible the use in electric reception of standard sets and standard type tubes. Both are tried and proved, and give by far

the clearest and truest reproduction. With this method there is no waiting for tubes to warm up. No difficulty in controlling volume. No noise. No AC hum. No crackling or fading of power. Instead the same high standard of reception to which you are accustomed.

In this method there is nothing experimental, nothing untried. It consists of two of the most dependable products in radio—a standard set and Balkite. And if you should already own a radio set, the cost of equipping it with Balkite is only a fraction of the cost of a new receiver.

By all means go to AC reception. Its convenience is the greatest improvement in radio. But be as critical of an AC receiver as you would of any other. That your AC receiver be a standard set equipped with Balkite *Electric* "AB." Then it will be as clear and faithful in reproduction as any receiver you can buy.

Two models, \$64.50 and \$74.50. Ask your dealer. Fansteel Products Co., Inc., North Chicago, Illinois.

Chicago Civic Opera
on the air Thursday Evenings, 10 o'clock Eastern time. Over stations WJZ, WBZA, WBZ, KDKA, KYW, WGN, WMAQ, WBAL, WHAM, WJR, WLW, WENR. 10:30 Eastern time: WEBH, KSD, WOC, WOW, WCCO, WHO, WDAF.
BALKITE HOUR

Balkite ELECTRIC AB

⌈ contains no battery ⌋

MAGNAVOX

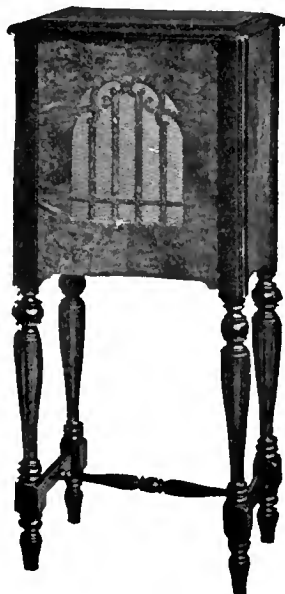

Dynamic Power Speaker for new all-electric A-C Sets

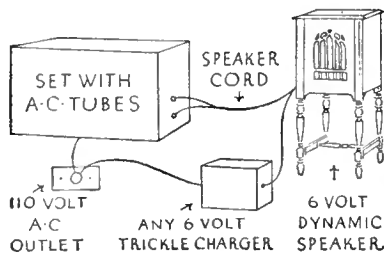

Hook it up like this sketch because the 6 volt rectified output of any standard trickle charger or "A" rectifier will energize the field of the Magnavox 6 volt Dynamic power speaker unit.

Aristocrat Model speaker (complete unit), illustrated above, \$85.

Beverly Model table type complete, \$65. Unit only, (type R-4, 6 volt) \$50. Fits any standard cabinet.

Only the Dynamic type speaker can bring out the full qualities of reproduction demanded today.

Write for speaker bulletins
THE MAGNAVOX CO.
 Oakland, California

The Radio Broadcast LABORATORY INFORMATION SHEETS

THE RADIO BROADCAST Laboratory Information Sheets are a regular feature of this magazine and have appeared since our June, 1926, issue. They cover a wide range of information of value to the experimenter and to the technical radio man. It is not our purpose always to include new information but to present concise and accurate facts in the most convenient form. The sheets are arranged so that they may be cut from the magazine and preserved for constant reference, and we suggest that each sheet be cut out with a razor blade and pasted on 4" x 6" filing cards, or in a notebook. The cards should be arranged in numerical order. In July, 1927, an index to all Sheets appearing up to that time was printed.

All of the 1926 issues of RADIO BROADCAST are out of print. A complete set of Sheets, Nos. 1 to 88, can be secured from the Circulation Department, Doubleday, Page & Company, Garden City, New York, for \$1.00. Some readers have asked what provision is made to rectify possible errors in these Sheets. In the unfortunate event that any such errors do occur, a new Laboratory Sheet with the old number will appear

—THE EDITOR.

No. 153 RADIO BROADCAST Laboratory Information Sheet January, 1928

Standard and Constant-Frequency Stations

BROADCASTERS WITH ACCURATE FREQUENCIES

THE *Radio Service Bulletin*, published monthly by the Radio Division of the Department of Commerce, Washington, District of Columbia, contains a list of standard and constant frequency broadcasting stations as determined by the Bureau of Standards. This bureau makes measurements on an average of about three times a month on the transmissions of a small number of stations and as a result of these tests data are published in the *Bulletin* on those stations which have been found to maintain a sufficiently constant frequency to be useful as standards. These are known as "Standard Frequency Stations." The list of "standard frequency stations" is supplemented with a list of "constant frequency stations." No regular tests are made on these latter stations but each station in the list employs a special device, such as a crystal, to maintain its frequency accurately so that they can be generally relied upon to maintain their correct frequency.

WBZ	900.00
KDKA	950.00
WBAL	1050.00

CONSTANT FREQUENCY STATIONS

Call Letters	Frequency Kc.
WMAQ	670
WJAD	670
WCCO	740
WTAM	750
WEAR	
WBBM	770
KGO	780
KTSH	780
WCAD	820
WJJD	820
WLS	870
WSM	880
WKAQ	880
KOA	920
KFAB	970
WBAA	1100
WHK	1130
WMBI	1140
WABQ	1150
WEBJ	1170
KWUC	1230
KFVS	1340

STANDARD FREQUENCY STATIONS

Call Letters	Frequency Kc.
WEAF	610.00
WRC	640.00
WJZ	660.00
WGY	790.00

No. 154 RADIO BROADCAST Laboratory Information Sheet January, 1928

The 112-A and 171-A Type Tubes

OPERATING CHARACTERISTICS

TWO new power tubes have recently become available; they are designed especially for use in the output of a receiver. These new tubes employ an improved type of filament which gives high emission at a filament current of 0.25 amperes at 5 volts. They are exactly similar to the older UX-112 and UX-171 type tubes with the exception that the filament consumption is only half that of the older types. The filament of the corresponding 112 and 171 type tubes is 0.5 amperes at 5 volts. The other characteristics of these new tubes remain the same as those of the 0.5 ampere filament tubes. These characteristics are given below.

The UX-112-A (CX-312-A) may be satisfactorily used as a detector, general-purpose tube, or as a power tube in the last stage of a receiver. When used as a detector, the plate voltage should be 45

volts. The UX-171-A (CX-371-A) must only be used in the last stage of a receiver, and a choke-condenser combination or output transformer should be used in the plate circuit to keep the plate current out of the loud speaker.

The advantage of these new tubes is in their greater efficiency. Under the same condition of plate voltage they produce the same plate current as the corresponding 0.5-ampere tubes with only half as much filament current.

These tubes must not be substituted for the UX-112 (CX-112) or UX-171 (CX-171) types in a receiver without changing the values of fixed filament control resistances or rheostats if they are used. Since they take the same filament current as a 201-A type tube, it follows the filament control resistances designed for the latter tube may be used in conjunction with these new tubes.

TYPE	FILAMENT VOLTS	FILAMENT CURRENT	PLATE VOLTAGE	NEGATIVE BIAS	PLATE IMPEDANCE	AMP. CONSTANT	PLATE CURRENT	OUTPUT MILLI-WATTS
UX-112-A (CX-312-A)	5	0.25	90	6	8800	8	2.5	40
			135	9	4800		6	120
			157 1/2	10.5	5500		8	195
UX-171-A (CX-371-A)	5	0.25	90	16.5	2500	3	10	130
			135	27	2200		16	330
			180	40.5	2000		20	700

SM

We Could Charge More— But a Better Transformer Can't Be Made



Just as the 220 transformer, compared with all other makes, gives you the sense of Gibraltar-like sturdiness and dependability truly in a class by itself, so does its performance far outclass that of other transformers.

IMITATED everywhere—never equalled—the S-M 220 audio transformer stands out to-day as the finest for audio amplification that money can buy just as it did when introduced a year and a half ago. The 220 has been copied in one or more of its characteristics by every high-grade transformer put on the market since then—in the rising low note or in 5000 cycle cut-off, features first offered by S-M. That's proof that the principles the 220 introduced are right—that the market is still trying to catch up with the leader.

Don't be misled by exaggerated claims—for it takes plenty of core and wire to make a good transformer. The 220 has from 25 to 50 per cent more steel and copper in its construction than any other transformer on the market. That alone means the high primary impedance through which real bass note amplification is made possible.

That's why S-M 220's and 221's are specified in more popular receiver designs—why they have outsold every other transformer in their price field. That's why they're sold on an unconditional money-back guarantee to give better quality than any other audio amplifying device available.

We could charge from 25 to 50 per cent more than we do, but at no price can you get a better transformer. The 220 audio is \$8.00, and the 221 output is \$7.50. They are priced low, but, you can't buy a better audio coupler at any price, for there's none better made.

The Finest Tone You've Ever Heard

—and complete A. C. operation. Complete light socket operation of the Improved Shielded Six using A. C. and power tubes is an accomplished dependable fact. You may build either the battery model with standard tubes or the A. C. model with the new C-327 and CX-326 tubes—and at a cost of less than half what you'd pay for nearly equivalent performance in a factory-built set.

Every one of the thousands who built last year's Shielded Six said the same thing—"The Six has the finest tone I ever heard." And now the new and improved 1928 model of this famous receiver, with the same fine tone as the original, and tremendously improved selectivity and distance getting ability is available for light socket, battery, or eliminator operation. Above all the Six is guaranteed to have finer tone than any other set you can build or buy. The 630 Shielded Six kit in the battery or eliminator model is \$95.00 and for complete light socket operation \$99.00.

The New 240 Audios

We can't make the 220's cheaper but if you desire a transformer somewhat lower in price, taking up a little less room, and with a little less core and wire, the new 240 audio and 241 output transformers are available—superior to most other transformers, and far and away ahead of anything in their price field. They have the same general characteristics as the famous 220's and 221's, but provide slightly less accentuation of frequencies below 80 cycles. They have the same 5000 cycle cut-off for which 220's are famous, eliminating the objectionable whistles and heterodyne squeals of congested broadcasting. The 240 audio sells for \$6.00 and the 241 output at \$5.00. Hard to beat at any price, they are impossible to equal at these prices. And—you can bring your old set up to the minute using them—they're small enough to fit in most anywhere.

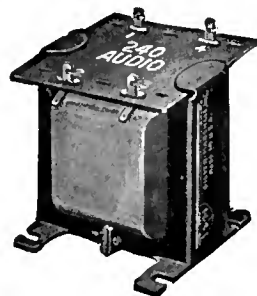

328 Super Power Transformer

A heavy power transformer for either full wave or half wave rectifiers—for UX-281 (or UX-216-B) rectifier tubes. Will furnish 480 volts at 100 milliamperes of thoroughly filtered direct current using two UX-281 tubes, the S-M 331 Unichoke, and only six microfarads of filter condenser. This is power for a 2 to push-pull amplifier at full voltage and to furnish receiver B power as well. Consists of two 550 volt secondaries, two 7½ volt, 2½ ampere filament windings and one 1½ volt, 2 ampere filament winding for UX-226 tubes. Price \$18.00.

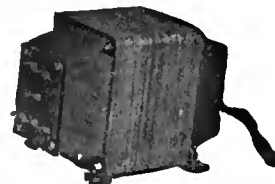

SILVER-MARSHALL, Inc.

838-B West Jackson Blvd.

Chicago, Ill.

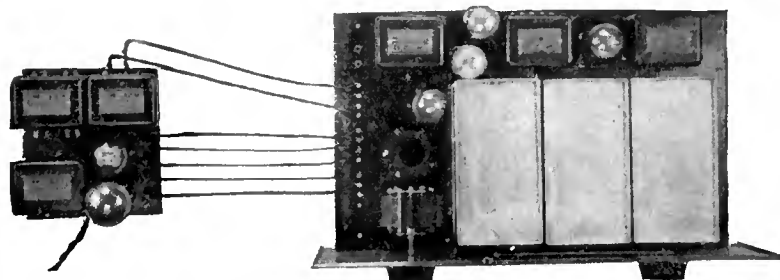

The A. C. Improved Shielded Six—a completely light socket operated batteryless set using the new A. C. tubes. It's illustrated above, with its complete dry ABC power unit—less than 7 inches square. Price, 630 A. C. receiver kit, \$99.00, and 652A, ABC socket power kit, \$34.50.

Only a few of the real S-M developments are listed here. 10¢ in stamps will bring you more real information on power equipment, A.C. operation, and other pertinent subjects than you can read in a week.

SILVER-MARSHALL, INC.
838-B West Jackson Blvd., Chicago.

Please send me all data on S-M audio transformers, power equipment, and new A.C. improved Shielded Six.

Name

Address

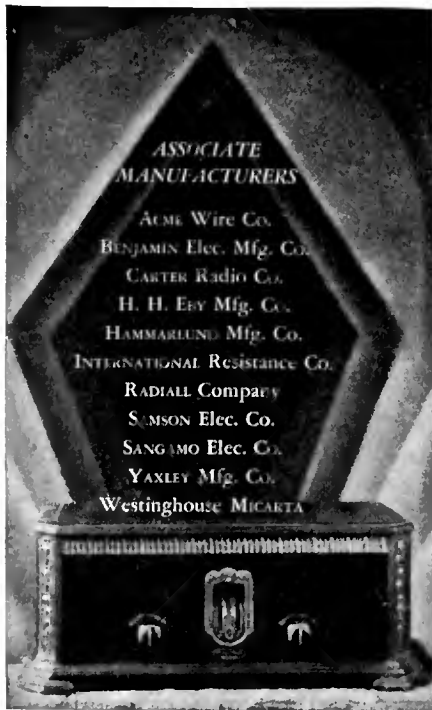

It Must Be Custom-Built!

The new improved Hammarlund-Roberts Hi-Q SIX Receiver has been designed by ten of America's foremost radio engineers entirely with an eye to finest possible reception. From the outset price was a secondary consideration.

Every modern constructional feature is included—the finest parts in America are used—perfect synchronization at last is realized and through such advanced features as four completely shielded stages of tuned frequency, Automatic Variable Coupling and Symphonic transformers—a truly deluxe quality of performance is achieved!

This wonderful instrument cannot be purchased ready-made. It must be CUSTOM-BUILT by yourself at home. Complete parts cost only \$95.80, whereas to market it completely built would mean a price of nearly \$300. Instruction book shows you how to build. Drilled foundation panels make construction a pleasure rather than a job. The finished instrument is accepted as the best in radio regardless of price. Ask your dealer for the "How to Build" Book or write direct. Price 25 cents.



HAMMARLUND-ROBERTS, Inc.
1182 Broadway, Dept. A, New York

No. 155

RADIO BROADCAST Laboratory Information Sheet

January, 1928

Wave Traps

THREE CIRCUITS

THE trend of broadcasting, for sometime, has been toward the use of high power, and this has made the problem of selectivity a serious one for many listeners located within a few miles of a high-power broadcasting transmitter. When difficulty is experienced in satisfactorily tuning-out such a station, it will be advisable to incorporate a wave trap in the antenna circuit. Wave traps are very easily constructed and cost little. They consist of any ordinary coil and a condenser, connected in the antenna circuit, and adjusted to absorb a large amount of the energy being received from the interfering station. The traps may be connected in several ways, as indicated on the diagram. The arrangement shown at A will give most complete elimination of the undesired signal but may also cause a considerable decrease in volume of stations operating on adjacent channels. The arrangement shown at B is probably the most flexible manner in which to connect a wave trap. If the coil is arranged with several taps an adjustment can be arrived at which gives most satisfactory results. Arrangement C is only useful in case of mild interference. The circuit tunes very sharply and will effectively eliminate interference provided it is not too great.

In constructing a wave trap, coil L may consist of 47 turns of No. 22 wire on a 3-inch diameter form

if the tuning condenser C_1 has a capacity of 0.0005 mfd.; with a 0.00035 condenser coil L should consist of 60 turns. With either size, coil L may consist of about 15 turns wound at the b end of the secondary coil. With arrangement B taps should be made at about every 10 turns.

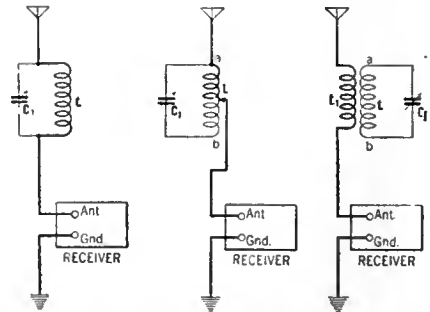

No. 156

RADIO BROADCAST Laboratory Information Sheet

January, 1928

Wavelength-Frequency Conversion

A TABLE FOR THE BROADCASTING BAND

ON LABORATORY Sheet No. 157 is given a wavelength-frequency conversion table covering the broadcasting band. Broadcasting is assigned to channels 10 kc. apart on frequencies that are divisible by 10. It is simple to use the table. If we knew that some station was transmitting on 1000 kc. we can determine from the table the corresponding wavelength, which in this case is approximately 300 meters. The wavelength corresponding to any given frequency can be determined by dividing the frequency in kc. into 300,000.

A 10-kc. separation between broadcasting stations is necessary to prevent bad interference between two stations on adjacent channels. When a broadcasting station is transmitting it actually uses a band of frequencies (side bands) 10,000 cycles wide—5000 cycles either side of the "carrier" frequency. The carrier frequency is the frequency assigned a station by the Federal Radio Commission, but as mentioned above, in the ordinary process of modulation a frequency band 10,000 cycles wide is used.

When a station is transmitting it also radiates a frequency exactly double its carrier frequency. The additional wave is called the second harmonic, being equal in frequency to the carrier frequency multiplied by two. Careful design and operation of the transmitter will keep these harmonics small in amplitude and this is essential if interference is to be prevented. If a station transmits on, say, 600 kc. and also radiates a strong second harmonic with a frequency of 1200 kc., it will interfere with another station transmitting on a carrier frequency of 1200 kc.

Any radio station might be considered to have two ranges; first the broadcasting range, being the distance area over which the program on the station may be received satisfactorily and, secondly, the interference range, being the area over which a station causes interference due to the production of a heterodyne whistle between its carrier and the carrier of another station. The first range is much smaller than the second and a station having a service area of 100 miles will have an interference range of probably about 1000 miles.

No. 157

RADIO BROADCAST Laboratory Information Sheet

January, 1928

Table for Wavelength-Frequency Conversion

KC.	METERS	KC.	METERS	KC.	METERS	KC.	METERS
550	545.1	800	374.8	1,050	285.5	1,300	230.6
560	535.4	810	370.2	1,060	282.8	1,310	228.9
570	526.0	820	365.6	1,070	280.2	1,320	227.1
580	516.9	830	361.2	1,080	277.6	1,330	225.4
590	508.2	840	356.9	1,090	275.1	1,340	223.7
600	499.7	850	352.7	1,100	272.6	1,350	222.1
610	491.5	860	348.6	1,110	270.1	1,360	220.4
620	483.6	870	344.6	1,120	267.7	1,370	218.8
630	475.9	880	340.7	1,130	265.3	1,380	217.3
640	468.5	890	336.9	1,140	263.0	1,390	215.7
650	461.3	900	333.1	1,150	260.7	1,400	214.2
660	454.3	910	329.5	1,160	258.5	1,410	212.6
670	447.5	920	325.9	1,170	256.3	1,420	211.1
680	440.9	930	322.4	1,180	254.1	1,430	209.7
690	434.5	940	319.0	1,190	252.0	1,440	208.2
700	428.3	950	315.6	1,200	249.9	1,450	206.8
710	422.3	960	312.3	1,210	247.8	1,460	205.4
720	416.4	970	309.1	1,220	245.8	1,470	204.0
730	410.7	980	306.0	1,230	243.8	1,480	202.6
740	405.2	990	302.8	1,240	241.8	1,490	201.2
750	399.8	1,000	299.8	1,250	239.9	1,500	199.9
760	394.5	1,010	296.9	1,260	238.0		
770	389.4	1,020	293.9	1,270	236.1		
780	384.4	1,030	291.1	1,280	234.2		
790	379.5	1,040	288.3	1,290	232.4		

KARAS A-C-FORMER

FILAMENT SUPPLY

TYPE 12

LIST PRICE
\$13.50

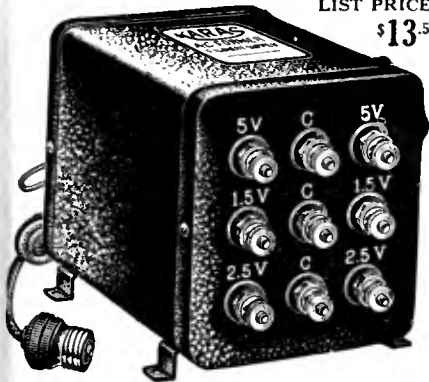

NO HUM!

At last you can step down your 110 volt A. C. house current to operate your set with standard A. C. tubes such as Cunningham, RCA and CeCo, without having to use separate device for center tap, and with ABSOLUTELY NO HUM. Let the Karas A-C-Former Filament Supply, Type 12, replace your "A" Battery and charger. Will operate 8 1 1/2-volt Type 226 or 326 Tubes, 2 2 1/2-volt Type 227 or 327 Tubes, and 2 5-volt Type 177 Tubes at one time. Compact, powerful, sturdy and built the Karas Way—by precision methods. Write for complete information about the new Karas A-C-Former and also data on the Knickerbocker 4 and Karas 2-Dial Equamatic.

KARAS ELECTRIC COMPANY
4033-A North Rockwell Street Chicago

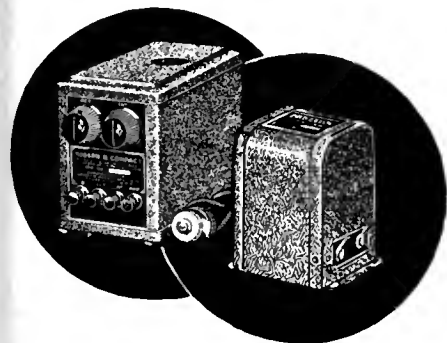

Two Aids to Better Radio MODERN "B" Compact

Type M Transformers

To improve your set or get the best results with any set you contemplate building, install Modern Type M Transformers, and then use a Modern "B" Compact—the dependable B current supply.

Modern radio products are designed and manufactured by engineers who know how to get results. They are guaranteed to serve you to your satisfaction and you are not enjoying radio to the fullest extent if you have not installed Modern Type M Transformers and a Modern "B" Compact.

Write for Type M audio amplifier circuits and booklet on "B" power unit operation. Address Dept. R.B.I.

THE MODERN ELECTRIC MFG. CO.
Toledo, Ohio

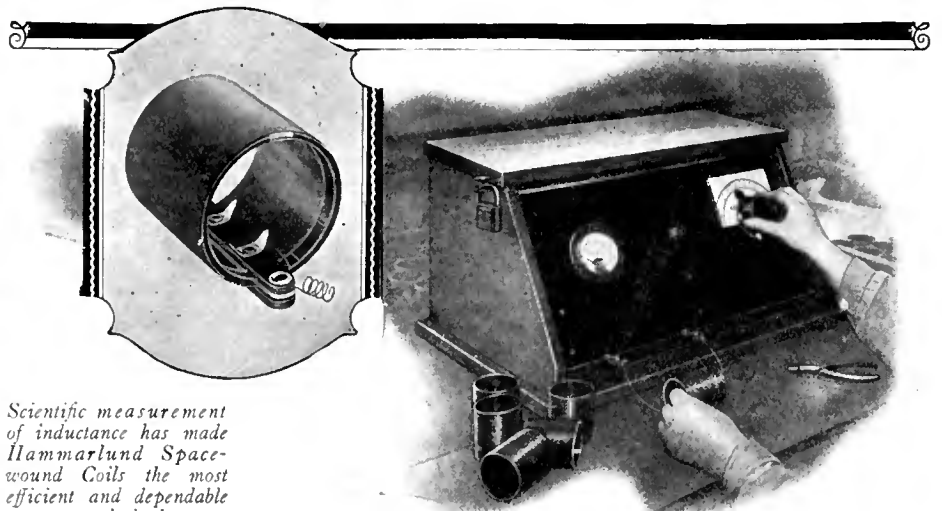

Scientific measurement of inductance has made Hammarlund Space-wound Coils the most efficient and dependable ever devised.

Hammarlund Coil Inductance Scientifically Measured

NOT very long ago, so many turns of wire on such and such size core were considered accurate enough for inductance measurement.

But in this age of multi-tuned, single-control circuits, guesswork is out of the question. Coils must be matched to the finest degree.

Not satisfied merely with producing the most efficient type of coil, Hammarlund devised the instrument pictured above, to insure accurate measurement of inductance values.

You can depend on Hammarlund precision. It means standardized quality and assurance that you get what you pay for.

Your dealer sells Hammarlund Matched Coils for the latest popular circuits.

HAMMARLUND MANUFACTURING COMPANY
424-438 West 33rd Street, New York

More than a score of radio designers officially specify Hammarlund Precision Products for their newest circuits

For Better Radio
Hammarlund
PRECISION
PRODUCTS

Dealer inquiries invited concerning several new and appealing Hammarlund developments, having a wide sales demand.

Electrostatic condensers for all purposes

Faradon

WIRELESS SPECIALTY APPARATUS COMPANY
Jamaica Plain Boston, Mass.

Why not subscribe to *Radio Broadcast*? By the year only \$4.00; or two years, \$6.00, saving \$2.40. Send direct to Doubleday, Page & Company, Garden City, New York.

EBY BINDING POSTS
SPECIAL CIRCUIT PACKAGES 15c

RADIO ACCESSORIES at WHOLESALE

Radio Sets, "B" Eliminators, Chargers, Tubes, Kits, Parts—everything new in Radio at lowest wholesale prices. Thousands of nationally advertised bargains. All listed and illustrated in my Big New Catalog and FREE Gift Book. 132 Pages of valuable Radio information—troubleshooting, set building—Radio knowledge of all kinds. Write today. HARRY SCHWARTZBERG PRES. AMERICAN AUTO & RADIO MFG. CO. Dept. 124 American Radio Bldg. Kansas City, Missouri

FREE BIG BARGAIN CATALOG

LYNCH



Write for this Book

The famous Lynch 5 tube de Luxe Deck. Simplifies home set-building at greatly reduced cost. Also the popular Lynch Complete Resistance Line. Fully described in this booklet.

Learn the Usefulness of "Resistance in Radio"

RADIO fans, set-builders, and engineers will find a wealth of reliable, boiled-down, and interesting information in "Resistance the 'Control Valve' of Radio." Simply written and clearly illustrated. Concisely presents the latest information on resistance coupled amplification, the function of resistance in a circuit, circuit arrangements on equalizers, and other radio matters of interest and importance. This valuable hand-book on resistance in radio is worth dollars—you can get a copy for only 25 cents.

Write for this book—

ARTHUR H. LYNCH, Inc.
1775 Broadway at 57th Street
General Motors Bldg., New York, N. Y.
Sales offices in most large cities

Arthur H. Lynch, Inc.
1775 Broadway
New York City

Gentlemen:

Please send me a copy of your new booklet "Resistance the 'Control Valve' of Radio." I am enclosing 25 cents.

Name.....

Street.....

City..... State..... R. B.

No. 158

RADIO BROADCAST Laboratory Information Sheet

January, 1928

The Three-Tube Roberts Reflex

CIRCUIT CONSTANTS

THERE have been many requests from readers for further information on the Roberts 3-tube receiver illustrated in the August, 1927 issue of RADIO BROADCAST on page 209. This receiver is a reflex set consisting of a stage of r.f. amplification, a regenerative detector, one stage of reflexed transformer-coupled audio amplification, followed by another straight audio stage. The circuit, which was not given in the article mentioned above, and which many readers have requested, is published on Laboratory Sheet No. 159. The list of parts is given below.

L₁, L₂—R. F. transformer. L₂ may consist of 45 turns of No. 24 wire wound on a 3-inch tube. L₁ should contain 40 turns of No. 24 wire with a tap at each 10 turns. L₁ should be wound alongside the filament end of L₂.

L₃, L₄, L₅—Interstage r.f. transformer. L₃ and L₄ have the same specifications as L₁ and L₂ with the exception that L₃ should be wound with No. 26 or No. 28 wire and should only be tapped at the exact center instead of at every 10 turns. That end of L₃ nearest the grid end of L₄ should connect to the plate of the r.f. tube, the center tap connects to transformer T₂, and the other end of L₃ connects to the neutralizing condenser. L₅ is a

movable tickler coil consisting of 20 turns of No. 26 on a 1½ inch tube.
T₁, T₂—Any good audio transformers.
T₃—Any good output transformer.
C₁, C₂—0.0005-mfd. variable condensers.
S₁—Antenna tap switch.
S₂—Filament switch.
J₁—Double-circuit interstage jack.
J₂—Single-circuit jack.
V—Volume control, 50,000-ohm variable resistance.
C₃—Neutralizing condenser, 0.000015 mfd.
C₄—Grid condenser, 0.00025 mfd.
R_g—4-megohm grid leak.
R₁—10-ohm rheostat.
R₂—0.5-ampere fixed filament control resistance.
C₅—0.001-mfd. fixed condenser.
C₆—0.00025-mfd. fixed condenser.
Eleven binding posts
Three sockets
Hook-up wire

For best results a power tube should be used in the last socket. If a 171 type tube is used with 180 volts on the plate, the C bias required is 40.5 volts.

When the receiver has been completed it should be neutralized by tuning-in some station, adjusting the tickler until the detector oscillates and a whistle is heard and then varying the neutralizing condenser until the whistle changes in pitch the least amount (its loudness will change considerably) as C₁ is varied.

No. 159

RADIO BROADCAST Laboratory Information Sheet

January, 1928

The Three-Tube Roberts Reflex

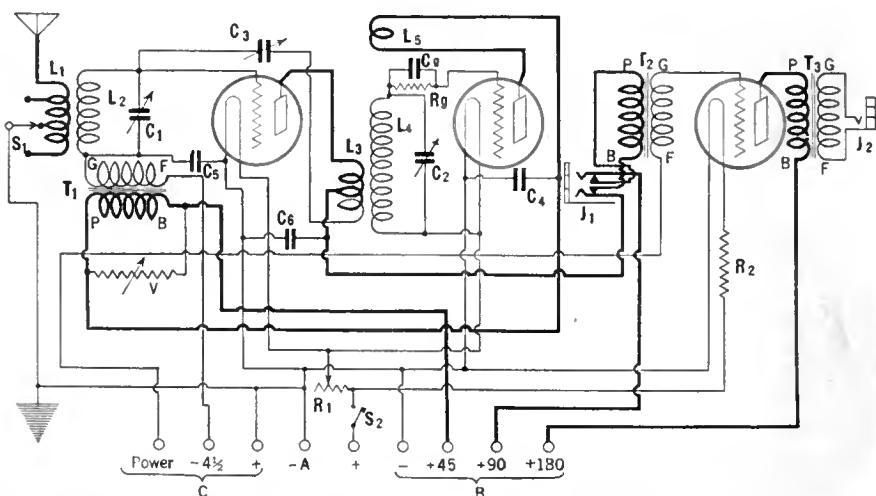

No. 160

RADIO BROADCAST Laboratory Information Sheet

January, 1928

Fading

HOW IT MAY BE PLOTTED

ON THIS Laboratory Sheet is published a curve showing how the signal strength from station WGY varied over a period of about 10 minutes during a fading test on this station made during the early part of November.

Anyone can make these measurements. To make fading measurements of this sort the only instrument needed is a 1.5- or 2-mA. milliammeter. The meter is connected in the B plus lead to the detector tube; it will read about 1 mA. if the detector is a 201-A type tube using a grid leak and condenser for detection with 45 volts on the plate. When a signal is tuned-in the meter deflection will decrease, the amount of the decrease depending upon the strength of the signals. If the meter deflection with the signal tuned-in is subtracted from the meter deflection when not receiving a signal, the difference will be the amount the meter deflection has changed due to the signal. If the normal plate current is 1 mA. and the signal causes the values to decrease to 0.6 mA. then the deflection due to the signal is 0.4 mA. If this value varies with time it indicates fading and can be plotted as a curve, as shown on this Sheet. An examination of this curve indicates that at the start of the test the meter deflection due to the signal was 0.5 mA. but that after about one minute the signal strength quickly fell to 0.25 mA.

and then increased and decreased several times in rapid succession.

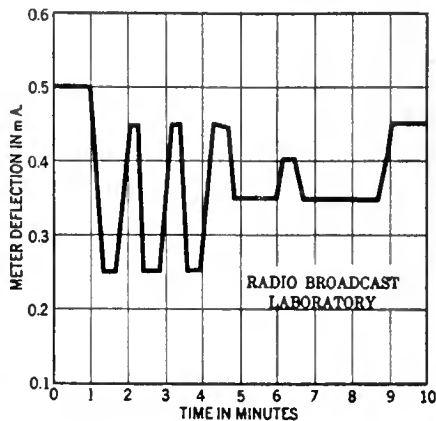

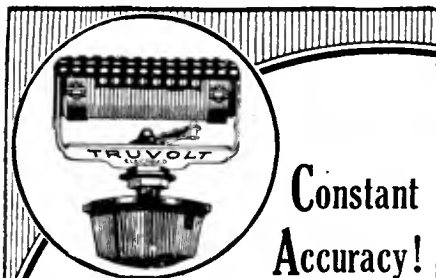

Constant Accuracy!

TRUVOLT

An All-Wire Variable Voltage Control

Install Truvolt in the B-Eliminator you are constructing and vary your voltage exactly. A new type wire variable high resistance kept cool by its greater radiation surface—like an air cooled motor.

Develops but $\frac{1}{2}$ the temperature of other resistances of like size; hence is permanently accurate and lasts indefinitely. Positive metallic contact always and 30 exact readings of resistance.

Type	Resistance Ohms	Current Milliampers
T-5	0 to 500	224
T-10	0 to 1,000	158
T-20	0 to 2,000	112
T-50	0 to 5,000	71
T-100	0 to 10,000	50
T-200	0 to 20,000	35
T-250	0 to 25,000	32
T-500	0 to 50,000	22.5

Price \$3.50 each
All rated at 25 watts.

At Your Dealers

Also a full line of Wire Fixed Resistances

Write for free Hook-up Circular

"This Is An Eliminator Year"

Dept. 14B, 175 Varick Street
New York

ELECTRAD



Improved Reception



Get it with the CARBORUNDUM GRID LEAK

ONE certain way of getting better and clearer reception is to slip a Carborundum Grid Leak into your set.

☐ Things will quiet down instantly. Carborundum Grid Leaks do not disintegrate—hence they are quiet. They are solid, fixed, dense rods of Carborundum. They assure an uninterrupted flow of current. They banish Grid Leak noises.

☐ Carborundum Grid Leaks are tested at the maximum operating grid voltage, namely—5 volts, and Resistors at 90 volts.

From your dealer, or direct
Send for Hook-Up Booklet D-2

THE CARBORUNDUM COMPANY, NIAGARA FALLS, N. Y.
CANADIAN CARBORUNDUM CO., LTD., NIAGARA FALLS, ONT.
Sales Offices and Warehouses in New York, Chicago, Boston, Philadelphia, Cleveland, Detroit
Cincinnati, Pittsburgh, Grand Rapids, Milwaukee
The Carborundum Co., Ltd., Manchester, Eng.
Deutsche Carborundum Werke, Dusseldorf, Ger.

[Carborundum is the Registered Trade Name used by The Carborundum Company for Silicon Carbide. This Trade Mark is the exclusive property of The Carborundum Company.]

RADIO PANELS

BAKELITE—HARD RUBBER

Cut, drilled and engraved to order. Send rough sketch for estimate. Our complete Catalog on Panels, Tubes and Rods—all of genuine Bakelite or Hard Rubber—mailed on request.

STARRETT MFG. CO.
521 S. Green Street Chicago, Ill.

BROWNING-DRAKE BLUE PRINTS?

Write to
Radio Broadcast Magazine
Booklet Department

Garden City New York
\$1.00 per set

Independent Radio Corporation

Manufacturers of

Precision Radio Apparatus

1516 Summer Street Philadelphia



RADIO WHOLESALE

Write for my Big 1928 Radio Catalog—just off the press. Thousands of marvelous bargains in nationally advertised goods. All the LATEST IN RADIOS and equipment. Lowest wholesale prices. Agents Wanted.

FREE Log and Call Book and Catalog. Get your copy today. Send postcard now!

American Auto & Radio Mfg. Co.
HARRY SCHWARTZBERG, PRES.
Dept. 123 American Radio Bldg., Kansas City, Mo. 3

**DEALERS
NEW
1928
CATALOG**

"RADIO BROADCASTS" DIRECTORY OF MANUFACTURED RECEIVERS

☐ A coupon will be found on page 258. All readers who desire additional information on the receivers listed below need only insert the proper number in the coupon, mail it to the Service Department of RADIO BROADCAST, and full details will be sent. New sets are listed in this space each month.

KEY TO TUBE ABBREVIATIONS

99—60-mA. filament (dry cell)
01-A—Storage battery 0.25 amps. filament
12—Power tube (Storage battery)
71—Power tube (Storage battery)
16-B—Half-wave rectifier tube
80—Full-wave, high current rectifier
81—Half-wave, high current rectifier
Hm—High-Mu tube for resistance-coupled audio
20—Power tube (dry cell)
10—Power Tube (Storage battery)
00-A—Special detector
13—Full-wave rectifier tube
25—Low-voltage high-current a. c. tube
27—Heater type a. c. tube

DIRECT CURRENT RECEIVERS

NO. 424. COLONIAL 26

Six tubes; 2 t. r. f. (01-A), detector (12), 2 transformer audio (01-A and 71). Balanced t. r. f. One to three dials. Volume control; antenna switch and potentiometer across first audio. Watts required: 120. Cabinet size: 34 x 38 inches. Headphone connections. The filaments are connected in a series parallel arrangement. Price \$250 including power unit.

NO. 425. SUPERPOWER

Five tubes: All 01-A tubes. Multiplex circuit. Two dials. Volume control: resistance in r. f. plate. Watts required: 30. Antenna: loop or outside. Cabinet sizes: table, 27 x 10 x 9 inches; console, 28 x 50 x 21. Prices: table, \$135 including power unit; console, \$390 including power unit and loud speaker.

A. C. OPERATED RECEIVERS

NO. 508. ALL-AMERICAN 77, 88, AND 99

Six tubes; 3 t. r. f. (26), detector (27), 2 transformer audio (26 and 71). Rice neutralized t. r. f. Single drum tuning. Volume control: potentiometer in r. f. plate. Cabinet sizes: No. 77, 21 x 10 x 8 inches; No. 88 Hiboy, 25 x 38 x 18 inches; No. 99 console, 27½ x 43 x 20 inches. Shielded. Output device. The filaments are supplied by means of three small transformers. The plate supply employs a gas-filled rectifier tube. Voltmeter in a. c. supply line. Prices: No. 77, \$150, including power unit; No. 88, \$210 including power unit; No. 99, \$285 including power unit and loud speaker.

NO. 509. ALL-AMERICAN "DUET"; "SEXTET"

Six tubes; 2 t. r. f. (99), detector (99), 3 transformer audio (99 and 12). Rice neutralized t. r. f. Two dials. Volume control: resistance in r. f. plate. Cabinet sizes: "Duet," 23 x 56 x 16 inches; "Sextet," 22½ x 13½ x 15½ inches. Shielded. Output device. The 99 filaments are connected in series and supplied with rectified a. c.; while 12 is supplied with raw a. c. The plate and filament supply uses gaseous rectifier tubes. Milliammeter on power unit. Prices: "Duet," \$160 including power unit; "Sextet," \$220 including power unit and loud speaker.

NO. 511. ALL-AMERICAN 80, 90, AND 115

Five tubes; 2 t. r. f. (99), detector (99), 2 transformer audio (99 and 12). Rice neutralized t. r. f. Two dials. Volume control: resistance in r. f. plate. Cabinet sizes: No. 80, 23½ x 12½ x 15 inches; No. 90, 37½ x 12 x 12½ inches; No. 115 Hiboy, 24 x 41 x 15 inches. Coils individually shielded. Output device. See No. 509 for power supply. Prices: No. 80, \$135 including power unit; No. 90, \$145 including power unit and compartment; No. 115, \$170 including power unit, compartment, and loud speaker.

NO. 510. ALL-AMERICAN 7

Seven tubes; 3 t. r. f. (26), 1 untuned r. f. (26), detector (27), 2 transformer audio (26 and 71). Rice neutralized t. r. f. One drum. Volume control: resistance in r. f. plate. Cabinet sizes: "Sovereign" console, 30½ x 60½ x 19 inches; "Lorraine" Hiboy, 25½ x 53½ x 17½ inches; "Forte" cabinet, 25½ x 13½ x 17½ inches. For filament and plate supply: See No. 508. Prices: "Sovereign" \$460; "Lorraine" \$360; "Forte" \$270. All prices include power unit. First two include loud speaker.

NO. 401. AMRAD AC9

Six tubes; 3 t. r. f. (99), detector (99), 2 transformer (99 and 12). Neutrodyne. Two dials. Volume control: resistance across 1st audio. Watts consumed: 50. Cabinet size: 27 x 9 x 11½ inches. The 99 filaments are connected in series and supplied with rectified a. c., while the 12 is run on raw a. c. The power unit, requiring two 16-B rectifiers, is separate and supplies A, B, and C current. Price \$142 including power unit.

NO. 402. AMRAD AC5

Five tubes. Same as No. 401 except one less r. f. stage. Price \$125 including power unit.

NO. 536. SOUTH BEND

Six tubes. One control. Sub-panel shielding. Binding Posts. Antenna: outdoor. Prices: table, \$130, Baby Grand Console, \$195.

NO. 537. WALBERT 26

Six tubes; five Kellogg a. c. tubes and one 71. Two controls. Volume control: variable plate resistance. Isofarad circuit. Output device. Battery cable. Semi-shielded. Antenna: 50 to 75 feet. Cabinet size: 10½ x 29½ x 16½ inches. Prices: \$215; with tubes, \$250.

NO. 484. BOSWORTH, B5

Five tubes; 2 t. r. f. (26), detector (99), 2 transformer audio (special a. c. tubes). T. r. f. circuit. Two dials. Volume control: potentiometer. Cabinet size: 23 x 7 x 8 inches. Output device included. Price \$175.

NO. 406. CLEAR TONE 110

Five tubes; 2 t. r. f., detector, 2 transformer audio. All tubes a. c. heater type. One or two dials. Volume control: resistance in r. f. plate. Watts consumed: 40. Cabinet size varies. The plate supply is built in the receiver and requires one rectifier tube. Filament supply through step down transformers. Prices range from \$175 to \$375 which includes 5 a. c. tubes and one rectifier tube.

NO. 407. COLONIAL 25

Six tubes; 2 t. r. f. (01-A), detector (99), 2 resistance audio (99), 1 transformer audio (10). Balanced t. r. f. circuit. One or three dials. Volume control: Antenna switch and potentiometer on 1st audio. Watts consumed: 100. Console size: 34 x 38 x 18 inches. Output device. All tube filaments are operated on a. c. except the detector which is supplied with rectified a. c. from the plate supply. The rectifier employs two 16-h tubes. Price \$250 including built-in plate and filament supply.

NO. 507. CROSLY 602 BANDBOX

Six tubes; 3 t. r. f. (26), detector (27), 2 transformer audio (26 and 71). Neutrodyne circuit. One dial. Cabinet size: 17½ x 5½ x 7½ inches. The heaters for the a. c. tubes and the 71 filament are supplied by windings in B unit transformers available to operate either on 25 or 60 cycles. The plate current is supplied by means of rectifier tube. Price \$65 for set alone, power unit \$60.

NO. 408. DAY-FAN "DE LUXE"

Six tubes; 3 t. r. f., detector, 2 transformer audio. All 01-A tubes. One dial. Volume control: potentiometer across r. f. tubes. Watts consumed: 300. Console size: 30 x 40 x 20 inches. The filaments are connected in series and supplied with d. c. from a motor-generator set which also supplies B and C current. Output device. Price \$350 including power unit.

NO. 409. DAYCRAFT 5

Five tubes; 2 t. r. f., detector, 2 transformer audio. All a. c. heater tubes. Reflexed t. r. f. One dial. Volume control: potentiometers in r. f. plate and 1st audio. Watts consumed: 135. Console size: 34 x 36 x 14 inches. Output device. The heaters are supplied by means of a small transformer. A built-in rectifier supplies B and C voltages. Price \$170, less tubes. The following have one more r. f. stage and are not reflexed; Daycraft 6, \$195; Dayrole, 6, \$235; Dayfan 6, \$110. All prices less tubes.

NO. 469. FREED-EISEMANN NR11

Six tubes; 3 t. r. f. (01-A), detector (01-A), 2 transformer audio (01-A and 71). Neutrodyne. One dial. Volume control: potentiometer. Watts consumed: 150. Cabinet size: 19½ x 10 x 10½ inches. Shielded. Output device. A special power unit is included employing a rectifier tube. Price \$225 including NR-411 power unit.

NO. 487. FRESHMAN 7F-AC

Six tubes; 3 t. r. f. (26), detector (27), 2 transformer audio (26 and 71). Equaphase circuit. One dial. Volume control: potentiometer across 1st audio. Console size: 24½ x 41½ x 15 inches. Output device. The filaments and heaters and B supply are all supplied by one power unit. The plate supply requires one 80 rectifier tube. Price \$175 to \$350, complete.

NO. 421. SOVEREIGN 238

Seven tubes of the a. c. heater type. Balanced t. r. f. Two dials. Volume control: resistance across 2nd audio. Watts consumed: 45. Console size: 37 x 52 x 15 inches. The heaters are supplied by a small a. c. transformer, while the plate is supplied by means of rectified a. c. using a gaseous type rectifier. Price \$325, including power unit and tubes.

NO. 517. KELLOGG 510, 511, AND 512

Seven tubes; 4 t. r. f., detector, 2 transformer audio. All Kellogg a. c. tubes. One control and special zone switch. Balanced. Volume control: special. Output device. Shielded. Cable connection between power supply unit and receiver. Antenna: 25 to 100 feet. Panel 71½ x 27½ inches. Prices: Model 510 and 512, consoles, \$495 complete. Model 511, console, \$365 without loud speaker.

NO. 496. SLEEPER ELECTRIC

Five tubes; four 99 tubes and one 71. Two controls. Volume control: rheostat on r. f. Neutralized. Cable. Output device. Power supply uses two 16-B tubes. Antenna: 100 feet. Prices: Type 64, table, \$160; Type 65, table, with built-in loud speaker, \$175; Type 66, table, \$175; Type 67, console, \$235; Type 78, console, \$265.

NO. 538. NEUTROWOUND MASTER ALLECTRIC

Six tubes; 2 t. r. f. (01-A), detector (01-A), 2 audio (01-A and two 71 in push-pull amplifier). The 01-A tubes are in series, and are supplied from a 400-mA. rectifier. Two drum controls. Volume control: variable plate resistance. Output device. Shielded. Antenna: 50 to 100 feet. Price: \$360.

NO. 413. MARTI

Six tubes; 2 t. r. f., detector, 3 resistance audio. All tubes a. c. heater type. Two dials. Volume control: resistance in r. f. plate. Watts consumed: 38. Panel size 7 x 21 inches. The built-in plate supply employs one 16-B rectifier. The filaments are supplied by a small transformer. Prices: table, \$235 including tubes and rectifier; console, \$275 including tubes and rectifier; console, \$325 including tubes, rectifier, and loud speaker.

NO. 417. RADIOLA 28

Eight tubes; five type 99 and one type 20. Drum control. Super-heterodyne circuit. C-battery connections. Battery cable. Headphone connection. Antenna: loop. Set may be operated from batteries or from the power mains when used in conjunction with the model 104 loud speaker. Prices: \$260 with tubes, battery operation; \$570 with model 104 loud speaker, a. c. operation.

NO. 540. RADIOLA 30-A

Receiver characteristics same as No. 417 except that type 71 power tube is used. This model is designed to operate on either a. c. or d. c. from the power mains. The combination rectifier—power—amplifier unit uses two type 81 tubes. Model 100-A loud speaker is contained in lower part of cabinet. Either a short indoor or long outside antenna may be used. Cabinet size: 42½ x 29 x 17½ inches. Price: \$495.

NO. 541. RADIOLA 32

This model combines receiver No. 417 with the model 104 loud speaker. The power unit uses two type 81 tubes and a type 10 power amplifier. Loop is completely enclosed and is revolved by means of a dial on the panel. Models for operation from a. c. or d. c. power mains. Cabinet size: 52 x 72 x 17½ inches. Price: \$895.

NO. 539. RADIOLA 17

Six tubes; 3 t. r. f. (26), detector (27), 2 transformer audio (26 and 27). One control. Illuminated dial. Built-in power supply using type 80 rectifier. Antenna: 100 feet. Cabinet size: 25½ x 7½ x 8½. Price: \$130 without accessories.

NO. 545. NEUTROWOUND, SUPER ALLECTRIC

Five tubes; 2 t. r. f. (99), detector (99), 2 audio (99 and 71). The 99 tubes are in series and are supplied from an 85-mA. rectifier. Two drum controls. Volume control: variable plate resistance. Output device. Antenna: 75 to 100 feet. Cabinet size: 9 x 24 x 11 inches. Price: \$150.

NO. 490. MOHAWK

Six tubes; 2 t. r. f., detector, 2 transformer audio. All tubes a. c. heater type except 71 in last stage. One dial. Volume control: rheostat on r. f. Watts consumed: 40. Panel size: 12½ x 8½ inches. Output device. The heaters for the a. c. tubes and the 71 filament are supplied by small transformers. The plate supply is of the built-in type using a rectifier tube. Prices range from \$65 to \$245.

NO. 522. CASE, 62B AND 62C

McCullough a. c. tubes. Drum control. Volume control; variable high resistance in audio system. C-battery connections. Semi-shielded. Cable. Antenna: 100 feet. Panel size: 7 x 21 inches. Prices: Model 62B, complete with a. c. equipment, \$185; Model 62 C, complete with a. c. equipment, \$235.

NO. 523. CASE, 92 A AND 92 C

McCullough a. c. tubes. Drum control. Inductive volume control. Technidyne circuit. Shielded. Cable. C-battery connections. Model 92 C contains output device. Loop operated. Prices: Model 92 A, table, \$350; Model 92 C, console, \$475.

BATTERY OPERATED RECEIVERS

NO. 542. PFANSTIEHL JUNIOR SIX

Six tubes; 3 t. r. f. (01-A), detector (01-A), 2 audio. Pfanstiehl circuit. Volume control: variable resistance in r. f. plate circuit. One dial. Shielded. Battery cable. C-battery connections. Etched bronze panel. Antenna: outdoor. Cabinet size: 9 x 20 x 8 inches. Price: \$80, without accessories.

NO. 512. ALL-AMERICAN 44, 45, AND 66

Six tubes; 3 t. r. f. (01-A, detector) 01-A, 2 transformer audio (01-A and 71). Rice neutralized t. r. f. Drum control. Volume control: rheostat in r. f. Cabinet sizes: No. 44, 21 x 10 x 8 inches; No. 55, 25 x 38 x 18 inches; No. 66, 27½ x 43 x 20 inches. C-battery connections. Battery cable. Antenna: 75 to 125 feet. Prices: No. 44, \$70; No. 55, \$125 including loud speaker; No. 66, \$200 including loud speaker.

NO. 428. AMERICAN C6

Five tubes; 2 t. r. f. detector, 2 transformer audio. All 01-A tubes. Semi balanced t. r. f. Three dials. Plate current 15mA. Volume control: potentiometer. Cabinet sizes: table, 20 x 8½ x 10 inches; console, 36 x 40 x 17 inches. Partially shielded. Battery cable. C-battery connections. Antenna: 125 feet. Prices: table, \$30 console, \$65 including loud speaker.

New AERO Circuits For Either Battery or A. C. Operation

The Improved Aero-Dyne 6, and the Aero 7—popular new circuits are built around these marvelous coils

You Should Learn About Them Now!

Proper constants for A. C. operation of the improved Aero-Dyne 6 and the Aero Seven have been studied out, and these excellent circuits are now adaptable to either A. C. or battery operation. A. C. blue prints are packed in foundation units. They may also be obtained by sending 25c for each direct to the factory.



AERO Universal Tuned Radio Frequency Kit

Especially designed for the Improved Aero-Dyne 6. Kit consists of 4 twice-matched units. Adaptable to 201-A, 199, 112, and the new 240 and A. C. tubes. Tuning range below 200 to above 550 meters. This kit will make any circuit better in selectivity, tone and range. Will eliminate losses and give the greatest receiving efficiency.

Code No. U-16 (for .0005 Cond.)...\$15.00
Code No. U-163 (for .00035 Cond.)... 15.00



AERO Seven Tuned Radio Frequency Kit

Especially designed for the Aero 7. Kit consists of 3 twice-matched units. Coils are wound on Bakelite skeleton forms, assuring a 95% air dielectric. Tuning range from below 200 to above 550 meters. Adaptable to 201-A, 199, 112, and the new 240 and A. C. tubes.

Code No. U-12 (for .0005 Cond.)...\$12.00
Code No. U-123 (for .00035 Cond.)... 12.00

NOTE—All AERO Universal Kits for use in tuned radio frequency circuits have packed in each coil with a fixed primary a twice-matched calibration slip showing reading of each fixed primary AERO Universal Coil at 250 and 500 meters; all having an accurate and similar calibration. Be sure to keep these slips. They're valuable if you decide to add another R.F. Stage to your set.

A NEW SERVICE

We have arranged to furnish the home set builder with complete Foundation Units for the above named Circuits, drilled and engraved on Westinghouse Micarta. Detailed blue-prints for both battery and A. C. operation and wiring diagram for each circuit included with every foundation unit free. Write for information and prices.

You should be able to get any of the above Aero Coils and parts from your dealer. If he should be out of stock order direct from the factory.

AERO PRODUCTS, Inc.

1772 Wilson Ave. Dept. 109 Chicago, Ill.

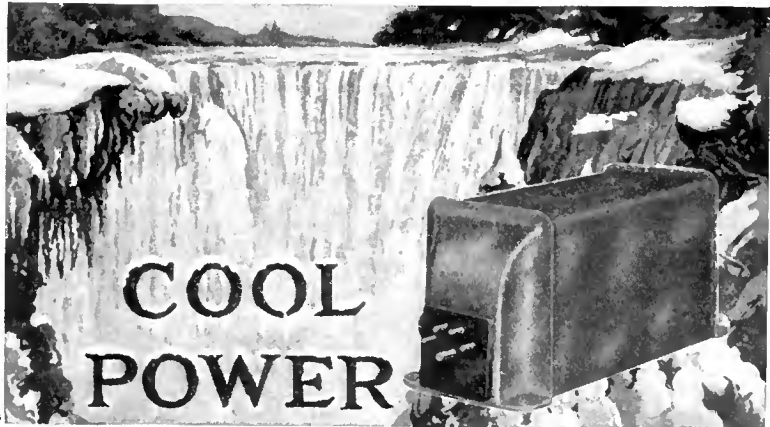

**COOL
POWER**

Samson Power Block No. 210—The only block which will supply 500 volts at 80 mils to two 210 tubes.

Powerize with Samson Units for Best Results

For new SAMSON Power Units insure the best there is in radio current supply by

1. Doing away with hum, motor boating and poor voltage regulation.
2. Remaining so cool after 24 hours continuous operation under full load that they will be well within the 20° rise of temperature specified by the A. I. E. E.
3. Being designed to more than meet the specifications adopted by the National Board of Fire Underwriters.
4. Insuring safety against shock because of protected input and output terminals.
5. Insuring for all tubes the correct filament voltages specified by their manufacturers.
6. Compensating for lighting circuit voltage variation by the use of a special input plug and terminal block to which is attached a six ft. flexible rubber-covered connecting cord and plug.

Our Power Units bulletin descriptive of these is free for the asking. In addition, our construction bulletin on many different "B" Eliminators and Power Amplifiers will be sent upon receipt of 10c. in stamps to cover the mailing cost.

Samson Electric Co.

Manufacturing Since 1882

Principal Office, CANTON, MASS.

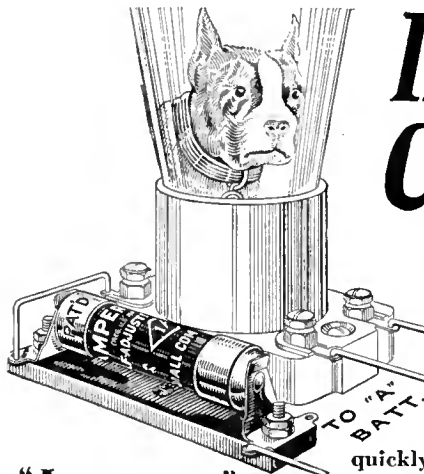

If TUBES! Could Talk!

They would tell you—that only at the precise and definitely prescribed filament current, or temperature, can their tonal qualities, clarity and sensitiveness be brought out to the full. That "A" battery current constantly varies according to the age of the battery and state of charge—and operation with too little or too great current is certain death to efficient tube performance—and too quickly, of the tube itself. That only AMPERITE can automatically supply and control this exact current despite battery variation—as long as sufficient current is to be had. That you should never confuse AMPERITE with fixed filament resistors which do not do the Amperite's job. AMPERITE is sold by dealers everywhere. Price \$1.10 mounted (in U. S. A.).

Write for FREE "Amperite Book" of the season's best circuits and latest construction data. Address Dept. R.H-1

Radiall Company

50 Franklin St., New York

AMPERITE

REG. U.S. PAT. OFF.

The "SELF-ADJUSTING" Rheostat

NO. 485. BOSWORTH B6

Five tubes; 2 t. r. f. (01-A), detector (01-A), 2 transformer audio (01-A and 71). Two dials. Volume control: variable grid resistances. Battery cable. C-battery connections. Antenna: 25 feet or longer. Cabinet size 15 x 7 x 8 inches. Price \$75.

NO. 513. COUNTERPHASE SIX

Six tubes; 3 t. r. f. (01-A), detector (00-A), 2 transformer audio (01-A and 12). Counterphase t. r. f. Two dials. Plate current: 32 mA. Volume control: rheostat on 2nd and 3rd r. f. Coils shielded. Battery cable. C-battery connections. Antenna: 75 to 100 feet. Console size: 18½ x 40½ x 15½ inches. Prices: Model 35, table, \$110; Model 37, console, \$175.

NO. 514. COUNTERPHASE EIGHT

Eight tubes; 4 t. r. f. (01-A) detector (00-A), 2 transformer audio (01-A and 12). Counterphase t. r. f. One dial. Plate current: 40 mA. Volume control: rheostat in 1st r. f. Copper stage shielding. Battery cable. C-battery connections. Antenna: 75 to 100 feet. Cabinet size: 30 x 12½ x 16 inches. Prices: Model 12, table, \$225; Model 16, console, \$335; Model 18, console, \$365.

NO. 506. CROSLY 601 BANDBOX

Six tubes; 3 t. r. f., detector, 2 transformer audio. All 01-A tubes. Neurodyne. One dial. Plate current: 40 mA. Volume control: rheostat in r. f. Shielded. Battery cable. C-battery connections. Antenna: 75 to 150 feet. Cabinet size: 17½ x 5½ x 7½. Price, \$55.

NO. 434. DAY-FAN 6

Six tubes; 3 t. r. f. (01-A), detector (01-A), 2 transformer audio (01-A and 12 or 71). One dial. Plate current: 12 to 15 mA. Volume control: rheostat on r. f. Shielded. Battery cable. C-battery connections. Output device. Antenna: 50 to 120 feet. Cabinet sizes: Daycraft 6, 32 x 30 x 34 inches; Day-Fan Jr., 15 x 7 x 7. Prices: Day-Fan 6, \$110; Daycraft 6, \$145 including loud speaker; Day-Fan Jr. not available.

NO. 435. DAY-FAN 7

Seven tubes; 3 t. r. f. (01-A), detector (01-A), 1 resistance audio (01-A), 2 transformer audio (01-A and 12 or 71). Plate current: 15 mA. Antenna: outside. Same as No. 434. Price \$115.

NO. 503. FADA SPECIAL

Six tubes; 3 t. r. f. (01-A), detector (01-A), 2 transformer audio (01-A and 71). Neurodyne. Two drum control. Plate current: 20 to 24 mA. Volume control: rheostat on r. f. Coils shielded. Battery cable. C-battery connections. Headphone connection. Antenna: outdoor. Cabinet size: 20 x 13½ x 10½ inches. Price \$95.

NO. 504. FADA 7

Seven tubes; 4 t. r. f. (01-A), detector (01-A), 2 transformer audio (01-A and 71). Neurodyne. Two drum control. Plate current: 43 A. Volume control: rheostat on r. f. Completely shielded. Battery cable. C-battery connections. Headphone connections. Output device. Antenna: outdoor or loop. Cabinet sizes: table, 25½ x 13½ x 11½ inches; console, 29 x 50 x 17 inches. Prices: table, \$185; console, \$285.

NO. 436. FEDERAL

Five tubes; 2 t. r. f. (01-A), detector (01-A), 2 transformer audio (01-A and 12 or 71). Balanced t. r. f. One dial. Plate current: 20.7 mA. Volume control: rheostat on r. f. Shielded. Battery cable. C-battery connections. Antenna: loop. Made in 6 models. Price varies from \$250 to \$1000 including loop.

NO. 505. FADA 8

Eight tubes. Same as No. 504 except for one extra stage of audio and different cabinet. Prices: table, \$300; console, \$400.

NO. 437. FERGUSON 10A

Seven tubes; 3 t. r. f. (01-A), detector (01-A), 3 audio (01-A and 12 or 71). One dial. Plate current: 18 to 25 mA. Volume control: rheostat on two r. f. Shielded. Battery cable. C-battery connections. Antenna: 100 feet. Cabinet size: 21½ x 12 x 15 inches. Price \$150.

NO. 438. FERGUSON 14

Ten tubes; 3 untuned r. f., 3 t. r. f. (01-A), detector (01-A), 3 audio (01-A and 12 or 71). Special balanced t. r. f. One dial. Plate current: 30 to 35 mA. Volume control: rheostat in three r. f. Shielded. Battery cable. C-battery connections. Antenna: loop. Cabinet size: 24 x 12 x 16 inches. Price \$235, including loop.

NO. 439. FERGUSON 12

Six tubes; 2 t. r. f. (01-A), detector (01-A), 1 transformer audio (01-A), 2 resistance audio (01-A and 12 or 71). Two dials. Plate current: 18 to 25 mA. Volume control: rheostat on two r. f. Partially shielded. Battery cable. C-battery connections. Antenna: 100 feet. Cabinet size: 22½ x 10 x 12 inches. Price \$85. Consoleette \$145 including loud speaker.

NO. 440. FREED-EISEMANN NR-8 NR-9, AND NR-66

Six tubes; 3 t. r. f. (01-A), detector (01-A), 2 transformer audio (01-A and 71). Neurodyne. NR-8, two dials; others one dial. Plate current: 30 mA. Volume control: rheostat on r. f. NR-8 and 9, chassis type shielding. NR-66, individual stage shielding. Battery cable. C-battery connections. Antenna: 100 feet. Cabinet sizes: NR-8 and 9, 19½ x 10 x 10 inches; NR-66, 20 x 10½ x 12 inches. Prices: NR-8, \$90; NR-9, \$100; NR-66, \$125.

NO. 501. KING "CHEVALIER"

Six tubes. Same as No. 500. Coils completely shielded. Panel size: 11 x 7 inches. Price, \$210 including loud speaker.

NO. 441. FREED-EISEMANN NR-77

Seven tubes; 4 t. r. f. (01-A), detector (01-A), 2 transformer audio (01-A and 71). Neurodyne. One dial. Plate current: 35 mA. Volume control: rheostat on r. f. Shielding. Battery cable. C-battery connections. Antenna: outside or loop. Cabinet size: 23 x 10½ x 13 inches. Price \$175.

NO. 442. FREED-EISEMANN 800 AND 850

Eight tubes; 4 t. r. f. (01-A), detector (01-A), 1 transformer (01-A), 1 parallel audio (01-A or 71). Neurodyne. One dial. Plate current: 35 mA. Volume control: rheostat on r. f. Shielded. Battery cable. C-battery connections. Output: two tubes in parallel or one power tube may be used. Antenna: outside or loop. Cabinet sizes: No. 800, 34 x 15½ x 13½ inches; No. 850, 36 x 65 x 17½. Prices not available.

NO. 444. GREBE MU-1

Five tubes; 2 t. r. f. (01-A), detector (01-A), 2 transformer audio (01-A and 12 or 71). Balanced t. r. f. One, two, or three dials (operate singly or together). Plate current: 30 mA. Volume control: rheostat on r. f. Bi-nocular coils. Binding posts. C-battery connections. Antenna: 125 feet. Cabinet size: 22½ x 9½ x 13 inches. Prices range from \$95 to \$320.

NO. 426. HOMER

Seven tubes; 4 t. r. f. (01-A); detector (01-A or 00A); 2 audio (01-A and 12 or 71). One knob tuning control. Volume control: rotor control in antenna circuit. Plate current: 22 to 25 mA. "Technidyne" circuit. Completely enclosed in aluminum box. Battery cable. C-battery connections. Cabinet size, 8½ x 19½ x 9½ inches. Chassis size, 6½ x 17 x 8 inches. Prices: Chassis only, \$80. Table cabinet, \$95.

NO. 502. KENNEDY ROYAL 7. CONSOLETTA

Seven tubes; 4 t. r. f. (01-A), detector (00-A), 2 transformer audio (01-A and 71). One dial. Plate current: 42 mA. Volume control: rheostat on two r. f. Special r. f. coils. Battery cable. C-battery connections. Headphone connection. Antenna: outside or loop. Consolette size: 36½ x 35½ x 19 inches. Price \$220.

NO. 498. KING "CRUSADER"

Six tubes; 2 t. r. f. (01-A), detector (00-A), 3 transformer audio (01-A and 71). Balanced t. r. f. One dial. Plate current: 20 mA. Volume control: rheostat on r. f. Coils shielded. Battery cable. C-battery connections. Antenna: outside. Panel: 11 x 7 inches. Price, \$115.

NO. 499. KING "COMMANDER"

Six tubes; 3 t. r. f. (01-A), detector (00-A), 2 transformer audio (01-A and 71). Balanced t. r. f. One dial. Plate current: 25 mA. Volume control: rheostat on r. f. Completely shielded. Battery cable. C-battery connections. Antenna: loop. Panel size: 12 x 8 inches. Price \$220 including loop.

NO. 429. KING COLE VII AND VIII

Seven tubes; 3 t. r. f., detector, 1 resistance audio, 2 transformer audio. All 01-A tubes. Model VIII has one more stage t. r. f. (eight tubes). Model VII, two dials. Model VIII, one dial. Plate current: 15 to 50 mA. Volume control: primary shunt in r. f. Steel shielding. Battery cable and binding posts. C-battery connections. Output devices on some consoles. Antenna: 10 to 100 feet. Cabinet size: varies. Prices: Model VII, \$80 to \$160; Model VIII, \$100 to \$300

NO. 500. KING "BARONET" AND "VIKING"

Six tubes; 2 t. r. f. (01-A), detector (00-A), 3 transformer audio (01-A and 71). Balanced t. r. f. One dial. Plate current: 19 mA. Volume control: rheostat in r. f. Battery cable. C-battery connections. Antenna: outside. Panel size: 18 x 7 inches. Prices: "Baronet," \$70; "Viking," \$140 including loud speaker.

NO. 489. MOHAWK

Six tubes; 2 t. r. f. (01-A), detector (00-A), 3 audio (01-A and 71 or 12). One dial. Plate current: 40 mA. Volume control: rheostat on r. f. Battery cable. C-battery connections. Output device. Antenna: 60 feet. Panel size: 12½ x 8½ inches. Prices range from \$65 to \$245.

NO. 547. ATWATER KENT, MODEL 33

Six tubes; 3 t. r. f. (01-A), detector (01-A), 2 audio (01-A and 71 or 12). One dial. Volume control: r. f. filament rheostat. C-battery connections. Battery cable. Antenna: 100 feet. Steel panel. Cabinet size: 21½ x 6½ x 6½ inches. Price: \$75, without accessories.

NO. 544. ATWATER KENT, MODEL 50

Seven tubes; 4 t. r. f. (01-A), detector (01-A), 2 audio (01-A and 12 or 71). Volume control: r. f. filament rheostat. C-battery connections. Battery cable. Special bandpass filter circuit with an untuned amplifier. Cabinet size: 20½ x 13 x 7½ inches. Price: \$120.

NO. 452. ORIOLE 90

Five tubes; 2 t. r. f., detector, 2 transformer audio. All 01-A tubes. "Triumf" circuit. Two dials. Plate current: 18 mA. Volume control: rheostat on r. f. Battery cable. C-battery connections. Antenna: 50 to 100 feet. Cabinet size: 25½ x 11½ x 12½ inches. Price \$85. Another model has 8 tubes, one dial, and is shielded. Price, \$185.

NO. 453. PARAGON

Six tubes; 2 t. r. f. (01-A), detector (01-A), 3 double impedance audio (01-A and 71). One dial. Plate current: 40 mA. Volume control: resistance in r. f. plate. Shielded. Battery cable. C-battery connections. Output device. Antenna: 100 feet. Console size: 20 x 45 x 17 inches. Price not determined.

NO. 543 RADIOLA 20

Five tubes; 2 t. r. f. (99), detector (99), two transformer audio (99 and 20). Regenerative detector. Two drum controls. C-battery connections. Battery cable. Antenna: 100 feet. Price: \$78 without accessories.

NO. 480. PFANSTIEHL 30 AND 302

Six tubes; 3 t. r. f. (01-A), detector (01-A), 2 transformer audio (01-A and 71). One dial. Plate current: 23 to 32 mA. Volume control: resistance in r. f. plate. Shielded. Battery cable. C-battery connections. Antenna: outside. Panel size: 17½ x 8½ inches. Prices: No. 30 cabinet, \$105; No. 302 console, \$185 including loud speaker.

NO. 515. BROWNING-DRAKE 7-A

Seven tubes; 2 t. r. f. (01-A), detector (00-A), 3 audio (Hmu, two 01-A and 71). Illuminated drum control. Volume control: rheostat on 1st r. f. Shielded. Neutralized. C-battery connections. Battery Cable. Metal panel. Output device. Antenna: 50-75 feet. Cabinet, 30 x 11 x 9 inches. Price, \$145.

NO. 516. BROWNING-DRAKE 6-A

Six tubes; 1 t. r. f. (99), detector (00-A), 3 audio (Hmu, two 01-A and 71). Drum control with auxiliary adjustment. Volume control: rheostat on r. f. Regenerative detector. Shielded. Neutralized. C-battery connections. Battery cable. Antenna: 50-100 feet. Cabinet, 25 x 11 x 9. Price \$105.

NO. 518. KELLOGG "WAVE MASTER," 504, 505, and 506.

Five tubes; 2 t. r. f., detector, 2 transformer audio. One control and special zone switch. Volume control: rheostat on r. f. C-battery connections. Binding posts. Plate current: 25 to 35 mA. Antenna: 100 feet. Panel: 7½ x 25½ inches. Prices: Model 504, table, \$75, less accessories. Model 505, table, \$125 with loud speaker. Model 506, console, \$135 with loud speaker.

NO. 519. KELLOGG, 507 AND 508

Six tubes; 3 t. r. f., detector, 2 transformer audio. One control and special zone switch. Volume control: rheostat on r. f. C-battery connections. Balanced. Shielded. Binding posts and battery cable. Antenna: 70 feet. Cabinet size: Model 507, table, 30 x 13½ x 14 inches. Model 508, console, 34 x 18 x 5½ inches. Prices: Model 507, \$190 less accessories. Model 508, \$320 with loud speaker.

NO. 427. MURDOCK 7

Seven tubes; 3 t. r. f. (01-A), detector (01-A), 1 transformer and 2 resistance audio (two 01-A and 12 or 71). One control. Volume control: rheostat on r. f. Coils shielded. Neutralized. Battery cable. C-battery connections. Complete metal case. Antenna: 100 feet. Panel size: 9 x 23 inches. Price, not available.

NO. 520. BOSCH 57

Seven tubes; 4 t. r. f. (01-A), detector (01-A), 2 audio (01-A and 71). One control calibrated in kc. Volume control: rheostat on r. f. Shielded. Battery cable. C-battery connections. Balanced. Output device. Built-in loud speaker. Antenna: built-in loop or outside antenna, 100 feet. Cabinet size: 46 x 16 x 30 inches. Price: \$340 including enclosed loop and loud speaker.

NO. 521. BOSCH "CRUISER," 66 AND 76

Six tubes; 3 t. r. f. (01-A), detector (01-A), 2 audio (01-A and 71). One control. Volume control: rheostat on r. f. Shielded. C-battery connections. Balanced. Battery cable. Antenna: 20 to 100 feet. Prices: Model 66, table, \$99.50. Model 76, console, \$175; with loud speaker \$195.

NO. 524. CASE, 61 A AND 61 C

T. r. f. Semi-shielded. Battery cable. Drum control. Volume control: variable high resistance in audio system. Plate current: 35 mA. Antenna: 100 feet. Prices: Model 61A, \$85; Model 61 C, console, \$135.

NO. 525. CASE, 90 A AND 90 C

Drum control. Inductive volume control. Technidyne circuit. C-battery connections. Battery cable. Loop operated. Model 90-C equipped with output device. Prices: Model 90 A, table, \$225; Model 90 C, console, \$350.

NO. 526. ARBORPHONE 25

Six tubes; 3 t. r. f. (01-A), detector (01-A), 2 audio (01-A and 71). One control. Volume control: rheostat. Shielded. Battery cable. Output device. C-battery connections. Loftin-White circuit. Antenna: 75 feet. Panel: 7½ x 15 inches, metal. Prices: Model 25, table, \$125; Model 252, \$185; Model 253, \$250; Model 255, combination phonograph and radio, \$600.

NO. 527. ARBORPHONE 27

Five tubes; 2 t. r. f. (01-A), detector (01-A), 2 audio (01-A). Two controls. Volume control: rheostat. C-battery connections. Binding posts. Antenna: 75 feet. Prices: Model 27, \$65; Model 271, \$99.50; Model 272, \$125.

NO. 528. THE "CHIEF"

Seven tubes; six 01-A tubes and one power tube. One control. Volume control: rheostat. C-battery connection. Partial shielding. Binding posts. Antenna: outside. Cabinet size: 40 x 22 x 16 inches. Prices: Complete with A power supply, \$250; without accessories, \$150.

NO. 529. DIAMOND SPECIAL, SUPER SPECIAL, AND BABY GRAND CONSOLE

Six tubes; all 01-A type. One control. Partial shielding. C-battery connections. Volume control: rheostat. Binding posts. Antenna: outdoor. Prices: Diamond Special, \$75; Super Special, \$65; Baby Grand Console, \$110.

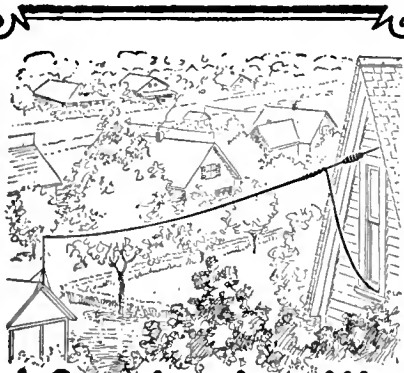

A Complete Aerial Kit that saves time and effort

It is much easier to buy a complete Belden Aerial Kit with Beldenamel Aerial Wire, Belden Lightning Arrester, etc., than to pick up the many odd items that are essential for a good aerial. Every item in the Belden Aerial Kit is matched for perfect performance.

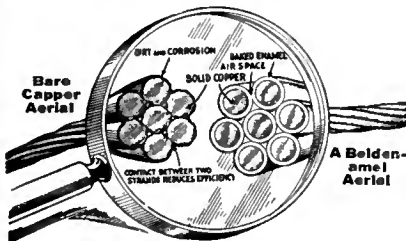

Insure yourself against aerial trouble. Ask your dealer for a Beldenamel Aerial Kit, today. A Beldenamel Aerial cannot corrode.

Belden Manufacturing Co.
2312-A S. Western Ave., Chicago

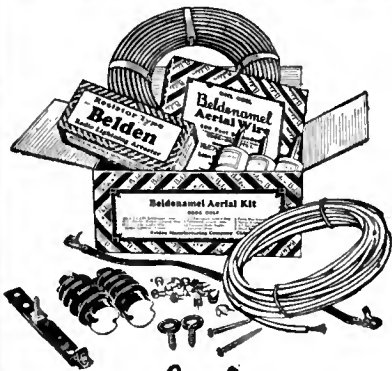

Specify
Belden
Aerial Kit



In the still of the Arctic Night

In the still of the Arctic night, broken only by the occasional bark of a far-off walrus, the Radio Operator cannot leave his ship, frozen into the ice pack, and run around the corner to the Radio Shack for a new filter condenser to replace the one that just blew out.

He has got to be sure when he starts

that his equipment is not going to give out.

That is why Cliff Himoe took TOBE Condensers with him on the Bowdoin for the MacMillan Arctic Expedition.

Here is a Radio message just received from the boat: The TOBE'S are up to the mark!

"Your filter condenser standing up well on Bowdoin's transmitter, with no signs of trouble at continuous 2000 volts dc regards from the arctic."

Himoe WNP

The University-of-Michigan-Greenland Expedition is also equipped with TOBE Condensers.

Make sure that your Radio Power Equipment includes TOBE Condensers. TOBE Condensers cure condenser worries permanently and painlessly.

Send for Price List B-1

Tobe Deutschmann Company
Cambridge Massachusetts

WANTED!

Radio Dealers

PROFESSIONAL

Set Builders and Radio Fans

IN every community to introduce and become our factory Representative on the newest, most revolutionary radio development in the history of the industry . . . The SUPER HILODYNE Circuit, a radio circuit that is modern and independent. See December issue of Radio News.

The SUPER HILODYNE is a new basic circuit employing nine tubes. Its all around performance will amaze you. You can help repeat Radio History and make money by representing us in your community in your full or spare time. Write TO-DAY for details. Dept. RB-128.

ALGONQUIN ELECTRIC CO., INC.
245 Fifth Avenue New York City

NO. 531. KOLSTER, 8A, 8B, AND 8C

Eight tubes; 4 t. r. f. (01-A), detector (01-A), 3 audio (two 01-A and one 12). One control. Volume control: rheostat on r. f. Shielded. Battery cable. C-battery connections. Model 8A uses 50 to 75 foot antenna; model 8B contains output device and uses antenna or detachable loop; Model 8C contains output device and uses antenna or built-in loop. Prices: 8A, \$185; 8B, \$235; 8C, \$375.

NO. 532. KOLSTER, 6D, 6G, AND 6H

Six tubes; 3 t. r. f. (01-A), detector (01-A), 2 audio (01-A and 12). One control. Volume control: rheostat on r. f. C-battery connections. Battery cable. Antenna: 50 to 75 feet. Model 6G contains output device and built-in loud speaker; Model 6H contains built-in B power unit and loud speaker. Prices: Model 6D, \$80; Model 6G, \$165; Model 6H, \$265.

NO. 533. SIMPLEX, SR 9 AND SR 10

Five tubes; 2 t. r. f. (01-A), detector (00-A), 2 audio (01-A and 12). SR 9, three controls; SR 10, two controls. Volume control: rheostat. C-battery connections. Battery cable. Headphone connection. Prices: SR 9, table, \$65; console/ette, \$95; console, \$145. SR 10, table \$70; console/ette, \$95; console, \$145.

NO. 534. SIMPLEX, SR 11

Six tubes; 3 t. r. f. (01-A), detector (00-A), 2 audio (01-A and 12). One control. Volume control: rheostat. C-battery connections. Battery cable. Antenna: 100 feet. Prices: table, \$70; console/ette, \$95; console, \$145.

NO. 535. STANDARDYNE, MODEL X 27

Six tubes; 2 t. r. f. (01-A), detector (01-A), 2 audio power tubes). One control. Volume control: rheostat on r. f. C-battery connections. Binding posts. Antenna: 75 feet. Cabinet size: 9 x 9 x 19½ inches. Prices: S 27, \$49.50; S 950, console, with built-in loud speaker, \$99.50; S 600, console with built-in loud speaker, \$104.50.

NO. 481. PFANSTIEHL 32 AND 322

Seven tubes; 3 t. r. f. (01-A), detector (01-A), 3 audio (01-A and 71). One dial. Plate current: 23 to 32 mA. Volume control: resistance in r. f. plate. Shielded Battery cable. C-battery connections. Output device. Antenna: outside. Panel: 17½ x 8½ inches. Prices: No. 32 cabinet, \$145; No. 322 console, \$245 including loud speaker.

NO. 433. ARBORPHONE

Five tubes; 2 t. r. f., detector, 2 transformer audio. All 01-A tubes. Two dials. Plate current: 16mA. Volume control: rheostat in r. f. and resistance in r. f. plate. C-battery connections. Binding posts. Antenna: taps for various lengths. Cabinet size: 24 x 9 x 10½ inches. Price: \$65.

NO. 431. AUDIOLA 6

Six tubes; 3 t. r. f. (01-A), detector (00-A), 2 transformer audio (01-A and 71). Drum control. Plate current: 20mA. Volume control: resistance in r. f. plate. Stage shielding. Battery cable. C-battery connection. Antenna: 50 to 100 feet. Cabinet size: 28½ x 11 x 14½ inches. Price not established.

NO. 432. AUDIOLA 8

Eight tubes; 4 t. r. f. (01-A), detector (00-A), 1 transformer audio (01-A), push-pull audio (12 or 71). Bridge balanced t. r. f. Drum control. Volume control: resistance in r. f. plate. Stage shielding. Battery cable. C-battery connections. Antenna: 10 to 100 feet. Cabinet size: 28½ x 11 x 14½ inches. Price not established.

NO. 542. RADIOLA 16

Six tubes; 3 t. r. f. (01-A), detector (01 A), 2 transformer audio (01-A and 112). One control. C-battery connections. Battery cable. Antenna: outside. Cabinet size: 16 x 8½ x 7½ inches. Price: \$69.50 without accessories.

NO. 456. RADIOLA 20

Five tubes; 2 t. r. f. (99), detector (99), 2 transformer audio (99 and 20). Balanced t. r. f. and regenerative detector. Two dials. Volume control: regenerative. Shielded. C-battery connections. Headphone connections. Antenna: 75 to 150 feet. Cabinet size: 19½ x 11½ x 16 inches. Price \$115 including all tubes.

NO. 457. RADIOLA 25

Six tubes; five type 99 and one type 20. Drum control. Super-heterodyne circuit. C-battery connections. Battery cable. Headphone connections. Antenna: loop. Set may be operated from batteries or from power mains when used with model 101 loud speaker. Price: \$165 with tubes, for battery operation. Apparatus for operation of set from the power mains can be purchased separately.

NO. 493. SONORA F

Seven tubes; 4 t. r. f. (01-A), detector (00-A), 2 transformer audio (01-A and 71). Special balanced t. r. f. Two dials. Plate current: 45mA. Volume control: rheostat in r. f. Shielded. Battery cable. C-battery connections. Output device. Antenna: loop. Console size: 32 x 45½ x 17 inches. Prices range from \$350 to \$450 including loud speaker and loud speaker.

NO. 494. SONORA E

Six tubes; 3 t. r. f. (01-A), detector (00-A), 2 transformer audio (01-A and 71). Special balanced t. r. f. Two dials. Plate current: 35 to 40mA. Volume control: rheostat on r. f. Shielded. Battery cable. C-battery connections. Antenna: outside. Cabinet size: varies. Prices: table \$110; semi-console, \$140; console, \$240 including loud speaker.

NO. 530. KOLSTER, 7A AND 7B

Seven tubes; 1 t. r. f. (01-A), detector (01-A), 2 audio (01-A and 12). One control. Volume control: rheostat on r. f. Shielded. Battery cable. C-battery connections. Antenna: 50 to 75 feet. Prices: Model 7A, \$125; Model 7B, with built-in loud speaker, \$140.

NO. 495. SONORA D

Same as No. 494 except arrangement of tubes; 2 t. r. f., detector, 3 audio. Prices: table, \$125; standard console, \$185; "DeLux" console, \$225.

NO. 482. STEWART-WARNER 705 AND 710

Six tubes; 3 t. r. f., detector, 2 transformer audio. All 01-A tubes. Balanced t. r. f. Two dials. Plate current: 10 to 25mA. Volume control: resistance in r. f. plate. Shielded. Battery cable. C-battery connections. Antenna: 80 feet. Cabinet sizes: No. 705 table, 26 x 11½ x 13½ inches; No. 710 console, 29½ x 42 x 17½ inches. Tentative prices: No. 705, \$115; No. 710, \$265 including loud speaker.

NO. 483. STEWART-WARNER 525 AND 520

Same as No. 482 except no shielding. Cabinet sizes: No. 525 table, 19½ x 10 x 11½ inches; No. 520 console, 22½ x 40 x 14½ inches. Tentative prices: No. 525, \$75; No. 520, \$117.50 including loud speaker.

NO. 459. STROMBERG-CARLSON 501 AND 502

Five tubes; 2 t. r. f. (01-A), detector (00-A), 2 transformer audio (01-A and 71). Neutrodyne. Two dials. Plate current: 25 to 35mA. Volume control: Rheostat on 1st r. f. Shielded. Battery cable. C-battery connections. Headphone connections. Output device. Panel voltmeter. Antenna: 60 to 100 feet. Cabinet sizes: No. 501, 25½ x 13 x 14 inches; No. 502, 28½ x 50½ x 16½ inches. Prices: No. 501, \$180; No. 502, \$290.

NO. 460. STROMBERG-CARLSON 601 AND 602

Six tubes. Same as No. 549 except for extra t. r. f. stage. Cabinet sizes: No. 601, 27½ x 16½ x 14½ inches; No. 602, 28½ x 51½ x 19½ inches. Prices: No. 601, \$225; No. 602, \$330.

NO. 472. VOLOTONE VIII

Six tubes. Same as No. 471 with following exceptions; 2 t. r. f. stages. Three dials. Plate current: 2-mA. Cabinet size: 26½ x 8 x 12 inches. Price \$140.

NO. 546. PARAGON "CONGRESS"

Six tubes; 2 t. r. f. (01-A), detector (01-A), 3 impedance-coupled audio (two 01-A and 12 or 71). One main control and three auxiliary adjustments. Volume control: resistance in r. f. plate circuit. Plate current: 40 mA. C-battery connections. Tuned double-impedance audio amplifier. Output device. R. F. coils are shielded. Cable or binding posts. Cabinet size: 7 x 18 x 19 inches. Price \$90.00; without cabinet, \$80.00.



New Formica Kit Panels

RECENT additions to the list of handsomely decorated panels for famous kits include the Madison Moore International One Spot (A. C.) E. T. Flewellings Super Eight, and the new B*T Power Six Electric Kit. There are also front and sub panels for Karas (two dial) World's Record Super Ten; Camfield Nine; Tyrman; Magnaformer, H. F. L. Victoreen and many others.

These panels are sold by all leading jobbers

THE FORMICA INSULATION COMPANY
4618 Spring Grove Avenue Cincinnati, Ohio

Any jobber or
dealer can get
Formica panels for you

FORMICA
Made from Anhydrous Bakelite Resins
SHEETS TUBES RODS

Formica has a
Complete Insulating
Service for
manufacturers.

Hoyt B ELIMINATOR VOLTMETER

Made for hard service but
always accurate and sensitive

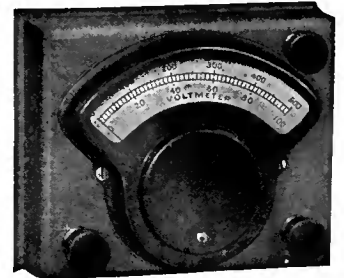

Resistance, 1000 ohms per volt,
—for Radio service men, dealers
and manufacturers. Precision
d'Arsonval movement, 3½ inch
scale, *hand-calibrated*. The
damping is very fine. Polished
base.

Ranges, 0-100
0-500 volts

Price \$28.00

*Write for booklet "Hoyt Meters
for Radio."*

BURTON-ROGERS CO.
Sole Selling Agents
Boston Mass.

SM

Selected for
Cooley Rayfoto



It is significant that the S-M 220 audio transformer was selected before all others for the Cooley Rayfoto telephoto apparatus. This logical selection bears our past performance—for authority upon authority has made the same selection until 220's are used in more popular receiver designs than any other transformer. Any number of unbiased laboratory tests show the 220 to be supreme in the audio field and the unofficial report of the testing laboratory of the largest telephone manufacturer rates 220's at the top of the list.

Remember, if it's real, true tone quality you want, you can pay out ten or twelve dollars for an audio transformer but you can't possibly get a better transformer than S-M 220's at \$8.00 each—for none better have ever been made!

SILVER-MARSHALL, Inc.

838-B West Jackson Blvd. Chicago, Ill.

ANNOUNCING

THE

BRACH RELAY

FOR THE

RAYFOTO RECEIVER

Approved by A. G. Cooley

Available Now, Write

L. S. BRACH Mfg. Corp.

129 Sussex Ave. Newark, N. J.

AEROVOX products are approved by Austin G. Cooley for his "RAY-FOTO" apparatus



Faithful Service

The function of a power resistance is to control voltage and current—accurately—permanently—silently.

AEROVOX PYROHMS used with GOOD equipment make a BETTER power unit.

AEROVOX PYROHMS are built last—are used by more than 20 leading power unit manufacturers.—This is conclusive evidence of their reliability—accuracy—worthiness.

Made in all values of resistance for continuous duty at 20, 40, 100 and 200 watts.

AEROVOX
"Built Better"
70 Washington St., Brooklyn, N. Y.

AERO Corona Coil

Used in New

Cooley "Rayfoto"

Of course the new Cooley "Rayfoto" uses an AERO Inductance Coil. This special coil is designed to meet the exact specifications of A. G. Cooley, whose "Rayfoto" receiver so many experimenters will build. For every inductance requirement AERO Coils are proved best—by experts and amateurs as well. Always specify AERO Coils if you want the finest in radio performance.

AERO PRODUCTS, Inc.

1722 Wilson Avenue Chicago, Ill.

Cooley Ray-Foto Printer Unit

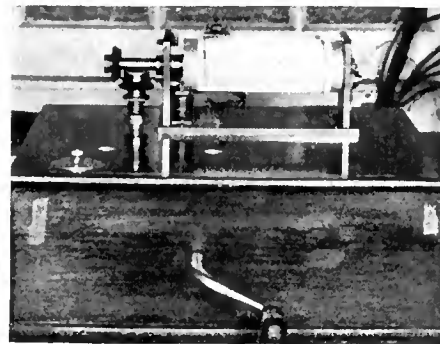

The only available recorder for this assembly

PRESTO Machine Products, in close association with Austin G. Cooley, inventor of the Cooley Ray-Foto Machine, is now manufacturing and accepting orders for the essential recording apparatus required for the complete assemble of this latest achievement in the science of radio.

Write for details, prices, etc.

Presto Machine Products Corp.

70 Washington Street Brooklyn New York

FREE The Greatest RADIO CATALOG

Send for This Great Book

Compiled exclusively for dealers in radio sets, radio parts, and for set builders. An Amazing Catalog containing the newest things in the world of radio.

Unbeatable values in Radio Parts, Kits and Supplies of National Fame. A complete array of Cabinets and consoles, in all latest styles, finishes and popular sizes at Unmatched Prices.

The high quality of our products eliminates loss. Large stocks offer you large selection. Our speedy shipments insure your customer's good will and bigger profits for you.

Silver Marshall Unipac in stock—all models and types. Fully described and priced in our catalog on page 64. Liberal discounts to the trade. Immediate delivery.

Short Wave Section

Our catalog contains a section devoted to a showing of the highest grade short wave receiving and transmitting apparatus. Also the finest electrical appliances for use in the home.

Shure Service means sure profits. You can take orders direct from our illustrated list price catalog.

Whatever your radio needs may be, you will find them in our 1928 catalog. Write for a copy TODAY.

Real Bargains to Dealers

SHURE RADIO COMPANY

343P West Madison Street, Chicago, Ill.

for
COOLEY
"RAY-FOTO"



We have a modulation transformer conforming to the specifications for the COOLEY "RAY-FOTO" Apparatus. The Price is

\$9.50

Write us for details

National Company, Inc.

W. A. Ready, Pres.

Malden Massachusetts

NATIONAL

Modulation Transformer

You'll like this

Distinctively Novel Treatment of Radio

(OFF PRESS DECEMBER 1)

A POPULAR GUIDE TO MODERN RADIO

By B. FRANCIS DASHIELL
of the U. S. Weather Bureau

Right up to the minute—
Clear explanations of the basic
sciences involved in radio—
Discussions of apparatus and
equipment—special treat-
ment of weather effects—
101 diagrams; 8 full-page
plates—

The finest sort of Christ-
mas remembrance for radio
fandom.

Price \$3.50

Clip this and mail with
remittance to

Williams & Wilkins Co.
Publishers of Scientific Books
Baltimore Maryland

Seventh Edition Just Off the Press

ROBISON'S MANUAL OF RADIO TELEGRAPHY AND TELEPHONY

Completely Revised and Up-to-Date
Of the 6th edition of this book reviewed by QST
it was said this is perhaps

"The Best Radio Book That Ever
Came To This Desk"

The standard Navy book on radio originally prepared in
1907 by Lieutenant (last year Admiral and C-in-C of U. S.
Fleet) S. S. Robison. The 6th edition and the present
edition revised by Commander S. C. Hooper, U. S. Navy,
late Radio Officer, U. S. Fleet.

Price \$5.50 postpaid
(former edition sold for \$8.00)

Address:

Secretary-Treasurer, U. S. Naval Institute
Annapolis, Md., U. S. A.

NEW PERPETUAL RADIO HANDBOOK

Loose-Leaf
Pocket Size

\$3.50

POST PAID

COMPLETE WITH LEFAX 6-RING
FLEXIBLE POCKET BINDER

WRITE FOR FULL PARTICULARS ON
LOOSE-LEAF RADIO DATA SERVICE

LEFAX, INC., PHILADELPHIA, PA.

THIS RADIO CHRISTMAS

by

Zeh Bouck

LIKE all people, I hate to brag. And I sincerely believe that there is no one in this world who knows more about giving things radio for Christmas than the writer. I have had a radio laboratory for some ten years now, to which manufacturers send samples of their products. With the exception of an occasional birthday, or a debt here and there, this apparatus accumulates until around this time of the year. And I'd give away a lot more Christmas presents if radio manufacturers only supplied green tissue paper and red ribbons.

So it is most fitting that I should be telling you how to spend your money on radio Christmas presents—or perhaps it isn't. I find myself in somewhat the reverse situation of Oscar Wilde's cynic who knew the price of everything but the value of nothing. At any rate, our ever-increasing horde of radio burglars will find what I have to say of unqualified use.

From One Dollar Up

WE—or rather you—may start your purchases from a dollar up. (Make sure you do not start them with a dollar down. This stretches Christmas out over too long a period of time with rather fatal results to the Christmas spirit.)

In the case of a radio Christmas present, not everything within the various price ranges can be considered. There are many parts particularly designed for special circuits and receivers, and unless you are aware that the recipient is interested in this particular apparatus you will do well to confine yourself, for the greater part, to accessories.

One Dollar to Three Dollars

This class recommends itself to gifts among the family—to brother, sister, cousins, aunts, and all the rest sacred to Gilbert and Sullivan. The following are really too useful for gifts:

- One or two 01A type tubes
- A loud speaker extension cord
- A battery cable
- A light socket antenna (for the gentleman with the loop set)
- An antenna set
- A set of 0.5, 1.0, 1.5, 2.0, 3.0, and 5.0-megohm metallic grid leaks

At the very beginning we run into the invaluable book. The following are on our own shelves:

FOR THE ENGINEER: *Engineering Mathematics*, D. Van Nostrand and Company

FOR THE AMATEUR: *The Radio Amateur's Handbook*, The American Radio Relay League, Hartford, Connecticut, \$1.00.

FOR THE AVERAGE FAN: *The Outline of Radio*, by John V. L. Hogan, Little Brown and Company, or *How Radio Receivers Work*, by W. Van B. Roberts, published by RADIO BROADCAST, Garden City, N. Y., \$1.00

A subscription to *The Bell Technical Journal* (195 Broadway, New York City) at \$3.00 will be gratefully received by the engineer in the family, and a subscription to QST (American Radio Relay League, Hartford, Conn.) at \$2.00 by the amateur or even broadcast fan.

Three Dollars to Five Dollars

As we go up a bit in price, the charity that should begin at home evidences itself in gifts outside the family—our purse strings loosen and we splurge with:

- Output filters
- A set of five 1.0-mfd. bypass condensers
- A telephone headset
- A power tube
- A filament relay

The following books for engineering folk: *Theory of Vibrating Systems and Sounds* by Crandall, \$5.00. (D. Van Nostrand & Co.)

The Thermionic Vacuum Tube by H. J. Van de Bijl, (McGraw Hill), \$5.00

A most acceptable and unique gift may be effected by obtaining a copy of *Radio Instruments and Measurements* from the Bureau of Printing and Engraving, Government Printing Office, Washington, for \$7.75 (no stamps) and having it bound by Brentano's or some similar establishment.

And a subscription to RADIO BROADCAST is never out of place.

Five Dollars to Ten Dollars

A slide rule is always an acceptable present to the engineering friend who possesses the inevitable book, if he hasn't a slide rule. Get a Keuffel and Esser Polyphase Mannheim ten-inch rule. Do not succumb to the seductive technicalities of various "duplex" and "log log" designs. The engineer would thank you, of course, for these last types, and use it, perhaps, as a straight edge; but that's about all.

You can always determine whether your technical friend has the book you want to give him or not. Just say to him, "I understand that in hyperbolic space the characteristic constant is negative, the degree of negativity varying directly with the divergence from Euclidean space. I want to check up on this. Lend me your Crandall, or your Morecroft or your Van de Bijl, will you?"

If he tells you he hasn't the book, you will know he has it but doesn't want to loan it to you.

The following are indispensable books:

The Manual of Radio Telegraphy and Telephony, Admiral S. S. Robison, United States Naval Institute, Annapolis, Md., \$5.50

Principles of Radio Communication, J. H. Morecroft, John Wiley and Sons, New York City, \$7.50 (and worth it!)

An electrical Engineering Handbook
Among parts and accessories, we have:
A QRS or Raytheon Rectifying tube
An output filter
A resistance-coupled amplifying kit
A filament control relay (to control your power unit and A battery from the set's on-off switch)

- A tube rejuvenator
- A Balsa Speaker kit
- A loud speaker unit

Ten Dollars to Fifteen Dollars

The customary way to give Christmas gifts is to establish the understanding that you do not believe in the exchange of gifts—that you are giving nothing except cards—and then give presents anyway to make your friends uncomfortable. We suggest the following in the line of this expensive misanthropy:

- An "A" supply filter such as the "A-Box"
- A good trickle charger
- A ——— kit.
- A Balsa speaker kit

Fifteen Dollars to Twenty Dollars

We are fairly well above the usual engineering books, but you might try a set of Rabelais. Boni and Liveright have a new limited edition selling for \$20.00

Then there are:

A complete set of "B" batteries (a really fine present!)

- A cone loud speaker
- A set of good audio transformers
- A ——— kit
- A standard high-rate charger
- A Balsa speaker kit

Twenty Dollars to Twenty-Five Dollars

We may now leave on the price tags, and suggest—

A cone loud speaker
 A complete set of A-C tubes
 An "A" battery and charger combination
 A _____ kit
 A radio table (a good one).

Twenty-Five Dollars to Fifty Dollars

We now leave gifts to the family and friends and consider presents for elevator boys, postmen, janitors, ice-men and others requiring special attention.

A very fine cone or Balsa speaker.
 A well-designed "B" and "C" battery eliminator.
 A _____ kit

From Fifty Dollars up

We started with gifts for the family, and we conclude with the same. If there is a very expensive bit of apparatus for which you have long yearned—some deluxe speaker, perhaps a Norden Hauck Super or a Radiola Borgia model, or maybe a Wheatstone Bridge or a Leeds & Northrup type K potentiometer—why give it to the family for Christmas.

And in closing let me advise you to do your Christmas shopping early—early on the morning of December twenty-fourth.

TO RADIO DEALERS!

The R. B. Laboratory Information Sheets have been appearing in RADIO BROADCAST since June, 1926. They are a regular feature in each issue and they cover a wide range of information of value to the radio experimenter and set builder. We have just reprinted Lab. Sheets Nos. 1-88 from the June, 1926, to April, 1927, issues of RADIO BROADCAST. They are arranged in numerical order and are bound with a suitable cover. They sell at retail for one dollar a set. Write for dealers' prices. Address your letter to

Circulation Dept.,
 RADIO BROADCAST
 Garden City, N. Y.

A HIGH-POWERED 10-TUBE MODEL FOR 1928

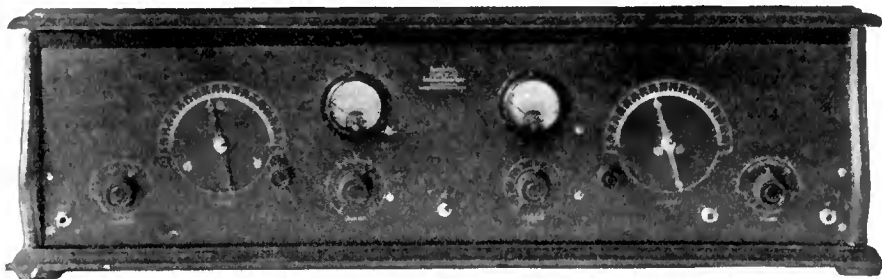

STANDARD ADMIRALTY MODEL

NORDEN-HAUCK IMPROVED SUPER-10

LICENSED UNDER HOGAN PATENT 1,014,002

"Highest Class Receiver in the World"

This new and advanced design brings to you all the luxury and performance you could possibly desire in a radio receiver. Absolutely nothing has been omitted to provide supreme reception—a new standard previously unknown.

The up-to-the-minute engineering principles found exclusively in the improved Super-10 are comparable to the high compression head and super charger in an automobile engine.

In the Norden-Hauck Improved Super-10 you have

- Wonderful Selectivity
- Faithful Reproduction with any Degree of Volume
- Signals received at only one point
- Two major tuning controls for all wave lengths
- Wave band 200/550 meters (adaptable down to low waves and as high as 6000 meters with removable coils)

Material and workmanship conform to U. S. Navy specifications.

The improved Super-10 is sold complete as a manufactured receiver, or we are glad to furnish blue prints and all engineering data for home construction.

Upon request, new attractive illustrated literature will be promptly mailed to you without cost or obligation on your part.

Tear off and mail today

Your correspondence or inquiry
 for further information is
 cordially invited

Write direct to

NORDEN-HAUCK, INC.
 ENGINEERS

"Builders of the Highest Class
 Radio Apparatus in the World"

MARINE BLDG., PHILA., PA., U. S. A.
 Cable: Norhauck

NORDEN-HAUCK, INC.
 MARINE BLDG., PHILA., PA.

Gentlemen:

- Without obligation on my part send me complete literature on the new improved Super-10.
- I enclose \$2.00, for which send me, postpaid, complete Blue Prints and operating instructions for the new improved Super-10.
- I enclose \$1.00 for which send me Blue Prints of the Model 500 B. C. Power Unit.

Name

Address

R. E. L.

YOU GET

Free Technical Advice by R. E. Lacaull, E. E.
 on Parts and Kits Purchased from Us
 Let Him Help You Select the Best
 Send for R. E. L. Handbook and Discount List

R. E. LACAULL
 Radio Electric Laboratories
 1931 Broadway New York City

Read Radio Broadcast

every month. You can't afford to miss an issue. Order your copy from your Newsdealer or Radio Store. If you wish to subscribe direct send \$4.00 for one year or \$6.00 for two years.

DOUBLEDAY, PAGE & COMPANY
 Garden City, N. Y.

Learn the Code at Home With the Omnigraph

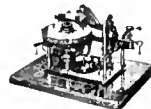

Morse and Wireless—taught at home in half usual time and at trifling cost. Omnigraph Automatic Transmitter will send, on Sounder or Buzzer, unlimited messages, any speed, just as expert operator would. Adopted by U. S. Govt. and used by leading Universities, Colleges, Technical and Telegraph Schools throughout U. S. Send 6c for Catalog.

OMNIGRAPH MFG. CO., 13K, Hudson St., New York

6 TUBE RADIO

Only \$32.50

ONE DIAL

Latest advanced circuit. All steel chassis totally shielded. Balanced parts of best quality. Marvellous power and selectivity. Gets the long range stations as clear as a bell. One dial single control. An unsurpassed value—just one of our many mighty bargains.

FREE Log and Call Book and Big New Catalog—just off the press. Full of Radio Bargains. Send for your free copy now!

American Auto & Radio Mfg. Co.
 HARRY SCHWARZBERG, Pres.
 Dept. 122 American Radio Bldg., Kansas City, Mo.



While your neighbors are cussin' the static

Your set, with its Dubilier Light-Socket Aerial, is bringing the programs in smooth as silk. It's a fact! This little aerial, which you simply attach to the set and plug into the nearest light socket, reduces both static and interference to a marked degree. It uses no current whatever and absolutely eliminates the lightning hazard. Costs you nothing to prove it, for the Dubilier Aerial is sold by all good dealers on a 5-day, money-back basis. If your dealer can't supply you, write direct to us. Price, \$1.50.

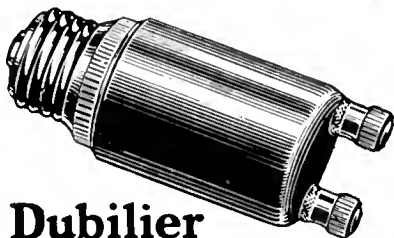

Dubilier LIGHT SOCKET AERIAL

If you're planning to build a power-unit make sure that the condenser blocks you intend to use are built to withstand long hours of heavy-duty service. Dubilier blocks have an excessive high factor of safety and a "life" that makes them by far the most economical to buy. Full instructions enclosed with each block unit.

DUBILIER CONDENSER CORP.
4377 Bronx Blvd. New York, N. Y.

Dubilier CONDENSERS

- 77. TUBES—A booklet for the beginner who is interested in vacuum tubes. A non-technical consideration of the various elements in the tube as well as their position in the receiver. CLEARTRON VACUUM TUBE COMPANY.
- 87. TUBE TESTER—A complete description of how to build and how to operate a tube tester. BURTON-ROGERS COMPANY.
- 91. VACUUM TUBES—A booklet giving the characteristics and uses of various types of tubes. This booklet may be obtained in English, Spanish, or Portuguese. DEFORREST RADIO COMPANY.
- 92. RESISTORS FOR A. C. OPERATED RECEIVERS—A booklet giving circuit suggestions for building a. c. operated receivers, together with a diagram of the circuit used with the new 400-milliamperer rectifier tube. CARTER RADIO COMPANY.
- 97. HIGH-RESISTANCE VOLTMETERS—A folder giving information on how to use a high-resistance voltmeter, special consideration being given the voltage measurement of socket-power devices. WESTINGHOUSE ELECTRIC & MANUFACTURING COMPANY.
- 102. RADIO POWER BULLETINS—Circuit diagrams, theory constants, and trouble-shooting hints for units employing the BH or B rectifier tubes. RAYTHEON MANUFACTURING COMPANY.
- 103. A. C. TUBES—The design and operating characteristics of a new a. c. tube. Five circuit diagrams show how to convert well-known circuits. SOVEREIGN ELECTRIC & MANUFACTURING COMPANY.
- 38. LOG SHEET—A list of broadcasting stations with columns for marking down dial settings. U. S. L. RADIO, INCORPORATED.
- 41. BABY RADIO TRANSMITTER OF 9XH-9EK—Description and circuit diagrams of dry-cell operated transmitter. BURGESS BATTERY COMPANY.
- 42. ARCTIC RADIO EQUIPMENT—Description and circuit details of short-wave receiver and transmitter used in Arctic exploration. BURGESS BATTERY COMPANY.
- 43. SHORT-WAVE RECEIVER OF 9XH-9EK—Complete directions for assembly and operation of the receiver. BURGESS BATTERY COMPANY.
- 58. HOW TO SELECT A RECEIVER—A commonsense booklet describing what a radio set is, and what you should expect from it, in language that any one can understand. DAY-FAN ELECTRIC COMPANY.
- 67. WEATHER FOR RADIO—A very interesting booklet on the relationship between weather and radio reception, with maps and data on forecasting the probable results TAYLOR INSTRUMENT COMPANIES.

USE THIS BOOKLET COUPON

RADIO BROADCAST SERVICE DEPARTMENT
RADIO BROADCAST, Garden City, N. Y.

Please send me (at no expense) the following booklets indicated by numbers in the published list above:

.....

Name.....

Address.....
(Name) (Street)

.....
(City) (State)

ORDER BY NUMBER ONLY
This coupon must accompany every request. RB 1-28

- 73. RADIO SIMPLIFIED—A non-technical booklet giving pertinent data on various radio subjects. Of especial interest to the beginner and set owner. CROSLLEY RADIO CORPORATION.
- 74. THE EXPERIMENTER—A monthly publication which gives technical facts, valuable tables, and pertinent information on various radio subjects. Interesting to the experimenter and to the technical radio man. GENERAL RADIO COMPANY.
- 76. RADIO INSTRUMENTS—A description of various meters used in radio and electrical circuits together with a short discussion of their uses. JEWELL ELECTRICAL INSTRUMENT COMPANY.
- 78. ELECTRICAL TROUBLES—A pamphlet describing the use of electrical testing instruments in automotive work combined with a description of the cadmium test for storage batteries. Of interest to the owner of storage batteries. BURTON ROGERS COMPANY.
- 95. RESISTANCE DATA—Successive bulletins regarding the use of resistors in various parts of the radio circuit. INTERNATIONAL RESISTANCE COMPANY.
- 96. VACUUM TUBE TESTING—A booklet giving pertinent data on how to test vacuum tubes with special reference to a tube testing unit. JEWELL ELECTRICAL INSTRUMENT COMPANY.
- 98. COPPER SHIELDING—A booklet giving information on the use of shielding in radio receivers, with notes and diagrams showing how it may be applied practically. Of special interest to the home constructor. THE COPPER AND BRAS RESEARCH ASSOCIATION.
- 99. RADIO CONVENIENCE OUTLETS—A folder giving diagrams and specifications for installing loud speakers in various locations at some distance from the receiving set. YAXLEY MANUFACTURING COMPANY.
- 105. COILS—Excellent data on a radio-frequency coil with constructional information on six broadcast receivers, two short-wave receivers, and several transmitting circuits AERO PRODUCTS COMPANY.
- 106. AUDIO TRANSFORMER—Data on a high-quality audio transformer with circuits for use. Also useful data on detector and amplifier tubes. SANGAMO ELECTRIC COMPANY.
- 107. VACUUM TUBES—Data on vacuum tubes with facts about each. KEN-RADIO COMPANY.
- 108. VACUUM TUBES—Operating characteristics of an a.c. tube with curves and circuit diagram for connection in converting various receivers to a.c. operation with a four-prong a.c. tube. ARCTURUS RADIO COMPANY.
- 109. RECEIVER CONSTRUCTION—Constructional data on a six-tube receiver using restricted field coils. BODINE ELECTRIC COMPANY.



Now That Everybody Demands Electrically-Operated Radios!

Dongan is in Production on All Types of A. C. Tube Transformers

Six months ago Dongan engineers were preparing for the day when the industry unanimously accepted complete electrical operation of receiving sets. For every new tube brought forth, Dongan designed the proper transformer or power unit.

To-day you can secure from the production line Transformers and Power Supply Units for whatever type of A C or A B C Tube you have chosen. For Dongan has been in production on approved types for many months.

Here is the Newest

No. 6515 Transformer for use with 4 UX 226, 1 UY 227 A C Tubes and 1 UX 171 Tube. Together with a B Eliminator, this new transformer will convert old type set into an efficiently operating A C set.

\$4.75 List

This is one of 14 types ranging in price from \$3.50 to \$8.00 for use with the new types of A C Tubes.

Manufacturers are invited to write for any kind of information from our engineering department.

Fans—order from your dealer or send check or money order to factory direct.



No. 5553 A B C POWER UNIT for UX 226, UY 227, UX 171, and UX 280 Tubes
\$22 List

DONGAN ELECTRIC MFG. CO.
2991-3001 Franklin St., Detroit, Michigan



- 110. RECEIVER CONSTRUCTION—Circuit diagram and constructional information for building a five-tube set using restricted field coils. BODINE ELECTRIC COMPANY.
- 111. STORAGE BATTERY CARE—Booklet describing the care and operation of the storage battery in the home. MARKO STORAGE BATTERY COMPANY.
- 112. HEAVY-DUTY RESISTORS. Circuit calculations and data on receiving and transmitting resistances for a variety of uses, circuits for popular power supply circuits, d.c. resistors for battery charging use. WARD LEONARDO ELECTRIC COMPANY.
- 113. CONE LOUD SPEAKERS—Technical and practical information on electro-dynamic and permanent magnet type cone loud speakers. THE MAGNAVOX COMPANY.
- 114. TUBE ADAPTERS—Concise information concerning simplified methods of including various power tubes in existing receivers. ALDEN MANUFACTURING COMPANY.
- 115. WHAT SET SHALL I BUILD?—Descriptive matter, with illustrations, of fourteen popular receivers for the home constructor. HERBERT H. FROST, INCORPORATED.
- 104. OSCILLATION CONTROL WITH THE "PHASATROL"—Circuit diagrams, details for connection in circuit, and specific operating suggestions for using the "Phasatrol" as a balancing device to control oscillation. ELECTRAD, INCORPORATED.



Bring
your set
up-to-date

Leading radio engineers approve and endorse the Sovereign Heater Type A-C Tube. They know that A-C Tubes give results that can be obtained in no other manner.

Think—with A-C Tubes all you ever will have to do is press a button—switch on your set just as you switch on an electric light. There's no bother with "A" batteries or "A" battery eliminators, or battery chargers, no noise, no microphonics—nothing but pure, round, undistorted tones.

Bring your set up-to-date. If your dealer cannot supply you with Sovereign A-C Tubes for standard sockets, write us. Special treatise with diagrams free. Write

Sovereign Electric & Mfg. Company
127 No. Sangamon St. Chicago, Illinois

A KEY TO RECENT RADIO ARTICLES

By E. G. SHALKHAUSER

THIS is the twenty-fifth installment of references to articles which have appeared recently in various radio periodicals. Each separate reference should be cut out and pasted on 4" x 6" cards for filing, or pasted in a scrap book either alphabetically or numerically. An outline of the Dewey Decimal System (employed here) appeared last in the January RADIO BROADCAST.

R402. SHORT-WAVE SYSTEMS. SHORT WAVES. *QST*, Aug., 1927. Pp. 9-14. "The 3-Meter Band Officially Opened," B. Phelps and R. S. Kruse.

Detailed information on 3-meter transmitting and receiving sets is presented. It is stated that tubes having the XL filaments have a very short life at these frequencies, best results being obtained from the old UV-202 tubes. The antenna system, and the methods used in determining the length of the wave transmitted, are shown. The field tests indicate the manner in which signals decrease in strength and show the location of dead spots.

R132.1. AMPLIFYING ACTION: INDUCTIVE COUPLING. AMPLIFIERS. *Audio* *QST*, Aug., 1927. Pp. 15-20. "Better Audio Amplification for Short-Wave Receivers," L. W. Hatry.

The writer shows the practical use of more than one audio stage of amplification for short-wave receivers. In order to insure more uniform volume from headphones, whether listening to foreign or domestic stations, a switching or a shunt resistance system is described. The type of audio transformer to be used depends greatly upon the type of reception desired, a scheme being shown whereby an amplifier may be made either peaked or flat by using a tuned rejector circuit.

R346. RADIO TELEPHONE SETS. TRANSMITTER, *Short-Wave Crystal*. (ELECTRON-TUBE). *QST*, Aug., 1927. Pp. 21-24. "Cuban 6 XJ," F. H. Jones and H. P. Westman.

The construction and the tuning of a first-class phone station operated on 20 meters, are outlined. A crystal, having a natural period of 159.6 meters, controls the transmitted frequency. The set consists of an oscillator and three amplifiers. Instead of using the Heising constant-current method of modulation, the series method of plate modulation is employed with good results. A circuit diagram and a list of parts are shown.

R213. HARMONIC METHODS. HARMONICS. *Determination of* *QST*, Aug., 1927. Pp. 34-35. "The Identification of Radio-Frequency Harmonics," J. E. Waters.

A method of determining and identifying radio-frequency harmonics when making measurements of radio-frequency oscillations is outlined. Use is made of a standard wavemeter, an oscillator, and a receiver.

R113. TRANSMISSION PHENOMENA. TRANSMISSION, *Short-Wave*. *QST*, Aug., 1927. Pp. 36-42. "Short-Wave Radio Transmission and Its Practical Uses," C. W. Rice. (Continued.)

The variation of signal strength with distance is discussed, taking into consideration the effect of multiple reflection. In order to choose the proper wavelength to use for distant transmission in summer daylight, a theoretical chart is prepared, showing probable performance of different waves. Conclusions drawn point to the following: Below 20 meters distant communication is impossible; the plane of polarization in the sky wave is no determining factor for energy flux density and for ray paths; different waves give best results between two given points; low-angle radiation is best for long-distance work.

R281.71. QUARTZ. QUARTZ. *RADIO BROADCAST*, Sept., 1927. Pp. 271-273. "Piezo-Electric Crystals," M. T. Dow. The writer explains the use of quartz crystal oscillators in the calibration of frequency meters. How to distinguish between the harmonics that are heard when two oscillators are in operation, is fully outlined. Photographs and circuit diagrams illustrate the points in question.

No
"A" Batteries
"A" Battery Eliminators
Special Sockets
Noise
Hum

Set Builders and Amateur Transmitters—

Here are your Instruments!



D. C. and A. C. Panel Types in flush style cases—Models 506, and 517, 2"; and Models 301 and 476, 3 1/2" sizes. A complete line of Voltmeters, Ammeters and Milliammeters, as well as Thermo-Couple types, all uniform in appearance. Nothing on the market can compare with them in quality of workmanship and electrical features.

It has required years to redesign the famous Weston Standards down to these small sizes and offer them at such low prices for such high quality. Improve upon your old sets when building the new. Write for Circular J—the new booklet which completely covers the Weston Radio Line.

WESTON ELECTRICAL INSTRUMENT CORPORATION
179 Weston Ave. Newark, N. J.



Micrometric Control for Your Set!

The Volume Control Clarostat now makes its bow. It's a little fellow, compact, good looking, inexpensive, handy—just the thing for applying adjustable yet positive resistance in various parts of the set. And it's a genuine Clarostat through and through.

Control loud-speaker volume; match transformers for best tone quality; tune loud-speaker to your taste; get maximum sensitivity out of r. f. and detector tubes; control regeneration micrometrically, especially on short waves—all with Volume Control Clarostat. And there are many other ways now becoming popular, for improving your set with micrometric resistance control.

The Volume Control Clarostat has resistance range of practically zero to 500,000 ohms in several turns of knob. Ample current-carrying capacity for all receiver applications. Holds its resistance adjustment. Silent in operation. Screw terminals. One-hole mounting. And only \$1.50 list.

VOLUME CONTROL CLAROSTAT

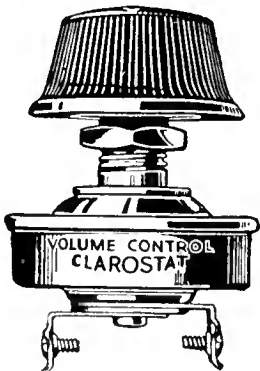

Of course you must continue to use the larger Standard Clarostat for B-eliminator applications, and the giant Power Clarostat for A-B-C power units, line-voltage control, and power amplifiers, as heretofore.

There's a Clarostat for every purpose. Make sure, however, you get a genuine Clarostat—look for distinctive green box and name CLAROSTAT stamped on nickel shell. Don't be fooled!

Ask your dealer for literature on Clarostats and how to improve your radio set. Or write us direct

American Mechanical Laboratories INCORPORATED

Specialists in Variable Resistors

285 N. Sixth Street
Brooklyn, N. Y.



R113. TRANSMISSION PHENOMENA. TRANSMISSION, Proc. I. R. E. June, 1927. Pp. 501-517. Short-Wave. "Some Practical Aspects of Short-Wave Operation at High Power," H. E. Hallborg.

Propagation data on the frequency range of 3000 to 30,000 kilocycles are submitted. A correlation is shown between wave frequency and angle of projection of the wave front. The effect of ionization on the angle of projection is indicated. Some calculations are given of probable values of attenuation constant.

The importance of frequency stabilization is discussed, and three typical circuits for utilizing control crystals are described. Features of the design and adjustment of a 20-kw. power amplifier are also outlined. Antenna and antenna feed systems are discussed, and graphical results of comparisons of various antenna types are given. The relative importance of static at short wavelengths is considered. The author's anticipation of the density of the short wave is summarized.

R612. SHORT-WAVE STATIONS. STATIONS, Proc. I. R. E. June, 1927. Pp. 467-499. Short-Wave. "Short-Wave Commercial Long-Distance Communication," H. E. Hallborg, L. A. Briggs, and C. W. Hansell.

The development of short-wave communication by the Radio Corporation of America is outlined. A summary of short-wave installations, with call letters, wavelengths, and services to which each installation is assigned, is submitted.

Traffic charts showing the diurnal and seasonal characteristic of various wavelengths over typical circuits are also shown. An outline of the technical problems inherent to the development of tubes and transmitter circuits is discussed. Methods are described for obtaining proper operation of tubes and transmitters at these very short wavelengths. The paper is illustrated with typical pictures and charts showing transmitter development and traffic performance.

R800 (512.82). COMPLEX VARIABLES. FUNCTIONS. Proc. I. R. E. June, 1927. Pp. 519-524. "Maximization Methods for Functions of a Complex Variable," V. B. Roberts.

The maxima and minima of a function of a real variable are found by equating to zero the derivative of the function. In the case of a function of a complex variable, however, the derivative is a vector quantity, so that conditions may be imposed upon its direction as well as upon its magnitude. These various conditions lead to maxima and minima of the various aspects of the function. Rules are developed for setting up equations giving the various maximizing conditions, and a simple example is given illustrative of the use of the rule.

R240. PHASE DIFFERENCE. PHASE RELATIONS. Radio, Aug., 1927. Pp. 21-ff. "Phase Relations in Radio," J. E. Anderson.

Of importance to radio experimenters is this discussion on the effect of phase relation between current and voltage in amplifier circuits. To illustrate the point, the phase conditions in a 4-tube resistance-coupled amplifier are analyzed in detail. Impedance- and audio-transformer coupled circuits are also discussed and the points to be observed are mentioned.

R334. FOUR-ELECTRODE TUBES. FOUR-ELECTRODE CHARACTERISTICS. Radio, Aug., 1927. P. 23-24. "The Static and Dynamic Characteristics of a Double-Grid Vacuum Tube," H. R. Lubcke.

Static and dynamic characteristics of Van Horne double-grid vacuum tubes are graphed and discussed. It is noted that (1) a change in characteristics accompanies a change in frequency; (2) high plate voltages should be used because of hi- μ characteristics; (3) the inner grid should have a 1-volt C bias and the outer grid a 3-volt C bias; (4) the plate impedance of the tube should match that of the transformer primary in radio-frequency amplification.

R800. (530.) PHYSICS. ULTRA-VIOLET RAYS. RADIO BROADCAST, Sept., 1927. Pp. 263-265. "A Discovery That Newton Missed," J. Stokley.

The history of ultra-violet rays, starting with the time of Newton two centuries ago, continuing with their discovery by Ritter, and ending with an explanation of their use made to-day in medical sciences, is given.

RR356. TRANSFORMERS. TRANSFORMERS. RADIO BROADCAST, Sept., 1927. Pp. 274-278. Construction of. "Home-Constructing Transformers and Chokes for Power-Supply Devices," H. S. Davis.

By means of charts and certain fundamental mathematical formulas, sufficient information may be obtained to design and construct power transformers and choke coils for use in a.c. operated receivers. Of importance is said to be the characteristics of secondary windings, i. e., voltage current and power values, total turns in each winding, size and amount of core and wire, etc.

R330. ELECTRON TUBES. ELECTRON TUBES. RADIO BROADCAST, Sept., 1927. Pp. 284-285. New A. C. "The New A. C. Tubes," Radio Broadcast, Laboratory Staff.

Information and data on the operation of various a.c. tubes now on the market show how these may vary in performance. From the writers' viewpoint, a.c. operated tubes still belong in the experimental class.

Erratum

AN ERROR occurred in the circuit diagram of the "Shielded Six" receiver published in the November, 1927, issue of RADIO BROADCAST. The connection indicated between terminal No. 6 of the third coil socket and the negative terminal of the detector tube socket, should be ignored. If this connection is made the C battery will be short-circuited and the detector will operate very inefficiently.

RADIO PARTS for Discriminating Set Builders

Bradleyunit-A



This fixed resistor is scientifically treated to resist moisture. It is not affected by temperature, moisture or age. Provides the ideal resistance for B-eliminator hookups requiring fixed resistors of quality.

Bradleyohm-E

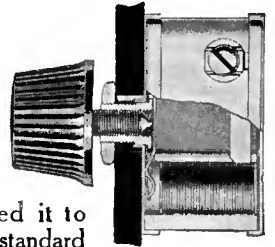

The remarkable accuracy of the Bradleyohm-E has caused it to become standard equipment for accurate plate voltage control on many leading B-eliminators. Use it on your power-unit hookups.

Bradleyleak

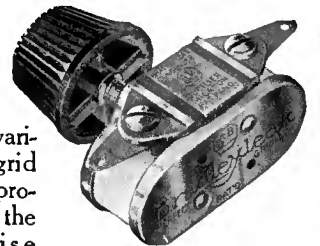

This variable grid leak provides the precise grid leak value for best results with every tube. Try it on your set and notice the greatly improved reception.

Bradleystat

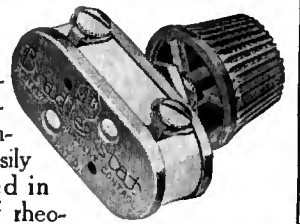

The perfect filament control. Easily installed in place of rheostats now in service. Gives noiseless, stepless filament control for all tubes. Use Bradleystats on your next set.

Allen-Bradley Co.

Electric Controlling Apparatus MILWAUKEE, WISCONSIN



Tone Control from your Easy Chair

The New No. 3
Centralab Modu-pluG
With 20 Feet of Cord

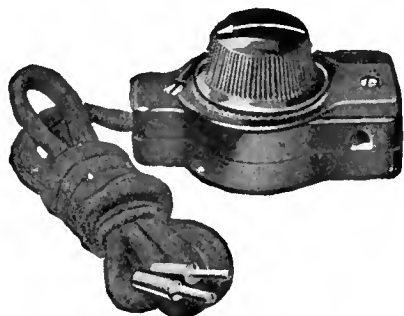

Just lounge in your easy chair, and let the program come in smoothly modulated as it changes in character. No more jumping up to adjust the dials every time the station changes from vocal to orchestration. Simply tune with your dials to maximum strength and clarity of station, then from your easy chair, with 20 feet of cord, use Modu-plug No. 3 to smooth the reception down to any degree of tone, without changing the ratio of high and low notes. Centralab Modu-Plug gives any degree of volume from a whisper to maximum. Can also be used to provide a very convenient method of connecting two speakers in series at some distance from the receiving set.

No 3, \$3.00; Regular Cord Type or Jack Type, each \$2.50. All mailed C. O. D.

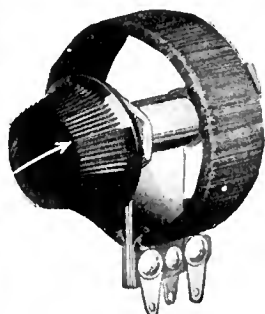

**Warp-Proof
Heat-Proof
for
Power
Circuits**

Centralab Power Rheostat

This sturdy unit is a "knock-out" for warp-proof, heat-proof performance in socket power circuits. The heat-proof characteristic permits continuous operation at temperatures of 482° F. and beyond. Special design and construction assure this. The resistance wire is wound on metal core, asbestos insulated. The wire is firmly held in position at all times because the metal core will expand under heat in the same degree as the wire. This provides a smooth acting control under all conditions.

Smooth regulation is further insured by narrow resistance strips. The narrow width gives small resistance jumps per turn.

Compact 2" diameter; 1" behind panel. Single-hole mounting. Bakelite knob. Ohms—500, 250, 150, 50, 15, 6, 3, 2, .5—price, \$1.25. Can also be furnished as a potentiometer.

At dealer's, or C. O. D. Send postal for new circuit literature. You need this ideal Power Rheostat.

Central Radio Laboratories
22 Keefe Ave., Milwaukee, Wis.



What Kit Shall I Buy?

THE list of kits herewith is printed as an extension of the scope of the Service Department of RADIO BROADCAST. It is our purpose to list here the technical data about kits on which information is available. In some cases, the kit can be purchased from your dealer complete; in others, the descriptive booklet is supplied for a small charge and the parts can be purchased as the buyer likes. The Service Department will not undertake to handle cash remittances for parts, but when the coupon on page 258 is filled out, all the information requested will be forwarded.

201. SC FOUR-TUBE RECEIVER—Single control. One stage of tuned radio frequency, regenerative detector, and two stages of transformer-coupled audio amplification. Regeneration control is accomplished by means of a variable resistor across the tickler coil. Standard parts cost approximately \$58.85.

202. SC-11 FIVE-TUBE RECEIVER—Two stages of tuned radio frequency, detector, and two stages of transformer-coupled audio. Two tuning controls. Volume control consists of potentiometer grid bias on r.f. tubes. Standard parts cost approximately \$60.35.

203. "H-Q" KIT—A five-tube tuned radio-frequency set having two radio stages, a detector, and two transformer-coupled audio stages. A special method of coupling in the i.f. stages tends to make the amplification more nearly equal over the entire band. Price \$63.05 without cabinet.

204. R. G. S. KIT—A four-tube inverse reflex circuit, having the equivalent of two tuned radio-frequency stages, detector, and three audio stages. Two controls. Price \$69.70 without cabinet.

205. PIERCE AIRO KIT—A six-tube single-dial receiver; two stages of radio-frequency amplification, detector, and three stages of resistance-coupled audio. Volume control accomplished by variation of filament brilliancy of r.f. tubes or by adjusting compensating condensers. Complete chassis assembled but not wired costs \$42.50.

206. H & H-T. R. F. ASSEMBLY—A five-tube set; three tuning dials, two steps of radio frequency, detector, and 2 transformer-coupled audio stages. Complete except for base-board, panel, screws, wires, and accessories. Price \$30.00.

207. PREMIER FIVE-TUBE ENSEMBLE—Two stages of tuned radio frequency, detector, and two steps of transformer coupled audio. Three dials. Parts assembled but not wired. Price complete, except for cabinet, \$35.00.

208. "QUADRAFORMER VI"—A six-tube set with two tuning controls. Two stages of tuned radio frequency using specially designed shielded coils, a detector, one stage of transformer-coupled audio, and two stages of resistance-coupled audio. Gain control by means of tapped primaries on the r.f. transformers. Essential kit consists of three shielded double-range "Quadraformer" coils, a selectivity control, and an "Ampitrol," price \$17.50. Complete parts \$70.15.

209. GEN-RAL FIVE-TUBE SET—Two stages of tuned radio frequency, detector, and two transformer-coupled audio stages. Volume is controlled by a resistor in the plate circuit of the r.f. tubes. Uses a special r.f. coil ("Duo-Former") with figure eight winding. Parts mounted but not wired, price \$37.50.

210. BREMER-TULLY POWER-SIX—A six-tube, dual-control set; three stages of neutralized tuned radio frequency, detector, and two transformer-coupled audio stages. Resistances in the grid circuit together with a phase shifting arrangement are used to prevent oscillation. Volume control accomplished by variation of B potential on r.f. tube. Essential kit consists of four r.f. transformers, two dual condensers, three small condensers, three choke coils, one 500,000-ohm resistor, three 1500-ohm resistors, and a set of color charts and diagrams. Price \$41.50.

212. INFRADYNE AMPLIFIER—A three-tube intermediate-frequency amplifier for the super-heterodyne and other special receivers, tuned to 3400 kc. (86 meters). Price \$25.00.

213. RADIO BROADCAST "LAB" RECEIVER—A four-tube dual-control receiver with one stage of Rice neutralized tuned-radio frequency, regenerative detector (capacity controlled), and two stages of transformer-coupled audio. Approximate price, \$78.15.

214. LC-27—A five-tube set with two stages of tuned-radio frequency, a detector, and two stages of transformer-coupled audio. Special coils and special means of neutralizing are employed. Output device. Price \$85.20 without cabinet.

215. LOFTIN-WHITE—A five-tube set with two stages of radio frequency, especially designed to give equal amplification at all frequencies, a detector, and two stages of transformer-coupled audio. Two controls. Output device. Price \$85.10.

216. KH-27—A six-tube receiver with two stages of neutralized tuned radio frequency, a detector, three stages of choke-coupled audio, and an output device. Two controls. Price \$86.00 without cabinet.

217. AERO SHORT-WAVE KIT—Three plug-in coils designed to operate with a regenerative detector circuit and having a frequency range of from 10,000 to 2306 kc. (15 to 130 meters). Coils and plug only, price \$12.50.

218. DIAMOND-OF-THE-AIR—A five-tube set having one stage of tuned-radio frequency, a regenerative detector one stage of transformer-coupled audio, and two stages of resistance-coupled audio. Volume control through regeneration. Two tuning dials.

219. NORDEN-HAUCK IMPROVED SUPER 10—Ten tubes; five stages of tuned radio frequency, detector, and four stages of choke- and transformer-coupled audio frequency. Two controls. Price \$200.00.

220. BROWNING-DRAKE—Five tubes; one stage tuned radio frequency (Rice neutralization), regenerative detector (tickler control), three stages of audio (special combination of resistance- and impedance-coupled audio). Two controls.

ACME



Flexible Celatsite Wire

A cable of fine, tinned copper wires with non-inflammable Celatsite insulation. Ideal for sub-panel or point-to-point wiring. Strips easily, solders readily. Nine beautiful colors; sold only in 25 ft. coils, in cartons colored to match contents.

Acme Celatsite Wire

Tinned copper bus bar hook-up wire with non-inflammable Celatsite insulation, in 9 beautiful colors. Strips easily, solders readily, won't crack at bends. Sizes 14, 16, 18, 19; 30 inch lengths.



Spaghetti Tubing

Oil, moisture, acid proof; highly dielectric—used by leading engineers. Nine colors, for wire sizes 12 to 18; 30 inch lengths. (We also make tinned bus bar, round and square, in 2 and 2½ ft. lengths.)

Stranded Enameled Antenna

Best outdoor antenna you can buy. Seven strands of enameled copper wire. Presents maximum surface for reception, resists corrosion; this greatly improves the signal. Outside diameters equal to sizes 14 and 16. (We also offer solid and stranded bare, and stranded tinned antenna.)

Loop Antenna Wire

Sixty strands of No. 38 bare copper wire for flexibility, 5 strands of No. 36 phosphor bronze to prevent stretching. Green or brown silk covering; best loop wire possible to make.

Battery Cable

A rayon-covered cable of 5, 6, 7, 8 or 9 vari-colored Flexible Celatsite wires for connecting batteries or eliminator to set. Plainly tabbed; easy to connect. Gives an orderly appearance.



Send for folder
THE ACME WIRE CO., Dept. B
New Haven, Conn.



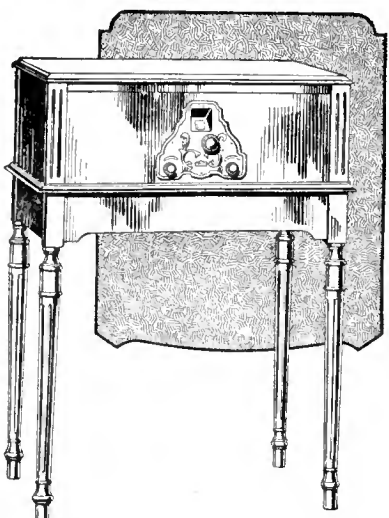

HOWARD
1928, A. C. 6

Aluminum shielded all electric; R. C. A. or Cunningham tubes. 425 volt amplifier. No batteries, Marvelous tone, volume, distance and selectivity. Complete \$311.50.

Ross V. Starkweather
Wholesale Electric Radio
Tools and Supplies
Room 506
19 S. Wells Street, Chicago, Ill.

WHAT KIT SHALL I BUY? (Continued)

- 221. LR₄ ULTRADYNE—Nine-tube super-heterodyne; one stage of tuned radio frequency, one modulator, one oscillator, three intermediate-frequency stages, detector, and two transformer-coupled audio stages.
- 222. GREIFF MULTIPLEX—Four tubes (equivalent to six tubes); one stage of tuned radio frequency, one stage of transformer-coupled radio frequency, crystal detector, two stages of transformer-coupled audio, and one stage of impedance-coupled audio. Two controls. Price complete parts, \$50.00.
- 223. PHONOGRAPH AMPLIFIER—A five-tube amplifier device having an oscillator, a detector, one stage of transformer-coupled audio, and two stages of impedance-coupled audio. The phonograph signal is made to modulate the oscillator in much the same manner as an incoming signal from an antenna.
- 224. BROWNING-DRAKE—Five tubes; one stage tuned radio frequency (with special neutralization system), regenerative detector (tickler control), three stages of audio (special combination of resistance and impedance-coupled audio). Two controls.
- 225. AERO SHOT-WAVE Transmitting Kit consists of interchangeable coils to be used in tuned-plate tuned grid circuit. Kits of coils, two choke coils, and mountings, can be secured for 20-40 meter band, 40-80 meter band, or 90-180 meter band, for \$12.00

USE THIS COUPON FOR KITS

RADIO BROADCAST SERVICE DEPARTMENT
Garden City, New York.

Please send me information about the following kits indicated by number:

.....

.....

Name.....

Address.....
(Number) (Street)

.....
(City) (State)

ORDER BY NUMBER ONLY. This coupon must accompany each order. RB1-28



**RADIO
DEALERS**

Send for our catalog illustrating the products of over 100 radio manufacturers.

WHOLESALE ONLY!

F. D. PITTS COMPANY
219-223 Columbus Ave.
BOSTON, MASS., U. S. A.
Established 1919

ELKAY
TRADE MARK REG

SUPPRESSOR

Controls the Squeals

Fits grid circuit of any tuned R. F. set. Stops tendency to "boil over" and squeal. 75c each; \$1 mounted. Satisfaction or money back. Describe set when ordering. Langhin-Kaufman Radio Co., Dept. 8, 62 Franklin St., New Haven Conn.

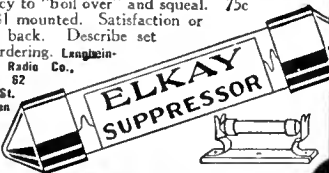

A New R. F. System

THE DE FOREST Company, which from the beginning has been one of the principal opponents of the rapidly augmenting position of the Radio Corporation in the radio patent field, recently announced that Dr. George A. Somersalo, a Finnish physicist, has developed a new system of radio-frequency amplification which does not conflict with the Alexanderson tuned radio-frequency patent. This system depends upon the use of a filter ahead of the first radio stage, the radio-frequency amplifier being untuned. The Alexanderson patent, however, is not the only one possessed by the Radio Corporation of America and a great battle of wits lies ahead for those who want to do entirely without Radio Corporation licenses. No one who has had extensive contact with the American inventor, however, would venture to predict that it cannot be done.

For the Radio
"that won't work on a
B-ELIMINATOR"

Your Next "B" Had Better Be the

**NATIONAL
BETTER-B**

Type 7180
NATIONAL CO., Inc.
W. A. Ready, Pres.
Malden Mass.

**FREE RADIO
CATALOG**

To Dealers: The new 136-page Colored and Illustrated 1928 Hamilton-Carr Wholesale Catalog is ready. Thousands of amazing values in kits, packs, nationally advertised accessories and parts. Features master-built, single-control six, seven and eight tube sets. Battery or all-electric operation. Beautiful consoles. Complete line of chassis. Full showing of "A" and "B" Eliminators, kits and parts. All merchandise guaranteed by pioneers in radio business. Immediate service. Write us today on your business letter-head for this wonderful catalog. The greatest assortment of merchandise ever shown at the lowest prices.

HAMILTON-CARR RADIO CORP.
711 West Lake St. Dep't. 376 Chicago, Ill.

USE THIS COUPON FOR COMPLETE SETS

RADIO BROADCAST SERVICE DEPARTMENT
RADIO BROADCAST, Garden City, New York.

Please send me information about the following manufactured receivers indicated by number:

.....

.....

Name.....

Address.....
(Number) (Street)

.....
(City) (State)

ORDER BY NUMBER ONLY

This coupon must accompany each order. RB 1-28

HELLO JAPAN!



The Unique RADIO THRILL of receiving Australia and Japan the same night was experienced September 11, 1927, by K. G. Ormiston, on a home-built Magnaformer 9-8. Nov. 6, 1927, R. C. Anderson, on his HOME BUILT Magnaformer 9-8 pulled in 1 New Zealand, 2 Australian, 2 Japanese and 61 long distance Western Hemisphere stations from the Atlantic to Pacific—6,000 to 9,000 miles on loud speaker with a world of volume. On his home-built Magnaformer 9-8 J. M. Douglas cut clearly through the blanketing barrage of the numerous, powerful local Chicago stations and pulled in 82 out-of-town stations without interference. Only a Magnaformer 9-8 can give you such performance. It is what out question the greatest Radio Set in the world. It brings them in not only from Coast to Coast but from Continent to Continent. It is NEW and decidedly DIFFERENT. Uses 9 tubes. Includes all latest scientific developments. Performance truly phenomenal. Has registered a profound impression on Engineers and Technical Editors everywhere. Being constantly featured in all radio magazines. Its fame is sweeping the earth. Amazing fidelity of tone. Even brings out the full, round, boom-boom of the bass drum entirely absent from other receivers. Easily and quickly built at home or in any radio shop. Simple and easy to operate. Absolutely Amazing Perfection of Tone Quality. Very highest class Super Receiver. Designed for those who want only the very best. The outstanding choice of Custom Set Builders. Full scientific explanation of Magnaformer Transformers, the cause of this set's remarkable performance and complete home-building instruction sheet, 28 in. x 34 in., printed both sides, full of illustrations and minutely detailed wiring diagrams, and photographs sent FREE, immediately. Mail your name and complete address at once, NOW. Radiart Laboratories, 1005 Association Bldg., Chicago, Ill.