

RADIO BROADCAST

VOLUME XII

NOVEMBER, 1927, to APRIL, 1928



GARDEN CITY

NEW YORK

DOUBLEDAY, DORAN & COMPANY, INC.

1928

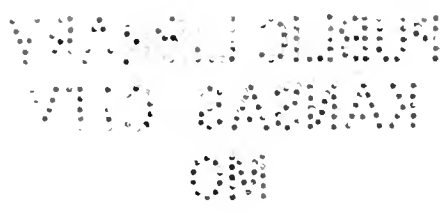

INDEX

(*Illustrated Articles. Editorials in Italics)

	PAGE		PAGE		PAGE
* A AND B Power Units, Testing (Howard E. Rhodes).....	443	* C JRM, Pioneer Picture Broadcasting Station (Edgar H. Felix)....	362	<i>Frequency Allocation Outstanding Achievement of International Conference</i>	280
*A Power Unit, A New (Ralph Barclay)	350	*C. W. Transmitter, A Short-Wave Phone and (Kendall Clough).....	410	*Freshman "Equaphase" Circuit, The (J. O. Mesa).....	42
*Accessories, Some Reliable Radio Power Supply.....	293	<i>Can the Serious Problem of Radio Patents Be Settled?</i>	198	From the Manufacturers.....	174
<i>Action from the Radio Commission</i>	15	*"Channel Numbers"? Meters, Kilocycles, or (Ralph H. Langley).....	18	* G AIN" of Your Radio Receiver, Measuring the (Keith Henney).....	123
<i>Advertising a Service? Is Direct Advertising? What is the Matter with Radio</i>	14	*Coils, Matching R. F. (F. J. Fox and R. F. Shea).....	308	<i>Growing Political Pressure on the Commission, The</i>	347
*Air Liner, The Eyes of a Future ("Anonymous").....	271	<i>Commission Announces a New Policy, The</i>	199	* H ELIUM ATOM, Radio Enlists the (Volney G. Mathison).....	195
*Aircraft Radio? What's the Trouble With.....	11	<i>Commission Improves Broadcasting Conditions, The</i>	278	<i>Here and There</i>	409
*A. C. "Bandbox," the (John F. Rider)	369	<i>Commission Retreats, The</i>	408	<i>High-Frequency Channels, Limitations to the Use of</i>	347
*A. C. Browning-Drake Receiver, An (Glenn H. Browning).....	343	<i>Commission Suggests Synchronization Schemes</i>	199	*Hogan, An Interview with J. V. L. (Edgar H. Felix).....	353
*A. C. Loftin-White Receiver, An (John F. Rider).....	438	<i>Commissioner Appointed, New</i>	281	*How Radio Developments Have Improved Recording and Reproducing (Sylvan Harris).....	414
*A. C. Push-Pull Amplifier and B Supply, An (J. E. Coombes).....	287	*Concomitants of Good Quality.....	230	*How the Cooley "Rayfoto" System Works (Austin G. Cooley).....	23
*A. C. Receiver, A Quality Five-Tube (James Millen).....	135	*Constant B-Device Output (G. F. Lampkin).....	304	*How the "NR-60" Was Engineered (John F. Rider).....	299
*A. C. Super-Heterodyne, A 45-kc (Dormand S. Hill).....	274	*Cooley Picture Receiver, Why I Installed an (Edgar H. Felix).....	215	<i>How the Radio Beacon Works</i>	108
*A. C. Tubes, Electrification Without (Lewis B. Hagerman).....	413	*Cooley "Rayfoto" System Works, How the (Austin G. Cooley).....	23	<i>How the Radio Commission Can Set Radio to Rights</i>	105
*Amplification—Why? Push-Pull (Howard E. Rhodes).....	202	D ESIGNING an R. F. Amplifier (Sylvan Harris).....	376	*How the "Synchrophase" Seven Was Developed (John F. Rider).....	232
*Applications of the Four-Electrode Tube (Theodore H. Nakken).....	109	<i>Direct Advertising a Service? Is Directory of Manufactured Receivers, "Radio Broadcast's"</i>	16	*How to Improve Your Old Receiver (Edgar H. Felix).....	133
*Are Programs Going in the Wrong Direction? (John Wallace).....	219	70, 154, 246, 322, 388		* I MPROVED Aristocrat, The (Arthur H. Lynch).....	46
*Aristocrat, The Improved (Arthur H. Lynch).....	46	*Do You Own a Battery Operated Set? (Howard E. Rhodes).....	30	*Improved Shielded Six (John E. McClure).....	44
*Armchair Engineer, The (Keith Henney).....	360	<i>Does Monopoly Rule the Commission?</i>	346	<i>Inside the Radio Industry</i>	281
*As the Broadcaster Sees It (Carl Dreher).....	50, 142, 235, 311, 367, 429	*DX Listener Finds a Champion, The (John Wallace).....	140	Interference, Suppressing Radio (A. T. Lawton).....	48, 217, 379
* B DEVICE Output, Constant (G. F. Lampkin).....	304	* E DUCATION, University Offerings in Radio (Carl Dreher).....	339	*Interview with J. V. L. Hogan, An (Edgar H. Felix).....	353
*B Device Shall I Buy? What (Howard E. Rhodes).....	120	*Electrification Without A. C. Tubes (Lewis B. Hagerman).....	413	<i>Is Direct Advertising a Service?</i>	16
*"Bandbox," The A. C. (John F. Rider)	369	*Electrifying the Browning-Drake (James Millen).....	33	K EY to Recent Radio Articles, A (E. G. Shalkhauser).....	76, 255
*Beauty—The Keynote in the New Radio Receivers.....	118	*Electrifying the "Hi-Q" (F. N. Brock)	436	Kit Shall I Buy? What 66, 170, 257, 330, 393	393
<i>Blue Laws of Radio, The</i>	409	*Electrifying Your Present Set (Zeh Bouck).....	416	* L AB" Receiver, The Four-Tube (Keith Henney).....	423
Book Reviews:		*Engineer, The Armchair (Keith Henney).....	360	*Laboratory Information Sheets, "Radio Broadcast's":	
<i>Drake's Radio Cyclopeda</i> , by Harold P. Manly (E. H. F.).....	236	<i>Engineering To-day, Radio</i>	16	Acoustics.....	318
<i>Inventions and Patents, Their Development and Promotion</i> , by Milton Wright (E. H. F.).....	125	*"Equaphase" Circuit, The Freshman (J. O. Mesa).....	42	A. C. Audio-Frequency Amplifier, An.....	148
<i>Principles of Radio Communication</i> , by J. H. Morecroft (Carl Dreher).....	394	*Experimental Screen-Grid Receiver, An (Charles Thomas).....	434	A. C. Tube Data.....	58
<i>Story of Radio, The</i> , by Orrin E. Dunlap (C. D.).....	137	*Eyes of the Future Air Liner, The ("Anonymous").....	271	Audio Amplification.....	316
Booklets Available, Manufacturers'.....	62, 153, 244, 320, 392	* F ACTS About the Fada "Special" Receiver (John F. Rider).....	128	Audio Amplification, A Problem in.....	448
<i>Broadcasting Conditions, The Commission Improves</i>	278	*Fantasy on Sponsored Programs, A (John Wallace).....	306	B Power Device Characteristics.....	146
<i>Broadcasting Conditions, What Readers Say About</i>	200	<i>First Rayfoto Transmission, The</i>	348	B Power Unit Characteristics.....	448
<i>Broadcasting Situation? What Is the True</i>	346	*45 kc. A. C. Super-Heterodyne, A (Dormand S. Hill).....	274	Characteristics of Speech.....	446
*Browning-Drake, Electrifying the (James Millen).....	33	*Four-Electrode Tube, Applications of the (Theodore H. Nakken).....	109	Circuit Diagram of an A. C. Audio Amplifier.....	148
*Browning-Drake Receiver, An A. C. (Glenn H. Browning).....	343	*Four-Tube "Lab" Receiver, The (Keith Henney).....	423	Coil Reactance.....	58
		*Four-Tube, Screened-Grid Receiver, A (McMurdo Silver).....	355	Comparing the 112, 171, and 210 Type Tubes.....	314
				cx-312 (uc-112) and cx-371 (ux-171), The.....	386

	PAGE		PAGE		PAGE
Data on the UX-222 (CX-322) Ear, The	384	<i>News of the Patent Field</i>	16, 108	*Rayfoto Picture Receiver, Operating Your (Austin G. Cooley)	296
Exponential Horn, The	446	*No "Motor-Boating" (H. O. Ward)	433	**"Rayfoto" System Works, How the Cooley (Austin G. Cooley)	23
Fading	242	**"NR-60" Was Engineered, How the (John F. Rider)	299	<i>Rayfoto Transmission, The First</i>	348
Filter Choke Coils	387			*Receivers and Their Chassis, Some Fine	226
Filter Condensers	450			Recent Radio Articles, A Key to (E. G. Shalkhauser)	76, 255
"Gain"	148	*OCTAMONIC" Circuit, The R. G. S. (David Grimes)	39	*Refinements of the Modern Radio Receiver (Edgar H. Felix)	26
Grid Bias	387	\$100,000 to Improve Broadcasting	107	*Roberts, Walter Van B.	286
How the Plate Circuit Affects the Grid Circuit	387	*Operating Your Rayfoto Picture Receiver (Austin G. Cooley)	296	<i>Rural Radio Listeners Served by Real-locations</i>	279
Inductive Reactance	58	*Our Readers Suggest	35, 131, 213, 293, 363, 421		
Loud Speakers	146	*Output, Constant B-Device (G. F. Lampkin)	304		
Modulated Oscillator, A	316	*Output Device? Why the (Keith Henney)	294		
Obtaining Various Voltages from a B-Power Unit	60			*SCREENED-GRID Receiver, A Four-Tube (McMurdo Silver)	355
112, 171, and 219 Tube Curves	314			*Screened-Grid Tube, The (Keith Henney)	208
112-A and 171-A Type Tubes, The	238			*Screened-Grid Tube, The (The Laboratory Staff)	282
Operating Vacuum Tubes in Parallel	56			*Set Shall I Buy? What (Edgar H. Felix)	211
Oscillation Control	150	*PATENTS:		*Shielded Six, The Improved (John E. McClure)	44
R. F. vs. A. F. Amplification	448	Can the Serious Problem of Radio Patents Be Settled?	198	Short-Wave Notes	331
Regulator Tube, The	386	<i>Patent Field, News of the</i>	16, 108	*Short-Wave Phone and C. W. Transmitter, A (Kendall Clough)	410
Resonant Circuits	318	<i>Prospects for Patent Pooling</i>	15	<i>Short-Wave Spectrum, The Shrinking</i>	407
Selectivity and Sensitivity	384	<i>Prospects of a Patent Pool, The</i>	198	*Some Fine Receivers and Their Chassis	226
Simple Wavemeter, A	386	*Phonograph Joins the Radio Set, The	112, 206	*Some New Loud Speakers and Sets	358
Single-Control	150	*Phonograph Records, The Month's New	441	*Some Reliable Radio Power-Supply Accessories	293
Solenoid Coil Data	60	<i>Picture Broadcasting Becomes a Practical Reality</i>	406	<i>South Has Few Stations, Why the</i>	107
Speech	150	*Picture Broadcasting Station, CJRM, Pioneer (Edgar H. Felix)	362	Standards, "Radio Industry"	107
Standard and Constant-Frequency Stations	238	*Picture Receiver, Make Your Own Radio (Austin G. Cooley)	114	**"Strays" from the Laboratory	228, 310, 427
Table for Wavelength-Frequency Conversion	240	*Picture Receiver, Operating Your Rayfoto (Austin G. Cooley)	296	*Super-Heterodyne. A 45 kc. A. C. (Dormand S. Hill)	274
Testing Receivers	316	*Picture Receiver, Why I Installed a Cooley (Edgar H. Felix)	215	*Suppressing Radio Interference (A. T. Lawton)	48, 217, 379
Three-Tube Roberts Reflex	242	<i>Political Pressure on the Commission, The Growing</i>	347	<i>Synchronization Schemes, The Commission Suggests</i>	199
Three-Tube Roberts Reflex, The	242	<i>Possibilities of Still Picture Broadcasting</i>	406	**"Synchrophase" Seven Was Developed, How the (John F. Rider)	232
Transmission Unit, The	60	*Power Devices	127		
Tuning	450	*Power Equipment, Loud Speakers and	373		
Type 280 and 281 Tubes. The	450	*Power Supply Accessories, Some Reliable Radio	293		
Unit of Capacity, The	56	*Power Unit, A New A (Ralph Barclay)	350		
Wave Traps	240	*Programs, A Fantasy on Sponsored (John Wallace)	306	*TECHNICAL Radio Problems for Broadcasters and Others (Carl Dreher)	311
Wavelength-Frequency Conversion	240	*Programs Going in the Wrong Direction? Are (John Wallace)	219	*Television in Europe (William J. Brittain)	103
*Laboratory, "Strays" from the	228, 310, 427	*Push-Pull Amplification—Why? (Howard E. Rhodes)	202	*Testing A and B Power Units (Howard E. Rhodes)	443
*Langley, Ralph H.	225	*Push-Pull Amplifier and B Supply, An A. C. (J. E. Coombs)	287	<i>Two Stations Cannot Occupy the Same Ether Space</i>	348
<i>Limitations to the Use of High-Frequency Channels</i>	347			**"Two-Ten" Power Amplifier, A New (William Morrison)	138
*Listeners—Guests or Customers? (John Wallace)	37	*QUALITY Five-Tube A. C. Receiver, A (James Millen)	135		
*Listeners' Point of View, The (John Wallace)	37, 140, 219, 306, 365, 419			*UNIVERSITY Offerings in Radio Education (Carl Dreher)	339
Listeners Served by Reallocations, Rural Radio	279	*R. G. S. "Octamonic" Circuit, The (David Grimes)	39		
*Loftin-White Receiver, An A. C. (John F. Rider)	438	<i>Radio Beacon Works, How the</i>	108		
*Loud Speakers	126	"Radio Broadcast's" Directory of Manufactured Receivers	70, 154, 246, 322, 388		
*Loud Speakers and Power Equipment	22, 373	"Radio Broadcast's" Laboratory Information Sheets (See Laboratory)	56, 146, 238, 314, 384, 446	*VACUUM-TUBE Voltmeter, A (The Laboratory Staff)	221
*Loud Speakers and Sets, Some New	358	<i>Radio Commission, Action from the</i>	15		
		<i>Radio Commission Can Set Radio to Rights, How the</i>	105	<i>WEAF Transmitters, The New</i>	108
		*Radio Education, University Offerings in (Carl Dreher)	339	*What B Device Shall I Buy? (Howard E. Rhodes)	120
		<i>Radio Engineering To-day</i>	16	<i>What Broadcasters Want</i>	107
		*Radio Enlists the Helium Atom (Volney G. Mathison)	195	<i>What Can the Commission Do?</i>	105
		*Radio Favorites, New Recordings by	289	*What is a Good Radio? (Keith Henney)	28
		*Radio Folk You Should Know	225, 286, 440	<i>What is the Matter with Radio Advertising</i>	14
		*R. F. Amplifier, Designing an (Sylvan Harris)	376	*What's the Trouble with Aircraft Radio? ("Anonymous")	11
		*R. F. Coils, Matching (F. J. Fox and R. F. Shea)	308	<i>What Is the True Broadcasting Situation?</i>	346
		<i>Radio Industry, Inside the</i>	281	What Kit Shall I Buy?	66, 170, 257, 330, 393
		"Radio Industry" Standards	107	<i>What Readers Say About Broadcasting Conditions</i>	200
		*Radio Interference, Suppressing (A. T. Lawton)	48, 217, 379	*What Set Shall I Buy? (Edgar H. Felix)	211
		*Radio Picture Receiver, Make Your Own (Austin G. Cooley)	23	<i>What to Tell the Consumer—And Where Who Buys This Year's Radio Sets?</i>	279
		*Radio Receivers for \$175 or Less	19	*Why I Installed a Cooley Picture Receiver (Edgar H. Felix)	215
		*Radio Receivers Representing a Wide Price Range	302	*Why the Output Device? (Keith Henney)	294
				<i>Why the South Has Few Stations</i>	107
				<i>Will the Radio Industry Do It Again?</i>	349

INDEX—Continued

AUTHORS	PAGE	AUTHORS	PAGE	AUTHORS	PAGE	
Barclay, Ralph	350	Nakken, Theodore H.	109	*Fadden, B. J.	201	
Bouck, Zeh	416	Rhodes, Howard E.	30, 120, 202, 443	Golden, Ernie	207	
Brittain, William J.	103	Rider, John F.	128, 232, 299, 369, 438	Goldsmith, Alfred N.	346	
Brock, F. N.	436	Shalkhauser, E. G.	76, 255	Hall, Anita DeWitte	38	
Browning, Glenn H.	343	Shea, R. F.	308	Hall, Bob	306	
Clough, Kendall	410	Silver, McMurdo	355	Hare, Ernest	113	
Cooley, Austin G.	23, 114, 296	Smith, Francis Gow	403	Hogan, J. V. L.	353	
Coombes, J. E.	287	Thomas, Charles	434	Jones, Billy	113	
Dreher, Carl		Wallace, John	37, 140, 219, 306, 365, 419	Jones, Lester L.	440	
50, 142, 235, 311, 339, 367, 394, 429		Ward, H. O.	433	Langley, Ralph H.	225	
Felix, Edgar H.	26, 133, 211, 215, 353, 362	PORTRAITS (*Portraits in "The March of Radio")			Lindbergh, Charles A.	113
Fox, F. J.	308	*Alexanderson, E. F. W.	406	*Marconi, Signora	17	
Grimes, David	39	*Bellows, Henry A.	198	Mengelberg, Willem	289	
Hagerman, Lewis B.	413	Boult Reber	38	Morecroft, J. H.	339	
Harris, Sylvan	376, 414	*Bown, Ralph	346	Palmer, Lester	306	
Henney, Keith	28, 123, 208, 294, 360, 423	*Butman, Carl H.	198	*Pickard, Sam	198	
Hill, Dormand S.	274	Buttolph, David	140	Roberts, Walter Van B.	286	
Lampkin, G. F.	304	Cason, Bob	38	Shumsky, Oskar	419	
Langley, Ralph H.	18	Coates, D. R. P.	362	Smith, Francis Gow	402	
Lawton, A. T.	48, 217, 379	Cooley, Austin G.	114, 215	Sokoloff, Nikolai	289	
Lynch, Arthur H.	46	Damrosch, Walter	289, 420	Theremin, Leon	427	
McClure, John E.	44	Dieckmann, Max	104	Verbrugghen, Henri	289	
Mathison, Volney G.	195	*Dillon, John F.	107	Wynn, Eunice	365	
Mesa, J. O.	42	Dole, Frank	307			
Millen, James	33, 135					
Morrison, William	138					

RADIO BROADCAST



CONTENTS

Refinements in Modern Radio Sets

A Directory of Manufactured Receivers

How the Cooley Rayfoto Picture Recorder Works

Let's Do Away With Meters and Kilocycles

What's the Matter With Aircraft Radio?

What is a Good Radio Set?

35 Cents

Doubleday Page & Company
Garden City, New York

NOV · 1927



Cunningham RADIO TUBES

The Right Tube in the Right Socket

There are now twenty distinct types of Cunningham Radio Tubes each expressing the correct balance in design and specification to perform a definite function most efficiently in your radio. Your dealer will tell you the correct type your radio is designed to use. Equip throughout with Cunningham Radio Tubes. By so doing you insure maximum performance in your radio.

*Twenty different types—
all in the Orange and Blue carton*

E. T. CUNNINGHAM, Inc.

NEW YORK

CHICAGO

SAN FRANCISCO

Since 1915—Standard for all Sets



TRY IT 30 DAYS FREE
BEFORE YOU BUY

ALL METAL SHIELDED CHASSIS

FACTORY PRICES - SAVE 50%
Choice of beautiful cabinets offered

3 Year Guarantee

8 tube - one dial

MIRACO
TRADE MARK REGISTERED

Only \$69.75

Retail List Completely Assembled

MAGNIFICENT TONE - SUPER SELECTIVE - POWERFUL DISTANCE GETTER

All Electric or Battery Set!

Big Discounts to User-Agents

MIRACO Users Say:

Reports from users everywhere leave little for us to add. These are only a few of the many in our files and which we receive daily. Send coupon for plenty of additional proof and testimony of nearby users.

CLEARER THAN A \$450.00 SET
Before I bought your set I tried out and heard quite a number of different makes sets and I believe I can truthfully say that I never yet have heard a set with such wonderful tone and clearness as the Miraco. I never thought that a set could be as clear and reproduce tones and voices as the Miraco. Saturday I listened to a \$450.00 set and it can't even come near your set for clearness and volume. I have logged some very distant stations on the Unitune and although people won't hardly believe me, the first week I had KFI Los Angeles on two nights to succession on a 30' temporary inside aerial. —FRANK A. OLDENBURG, Los Angeles, Wis.

SHARPLY SEPARATES STATIONS
The Unitune brings in stations very clearly and with a selectivity that is amazing when you take in consideration the mass of stations on the air at the same time. I have heard three and four stations that were on almost same wavelengths at the same time and was able to tune out one after the other with the least interference. —W. L. BROBACK, San Francisco, Calif.

EXPERIENCED FAN PRAISES SET
Miraco is the most wonderful radio I have ever seen. I have had experience with many popular makes of radios, also have built a number of them myself but in tone quality it is far superior to all. For sensitiveness I can say it is more like a super-heterodyne. —R. D. WHITE, Proctor, W. Va.

HAS POWER TO SPARE
"Well Pleased" with Miraco would be putting it mildly. Haven't heard anything to equal it regardless of price. With temporary aerial tuned to WEAF then WIOD Florida felt sure this must be the best of the best of this locality. Stations all coming in clear with wonderful tone and tremendous volume. Set does not have more than said of volume turned on. A local agent insisted he could prove his set superior but to his surprise and astonishment my family and neighbors and the agent himself admitted his \$115 set had to step out of the way for Miraco. —H. W. HOEFFEL, Parkton, Pa.

America's big, old, reliable Radio Corporation* (8th successful year) **guarantees** in its big, powerful, latest 6, 7 and 8 tube Miraco sets "the finest, most enjoyable performance obtainable in high grade radios." Unless 30 days' use in your home fully satisfies you a Miraco is unbeatable at any price for beautiful, clear cathedral tone, razor-edge selectivity, powerful distance reception, easy operation, etc. — **don't buy it! Your verdict final.** Save or make lots of money on sets and equipment — write for testimony of nearby users and **Amazing Special Factory Offer.**

Miraco's work equally fine on "AC" electric house current or with batteries. Take your choice. Many thousands of Miraco users — who bought after thorough comparisons — enjoy programs Coast

to Coast, Canada to Mexico, loud and clear — with the magnificent cathedral tone quality of costliest sets. Don't confuse Miraco's with cheap, "squawky" radios. Miraco's have finest parts, latest approved shielding, metal chassis, etc. — as used in many \$200 sets.

Deal Direct with Big Factory

Your Miraco reaches you completely assembled, rigidly tested, fully guaranteed. Easy to connect and operate. **30 days' trial free.** 3 year guarantee if you buy. You take no risk, you insure satisfaction, you enjoy **rock-bottom money-saving prices** by dealing direct with one of radio's oldest, most successful builders of fine sets. 8th successful year in the radio manufacturing business.



Dealers Write! USER-AGENTS! Make big profits showing Miraco to friends. Get Our Special Wholesale Prices! —MIDWEST RADIO CORPORATION, Cincinnati, O.

BEAUTIFULLY ILLUSTRATED CATALOG AND AMAZING SPECIAL OFFER

Free! SEND NO MONEY—30 DAYS' TRIAL, Special Wholesale Price Offer to User-Agents, Bank References, testimony of nearby Miraco users — *all the proof you want*—sent with catalog.

mail coupon right now!

MIRACO "Powerplus" sets — both in 8 and 7 tube models — have magnificently beautiful, clear cathedral tone quality. Turn one dial for stations everywhere. Ultra-selective. Miraco multi-stage distance amplification gives "power-plus" on far-off stations. Latest all-metal shielded chassis. Illuminated dial. Fully guaranteed. *Try one free for 30 days!* Choice of beautiful cabinets.

7 tube one dial METAL SHIELDED CHASSIS \$49.75 RETAIL LIST

Electrify Any Radio with MIDWEST NO-BATTERY "AC" Light Socket Power Units



BIG DISCOUNT TO User-Agent

"A", "B" and "C" power, direct from light socket, without batteries! Write for Midwest prices and discounts. Midwest Units are highest grade — lasting dependable, quiet in operation, fully guaranteed.

THIS COUPON IS NOT AN ORDER

MIDWEST RADIO CORPORATION
Pioneer Builders of Sets
406-E Miraco Building, Cincinnati, Ohio.

Without obligation, send free catalog, AMAZING SPECIAL OFFER, testimony of nearby Miraco users. User Agent Dealer

NAME
ADDRESS

Another Big Bargain! Famous powerful big Miraco Super 6, 1928 model — ultra selective! Thousands find it outperforms sets of much higher price. **30 Days' Trial Free. Fully Guaranteed.**

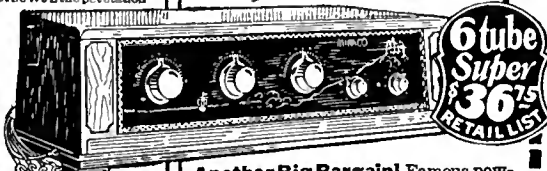

RADIO BROADCAST

NOVEMBER, 1927

WILLIS KINGSLEY WING, Editor
KEITH HENNEY
Director of the Laboratory

EDGAR H. FELIX
Contributing Editor

Vol. XII, No. 1

CONTENTS

Cover Design	From a Design by Harvey Hopkins Dunn	
Frontispiece	Proper Radio Equipment on an Airplane	10
What's the Trouble With Aircraft Radio?	Anonymous	11
The March of Radio	An Editorial Interpretation	14
What's the Matter With Radio Advertising? Action from the Federal Radio Commission Prospects for Patent Pooling Is Direct Advertising a Service?	Radio Engineering Today News of the Patent Field The Month in Radio	
Meters, Kilocycles, or "Channel Numbers"?	Ralph H. Langley	18
Radio Receivers for \$175 or Less		19
Loud Speakers and Power Equipment		22
How the Cooley "Rayfoto" System Works	Austin G. Cooley	23
Refinements of the Modern Radio Receiver	Edgar H. Felix	26
What is a Good Radio?	Keith Henney	28
Do You Own a Battery Operated Set?	Howard E. Rhodes	30
Electrifying the Browning-Drake	James Millen	33
Our Readers Suggest.		35
Listeners—Guests or Customers?	John Wallace	37
The Listeners' Point of View		
The R.G.S. "Octamonic" Circuit	David Grimes	39
The Freshman "Equaphase" Circuit	J. O. Mesa	42
The Improved Shielded Six	John E. McClure	44
The Improved Aristocrat	Arthur H. Lynch	46
Suppressing Radio Interference	A. T. Lawton	48
As the Broadcaster Sees It	Carl Dreher	50
Putting Freak Broadcasting In Its Place Background Noises	Abstract of Technical Article Auditorium Acoustics	
"Radio Broadcast's" Laboratory Data Sheets		56
No. 137 Operating Vacuum Tubes in Parallel	No. 142 Obtaining Various Voltages from a B-Power Unit	
No. 138 The Unit of Capacity	No. 143 Solenoid Coil Data	
No. 139 Inductive Reactance	No. 144 The Transmission Unit	
No. 140 Coil Reactance		
No. 141 A. C. Tube Data		
Manufacturers' Booklets Available		62
What Kit Shall I Buy?		66
"Radio Broadcast's" Directory of Manufactured Receivers		70
A Key to Recent Radio Articles	E. G. Shalkhauser	76

AMONG OTHER THINGS.

FOR more reasons than one, the New York Radio Show is generally accepted as the event which crystallizes interest in all things radio. This is written as the show closed and a more impressive show we have never seen. "Impressive" from the point of view of the exhibits, certainly, but more impressive because of the tremendous interest in all things radio demonstrated by all sorts and conditions of people who thronged Madison Square Garden. Careful observation of the crowds and their interest indicated that while the complete sets drew much attention, the home-assembled receivers—built from kits, were equally interesting. This definite and lively interest in the home-built sets is especially important in view of the pronouncements of some knowing radio sages who aver that home building is seriously on the decline.

ACTUAL transmission and reception of "still" pictures by radio was demonstrated thousands of times during the week of the show by Austin G. Cooley who set up a complete Cooley "Rayfoto" transmitter and receiver in a special booth provided through the courtesy of G. Clayton Irwin, Jr., manager of the show. The picture converter or transmitter was set up, connected to a small radio transmitter and through a standard broadcast receiver, the pictures were received with great rapidity and success before the very eyes of eager crowds. The simplicity and speed of the receiver astounded those who saw the demonstration, and every visitor was eager to know when he could build the apparatus and how soon pictures would be sent and where he could get information. Experimental picture transmissions from various broadcasting stations will be sent even before you read these words; complete information on how the system works, how to build and operate it appears exclusively in this and following issues of RADIO BROADCAST. And those who wish to receive printed matter describing details of the system should at once address a letter to the undersigned who will see that all information is mailed at once. The impressive success of the Cooley "Rayfoto" demonstration proves beyond all question that a new era has dawned for the home experimenter, and to be frank, we are as enthusiastic over the possibilities opened up as the keenest of experimenters.

A WORD about the authors in this issue: the anonymous figure in aviation and radio. Ralph Langley, who explains his scheme for numbering broadcast channels, is executive assistant to the president, Crosley Radio Corporation. He was until recently in charge of receiver design for the General Electric Company. Howard E. Rhodes who describes what's new in A-power units is one of the able technical staff of this magazine. James Millen, who is a consulting engineer and a native of Long Island, will shortly desert these parts and settle in Boston.

IN THE next issue we shall have an important article by T. H. Nakken on the shielded grid tube indicating what such a tube means to American radio. There will be valuable constructional articles and a description of the technical features of well known manufactured receivers—information never published before. Austin Cooley will tell how to build a Cooley "Rayfoto" receiver—facts for which many experimenters are waiting.

—WILLIS KINGSLEY WING.

Doubleday, Page & Co.
MAGAZINES
COUNTRY LIFE
WORLD'S WORK
GARDEN & HOME BUILDER
RADIO BROADCAST
SHORT STORIES
EDUCATIONAL REVIEW
LE PETIT JOURNAL
EL ECO
FRONTIER STORIES
WEST WEEKLY

Doubleday, Page & Co.
BOOK SHOPS
(Books of all Publishers)
LORD & TAYLOR BOOK SHOP
PENNSYLVANIA TERMINAL (2 Shops)
GRAND CENTRAL TERMINAL
38 WALL ST. and 526 LEXINGTON AVE.
848 MADISON AVE. and 166 WEST 32ND ST.
ST. LOUIS: 223 N. 8TH ST. and 4914 MARYLAND AVE.
KANSAS CITY: 920 GRAND AVE. and 206 W. 47TH ST.
CLEVELAND: HIGBEE CO.
SPRINGFIELD, MASS.: MEEKINS, PACKARD & WHEAT

Doubleday, Page & Co.
OFFICES
GARDEN CITY, N. Y.
NEW YORK: 285 MADISON AVENUE
BOSTON: PARK SQUARE BUILDING
CHICAGO: PEOPLES GAS BUILDING
SANTA BARBARA, CAL.
LONDON: WM. HEINEMANN LTD.
TORONTO: OXFORD UNIVERSITY PRESS

Doubleday, Page & Co.
OFFICERS
F. N. DOUBLEDAY, President
NELSON DOUBLEDAY, Vice-President
S. A. EVERITT, Vice-President
RUSSELL DOUBLEDAY, Secretary
JOHN J. HESSIAN, Treasurer
LILLIAN A. COMSTOCK, Asst. Secretary
L. J. McNAUGHTON, Asst. Treasurer

DOUBLEDAY, PAGE & COMPANY, Garden City, New York

Copyright, 1927, in the United States, Newfoundland, Great Britain, Canada, and other countries by Doubleday, Page & Company. All rights reserved.
TERMS: \$4.00 a year; single copies 35 cents.

*When you have
decided to use
house current
for your receiver-*

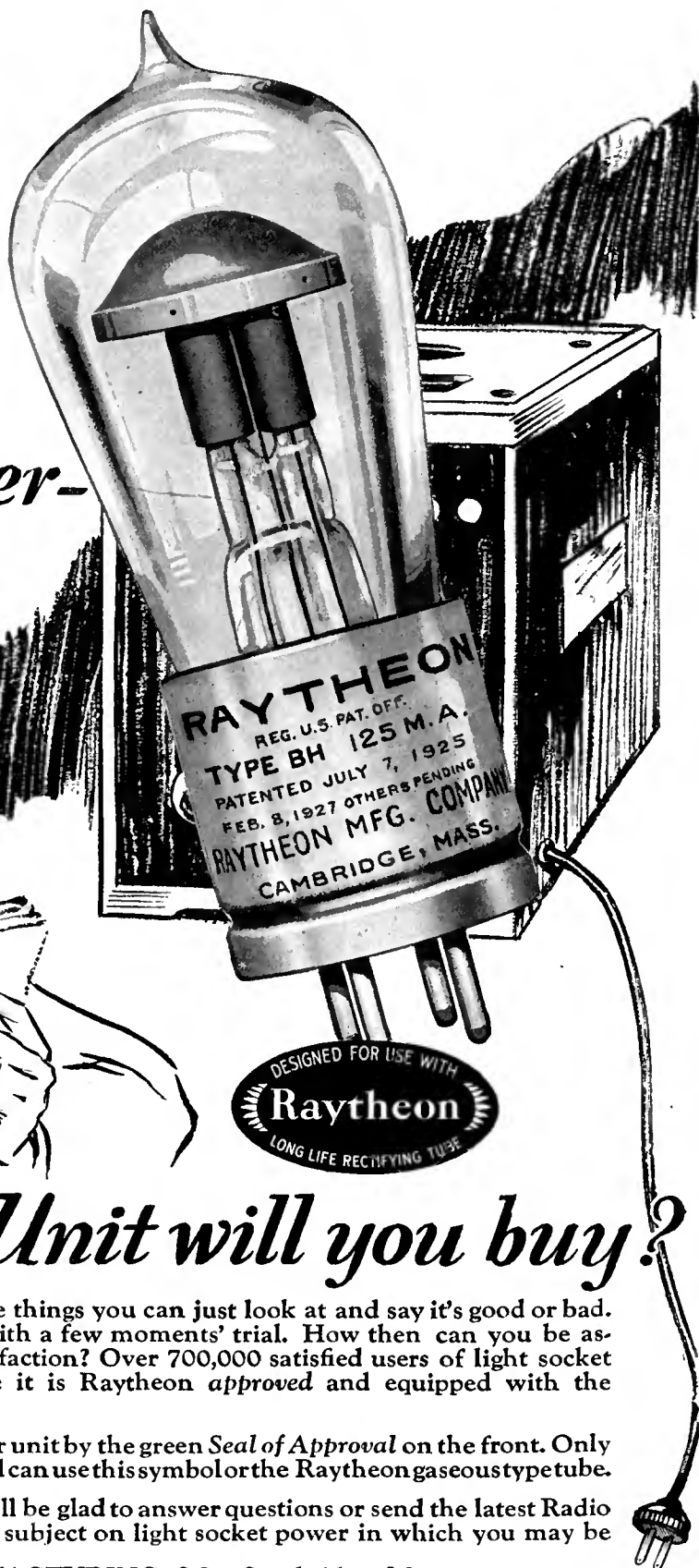

..what Power Unit will you buy?

A battery eliminator isn't one of those things you can just look at and say it's good or bad. Nor can you determine its qualities with a few moments' trial. How then can you be assured of a reliable unit of lasting satisfaction? Over 700,000 satisfied users of light socket power units will tell you to be sure it is Raytheon *approved* and equipped with the Raytheon long life rectifying tube.

You can identify a Raytheon type power unit by the green *Seal of Approval* on the front. Only units that have been tested and approved can use this symbol or the Raytheon gaseous type tube.

Our Technical Service Department will be glad to answer questions or send the latest Radio Power Bulletin covering in detail any subject on light socket power in which you may be interested.

RAYTHEON MANUFACTURING CO., Cambridge, Mass.

Type BH
125 m.a. 300
volts

Type BA
A-B-C power
350 m.a.

Raytheon
THE HEART OF RELIABLE RADIO POWER

Type A
2½ Amps.

Type R
90 V. 60 m.a.

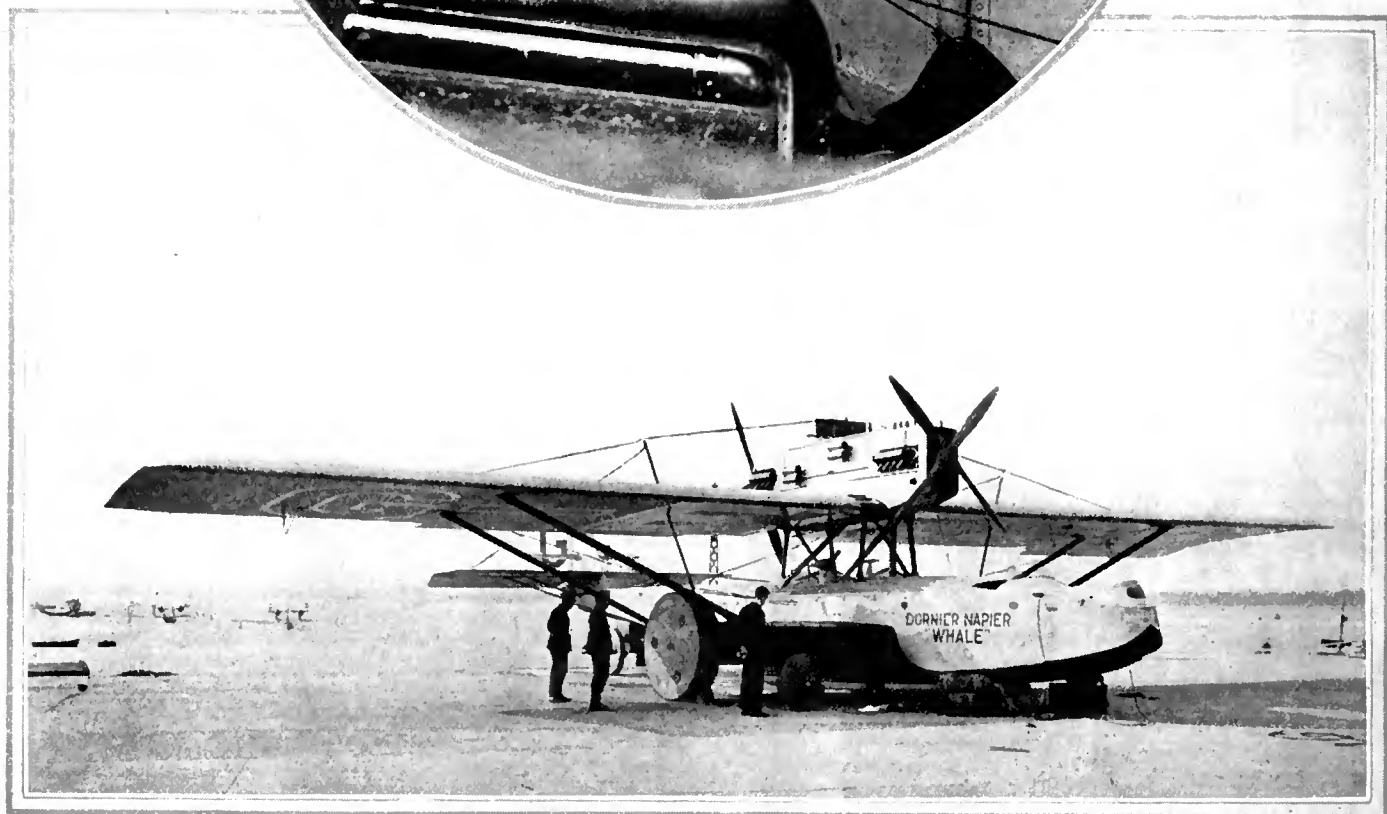
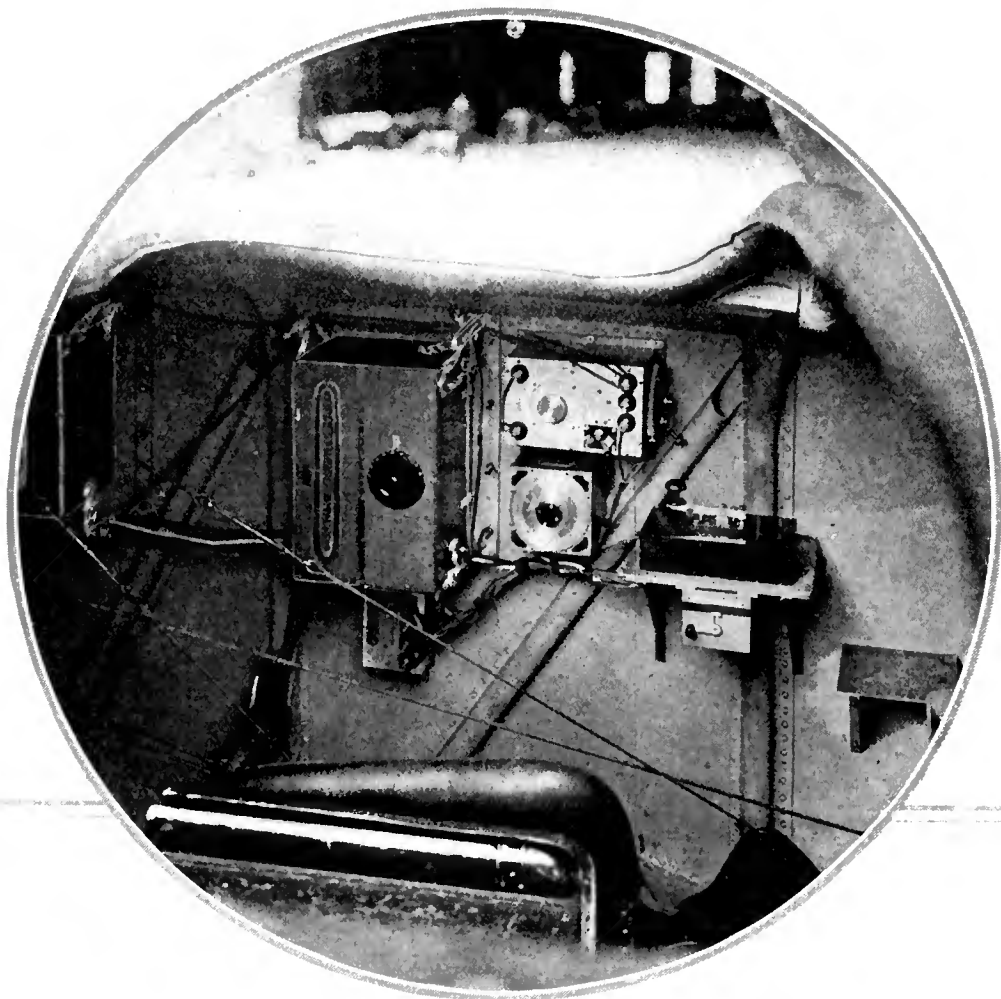

ONE AEROPLANE ON WHICH PROPER RADIO EQUIPMENT IS USED

THE Dornier-Napier Whale of Captain F. T. Courtney, originally designed for a flight from London to the United States and return, has a 500-watt Marconi i.c.w. transmitter, using a 200-foot trailing antenna, an eight-tube r.f. amplifier ahead of a four-tube super-heterodyne, usable on commercial wavelengths, and a Marconi Bellini-Tosi direction finding antenna. The all-metal construction of the slip introduced special receiving problems which had to be solved. Note in the lower illustration part of the receiving antenna rising over the motor nacelle. The top photograph shows the radio controls. A wind-driven generator supplies power for the transmitter and charges special storage batteries. In case of a forced landing, a 40-foot mast can be erected, and the batteries are made to supply current to the motor generator which runs the main set. Few airships have been so completely equipped.

What's the TROUBLE with Aircraft RADIO?



"Anonymous"

WHO is to blame for the fact that radio communication is not in general use in flying? Is it the radio engineer? Or can it be shown that the fault lies with the airman? Why did not Lindbergh and Chamberlin use radio? Who knows in what different manner the fatal flight of Nungesser and Coli might have ended had there been radio equipment aboard the *White Bird*? What of the *Golden Eagle* and the *Miss Doran*? Had these planes been equipped with radio would they have been lost? Probably not. There is reason to believe that even though forced down, so well would they have been followed by radio watchers on land that they might have been quickly found.

Commander Byrd made good use of radio at times in the flight that ended just short of Paris. But did he, schooled in the Navy and certainly aware of the possibilities for its use, make the most of his radio? One wonders. Why, when approaching the French coast, was he unable to learn the kind of weather awaiting him at Paris?

Hegenberger and Maitland were able to use their radio equipment but a small part of the time on their flight to Hawaii. Receiver trouble developed soon after leaving the Pacific Coast and it was not until they were within eight hundred miles of their goal that they were able to pick up signals again. The preparations for their flight were said to have been most thorough. The radio must surely have been thoroughly tested before the take-off, yet it failed them in time of need. They had

planned to fly the course laid down by the radio beacon. To do this it was necessary to make continuous use of the radio receiver. Fortunately, when it failed, they were prepared to navigate by better-known means. Such was the thoroughness of Army Air Corps methods of preparation.

However, there has been no excuse for the lack of radio equipment of some sort on all of the trans-oceanic flights. The disturbance created by the ignition system which is almost always offered as an argument against it, is not an absolute bar to the use of radio. Ignition disturbance has no effect on the radio transmitter. Even a receiver could have been used to some extent in the presence of ignition noise. This is particularly true for a plane in which the cabin is located some little distance from the engine. Furthermore, the receiver could have been successfully used while passing over vessels at sea. The ship's transmitter under the circumstances of such short range would have pushed signals

through the ignition disturbance at least sufficiently to have given information on weather and course.

RADIO MUST BE USED ON LONG FLIGHTS

IT WOULD be very interesting to know the reasoning which led to a decision to leave radio out of the plans for some of these flights. Undoubtedly the real reasons will not be given to the public. One strongly suspects that the lack of ability to handle radio on the part of the crew aboard each of these planes had a great deal to do with the matter. Of course, Lindbergh flew alone and could have made little use of any kind of radio equipment for that reason. Chamberlin knew little or nothing about radio, and it is likely that Levine, his passenger, knew less, inexperienced as he was in such matters. There is no telling how much Coli or Nungesser or Captain Hamilton, the British pilot, knew about the use of radio equipment.

None of these flights should have been undertaken without radio equipment, and a competent radio operator to handle it. On some of the flights one of the pilots acted as radio operator. This did not prove entirely satisfactory. Hegenberger, who flew with Maitland to Hawaii was fairly familiar with radio apparatus, but when his receivers (there were two aboard) became inoperative, he was unable to locate the source of trouble. It is doubtful if his knowledge of radio was sufficient to have enabled him to diagnose trouble as a trained radio operator could have done.

"ANONYMOUS" conceals the identity of an individual who is excellently qualified to write on the closely related problems of the airplane and radio. All we can say is that he is an expert who is well known in both fields. The author knows aviation—not from a swivel-chair vantage point, but from long flying experience and he knows radio from both the practical and distinctly technical angles. Too few radio men know anything about the problems that the aviator has to meet, and too few of the airplane folk know radio. Certainly there is a middle ground on which both may meet and this article is the first of several which will discuss this interesting field. The increasing fatality list of those attempting stupid and pointless trans-oceanic flights has demonstrated to almost the whole world that long-distance flying must be made safer and surer by every means at our command. And through radio will come much of this essential surety.

—THE EDITOR.

The desire to carry passengers on these flights has prevented a good radio operator being present. Miss Doran in the Pacific flight, and the Princess Lowenstein-Waltheim in the Atlantic flight of Captain Hamilton, and Philip Payne in *Old Glory* should have been replaced with radio operators, and, at least, radio receiving equipment. The fact that Brock and Schlee flew successfully to England without radio is no proof that radio was not needed. Redfern carried neither companion nor radio. He should not have been permitted to leave without both. And his companion should have been a good radio man.

Thus it is seen that some of these fliers were unmindful of the value of radio, and that others were unable to make the most of equipment which they had chosen to use.

Who is to blame that the value of radio has been so vastly underestimated in these flights? The question is important. Upon the correctness of the answer depends in a great measure the solution of one of the problems which at present confronts aviation.

WHY AVIATORS DON'T LIKE RADIO

THERE have been many discussions on this subject between flying folk and men interested in radio. These discussions have usually been of a character to which the terms "heated," and sometimes "overheated," could justly be applied. Generally, the debates ended only in disagreement. The pilot and the engineer have not been brought to the same way of thinking. Not only have they disagreed as to who is to blame for the neglect of radio, but the pilot has strenuously objected times without number to the use of radio on his plane.

It is, of course, true that the military and naval flier has on occasion done much with the equipment designed for him by the radio engineer. Very often it was only because that flier was a member of an organization, in which obedience to an order is almost instinctive, that he made real use of his equipment. Often, it is true, he was pleased with the results of his effort and so converts to the cause of radio have gradually been made. They are, however, all too few. As for the commercial fliers, apparently little belief in the need for radio exists. One never hears of radio being used on their planes. Not even the Air Mail companies, or our own Post Office department, have seen fit to equip mail planes with even a receiver with which to receive information on the weather. The Air Mail for a time carried out experiments with radio but no

practical or extensive use has yet been made of it.

What has the radio engineer to say for himself in the face of this obvious disdain on the part of the flier for radio? Were he a psychologist it might occur to him that the feeling of the pilots about the matter might be based on something inherent in the flying profession, or in the flier's training. Could he put himself in the place of the average war-trained flier he would remember that in the exciting days of the war the urge to fly was the strongest thing in his life. It was for that reason that he joined the Air Service instead of going into some other branch of the Service. That was why he worked as he never had worked before during preliminary training days at ground school. His eyes were always lifted to the men in the air. Everything but flying was subordinated. Nothing appealed to him either at ground school or at the flying

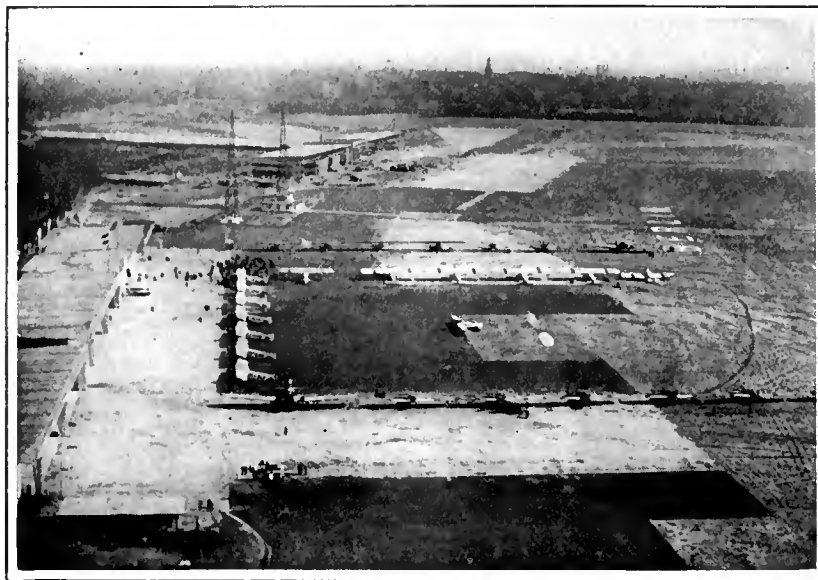

AT AN EUROPEAN AIRPORT

Elaborate means of radio communication are required by law on passenger air routes in some European countries. The two radio towers at the Tempelhof, Berlin, airport, are clearly discernable in this aerial picture

school to which he was later ordered, as strongly as the airplane and flying. Motors, navigation, gunnery, photography, radio—all had to be learned; but he learned them, for if they were not learned he would not be taught to fly. But flying was the thing—devil take the rest. Whom did he worship the most, his gunnery instructor or his radio instructor, or any of the other ground instructors? None of these. He worshipped the man who taught him how to fly. Usually his flying instructor was the biggest man on his horizon. His radio instructor was usually a non-flier, "Keewee" being the term contemptuously applied to any ground officer of the Air Service. Usually this man made no impression, or a poor one at the most. He often stood between the cadet and his flying goal. For all who would fly must, in addition to many other things, learn to send and receive radio signals. If he could not pass the speed test he could not fly. That was the regulation, and many

a good man was "shot down" by the elusive *da-dit-da* before he ever had a chance to learn to fly, and was accordingly sent away from flying school. At the advanced flying school came practice with actual transmitting and receiving of signals while in the air. This was usually even more boring than the practice in the code room. Generally, the radio failed to function. Anyhow, who wanted to sit in the rear cockpit of a ship which was being flown by someone else and fiddle with knobs and dials and try to pick up the faint signals bravely endeavoring to penetrate the noise and roar of the motor and the disturbance created by the ignition system?

Thus was built up all through the fliers' training, a genuine dislike for radio. As so many of the present fliers were war-trained, it is little to be wondered at that radio still has no appeal for them, and that the average flier has but little faith in it. A man was generally judged by his ability to handle his "ship." If he was clever with radio, providing he was able to fly, he was forgiven by his fellows.

Experienced fliers are among the most conservative of men, strange as that may seem. Little do they relish change or innovation. They have been flying through all kinds of weather and over all kinds of country without the use of radio. Why change now? Radio is just another thing to worry about. It probably won't work anyway, and the receivers in the helmet hurt your ears and you can't hear your motor. So poor old radio goes for consolation to the amateur who has been such a good friend all these years. All of which the radio engineer has probably not realized.

TECHNICAL PROBLEMS IN THE PLANE

IN ADDITION to the obstacles formed by the fliers' attitude, there have been many technical difficulties to overcome. Chief of these is the interference caused by the ignition system of the airplane engine. This has been a most serious obstacle and has not been completely overcome. It is true that, by completely shielding the ignition system, the troublesome noise can be reduced to a point where very satisfactory reception in an airplane is attained, but such shielding is difficult to install and even more difficult to maintain.

How is a motor shielded to reduce this interference? How does the ignition system of a motor produce interfering noises in a radio receiver?

The ignition system consists of a high- and low-tension side. The low-tension side consists of everything from the switches to

the low-voltage side of the magneto in magneto ignition; and everything from the battery, including switches, generator, meters, voltage regulator, and distributors in the battery type of ignition. In the high-tension side we have everything from the high-tension side of the magneto in the first type of ignition, and from the distributors in the second type, down to the spark plugs. In these systems every make and break contact, as in voltage-regulator relay or distributor, produces a disturbance each time the circuit is opened or closed, which should be regular and very frequent, otherwise the pilot has something much more serious to worry about than the QRM from his ignition. The spark plug has not been mentioned in detail yet. Usually there are two of these little short-wave transmitters in each cylinder of the motor. The average airplane engine runs at speeds of from 1400 to 1800 revolutions per minute. This means that in an eight-cylinder, four-stroke-cycle engine, equipped with but one spark plug per cylinder, there will be at 1500 r.p.m., six thousand sparks per minute, or one hundred sparks per second. This produces a noise in a radio receiver which resembles the noise produced by a stream of shot on a loose tin roof. Oscillograms of this QRM indicate that part of the noise is due to induction, just as the "click" heard in a receiver when an electric light switch nearby is opened or closed, is caused by the change in current. The rest of the noise is produced by the oscillating spark in the gap in the spark plug itself. This is a true electro-magnetic disturbance of a definite wavelength. Apparently, then, it should be easy to reduce this interference by means of a short-wave trap; and so it should, but due to the difference in the constants of these small oscillating systems, the use of wave traps has not proved very satisfactory. Up to the present time the most satisfactory method of freeing the receiver of this annoying disturbance is by shielding the whole ignition system.

Completely shielding the ignition system requires that every wire and electric device about the whole plane which carries current be covered with an electric shield. This is usually a braided copper sleeve, slipped over the wire, or a metal container for such devices as regulators, distributors, and switches. This shield must be connected to the ground of the plane. The ground of an airplane consists of all the metallic parts, such as the motor, brace wires, cables and fittings. If you have a few inches of frayed shielding it will cause all the noise to come right back to the receiver. Shielding produces a hazard, the danger of which may be readily realized. If there is faulty insulation anywhere in the system, the vital ignition current will jump through to the ground and out goes part or all of the ignition, depending upon where the break occurs, and, it is needless to say, down comes the plane, to make as safe a landing as the pilot can. It would appear that the solution of this problem is to use nothing but the best of insulation. This is more diffi-

cult than it sounds. When a high-tension lead is shielded a corona discharge takes place through the insulation to the grounded shield. The corona produces a chemical change in insulation and it no longer insulates, the engine ceases to "percolate," and the aviator to "aviate."

Now, the pilot knows all this and his feeling for radio has increased in warmth, but not in a direction the radio engineer would like to see. The old feud still exists. The pilot says the engineer loads his plane with hazardous equipment, and the engineer says the pilot is too fussy about what happens to him.

THE FUTURE—WORK FOR ALL

AND so it stands, until the necessity for radio communication between the air and the ground is made apparent to all concerned with flying. That this necessity exists there is no doubt in the minds of many besides the radio engineer, but now the demand for radio is insufficient to induce very much research on these problems.

Such problems can be and are, of course, being worked on in laboratories. However, there is a definite limit to what can be done in a laboratory on the ground. The conditions existing in a plane—the vibration, the noise of wind and motor and ignition, cannot be adequately reproduced in a laboratory; nor can engineers conceive of the conditions except by repeatedly experiencing them in test flights. What I am driving at is this. There should be a laboratory in which the ground and air work is connected and closely related. The engineer should be placed in a position not only to see the problem as the flier sees it, but both flier and engineer should be encouraged to work together. Confidence in the ability and work of the engineer will then come to the flier. Better radio sets will be built, and let us hope that they will be built as a

part of the plane and not tacked on—an afterthought. Airplane designers will make provisions for these sets and the power required to operate them. Then, and then only, will pilots want radio, and make good use of what they get.

Before passenger carrying air lines are permitted to operate either in this country or on trans-oceanic flights, this matter of radio should be included in the regulations covering the safety and inspection of the planes. The Department of Commerce should make regulations to fit the needs of the moment. Because commercial aviation is in its growing stage, the regulations should be fairly elastic. But before passengers are permitted to risk their lives, regulations regarding suitable radio equipment and personnel to operate it should be laid down. These should cover all long flights, whether over water or land. By long flights is meant anything over 500 miles.

The radio beacon has had but a very short test outside of the Air Corps experimental tests. But it is apparent even on such short trial that regular flights over long distances of water should not be thought of without contemplating the use of such a beacon. For regular passenger routes over land, the beacon should be depended upon at least for night flying. However, the story of this beacon and its possibilities is too long to include here.

As in so many other things, practice and test are essential to development, and this is no less true of radio on aircraft. The more use made of it the more experience gained. Radio has a very definite and important place in aviation, and it is only to be regretted that use has not been made of it on all transatlantic and transpacific flights. It is likely that the unsuccessful flights would not have had so tragic an ending, had radio played the part that it must come to play in the future of aviation.

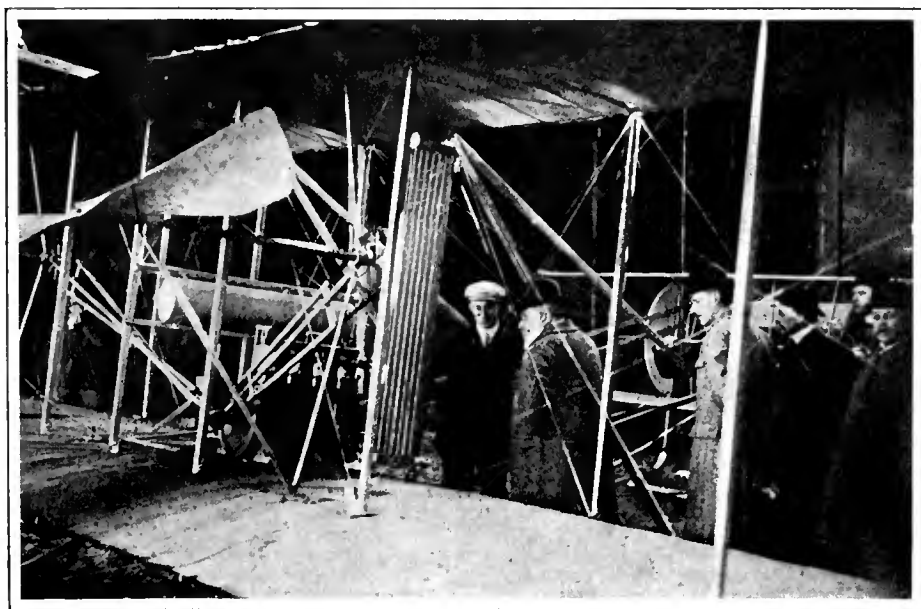

WHEN RADIO WAS NO MORE THAN A DREAM

King Edward VII receives a lesson in aeronautics at the hands of Wilbur Wright. Planes of ten years hence, equipped with powerful radio transmitters and receivers, will probably be as much in advance of present day design as are the planes of to-day as compared to this fragile looking craft of Wright's

THE MARCH OF RADIO

NEWS AND INTERPRETATION OF CURRENT RADIO EVENTS

What is the Matter With Radio Advertising?

FROM time to time, trade associations and better business bureaus formulate codes of ethics for the guidance of writers of radio advertisements. These codes aim to curb exaggerated claims as to long distance reception, quality of tone and other excesses so freely used in radio announcements.

The beautifully worded hyperboles, characterizing modern advertising, have received such spirited attacks recently, that we may look forward to saner and more informative advertising copy. So great is public interest that a book on this subject, *Your Money's Worth*, is threatening to become a best seller. Radio advertising receives its share of scathing criticism from these authors who leave no one unscathed.

Imagination—at least—is lacking when an entire industry depends upon a few standardized general appeals to sell its products to the public. If the advertising is to be believed, all receiving sets possess unbelievable selectivity, marvelous sensitiveness and magnificent tone quality, regardless of price. Rarely does any enlightening information appear in a radio advertisement by which a prospective purchaser may judge the superiority of one receiver over another. Magical phrases are concocted, playing upon the ignorance of the non-technical, to suggest fancied engineering superiority. The uninitiate must be guided by such medicine-man hokum as "utilizing the new intra-paralytic principle of interference submergence," "delightful tone quality obtained with the mastertonic sliding trombone transformers," or "securing magical selectivity by the matched prismatic quartz inductances."

Aside from such senseless and meaningless technical appeals, most radio advertising confines itself to generalized boasts. The same charge may be made not only against the advertising of radio sets, but that of automobiles, iceless refrigerators, and any mechanical or electrical product. The readers of RADIO BROADCAST frequently demand that some comparative technical tests be made to form a basis of judging the relative qualities of sets.

We have given considerable thought to this problem and we would unhesitatingly publish comparative information, could we discover a method of making comparative tests which would not involve the human element and which would be a real test of merit, taking into

consideration all of the factors which contribute to the desirability of a radio receiver.

Take, for example, the factor of gain in the radio-frequency amplifier. We may impress a standard modulated signal from an oscillator upon a receiver and measure the resultant fluctuations in plate current of the detector circuit, thus giving an evaluation in the over-all gain of the radio-frequency amplifier. We may also obtain a selectivity curve for each receiver which gives a fair index to that quality. Furthermore, given an adjustable audio frequency oscillator, with which to modulate the incoming test signal, we can determine with a fair degree of accuracy the tonal range and characteristics of the audio frequency amplifier. These three tests would give an index to the three major qualities of a receiving set, namely its sensitiveness, selectivity and fidelity.

Unfortunately, carrying out such tests is far from simple. Most receivers have a gain control in the radio-frequency amplifier system which greatly complicates laboratory tests as a means of comparing receiving sets. Testing a five-tube receiver, the gain might well be adjusted as high as possible, so that it would show maximum amplification per stage. However, when so adjusted, it is likely to show more than normal dis-

tortion in its audio-frequency amplifier. On the other hand, more conservative adjustment of the radio frequency gain would handicap its sensitivity rating, although it might improve its showing with respect to tone quality. Five engineers could test a number of receivers and secure entirely different results.

If a sufficient number of test conditions are fixed so that the element of adjustment would be minimized, some receiving sets would be unduly handicapped by the test conditions in one respect or another. Consequently, laboratory comparisons, with the test methods we now have available, do not, for the present at least, seem to offer a means of supplanting generalities in radio advertising. But we may look forward to developments in this direction, as our experience with laboratory measurements of sets increases.

Another possible method of making advertising copy more informative is to give a few outstanding facts regarding a receiver, such as number of tubes, number of controls, and other specifications. But the number of tubes in a receiver is hardly a guide to its efficiency. There are ten-tube receivers which give no better results than other six-tube sets. The writer, for instance, has a four-tube receiving set with a 210 tube in the output, which he would confidently enter in any contest for sensitiveness, selectivity and tone quality. But, as a commercial product, it is practically useless. It takes an expert to tune the set and the filters, chokes and by-pass condensers, which are a part of it, would not fit into two set cabinets of normal dimensions. So the listing of specifications is hardly a panacea for indefiniteness in radio advertising.

What remains to assist the honest advertiser in preparing truly informative copy? If we rule out bunk, generalities and specifications, of what may the set manufacturer speak without being frowned upon? Only three general points suggest themselves—outward appearance, price, and reputation, the same factors which the automobile industry has found successful as selling appeals.

Another possibility is to consider some one, simple, technical detail—the thickness of shielding, the strength and rigidity of the chassis, or the accuracy with which tuning circuits are matched—as an indication of the skill and care displayed throughout the whole receiver. Such



SENATORE MARCONI TESTING BEAM TRANSMISSION
The inter-continental beam transmitters of the Marconi Company, now in operation, resulted from a long series of tests. This illustration shows Senator Marconi testing a short-wave transmitter from a boat on a lake at Livorno, Italy, in 1916

a policy has advantages, being informative, specific, interesting, and, above all, based on facts instead of on generalities.

Prestige and reputation are the product of years of successful manufacture, and, consequently, production figures and value of sets sold by a manufacturer are a foundation of fact by which an old established manufacturer may distinguish himself from others.

A method, which has been successful in other fields, is to "sell" the engineer who designs the product. Certain companies have engineering and research staffs of acknowledged competence and reputation, whose designs are worthy of great public confidence.

A thorough and detailed study of the radio receiver and those who build it, on the part of the advertising copy writer, is the best preparation for writing advertising which features facts rather than fancy.

Action from the Radio Commission

THE Federal Radio Commission has begun suit against station KWKH, which it charges with the misdeed of using three times the power permitted by its license, for forty successive days. As a result, KWKH is liable to fines aggregating \$20,000 at the rate of \$500 a violation. If the Commission has a good case and wins out in the courts, it will certainly gain wide respect. The numerous violations of the Commission's regulation as to maintenance of assigned frequencies are likewise subject to fines of five hundred dollars a day. Certain stations frequently wander as much as ten kilocycles from their channels. The former WSOB, for example, was found at different times, within eight days, 24.8, 23.9, 12.5 and 16.1 kc. from its assigned channel.

The Commission, in a public statement,

threatened to eliminate about twenty-five of the most flagrant wavelength wobblers but, as usual, grew softhearted in the end and gave them additional grace. Heterodyning is far too widespread to make listening to any but relatively nearby stations any very great pleasure.

The Commission's claim, however, that practically all heterodyning is due to frequency wobbling is not entirely founded on fact. There are altogether too many assignments of stations to the same frequency whose carrier waves are bound to create interference. The clearest broadcasting channels as a matter of fact, are at this time the higher frequencies between 1250 and 1500 kc. On these frequencies, we find mostly low-powered stations which do not interfere with each other.

The numerous hearings held in Washington, upon demand of some of the stations now assigned to these superior channels, are based on the fallacious superstition that the lower frequencies are the most desirable. At one time, when the lower frequencies were reserved for the better stations, while as many as twenty and thirty low- and medium-powered stations were huddled on the lower end of the broadcast band, the ambition to leave the higher frequencies was justified. Although conditions have changed, prejudice against the higher frequencies persists.

Mr. May, seeking a lower frequency for his advertising station, KMA, for example, testified before the Commission that it was a well known fact among radio engineers that the channels below 350 meters were "practically no good for broadcasting purposes," although, as an expert brought out, KDKA, KOA, WBBM, WOK, and numerous other stations, occupying these allegedly unsatisfactory frequencies, have built up nationwide audiences.

The claim that stations do not "get out"

on the very high frequencies is made because the public is not accustomed to looking for its programs on these channels. There are too few worthwhile stations using them. Why not assign a few really good stations to the higher frequencies, so as to distribute the public's attention throughout the broadcast band?

Prospects for Patent Pooling

THE Radio Manufacturers' Association is looking into the matter of patent pooling and seeking to inaugurate a system of cross-licensing in the same manner that the automobile industry accomplished this through the National Automobile Chamber of Commerce. There is one great difference, however, in the radio situation and that lies in the fact that a single group has already concentrated most of the patents in its own hands and consequently no one has much to offer it for bargaining purposes.

We learn of the formation of a Radio Protective Association in Chicago with the object of battling against "radio monopoly" which, say the sponsors for the new organization, "will be taken to Congress, to the Department of Justice and to the Courts."

No matter how much outsiders may protest, there is no question about the fact that the Radio Corporation of America has in its hands most of the essential patents to the manufacture of the radio receiver and it is not at the mercy of any outside group. A patent is an entirely legal monopoly created by legislation in accordance with provisions in the Constitution of the United States. Furthermore, the Radio Corporation is extending licenses to competing companies on what appears to be a fair basis. A rather large minimum royalty guarantee is required of the set

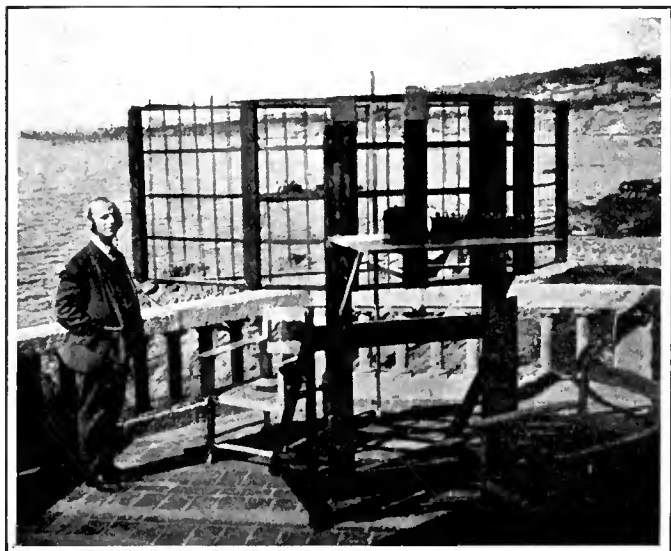

TESTING "BEAM" TRANSMISSION IN 1916

Senatore Marconi's principal assistant in the development of the short-wave "beam" is C. S. Franklin who is here shown on the lake at Livorno, Italy, testing a short-wave receiver with transmissions from the parabolic reflector shown in the accompanying photograph. (Right) The "beam" system of short-wave communication has already satisfactorily linked

England with Canada, India, Australia and South America, and the New York-London link will shortly be opened. C. S. Franklin, Senatore Marconi's chief research engineer, famed for his work in developing the "beam" method is shown here operating the beam transmitter with its parabolic reflector from the shore of the lake at Livorno

maker; said to be \$100,000 a year, which effectively throttles the small producer. Under the patent law, a patent holder has full rights to deny the issuance of licenses to anyone he chooses and, therefore, unless the legal attitude of the patent law is completely reversed, the R.C.A. is entirely within its rights.

The object of the patent law is to assure that inventors are encouraged and properly rewarded. Times have changed and invention is much less a product of individual genius than it is the marshalling of many minds, research facilities and laboratory experience. The reward, instead of going to individual inventors and their backers, now goes to large corporations which make it possible for the complex invention of this day to be made.

The major purpose of the patent is thus fulfilled, both under modern conditions and under those which obtained in the past. We may add a new interpretation in that the patent monopoly shall not be used in restraint of competition and compel patent holders to extend licenses to all those willing to pay just license fees. This plan is followed in Canada. But such a course in this country would be a new situation, a reversal of precedents. It would require new legislation. A possible and, indeed, probable solution of the present radio situation is that the Radio Corporation will extend licenses to smaller concerns on a smaller minimum guarantee, but upon a higher percentage of royalties than it extends to those guaranteeing \$100,000 a year.

The radio industry is suffering from the existence of too many incompetent small manufacturers which are bound, in time, to be eliminated by natural economic processes. Hastening their passing by patent pressure is a painful but effective method which, however, reacts unfavorably against those exerting it. But, whatever the considerations animating the policy, the legality of the R. C. A.'s present patent course does not appear to be open to question.

Is Direct Advertising a Service?

A NUMBER of the direct advertising stations have appeared before the Commission, claiming great losses of audience and service range because of their high frequency assignments. Mr. May, speaking for KMA, recently spent three and a half hours on the stand, a record for a single witness before the Commission to date, to prove himself the most popular announcer in the United States and his station the greatest service to humanity of any station in the corn belt. 450,000 people wrote him during the first seven months of the year, a larger number than practically any but one or two key chain stations can claim.

On the other hand, every questionnaire,

not specially circulated by the stations themselves or by farm papers, indicate the wholehearted public condemnation of direct advertising by radio. RADIO BROADCAST'S questionnaire, in which 10,886 expressions of approval and disapproval were made, found KFNZ the most unpopular broadcasting station in the country, 18.8 per cent. of the audience demanding its removal. Considering the fact that those who answered this questionnaire were distributed all over the United States, this seems to represent about 100 per cent. of the listeners within the annoyance range of this station. WJAZ won the disapproval of 15 per cent. of the listeners, most of this vote being a spite vote because WJAZ upset the Radio Act of 1912, rather than because of present day program unpopularity; while KMA came out third with condemnation from 13 per cent. of those answering.



SIGNORA MARCONI

The illustration shows the wife of the noted Italian with the radio receiver fitted up for her use in their palace in Rome. Signora Marconi was formerly the Countess Maria Cristina Bezzi Scali

However, 450,000 people do not write a station for nothing. There is no question but that there is a field for the local broadcasting station in the service of the small local merchant. The public, however, resents being sold harness, glue, tires, and laundry service in the guise of entertainment. The mail order buyer in the rural district is about the only group which responds. Evidently, in spite of the harsh dislike which we have of the direct advertising stations, we must confess that they have an audience and, as such, deserve consideration, but only in proportion to the importance of that audience.

Radio Engineering To-day

RALPH H. LANGLEY of the Crosley Company writes us at some length in comment on D. A. Johnson's criticism of radio engineers, which we headed, some months ago, "There Are no Radio Engineers." Mr. Langley points out

the excellent progress made in building up technical knowledge through the work of the Institute of Radio Engineers and describes what is being done in the way of standardizing symbols and terms and measurements. Mr. Langley says:

No branch of engineering can become an exact science, until its methods of measurement have been developed and standardized. But the progress which radio science has made in this respect during the past three years is remarkable and gratifying. It is now possible to predict with reasonable accuracy the field strength which will be delivered at any receiving point by any transmitter. The characteristics of the transmitted wave are accurately measurable. The field strength necessary to produce a given output voltage on any receiver can be determined from the measured characteristics of the receiver and of the antenna. The ability of the receiver to exclude undesired signals and its acoustic performance, as well as that of the loud speaker, are also subject to precise measurement. Transmitters have been metered and their characteristics known for many years. Thus every part of the broadcast mechanism has yielded to precise determination.

As a mushroom and a boom industry, radio was certainly unscientific. But progress has been made. An inspection of the twenty leading manufacturers' plants would quickly convince Mr. Johnson that the design and manufacture of the radio product is a precision task of the highest order, performed to the most rigid standards.

News of the Patent Field

A RECENT licensee under Radio Corporation patents, and probably the most important from the standpoint of royalties to be paid, is the Atwater Kent Manufacturing Company. This brings the total number of licensees to twenty-three, including some of the principal manufacturers of the industry. Within the pale are a number of companies who must produce considerably more sets and do a much larger share of the total radio business this year than last if they are to earn their royalty guarantee. On the other hand, there are still one or two large manufacturers outside the pale who have not yet indicated any intention or desire to obtain a license. No one knows yet just what their course will be. One possibility is an attempt to build receiving sets completely evading infringement of Radio Corporation patents. There are engineers who contend that this is not impossible, although really more than this result must be achieved. The sets must not only avoid patent difficulties, but must be as inexpensive to manufacture and as efficient so far as results are concerned as receiving sets made under Radio Corporation licenses. That is no small problem. ¶ ¶ ¶ Heins and Bolet accepted a consent decree in a case brought by the Westinghouse Company under Armstrong, Fessenden and Vreeland patents. ¶ ¶ ¶ The decree against the Claremont Machine Company, secured by the C. F. Mueller Company, for a machine for folding noodles was sustained. ¶ ¶ ¶ A decision rendered in the U. S. Circuit Court at Philadelphia upheld the Lektophone patent 1,271,529, declaring that Lumière's invention does not anticipate Hopkins and that the de-

fendants' device, employing a flexible rubber liaison member, held in place by a rigid frame and covered by an ornamental hood, is an infringing device. ¶¶¶ The following sets are now licensed under R. C. A. patents: Zenith, Splittorf, Stromberg-Carlson, Bosch, Crosley, All-American, Freed-Eisemann, Howard, King, Fada, Federal, Murdock, Freshman, Amrad, Steinite, Gilfillan, Day-Fan, Bremer-Tully, Atwater Kent, Federal-Brandes, A. H. Grebe, Pfansteihl and United States Electric (Apex, Case, Slagle, Workrite, and Sentinel).

The Month In Radio

THE evolution of marine radio communication was recently described by T. M. Stevens, General Superintendent of the Marine Department of the R. C. A. Broadcasting considerably hastened the adoption of a continuous wave transmission on a new series of channels, greatly mitigating interference with broadcasting. In 1922, there were twelve spark stations, using principally the waves of 450 and 600 meters, along the coast from Cape May to Bar Harbor. Both on account of congestion and because of the protests of broadcast listeners, seven of these twenty spark stations are now closed down and the remainder have been replaced by more efficient vacuum tube transmitters. Three hundred ship spark transmitters have also been converted into modified tube transmitters so that they no longer interfere with broadcasting programs.

A few small independent companies are still compelled to use spark transmitters, while many foreign ships with spark transmitters are still working in a manner to interfere with broadcast listening. It is understood that the independent radio companies, operating spark stations, are experiencing difficulty in obtaining properly licensed vacuum tube transmitting equipment. The foreign ship interference will probably be tackled by the International Conference at Washington. Under the circumstances, spark interference with radio programs is likely to be a thing of the past within two or three years, and, possibly sixty to eighty per cent. of the interference is already eliminated. ¶¶¶ Things have changed for ship operators since the writer pounded the key some twelve years ago. In those days, the emolument was sixteen dollars a month and now it averages a hundred. Considering that the work is generally pleasant and practically all expenses are paid, the radio operator's lot is one to be envied, when compared with that of the clerk with his dull routine and the artisan with his arduous and confining tasks. The radio operator's principal complaint, as we have gathered from interviewing a few, is that once senior operator on a desirable ship, contact with superiors is so limited that the opportunities for advancement are practically nil. Nevertheless, most of the executives of commercial radio companies were once "brass pounders." There is no employment more romantic, responsible and broadening than that of radio operating for the young enthusiast, seeking a career of adventure and promise. ¶¶¶ The listeners of KFWO, an efficient little 250-watter at Avalon, owned by Lawrence Mott of short-wave fame, have been receiving play-by-play reports of the games played in Chicago by the Cubs. Why this station should go so far afield to present its listeners with this feature is explained by the fact that Mr. William Wrigley, Jr., is so interested in the doings of the Cubs that, while he summered at Catalina, play-by-play reports were sent him by telegraph.

Mr. Mott suggested to Mr. Wrigley that these play-by-play reports be diverted to KFWO and then broadcast. Colonel Green has a rival! ¶¶¶ The Egyptian government plans to erect a broadcasting station. There are already three thousand sets in operation which, to receive the principal European programs, must be highly sensitive. Eighty-five per cent. of the population of Egypt lives within 150 miles of Cairo and hence a single station can greatly stimulate a market which American manufacturers may do their share in supplying. ¶¶¶ Any listeners, hearing broadcasting station sot, have been victims of a slight error which is excusable, due to the distance involved. They are doubtless hearing station xol, operated by the Tientsin Government in China. Its power is 500 watts and it uses a wavelength of 480 meters. A special license is required from the Chinese government to act as an importer of radio sets and one American Company has taken advantage of this privilege by conforming with the regulation. ¶¶¶ A beam station, another link in the Marconi worldwide service, has recently been opened for commercial use at Johannesburg, South Africa. ¶¶¶ WLW, using its short wavelength, supplied an Australasian program recently, enjoyed by listeners of 2 FC, Sydney, Australia, and 1 YZ, Auckland, New Zealand. America is the largest exporter of broadcasting programs in the world. ¶¶¶ The interference problems of Australia are causing distressing controversy. A new 15-kw. broadcaster is to open at Wellington on 420 meters. What worries the Australians is if Sydney on 440 and Adelaide on 400 meters will not suffer serious interference. Cautious fellows these Australians! ¶¶¶ JOAK, Tokio, already frequently heard on the Pacific Coast on its thousand watts, is to go on 40,000 watts, which should certainly bring it within range of a good part of the United States during early morning, midwinter hours. It won't be long now before a few American broadcasters will have to close down because of foreign interference. ¶¶¶ There are 206,334 listeners in Australia, duly licensed and paying license fees. ¶¶¶ The British Broadcasting Corporation issued a statement recently that it had discovered the advantages of rating stations in terms of kilocycles rather than meters. The advantages of the kilocycle rating have become obvious to the American listener and have been used in this magazine since August, 1925. In talking to the members of the Federal Radio Commission, we have been pleased to notice that, though at the first the word "wavelength"

was rather frequently in the conversation, it did not take long for the Commission to adopt "frequency" as the only practical term to designate the radiation of a broadcasting station.

WHO REPRESENTS THE LISTENER?

OUR editorial some months ago, entitled "Where Are the Listeners' Organizations?" has brought forward a good deal of correspondence from ambitious would-be executive secretaries, disillusioned leaders who have attempted to form local organizations and readers requesting RADIO BROADCAST to sponsor such an organization. A number have expressed the opinion that listener organizations would be more of a nuisance than an aid to broadcasting. W. W. Waltz, for example, writes that, although in his area WJZ, WEAJ, WGY and KOKA are the obvious program leaders, there is a certain advertising station which any Philadelphia listener will recognize, "whose sole idea is to sell every ampere that can be forced off of their antenna. There is no use in trying to describe the junk they broadcast. Everything from near-dirty stories to grand opera selections by the most horrible orchestras in existence. One complaint after another has been made, officially and otherwise, in regard to the manner of operation of this station. Their equipment is modern, but it is adjusted to give a wave like a spark set. And believe it or not—is the most popular station in the city!" The conclusion to be drawn is that no organization can be truly representative of listener tastes.

HOW LONG, OH LORD, HOW LONG?

WE TAKE a special delight in reminding the authors of publicity statements boasting of revolutionary inventions, of the prior discovery and origin of these same inventions, in the hope that more care and conservatism may be displayed, as time goes on, by the publicity romance writers. We note that Mr. C. Francis Jenkins, who has spent many years in research in telephotography, announces the development of radio guiding channels to keep aviators on a definite course and of a receiving set giving visual indication of deviation from the guiding course. The former has already been widely used experimentally, especially by the Navy Department, and is a well known invention. The visual indicator is not so widely used, although its development in direction-finding apparatus was recorded in these columns several months ago. About twenty-five ships on the Great Lakes are already equipped with the visual direction indicator.

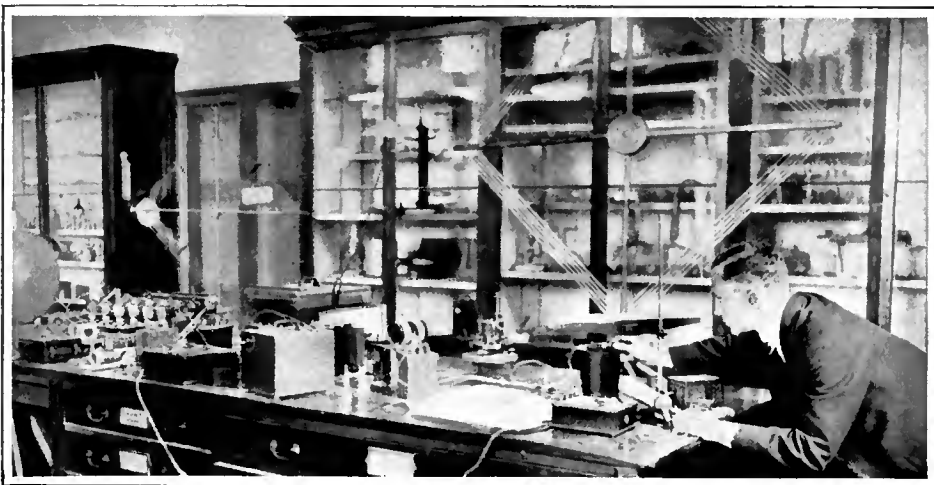

FADING TESTS AT MELBOURNE, AUSTRALIA

Station 3 LO at Melbourne has made a gift to the University of Melbourne for research on the causes of radio fading. R. O. Cherry, working under Professor Laby of the University, is here seen calibrating the portable receiver for measuring signal intensities. The set is carried in an automobile

METERS, KILOCYCLES, OR "CHANNEL NUMBERS"?

By RALPH H. LANGLEY

Crosley Radio Corporation

ONE of the most practical and interesting suggestions tending to simplification of radio receivers as far as the non-technical user of radio receivers is concerned is that of Mr. Langley, which he so interestingly discusses in this article. The use of radio receivers will become more and more widespread as the receiver becomes more simple to operate. Great strides in this direction have been made, what with single-control operation and direct light-socket powering of sets. But still, thousands of listeners who don't even know the difference between alternating and direct current, try to solve the dual mysteries of wavelengths and kilocycles which confront them in their local newspaper radio programs and on the dials of their receiving sets. Mr. Langley rightly asks, why should they bother with this wavelength-kilocycle terminology? Frequency calculations in kilocycles—or meters if you belong to that school—are important and necessary for the engineer and the technician, but the listener has no earthly concern for them.

A committee of the National Electrical Manufacturers' Association has been appointed to consider Mr. Langley's suggestion and to take appropriate action. That committee consists of R. H. Langley, chairman; L. W. Chubb, George Lewis, M. C. Rybinski, J. M. Skinner, R. H. Manson, and A. E. Waller.

—THE EDITOR.



PERHAPS there is no such thing as "the average broadcast listener." But millions of them come pretty close to the average, and I wonder just what they think when they hear the announcer say that he is broadcasting "on a frequency of twelve hundred and sixty kilocycles." In all but a very few cases, I venture to say that their thoughts have nothing to do with the meaning of these words. Last year it was a "wavelength of two hundred and ninety one and one tenth meters" and that was even worse. Why so many numbers and so many strange words?

Wavelength in meters, and frequency in kilocycles; related to each other by some mathematical law, and yet not related to anything the man in the street has ever heard of. Even the radio engineer must resort to a tabulation or a slide rule to translate one into the other, and yet each and every broadcast listener is expected to use them when he wants to hear his favorite stations. The newspapers print them, and you are expected to know, or somehow to find out, where they all come on the dials of your receiver.

The change from "wavelength" to "frequency" was, of course, a very logical one. It can easily be demonstrated that the current in your receiver or in the distant transmitter has a frequency. The wave out in space is the thing that has a wavelength (as well as a frequency). Primarily we are not interested in the wavelength out in space—but the currents in the receiver—which the listener can hear. Then again, the wavelength listings were irregular and had to be given with at least four figures and a decimal point. The frequencies are given in three or four figures, and the last one is always a zero, because the frequencies are spaced in multiples of ten. But they start at 550 and stop at 1500, and the system is still far from being simple for Mr. Average Listener to understand.

Some manufacturers have tried to put these strange numbers on the dial of the receiver when it was built. Then if you knew and could remember the wavelength or the frequency of the

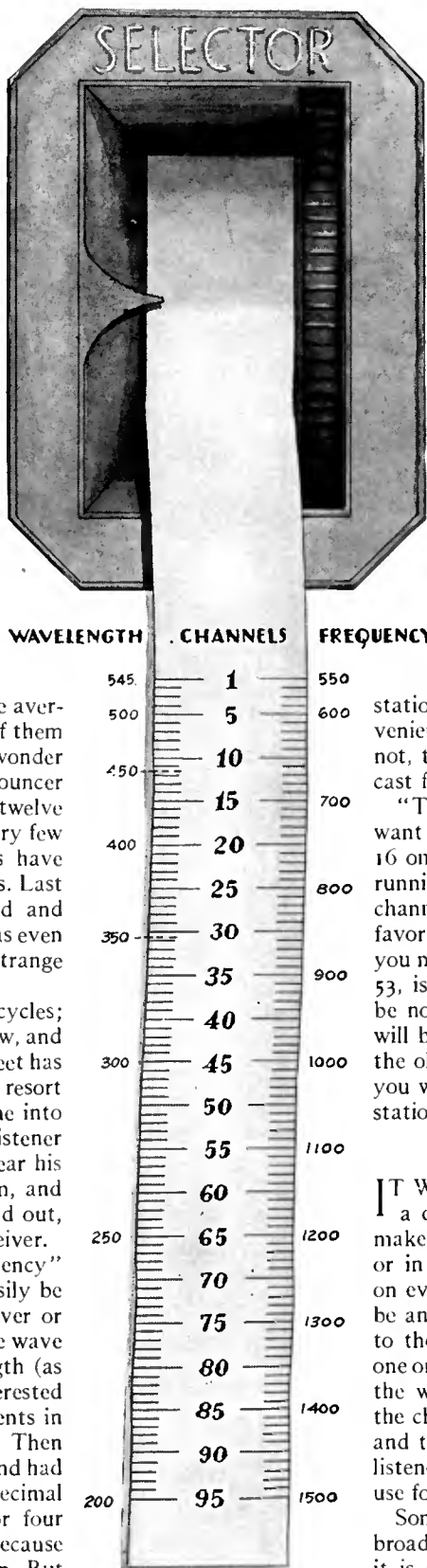

station you wanted to get, you could set the receiver to that point, and there was the station. There were a lot of mechanical difficulties in doing this, but more than anything else, it was the complexity of the numbers themselves that kept the conventional "zero to one hundred" dial on the sets. Here, of course, is another set of numbers, that must be read from a dial and related to the wavelength or the frequency or the call letters of the stations. It is no secret that the average listener does not know to whom he is listening, or how to find a particular station, except in the case of a very few that are near to him. The others are too hard to find, and many that he could hear and hear well, he does not bother with.

It would be possible to record the locations of our homes and places of business by their latitude and longitude. Your home address, for example might be given as "north 43° 28' 37.42", east 76° 18' 58.13". That would be just about as easy and just about as logical and just about as technically correct as wavelength in meters or frequency in kilocycles for a broadcasting station. But our houses and our offices are conveniently numbered and so are our telephones. Why not, then, use plain simple numbers for the broadcast frequencies and wavelengths?

"This is station xyz on Channel 16." When you want station xyz again, you will turn to the number 16 on the dial. There will be numbers on the dial running from 1 to 96, representing the 96 broadcast channels. You will soon remember the fact that your favorite stations are at 16, 23, 38, 67, and 84. If you notice in the paper that station PQR, on channel 53, is giving an unusually good program, there will be no difficulty about finding it. And the numbers will be the same on all receivers. When you trade in the old set, or when you go over to John's house, you will not be at a loss to know where to find the stations.

A DIAL WITH NINETY-SIX NUMBERS

IT WILL be more desirable, of course, to arrange a dial with these simple numbers, than it is to make one that reads in frequencies from 550 to 1500, or in wavelengths from 199.9 to 545.1 with tenths on every one of the 96 of them. And there will not be any unnecessary "meters" or "kilocycles" tied to them. They will just be plain numbers like the one on your front door. You can have a table showing the wavelengths and frequencies corresponding to the channel numbers if you want it; the newspapers and the magazines will print them. But the average listener will not want any such list; he will have no use for it.

Some day the range of frequencies allotted to broadcasting may be increased. When this is done, it is almost certain to be in the direction of the short waves. Then our series of 96 numbers will have to be continued, from 96 up. By starting the number series at the long-wave or low-frequency end, we shall leave room for expansion into the short waves, and we shall also have the smaller numbers for those channels now assigned to the larger and more widely known stations.

RADIO RECEIVERS for \$175 or less

GOOD NEWS for the AVERAGE CITIZEN

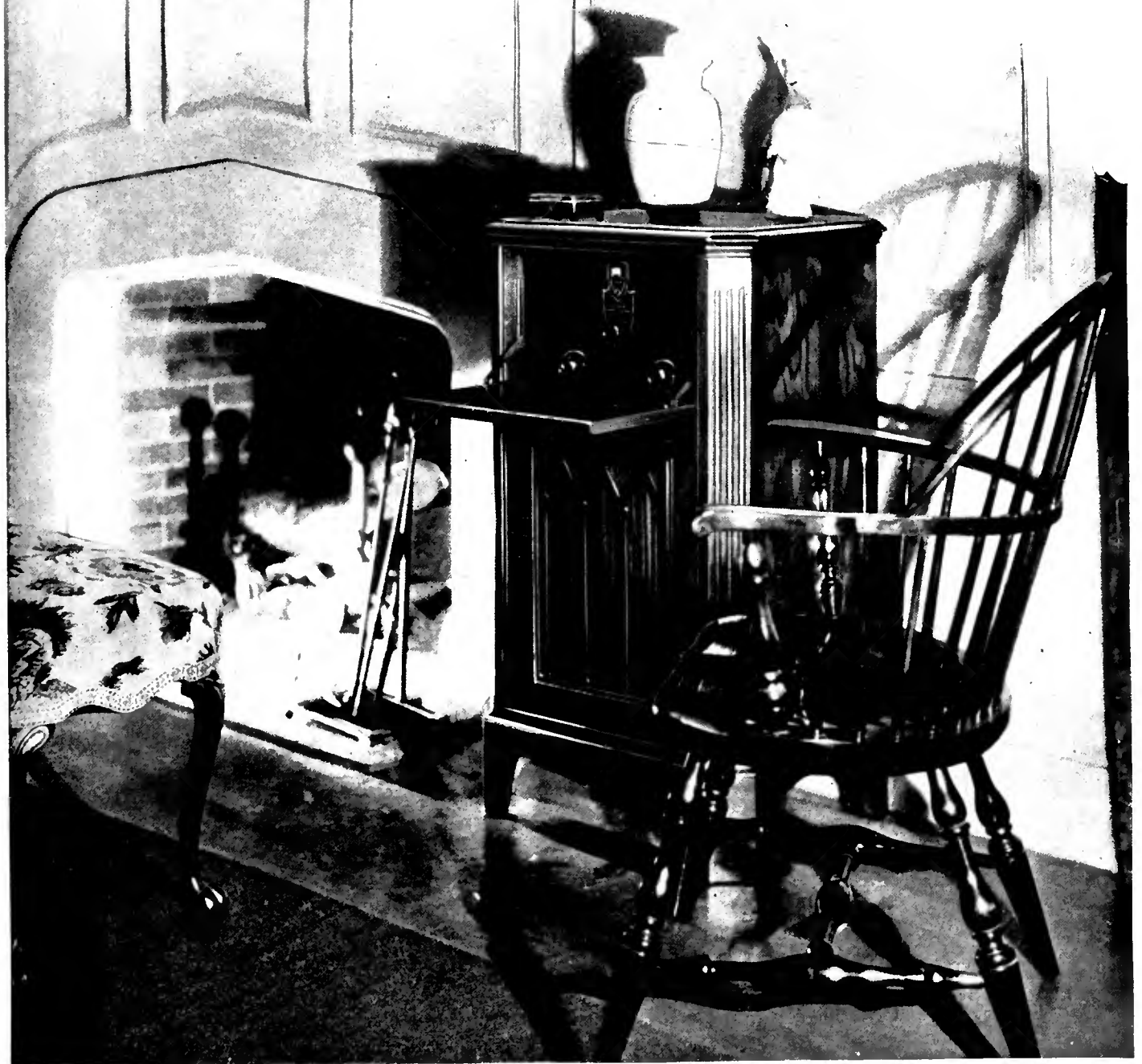

IT IS an erroneous impression that to possess a modern radio receiver combining both artistic merit and fidelity of reproduction one must spend an inordinate amount of money. The fact is that set makers have produced electrically good receivers and housed them in cabinets that will grace any home—and all at a genuinely moderate price. This and the following pages show attractive moderate-priced receivers ranging in cost from \$175 to less than \$100. The inspiration for the Bosch 76 receiver shown above is Gothic and it is evident how effectively it may be combined with the furnishings of many a living room. This six-tube RFL circuit receiver uses either a loop or antenna and has an interesting volume control and vernier tuning adjustment. Its price is \$175

THE "MILAN"

A cone loud speaker is supplied with this Apex receiver, the price for chassis, cabinet, and loud speaker, being only \$135.00. The circuit comprises six tubes, the audio amplifier employing impedance coupling, which is responsible for excellent quality of reproduction. The set is fully shielded and a single dial controls the tuning.

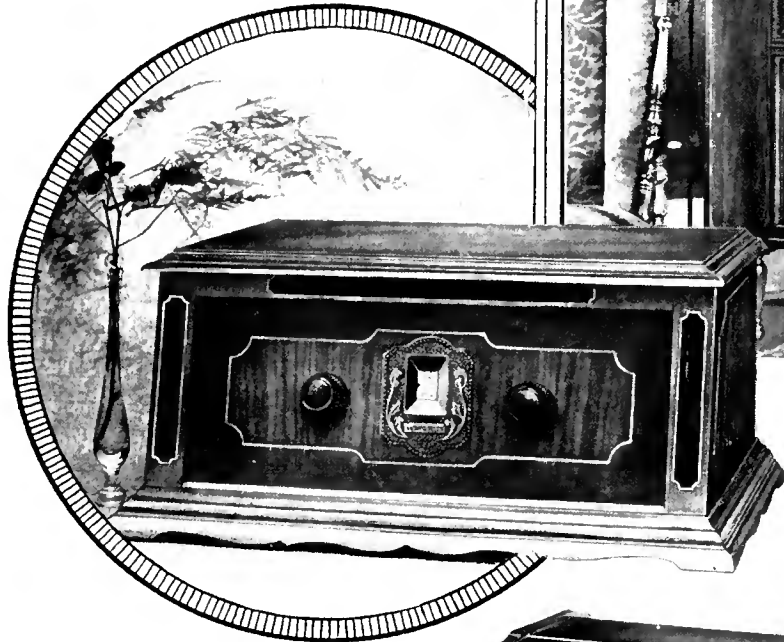

FOR LESS THAN \$100

The Workrite 17 has an all-metal chassis, shielded r. f. coils, single-control illuminated drum dial, and a combination switch and volume control. Price \$95.00

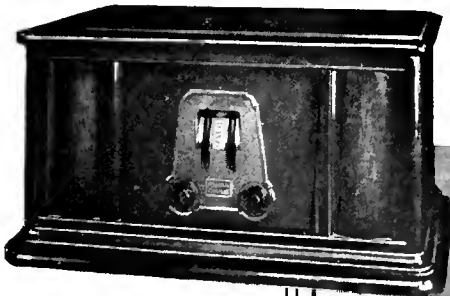

WHAT \$70.00 WILL BUY

A table model of the Freshman "Equaphase." As described elsewhere in this issue of RADIO BROADCAST, the "Equaphase" principle makes possible the elimination of the cause of oscillation.

THE "IROQUOIS" CONSOLE

This attractive six-tube, one-dial receiver, by Mohawk of Chicago, retails for \$130.00, less accessories, for battery operation. For electrical operation the receiver may be obtained at an additional cost of \$110.00, in which case it is complete with accessories.



BELOW
The Kennedy "Coronet," priced at \$125.00. Seven tubes, including four matched r. f. stages, are used.

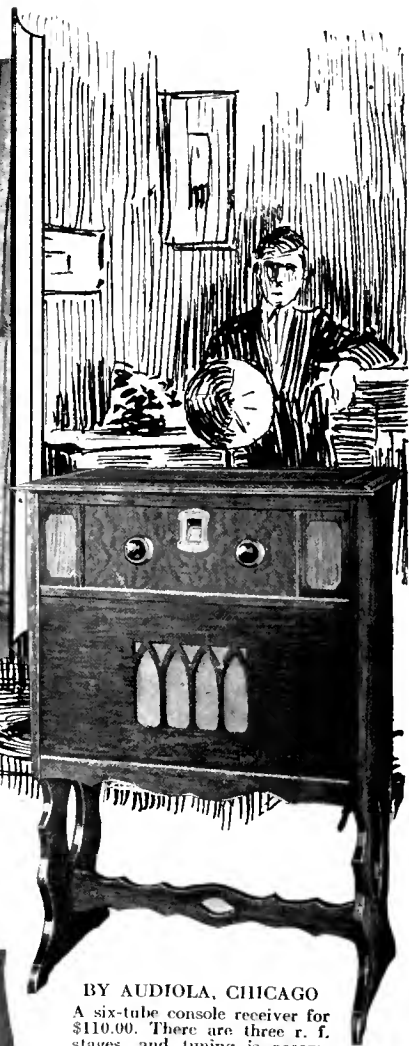

BY AUDIOLA, CHICAGO
A six-tube console receiver for \$110.00. There are three r. f. stages, and tuning is accomplished by means of a single knob.

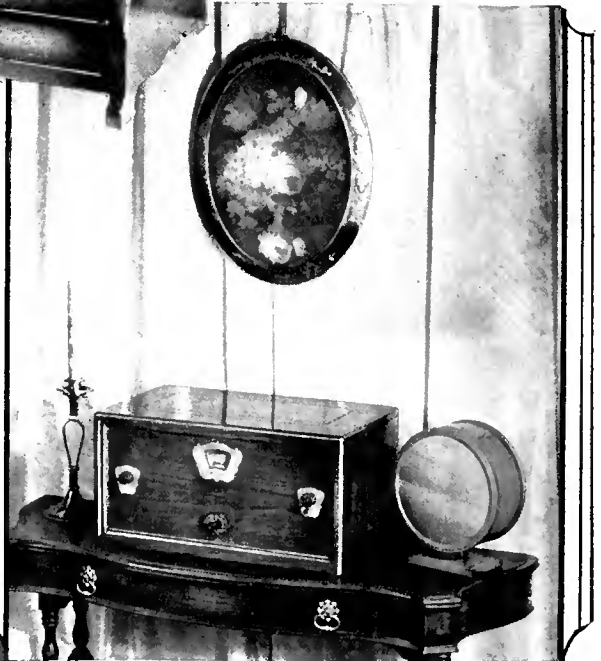

AN EXAMPLE OF COMPACTNESS

Here is a six-tube receiver by Stewart-Warner which is offered at \$80.00. There are three r. f. stages, one of which is autuned. A single dial controls tuning, but there is an auxiliary one for bringing the antenna circuit into exact resonance, and also a volume control.



McMILLAN'S "RIDGEWAY"
 Yet another shielded six-tube, single-control receiver, this one being priced at \$110.00. A long air column and deep-toned horn are included. There is ample space for batteries or power equipment

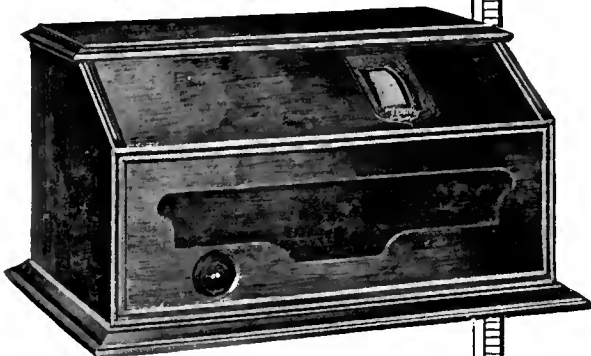

ZENITH MODEL 12
 Single control is again manifest in this six-tube receiver, four variable condensers being manipulated by a simple movement of the illuminated dial. The chassis is of metal, and the receiver is completely shielded. The cabinet is of mahogany. Price \$100.00

OF THE NEUTRODYNE FAMILY

For \$100.00 it is now possible to obtain a single-control neutrodyne receiver. The Freed-Eisemann NR-9 is such a receiver and, in addition to the single-control feature, it is completely shielded and has a pilot light on the front panel. Equal amplification throughout the broadcasting frequency spectrum is claimed by the manufacturers



BY SPLITDORF

This is a receiver for the man who still believes in two-dial tuning. There are six tubes in all, three of these being r. f. stages. It is wired for use of a power tube in the last audio stage. The price is \$75.00. The elliptical cone shown is priced at \$35.00



RELOW

The "Warwick," at \$138.00, is one of the offerings of Amrad for the 1927-28 season. It is a single-control neutrodyne, completely shielded, and may be used with either loop or antenna

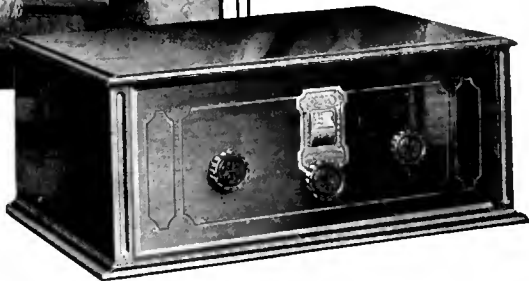

What Receiver Shall I Buy?

THE moderate-priced receivers exhibited at radio shows throughout the country this Fall are attracting widespread attention because the offerings in this class more than those in any other price range present greater values than ever before. Radio is now old enough so that those who bought radio sets two and three years ago are now thinking about replacing the old outfit with a more modern and satisfactory one. These pages show a few of these decidedly interesting receivers which can be had at a moderate price and which at the same time guarantee excellent electrical performance. These receivers are simple to control, more than ordinarily compact, and what is of growing importance, are handsome. There are table receivers for those who have but little space for a set, and more pretentious console sets for those who want both a radio receiver and an attractive piece of furniture. Practically all the console models in the medium-price range not only provide space for a loud speaker but also have convenient compartments for A and B socket power units and the convenient relay switch which, through the on-off switch on the receiver panel, controls both A and B units. Many buyers are interested in the console set with these compartments because they can at any time purchase A and B units for their set and, in effect, completely "socket-power" it.

A HOLA CONE

Here is a table model of the well-known Rola cone loud speaker, retailing at \$28.50. This unit is equipped with a low-pass electrical filter for the elimination of tube distortion. The heavy turned-wood disk serves as an acoustical baffle surface.

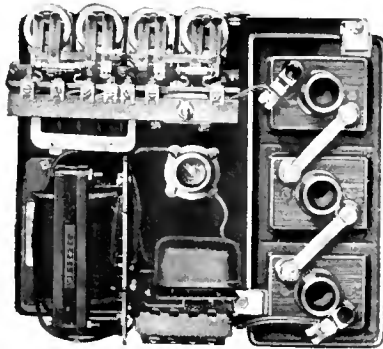

FOR A AND B CURRENT

This Phileo power unit will provide 180 volts at 60 mils., and therefore is adequate for a receiver employing six or more tubes, with a power tube in the output stage. The unit, costing \$79.50, is supplied in an attractive metal case. A built-in trickle charger keeps the A battery in good condition.

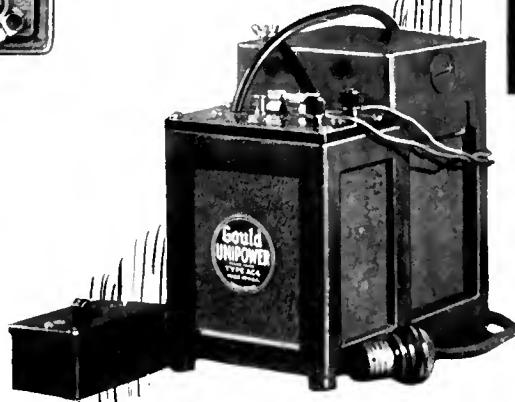

A CONSOLE LOUD SPEAKER

The exponential horn type of loud speaker, of which this is an example, is becoming increasingly popular, due to its excellent reproducing qualities. The one here is by Temple, Chicago, and lists at \$65.00.



THE "UNIPOWER"

A trickle charger and storage battery are combined in this useful device, by Gould. It may be obtained in either a four- or six-volt output form.

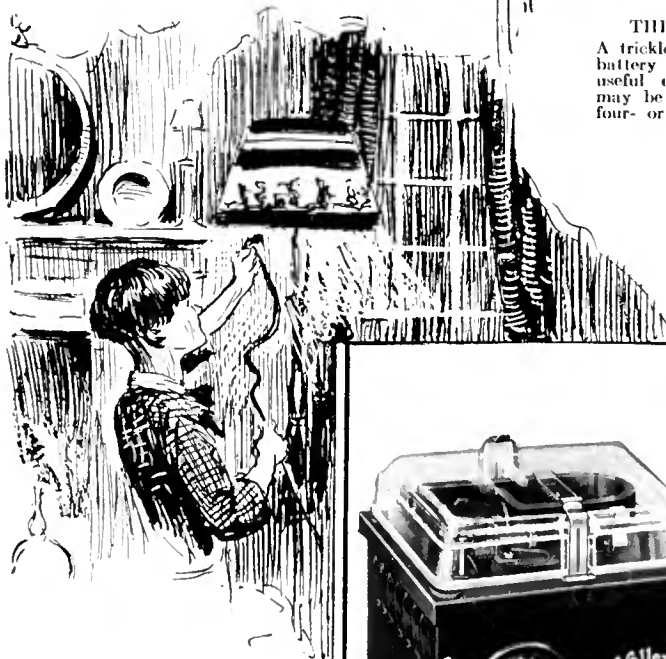

AN INEXPENSIVE CHARGER

A six-volt storage battery may be quickly charged with this device, a product of the Valley Electric Company, St. Louis. The charging rate is 6 amperes and the price, \$19.50.

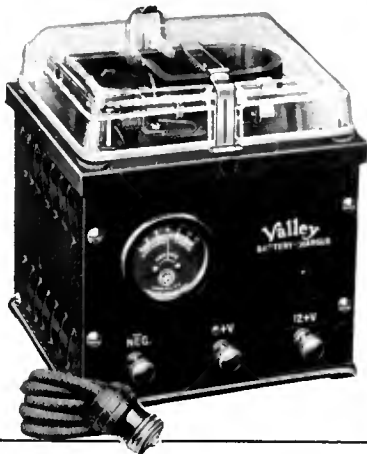

FOR A AND B CURRENT

Another device which is capable of converting your a. c. house current into suitable power for your receiver—by Exide. The B output is 180 volts maximum, while the A supply is six volts. A trickle charger keeps the A battery well charged. The approximate cost of operating this device is one cent an hour.

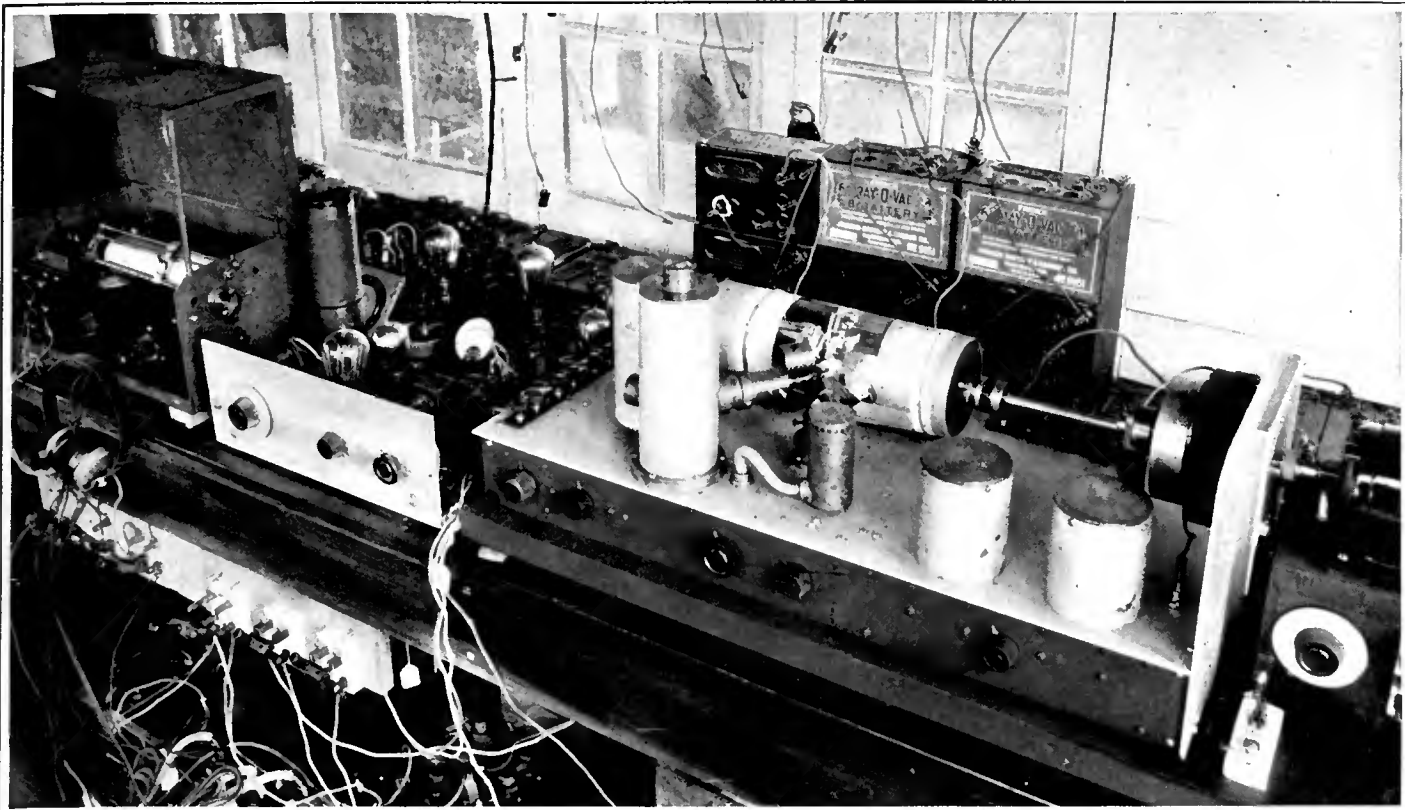

RADIO BROADCAST Photograph

AN EXPERIMENTAL SET-UP

This photograph, taken about four years ago in RADIO BROADCAST Laboratory, shows some of the early photograph transmission and reception apparatus designed by the author

How the Cooley "Rayfoto" System Works

By AUSTIN G. COOLEY

THE articles announcing a system of radio picture reception appearing in the September and October issues of RADIO BROADCAST have attracted widespread attention among radio experimenters. Even without specific data as to the actual operation of the Cooley "Rayfoto" system, experimenters have been fairly besieging the writer since the appearance of these articles and the demonstration of the "Rayfoto" transmitter and receiver at the New York Radio Show.

All the obstacles to making this new field available to the experimenter are being removed, one by one. Engineers are busy designing components and manufacturers are busy getting into production to meet the demand. And, for the broadcasters, an important method of supplying broadcasting stations with "picture" programs has been evolved. In this article we shall sketch briefly just how the Cooley "Rayfoto" system functions, what each part does, and what its purpose is. These technical details will give the experimenter a clear picture of what the difficulties are and what technical knowledge is needed for him to assemble and operate the apparatus. The Cooley "Rayfoto" recorder is no more difficult to build than a five-tube receiver.

THE SYSTEM IN BRIEF

IN A few words, the cycle of transmitting and receiving a "Rayfoto" picture is as follows: The subject, any ordinary positive or negative print, is placed on the drum of the transmitter or convertor which revolves and feeds it along a

shaft before an optical system, which, in turn, focuses the reflected light on to a photo-electric cell.

The amplified currents from this cell are 800-cycle audio-frequency currents varying in amplitude in accordance with the subject. These currents control the radio transmitter output and the signals are received on a conventional broadcast receiver. They are then fed into the "Rayfoto" printer which produces a corona discharge in accordance with the strength of the received signal. The corona discharge

All you need for picture reception is a standard receiver, an oscillator, a stop-start motor mechanism, photographic paper, and enthusiasm. The important part of the receiving mechanism is the motor mechanism. With oscillators and receivers we are all familiar. The motor mechanism and all other necessary components duly approved and labelled with the Cooley Rayfoto label will soon be on the market. Those eager to be the first in their communities to receive pictures by radio may send their names and addresses to RADIO BROADCAST and these will be sent to the manufacturers making the parts. The total cost will not be more than \$100.—THE EDITOR

takes place at the point of a corona needle which feeds along a revolving drum as the needle traces over a photographic paper wrapped around the drum. At the end of each revolution of the drum the received signals are diverted from the printer unit to a relay which is actuated when a synchronizing signal is received at the beginning of the revolution of the convertor drum. This relay in turn operates the trip magnet which releases the recorder drum so it may start off at the same time as the convertor drum. After the needle has fed along the entire length of the paper, the latter is removed from the drum, developed, washed, fixed, and washed again. The result is a picture of a prize fighter who has been knocked out a few minutes before; or a picture of a railroad wreck just occurred; or maybe a picture of some sweet young thing who may have won a bathing beauty contest in the afternoon.

Phototelegraphy is not complicated and involves nothing that is really new in physical science, but many of the "kinks" involved must be well understood if good initial success is to be expected. Most of the difficulties ordinarily involved in picture reception work will be prevented because manufacturers will supply equipment especially designed for the purpose and if the experimenter understands the principles of the system and can handle amplifier and oscillator circuits, he should have no difficulty in setting up his "Rayfoto" recorder and having good picture reception right from the beginning.

All systems of phototelegraphy have one

limitation in common: They can transmit only one shade and one unit area of the picture at a given instant and therefore transmission must be accomplished by dividing up the subject to be transmitted into thousands of small areas.

The "Rayfoto" and many other systems transmit the signals for each unit area in rapid succession and the resultant signal varies in amplitude in accordance with the shading of the picture. The speed at which the impulses are transmitted depends largely upon the ability of the receiving apparatus to reproduce rapidly the electrical impulses on the recording medium. The corona method of printing used by the Cooley "Rayfoto" system is capable of printing faster than any other system the author knows of, but for simplicity and low first cost we are using a signal frequency of about 800 cycles per second, which does not permit printing as rapidly as is possible with the system when higher frequencies are used. The possibility of operation at higher frequencies has been taken into consideration in designing the present equipment so that the speed of transmission can gradually be increased without necessitating any radical changes in equipment.

As explained in the October issue of RADIO BROADCAST, the picture or subject to be transmitted is placed, at the transmitting station, upon the drum of the picture transmitter, which we will hereafter call the "convertor." A small spot of the picture is illuminated and the reflected light from this spot actuates a photo-electric cell, the signals from which control the radio transmitter after the photo-electric cell currents have been sufficiently amplified. Each time the drum is revolved, the spot of light traverses a different path an eightieth of an inch wide across the picture. The line is broken up into 480 sections by the optical system so that 480 electrical impulses are transmitted every revolution of the drum and each impulse corresponds in intensity to the reflected light from a small area of the picture. The result is that 480 electrical impulses are transmitted for each

revolution of the drum, or about 800 per second when the drum is making one hundred revolutions per minute. Running at this speed the drum feeds along the shaft T, Fig. 1, at the rate of one and a quarter inches per minute. The drum is two inches in diameter and about five inches long. This will give us an operating speed of four minutes for a five-by-six-inch picture.

The beginning of each revolution is marked by an impulse made up of twenty strong 800-cycle signals in succession. This impulse is used at the receiver to start the recording drum off at exactly the same time as the transmitter drum, for it is necessary that the two drums start off together. To accomplish synchronism in this way, known as the "stop-start" method, the recording drum must start a revolution at the same instant as the transmitter drum. It is necessary that the recorder drum run slightly faster than the convertor drum, then stop at the end of the revolution for an instant until the convertor drum completes its revolution. A trip magnet operated by the strong synchronizing impulse releases the recording drum at the proper time.

This trip magnet is operated through a relay which is connected to the rest of the system only after the revolution of the recording drum has been completed. Between the time the recorder drum stops and the time the synchronizing impulse is received, there must be no strong signals received, so we paste a strip of white paper at the end of the picture being transmitted so the signals will be weak while the recorder drum is stopped. Should a crash of static or some other disturbance be received during this waiting period, or "recorder lap," as it is called, the recorder drum will be released in advance of the synchronizing signal. By making the recorder lap very small, the danger of such a "static slip" will be reduced proportionately. The wider the white strip on the picture being transmitted, the greater will be the chances of a good start after a static slip so that the only marring effect will be one line slightly out of place.

We will consider here a few of the principles involved that affect the characteristics of the received picture. In picture work, we wish to reproduce at the recorder shades of light and dark corresponding exactly to those of the transmitted subject. The light reflected from the subject varies the current through the photo-electric cell in a ratio almost directly with the intensity of the light, and this current, after amplification, is made to control the power input to the radio transmitter modulator which therefore varies directly proportionately to the reflected light, due to the characteristics of the Heising modulator.

The final modulated radio signal sent out over the air will vary as the square root of the reflected light. The received signal is amplified lineally in the radio-frequency stages of the receiver. The detector output varies as the input squared, however, and therefore the current in the plate circuit of the detector will be directly proportional to the reflected light. The signal then can be amplified in the audio amplifier and delivered to the "Rayfoto" printer with an intensity directly proportional to the reflected light at the transmitter.

Limited by the data available at the present time, this is as far as we can go with the signal and know definitely what we are doing in the way of maintaining the proper signal ratio through the various circuits. We have no exact data on the relation of the input to output of the Cooley "Rayfoto" printer. Also we do not know the relation of the power delivered by the "Rayfoto" printer to the effect it has on the receiving paper. This factor is quite flexible and can be controlled considerably by the selection of the printing paper and its time of development in the photographic solutions. The printing paper we recommend today probably will not be the paper you will be using next year. It is therefore necessary to have some control over the system so we may match our amplification characteristics to conform with those of the recording paper we may choose to use. For example, if the received picture does not show sufficient contrast in the lighter shades but too much in the darker shades, we must adjust our amplification characteristics to correct for this. One way it can be done is to reduce the filament voltage on one of the amplifier tubes so that the strong signals are cut off somewhat by running over the top knee of the characteristic curve while the signals of lower value are on the straight portion of the curve. Additional correction may be obtained by reducing the time of development in the photographic solution.

The most convenient place for signal characteristic control is in the detector circuit, because of its "squared" characteristic. This characteristic may be varied considerably by proper proportioning of the grid condenser and grid leak. If the grid leak can be brought down to a very low resistance, say 500 ohms, and the plate voltage made adjustable over a range of from 4 to 40 volts, additional control of considerable value will be gained. Instead of varying the plate voltage, a variable grid battery may be used.

EFFICIENT AUDIO STAGES NECESSARY

A GOOD picture must not only represent exact shadings of the subject but it must also show up most of the small details of the original. A poor audio amplifier system will blur up the details in black shades and will not permit any of the details in the light shades to appear. The amplifier must not oscillate at any audio or super-audio frequency or even tend to oscillate. Oscillations in audio amplifiers most generally occur because of feed-back through the B batteries from one stage to another and can be pre-

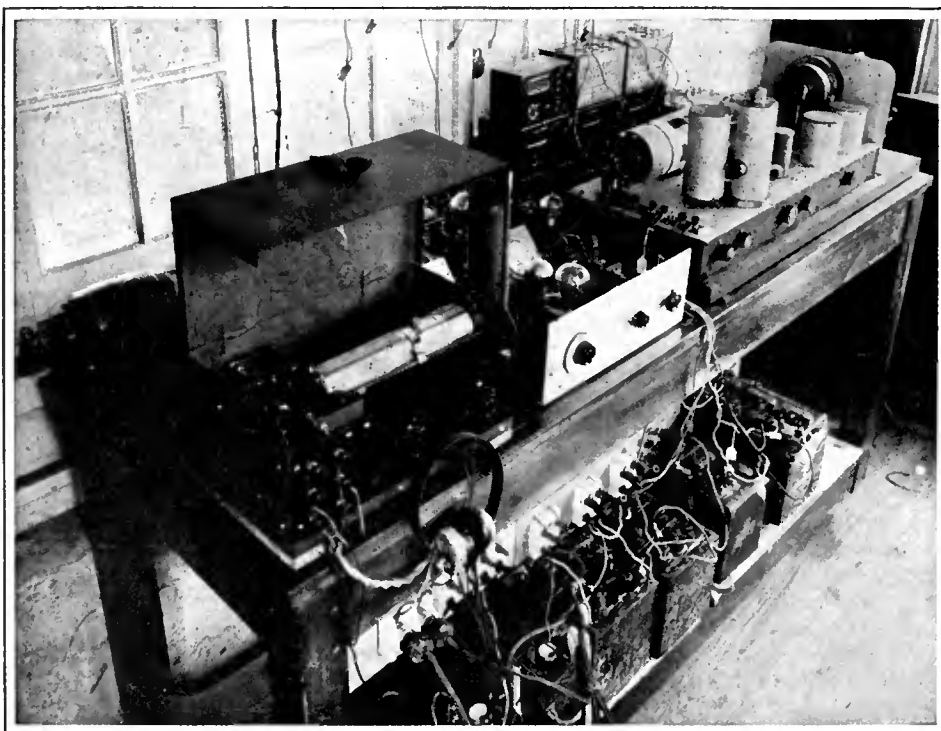

RADIO BROADCAST Photograph

SOME EARLY "RAYFOTO" EQUIPMENT IN RADIO BROADCAST LABORATORY

The apparatus on the right of this picture is a Cooley photograph transmitter and in the center is an amplifier and "corona" apparatus. The picture receiver at the left has been redesigned in many ways to make its operation as simple as possible. This apparatus was photographed four years ago

vented by the use of low-resistance batteries, a very large condenser across batteries of moderately high resistance, or by the use of independent batteries for the audio amplifier. The first pictures transmitted will contain sufficient contrast so that imperfect amplifying characteristics will not appear very noticeable. Nevertheless, the progressive experimenter should try to keep one step ahead of the game.

The plate current drain on the B batteries due to the Cooley "Rayfoto" printer will be about 10 or 15 milliamperes, so that the total current drain of the printer and an ordinary five-tube receiver will be in the neighborhood of 45 milliamperes. However, this additional drain of 15 milliamperes will only be present when the printer is being used and, since it will not be operated for long periods at a time, an ordinary set of B batteries should be good for many months of service. A total voltage of about 200 volts is required.

Naturally an amplifier that can be operated without oscillating is much more efficient than one that tends to oscillate and which therefore requires the introduction of some loss to prevent oscillations. In many cases, however, it is more convenient to use an amplifier we already have and which can be "doctored" up a little to make it serviceable for "Rayfoto" work. A resistance across the secondary of one or more of the transformers will prevent the amplifier from oscillating. The required resistance may vary between 100,000 ohms and 2 megohms.

Many broadcast receivers have sufficient amplification in their own system so that additional audio amplification is not necessary. You may test out your receiver in the following manner to determine whether any additional amplification is required to operate the recorder: Place a milliammeter in the plate circuit of the last amplifier stage; cut the current down to 0.2 milliamperes by increasing the C battery potential; short-circuit the loud speaker terminals; then tune-in a local broadcasting station. If the milliammeter jumps up over 15 milliamperes, no additional amplifier stage is needed. Even if it only goes to ten mills, it will not be necessary to use the added stage but this amount of current will allow only a very small margin of safety.

If an added stage of amplification is required, a special transformer should be used, one that is capable of operating without saturation and which will not produce oscillations in the audio system. Special transformers for this work will soon be available.

The Cooley "Rayfoto" printer is the device for producing the corona discharge that affects the photographic recording paper. It converts the received audio-signal into a fluctuating source of light corresponding to the transmitted signal. This unit consists of a modulated oscillator feeding a corona coil. The corona discharges are secured from the high-voltage side of the corona coil secondary winding.

Readers may wish to have some explanation of the nature of the corona we refer to here. Visually, the corona discharge at the needle point riding on the paper is a small spray of blue sparks similar in appearance to those produced by a violet-ray machine. This discharge occurs when a difference of potential of 13,000 to 26,000 volts per centimeter (which, incidentally, won't hurt you) exist around the needle point. This potential is produced by the radio-frequency amplifying transformer, known as the corona coil. The primary of this coil is part of a vacuum-tube oscillator operating at a frequency of 333 kc. (about 900 meters). The plate circuit is supplied by the signals from the radio receiver. After being amplified to supply enough power to the modulation transformer, these signals are strong enough to produce a strong corona discharge when strong signals are received. For the sake of efficiency and shading, about one hundred volts of direct current is supplied, in series with the modulation transformer to the plate of the oscillator. This boosting voltage must not be sufficient to produce a corona that will print when weak signals are coming through.

The oscillator of the "Rayfoto" printer radiates for some distance if the frequency is high, and to prevent such interference we have chosen the reasonably low frequency of about 333 kc.

We do not recommend an oscillator frequency corresponding to more than this unless careful shielding is used.

The "Rayfoto" recorder is the mechanical unit of the system which consists of the receiving drum driven by a motor and controlled with a "stop-start" system of synchronizing. A screw feed arrangement feeds the corona needle along the drum as it revolves so that the needle moves along at approximately the same speed that the convertor drum as the transmitter moves along its shaft.

The "stop-start" mechanism consists of a slip clutch between the motor drive and the drum, and a trip magnet arrangement that stops the drum at the end of each revolution until the synchronizing impulse is received. This impulse trips the armature of the magnet which operates through a relay. By this system, the transmitter and receiver are synchronized about twice a second, thereby eliminating much delicate and expensive synchronizing apparatus.

The recorder drum is the same size as the one at the transmitter but since the recorder has a slight "lead," that is, runs slightly faster than the convertor drum, the received picture will be stretched out a small amount, depending upon the amount of lead. To compensate this, the gears between the drum and screw feed shaft will be of such a ratio that the needle will feed along a little faster than the transmitter drum so that the proper proportions are restored. As a result the received picture will be slightly larger than the one transmitted.

It is desired to keep the lead as small as possible so as to prevent excessive stretching of the picture. Also, if the lead is too much, the trip magnet may be tripped from a subject signal instead of the synchronizing signal. If the lead is too small, the synchronizing signal may be received before the recorder drum has finished its revolution and has switched the relay in the circuit. Consequently the relay will be operated by the next strong subject signal.

Complete constructional data for a Cooley "Rayfoto" receiver which may easily be made at home is scheduled for next month's RADIO BROADCAST.

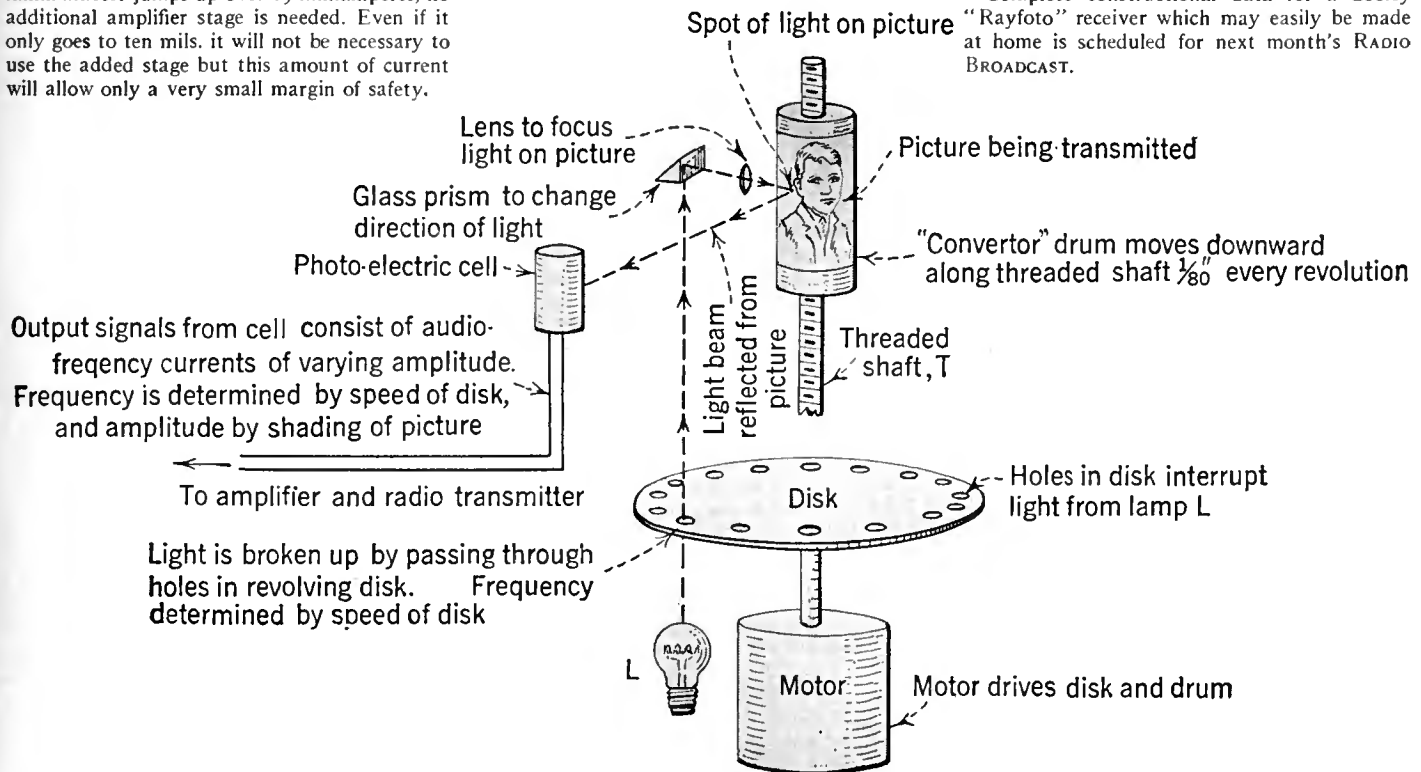

A PICTURE DIAGRAM OF THE COOLEY TRANSMITTER

This drawing shows graphically how the Cooley picture transmitter produces electrical signals varying in strength in accordance with the shading of the picture being transmitted

IN Stromberg-Carlson receivers, a manufacturing refinement, not evident to the casual ob-



server, is found in the cord connecting the set to the light socket. It is made with unusual care

REFINEMENTS OF THE MODERN RADIO RECEIVER

By EDGAR H. FELIX

THE modern manufactured receiver has become a precision product, built under most exacting conditions prescribed by skilled engineering departments. It is no longer a heterogeneous combination of parts, wired together in conformation to circuits supposedly possessed of magical qualities. Performance is the product of a thousand and one engineering decisions carried out with a care so far above and beyond that which the average buyer can appreciate that engineering refinements are no longer considered suitable as selling arguments by which to sway the buyer's preferences.

Where should the by-pass condenser across the filament leads be placed? Is the improved performance attained by placing it directly underneath the tube sockets sufficient to warrant a special moulding? Does a one per cent. difference in moisture content of the insulating paper of fixed condensers reduce losses sufficiently to justify an additional cost of twelve cents per receiver and does that involve an increasing percentage of condenser breakdowns? Should three more turns be used on the radio-frequency transformer primary to get slightly improved quality or does that involve a sacrifice in selectivity too great to be permitted under present broadcasting conditions? Should the audio-frequency system be designed to cut off at 5500 cycles or at 4800, in the first case giving slightly improved reproduction; in the other, slightly reducing the effect of certain types of interference noises?

It is such highly technical questions as these, clouded in a veil of mystery to all but the experienced radio engineer, that makes one radio set better than another. The placing of a socket half an inch one way or another may make an

imperceptible difference in performance, but it is the multiplication of such details, carefully determined after engineering study, that assures the buyer of his money's worth.

In a sense, we have come to a parting of the ways between the factors that make real radio performance and those which make up the buyer's mind between one radio set and another. There is a premium on the little, superficial improvements which the buyer can appreciate because they are the only practical ways of expressing engineering ingenuity to the ultimate consumer.

ONE REFINEMENT OF FADA

THE Fada receivers of this year, for example, employ a new simplified power switch and volume control, an obvious convenience which any prospective purchaser will appreciate. One control takes the place of two. Hidden in the beautiful cabinet, is a chassis made of $\frac{1}{8}$ inch pressed automobile body steel. It is supported on a three-point suspension with absolute rigidity so that the parts mounted in it cannot get out of alignment. The accurate matching of variable condensers contributes not only to selectivity but to quality of reproduction. In past years, an accuracy of one per cent. in capacity throughout the tuning range has been considered satisfactory. The Fada condensers are matched to an accuracy of $\frac{1}{8}$ of 1 per cent. and the same standard is applied to the tuning inductances coupled with them. These are a few of the hidden values which make for good performance.

The shaft on which the tuning drums and variable condensers are mounted is one-half-inch flash copper plated piston rod steel and is gauged to a tolerance of .0005 of an inch! The day of the

curtain rod condenser support is over. The pistons in your automobile are gauged to no closer tolerance.

Advertisements shout uniformly about the most selective receiver with the best tone quality, but give the discriminating buyer no real facts to help him appreciate the performance of a receiver. Generalities may sell the uninformed and help to create name familiarity, but sterling worth, built in by ingenious engineering and painstaking manufacture, is hardly ever conveyed to the reader of advertising.

GOOD THINGS YOU DON'T SEE

ANOTHER instance of superficial selling points which make an obvious appeal to the uninformed buyer and the equally important hidden refinements which contribute even more significantly to good performance is found in the Freed-Eisemann receiver. Several models are equipped with a voltmeter so that the set owner can readily check the A, B, and C voltage applied to every tube of his receiver. Since accurate voltage supply is of vital importance in the performance of the receiver, the selling value of that feature is obvious. But how many buyers know of the two special bonding clips which ground the shielding of the detector stage in order to dissipate more readily the radio-frequency currents generated in that shield? It is a minor point, but an expression of the engineering care which makes the modern radio receiver.

Recently, the writer visited the Stromberg-Carlson factory at Rochester, New York. A complete understanding of the refinement which is concealed in the cabinet of the Stromberg-Carlson receiver hardly ever penetrates beyond the monument to engineering skill and idealistic

production standards which that new factory actually is. One could write a thousand words on how the cord by which you tap the a. c. power line is made! Only a detail, but it assures unflinching service for a period of years. It means no frayed cord and no breakdowns, an advantage which passes practically unnoticed in the attention of almost every buyer of that receiver. But to give him that advantage, special engineering standards have been set for every item of material used in the flexible cord. The fine copper wires which, woven together, make an everlasting cable, are ten times as strong as ordinary wire. Special flexible conductor, which does not break if sharply bent, is employed. The individual strands are so fine that they cut the finger like a razor blade. Covering these wires are insulating materials adding a factor of safety far above and beyond that considered necessary. And finally, selected cotton is woven over the insulating material, giving a mechanical strength so that the copper wire itself is relieved of most of its load. Last, but not least, comes an outer covering of silk so woven that there will be no untwisting of the cable and it will hold its lustre for a period of years. Outwardly, there is but little to distinguish this little engineering masterpiece from an ordinary power connecting cord which will fray, untwist, and break in the course of time, particularly if it must be pulled out each time the vacuum cleaner is used. Probably not one salesman in ten thousand selling the Stromberg-Carlson receiver ever considers this refinement—one of a thousand which conscientious engineering has built into that product.

SOMETHING ABOUT CONDENSERS

ONE feature which every radio enthusiast appreciates is the advantage of straight frequency-line tuning condensers over the straight capacity-line type. The desirability of even spacing of stations over the broadcast range is obvious. But, with the almost universal tendency toward multiple condensers, needed to obtain single control, the necessity for straight frequency-line condensers has caused many an engineer gray hairs. It is very difficult to secure uniformity in quantity with condensers having the peculiarly shaped plates necessary in straight frequency-line tuning. With straight capacity-line used in connection with matched inductances, uniformity is easily attained and tuning circuits readily matched. All that need be done to match the stages is to adjust the condensers at any point on the wavelength scale, after the receiver is assembled. Once that is done, absolute accuracy is likely to obtain at all dial settings. But straight capacity-line condensers mean that, at the short wavelength end of the dial, stations are hopelessly crowded, while, at the upper end, they are widely and wastefully separated.

A fine example of engineering refinement in meeting this problem is embodied in the Federal receiver. Condensers with square plates, sliding in rigid grooves, assure absolute uniformity of capacity variations and attain a standard of accuracy almost impossible to secure with condensers having specially formed plates to secure the straight frequency-line effect. But the buyer of a Federal does not sacrifice the advantages of straight frequency-line tuning by the use of these condensers. An ingenious and well designed gang tuning control mechanism gives him all the advantages of straight frequency-line tuning

The mechanism is a masterpiece of mechanical design.

Another example of true engineering beauty is embodied in the antenna tuning compensator which is a part of the mechanism. With multiple tuned circuits, the designer has the choice of several ways to compensate any variations in antenna capacity. He may use a broadly tuned antenna or input stage which gives but little or no amplification. Such a stage contributes its share of tube noise and accentuates nearby station interference. Or else he may employ a sharply tuned stage which has a separately adjusted compensating condenser. Of course, the most efficient and satisfactory method to the user is an antenna stage which tunes sharply and contributes its share of amplification. Those having receivers with a vernier antenna compensating condenser have noticed that, although they have a main tuning dial which gives the set the appearance of one control, they must actually adjust two dials—the main tuning control and the compensator—to tune-in a station properly.

With the Federal receiver, the compensator is geared with the main tuning adjustment and automatically keeps the antenna circuit in step with all the rest throughout the tuning range.

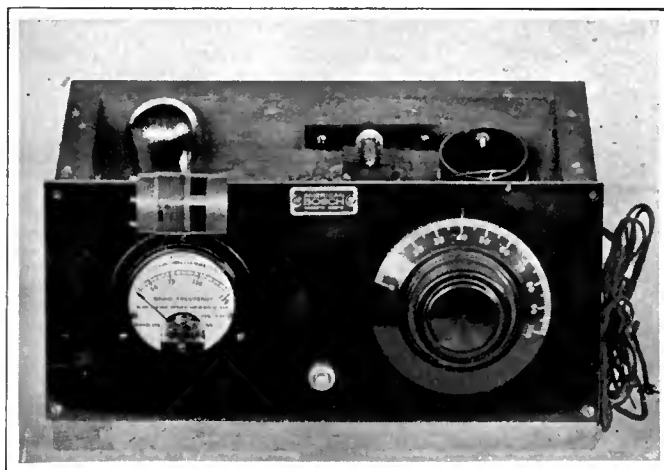

THE R.F. OSCILLATOR USED BY BOSCH TO MATCH COILS

The author would not be surprised to discover that the electrical law determining the correct compensating adjustment needed for all types of antenna systems and working out the mechanical arrangement which assures adherence to that law was a bigger engineering job than designing the entire radio set marketed in 1924.

All this engineering precision applied in design may be nullified by carelessness in production. The electrical and mechanical measurements made in the modern radio plant are of an order of precision unrivaled in any field of quantity production. Atwater Kent, for example, makes 150 precise tests, each requiring engineering knowledge to perform, in producing a single receiver. Some of these tests entail mechanical precision measurements; others electrical measurement of currents of mere millionths of an ampere. But every test contributes to the purchaser's assurance of reliable radio service.

MATCHING INDUCTANCES IN QUANTITY

HOW one manufacturer applies engineering precision to production is best expressed in the words of William F. Cotter, radio engineer for the American Bosch Magneto Corporation:

"The subject of sorting and matching of inductance coils is one to which we have given considerable thought. Its importance is recognized by every manufacturer. With one test

fixture capable of handling the job, it would be comparatively easy to install a check of the manufactured product and be assured of a high degree of accuracy. However, when two or more test fixtures are required to handle the volume of coils manufactured, and where it is desired to check these coils at radio frequency, a more serious problem presents itself.

"We have employed several methods over the last three years. The one I describe, however, represents our latest development and is the result of all our past experience.

"A radio-frequency oscillator is built up around the standard 201-A tube. Incorporated in the tuned circuit of the oscillator at nearly ground potential is a resistance of approximately 10 ohms. Across this resistance is shunted in series the coil to be tested and a variable condenser with its separate vernier condenser. When this series circuit is brought to resonance, the total resistance of the shunt circuit comes down somewhat in the neighborhood of the 10-ohm resistance, and one-half of the oscillation current is diverted to the series tuned circuit. Included in this tuned circuit is, of course, the usual thermo-galvanometer.

"By means of a properly chosen vernier condenser, the coils coming through can be checked for accuracy and sorted in as many divisions as experience shows necessary. However, while this is suitable for one test fixture, the problem of keeping two or three fixtures oscillating at the same frequency presented itself. Naturally, if the frequency of the individual oscillators varies, say 10 per cent, it is quite impossible to group coils together just by dial readings.

"We have solved this problem by building a crystal oscillator as one of the test fixtures. Other oscillators of ordinary type are built and each is equipped with a vacuum-tube detector. The oscillators are placed so that it is possible to couple in some of the energy from the crystal oscillator. By means of a headset, the operator adjusts his oscillator to zero beat with the crystal oscillator. Usually, it is not necessary to check this setting more than two or three times a day. By this method, coils may be checked and sorted with an accuracy of a few tenths of one per cent."

That is engineering refinement. It is the kind of "detail" which makes the 1927 radio receiver a precision product.

The broadest appeal to the radio buyer, and one to which most people respond, by and large, is the outward beauty of the product and the name reputation of the manufacturer. Faced, as a prospective buyer is, with numerous products attractive from these standpoints, he is easily swayed from one brand to another by superficial selling points. The more discriminating and intelligent buyer—and in the radio field, because of the host of persons who have a smattering of technical knowledge, this class is predominant and influential—looks to the hidden qualities, the expression of engineering ingenuity and manufacturing skill, as well as the performance qualities, in deciding between one receiver and another. The glittering generalities which have characterized successful advertising and have successfully built up huge quantity production, are at last beginning to suffer a reaction. There are too many "best" automobiles and too many "finest" radio sets. But facts, the refinements, the details, presented to those who can understand them, are indisputable evidence of inherent quality.

A RADIO receiver, as any engineer will tell you, is a complicated and highly organized machine, designed to perform several functions none of which is independent of the others. It is because of these interconnected functions that the engineer will wish he were in Europe if you ask him:

"What is the best radio?"

An automobile, on the contrary, is comparatively simple. It has but one function to perform, it must take energy in some inert form, say unconfined gasoline, and convert it into some other dynamic form which is useful in carrying someone somewhere.

To answer a question regarding the best automobile, then, is simpler, especially since the automobile industry has been established long enough for the most expensive car to be usually the best. Unfortunately, radio has not even this truth to go on, for, all things considered, the most expensive radio does not always pan out to be the best.

A radio must do three things, and therefore there are three problems of design. They deal with:

1. SENSITIVITY. The receiver must be sensitive enough to pick up the signals one wants and amplify them sufficiently to give good loud speaker volume.
2. SELECTIVITY. The receiver must accept signals from the one station the owner wants and reject all others.
3. FIDELITY. The loud speaker signals must be a faithful reproduction of the original in tone and in relative volume.

Thus a perfectly selective and sensitive receiver would pick up any station operating at any distance on any frequency, and would turn a deaf ear to all others, no matter how near the given station in frequency or distance, or how great their power. If the receiver has 100 per cent. fidelity of reproduction, signals as loud as the original would come from the loud speaker, and with all tones exactly as they originate in the studio.

Needless to state, there is no such receiver.

There are several reasons for this. As mentioned above, these varied functions of a receiver depend upon each other, and not always to the same degree. For example, an infinitely selective receiver would be in the present state of the art, highly unsatisfactory from the standpoint of fidelity. Advertising writers to the contrary, one cannot have something for nothing, even in radio.

There are those, however, who desire to know which of two receivers is the better, and among these are the reputable manufacturers themselves. It is for this reason that set testing methods have changed.

Not so long ago, when a receiver had been put together and wired someone took it to a test bench where it was hooked to batteries and an antenna. If signals came out of a horn somewhere the set worked. It was sent to the dealer at once. This was an obvious test.

The obvious, as we all know, is not always the best. In the case of good radio receivers, this older, obvious test has given way to more scientific tests which do not depend upon a smoke covered antenna or the often tired ears of a test man, but upon tireless and unemotional instruments.

In spite of the fact that these tests have been practised—sporadically, we suspect—in the better known laboratories, it has been only within the last half year that descriptions of them began to appear in the technical literature. So new is the industry that standard tests have not been developed, nor have engineers even agreed among themselves regarding even the nature of these tests. Probably while this is being read, committees of the various radio organizations and

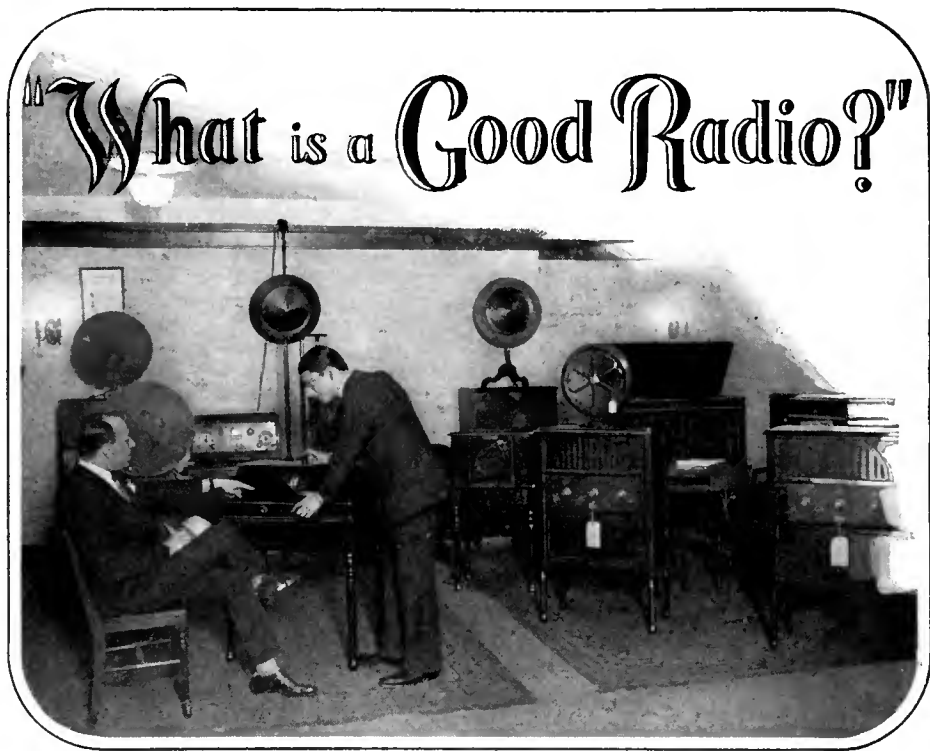

By KEITH HENNEY

Director of the Laboratory

radio engineering societies will be weighing conditions of test and endeavoring to set definitions of the perfect receiver, definitions that everyone will recognize.

WHAT HAPPENS INSIDE THE BOX?

NOW, before trying to find how much of anything a receiver does, it is well to get an idea of what happens inside the box, to discover if possible what should happen and how much. Then we shall have some idea of what to look for and what the relative order of magnitude will be. For example, harking back to the automobile, almost everyone knows that an automobile has a carburetor. Some people know what it is for; the writer does not. There is also a clutch and some other apparatus which everyone who is about to buy or run or design or fix a car should know all about. He should know what these various pieces of equipment are for, what happens if you leave some of them at home, and when the car runs properly, what the magnitudes of the various operations are. The quantity of gas and oil per mile, or hour, revolutions per minute, miles per hour, ability to climb hills, "pick-up," etc., are all terms that have both definition and dimensions.

A radio receiver also has several pieces of component apparatus. Each has a different function, and in each piece of apparatus something happens when the set is operating properly. What we must know first is what is each part for, how it does its work, and then how much should a good unit do? This will enable us to define a perfect receiver, and if we have laboratory equipment and patience, or if the manufacturers will supply us with the proper data, we shall be able to decide just where in the scale of goodness our particular receiver stands.

The inner works of the receiver, except superheterodynes, consist of three parts: a set of tubes which serve as radio-frequency amplifiers, boosting in magnitude the incoming signals without change in form and very sharply tuned; a de-

detector more broadly tuned which changes the signals into an audible form; and third, audio amplifiers which bring the detector signals to loud speaker volume. The last are not tuned at all, or at least very broadly.

The radio frequency amplifiers are intimately connected with the transmitting station. The receiving antenna or loop is situated in a reservoir of energy, part made by man, part by nature; part useful, part disturbing. A fair share of this energy is created by broadcasting stations which pour their output into what scientists call the "ether" and what the layman calls the "air."

The energy one wishes to receive speeds from the broadcasting station with the velocity of light, so fast that it may be heard from the loud speaker before it is heard in the rear of an auditorium in which the broadcasting may occur. This is because sound travels through air at 1100 feet a second and radio waves through the ether at 186,000 miles a second.

The receiving antenna is almost as intimately connected with the transmitter as if a wire joined them metallically, although less efficiently to be sure. What comes out of the transmitter sets up a voltage across the receiving antenna. Naturally, the stronger the transmitter, the nearer to the receiver, or the higher the receiving antenna the greater is the received voltage.

Here is where we start on our measuring expedition. How can we measure the relative strength of a transmitter at a given locality?

HOW RECEIVED ENERGY IS MEASURED

IN THEORY the problem is about as follows. The actual voltage across a given antenna is measured by the substitution method. That is, a given deflection on a meter is secured from the distant station. Then a voltage which can be read on another meter is substituted for the distant transmitter and when the proper deflection is secured the voltages are equal. The process may be changed as follows. The given deflection is secured. Then a much greater voltage, which

WHAT IS A GOOD RADIO?

NOVEMBER, 1927

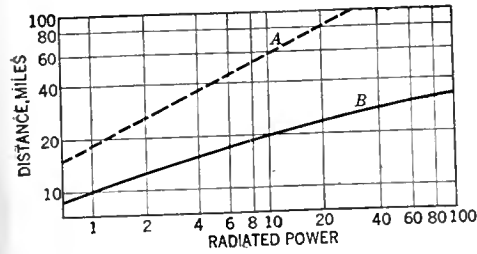

CONDITIONS UNDER WHICH SETS WORK

Estimates agree that a radio set must have delivered to its antenna a signal strength of between one and ten millivolts per meter for "good" service. This means that the received signal will then be strong enough to override ordinary static and local electrical disturbances. This curve shows the increase in power necessary at the broadcasting station to increase the range at which a field strength of ten millivolts per meter is delivered. Curve A shows the power required to lay down this field strength *without* any absorption of the wave; Curve B shows the unit power needed to lay down an equivalent field strength *with* all sources of absorption included. Note that at a distance of about 20 miles from the station, only about 1.1 units power is required for ten millivolts while, with absorption, ten units are required to produce the equivalent signal

can be easily measured, is cut down in known steps until the same deflection is noted. In this manner the field strength of a given station may be definitely measured.

Since the field strength at a given receiver varies with the antenna height, the usual basis of comparison is field strength per meter height. It is merely the actual voltage measured divided by the effective height of the receiving antenna. This is expressed in millivolts per meter and is a factor which is a measure of the effectiveness of a given transmitter at a given locality at a given time of day.

A given number of millivolts per meter will produce a certain loud speaker response with a given receiver. The more sensitive the receiver the greater loud speaker signal will be secured from a given field strength, or conversely, a given

signal may be produced by a weaker field strength the more sensitive the receiver.

What, then, may be considered a good signal? Here we are talking dimensions or magnitude. What we want to know is the field strength that will override static and other interference to produce a good lusty loud speaker signal, one that will be good, day or night, rain or shine.

The following table is taken from Dr. Alfred N. Goldsmith's paper in the *I. R. E. Proceedings* for October 1926 and shows what may be expected from various field strengths.

SIGNAL FIELD STRENGTH	NATURE OF SERVICE
0.1 millivolt per meter	poor service
1.0 " " "	fair service
10.0 " " "	very good service
100.0 " " "	excellent service
1000.0 " " "	extremely strong

So far so good. Let us see how powerful a station must be to deliver such a field strength over a certain distance. Again quoting from Doctor Goldsmith's paper we have the following data.

ANTENNA POWER	SERVICE RANGE
5 watts	1 mile
50 " "	3 miles
500 " "	10 " "
5000 " "	30 " "
50,000 " "	100 " "

There seems to be some regular progression here between the power and the range of station—in fact a law exists stating that the range of the station varies with the square of the power of the station. That is, to double the range we must quadruple the power. To increase the service range three times we actually increase the power the square of three or approximately ten times.

Now quoting Lloyd Espenschied in the *Bell System Technical Journal* (January 1927), we find:

Fields between 5 and 10 millivolts per meter represent a very desirable operating level, one which is ordinarily free from interference and which may be expected to give reliable year-round reception, except for occasional interference from nearby thunder storms.

From 0.10 to 1 millivolt per meter, the results

may be said to run from good to fair and even poor at times.

Below 0.1 millivolt per meter, reception becomes distinctly unreliable and is generally poor in summer.

Fields as low as 0.1 millivolt per meter appear to be practically out of the picture as far as reliable, high quality entertainment is concerned.

WHAT POWER DO STATIONS DELIVER?

FROM a given station the field strength falls off according to an inverse law, that is, if we double the distance we shall halve the field strength: "a 5 kw. station may be expected to deliver a field of 10 millivolts from 10 to 20 miles away and a 1.0 millivolt field not more than 50 miles away."

In a Bureau of Standards paper, "General Report on Progress of Radio Measurements," (April, 1924) the following data were published. When WEAF was transmitting with 3 kw., its field strength at 10 miles was 32 millivolts per meter. When WKBA has a nominal power of 10 kw. its field at 10 miles was 43 millivolts.

All of these statements may be expressed graphically and the curves on these pages contain much meat for thought. What everyone wants is good lusty signals from a high quality station, day and night, without resorting to regenerative receivers to boost the volume at the cost of fidelity, without being forced to listen to nearby poor quality stations riding in on an adjacent channel, or without having his program more than liberally punctuated with static or extraneous noises. It is up to broadcasting stations to produce a field strength that will insure programs and transmission of this desirable quality. It is up to design engineers to produce receivers that will serve their owners with loud speaker signals from the field strengths laid down by high quality stations. Mathematics alone is not infallible; some experiment and laboratory work must go with it to make certain all the factors have been considered.

Subsequent articles will deal with methods by which engineers check up on the soundness of their design; methods by which sensitivity, selectivity, and fidelity may be measured.

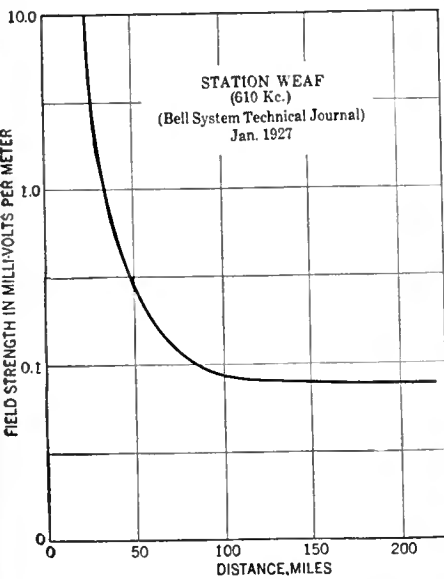

HOW FIELD STRENGTH DECREASES

This curve, from the *Bell System Technical Journal* graphically shows how the field strength of WEAF falls off with distance from the station. Any receiver, to be subject to tests which indicate anything, must operate under standard conditions, which are gradually being agreed upon

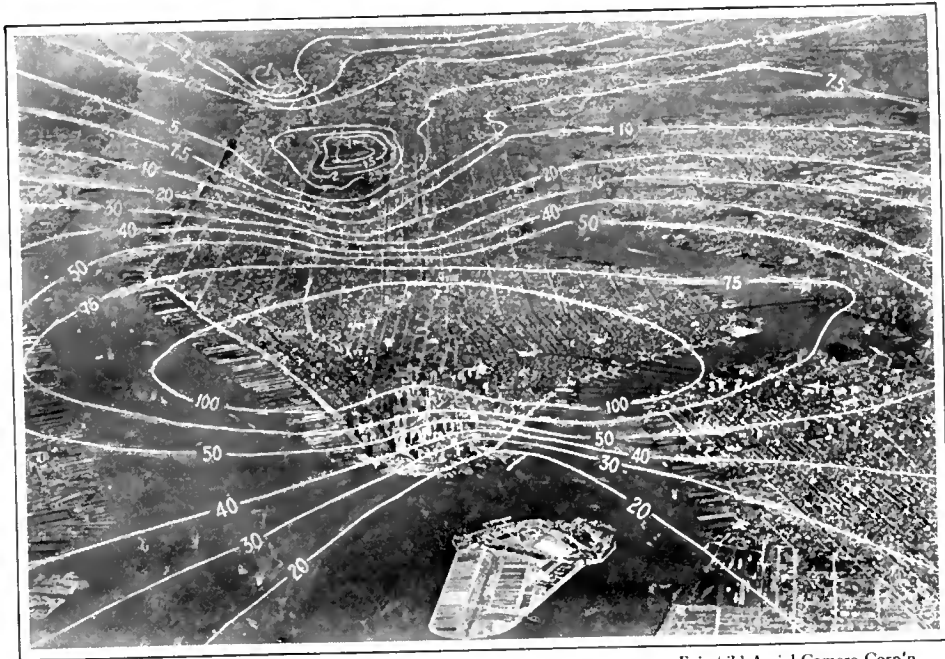

Fairchild Aerial Camera Corp'n

A RADIO "MAP" OF WEAF'S SIGNALS

Although made some time ago when WEAF was transmitting from Walker Street, New York, this illustration shows that in various parts of New York City WEAF signals were very faint indeed. A receiver, no matter how good, could not successfully "pull in" this station. The answer is greater power and location of broadcasting stations away from areas of great absorption

Do You Own a Battery-Operated Set?

Many Fine Types of A-Power Supply Units Are Now Available to Convert Your Battery-Operated Set to One Which Requires Almost No Attention

By HOWARD E. RHODES

NOT so long ago, the only way to heat the filaments of your tubes was to use a battery. And practically everyone who had a radio set had a storage battery; few indeed, even in the olden days, used dry cells to light their tube filaments unless that was a necessity. Then the storage battery passed through a cycle of development. The crude battery which radio borrowed from the automobile industry was dressed up. The case became polished wood or even glass and special precautions were taken by the makers to keep the acid electrolyte where it should be, for this battery was not to be housed in the interior regions of a motor car but in the parlor of high society. And now, to compete with the steady old battery come socket A-power units. What are they? How much do they cost? How many tubes will they supply? Do they need regular attention? Can a socket A-power unit be installed and be depended upon to light the filaments of the tubes "when, as, and if wanted"? These and goodness knows how many other questions are being asked by technical and non-technical radio folk these days as the offerings of 1927 are more and more widely announced.

The owner of a good radio set of some years back realizes that the tempting new 1927 models, operated directly from the light socket, probably are as superior to his outfit in convenience and performance as Whiskery is to Dobbin. But for one reason or another our loyal owner decides to keep his receiver. Can't he buy gadgets to turn his set into a light-socket outfit? Why not, for there are plenty of good B socket-power units and a goodly number of A socket-power units advertised? Well, so he can. He can buy a reliable A socket-power unit, a good B socket-power unit, a relay switch, and there you are—complete light-socket operation! He has achieved convenience which he seems to be pursuing strenuously. The economics of the change is another matter. Of the convenience and reliability there is no question.

Take the case of a set owner who bought a receiver a year ago. He may not be quite ready to buy a new outfit, but complete light-socket operation tempts him. His receiver must be operated by these A and B power units without any sacrifice in tone quality or volume. If the power units can-

not accomplish this—and for a reasonable length of time, without renewal of parts—they are not worth purchasing. There are, fortunately, many A-power units capable of giving as satisfactory reception as can be obtained from the unadorned storage battery.

The storage battery as a source of filament power is in many ways an almost ideal device. The current it supplies is perfectly steady. Its voltage is practically constant during a greater part of its discharge, and the slight decrease in voltage that does take place as the battery be-

charging A batteries is a serious annoyance to many radio users.

TWO GENERAL TYPES OF A UNITS

THE radio set can be operated from the light socket by the use of A and B power units, or by designing the receiver to operate with special a.c. tubes, receiving their filament current from the power mains. The purchaser of a new set finds his problem largely solved, for the makers of light-socket sets have engineered their sets beforehand. It is to the owner of a battery-operated set that this article is addressed.

A power units fall into two classes:

- (a) units using a rectifier and filter system connected through a transformer to the a.c. line. (See Table I).
- (b) units using a special storage battery in conjunction with a trickle charger. (See Table II).

The various A-power units listed in Table I are all essentially similar in design but they differ in minor ways that are of interest. All A-power units in Table I must contain (1) a step-down transformer (to lower the voltage of the line to the proper value required by the rectifier unit); (2) a rectifying unit (to change the reduced a.c. to a sort of d.c.); and (3) a filter system (to smooth out the product of the transformer-rectifier circuit). The filter must eliminate the "hum" which is always present in unfiltered, rectified a.c.

Enormous capacity in the filter condenser is necessary to remove this troublesome hum. With electrolytic condensers a capacity of 30,000 mfd. can be attained in a reasonable space and at reasonable cost, and such a large capacity as this is necessary for adequate filtration. The electrolytic condensers are shipped dry and when they are put into service, distilled water is gradually added to the condenser container. The contained chemical, which in some cases is potassium hydroxide, dissolves in the water. When it completely dissolves, the unit is ready for use.

These electrolytic condensers require practically no upkeep. Every six months or so a small amount of distilled water must be added. If the user is absent minded and lets the water get too low, the unit is not damaged, but indicates its need of attention by causing the unit to produce an audible hum which is heard in the loud speaker. If, "by a set of curious chances," too much water is put into the condenser unit, it will fail to function properly. Excess liquid can and must be removed with a syringe. When the water is first put into the condenser can some heat will be generated for a short time.

The Balkite and Abox units both use the form of electrolytic condenser discussed above. An interesting feature of each of these two outfits is that the chemical rectifier electrode is immersed in the same electrolyte used for the condenser. The outer plates of the condenser act as the second electrode of the electrolytic rectifier. This

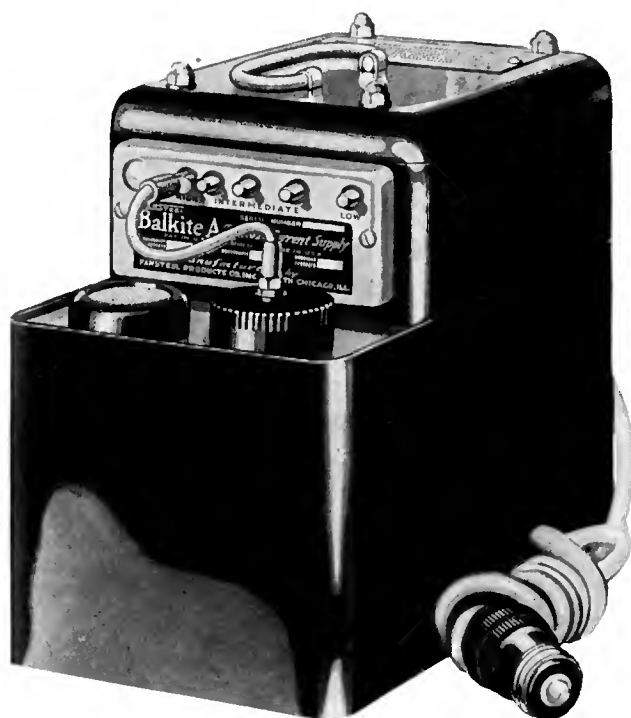

THE BALKITE A-POWER SUPPLY

This device will supply filament current to receivers having up to eight tubes and it requires practically no attention. Inside the case is a transformer and electrolytic rectifier and an electrolytic condenser. The list price is \$32.50

comes discharged does not affect the operation of the receiver adversely because tubes of present-day design will operate satisfactorily at slightly lower than rated filament voltage. Automatic A-power units have been developed because the public demands convenience. The necessity of

TABLE I

NAME OF UNIT	PRICE	TYPE OF RECTIFIER	MAX. NUMBER OF 1/2 AMP. TUBES UNIT CAN SUPPLY	POWER INPUT FROM LINE	SIZE OF CONTAINER L X W X H
Abox	\$32.50	Electrolytic	8	—	—
Balkite A	32.50	Electrolytic	8	100	11 1/2 x 6 1/2 x 8 1/2
Electron Electric A					
Regular	45.00	Tube	7	—	12 1/2 x 7 1/2 x 9
Giant	49.50	Tube	12	32	—
Marco A Socket Power No. 500	60.00	Tube	10	47	11 1/2 x 7 1/2 x 9
Sterling A Supply	42.50	Tube	8	—	7 x 11 x 8
Valley Socket A	39.50	Tube	12	36	9 1/2 x 5 1/2 x 11
White A Socket Power	43.50	Tube	9	39	11 1/2 x 7 x 6 1/2

ingenious scheme achieves very compact construction. Both these units are supplied with external taps which insert resistance in the secondary circuit to control the output voltage. It is always advisable to use the lowest resistance tap that gives satisfactory results. In the Abox unit, there is a film of oil on top of the electrolyte which prevents excessive evaporation of the fluid. Both units require the addition of a small amount of water every six months but do not require any other attention.

Another interesting A-power unit uses the Raytheon "A" cartridge—a new type of dry rectifier. Units of this type are made by Electron, Marco, Valley, and Sterling. Some of these use one Raytheon cartridge, others two. The Marco product, for example, boasts two cartridge rectifiers. A rheostat in the primary circuit allows regulation for different loads. A meter on the front of the panel simplifies proper adjustment. Inside the box is a relay with silver contacts—to avoid sticking—so that the power unit can be controlled by the filament switch in the receiver.

Either one or two Raytheon "A" cartridges may be used in the Valley A-power unit, depending on the number of tubes in the receiver to be supplied. Full-wave rectification obtains with the use of two cartridges. Valley suggests using the full complement of two cartridges for receivers with seven or more tubes. A single cartridge will suffice for more modest receivers. This Valley device also uses an electrolytic condenser to smooth the output of the cartridge rectifiers. Since it is shipped without liquid, the dry chemical may rattle in the condenser can and excite some curiosity on the part of the purchaser. The addition of water, according to directions, makes all things as they should be. Between the rectifier and filter system is the control rheostat which provides sufficient regulation for various loads imposed by the receiver.

The A-power unit from Sterling uses a single Raytheon cartridge, is equipped with an automatic filament circuit relay, a control rheostat, and a meter to facilitate the correct voltage adjustment.

The White unit among those listed in Table I is the only one on which we have information which uses a Tungar or Rectigon tube as a rectifier. The transformer in this device delivers about 8 volts to the plate and about 2 volts to the filament of the rectifier tube. The rectifier tube has a rating of 2 amperes, which, according to its manufacturers, is conservative; the unit, when operating under normal loads, should therefore have a long life. The filter circuit in this device, besides the usual electrolytic condenser, contains a 4-henry choke to assure complete elimination of hum. A calibrated rheostat to control the output is connected between the tube and filter system and the meter scale on the front panel enables the user to adjust the unit accurately and with ease. A six-foot cord with a pendant switch is supplied to control the a.c. input.

YOU WON'T RECOGNIZE THE STORAGE BATTERY

ALL the units listed in Table I are grouped there because they provide a source of A supply by utilizing a rectifier and filter system, while those of Table II combine a storage battery and trickle charger. There are many radio users who are convinced that the ideal A-socket power unit is one that is innocent of liquid of any sort. An unfortunate experience

with the old storage battery may have instilled this dislike of an A-supply involving liquids. But as radio has developed and the inevitable and fortunate process of refinement has occurred, ingenious ways have been found to mould the storage battery into a highly desirable product indeed. Another school of manufacturing thought therefore has worked along these lines. They have taken the storage battery, designed it exactly to fit modern radio needs, and in the process have succeeded in producing a unit which has none of the disadvantages always quoted against it. Since any of the two distinct types of socket-power A units listed in Tables I and II supply satisfactory A potential to the receiver, and differ largely in the electrical means used to produce the direct current for the tube filaments, whether one chooses one type or the other is entirely a matter of personal preference.

The principles of operation of this type of device have not been changed, but this year many important improvements have been made which insure satisfactory service and almost entire freedom from user attention. Unusually thick plates, especially designed vent caps, built-in "state of charge" indicators, conveniently located controls to vary the charging rate, and special cell construction to insure long life in trickle-charging service—all contribute to make the combination trickle charger and storage battery a convenient and satisfactory A socket-power unit.

Let us discuss some of the points of interest in these devices. The Acme A-power unit, type APU-6, is designed to supply 8 to 10 tubes. The battery unit can be charged at two rates: $\frac{1}{2}$ and $1\frac{1}{2}$ amperes. This wise provision permits adjustment of the unit to take care of the demands of a receiver with many tubes, or the lesser current requirements of a set with fewer tubes.

The Westinghouse "Autopower" has much to commend it. Our friends in East Pittsburgh have combined in a compact unit both a storage battery and an efficient trickle charging device, the latter developed during the last year. This rectifier, which is the heart of the charger, is interesting enough to merit a slight digression. Several years ago, it was found possible to make a solid body of matter conduct electricity more freely in one direction than in the opposite one. This was the origin of Rectox, the trade name of the rectifier used in the "Autopower" and some units by other makers, operating under Westinghouse licenses. The first materials to show this property offered three times as much resistance to the passage of electric current in one direction as in the other. The present Rectox units, developed after considerable research, have increased this resistance ratio of 3 to 1 to as high as 20,000 to 1 in the final units. The life of this rectifier unit is said to be indefinite.

A special clip on the front of the "Autopower" makes it possible to obtain three different rates of trickle charging. In addition, a "booster" rate can be used to revivify the battery if the receiver has been used for an excessive length of time. (One thinks of the 11 $\frac{1}{2}$ -hour continuous Lindbergh broadcast of last June!) The unit contains a relay, which, when the set is turned on, automatically disconnects the a.c. from the trickle charger and connects it instead to two leads terminating in a plug on the side of the "Autopower" unit into which the connecting cord of a B-power unit is connected. When the radio receiver is turned off, the relay automatically closes the trickle-charger circuit and the battery begins to charge. At the same time, the relay opens the

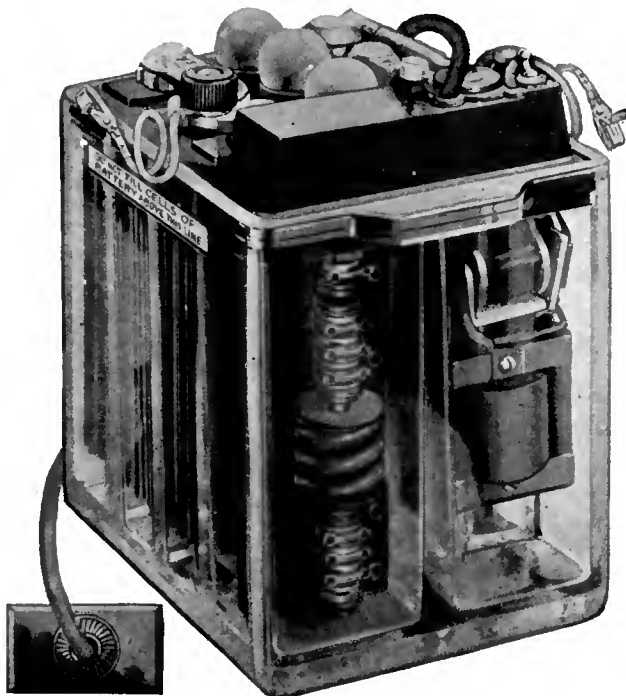

THE VESTA GLASS ENCASED A-POWER UNIT

This is a combination storage battery and trickle charger combined with a relay so that its operation is entirely automatic. A distinctive feature is that the entire unit is enclosed in a moulded glass case so that all the parts are visible. The list price is \$47.50

Storage battery makers, since radio became popular, have sought to reduce the routine attention demanded by the storage battery. Today's battery requires only the occasional addition of distilled water. Keeping the battery "up" is automatically accomplished by a trickle charger. By a study of the demands on storage batteries used by a wide variety of radio owners, sufficient data have been collected to accomplish a storage battery-trickle charger combination which needs only slight attention.

TABLE II

NAME OF UNIT	WATTS INPUT	PRICE	MAX. NUMBER OF TUBES UNIT CAN SUPPLY	TYPE RECTIFIER USED IN CHARGER	SIZE L X W X H
Acme A power	—	\$35.00	10	Tube	11 $\frac{1}{2}$ x 7 x 9 $\frac{1}{2}$
Autopower	22	35.00	10	Copper oxide	11 x 6 $\frac{1}{2}$ x 9 $\frac{1}{2}$
Basco A power	35	40.00	12	Tube	12 $\frac{1}{2}$ x 5 $\frac{1}{2}$ x 10
Compo	26	42.50	8	Tube	10 $\frac{1}{2}$ x 5 $\frac{1}{2}$ x 8 $\frac{1}{2}$
Exide Radio Power	17	31.90	10	Tube	11 x 5 $\frac{1}{2}$ x 9
Philco A Socket Power (603)	—	32.50	6	Electrolytic	12 $\frac{1}{2}$ x 9 $\frac{1}{2}$ x 7 $\frac{1}{2}$
Unipower—AC-6-K	24	39.50	10	Electrolytic	11 $\frac{1}{2}$ x 7 $\frac{1}{2}$ x 10
Universal	—	32.50	8	Dry disk	8 $\frac{1}{2}$ x 8 x 7 $\frac{1}{2}$
Vesta A Power	—	37.50	—	Dry rectifier or electrolytic	9 $\frac{1}{2}$ x 7 $\frac{1}{2}$ x 9 $\frac{1}{2}$
Greene-Brown	29	30.00	10	Tube	8 $\frac{1}{2}$ x 3 $\frac{1}{2}$ x 10 $\frac{1}{2}$

circuit to the B-power unit so that this unit is automatically disconnected. The "Autopower" requires no attention except the occasional addition of distilled water to the battery.

WHAT THE UNITS CONTAIN

THE Basco A-power unit contains in a single case the storage battery, the rectifier, an automatic relay (similar to the type just described above), an emergency switch, transformer, fuses, and a terminal board. The battery is an all-glass Exide unit with a capacity of 45 ampere hours. It is equipped with colored indicator balls to show the condition of charge. A thin film of oil on the surface of the electrolyte prevents undue evaporation and also prevents spraying and corroding of battery terminals. This battery has a large water space and the ordinary user will not have to add distilled water oftener than every half year. The Basco A unit is connected to the receiver just as if it were an ordinary battery and when the receiver is turned on, the current from the battery flows to the tubes and at the same time passes through an automatic relay which closes a circuit and makes 110 volts (for your B-power unit) available at a plug on the side. When you are through using the set, turn off the switch. The relay automatically opens the B-power unit circuit and puts the battery on charge. A Raytheon "A" rectifier is used as the charging rectifier. This rectifier has the advantage that its rate of charge automatically decreases as the battery becomes charged. Danger of overcharging is decreased. The "emergency" switch mentioned above is used to recondition the battery after it has stood idle for some time. Turning this switch recharges the battery at a high rate and inconvenience is reduced to a minimum.

A 35-ampere hour battery in a composition jar with a special cellulose moisture-proof pad on top of the plates and a paste electrolyte are features of the Compo A-unit. An eye-dropper full of distilled water in each cell about every four months is all the attention the unit requires.

Three rates of trickle charging are available: 0.2, 0.4, and 0.6 amperes.

The Exide model 3A 6-volt A-power unit is designed to supply constant voltage direct current for the operation of the filaments of the tubes in any standard radio set. It comprises a storage battery and trickle charger with three taps, each affording a different charging rate. This rate depends, of course, on the number of tubes in the receiver and the number of hours the set is used. The battery is a standard Exide unit of excellent design and construction and contains ample space for excess electrolyte over the tops of the plates, thus making necessary the addition of distilled water only once or twice a year. The makers recommend it be used with the Exide master control switch which contains an extra plug for the a.c. supply for a B-power unit. The unit has a visible charge indicator consisting of two small colored balls so that the condition of the battery can be told at a glance. The entire unit is contained in a nicely finished sheet steel enameled case, fitted with two carrying handles.

The Philco A socket-power unit also affords a dependable source of filament potential. Philco has refined this unit in many ways during the last year to make it entirely fool-proof and economical in operation. The model 603A power unit, listed in Table II, consists of a high-efficiency transformer and rectifier with a battery especially designed for trickle charging service. The battery has unusually thick plates and separators. Spray-proof construction, preventing the leakage of electrolyte from the battery, and the built-in state-of-charge indicator, are two important improvements. These heavy plates and separators insure long life and freedom from the danger of internal short-circuit. Without the built-in Philco indicator there would be no simple means of determining the condition of the battery except through the use of a hydrometer and when it is used there is always the possibility that some acid will be spilled, incurring the righteous wrath of the housewife. Special vent-caps have been

incorporated in the Philco units which make possible the addition of water to the battery without removing them. And water need not be added to these cells oftener than twice a year. Water will flow down these vent-caps, but it is impossible for any of the enclosed acid to leak out. In normal operation the vent-caps need never be removed. Philco units employ an "economizer" which permits the user to adjust the charging rate to the lowest current consumption which will, at the same time, keep the battery properly charged as shown by the visual indicators. By using the lowest possible rate, gassing of the electrolyte is prevented, and this reduces the frequency with which water need be added. Three charging rates are available with a "booster" rate for emergency use. The batteries are in a glass container. Philco units can be had for operation on 25- 30- 40- 50- or 60- cycle a.c. Type A603 is designed to supply up to six tubes and type A-36 is designed to supply up to ten tubes. The latter type contains a dry trickle charger which provides three rates: 0.25, 0.5, 0.26 amperes and a 1.0-ampere rate for booster service.

The Unipower type Ac-6K provides, according to its makers, three unique features. First, a "Kathode" cell construction which insures long battery life; secondly, an automatic cut-off in the rectifier cell which suspends charging if the user fails to add water when necessary, and third, five charging rates with a high rate of 1½ amperes—meeting the requirements of all grades of receivers.

In the "Kathode" design, porous glass wool mats are fitted against the positive plates to prevent the shedding of active material which frequently occurs if the battery is overcharged. The glass mats, by capillary action, draw fresh acid to the plates, increasing efficiency. The Unipower, cased in rubber, contains three "Kathode" constructed battery cells, a rectifier cell, a transformer, as well as the essential switches, terminals, and connections. All these cells are watered at once and the rectifier is designed so that when the level of electrolyte exposes the tops of the cell plates, the charging current is automatically cut off until water is added. The makers feel this safeguard is essential to the proper operation of the battery. On the front of the unit, a dial regulates the charging rate, which ranges from 0.25 to 1.5 amperes in five steps.

A Rectox dry disk rectifier is used in the Universal A-power unit. The 36-ampere-hour battery is assembled in a three-compartment glass jar with mounted hard rubber covers. This A-power unit has a visible state-of-charge indicator, and the whole device is supplied in a steel container.

One of the first battery-trickle charger combinations received in the Laboratory in which glass was the container was the handsome Vesta A-power unit. Vesta now makes two A-power units, one containing an electrolytic trickle charger and the other a dry trickle charger. A visible charge indicator shows the state of the battery; when the three colored balls float at the top of a small compartment, the battery is fully charged and as the charge decreases, one ball after another gradually sinks to the bottom of the compartment. The Vesta unit has a socket into which the a.c. plug for the B socket-power unit may be plugged.

So the A-power devices of 1927 look and perform very differently from the indiscriminate units with which the radio user of some years ago was content. If a variety of A-power devices are offered the purchaser and he does not know what type to use, he should ask his local dealer to install them in his home so he can easily choose the one which best fits his own needs and his local conditions.

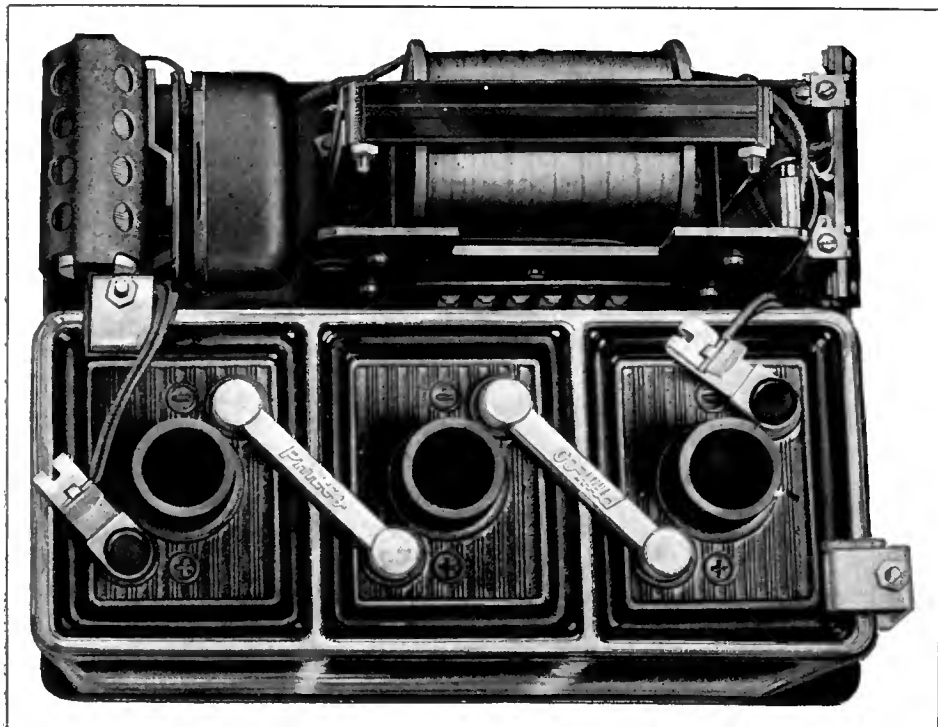

A PHILCO UNIT

This Philco unit incorporates several interesting features among which are a visible indicator of the state of charge of the battery and special vent caps on the battery which absolutely prevent any acid from leaking out of the battery. These vent caps do not have to be removed in order to add water to the battery

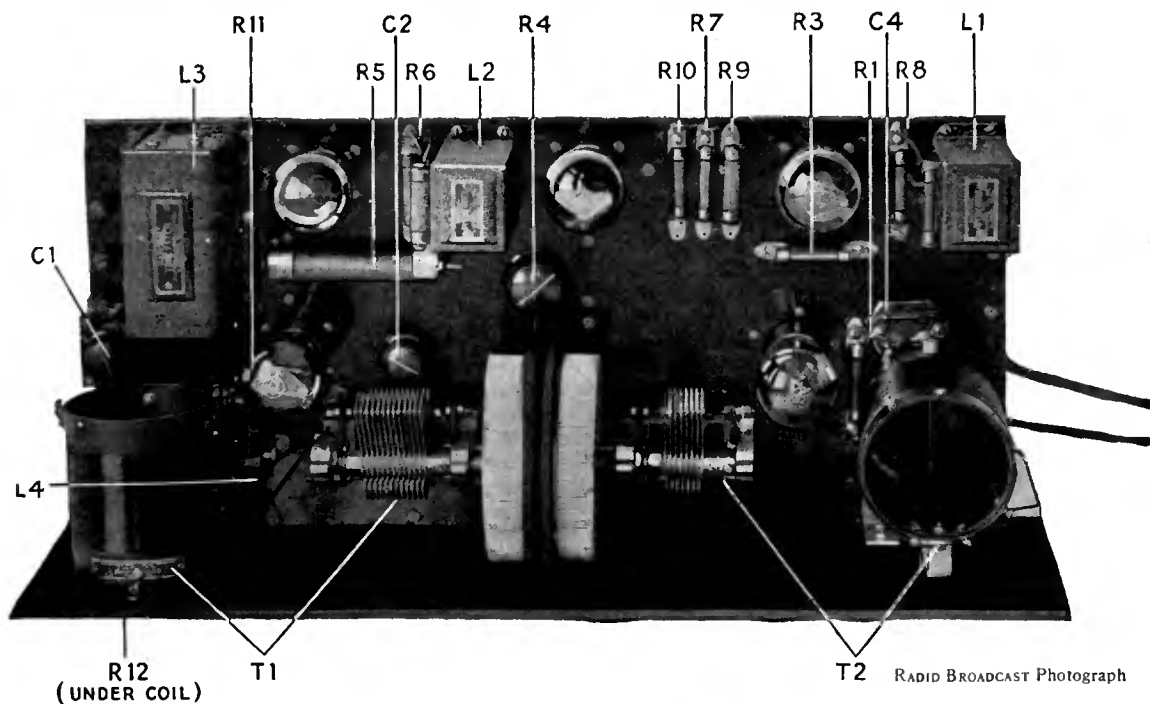

A NEW BROWNING-DRAKE RECEIVER

The new Browning-Drake receiver shown above is to be described constructionally next month. It has been designed for complete a.c. operation although batteries may be used if desired. This first article discusses the various a.c. tubes suitable for the purpose

Electrifying the Browning-Drake

A Discussion of the New A. C. Tubes and How They May Be Incorporated in a New Design Browning-Drake Receiver

By JAMES MILLEN

WITH the availability of really good a.c. tubes, another and important step toward the ideal radio set is made. With the a.c. tube, no storage battery or A-power unit is required. All that is necessary is merely a compact little transformer for decreasing the line voltage to a suitable operating value. As far as actual performance is concerned, the new a.c. tubes are essentially the same as the well-known 201-A or 301-A type tubes. The person with a set equipped with standard tubes will not improve the performance of his set by changing it over for a.c. tube operation. If his storage battery, charger, and tubes are in good condition, there is nothing to be gained by such a change. If, however, the batteries have about run their useful life, or if the charger has died of old age, the new tubes offer a number of worthwhile attractions to the home constructor. First, they open new fields for experiment; second, they enable him to build a completely lamp-socket operated receiver for less money than a battery operated receiver with its associated storage battery and charger, and at the same time there results a receiver somewhat simpler to maintain.

Once a few of the little tricks of the use of a.c. tubes are acquired one will have no difficulty in constructing any of the popular circuits for a.c. operation or in replacing old tubes in any standard receiver with new a.c. tubes. Perhaps the best way of acquiring this knowledge is to carefully follow the details in connection with

the construction of some popular circuit for use with the new tubes. With this in mind, we have selected the Browning-Drake as one of the most popular receivers which has been described in past issues of RADIO BROADCAST, and have re-designed it not only for complete a.c. operation, but also to incorporate the latest ideas on layout, audio amplification, and other slight modifications of the original Browning-Drake circuit. Furthermore, the set has been so designed that it may, if desired, be wired for battery operation where the constructor is not so fortunately situated as to have a.c. on tap. The photograph gives an idea of how the completed receiver looks. Complete construction data on this set will be given in the next article. In this article we will consider some of the general problems involved in the use of a.c. tubes. First of all let us consider the different a.c. tubes available for all but the last audio stage. The last audio, or power tube, be it of the 112, 171, or 210 variety, may be operated on raw a.c. just as well as on batteries. No special a.c. tube is required, therefore, in the last audio stage.

It will be seen from the table on the next page that the a.c. tubes may be divided into two general types, *i. e.*, those using a low-voltage high-current filament, and those having a separate heater element. The heater type tubes are better suited as detectors than the filament type, but either type are about equally well suited as radio and audio amplifiers. Since the heater tubes are, in general, more expensive and have shorter lives,

it is advisable to restrict their use to the detector socket.

The different filament heating transformers available are mostly designed for direct operation with the RCA-Cunningham tubes without the use of rheostats or other resistors. The voltage taps on some of the transformers available at present are:

MANUFACTURER	TAPS (IN VOLTS)
Amertran	1.5, 2.5, 5.0
Dongan	1.5, 2.5, 5.0
General Radio	2, 3.5, 5.0, 7.5
Modern	1.5, 2.5, 5.0
National	1.5, 2.5, 5.0
Silver-Marshall	1.5, 2.5, 5.0
Thordarson	1.5, 2.5, 5.0

When a.c. tubes of other manufacturers are used with transformers having the proper taps for the RCA-Cunningham tubes, special rheostats made by General Radio and Carter should be used in the low-voltage transformer leads. When tubes of the Armour-Van Horne type are used throughout, then two short lengths of resistance wire with a total resistance of about 0.1 ohms should be inserted in the leads to the detector and audio amplifier tubes so that they operate at a slightly lower voltage than the radio-frequency amplifier tube. Several manufacturers make special resistors for just this use.

Where the Kellogg tube is used only as a detector, the 2.5-volt filament transformer winding

will be found just right. Where Kellogg tubes are used throughout, then the 1.5- and 2.5-volt windings should be connected in series (that is, so that their voltages add rather than subtract) to give 4 volts which may be dropped down to the desired 3 volts with a suitable rheostat or fixed resistor. The filament voltages required by any of the tubes are far from critical and the tubes will be found to perform excellently with voltages considerably below the rated values. Operating the detector at a lower voltage often results in almost complete elimination of any hum. If the heater voltage of a *UY-227* detector is excessive, the set will cease to regenerate, and, in fact, practically stop operating. Generally, about 2.2 volts seems to work best with the 227's when used as detectors and a six-inch length of wire from an old-ten ohm rheostat, in series with one of the 2.5-volt transformer leads, will give this lower voltage.

The 1.5- and 2.5-volt transformer windings should not be center-tapped as potentiometers located close to the tube sockets are necessary for the best results. The 5-volt winding for the 171 or the 7.5-volt winding for the 210, however, may just as well have a center tap and thus eliminate the need for one potentiometer. The detector and the power-tube filament circuits should be wired with No. 18 equivalent rubber covered twisted wire. The proper size wire for the radio and first audio stages, containing high-current tubes, may be determined by estimating the total current drawn by these tubes from the table of characteristics and then selecting a wire that will carry such a current from the table below. In the case of the Browning-Drake receiver using RCA tubes, No. 18 may be used, but if the Van Horne-Armour type tubes are used, then No. 16 will be necessary. The following table gives the current-carrying capacity of rubber covered copper wire:

WIRE SIZE	CURRENT
14	11 amperes
16	6 "
18	3 "
20	1.5 "

THE R. F. AMPLIFIER

EITHER the heater or the filament type of tube will work well in the radio stages, but because of its longer life, lower cost, and simpler connections, the filament type is generally to be preferred. There is, however, one real advantage that the heater types have over the filament types when used with some circuits, and that is lower inter-electrode capacity, which often facilitates neutralization. The filament type a.c. tube may be employed in the r.f. stage of a Browning-Drake receiver with materially improved results over those obtained with the customary 199 type tube.

While frequently no negative grid bias is employed on the r.f. tubes in a battery operated receiver, the use of this bias is essential with the a.c. filament type tube. This biasing voltage may be obtained from a C battery or

by utilizing the voltage drop across a suitable resistor which can also provide the bias for the first and second audio-frequency stages.

The optimum r.f. tube plate voltage for minimum hum does not seem to be at all critical and the 67½-volt tap on the average B supply unit gives as good results as any, with less tendency for the radio-frequency stage to oscillate than when the 90-volt terminal is used. The C bias on the r.f. tube should be a little more negative, for a given plate voltage, than on the a.f. stages. The use of a somewhat lower plate voltage on the r.f. tube than on the a.f. tubes permits the use of the same C voltage on both the audio- and radio-frequency tubes.

The use of a.c. tubes and a B power unit make two of the forms of volume controls considered more or less standard with battery operated receivers—the r.f. filament rheostat and the variable series resistor in the r.f. plate circuit—unsuited for the electric receiver. There are, however, at least two other systems of volume control which will give satisfactory results. One is a variable antenna coupling coil, and the other is a variable resistor across the primary of the r.f. transformer. By this means it is possible to control the volume by varying the r.f. input to the detector circuit.

A potentiometer across the filament circuits of both the radio and first audio stages must be employed. As the voltage is low, this unit may be a 30-ohm rheostat with a third connection made to the "open" end of the winding. As this potentiometer may, from time to time, require a minute change of adjustment, it is well to locate it in some convenient place on the sub-panel. The potentiometer should not in general be mounted on the front of the panel, as for best results it must be hung directly across the filament leads at about an equal electrical distance from all the tubes. The adjustment of this potentiometer is quite critical, and a very slightly different setting is frequently required at night than during the day in order almost completely to eliminate all the hum—and the hum can certainly be reduced to a very low order if the receiver is carefully constructed and adjusted.

A. C. TUBES IN THE AUDIO AMPLIFIER

AS THERE is nothing to be gained by the use of the more expensive heater type tube in the first audio stages, the filament type is to be recommended. As already mentioned, the one potentiometer and grid bias resistor serves both the radio and the audio stages. In the case

of the *UX-226* (*CX-326*) tubes with 90 volts on the plate, the grid bias should be adjusted until the drop across its terminals, as measured with a high-resistance voltmeter, is about 6 volts. In the case of the Browning-Drake receiver to be described in detail next month, a fixed 500-ohm wire-wound resistor is used to obtain C bias and this value of resistance is just right. Any of the several different forms of audio amplification may be employed with excellent results.

Where the grid bias for several stages is obtained by taking the voltage drop across one resistor, as in this case, then the use of a "grid return filter" in each stage is recommended and such filters have been used in the a.c. Browning-Drake receiver. These filters merely consist of a 0.1-megohm resistance and a 1-mfd. condenser connected so as to prevent any of the audio-frequency currents from flowing through the grid bias resistance. In the last or power stage, the 171 is recommended as the tube best suited for home use. A 2000-ohm wire-wound resistor will automatically provide the proper grid bias for this tube regardless of the plate voltage, within reasonable limits. A loud speaker protective device to eliminate the direct current from the loud speaker windings should be employed.

THE DETECTOR

WHILE either form of a.c. tube may be used as a detector, the *UY-227* type of heater type tube has several advantages over the filament type. First, the a.c. hum can be, for all practical purposes, entirely eliminated. The hum from a filament type a.c. tube is not what could in any way be termed objectionable, yet, it is there. The heater tube may be used with either a grid-leak condenser arrangement or with C bias, whereas, the 226 type of tube, while it will function quite well with a grid-leak condenser, is better suited for plate rectification. Plate rectification, however, is not as sensitive as the grid-leak condenser arrangement and its use in connection with an all a.c. operated receiver also leads to other complications. The Kellogg a.c. tube may be used as a detector with excellent results.

In using the heater type tube as a detector, either a negative or a positive bias of about 40 volts or so should be applied to the heater element by means of a potentiometer. In some instances a positive bias seems best and in others, a negative, and either of these biases are readily obtainable from the 40-volt tap supplying C bias to the power tube or the plus 45-volt tap for the detector. The adjustment of this bias voltage is not at all critical, and once set, will require no further attention. In fact, a fixed resistor with center tap, such as the type 438 General Radio, will serve the purpose excellently. This resistor is so designed as to mount directly on the terminals of the detector tube socket.

In a second article which will appear next month, constructional details and adjustment suggestions on the a.c. Browning-Drake receiver will be given.

A. C. TUBES								
Heater Type								
NAME	E _f	I _f	I _p	R _p	M _u	G _m	E _p	E _g
<i>C-327</i>	2.5	1.75	4.2	8600	7.8	905	90	-4.5
<i>UY-227</i>	2.5	1.65	3.5	10350	8.7	860	90	-4.5
McCullough	3.0	1.0	4.2	9400	8.6	870	90	-4.5
Sovereign	3.0	1.5	4.6	9100	8.5	935	90	-4.5
Marathon	5.5	1.0	4.2	9500	7.3	775	90	-4.5
Arcturus	15.0	0.35	3.1	12150	10.5	870	90	-4.5
Magnatron	2.5	1.50	4.6	8700	9.3	1070	90	-4.5
Filament Type								
<i>CX-326</i>	1.5	1.05	4.6	9000	8.5	935	90	-4.5
<i>UX-226</i>	1.5	1.05	4.4	9150	8.7	950	90	-4.5
Armor	1.0	2.4	3.8	11200	7.8	690	90	-4.5
Van Horne	1.0	2.0	4.4	9000	9.0	1000	90	-4.5
CeCo	1.5	1.05	2.8	14200	9.2	730	90	-4.5
Magnatron	1.5	1.05	4.0	10800	8.8	830	90	-4.5

E_f = Filament Volts I_p = Plate Current
 E_p = Plate Volts R_p = Plate Resistance
 E_g = Grid Volts M_u = Amplification Factor
 I_f = Filament Current G_m = Mutual Conductance

“Our Readers Suggest—”

THESE two pages are reserved for the many interesting contributions from our readers, some of whom may have run across many ingenious ideas in the operation of broadcast receivers and accessories. These pages will appear regularly in RADIO BROADCAST and all contributions accepted will be paid for at our regular rates. In addition, each month, a prize of \$10 will be paid for the best contribution published.

Contributions are especially desired about changes and simple adaptations dealing with ready-made receiving sets and accessories. Those who have made their own receivers are, in a sense, experts, and are usually well aware of the possible improvements in the use of their own equipment. Each contribution will be published as the writer prepares it, telling how he solved his problem, to which will be added some comments from the staff. Address all contributions to The Complete Set Editor, RADIO BROADCAST, Garden City, New York.—THE EDITOR.

Rewiring an Atwater Kent Receiver for A. C. Tubes

THERE seems little doubt in the minds of engineers that the alternating-current tube will eventually find a place in the majority of radio receivers. It is in anticipation of this eventuality that RADIO BROADCAST has already devoted considerable space to the problems of A battery elimination and the characteristics of a. c. tubes. We are interested in the following description of how a reader, Henry March, of New York, altered a popular type of receiver for a. c. operation, necessitating few and simple circuit changes. He writes:

“It has been my pleasure to discover that the Atwater Kent Model 35 receiver can be easily adapted to a. c. operation through the use of a. c. tubes. I presume that the same simplicity of conversion holds true for many other receivers—a fact that may interest your readers.

“I rewired my receiver for Arcturus tubes (type 28 amplifier, type 26 detector, and type 30 power tube), choosing these tubes because of the fact that they plug into the four-prong socket which is standard equipment on practically all receivers wired for storage battery tubes. Thus no additional filament wiring or special sockets are

required—greatly simplifying the necessary changes, which are illustrated clearly in the accompanying diagrams. Fig. 1 shows the original wiring in the receiver. The parts of the circuit to be changed have been drawn in heavy lines. Fig. 2 shows the circuit with the changes made.

“All grounds have been eliminated from the filament circuit. The lower terminals of all r. f. and a. f. secondaries, excepting that of the power tube, have been grounded. The detector grid return to the potentiometer has been eliminated, and the return is now effected through a 4.5- to 9.0-volt C battery, positive to the grid. Detector C minus is connected to the B minus post. The plus terminal of the main C battery also connects to B minus. Minus 1.5 C battery is

STAFF COMMENT

AS OUR contributor suggests, a. c. tubes of this type (the characteristics of the Arcturus tubes are given on page 34) may be used in many receivers after relatively simple changes have been made. However, the operation of alternating-current tubes is essentially a complicated proposition, and it is recommended that readers secure specific information on the changes required in their particular receivers before proceeding with the alteration. This information can generally be secured from the manufacturers of the tubes selected, and from the technical department of this magazine.

However, a few generalities may be laid down

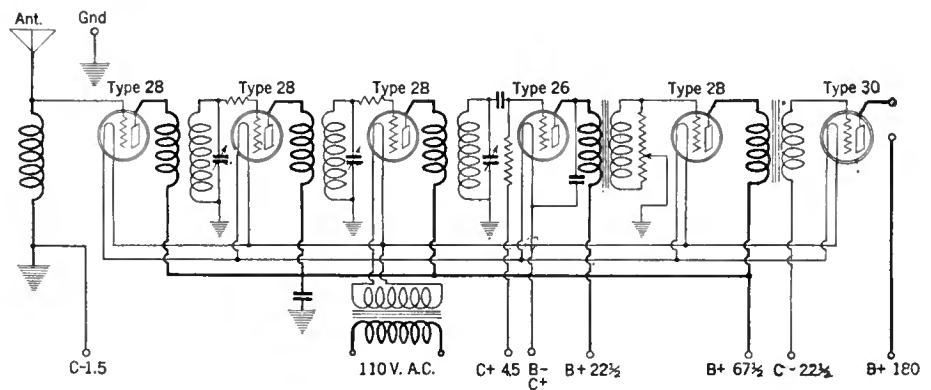

FIG. 2

grounded (supplying the r.f. tubes), while 22.5 minus runs to the power tube in the usual manner. A Centralab modulator is connected across the secondary of the first audio transformer as a volume control.

“The a. c. filaments are operated from an Ives step-down ‘toy’ transformer (type 204) at the 14.5 volt tap. All plate voltages remain the same as in the d.c. set, excepting that 180 volts is applied to the output power tube, increasing the possible undistorted power output of the receiver.”

for the adaptation of d. c. receivers to a. c. operation. Much of this is covered diagrammatically in the accompanying circuits.

All grounds must be eliminated from the filament circuit. Ground all secondaries (filament side) having the same negative bias. A bias of minus 1.5 to 3 volts is generally applied to all r. f. grids.

Run the two filament wires as close together as possible, lacing or twisting them when convenient. Be sure that all plus filament posts are connected together. Connect minus B to what previously were the positive posts. Connect the r. f. and the a. f. C plus and the detector C minus to B minus.

Eliminate all filament rheostats and potentiometer r. f. controls. It is not practicable to use these forms of volume and sensitivity control with a. c. tubes. With the potentiometer device, sensitivity is governed by varying the bias on the r. f. tubes which, with a. c. tubes, would introduce hum at certain adjustments. A 250,000-ohm variable resistor connected across the r. f. secondary preceding the detector tube is a preferred volume control.

Receivers wired for four-prong base a. c. tubes can be used with d. c. tubes at any time, merely by substituting an A battery for the transformer. No other changes are necessary for d. c. operation of such a receiver.

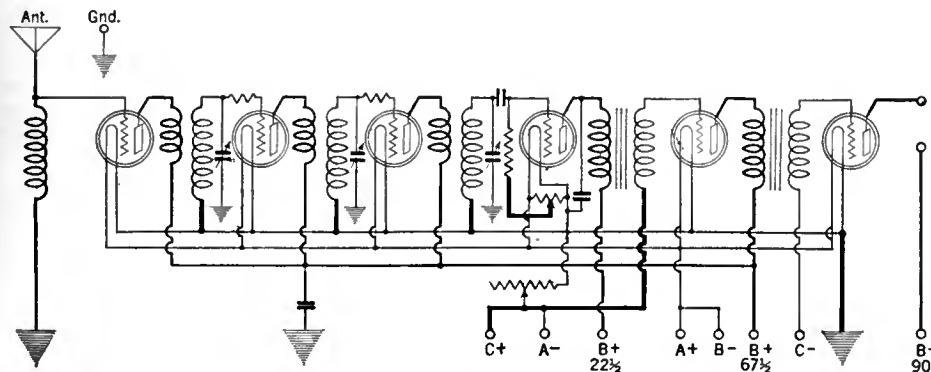

FIG. 1

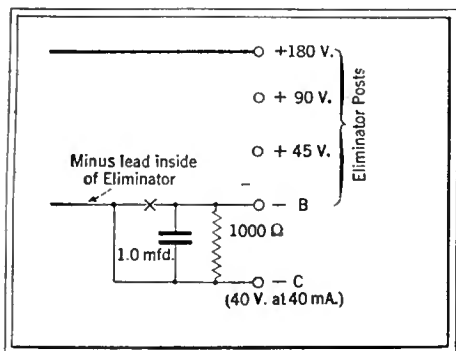

FIG. 3

C Bias from a Mayolian Socket Power Unit

B-SOCKET power units in the future will undoubtedly incorporate extra resistors making it possible to secure C bias for at least the power tube. It is not difficult to incorporate this feature in the average power unit along the lines described by a contributing reader, James J. Corrigan, of Des Moines, Iowa:

"I have a Mayolian B power unit, the utility of which I have doubled by adding an extra resistance and bypass condenser. The drop across the resistance supplies the C voltage to my power tube.

"The lead to the negative binding post is broken at 'X' inside the case (Fig. 3). A 1000-ohm, two-watt resistor is connected in the break and bypassed with a 1.0-mfd. condenser. The post marked B minus connects as usual to the receiver, while the C bias voltage is tapped in the eliminator side of the resistor. A forty-volt C battery is supplanted by this means.

STAFF COMMENT

THIS is a simple and practical method of C battery elimination, readily applicable to all eliminators giving voltages, under load, in excess of 180. The C voltage is necessarily subtracted from the B voltage, and the compromise is sometimes undesirable. If your eliminator has a no-load potential of about 250 volts, C elimination is quite worth while. Many B-socket power units fill the bill. Among them are: Kodak, Burns, Greene-Browne, Kellogg, and General Radio.

However, the use of a fixed resistor is not recommended as it is almost impossible to secure the right bias. It is suggested that a variable resistor, connected as shown in Fig. 4, be used instead. Amsco Products manufacture a zero to 2000-ohm variable resistor known as a Duostat, made especially for this purpose. It is equipped with two variable arms, making it possible to secure two C bias potentials, one for the power tube and one for the other a. f. tubes. Each arm of the Duostat must be bypassed with a 1.0-mfd. condenser. Other variable 2000-ohm C bias resistors are made by Carter and Electrad.

A rough adjustment of the bias potentials can be made by ear. However, a much more scientific

job can be done with the aid of a small milli-ampere meter, reading up to 25 milliamperes. This should be placed in the plate circuit of the tube on which the bias is being adjusted. The variable arm is moved until, on a loud signal, the needle is motionless, or practically so. Any movement of the needle is an indication of distortion. If the needle kicks up, turn down the resistance (lowering the C bias); if the needle kicks down, increase the resistance.

This careful adjustment is generally made only on the output tube. The meter is connected in series with the loud speaker, or the primary winding of the output device if such is used. As the power handled in the preceding tubes is generally small, a rough adjustment by ear is adequate.

Getting High Notes from the Resistance-Coupled Set

IHAVE a Ferguson Model 12 receiver, in which were incorporated three stages of resistance-coupled amplification. I operated this set in conjunction with a Western Electric 540 AW cone loud speaker. While the tone quality of this combination was distinctly superior to that of the average set, there was, at times, a disconcerting rumble on low notes, which quite counteracted my pleasure in the unusual reproduction of these

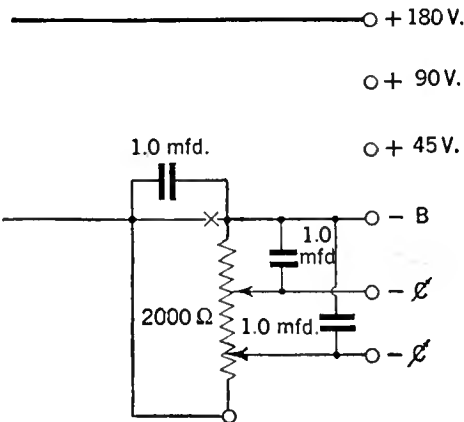

FIG. 4

low frequencies. There seemed to be a resonance point in the output system in the neighborhood of fifty cycles. A friend of mine has an impedance-coupled set, which, while quite free from the particular disturbance I mention, is distinctly partial to higher notes. It occurred to me that a compromise between resistance and impedance coupling might be ideal in my particular case.

Upon the advice of an experienced fan, I removed the coupling resistor from the second audio stage, and ran two wires from the prongs to the primary of an old audio-frequency transformer. I left the grid leak exactly the same as when resistance coupling was used (See Fig. 5).

The result is most gratifying. There is no

longer any rumble on the troublesome notes, and it seems to me that the speaking voice is cleared up a bit . . . it is more natural. Also there is a slight improvement on the higher notes such as are occasionally reached by sopranos and violins. A certain vague sense of muffled sound has altogether disappeared.

STAFF COMMENT

THE experimenter writing the above experience, Frank Wendell, of Los Angeles, has accomplished what is being done nightly in the large broadcasting stations, where the process of balancing the scale of frequencies is known as "equalization." With outside or "nemo" pickups, transmitted over landline to the broadcasting station, certain frequencies are transmitted with less fidelity than others, and the boosting up of the delinquent tones is accomplished in much the same manner as our correspondent brought up his high notes.

The average cone loud speaker in comparison with the average horn, is much better on the low notes. The same holds true of the resistance-coupled amplifier as compared with other amplifying systems; but this type of amplifier also has a distinct cut-off on high frequencies. The combination, therefore, is one that favors the low frequencies—often to such an extent that there exists the low-frequency rattle referred to.

In the case under consideration, the high notes have been boosted by substituting a reactance in place of the resistance. It is probable that the response curve of the reproducing system has been leveled out a bit. That is, all frequencies reach the ear with a closer approach to their relative amplitudes or volumes.

Taking out a coupling resistor and substituting a comparatively low inductance choke coil will always increase the amplification of the higher notes more than it increases the amplification of the low notes. The lower the inductance of the choke coil, the more will be the difference. There is no reason why the average broadcast fan should not improve reception by "equalizing" his receiver in this manner. A resistance-coupled amplifier (in any receiver) most easily lends itself to changes of this nature.

VARYING THE AMOUNT OF EQUALIZATION

AN ORDINARY amplifying transformer is probably the most readily available form of inductance or choke coil. The primary, in the case of the average transformer which may be on hand, should be used.

The high notes will be brought up most if only the primary of the transformer is used. There will be less difference from straight resistance coupling if the secondary is used. Different degrees of equalization will be obtained if the primary and secondary are connected in series, with, first, the grid and plate posts strapped (using the B and F posts as terminals) and, secondly, with the grid and B posts strapped.

The grid leak of the tube outputting to the choke coil is not touched but the bias applied through the leak should be increased by about 4.5 volts.

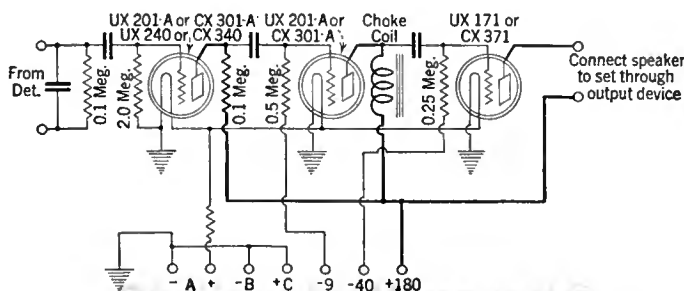

FIG. 5

The Listener's Point of View

LISTENERS—GUESTS OR CUSTOMERS?

By John Wallace

A READER at Long Beach, California, addressed us not long ago as follows:

SIR:
May I be permitted to call to your attention the excellent and timely article appearing on page 15 of *Radio News* for July, 1927, entitled "The Fly in the Ointment," by one Nellie Barnard Parker?

A great many listeners hereabouts were struck by the miserably poor taste displayed by the writers of the "can't-the-announcer-be-choked" and the "sprayed-with-petroleum" telegrams to which the writer refers; and one of us, at least, was equally impressed by the sportsmanship displayed by the announcer in reading such telegrams to us at all. I think that you will agree with the author of the article in question that "... when a company has spent thousands of dollars to broadcast a program, it has bought the right to let you know who your host is and what it has to sell."

I, for one, would like to see a similar stand taken by RADIO BROADCAST; and I believe that such a stand, in your columns, would more nearly present the average "Listener's Point of View" than does much that now appears there.

G. I. RHODES.

Here, indeed, was an invitation for your department editor to adopt a policy—and if there is anything an editor, of any variety, keeps an eagle eye out for, it is "policies." Policies are what enable him to get his stuff written. So we swam into the article, a most entertaining one.

The specific fly in the ointment complained of was an incident in connection with the broadcasting of opera by KFI and KPO last season, as the indirect advertising donation of a certain petroleum corporation.

The opera broadcast was unquestionably one of the outstanding musical treats afforded West Coast listeners that season. In the intervals between the acts the announcer read a number of telegrams of commendation and explained, with some precision, just who was financing the broadcast. "And then," says the author of the article referred to, "right out of the sky, came the fly in the ointment! A man wired in: 'We are enjoying the program but can't the announcer be choked off and let us have opera without telegrams and advertising?' And pretty soon another 'guest' wired his objections against being 'sprayed with petroleum' while he listened. Clever, yes, but it struck one listener at least that when a company has spent thousands of dollars to broadcast a program, it has bought the right to let you know who your host is and what it has to sell."

That was the case in question. We are hardly fitted to pass on its merits since we didn't hear the broadcast. It is quite possible that the number of telegrams read and the amount of advertising dished out were entirely within the bounds of reason. In fact this seems probable if there were but two unfavorable comments on it. As the writer points out with some show of logic, the

reading of a telegram of commendation suggests the sending of them to other listeners, and if a large number is received "they are permanently bound and the next time there seems a possibility of interesting some firm in paying the fiddler for an expensive program, this bulky volume is brought forth." Thus the telegram reading may in some cases react finally to the listeners' benefit.

But departing from this particular instance wherein the adverse criticism may not have been entirely warranted, the writer goes on to generalize and takes the stand that adverse and destructive criticism of a better-than-average program is never justifiable. This, it seems to us, is stretching the point to absurdity. She says:

You are free to steer your airship where you please, casting out your line knowing that there are just as good tunes on the air as ever were caught. Such being the case, why send in thoughtless messages to mar the perfect pleasure of your host? Let him sing his little solo without having the anvil chorus crab the act!

It is only fair to say that those who criticize the big programs are in the minority, but there are just enough of them to destroy that fine edge of joy and what-a-good-boy-am-I feeling the sponsors and operators have.

Every graduate operator of a radio is a super-critic of the air. Like an insect of the ether, the true radio bug goes sniffing through the air with his little feeler; when he "contacts" with something he likes, he settles upon it with a pleasant little hum. But if it pleases him not, he is liable to plant a sting, if he is that kind of a bug. How much nicer it would be if he would remember that the sponsors and announcers are just big boys trying to get along! They are not inoculated against praise. It takes on them beautifully and they break out with brighter and better

programs. They invite and welcome constructive criticism and helpful suggestions, but mere "razzing" and discourtesy never fanned a generous impulse into flame. Just be human, kindly and courteous, remembering that the announcer, like the fiddler, is doing the best he can.

And don't be the fly in the ointment!

We quote this writer at such length because hers is a point of view that is all too widely held, namely: that the purveyor of radio programs is your host and that all the rules for polite drawing room conduct should operate in your attitude toward him.

When a man invites you to his home for dinner he does so as a private individual, and however burnt the potatoes may be, it is not common politeness for you to throw them at him. But if the same man sets up a restaurant and you happen in there to eat, you are perfectly justified in calling him all sorts of names if his chef has too highly seasoned the lobster *thermidor*. He has removed himself from the rôle of private individual and become a purveyor to the public. He has become, to use the word loosely, an artist, and by universal assent any and all of the products of the artist are open to criticism and he may not protest. By his very act of setting himself up as an artist he tacitly agrees to submit to any opprobriums that the citizenry feels inclined to hurl at him. This is true of every sort of artist—chef, singer, movie producer, poet, electric refrigerator manufacturer, sculptor, street cleaner, painter or sponsor of broadcast programs.

If a man wants to buy himself a box of paints and surreptitiously records on canvas his impression of the cherry tree in the back yard or sunset on the drainage canal no one has a right to comment on the way he does it. It is entirely his own affair as long as he keeps it his own affair by contenting himself with hanging the finished works on his own wall. But if he starts sending his pictures to the exhibition galleries he, by that gesture, professes himself to be an artist, and his work to be art; and he automatically becomes perfectly legitimate meat for anyone to pounce upon who cares to.

If what he exhibits as art is inexcusably bad, the good name of Art is threatened. And since Art is not his own private possession but is held by common consent to be in the custody of the great unwashed public, it is incumbent upon that public to weed out with vituperatives anything that threatens to cast a smirch upon it. The commentary that the public makes is known as Criticism. Criticism may be of many kinds, favorable or unfavorable, constructive or destructive, gentle or splenetic, competent or incompetent. The writer of the article discussed, and those of the same misguided frame of mind, would object to any criticism that does not fall into the category of favorable or constructive. This is obviously silly and results from a complete misconstruction of the function of criticism. Gentle-spirited sentimentalists get all hot and bothered



THE SANKA AFTER DINNER COFFEE HOUR AT WEAF
Heard over this station on Tuesday evenings at 7:30. They should receive some kind of reward for getting the maximum number of words into the title. Anyhow, here are the performers

and are filled with great sympathetic aches when some public performer gets it in the neck from a sharp tongued critic. They decry the critic as mean and lacking in human qualities. But in the case of a genuine artist their sympathy is wasted. A true artist doesn't mind adverse criticism—much; he is his own best judge of whether his work is good or bad. On the contrary he is rather stimulated by it. Splenetic or strongly biased criticism may be far more effective in egging him on to do better work than soporific boquets. The only criticism to which he is likely to object is the incompetent kind—and of this there is, of course, plenty.

The two critics of the KFJ-KPO opera broadcast may have been incompetent; they may not have been aware of all the facts, viz.: that a certain amount of advertising was necessary if the broadcast was to pay for itself. As we have said, we did not hear the program and do not know whether this reading of telegrams was carried to excess or not. But not all criticism of radio programs by minority calamity howlers is incompetent. A great deal of it is very much to the point (including, of course, all our own sage pronouncements.)

The fact that a majority of the listeners are perfectly satisfied with the way any given radio program is presented does not mean that any criticism on the part of a few of the minority is worthless. The oft-repeated phrase about *giving the public what it wants* is, at best, just a phrase. True, some effort is made in this direction, but the public is not at all sure what it does want, seldom expresses itself on the subject, and finally, finds it the course of least resistance to *take what it gets*.

The masses continue to be satisfied with what they are getting until something better comes along. Then they accept the improvement with the same placid satisfaction—perhaps wonder why they were so easily pleased with the old—but make not the slightest effort to secure further betterment. It is up to the minority kickers and mud slingers to secure for them these improvements.

Your average radio listener was perfectly satisfied with broadcasting as it existed in 1923. His unimaginative and uncritical mind could conceive of nothing better. He was getting programs made up largely of cheap jazz and cheaper talks. To live up to their views, the advocates of "throw-away-your-hammer-and-get-a-horn" would have to argue that things should have been left for him just as they were. He was satisfied; his cup of joy was full; why attempt to overfill it?



BOB CASON AND REBER BOULT

Artists at station WLAC, pianist and baritone respectively. They call themselves the "Thrift Twins" for some reason not apparent in the photograph

But what has happened since then? Programs have improved and his taste has improved with them. He has thrown away the cup and has graduated to the mug, which also is filled to the brim. Having a mug, will he now demand a schooner? He will not.

The conclusion that we have been laboring, somewhat heavily, to reach, is that it is to the mud slingers and knockers, the minority critics—or "Flies In the Ointment"—that most of the credit is due for the rapid strides that radio has made. Back in radio's dark ages at least fifty per cent. of every station's time was devoted to unendurable tin pan jazz. The passive listeners stood for it. The knockers objected. It was eliminated and the passive listeners found themselves with fifty per cent. more entertainment for their money and all through no effort of their own.

Radio has grown up considerably but it still has a few bad habits hanging over from its infancy. It is up to the knockers to knock these out. If radio is to be a Bigger and Better man than it was a boy it is up to the knockers to pummel it into this new shape. The soft soapers and dispensers of ointment can do no more for it than to make it a self satisfied mollicoddle. Let there be more flies in the ointment!

The British Broadcasting Company Gets Razzed

WE ARE unable to give any very valuable dissertation on broadcasting conditions in England, at this distance. But from what we read there seem to be continual rumblings in the tight little isle, and most of them to the effect that the British Broadcasting Company is too highbrow. We have just received a copy of a thirty-eight page pamphlet by one Corbett-Smith flaying the administration of the B.B.C. A decidedly long-winded affair, it gets down to points occasionally:

When one sets out to give a radio entertainment, whether music, poetry, drama, speech, "variety," or anything else, one visualizes (or should visualize) not the few who are already educated in some measure to appreciate the best in these various forms of art, but the vast many of our people to whom beauty has hitherto been a closed book—the great mass of our folk who have never heard good music or noble poetry or any of our incomparable English literature—and so who pretend impatiently to disdain these necessities of civilization, as they would call them. . . . *Every single radio program should be so built and presented as to form a perfect fusion of art, education and popular entertainment.*

The type of mind which is usually associated with scholastic education is hopelessly out of place in radio work. And there is another cause of the B. B. C.'s failure. It is the born showman of a very special quality that is needed. The man with the widest possible range of interests, with "an acute sense of the inter-relationship of every kind of activity." Radio entertainment demands not the depth of the scholar but the breadth of the sensitive man of the world.

Showmanship, in varying degree, is needed for every single feature of radio entertainment. The "superior person" may sometimes scoff; but that person does not interest us. We have to compel and to rivet attention. We need, also, strong and vivid personality. The personality of the leader of men, not of a cold-blooded corporation. And we need absolute sincerity, both of purpose and utterance.

Now the B. B. C. have not begun to appreciate anything of this. Instead of making a Charles Dickens their director of programs they have put in a Matthew Arnold, the apostle of culture. Dickens enjoyed everybody and everything, even Fagin and Mr. Murdstone. That was the secret of his art and of his success. The B. B. C. seem to enjoy nothing, not even themselves.

It is necessary to emphasize this total lack of

sympathy with the people at large, because it strikes at the root of the matter. The B. B. C. are forever vaunting the intensely democratic character of their service when, in fact, it is about the most aristocratic business in the country. The House of Lords is an assembly of plebs beside it.

Wherein, if Mr. Corbett-Smith's words are to be taken as true—and he certainly sounds convincing—we see that a government-controlled monopoly is not one of the best ways of providing satisfactory radio programs. The point that the writer pounds in throughout the length of his diatribe is one which, we think, is well worth making, namely: that radio's principal service is, after all, for the masses. The so-called intellectual class is not interested in radio at all. Its members do not own receiving sets nor would they listen to one if it were given them. This is not due merely to snobbishness; their time is otherwise occupied, and of other means of entertainment they have more at their hand than they can make use of.

But we in the United States have no reason to fear such a state of affairs as Mr. Corbett-Smith complains of. Radio stations in this country are operated essentially for the masses. This is the natural result of a competitive system which depends for its reimbursement on advertising, direct or indirect. A maximum number of listeners must be the aim of every station which is not endowed or privately financed. In fact, here, a condition exactly the opposite of that alleged to exist in England is likely to obtain. A majority of stations, in their devotion to the masses, quite neglect the upper fringe of listeners. This is not true of the two score or so better stations. Careful and intelligent planning has enabled them to present programs appealing to the widest possible range of tastes. Their procedure is, first, to arrange a program that definitely appeals to the great mass of listeners, and secondly, to further manipulate it so as to effect a compromise with the upper crust of listeners.

We, from viewing the subject too closely, are likely to forget how exceedingly well this has been done. Take, as an example, the Atwater Kent Hour. A straight appeal to the masses is made in the making up of these programs. While the selections are limited to the classics and to the opera, it is almost exclusively the sure-fire hits and tried and true tunes that finally find their way on to the program. But while the highbrow may think some of the tunes are banal and over-worked, they've got him on another score: he cannot afford to ignore the importance and artistry of the performers. Atwater Kent employs to put them over.



ANITA DEWITTE HALL OF KOIL

She is the versatile program director, organist, pianist, and "Mother Hubbard" of the staff

The R. G. S. "Octamonic" Circuit

How Laboratory Discoveries Were Moulded to Produce the Commercial Design of a Sensitive and Selective Set—Details of a Striking 1928 Development

By DAVID GRIMES

THE first article in this series (RADIO BROADCAST for October) described the conception and theory of the fundamental "Octamonic" principle, which obtains a high degree of selectivity by a function of the vacuum tube rather than by any special circuit contraptions. It was shown that the super-selectivity did not impair the tone quality as is the experience in tuned radio-frequency circuits. The high frequency of the second harmonic current permits a very sharp resonance curve without unduly compromising the side band amplification which is absolutely necessary for the proper reproduction of the high-frequency audio tones.

Other points of invention were also discussed, but it is a long road from invention to commercial design. It is one thing to build a laboratory model which proves the principle of an idea and quite another thing to plan the construction of a radio receiver which will meet all of the commercial conditions encountered in the field without a great many operating controls.

The purpose of this article is to reveal the design and constructional information which have been found necessary. These data have been acquired only after a great amount of original investigations, for there appeared to be little or no information available on the subject of second harmonic generation, tuning, amplification, and detection. The subjects will be discussed in the order in which they occur in our laboratory notebook. While the order may appear to be unusual, the facts were accumulated in just that sequence.

The first study was confined to the harmonic generating tube. The proper operation of this tube insures the success of the entire receiver. The first article showed a C potential bias on the grid of the harmonic generator—this bias causing the tube to operate on the lower knee of the grid voltage-plate current characteristics. This point of the characteristic gives the greatest amount of second harmonic energy as the unequal amplification between the two halves of the carrier wave is greatest at this point. However, with the standard commercial types of vacuum tubes operating on standard units of B potential such as 22 volts, 45 volts, or 90 volts, the amounts of negative C bias required for harmonic generation do not correspond with the commercial units of C potential available with the standard C battery. For instance, the maximum amount of second harmonic energy appeared to be generated by a standard CX-301-A tube operating on 45 volts plate potential with about 2 volts minus grid potential. Such a C bias cannot be obtained conveniently from dry batteries.

Of course, the easiest way to obtain a 2-volt negative bias on the grid of the harmonic generating tube is to utilize the principle of an IR drop. By running the filament return of the tube through a fixed 6-ohm resistance, a 2-volt drop may be obtained and if this fixed resistance is placed on the negative filament lead a negative 2-volt bias is available for the grid. Fortunately the operation of the second harmonic tube was not affected by running its filament on 4 volts, the remaining A battery potential available for the filament after 2 volts had been extracted by the fixed resistance for the grid bias. In fact,

it was found that the filament of the harmonic tube could be run much lower than this without in any way impairing its second harmonic generating properties. This is explained graphically by Fig. 1 which shows the grid voltage-plate current characteristic of a vacuum tube which is operated at various filament voltages. The various filament temperatures materially affect the upper portions of the characteristic but have

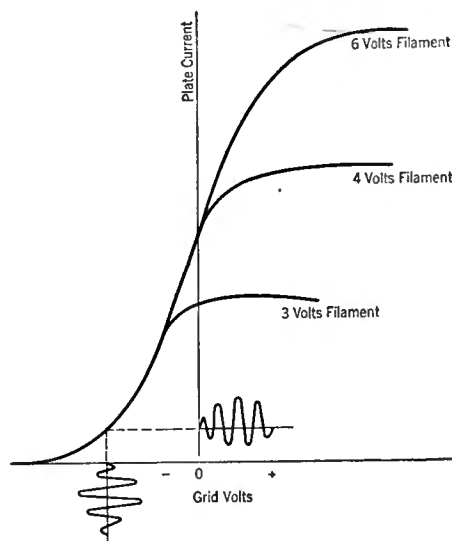

FIG. 1

little or no effect on the lower knee of the curve. The filament voltages only affect the saturation point of the tube.

In the vernacular, this is a fortunate "break" in design work as it affords a very simple arrangement for the harmonic generator which is very stable in its performance and exceedingly inexpensive. As a matter of fact, a series of tests shows that the filament voltage of the tube

could be cut down as low as $2\frac{1}{2}$ volts before the second harmonic currents were affected, and the C bias could vary from $1\frac{1}{2}$ to 2 volts. This more than covers the variation in A battery potential during the period between full charge and discharge of the A battery. The 45 volt B battery on the harmonic generator was also found to be a non-critical factor. Fairly large amounts of second harmonic currents were generated by this tube when the voltage had dropped as low as 34 volts or was raised as high as 50 volts.

PROBLEMS IN THE HARMONIC GENERATOR

EXCESSIVE B potentials on the harmonic generator created an unusual and peculiar difficulty. There existed a tendency toward oscillation on the short wavelengths of the input tuning condenser to this harmonic generator when the plate voltage was boosted too high. The source of this oscillation is not obvious and evaded detection for some little time. One is accustomed to expect oscillation in a tube only when there is a deliberate external feed back circuit or through the internal electrode capacities only when the plate circuit is tuned to the same frequency as the grid circuit—such as occurs in a tuned radio-frequency system. As seen in Fig. 2, the plate circuit of the harmonic generator is tuned an octave higher in frequency than the grid circuit and under these conditions the well known ordinary oscillation cannot occur. As a matter of fact the primary of the second harmonic transformer possesses considerable effective inductance as the result of the tuning to the higher octave. The number of turns in the harmonic transformer primary alone is insufficient to cause oscillation in the harmonic tube unless the secondary is tuned to the higher octave. When this is done, there is an increase in effective inductance over and above the actual inductance which causes the oscillatory difficulties mentioned, with excessive plate voltages on the harmonic tube.

The remedy for the difficulty outlined above

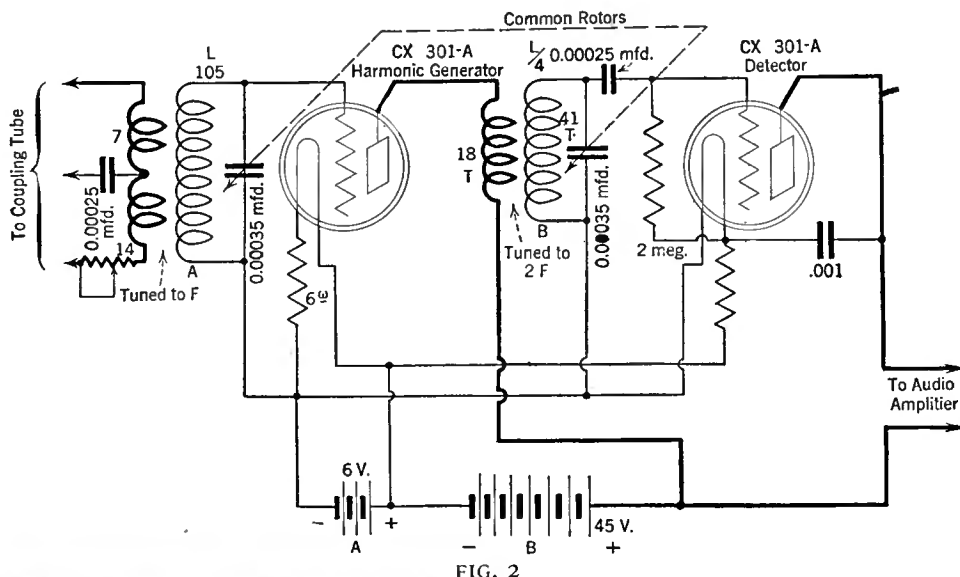

FIG. 2

lies in reducing the number of primary turns in the harmonic transformer to such a point that the effective inductance at the highest commercial voltage will not produce the oscillation described at the short broadcast wavelengths. Fig. 3 shows the design details of the tuned harmonic transformer used for connecting the output of the harmonic generator to the input of the detector tube. It will be noted that the secondary of this transformer has been made unusually small—much smaller than would be expected for merely tuning the double frequency involved. Commercial considerations have controlled the design of this transformer as well. The general tendency in the modern design of the radio receiver is to combine as many of the tuning condensers as possible on one shaft—exercising the proper care in the balancing of the condensers and coils so that they will tune alike for all the broadcast wavelengths. In the R. G. S. "Octamonic" design, it seemed desirable to combine the tuning condenser on the secondary of the harmonic transformer with the tuning condenser on the input to the harmonic generator. The problem is not as simple as the combining of condensers controlling similar circuits. The harmonic condenser must always tune to half the wavelength of the fundamental tuning condenser in the input of the harmonic generator. Furthermore, another limitation is imposed because all available gang condensers have been designed for tuned radio-frequency circuits and have therefore equal capacity in all the individual members of the gang.

This means that the second harmonic transformer must be so designed that a standard 0.00035-mfd. tuning condenser must tune the half wavelength band from 100 to 275 meters at exactly the same settings on the dial as a similar condenser tunes the fundamental coil for the respective corresponding fundamental wave between the 200 and 550 meter broadcast band. A consideration tuning formula shows that this can easily be accomplished if the inductance of the secondary of the harmonic transformer is made exactly equal to $\frac{1}{4}$ of the inductance of the fundamental tuned secondary on the input to the harmonic generator tube.

SOURCES OF SELECTIVITY

ANOTHER fortunate "break" aids in the ganging of these two condensers, as one of them is extremely sharp in tuning while the other is relatively broad. The real selectivity of the receiver is obtained by the tuning condenser on the input to the harmonic generator as the harmonic currents generated in this tube are proportional to the square of the resonant input carrier voltages resulting from this tuning condenser. The tuning condenser across the secondary of the harmonic transformer is no sharper than the ordinary tuning circuit on the input to a detector tube. Slight variations are therefore permissible in the coils and condensers without jeopardizing the performance of the receiver.

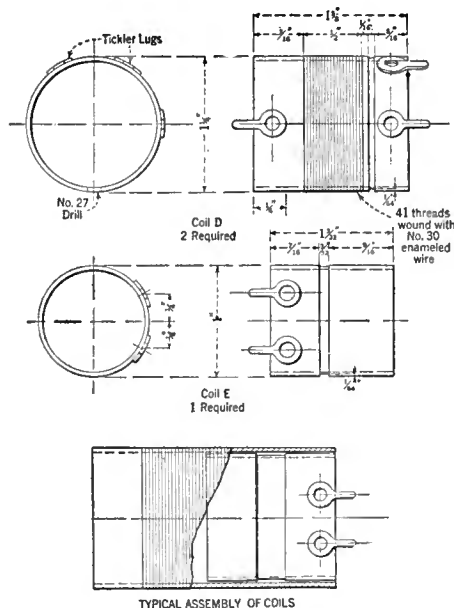

FIG. 3

The two gang condensers may have the same grounded rotor shaft as there is no need for any special insulating between these circuits. It is true that there are different grid biases on the two tubes to be tuned, but the positive bias on the grid of the detector tube may be supplied by the grid leak connecting from the plus filament of the detector tube directly to the grid, while the negative C bias on the harmonic generator is supplied through the common rotor and the secondary of the fundamental transformer in the grid circuit of the harmonic generator. The blocking condenser in the grid circuit of the detector effectively separates the positive potential on the grid of the detector and the negative C bias which exists in the rest of the harmonic secondary by virtue of the common grounded rotor shaft. As the negative potential is obtained by a resistance drop, as previously described, it is obvious that both the high-frequency currents in the detector grid circuit and the broadcast frequency currents in the harmonic grid circuit must return to their respective filaments through this resistance. Feed-back difficulties and oscillation would absolutely occur at this point in a tuned radio-frequency system, but no difficulties are encountered in the R. G. S. "Octamonic" because these two carrier currents are of different frequency and cannot, therefore, interfere with one another.

One thing should be made very clear at this point of the discussion. There is a fundamental difference between detection as such, and the generation of second harmonics. As discussed in the first article of the series the operation of a tube on the knee of its characteristic curve will produce not only second harmonic but

audio currents as well. In this circuit the tube is acting not only as a harmonic generator but, incidentally, as a detector. No method is known at present for the efficient generation of second harmonics without the incidental detector action occurring simultaneously. However, in the detector stage, two possibilities are present. Either the grid leak system of detection or the C battery system of detection may be used. The grid leak system is slightly more sensitive on very weak signals while the C battery system will deliver more audio energy on local reception without distortion. A study of these two types reveals some interesting facts. There is present, along with the detector action, some incidental generation of second harmonics, when the C battery detector is employed. This would be expected from the considerations already discussed in connection with the harmonic generator. However, second harmonic currents are almost wholly absent in a detector tube employing the grid leak system. This means that detector action cannot be confused with harmonic generation. They may or may not occur simultaneously. The grid leak detector simply cannot be used in the generator stage for the creation of second harmonics. The harmonic generator is not a detector.

WHAT TYPE OF DETECTOR CIRCUIT?

IT NOW remains to determine which type of circuit should be used in the detector stage. Both the C battery and grid leak circuits were subjected to an extensive series of tests. The grid leak system was found to be much more satisfactory and much more stable. The tone quality was not impaired by the grid leak system and the distortion which occurred on local reception when using the C battery system, entirely disappeared when the grid leak system was substituted. The results were so consistently contrary to those anticipated that considerable data was gathered in an effort to explain the cause. Fig. 4 shows graphically just what occurred and why it is desirable to employ the grid leak system in the bona fide detector. It will be noted that the incidental detection occurring in the plate circuit of the harmonic generator is represented by an increase in the plate current—the increase being proportional to the modulation on the incoming carrier waves. Quite the reverse takes place in the detector circuit. Here the plate current decreases upon detection due to the choking action of the grid leak and condenser in the grid circuit. The decrease in plate current is proportional to the modulation on the incoming carrier waves. The rectified or audio currents existing in the plate of the harmonic generator are not utilized but, in turn, flow through the B battery circuit. The detected or audio currents in the plate circuit of the detector go through the primary of the first audio transformer and then flow through the B battery circuit. With these two audio currents opposing each other in the B battery at all times there is no audio voltage drop occurring therein. If a C-battery detector were employed the two audio currents would increase and decrease simultaneously, causing excessive audio voltage drops in the common B battery.

As brought out in the previous article, the R. G. S. "Octamonic" receiver obtains its super-selectivity through the sacrifice of some of the radio-frequency energy. But as radio-frequency energy is very easily obtained by any number of r.f. amplifying circuits and selectivity is not so easily obtained, the sacrifice is well worth while. However, some form of r.f. amplification must be placed ahead of the "selectivity" circuits just discussed. Various r.f. arrangements have been investigated and the one shown in Fig. 5 is

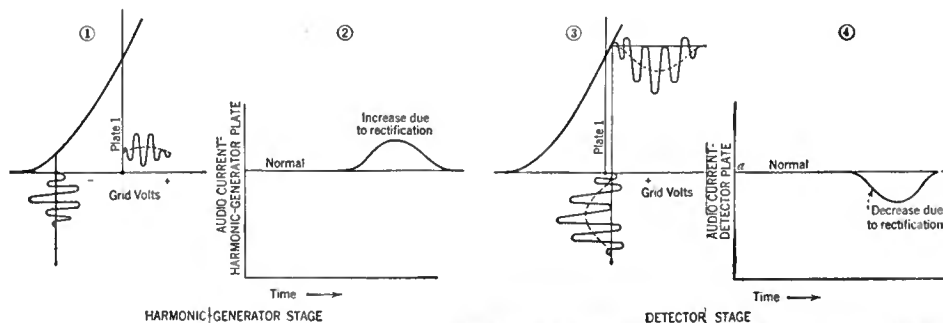

FIG. 4

recommended. This shows one stage of radio-frequency amplification only as one stage has been found to be more than ample for operating the harmonic generator on even the most distant stations. The antenna is very closely coupled to a tuning circuit which serves mainly to bring the antenna circuit to resonance at the frequency desired. The carrier wave is then amplified and applied to the harmonic generator through a special equalizing coupling circuit which is designed to pass all of the broadcast frequencies with approximately undiminished amplitude on to the harmonic generator. The theory of the operation of this unusual coupling is rather simple. The total winding consists of 21 turns which is the proper primary for the longest wavelength of 550 meters. Then a tap is taken off at 7 turns which is approximately the proper primary for the shortest wavelength of 200 meters. A 0.00025-mfd. fixed condenser is connected between the tap and the filament of this amplifying or coupling tube. A variable non-inductive 250-ohm equalizing resistance is placed in series with the total winding. The short waves pass readily through the fixed condenser to the filament while the longer waves tend to pass more and more through the entire winding because of the increasing reactance of the fixed condenser to the lower frequencies of the longer waves.

This first amplifying tube has been designated a coupling tube since its main function is purely a coupling and amplifying action rather than any aid to the tuning. The coupling to the antenna is made as close as possible so as to derive the maximum amount of energy therefrom throughout the broadcast band. Such close coupling makes the tuning very broad and non-critical—the real super-selectivity of the receiver being created by the tuning condenser on the input to the harmonic generator. In actual operation, this antenna condenser appears to be sharper in its tuning than it really is because, after all, it has an indirect effect, though broad, on the amount of energy being transformed into second harmonic currents by the generating tube. This action gives it an apparent sharpness greater than that which is really occurring in the antenna circuit.

CURIOUS MODULATION EFFECTS

ONE very important factor in the design of the coupling tube circuit is *modulation*. Great care must be exercised in the design of this circuit to avoid any possibility of rectification action even on the louder signals. Otherwise, the extreme selectivity of the harmonic generator will be somewhat modified by a cross-talk or

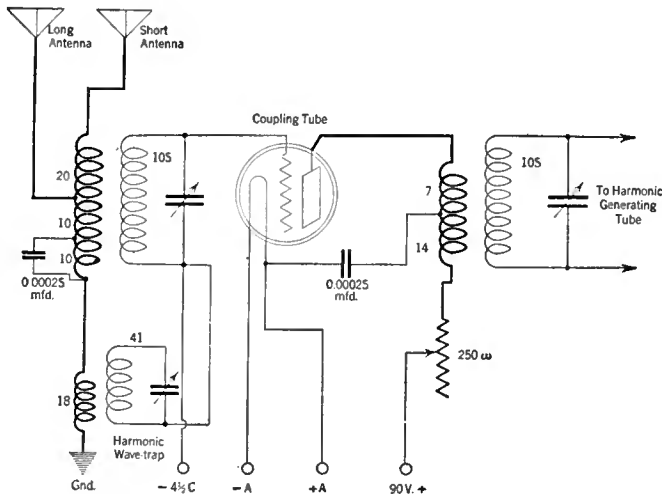

FIG. 5

modulating action between a near-by high-powered local station and a distant station operating on an adjacent carrier channel. The action is as follows: The receiver in New York City is tuned to a weak station such as WOO in Philadelphia operating on 508 meters. It is found that several dial degrees of silence are obtained between this Philadelphia station and WEA F, New York City, operating on 492 meters. However, WEA F is coming in with considerable field strength impressing considerable 492 meter energy on the grid of the coupling tube along with the energy from the Philadelphia station. If any rectification occurs on the strong signals from WEA F, audio currents will be set up in the plate circuit of this radio coupling tube which correspond to the program being sent out by WEA F. It must be remembered here that the first circuit is broad—its function being amplification

and not tuning. As a result, more WEA F energy may be present than the energy coming from Philadelphia even though the antenna tuning condenser has been set in favor of the Philadelphia station.

Now, the audio currents occurring in the plate circuit of the coupling tube as a result of the rectification of the WEA F carrier wave, will cause a plate voltage variation in this tube which corresponds to the program on the carrier wave of WEA F. This action will, in turn, affect and vary the amplification of any other carrier wave coming through the tube at the time, such as the Philadelphia station which is desired. The audio modulation or WEA F's program will then impress itself on the carrier wave of the Philadelphia station in the same manner that the original audio currents at the studio of WEA F impressed themselves on the

original carrier wave being sent out from WEA F on 492 meters. The result is that, while several dial degrees of silence are obtained between WEA F and WOO, as soon as the Philadelphia station is tuned-in, the program from WEA F is found also to exist thereon in the form of cross-talk or cross-modulation.

The remedy is to operate the coupling tube on the straightest portion of the grid-voltage plate-current characteristic curve. For the standard CX-301-A tube, this requires 90 volts on the plate and 4 1/2 volts negative bias on the grid. This point is very essential. In addition, it is desirable to have the maximum of coupling to the harmonic generating tube, not only from the standpoint of energy transfer, but also for the purpose of obtaining a fairly high effective resistance in the plate circuit of the coupling tube at the particular frequency for which the input to the harmonic generating tube is tuned. It is a well known fact that the resistance of a primary winding increases considerably at the resonant frequency of the secondary. At the same time the reactance passes through zero, of course. The closer the coupling the greater is the effective resistance of the plate circuit and resistance in the plate circuit tends to flatten out the characteristic curve of the coupling tube. This is shown in Fig. 6. This flattening of the characteristic curve still further reduces any tendency toward rectification in the coupling tube.

A detailed discussion on the audio amplifier as well as a full explanation of the theory and operation of the harmonic wave-trap shown in the antenna circuit will be taken up in the next article of the series. The next article will also describe in further detail the best wiring arrangements.

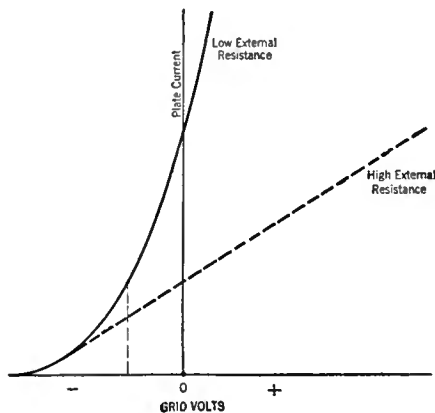

FIG. 6

The "Equaphase"

Better Control of Oscillation Is a Feature of This New Receiver—
The Story of Some of the Difficulties Surmounted in Its Design

By J. O. MESA

ANY radio engineer can make a single receiver work in the laboratory but when a factory turns out five hundred a day, each of which must be thoroughly tested, the problem becomes somewhat more complex. It becomes one not only of manufacturing small mechanical parts to a high degree of precision and of simplified assembly so that mistakes are difficult to make, but one of following a circuit that is electrically sound and as foolproof as possible.

Circuits that are highly sensitive are often highly critical in their adjustment, necessitating that they pass through the hands of a well trained tester before they can be released. What every set manufacturer wants is a receiver design such that manufacturing costs and assembly problems are reduced to the bone, that testing methods are neither complicated nor expensive in point of time, and that adjustments are few. Simplicity of design is not the controlling factor, for the simplest circuit must embody the same trouble producing elements as the most complex. For example, every engineer knows that inductance in the plate circuit of a radio-frequency amplifier is necessary to transfer energy from one circuit to the following tube; but he knows too well that including this inductance tends to make the previous tube oscillate. One method of preventing oscillation is to feed back to the input circuit some of the energy that appears in the output circuit in such magnitude and phase that the tube is no longer unstable. Owing to the fact that unity coupling is necessary to obtain complete prevention of oscillation (neutralization) at all frequencies, it is impossible to neutralize the amplifier over more than a narrow band at one time. Often the circuits are balanced at the shortest wavelengths, for the tendency to oscillate is greatest there; but this is apt to result in poor transfer of energy on the longer waves.

If it were possible to neutralize a receiver completely throughout its tuning range and to include sufficient primary inductance with close enough coupling to the secondary to produce proper amplification on the longer waves, the design engineer's problem would be simple. Unfortunately, in spite of the neutralization process, it is often impossible to utilize the utmost desirable amount of primary inductance and coupling, and the longer waves suffer.

A method that has been used to maintain the circuits in a two- or three-stage radio-frequency amplifier free from oscillations is that of including

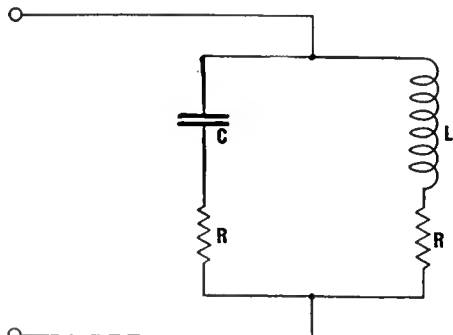

FIG. 3.

resistances in the grid circuits of the amplifying tubes. It was found in the Freshman laboratories that, with sufficiently large primary coils, the resistances became rather large, of the order of 500 ohms. This method of "holding down" an amplifier is shown in Fig. 1, and in Fig. 2 is the equivalent circuit.

Mathematics will show that for every resistance, another, smaller in actual value, can be substituted, as in Fig. 2, in the tuned circuit itself to accomplish the same end, namely, cessation of troublesome oscillations. In fact, when such external resistances are used, the selectivity of the circuit suffers, and at the same time the amplification falls off, showing conclusively that this external resistance has in effect added considerable damping to the tuned circuit itself.

There is a very serious objection to the use of

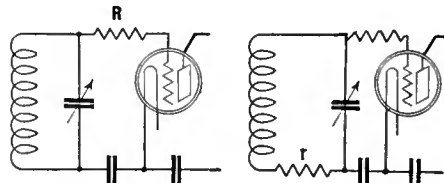

FIG. 1

FIG. 2

resistances as in Fig. 1. Under the usual conditions obtaining in a high-amplification circuit, the value of the stabilizing resistance is somewhat critical. If the correct value is exceeded, the overall voltage gain of the radio-frequency amplifier is considerably reduced, while if the resistance is too small, the circuit oscillates violently. Furthermore, any slight variations in the component parts which make up the radio-frequency amplifier change the value of resistances needed for best operation.

The solution, naturally, lies in very close manufacturing limits on the values of inductance, capacity, and resistance, and for some time receivers employing the resistance arrangement of Fig. 1 were built in the Freshman plant. In spite of the fact that the resistances were held accurate to within plus or minus 1.25 per cent., difficulty occurred from oscillation or poor selectivity and lack of amplification too frequently for comfort. It became necessary to develop another stabilizing system.

The new method of overcoming oscillations without the disadvantages previously mentioned was found by Mr. W. L. Dunn, Jr., and was developed by the engineers of the Freshman laboratory. This method is based on a principle which has been used for a long time in telephone equalizing circuits, and has been discussed mathematically by K. S. Johnson in his *Transmission Circuits for Telephonic Communication* and by Morecroft on page 92 of the new edition of his well known *Principles of Radio Communication*.

The circuit which has been utilized is shown in Fig. 3, and it may be seen to consist of a coil and condenser in parallel with a resistance in each branch of the parallel circuit. If the resistances in the two paths are equal to each other and

equal to the square root of the inductance divided by the capacity, or:

$$R_L = R_c = \sqrt{L/C}$$

the impedance of the circuit looked at from the standpoint of the previous tube is a pure resistance at all frequencies.

Therefore, the plate circuit of the previous amplifier has no inductive reactance in it and so the tube cannot oscillate, provided the values of inductance, capacity, and resistance are properly adjusted.

Limiting the magnetic feed back in the circuit by using small diameter coils and placing them at right angles to each other, and by using proper bypass condensers across impedances which are common to more than one stage, naturally aid in keeping the amplifier performing its required tasks.

The method of applying this interesting case of parallel resonance is shown in Fig. 4. Owing to the fact that some resistance is reflected into the circuit when a secondary coil is coupled to it and is tuned to resonance, the actual values of resistance used are different, 380 ohms being used in the condenser, or plate branch, and 350 ohms in the inductance branch. The capacity used is about 100 micro-microfarads and is of the fixed-variable type, that is, a fixed condenser having attached to it a small variable capacity which may be adjusted in the factory so that the receiver does not oscillate.

When it is realized that closer coupling and greater primary inductance may be used when such a circuit is employed, the gain over the grid resistance method of stabilization is evident. Nearly double the coefficient of coupling may be used between primary and secondary in this new system.

THE RECEIVER

THE schematic diagram of a battery operated receiver using this principle is shown in Fig. 5. This receiver is now being manufactured with large quantity production methods. It has been found that it is not subject to the difficulties encountered in the case of the grid resistances method of preventing oscillation. The condenser in the plate circuit of the radio-frequency tubes consists of curved spring plates with mica dielectric which can be flattened by means of a screw which is accessible to the inside of the cabinet. This condenser is adjusted at the factory

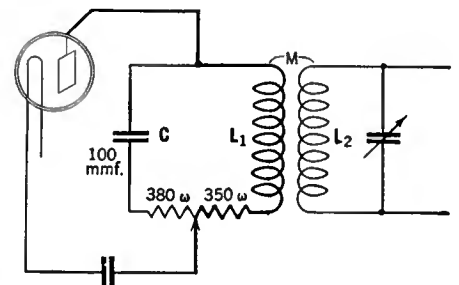

FIG. 4.

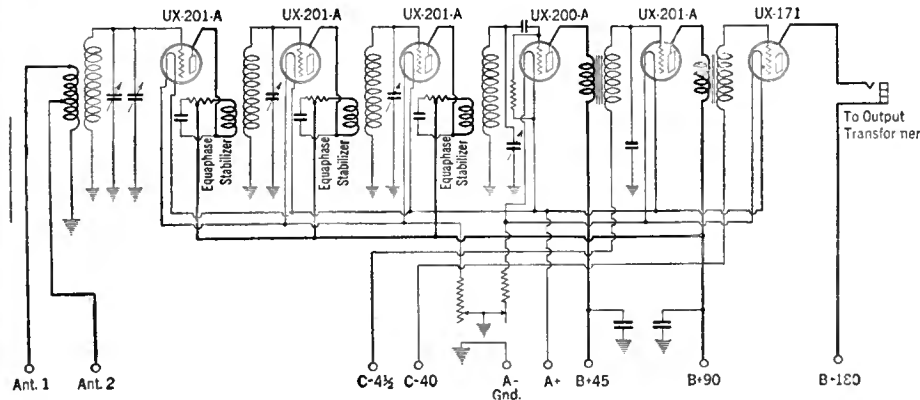

FIG. 5

so that the amplifier does not oscillate and does not require readjustment thereafter so long as tubes having the same plate impedance are used in the radio-frequency amplifier. When a.c. tubes are used a smaller capacity is needed owing to the high low impedance of these tubes compared with the average d.c. tube.

The radio-frequency transformers have secondaries which are wound on a small bakelite tubing and have individual turns slightly spaced. It has been found that this type of winding can be controlled so that the inductance of the coil may be held to within about 0.5 per cent. of accuracy when manufactured in large quantities. The primary of the radio-frequency transformer is a spiral wound on a wooden form, and is placed at the ground end of the secondary, thus having the advantage of a comparatively large coupling and at the same time small capacity between the primary and secondary.

The audio transformers are mounted on the tube shelf and have a 4 to 1 turn ratio. The secondary windings are of the split or balanced type which have very low distributed capacity and very low capacity between windings, with the result that a quite uniform amplification is obtained between 100 and 5000 cycles per second.

The radio-frequency inductances and audio-frequency transformers as well as all the other apparatus which is not accessible to the controls on the front panel, are mounted on a spring suspended metal shelf. This shelf carries the tubes and is provided with rubber dampers so that there is no microphonic feed back.

The variable condensers used are selected so that their capacities are equal to within 0.25 per cent. at two points. Since the plates are of heavy construction and have rather wide spacing, the capacities of the condensers in any receiver are practically identical throughout their entire range. The arrangement of the front panel of the "Equaphase" may be seen in the photograph of this receiver which appears on page twenty.

AUDIO FREQUENCY CHARACTERISTIC

Device Tested: Transformer ES 2774
 Circuit Data: E_A 5.0, E_B 90, E_C 4.5

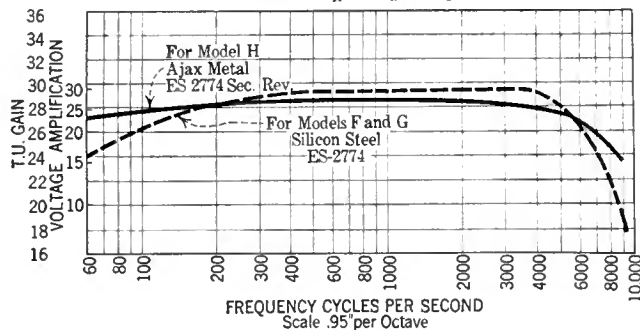

INTERESTING CURVES

Showing the characteristics of the audio transformers used in the "Equaphase"

The volume control of the battery operated receivers is obtained by means of a rheostat in series with the filaments of the radio-frequency tubes. This method has been used for several years on Freshman Masterpiece receivers and has left nothing to be desired.

As mentioned before, a slight modification of

the constants of the elements used in the plate circuit of the radio-frequency amplifiers is necessary to adapt the circuit to the use of the alternating current tubes of the UX-226 (CX-326) type. Since the circuit does not oscillate and has high amplification throughout the broadcast range, the volume control can be obtained by means of a potentiometer across the secondary of the first audio-frequency transformer. This potentiometer has the so-called logarithmic scale, that is, its resistance varies so that equal angular increments on the control produce equal increments of volume. A schematic diagram of the house current operated "Equaphase" receiver and its power supply is shown in Fig. 6. The plate supply is of the conventional type using a UX-280 full-wave rectifier tube and having a two-section filter. Various plate voltages are obtained from taps on a resistor connected across the output of the filter. The grid bias for the various tubes is obtained from the drop across the resistance in the plate circuit of the tubes.

Two independent tests are made on the sensitivity of each receiver before it is packed. These tests are made by two men who check each other's work without either knowing the other's. Around the laboratory is fed a continuous 1000-cycle tone of a certain amplitude which is maintained constant. This is available at each test bench, and is used to modulate a small radio-frequency oscillator. A very small part of this energy is picked up on a dummy antenna whence it goes through the receiver just as a radio signal would. The test man listens to it comparing it with the standard input 1000-cycle tone by means of an attenuation box which is placed in the receiver output. In this way he reads the relative amplification of the receivers, and after fixing a certain standard he can reject any which fall below the required limit. Phonograph music is also fed around the test benches so that the test man can listen to music as well as his standard 1000-cycle signal.

Any slight error in a component part is discovered in this way before the receiver leaves the factory, in which case it can be sent back to the repair bench for final adjustment.

It can easily be appreciated that this method of preventing oscillation is one which does not affect the selectivity of the receiver once it is properly adjusted. The selectivity of the "Equaphase" is quite satisfactory enough for congested districts.

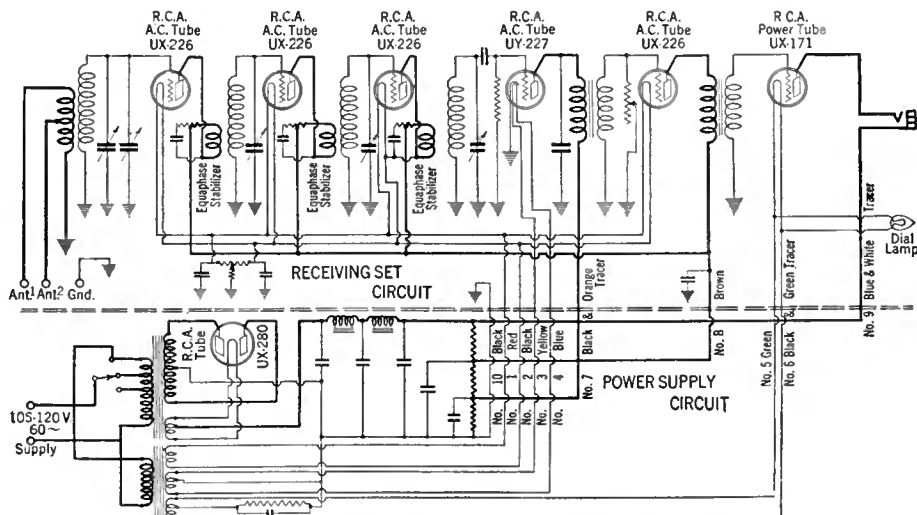

FIG. 6



The Improved "Shielded Six"

By JOHN E. McCLURE

IT IS seldom that a radio receiver design, or kit, outlives a single season's popularity, and when the exception comes along, it gives assurance that it must be an unusually fine set. Such is the "Shielded Six." During this last year certain refinements of design have been developed, and the new improved model is now ready for the 1927-28 season.

Mechanically, the design of the receiver is one of the prettiest of kit jobs, and the "Shielded Six" looks more like a carefully worked-out assembly for quantity production in a modern factory than a kit receiver. The whole set builds up progressively on a die-formed and pierced steel chassis, which is a radical departure from the often makeshift packing-case baseboards to which the home constructor is accustomed. The panel also is of metal, bronze, attractively decorated in the fashion of the new expensive factory-built sets, being utilized for this purpose.

Electrically, the circuit design involves three stages of tuned radio-frequency amplification with controlled regeneration, a grid-biased detector tube, and two stages of transformer-coupled audio-frequency amplification. In these respects the improved model is very like the original, and the only really startling improvements found in the set are circuit changes resulting in greatly increased selectivity, and the addition of vernier tuning dials found necessary because of the greatly increased sharpness of tuning.

The antenna stage, or first radio-frequency amplifier, is left unshielded in the new model to increase the coil pick-up to a point where the receiver may be operated in apartment houses with no antenna at all, and yet give adequate loud speaker volume on powerful local stations. If the second, third, or fourth coils were unshielded, selectivity would be affected, for energy pick-up on these coils would affect the selective tuning action of the tuned circuits. Shielding not only prevents pick-up of external interference, but possibly more important, entirely prevents extraneous interstage coupling.

Losses in the r.f. circuits have been reduced to a minimum through the use of quite low resistance inductances, wound on threaded ribs of bakelite coil forms in such a fashion that they are practically air-supported. These inductances are tuned by means of newly designed, very rugged, condensers providing a semi-straight-frequency, straight-wavelength tuning curve which gives most satisfactory spacing of stations over the tuning dial scales. The set may be adapted for loop reception without a single change except to pull out the antenna coil and clip on two loop leads to coil socket posts 3 and 6. The new set seems amply selective for present broadcasting conditions, for, in Chicago, it will cut through a mass of thirty local stations and bring in out-of-town stations.

While four tuned circuits are employed, only

two tuning controls are used, this being made possible through extremely accurate matching of condensers and coils. All coils for a set are matched to within a quarter of one per cent. and the condensers are all checked and held within one per cent. of each other. Since the tuning of the three right-hand circuits is substantially identical, a mechanical link serves to turn all three condensers as the right-hand dial is turned. The antenna stage condenser is tuned separately.

The audio-frequency amplifier has a highly desirable characteristic in that it amplifies practically uniformly all frequencies between 30 and 5000 cycles, above which frequency there is practically no amplification. The highest fundamental note of any musical instrument is 4192 cycles and the 5000-cycle upper limit allows plenty of leeway for the handling of the highest fundamental frequency in music, and it has been proved that frequencies above 5000 cycles do not contribute, in any measure, to fidelity of reproduction. Thus the interference caused by heterodyne squeals developed between transmitting stations, by atmospheric noise and by the tube and battery noises, all of which are generally above 5000 cycles, are almost entirely absent.

A group of people listening to the improved "Shielded Six" receiver operating in conjunction with a good cone loud speaker and receiving an organ program, will actually feel the vibration of the room in which the receiver is located, as

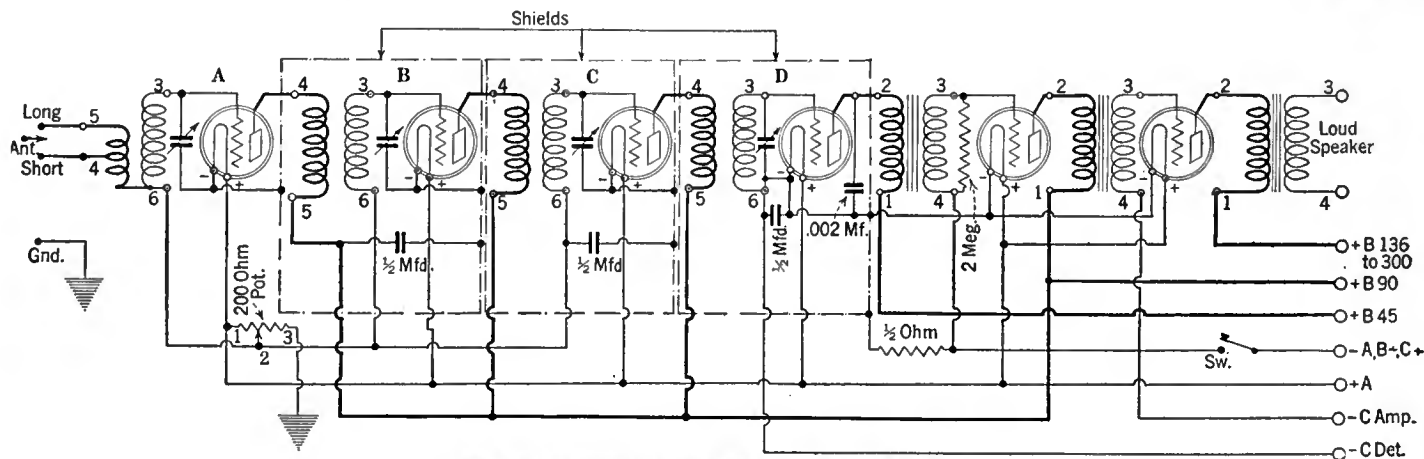

THE CIRCUIT DIAGRAM OF THE IMPROVED "SHIELDED SIX" RECEIVER

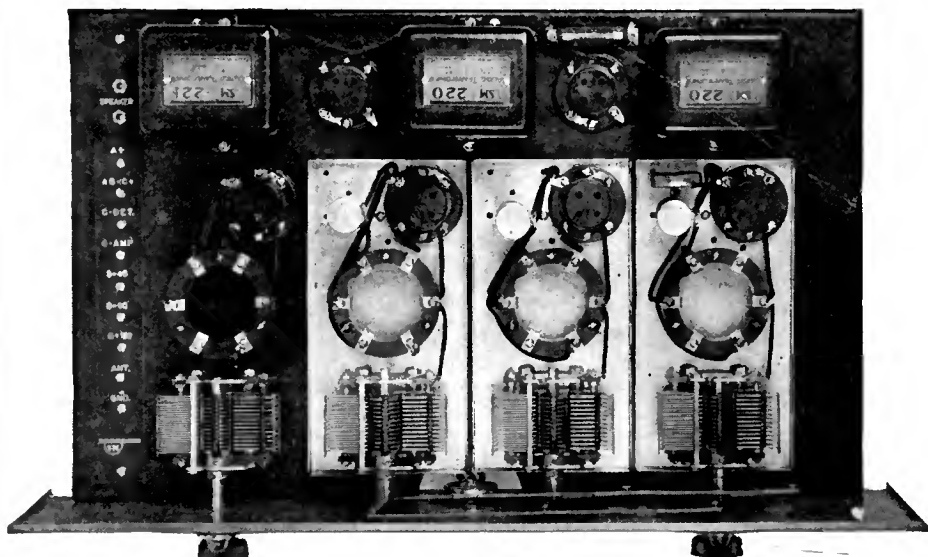

PREPARATORY TO PLACING THE STAGE SHIELDS IN POSITION

The arrangement of the Silver-Marshall triple link motion is distinctly shown in this photograph. The transformers are, from left to right, output, second audio, and first audio

they would were they in the original building in which the organ itself was located.

A. C. OPERATION

A. C. OPERATION is so ridiculously simple with the "Shielded Six" as to require little description and if Sovereign or equivalent heater tubes are used, lighted from a filament transformer, only minor changes need be made in the wiring. The standard Sovereign tubes have the heater leads coming out on top and all tubes should have their heater elements connected in parallel and to the 2½-volt winding of a filament heating transformer. It is also well to ground one side of this winding. The F—terminal of each tube socket should be connected to the receiver chassis while the F+ terminal of each tube socket should be ignored. The 200-ohm potentiometer should be eliminated and in its place a Carter 6000-ohm potentiometer used (the two center shields will have to have their corners clipped away to accommodate the new 6000-ohm potentiometer). Terminals 6 of the three left-hand r.f. transformers, which previously connected to the center arm of the potentiometer, should ground to the chassis. The 0.5-mfd. potentiometer bypass condenser is eliminated. The new potentiometer should be connected with one end to the chassis, the other end to the +90 binding post, and the arm connecting to one end of the B-90 bypass condenser and to terminals 5 of the three right-hand r.f. transformers. Five Sovereign a.c. tubes are used, with a cx-371 (UX-171) type tube in the last audio stage. The two filament leads from this latter power tube socket are run directly to the 5-volt terminals of the filament transformer. The center tap of

a Frost FT 64 resistance shunting the power tube filament connects through a 2000-ohm Carter fixed resistance to the chassis of the receiver or ground. A regular B supply, such as the Silver-Marshall 652A (which will also supply A potential to the tubes) will then furnish B potential to the entire receiver, and A, B, and C potential to the second audio stage, while a 4½-volt C battery will have to be used for the detector and the first audio stage (terminal 4 of the first audio transformer should connect to the C—Det. binding post of the receiver).

The parts needed for the Improved Model are listed below. They total exactly \$95.00. While this price may seem a bit high in that fifty-dollar six-tube sets, completely constructed, are available, it must be remembered that the "Shielded Six" has been designed with unusual care and that all the parts have been very carefully matched to insure satisfactory operation.

3—S-M 631 Stage Shields	\$ 6.00
2—S-M 316A Matched Condensers	9.00
2—S-M 316B Matched Condensers	9.00
4—S-M 515 Coil Sockets	4.00
3—S-M 118A Matched Coils	7.50
1—S-M 116A Coil, Matched with Above	2.50
6—S-M 511 Tube Sockets	3.00
2—S-M 220 Audio Transformers	16.00
1—S-M 221 Output Transformer	7.50
1—S-M 632 Triple Link Motion	2.50
1—Polymet 0.25-Meg. Grid Leak25
1—Polymet Resistor Mounting50
1—Carter 0.002-Mfd. Condenser50
3—Carter 105 or Polymet Condensers, 0.5 Mfd.	2.70
1—Carter M-200 Potentiometer (200 Ohms)75
2—Carter No. 10 Tip Jacks20
1—Carter H-½ Resistor25
2—Marco Walnut Vernier Dials	5.00
1—636 Terminal Strip, 1½ x 11 inches	2.00
1—Crowe 633 Drilled and Engraved Metal Panel, Size 7 x 21 Inches	8.50
1—Crowe 634 Steel Chassis, Size 12 x 19½ x 1¼ Inches	6.00
1—Carter No. 12 Antenna Switch60
1—Carter "Imp" Battery Switch50
1—Coil Kellogg Fabricated Hook-up Wire, Screws, Nuts, Lugs, and Complete Building Instructions25
Total	\$95.00

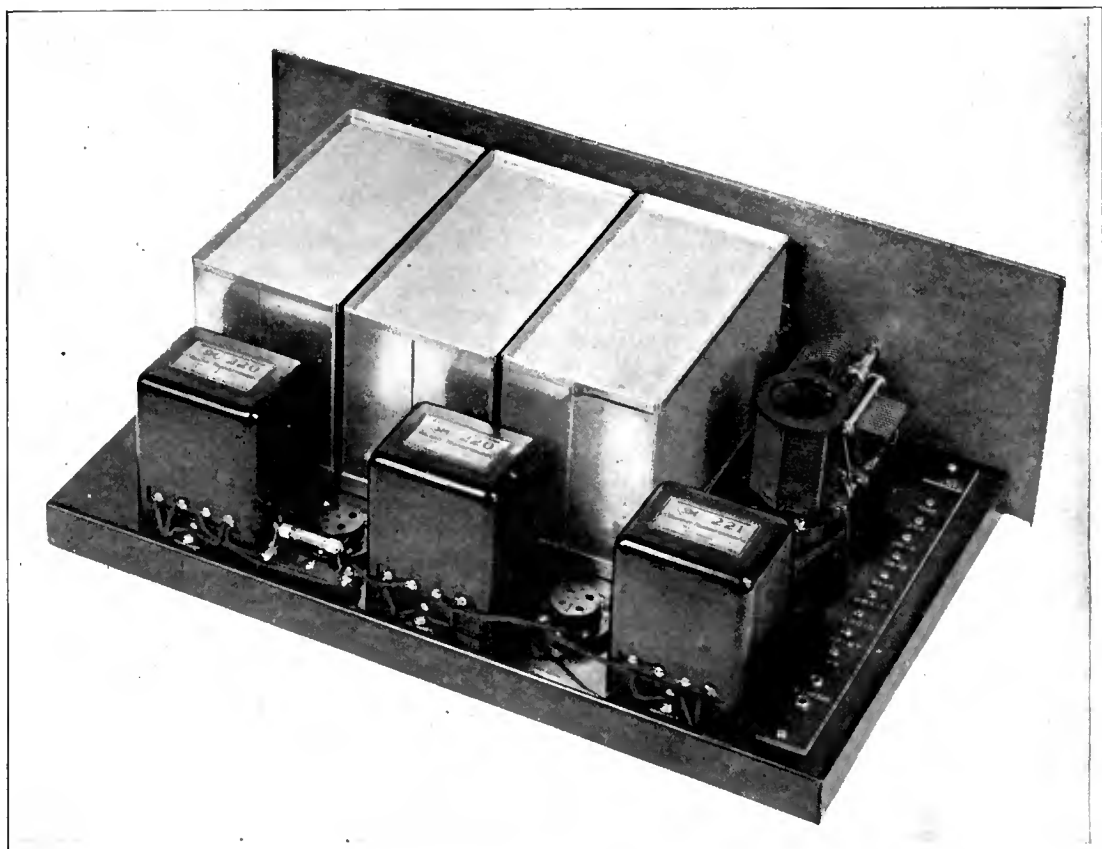

THERE IS AN ADVANTAGE IN LEAVING ONE TUNED STAGE UNSHIELDED

The antenna tuning stage, the only one of the four tuned stages not shielded, has purposely been left in this condition. By so doing, the coil pick-up is increased to a point where the receiver may be operated in apartment houses with no antenna at all, and adequate volume obtained on the loud speaker when receiving powerful local stations

The IMPROVED Aristocrat

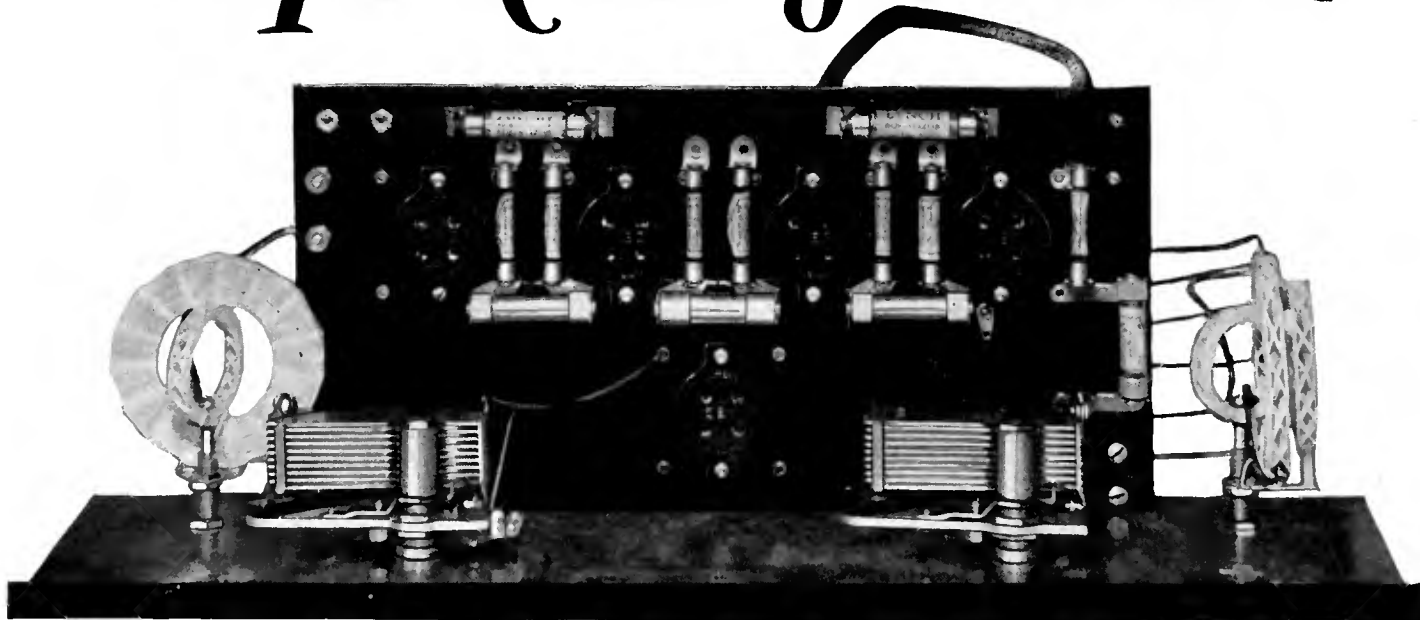

RADIO BROADCAST Photograph

A SUITABLE LAYOUT THAT MAKES FOR SIMPLICITY OF CONSTRUCTION

There are many possible variations of design for the new "Aristocrat," the layout here, in fact, not being exactly similar to that described in the text. The "deck," for example, is mounted away from the front panel in the model described, and one variable rheostat takes the place of the two ballasts shown in the photograph. New Eby sockets have been substituted for the older pattern ones shown, and binding posts are used for Antenna, Ground, and Loud Speaker

By ARTHUR H. LYNCH

EXACTLY two years ago RADIO BROADCAST first described the "Aristocrat" receiver. This receiver became unusually popular and many interesting letters were received telling of the good results that were obtained. It was a five-tube affair consisting of a stage of tuned radio frequency followed by a regenerative detector, and the audio circuit comprised a three-stage resistance-coupled amplifier. Correspondence is still received from many readers regarding the receiver and evidently many "Aristocrats" are still giving good service. We do not intend in this article to describe a radically new "Aristocrat" receiver. The original circuit was carefully thought out and even though two years have elapsed since it was first described there are only minor ways in which it can be improved. An "Aristocrat" receiver carefully constructed in accordance with the original description would be found selective, sensitive, and capable of giving good quality reproduction in the majority of cases; there are, however, a few rearrangements that might be made in the mechanical design which will make the construction of this receiver simpler and better looking.

Before going into the details concerning these suggested changes, a very brief description of the circuit in its revised form, with special reference to the ways in which it differs from the original, will be given. The circuit diagram of the new "Aristocrat" is given in Fig. 1. An important difference between the new and the old set is immediately evident to those who are familiar with the original circuit, *i. e.*, that the antenna stage now uses a variocoupler instead of a tapped coil. Antenna tuning in the original receiver was accomplished by means of the taps on the primary of the antenna coil and by proper use of this adjustment it was possible to obtain high efficiency

from the receiver with various lengths of antennas. The new antenna coil of the "Aristocrat" contains a secondary with primary inside it, variable coupling between the two coils accomplishing the same results as did the taps in the original coil; with the new arrangement the adjustment can be made more readily and more accurately. The variable antenna coil is a distinct improvement and should be incorporated in the new "Aristocrat" receiver and might also be used to advantage in receivers constructed according to the original circuit.

The detector stage of the new "Aristocrat" remains the same as the original circuit. The audio amplifier is arranged so that somewhat greater voltage is placed on the plate circuits of the first two stages than was originally used. The new high- μ tubes should be operated with at least 135 volts on their plates.

Simplicity of construction is the keynote of the new receiver. The improvements that have been made in the constructional features of the "Aristocrat" are, first, the use of a metal panel of special design and, secondly, a new and unique type of sub-panel construction. The special metal panel is designed to accommodate two variable condensers of the single-hole mounting type and the panel is also made for use with illuminated dials. There are three additional holes

in the panel, the one at the left being for the antenna rotor control, the center one for the rheostat knob, and another hole at the right is for the regeneration control. This panel and dial combination can be used in constructing any number of circuit combinations where there are only two tuning controls and its use in the "Aristocrat" is a good example of its utility. The panel measures seven by eighteen inches and is a product of the Wireless Radio Company, of Brooklyn, New York.

The new special sub-panel, or "deck" as it is called, has five Eby DeLuxe sockets mounted on it and audio amplifying equipment for a five-tube receiver. It is made of Westinghouse Micarta, and is built to accommodate ten binding posts. In the model illustrated the six-wire cable obviates the use of six of these binding posts, connection for the batteries being made directly to the wiring of the receiver by means of this six-wire cable. The audio amplifier is a three-stage resistance-coupled affair and both the resistances and condensers are held in place on the "deck" by clips so that constructors may use any values which they may prefer. The person who wishes to experiment can procure additional values of resistance and condensers than those which come with the deck and substitute them when desired.

There are available many different antenna couplers and three-circuit tuners that may be used in the "Aristocrat." In the particular receiver illustrated in the photographs accompanying this article, Sickles "Aristocrat" coils have been used in conjunction with Cogswell condensers. The Cogswell antenna tuning condenser has been made in a very ingenious fashion. Its stator plates form one side of the neutralizing condenser, while the other plate of the latter is mounted on a pair of hinges and is

PLATE VOLTAGE	NEGATIVE C BATTERY VOLTAGE REQUIRED			
	Power	Semi-power	Audio	Radio
45	—	—	—	0
90	16.5	6.0	—	3
135	27	9.0	1.5	—
180	40.5	12.0	3.0	—

adjusted by turning a small screw which pushes against an eccentric cam. It is all very small, very simple, convenient, and very effective, as well as being cheap. At the end of this article there is given a list of those parts used in the model that is illustrated, and the photographs and the circuit diagram should enable experienced constructors to build the receiver with little difficulty.

NEW TUBES

IT IS possible to procure an improvement in results from either an old or new "Aristocrat" by making proper use of the several new types of tubes that have become available since the "Aristocrat" first made its bow. A special detector tube, for example, may be used in the receiver instead of a 201-A type and it will increase the sensitivity and volume very considerably. In this case the detector grid return should go to negative A instead of to positive as indicated in Fig. 1, unless a special Ceco type H detector tube is used, when no change is necessary. Ceco type G high-mu tubes should be used in the first and second stages of the audio amplifier. High-mu tubes of other manufacturers should not be used unless the condenser and resistor values are changed to comply with the specifications of the individual makers. The output tube should be of the semi-power type with proper C and B voltages. Ceco makes special radio-frequency amplifier tubes which will give slightly increased gain in the r. f. stage. They are known as the type K tubes. These new tubes, without regard to any other improvements that might be made, will give greater distance, sharper tuning, and more volume than can be obtained when ordinary tubes are used.

In the table accompanying this article there are given data on the C and B voltages that should be used on the various tubes. The column headed "Power" gives the voltages when a UX-171, CX-371, or Ceco J-71, is used in the output stage. The column head "Semi-Power" gives the required voltages when a UX-112, CX-112, or Ceco type F is used in the output. The voltages given under the column headed "Audio" refer to the high-mu tubes in the audio amplifier. The values given under the column headed "Radio" apply to either 201-A's or special radio-frequency

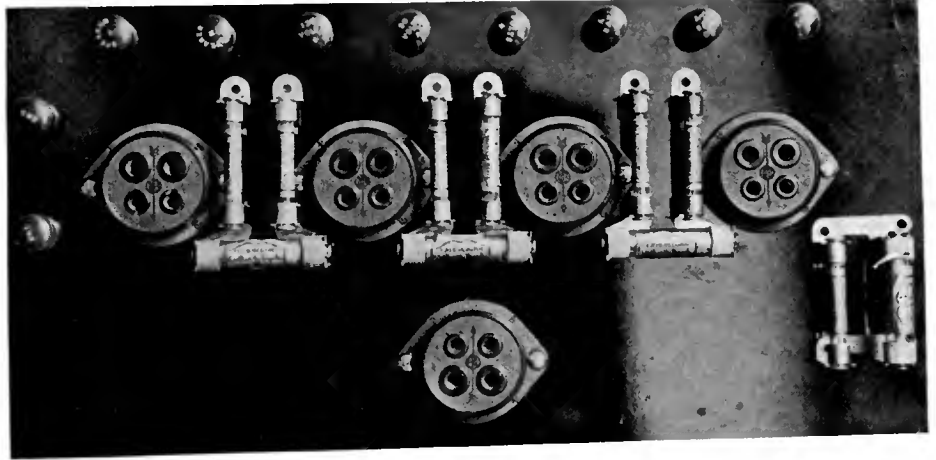

THE LYNCH "DECK"

Its utilization considerably simplifies receiver construction. The list of parts below tells just what the "deck" comprises

amplifier tubes. If a 171, 371, or J-71 power tube is used in the output of the receiver, an output filter or output transformer should be used in the plate circuit of the tube to protect the windings of the loud speaker from the high plate current. As shown, the circuit is wired for a 112 or Ceco F type tube. C bias for the first two audio tubes is obtained by inserting a battery in the common grid lead at the point marked "X," the positive terminal of the grid battery connecting to negative A.

The results obtainable from the improved "Aristocrat" receiver do not suffer at all in comparison with the original set, while the total cost of building the receiver has been materially reduced. The automobile business is not the only one in which the honest claim that production methods enable you to purchase a better product for a lower price. In the case of the improved "Aristocrat," production methods have been applied to radio.

- L₁, L₂—Sickles "Aristocrat" Coils \$ 4.50
- C₁—Cogswell Variable Condenser, Type A, 0.00035 Mfd. 2.25
- C₂—Cogswell Variable Condenser, Type B, 0.00035 Mfd., Neu-

trailing Condenser (C ₅) Attached	2.75
C ₃ , C ₄ —Sangamo 0.004 Mfd. Fixed Condensers	1.20
Four Eby Binding Posts	.60
Six-Wire Cable	.60
Wireless Radio Company's Panel, 7 x 18 Inches, with Mounting Brackets, Illuminated Dials, and Filament Rheostat (R ₁)	4.50
Two Kurz-Kasch Knobs	.50
Lynch Deck, Including the Following Parts, Mounted and Ready for Wiring:	
Westinghouse Micarta Panel	
Seven Resistor-Condenser Mounts	
R ₂ , R ₃ , R ₄ —0.1-Meg. Metallized Resistors	12.50
R ₅ , R ₆ , R ₇ —0.5-Meg. Metallized Resistors	
R—2-Meg. Metallized Resistor	
C ₇ , C ₈ , C ₉ —0.006-Mfd. Tubular Condensers	
C ₆ —0.00025-Mfd. Tubular Condenser	
Five Eby DeLuxe Sockets	
Total	\$29.40

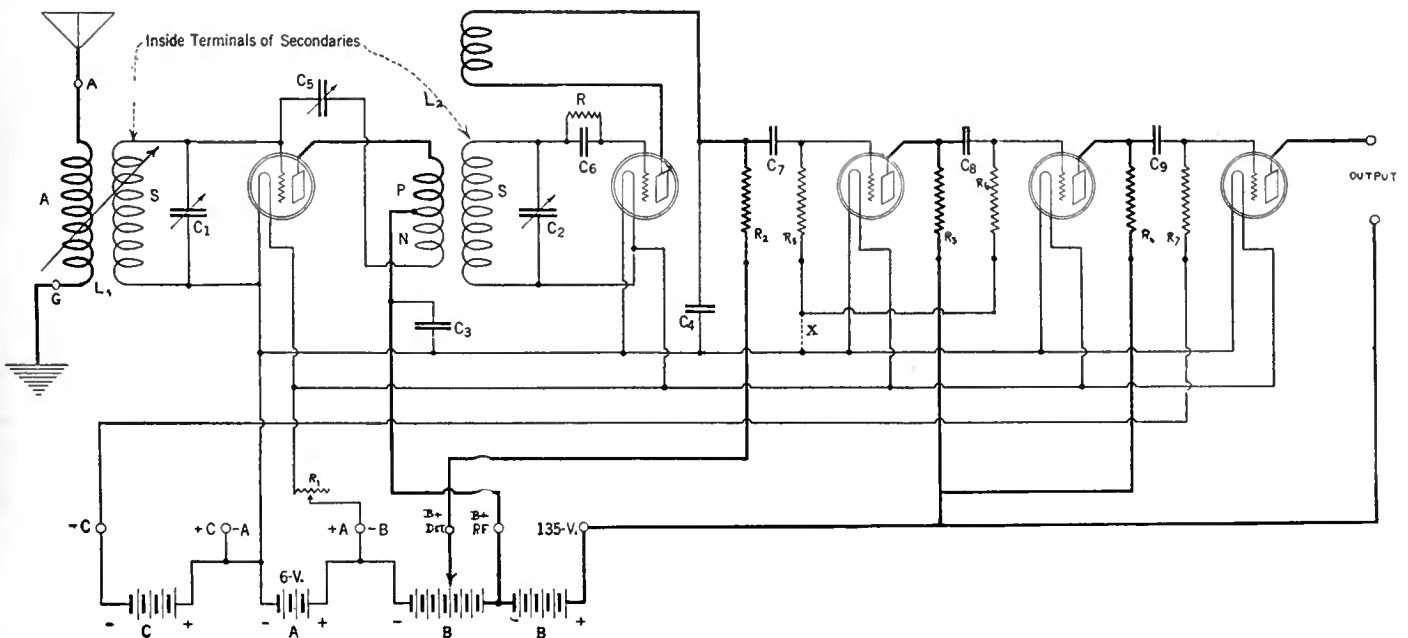

THE CIRCUIT DIAGRAM OF THE "ARISTOCRAT" RECEIVER

Suppressing Radio Interference

Interference from Motion Picture Theatres, Telephone Exchanges, Arc Lamps, Incandescent Street Lamps, Flour Mills, Factory Belts, Electric Warming Pads, Precipitators, Etc., Is Discussed, and Remedies Are Suggested

By A. T. LAWTON

ALTHOUGH this article is really the second of a series, the first of which appeared in the September RADIO BROADCAST, it is nevertheless complete in itself, and the reader who is suffering from interference of any of the forms outlined here will profit considerably from a study of this paper. The data presented here result from a two-and-a-half-year study conducted by the author in more than 132 cities. The forms of interference covered in the September article were those due to oil-burning furnaces, perhaps the most common source of man-made static, X-ray equipment, and dental motors. The first kind of interference to be considered here is that originating at motion picture theatres.

MOTION PICTURE THEATRES

THE radius of interference from this source is ordinarily about 200 yards, occasionally greater, depending on exterior wiring. In the great majority of cases the direct-current generator is responsible for the trouble. Contrary to popular belief, the arc lamps themselves cause practically no interference; in fact, there is often less disturbance with the arcs lighted than before they are "struck," *i. e.*, with the generator running unloaded. The difference in certain cases is decided, absorption of the interference occurring as soon as the arcs are put on.

Fig. 1 shows a method used to eliminate this interference with success in actual practice. Five-ampere fuses are used. If the commutator is badly worn, it should be turned down in a lathe, and we might remark here that the quality of the carbon brushes used have a noticeable effect on the intensity of commutation interference.

Squirrel cage induction motors are in common use for driving these generators and, ordinarily, give no trouble unless some defect is present.

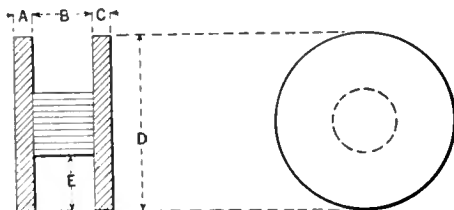

A- $\frac{1}{4}$ " B- $\frac{3}{8}$ " C- $\frac{1}{2}$ " D-2 $\frac{1}{2}$ " E- $\frac{3}{8}$ "
Hardwood Bobbin, approx. 300
turns No.22 (about 125 ft.)

FIG. 2

Constructional details for the choke coils recommended for elimination of interference originating in telephone exchanges

TELEPHONE EXCHANGES

IT IS probable that in most cities interference from this source has been cleared up. The larger operating companies have been active in this regard, but in smaller towns and rural communities much trouble exists. On the larger type motor ringers, high-tone and low-tone (sometimes referred to as trouble tone and howler) circuits are mainly responsible. Complete elimination is secured by inserting a choke coil in each of the two brush leads, close up to the machine. Details of the coil required are shown in Fig. 2.

Complications arise if connection is made at a distance of more than four inches from the brushes—incomplete elimination resulting.

The greatest offenders in the category of telephone ringing apparatus are pole changers and frequency converters. These constitute standard equipment in thousands of small exchanges; in some larger exchanges they are operated only after 10 P. M. when the rush hours have passed. The interference is of a rapid clicking nature and may carry half a mile or more, depending on the proximity and layout of the city distribution and telephone wiring.

For pole changers, definite and conclusive re-

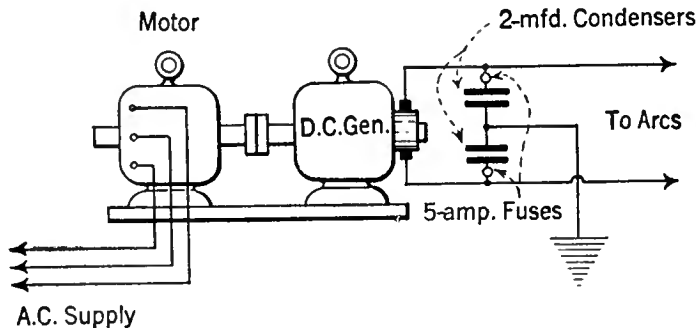

FIG. 1

sults are obtained by inserting the coils described in Fig. 2 in the ringing leads and at least 95 per cent. of the trouble disappears. Up to the present we know of only one instance where this method failed—and peculiarly enough, a simpler method cleared up the trouble. A single one-half microfarad condenser bridged across the contacts gave 100 per cent. elimination.

Frequency converters are a different proposition, operating off a. c. instead of d. c. as in the case of pole changers. The surge trap applicable to pole changers gives only 50 or 60 per cent. reduction.

A special surge trap is made up for this source by companies manufacturing the frequency converter, and it will be found more economical in the long run to purchase this complete rather than endeavor to make it up locally. For all practical purposes, complete elimination is obtained through the installation of the special surge trap.

Automatic telephones, now coming into such general use, contribute their little quota of dis-

turbance. Usually they affect radio receivers only in the same residence where the dialing operation is being carried out, although several cases are on record where radio sets of next-door neighbors were also affected.

A single condenser of one microfarad capacity placed across the dialing circuit will cut out the clicking noise and does not appear to have any detrimental effect on the speech transmission or proper functioning of the line. However, permission of the telephone company should be obtained before making any attachments.

ARC LAMPS

STRANGE as it may seem, flickering arc lamps cause practically no radio interference. If the arc is jumping violently, however, then clicks are recorded on radio receivers in the vicinity; a short distance away interference is not material. This doesn't mean that arc lamps cause no disturbance. On the contrary, during a recent investigation one arc lamp practically killed radio reception for eleven city blocks along one street. It was burning perfectly steadily and showed no sign whatever of defect.

The characteristics were slow clicking in dry weather, fast clicking in moist atmosphere, and rapid clicking during rainy weather. On a five-tube set with loud speaker, the noise was violent, resembling very much the operating of a pneumatic hammer. The source of trouble here was a minute fissure in the composition head ring which, filling up with moisture, caused a high-resistance short across the 4000-volt lines. Evidently the spark dried up the moisture at each crossover, and time was required for the path to reform, otherwise we should have gotten steady buzzing here.

During all the days this case was under observation not once did it come on coincident with the lighting of the arcs, but always twenty minutes or twenty-five minutes afterward. It took time to develop, possibly a slight heating and consequent expansion of the parts being involved.

If arc lamp interference comes on directly the lamps are lighted the source is very likely to be line trouble, such as wires scraping on iron bracket arms, loose splices, etc.

In many localities where it is prevalent arc lamp circuit interference starts up before the lamps are lighted, perhaps twenty-five or thirty minutes previous to lighting, and it is quite regular every evening.

This is caused by the rectifying tubes in the power house or sub-station. These tubes are "warmed up" for service prior to the line being switched in; the operation takes twenty-five minutes or so, and radio-frequency surges pass out on the line despite the open switch, so even before the lamps are actually lighted interference starts. Intensity of the interference is increased when the lights come on and continues all night, until the daylight shut-down. Generally speaking, new rectifying tubes do not give trouble, nor older ones, paralleled. Overloaded tubes, how-

ever, or those which have become hard through long usage, are liable to set up interfering surges that will travel long distances over the system.

The obvious thing to do with a defective lamp is to have it repaired; the same thing applies to line defects. Rectifying tube disturbance, by far the worst trouble because of its continuous nature and wide range, can be cleared up by putting a choke coil as described in Fig. 3, in each outgoing d. c. feeder.

Two hundred turns of No. 16 d. c. c. wire are required on a wooden cylinder $3\frac{1}{2}$ inches diameter and about 12 inches long. Longitudinal slots are cut in the cylinder for insertion of fibre strips which keep the wire off the wood and provide adequate heat radiation facilities. This is for 4-ampere arcs; for 6-ampere arcs it may be as well to use No. 14 wire.

It seems that in certain instances of this nature, seventy-turn chokes were large enough to give satisfactory elimination; in the particular case in mind they were ineffective.

INCANDESCENT STREET LAMPS

IT MAY come as a little surprise when we say that, given any city where the street lighting system consists of, say two thousand series arcs and two thousand series incandescent lamps, on various circuits, more radio interference will be caused by the incandescent lamp circuits than by the arc system.

This is due to less careful installation in the case of the incandescent system—not because of any inherent defect. The condition is general.

Of one hundred cases of radio interference due to faults on series incandescent lighting systems:

- 42 were caused by down-lead wires scraping on the iron brackets.
- 15 by loose connections of the wires at the lamps.
- 10 by internal defects in the lamp fixture proper.
- 10 by partial shorting of the wires in conduit prior to connection at the lamp.
- 9 by poor line splices.
- 5 by leakage or spitting at the disc fuses in the lamp head.
- 5 by lamps loose in their sockets.
- 4 by defective mercury or other type automatic time switches.

It may be remarked here that sources on a series lighting system giving rise to radio interference are most difficult to locate. What occurs at a defective lamp seems to be duplicated in many lamps either side of the faulty one; intensity values of the interference are misleading and very careful observation is required.

FLOUR MILLS

IN PRACTICALLY every flour mill the chlorine process of bleaching has been superseded by the electrical method. This consists of a twenty-thousand volt spark oscillating directly in the path of a blast of air, the latter becoming ozonated, passes on to the grain in process of crushing.

Direct radiation is confined to a few hundred feet. The source, however, is a vigorous one and distribution wiring carries the disturbance to great distances; it is capable of mutilating radio reception practically all over the average small town.

Methods of elimination are simple and definite. One hundred-and-fifty turn choke coils wound on three or three and a half inch tubing will kill at least 85 per cent. of the noise and will not interfere in the least with normal operation.

Operating current here is 12 to 15 amperes; if the coils are not banked, No. 10 wire will be suitable. To conform to Electrical Inspections

requirements, enclosure of the coils in a standard outlet box is recommended, the knockout holes of which have been opened and covered with fine wire gauze. This latter affords good ventilation while preventing grain dust accumulating on the coils.

Self-contained bleachers of the arc type cause no trouble. They are, however, being rapidly displaced by the more efficient spark type.

FACTORY BELTS

HIGH-SPEED belts are a fruitful source of radio interference, especially noticeable in cold, dry weather. Friction between the pulleys and belting causes a static charge to form on the belt and this, after rising to a high potential, will spark to nearby metal objects, setting up a "crackling" noise in the receiver.

As most heavy rotary machines are well connected to ground one would imagine that this static charge would filter away gradually, and fail to build up to any material potential. The fact is, and it can be demonstrated, that the film of oil in the machine bearings is sufficient to insulate the rotating parts from ground.

A "static collector" is used to get rid of this trouble. It consists of a wiping contact of springy

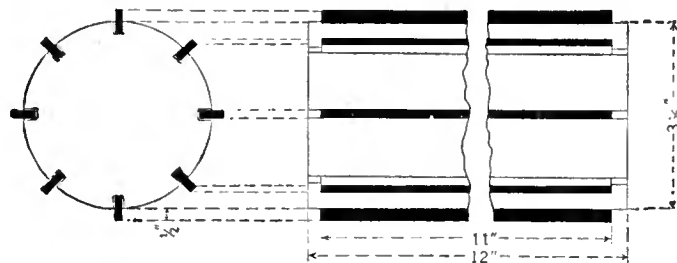

FIG. 3

metal, at all times resting on the belt in motion and permanently connected to earth.

A metal laced belt can set up quite a loud clicking interference. Every time the metal lacing passes over an iron pulley the click is heard. No such effect is noted, of course, where wooden pulleys are used, but in the cases cleared up we simply removed the metal lacing and substituted rawhide.

ELECTRIC WARMING PADS

WHETHER interference from this source is to be regarded as serious or not depends on how far away you live from the offending pad. The radius is about two dwellings either side of the one in which the pad is being used, assuming that the houses are close together.

Little thermostats inside the pad automatically break the supply current when the pad becomes sufficiently heated and switch it on again when the elements cool sufficiently. This alternate opening and closing of the 110-volt supply line sets up clicks which are extremely annoying to broadcast listeners in the immediate vicinity.

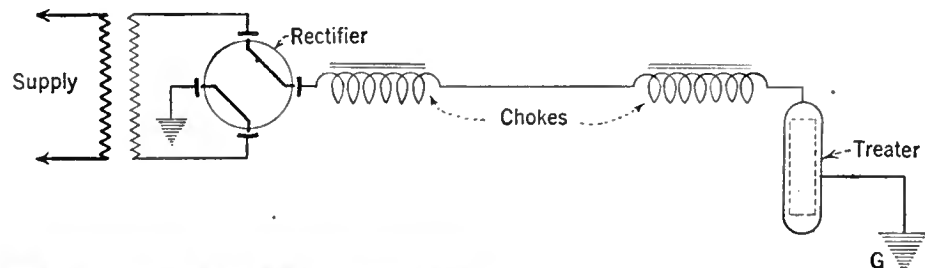

FIG. 4

Intensity of the trouble varies with the make of pad and also with length of service. It seems that corroded or burned contacts are responsible for most of the trouble and before going to the expense of purchasing condensers, etc., it is usual to open the warming pad and readjust the thermostat contacts after cleaning them up properly.

A different problem is presented in the case of hospitals. Take a literal, specific example: Two hundred patients, two hundred pairs of telephones (no loud speaker allowed) and, incidentally, two hundred warming pads (one for each cot), were in use. Every time a patient gets restless and kicks out his feet he jars the pad thermostats and treats the other hundred and ninety-nine to a series of sharp clicks usually resulting in reciprocation.

Substitution of quiet types for the noisy ones and condenser absorption would seem to be the best recommendation.

PRECIPITATORS

THIS apparatus is used in the treatment of various ores as well as for the purpose of smoke and dust precipitation. Its radio interference can be heard ten miles; at five miles it hurts reception and in the vicinity of the plant, normal reception is impossible.

As in the case of the notorious oil-burning furnace, methods of elimination which clear up the trouble in one installation fail to give the desired results when applied to another plant.

Several cases have been cleared up using high-frequency chokes, i.e., placed in the high-

tension circuit. The coils consist of 500 turns of No. 18 or No. 20 bare or covered wire on a tube three and one half inches in diameter. Individual turns should be spaced about one eighth inch apart except at the ends, where one-quarter inch spacing is recommended.

Fig. 4 shows an arrangement which has given satisfactory results. It may be necessary in other cases to split this 500 turn choke, i.e., putting 250 turns near the rectifier and 250 near the treater.

In the types where the high-tension energy for the rectifier is obtained through transformer action direct from a transmission line, interference is naturally heavier than that experienced from the more or less self-contained motor generator type although the actual energy in the former is less than in the case of the latter. Average energy values will be about 70 milliamps. at 30,000 volts and 80 milliamps. at 50,000 volts, respectively.

Considerable experimental work has been carried out by different precipitation plants in this connection and while special treatment was found necessary in several instances practically all cases investigated have been cleared up.

AS THE BROADCASTER SEES IT

BY CARL DREHER

Drawing by Franklyn F. Stratford

Putting Freak Broadcasting in Its Place

IN ALL human affairs the tendency is toward quiescence and boredom. Among vigorous peoples this drift toward monotony is resisted by a constant seeking for innovations. Now and then some fruitful bit of originality rewards the quest. In the main, however, the innovations are failures. They have no deep roots in human desires or interests, and, after the first glance, they amuse the normal spectator even less than the old shows he is weary of. The spirit is praiseworthy, but the results are dreadful, especially in the arts. Consider the poets, for example. Here and there one of them, distressed by his inability to convince the world that he is another Shelley, decides to be entirely original by printing a magazine of verse with a fake Nujol advertisement on the cover, no capital letters, and half the words upsidedown. His originality is hard on the compositors. To be original, in the sense of doing something that is not commonly done, is very easy. To that degree you can be an exponent of novelty, by entering the nearest drug store and ordering a pineapple soda with chocolate cream. But to be fruitfully original requires more than twenty cents.

We are similarly beset in the art of broadcast entertainment. The innovations are many, but most of them are of the twenty-cent variety. I do not intend to itemize all the varieties of freak broadcasting; it would be impossible, and, besides, a certain portion of this department is consecrated to sensible subjects. A few samples will suffice.

The broadcasting of alleged disembodied spirits seems to me to fall into the category of futilities politely hinted at above. I have no animus against the spirits as such. It is true that I have never seen one, and, since studying psychopathology, have doubted their existence. Nevertheless, as I have not seen everything in the universe, and don't expect to, I acknowledge that such things as ghosts may exist. But why broadcast them? If a ghost wants to see me, let him or her call on me at my office, or in the dark reaches of the night. But as a broadcast listener, I like to be entertained. As a broadcast listener, I also object to the imputation that I am a total ass. No doubt I am an ass in some respects, but not to the extent that I can be kidded, on hearing the tinkling of glass, a noise like a \$6 saxophone, and some mumbling through my loud speaker, into believing that authentic goblins are disporting themselves in the studio of the puissant broadcaster who is striving to instruct me. And, when

a committee of spiritualist investigators assure me that everything is aboveboard, I guffaw openly at their discourse. Who are they to tell me so? What do they know about the tricks of broadcast transmission?

The method used in broadcasting the shades is to turn on the microphone and, with the studio doors locked and no one in the room, to listen for mysterious sounds on the station carrier, which is assumed to be quiet. The investigating committee watches the studio doors and snoops around otherwise at their discretion. But can they assert with any semblance of plausibility that they know all the sources of input to the speech amplifiers of the transmitter? Nothing could be simpler than to rig up an additional microphone somewhere in the building and, paralleling it with the transmitter in the empty studio, to broadcast any sounds one cares to. Not even that is necessary. One of the operators can tap a tube in the speech amplifier and make noises which will seem inexplicable to the ghost-chasers. The business of spiritualistic investigation is at best full of complications, and to complicate it further by adding the technical intricacies of a broadcast transmitter is beyond all sense. Whether there is fraud or not—and certainly in connection with struggling stations avidly bent on cadging every possible square inch of newspaper space the possibility of deception is not remote—the pretence of scientific investigation under such conditions is simply silly. The broadcast listeners may not be Newtons, Goethes, and Mommsens, but they are not voodoo worshippers either. The studio manager who first conceived the idea of broadcasting spirits may have been original, but he omitted to mix a few brains with his originality.

Even more infantile is the menagerie broadcasting stunt. The only justification I can see for it is in connection with a children's hour. The noises made by sea lions and rhinoceroses

are neither agreeable nor intellectual, and, being full of steep wave fronts and tones outside the band of transmittable frequencies, they don't get over anyway. If a man roared into the transmitter it would sound as much like a lion when it got through the loud speakers as if a lion did the roaring.

As one listener, I ask to be spared such buffooneries. I respect the urge for originality, but it must take a more convincing shape than in such procedures, which have no other use than to get some station's publicity matter a transient hearing. If there is nothing interesting left to say, and nothing beautiful left to play, my counsel is to shut down the transmitter and economize on electricity at the rate of three cents per kilowatt hour.

Background Noises

MR. A. S. DANA of Seymour, Connecticut, writes us as follows:

The better grade of broadcasters have made such improvement in their quality that there is but one factor which could be improved in so far as my ability to judge quality goes.

Is it not possible for them to reduce or eliminate the noise background which accompanies the transmission? In other words, cannot the equipment be improved so that it is not possible to tell when a station is on the air unless speech or music enters the microphone? According to present standards, it is easy to locate and tune-in a station when they are not broadcasting simply by the racket which occurs when the station is in tune.

Mr. Dana seems to think that the noise in question is all generated at the transmitter. Actually there are three possible sources. In some cases all are in evidence, and in others none.

Background noise may have its inception right at the microphone. The transmitter itself has a degree of internal hiss caused by current passing through the carbon in the case of a microphone, and by tube irregularities in the first stages of the amplifier associated with a condenser transmitter. But if the microphone is well designed and the carbon of high quality, and not too old, the sensitivity to external sounds is so great that the hiss is seldom audible. In the case of speech input some slight hiss is usually observable, and occasionally during pianissimo passages of musical performances, but with proper microphone care the internal

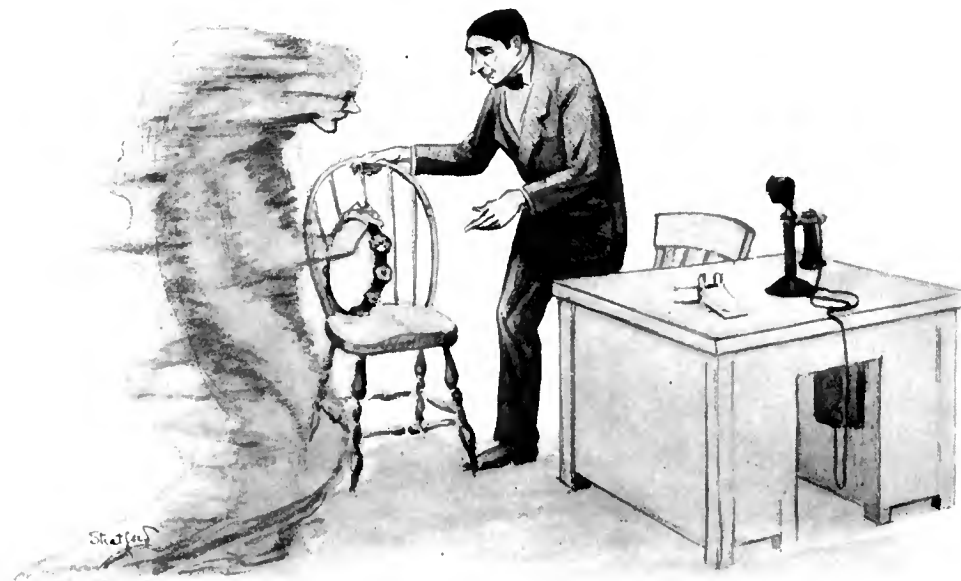

"LET THE GHOST CALL AT MY OFFICE"

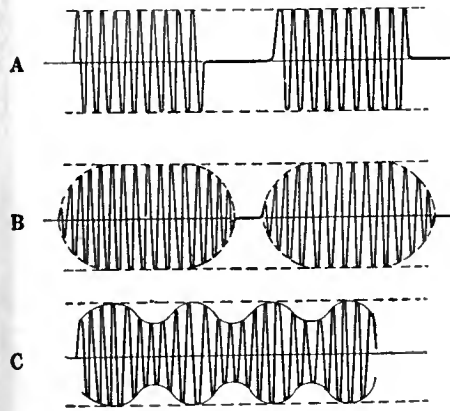

FIG. 1

noise level is negligible. If the tubes in the associated amplifier of a condenser transmitter are carefully picked this instrument is practically noiseless with normal inputs. Of course any type of transmitter will pick up room noises, and broadcasters cannot always secure their material in perfectly quiet places. But in general we may say that most well regulated stations transmit practically noise-free modulation. By that I mean that at a distance of a few feet from the monitoring cone in the station, which is assumed to emit a loud signal during modulation, no sound is audible in the intervals. Of course, by placing one's ear on the cone one can hear plenty of rustle, but that is going out of one's way. It is like saying that the alarm clock in my house, which I can hear ticking 33 feet away if I listen hard enough, is causing a disturbance which should be eliminated.

But after leaving the transmitting antenna, the modulated wave must run the gauntlet of electromagnetic disturbances in the medium between transmitter and receiver. The metaphor I have used here may be an unfortunate one, if it confirms the popular supposition that the carrier, in some mysterious way, picks up noises on its journey through space. People jump to this conclusion because they find, in tuning their receivers, with the sensitivity control well down, that they hear nothing over a certain section of the broadcast frequency range, and then, running across a blank carrier, they get a more or less audible background. The actual sequence here is more along the following lines, however: The receiver has been picking up slight disturbances—static, distant violet-ray machines, transmission lines, bells, and the like, right along, but at a level below audibility, when the receiver sensitivity is low. But the carrier coming in increases the receiver sensitivity through its heterodyne amplification, hence the noises come up when the receiver is tuned to a carrier. Of course neighborhoods vary in the relative strength of external disturbances, and anywhere there is a variation with time; normally the atmosphere may be quiet, but when there is local lightning plenty of crashes and rumbles will be picked up by all receivers. However, Mr. Dana's question probably does not include these relatively rare periods of acute disturbance.

Finally we must take into account the internal noises of the receiver itself. There is a tendency for slight gaseous irregularities in the radio frequency tubes to be amplified through each successive stage until quite a noticeable rustle results in the loud speaker. But if the tubes are properly exhausted there should be no trouble from this source. I have an eight-tube receiver, and, in testing it as I write with the sensitivity control all the way up and the loop removed to eliminate r.f. input, I am unable to hear any

sound whatsoever. With the loop in position I can hear the elevator motors in nearby apartments and a medley of undifferentiated noises, but then in practice I should never think of using the receiver in this state of excessive sensitivity. The receiver may also develop internal noises through regeneration at radio or audio frequency, or through an impure plate or filament supply. When at a low level, many such sources of disturbance manifest themselves as rustling or murmuring sounds which may be ascribed to the broadcast transmitter.

The increase of transmitting power has undoubtedly reduced background noise in radio reception, by permitting the use of less stages of amplification and lower sensitivity at the receiver, for the same signal volume. But the factor of modulation depth comes into the problem forcefully. A weakly modulated carrier simply amplifies static and interference at the expense of its intelligence-bearing side bands. Deep modulation is highly desirable on this account, and limitations on adequate modulation—which means 80-90 per cent. peaks, are as bad as inadequate field strength. Of course the best thing is to get rid of the carrier altogether, but that is a technical step feasible, at this stage, only in radio circuits professionally operated at both ends.

Abstract of Technical Article. VII

Making the Most of the Line—A Statement Referring to the Utilization of Frequency Bands in Communication Engineering, by Dr. Frank B. Jewett. Presented before Philadelphia Section of the A. I. E. E. on October 17, 1923. Reprinted May, 1924 by Bell Telephone Laboratories, Inc.

(Continued from October RADIO BROADCAST)

IN A carrier-current telegraph system free of capacity and inductance, a series of dashes made at the transmitting key will be reproduced accurately as oscillations of the carrier frequency within a rectangular envelope, as

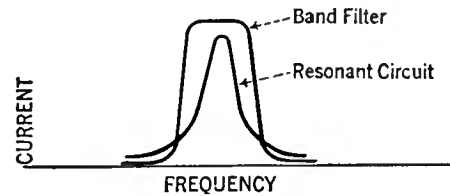

FIG. 3

shown in Fig. 1-A. If, now, inductance and capacity be inserted into the circuit so that it becomes resonant to the carrier frequency, the same keying action will produce, at the receiving end, a trace like that of Fig. 1-B. The circuit now has a certain "stiffness," so that it takes some time for it to reach the full amplitude of oscillation at the carrier frequency, and again,

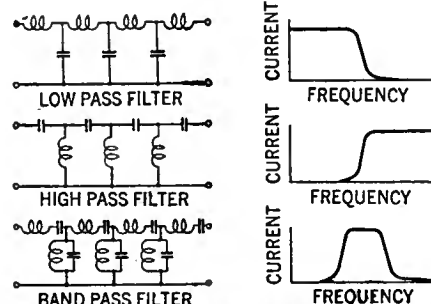

FIG. 4

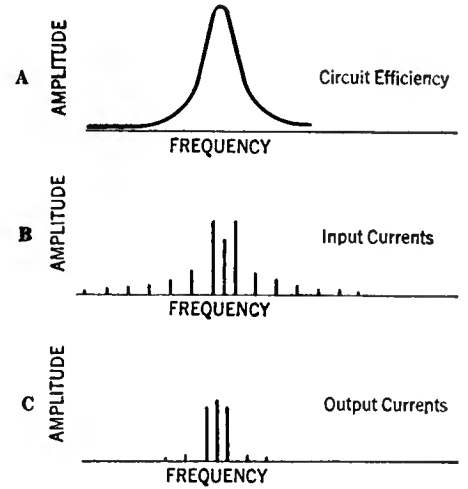

FIG. 2

after the key has been opened, the oscillations continue in a decaying wave train like that of the old spark transmitters. The faster the rate of signalling, the more serious the distortion; if, for example, dots and dashes are made too rapidly, the amplitude will never drop to zero at all, as shown in Fig. 1-C, although complete breaks are made at the key. The reason for this appears in Fig. 2. The top curve (A.) is a typical resonance peak, showing how the circuit efficiency, by virtue of the tuning effect, varies with frequency. This property, as we saw in the first instalment of this abstract, is a valuable means of frequency discrimination. But the effect also involves changing the amplitude of the various components shown in the input currents of Fig. 2-B to the output currents of Fig. 2-C. As we saw in the earlier discussion, 2-B includes the components of a square-topped wave. The suppression of the higher harmonics and the exaggeration of the carrier frequency have destroyed the rectangular wave shape. We could get it back by sacrificing selectivity—by broadening the circuit—but then we sacrifice also the power of discrimination on which we must depend if we are to make the most of the line. Obviously what is needed is a form of frequency discrimination which will pass a certain band of frequencies with substantially equal efficiency, and cut off sharply frequencies outside of this band. Reactive networks known as "filters" have been devised by telephone engineers to give this effect. Fig. 3 shows the difference in transmission characteristics between a resonant circuit and a filter designed to pass a band of frequencies in the same neighborhood. Fig. 4 illustrates the principal types of filters and their respective properties. Such circuits are of the utmost importance, not only in the practical communication arts, but also in investigations of the nature of speech and music. (Cf. Jones: "The Nature of Language," abstracted in April, 1927, RADIO BROADCAST.)

Besides the property of selective frequency transmission, the characteristic impedance of such networks is of importance. Fig. 5 illustrates two types of band filter with substantially similar elements, but designed for different connections. A is feasible for parallel connections, the impedance being very high for all frequencies save the band the network is designed to pass. But when the terminating elements are as shown in B the impedance to frequencies other than those in the transmitted region is low, so that such filters may only be connected in series. By the use of networks suitably designed and connected a number of carrier frequencies may be delivered to a line without mutual absorption,

and then separated for individual demodulation at the receiving end of the line.

By the methods described above the multiplexing of lines is accomplished. As an example, Jewett gives the schematic circuits for the multiplication of telephone channels over an open wire toll line.

Up to about 100 cycles per second the line is available for d.c. telegraph purposes. Above this point comes the d.c. telephone band with its 300-2800 cycle range, approximately. From 3000 cycles up to about 35,000 may be used for carrier-current telephone channels. It is customary in most cases to use the frequencies below 20,000 cycles for transmission from east to west, and those above this figure for transmission from west to east. The attenuation suffered by currents in the upper range is naturally greater and correspondingly higher amplification is required for equal received energy. A band about 2500 cycles wide must be allowed for each carrier channel, and a space of 1000 cycles is required for separation between channels with band filters

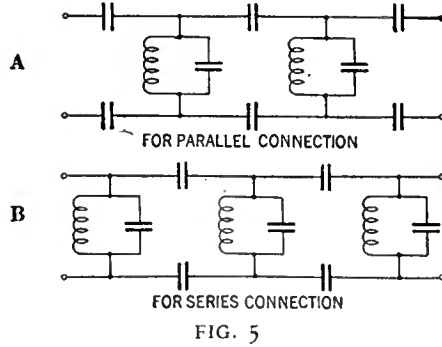

FIG. 5

vertical line. The importance of this feature will appear later on. When the subscriber on this end talks the voice currents generated in his desk set modulate the output of one of the carrier oscillators, and, passing through a band filter, which selects one of the side bands, merge with other side bands and go to the trunk line. First, however, it will be noted that they pass through a low-pass filter, designed to transmit the east-bound group of frequencies below 20,000 cycles. This filter prevents the transmitting carrier circuits from absorbing incoming energy intended for the receiving channels.

At the other terminal of the line, sketched in Fig. 7, the receiving process may be traced. Again the common line is connected to a low-pass and a high-pass filter. At this crossroads the low-pass filter selects currents associated with d. c. telegraphy and telephony and admits them to the composite set. The high pass filter selects the carrier side bands coming in from the west terminal and conducts them to the grouping filters, where the incoming currents are led to the receiving modulators. Again a band filter selects the appropriate side band for each branch. The demodulated currents pass to their respective jacks on the toll operators' board, through the low frequency balancing circuits. If it were not for these circuits obviously the received voice currents would be sent back through the transmitting carrier equipment, instead of being confined to the subscriber at the east terminal.

Jewett sums up the process physically as follows:

We have . . . followed through, from one toll board to the other, a particular signal and have seen how it is moved about on the frequency scale to a position which identifies it from other similar signals, how it is associated with such signals on a common line, transmitted to the distant terminal, isolated at the receiving end from these other signals and finally restored to its original position upon the frequency scale.

When a circuit is to be multiplexed for telegraph the range between 3000 and 10,000 cycles is normally devoted to this purpose. The directional dividing line is then usually at 6000 cycles, frequencies below this point being used for transmission from west to east and frequencies above 6000 for transmission from east to west. Various combinations of carrier telephone and telegraph are possible. One layout shown in Jewett's paper comprises the following facilities: 2 full duplex normal telegraph channels; 1 normal telephone channel; 10 full duplex carrier telegraph

channels; 3 carrier telephone channels. This amounts to a total capacity of 24 one-way telegraph messages and 7 one-way telephone messages for one pair of wires.

Carrier channels, employing currents of relatively high frequency, are subject to correspondingly greater attenuation and must sometimes be provided with repeaters at points where low frequency channels do not require amplification. At such a repeater station the low frequency currents are carried around the carrier repeaters by means of two low pass filters and a wire circuit. By means of group filters the telegraph channels are separated from the telephone channels, and finally each individual frequency is led by a band filter to the repeater designed for it.

Jewett ends his paper by a brief discussion of the multiplexing of radio circuits. He points out that at the high frequencies employed in radio transmission the range covered by a simple resonant circuit is usually sufficient to include a band wide enough for good telephonic quality, so that filters, with their rectangular characteristics, are not required.

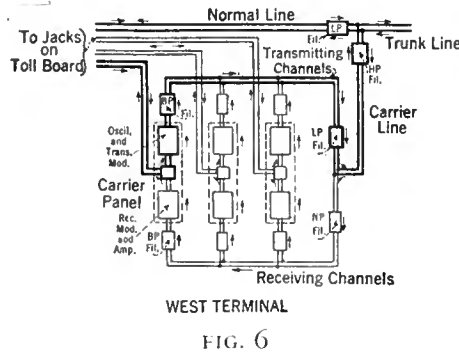

FIG. 6

possessing the usual discrimination characteristics.

Fig. 6 shows one terminal of a carrier telephone system. At this end we shall follow out the steps involved in multiplex transmission. As the line is also used for d.c. telegraphy and telephony, a low-pass filter is inserted in the metallic circuit to prevent the carrier frequencies from reaching subscribers through the toll board. Likewise in the carrier line, a two-way high pass filter prevents the currents below 3000 cycles from being absorbed in the carrier apparatus. Three pairs are shown leading from the toll board to the carrier equipment. In the case of the channel which is shown in heavy lines, the voice currents pass first through a low frequency circuit which permits the passage of current between the normal line and either the transmitting or receiving side of the carrier equipment, but which blocks currents between these two halves in a

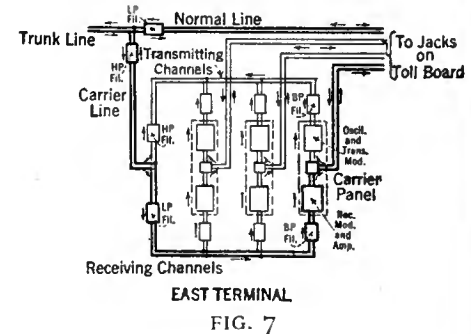

FIG. 7

A spectrum chart of electromagnetic waves, with frequency plotted on a logarithmic scale, taking in everything from the commercial d. c. telegraph to the gamma rays of radium, is also supplied, and is reproduced here as a matter of general interest (Fig. 8).

Auditorium Acoustics

THE Celotex Company of 645 North Michigan Avenue, Chicago, have issued a good-sized booklet describing their patented sound absorbing material, Acousti-Celotex, which, among other applications, has found use in various broadcasting studios in this country. About eight pages of the pamphlet are devoted to a fairly technical discussion of "Analyzing the Acoustics of Auditoriums," the subject matter covered being the same as that of our article on "Studio Design" in the June, 1927, issue of RADIO BROADCAST. The former article, being considerably longer, goes into more detail and takes up special problems, such as the effect of stage openings and balconies in auditoriums, factors influencing distribution of sound, etc. Naturally Acousti-Celotex is the absorbing material used in the examples, but the discussion is commendably general and only a small portion of the space in this section is devoted to advertising the manufacturer's product. The pamphlet should prove of interest to many broadcasters and acoustic engineers.

A word about commercial aspects in such matters. This department does not recommend specific products to its readers, but neither does it labor under any phobia as regards commercial publications. It is glad to receive them, and, when the material appears interesting and useful to technical broadcasters, in the personal judgment of the one who happens to be writing these papers, they will be mentioned at suitable times

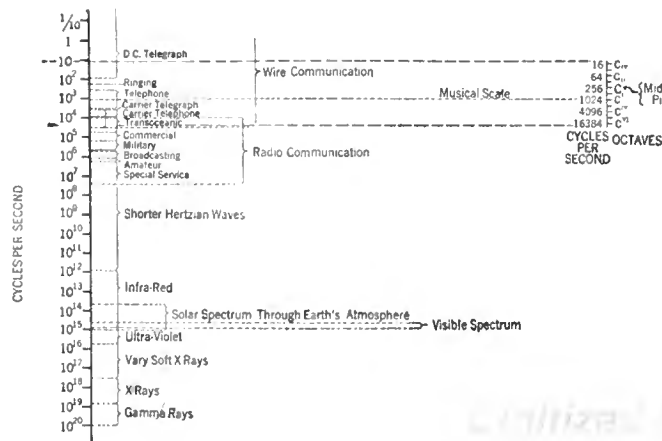
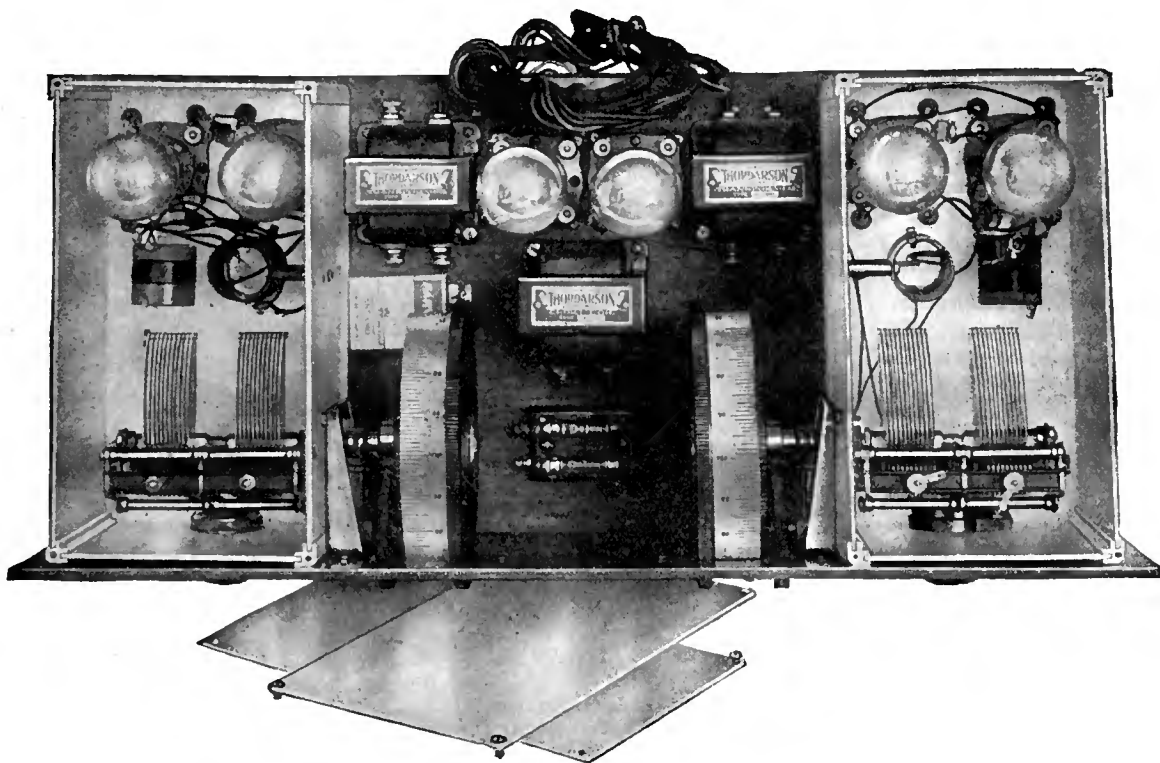

FIG. 8

ALUMINUM

AT THE RADIO SHOWS



THIS year's Radio Shows demonstrate that Aluminum has been adopted for shielding by more of the leading manufacturers and Radio Engineers than ever before.

The RGS "Octa-Monic" is an outstanding example of the use of Aluminum in prominent sets. The specifications call for Aluminum Box Shields



to insure amplification, tone quality, sensitivity and selectivity.

The standard "knock-down" ALUMINUM BOX SHIELDS—5" x 9" x 6"—are adaptable to many hook-ups.

Write for new booklet, "Aluminum for Radio," telling of the advantages of Aluminum in Radio apparatus.

ALUMINUM COMPANY OF AMERICA

2464 Oliver Building, Pittsburgh, Pa.

Offices in 18 Principal American Cities

Employing the New  "Octa-Monic" Principle

Not Regenerative! Not Tuned Radio
But the Radically and

R. G. S.

A. C. Tube Models

R. G. S. "Octa-Monic" A-C Tube Kit

including instructions and blue-prints; all necessary apparatus, ready to build, \$119.60



R. G. S. "Octa-Monic" A-C Tube Chassis

Completely assembled according to latest laboratory methods, (carefully tested and selected heavy duty wire, lamp socket connections, cable, Power (A-C) Transformer, etc., etc.) with instructions and blue-prints for installation, ready to plug in your lamp socket and operate, \$129.60

R. G. S. "Octa-Monic" A-C Tube Receiver

housed in an attractive, partitioned, walnut table cabinet, \$149.60

NOTE: All models of the R. G. S. "Octa-Monic" have been adapted to the Cunningham A-C and Power Tubes (Four (4) CX 326, one (1) C 327, and one (1) CX 371.) The "B" Battery Eliminator and the Cunningham Tubes are not included in the following prices. This eliminates an unnecessary expenditure on your part because the A-C Tube models of the R. G. S. "Octa-Monic" have been designed to operate satisfactorily with any good "B" Eliminator. It is recommended if your "B" Eliminator has no "C" battery tap, that you use the regular 40 volts of C battery.

Price Notice

Above prices do not include Cunningham A-C and Power Tubes nor the "B" Battery Eliminator. All A-C models will operate on any good eliminator. This, therefore permits the use of your own "B" Battery Eliminator, thereby representing a very distinct saving to you.

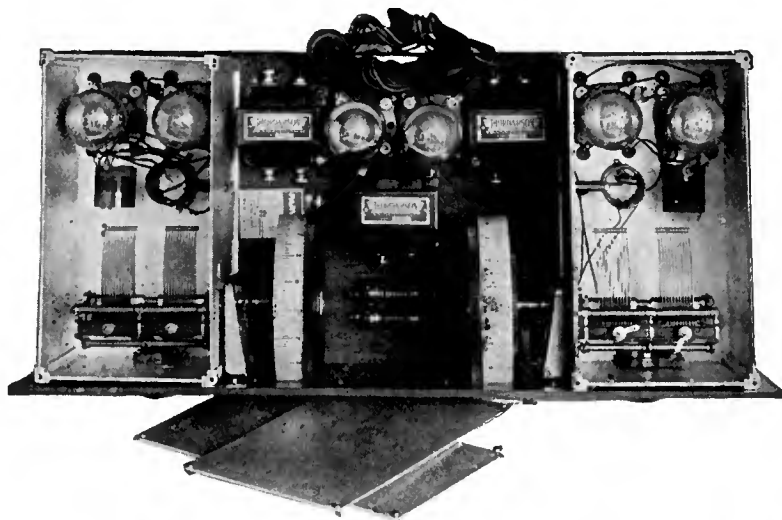

The fundamentally new R. G. S. "Octa-Monic" Receiver developed by David Grimes is one of the four great radio developments of the past 10 years. The R. G. S. "Octa-Monic" principles are fully as important and represent as basic a contribution to the Radio Art as did any of the discoveries of DeForest, Armstrong, Alexanderson, etc., etc.

These new and revolutionary principles of tuning, or the radio frequency end of the R. G. S. "Octa-Monic," produce results not only superior but, these principles of tuning place this Receiver far in advance of any receiver developed to date. The R. G. S. "Octa-Monic" is fundamental and is as radically new as was the Super-Heterodyne.

These highly efficient principles employed in the new R. G. S. "Octa-Monic" cover not only the tuning or radio frequency end of this receiver but they cover the amplification end as well. The R. G. S. "Octa-Monic" amplifier (Power tube in the last stage,) gives, unquestionably, as perfect reproduction as it is possible to buy, regardless of cost.

The R. G. S. "Octa-Monic" comes to you more heavily endorsed by able authorities than any other receiver ever presented to the Radio Public. The editor of one of the most important radio publications in America said that it was the only receiver he had ever seen in his career as an editor to which the terms "new and revolutionary" could be applied in good faith.

Selectivity superior to the super-heterodyne without cutting side bands. Selectivity enough to eliminate the heterodyne squeals of local stations, operating on a higher octave; selectivity that is equal over the whole dial without being at all critical at any point; selectivity enough to separate with ease the local jumble of Metropolitan (New York City, Chicago, San Francisco, etc.) stations; selectivity enough to give five (5) degrees of silence between stations WEF and WNYC in a location 200 yards away from WNYC.

Selectivity positive enough to make use of vernier control unnecessary.

Sensitivity or Distance-Getting Ability. Can work right down to static level. This insures trans-continental or trans-oceanic reception on favorable occasions.

Volume sufficient to fill a hall that will seat 3500.

Tonal Quality that is as nearly perfect as development in the Radio Art will permit.

Straight Line Audio Amplification.

Stability Margin of 800 ohms. The average receiver has a stability margin of from 6 to 20 ohms. This high stability margin of the R. G. S. "Octa-Monic" eliminates any possibilities of howling from poor batteries or "motor-boating" from eliminators. Batteries registering as low as 10 volts will deliver a clear tone, free from howling, in this receiver.

Straight Line Radio Amplification insuring reception at all broadcast wavelengths.

Straight Line Volume Control that makes distorting of tone impossible.

DEALERS: Write for Complete Merchandizing Proposals

BUILT FOR MODERN  BROADCAST CONDITIONS

Employing the New  "Octa-Monic" Principle

Frequency! Not a Super-Heterodyne!
Fundamentally New

"OCTA-MONIC"*

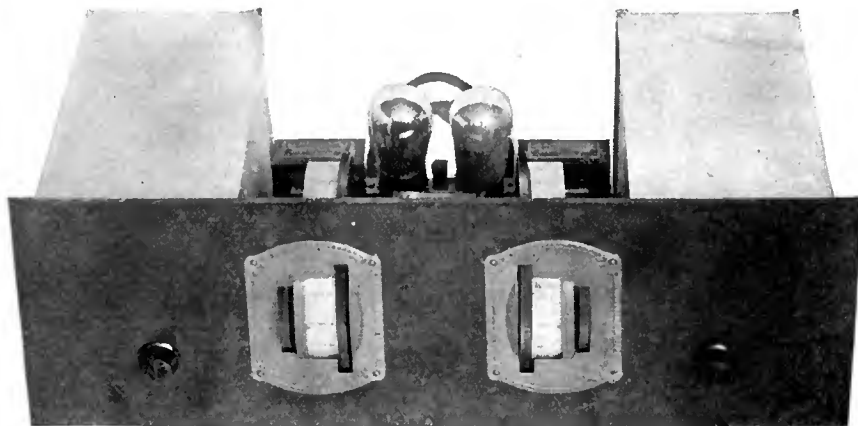

Automatic Wavetrap for prevention of heterodyning and whistling resulting from stations operating on one-half wave-length or on first octave beat.

Automatic Filament Control.

Employs 135 Volts or 180 Volts. Draws 22 mls.

Each R. G. S. "Octa-Monic" is carefully tested with scientific apparatus and under actual broadcasting conditions before it leaves the laboratories; while every piece of apparatus is just as thoroughly tested before it is built into this receiver.

The R. G. S. "Octa-Monic" is a closely co-ordinated Receiver built of quality apparatus. Careful tests are the basis for the choice of each piece of apparatus, tests that not only determine the merits of each individual part, but more importantly its relation to the whole receiver.

Standard Cunningham tubes (5 CX301-A's and 1 CX371, Power tube in last stage) and Western Electric Cone are recommended for best results.

The R. G. S. "Octa-Monic" is highly attractive in appearance. It is built on five-ply, specially shellaced sub-panel (20" x 9") to which is mounted a beautiful walnut finished, standard size panel (7" x 21") that will fit any good cabinet or fine console 7" x 21". The panel and drum escutcheons are trimmed in dull bronze.

You will find your R. G. S. "Octa-Monic" mighty easy to operate.

There are but two drums with vernier adjustments and two control knobs, one of which is an ordinary volume control and filament switch, the nearest approach to tuning efficiency, **possible**. Stations actually "click" or "tumble-in" as you slowly revolve your drums.

The customary need of wooden screw-drivers or involved balancing devices is entirely removed in the R. G. S. "Octa-Monic." Major or minor adjustments are unnecessary. The R. G. S. "Octa-Monic" is free from ordinary service. Tuning condensers are the only moving parts, and as a consequence, there are no fussy mechanisms, either mechanical or electrical, to get out of order.

The R. G. S. "Octa-Monic" operates satisfactorily on either a good "B" battery eliminator or batteries without "motor-boating" or howling.

Orders cannot be accepted for individual pieces of apparatus or blueprints.

The R. G. S. "Four" employing the Inverse Duplex System (1) R. G. S. "Four" Kit, all parts, complete instructions, \$74.40. (2) Chassis, assembled according to latest laboratory methods, \$84.40.

All prices slightly higher west of Denver. Canadian and Export prices on request.

Go to your dealer to-day and insist on a demonstration. If he hasn't stocked the R. G. S. "Octa-Monic" yet, tear off and mail to us the attached coupon with the required information. Every effort will be made to arrange a demonstration for you.

Arrange for that demonstration now because you have a real radio thrill waiting for you. In the R. G. S. "Octa-Monic" you will hear radio at its best. And when you hear the R. G. S. "Octa-Monic" you will know why it is: **"The Synonym of Performance."**

All models of the R. G. S. "Octa-Monic" and the R. G. S. "Four" are fully protected by Grimes Patents issued and pending.

*Trade Mark Registered.

DEALERS: Write for Complete Merchandizing Proposals

R-G-S Manfg. Co., Inc.

Staten Island

New York

Battery or "B" Eliminator Models

R. G. S. "Octa-Monic" Kit
of parts including all required apparatus, complete instructions and blue-prints, ready to build, **\$84.60.**

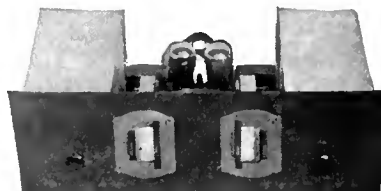

R. G. S. "Octa-Monic" Chassis
completely assembled according to latest laboratory methods, (closely co-ordinated and specially designed apparatus, eight foot Da Hery cable, etc., etc.) with complete operational instructions, ready to operate, **\$89.60.**

R. G. S. "Octa-Monic" Receiver
housed in an attractive, well-designed, walnut table cabinet, **\$104.60**

R. G. S. "Octa-Monic" Tuning Kit
including all necessary apparatus and complete blue-prints and instructions, **\$63.60**

R. G. S. "Octa-Monic" Tuning Chassis
completely assembled according to latest laboratory methods with complete instructions and ready to wire to your favorite amplifier, **\$66.60**

Price Note

The apparatus required to build the radically new and fundamental R. G. S. Octa-Monic actually lists at over \$100.00.

R. G. S. MANFG. CO., Inc.
Staten Island, New York

Gentlemen:
Please arrange with my dealer, whose address I have printed below, for a demonstration of the new and revolutionary R. G. S. "Octa-Monic". I am much interested in this receiver but this request for a demonstration and literature, you understand, entails no obligation on my part.

My Name.....
Street.....
City or State.....
My Dealer's Name.....
His Address.....

BUILT FOR MODERN  BROADCAST CONDITIONS

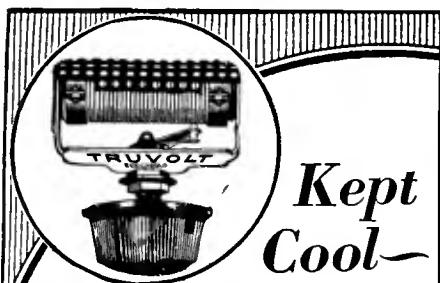

**Kept
Cool—**

*Like the Best
Airplane Motors*

TRUVOLT

**An All-Wire Variable
Voltage Control**

Here is the finest voltage control you can possibly buy for your power devices! Its special mechanical construction gives greater radiation area and keeps it cool like an air-cooled engine. This prevents deterioration and assures permanent accuracy with long life.

Resistance made entirely of nichrome wire with very low temperature coefficient and exposed directly to air—heat not held in by enamel coverings as in other resistances. Permits potentiometer control and gives positive metallic contact at all times with 30 exact readings of resistance.

Type	Ohms Resistance	Milliamperes Current
T-5	0 to 500	224
T-10	0 to 1,000	158
T-20	0 to 2,000	112
T-50	0 to 5,000	71
T-100	0 to 10,000	50
T-200	0 to 20,000	35
T-250	0 to 25,000	32
T-500	0 to 50,000	22.5

Eight stock types with resistances up to 50,000 ohms. All rated at 25 watts.

List \$3.50 each

Also full line of fixed wire resistances.

Write for free circular

**“This Is An
Eliminator Year”**

Dept. 14A

175 Varick Street

New York

ELECTRAD

The Radio Broadcast LABORATORY INFORMATION SHEETS

THE RADIO BROADCAST Laboratory Information Sheets are a regular feature of this magazine and have appeared since our June, 1926, issue. They cover a wide range of information of value to the experimenter and to the technical radio man. It is not our purpose always to include new information but to present concise and accurate facts in the most convenient form. The sheets are arranged so that they may be cut from the magazine and preserved for constant reference, and we suggest that each sheet be cut out with a razor blade and pasted on 4" x 6" filing cards, or in a notebook. The cards should be arranged in numerical order. An index appears twice a year dealing with the sheets published during that year. The first index appeared on sheets Nos. 47 and 48, in November, 1926. In July, an index to all sheets appearing since that time was printed.

The June, October, November, and December, 1926, issues are out of print. A complete set of Sheets, Nos. 1 to 88, can be secured from the Circulation Department, Doubleday, Page & Company, Garden City, New York, for \$1.00. Some readers have asked what provision is made to rectify possible errors in these Sheets. In the unfortunate event that any such errors do appear, a new Laboratory Sheet with the old number will appear.

—THE EDITOR.

No. 137

RADIO BROADCAST Laboratory Information Sheet November, 1927

Operating Vacuum Tubes in Parallel

METHODS AND RESULTS

IT IS sometimes desirable to operate several tubes in parallel in order to obtain a greater power output, and it is of interest to know how efficiently this may be done.

If two tubes are to be used in parallel in the output of an audio amplifier the two sockets are wired so that the grid of one tube connects to the grid of the other tube and the two plates connect together. The two filaments are also connected together. The result is that from these two tubes we will have only four leads—one from the grids, another from the plates, and two others from the filaments.

The amplification constant of the combination will be equal to the constant of a single tube, provided both of the tubes have the same constant. If one of the tubes had a low amplification constant and the other a high constant the resultant amplification constant of the two would be equal to the arithmetic mean. If the amplification constant of one tube is six and the other four, the resultant amplification constant will be five.

The resultant plate impedance will be equal to one half the impedance of a single tube, and if unlike tubes are used, the total impedance can be calculated by the simple laws governing resistances in

parallel. The combined impedance can be stated as follows:

$$\text{Imped. of one tube} \times \text{Imped. of other tube} \\ \text{Imped. of one tube} + \text{Imped. of other tube}$$

The greatest power output is obtained when the two tubes have identical plate impedances and amplification constants. Fortunately, however, a very large fraction of the total power of the two tubes can be obtained even if they differ considerably.

To illustrate, two tubes might be connected in parallel, the amplification constants of which are in a ratio of 2 to 1, and the plate impedances of which are equal, and from the combination we could obtain 90 per cent. as much power as could be obtained if the tubes were operated in separate circuits. If, with equal amplification constants, the plate impedances are in a ratio of 2 to 1, the total power will be about 90 per cent. of the maximum possible value. It is evident, therefore, that the total power will not be decreased by any great amount even if tubes quite widely differing in characteristics are used. From two perfectly matched tubes, feeding into a load resistance equal to their combined plate impedance, we can obtain twice as much power as can be obtained from a single tube feeding into a load resistance equal to its plate impedance.

No. 138

RADIO BROADCAST Laboratory Information Sheet November, 1927

The Unit of Capacity

CALCULATION AND FORMULAS

THE capacity of a condenser is stated in terms of the quantity of electricity it will hold per volt. When a condenser stores a specific quantity of electricity known as a coulomb and there is an electrical pressure of one volt across its terminals then the capacity of the condenser is one "farad." A condenser must be very large to have a capacity of

where C = capacity of condenser in microfarads
K = dielectric constant
A = total area of dielectric between plates in square inches
d = thickness of dielectric in inches

Example:

What is the capacity in microfarads of a condenser having 2000 plates? The dielectric consists of paraffined paper 0.002 inch thick. The part of

Vaseline	Ebonite	Glass	Mica	Paraffin Wax	Porcelain	Quartz	Resin	Shellac	Castor Oil	Olive Oil	Petroleum Oil
2.0	3.0	7.0	6.0	2.5	4.0	4.5	2.5	3.5	5.0	3.0	2.0

a farad and therefore a millionth part of a farad has been adopted as the practical unit and it is called the "microfarad," meaning one-millionth of a farad. Capacities smaller than one microfarad can be expressed in micro-microfarads, corresponding to a millionth of a microfarad.

The capacity of a condenser may be computed from the general equation:

$$C = \frac{2250 AK}{10^{10}d}$$

each sheet of dielectric actually between the plates has an area of 6.3" x 8".

From the table in this sheet it will be seen that the constant of the dielectric is 2.5.

The total area, A, of the dielectric is:—

$$A = 6.3 \times 8 \times 2000$$

= 100,000 square inches, approximately

Therefore

$$C = \frac{2250 \times 100,000 \times 2.5}{10^{10} \times 0.002} \\ = 28.1 \text{ microfarads}$$

... Modern



Here is the Eveready Layerbilt "B" Battery No. 486, Eveready's longest-lasting provider of Battery Power.

Radio is better with *Battery* Power

NOT because they are new in themselves, but because they make possible modern perfection of radio reception, batteries are the modern source of radio power.

Today's radio sets were produced not merely to make something new, but to give you new enjoyment. That they will do. New pleasures await you; more especially if you use Battery Power. Never were receivers so sensitive, loud-speakers so faithful; never has the need been so imperative for pure DC, Direct Current, that batteries provide. You must operate your set with

current that is smooth, uniform, steady. Only such current is noiseless, free from disturbing sounds and false tonal effects. And only from batteries can such current be had.

So batteries are needful if you would bring to your home the best that radio has to offer. Choose the Eveready Layerbilt "B" Battery No. 486, modern in construction, developed exclusively by Eveready to bring new life and vigor to an old principle—actually the best and longest-lasting Eveready Battery ever built. It gives you Battery Power

for such a long time that you will find the cost and effort of infrequent replacement small indeed beside the modern perfection of reception that Battery Power makes possible.

NATIONAL CARBON CO., INC.
New York  San Francisco
Unit of Union Carbide and Carbon Corporation

Tuesday night is Eveready Hour Night
—9 P. M., Eastern Standard Time

- | | |
|------------------|--------------------|
| WEAF—New York | WOC—Davenport |
| WJAR—Providence | WCCO—{ Minneapolis |
| WEEL—Boston | { St. Paul |
| WFI—Philadelphia | KSD—St. Louis |
| WGR—Buffalo | WDAF—Kansas City |
| WCAE—Pittsburgh | WRC—Washington |
| WSAI—Cincinnati | WGY—Schenectady |
| WTAM—Cleveland | WHAS—Louisville |
| WWJ—Detroit | WSB—Atlanta |
| WGN—Chicago | WSM—Nashville |
| | WMC—Memphis |

Pacific Coast Stations—
9 P. M., Pacific Standard Time
KPO—KGO—San Francisco KFI—Los Angeles
KFOA—KOMO—Seattle KGW—Portland

EVEREADY
Radio Batteries
—they last longer

The air is full of things you shouldn't miss

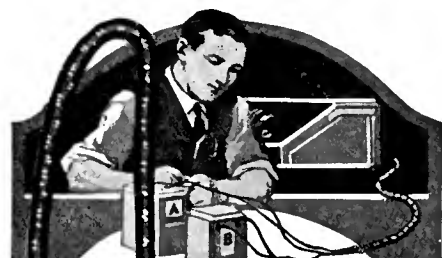

ACME

Celatsite Battery Cable

A rayon-covered cable of 5, 6, 7, 8 or 9 vari-colored Flexible Celatsite wires for connecting batteries or eliminator to set. Plainly tabbed; easy to connect. Gives set an orderly appearance.

Stranded Enamelled Antenna



Best outdoor antenna you can buy. Seven strands of enamelled copper wire. Presents maximum surface for reception, resists corrosion; this greatly improves the signal. Outside diameters equal to sizes 14 and 16. (We also offer solid and stranded bare, and stranded tinned antenna.)

Loop Antenna Wire

Sixty strands of No. 38 bare copper wire for flexibility, 5 strands of No. 36 phosphor bronze to prevent stretching. Green or brown silk covering; best loop wire possible to make.

Flexible Celatsite for sub-panel wiring



A cable of fine, tinned copper wires with non-inflammable Celatsite insulation. Ideal for sub-panel or point-to-point wiring. Strips easily, solders readily. Nine beautiful colors; sold only in 25 ft. coils, in cartons colored to match contents.

Acme Celatsite Wire



Tinned copper bus bar hook-up wire with non-inflammable Celatsite insulation, in 9 beautiful colors. Strips easily, solders readily, won't crack at bends. Sizes 14, 16, 18, 19; 30 inch lengths.

Spaghetti Tubing

Oil, moisture, acid proof; highly dielectric — used by leading engineers. Nine colors, for wire sizes 12 to 18; 30 inch lengths. (We also make tinned bus bar, round and square, in 2 and 2½ ft. lengths.)

Send for folder
THE ACME WIRE CO., Dept. B
 New Haven, Conn.

ACME WIRE
 MAKES BETTER RADIO

No. 139

RADIO BROADCAST Laboratory Information Sheet November, 1927

Inductive Reactance

HOW IT IS CALCULATED

IF AN inductance coil is connected in series with an a. c. ammeter to a source of alternating current, a certain amount of current will flow in the circuit, depending upon the size of the coil and the frequency of the current. If the voltage of the source is divided by the current, the quotient will be the "reactance" of the coil in ohms. For example, if the frequency of the current being supplied by the source of potential was 60 cycles and the voltage was 110 volts and the coil had an inductance of 1.0 henry, we would find that 0.292 amperes of current would flow through the circuit. Then 110 volts divided by 0.292 gives 377, which is the reactance in ohms at 60 cycles of a coil with an inductance of 1.0 henry. The reactance of a coil depends upon its inductance and upon the frequency of the current. It can be calculated by means of the following formula:

$$\text{Reactance} = 6.28 FL$$

where F = the frequency of the current in cycles

per second, and L = the inductance of the coil in henries.

In many calculations it is necessary to know the reactance of some particular coil at some frequency and for this reason on Laboratory Sheet No. 140 is given a table of reactance for inductance coils between 0.01 and 100 henries at frequencies from 60 to 100,000 cycles. From the formula given herewith it is evident that the reactance of a coil is directly proportional to the inductance of the coil and also directly proportional to the frequency. Doubling the size of the coil gives twice the reactance and twice the reactance is also obtained if the frequency is doubled. If these two factors are remembered it is a simple matter to calculate mentally the reactance of any coil not given in the table on Laboratory Sheet No. 140. For example a 30-henry coil at, say, 100 cycles. Since the reactance of a 10-henry coil at 100 cycles is 6280 ohms, it follows that the reactance of a 30-henry coil at the same frequency must be 18,840 ohms.

No. 140

RADIO BROADCAST Laboratory Information Sheet November, 1927

Coil Reactance

COIL INDUCTANCE IN HENRIES	REACTANCE IN OHMS AT VARIOUS FREQUENCIES						
	60	100	250	500	1000	10,000	100,000
0.01	3.77	6.28	15.7	31.4	62.8	628	6,280
0.05	18.8	31.4	78.5	157	314	3,140	31,400
0.1	37.7	62.8	157	314	628	6,280	62,800
0.5	188.5	314	785	1,570	3,140	31,400	314,000
1.0	377	628	1,570	3,140	6,280	62,800	628,000
2.0	754	1,256	3,140	6,280	12,560	125,600	1,256,000
5.0	1,885	3,140	7,850	15,700	31,400	314,000	3,140,000
10.0	3,770	6,280	15,700	31,400	62,800	628,000	6,280,000
20.0	7,540	12,560	31,400	62,800	123,600	1,236,000	12,360,000
30.0	11,310	18,840	47,200	94,200	188,400	1,884,000	18,840,000
40.0	15,080	24,720	61,800	123,600	247,200	2,472,000	24,720,000
50.0	18,850	31,400	78,500	157,000	314,000	3,140,000	31,400,000
100.0	37,700	62,800	157,000	314,000	628,000	6,280,000	62,800,000

This table shows how the reactance of various inductance coils varies with different frequencies. Laboratory Sheet No. 139 explains what inductive reactance is and upon what it depends.

No. 141

RADIO BROADCAST Laboratory Information Sheet November, 1927

A. C. Tube Data

"HEATER" AND FILAMENT TYPES

ON THIS Laboratory Sheet are given data on the new a. c. tubes, type UY-227 (c-327) and type UX-226 (cx-326). The former tube is of the heater type whereas the latter is of the a. c. filament type. The heater tube requires a special five-prong socket whereas the type 26 may be used with any standard socket. The filament voltage and current of the type 27 are 2.5 volts and 1.75 amperes respectively. The type 26 requires a filament voltage of 1.5 volts and the filament current is 1.05 amperes. The filament current of these tubes is quite large, especially so in a multi-tube receiver, and for this reason it is essential in wiring the filament leads

that heavy wire be used. Determine the total current required by all the tubes and table No. 1 below will tell you what size of wire to use.

TABLE NO. 1

Size (B & S Gauge)	Current
12	20 amperes
14	11 amperes
16	6 amperes
18	3 amperes
20	1.5 amperes

Table No. 2 on this sheet gives the characteristics of these tubes under various conditions of plate and grid voltage.

TABLE NO. 2

TYPE OF TUBE	PLATE VOLTAGE	NEGATIVE GRID VOLTAGE	PLATE CURRENT	PLATE IMPEDANCE	MUTUAL CONDUCTANCE	UNDISTORTED POWER OUTPUT IN WATTS
UY-227 & c-327	90	5	3	11,300	725	0.020
	135	9	5	10,000	820	0.055
	180	13.5	6	9,400	870	0.140
UX-226 & cx-326	90	6	3.7	9,400	875	0.020
	135	9	6	7,400	1100	0.070
	180	13.5	7.5	7,000	1170	0.160

Balkite has pioneered— but not at public expense



Licensed under Andrew-Hammond patent applications

Balkite "A" Contains no battery. The same as Balkite "AB" but for the "A" circuit only. Not a battery and charger but a perfected light socket "A" power supply. One of the most remarkable developments in the entire radio field. Price \$32.50.



Balkite "B" One of the longest lived devices in radio. The accepted tried and proved light socket "B" power supply. The first Balkite "B," after 5 years, is still rendering satisfactory service. Over 300,000 in use. Three models: "B"-W, 67-90 volts, \$22.50; "B"-135, 135 volts, \$32.50; "B"-180, 180 volts, \$39.50. Balkite now costs no more than the ordinary "B" eliminator.



Balkite Chargers

Standard for "A" batteries. Noiseless. Can be used during reception. Prices drastically reduced. Model "J,"* rates 2.5 and .5 amperes, for both rapid and trickle charging, \$17.50. Model "N,"* Trickle Charger, rate .5 and .8 amperes, \$9.50. Model "K" Trickle Charger, \$7.50.

*Special models for 25-40 cycles at slightly higher prices

Prices are higher West of the Rockies and in Canada

The great improvements in radio power have been made by Balkite

First noiseless battery charging. Then successful light socket "B" power. Then trickle charging. And today, most important of all, Balkite "AB," a complete unit containing no battery in any form, supplying both "A" and "B" power directly from the light socket, operating only while the set is in use.

This pioneering has been important. Yet alone it would never have made Balkite one of the best known names in radio. Balkite is today the established leader because of Balkite performance at the hands of its owners.

Because with 2,000,000 units in the field Balkite has a record of long life and freedom from trouble seldom equalled in any industry.

Because of the first 16 light socket "B" power supplies put on the market, Balkite "B"

alone remains in its original form; all others have either been radically revised in principle or completely withdrawn.

Because the first Balkite "B," purchased 5 years ago, is still in use and will be for years to come.

Because to your radio dealer Balkite is a synonym for quality.

Because the electrolytic rectification developed and used by Balkite is so reliable that today it is standard on the signal systems of most American as well as European and Oriental railroads.

Because Balkite is permanent equipment. Balkite has pioneered—but not at the expense of the public.

Today, whatever type of set you own, whatever type of power equipment you want (with batteries or without), whatever you want to pay for it, Balkite has it. And production is so enormous that prices are astonishingly low.

Your dealer will recommend the Balkite equipment you need for your set.

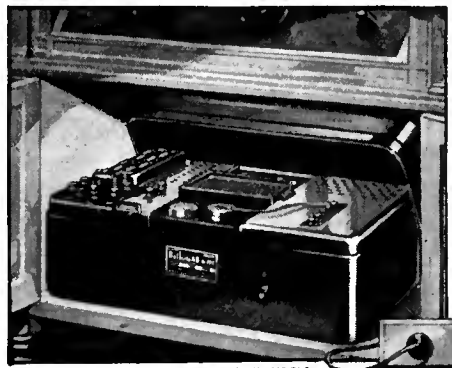

LICENSED UNDER HAMMOND-ANDREWS PATENT APPLICATIONS

Balkite "AB" Contains no battery.

A complete unit, replacing both "A" and "B" batteries and supplying radio current directly from the light socket. Contains no battery in any form. Operates only while the set is in use. Two models: "AB" 6-135,* 135 volts "B" current, \$59.50; "AB" 6-180, 180 volts, \$67.50.

FANSTEEL PRODUCTS COMPANY, INC., NORTH CHICAGO, ILLINOIS

Licenses for Germany:
Siemens & Halske, A. G. Wernerwerk M
Siemensstadt, Berlin

Sole Licenses in the United Kingdom:
Messrs. Radio Accessories Ltd., 9-13 Hythe Rd.
Willesden, London, N. W. 10

FANSTEEL Balkite

Radio Power Units

KARAS

Parts Make the 2-Dial Karas Equamatic the World's Best 5-Tube Receiver



The NEW Karas Type 28 Audio Transformer Price, \$8.00

YOU have read and heard much about the new 2-Dial Karas Equamatic—the 5-Tube Receiver that is the talk of the country because of its perfect neutralization and its completely balanced operation. The results you may expect from this receiver naturally are Phenomenal, and the 2-Dial Equamatic delivers even more than you expect. The use of Karas Parts insures this. These parts are essential to the perfect operation of the 2-Dial Equamatic, for the receiver is built around them. Some of these famous parts are shown here. You will find a complete list of all the necessary Karas Parts elsewhere in this advertisement.

A Marvelous Purity of Tone

THE 2-Dial Karas Equamatic possesses a marvelous purity of tone, due to its utilization of the new Karas Type 28 Impregnated Audio Transformers—the new Karas Transformers inclosed in spun-sealed lifetime steel-clad cases. The new Karas Output Filter also aids in building up a clear, sweet tone for the 2-Dial Equamatic. This receiver owes much of its extremely efficient operation to the use of the new Karas S. F. L. Variable Condensers, and Karas Micrometric Dials aid in giving the set 1-1000 of an inch tuning. The heart of the Equamatic of course is the Karas Equamatic Inductance Coils, with their variable primaries and adjustable secondaries which enable the energy transfer between these two coils to be automatically and continuously maintained at every wave length setting of the dials.



The NEW Karas Output Filter, Price \$8.00

Easy to Build this Receiver

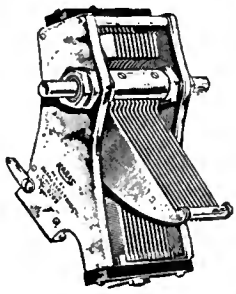

The NEW Karas S.F.L. Condenser with Removable Shaft, Prices: .00025 mfd., \$5; .00037 mfd. \$5.25; .0005 mfd. \$5.50

YOU can easily build this 2-Dial Karas Equamatic 5-Tube Receiver in a short time by following our simple, easily understood instructions. Your dealer can supply you with the necessary Karas and other parts. We supply FREE complete blue prints and instructions for building. The Karas Parts you will need are as follows: 2 Type 28 Karas Audio Transformers, each \$8; 1 Karas Output Filter, \$8; 3 New Karas Type 17 Variable Condensers, each \$5.25; 3 Karas Equamatic Coils, each \$4; 2 Karas Micrometric Dials, each \$3.50; 3 Karas Subpanel Brackets, per set, 70c; 1 Karas Control System, including complete hardware, \$3. Fill out and mail the coupon below for blue

prints, wiring and assembly instructions, full particulars. FREE. Build this great receiver NOW.

KARAS ELECTRIC CO.

4033-K No. Rockwell St., CHICAGO, ILL.

Have You Heard the Knickerbocker 4—The Wonder Set?



Coupon

KARAS ELECTRIC CO. 4033-K North Rockwell St., Chicago, Ill.

Please send me FREE your blue prints and complete instructions on the receivers I have checked as well as my catalog of all Karas Parts.

2-Dial Karas Equamatic 5-Tube Receiver

Knickerbocker 4—The Wonder Set

Name

Address

City .. State ..

No. 142

RADIO BROADCAST Laboratory Information Sheet November, 1927

Obtaining Various Voltages from a B-Power Unit

VALUES AND CURRENT-CARRYING CAPACITY

IT IS comparatively simple to calculate the resistance values required in the output circuit of a B-power unit in order to obtain any specific voltages. This Laboratory Sheet will explain how to calculate the values of these resistances.

Consider the fundamental output circuit of a B-power unit as illustrated in the sketch. The diagram of the rectifier and filter has been omitted since they play no important part in the calculation of resistance values. Suppose tap No. 1 is to be 45 volts and is to be used to operate a detector tube. We will assume that the loss current through R_3 is 3 milliamperes, or 0.003 amperes. This is an average figure for the loss current and can generally be used in this type of calculation. If the voltage at tap No. 1 is to be 45, then the voltage drop across resistance R_3 must be 45. The resistance of R_3 will be equal to the voltage across it divided by the current through it or, in this case, 45 divided by 0.003, which gives 15,000 ohms as the value of R_3 . The voltage at tap No. 2 is to be 90. Since the voltage drop across R_3 is 45, it follows that the voltage drop across R_2 will also be 45 in order to make the total voltage between the negative B and tap No. 2 equal to 90. The current flowing through the resistance R_2 will be equal to the loss current at 3 milliamperes plus the current drawn by the detector tube, which is 1 milliampere. Therefore the value of resistance R_2 will be equal to the voltage across it, 45, divided by the current through it, which is 0.003 plus 0.001, or a total of 0.004 amperes. This gives a value of 11,250 ohms for R_2 . Suppose that

the total drain from the 90-volt tap is 10 milliamperes. Then the total current flowing through R_1 will be equal to 10 plus 1 plus 3, or 14 milliamperes. If the maximum voltage available from the power unit is 180 and the voltage at terminal No. 2 is to be 90, it follows that the voltage drop across R_1 must be 90. Ninety volts divided by 0.014 amperes gives 6400 ohms as the value of R_1 .

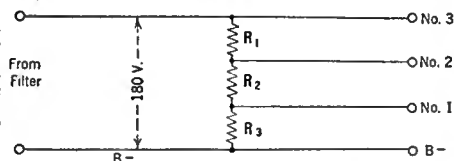

Resistance units for B power units are usually rated in watts and it is essential that the resistances used be capable of carrying the necessary load without overheating. The load in watts being handled by a resistance can be determined by multiplying the resistance in ohms by the square of the current in amperes. In this particular example:

Watts through R_3 = 15000×0.003^2
 = 0.135 watts
 Watts through R_2 = 11250×0.004^2
 = 0.18 watts
 Watts through R_1 = 6400×0.014^2
 = 1.25 watts

No. 143

RADIO BROADCAST Laboratory Information Sheet November, 1927

Solenoid Coil Data

UNITS FOR THE BROADCAST BAND

THIS Laboratory Sheet gives the data necessary to wind the secondaries of solenoid type coils for use with 0.0005-mfd., 0.00035-mfd., or 0.00025-

mfd. variable condensers. The wavelength range of the coil will be approximately 200 to 550 meters. The coils may be wound on hard rubber or bakelite tubing, or some type of self-supported winding may be used.

DIAMETER OF TUBE IN INCHES	SIZE OF WIRE	NUMBER OF TURNS OF D.C.C. WIRE REQUIRED WITH VARIOUS SIZES OF TUNING CONDENSERS		
		0.0005 mfd.	0.00035 mfd.	0.00025 mfd.
3½	28	28	38	50
	26	31	42	54
	24	34	46	58
	22	38	50	64
	20	42	55	72
3	28	35	48	62
	26	39	52	67
	24	43	56	73
	22	47	61	81
	20	51	67	88
2½	28	42	54	63
	26	45	58	73
	24	48	63	80
	22	51	70	90
	20	53	78	98

No. 144

RADIO BROADCAST Laboratory Information Sheet November, 1927

The Transmission Unit

CORRECTION OF LABORATORY SHEET NO. 114

TWO errors occurred in LABORATORY SHEET NO. 114 published in the August, 1927, RADIO BROADCAST. In the last line in the first column, the word "natural" should be changed to read "common," and in the first line in the second column, the same change should be made.

The chart on this sheet makes it possible to determine easily the number of telephone transmission units if the current or voltage ratio is known. For example, from the curve it is evident that if two voltages or two currents are in a ratio of 5, then the TU difference between them is 14. If we are dealing with powers rather than currents or voltages, it is merely necessary to divide the number of TU obtained from the curve by 2 in order to determine the TU difference of any two powers. For example, two powers in the ratio of 8 to 1 have a TU difference of 9. To determine this value we look up the number of TU corresponding to a ratio of 8 which gives 18 and then divide by 2.

To illustrate the use of the curve we might take an audio amplifier requiring a tenth of a volt input to produce three volts at the output. If we wanted to know the overall gain in TU we would divide three by 0.1, which gives 30. This ratio on the curve corresponds to a 29.5 TU voltage gain.

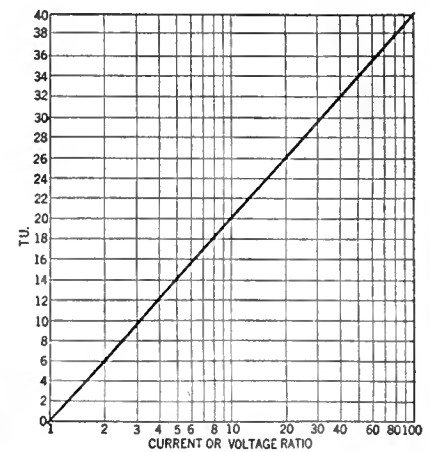

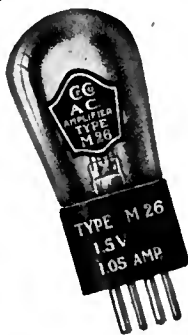

Amplifier
Type M-26

**A. C.
AMPLIFIER**
Type M-26

Fil. Volts (220) 1.5
 Fil. Amp. 1.05
 Plate Volts 90-135
 Not to Exceed 180
 List Price \$3.00



Detector
Type N-27

**A. C.
DETECTOR**
Type N-27

(227) 2.5
 Heater Volts 1.75
 Heater Amps. 45
 PLATE VOLTS 90-135
 As Detector 180
 As Amplifier
 Not to Exceed
 List Price \$6.00

Announcing
A. C. TUBES
 Alternating Current

The new M-26 and N-27 tubes are tubes using raw A. C. on the Filament or Heater and can be used in any set specifying these types. The M-26 is used in the radio and audio frequency stages and has a standard base. The N-27, of the separate heater type is used as a detector or amplifier and has a five prong base. These tubes will give superior results and maximum useful life in any set designed to use A. C. tubes of this type.

Write for particulars

C. E. MFG. CO., Inc.

Providence, R. I. U. S. A.

Largest Plant in the World Making Radio Tubes Exclusively

CEC
**RADIO
 TUBES**

CEC

*A Tube for Every
 Radio Need*

- General Purpose Tubes
- Special Purpose Tubes
- Power Tubes
- Filament Type Rectifiers
- Gas Filled Rectifiers
- A. C. Tubes

*Make a
 Good Receiver
 Better*



CeCo announces a complete kit of tubes for the "Improved Aristocrat" by Arthur H. Lynch. Get the kit from your dealer and be sure you are right.

1	Type K, R. F. Amp.	-	-	Price \$3.00
1	" H, Spl. Detector	-	-	" 2.50
2	" G, HiMu Amp.	-	-	" 5.00
1	" F, Semi Power	-	-	" 4.50
				Total for kit \$12.50

The specified types for the improved Aristocrat can not be substituted due to there not being any other brand having similar characteristics to the Hi-Mu, Detector and Special Radio Frequency types. Demand CeCo.

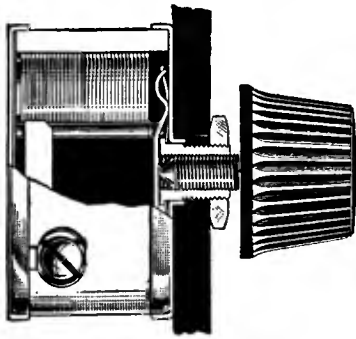

Bradleyohm-E

PERFECT VARIABLE RESISTOR

The graphite disc principle, utilized in the construction of Bradleyohm-E assures noiseless, stepless regulation of plate voltage when used in B-Eliminator hookups.

By turning the bakelite knob, the plate voltage output of the B-Eliminator can be adjusted, without steps or jumps, to the precise value for maximum volume. That is why prominent B-Eliminator manufacturers have adopted Bradleyohm-E.

Ask your dealer for Bradleyohm-E in the distinctive checkered carton.



Bradleyunit-A

PERFECT FIXED RESISTOR

This is a solid, molded fixed resistor that does not depend upon hermetic sealing for accuracy. It is not affected by temperature or moisture and can be soldered without disturbing its rating.

For resistance-coupling, grid leaks, and other applications, ask your dealer for Bradleyunit-A in any desired rating.

Allen-Bradley Co.
ELECTRIC CONTROLLING APPARATUS

278 Greenfield Ave.  Milwaukee, Wis.



Manufacturers' Booklets

A Varied List of Books Pertaining to Radio and Allied Subjects Obtainable Free With the Accompanying Coupon

READERS may obtain any of the booklets listed below by using the coupon printed on page 64. Order by number only.

1. FILAMENT CONTROL—Problems of filament supply, voltage regulation, and effect on various circuits. RADIAL COMPANY.
2. HARD RUBBER PANELS—Characteristics and properties of hard rubber as used in radio, with suggestions on how to "work" it. B. F. GOODRICH RUBBER COMPANY.
3. TRANSFORMERS—A booklet giving data on input and output transformers. PACENT ELECTRIC COMPANY.
4. RESISTANCE-COUPLED AMPLIFIERS—A general discussion of resistance coupling with curves and circuit diagrams. COLE RADIO MANUFACTURING COMPANY.
5. CARBORUNDUM IN RADIO—A book giving pertinent data on the crystal as used for detection, with hook-ups, and a section giving information on the use of resistors. THE CARBORUNDUM COMPANY.
6. B-ELIMINATOR CONSTRUCTION—Constructional data on how to build. AMERICAN ELECTRIC COMPANY.
7. TRANSFORMER AND CHOKE-COUPLED AMPLIFICATION—Circuit diagrams and discussion. ALL-AMERICAN RADIO CORPORATION.
8. RESISTANCE UNITS—A data sheet of resistance units and their application. WARD-LEONARD ELECTRIC COMPANY.
9. VOLUME CONTROL—A leaflet showing circuits for distortionless control of volume. CENTRAL RADIO LABORATORIES.
10. VARIABLE RESISTANCE—As used in various circuits. CENTRAL RADIO LABORATORIES.
11. RESISTANCE COUPLING—Resistors and their application to audio amplification, with circuit diagrams. DEJUR PRODUCTS COMPANY.
12. DISTORTION AND WHAT CAUSES IT—Hook-ups of resistance-coupled amplifiers with standard circuits. ALLEN-BRADLEY COMPANY.
13. B-ELIMINATOR AND POWER AMPLIFIER—Instructions for assembly and operation using Raytheon tube. GENERAL RADIO COMPANY.
14. B-ELIMINATOR AND POWER AMPLIFIER—Instructions for assembly and operation using an R. C. A. rectifier. GENERAL RADIO COMPANY.
15. VARIABLE CONDENSERS—A description of the functions and characteristics of variable condensers with curves and specifications for their application to complete receivers. ALLEN D. CARDWELL MANUFACTURING COMPANY.
16. BAKELITE—A description of various uses of bakelite in radio, its manufacture, and its properties. BAKELITE CORPORATION.
17. POWER SUPPLY—A discussion on power supply with particular reference to lamp-socket operation. Theory and constructional data for building power supply devices. ACME APPARATUS COMPANY.
18. AUDIO AMPLIFICATION—A booklet containing data on audio amplification together with hints for the constructor. ALL AMERICAN RADIO CORPORATION.
19. HIGH-FREQUENCY DRIVER AND SHORT-WAVE WAVE-METER—Constructional data and application. BURGESS BATTERY COMPANY.
20. AUDIO-FREQUENCY CHOKES—A pamphlet showing positions in the circuit where audio-frequency chokes may be used. SAMSON ELECTRIC COMPANY.
21. RADIO-FREQUENCY CHOKES—Circuit diagrams illustrating the use of chokes to keep out radio-frequency currents from definite points. SAMSON ELECTRIC COMPANY.
22. TRANSFORMER AND IMPEDANCE DATA—Tables giving the mechanical and electrical characteristics of transformers and impedances, together with a short description of their use in the circuit. SAMSON ELECTRIC COMPANY.
23. BYPASS CONDENSERS—A description of the manufacture of bypass and filter condensers. LESLIE F. MUTER COMPANY.
24. AUDIO MANUAL—Fifty questions which are often asked regarding audio amplification, and their answers. AMERTRAN SALES COMPANY, INCORPORATED.
25. SHORT-WAVE RECEIVER—Constructional data on a receiver which, by the substitution of various coils, may be made to tune from a frequency of 16,600 kc. (18 meters) to 1999 kc. (150 meters). SILVER-MARSHALL, INCORPORATED.
26. AUDIO QUALITY—A booklet dealing with audio-frequency amplification of various kinds and the application to well-known circuits. SILVER-MARSHALL, INCORPORATED.
27. VARIABLE CONDENSERS—A bulletin giving an analysis of various condensers together with their characteristics. GENERAL RADIO COMPANY.
28. FILTER DATA—Facts about the filtering of direct current supplied by means of motor-generator outfits used with transmitters. ELECTRIC SPECIALTY COMPANY.
29. RESISTANCE COUPLING—A booklet giving some general information on the subject of radio and the application of resistors to a circuit. DAVEN RADIO CORPORATION.
30. RESISTORS—A pamphlet giving some technical data on resistors which are capable of dissipating considerable energy; also data on the ordinary resistors used in resistance-coupled amplification. THE CRESCENT RADIO SUPPLY COMPANY.
31. RADIO-FREQUENCY AMPLIFICATION—Constructional details of a five-tube receiver using a special design of radio-frequency transformer. CAMFIELD RADIO MFG. COMPANY.
32. FIVE-TUBE RECEIVER—Constructional data on building a receiver. AERO PRODUCTS, INCORPORATED.
33. AMPLIFICATION WITHOUT DISTORTION—Data and curves illustrating the use of various methods of amplification. ACME APPARATUS COMPANY.
34. SUPER-HETERODYNE—Constructional details of a seven-tube set. G. C. EVANS COMPANY.
35. IMPROVING THE AUDIO AMPLIFIER—Data on the characteristics of audio transformers, with a circuit diagram showing where chokes, resistors, and condensers can be used. AMERICAN TRANSFORMER COMPANY.
36. PLATE SUPPLY SYSTEM—A wiring diagram and layout plan for a plate supply system to be used with a power amplifier. Complete directions for wiring are given. AMERTRAN SALES COMPANY.

37. FIVE-TUBE RECEIVER—Data are given for the construction of a five-tube tuned radio-frequency receiver. Complete instructions, list of parts, circuit diagram, and template are given. ALL-AMERICAN RADIO CORPORATION.
38. BETTER TUNING—A booklet giving much general information on the subject of radio reception with specific illustrations. Primarily for the non-technical home constructor. BREMER-TULLY MANUFACTURING COMPANY.
39. SIX-TUBE RECEIVER—A booklet containing photographs, instructions, and diagrams for building a six-tube shielded receiver. SILVER-MARSHALL, INCORPORATED.
40. SOCKET POWER DEVICE—A list of parts, diagrams, and templates for the construction and assembly of socket power devices. JEFFERSON ELECTRIC MANUFACTURING COMPANY.
41. FIVE-TUBE EQUAMATIC—Panel layout, circuit diagrams, and instructions for building a five-tube receiver, together with data on the operation of tuned radio-frequency transformers of special design. KARAS ELECTRIC COMPANY.
42. FILTER—Data on a high-capacity electrolytic condenser used in filter circuits in connection with A socket power supply units, are given in a pamphlet. THE ABOX COMPANY.
43. SHORT-WAVE RECEIVER—A booklet containing data on a short-wave receiver as constructed for experimental purposes. THE ALLEN D. CARDWELL MANUFACTURING CORPORATION.
44. SUPER-HETERODYNE CONSTRUCTION—A booklet giving full instructions, together with a blue print and necessary data, for building an eight-tube receiver. THE GEORGE W. WALKER COMPANY.
45. SHORT-WAVE TRANSMITTER—Data and blue prints are given on the construction of a short-wave transmitter, together with operating instructions, methods of keying, and other pertinent data. RADIO ENGINEERING LABORATORIES.
46. IMPEDANCE AMPLIFICATION—The theory and practice of a special type of dual-impedance audio amplification are given. ALDEN MANUFACTURING COMPANY.
47. B-SOCKET POWER—A booklet giving constructional details of a socket-power device using either the BH or 313 type rectifier. NATIONAL COMPANY, INCORPORATED.
48. POWER AMPLIFIER—Constructional data and wiring diagrams of a power amplifier combined with a B-supply unit are given. NATIONAL COMPANY, INCORPORATED.
49. A, B, AND C SOCKET-POWER SUPPLY—A booklet giving data on the construction and operation of a socket-power supply using the new high-current rectifier tube. THE Q. R. S. MUSIC COMPANY.
50. USING CHOKES—A folder with circuit diagrams of the more popular circuits showing where choke coils may be placed to produce better results. SAMSON ELECTRIC COMPANY.

ACCESSORIES

51. A PRIMER OF ELECTRICITY—Fundamentals of electricity with special reference to the application of dry cells to radio and other uses. Constructional data on buzzers, automatic switches, alarms, etc. NATIONAL CARBON COMPANY.
52. AUTOMATIC RELAY CONNECTIONS—A data sheet showing how a relay may be used to control A and B circuits. YAXLEY MANUFACTURING COMPANY.
53. ELECTROLYTIC RECTIFIER—Technical data on a new type of rectifier with operating curves. KODEL RADIO CORPORATION.
54. DRY CELLS FOR TRANSMITTERS—Actual tests given, well illustrated with curves showing exactly what may be expected of this type of B power. BURGESS BATTERY COMPANY.
55. DRY-CELL BATTERY CAPACITIES FOR RADIO TRANSMITTERS—Characteristic curves and data on discharge tests. BURGESS BATTERY COMPANY.
56. B BATTERY LIFE—Battery life curves with general curves on tube characteristics. BURGESS BATTERY COMPANY.
57. HOW TO MAKE YOUR SET WORK BETTER—A non-technical discussion of general radio subjects with hints on how reception may be bettered by using the right tubes. UNITED RADIO AND ELECTRIC CORPORATION.
58. TUBE CHARACTERISTICS—A data sheet giving constants of tubes. C. E. MANUFACTURING COMPANY.
59. FUNCTIONS OF THE LOUD SPEAKER—A short, non-technical general article on loud speakers. AMPLION CORPORATION OF AMERICA.
60. METERS FOR RADIO—A catalogue of meters used in radio, with connecting diagrams. BURTON-ROGERS COMPANY.
61. SWITCHBOARD AND PORTABLE METERS—A booklet giving dimensions, specifications, and shunts used with various meters. BURTON-ROGERS COMPANY.
62. COST OF B BATTERIES—An interesting discussion of the relative merits of various sources of B supply. HARTFORD BATTERY MANUFACTURING COMPANY.
63. STORAGE BATTERY OPERATION—An illustrated booklet on the care and operation of the storage battery. GENERAL LEAD BATTERIES COMPANY.
64. CHARGING A AND B BATTERIES—Various ways of connecting up batteries for charging purposes. WESTINGHOUSE UNION BATTERY COMPANY.
65. CHOOSING THE RIGHT RADIO BATTERY—Advice on what dry cell battery to use; their application to radio, with wiring diagrams. NATIONAL CARBON COMPANY.
66. TUBE REACTIVATOR—Information on the care of vacuum tubes, with notes on how and when they should be reactivated. THE STERLING MANUFACTURING COMPANY.
67. ARRESTERS—Mechanical details and principles of the vacuum type of arrester. NATIONAL ELECTRIC SPECIALTY COMPANY.
68. CAPACITY CONNECTOR—Description of a new device for connecting up the various parts of a receiving set, and at the same time providing bypass condensers between the leads. KURY-KASCH COMPANY.

(Continued on page 64)



The Celestial Stradivarius The Advanced Hi-Q* Six BOTH CUSTOM-BUILT!

JUST as Antonio Stradivari gave the priceless Custom-built violin to musicians of his day, so does Hammarlund-Roberts offer music lovers of our day the Custom-built Radio.

The advanced "Hi-Q Six"—designed by ten of America's leading manufacturers—made with America's finest parts—incorporating every modern constructional feature—and built under your own eyes from plans so complete, so exacting and so clear cut that the only outcome can be absolute radio perfection.

In addition to its unprecedented performance, the Hi-Q Six offers equally unprecedented economy, for by building it yourself you can save at least \$100.00 over the cost of finest factory-assembled sets. Complete parts including Foundation Unit chassis, panels, with all wire and special hardware cost only \$95.80.

The Hi-Q Instruction Book tells the complete story with text, charts, diagrams and photos. Anyone can follow it and build this wonderful instrument. Get a copy from your dealer or write us direct. Price is 25 cents.



HAMMARLUND-ROBERTS, INC.
1182 Broadway Dept. A New York City

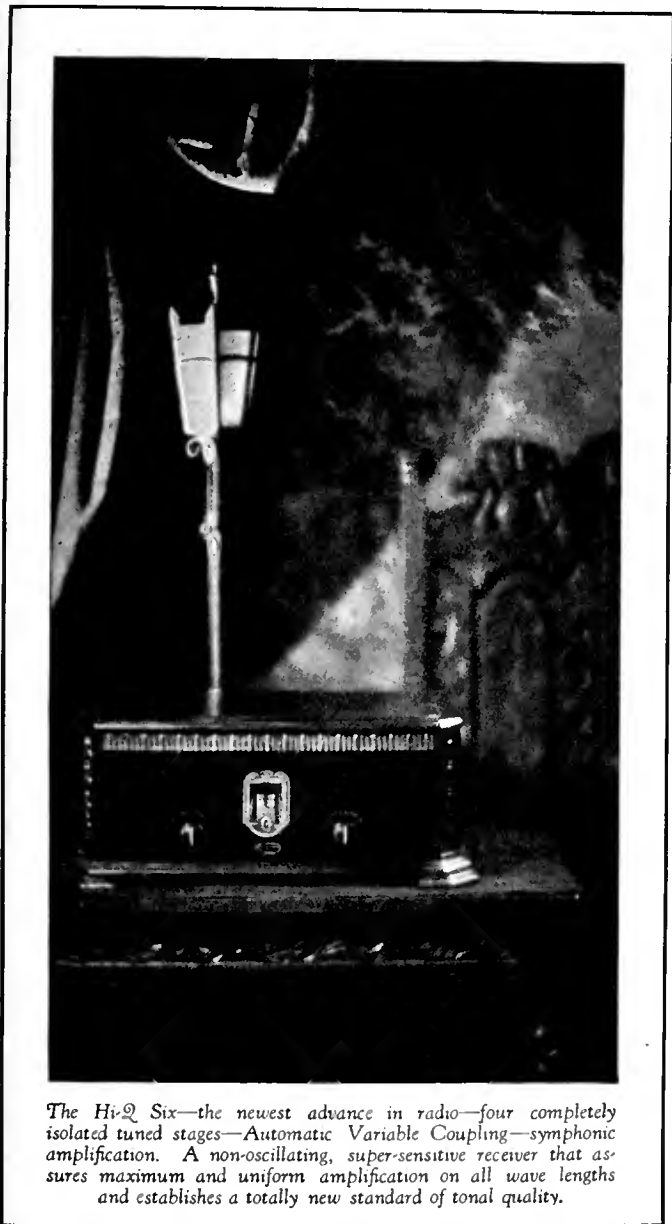

The Hi-Q Six—the newest advance in radio—four completely isolated tuned stages—Automatic Variable Coupling—symphonic amplification. A non-oscillating, super-sensitive receiver that assures maximum and uniform amplification on all wave lengths and establishes a totally new standard of tonal quality.

Associate Manufacturers



NEW!

the Two Tube Official BROWNING- DRAKE Kit Set

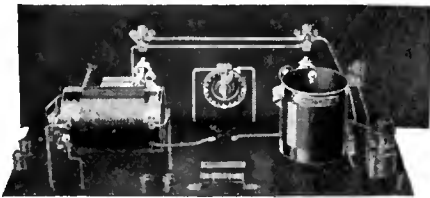

This new assembly, the two tube Official Browning-Drake has been designed to be used with any good audio transformer system now on the market, such as Amertran, Thordarson, etc. The combination gives remarkable tone quality and great volume. This two tube assembly uses only the detector and R. F. tubes. Special type T foundation unit makes construction easy. The Official Browning-Drake Kit is used. Other Browning-Drake Corporation products incorporated in the assembly are the cartridge resistance and the neutralizer.

If your dealer does not carry all of the specified parts, send us his name and your requirements will be met immediately.

DEALERS:—There is profit and satisfaction in handling popular products. Write or wire TODAY about the Browning-Drake line of parts and the Browning-Drake line of factory-built receivers.

LOOK FOR THIS



TRADE MARK

BROWNING-DRAKE CORP.
Cambridge :: Massachusetts

BROWNING DRAKE

60. VACUUM TUBES—A booklet giving the characteristics of the various tube types with a short description of where they may be used in the circuit. RADIO CORPORATION OF AMERICA.

77. TUBES—A booklet for the beginner who is interested in vacuum tubes. A non-technical consideration of the various elements in the tube as well as their position in the receiver. CLEARTRON VACUUM TUBE COMPANY.

87. TUBE TESTER—A complete description of how to build and how to operate a tube tester. BURTON-ROGERS COMPANY.

91. VACUUM TUBES—A booklet giving the characteristics and uses of various types of tubes. This booklet may be obtained in English, Spanish, or Portuguese. DEFORREST RADIO COMPANY.

92. RESISTORS FOR A. C. OPERATED RECEIVERS—A booklet giving circuit suggestions for building a. c. operated receivers, together with a diagram of the circuit used with the new 400-milliamperer rectifier tube. CARTER RADIO COMPANY.

97. HIGH-RESISTANCE VOLTMETERS—A folder giving information on how to use a high-resistance voltmeter, special consideration being given the voltage measurement of socket-power devices. WESTINGHOUSE ELECTRIC & MANUFACTURING COMPANY.

102. RADIO POWER BULLETINS—Circuit diagrams, theory constants, and trouble-shooting hints for units employing the BH or B rectifier tubes. RAYTHEON MANUFACTURING COMPANY.

103. A. C. TUBES—The design and operating characteristics of a new a. c. tube. Five circuit diagrams show how to convert well-known circuits. SOVEREIGN ELECTRIC & MANUFACTURING COMPANY.

MISCELLANEOUS

38. LOG SHEET—A list of broadcasting stations with columns for marking down dial settings. U. S. L. RADIO, INCORPORATED.

41. BABY RADIO TRANSMITTER OF 9XH-9EK—Description and circuit diagrams of dry-cell operated transmitter. BURGESS BATTERY COMPANY.

42. ARCTIC RADIO EQUIPMENT—Description and circuit details of short-wave receiver and transmitter used in Arctic exploration. BURGESS BATTERY COMPANY.

43. SHORT-WAVE RECEIVER OF 9XH-9EK—Complete directions for assembly and operation of the receiver. BURGESS BATTERY COMPANY.

58. HOW TO SELECT A RECEIVER—A commonsense booklet describing what a radio set is, and what you should expect from it, in language that any one can understand. DAY-FAN ELECTRIC COMPANY.

67. WEATHER FOR RADIO—A very interesting booklet on the relationship between weather and radio reception, with maps and data on forecasting the probable results. TAYLOR INSTRUMENT COMPANIES.

73. RADIO SIMPLIFIED—A non-technical booklet giving pertinent data on various radio subjects. Of especial interest to the beginner and set owner. CROSLYER RADIO CORPORATION.

74. THE EXPERIMENTER—A monthly publication which gives technical facts, valuable tables, and pertinent information on various radio subjects. Interesting to the experimenter and to the technical radio man. GENERAL RADIO COMPANY.

75. FOR THE LISTENER—General suggestions for the selecting, and the care of radio receivers. VALLEY ELECTRIC COMPANY.

76. RADIO INSTRUMENTS—A description of various meters used in radio and electrical circuits together with a short discussion of their uses. JEWELL ELECTRICAL INSTRUMENT COMPANY.

78. ELECTRICAL TROUBLES—A pamphlet describing the use of electrical testing instruments in automotive work combined with a description of the cadmium test for storage batteries. Of interest to the owner of storage batteries. BURTON ROGERS COMPANY.

95. RESISTANCE DATA—Successive bulletins regarding the use of resistors in various parts of the radio circuit. INTERNATIONAL RESISTANCE COMPANY.

96. VACUUM TUBE TESTING—A booklet giving pertinent data on how to test vacuum tubes with special reference to a tube testing unit. JEWELL ELECTRICAL INSTRUMENT COMPANY.

98. COPPER SHIELDING—A booklet giving information on the use of shielding in radio receivers, with notes and diagrams showing how it may be applied practically. Of special interest to the home constructor. THE COPPER AND BRASS RESEARCH ASSOCIATION.

99. RADIO CONVENIENCE OUTLETS—A folder giving diagrams and specifications for installing loud speakers in various locations at some distance from the receiving set. YAXLEY MANUFACTURING COMPANY.



USE THIS BOOKLET COUPON

RADIO BROADCAST SERVICE DEPARTMENT
RADIO BROADCAST, Garden City, N. Y.
Please send me (at no expense) the following booklets indicated by numbers in the published list above:

.....
.....
.....
Name
Address
..... (Name) (Street)
..... (City) (State)

ORDER BY NUMBER ONLY

This coupon must accompany every request. RB 11-27

*The final improvement
to be made in your set,
install—*



MODERN Type M Transformers

Regardless of how perfectly your set may be working, there is still finer reception in store for you. The performance of Modern Type M Transformers represents such an advance in audio amplification that they represent a new standard by which transformers may be judged. They combine high inductance, large core and wire sizes and perfectly proportioned windings. Impedances have been carefully matched to the units with which they must work.

The result is an almost flat performance curve with full response at 30 cycles and all harmonics and over amplified high notes fully eliminated.

Satisfactory performance of Type M Transformers is guaranteed. Prices 1st and 2nd stage, \$8.50 each; Output \$8.00; Push-Pull, \$10.00 each.

Mail coupon below for blueprint folder showing Type M audio amplifying circuits

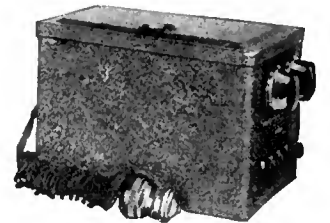

MODERN "B" Compact

A Raytheon "B" power unit that has been proven dependable and is guaranteed. Price \$26.50 without tube. Sent by mail, postpaid, if your dealer cannot supply you.

The Modern Electric Mfg. Co.
Toledo, Ohio

.....
The Modern Electric Mfg. Co.
Toledo, Ohio
Please send prints of Type M audio circuits. I enclose 2c stamp.
Name
Address
City (State)

R.B.-11

NATIONAL

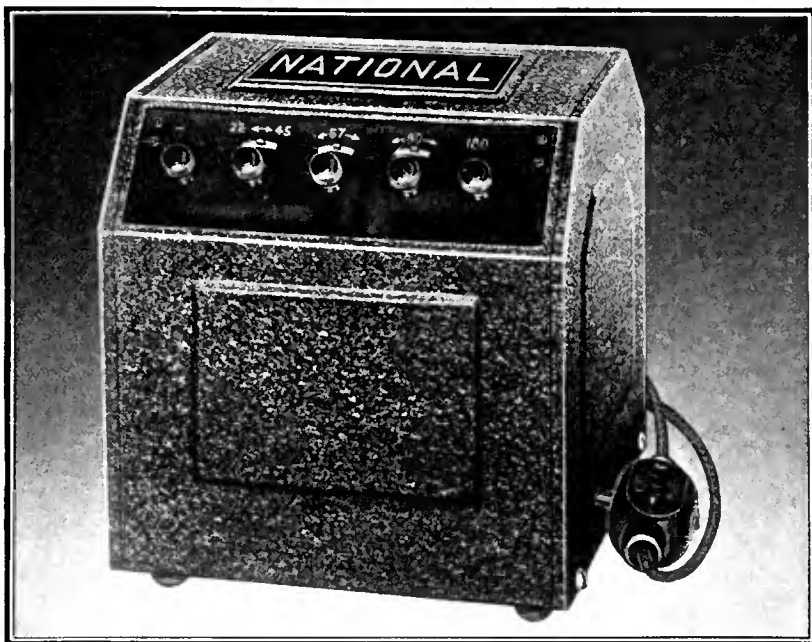

AN ENTIRELY NEW AND UNIQUE HEAVY-DUTY BETTER-B

Supplies

Detector voltages, 22 to 45, adjustable;
R. F. voltages from 50 to 75;
A. F. voltages from 90 to 135;
Power tube voltage 180 fixed.

A Strictly Heavy-Duty Power Unit

Output rating is 70 mils at 180 volts.
Uses R. C. A. UX-280 or Cunningham CX-380 Rectron.

An Exclusive Feature

Tubes and by-pass condensers are protected against excessive and harmful voltages.

Licensed under patents of Radio Corporation of America and Associated Companies.

For 105-115 Volts, 50-60 cycles A. C. List price with cord, switch and plug, \$40. Rectifier tube \$5.

Write National Co., Inc., W. A. Ready, Pres. Malden, Mass. for new Bulletin B-124

Designed for lasting service with liberal factors of safety.

NATIONAL-B

Type 7180

A "B" That's Built for Service

See our Exhibit, Booth No. 8, Chicago Show, Oct. 10th-16th



TONE FILTER
FOR BETTER TONE AND
SPEAKER PROTECTION

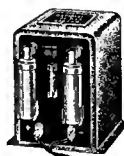

R-26 BATTERY-CHARGER
2 1/2 TO 5 AMPERES



FILAMENT TRANSFORMER
NO. 122 FOR THE
NEW A. C. TUBES



IMPEDANCEFORMER
FOR QUALITY AUDIO



**THE ORIGINAL
VELVET VERNIER DIAL
TYPE A**



**ILLUMINATED VELVET VERNIER
DIAL TYPE C**



**POWER TRANSFORMER
FOR PLATE
SUPPLY UNITS**



**FILTER CHOKES
TYPE 80**

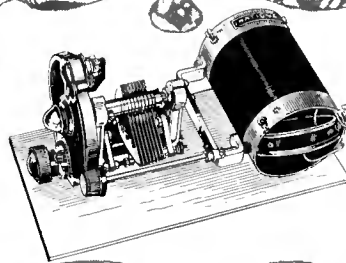
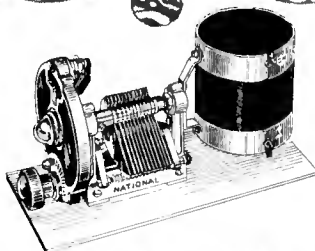

NATIONAL TUNING UNITS — THE HEAVENLY TWINS
More National Tuning Units have been used by set builders than all other similar components combined.
Standard since 1923

Approved By **BROWNING & DRAKE** The OFFICIAL Design

New AERO Circuits Worth Investigating

The Improved Aero-Dyne 6 and the Aero 7 and Aero 4 are destined to be immensely popular this season!



AERO Universal Tuned Radio Frequency Kit

Especially designed for the Improved Aero-Dyne 6. Kit consists of 4 twice-matched units. Adaptable to 201-A, 199, 112, and the new 240 and A. C. tubes. Tuning range below 200 to above 550 meters. This kit will make any circuit better in selectivity, tone and range. Will eliminate losses and give the greatest receiving efficiency.

Code No. U-16 (for .0005 Cond.)...\$15.00
Code No. U-163 (for .00035 Cond.)... 15.00



AERO Seven Tuned Radio Frequency Kit

Especially designed for the Aero 7. Kit consists of 3 twice-matched units. Coils are wound on Bakelite skeleton forms, assuring a 95% air dielectric. Tuning range from below 200 to above 550 meters. Adaptable to 201-A, 199, 112, and the new 240 and A. C. tubes.

Code No. U-12 (for .0005 Cond.)...\$12.00
Code No. U-123 (for .00035 Cond.)... 12.00

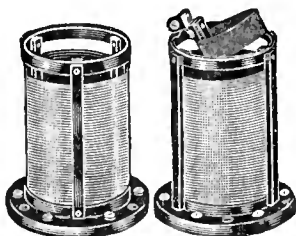

AERO Four Kit

An exceptionally efficient kit for use in the Aero 4 and other similar circuits. Consists of one Aero Universal Radio Frequency Transformer and one Aero Universal 3-Circuit Tuner. Uses 201-A, 112, 199 and new A. C. tubes.

Code No. U-95 (for .0005 Cond.)...\$8.00
Code No. U-953 (for .00035 Cond.)... 8.00

NOTE—All AERO Universal Kits for use in tuned radio frequency circuits have packed in each coil with a fixed primary a twice matched calibration slip showing reading of each fixed primary coil at 250 meters and at 500 meters; all having an accurate and similar calibration.

A NEW SERVICE

We have arranged to furnish the home set builder with complete Foundation Units for the above named Circuits and for the Chicago Daily News 4-Tube Receiver, drilled and engraved on Westinghouse Micarta. Detailed blueprints and wiring diagram for each circuit included in foundation units free. Write for information and prices.

You should be able to get any of the above Aero Coils and parts from your dealer. If he should be out of stock order direct from the factory.

AERO PRODUCTS, Inc.

1772 Wilson Ave. Dept. 109 Chicago, Ill.

What Kit Shall I Buy?

THE list of kits herewith is printed as an extension of the scope of the Service Department of RADIO BROADCAST. It is our purpose to list here the technical data about kits on which information is available. In some cases, the kit can be purchased from your dealer complete; in others, the descriptive booklet is supplied for a small charge and the parts can be purchased as the buyer likes. The Service Department will not undertake to handle cash remittances for parts, but when the coupon on page 68 is filled out, all the information requested will be forwarded.

201. SC FOUR-TUBE RECEIVER—Single control. One stage of tuned radio frequency, regenerative detector, and two stages of transformer-coupled audio amplification. Regeneration control is accomplished by means of a variable resistor across the tickler coil. Standard parts; cost approximately \$58.85.

202. SC-II FIVE-TUBE RECEIVER—Two stages of tuned radio frequency, detector, and two stages of transformer-coupled audio. Two tuning controls. Volume control consists of potentiometer grid bias on r.f. tubes. Standard parts cost approximately \$60.35.

203. "HI-Q" KIT—A five-tube tuned radio-frequency set having two radio stages, a detector, and two transformer-coupled audio stages. A special method of coupling in the r.f. stages tends to make the amplification more nearly equal over the entire band. Price \$63.05 without cabinet.

204. R. G. S. KIT—A four-tube inverse reflex circuit, having the equivalent of two tuned radio-frequency stages, detector, and three audio stages. Two controls. Price \$69.70 without cabinet.

205. PIERCE AIRO KIT—A six-tube single-dial receiver; two stages of radio-frequency amplification, detector, and three stages of resistance-coupled audio. Volume control accomplished by variation of filament brilliancy of r.f. tubes or by adjusting compensating condensers. Complete chassis assembled but not wired costs \$42.50.

206. H & H-T. R. F. ASSEMBLY—A five-tube set; three tuning dials, two steps of radio frequency, detector, and 2 transformer-coupled audio stages. Complete except for base-board, panel, screws, wires, and accessories. Price \$30.00.

207. PREMIER FIVE-TUBE ENSEMBLE—Two stages of tuned radio frequency, detector, and two steps of transformer-coupled audio. Three dials. Parts assembled but not wired. Price complete, except for cabinet, \$35.00.

208. "QUADRAFORMER VI"—A six-tube set with two tuning controls. Two stages of tuned radio frequency using specially designed shielded coils, a detector, one stage of transformer-coupled audio, and two stages of resistance-coupled audio. Gain control by means of tapped primaries on the r.f. transformers. Essential kit consists of three shielded "double-range" "Quadraformer" coils, a selectivity control, and an "Ampitrol," price \$17.50. Complete parts \$70.15.

209. GEN-RAL FIVE-TUBE SET—Two stages of tuned radio frequency, detector, and two transformer-coupled audio stages. Volume is controlled by a resistor in the plate circuit of the r.f. tubes. Uses a special r.f. coil ("Duo-Former") with figure eight winding. Parts mounted but not wired, price \$37.50.

210. BREMER-TOLLY POWER-SIX—A six-tube, dual-control set; three stages of neutralized tuned radio frequency, detector, and two transformer-coupled audio stages. Resistances in the grid circuit together with a phase shifting arrangement are used to prevent oscillation. Volume control accomplished by variation of B potential on r.f. tube. Essential kit consists of four r.f. transformers, two dual condensers, three small condensers, three choke coils, one 500,000-ohm resistor, three 1500-ohm resistors, and a set of color charts and diagrams. Price \$41.50.

212. INFRADYNE AMPLIFIER—A three-tube intermediate-frequency amplifier for the super-heterodyne and other special receivers, tuned to 3490 kc. (86 meters). Price \$25.00.

213. RADIO BROADCAST "LAB" RECEIVER—A four-tube dual-control receiver with one stage of Rice neutralized tuned-radio frequency, regenerative detector (capacity controlled), and two stages of transformer-coupled audio. Approximate price, \$78.15.

214. LC-27—A five-tube set with two stages of tuned-radio frequency, a detector, and two stages of transformer-coupled audio. Special coils and special means of neutralizing are employed. Output device. Price \$85.20 without cabinet.

215. LOFTIN-WHITE—A five-tube set with two stages of radio frequency, especially designed to give equal amplification at all frequencies, a detector, and two stages of transformer-coupled audio. Two controls. Output device. Price \$85.10.

216. K.H.-27—A six-tube receiver with two stages of neutralized tuned radio frequency, a detector, three stages of choke-coupled audio, and an output device. Two controls. Price \$86.00 without cabinet.

217. AERO SHORT-WAVE KIT—Three plug-in coils designed to operate with a regenerative detector circuit and having a frequency range of from 10,000 to 2306 kc. (15 to 130 meters). Coils and plug only, price \$12.50.

218. DIAMOND-OF-THE-AIR—A five-tube set having one stage of tuned-radio frequency, a regenerative detector, one stage of transformer-coupled audio, and two stages of resistance-coupled audio. Volume control through regeneration. Two tuning dials.

219. NORDEN-HAUCK SUPER 10—Ten tubes; five stages of tuned radio frequency, detector, and four stages of choke- and transformer-coupled audio frequency. Two controls. Price \$291.40.

220. BROWNING-DRAKE—Five tubes; one stage tuned radio frequency (Rice neutralization), regenerative detector (tickler control), three stages of audio (special combination of resistance- and impedance-coupled audio). Two controls.



Use an Aerial Kit to get Matched Parts

Every part of your aerial installation should be of uniformly high quality, because one poor unit will affect the entire job.

For complete satisfaction year in and year out, buy a Belden Aerial Kit with Beldenamel Aerial Wire and the well-known Belden Lightning Arrester. Don't take a chance with a poor antenna system. Ask your dealer for a Belden Aerial kit.

Belden Manufacturing Co.
2312-A S. Western Ave., Chicago

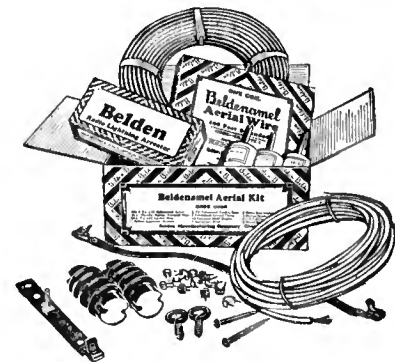

Specify
Belden
Aerial Kit

Your "B" Battery Eliminator
will give you better service with

Q · R · S

(Trade Mark Registered)

**Gaseous
Rectifier Tubes
ARE BETTER**

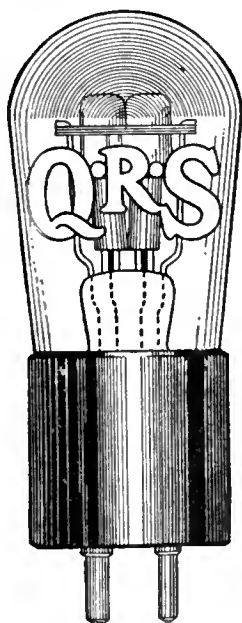

60 Milliamperes	-	\$4.50
85 Milliamperes	-	4.50
400 Milliamperes	-	7.00

Ask for Catalog of full line of Standard Tubes.

Guaranteed

The standing of the Q·R·S Company, manufacturers of quality merchandise for over a quarter of a century, establishes your safety.

Orders placed by the leading Eliminator Manufacturers for this season's delivery, approximating Four Million Dollars' worth of Q·R·S Rectifier Tubes, establishes the approval of Radio Engineers. Ask any good dealer.

THE Q·R·S COMPANY

Manufacturers

Executive Offices: 306 S. Wabash Ave., Chicago

Factories: Chicago—New York—San Francisco—Toronto, Canada—Sydney, Australia—Utrecht, Holland

Established 1900. References—Dun, Bradstreet, or any bank anywhere

Radio • Is • **BETTER** • With • Dry • Battery • Power



You can candle
an egg—but not
a battery

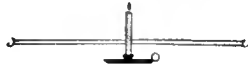

THERE isn't much difference in the size or shape of batteries. And you can't tell how good they are before you use them. If you could, one element alone would win your preference for Burgess. That element is *Chrome*. Chrome is the preservative that maintains an abundance of unfailing energy in Burgess Batteries—long after most dry cells cease to function. The black and white stripes are individual marks for identifying Burgess *Chrome* Batteries. Buy them for long lasting, dependable performance!

Chrome—the preserving element used in leather, metals, paints and other materials subject to wear, is also used in Burgess Batteries. It gives them unusual staying power. Burgess *Chrome* Batteries are patented.

Ask Any Radio Engineer

BURGESS BATTERY COMPANY

General Sales Office: CHICAGO

Canadian Factories and Offices:
Niagara Falls and Winnipeg



BURGESS
FLASHLIGHT & RADIO
BATTERIES

WHAT KIT SHALL I BUY? (Continued)

- 221. LR4 ULTRADYNE—Nine-tube super-heterodyne; one stage of tuned radio frequency, one modulator, one oscillator, three intermediate-frequency stages, detector, and two transformer-coupled audio stages.
- 222. GREIFF MULTIPLEX—Four tubes (equivalent to six tubes); one stage of tuned radio frequency, one stage of transformer-coupled radio frequency, crystal detector, two stages of transformer-coupled audio, and one stage of impedance-coupled audio. Two controls. Price complete parts, \$50.00.
- 223. PHONOGRAPH AMPLIFIER—A five-tube amplifier device having an oscillator, a detector, one stage of transformer-coupled audio, and two stages of impedance-coupled audio. The phonograph signal is made to modulate the oscillator in much the same manner as an incoming signal from an antenna.
- 224. BROWNING-DRAKE—Five tubes; one stage tuned radio frequency (with special neutralization system), regenerative detector (tickle control), three stages of audio (special combination of resistance- and impedance-coupled audio). Two controls.
- 225. AERO SHORT-WAVE Transmitting Kit consists of interchangeable coils to be used in tuned-plate tuned grid circuit. Kits of coils, two choke coils, and mountings, can be secured for 20-40 meter band, 40-80 meter band, or 90-180 meter band for \$12.00

USE THIS COUPON FOR KITS

RADIO BROADCAST SERVICE DEPARTMENT
Garden City, New York.

Please send me information about the following kits indicated by number:

.....
 Name
 Address
 (Number) (Street)
 (City) (State)

ORDER BY NUMBER ONLY. This coupon must accompany each order. RB11-27

Thumb Nail Reviews

WLS—A skit having to do with various and droll adventures around the lion's cage in a circus and centering about one J. Walter Sapp. The mechanically simulated lions' roars were perfectly swell. As for the spoken lines, they were not at all bad, but suffered from high-schoolish and unconvincing delivery—a frequent enough radio play complaint.

WOR—The Kapellmeister String Quartet, excellent interpreters of chamber music, playing on this occasion the Schubert Quartet in D minor.

WBBM—The station's own string trio performing its routine tasks with great gusto and a splendid attack.

WJZ—The Arion Male Chorus singing "Sleep Kentucky Babe" in mellow fashion and introducing some tricky guitar effects against a background of humming.

JOHN WALLACE.

USE THIS COUPON FOR COMPLETE SETS

RADIO BROADCAST SERVICE DEPARTMENT
RADIO BROADCAST, Garden City, New York.
Please send me information about the following manufactured receivers indicated by number:

.....
 Name
 Address
 (Number) (Street)
 (City) (State)

ORDER BY NUMBER ONLY
This coupon must accompany each order. RB 11-27



The Newest A B C Power Supply Unit

used with R C A 226 and 227 A C tubes and the Raytheon BH tube



No. 5552
\$20.00
List

This latest development of the Dongan laboratories combines in one small, compact case the essential transformers and chokes designed for use with R. C. A. 226 and 227 A. C. Filament Tubes (also UX171 power amplifier tube) and the Raytheon BH Rectifier Tube. Complete power supply is secured, eliminating the need of batteries and charger. R. C. A. 226 and 227 A. C. tubes also take the place of standard 201 A tubes. For complete information write to Dongan laboratories. If your dealer cannot supply you send check or money order direct.

DONGAN ELECTRIC MFG. CO.
2991-3001 Franklin St., Detroit, Michigan

TRANSFORMERS of MERIT for FIFTEEN YEARS



Eternal Life

We cannot guarantee eternal life, but we do guarantee the AEROVOX FILTER CONDENSER when properly used to outlast all the other equipment used in conjunction with it.

WHY???

Because—

each section of a block is individually sealed and impregnated against moisture absorption.

the safety factor used in manufacture, testing and rating will permit indefinite continuous operation at the rated working voltage without injury.

For all eliminators

AEROVOX
"Built Better"
70 Washington St., Brooklyn, N. Y.

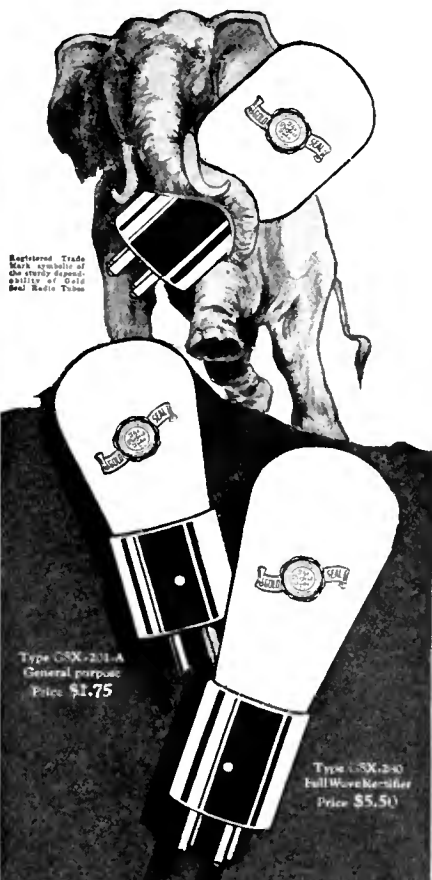

Registered Trade Mark consisting of the stylized elephant, quality of Gold Seal Radio Tubes

Type GSX-231-A
General purpose
Price \$1.75

Type GSX-230
Full Wave Rectifier
Price \$5.50

**Best tubes—
Best reception**

New broadcast developments make it necessary to have the latest types of tubes for fullest enjoyment of your receiving set.

Bring it up to date with a complete installation of the new Gold Seal radio tubes—specially developed for modern reception. You will be delighted with the improvement.

You can make the changes yourself—no trouble. Our new booklet tells you all about it. Send today for your copy—it is free. Use coupon below.

All Standard Types

Gold Seal Electrical Co., Inc.
250 Park Ave., New York

Send me copy of the new booklet.

Name _____

Address _____

R. B. 11-27

**Gold Seal
Radio Tubes**

*When Static Ruins Good
Programs—Switch
Over to a*



**Dubilier
LIGHT-SOCKET AERIAL**

Just connect this neat little device to your set, plug into the nearest light-socket—and listen to the difference! It takes only one program to convince you that crazy poles, loose wires, lead-ins, etc., are not only unnecessary, but downright inefficient when compared to the Dubilier Light Socket Aerial. Works perfectly on AC or DC, totally

eliminates the lightning hazard and uses absolutely no current. Sold at all good radio stores on a 5-day money-back basis. Price \$1.50.

*Used in the Power-Units
You Consider Best*

Dubilier Condenser Blocks are the choice of manufacturers whose battery eliminators are known for reliability and long life. In building your own unit remember that the condenser blocks are the most expensive and important elements in the circuit. Make sure that yours will stand heavy loads and long hours of service by insisting on Dubilier. Diagrams upon request.



Dubilier Micadon

The Standard Fixed Condenser of Radio in a new case of moulded Bakelite, shaped to meet the newest type of receiver construction. Terminals adapted to either screwed or soldered connections. All standard capacities. Priced from 45c to \$1.50.

Dubilier Metaleak

Accurate resistance ratings and extremely quiet performance make these tubular grid leaks popular with amateurs who build with great care. They are small, but highly important items in the construction of any type of receiver. All standard resistance—prices—75c and 50c.

DUBILIER CONDENSER CORP., 4377 Bronx Blvd., New York

**Dubilier
CONDENSERS**

"RADIO BROADCASTS" DIRECTORY OF MANUFACTURED RECEIVERS

A coupon will be found on page 68. All readers who desire additional information on the receivers listed below need only insert the proper numbers in the coupon, mail it to the Service Department of RADIO BROADCAST, and full details will be sent. New sets are listed in this space each month.

KEY TO TUBE ABBREVIATIONS

99—60-mA. filament (dry cell)
01-A—Storage battery 0.25 amps. filament
12—Power tube (Storage battery)
71—Power tube (Storage battery)
16-B—Half-wave rectifier tube
80—Full-wave, high current rectifier
81—Half-wave, high current rectifier
1Hmu—High-Mu tube for resistance-coupled audio
20—Power tube (dry cell)
10—Power Tube (Storage battery)
00-A—Special detector
13—Full-wave rectifier tube
26—Low-voltage high-current a. c. tube
27—Heater type a. c. tube

DIRECT CURRENT RECEIVERS

NO. 424. COLONIAL 26

Six tubes; 2 t. r. f. (01-A), detector (12), 2 transformer audio (01-A and 71). Balanced t. r. f. One to three dials. Volume control; antenna switch and potentiometer across first audio. Watts required: 120. Console size: 34 x 38 x 18 inches. Headphone connections. The filaments are connected in a series parallel arrangement. Price \$250 including power unit.

NO. 425. SUPERPOWER

Five tubes: All 01-A tubes. Multiplex circuit. Two dials. Volume control; resistance in r. f. plate. Watts required: 30. Antenna: loop or outside. Cabinet sizes: table, 27 x 10 x 9 inches; console, 28 x 50 x 21. Prices: table, \$135 including power unit; console, \$390 including power unit and loud speaker.

A. C. OPERATED RECEIVERS

NO. 508. ALL-AMERICAN 77, 88, AND 99

Six tubes; 3 t. r. f. (26), detector (27), 2 transformer audio (26 and 71). Rice neutralized t. r. f. Single drum tuning. Volume control; potentiometer in r. f. plate. Cabinet sizes: No. 77, 21 x 10 x 8 inches; No. 88 Hiboy, 25 x 38 x 18 inches; No. 99 console, 27½ x 43 x 20 inches. Shielded. Output device. The filaments are supplied by means of three small transformers. The plate supply employs a gas-filled rectifier tube. Voltmeter in a. c. supply line. Prices: No. 77, \$150, including power unit; No. 88, \$210 including power unit; No. 99, \$285 including power unit and loud speaker.

NO. 509. ALL-AMERICAN "DUET"; "SEXTET"

Six tubes; 2 t. r. f. (99), detector (99), 3 transformer audio (99 and 12). Rice neutralized t. r. f. Two dials. Volume control; resistance in r. f. plate. Cabinet sizes: "Duet," 23 x 56 x 16½ inches; "Sextet," 22½ x 13½ x 15½ inches. Shielded. Output device. The 99 filaments are connected in series and supplied with rectified a. c., while 12 is supplied with raw a. c. The plate and filament supply uses gaseous rectifier tubes. Milliammeter on power unit. Prices: "Duet," \$160 including power unit; "Sextet," \$220 including power unit and loud speaker.

NO. 511. ALL-AMERICAN 80, 90, AND 115

Five tubes; 2 t. r. f. (99), detector (99), 2 transformer audio (99 and 12). Rice neutralized t. r. f. Two dials. Volume control; resistance in r. f. plate. Cabinet sizes: No. 80, 23½ x 12½ x 15 inches; No. 90, 37½ x 12 x 12½ inches; No. 115 Hiboy, 24 x 41 x 15 inches. Coils individually shielded. Output device. See No. 509 for power supply. Prices: No. 80, \$135 including power unit; No. 90, \$145 including power unit and compartment; No. 115, \$170 including power unit, compartment, and loud speaker.

NO. 510. ALL-AMERICAN 7

Seven tubes; 3 t. r. f. (26), 1 untuned r. f. (26), detector (27), 2 transformer audio (26 and 71). Rice neutralized t. r. f. One drum. Volume control; resistance in r. f. plate. Cabinet sizes: "Sovereign" console, 30½ x 60½ x 19 inches; "Lorraine" Hiboy, 25½ x 53½ x 17½ inches; "Forte" cabinet, 25½ x 13½ x 17½ inches. For filament and plate supply: See No. 508. Prices: "Sovereign" \$460; "Lorraine" \$360; "Forte" \$270. All prices include power unit. First two include loud speaker.

NO. 401. AMRAD AC9

Six tubes; 3 t. r. f. (99), detector (99), 2 transformer audio (99 and 12). Neutrodyne. Two dials. Volume control; resistance across 1st audio. Watts consumed: 50. Cabinet size: 27 x 9 x 11½ inches. The 99 filaments are connected in series and supplied with rectified a. c., while the 12 is run on raw a. c. The power unit, requiring two 16-B rectifiers, is separate and supplies A, B, and C current. Price \$142 including power unit.

NO. 402. AMRAD ACS

Five tubes. Same as No. 401 except one less r. f. stage. Price \$125 including power unit.

NO. 536. SOUTH BEND

Six tubes. One control. Sub-panel shielding. Binding Posts. Antenna: outdoor. Prices: table, \$130, Baby Grand console, \$195.

NO. 537. WALBERT 26

Six tubes; five Kellogg a. c. tubes and one 71. Two controls. Volume control; variable plate resistance. Isofarad circuit. Output device. Battery cable. Semi-shielded. Antenna: 50 to 75 feet. Cabinet size: 10½ x 29½ x 16½ inches. Prices: \$215; with tubes, \$250.

NO. 484. BOSWORTH, B5

Five tubes; 2 t. r. f. (26), detector (99), 2 transformer audio (special a. c. tubes). T. r. f. circuit. Two dials. Volume control; potentiometer. Cabinet size: 23 x 7 x 8 inches. Output device included. Price \$175.

NO. 406. CLEARSTONE 110

Five tubes; 2 t. r. f. detector, 2 transformer audio. All tubes a. c. heater type. One or two dials. Volume control; resistance in r. f. plate. Watts consumed: 40. Cabinet size: varies. The plate supply is built in the receiver and requires one rectifier tube. Filament supply through step down transformers. Prices range from \$175 to \$375 which includes 5 a. c. tubes and one rectifier tube.

NO. 407. COLONIAL 25

Six tubes; 2 t. r. f. (01-A), detector (99), 2 resistance audio (99). 1 transformer audio (10). Balanced t. r. f. circuit. One or three dials. Volume control; Antenna switch and potentiometer on 1st audio. Watts consumed: 100. Console size: 34 x 38 x 18 inches. Output device. All tube filaments are operated on a. c. except the detector which is supplied with rectified a. c. from the plate supply. The rectifier employs two 16-B tubes. Price \$250 including built-in plate and filament supply.

NO. 507. CROSLY 602 BANDBOX

Six tubes; 3 t. r. f. (26), detector (27), 2 transformer audio (26 and 71). Neutrodyne circuit. One dial. Cabinet size: 17½ x 5½ x 7½ inches. The heaters for the a. c. tubes and the 71 filament are supplied by windings in B unit transformers available to operate either on 25 or 60 cycles. The plate current is supplied by means of rectifier tube. Price \$65 for set alone, power unit \$60.

NO. 408. DAY-FAN "DE LUXE"

Six tubes; 3 t. r. f. detector, 2 transformer audio. All 01-A tubes. One dial. Volume control; potentiometer across r. f. tubes. Watts consumed: 300. Console size: 30 x 40 x 20 inches. The filaments are connected in series and supplied with d. c. from a motor-generator set which also supplies B and C current. Output device. Price \$350 including power unit.

NO. 409. DAYCRAFT 5

Five tubes; 2 t. r. f. detector, 2 transformer audio. All a. c. heater tubes. Reflexed t. r. f. One dial. Volume control; potentiometers in r. f. plate and 1st audio. Watts consumed: 135. Console size: 34 x 36 x 14 inches. Output device. The heaters are supplied by means of a small transformer. A built-in rectifier supplies B and C voltages. Price \$170, less tubes. The following have one more r. f. stage and are not reflexed: Daycraft 6, \$195; Dayrole 6, \$235; Dayfan 6, \$110. All prices less tubes.

NO. 469. FREED-EISEMANN NR11

Six tubes; 3 t. r. f. (01-A), detector (01-A), 2 transformer audio (01-A and 71). Neutrodyne. One dial. Volume control; potentiometer. Watts consumed: 150. Cabinet size: 19½ x 10 x 10½ inches. Shielded. Output device. A special power unit is included employing a rectifier tube. Price \$225 including NR-411 power unit.

NO. 487. FRESHMAN 7F-AC

Six tubes; 3 t. r. f. (26), detector (27), 2 transformer audio (26 and 71). Equaphase circuit. One dial. Volume control; potentiometer across 1st audio. Console size: 21½ x 41½ x 15 inches. Output device. The filaments and heaters and B supply are all supplied by one power unit. The plate supply requires one 80 rectifier tube. Price \$175 to \$350, complete.

NO. 421. SOVEREIGN 238

Seven tubes of the a. c. heater type. Balanced t. r. f. Two dials. Volume control; resistance across 2nd audio. Watts consumed: 45. Console size: 37 x 52 x 15 inches. The heaters are supplied by a small a. c. transformer, while the plate is supplied by means of rectified a. c. using a gaseous type rectifier. Price \$325, including power unit and tubes.

NO. 517. KELLOGG 510, 511, AND 512

Seven tubes; 4 t. r. f. detector, 2 transformer audio. All Kellogg a. c. tubes. One control and special zone switch. Balanced. Volume control; special. Output device. Shielded. Cable connection between power supply unit and receiver. Antenna: 25 to 100 feet. Panel 7½ x 27½ inches. Prices: Model 510 and 512, consoles, \$435 complete. Model 511, console, \$365 without loud speaker.

NO. 496. SLEPER ELECTRIC

Five tubes; four 99 tubes and one 71. Two controls. Volume control; rheostat on r. f. Neutralized. Cable. Output device. Power supply uses two 16-B tubes. Antenna: 100 feet. Prices: Type 64, table, \$160; Type 65, table, with built-in loud speaker, \$175; Type 66, table, \$175; Type 67, console, \$235; Type 78, console, \$265.

NO. 538. NEUTROWOUND, MASTER ALLECTRIC

Six tubes; 2 t. r. f. (01-A), detector (01-A), 2 audio (01-A and two 71 in push-pull amplifier). The 01-A tubes are in series, and are supplied from a 400-mA. rectifier. Two drum controls. Volume control; variable plate resistance. Output device. Shielded. Antenna: 50 to 100 feet. Price: \$360

NO. 413. MARTI

Six tubes; 2 t. r. f. detector, 3 resistance audio. All tubes a. c. heater type. Two dials. Volume control; resistance in r. f. plate. Watts consumed: 38. Panel size: 7 x 21 inches. The built-in plate supply employs one 16-B rectifier. The filaments are supplied by a small transformer. Prices: table, \$235 including tubes and rectifier; console, \$275 including tubes and rectifier; console, \$325 including tubes, rectifier, and loud speaker.

NO. 417. RADIOLA 28

Eight tubes; five type 99 and one type 20. Drum control. Super-heterodyne circuit. C-battery connections. Battery cable. Headphone connection. Antenna: loop. Set may be operated from batteries or from the power mains when used in conjunction with the model 104 loud speaker. Prices: \$260 with tubes, battery operation; \$570 with model 101 loud speaker, a. c. operation.

NO. 540. RADIOLA 30-A

Receiver characteristics same as No. 417 except that type 71 power tube is used. This model is designed to operate on either a. c. or d. c. from the power mains. The combination rectifier—power—amplifier unit uses two type 81 tubes. Model 100-A loud speaker is contained in lower part of cabinet. Either a short indoor or long outside antenna may be used. Cabinet size: 42½ x 29 x 17¼ inches. Price: \$495.

NO. 541. RADIOLA 32

This model combines receiver No. 417 with the model 104 loud speaker. The power unit uses two type 81 tubes and a type 10 power amplifier. Loop is completely enclosed and is revolved by means of a dial on the panel. Models for operation from a. c. or d. c. power mains. Cabinet size: 52 x 72 x 17¼ inches. Price: \$895.

NO. 539. RADIOLA 17

Six tubes; 3 t. r. f. (26), detector (27), 2 transformer audio (26 and 71). One control. Illuminated dial. Built-in power supply using type 80 rectifier. Antenna: 100 feet. Cabinet size: 25½ x 7½ x 8½. Price: \$130 without accessories.

NO. 545. NEUTROWOUND, SUPER ALLECTRIC

Five tubes; 2 t. r. f. (99), detector (99), 2 audio (99 and 71). The 99 tubes are in series and are supplied from an 85-mA. rectifier. Two drum controls. Volume control; variable plate resistance. Output device. Antenna: 75 to 100 feet. Cabinet size: 9 x 24 x 11 inches. Price: \$150.

NO. 490. MOHAWK

Six tubes; 2 t. r. f. detector, 2 transformer audio. All tubes a. c. heater type except 71 in last stage. One dial. Volume control; rheostat on r. f. Watts consumed: 40. Panel size: 12½ x 8½ inches. Output device. The heaters for the a. c. tubes and the 71 filament are supplied by small transformers. The plate supply is of the built-in type using a rectifier tube. Prices range from \$65 to \$245

NO. 522. CASE, 62 B AND 62 C

McCullough a. c. tubes. Drum control. Volume control; variable high resistance in audio system. C-battery connections. Semi-shielded. Cable. Antenna: 100 feet. Panel size: 7 x 21 inches. Prices: Model 62 B, complete with a. c. equipment, \$185; Model 62 C, complete with a. c. equipment, \$235.

NO. 523. CASE, 92 A AND 92 C

McCullough a. c. tubes. Drum control. Inductive volume control. Technidyne circuit. Shielded. Cable. C-battery connections. Model 92 C contains output device. Loop operated. Prices: Model 92 A, table, \$350; Model 92 C, console, \$475.

BATTERY OPERATED RECEIVERS

NO. 542. PFANSTIEHL JUNIOR SIX

Six tubes; 3 t. r. f. (01-A), detector (01-A), 2 audio. Pfanstiehl circuit. Volume control; variable resistance in r. f. plate circuit. One dial. Shielded. Battery cable. C-battery connections. Etched bronze panel. Antenna: outdoor. Cabinet size: 9 x 20 x 8 inches. Price: \$80, without accessories.

NO. 512. ALL-AMERICAN 44, 45, AND 66

Six tubes; 3 t. r. f. (01-A, detector) 01-A, 2 transformer audio (01-A and 71). Rice neutralized t. r. f. Drum control. Volume control; rheostat in r. f. Cabinet sizes: No. 44, 21 x 10 x 8 inches; No. 55, 25 x 38 x 18 inches; No. 66, 27½ x 43 x 20 inches. C-battery connections. Battery cable. Antenna: 75 to 125 feet. Prices: No. 44, \$70; No. 55, \$125 including loud speaker; No. 66, \$200 including loud speaker.

NO. 428. AMERICAN C6

Five tubes; 2 t. r. f. detector, 2 transformer audio. All 01-A tubes. Semi balanced t. r. f. Three dials. Plate current 15 mA. Volume control; potentiometer. Cabinet sizes: table, 20 x 8½ x 10 inches; console, 36 x 40 x 17 inches. Partially shielded. Battery cable. C-battery connections. Antenna: 125 feet. Prices: table, \$30; console, \$65 including loud speaker.

**30 Days
FREE
TRIAL
5 Year
Guarantee**

MARWOOD

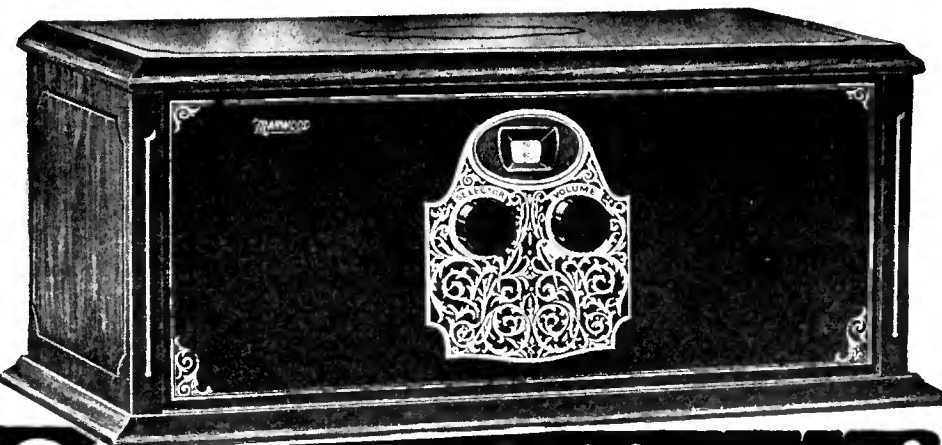

The 1928 Sensations! 8 Tube-1 Control



All Electric or Battery Operation

AGAIN Marwood is a year ahead—with the Radio sensation of 1928—at a low price that smashes Radio profiteering. Here's the sensation they're all talking about—the marvelous 8 Tube Single Control Marwood for BATTERY or ALL ELECTRIC operation. Direct from the factory for only \$69.00 retail price—a price far below that of smaller, less powerful Radios. Big discount to Agents from this price. You can't beat this wonderful new Marwood and you can't touch this low price. Why pay more for less quality? To prove that Marwood can't be beat we let you use it on 30 Days' Free Trial in your own home. Test it in every way. Compare it with any Radio for tone, quality, volume, distance, selectivity, beauty. If you don't say that it is a wonder, return it to us. We take the risk.

New Exclusive Features

Do you want coast to coast with volume enough to fill a theatre? Do you want amazing distance that only super-power Radios like the Marwood 8 can get? Do you want ultra-selectivity to cut out interference? Then you must test this Marwood on 30 Days' Free Trial. An amazing surprise awaits you. A flip of your finger makes it ultra-selective—or broad—just as you want it. Every Marwood is perfectly BALANCED—a real laboratory job. Its simple one drum control gets ALL the stations on the wave band with ease. A beautiful, guaranteed, super-efficient Radio in handsome walnut cabinets and consoles. A radio really worth double our low price.

Buy From Factory—Save Half

Why pay profits to several middlemen? A Marwood in any retail store would cost practically three times our low direct-from-the-factory price. Our policy is highest quality plus small profit and enormous sales. You get the benefit. Marwood is a pioneer, responsible Radio, with a good reputation to guard. We insist on the best and we charge the least. If you want next year's improvements NOW—you must get a Marwood—the Radio that's a year ahead.

AGENTS

Make Big Spare Time Money

Get your own Radio at wholesale price. It's easy to get orders for the Marwood from your friends and neighbors. Folks buy quick when they compare Marwood quality and low prices. We want local agents and dealers in each territory to handle the enormous business created by our national advertising. Make \$100 a week or more in spare time demonstrating at home. No experience or capital needed. We show you how. This is the biggest season in Radio history. Everybody wants a Radio. Get in now. Rush coupon for 30 days' Free Trial, beautiful catalog, Agents' Confidential Prices and Agents' New Plan.

MARWOOD RADIO CORP.

5315 Ravenswood Avenue
Department A-17 Chicago, Illinois

Only
\$69 RETAIL PRICE
Big Discount
to Agents
From This
Price

Get Our Discounts Before You Buy a Radio

Don't buy any Radio 'till you get our big discounts and catalog. Save half and get a Radio that IS a Radio. Try any Marwood on 30 Days' Free Trial at our risk. Time in coast to coast on loud speaker with enormous volume, clear as a bell. Let your wife and children operate it. Compare it with any Radio regardless of price. If you don't get the surprise of your life, return it. We take the risk. Don't let Marwood low prices lead you to believe Marwood is not the highest quality. We have smashed Radio prices. You save half.

6 Tube—1 Control

This is the Marwood 6 Tube, 1 Control for BATTERY or ALL ELECTRIC operation. Gets coast to coast on loud speaker with great volume. Only \$47.00 retail. Big discounts to Agents. Comes in handsome walnut cabinets and consoles. This low price cannot be equalled by any other high grade 6 tube Radio. Has the volume of any 7 tube set. If you want a 6 tube Radio you can't beat a Marwood and you can't touch our low price.

\$47

RETAIL PRICE
Big Discount
to Agents
from This
Price



Rush for Free Trial

MARWOOD RADIO CORPORATION
5315 Ravenswood Ave., Dept. A-17, Chicago, Ill.
Send Agents' Confidential Prices, 30 Days' Free Trial, New Catalog and Agents' New Money Making Plan. No obligation on my part.

Name.....
Address.....
St. or R.F.D.....
City..... State.....

**ALL
ELECTRIC
8 Tube
1 Control
\$98** RETAIL PRICE

Big Discount to Agents From this Price

Has Complete A-B Power Unit

A REAL ALL ELECTRIC Radio with one of the best A-B power units on the market—no batteries needed—at the world's lowest price. This Marwood can't be excelled at ANY price. If you have electricity in your home, just plug into the light socket and forget batteries. No more battery trouble and expense. Costs less than 2c a day to operate. Always have 100% volume. ALL ELECTRIC Radios are high priced because they are new. We cut profit to the bone and offer a \$250.00 outfit for \$98.00 retail price. Big discount to Agents. Don't buy any Radio 'til you get details of this sensational new ALL ELECTRIC Marwood.

NO. 485. BOSWORTH B6

Five tubes; 2 t. r. f. (01-A), detector (01-A), 2 transformer audio (01-A and 71). Two dials. Volume control: variable grid resistances. Battery cable. C-battery connections. Antenna: 25 feet or longer. Cabinet size 15 x 7 x 8 inches. Price \$75.

NO. 513. COUNTERPHASE SIX

Six tubes; 3 t. r. f. (01-A), detector (00-A), 2 transformer audio (01-A and 12). Counterphase t. r. f. Two dials. Plate current: 32 mA. Volume control: rheostat, on 2nd and 3rd r. f. Coils shielded. Battery cable. C-battery connections. Antenna: 75 to 100 feet. Console size: 18½ x 40½ x 15½ inches. Prices: Model 35, table, \$110; Model 37, console, \$175.

NO. 514. COUNTERPHASE EIGHT

Eight tubes; 4 t. r. f. (01-A), detector (00-A), 2 transformer audio (01-A and 12). Counterphase t. r. f. One dial. Plate current: 40 mA. Volume control: rheostat in 1st r. f. Copper stage shielding. Battery cable. C-battery connections. Antenna: 75 to 100 feet. Cabinet size: 30 x 12½ x 16 inches. Prices: Model 12, table, \$225; Model 16, console, \$335; Model 18, console, \$365.

NO. 506. CROSLY 601 BANDBOX

Six tubes; 3 t. r. f., detector, 2 transformer audio. All 01-A tubes. Neutrodyne. One dial. Plate current: 40 mA. Volume control: rheostat in r. f. Shielded. Battery cable. C-battery connections. Antenna: 75 to 150 feet. Cabinet size: 17½ x 5½ x 7½. Price, \$55.

NO. 434. DAY-FAN 6

Six tubes; 3 t. r. f. (01-A), detector (01-A), 2 transformer audio (01-A and 12 or 71). One dial. Plate current: 12 to 15 mA. Volume control: rheostat on r. f. Shielded. Battery cable. C-battery connections. Output device. Antenna: 50 to 120 feet. Cabinet sizes: Daycraft 6, 32 x 30 x 34 inches; Day-Fan Jr., 15 x 7 x 7. Prices: Day-Fan 6, \$110; Daycraft 6, \$145 including loud speaker; Day-Fan Jr. not available.

NO. 435. DAY-FAN 7

Seven tubes; 3 t. r. f. (01-A), detector (01-A), 1 resistance audio (01-A), 2 transformer audio (01-A and 12 or 71). Plate current: 15 mA. Antenna: outside. Same as No. 434. Price \$115.

NO. 503. FADA SPECIAL

Six tubes; 3 t. r. f. (01-A), detector (01-A), 2 transformer audio (01-A and 71). Neutrodyne. Two drum control. Plate current: 20 to 24 mA. Volume control: rheostat on r. f. Coils shielded. Battery cable. C-battery connections. Headphone connections. Antenna: outdoor. Cabinet size: 20½ x 13½ x 10½ inches. Price \$95.

NO. 504. FADA 7

Seven tubes; 4 t. r. f. (01-A), detector (01-A), 2 transformer audio (01-A and 71). Neutrodyne. Two drum control. Plate current: 43 mA. Volume control: rheostat on r. f. Completely shielded. Battery cable. C-battery connections. Headphone connections. Output device. Antenna: outdoor or loop. Cabinet sizes: table, 25½ x 13½ x 11½ inches; console, 29 x 50 x 17 inches. Prices: table, \$185; console, \$285.

NO. 436. FEDERAL

Five tubes; 2 t. r. f. (01-A), detector (01-A), 2 transformer audio (01-A and 12 or 71). Balanced t. r. f. One dial. Plate current: 20.7 mA. Volume control: rheostat on r. f. Shielded. Battery cable. C-battery connections. Antenna: loop. Made in 6 models. Price varies from \$250 to \$1000 including loop.

NO. 505. FADA 8

Eight tubes. Same as No. 504 except for one extra stage of audio and different cabinet. Prices: table, \$300; console, \$400.

NO. 437. FERGUSON 10A

Seven tubes; 3 t. r. f. (01-A), detector (01-A), 3 audio (01-A and 12 or 71). One dial. Plate current: 18 to 25 mA. Volume control: rheostat on two r. f. Shielded. Battery cable. C-battery connections. Antenna: 100 feet. Cabinet size: 21½ x 12 x 15 inches. Price \$150.

NO. 438. FERGUSON 14

Ten tubes; 3 untuned r. f., 3 t. r. f. (01-A), detector (01-A), 3 audio (01-A and 12 or 71). Special balanced t. r. f. One dial. Plate current: 30 to 35 mA. Volume control: rheostat in three r. f. Shielded. Battery cable. C-battery connections. Antenna: loop. Cabinet size: 24 x 12 x 16 inches. Price \$235, including loop.

NO. 439. FERGUSON 12

Six tubes; 2 t. r. f. (01-A), detector (01-A), 1 transformer audio (01-A), 2 resistance audio (01-A and 12 or 71). Two dials. Plate current: 18 to 25 mA. Volume control: rheostat on two r. f. Partially shielded. Battery cable. C-battery connections. Antenna: 100 feet. Cabinet size: 22½ x 10 x 12 inches. Price \$85. Console \$145 including loud speaker.

NO. 440. FREED-EISEMANN NR-8 NR-9, AND NR-66

Six tubes; 3 t. r. f. (01-A), detector (01-A), 2 transformer audio (01-A and 71). Neutrodyne. NR-8, two dials; others one dial. Plate current: 30 mA. Volume control: rheostat on r. f. NR-8 and 9; chassis type shielding, NR-66, individual stage shielding. Battery cable. C-battery connections. Antenna: 100 feet. Cabinet sizes: NR-8 and 9, 19½ x 10 x 10½ inches; NR-66, 20 x 10½ x 12 inches. Prices: NR-8, \$90; NR-9, \$100; NR-66, \$125.

NO. 501. KING "CHEVALIER"

Six tubes. Same as No. 500. Coils completely shielded. Panel size: 11 x 7 inches. Price, \$210 including loud speaker.

NO. 441. FREED-EISEMANN NR-77

Seven tubes; 4 t. r. f. (01-A), detector (01-A), 2 transformer audio (01-A and 71). Neutrodyne. One dial. Plate current: 35 mA. Volume control: rheostat on r. f. Shielding. Battery cable. C-battery connections. Antenna: outside or loop. Cabinet size: 23 x 10½ x 13 inches. Price \$175.

NO. 442. FREED-EISEMANN 800 AND 850

Eight tubes; 4 t. r. f. (01-A), detector (01-A), 1 transformer (01-A), 1 parallel audio (01-A or 71). Neutrodyne. One dial. Plate current: 35 mA. Volume control: rheostat on r. f. Shielded. Battery cable. C-battery connections. Output: two tubes in parallel or one power tube may be used. Antenna: outside or loop. Cabinet sizes: No. 800, 34 x 15½ x 13½ inches; No. 850, 36 x 65½ x 17½. Prices not available.

NO. 444. GREBE MU-1

Five tubes; 2 t. r. f. (01-A), detector (01-A), 2 transformer audio (01-A and 12 or 71). Balanced t. r. f. One, two, or three dials (operate singly or together). Plate current: 30 mA. Volume control: rheostat on r. f. Binocular coils. Binding posts. C-battery connections. Antenna: 125 feet. Cabinet size: 22½ x 9½ x 13 inches. Prices range from \$95 to \$320.

NO. 426. HOMER

Seven tubes; 4 t. r. f. (01-A); detector (01-A or 00A); 2 audio (01-A and 12 or 71). One knob tuning control. Volume control: rotor control in antenna circuit. Plate current: 22 to 25 mA. "Technidyne" circuit. Completely enclosed in aluminum box. Battery cable. C-battery connections. Cabinet size, 8½ x 19½ x 9½ inches. Chassis size, 6½ x 17 x 8 inches. Prices: Chassis only, \$80. Table cabinet, \$95.

NO. 502. KENNEDY ROYAL 7. CONSOLETTA

Seven tubes; 4 t. r. f. (01-A), detector (00-A), 2 transformer audio (01-A and 71). One dial. Plate current: 42 mA. Volume control: rheostat on two r. f. Special r. f. coils. Battery cable. C-battery connections. Headphone connection. Antenna: outside or loop. Console size: 36½ x 35½ x 19 inches. Price \$220.

NO. 498. KING "CRUSADER"

Six tubes; 2 t. r. f. (01-A), detector (00-A), 3 transformer audio (01-A and 71). Balanced t. r. f. One dial. Plate current: 20 mA. Volume control: rheostat on r. f. Coils shielded. Battery cable. C-battery connections. Antenna: outside. Panel: 11 x 7 inches. Price, \$115.

NO. 499. KING "COMMANDER"

Six tubes; 3 t. r. f. (01-A), detector (00-A), 2 transformer audio (01-A and 71). Balanced t. r. f. One dial. Plate current: 25 mA. Volume control: rheostat on r. f. Completely shielded. Battery cable. C-battery connections. Antenna: loop. Panel size: 12 x 8 inches. Price \$220 including loop.

NO. 429. KING COLE VII AND VIII

Seven tubes; 3 t. r. f., detector, 1 resistance audio, 2 transformer audio. All 01-A tubes. Model VIII has one more stage t. r. f. (eight tubes). Model VII, two dials. Model VIII, one dial. Plate current: 15 to 50 mA. Volume control: primary shunt in r. f. Steel shielding. Battery cable and binding posts. C-battery connections. Output devices on some consoles. Antenna: 10 to 100 feet. Cabinet size: varies. Prices: Model VII, \$80 to \$160; Model VIII, \$100 to \$300.

NO. 500. KING "BARONET" AND "VIKING"

Six tubes; 2 t. r. f. (01-A), detector (00-A), 3 transformer audio (01-A and 71). Balanced t. r. f. One dial. Plate current: 19 mA. Volume control: rheostat in r. f. Battery cable. C-battery connections. Antenna: outside. Panel size: 18 x 7 inches. Prices: "Baronet," \$70; "Viking," \$140 including loud speaker.

NO. 489. MOHAWK

Six tubes; 2 t. r. f. (01-A), detector (00-A), 3 audio (01-A and 71). One dial. Plate current: 40 mA. Volume control: rheostat on r. f. Battery cable. C-battery connections. Output device. Antenna: 60 feet. Panel size: 12½ x 8½ inches. Prices range from \$65 to \$245.

NO. 543. ATWATER KENT, MODEL 33

Six tubes; 3 t. r. f. (01-A), detector (01-A), 2 audio (01-A and 71 or 15). One dial. Volume control: r. f. filament rheostat. C-battery connections. Battery cable. Antenna: 100 feet. Steel panel. Cabinet size: 21½ x 6½ x 6½ inches. Price: \$90, without accessories.

NO. 544. ATWATER KENT, MODEL 50

Seven tubes; 4 t. r. f. (01-A), detector (01-A), 2 audio (01-A and 12 or 71). Volume control: r. f. filament rheostat. C-battery connections. Battery cable. Special band-pass filter circuit with an untuned amplifier. Cabinet size: 20½ x 13 x 7½ inches. Price: \$150.

NO. 452. ORIOLE 90

Five tubes; 2 t. r. f., detector, 2 transformer audio. All 01-A tubes. "Trinum" circuit. Two dials. Plate current: 18 mA. Volume control: rheostat on r. f. Battery cable. C-battery connections. Antenna: 50 to 100 feet. Cabinet size: 25½ x 11½ x 12½ inches. Price \$85. Another model has 8 tubes, one dial, and is shielded. Price \$185.

NO. 453. PARAGON

Six tubes; 2 t. r. f. (01-A), detector (01-A), 3 double impedance audio (01-A and 71). One dial. Plate current: 40 mA. Volume control: resistance in r. f. plate. Shielded. Battery cable. C-battery connections. Output device. Antenna: 100 feet. Console size: 20 x 46 x 17 inches. Price not determined.

NO. 543. RADIOLA 20

Five tubes; 2 t. r. f. (99), detector (99), two transformer audio (99 and 20). Regenerative detector. Two drum controls. C-battery connections. Battery cable. Antenna: 100 feet. Price: \$78 without accessories.

NO. 480. PFANSTIEHL 30 AND 302

Six tubes; 3 t. r. f. (01-A), detector (01-2A), transformer audio (01-A and 71). One dial. Plate current: 23 to 32 mA. Volume control: resistance in r. f. plate. Shielded. Battery cable. C-battery connections. Antenna: outside. Panel size: 17½ x 8½ inches. Prices: No. 30 cabinet, \$105; No. 302 console, \$185 including loud speaker.

NO. 515. BROWNING-DRAKE 7-A

Seven tubes; 2 t. r. f. (01-A), detector (00-A), 3 audio (Hmu, two 01-A, and 71). Illuminated drum control. Volume control: rheostat on 1st r. f. Shielded. Neutralized. C-battery connections. Battery Cable. Metal panel. Output device. Antenna: 50-75 feet. Cabinet, 30 x 11 x 9 inches. Price, \$145.

NO. 516. BROWNING-DRAKE 6-A

Six tubes; 1 t. r. f. (99), detector (00-A), 3 audio (Hmu, two 01-A and 71). Drum control with auxiliary adjustment. Volume control: rheostat on r. f. Regenerative detector. Shielded. Neutralized. C-battery connections. Battery cable. Antenna: 50-100 feet. Cabinet, 25 x 11 x 9. Price \$105.

NO. 518. KELLOGG "WAVE MASTER," 504, 505, AND 506.

Five tubes; 2 t. r. f., detector, 2 transformer audio. One control and special zone switch. Volume control: rheostat on r. f. C-battery connections. Binding posts. Plate current: 25 to 35 mA. Antenna: 100 feet. Panel: 7½ x 25½ inches. Prices: Model 504, table, \$75, less accessories. Model 505, table, \$125 with loud speaker. Model 506, console, \$135 with loud speaker.

NO. 519. KELLOGG, 507 AND 508.

Six tubes, 3 t. r. f., detector, 2 transformer audio. One control and special zone switch. Volume control: rheostat on r. f. C-battery connections. Balanced. Shielded. Binding posts and battery cable. Antenna: 70 feet. Cabinet size: Model 507, table, 30 x 13½ x 14 inches. Model 508, console, 34 x 18 x 54 inches. Prices: Model 507, \$190 less accessories. Model 508, \$320 with loud speaker.

NO. 427. MURDOCK 7

Seven tubes; 3 t. r. f. (01-A), detector (01-A), 1 transformer and 2 resistance audio (two 01-A and 12 or 71). One control. Volume control: rheostat on r. f. Coils shielded. Neutralized. Battery cable. C-battery connections. Complete metal case. Antenna: 100 feet. Panel size: 9 x 23 inches. Price, not available.

NO. 520. BOSCH 57

Seven tubes; 4 t. r. f. (01-A), detector (01-A), 2 audio (01-A and 71). One control calibrated in kc. Volume control: rheostat on r. f. Shielded. Battery cable. C-battery connections. Balanced. Output device. Built-in loud speaker. Antenna: built-in loop or outside antenna, 100 feet. Cabinet size: 46 x 16 x 30 inches. Price: \$340 including enclosed loop and loud speaker.

NO. 521. BOSCH "CRUISER," 66 AND 76

Six tubes; 3 t. r. f. (01-A), detector (01-A), 2 audio (01-A and 71). One control. Volume control: rheostat on r. f. Shielded. C-battery connections. Balanced. Battery cable. Antenna: 20 to 100 feet. Prices: Model 66, table, \$99.50. Model 76, console, \$175; with loud speaker \$195.

NO. 524. CASE, 61 A AND 61 C

T. r. f. Semi-shielded. Battery cable. Drum control. Volume control: variable high resistance in audio system. Plate current: 35 mA. Antenna: 100 feet. Prices: Model 61 A, \$85; Model 61 C, console, \$135.

NO. 525. CASE, 90 A AND 90 C

Drum control. Inductive volume control. Technidyne circuit. C-battery connections. Battery cable. Loop operated. Model 90-C equipped with output device. Prices: Model 90 A, table, \$225; Model 90 C, console, \$350.

NO. 526. ARBORPHONE 25

Six tubes; 3 t. r. f. (01-A), detector (01-A), 2 audio (01-A and 71). One control. Volume control: rheostat. Shielded. Battery cable. Output device. C-battery connections. Loftin-White circuit. Antenna: 75 feet. Panel: 7½ x 15 inches, metal. Prices: Model 25, table, \$125; Model 252, \$185; Model 253, \$250; Model 255, combination phonograph and radio, \$600.

NO. 527. ARBORPHONE 27

Five tubes; 2 t. r. f. (01-A), detector (01-A), 2 audio (01-A). Two controls. Volume control: rheostat. C-battery connections. Binding posts. Antenna: 75 feet. Prices: Model 27, \$65; Model 271, \$99.50; Model 272, \$125.

NO. 528. THE "CHIEF"

Seven tubes; six 01-A tubes and one power tube. One control. Volume control: rheostat. C-battery connection. Partial shielding. Binding posts. Antenna: outside. Cabinet size: 40 x 22 x 16 inches. Prices: Complete with A power supply, \$250; without accessories, \$150.

NO. 529. DIAMOND SPECIAL, SUPER SPECIAL, AND BABY GRAND CONSOLE

Six tubes; all 01-A type. One control. Partial shielding. C-battery connections. Volume control: rheostat. Binding posts. Antenna: outdoor. Prices: Diamond Special, \$75; Super Special, \$65; Baby Grand Console, \$110.



Kingston

Everything that Radio Has to Give

The Kingston B Supply Unit brings to your radio evenings a new richness and a new delight—full tones, clearness and perfect reception always! It maintains your set at its perfection peak, operates silently, and forever removes the trouble and expense of batteries. The Kingston is beautifully made, is smartly finished in satin black, and is built by experts with extreme care and accuracy. There are provided three voltage terminals, each adjustable over a wide range, making possible any desired voltages from 5 to 200. In keeping with Kingston quality, the Raytheon 125 milliamper type BH tube is used as a rectifier.

Kingston service goes all the way through, and Kingston dealers know that this company stands squarely behind its products. The new Kingston B Battery eliminator is fully guaranteed to be all and do all that is claimed for it.

If your dealer can't supply you ask us

KOKOMO ELECTRIC CO.

KOKOMO, IND.

PRICES

Type 2, for 110-120 Volt AC 50 or 60, Cycle Current, \$35.00.

For receiving sets having not more than eight tubes and not having type UX171 power tube or equivalent.

Type 2A, for 110-120 Volt AC 50 or 60 Cycle Current, \$42.50.

For all sets using type UX171 power tube or equivalent and for all large sets having nine or more tubes.

Type 2C, for 110-120 Volt AC 25, 30 or 40 cycle current, \$47.50.

Prices include type BH Raytheon tube.

Any of these models will be furnished with an automatic control switch built in the unit for \$2.50 additional. With this the B unit is automatically switched on or off when switch on the radio set panel is turned.

Quietness The Carborundum GRID-LEAK



SLIP a Carborundum Grid-Leak into your set and you will notice an improved reception instantly.

Carborundum Grid-Leaks are quiet. They are dense solid rods of Carborundum that provide for an uninterrupted flow of current.

No chance for the creation of minute noisy arcs—no glass tube. They can't disintegrate. They are unbreakable.

All standard values, both Grid-Leaks and Fixed Resistors.

The Grid-Leaks are tested for values at 5 volts—the Resistors at 90 volts.

- No. 77 Carborundum Grid-Leaks, values 0.25, 0.50, 1 to 10 Megohms, each \$0.50
- No. 79 Carborundum Resistors, values 2500 and 5000 Ohms, each 1.00
- No. 79 Carborundum Fixed Resistors, values 12,000, 25,000, 50,000, 75,000 and 100,000 Ohms, ea., .75

From your dealer or direct

THE CARBORUNDUM COMPANY, NIAGARA FALLS, N. Y.
CANADIAN CARBORUNDUM CO., LTD., NIAGARA FALLS, ONT.

Sales Offices and Warehouses in
New York, Chicago, Boston, Philadelphia, Cleveland, Detroit, Cincinnati, Pittsburgh, Milwaukee, Grand Rapids
The Carborundum Co., Ltd., Manchester, Eng. Deutsche Carborundum Werke, Dusseldorf, Ger.

Carborundum is the Registered Trade Name used by The Carborundum Company for Silicon Carbide. This Trade Mark is the exclusive property of The Carborundum Company.

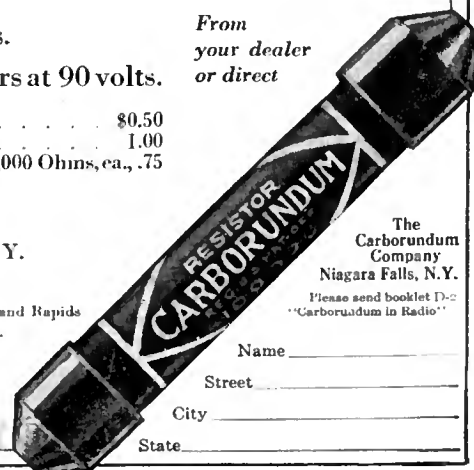

The Carborundum Company
Niagara Falls, N. Y.
Please send booklet "Carborundum in Radio"

Name _____
Street _____
City _____
State _____

NO. 530. KOLSTER, 7A AND 7B

Seven tubes; 4 t.r.f. (01-A), detector (01-A), 2 audio (01-A and 12). One control. Volume control; rheostat on r.f. Shielded. Battery cable. C-battery connections. Antenna: 50 to 75 feet. Prices: Model 7A, \$125; Model 7B, with built-in loud speaker, \$140.

NO. 531. KOLSTER, 8A, 8B, AND 8C

Eight tubes; 4 t.r.f. (01-A), detector (01-A), 2 audio (two 01-A and one 12). One control. Volume control; rheostat on r.f. Shielded. Battery cable. C-battery connections. Model 8A uses 50 to 75 foot antenna; model 8B contains output device and uses antenna or detachable loop; Model 8C contains output device and uses antenna or built-in loop. Prices: 8A, \$185; 8B, \$235; 8C, \$375.

NO. 532. KOLSTER, 6D, 6G, AND 6H

Six tubes; 3 t.r.f. (01-A), detector (01-A), 2 audio (01-A and 12). One control. Volume control; rheostat on r.f. C-battery connections. Battery cable. Antenna: 50 to 75 feet. Model 6G contains output device and built-in loud speaker; Model 6H contains built-in B power unit and loud speaker. Prices: Model 6D, \$80; Model 6G, \$165; Model 6H, \$265.

NO. 533. SIMPLEX, SR 9 AND SR 10

Five tubes; 2 t.r.f. (01-A), detector (00-A), 2 audio (01-A and 12). SR 9, three controls; SR 10, two controls. Volume control; rheostat. C-battery connections. Battery cable. Headphone connection. Prices: SR 9, table, \$65; console, \$95; console, \$145. SR 10, table \$70; console, \$95; console, \$145.

NO. 534. SIMPLEX, SR 11

Six tubes; 3 t.r.f. (01-A), detector (00-A), 2 audio (01-A and 12). One control. Volume control; rheostat. C-battery connections. Battery cable. Antenna: 100 feet. Prices: table, \$70; console, \$95; console, \$145.

NO. 535. STANDARDYNE, MODEL S 27

Six tubes; 2 t.r.f. (01-A), detector (01-A), 2 audio (power tubes). One control. Volume control; rheostat on r.f. C-battery connections. Binding posts. Antenna: 75 feet. Cabinet size: 9 x 9 x 19 1/2 inches. Prices: S 27, \$49.50; S 950, console, with built-in loud speaker, \$99.50; S 600, console with built-in loud speaker, \$104.50.

NO. 481. PFANSTIEHL 32 AND 322

Seven tubes; 3 t.r.f. (01-A), detector (01-A), 3 audio (01-A and 71). One dial. Plate current: 23 to 32 mA. Volume control; resistance in r. f. plate. Shielded. Battery cable. C-battery connections. Output device. Antenna: outside. Panel: 17 1/2 x 8 1/2 inches. Prices: No. 32 cabinet, \$145; No. 322 console, \$245 including loud speaker.

NO. 433. ARBORPHONE

Five tubes; 2 t.r.f., detector, 2 transformer audio. All 01-A tubes. Two dials. Plate current: 16 mA. Volume control; rheostat in r.f. and resistance in r.f. plate. C-battery connections. Binding posts. Antenna: taps for various lengths. Cabinet size: 24 x 9 x 10 1/2 inches. Price: \$65.

NO. 431. AUDIOLA 6

Six tubes; 3 t.r.f. (01-A), detector (00-A), 2 transformer audio (01-A and 71). Drum control. Plate current: 20 mA. Volume control; resistance in r.f. plate. Stage shielding. Battery cable. C-battery connection. Antenna: 50 to 100 feet. Cabinet size: 28 1/2 x 11 x 14 1/2 inches. Price not established.

NO. 432. AUDIOLA 8

Eight tubes; 4 t.r.f. (01-A), detector (00-A), 1 transformer audio (01-A), push-pull audio (12 or 71). Bridge balanced t.r.f. Drum control. Volume control; resistance in r.f. plate. Stage shielding. Battery cable. C-battery connections. Antenna: 10 to 100 feet. Cabinet size: 28 1/2 x 11 x 14 1/2 inches. Price not established.

NO. 542. RADIOLA 16

Six tubes; 3 t. r. f. (01-A), detector (01-A), 2 transformer audio (01-A and 71). One control. C-battery connections. Battery cable. Antenna: outside. Cabinet size: 16 1/2 x 8 1/4 x 7 1/2 inches. Price: \$69.50 without accessories.

NO. 456. RADIOLA 20

Five tubes; 2 t.r.f. (99), detector (99), 2 transformer audio (99 and 20). Balanced t.r.f. and regenerative detector. Two dials. Volume control; regenerative. Shielded. C-battery connections. Headphone connections. Antenna: 75 to 150 feet. Cabinet size: 19 1/2 x 11 1/2 x 16 inches. Price \$115 including all tubes.

NO. 457. RADIOLA 25

Six tubes; five type 99 and one type 20. Drum control. Super-heterodyne circuit. C-battery connections. Battery cable. Headphone connections. Antenna: loop. Set may be operated from batteries or from power mains when used with model 104 loud speaker. Price: \$165 with tubes, for battery operation. Apparatus for operation of set from the power mains can be purchased separately.

NO. 493. SONORA F

Seven tubes; 4 t.r.f. (01-A), detector (00-A), 2 transformer audio (01-A and 71). Special balanced t.r.f. Two dials. Plate current: 45 mA. Volume control; rheostat in r.f. Shielded. Battery cable. C-battery connections. Output device. Antenna: loop. Console size: 32 x 45 1/2 x 17 inches. Prices range from \$350 to \$450 including loop and loud speaker.

NO. 494. SONORA E

Six tubes; 3 t.r.f. (01-A), detector (00-A), 2 transformer audio (01-A and 71). Special balanced t.r.f. Two dials. Plate current: 35 to 40 mA. Volume control; rheostat on r.f. Shielded. Battery cable. C-battery connections. Antenna: outside. Cabinet size: varies. Prices: table, \$110; semi-console, \$140; console, \$240 including loud speaker.

NO. 495. SONORA D

Same as No. 494 except arrangement of tubes; 2 t.r.f., detector, 3 audio. Prices: table, \$125; standard console, \$185; "DeLuxe" console, \$225.

NO. 482. STEWART-WARNER 705 AND 710

Six tubes; 3 t.r.f., detector, 2 transformer audio. All 01-A tubes. Balanced t.r.f. Two dials. Plate current: 10 to 25 mA. Volume control; resistance in r.f. plate. Shielded. Battery cable. C-battery connections. Antenna: 80 feet. Cabinet sizes: No. 705 table, 26 1/2 x 11 1/2 x 13 1/2 inches; No. 710 console, 29 1/2 x 42 x 17 1/2 inches. Tentative prices: No. 705, \$115; No. 710 \$265 including loud speaker.

NO. 483. STEWART-WARNER 525 AND 520

Same as No. 482 except no shielding. Cabinet sizes: No. 525 table, 19 1/2 x 10 x 11 1/2 inches; No. 520 console, 22 1/2 x 40 x 14 1/2 inches. Tentative prices: No. 525, \$75; No. 520, \$117.50 including loud speaker.

NO. 459. STROMBERG-CARLSON 501 AND 502

Five tubes; 2 t.r.f. (01-A), detector (00-A), 2 transformer audio (01-A and 71). Neurodyne. Two dials. Plate current: 25 to 35 mA. Volume control; rheostat on 1st r.f. Shielded. Battery cable. C-battery connections. Headphone connections. Output device. Panel voltmeter. Antenna: 60 to 100 feet. Cabinet sizes: No. 501, 25 1/2 x 13 x 14 inches; No. 502, 28 1/2 x 50 1/2 x 16 1/2 inches. Prices: No. 501, \$180; No. 502, \$290.

NO. 460. STROMBERG-CARLSON 601 AND 602

Six tubes. Same as No. 549 except for extra t.r.f. stage. Cabinet sizes: No. 601, 27 1/2 x 16 1/2 x 14 1/2 inches; No. 602, 28 1/2 x 5 1/2 x 19 1/2 inches. Prices: No. 601, \$225; No. 602, \$330.

NO. 486. VALLEY 71

Seven tubes; 4 t.r.f. (01-A), detector (01-A), 2 transformer audio (01-A and 71). One dial. Plate current: 35 mA. Volume control; rheostat on r.f. Partially shielded. Battery cable. C-battery connections. Headphone connection. Antenna: 50 to 100 feet. Cabinet size: 27 x 6 x 7 inches. Price \$95.

NO. 472. VOLOTONE VIII

Six tubes. Same as No. 471 with following exceptions: 2 t.r.f. stages. Three dials. Plate current: 2-mA. Cabinet size: 26 1/2 x 8 x 12 inches. Price \$140.

"The human ear could not detect further tone improvement"

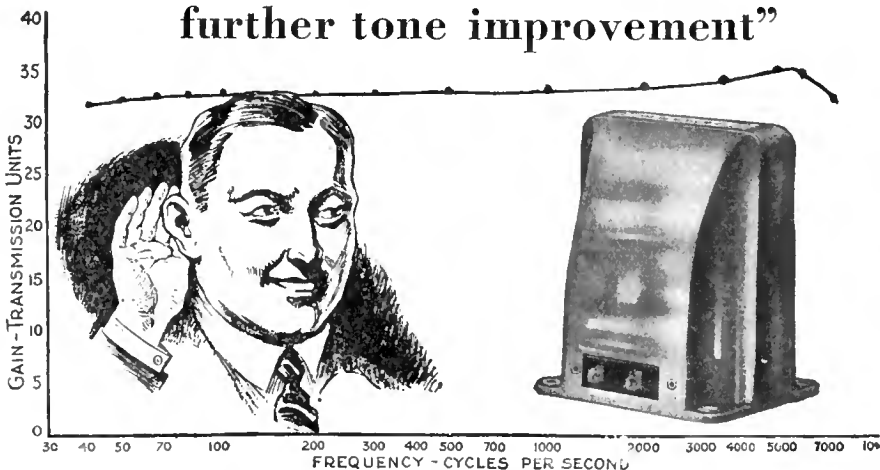

Engineers told us this as Samson Symphonic Transformers were tested in famous laboratories. Musicians confirmed it frequently.

The curve above shows audible music is amplified with remarkable evenness from lowest to highest frequency. This frequency characteristic of the Symphonic Transformer is more uniform than that of the average broadcast station or any loud speaker in common use. Samson power units will supply dependable A, B and C currents for the above.

"Audio Amplification," a book rich in highly practical, original information for bettering quality of reproduction sent on receipt of 25c.

Learn how to get supreme coil efficiency from new "Inductance Units Bulletin." Send 10c to cover mailing.

How to apply RF and AF Chokes to 17 popular circuits, or your own, is illustrated in Make-Em-Better Sheet. Send 5c to cover mailing.

SAMSON ELECTRIC COMPANY

Manufacturers
Since 1882



Principal Office
Canton, Mass.

RADIO at **WHOLESALE**

Radio Sets, "B" Eliminators, Chargers, Tubes, Kits, Parts - everything new in Radio at lowest wholesale prices. Thousands of nationally advertised bargains. All listed and illustrated in my Big New Catalog and FREE Call Book.

FREE 132 Pages of valuable Radio information - trouble finding - set building - Radio knowledge of all kinds. Write today. **HARRY SCHWARTZBERG PRES.**

AMERICAN AUTO & RADIO MFG. CO.
Dept. 124 American Radio Bldg.
Kansas City, Missouri

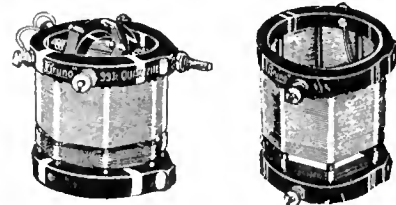

BRUNO QUARTZITE TUNING COILS have been repeatedly specified in new circuits for their high degree of efficiency, selectivity, and sensitiveness.

The No. 99 Jr. Tuning Coil has been designed to be used with a .0005 mfd. condenser across the secondary winding. When used with the No. 99 TRF Coil, if the condensers have the same capacity, the two readings should be alike. Absorption losses are completely eliminated. Wavelength 200 to 575 meters. List price . . . **\$5.50.**

The No. 99 Jr. TRF Coil when used in conjunction with a .0005 mfd. condenser will cover the entire wavelength band from 200 to 575 meters. Furthermore it is suitable for any circuit employing tuned radio frequency. List price **\$3.00.**

Both Coils are perfectly made and wound with green and orange silk covered wire on Quartzite—a special glass containing no metallic base. Get them from your dealer or write us.

BRUNO RADIO CORPORATION
Long Island City New York

BENJAMIN
TRADE MARK

**Cle-Ra-Tone
Sockets**

are specified for the
**Hammerlund-Roberts
Hi-Q Circuit**

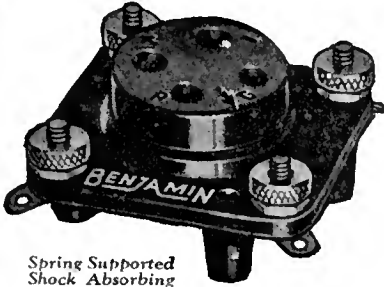

Spring Supported
Shock Absorbing

Tube holding element "floats," independently of the base, on four perfectly balanced springs. Positive tube to terminal connections. Shock absorbing feature is not affected by stiff bus wiring.

Non-Microphonic. The greatest aid to the non-noisy operation of the set. Gives longer life to the tubes.

The choice of experts and amateurs for practically every prominent and successful circuit for several years.

Among the most recent circuits, in addition to the Hammerlund-Roberts Hi-Q, for which it has been specified, are:

Magnaformer 9-8, Camfield Super-Selective 9, Lynch Suppressor Circuit, H.F.L. Nine in Line, World's Record Super 10, Melo-Heald Fourteen, St. James Super, Two-Dial Equamatic, Knickerbocker 4, 8-Tube Stroboddyne.

Push Type, on Mounting Base:
Benjamin Cle-Ra-Tone Sockets, 75c each
Without Mounting Base 50c each

New Y Type Socket

Specially designed, for use with 5-pronged A. C. Radio Detector Tubes:
For direct attachment to panel 90c each
For mounting on top of panel \$1.20 each

At all Radio Jobbers and Dealers

Made by

Benjamin Electric Mfg. Co.
120-128 S. Sangamon St., Chicago

247 W. 17th St.
New York

448 Bryant St.
San Francisco

Manufactured in Canada by the Benjamin Electric Mfg. Co., Canada, Ltd., Toronto, Ontario

**Push-Pull
Amplification**

increases undistorted power
output of amplifier tubes

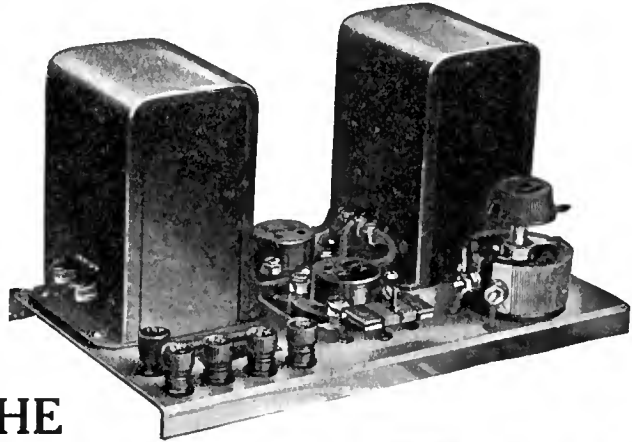

THE
GENERAL RADIO

Type 441 Push-Pull Amplifier

In a search for an amplifier combination which would give the maximum in quality and volume, the push-pull method has proved particularly satisfactory.

While push-pull transformer coupling does not increase the amplification per stage, the maximum undistorted power output is greatly increased. The reason for this is that distortion due to tube overloading cancels out, permitting a greater output from each tube than would be possible if the tubes were used as in other methods of coupling. A further advantage of push-pull amplification when using an A. C. filament supply is that hum voltages also cancel out, rendering the amplifier very quiet.

The type 441 unit with two type 171 power tubes having a plate voltage of 180 will give more volume and better quality than a single transformer coupled stage using the type 210 power tube with 400 volts on the plate.

The General Radio Type 441 unit is completely wired and mounted (as illustrated) on a brass base-board with conveniently located binding posts so that the unit may be built into a receiver or connected with an existing set as a separate unit.

The type 441 may be used with either the UX-226, UX-326, or UX-171, CX-371 tubes.

Type 441 Push-pull amplifier \$20.00

The Type 441 unit is licensed by the Radio Corporation of America for radio amateur, experimental, and broadcast reception only, and under the terms of the R. C. A. license the unit may be sold only with tubes.

Type UX-226 or CX-326 Amplifier Tube \$3.00
Type UX-171 or CX-371 Amplifier Tube \$4.50

GENERAL RADIO COMPANY
Cambridge Massachusetts

YAXLEY

APPROVED RADIO PRODUCTS

for Radio Fans with Exacting Demands

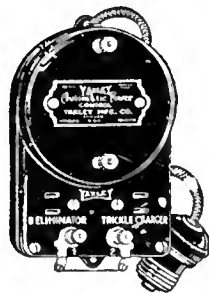

Automatic Power Control

You can get greater pleasure through your radio set with this great convenience. Eliminates the fussing with your radio when you turn it on or shut it off. The Automatic Power Control switches on the B eliminator and cuts out the trickle charger when you turn on the set. The B eliminator is cut out automatically and the trickle charger cut in when the set is turned off. It controls both B eliminator and trickle charger in combination or switches either eliminator or charger separately when either is installed alone. Makes your receiver a power operated set.

No. 444—Series Type. With the exclusively Yaxley feature that keeps the voltage drop less than two-tenths (2-10) volts when used with sets having a current draw equivalent to four 199 type tubes up to eleven 201 type tubes \$5.00

Air-Cooled Switching Rheostat

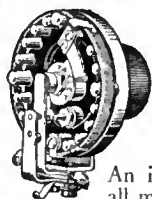

An ideal combination for all modern radio receivers. Controls the switching of the set and at the same time permits building up of filament voltage slowly and holding it at exactly the right point for perfect reception. Furnished complete with Bakelite knob. 2 to 100 ohms. each, \$1.75

At your dealer's. If he cannot supply you send his name with your order to

YAXLEY MFG. CO.
Dept. B, 9 So. Clinton St.
Chicago, Ill.

A KEY TO RECENT RADIO ARTICLES

By E. G. SHALKHAUSER

THIS is the twenty-fourth installment of references to articles which have appeared recently in various radio periodicals. Each separate reference should be cut out and pasted on 4" x 6" cards for filing, or pasted in a scrap book either alphabetically or numerically. An outline of the Dewey Decimal System (employed here) appeared last in the January RADIO BROADCAST.

R402. SHORT-WAVE SYSTEMS. SHORT-WAVE TRANSMISSION. QST, July, 1927. Pp. 8-14. "Short-Wave Radio Transmission and Its Practical Uses," C. W. Rice. Part 1.

The ionization of the atmosphere through cosmic radiation as well as through propagation of electron streams from the sun determines the nature of electromagnetic waves, as stated. How this ionization affects day and night and also seasonal variations is explained from experimental data obtained to date. Comparison is made between auroral phenomena and the theory of ionization as well as the effect of terrestrial magnetism on the motion of the electron. Skip distance effect is said to be due to the bending of the waves in the upper atmosphere, the degree of bending depending on the wavelength.

R201. 6. HIGH-FREQUENCY BRIDGE. BRIDGE, QST, July, 1927. Pp. 15-20. High-Frequency. "A Bridge to Measure Capacity, Power Factor, Resistance, and Inductance," J. Kutzman.

The purpose of the article is to describe and explain the important factors of the Wien Series Resistance Bridge when used to measure C, L, R and power factor accurately to 1/10 of 1 per cent.

R344.3. TRANSMITTING SETS. TRANSMITTERS, QST, July, 1927. Pp. 24-28. Tuning.

"Some Light on Transmitter Tuning," R. A. Hull. The construction of a shielded oscillator and its use in tuning transmitter circuits for good signal output are outlined. Good plate and filament supply regulation is one of the main requirements. The proper method of tuning various circuits to adjust the wavelength of the oscillator and the antenna, and the correct amount of grid excitation to be used are told. Key thumps can be greatly reduced by having proper coupling and antenna tuning.

R402. SHORT-WAVE SYSTEMS. SHORT-WAVES. QST, July, 1927. Pp. 20-30.

"An Investigation of the 5-Meter Band," E. M. Guyer and O. C. Austin. Some problems on the construction and the operation of 5-meter transmitters are related, photographs of several sets being shown with a list of material for their construction appended.

R342. AMPLIFIERS. KEYING AMPLIFIERS. QST, July, 1927. Pp. 33-35.

"Keying the Amplifier," A. G. Shafer. A keying system, whereby a specially constructed key is placed in the grid circuit of one of the amplifier tubes, is utilized to prevent key thumping. The system consists of changing the capacity of the coupling capacity to such an extent as to prevent proper transfer of energy from the oscillator without actually breaking any part of the circuit.

R344.3. TRANSMITTING SETS. TRANSMITTER, QST, July, 1927. Pp. 36-40. Short-Wave.

"A Constant Frequency Transmitter," W. H. Hoffman. A non-crystal oscillator, capable of maintaining a constant frequency output, yet flexible enough that the frequency may be shifted to other amateur wavelengths, is described and illustrated.

R344.5. ALTERNATING-CURRENT SUPPLY. SOCKET POWER, Radio, July, 1927. Pp. 25-ff. "A-B-C"

"ABC Socket Power For Large Tubes," G. M. Best. A discussion on the assembly and the operation of several combination ABC socket power units and the results obtained when used with a Browning-Drake receiver are given. The Raytheon 350-mA. tube is used with each combination. All wiring details of the units, including those of the Browning-Drake receiver, are shown.

R160. RECEIVING APPARATUS. RECEIVER, Single-Control. "Trouble Shooting the Single-Control Set," M. P. Gilliland.

In adjusting single-control receivers for selectivity the following points are said to be of importance: Proper neutralizing of all radio-frequency stages; balancing of tuned circuits. For volume control a shunt resistance across the secondary of the first audio transformer is recommended.

R330. ELECTRON TUBES. ELECTRON TUBES. Radio, July, 1927. Pp. 47-ff.

"Vacuum Tube Characteristics." The characteristics of dry cell tubes, power tubes, high-mu tubes, and special detector tubes, also of the new a.c. filament tubes such as the UX-226, the UX-280, the UX-281, the UX-327, are given. The quadratron, the Emerson multi-valve, the Sovereign A-C tube, the Van Horne A-C tube, the new A-C Magnatron tubes and the Armor A-C 110 tube are described.

R160. RECEIVING APPARATUS. RECEIVER Proc. I. R. E. May, 1927. Pp. 387-395. MEASUREMENTS.

"Notes on Radio Receiver Measurements," T. A. Smith and G. Rodwin. The comparison of radio receivers electrically involves the three main points: sensitivity, selectivity and fidelity, as stated. The method of test and of making and interpreting the curves presented are outlined.

Cure Lead-In Ills

ELECTRAD

Certified Lead-In

You can eliminate all lead-in troubles with this improved Electrad Lead-In. No holes to bore, no losses, no work to install.

Bends or twists any shape to fit neatly under window or doors. You lock them tight upon it. One piece heavily tinned copper strip covered with triple-ply insulation 10 inches long.

Waterproof, all connections riveted and soldered. Fahnestock clips. Get the genuine "Electrad." 40c at dealers or write.

Free Descriptive Circulars on Request

Dept. 61A, 175 Varick St., New York, N. Y.

ELECTRAD



Your Neighbors Will Pay You \$75⁰⁰ a week for Your Spare Time

You can easily sell them your spare hours for \$3 each by serving as "radio doctor," building their sets, selling them supplies at less than retail. A membership in the Association shows you how to cash in on Radio now and trains you for the \$3,000 to \$10,000 openings awaiting qualified men. The Association starts you in business if you wish. Investigate all it has done for others, all it can do for you. A MEMBERSHIP NEED NOT COST YOU A CENT.

Earned \$500 in Spare Hours

Our members are making big money with Radio. Warner Eichler, N. Y., earns \$50 a week—Lyle Follick, Mich., has earned \$300—F. J. Buckley, Mo.—makes as much as he receives from employer—all in spare time. Our members are starting radio stores, getting better positions, increasing their salaries, earning money spare time.

ACT NOW for No-Cost Membership

Limited number of these memberships now available. They need not—should not—cost you a cent. To secure one, write to-day for details and our book, "Your Opportunity in the Radio Industry" that will open your eyes.

Radio Association of America
Dept. RB-11 4513 Ravenswood Ave. Chicago

Send me your book and details of your Special Membership Plan.

Name

Address

City

State

Six New Precision Radio Products

By the Makers of the Famous



Illuminated DRUM DIAL

Makes single-control of multiple circuits practicable. Two circuits tuned as one, or individually. Translucent wave length scales illuminated from back. Beautifully embossed, oxidized bronze escutcheon plate gives distinction to panel.

(1)



Flexible COUPLING

Permits coupling condensers in tandem without exact alignment. Bakelite insulation makes the two sides electrically independent of each other. Tough spring phosphor-bronze with brass bushings and hardened steel set screws.

(2)



EQUALIZER

For neutralizing R. F. circuits or equalizing multiple tuning units. Small size fits limited space. Bakelite base, mica dielectric, phosphor-bronze spring plate.

(3)

HAMMARLUND "Midline" CONDENSER

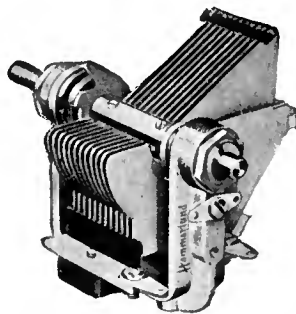

Write for Folders

Radio-Frequency CHOKE COIL

Special winding and impregnating gives minimum distributed capacity for a given inductance and provides extremely high impedance to all broadcast frequencies. Distinctive Bakelite case. Two sizes: 85 and 250 millihenries.



(4)

The Improved "HAMMARLUND, JR"

A new, high-ratio midget condenser with all the distinctive Hammarlund features—plus sturdier, simplified construction. Has new locking device for fixing rotor plates in any position. Knob included.

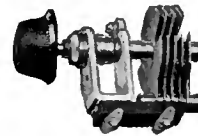

(5)

HAMMARLUND MANUFACTURING CO.
424-438 W. 33rd St. New York

New AUTO-COUPLE

Specified for Hammarlund-Roberts Hi-Q Six Receiver. Essentially the same as previous model, but designed for use with the new Hammarlund Drum Dial.

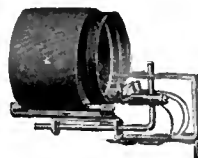

(6)

For Better Radio
Hammarlund
PRECISION
PRODUCTS



RADIO MEN—LOOK!

The Last Word in Radio

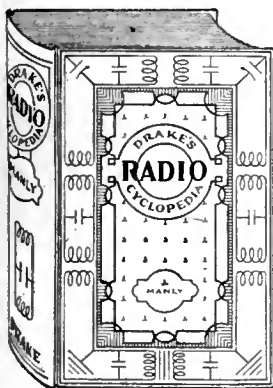

Radio is an *exact* science. There is a right and a best way for everything. But it is so new there is still much that is incorrect and unscientific in radio. The results are faulty reception, complaints and service problems for the dealer.

You can now *be the man who knows!* To meet this need we have compiled the exact facts covering every type of receiver and the entire scope of radio into a fine, big, new book.

DRAKE'S RADIO CYCLOPEDIA

Solves the Dealer's Service Problem

If you design, build, rebuild, repair or service radio receivers, this book will prove of great value. All subjects from "A-Battery" to "Zero Beat" are alphabetically arranged and clearly explained, with hundreds of cross references, 1672 headings, 985 illustrations, diagrams, etc., and 240 combinations of receiver layouts. All arranged so you can quickly find what you want.

SEND FOR THIS BOOK TODAY. There is nothing else like it. You will surely need it, and it quickly earns many times its cost. Distributed through main branches of American News Company and for sale at all book stores, or we will send you direct on receipt of price, \$6.00. Order today.

F. J. DRAKE & CO.,
1013 S. Michigan Blvd., Chicago.

I enclose \$_____. Please send me at once _____ copies of Drake's Radio Cyclopedic, postpaid. Also send catalog of 200 other practical mechanical books, free.

Name _____
Street _____
City _____ State _____

FREDERICK J. DRAKE & CO. Publishers
1013 S. Michigan Blvd. Chicago

Nature's Sounding Board

The Lata Balsa Reproducer, successful beyond approach in tone qualities, is a real work of art and an adornment which fits into the house-furnishing scheme of any tasteful home.

Its remarkable, non-resonant characteristics, its ability to reproduce any frequency in the musical scale, combined with beauty makes Lata Balsa Reproducers the outstanding success in 1927 radio speakers.

Write for booklet illustrating and describing the four attractive models.

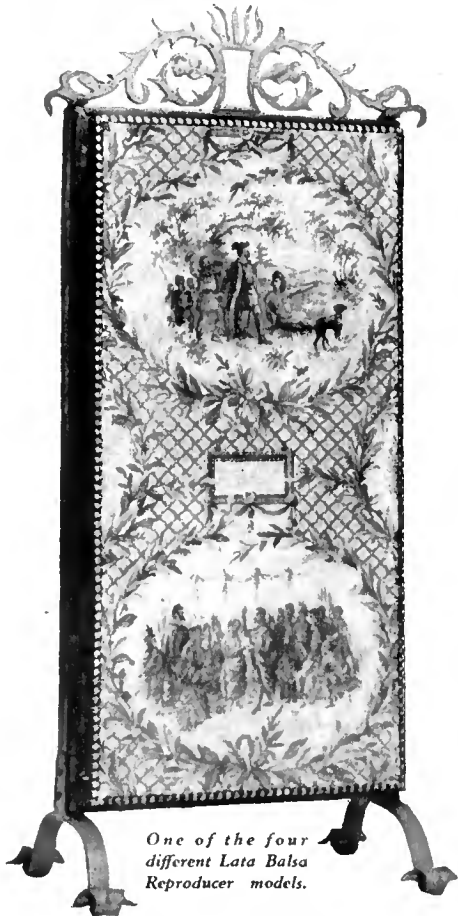

One of the four different Lata Balsa Reproducer models.

Sole Distributor
ARTHUR H. LYNCH, INC.
 General Motor Bldg.
 1775 Broadway at 57th St. New York City

BALSA WOOD REPRODUCER CORP.
 331 Madison Avenue
 New York City

R376.3. LOUD-SPEAKING REPRODUCERS. LOUD SPEAKERS.
Proc. I. R. E. May, 1927. Pp. 363-376.
 "Loud-Speaker Testing Methods," I. Wolff and A. Ringel.
 An electric oscillator method is used in obtaining quantitative measurements in testing loud speakers. The output of an oscillator, having a continuously variable frequency is fed to the loud speaker. The results are recorded on a revolving drum mechanism. The curves, showing variation of sound pressure against frequency, reveal interesting characteristics, as explained.

R1113.3. DIRECTIONAL VARIATIONS. TRANSMISSION PHENOMENA.
Proc. I. R. E. May, 1927. Pp. 377-385.
 "High Angle Radiation of Short Electric Waves," S. Uda.
 The paper describes some accounts of experimental work on the field distribution due to straight vertical unloaded antenna operating at one of its harmonics. Short waves of 2.66 meters were employed, and observations have been made with the grounded and the ungrounded antennas.
 The paper also gives the test results on a new wave projector devised by the author with special reference to high angle radiation of short electric waves.

R344.3. TRANSMITTING SETS. TRANSMITTER.
Proc. I. R. E. May, 1927. Pp. 397-400.
 "The Tuned-Grid Tuned-Plate Circuit Using Plate-Grid Capacity for Feed-Back. A Derivation of the Conditions for Oscillation," J. B. Dow.
 Mathematical equations are developed showing the conditions required for oscillation in the tuned-grid tuned-plate circuit of a transmitter.

R162. SELECTIVITY OF RECEIVERS. RECEIVERS.
Proc. I. R. E. May, 1927. Pp. 401-423.
 "Selectivity of Tuned Radio Receiving Sets," K. W. Jarvis.
 The question of modern receiver design, incorporating selectivity, fidelity of reproduction, and adequate sound volume, is discussed. The resonance circuit and its requirements are analyzed mathematically and curves presented showing relation between amplification and selectivity of radio-frequency stages. Discussing quality of reproduction the problem of regeneration, the phase shift of the side bands and the transient response of the circuit are mentioned.

R113.3. DIRECTIONAL VARIATIONS. TRANSMISSION PHENOMENA.
Proc. I. R. E. May, 1927. Pp. 425-430.
 "Radio Phenomena Recorded by the University of Michigan Greenland Expedition—1926," P. C. Oscanyan, Jr.
 The experiences encountered by the writer when using short waves for transmission on Maligiak Fiord, North of the Arctic Circle, are related. It was noted that when attempting to receive signals from stations working on wavelengths of 50 meters or below, complete screening was effected when the receiver was placed at the foot of a hill which is of a height greater than 17 degrees from the horizontal of the station. Photographs of the station are shown.

R500. APPLICATIONS OF RADIO. APPLICATIONS, RADIO BROADCAST.
Aug. 1927. Pp. 199-202.
 "Saving Paper!" J. Millen.
 The device illustrated and described consists of an oscillating circuit coupled to a tuned circuit, a thermal meter recording the deflection when in resonance. The material to be measured acts in the capacity of a dielectric, thus changing the frequency of the resonant circuit, this change being recorded on the thermal meter.

R134.8. REFLEX ACTION. REFLEX CIRCUIT.
RADIO BROADCAST, Aug. 1927. Pp. 208-210.
 "Have You a Roberts Reflex?" J. B. Brennan.
 Improvements which can be made in the Roberts circuit consist in increasing the sensitivity and selectivity, improving the quality of reproduction, making it more stable in operation, and increasing its volume. These changes are discussed in detail.

R376.3. LOUD-SPEAKING REPRODUCERS. LOUD SPEAKERS.
RADIO BROADCAST, Aug. 1927. Pp. 211-212.
 "The Balsa Wood Loud Speaker."
 Data on the assembly and the properties of the new Balsa wood loud speaker are given. The wood is obtainable in kit form, and by careful assembly of the parts a speaker of excellent reproducing qualities is said to result. Suggestions concerning changes and improvements are offered for those who experiment with this type of loud speaker.

R344.3. TRANSMITTING SETS. TRANSMITTER.
RADIO BROADCAST, Aug. 1927. Pp. 213-217.
 "A Flexible Short-Wave Transmitter," H. E. Rhodes.
 The construction of a portable telegraph-telephone transmitter for short-waves, using tuned-plate tuned-grid circuit, is outlined, many data being given concerning the general characteristics of the circuit employed. The set operates between 7900 kc. and 2650 kc. (38 to 113 meters). A series of tests were carried on, the results of which are shown graphically and discussed in detail. These include: 1, The effect of varying the grid leak resistance; 2, the effect of varying the resistance of either the tuned-grid or tuned-plate circuit; 3, the effect of varying the coupling between the plate and the antenna coils; 4, the effect of varying the plate voltage.

R200. RADIO MEASUREMENTS AND STANDARDIZATION. TONE QUALITY.
RADIO BROADCAST, Aug. 1927. Pp. 224-226.
 "Judging Tone Quality," E. H. Felix.
 The subject of distortion in radio receivers is discussed from the standpoint of the listener when trying to discriminate between good and poor tone quality. What is desired is faithful reproduction throughout, from microphone to loud speaker. Because of the importance of harmonics in distinguishing different instruments it is essential that frequencies up to 6000 cycles be reproduced. Suggestions as to methods which can be used in judging the reproducing qualities of receivers are offered.

R220. CAPACITY. CAPACITY MEASUREMENTS.
RADIO BROADCAST, Aug. 1927. Pp. 227-228.
 "Condenser, Coil, Antenna Measurements," K. Henney.
 The measurements of variable and fixed condensers, distributed capacity of inductance coils and of antenna capacity and inductance can readily be made with the aid of a calibrated modulated oscillator. Data for the use of this instrument and typical measurements are presented.

FREE The Greatest RADIO CATALOG

Send for This Great Book

1928 WHOLESALE RADIO CATALOG

Compiled exclusively for dealers in radio sets, radio parts, and for set builders. An amazing catalog containing the newest things in the world of radio.

Unbeatable values in radio parts, kits and supplies of national fame. A complete array of cabinets and consoles, in all the latest styles, finishes and popular sizes, at unmatched prices.

The high quality of our products eliminates loss. Large stocks offer you large selection. Our speedy shipments insure your customers' good will and bigger profits for you.

Wholesale Vest Pocket Price List and Discount Sheet

This wholesale vest pocket price list and discount sheet will be sent with the catalog.

Short Wave Section

Our catalog contains a section devoted to a showing of the highest grade short wave receiving and transmitting apparatus. Also the finest electrical appliances for use in the home.

Shure Service means sure profits. You can take orders direct from our illustrated list price catalog.

Whatever your radio needs may be, you will find them in our 1928 catalog. Write for a copy TODAY.

Real Bargains to Dealers

SHURE RADIO COMPANY
 339-P W. Madison Street, Chicago, Ill.

Why not subscribe to *Radio Broadcast*? By the year only \$4.00; or two years, \$6.00, saving \$2.40. Send direct to Doubleday, Page & Company, Garden City, New York.

INSIST

AMPERITE is the only automatic filament control that keeps the temperature or voltage of the tube filament constant despite variations in the "A" Battery voltage. It guarantees improved tube performance and increased tube life through always operating tubes at their proper filament temperature. Simplifies wiring, panel design, tube control, tuning. Eliminates hand rheostats. Do not confuse with fixed filament resistors which attempt to imitate AMPERITE but are entirely different in principle and operation. Insist upon AMPERITE. Price \$1.10 mounted (1a U. S. A.). For sale by all dealers.

Write for FREE "Amperite Book" of season's best circuits and latest construction data.

Address Dept. R. B-11

Radiall Company
 50 FRANKLIN ST., NEW YORK

AMPERITE

REG. U. S. PAT. OFF.

The "SELF-ADJUSTING" Rheostat

LYNCH

Improved Aristocrat

tube de luxe Deck

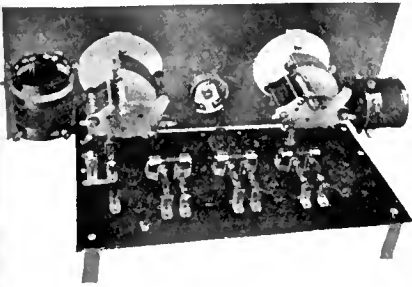

New and Different

Here is an example of a real receiver made with the Lynch 5 tube De Luxe Deck. This is one model of the Improved Aristocrat—The list price for all the parts necessary is less than \$30.00.

For Use in Building any 5-Tube Receiver

The Deck includes, all mounted ready for wiring

- 1 Westinghouse 6" x 12" Micarta Panel
- 5 Eby De Luxe Sockets
- 4 Lynch Cartridge Condensers
- 7 Lynch Metalized Resistors
- 4 Lynch Special Mounts

The Deck is a Lynch innovation which greatly reduces the cost; improves the appearance and performance and simplifies home construction beyond belief.

The Lynch 5-Tube Deck

\$12.50

and Now

The LYNCH BOOK

Just off the Press

"Resistance the Control Valves of Radio"

A very thorough treatise on the proper use of resistors of every type for every radio purpose. Many pages—Many illustrations—Many dollars worth of sound information for a quarter.

Send your quarter and we'll send the book today

ARTHUR H. LYNCH, Inc.

General Motors Building

New York City

Sales Offices in Most Large Cities

Vee Dee

Metal Cabinet for Latest Hook-Ups

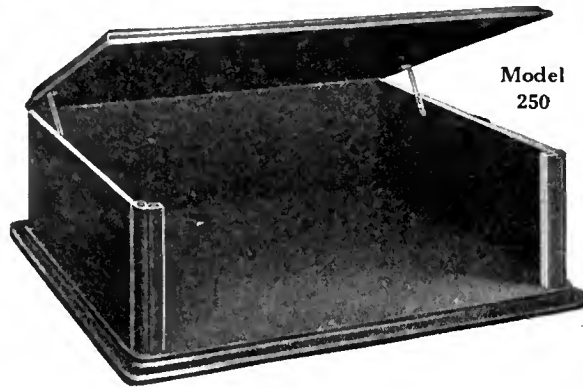

Model 250

Model 250
For A. C. or Battery Sets using panels size 7 x 18, 7 x 21, 8 x 18, 8 x 21 panels.
Inside dimensions 25" x 14 1/4" x 9 1/8". Hinged top—with stay joint. Rigidly formed for strength and appearance. Felt foot rests—rubber lid stops. A welded job doing away with troubles of swelling, shrinking, cracking, splitting and the uncertain fit of wood cabinets.

The original beauty of natural wood grains combined with the efficiency of all metal construction! By our photo litho process, we reproduce mahogany and walnut hardwood, and novelty finishes, so gorgeous in their conception that they excite the admiration of

all. Spacious interior dimensions are demanded for housing all the latest hook-ups! Vee Dee metal cabinets are designed for that purpose. 90% of all the 1927-1928 hook-ups are covered by the dimensions of Vee Dee No. 250 cabinet. Beautiful—practical! Low price!

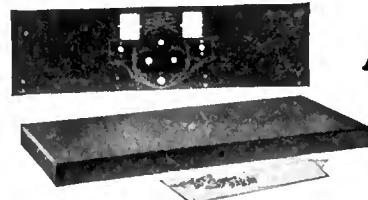

Metal Panel and Chassis for Silver-Marshall Improved Laboratory Model

Complete assembly consisting of panel and chassis, fully drilled, beautiful wood finish with special two-color decoration, all fibre bushings and washers included, also screws, bolts and hardware accessories.

Vee Dee Assembly Units

Complete with Bushings, washers and all necessary hardware.



S. C. 2 Assembly Unit (Silver-Cockaday)

Designed and drilled for this popular receiver, but dimensions are such as to make it easily adapted for any Power Pack assembly.

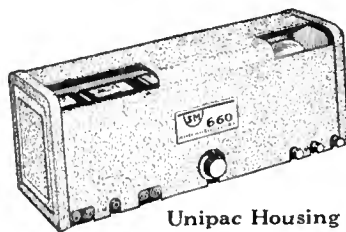

Unipac Housing

Especially designed and provided for Silver-Marshall Power Hook-ups—including cabinet and chassis, drilled and with all small hardware.

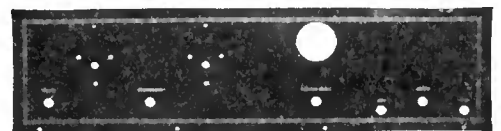

Metal Panels for Citizens Super Eight

Constructed in accordance with Citizens Radio Call Book and McMurdo Silver, Remler, Cockaday co-ordinated designing.

Metal Panels and Chassis in All Standard Sizes

JOBBERS, DEALERS—WRITE FOR PRICES

Set Builders—If your dealer cannot supply, write direct

The Van Doorn Company

160 North La Salle Street

Factory, Quincy, Illinois

Chicago, Illinois

Volume Control for any Circuit Centralab Standard Radiohm

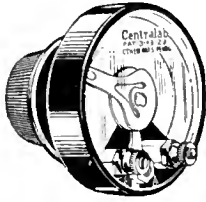

The exclusive Centralab feature of making contact on a resistance element by a pressure shoe and tilting disc, assures long life and permanently noiseless adjustment. Centralab Radiohms with 2 terminals, and Modulators with 3 terminals, provide gradual, silent control of oscillation or volume.

Centralab Radiohms with resistance value of 2,000 ohms are used as stabilizing resistance in Reflex or Superheterodyne. Also used in the RF grid return circuits of tuned radio frequency sets. They provide excellent control of regeneration when shunted across the tickler in such circuits as Browning-Drake, Samson TC, Radio Broadcast, Aristocrat and others employing feedback principle. 25,000 ohms are especially adapted for the S-C circuits. 100,000, 200,000 and 500,000 ohms are the most satisfactory plate circuit resistance for controlling RF oscillation in tuned radio frequency circuits. Also used to provide volume control.

There is a resistance and correct taper for every circuit, providing a perfect control of the circuit, with simplified panel appearance. Can be smoothly varied throughout their entire range from zero to maximum, and give full resistance variation with a single turn of the knob. Non-inductive; no sliding contacts carrying current. Exact resistance values are maintained as adjusted.

Resistances 2,000, 25,000, 50,000, 100,000, 200,000 or 500,000 ohms. \$2.00

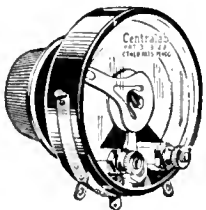

Switch Type Radiohm

Same construction as Standard Radiohms and combine with the Radiohm a quick-acting "A" battery switch. This removes

one more knob from the panel and makes the set simpler and easier to operate. Provides two essential controls at little more than the price of one. Turning the knob to the right, lights the tubes and then increases volume. Turning the knob to the left decreases volume and then cuts off the battery. "A" battery switch parts are spring bronze, nickel plated with positive acting silver contacts.

200,000 ohms and 500,000 ohms. \$2.30

Centralab Modulator

The ideal panel-mounted volume control. Has 3 terminals and a special taper of resistance to provide smooth, noiseless volume control from a whisper to maximum. A sure cure for overloaded tubes and harsh amplifiers.

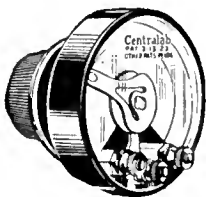

Resistances 250,000 or 500,000 ohms . . . \$2.00
500,000 ohms with "A" battery switch combined in one unit. \$2.30

At your dealer's, or C. O. D.

CENTRAL RADIO LABORATORIES
22 Keefe Avenue Milwaukee, Wis.



R343. ELECTRON-TUBE RECEIVING SETS. RECEIVER Neutrodyne, AC.

RADIO BROADCAST, Aug. 1927. Pp. 232-234.
"Constructing a Five-Tube Neutrodyne," H. E. Rhodes.
A shielded, two radio-frequency, detector and two audio-frequency tube neutrodyne, using the new a. c. tubes, is shown and details for its construction given. Great sensitivity, selectivity and ease of operation are claimed for this circuit arrangement.

R330. ELECTRON TUBES. ELECTRON TUBES, RADIO BROADCAST, Aug. 1927. Pp. 238-240. High mu. "Use of Tubes Having High Amplification," A. V. Loughren.

The amplification characteristics of high-mu tubes are treated. The discussion analyzes the frequency characteristics of each stage in a resistance-coupled amplifier and the choice of the amplification factor. Oscillographs and curves show the results to be expected.

R270. SIGNAL INTENSITY. SIGNAL INTENSITY, Radio News, July, 1927. Pp. 12-13. Broadcast.

"The Service Area of a Broadcast Station," S. R. Winters.
Results of measurements made with a loop test set by S. W. Edwards, radio supervisor of the 8th radio district, on signal strength from several broadcast stations, are given. These show to what extent steel buildings, static, electrical disturbances and other noises affect radio reception at a distance. The working standard of 10,000 micro-volts per meter intensity was used to determine a reliable reception area about the station.

R3. 2.7. AUDIO-FREQUENCY AMPLIFIERS. TRANSFORMERS Radio News, July, 1927. Pp. 25-ff. Coupling.

"Why Loud Speaker Coupling Devices are Necessary," I. F. Jackowski.
An explanation is given of the necessity of coupling the loud speaker to the audio amplifier through some coupling transformer and auxiliary apparatus, in order to bypass the direct-current component of the power tube output energy.

R800. (535.3) PHOTO-ELECTRIC PHENOMENA. CRYSTALS, Radio News, July, 1927. Pp. 32-ff. Photo-electric.

"Light-Sensitive Crystals," G. C. B. Rowe.
The construction of simple light-sensitive cells, using ordinary metals such as copper, zinc, etc. or molybdenite and the substance selenium, is described. The numerous applications of such cells are mentioned and diagrams show how such cells may be used by the experimenter.

R330. ELECTRON TUBES. ELECTRON TUBES, Radio News, July, 1927. Pp. 50-51. High mu.

"A New Electron Tube," S. Harris.
A tube having a fourth element has been developed for use in circuits where objectionable feed-backs are encountered. With the aid of the fourth element, known as the "shielded grid," the effect of plate to grid capacity has been eliminated. It is stated that the amplification obtainable with this tube is as high as 200 per tube at 50 kc.

R387. I. SHIELDS. SHIELDING, Radio News, July, 1927. Pp. 52-ff.

"The Effects of Shielding," H. A. Zahl.
The effect that shielding has on the electrical properties of circuits is discussed in detail, with curves shown, and the method of making the measurements is described.

R201. FREQUENCY, WAVELENGTH FREQUENCY. MEASUREMENTS. MEASUREMENTS.

Exp. Wireless (London), July, 1927. Pp. 304-401.
"The Exact and Precise Measurement of Wavelength in Radio Transmitting Stations," R. Brailard. (Concluded).
The description of the wavemeter is continued from the previous article and the method of standardization is outlined. Its accuracy is said to be exceptional, transmitters being adjustable to a variation limit of 10,000 of their wave.

R13475. SUPER-HETERODYNE. SUPER-HETERODYNE. Exp. Wireless (London), July, 1927. Pp. 402-411.

"Design and Construction of a Super-heterodyne Receiver," P. K. Turner. (Concluded).
In the last of a series of articles on the super-heterodyne the author discusses the intermediate stages of amplification and the low-frequency stages, and proceeds to give a detailed analysis of the actual construction of the set.

R800 (621.354). BATTERIES, SECONDARY. BATTERIES, Amateur Transmitter, April, 1927. Pp. 10-ff. Edison.

"Edison Storage B Batteries," H. Rodloff.
The construction of small Edison cells from standard parts is described. Considerable information as to their characteristics and their properties is related.

R382. INDUCTORS. CHOKE Amateur Transmitter, May, 1927. P. 11. COILS.

"Radio-Frequency Choke Design," Wm. Zeidlik.
In order to obtain maximum efficiency in the operation of any shunt-fed transmitter, properly designed radio-frequency choke coils are essential, as stated. The method of determining correct coils for such purposes is outlined.

R800(621.313.7). RECTIFIERS. RECTIFIERS, Amateur Transmitter, May, 1927. Pp. 12-15. Electrolytic.

"Electrolytic Rectifiers, Lead-Aluminum Type," J. E. Hall.
The theory and the principle underlying electrolytic rectifiers is given. Information concerning the electrolytes used, the forming process, the heating of the cells and the capacity of the units constructed, is outlined in detail.

R3443. TRANSMITTER SETS. TRANSMITTER, Amateur Transmitter, June, 1927. Pp. 7-ff. Short-Wave.

"Master Oscillator Kinks," K. M. Ehret.
The design and construction of a master-oscillator, power-amplifier transmitter, using two UX-210 tubes are outlined in detail. The circuit differs somewhat from the usual, but is considered to give very good results and a sharp signal when adjusted properly. Complete circuit diagram and list of parts are presented.



RADIO PARTS DEALERS PROFESSIONAL SET BUILDERS and SCHOOLS and COLLEGES

Should first get our free 400 page Radio Catalog illustrating the products of over 100 radio manufacturers. Save time and money by consolidating your purchases with us. Parts and accessories for all the popular circuits.

F. D. PITTS COMPANY

219-223 Columbus Ave., Boston, Mass., U. S. A.
Distributing Radio Since 1919

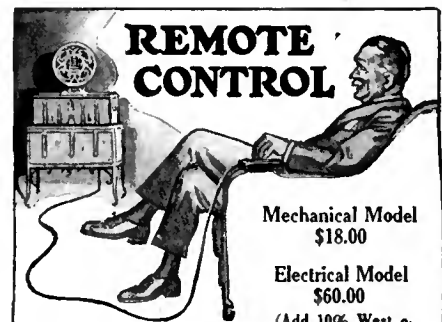

REMOTE CONTROL

Mechanical Model \$18.00

Electrical Model \$60.00

(Add 10% West of Rocky Mts.)

Write for illustrated descriptive circular

IMAGINE the pleasure of tuning your radio without having to get up once all evening! Turn set "on" or "off," tune, regulate volume—from your easy chair! Easily attached to any single removable dial receiver in a few minutes.

"Algonquin"

Electric Company, Inc.
245 Fifth Avenue, New York City

"THE NEW"

Algonquin

TRADE MARK REG. U. S. PAT. OFF.

Remote Control Radio Tuning Unit