

RADIO BROADCAST

WILLIS KINGSLEY WING, Editor

JUNE, 1927

KEITH HENNEY
Director of the Laboratory

JOHN B. BRENNAN
Technical Editor

Vol. XI, No 2

EDGAR H. FELIX, Contributing Editor

CONTENTS

Cover Design	From a Painting by Fred J. Edgars	
Frontispiece	Radio Programs at Sea	74
What Do We Know About Radio Waves in Transit?		
	R. W. King	75
The March of Radio	An Editorial Interpretation	78
Why Radio Home Construction Continues to be Fascinating	What About the Canadian Demand for More Wavelengths?	
Patent Licensing Points to a Bright Radio Future	Conditions for Long Distance Receiving Do Vary	
Stabilizing the Broadcasting Situation	Direct Advertising Over the Air from Corsets to Callopes	
Pleas for a Blue Radio Sunday	Latest Television Developments	
The Wisely Chosen Radio Commissioners	The Month in Radio	
Why Shielding?		Edgar H. Felix 83
Building an Electrical Phonograph		James Millen 86
"Strays" from the Laboratory		90
Growth of the Laboratory	Crystal Control on Short Waves	
The Facts About the A. C. Tube	New Nomenclature for Our Tubes?	
An Instrument for the Home Laboratory		Keith Henney 92
The Listeners' Point of View		John Wallace 97
"Radio Pests" and How to Be One	Thumb Nail Reviews	
Making Up the "Sponsored" Program	Microphone Miscellany	
An Evening of Chain Programs	Correspondence	
Problems of A. C. Filament Supply		Roland F. Beers 101
How to Design a Loop Antenna		Homer S. Davis 104
As the Broadcaster Sees It		Carl Dreher 106
The Difficult Business of Running a Broadcasting Station	Design and Operation of Broadcasting Station, 16: Studio Design	
Man and Modulation	Shrapnel from Cleveland	
Technical Problem No. 1	Memoirs of a Radio Engineer: XVIII	
	Solution of Technical Problem No. 1	
Book Reviews		110
Theory of Vibrating Systems and Sound. Reviewed by Carl Dreher	The Radio Encyclopedia. Reviewed by Edgar H. Felix	
Analyzing the Power Amplifier		D. E. Harnett 111
"Radio Broadcast's" Laboratory Information Sheets		116
No. 97 Methods of Generating High-Frequency Energy	No. 101 Lightning Arresters	
No. 98 Audio Amplifying Systems	No. 102 Efficiency of Amplifying Systems	
No. 99 Data on the "Universal" Receiver	No. 103 Audio Transformers	
No. 100 Circuit Diagram of the "Universal" Receiver	No. 104 Socket Power Units	
Equipment for the Home Constructor		120
Manufacturers' Booklets Available		123
What Kit Shall I Buy?		125
A Key to Recent Radio Articles		E. G. Shalkhauser 126

AMONG OTHER THINGS. . .

AS ANNOUNCED on page 78, the July number of RADIO BROADCAST will appear with a new cover design. For the last six months, we have been examining sample designs and searching the field for an artist who could supply us with a design which properly reflected the character of this magazine. Finally, Harvey Hopkins Dunn, of Philadelphia, presented a design which drew unqualified approval. Mr. Dunn is internationally known as a typographical designer and his most recent cover design has been used by *International Studio*. Our July cover will appear in an unusually attractive shade of yellow, green, and black, and is distinguished by its simplicity and effectiveness.

THIS number of RADIO BROADCAST contains an exceptionally wide range of editorial features, starting with R. W. King's review of present knowledge of how radio waves are propagated. Then comes a short article on what one should know about shielding, of distinct help to those who sell and those who buy shielded receivers. James Millen's second article on radio and the electric phonograph gives a wealth of practical information to those who are planning to make their present phonograph equipment work with their high-quality radio receiver. The spring and summer months offer an excellent time to make these not very difficult changes. We call especial attention to the "Strays" from the Laboratory—a new feature of this magazine, which will, from month to month, provide a place where our readers may find comment and news of great interest. Another new feature in the popular department "As the Broadcaster Sees It" is found in the presentation of a technical problem, and its appended solution. These problems will cover a wide range and will prove of value not only to the technical broadcaster but to the general reader as well. Homer Davis' "How to Design a Loop Antenna" has long been awaited by our readers and is of distinctly practical nature. The second of Roland F. Beers' articles on the problems of series filament connections in receiving sets appears, presented in a very clear manner. The Radio Club of America paper this month casts more light on the design of power amplifiers and should attract wide interest because of the increasing popularity of this accessory.

PRINTERS' INK. in its tabulation of advertising lineage for April magazines shows that RADIO BROADCAST printed 15,315 lines, being exceeded only by *Radio News* with 15,454. Radio printed 11,129 lines, *Popular Radio* 10,510 and *Radio Age* 3,728.

ANSWERS from our readers to the question posed in our May number: "Which Stations Shall Broadcast?" are coming in great numbers, and are rapidly being tabulated for the Federal Radio Commission. These reflections of opinion from our readers provide an unusually reliable cross-section of opinion and important information about local conditions from the entire country and from Canada.

THE July magazine, among many other important features, will contain an exclusive article on the new Raytheon "A" tube, showing its use and value in A-battery charging circuits; two complete constructional articles will tell how to use the QRS 400-mA. rectifier tube and the Raytheon 350-mA. tube.
—WILLIS KINGSLEY WING.

Doubleday, Page & Co.
MAGAZINES
COUNTRY LIFE
WORLD'S WORK
GARDEN & HOME BUILDER
RADIO BROADCAST
SHORT STORIES
EDUCATIONAL REVIEW
LE PETIT JOURNAL
FI. ECO
FRONTIER STORIES
WEST

Doubleday, Page & Co.
BOOK SHOPS
(Books of all Publishers)
LORD & TAYLOR BOOK SHOP
PENNSYLVANIA TERMINAL (2 Shops)
NEW YORK: }
GRAND CENTRAL TERMINAL
38 WALL ST. and 520 LEXINGTON AVE.
848 MADISON AVE. and 166 WEST 32ND ST.
ST. LOUIS: 223 N. 8TH ST. and 4014 MARYLAND AVE.
KANSAS CITY: 920 GRAND AVE. and 206 W. 47TH ST.
CLEVELAND: HIGBEE CO.
SPRINGFIELD, MASS.: MEEKINS, PACKARD & WHEAT

Doubleday, Page & Co.
OFFICES
GARDEN CITY, N. Y.
NEW YORK: 285 MADISON AVENUE
BOSTON: PARK SQUARE BUILDING
CHICAGO: PEOPLES GAS BUILDING
SANTA BARBARA, CAL.
LONDON: WM. HEINEMANN LTD.
TORONTO: OXFORD UNIVERSITY PRESS

Doubleday, Page & Co.
OFFICERS
F. N. DOUBLEDAY, President
NELSON DOUBLEDAY, Vice-President
S. A. EVERITT, Vice-President
RUSSELL DOUBLEDAY, Secretary
JOHN J. HESSIAN, Treasurer
L. A. COMSTOCK, Asst. Secretary
L. J. McNAUGHTON, Asst. Treasurer

DOUBLEDAY, PAGE & COMPANY, Garden City, New York

Copyright, 1927, in the United States, Newfoundland, Great Britain, Canada, and other countries by Doubleday, Page & Company. All rights reserved.
TERMS: \$4.00 a year; single copies 35 cents.

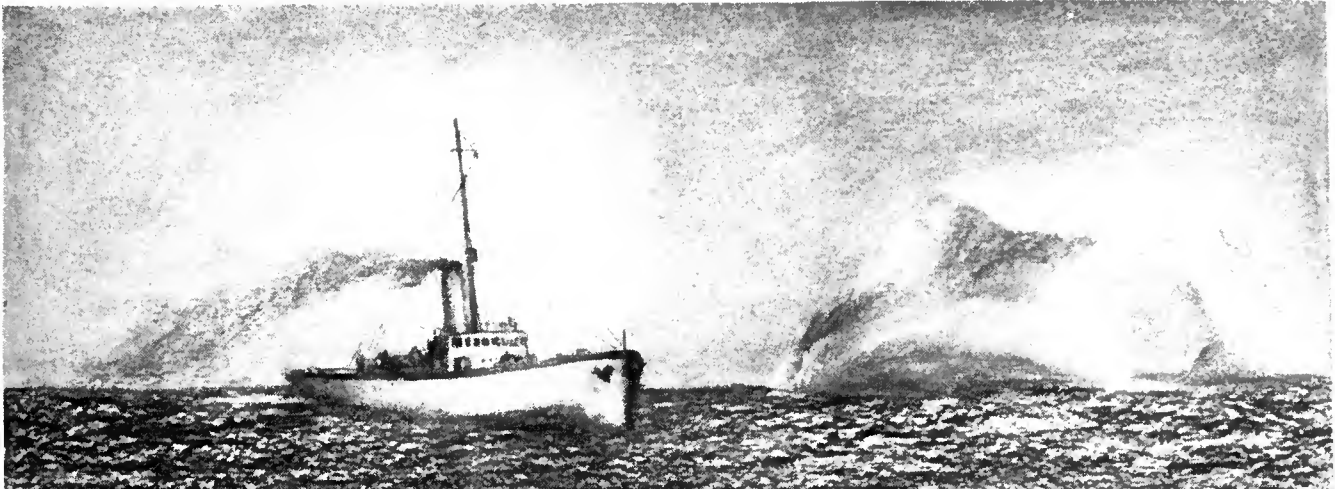

Dependability

From the far northern Ice Patrol Service to the tropic Radio Station, Faradon Capacitors have been generally accepted for exacting fixed electrostatic condenser needs.

The continued increasing use of Faradon capacitors by quality Equipment Manufacturers is most convincing evidence of Faradon dependability.

When planning new equipment remember that the twenty years' experience of the Wireless Specialty Apparatus Company is at your service for fixed condenser needs.



Faradon

WIRELESS SPECIALTY APPARATUS CO.
Jamaica Plain, Boston, Mass., U. S. A. 869

Established 1907

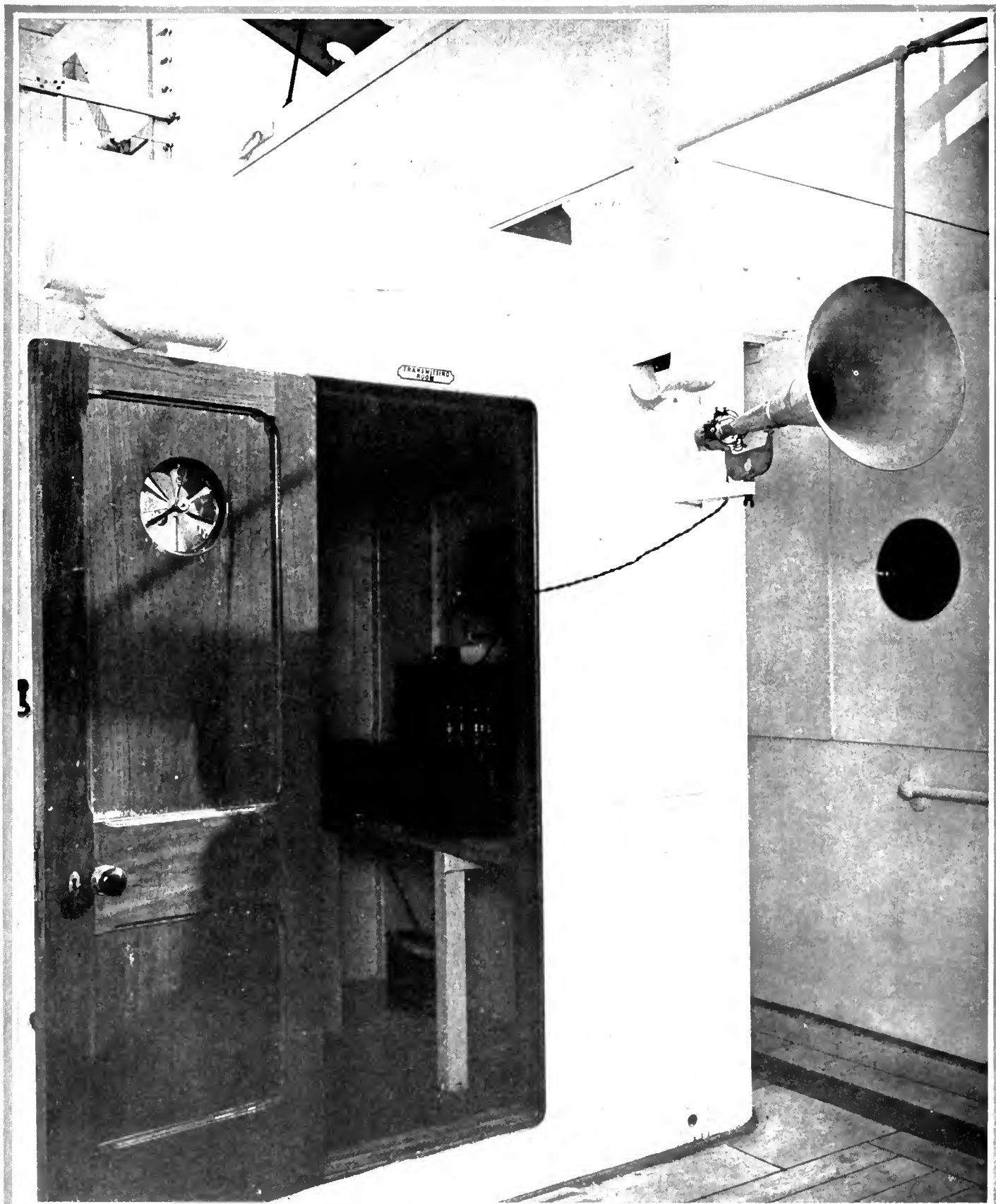

RADIO PROGRAMS AT SEA

One of a number of loud speakers of the speech equipment installed aboard the motor vessel Asturias, one of the newest passenger ships. The various loud speakers may be connected to an electrical attachment to reproduce phonograph music, to a local microphone, or to the output of a broadcast receiver. The transmitting room of the ship's radio installation is in the foreground, while at the top left extreme can be seen the antenna frame of the radio direction finder

RADIO BROADCAST

VOLUME XI



NUMBER 2

JUNE, 1927

What Do We Know About Radio Waves in Transit?

*How Radio Waves Behave After Leaving the Transmitter—
The Queer Influence of Various Phenomena Upon Them*

By R. W. KING

American Telephone and Telegraph Company

THE ancient Greek god with the winged sandals has been replaced by invisible electric waves. These waves are the conveyors for all of our many forms of electrical communication. Speeding at well-nigh incredible velocities, they bear alike the code message of the familiar Morse telegraph, the voice that flows over the wires of the household telephone, and the music which leaves the antenna of the radio broadcasting station.

In the case of the wire telephone and telegraph, the waves are closely harnessed and obediently follow a given pair of wires or a single wire with "ground return." As radiated from the broadcasting antenna, we commonly think of the waves as being free and spreading out in all directions. Yet they cannot be entirely free and unconstrained. Apparently the atmosphere exerts upon them a sort of guiding influence sufficient to prevent their being lost in space. A fundamental fact of radio transmission as we observe it on the earth is its following not straight but curved paths. The earth is a ball and radio waves, instead of traveling out along a tangent plane, curve their course sufficiently to conform to the roundness of the earth.

Just how great is the curvature involved we can visualize more readily by constructing a small-scale model. If we have a single medium propagating waves without absorption or dispersion, a principle of optics states that all wave paths remain similar when the scales of time and space are reduced in the same ratio. Application of this principle leads to the result that if, on the one hand, we have waves 100 meters long traveling over an earth 8000 miles in diameter, and on the other hand, waves of red light (rather less than one millionth of a meter long) and a sphere about two

inches in diameter, then the geometry of the two cases will be identical. Experience tells us, however, that red light would not creep to any appreciable degree around a sphere the size of a billiard ball. The sphere would cause a very apparent shadow if held so as to intercept light falling upon a screen, and if radio waves crept around the earth to no greater extent than this light would around the darkened portion of the ball, long-distance signaling by radio would be quite impossible.

Among those skilled in the science of optics no small amount of surprise was occasioned, therefore, by Marconi's announcement about twenty-five years ago that radio signals had been successfully transmitted across the Atlantic Ocean. This at once gave rise to speculation as to how the beam of waves could bend itself around the protuberance of the curved earth, it having naturally been taken for granted that to such waves the atmosphere would be merely a uniform and transparent medium.

Besides constraining radio waves to travel around our spherical earth—a very fortunate fact—the atmosphere causes in them variations of strength with

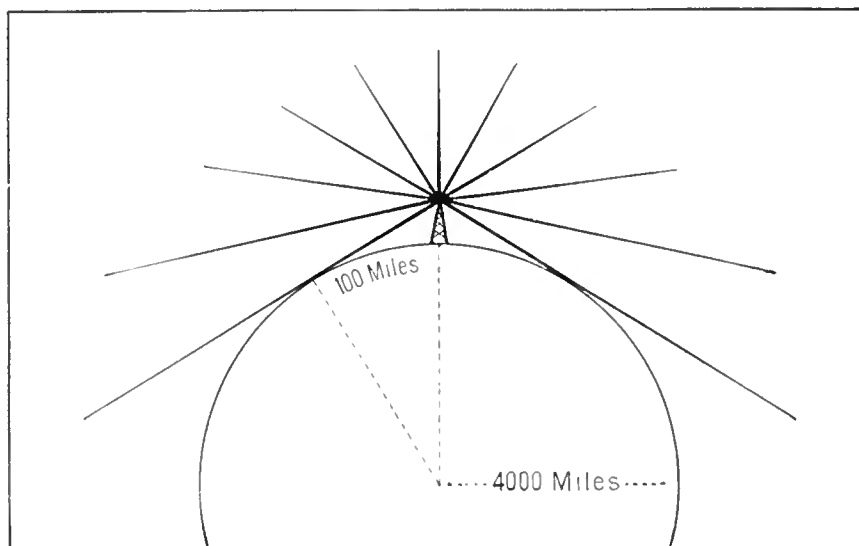

FIG. 1

If the earth's atmosphere had no effect on the transmission of radio waves, their propagation would be along straight lines as shown in this drawing. An antenna, one mile high, would be capable of transmitting signals to a distance of about 100 miles before the shadow cast by the earth's curvature would cut them off. If the receiving antenna were also a mile high, the distance of transmission would be increased to about 200 miles

time of day and year, erratic fluctuations known as "fading," and sometimes irregularities of such a sort as to result in serious loss of quality to the messages it carries. These latter effects of the atmosphere are not particularly fortunate so far as the radio engineer is concerned. However, all effects, fortunate and unfortunate, may be so related in cause that if the atmosphere were to yield the secret of why it guides waves to follow the surface of the earth, it might also yield secrets helping to master the troublesome phenomena of fading and loss of quality. The near future is likely to see us in possession of the reason why the atmosphere acts as a guide to waves and if, in acquiring this knowledge, we gain an insight into other facts, the radio engineer will have occasion to be thankful that he lives on an earth that is round.

Unfortunately it is only in thought that we can pass from considering 100-meter waves traveling around the earth to waves of red light traveling around a billiard ball. If we could but experiment with the latter with its proper diminutive atmosphere surrounding it, we might hope to vary one factor at a time and thus more readily discover the cause or combination of causes for radio waves traveling in curved beams. But it appears that we are limited to experiment on the full-scale earth itself. And here not even Joshua of old, commanding the sun to stand still, could help us very much. By stopping our celestial luminary, he could, to be sure, supply uninterrupted daylight and night conditions, and these would undoubtedly help in understanding the differences

they present to radio transmission, but it seems likely that the presence or absence of daylight is only one of many factors entering the problem. To mention just a few others, there are lightning flashes attended by the possible liberation of very high speed electrons, the "cosmic rays" which are known to increase in intensity as we ascend to high altitudes, probable electric discharges from the sun (these are now commonly supposed to be the principal cause of the aurora borealis), and, in turn, the pressure, temperature, and compositions of the upper strata of the atmosphere.

Here is a complexity of influences almost sufficient to satisfy the mathematician who aspired to develop his technique to the point that he could predict the orbit of a house fly.

Returning to the original problem, an explanation of why radio waves bend around the earth has been sought in many directions. One of the first attempts was to call upon the fact that the earth is

an electrical conductor. Waves started from a grounded antenna would, of course, be in contact at the outset with the earth, and it was thought possible that the interaction between the waves and the currents they would induce in the surface of the earth would be such as to cause them to remain closely attached to the earth as they spread out. This tendency actually does exist but calculations soon showed that it was far too minute to account for the known strength of signals received at a great distance.

The way was prepared, however, for the suggestion of the so-called Heaviside layer, a conducting region in the upper atmosphere which would imprison radio waves between itself and the conducting earth below, and constrain them to move only in the annular region between. Whether such a conducting layer actually exists, it is as yet impossible to say. So far as the electrical properties of gases are known, it could re-

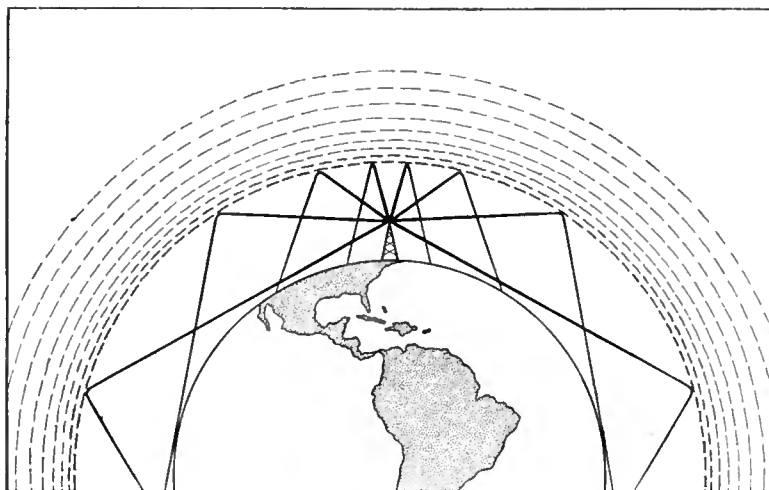

FIG. 2

This drawing illustrates the general manner of radio propagation assuming a rather sharply defined conducting (reflecting) layer in the upper atmosphere. The Heaviside layer is ordinarily assumed to possess this character. By means of the conducting stratum of air above, and the conducting earth below, radio waves are guided essentially as waves are guided along a pair of wires in wire communication

sult only from rather sharply defined ionization in the upper atmosphere. When we speak of a gas as ionized, we mean that certain of its molecules have been robbed of one or more of their normal electrons. These ionized molecules then constitute freely moving positive charges. The electrons which they have lost may continue to circulate as individual negative charges, or they may attach themselves to neutral molecules of gas, still retaining their negative charges but losing considerably in mobility because of the relatively heavy molecules with which they are associated.

The air at the surface of the earth is always somewhat ionized—on an average to the extent of perhaps 1000 negative ions and 1000 positive ions for the 30 quintillion molecules actually present per cubic centimeter of gas. A small amount, indeed, but very important perhaps. This ionization may originate partly through radioactive materials in the earth and in the air, and to a smaller extent through the agency of the so-called cosmic rays. Ultra-violet light

from the sun may also cause appreciable ionization in the upper strata where it is largely absorbed, but this doubtless does not persist through the night, and therefore is merely one of the agencies causing radio waves to behave as they do.

It should be borne in mind, however, that the current explanation of the aurora is based upon ions which are hypothecated as streaming from the sun and bending around into the darkened hemisphere under the influence of the earth's magnetic field. It may be such ions as these that account for the bulk of both day time and night time conductivity in the upper atmosphere. See Fig. 5.

Another factor, recently pointed out by Professor C. T. R. Wilson, which may be by no means the least important in determining the electrical state of the upper atmosphere, is thunder storms. From a statistical study of the distribution of thunder storms, the English Meteorological Office concludes that about 1800 thunder storms are, on the average, in progress at a given moment, producing about 100 lightning flashes per second. The quantity of electricity discharged in a flash is of the order of 20 coulombs, and the potential difference which causes the discharge may rise to as high, it is estimated, as one billion volts. Thus Professor Wilson suggests that the power expended in producing lightning by thunder clouds the world over may be as great as one ten-thousandth part of the total power received by the earth from the sun. Now, as a celestial receiving set, the earth does a very creditable

job, picking up, from the power which the sun broadcasts, about one hundred trillion horsepower. It is indeed noteworthy, therefore, that if 1-10,000th part, or even a much smaller fraction, of this power is turned loose in the form of lightning—and therefore in a form which generates *static*—it offers to our man-built radio stations competition of no insignificant order of magnitude.

Not only is the electric power expended by thunder clouds large, but both the current and the voltage involved are of the order of magnitude which suggests the possibility of important effects on the electrical state of the upper atmosphere. Thus, the voltage of a thunder cloud is such that it may act as a source of extremely high speed electrons and also X-rays.

It is conceivable that high-speed electrons or beta rays from lightning flashes may pass upward through the outer atmosphere, and, due to the earth's magnetic field, reënter the atmosphere in widely scattered regions contributing, perhaps, to auroral phenomena and to the

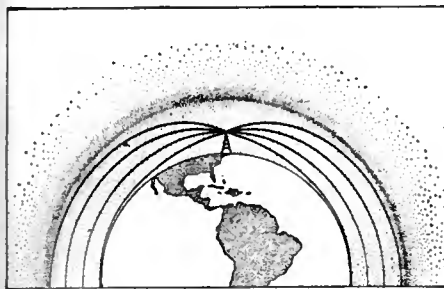

FIG. 3

This drawing illustrates the bending effect of ionization permeating the atmosphere. Downward refraction toward the earth would be due to an ionization that becomes greater with increased altitude

penetrating "cosmic" radiation as well as to such atmospheric ionization as is important in radio transmission. In this connection, it is interesting to recall that the green spectrum line which is so characteristic of the light of the aurora has been found by Lord Rayleigh in the radiation from the normal night sky.

Attempts are being made to associate radio reception conditions with the weather (see articles by J. C. Jensen and Eugene van Cleef in *RADIO BROADCAST*, and a recent paper, by G. W. Pickard read before the Institute of Radio Engineers) and, in accordance with this theory of C. T. R. Wilson, it may not be impossible to find a connection between reception, aside from static and thunder storms, both local and remote.

Another theory, and one of the latest to be proposed (Sir J. Larmor, *Phil. Mag.*, Vol. 48, page 1025, 1924), is based upon ionization in the atmosphere but does not require that this exist in the form of a layer whose lower surface is sharply defined. Larmor shows that if the amount of ionization increases with altitude, the more elevated portions of a wave train will travel faster than the portion near the earth and the train as a whole will be deflected downward. This downward deflection may easily be sufficient to cause the wave train to conform to the curved surface of the earth or even to dive into the earth at a slight angle. On this theory the bending of radio waves downward is rather analogous to the bending upward of light waves to produce a mirage. It will be recalled that a mirage is seen across a flat, heated, landscape, the layers of air closest to the earth being most highly heated and, therefore, of lowest density, transmitting light with a slightly greater velocity than the cooler overlying layers

Which of these two theories is better, or whether there is some theory, or

combination of theories, as yet unproposed, which will ultimately win out, it is, of course, scarcely worth our while to speculate at this juncture. As matters now stand, some may prefer to entertain the idea of a more or less sharply defined and reflecting layer of ionization, located perhaps ten miles, perhaps fifty miles, above the surface of the earth, while others may prefer to think in terms of a widely diffused ionization gradually increasing with increasing altitude, which acts prismatically to bend radio waves earthward. A paper given at the 1926 midwinter Convention of the A. I. E. E. by Baker and Rice, attempts a quantitative statement of the distribution of ions.

WORK FOR THE AMATEUR

IN THIS work the radio amateur occupies a very strategic position. Curiously enough, it is short-wave transmission that is bringing to light facts so striking that they cannot fail to be crucial to any theory of transmission. One of the outstanding pieces of work in this new field is that of Dr. A. H. Taylor who has correlated many results obtained by amateurs with the short-wave experience of the Navy. Among the striking phenomena now commonly recognized may be mentioned "skip distance." No one was very much surprised when it became known that short wavelengths die away very rapidly as one recedes from the transmitting antenna. But when these short waves, which presumably had disappeared entirely at a distance of, say, 200 miles, were found to reappear at a distance of 600 or 1000 miles, it became evident that a new phenomenon had to be reckoned with. Data recently published (for example, by Heising, Schelleng, and Southworth, of the Bell Telephone System) indicate, furthermore, that the "skip distance" lengthens as the wavelength decreases. This fact is not out of harmony with the theory of a refracting ionization distributed throughout the atmosphere, but neither can it be said as yet to prove that such ionization exists.

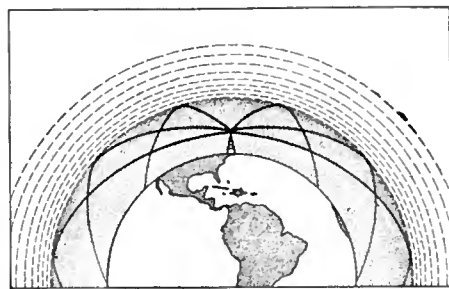

FIG. 4

If the effects shown in Figs. 2 and 3 were combined, they would result in a type of transmission shown in this drawing

The "skip distance" displayed by short-wave transmission seems to indicate that, of the waves which leave the transmitting antenna, those which travel near the surface of the earth are rapidly absorbed, while those starting upward, perhaps at a slight angle to the earth's surface, soon reach a rarified region through which they travel with little absorption, but which gradually bends them downward, either by reflection or refraction, until they again reach the earth, hundreds or even thousands of miles away.

If this view is correct, it means that a beam of short waves constitutes a messenger which we can send up perhaps to the outermost confines of the atmosphere and have return to us again. There is no doubt but what scientists will quickly devise means for determining what alterations these returning waves have undergone, and thus interpret the message which they bring back regarding the constitution of the upper atmosphere.

In studying electric waves as messengers returning from the upper strata of the atmosphere, it will be increasingly important to take into account the effect of the earth's magnetic field in such ways as were pointed out by Nichols and Schelleng in the Bell System *Technical Journal*, April, 1925. In enlarging the theory of Larmor to

include the earth's magnetic field, they found that under some circumstances it is possible for a ray to follow the bend of the earth, even though the number of ions decreases with altitude. They also concluded that, for low frequencies (long wavelengths), the magnetic field prevents the electrons from moving in as large orbits as they otherwise would describe, which results, in turn, in smaller absorption of energy and therefore in reduced attenuation. A magnetic field permeating the ionized atmosphere may also divide a beam into differently polarized components, thus giving additional data on the nature of the transmission path supplied by the upper atmosphere.

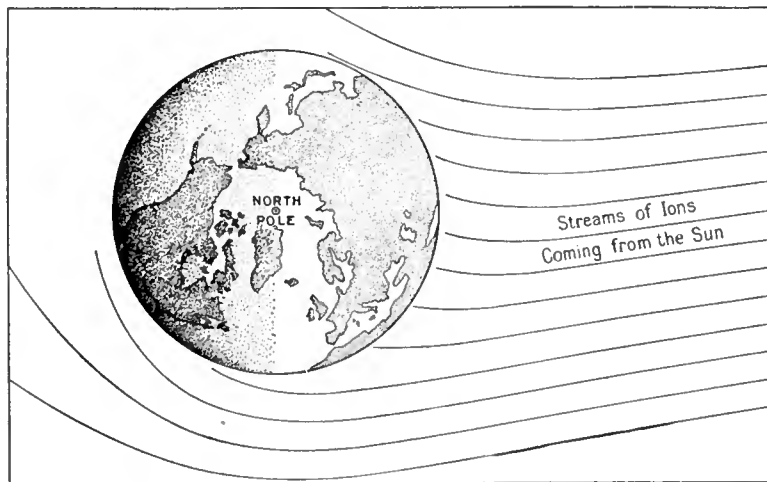
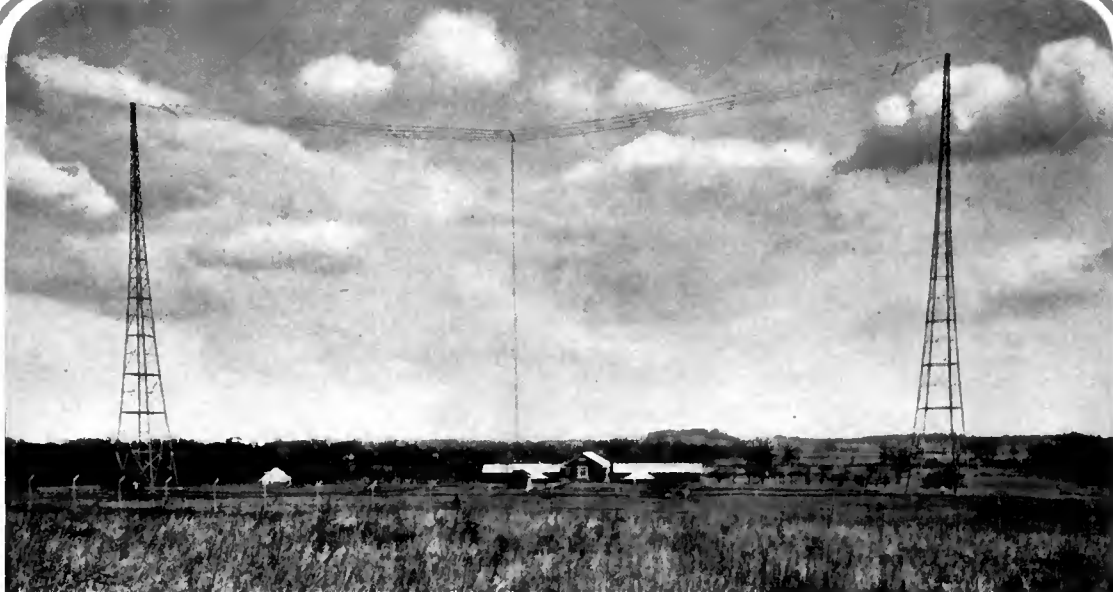

FIG. 5

This drawing illustrates how streams of negative electrons or ions emitted by the sun would be swerved by the earth's magnetic field. Some of these rapidly moving ions would reach the upper atmosphere over the darkened hemisphere of the earth and would therefore be available to influence night-time transmission. A stream of positive ions coming from the sun would be deflected downward and not upward



THE MARCH OF RADIO

News and Interpretation of Current Radio Events

Why Radio Home Construction Continues to be Fascinating

WHEN the moguls of the radio industry gather nowadays, they no longer discuss heatedly the relative prospects of the home-built versus the manufactured receiver. The normal level of the parts business is now founded upon that percentage of listeners which finds pleasure and satisfaction in its own receiver; economy no longer acts as the chief stimulant to augment the ranks of the army of set builders. It is easier and in many cases, cheaper to buy a good receiver of all around efficiency than to build one. The man who builds his own does so because he likes to work with his hands or because he prefers exceptional performance in one or more particular qualities, like selectivity, sensitivity, efficiency, or economy. Other hobbies and pastimes in a similar position have thrived for years with no firmer foundation for their prosperity.

The small tool business, for example, owes half its volume to the man who putters with tools for the fun he gets out of them. There is no economic reason for building your own chair, desk, or bookshelf. With less trouble and expenditure, you can buy

an article. But no one worries especially about the future of the small tool business.

Our contact with thousands of readers through questionnaires and letters shows that the set builder recognizes his enthusiasm as a pastime and not altogether as a money making proposition. A very significant point, brought out by a recent study,



WATCH FOR OUR NEW COVER

STARTING with July, RADIO BROADCAST will make its appearance with a new cover, designed by Harvey Hopkins Dunn of Philadelphia. Mr. Dunn, who is internationally known as a decorative designer and typographer, in creating this new cover, has provided one of unusual and effective design, which we feel will add great distinction to the magazine, and be a just reflection of the quality of contents which we strive always to maintain.

—THE EDITOR



is the fact that many set builders have made ten and fifteen sets in the last few years and eagerly await new and superior designs so that they may make more. Set building is a habit; the turnover in set builders is small, while their ranks continue to grow steadily. These same home constructors stated that they recommend manufactured sets to their friends, sets pos-

sessing characteristics frequently different from those of the delicate and sensitive receivers which they delight particularly in making. Predominant in their recommendations for the many friends who consult them as radio experts are such well recognized manufactured types as the superheterodyne, the neutrodyne, and tuned radio-frequency receivers, a decided contrast to the sensitive, super-efficient, and often more difficult to tune, radio frequency-regenerative detector sets which are the favorites of the home constructor.

This stabilized relationship between the parts and the complete set business removes to a large degree any uncertainty prevailing as to the future of the parts business. So long as parts engineers continue to show ingenuity in developing really improved and novel designs for the home builder, the position of the parts business remains impregnable. True, the number of complete set owners grows more rapidly than that of set builders, but the fruitfulness of the latter field is ample enough to warrant a hopeful and promising outlook.

One important recommendation which we would make to the complete set manufacturer as a result of our investigation is that advertising in the radio magazines be prepared with better appreciation of what

The photograph forming the heading shows the antenna system of station 3 XX, the experimental station of the Bell Telephone Laboratories at Whippany, New Jersey. Important radio television tests were made between 3 XX to New York. Transmitters of from 5 to 50 kw. are installed here.

kind of information their readers want. All of them are better informed on radio subjects than those who respond to general advertising; in fact, one third of our readers are professional radio men—dealers, manufacturers, and engineers. Many have asked us to give them technical and quantitative analyses of the performance of manufactured products in order that they might be better qualified to advise those who seek them out as experts. The advertiser may well take heed of this demand by substituting for his general claims about tone quality, selectivity, and sensitiveness, in his radio magazine advertising specific facts about the mechanical and electrical construction of his receiver and its efficiency and performance as indicated by gain, selectivity, and frequency curves. The reader of radio magazines is entitled to this special attention because he is the local radio oracle, whose advice influences the purchase of from three to twenty individual radio sets a year, while his professional activities control huge quantity purchases.

Patent Licensing Points to a Bright Radio Future

THE recent licensing by the Radio Corporation of the Radio Receptor, Zenith, All-American and Splitdorf companies is the first step toward widespread inter-licensing somewhat along the lines suggested by the articles by French Strother in this magazine, for October, November, and December, 1926, which aroused widespread and favorable comment in the industry. Upon the heels of these encouraging signs comes notice of the Hazeltine suit against Zenith over their Latour patents. The impending battle between these powerful interests, Hazeltine and Radio Corporation, already preceded by many preliminary skirmishes, promises at last to enter into a final and decisive stage which will make possible a comprehensive and satisfying appraisal of the value of their respective rights. It is a question of weighing the work of Latour and Hazeltine against that of Alexander Langmuir, Rice, Hartley, and others. We regard the peace which will follow this engagement as perhaps the last important step in patent stabilization which will establish definitely the position not only of the interested parties but of all the independents as well. We are certain, also, that liberal licensing on an equitable basis will end the patent bootlegging now current and establish the industry finally on a sound business basis.

Stabilizing the Broadcasting Situation

BRIGHT and hopeful as our two preceding items are, even more significant are the encouraging aspects of the broadcasting situation. We write just as we return from the public hearings before the Federal Radio Commission in Washington. At these hearings, there were practic-



A WAVEMETER FOR BROADCASTING STATIONS

A Bureau of Standards employee with a portable type wavemeter for use in measuring the emitted frequency of a broadcast station

ally no representatives from the listening public. Only the interests of the broadcasting stations themselves were actually represented. Nevertheless, out of this group, came the exposition of sound principles and promising recommendations which we hope will be translated into action before these lines appear in print. RADIO BROADCAST presented a plea for the broadcast listener along lines familiar to our readers through these columns. It found before it four commissioners disposed to weigh and not to jump hurriedly to conclusions. They repre-

sent fearlessness and stability, if ever government commission represented those qualities. Until their course is finally set, these men are conscientious and open minded. They pleaded for a free expression of views and were rewarded by recommendations which, one by one, deprived them of means of accommodating all the 732 broadcasters who seek to continue to impress themselves upon the listener. Broadening the band was disposed of with a finality which leaves little hope for the revival of that pernicious proposition; division of time was frowned upon as uneconomical; narrowing the width of the ten-kilocycle channel and simultaneous broadcasting of interconnected stations on the same channel, were dismissed as technically unfeasible at the moment; power reduction by large stations was demonstrated as a restriction of the broadcast listeners' opportunity, so that, toward the end of the sessions, the commissioners were convinced that less stations was the only answer. Although hundreds of stations were represented, no one was heroic enough to offer to close down voluntarily, although, doubtless, many realized that their doom had been spelled by the recommendations of the conference.

Two plans for the administration of broadcasting station allocation were presented. One suggested that two thirds of the broadcast band be given over to ten per cent. of the existing stations, a glorious and courageous conception, altogether too easily criticised as the forerunner of a monopoly. Rome was not built in a day and we rather doubt that radio heaven can be created by any means so drastic. A second plan provides a somewhat more liberal reprieve to the less able stations by confining them to fifty-watt power on thirty channels set aside for that purpose and

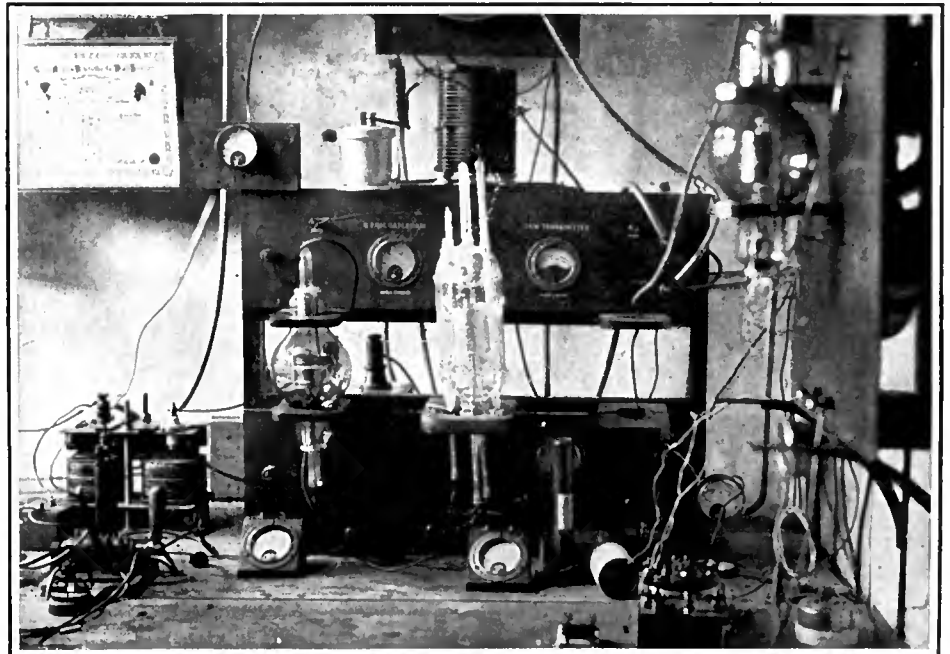

THE TRANSMITTING STATION OF A FAMOUS BRITISH AMATEUR

The name of Gerald Marcuse, G 2 NM, is well known among the amateur operating fraternity throughout the world. The illustration shows his 1000-watt transmitter with a silica Mullard tube in the foreground

© Barratt's

permitting all the well established key stations to continue on their present powers. Eventually, it is likely that the fifty-watt station will prove uneconomic and, in the execution of that plan, lies hope that we will gradually find less than three hundred medium and high-power stations remaining, giving equitable service to the listener in every part of the country.

One could not help but be impressed by the way in which this commission went about its business. It hinted at no convictions or opinions; it was there to absorb. We regret that the fifth commissioner and chairman, Rear Admiral W. H. G. Bullard, could not be present. We heard occasional whisperings, from those having a sensitive ear to monopoly scandal, that the Admiral might have monopolistic leanings. These silly, back-stair comments arise out of the fact that he, almost alone, is responsible for the existence of an American owned system of worldwide communication, the creation of which he fostered as a measure of national defense, by encouraging the electrical interests to acquire the British owned Marconi Company and to form the Radio Corporation of America. For this accomplishment, he deserves the homage of his fellow citizens. Now that he has been entrusted with the equally important task of assuring an equitable service to the broadcast listener, we are sure he will be just as fearless in the attainment of that end. In that task, his eye will be ever vigilant to prevent the usurpation of the ether channels by any domestic monopoly just as he once so ably released American radio communication from foreign monopoly.

Pleas for a Blue Radio Sunday

THE church folk, as usual were present at the conference, seeking special privileges; in effect, they requested exclusion of all competition for their Sunday

programs. At the risk of being called irreligious, we will take the liberty of trying to show that such a monopoly would certainly curtail the effectiveness of the Sunday religious radio offerings. We wish we could use the same subtlety and skill in presenting that argument as did Mr. George Furness before the conference. He answered the churchmen so effectively that we heard one of them remark that his reply was a "blamed good job."

The broadcast listener now has choice between two kinds of Sunday afternoon programs—second-rate jazz and unadulterated moral food. There are exceptions, of course, to so broad a generality. Purely from the broadcasting standpoint, neither of these program types are capable of attracting large Sunday radio audiences. Indeed it is fair to say that the one day of the week on which the largest radio audiences could be obtained is, from the program attractiveness standpoint, the weakest of the seven. Singing congregations if for no better reason than the acoustic conditions under which they appear before the microphone, naturally make poor broadcasting, while the spirited admonitory messages which predominate from the pulpit cause many sinful listeners to shut down their radio sets for relief. A monopoly of Sunday programs would serve only to eliminate those who like dance music from the listening audience; certainly it would not augment the "religious" listener group.

Now, supposing that Sunday programs were highly developed with a good balance of classical and chamber music, of educational material and well-presented religious material. The first effect would be to tenfold Sunday afternoon audiences. Better radio showmanship on the part of the churches would enhance the opportunity to win a following to the magnificence of church music. The religious element need not fear that its radio appeal will suffer

seriously from good competition. There are no finer soloists than those of the great churches nor more impressive music than that of the church organ. With a larger Sunday audience, the church can find no greater opportunity than radio offers to augment its following.

The Wisely Chosen Radio Commissioners

BY THE generous coöperation of various governmental departments in the matter of space, furniture, and personnel, the Radio Commission is able to function despite Senator Howell of Nebraska who, at one time, was the only Senator to object to the passage of the appropriation bill which would give the commission funds with which to work. The Senate had time to confirm three of the commissioners but awaited the opportunity to better acquaint itself with two members of the commission. Confirmation was further complicated by the fact that one or two Senators had private secretaries whom they wanted to have appointed. The personnel of the commission has been so well selected, from the standpoint of ability and judgment, that there can be little doubt of their ultimate confirmation.

What About the Canadian Demand for More Wavelengths?

ONE of the first problems which focussed attention on the Radio Commission was the demand of Canada for additional broadcasting channels. Prior to radio chaos (we can now use that expression safely), Canada had six exclusive channels and shared twelve others. Inasmuch as the twelve shared channels were so allocated in the United States as to permit of the use of 500-watt Canadian stations on them, and considering that the populated

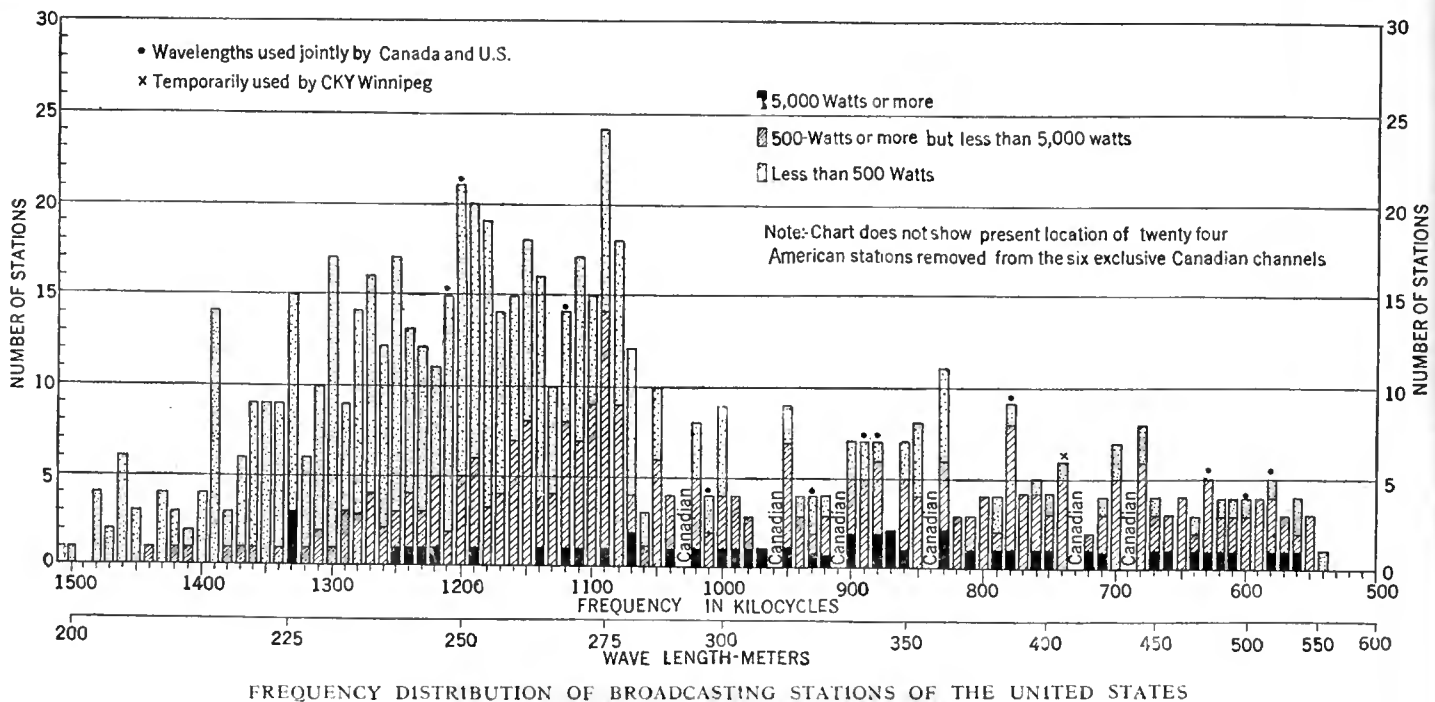

area of Canada is roughly only one-fifth that of the United States and that its total population is less than one tenth that of the United States, eighteen channels for Canadian use seemed a fairly liberal proportion of the 95 available. This allocation permits the simultaneous operation of twelve stations of 500 watts power and six more of practically unlimited power. The latest Canadian demand is for fifteen exclusive channels in addition to the twelve shared channels, the granting of which would involve giving Canada substantially more channels and broadcasting facilities, in ratio to population and inhabited area, than we ourselves enjoy. The negotiations are being handled by the Department of State and they are seriously complicated by the antagonism which our ruthless wave jumpers so deliberately aroused by the appropriation of Canadian channels. Again we renew our plea that any station which took upon itself the endangering of our friendly relations with neighboring countries by injuring their broadcasting service, be promptly and forever disbarred from the ether.

Conditions for Long-Distance Receiving Do Vary

AN EXCELLENT indicator of the changes in the responsiveness of the ether medium to the transmission of radio signals is given by the varying experience of British listeners in hearing American broadcasting. During the 1923-1924 season, WGY was heard much more frequently than other American stations, although KDKA, WOR, and WJZ were occasionally reported. During the following season all of these except WGY disappeared from the picture, but WBZ and WPG took their places. The 1925-1926 season was notable for its complete absence of American signals, checking with our own season of mediocre long-distance reception. This season is remarkably good, many listeners having reported as many as five American stations on the loud speaker in a single evening. The improvement is in part due to the use of increased power, but also to better transmission characteristics of the ether.

Direct Advertising Over the Air from Corsets to Calliopes

FROM the Middle-West come many complaints regarding certain undesirable broadcasting stations which do nothing but inflict atrocious direct advertising upon the listening audiences. Some of these stations are of considerable power and we have been able to hear them for short periods. The surprising thing about these disgraces is that the bargain corsets and harnesses which they offer are purchased by numerous dull-witted listeners who are thereby filling with numerous shekels the coffers of these miserable ether polluters. Easterners, accustomed to a comparatively pure ether

from the advertising standpoint (and this includes only that large proportion which concentrate on the bigger and better stations), sometimes become irritated when WEAF ventures to tell with excessive detail how many gas, electric, and traction companies certain of its clients control. These listeners would have a surprising disillusionment were they to hear the bargain ballyhoo to which Central Western listeners must submit. Fortunately most of these stations are pirates of the worst order and will probably be among the first to go at the behest of our courageous radio commission.

Latest Television Developments

DURING the first week of April, a remarkable German film was showing in New York. The picture dealt with the mechanical advance of civilization. Television—the local reproduction of distant scenes, played a leading part. On April 7th, the American Telephone & Telegraph Company fulfilled the prophecy and demonstrated an operative television system which brought the voice and face of speakers in Washington over telephone wires to New York in an astoundingly

clear fashion. After the wire television method was shown to be workable, the immensely more difficult television by radio was undertaken between the Bell Laboratories in New York and experimental station 3XN at Whippany, New Jersey, about 30 miles away. Visual and audible reproduction was excellent in this medium as well.

With the attainment of television, the Bell Telephone Laboratories have, in the space of but a few months, contributed to the perfection of three extraordinary scientific tools of modern life. First came the transatlantic radio telephone, then the Vitaphone, and now workable television. It is of course true that, in each of these accomplishments, the telephone engineers borrowed freely from all that had gone before, but all honor to the Telephone Company for actually accomplishing what others have attempted. Much notice has been attracted by the work of John L. Baird with television in England, and our readers will recall a descriptive article on his accomplishments in these pages recently. Since there has been no demonstration of the Baird system in this country, it is impossible to compare the two systems.



TELEVISION APPARATUS AT THE BELL TELEPHONE LABORATORIES

The large illustration shows President Walter S. Gifford of the A. T. & T. Company talking into an ordinary subscriber's set placed in front of the television screen which shows a moving and illuminated image about the size of a vest pocket size snapshot. Dr. Herbert Ives, the man who is chiefly responsible for the development of the system, is standing at the extreme right. In the circle is Dr. Frank Gray, standing next to the large glass screen which is used when the distant scene is made visible to a large group. A loud speaker is in the lower section of the standard. At present, the small screen for individual use is much more successful than the large screen, although the results with the large screen, considering the problems involved, are remarkable

Baird claims the use of a mysterious "secret cell" but, by the lack of full disclosure, aids the doubters. The Telephone Company state that they have done nothing essentially new and shroud their accomplishment with no mystery. It became necessary to use a large photoelectric cell; forthwith Dr. Herbert Ives developed the largest ever built (it is nearly as large as a 250-watter). An operative method of synchronism was required; H. M. Stoller and E. R. Morton developed a motor control synchronizing cleverly with 18 and 2000 cycles, and the requirement is met; a score of specialist-engineers work unceasingly on the wire and radio problems involved. Under the synthesizing guidance of Doctor Ives, television is accomplished. The story is simple and not dramatic, but the world of practical science owes much to these Bell Laboratories men. They are content to let the other fellow do the talking while they iron out the trouble.

Speculation is wide and commentators both serious and humorous are hard at work pointing out what can and will be done with television. Application of the system is certainly not to be expected very soon, and time, not prophesy, will tell what use the world will make of this distance-conquering eye.

The Month In Radio

IN our March issue, we suggested the elimination of a great number of stations in the New York area and received in response a well-worded protest from WAAM which clearly demonstrated priority of service and adherence to its assigned wavelength, despite encroachments from wave-jumpers. These considerations entitle that station to better treatment than that suggested for some of those mentioned in our proposal. We are pleased to accord WAAM our assurance of continued support of the principle of priority, based upon length of service on the frequency actually in use when the Radio Act went into effect.

RUMORS of significant radio mergers are becoming more frequent. Many of these surround the already powerful Crosley Radio Corporation which has already, in effect, absorbed DeForest, Amrad, and other radio concerns. Now that patent and broadcasting stabilization is in sight, the next trend in the radio industry will be the merger of small concerns, which find their limited opportunities a handicap. The accomplishment of similar mergers in the automobile business has had an important influence in bringing that industry to its healthy and enviable position. Radio mergers will make for better and cheaper receivers and for more efficient coordination in the encouragement of good broadcasting.

WESTINGHOUSE engineers announce a new rectifier suited to use in A, B, and C battery elimination, consisting of units of copper and copper oxide which introduce some sort of electrolytic action. By the assembly of a sufficient number of units, currents of an order of magnitude adequate for radio reception purposes are secured. It must be kept in mind that this development is only in the laboratory stage. It is one of great promise because the life of the elements appears to be practically indefinite.

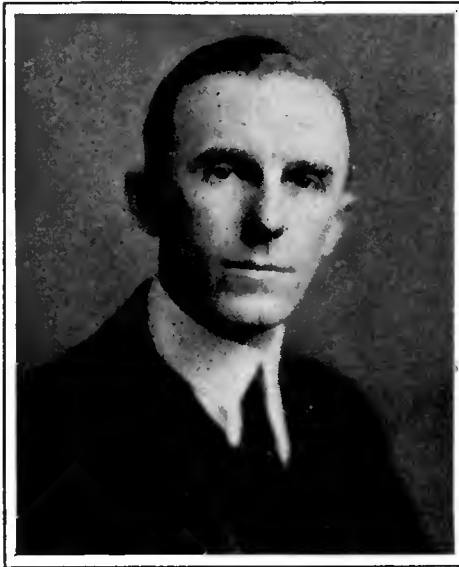

RAY H. MANSON

Rochester

Chief Engineer, Stromberg-Carlson Telephone Manufacturing Company, Rochester, New York. Especially written for RADIO BROADCAST:

"Radio is, in my estimation, rapidly advancing into a new era. Much research has been made along electrical and mechanical lines in the laboratories of many radio manufacturers, but in the minds of many engineers this has not been sufficient and, accordingly, there has been established in a very few manufacturing plants what is coming to be known as the electro-acoustical laboratory. We of the Stromberg-Carlson Company, being thoroughly convinced of the necessity of this phase of the work, feel fortunate in having established at our plant one of the few such laboratories in the country.

"The electro-acoustical laboratory deals with the experiment and measurement of audio frequencies. The work, which, by the way, is just beginning, has made rapid strides and has furnished much data for the design of radio receivers, but the main work centers around loud speaker design.

"It is my expectation that through the work of the electro-acoustical laboratories of the country, a new conception of radio entertainment, and a new naturalness and realism of reproduction, will be effected."

THE National Electrical Manufacturers Association took gratifying cognizance (or at least we flatter ourselves that they did) of our series of articles by French Strother on the patent situation and also our recommendations regarding the limitations of the total number of broadcasting stations. Resolutions adopted at its recent Briarcliff Convention, urged cross-licensing and the reduction of broadcasting stations to 200.

ONE of the recommendations of the American Engineering Council to the Radio Commission provides the adoption of a unit of ten millivolts per meter as the criterion which should determine the service range of a broadcasting station. A signal of that strength, even with our huge layout of broadcasting stations to-day, is available in an area less than one per cent. of the total of the United States and therefore represents an ideal which is so far from immediate attainment that it is of little practical value. The practical service range of a broad-

casting station is far in excess of that indicated by this ideal unit. It would be most unfortunate if this value were adopted by the commission on the basis that it represented the limit of satisfactory reception, because it would involve the acceptance of heterodyne interference on ranges beyond this ideal service range as being of no account. Thus, if a listener twenty miles from a 500-watt broadcasting station complained of heterodyne interference from a distant station, he would be disregarded on the ground that he is beyond the service range of the station in question. Admittedly, we would all be very happy to have a signal of this strength, but while that privilege is now available to so small a proportion of the country, we recommend the adoption of a substantially smaller unit, permitting of unheterodyned reception of 500-watt stations for at least 200 miles until better coverage of the United States is an accomplished fact.

WE ALMOST suffered collapse when we received the extraordinary and gratifying announcement that the Radio Manufacturers' Association and the National Association of Broadcasters had combined in the establishment of a single office to serve both organizations in New York, Washington, and Chicago. L. S. Baker has been chosen to direct this work. Such working together in the industry is an unheard of precedent, the result of cooperation during the difficult days of the halting progress of the radio bill through Congress. This new tendency toward cooperation and the disappearance of mutual jealousies will perform miracles for the rejuvenated industry. Now we are prepared for the shock of an announcement that the R. M. A. and the N. E. M. A. standards committees have joined forces, but perhaps that is too much to hope for at this stage.

STATION KERC of San Francisco, has the distinction of being the first to rebroadcast a Japanese program. This feat was accomplished on the morning of March 16 when the listeners of the Frisco station enjoyed an hour's reception of JOAK, stated by the publicity men to be with "perfect volume and clarity." Considering that the distance is about six thousand miles, these Pacific coast geniuses must therefore be at least twice as good as the Radio Corporation engineers, whose transatlantic rebroadcasting was hardly of high standard.

THE following patents are now involved in litigation: 1,018,502, General Electric vs. Crown Electric Co. Inc. (bill dismissed without prejudice); 1,050,441, 1,050,728, and 1,113,149, Westinghouse Electric & Manufacturing Co. vs. W. Egert; 1,180,264, Westinghouse Lamp Co. vs. C. E. Manufacturing Co. Inc.; 1,195,632, 1,231,764, 1,251,377, Radio Corporation of America vs. Radio Receptor C. (presumably this is the case which resulted in licensing of the latter by the former); 1,231,764, 1,251,377 Radio Corporation of America vs. Epom Corp.; 1,018,502 and others, General Electric Co. vs. H. & D. Radio Co.; 1,271,527 and others, Lektophone Corp. vs. Brandes Products Co. (decree dismissing bill, January 27, 1927); 1,377,405, DeForest Radio Co. vs. North Ward Radio Co.; 1,571,501, Dubilier C. & R. Corp. vs. N. Y. Coil Co. (decree of D. C. affirmed); design 68,770, The Pooley Co. vs. Blue Bird Furniture Manufacturing Co.; 1,271,527, Lektophone Corp. vs. Western Electric Co. (claims 2930, held not infringed); 1,271,520, as above (claims 1 to 4 and 8 held not infringed).

THE number of radio beacons on the coast of France will soon be increased from four to ten, according to the Department of Commerce.

Why Shielding?

What to Look for and What to Look Out for in Judging a Set's Shielding

By EDGAR H. FELIX

THE superior performance of completely and carefully shielded receivers has led to the widespread adoption of the phrase "fully shielded" in connection with any set having a stray piece of sheet metal in its anatomy. Shielding is generally considered as a sort of electrical mudguard which prevents the spattering of undesired electrons upon neighboring circuits. So indeed it is, but the significant influence of shielding upon the performance of a receiver is hardly indicated by this limited conception. The confinement of the energy in every element of the receiver strictly to the performance of useful service, accomplished by effective shielding, tremendously enhances selectivity, sensitiveness, and permissible amplification of the instrument.

Specifically, the principal results of complete shielding are: (1) Compactness, permitting the embodiment of many stages of radio and audio amplification in a receiver of small proportions without destructive interactions; (2) greater permissible amplification because relatively large radio- and audio-frequency currents can be conducted through circuits without consequent couplings to neighboring stages; (3) stable neutralization throughout the wavelength range, because all unwanted inductive and capacitive coupling is eliminated; (4) increased selectivity resulting from the use of more stages of radio-frequency amplification with consequently greater filter action; (5) uniform amplification throughout the wavelength range without increased tendency toward self-oscillation at the higher frequencies; (6) elimination of electromagnetic pick-up (except that coupling purposely introduced through the primary of each stage's transformer) from the antenna and preceding stages and, with it, the resultant broadened tuning; (7) reduced influence of static and power line induction because pick-up is limited to the antenna circuit itself; (8) greater mechanical rigidity attained by supporting effect of substantial shielding and chassis construction; (9) foolproof wiring, largely concealed in enclosed cans; and (10) reduced losses due to dust and dirt on condenser plates and other exposed parts.

The term "shielding" describes any metallic conductor installed in the radio set for the purpose of eliminating undesired electrostatic or electromagnetic reactions, whether it be a modest strip of tin-foil pasted to the back of the panel near the dials to reduce hand capacity, or the complete sealing cases for each stage of amplification, embodied in the latest receivers. Shielding has been fully discussed in various technical

papers, references to which are given in the bibliography at the end of this article. Our concern here, however, is not a technical discussion but a simple exposition on how to judge, by inspection and demonstration, the effectiveness of shielding in a receiver. This is a relatively difficult task, however, because a receiver can be built to appear perfectly shielded while the only thing actually accomplished by improperly applied shielding may be the introduction of high-resistance losses and consequent reduction in amplification and efficiency.

The theory of shielding is quite simple. Any

also the upper limit of energy which practical shielding can confine.

Experimenters who have tried to use shielding without a thorough understanding of its proper application have been known to argue against it because they have obtained poorer results by adding shields in their receivers. But to argue against any and all shielding because of an experience with mis-applied shielding is like condemning a twelve-room house because it cannot be built on a twenty-five foot lot. Unless a receiver is specially designed for it, shielding is as likely to decrease efficiency as it is to improve it.

The most fundamental and simple principles of electricity explain the functioning of shielding. You probably remember the experiment of rubbing a piece of glass with fur and using it to pick up small bits of paper. The effect of rubbing the glass rod is to charge it. The effect of the charge on neighboring objects is to induce an opposite charge on them, an influence sufficiently strong to actually lift a bit of paper to the glass rod. Any part of a circuit in a radio set, the potential of which is raised or lowered with respect to the potential in neighboring conductors, exerts its influence by drawing or repelling electrons in neighboring conductors. A condenser is a device especially designed to accentuate such electrostatic effects. Obviously, any change

of potential in a conductor in a radio set will cause potential changes in all near-by conductors. Warding off the influence of the electrostatic field is simple and the most elementary application of shielding will accomplish it. The electrostatic influence is reticited by placing a grounded conductor between any point where potentials rise or fall, and neighboring objects which are likely to be influenced by the electrostatic effects resulting therefrom. If a good conducting path is provided to the ground, the influence of the electrostatic field does not penetrate beyond the shield.

In a circuit in which there are changes in current taking place, a varying magnetic field surrounds the conductors. The extent of the magnetic field is determined by the intensity of the current and the form of windings used. It is not difficult to cause response in a detector circuit following two stages of radio-frequency amplification with a coupling of two feet between the second r. f. stage and the detector grid coil, provided the incoming signal is strong. The interactions taking place in radio receivers are surprisingly extensive and complex, every tuned circuit actually influencing every other tuned circuit. Such effects are minimized, but by no means eliminated, by skilful placing of parts so that these influences are neutralized.

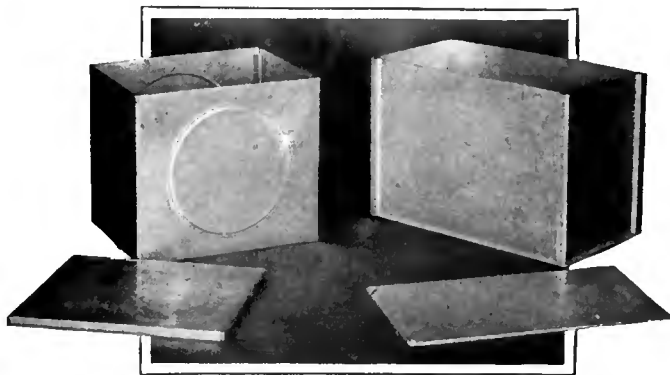

RADIO BROADCAST Photograph

INDIVIDUAL SHIELD CANS

Several manufacturers now supply them in knock-down form

circuit carrying a radio-frequency current is constantly surrounded by electromagnetic and electrostatic fields. The extent of these fields is proportional to the energy in the circuits. The greater the amplification, the greater the need for shielding or, in its absence, for great spacing between stages. With small amplification, no shielding is essential, although it may serve usefully even in a receiver consisting of but one stage of radio amplification combined with a detector. A receiver with four efficient stages of radio-frequency amplification, however, approaches the limit of practical amplification and

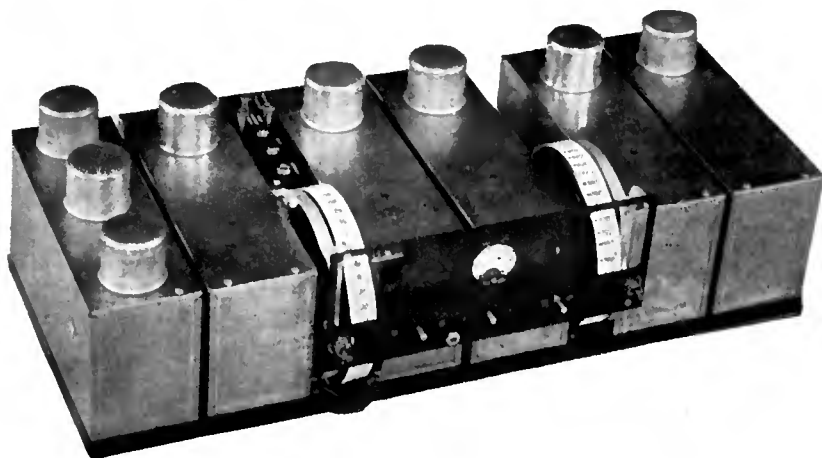

AN EXCELLENT EXAMPLE OF TOTAL SHIELDING

The five sections to the right all enclose tuned stages while the three audio stages are to the left

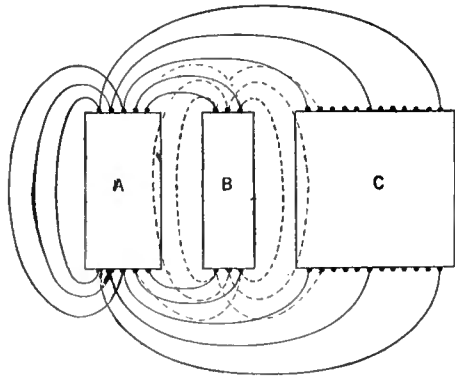

FIG. 1

With alternating currents of low frequency and through the audio ranges, the magnetic fields may be deflected by soft iron. The reason iron or steel reduces the extent of the magnet's field is because magnetic lines of force seek the easiest way and concentrate through the iron path so provided. The fields surrounding conductors carrying radio-frequency currents, however, are practically uninfluenced by the presence of iron or steel. Shielding accomplishes the constraint of magnetic fields, not by deflection or insulation, but by setting up equal and opposite magnetic fields; in other words, by magnetic neutralization. Recognition of this principle makes it easier to identify effective and ineffective shielding.

An elementary electrical theory calls to mind that a conductor within the influence of a changing magnetic field has an electric potential induced in it as a result. Suppose we have three coils, A, B, and C, as in Fig. 1, A being the primary and C the secondary of a radio-frequency transformer. A radio-frequency current in A induces a similar current in coil B, lagging half a cycle behind that flowing in A. The fields resulting from the current in B induce a potential in C, lagging half a cycle behind that in B. Now suppose these coils are so placed that the influence of coil A on coil C is exactly equal to that of coil B on coil C. The result would be two similar and equal magnetic fields, half a cycle apart, influencing coil C. Being equal and opposite to each other, each would neutralize the other's influence, so that their total effect would be nil.

A thick metal shield performs the same function as coil B in our illustration by having induced in it currents by any magnetic field playing upon it. These eddy currents, in turn, set up magnetic fields but, if the shielded conductor is sufficiently thick and of low resistance, the eddy currents are so diffused that the magnetic fields set up by them do not influence surrounding circuits. Even so, with five stages of radio-frequency amplification, the eddy currents are of such magnitude that the receiver is unstable.

It is clear that the effectiveness of shielding bears a close relation to the energy in the circuit. Since eddy currents are built up in the shield by radio-frequency energy withdrawn from useful purposes, the resistance of the shield should not be too high, or the tuning of the circuits will be broadened. Too thin shielding, or shielding of high resistance, broadens tuning and fails to eliminate magnetic interaction between circuits.

THICKNESS OF SHIELDING MATERIAL

PROFESSOR John H. Morecroft, in his comprehensive paper appearing in the August, 1925, issue of the *Proceedings of the Institute of Radio Engineers*, shows by a series of curves the influence of thickness of shielding upon its effectiveness. The general conclusion

of authorities is that, for the shielding of broadcast frequencies, copper at least $\frac{3}{32}$ of an inch thick should be used in order that resistance losses are not introduced into the tuned circuits. Aluminum, having lower specific conductivity than copper, must be $\frac{3}{16}$ of an inch in thickness, and brass $\frac{1}{8}$ of an inch thick to secure the same result. Copper is widely used for effective shielding because it is easily nickel plated to give good appearance, and is easily soldered. Aluminum has the advantage of light weight and good appearance, but is difficult to solder. Sheet aluminum of the necessary thickness, though half again as thick as the equivalent copper sheet, is the lightest of the three materials; copper $\frac{3}{32}$ of an inch thick is half again as heavy; brass $\frac{1}{8}$ of an inch thick is six times as heavy as aluminum sheet.

The good conductivity of shielding must not be limited to the shielding plates themselves, but also to the connections through which they are grounded. This becomes of increasing importance in succeeding radio-frequency amplifier stages. The detector stage of the Fred-Eisemann shielded set, following four stages of radio frequency, has special bonding between the de-

fectiveness by horizontal slits or cuts at points where eddy currents are likely to be induced. Morecroft states in his paper that the effect of a slit diametrically across a shield of copper 0.021 cm. thick reduced its effectiveness as a shield by four per cent. and a second diametric slit, at right angles to the first, subtracted another four per cent. from the effectiveness of the shield. While Mr. Morecroft's measurements were made at audio and low radio frequencies, it must be borne in mind that shielding seriously cut up with slits to accommodate wiring is not as effective as solid sheet. For example, in Fig. 2, a long slit in the base of a shield will confine eddy currents to the two legs at A and B, thus building up relatively strong fields at those points, influencing the tuned circuits of the adjacent stage.

A receiver having each stage confined in a can of suitable thickness and conductivity, may yet fail to accomplish the desirable results of shielding if the power supply leads, both of the A and B sources, carry radio-frequency energy from one circuit to the next. Such shielding is about as useful as a pail with a hole in the bottom.

The Stromberg-Carlson receiver, the pioneer

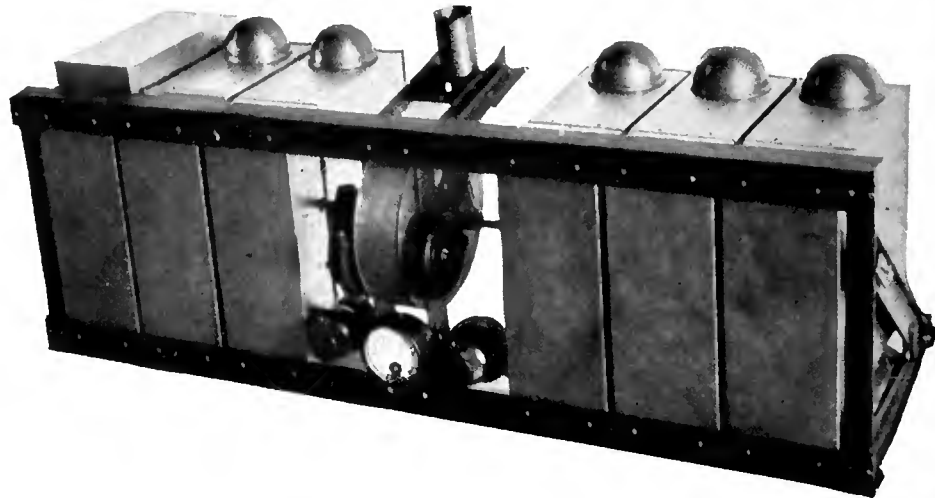

SELECTIVITY AND STABILITY ARE IMPROVED BY SHIELDING

Many modern commercial receivers are now totally enclosed in metal

detector and and that of the third r. f. stage to insure it good ground. Referring again to Morecroft's paper, he states: "An ordinary piece of copper mesh was used as a shield for different frequencies and the results showed very little shielding effect. A border of solder 0.5 cm. wide was put around the edge of this shield so as to make good contact between the ends of the wires, and the shielding was increased approximately seventy-five per cent."

You need, therefore, not only a shield of adequate thickness and conductivity, but also it must have good electric contact with the ground and with neighboring shields along all its edges. To quote Professor Morecroft again: "Any imperfect joint in the shield, which tends to constrain the eddy currents to restricted paths, will seriously interfere with the shielding obtainable."

Furthermore, shielding can be reduced in ef-

of fully shielded sets, has a 1-mfd. bypass condenser between the plus A and minus A filament terminals of each tube, and another condenser of the same size for carrying the radio-frequency currents to ground, thus confining the radio-frequency energy entirely within the cans of the radio-frequency amplifier. As a further precaution, a 200-henry choke is used in the detector circuit to keep all audio-frequency currents out of the B battery, while radio-frequency chokes are used in the r. f. plate power leads of each stage.

Speaking of these and other bypass and filtering precautions, Dreyer and Manson, in their valuable paper on the subject, delivered before the Institute of Radio Engineers, state that all of these are not necessary in a three-stage receiver but: "... they become of more and more importance the higher the total amplification, and all of them appear to be necessary in a four-stage receiver. Even with precautions of this type, there seems to be an upper limit to the amplification that may be obtained at the broadcasting frequency. This limit is not reached with a three-stage receiver but may be with a four-stage one. It appears to be due to radio-frequency potentials which build up upon the shielding of the last stage. These potentials are capable of feeding back energy to the antenna through the inherent capacity between these shields and the antenna."

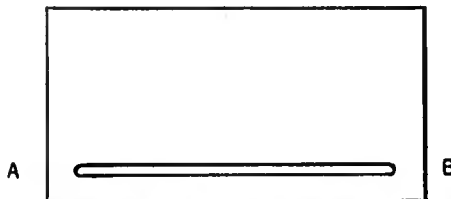

FIG. 2

An added advantage of bypassing and filtering of audio- and radio-frequency currents from the A and B power sources is that it minimizes the effect of resistance coupling in the B power source. Increased B battery resistance of old batteries, or that resistance inherent in B socket power devices, with receivers having well filtered and bypassed power leads, does not contribute any tendency to whistle.

NEUTRALIZATION SIMPLIFIED

BY THE observance of these elaborate precautions, applied to expensive receivers, the useful energy of receiving circuits is limited and confined to where it belongs. There being no magnetic or electrostatic interstage influences to consider, except that unavoidably introduced by the capacity between the grid and plate of each tube, the problem of neutralization is tremendously simplified. There is only one capacity coupling to neutralize and that practically independent of frequency. As a consequence, not only is perfect neutralization obtainable, but the influence of neutralization is more uniform throughout the frequency range. The receiver, consequently, delivers more even amplification over the entire wavelength band. Furthermore, the highest possible amplification per stage, by the use of r. f. transformers giving the largest gain, is made possible by shielding. The tendency toward oscillation at the high frequencies no longer limits the amplification of middle and lower frequencies. Thus we gain much greater sensitiveness by the aid of a correctly designed shielded receiver. Transformer design is largely a matter of compromise among selectivity, sensitiveness, efficiency, and tendency to oscillate. By elimination of the last consideration through effective shielding, the necessity for sacrificing the first three factors in favor of the last is practically done away with.

L. A. Hazeltine, commenting on Manson and Dreyer's paper, shows that we may select an r. f. transformer ratio which gives, within a few per cent., maximum amplification at resonance and, at the same time, gives twenty per cent. lower amplification at a frequency only ten per cent. off resonance. This applied successively through three or four stages gives a considerable advantage to a weak signal at resonance over a powerful signal ten per cent. off resonance. This accounts for the vastly superior selectivity of well-designed shielded receivers.

One of the rules of successful application of shielding is not to place any inductance too close to the metal shield itself. Look for at least an inch of separation between the shield, high potential wiring, and tuning inductances. The end of the coil is preferably so placed that it does not come up against a shielded plate, but at right angles to it. Variable condensers of higher maximum capacity are sometimes necessary in connection with completely shielded receivers. It is well to confirm when testing a shielded receiver, that tuning condensers of adequate size are used, by tuning

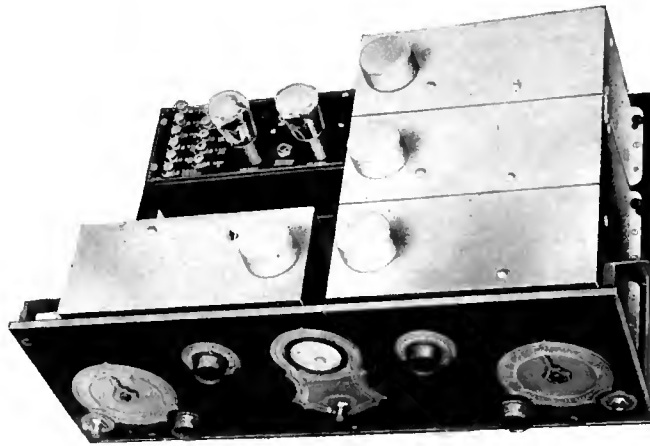

WHERE SHIELDING HELPS STABILITY

There are three stages of tuned r.f. in this receiver, a condition which calls for the utmost care in design. Shielding of the tuned stages greatly improves results

in to stations at both ends of the frequency scale.

As we have seen, the electromagnetic and electrostatic fields surrounding a radio-frequency circuit are proportionate to the strengths of the radio-frequency currents flowing in it. Receivers employing but one stage of radio-frequency amplification and a regenerative detector have most of their energy confined in the detector circuit with comparatively small currents flowing in the radio-frequency amplifier. A single sheet of shielding between the end or side of the radio-frequency coil next the detector coil is often sufficient to eliminate a great deal of the interaction occurring. With two stages of tuned neutralized radio-frequency amplification, adequately spaced, it is possible to eliminate any serious influence of interaction, if the coils are properly placed. A small shield between the radio-frequency transformers contributes to stability. But any attempt at three stages of r. f. without heavy, highly conductive, shielding, completely enclosing each stage, is bound to result in so much interaction that stability, selectivity, and high amplification per stage is quite impossible. With four stages of radio fre-

quency, we must not only meet the foregoing requirements, but also be certain that there is adequate bypassing of all r. f. and a. f. currents and, in addition, that filters are used in the power leads to further suppress any of these currents which tend to stray from their appointed paths.

The attainment of highest possible gain per stage is not so easily determined as the physical qualities of shielding which mark the well-designed receiver. However, any very marked indication of lower stability at the higher frequency end of the receiver than at the lower is one sign that shielding is not complete or that some element of design has not been successfully carried out. In testing a receiver, increase the filament brilliancy to the maximum and tune to the shortest wavelength of which the receiver is capable. If there is a tendency toward oscillation at that end of the spectrum, which disappears at the upper end, it is tell tale evidence that shielding has not been perfectly applied, or that the receiver is not properly neutralized.

Another significant indicator is the sharpness with which a near-by, high-power, local station is tuned out. With three or more well shielded stages, extraordinary selectivity without sacrifice of quality is attainable. This should manifest itself conclusively when tuning, both at the high and particularly at the low end of the frequency scale. The customary broadness of tuning experienced with average receivers at the upper wavelengths is due to reduced regenerative amplification and also to induction from the antenna and the first and second radio-frequency transformers upon the detector circuit. Good shielding should correct both of these undesirable effects.

Recapitulating, the obvious mechanical qualities of shielding are adequately thick shielding material of high conductivity, low resistance grounding and firm corner connections at all edges, absence of any extensive slits which tend to force eddy currents to a restricted path, and suitable placement of instruments in each stage at a sufficient distance from the shielding. Electrically, tuning condensers of sufficient capacity to cover the wavelength range and, for multi-stage sets, adequate bypassing and filtration of A and B power leads are necessary. In performance, watch for equal stability and sensitiveness throughout the frequency range and, with multi-stage radio-frequency receivers, for great selectivity even with high-power locals. There are an encouraging number of high-grade shielded receivers on the market which fulfill these exacting requirements.

Bibliography

John H. Morecroft and Alva Turner, "The Shielding of Electric and Magnetic Fields," *Proc. I. R. E.*, August, 1925.
 John F. Dreyer, Jr. and Ray H. Manson, "The Shielded Neutrodyne Receiver," *Proc. I. R. E.*, April, 1926.
 L. A. Hazeltine, Discussion of Above, *Proc. I. R. E.*, June, 1926.

SOME ADVANTAGES OF SHIELDING

SHIELDING Having the Following Properties:

1. Thickness adequate to assure dissipation of all eddy currents.
2. Conductivity of a high order to prevent resistance losses.
3. Bonding and grounding of a character avoiding resistance losses and concentration of eddy currents.
4. Solidity of material, by absence of long cuts or slits for wires.
5. Completeness, by confinement, through efficient bypassing and choking of power leads, of each circuit's magnetic and electrostatic fields within its respective shield.
6. Spacing between shields and coils sufficient to prevent excessive electrostatic capacity at minimum tuning adjustment and to minimize eddy currents in the shield.

—PERMITS the Design of a Receiver with the Following Properties:

1. Compactness, allowing the embodiment of many stages of amplification in a relatively small cabinet.
2. Higher permissible amplification because relatively larger radio- and audio-frequency currents can be conducted through circuits without interaction.
3. Stable neutralization throughout the wavelength range with more equal amplification of both low and high radio frequencies.
4. High selectivity, resulting from filter effect of added radio-frequency amplifier stages.
5. Elimination of external pick-up except that introduced by the antenna, reducing power line influence, static, and interference from near-by high-power stations.
6. Greater mechanical strength and reduced resistance losses from dust and corrosion.

Building ⌘ an Electrical ⌘ Phonograph

Suggestions for a High-Quality Combined Radio and Electrical Phonograph—Making a Baffleboard Loud Speaker—An A. C. Amplifier for the Electrical Phonograph

By
JAMES MILLEN

THERE are at least two distinct angles from which the design of an electrically operated phonograph may be approached. The first considers the phonograph as a companion instrument and component physical part of a high-grade radio receiver, while the second views it as an instrument entirely separate from the radio.

From the first point of view, it is hard to find as a basis for the design of the radio and electric phonograph a more satisfactory combination than that described in the January issue of *RADIO BROADCAST* by John B. Brennan and the writer. A two-tube "Lab" circuit receiver and a separate high-quality lamp socket powered resistance-coupled amplifier form a nucleus about which a console cabinet, record turntable, pick-up, needle scratch filter, and the other essential components of the combined radio-phonograph, may be gathered.

The writer's own machine, as shown in the accompanying illustrations, consists of a re-vamped Pathé console arranged to accommodate the receiver proper as well as the automatic relay switch and A power-supply unit in the left-hand record compartment. In the rear of the central compartment, formerly taken up by the horn, is placed the amplifier, while immediately behind the grille work is mounted a baffleboard type loud speaker. The electromagnetic pick-up is mounted in place of the mechanical one in the turntable compartment and the leads brought down through the hollow base and the opening to which was formerly fitted the neck of the horn. Such an arrangement is very satisfactory and if the reader decides to use this set-up, he should proceed as outlined in this article.

Before starting the cabinet work associated with the re-vamping of a console, remove the shelf carrying the turntable and motor. In almost every phonograph, this shelf may be removed by first removing the crank, and then unfastening the screws that hold the shelf in place. The entire back of the cabinet may generally be removed by taking out a few more screws. It is very seldom

that the back is glued in place. However, should the back panel be glued, or prove difficult to remove, then leave it in place, as the primary reason for taking it off is to facilitate the removal of the horn.

The horn may, with a little juggling, be unfastened and removed, when necessary, through the opening made by the removal of the motor shelf. The horns are usually fastened by means of wood screws but without glue.

To remove the partitions in the record compartments is not always quite as simple as removing the horn. In the case of the Pathé console shown in the illustration, it was necessary to slightly raise the entire left-hand section of the top, which is held in place with wood dowel pins. A small piece of wood was placed along the under edge of the top and gently tapped with a hammer until the glue holding the dowel pins became loose.

After the removal of the partitions, the panel for the radio set may be cut and fitted into place, keeping in mind that it must be set back sufficiently far to permit the closing of the compartment door without hitting any of the knobs. In many instances it will be found that one of the veneer partitions removed from the former record compartment will make a very fine panel for the radio set.

Should some readers have the parts for, or prefer to use some other type of set, such as the "Universal," the Browning-Drake, or any of the many other receivers, then such a receiver may of course be used in place of the *RADIO BROADCAST* "Lab" receiver. It is essential, however, that it be equipped with a good audio amplifier with an output power tube, or, if a separate amplifier is used, the amplifier may well be any of those combination power supply and high-quality audio channel units described by the writer in the last few issues of *RADIO BROADCAST*.



RADIO BROADCAST Photograph

THE AUTHOR'S RADIO-PHONOGRAPH COMBINATION

The circuit arrangement of this particular layout is shown in Fig. 2, the combination illustration on page 89. The cabinet originally housed only the Pathé phonograph

The amplifier unit shown in the photographs, and described in the January *RADIO BROADCAST*, consists of a stage of impedance and two of resistance coupling, with a phase shifting grid choke in the last or power stage. The power supply uses a Raytheon BH tube. Filament current for the power tube is obtained from a special filament winding on the power transformer while that for the first two amplifier tubes, as well as the tubes in the receiver proper, is obtained from an A power unit, such as the Westinghouse "Autopower." This latter consists of a battery and trickle charger combination. The receiver should be so constructed that the output of the detector tube may be fed directly into the amplifier unit.

The detector tube socket should be of the spring suspended type, such as the Benjamin, and a lead or heavy rubber cap or weight placed on top of the detector tube in order to prevent microphonic howling when the loud speaker is mounted in the same cabinet.

Some constructors may wish to place a lamp on top of the cabinet after the construction work has been completed. It will generally be found that when this is done some hum will be induced in the receiver due to pick-up from the lamp cord. Placing the lamp cord in a different position may eliminate the trouble but in those cases where this is not effective it will be necessary to use a shielded receiver. Also, when a lamp is placed on top of the console, it tends to place the tuning control in a shadow and for this reason any constructor who expects to top off the job by using a lamp on the console will do well to use illuminated dials in the receiver.

THE LOUD SPEAKER

GOOD loud speakers are of two types; the large cones, such as the Western Electric, and the small baffle cones such as those due to Messrs. Rice and Kellogg and used in the "Electrola" and "Panatropé." This latter type of loud speaker is particularly well suited, because of its small size and method of mounting, for use in a home-constructed electrical phonograph. Baffle cone loud speakers are made by several different loud speaker companies, such as RCA, Rola, Magnavox, and Peerless.

If an RCA No. 100 loud speaker is available it should be removed from its case and fastened directly to a baffleboard which should be constructed as follows:

It should be about $\frac{1}{2}$ inch thick and of white pine or other soft wood. A round hole, approximately 8 inches in diameter, should be cut in the center of the board and so beveled that the outside diameter is slightly larger than the inside diameter. The cone frame-work is then bolted in place so that the cone is centered behind the hole.

Very thin veneer should not be used as a baffleboard as it may prove to be resonant at some frequency within the audible range.

The baffleboard may be mounted so as to close the opening of the phonograph made by the removal of the horn. In mounting the baffleboard, it should be set back far enough to permit replacement of the silk-covered grille work if desired. By making the baffleboard slightly larger than the opening, it may be mounted from the rear in much the same manner as a glass is inserted in a picture frame. The filter circuit contained in the small box in the bottom of the RCA No. 100 loud speaker case should be disconnected from the loud speaker unit and discarded.

A large opening, which may well be covered with a light dust-proof silk curtain, should be provided in the rear of the compartment in which the cone is placed. Such an opening will be found to improve materially the acoustical performance of the loud speaker.

In the case of the Pathé console, it was found necessary to raise the shelf on which is mounted the motor and turntable, a quarter of an inch, in order to place the amplifier under the motor. The only difficulty encountered in this process was the necessity of enlarging the hole through which the crank passed.

While it is desirable to so place the amplifier that the controls are readily accessible, such a location is not of prime importance, as once the controls have been properly set, they will require no further attention.

When the mechanical pick-up is removed, a large hole is exposed through which the neck of the horn formerly passed. By mounting the electric pick-up in the same place as the former one, this hole is covered. Furthermore, the cord from the pick-up to the control switch may be brought down through a hole made in the base of the pick-up stand directly over the hole in the turntable shelf, thus exposing no wires. In mounting the pick-up, fasten its base in such a position that the needle, when swung to the center of the record, will rest in the exact center of the turntable shaft. Most pick-ups have a volume control located on the base of the stand. If not, then a 25,000-ohm resistance, such as a Royalty or the Centralab Radiohm, may either be mounted in the turntable compartment or on the panel of the receiver. The pick-up selected must be capable of high-quality reproduction or the best results cannot be expected. The Pacent, the Grimes "Gradeon," the Crosley "Merola," the Baldwin, and the Bosch "Recreator," have been found satisfactory.

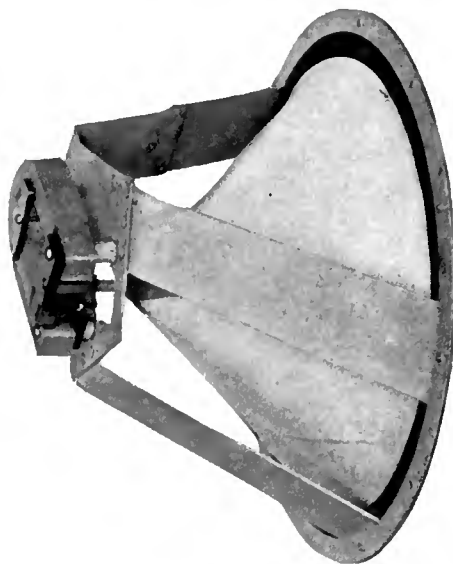

THE RCA 100 CONE

Few will recognize this popular loud speaker as shown here. It is stripped of its surrounding bronze metal case and gauze front and back. An excellent baffleboard loud speaker can be made with this unit, as explained in the text

THE SCRATCH FILTER

THE scratch filter, as described in detail in the May article, is for the purpose of electrically removing from the output of the loud speaker the "hiss" due to the contact of the needle on the record.

While the connection of a 0.006-mfd. fixed condenser across the output of the pick-up or input to the amplifier, will remove this noise, such an arrangement will also remove many of the higher audio frequencies and thus lower the quality of reproduction. For this reason an

electrical filter circuit tuned to stop the passage of only those currents in the neighborhood of the scratch frequencies is used.

The difficulty in completely eliminating the scratch lies in the fact that the scratch frequency is not any one frequency, but quite a wide frequency band. If, however, the filter circuit is tuned to approximately 4500 cycles, the greater part of the scratch noise is removed without the sacrifice of tone quality. The residual hiss, when a scratch filter is employed, is practically unnoticeable and cannot be detected except for the first few seconds or so before the music starts.

Such a device may either be purchased as a complete unit (one is made by the National Co.), or may be home constructed from a choke coil and condenser so selected as to be most effective at about 4500 cycles. This frequency peak should be somewhat "broadened" by the use of a very small quantity of iron in the construction of the inductance. A scratch filter can be assembled by employing a 1500-turn honeycomb coil with a 0.008-mfd. fixed condenser. The circuit for the scratch filter is shown to the extreme left of Fig. 1.

A Yaxley No. 63 triple-pole double-throw jack switch is mounted at some place convenient and so connected, as shown in Fig. 2, that when in the central position, both the phonograph and the radio are shut off, while on one side the radio is turned on and the other, the pick-up system is thrown into use.

One pole controls the input of the amplifier, either radio or phonograph, while the other two control the A power either to both the amplifier and the radio set or just to the amplifier alone. A Yaxley automatic relay switch is used to control the 110-volt power, to both the amplifier and the "Autopower." The switch on the front of the "Autopower" must at all times be kept in the "off" position and connections of the two A leads soldered directly to the battery terminals and not fastened to the terminals provided on the "Autopower." This arrangement is necessary in

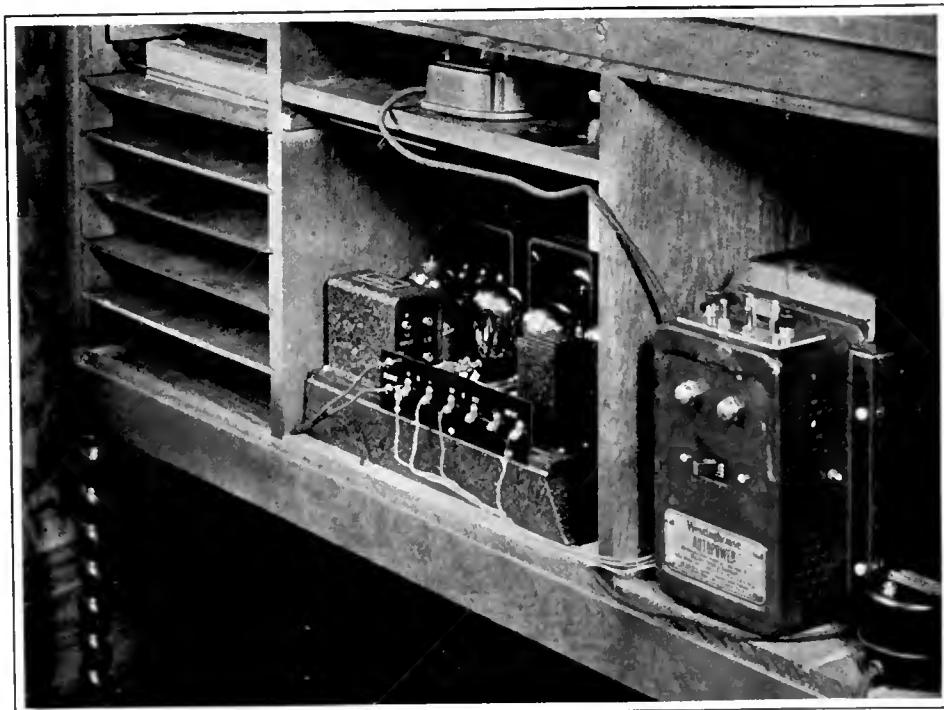

RADIO BROADCAST Photograph

A REAR VIEW OF THE AUTHOR'S OUTFIT

This picture gives some idea of the simplicity of the equipment necessary for the phonograph-radio combination. This is a rear view of the outfit shown in the photograph at the top of the first page of this article. The two-tube "Lab" receiver is hidden in front of the Westinghouse Autopower. Fig. 2 is the circuit diagram for this particular arrangement

order to use the relay switch for automatic control rather than the manual switch on the front of the A power unit, which is generally rather difficult to get at.

And now, after the above changes have been made, we will have a truly modern instrument as far as performance is concerned. The only "antique" device in the system being the spring motor of the phonograph. Though the preferred arrangement for an a. c. operated phonograph is the use of an induction motor to operate the turntable, such motors of the proper size are rather difficult to obtain. Most phonograph dealers, however, stock excellent motors of the universal type, which, as they are only run when the radio receiver is not in operation and will therefore cause no interference, are entirely satisfactory. Such motors cost from \$15.00 to \$30.00, depending upon the type, and generally an allowance is made for the spring motor if it is turned in at the same time.

If the spring motor is retained in the phonograph then the amplifier should be so placed that the Raytheon and power tubes, which become quite warm in operation, are not directly under the motor, for such placement might result in the graphite in which the spring is packed being melted.

If the spring motor is replaced with an electric drive, then, of course, no thought need be given to the location of the amplifier.

ELÉCTRIC PHONOGRAPH WITHOUT RADIO

THERE are doubtless some who wish to modernize their old phonograph and make it electrically operated but entirely independent of the radio installation. Such a person will do well to construct a compact power amplifier, preferably lamp-socket operated, or to make up an ordinary amplifier and use it in conjunction with a B power unit capable of supplying sufficient voltage for a power tube.

Several manufacturers are at present working on completely a. c. operated amplifiers which

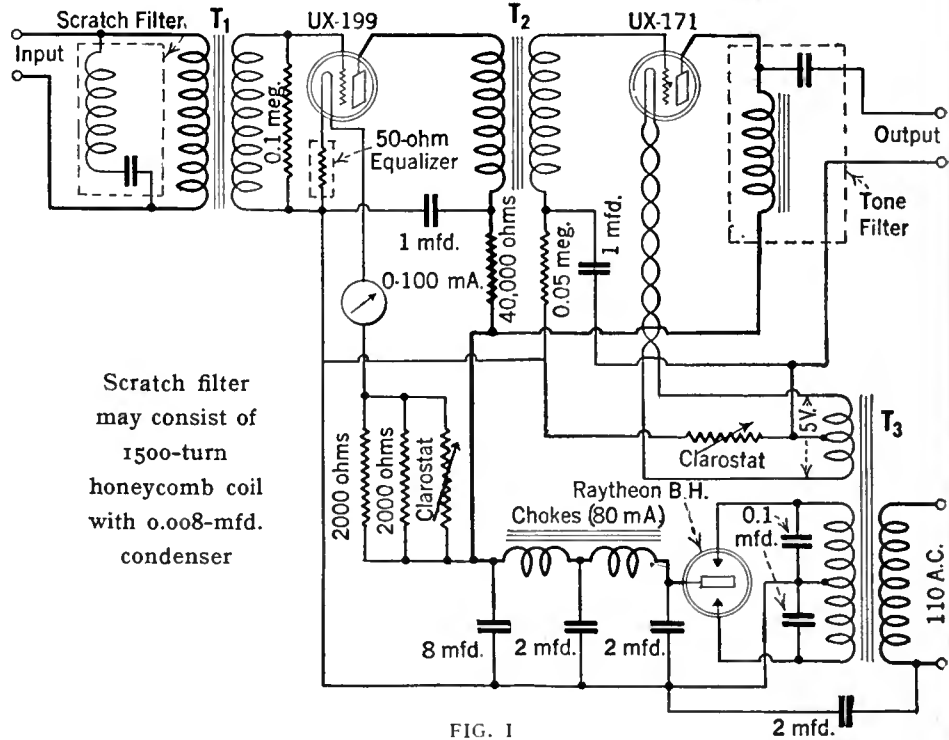

Scratch filter may consist of 1500-turn honeycomb coil with 0.008-mfd. condenser

FIG. 1

For those who wish to build an amplifier solely for the purpose of using it with the phonograph, the diagram above should be followed. Both of the amplifier tubes obtain their A, B, and C potentials from the mains, no batteries whatsoever being required. A list of parts is given in the text—on this page and a photograph is shown below

will be satisfactory for use in conjunction with a phonograph pick-up. At the present time, however, there are no completely a. c. operated units on the market. It is, of course, possible for anyone with the necessary apparatus to home construct an a. c. operated power amplifier. The author has constructed such an amplifier and it gives very satisfactory results. The circuit diagram is

given in Fig. 1. This amplifier consists of an input transformer, T₁, with a scratch filter connected in its primary, a first-stage amplifier tube of the 199 type supplied with filament current from the filter system, a second transformer, T₂, and a power tube feeding the output, to which should be connected a high-quality cone type loud speaker. The list of parts used in constructing this amplifier is given below:

National Power Transformer . . .	16.50
National Filter Choke, Type 80 . . .	10.00
National Filter Condenser Block . . .	17.50
National Tone Filter . . .	8.00
National Scratch Filter . . .	5.50
1 Pair AmerTran DeLux Transformers . . .	20.00
2 General Radio Sockets . . .	1.00
2 Clarostats . . .	4.50
2 1-Mfd. Tobe Condensers . . .	2.50
1 2-Mfd. Tobe Condenser . . .	1.75
2 2000-Ohm Wire-Wound Heavy Duty Resistors . . .	2.50
1 0.1-Meg. Metalized Resistor75
1 0.05-Meg. Metalized Resistor75
3 Mounts . . .	1.05
1 50-Ohm Fixed Filament Resistor . . .	1.00
1 40,000-Ohm Resistor . . .	1.10
1 Weston 0-100 Milliammeter . . .	8.00
1 Terminal Strip75
1 Baseboard50
1 Set Tobe Buffer Condensers . . .	1.40
1 Ceco Type B (ux-199) . . .	2.00
1 CeCo Type J-71 (ux-171) . . .	4.50
1 Raytheon BH . . .	6.00
TOTAL	\$117.55

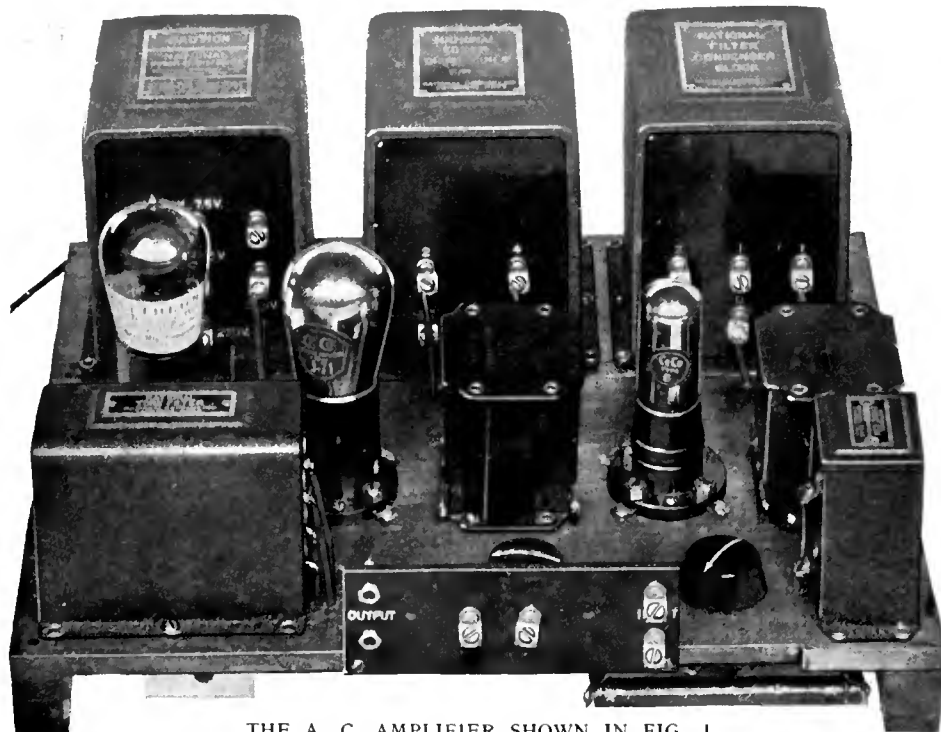

THE A. C. AMPLIFIER SHOWN IN FIG. 1

With this amplifier, a pick-up device, and good cone loud speaker, we have all the essentials for converting a phonograph of the mechanical reproduction type to one of the electrical reproduction form. No batteries are required—not even the usual C batteries. The two center binding posts are for connecting the milliammeter used to adjust the filament current of the 199 tube. The others are the input and output connections

In this amplifier two transformer stages are used so as to keep low the number of stages of amplification required. It is not essential that the parts specified be used, and other high-grade apparatus manufactured by other companies will be quite satisfactory provided their electrical characteristics are satisfactory.

It is essential that the chokes employed in the filter system be capable of giving satisfactory results with 80 milliamperes flowing through

them. Two 2000-ohm resistors are employed in parallel rather than a single 1000-ohm unit, first because 2000-ohm units are more readily obtainable, and secondly because two 2000-ohm units in operation will heat up much less than a single 1000-ohm resistance.

C voltage for the 199 tube is obtained by taking the voltage drop across a 50-ohm resistance in the negative filament lead of this tube, while C voltage for the power tube is obtained by utilizing the voltage drop across a resistance in the lead to the center tap of the power tube's filament transformer. With this arrangement there is no common interstage coupling in the C bias resistances and this is distinctly advantageous in preventing distortion. Care will be necessary in adjusting an amplifier of the type illustrated in Fig. 1, to make certain that the filament current in the 199 tube is exactly 60 mils. Unfortunately it will be found that using the resistance units that are available the current through the 199 will increase as the resistances heat up. It is therefore best to properly adjust the 199 filament after the amplifier has been in operation for about ten minutes. An occasional check on the filament current through the 199 should be made to make

certain that it is not exceeding the rated 60 milliamperes. The two 2000-ohm resistors are shunted around the Clarostat controlling the filament current of the 199 in order to reduce the current that must be passed by this latter resistor. Also, the wire-wound resistor has a positive temperature coefficient whereas the Clarostat has a negative temperature coefficient and the combination of these two tends to neutralize each other and therefore keep at a minimum the variation current that occurs as the resistors heat up.

It is not at all essential that the amplifier be included in the phonograph proper, and the installation will be made much simpler if the old phonograph is not disturbed and the amplifier placed instead in a small external cabinet of its own. The pick-up can be mounted so as not to disturb the mechanical pick-up ordinarily used with the phonograph. Just how the installation is arranged will depend entirely upon the individual taste and desire of the constructor. Electrically, one arrangement is just as satisfactory as the other.

A great deal of information prepared by the author regarding the construction of satisfactory

amplifiers can be obtained by glancing through several recent issues of RADIO BROADCAST (the January, February, March, and April issues) in which many different types of units have been illustrated. In the March issue of RADIO BROADCAST will be found a description by John B. Brennan of a simple two-stage transformer-coupled amplifier that might be used in conjunction with a separate B power unit to operate the loud speaker.

GROUND CONNECTIONS

A ground connection to the negative side of the filter circuit is absolutely essential. In most instances this connection may be obtained by connecting through a 2-mfd. condenser to one side of the 110-volt line as shown in Fig. 1. The 110-volt line connections may have to be reversed to see which way is best. This is readily accomplished by merely plugging into the lamp socket or base outlet first one way and then the other.

In conclusion, the writer wishes to emphasize the importance of using the new electrically cut records for obtaining the best of results with the electric phonograph.

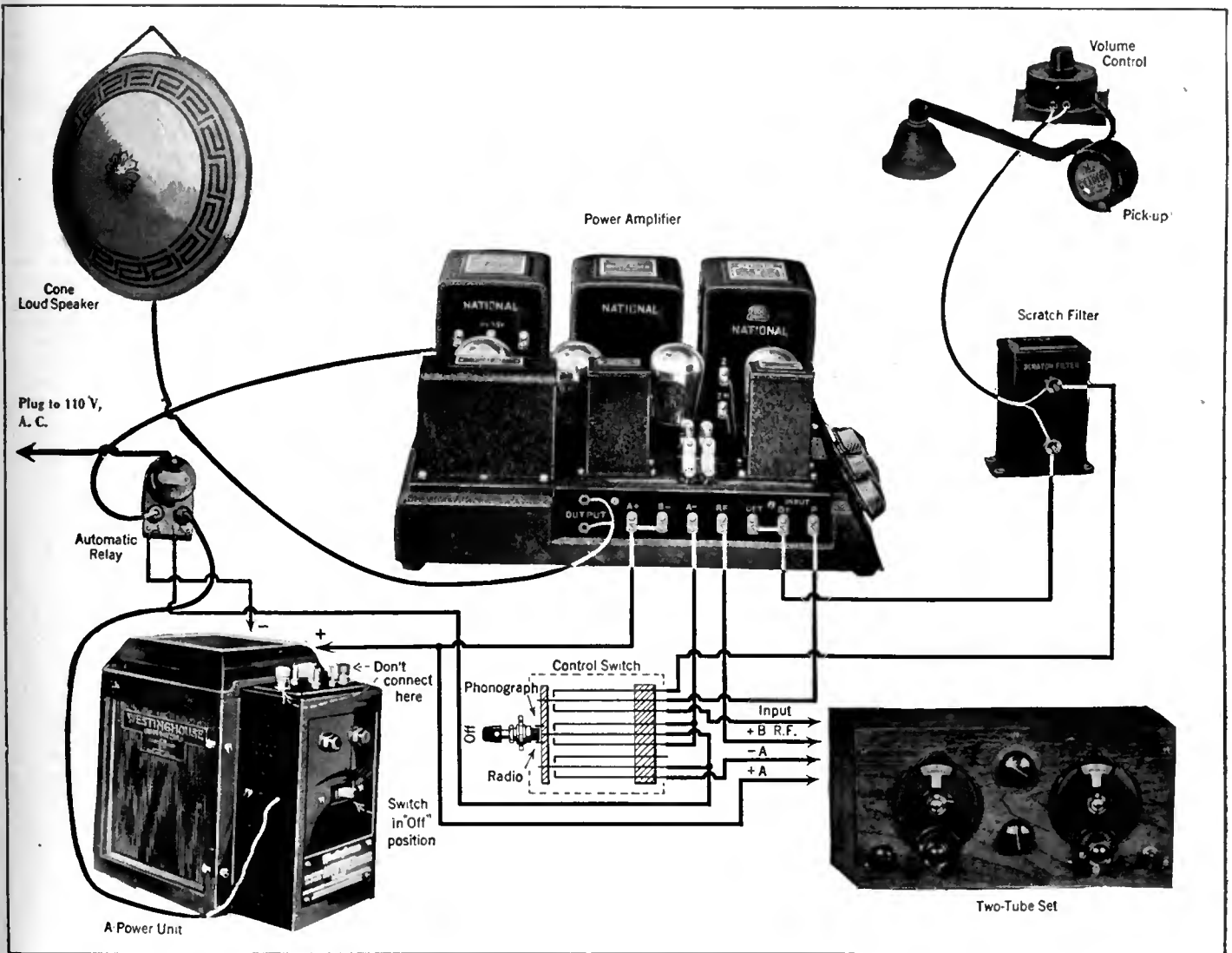
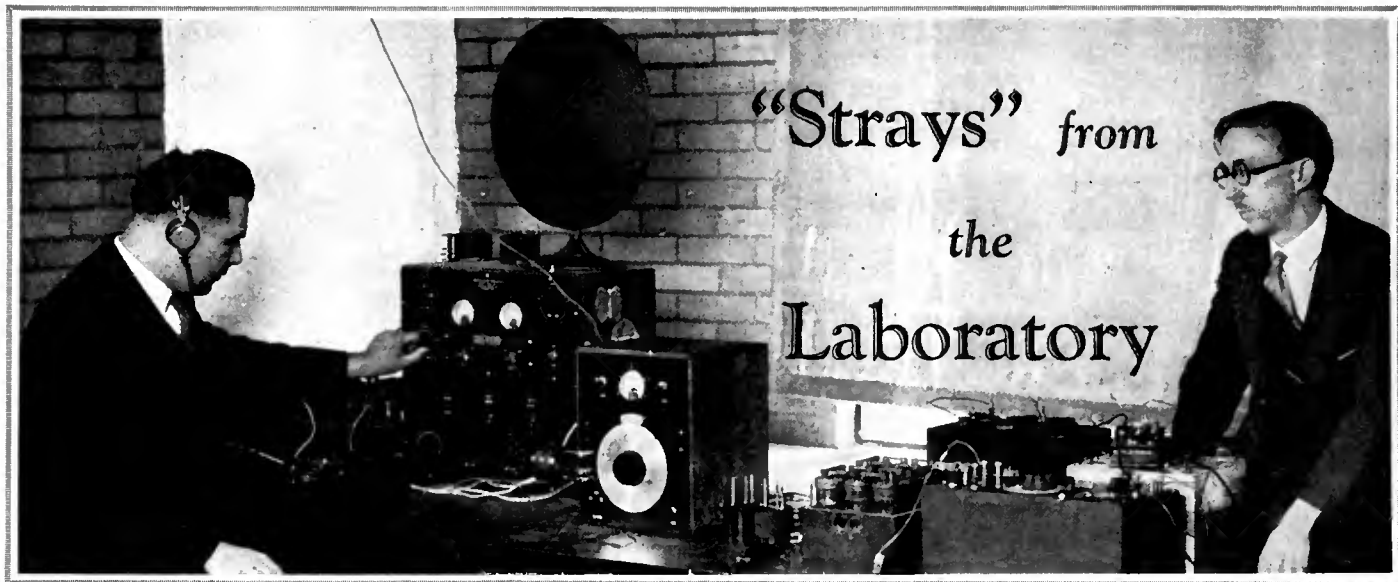

FIG. 2

This is the layout of apparatus recommended by the author for a combination electrical reproduction phonograph and radio, and employed by him in the phonograph illustrated on pages 86 and 87 of this article. The power amplifier was described in RADIO BROADCAST for January of this year, as was also the two-tube "Lab" receiver. By a simple turn of the triple-pole double-throw Yaxley jack switch (marked "Control Switch" in this diagram) either the phonograph or radio receiver is connected to the power amplifier, while a central position of the switch disconnects both. The automatic relay switches either the trickle charger or B socket-power device to the electric light mains, depending on whether the outfit is in use or not. Although this illustration shows a cone loud speaker (which may certainly be used) the author explains the construction of a baffleboard loud speaker in the text



“Strays” from the Laboratory

Growth of the Laboratory

RADIO BROADCAST Laboratory began its existence in its present form about the beginning of 1925. There were several reasons why a well-equipped and well-staffed laboratory was necessary. In the first place, nearly everyone who manufactured any kind of electrical apparatus, or automobile accessories, or did a seasonable business of any kind, had in some way or other got into the radio game. These manufacturers found it necessary to advertise their products in nationally known magazines with the result that the advertising staff of RADIO BROADCAST and the fellows that set type downstairs did a flourishing business. Since very few people knew much about radio—even in 1925—the sky was the limit to what a manufacturer could say about his product with the moral certainty that no one could catch him up on it. As a matter of fact the manufacturer himself probably believed what his advertising stated because he, too, was in a new field with little or no background of past experience.

About the middle of the 1925 season, however, a change was taking place. Already there were manufacturers in the field who were more conscientious and readers were becoming more critical—and a bit wary.

To protect the readers, not only of RADIO BROADCAST, but of all Doubleday-Page publications which ran radio advertising, and to protect those manufacturers whose products were wheat from those who made mostly chaff, as well as to aid the latter in case they desired technical advice, the Laboratory became a necessity. Soon the entire “Quality Group,” consisting of *World's Work*, *Harper's Magazine*, *The Atlantic Monthly*, *The Golden Book*, *Scribners*, and *Review of Reviews*, availed themselves of the Laboratory's service so that their advertising pages too could be protected.

It was also true that radio circuits were coming out at that time in all radio publications so thick and fast that only a few readers could keep up. Here again it had become necessary to scrutinize carefully, to test receivers before they were described, and to develop circuits with the certainty that they were technically correct. Here was another crying need for a well-equipped laboratory.

Due to the far-sighted policy of the publishers of RADIO BROADCAST, the Laboratory was well equipped from the start—and this equipment has steadily increased. It is now possible to make practically any radio- or audio-frequency meas-

urement with the aid of instruments that are always on hand in the Laboratory.

The very first task of the Laboratory is representative of what the staff has done from the time of its inception. Several pages of lurid advertising were sent in from a manufacturer of tubes for insertion in RADIO BROADCAST. These several pages contained some very exaggerated statements which, when boiled down, came to these claims:

These tubes require half the battery current and deliver twice as much volume. Distance doubled. Will last indefinitely.

A simple test in the Laboratory did indeed reveal the fact that the plate current of the tubes was about half that of a normal 201-A tube under the same conditions of filament voltage and current. So far, so good. In a receiver, however, the volume was “way down,” as was to be expected. The filament wire was poor, having low emission, which gave the tubes a high impedance.

When the advertising was rewritten to conform with more reasonable claims, the advertising manager of the manufacturer said “nothing doing” in emphatic tones, and the magazine lost the advertising.

Not long after, the largest retail store in New York refused to sell these particular tubes, and in a few months the manufacturer was out of business. During this time various other publications ran the advertising without any hesita-

tion although they claimed to have tested and passed all apparatus before accepting advertising.

Since that time the Laboratory has tested tubes of every manufacturer known to be building tubes in the United States. Not only have tubes come from the manufacturer for test but nationally known manufacturers of receiving sets have relied upon the Laboratory for information regarding tubes that could be recommended to their dealers and jobbers. Some tube manufacturers have sent representative lots of tubes as often as once a month for two years.

As a clearing house for unbiased technical data and information, the Laboratory soon became well known. It was possible to obtain data here that were untainted by manufacturing jealousy or secrecy. Representative apparatus from every manufacturer of note was examined in the Laboratory and data kept on file. It was possible for dealers and manufacturers to have various units tested in the Laboratory without the expense of building a laboratory of their own.

For example, a builder of an “extraordinary” new loud speaker came to Garden City bringing with him his inventor and one of the strangest contraptions we had seen. It looked like a butter bowl and was guaranteed to be more sensitive than any existing loud speaker. The inventor, who had little to say, was touted as having designed the Western Electric 540-AW cone which, we decided, was to be the basis of comparison.

Our “beat” oscillator, whose frequency is continuously variable from zero to 20,000 cycles, was wound up and applied to the two loud speakers in turn, and everyone noted when, in his estimation, sound could be heard from the 540-AW, and when the “butter bowl” took interest in the proceedings. The same process was repeated at 1000 cycles but with varying input voltages. The Western Electric cone could be heard long after the “butter bowl” was perfectly dead, not only with respect to frequency but to input voltage as well—all of which did not speak well for the inventor who, as he claimed, was responsible for the 540-AW.

“What do we care,” said the manufacturer, “it's price that counts. People won't know the difference. I'm going to sell a million of these.”

That loud speaker never came on the market. In the two years and a half that the Laboratory has existed, its activities have gradually changed. Organized to protect the advertising pages of RADIO BROADCAST and other

EVER since its establishment, the RADIO BROADCAST Laboratory has served as a means of contact between our readers, the work of the manufacturer, and indeed, the entire technical field of radio. It is the purpose of these pages to extend that contact by presenting an opportunity for the Director of the Laboratory and his associates to discuss various subjects of technical interest in a way which should be of greatest value to our readers. “Strays” from the Laboratory will treat of a wide range of subjects—suggestions for productive fields of experiment, reference to interesting developments of manufacturers, brief abstracts of important technical articles, and suggestions from readers.

—THE EDITOR.

magazines, it was only a question of time until the chaff manufacturers were weeded out, and those who made wheat remained. There are few radio junk manufacturers who advertise nationally. Some newspapers still carry considerable wildcat claims, especially in their Saturday radio sections, and some magazines dig up advertising of this nature, but the Quality Group and RADIO BROADCAST no longer worry.

In those two years and a half the magazine has lost enough advertising to make the salesmen weep, but in nearly every instance the manufacturer went out of business before the accounting department could have collected, had the magazine run the copy.

At the present time the duties of the Laboratory staff are many and varied. It still exercises a strict censorship over advertising; it examines and tests all manner of radio equipment—every piece of apparatus that is described in RADIO BROADCAST for home constructors is put through its paces. It has complete laboratory tests on two thousand tubes from nearly one hundred manufacturers; data on socket power devices, many of which never saw the daylight of a dealer's shelf; life tests on batteries and tubes; tests on condensers, resistances, and audio transformers. The staff scans radio and scientific periodicals of this and many foreign countries in search of material for its clientele—readers of the magazine.

In such foreign papers the staff finds material that delights the heart of any one who is interested in radio, and an attempt will be made to bring the gist of these articles to the readers of RADIO BROADCAST through this department every month as well as news that floats in on all manner of carrier waves, news from manufacturers, from technical laboratories, from amateur stations, and all other sources of radio information and trade gossip. It is the staff's fervent hope that these pages will bring the Laboratory into closer touch with those who are seriously interested in radio engineering and experimenting.

The Facts About the A. C. Tube

THE New York public, and that of other cities, has been stangely upset by an announcement, more or less premature, about the RCA's new tube that uses raw a. c. and, as the papers say, "eliminates all batteries." It seems that at every opportunity the papers use that phrase as though they had a grudge against batteries. Of course the tube is reported as "revolutionizing radio," another pet phrase.

The statements of Mr. Elmer Bucher, general sales manager of the Radio Corporation, and Herbert H. Frost, general sales manager of E. T. Cunningham, Incorporated, the following day, are significant, and will allay the fears of all who see in this news story the utter destruction of present plans for the coming year. The unipotent cathode tube has been known for years and engineers are excited periodically by reports of tubes with amplification factors of 20 and plate impedances of 2000 ohms, for such seems possible with tubes of this type. Many efforts have been made to bring it to a point of reality. The nearest approach is the McCullough tube. Mr. Frost says in the New York Times of March 26th:

Considerable publicity has been given this week to a so-called new a. c. radio tube. This alleged development has been designated as "revolutionary." The following statements and claims for this tube appeared in the news article in one of New York's leading morning newspapers on Wednesday, March 24th:

"Batteries and current supply devices will be dispensed with in broadcast receivers by a new alternating current tube . . ."

"... a revolutionary development . . ."
"The tube seen here yesterday was marked UX-225."

"... an alternating current detector and amplifier tube which could be used in direct connection with the 110-volt house lighting sockets in much the same fashion as an incandescent lamp, thereby dispensing with all B batteries, trickle chargers, storage batteries, dry cells, and current-supply devices, such as A and B eliminators."

"... 1927's greatest contribution to the revolutionary developments in radio."

"... a set which will not require batteries or current supply devices."

"The necessity for batteries and battery eliminators is obviated. . ."

Mr. Frost continues:

Type CX-325, our equivalent of UX-225, referred to above, has been in an experimental and developmental stage for nearly two years. Its output and capabilities are similar to those of our well-known type CX-301-A. In CX-325 we are attempting to replace the filament with a cathode heated directly by house a. c. supplied through a step-down transformer. When and if successful,

PRESENT AMERICAN PLAN	REVISED PLAN	DESCRIPTION
UX-190	3V106	Dull Emitter—General Purpose.
UX-120	31V12	Dull Emitter—Power Amplifier.
UX-201-A	51X25	Five Volt—General Purpose.
UX-112	51X50	Five-Volt Power— $R_p=6000$.
UX-171	51V50	Five-Volt Power— $R_p=2500$.
UX-210	71X125	Seven-Volt— $R_p=6000$.
UX-216-B	7.5R125	Half-Wave Rectifier.
UX-213	{ 5R200 } { 5R200 }	Full-Wave Rectifier.
UX-876	50B170	Ballast Tube.
UX-174	90C50	Protective Tube.
UX-200-A	5D25	Detector (Vapor-Filled).
UX-877	{ 5P20 } { 3P90 }	Protective Tube.

this tube would eliminate the A battery, substituting raw a. c. It will not eliminate the B and C batteries, or B eliminators. This tube has not yet reached a commercial stage. It is difficult to manufacture and would have to sell at a price from \$6.00 to \$9.00 each. It is our opinion that the practical difficulties connected with the manufacture of CX-325 will prevent it ever being commercialized. If perfected, it could not by any stretch of the imagination be called a revolutionary development. The CX-325 tube could not be used in present equipment without substantial wiring changes, and then would not improve reception but merely eliminate the A battery.

Crystal-Control on Short Waves

ONE OF a number of excellent papers recently delivered before the Radio Club of America was the work of an old time amateur, Mr. C. R. Runyon, Jr., and described the equipment of his more or less "high-powered" amateur short-wave station. As is the case with many of our best stations, Mr. Runyon's 2 AG is crystal controlled, which brings up a point that many amateurs evidently debate among themselves: Is crystal control worth while?

A quartz-controlled transmitter is simply a master oscillator system in which a small tube whose frequency is determined by the crystal drives a large tube acting as an amplifier. Owing to the fact that the quartz plate oscillates only in an extremely small band of frequencies, the transmitting wavelength for all practical purposes is fixed. Changes in tube constants, antenna height, even adjustments of inductance and capacity have no effect upon the emitted frequency. It is also true that the note of the station will be dis-

tinctive, and that even with raw a. c. on the plates of the tubes, the note will be good.

All of this means that a crystal-controlled station will have a good note on a definite frequency.

For stations that carry on schedule communications, or point-to-point service, or transmit traffic for considerable periods, nothing could be better than absolute steadiness of frequency. For amateur work the case is somewhat different.

For example, at 2 GY, the experimental station of the Laboratory, considerable effort was put forth to make a 500-watt crystal-controlled station. The apparatus was as extensive as Mr. Runyon's. There were two 7.5-watt oscillators, two 7.5-watt amplifiers operating at double the oscillator frequency, two 50 watters amplifying the output of the two 7.5-watt tubes, and at the same frequency, and finally two 250-watt tubes which fed into the antenna. It was possible to deliver considerable power to the antenna on the 40-meter (7500-kc.) band and the note was beautiful, but no sooner had the station gone on the air than FW, in France, settled on the same frequency, or so near it that interference was unavoidable. The result was that distant amateurs could not hear 2 GY when the St. Assise station was in operation, which was from about 4:30 p. m., E. S. T. until much later in the morning than 2 GY could be kept open.

On amateur bands, and with purely amateur traffic, there is need occasionally to change the frequency slightly to avoid interference. Crystal-controlled stations are sadly handicapped here, unless several quartz slabs are handy and unless the operator can go through a somewhat complicated rigmarole in re-tuning. Quartz-controlled oscillators using a good source of plate supply (batteries or good d. c.), turn out a note that is extremely tiring to the ears; and on the higher frequency bands a series of tubes are necessary with

more or less critical adjustments. It is true that the Army stations which use raw a. c. for filament, grid, and plate voltage, have notes that are penetrating and fairly easy on the ear, and when night after night one hears them pounding away somewhat below the 40-meter amateur band, it is easy to get the idea that crystal transmitters are greatly to be desired. But few amateurs have the funds, few care to bother adjusting many circuits, and few seem to realize that a 250-watt tube which will handle 500 watts as an oscillator will only take care of 250 when used as an amplifier.

more or less critical adjustments. It is true that the Army stations which use raw a. c. for filament, grid, and plate voltage, have notes that are penetrating and fairly easy on the ear, and when night after night one hears them pounding away somewhat below the 40-meter amateur band, it is easy to get the idea that crystal transmitters are greatly to be desired. But few amateurs have the funds, few care to bother adjusting many circuits, and few seem to realize that a 250-watt tube which will handle 500 watts as an oscillator will only take care of 250 when used as an amplifier.

New Nomenclature for our Tubes?

ONE OF the most encouraging signs in the radio industry is the manifest desire for standardization on the part of the better manufacturers. Under the untiring efforts of Mr. George Lewis, chairman of the vacuum-tube committee of the Radio Manufacturers' Association, tubes have come in for their share of attention. At the Chicago convention and trade show of this association, June 13-17, an important question will be discussed, that of tube nomenclature. Criticizing our present system of naming tubes by nondescript numbers, viz., 199, 213, 171, Mr. Lewis suggests the following system and will welcome suggestions. Tubes will be known by a number giving first the filament voltage in Arabic, then a Roman numeral denoting the amplification factor, and finally the filament current in Arabic. Special tubes will be designated by a letter indicative of the service performed. The table on this page gives Mr. Lewis' suggested nomenclature.

An Instrument for the Home Laboratory

How to Construct a Useful Device—a Modulated Oscillator—That Will Measure Coils, Calibrate Receivers, and Help Locate Trouble

By

KEITH HENNEY

Director of the Laboratory



RADIO BROADCAST Photograph

THE MODULATED OSCILLATOR

With the several tuning coils necessary to cover four slightly overlapping wave bands, is illustrated here. A specially made Karas dial, shown in front, was satisfactorily substituted for the aluminum one in the Laboratory

EVERY laboratory, regardless of its size, must possess certain equipment without which the investigator is handicapped. The home radio laboratory, housed in a corner of the den, or the attic, or the basement, and costing probably no more than a high-grade receiver, differs in this respect not a whit from the huge industrial or college laboratory with an endowment of many thousands of dollars within the walls of which may work hundreds of highly trained and skilled investigators.

One of these essential pieces of equipment was described nearly two years ago, September, 1925, in RADIO BROADCAST. It was called a modulated oscillator, and so many uses for the instrument have been found in the Laboratory and by the many readers who followed the series of articles written around that small generator of radio waves, that a new description at this time seems more than worth while.

The present unit differs but little from that described before. It consists essentially of two oscillators coupled together. As described, one covers the frequency range from 500 to 6000 kilocycles (50 to 600 meters), by means of four plug-in coils, and will be useful either as a source of radio-frequency waves for various laboratory experiments, or as an accurate and sensitive frequency meter or wavemeter. The other oscillator is a fixed frequency generator, oscillating at approximately 1000 cycles and providing a source of audible tone for certain other laboratory work. When desired, the radio-frequency tube may be operated alone, emitting a pure unmodulated carrier wave, or it may be modulated with the

1000 cycles of the second tube, and be useful in another set of experiments.

USES OF THE OSCILLATOR

THE most obvious use of the complete instrument is as a source of modulated high-frequency signals. By their aid, a receiver can be calibrated in kilocycles or wavelengths without the bother of waiting until broadcasting stations come on the air. The frequency of either the audio or radio oscillator can be varied, the entire outfit being under the control of the experimenter. The method of calibration is simple. A receiver is set up and the oscillator turned on. When the receiver is tuned to the same frequency as the oscillator the latter's tone will be heard in the loud speaker. Of course it is possible to set a receiver to a known frequency by this same process if, for example, the experimenter desires to listen for some definite station the frequency of which is known. It is also possible to measure the frequency of incoming signals. It is only necessary to tune the oscillator until its signals are heard at the same receiver condenser setting as the distant station.

The grid meter of the radio oscillator makes this unit a very sensitive and accurate resonance indicator. For example, suppose we have a coil and condenser combination and we desire its range in kilocycles or meters. Or suppose we have a choke coil for a short-wave transmitter and we want to know its natural wavelength so that it will not absorb energy on any wavelength to which the transmitter may be tuned.

The grid meter of the radio oscillator makes this unit a very sensitive and accurate resonance indicator. For example, suppose we have a coil and condenser combination and we desire its range in kilocycles or meters. Or suppose we have a choke coil for a short-wave transmitter and we want to know its natural wavelength so that it will not absorb energy on any wavelength to which the transmitter may be tuned.

The coil, or choke, is brought near the oscillator inductance, and when the latter is tuned

to resonance, a sharp dip in the grid current reading will be noted. Extremely loose coupling can be used, materially increasing the sensitivity of the instrument. It is also possible to show the effect of coupling two circuits too closely together. As the tuning condenser is varied, there will be two dips, indicating that the two circuits are so closely coupled that neither has a chance to oscillate at its own frequency, or that the two circuits are not closely enough tuned to the same frequency to give a single response.

With the radio oscillator as a source of unmodulated energy, it is possible to measure the overall gain of radio-frequency amplifiers. The same is true of audio amplifiers, by using the low-frequency tube.

The tone alone, obtained from the low-frequency tube, can be used for testing circuits (where a dry cell and buzzer could not be used) or as a source of tone for bridge work in measuring inductance, resistance, or capacity.

The circuit diagram of the complete modulated oscillator is shown in Fig. 1, and is not difficult to follow; nor is the set-up difficult to get working. The tubes can be any of the general purpose tubes now used, viz., 199, 12, or 201-A type. In the Laboratory wd-12 type tubes were used, since it was possible to place both A and B batteries for the outfit in the same cabinet which housed the tubes, transformer, and condenser, thereby making the combination frequency meter and oscillator a truly portable affair that can be "lugged" out of the Laboratory into the field for experiments on antennas, etc.

The layout of this useful instrument is due to Mr. John Brennan. The only important change in the circuit from that first described is the inclusion of the grid-current meter in the radio oscillator, which makes it an extremely sensitive frequency meter; other minor variations in the circuit resulted from the natural desire to make the completed equipment more useful.

Both oscillators follow the Hartley circuit, presenting several points of especial interest. One of these points relates to the inclusion of the grid-current meter in the radio oscillator, as stated above. The second point to note is the radio-frequency choke through which the B-battery voltage is fed to the second oscillator. This is necessary to prevent the radio-frequency energy from going into the center tap of the audio transformer, which is at ground potential with respect to r. f. voltages. It will be noted, too, that the tuning condenser is across half the coil only.

The grid meter increases the

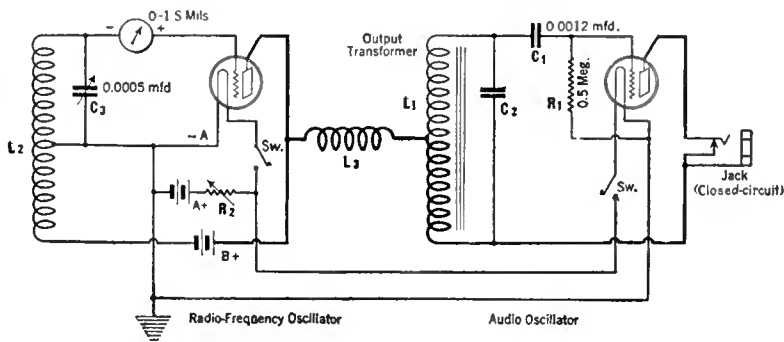

FIG. 1

The circuit diagram of the modulated oscillator

cost of the instrument somewhat, and is not vitally necessary for the operation of the modulated oscillator. It does, however, make the radio oscillator into a sensitive wavemeter, extending the uses to which the complete equipment may be put. Its inclusion is strongly urged.

The low-frequency oscillator consists of an output transformer connected as shown in Fig. 2. A push-pull output transformer may be used if desired, as also shown in Fig. 2. The frequency of the audio oscillator is controlled by the inductance of the transformer and the capacity across

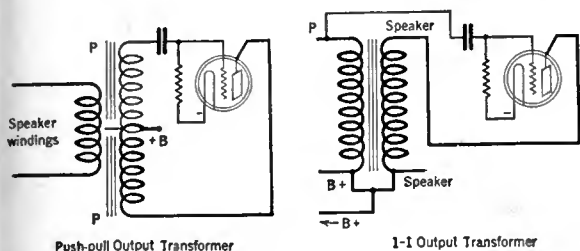

FIG. 2

Either push-pull or output transformer may be employed in the audio-frequency oscillator

was made for the Laboratory from aluminium by Mr. Harold Benner of Cruft Laboratory, Harvard University, and has the dimensions shown in Fig. 3. Very accurate adjustments are possible with this dial, and its accompanying vernier makes it possible to read to within one kilocycle in the broadcast frequency band, two kilocycles in the intermediate band, and three in the higher band. Any good vernier or slow-motion dial can be used.

An even more accurate instrument could be made by reducing the overlap so that each coil covered only the frequency band desired. In this way the smallest coil would cover exactly 3000 kilocycles, the intermediate ranges would be 2000 and 1000, and the largest coil would cover 500 kilocycles. Fewer turns will be necessary and the experimenter will be forced to rely upon his own ingenuity in winding them.

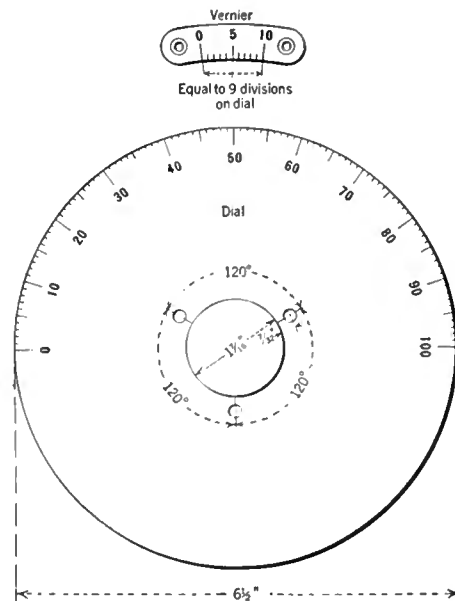

FIG. 3

The dimensions of the vernier dial

THE coils used in the Laboratory oscillator were General Radio type 277 and have the following dimensions:

COIL	TURNS	SIZE WIRE	DIAMETER	LENGTH OF WINDING	INDUCTANCE
277-A	15	21	2 1/2"	1 1/2"	0.014mh.
277-B	30	21	"	1 1/2"	0.055 "
277-C	60	21	"	1 1/2"	0.217 "
277-E	90	27	"	1 1/2"	0.495 "

CALIBRATION

IT IS a simple matter to calibrate such an oscillator. It is best to do this without the low-frequency tube oscillating. The accessory apparatus is not extensive, only a two-tube blooper, or any other receiver that can be made to oscillate, being necessary.

In addition to the oscillator and blooper, a single accurately known frequency is required.

This is provided by any well-known broadcasting station, preferably near the lower edge of the frequency band, say 400 or 500 meters. If such a station cannot be heard in the daytime, or when the calibration is to take place, the station should be picked up wherever possible on the blooper (which should be set up and running for several minutes before the final tuning is done) and no changes made, except to turn off the tube. The next day, or whenever the calibration takes place, the tube should be lit for several minutes to permit it and the batteries to settle down to a steady state. The detector tube is made to oscillate and the blooper is set accurately on the broadcaster's frequency by tuning to zero beat with him.

This must be done with a vernier condenser or with a single-plate condenser shunted across the large tuning condenser. As the blooper's frequency nears that of the broadcasting station, a lowering in tone of the beat note will be heard. It will soon become inaudible, to rise again on the other side of exact resonance, as indicated in Fig. 4. Halfway between the limits of this inaudible area is the exact frequency desired. With care, the experimenter can set his blooper to within 100 cycles of a station operating at 100 kilocycles.

The blooper is now oscillating at exactly, say 750 kilocycles (400 meters), and should not be touched or approached by the hand throughout the following procedure. At least one stage of audio should be used on the blooper and a pair of phones in the output of this amplifier should be used to indicate resonance between harmonics of the blooper and harmonics of the oscillator.

The blooper and oscillator have in their output not only the wavelength to which the coil and condenser are tuned but harmonics of this wavelength as well. That is, if the wavelength is 400 meters, in the output will also be one half,

it, as well as by the plate and filament voltage and grid leak values. In such a simple piece of apparatus it is neither necessary to know the exact audio frequency or to go to great labor to maintain it constant. The radio oscillator varies in frequency too, but not sufficient to be measured on an ordinary wavemeter.

A Jefferson push-pull output transformer, with 0.015 mfd. C₂ across the grid and filament of the tube, oscillated in the Laboratory at 900 cycles, and a Pacent output transformer 27B tuned according to the table below when a WD-12 tube was used and connected as shown in Fig 1:

C ₂ CAPACITY	FREQUENCY
None	3000 cycles
0.000125 mfd.	2000 "
0.0008 "	1000 "
0.00125 "	650 "
0.00275 "	550 "
0.012 "	240 "
0.02 "	160 "
0.04 "	130 "

If it is desired to use more than one tone from the oscillator, a pair of binding posts may be brought out on the panel and a small capacity unit, consisting of several condensers connected to a switch, may be attached to the low-frequency tube. The exact frequencies obtained may differ from those shown in the table. For this reason, it is not necessary or useful to get condensers of exactly the same capacity as specified. They may be obtained by connecting several condensers together so that the resultant capacities are similar to those given.

With the tuning condenser across the grid-filament half of the coil, the tuning ranges are approximately as shown below when WD-12 tubes are used as oscillators. If the dial is divided into 100 degrees, and has a straight frequency-line condenser, each degree will cover about the number of kilocycles shown in the table:

COIL	WAVELENGTH RANGE	FREQUENCY RANGE	KILOCYCLES PER DEGREE
15 turns	45-120	2500-6660	31.60
30 turns	80-210	1430-3750	23.30
60 turns	165-400	750-1820	10.70
90 turns	265-620	485-1130	6.50

The dial should be large and provided with a fine adjustment. That shown in the photograph

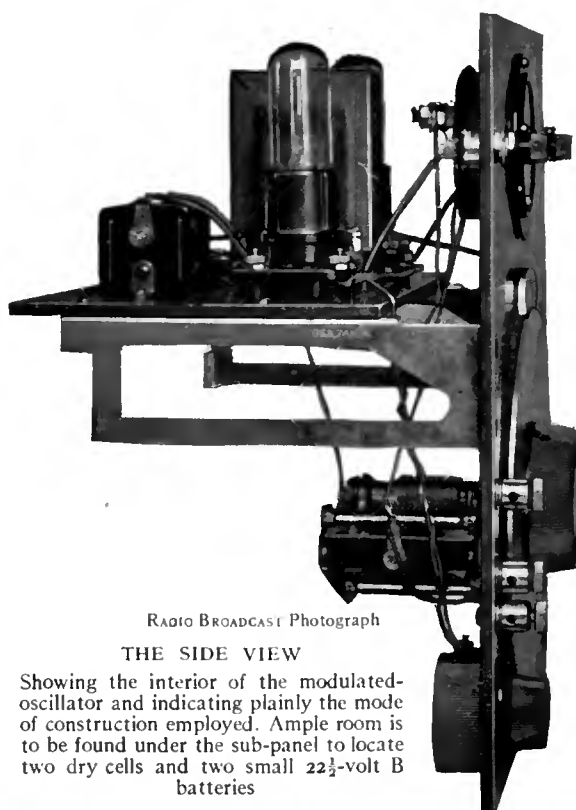

RADIO BROADCAST Photograph

THE SIDE VIEW

Showing the interior of the modulated-oscillator and indicating plainly the mode of construction employed. Ample room is to be found under the sub-panel to locate two dry cells and two small 2 1/2-volt B batteries

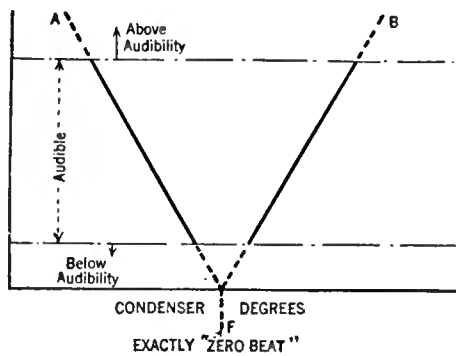

FIG. 4

one third, one fourth, etc., of this figure, or 200, 133, 100, etc., meters. Whenever the oscillator is tuned to one of these wavelengths a beat note between the oscillator fundamental and the blooper's harmonic will be heard. A beat will also take place when the second harmonic of the blooper beats with the third of the oscillator, and so on down the line. The number of wavelengths that can be secured in this manner are shown by Table No. 1, which has 400 meters as the basis of reference. The figures at the top represent the oscillator's harmonics, while those along the left-hand vertical line represent the harmonics of the blooper. For example, if the oscillator is set at 600 meters, its third harmonic will beat with the second of the blooper. The other wavelengths in the table may be found by multiplying 400 by $\frac{1}{2}, \frac{1}{3}, \frac{1}{4}, \frac{1}{5}, \frac{1}{6}, \frac{1}{7}, \frac{1}{8}, \frac{1}{9}, \frac{1}{10}$, etc. In calibrating the Laboratory oscillator with the coupling indicated in Fig. 5, twenty-two of these wavelengths were found and, with closer coupling all of those given in Table No. 1 and others should be found. The ones in this table to be expected are denoted by heavy type. In our note book we set down our data as shown in Table No. 2, noting the condenser setting for each beat note, and marking with an asterisk the strongest. These will correspond to exact harmonics of the blooper, that is, the second, third, fourth, etc., or small fractional harmonics, that is $\frac{2}{3}, \frac{3}{4}, \frac{4}{5}, \frac{5}{6}$, etc.

Now, all of this probably sounds complicated and difficult to the uninitiated. There is no reason, however, for getting stage fright at this point. Suppose we have set up the blooper and that it is tuned accurately to 400 meters. We are listening in the plate circuit of a stage of audio amplification behind this oscillating detector. The oscillator, too, is ready to operate, the filament

having been lighted for several minutes. We place the 90-turn coil in the oscillator, arrange the coupling about as shown in Fig. 5, and turn the oscillator dial. We get a strong whistle at 34 degrees. We make mental record of how loud the beat note is and are certain that we have hit 400 meters, and turn the dial again. At about 92, 12, and 4 we get other squeals. Now we know that the 90-turn coil will go to about 600 meters and we note from our table of those wavelengths at which beat notes will be heard that, when the oscillator is tuned to 600 meters, its third harmonic (200 meters) will beat with the second of the blooper (also 200 meters), to produce an audible note. By the same reasoning, when the oscillator is tuned to 300 meters, its third harmonic, or 100 meters, will beat with the fourth of the blooper, also 100 meters. The loud beat at 4 degrees corresponds to 266 meters.

In the calibration process so far we have been certain of but one point, 400 meters at 34. If we listen closely, or use somewhat closer coupling, we shall also hear beat notes at 69, 59, 16, and 9 degrees on the oscillator dial. Using our table of wavelengths we guess again, and assume

BLOOPER HARMONICS	OSCILLATOR HARMONICS									
	1	2	3	4	5	6	7	8	9	10
1	400	800	1200	—	—	—	—	—	—	—
2	200	—	600	—	—	—	—	—	—	—
3	133	266	—	533	—	—	—	—	—	—
4	100	—	300	—	500	—	—	—	—	—
5	80	160	240	320	—	—	—	—	—	—
6	66.6	—	—	—	333	480	—	—	—	—
7	57.1	114.3	—	228	286	343	—	—	—	—
8	50	—	150	—	250	—	350	—	457	514
9	44.5	80.0	134	178	222	—	311	356	—	445
10	40	—	120	—	—	—	280	—	360	—

TABLE NO. 1

that the wavelengths are 533, 500, 320, and 280 meters. Everything but the 400-meter point has been guessed at, but if we plot a curve of wavelengths against condenser degrees it will tell at once if we have erred. If a good curve results, our guesses have been correct. If one or more points refuse to fall in line we have guessed wrong and we must listen for beat notes again.

On the 60-turn coil, we get a very loud note at 98, weaker notes at 50, 37, and 15, and still weaker notes at 69, 65, 59, 45, 28, 24, and 6 degrees. By our process of guessing — assuming that the 98 degree point is 400 meters — we put

down the wavelengths as given in Table No. 2. The same process is carried out in getting points on the 30- and 15-turn coils.

If the coils are well made, the smaller inductances having half the number of turns of the preceding coil, beats will be heard at approximately the same condenser settings as Table No. 2 shows. If a condenser with a straight wavelength calibration is used, the problem is simplified, since we can guess fairly accurately where the next beat note is to be found. The same applies with a straight frequency calibration except that we must think in terms of frequencies and not wavelengths. With a straight capacity-line condenser, the wavelengths can be estimated by remembering that the wavelengths corresponding to two condenser settings are proportional to the square roots of the capacities involved. If the condenser has one of the modified calibrations, the experimenter is up against it. He had better use a condenser whose calibration is known. Practically all well-known condenser manufacturers have units that will have a straight frequency-line. An excellent condenser is the National Equicycle, which uses a 270-degree arc instead of 180 degrees. This will spread out the frequency band considerably.

For general work around the laboratory, the modulated signal may be used, but for careful measurements the pure carrier wave is better. Coupling to a receiver using one stage of audio need be no closer than the opposite sides of a rather large room. When the high-frequency oscillator is modulated it is possible to pick up the tone in two places very near the carrier which will be comparatively quiet. These two signals represent the side bands which are one thousand cycles on either side of the carrier in the case of a thousand-cycle signal.

In a later article a bridge for measuring vacuum-tube characteristics will be described. The tone will be very useful in conjunction with this instrument. Among other articles in this series for the home laboratory will be methods of measuring inductance and capacity, and here again the tone will be necessary. Still another article has been prepared on the vacuum-tube

Blooper Set at 400 Meters							
90-Turn Coil		60-Turn Coil		30-Turn Coil		15-Turn Coil	
Condenser Degrees	Meters	Condenser Degrees	Meters	Condenser Degrees	Meters	Condenser Degrees	Meters
92*	600	98**	400	96*	200	77*	100
69	533	69	343	68	171		
		65	333				
59	500	59	320	58	160		
		50*	300				
34**	400	45*	280	36.5*	133	46*	80
		37*	266			28.5	66.6
16	320	28	240	23	114.3	18	57
		24	230	15*	100	11	50
12*	300	15*	200				
9	280						
4*	266	6	171			3	44.4

TABLE NO. 2

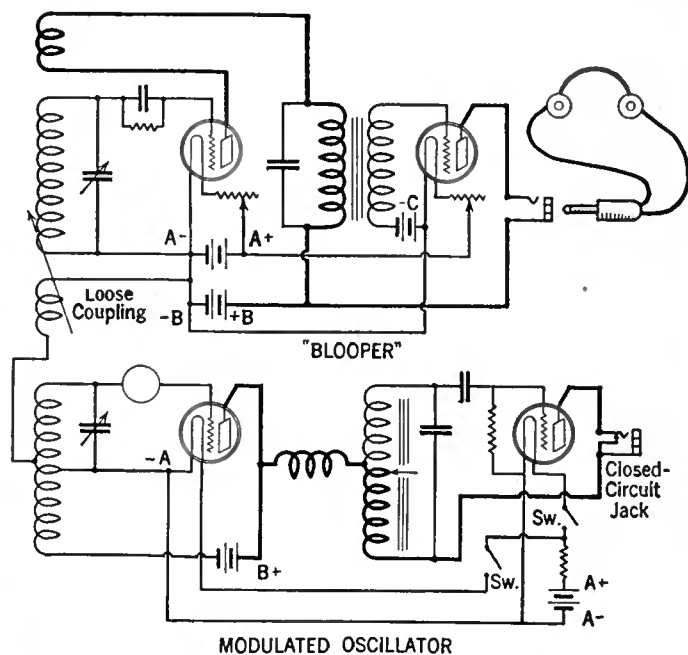

FIG. 5

The circuits employed in calibrating the modulated oscillator

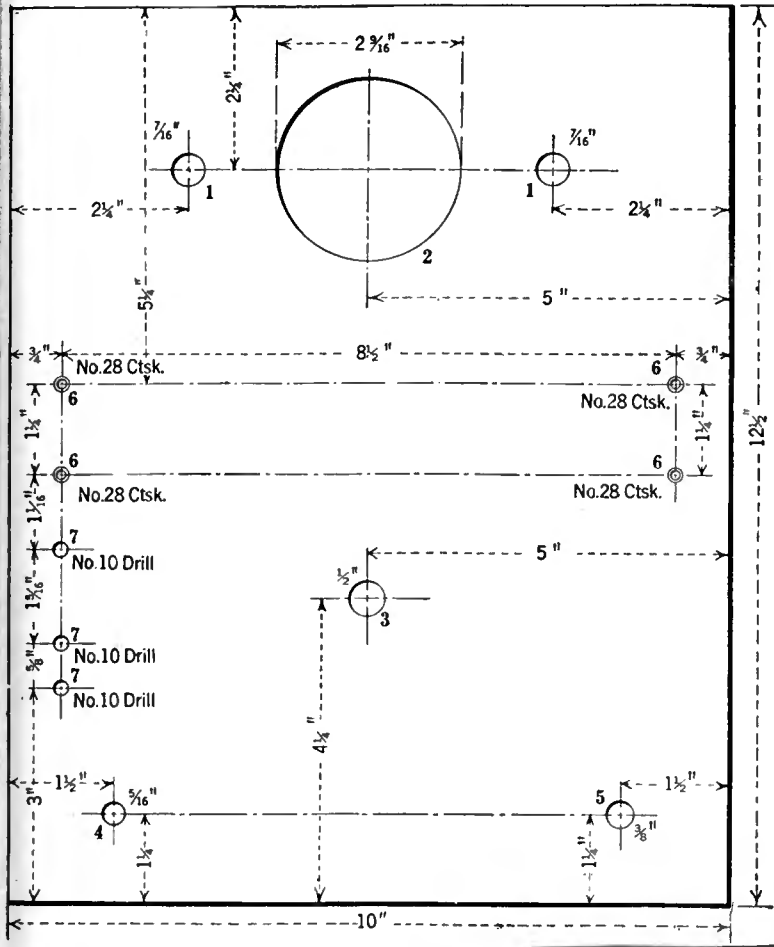

FIG. 6 (Above)

In this panel layout the various parts are mounted in the holes which are numbered, as follows: 1, filament switches; 2, meter; 3, tuning condenser; 4, rheostat; 5, output jack; 6, brackets; 7 binding posts

voltmeter, and for this instrument both the high and low frequencies will be needed.

A jack is provided in the plate circuit of the low-frequency oscillator so that the tone may be utilized at any desired point.

The necessary dimensions and layout for the various pieces of apparatus are shown in the accompanying diagrams, and the following list of parts covers the apparatus actually used in the Laboratory oscillator:

LIST OF PARTS

L ₁ -1	Pacent 27B Output Transformer	\$ 7.50
L ₂ -4	General Radio Coils	
	277-A	1.25
	277-B	1.25
	277-C	1.25
	277-E	1.50
L ₃ -1	Samson Radio-Frequency Choke No. 85.	1.50
C ₁ -1	Sangamo Condenser 0.0012 Mfd.	.50
C ₂ -1	Small Fixed Condenser (see p.93)	.50
C ₃ -1	Karas Straight Frequency-Line Condenser, 0.0005 Mfd.	7.00
R ₁ -1	Carborundum Grid Leak, 0.5 Megs.	.35
R ₂ -1	Frost Rheostat, 10 Ohms	.50
	2 Carter "Imp" Battery Switches	1.30

(Continued on page 96)

TO THE RIGHT

This picture shows clearly the disposition of the parts employed in the construction of the modulated oscillator

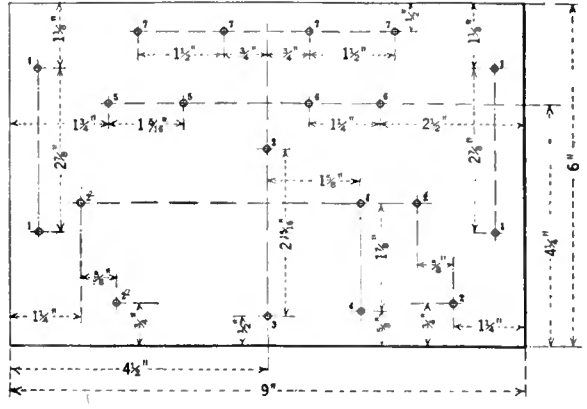
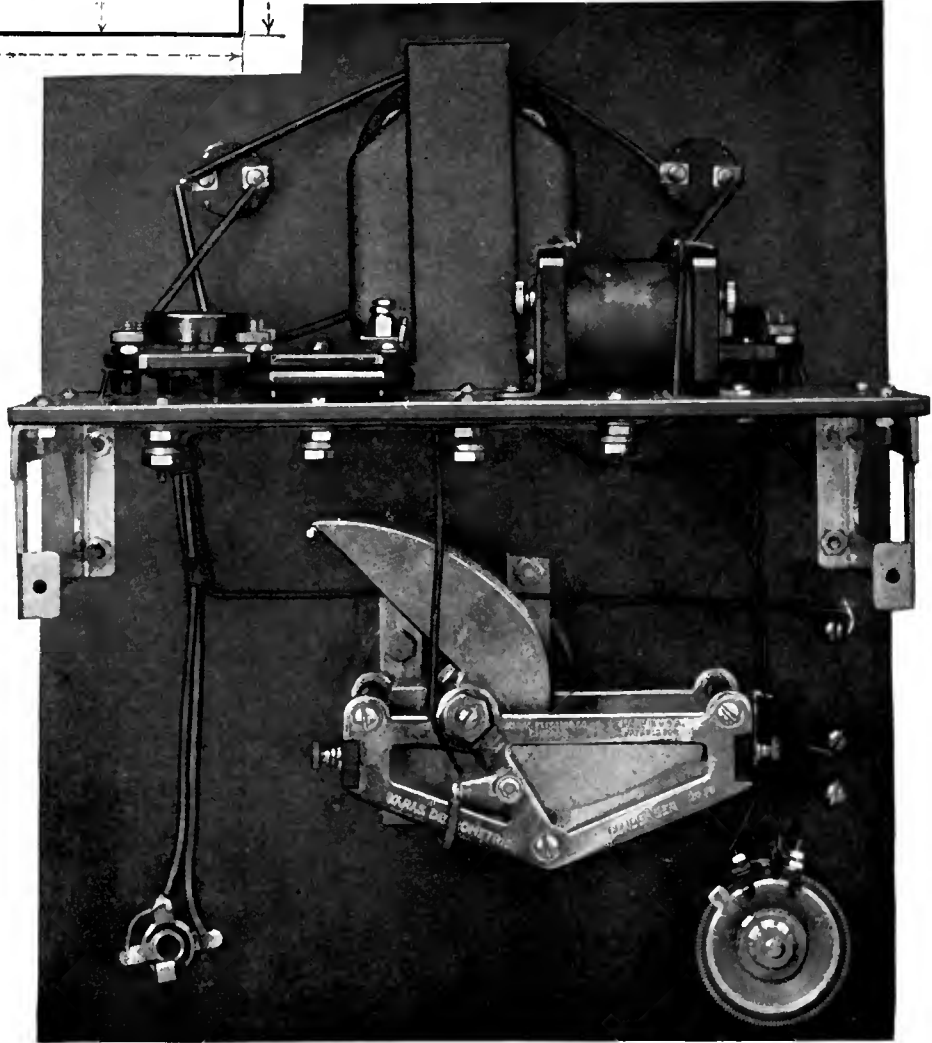

FIG. 7

The sub-panel layout, as shown here, supports the following pieces of apparatus, as numbered: 1, brackets; 2, sockets; 3, transformer; 4, grid leak; 5, radio-frequency choke coil; 6, fixed condenser; 7, binding posts or machine screws

USES OF THE OSCILLATOR

1. *Radio Oscillator*
 - (a) Heterodyne wavemeter.
 - (b) Radio-frequency driver.
 - (c) Measuring gain and frequency range of amplifier.
 - (d) Tuning range of coil—condenser combination.
2. *Audio Oscillator*
 - (a) Source of tone for circuit testing.
 - (b) Source of tone for measuring capacity, inductance, or resistance.
 - (c) Source of tone for measuring gain of audio amplifiers.
3. *Modulated Oscillator*
 - (a) Measure unknown frequencies.
 - (b) Measuring tuning range of receivers.
 - (c) Setting receiver to known frequency.



RADIO BROADCAST Photograph

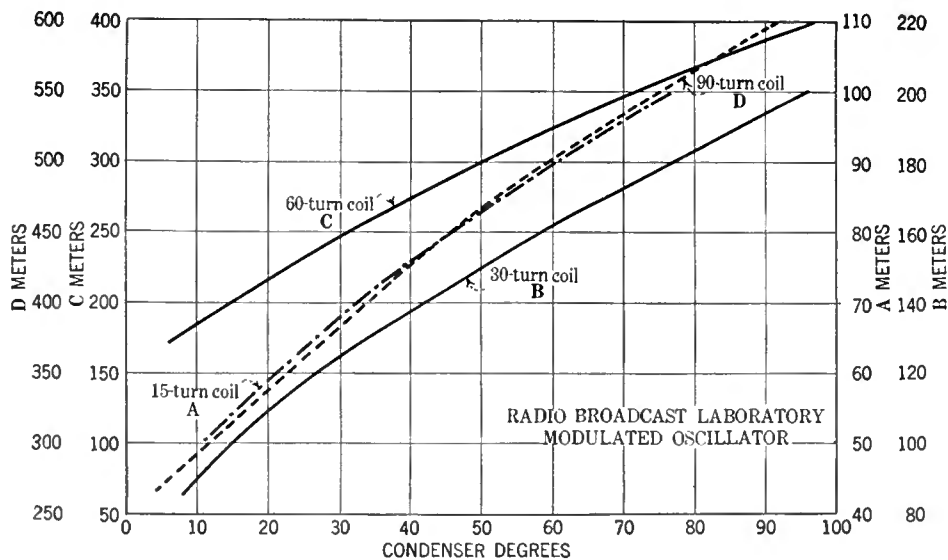

THE CALIBRATION CHART

For the four coils employed in the radio-frequency end of the modulated oscillator, will closely resemble the one shown here, when a straight capacity-line condenser, such as the General Radio 247 type is used

1 Carter Closed-Circuit Short Jack	.80
1 Weston Milliammeter—0-1.5 Mils.	12.00
2 Benjamin Brackets	1.40
3 General Radio Binding Posts	.45
2 Benjamin Sockets	1.50
1 Main Panel 10" x 12½" x ⅜"	2.50
1 Sub-Panel 6" x 9" x ⅜"	1.08
Machine Screws, Wire, Solder, Etc.	.50
TOTAL	\$44.63

pass through the holes numbered "1" on the sub-panel to fasten it to the top of the brackets. After this operation is completed, the audio transformer, sockets, fixed condenser, r. f. choke,

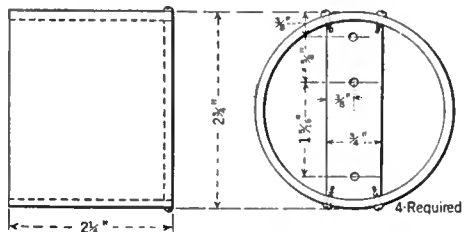
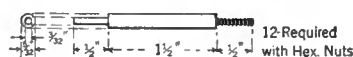

FIG. 8

Dimensions for the coil forms and connector pins

and grid leak are mounted on top of the sub-panel.

Prop up the rear edge of the sub-panel to maintain the assembly in an upright position and then mount the main panel instruments thereon.

The wiring is next. Point to point connections are made which make for short direct leads. This system of wiring is more to be desired over the system where right-angle turns add to the neatness of wiring but otherwise do not materially improve matters.

The specifications for the coil forms are given in Fig. 8. If General Radio plug pins are used a different arrangement for connecting them to the unit will have to be devised. The pins shown in Fig. 8 allow the coils to be mounted in the binding posts and to extend somewhat over the edge of the panel.

FOR CALIBRATION

SIGNALS from any of these stations may be used in calibrating wavemeters. They are maintained very closely to the frequency indicated here.

STANDARD FREQUENCY STATIONS

Station	Location	Frequency
WEAF	New York, New York	610
WRC	Washington, District of Columbia	640
WJZ	Bound Brook, New Jersey	660
WGY	Schenectady, New York	790
WBZ	Springfield, Massachusetts	900
KDKA	East Pittsburgh, Pennsylvania	970

CONSTANT FREQUENCY STATIONS

WHO	Des Moines, Iowa	570
KFRU	Columbia, Missouri	600
WOC	Davenport, Iowa	620
WTIC	Hartford, Connecticut	630
WMAQ	Chicago, Illinois	670
KLDS	Independence, Missouri	680
KPO	San Francisco, California	700
WLW	Harrison, Ohio	710
WCCO	St. Paul-Minneapolis, Minnesota	720
WTAM	Cleveland, Ohio	770
KTBS	Hot Springs, Arkansas	800
WJJD	Mooseheart, Illinois	810
KGO	Oakland, California	830
WJAD	Waco, Texas	850
WWJ	Detroit, Michigan	850
WLS	Crete, Illinois	870

Other parts than those specified in this list may be used provided they are of equal quality. The main requirements are that the condenser be rigid in its bearings, that the dial be easily and accurately read, and that the device be recalibrated when tubes are changed. It is a good idea to lock the tubes and batteries into the cabinet.

Following articles will discuss in detail the varied uses of this modulated oscillator. The Laboratory will be glad to hear from readers at any time regarding the uses which they have found for the apparatus described here.

The following construction hints are from Mr. Brennan who is responsible for the construction of the unit used in the Laboratory.

The panel layouts shown are based on the use of the material listed here and should be altered accordingly if substitutions are made

The first step in the construction of the oscillator is the preparation of the main panel, Fig. 6, for drilling. The various hole centers should be spotted with the aid of a hammer and centerpunch, and then drilled with a small drill, say No. 28. Then those holes which require enlarging may be so enlarged by the use of Stevens tapered reamers, which are indispensable for such work. The hole for the meter may be made by drilling a number of small holes around the periphery of the circle and then filing it clean. Better yet, a circle drill may be used to make a clean-cut hole just slightly larger than the diameter of the body of the meter.

The sub-panel is next prepared, and after all the holes have been drilled in accordance with Fig. 7, the two Benjamin brackets are mounted in place on the main panel in the holes numbered "6." Round-head machine screws, ½" x ⅜",

RIGHT
The layout of parts on the sub-panel

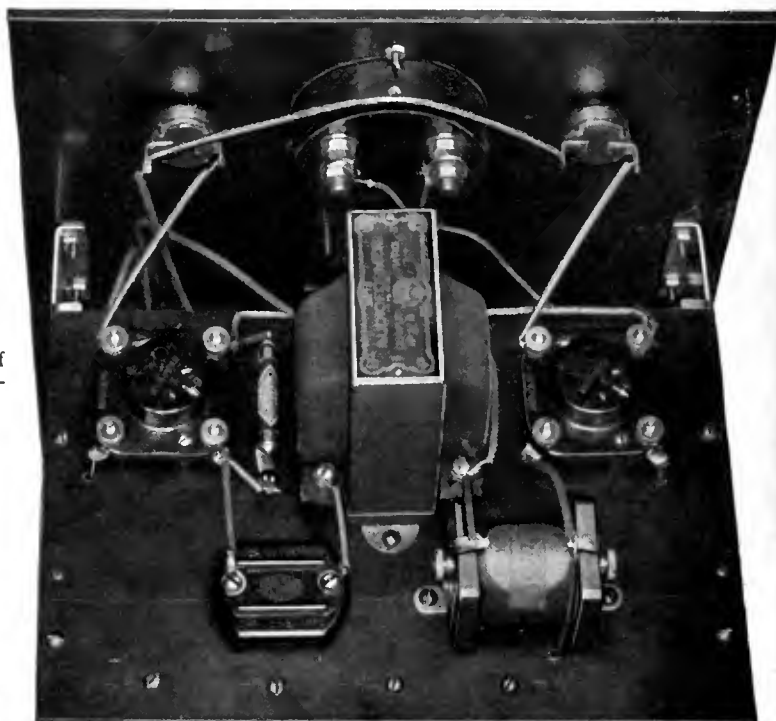

RADIO BROADCAST Photograph

THE LISTENERS' POINT OF VIEW

Conducted by John Wallace

"Radio Pests" and How to Be One

WHEN we proposed to the readers of this department the question: "Do you listen to your radio in the evenings as you would to a regular show or do you simply turn it on and use it as a background to other activities?" it was with malice aforethought. We were gathering ammunition for a little tirade against the radio pest who turns on his radio at about six A. M. and leaves it in that distressing condition until midnight.

The questionnaire showed that one out of every ten listeners employs his radio almost exclusively as a background. This does not mean that one out of every ten radio receiver operators is a pest; if that were true, it would put us in the pest class, for there are many occasions when we utilize the radio as a background. But the flagrant offenders are included within that number; just how large a part of it they make up you can decide for yourself.

At any rate you know the beast. When you open the door of his house for a friendly little call of an evening you are immediately greeted by a resounding blare from a loud speaker in the next room. And whether the order of the evening be bridge or poker, ping pong or conversation, that infernal loud speaker continues to vibrate viciously the evening through. It vibrates from string quartet to brass band, from election speech to bed time story, from wheezy soprano to musical saw player, from stock market report to bee keeping instruction, and back again—and all over again.

All the while nobody is paying it the slightest bit of attention. To add to the misery, some fluctuation in factors radio and electrical has thrown it out of tune and interference has been set up by some powerful local bird store.

When we say nobody is paying attention to it we refer particularly to its owner and the members of his family. They have, through long exposure, developed an immunity to it. But you, however (we assume you to be a sensitive being whose ears are normally free of impedimenta), are woefully aware that it is "going." Gradually its cumulative effect is to grind down your nerves to rather small shreds. Finally, at the end of a couple of hours, the one nerve left you unground tautens itself in the superhuman paroxysm and you arise, devour the pack of cards, kick over the receiving set, shoot your host, and rush out into the night.

To radio receiver owners of this ilk may be laid the blame for the not at all small army of scoffers who steadfastly refuse to consider radio seriously. The scoffer is a scoffer, nine times out of ten, because his first introduction to radio was in the home of a Radio Pest.

Naturally he considers the device an instrument of the devil; for an instrument of the devil it is when so operated.

Any radio owner, no matter who he be, and including ourself, can profit by an occasional

recalling of the old saw: "Familiarity breeds contempt." To get the maximum enjoyment out of a set it must be treated with a certain amount of respect. The greatest advantage of radio is that it requires no more than the flip of a switch to bring music and other entertainment right into your own home. But, paradoxical though it may seem, this is also radio's greatest drawback. By the time one has struggled into his dinner clothes, taxied a half hour or more to the theater, and laid out eight-eighths for tickets he is in a frame of mind to enjoy the performance or die in the attempt.

The fact that it takes some effort to get to the source of entertainment undeniably adds something to the pleasure to be derived. On this score radio is at a decided disadvantage. Asking little it receives even less (that is, understand us correctly, in the home of the Radio Pest).

We hesitate to adopt such a smug and paternalistic course as to set forth a set of rules for the proper operation of a receiver, especially because we suspect that the great majority of our readers knows a lot more about it than we do. But perhaps you number a Radio Pest among your friends and would like to have the table of laws to clip and mail to him anonymously. Hence we advance these suggestions on:

HOW TO OPERATE A RADIO RECEIVER FOR MAXIMUM PLEASURE

First: Keep the fool thing in proper mechanical shape. A receiver with a defective tube or a weak battery or some other wheeze-provoking ailment should be immediately retired from service and kept retired until its ills are attended to. A distorting set is ninety-nine times worse than no set at all.

Second: As a general rule, don't use the radio simply as a background, at least while some sensitive soul like ourself is parked in your parlor. Like all rules this one is largely invalid because certain types of broadcasts are genuinely fitting as background. Almost any program of instrumental music (excepting jazz) may serve as a pleasant obligato to bridge or conversation, or even reading, providing it is rheostated down to a sufficiently *sotto* volume. But speeches, songs, and static are a suitable background for nothing we know of outside of a tea party in a mad house.

Third: The most genuine enjoyment from a radio program is to be secured by preparing for it in advance and listening to it with reasonable reverence. Consult some advance program and find out the exact hour that some feature you want to hear is scheduled. Let the receiver remain deathly silent until two minutes before that hour. Then provide



THE SMITH BROTHERS

"Trade" and "Mark" who in their non-microphone life are "Scrappy" Lambert and Billy Hillpot. You may remember hearing them with Ben Bernie and his orchestra. They are the Smith Brothers for a half hour beginning at ten p.m. over the WEAf network on Wednesday nights



REAL HAWAIIANS AT KHJ

The Moana Hawaiian Entertainers, reported to have come "direct from the Islands," played a week's engagement recently at KHJ, Los Angeles



ETHEL AND JANICE

Who are known to the listening world who tune-in on KMOX at St. Louis as the "music mixers," whatever that means

yourself with an easy chair (formal clothes not imperative) and tune-in the desired program right on the instant of the first word of the first announcement. If you can provide yourself in advance with an itemized program of the feature it will contribute to the illusion of being at a concert. Try it some time if you haven't already (selecting, of course, a program that's worth the ritual) and you'll be surprised how much this slight mark of respect for the program repays you in enjoyment of it.

Making Up the "Sponsored" Program

AN INTERESTING insight into the advertising man's ideas concerning radio advertising was afforded in an article by Uriel Davis in *Printers' Ink*. He suggests methods of procedure for the prospective air advertiser and says in part:

"The product or company should be humanized, dramatized. The narrator's voice, without

which the dramatic element will not succeed, should be studied and analyzed for timbre, intensity, and pitch, and its quality so finely determined that a suitable musical accompaniment, in proper register, may be provided by a single instrument or an ensemble.

"The name of the company, or its product, should be introduced in as subtle a manner as possible. The announcement of the name or product could recur from time to time during the actual performance instead of between musical or other selections, which is the custom to-day. Under no circumstances should the advertisement appear too obvious. Where there is no good reason, from the standpoint of entertainment, to mention the name of the product or the company, it should be omitted.

"There can be no advertising loss in a plan of this kind. As a matter of fact, the value of subtle advertising of this kind should be far greater than that obtained from 'program interference,' as the present-day announcements may be termed.

"An hour or any period of radio entertainment must have continuity. Continuity is essential to hold the listener's attention over even a short period. He is constantly looking for something he likes to hear. When he attends a theatrical performance, his mind is not on the show appearing at another theatre. Why could not his mind be put in just as receptive a mood when he listens in on a radio hour? To obtain such continuity it is necessary to build programs upon a basis similar to that employed in the preparation of moving picture scenarios.

"Since music is essential in successful radio performance, there should be a continuous tie-up between the spoken word and the orchestra or whatever group of musical instruments that may be used. The music, when not an actual part of the program, may be employed as a background or setting for the voices used for descriptive purposes as well as for song.

"Pauses between selections as well as between the voices and music may be eliminated with ease if the scenario, so called, will provide for absolute synchronization whereby the music will always shortly begin before the voice ceases speaking, and *vice versa*.

"Continuity of performance or program, in other words, the use of a scenario, should enable advertisers to provide not only a high grade of entertainment, but a program sufficiently interesting to hold the listener's attention throughout its entire length. It should arrest the attention of the casual tuner-in to such extent that once the program is brought in on a set it will not be dismissed until completion.

"Successfully to carry out the suggestions I have made would require not only careful preparations of the scenario and attendant musical program, but a careful study of the advertiser's product as well."

We are glad if the advertisers are to be convinced that "where there is no good reason, from the standpoint of entertainment, to mention the name of the product or company, it should be omitted."

But we are filled with grief at the other doctrine Mr. Davis preaches: "An hour or any period of radio entertainment must have continuity."

Heaven deliver this listener from the type of "continuity" employed in the Don Ameizo hour. Such continuity smacks of the earliest days of the movie subtitle. It is not our business as a radio reviewer to tell the advertising men how to run theirs. So we will acquiesce to their superior wisdom and concede that there may be some necessity for continuity to hold the attention of some of the listeners. But it gives us the willies. If the artists on a given hour are good we will stay with them regardless of the omission or inclusion of such stuff as:

"... and now our Coral Throated Baritone and Sarah Szbisco, the Soprano with a Soul, bid tearful farewell to the sturdy Volga boatmen and boarding their Peerless Yacht Company Auxiliary barge they drift slowly down the Danube, past the lovely rock of the Lorelei, where, amid the twitter of the birds and the bees, we hear emerging from the forest, as from the mellifluous dulcimer, the tender strains of 'Down on the Mississippi'."

It is notable that several of the most popular "hours" omit continuity entirely or use it very sparingly. But if we are to have it with us permanently, as seems inevitable, how's for the advertising agencies who handle these programs applying a little ingenuity to the writing of better continuity? It could be made non-obnoxious. In fact it could be made right entertaining. But it would take a lot more labor than it is now accorded. If one sixth of the time in an advertising hour is to be turned over to an announcer we do not see why he should not be supplied with text written by a first rate copy writer and at a fee at least equal to one sixth of the cost of the hired performers.

As a schooling for the prospective composer of continuity we can think of nothing better than a thorough study of the evolution of movie subtitles. As we said a while back, radio continuity is in the same stage of development as was the movie subtitle in the days of "Came The Dawn."

The "Came The Dawn" subtitles have largely disappeared and very excellently and succinctly composed ones have supplanted them. However, in the movies, it took fifteen years or more. Let the radio advertisers profit by this example and see if they can't cut down this fifteen-year wait by a month or two.

And now to present the broadcasting station's point of view of the advertising program, which, by coincidence, comes to our desk as we are writing this article:

Program features originating with the National Broadcasting Company fall into two main classifications—"sponsored" features put on the



A POPULAR FEATURE AT WTAM, CLEVELAND

Guy Lombardo's Royal Canadians are among the most popular of the Middle-West radio dance orchestras. Where the other instruments in the band are, we cannot say. The players at least, have reported for duty

air under the auspices of commercial concerns for the purpose of building institutional good-will, and "sustaining" features, including broadcasts by the various National Broadcasting Company "stock" companies, educational and religious and musical programs of all kinds from hotels, night clubs, and prominent motion picture theatres.

The life of a sponsored feature really begins, so far as the whole personnel of WEAf and WJZ is concerned, when a contract has been made between the Company's Commercial Department and a commercial concern for the use of time on the air. Immediately, the machinery of the Program Department of the station involved starts to function.

The contract itself may specify what entertainers are to broadcast during the time allotted to the new feature, and in this case, the work of the Program Department is lessened. Usually, however, the Commercial Department, the new client, the Station Manager, and the Program Department will combine to decide upon the artists, leaving the working out of the details to the Program Department.

The period of planning may involve almost any amount of work. The elusive idea must be pursued and captured and a definite scheme of entertainment mapped out. In some cases, three or four complete plans are made. Conferences are held between the Program Department, the Commercial Department, and the sponsor and the type of entertainment is decided upon. The time at which the feature will appear on the air must also be decided, a process which involves many considerations. The station management must balance its entire program for the evening and make sure that every feature attains as much prominence as possible. In other words, a whole evening's program must be varied if it is to be effective. Two periods of the same sort of entertainment should not follow each other, or both of them will lose in effectiveness because of the fact.

When a plan has been approved, work is begun on detailed programs. Artists are engaged, a process which may require auditions attended by representatives of the various departments and by the sponsor. A continuity is prepared for the opening program and an announcer is chosen for the feature. The artists are given the detailed program in order that they may start rehearsing. In short, a sample program is prepared for presentation.

In preparing the continuity, care is taken that the program shall merely create good-will rather than describe the sponsor's products. The spoken portion of any sponsored feature should relate to the musical selections, if the entire program is to accomplish its object. The detailed program is submitted to the Department of Musical and Literary Research in order that all copyrights on the various selections may be investigated. In some cases, numbers are changed to comply with copyright restrictions.

When the sample program has been prepared, it is assembled as a unit for rehearsal at the studio. This rehearsal is attended by a Commercial Department representative, a member of the Program Department, and the sponsor. In instances which involve unusual pick-up problems, a member of the Operations and Engineering Department is also present to work out proper microphone placement and insure the best possible pick-up.

In the meantime, three other activities have been begun, looking forward to the time when the feature will first be heard on the air. The Traffic Department has communicated with the various stations through which the sponsor desires his program to be heard and has arranged for telephone facilities to carry the program to these stations.

The clerical force of the Program Department has prepared program material on the feature and forwarded it to the Publicity Department, so that proper announcement of the coming feature may be made.

The rehearsal at the studio is criticized by those who attend it and any desired changes are made in the program. Other rehearsals will

take place before the initial broadcast of the series goes on the air, and rough spots in the presentation will be smoothed off. Shortly after the first rehearsal, however, the various departments which have helped to get the first program ready start to work on the second and third appearances of the feature. Detailed programs are made up and given to the artists three weeks in advance so that every detail of each presentation may be carefully worked out. The final step in the presentation of the first program takes place when it goes on the air. The broadcast is listened to by the Station Manager or his representatives, for he is really the stage manager of the station. In every case where contact occurs between various departments, printed forms are used to make sure that information is transmitted accurately. No details are left to memory or to oral agreement. Once the first program has been broadcast, a regular rehearsal schedule is maintained for further features in the series. Every broadcast must be rehearsed in the studio twice before it goes on the air, necessitating an elaborate schedule.



LOUIS KATZMAN

Leader of the Anglo-Persians. The Whittall Anglo-Persian Orchestra has been a regular and well-liked feature of the WEAf network programs for many months

An Evening of Chain Programs

OCCASIONALLY there come to our ears certain distant mumblings and mutterings of rage against the "Big Radio Chain Monopoly." It is characteristic of the American to growl gutturally when confronted by anything exuding the faintest odor of monopoly. It is also characteristic of him to slough off his prejudices and form one himself the minute he gets a chance.

It may be that some of the epithets, such as "Radio Trust," "Un-American," "Capitalistic," etc., hurled at the big chain are not without justification. However, we do not propose to examine the facts of the case. For, frankly, we do not care. Our duty as radio reviewer requires us to make use, not of our vague recollections of Economics 51, nor of our theories of business ethics, but simply of our ears. And our

ears find it good. As a "listener" we are little concerned with what goes on at the other end of this wireless transaction. Our concern is with the things that come out of the loud speaker and our special concern is with the things that are good.

So heark ye to the very pleasant evening we were enabled to put in on Friday, March 18, relying exclusively on chain broadcasts from three of the local (Chicago) stations:

WL1B—7 P. M. About the best brass band available to the radio audience, that of Edwin Franko Goldman, playing, with nice regard for the exactions of the microphone, such acceptable pieces as Tschaikowsky's "1812" Overture, the "Peer Gynt" suite, and the Procession of the Knights of the Holy Grail from Wagner's "Parsifal."



THE HERMANN TRIO AT WLW

This trio, composed of Emil Hermann, concert master of the Cincinnati Symphony Orchestra; Thomie Prewitt Williams, and Walter Hermann, is heard each Wednesday evening at 10, Eastern Standard Time. Indications are that this group of artists is one of the most popular heard from WLW

KYW—7:30 P. M. The Royal Hour featuring Helen Clark, the "Royal Heroine" and Charles Harrison the "Hero" in a series of solos and duets alternated with orchestral selections. This program was made up of popular songs of Arabian and Egyptian coloring, which same coloring, unauthentic though it may be, is responsible for one of the most ingratiating modes of popular composition. Such titles as "Sand Dunes," "Song of Araby," "There's Egypt in Your Dreamy Eyes," "Lady of the Nile" and "Africa."

WGN—8 P. M. The National Grand Opera Quartet composed of Zielinska, soprano, Nadworney, contralto, di Benedetto, tenor, and Ruisi, basso—all voices specially selected for their adaptability to broadcasting. They were able to sing the Rigoletto quartet so that it "came over" in assimilable form, without all the voices being blurred together like the kernels of over-cooked rice—a common enough fault with most radio renditions of this exacting and amazing composition.

KYW—8 P. M. Two Metropolitan stars, Mario Chamlee, tenor, and Florence Easton, soprano, and the violinist, Max Rosen, collaborating in a Brunswick Concert. To be sure, the program was made up of somewhat over-familiar compositions such as the Volga Boatmen's song, "Connais Tu Le Pays?" "Songs My Mother Taught Me," and so forth, but such is the practice of radio, and besides they were so well presented as to give new zest to the hearing. Florence Easton's is a good radio soprano voice.

WGN—9 P. M. Louis Katzman and his very good orchestra, the Whittall Anglo-Persians. Here was music well played, though again we might have been better pleased had the program been of less orthodox radio makeup. It included Thomas' "Mignon Overture," Sibelius' "Valse Triste," Gautier's "Le Secret," Dvorak's "Humoresque," and Jessel's "Parade of the Wooden Soldiers."

But all in all, we point out a most enjoyable and varied evening of music, and one which would require much jumping about in taxi-cabs, and the outlay of a pretty penny, to obtain first hand at the concert halls.

THUMB NAIL REVIEWS

WJZ—Announcing that, of the next three numbers to be played from the Commodore Hotel, the third was to be a brand new number from "Lucky," then only twenty-four hours old on Broadway—a number which we particularly desired to hear. A miscalculation in time made necessary a return to the studio right in the middle of the second selection. Station wjz offends too frequently in this respect.

WARS (New York)—An announcement to the effect that: "You are listening to Don Meaney's Midnight Frolics direct from KNX, Los Angeles." The fact that this was an itinerant company from a Californian station, broadcasting through a New York one, was announced, so it appeared to us, almost *solito voce*. We wonder how many New Yorkers thought they got Los Angeles "direct" that night!

SUGGESTED SPORT FOR CALIFORNIANS

A READER in Los Angeles writes us: "In your article 'Why There Should be More Vice in Radio,' you have hit the nail on the head. In this city are two persons that I know thousands of listeners would get an enormous kick out of if they ever tangled over the air. One is a

preacher and the other a female evangelist. If I could be drawn into a debate over the 'mike' of a neutral station I don't think the other stations in town would have 25 listeners apiece that night. The above mentioned each have powerful broadcasting stations. Draw your own conclusions." The which we print in hopes that our correspondent's suggestion may reach the "above mentioned" and start the fun.

WHAT CENSORS CENSOR

ON THE subject of the freedom of the air we note, since last writing, that complaint was registered by Representative Celler of New York that WEAf censored his address on George Washington of all statements that the father of his country liked his toddy, gambled, and in one of his Virginia campaigns, supplied rum and rum punch to the voters. Mr. Celler protested that "the radio management should permit discussion of the foibles of our great men if it adheres to the truth and is not phrased in a tone of disrespect. The things I proposed to say about Washington were not prepared with a view to belittling him. They are human qualities that detract none from his stature as a statesman or a man."

As a counterbalance to this censorship we have as exhibit B the extraordinary temerity evinced by KOA in allowing Judge Ben B. Lindsey to talk from its studio on companionate marriage, "the revolutionary theory that has scandalized society, brought down the wrath of the church, and set the whole world talking." We regret that interference kept us from hearing this decidedly controversial broadcast but we did "get" KOA the night before and heard advance information from director Freeman H. Talbot to the effect that: "Our station, like a magazine, will not assume responsibility for the principles advocated. But because of Judge Lindsey's prominence, because of his work in behalf of women and children, not only in the United States but in foreign lands, we believe he is entitled to an unbiased hearing."

Microphone Miscellany

BETWEEN the hours of eight and nine February 11, KFI, and ten other Pacific Coast stations presented what they termed an Interference Hour. The stations were paired off and so changed their wavelengths as to interfere seriously with one another.

After an hour of squeals, howls, indistinguishable announcements, and distorted music, the stipulated wave-lengths were resumed, following which pleas were made from each of the stations in support of the radio bill then before the senate.

WE ENJOYED Walter Damrosch's elucidation of Beethoven's Fifth Symphony considerably more than we were wont to enjoy his piano talks on Wagner. His enthusiasm is most contagious and he succeeds uncannily in making a piano sound like a section of a symphony orchestra, whether string or brass. His appearance on this "Beethoven Hour" was sponsored by the Columbia Phonograph Company, which company, in connection with its booming of Beethoven Week, made a canvass of the public's preference in composers. The comparative rating resulting from the ballot was:

Beethoven, 100; Wagner, 90; Bach, 87; Mozart, 82; Brahms, 78; Schubert, 76; Chopin, 75; Tchaikowsky, 62; Handel, 56; Schumann, 52; Mendelssohn, 47; Haydn, 38; Liszt, 32; Verdi, 27; Debussy, 26; Grieg, 26; Palestrina, 22; Franck, 20; Dvorak,

18; MacDowell, 16; Puccini, 15; Strauss, 12; Saint-Saens, 9; Weber, 7; Rimsky-Korsakoff, 7; Gluck, 4; Moussorgsky, 4; Massenet, 3; Rossini, 2; Berlioz, 2; Mascagni, 1; and Leoncavallo, 0.1

URIEL Davis, who controls the destinies of more than a thousand musicians, organized in a hundred combinations, made some observations in *The Billboard* on the selection of musical numbers for different kinds of audiences, which should interest every ambitious program director. He points out that the numbers selected for resort orchestras, for provincial towns, and for principal cities, vary greatly. The best index found to audience tastes of any locality is through the kind of phonograph records which sell the best. The resort audiences want popular music but numbers which have had an opportunity over a period of months to become well known; the small town and country audiences, time-worn numbers, known to the trade as semi-standard music; the big cities will not tolerate a number if the ink has had a chance to dry on the music. This may give a new angle to some program directors who have difficulty in accounting for the popularity of certain programs which nobody with whom they come in contact seems to like.

A DEPARTMENT of Commerce report states that the Tokio broadcasting station is soon to increase power to ten kilowatts. It states further that there are already 326,000 subscribers to the present one-kilowatt station. Eighty per cent. use crystal sets, although there is a strong demand now for much better vacuum tube receivers.

Correspondence

Los Angeles, Calif.

SIR:

Right here and now I want to protest your statement in the March RADIO BROADCAST. In the "Answers to questionnaires" story, you refer to the lack of feminine radio fans.

First, I am feminine,—and the most rabid kind of a fan,—tone, DX, quality programs, home-built, and factory-made sets. In fact, I have been completely "broke" buying radio parts ever since your magazine caused my downfall some eighteen months ago with a circuit. You see, the trouble was that the darn thing worked, otherwise I should have become discouraged and been saved! To date, I have built twenty-three sets, and lost hours of sleep trying them out.

But I believe that there is a reason; I have had no intolerant males to push me aside and let them show me how it is done. My trials and triumphs have been my own, and there have been considerably more trials than triumphs.

I'll make a wager with you: Let every woman who is even mildly interested, have her own set, tune-in her own stations, get that crackling, whistling elusive sound that means DX. She will show a longer log than friend husband.

It doesn't make any difference how much of a fan you are. Sit in a chair alongside your receiver, let the other fellow put the phones on and do the fishing; you'll be just as bored as though you didn't give a hang about radio.

Just try it!

Anyway, I like your magazine, even though it has kept me in a state of bankruptcy ever since I followed that circuit you published. And give me my choice between an evening at the theater and an evening at home listening to a really fine program,—I'll remain at home, thank you.

MARJORIE DOUGAN.

Problems of A. C. Filament Supply

Solving Some of the Difficulties Encountered in A. C. Operation of 201-A Type Tubes

By ROLAND F. BEERS

THE principles of series filament connections outlined in the first article of this group, published in the May RADIO BROADCAST, related the facts which pertained to 199 type radio tubes. It will be remembered that several typical circuits were discussed in detail, and two methods were outlined whereby the radio constructor could build up a receiver of this type.

In this, the second article of the series, the discussion will be extended to include 201-A type tubes, and data will be given regarding the theory of the power supply apparatus necessary to supply this type of tube.

The problem of supplying filament and plate current to 201-A tubes in series finds difficulties in the design and construction of the power unit rather than in the actual connection of the series filaments. There are three main problems which confront the home constructor of this type of unit. They relate to the transformer, rectifier, and filter circuit. In general, it is not possible to employ apparatus which is not specially designed for the circuit. The reasons for this statement will appear later.

In order to have an adequate understanding of the design of the power transformer, we must first consider the type of rectifier with which it is to be used. The requirements of the circuit demand a device of reasonably long life (say a minimum of 1000 hours), with uniform and stable characteristics throughout this period. The rectifier should also show good efficiency, particularly at full load. This quality is exceedingly desirable in order that the size and cost of the power transformer may be kept as small as possible. Early attempts of the writer to build a $\frac{1}{2}$ -ampere power supply unit led to the design of a transformer which weighed nearly 25 pounds because it was called upon to supply a great deal of power which was lost by the inefficient rectifiers used at the time. It was not until efficient high-current rectifiers were available that an economically satisfactory transformer could

be built. The efficiency of the rectifier also has considerable bearing on the design of the filter circuit, for the ease of filtering a given amount of power is dependent directly upon the voltage rectifying efficiency of the rectifier.

A third quality which must be considered in the design of a high-current rectifier is the voltage regulation which it contributes to the entire circuit. By this we mean the change in output voltage for either a change in load or a change in line voltage. What would be most desirable, of course, is a constant voltage output for all loads

to obtain the high currents necessary to supply a 201-A filament. In the first place, a thermionic rectifier has a point of temperature saturation. Temperature saturation is that state which occurs when the plate draws the entire electron emission from the filament and under such conditions a further increase in applied plate voltage produces no increase in plate current. The effect of this characteristic is to limit the amount of current that can be taken from a power unit, and it is essential that in ordinary operation no attempt be made to exceed this limit.

Line voltage variations assume relatively major importance with respect to the regulation of a power supply unit using a thermionic rectifier, by virtue of this temperature saturation effect. For example, if the rectifier were to be entirely independent of line voltage for its filament supply, a 10 per cent. decrease in line voltage would produce a certain decrease in d. c. output voltage, but if the rectifier filament were entirely dependent on the line voltage, it too would drop 10 per cent. and there would be an additional falling off in d. c. output. The total loss in output would then be the sum of those two separate effects. The curve in Fig. 1, marked "Thermionic Rectifier," shows how the output voltage of such a unit varies with different input voltages across the primary of the power transformer.

A gaseous rectifier contains no filament and therefore this double effect upon lowering the input voltage is not noticed. As a result, the regulation for the gaseous rectifier is much better than for the thermionic rectifier.

There is yet another effect inherent in a thermionic rectifier which also affects the regulation of a power unit in which it may be incorporated, *i. e.*, the voltage lost in a rectifier increases with increases in load, as shown by curve A, in Fig. 2. The voltage loss constantly increases with increasing current, and at the same time the losses in the filter circuit increase in the same manner, and the overall effect of the tube and the filter is shown by curve A in Fig. 3.

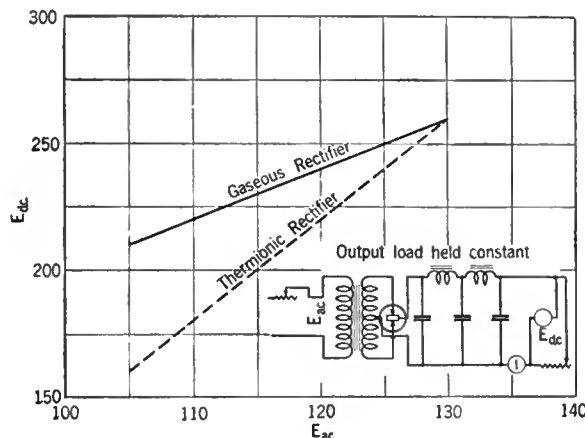

FIG. 1

and for any line voltage. This is not entirely possible, on account of losses in the filter circuit which cannot be completely offset, but it is possible to achieve a great improvement in regulation over that of many existing power units. This improvement is to be found in the design of the rectifier, as will be shown from the following discussion.

Let us first consider the thermionic rectifier. The performance of a device of this type is so well known that only those features will be considered that are important when using a rectifier

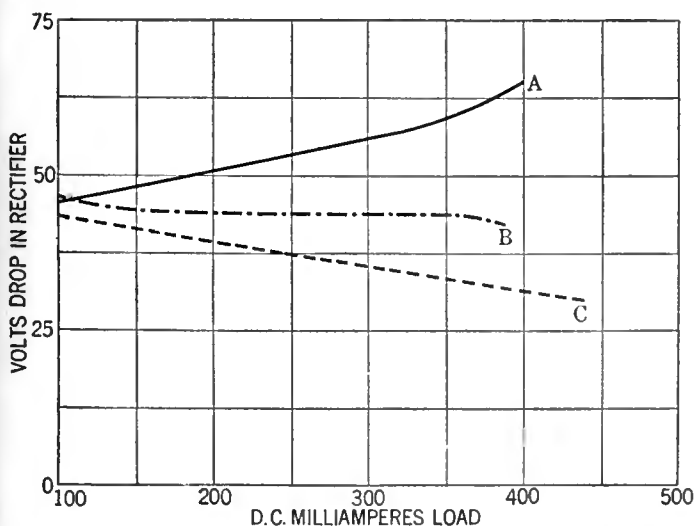

FIG. 2

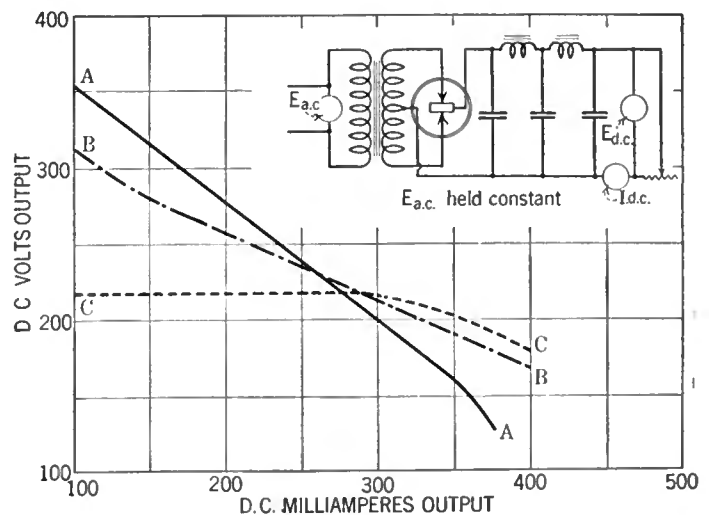

FIG. 3

It is possible to design a gaseous rectifier which will have a nearly constant voltage drop throughout the entire range of its load. Such a device will have a characteristic as shown in "B," Fig. 2. This rectifier would neither add to nor subtract from the overall regulation of a power unit, and the curve of this type of unit is shown at "B," Fig. 3. It can be seen that the improvement gained is considerable. However, a still greater benefit is available from the rectifier design. It is possible to construct a device of this type which will have a negative regulation characteristic such as that shown by "C," Fig. 2, in which the voltage loss in the tube decreases with increases in load. The advantages of a device of this type are at once apparent. If the negative slope of this line can be made equal in magnitude, and opposite in sign to the positive slope of the filter circuit, the overall regulation of the power unit will be nearly a horizontal straight line such as "C," Fig. 3. The curves in Figs. 3 and 4 were taken using various rectifiers constructed by the author.

The question might be asked most logically: Why is regulation so desirable in a series filament receiver? The answer is tied up in several fine points, no one of which seems important by itself, but their accumulated effect is great. In the first place, consider the result of removing a tube from its socket in a series filament receiver. The current load on the power unit drops from—say,

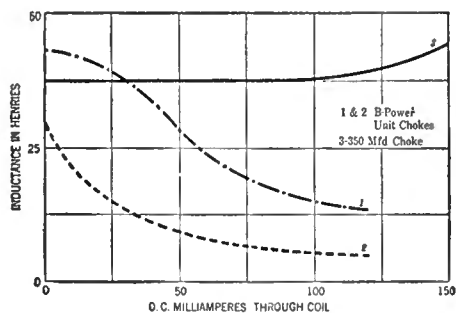

FIG. 5

350 milliamperes to less than 20 milliamperes. In a unit such as that represented by "A," Fig. 3, there is immediately an enormous increase in the output voltage. This high voltage is extremely hazardous to the filter condensers and may puncture any of them. Therefore, in order to build a reliable power unit of this type a very costly condenser must be employed. If our power unit has the characteristics shown by "C," Fig. 4, it is readily seen that the no-load voltage on the condensers is not excessive. There is also much less danger to associated apparatus. The cost of construction is therefore lowered.

Further considerations for good regulation lie in the design of the filter circuit. If the rectifier has a characteristic such as that shown by "C," Fig. 2, it is possible to match this curve by the positive slope of the filter circuit regulation. There is the possibility of building a fairly small filter choke whose resistance would ordinarily be too great but which would give satisfactory regulation in connection with the improved type of rectifier. The fact that the rectifier has less voltage loss at high current than at low current contributes a considerable gain to the ease of filtering at high loads. All of these factors greatly assist in reducing the ultimate cost of filtering.

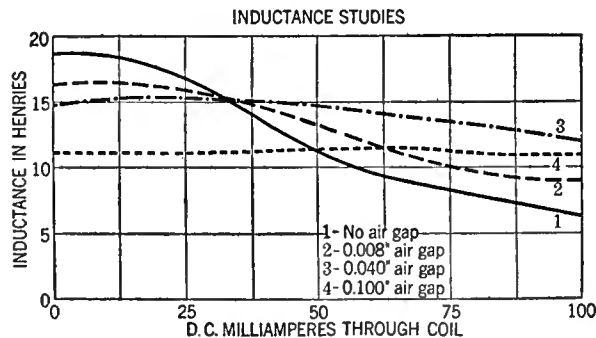

FIG. 4

A FILTER FOR 350 MA.

THE design of a filter circuit for 350 mA. presented a large number of problems at the outset. The main question was how to obtain satisfactory and reasonably proportioned filtering in a circuit. The first attempts along this line resulted in filter circuits weighing nearly 50 pounds, and while a device of this size might be acceptable to some set builders, it certainly would not meet universal approval. A study was therefore made to determine the smallest weight of filter circuit which would give satisfactory quality.

The first problem of design was that of the filter chokes. Very little data were available on the performances of inductances under high d. c. loads. It was known in a general way that the inductance of a given choke coil decreased as the d. c. through it was increased. The starting point of the design was therefore to determine the actual relations which obtain in high-current choke coils. Several different models were made up having different sized cores, a different number of turns, and adjustable air gaps. Fig. 4 shows the performance of various models constructed by the writer in the development of a high-current choke coil. The measurements of inductance were taken at the Massachusetts Institute of Technology. By the variation of different factors, a set of curves was finally evolved whereby a design for a given value of inductance at a given d. c. load could be determined. The curves of Fig. 5 show why it is not possible to employ ordinary filter circuits for 350 mA d. c. load. As the direct current through the windings of a choke coil is increased, the core becomes more saturated, until the effective permeability becomes very low. At extreme values of current saturation, the permeability approaches that of air. This portion of the saturation curve is shown by the dropping off of the inductance curves. Curves 1 and 2 show how ordinary B power-supply chokes lose their inductance with increasing d. c. load.

The second reason why ordinary filter circuits cannot be used at high 350 mA. load is that there is not sufficient condenser capacity in which to store up energy. The rate at which energy is being taken from the filter circuit is proportional to the current output. It is therefore apparent that

more capacity will be required for high-current filter circuits than for low-current ones. The result of using insufficient capacity is an increase in the hum.

The magnitude of this hum depends very largely upon the amplification characteristics of the radio receiver. Poor quality sets which give very little amplification at low frequencies can be operated from a power unit which has a large ripple in the output, without giving objectionable hum. As the amplification of low frequencies is increased, however, it is necessary that the ripple in the power unit be reduced to not more than 0.1 per cent.

One very bad effect which will be produced by the lack of sufficient capacity in the filter circuit is the tendency to audio regeneration in the receiver. From the standpoint of the power supply unit, this may come from two separate causes. The first cause is that the terminal capacity on the filter circuit is too small. If this is the case, it is possible that the effective impedance of the filter in the plate circuit of the amplifier tubes will be very large. It is, of course, well known that the impedance of a condenser, such as the last one in the filter circuit, increases as the frequency decreases. At ordinary audio frequencies this impedance may be a very few ohms, and in this case its effect on reproduction is negligible. If the amplifier is slightly unstable, it is possible that an incipient oscillation of from 2 to 10 cycles per second might arise in one stage, and being coupled to the other stages through the filter condenser, it might cause trouble. At this low frequency, the effective impedance of the filter condenser would be very large, and would offer sufficient coupling between the amplifier stages to induce sustained oscillation. This effect is commonly known as "motor-boating," and its remedy is frequently found in an increase in the terminal capacity of the filter circuit.

A second cause for this type of regeneration is found in the presence of a large a. c. ripple in the output of the power unit. If this variation exceeds 0.1 per cent, it can readily be shown from Fig. 6 that the amplification of the hum from the detector plate to the power amplifier stage would result in an enormous a. c. grid voltage.

Assume the plate voltage on the amplifier tubes is 100 volts and that the plate voltage on the detector is 50 volts. Also assume that the ripple in the power unit has a frequency of 120 cycles and that the transformer amplification at this frequency is 2. The amplification in the tube would be 8. If K equals the percentage ripple in the B supply source then:

$$\begin{aligned} \text{A. C. voltage} &= K \times \text{D. C. volts} \\ \text{Detector} &= \frac{K}{100} \times 50 = \frac{K}{2} \text{ volts} \\ \text{Amplifiers} &= \frac{K}{100} \times 100 = K \text{ volts} \end{aligned}$$

If we then calculate the a. c. voltage on the grid of the power tube at various percentages of ripple in the power supply unit we obtain the following values:—

K%	A. C. hum voltage on power amplifier grid
.05	0.9
.10	1.8
.20	3.6
.30	5.4
.40	7.2
.50	9.0
.60	10.8
.70	12.6
.80	14.4
.90	16.2
1.00	18.0
2.00	36.0

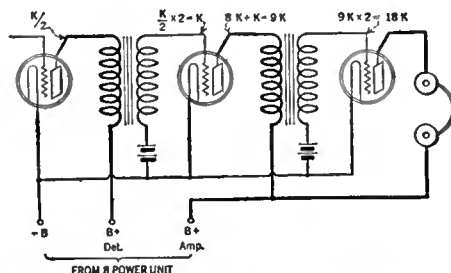

FIG. 6

If the a. c. hum voltage is greater than the normal C bias on the power amplifier grid at any part of the cycle, there would result a great increase in the plate current of this tube. This increase would occur periodically, and frequently would attain such a magnitude that the output condenser of the filter would be almost completely discharged. It would result in a failure of voltage at the terminals of the power-supply unit, until the filter circuit could fill up again with energy.

The remedy for this situation is to improve the quality of filtering or to increase the negative bias on the power amplifier tube. The latter remedy sacrifices some amplification, and for best results it is therefore recommended to add capacity to the filter circuit until the difficulty is stopped. The subject of "motor-boating" is given such consideration here because it gives much more trouble in series filament receivers than is customary. The reason for this is that the failure of voltage at the power supply output caused by "motor-boating" results not only in decreased plate potential, but also in a dropping of the filament temperature. The addition of these two separate effects frequently stops the operation of the receiver entirely, because they are both accumulative in the same direction. One general method of overcoming the difficulty just mentioned is to isolate troublesome stages from the common power-supply source. This can be very well done by the use of choke coils and bypass condensers, which are placed in the plate circuit as shown in Fig. 7. These units effectively restrain the alternating currents to their proper paths and prevent mutual coupling in the impedance of the power supply unit.

When we actually connect up a radio receiver with 201-A tubes in series there are not more than two or three principles which must be remembered. The first of these is the manner in which grid bias is to be obtained, and the second is the order in which the tubes shall be arranged in sequence. As a matter of secondary importance there is a possibility that it will be necessary to place shunt resistances around certain of the filaments in series, in order to limit the current through them to safe amounts.

A method of obtaining grid bias is to place in the filaments, series resistances of the proper value, whose voltage drop will give the required grid bias. The value of resistance depends upon the amount of bias required, and is equal to the required voltage multiplied by 4. For example—if 4.5 volts grid bias is desired, this is obtained

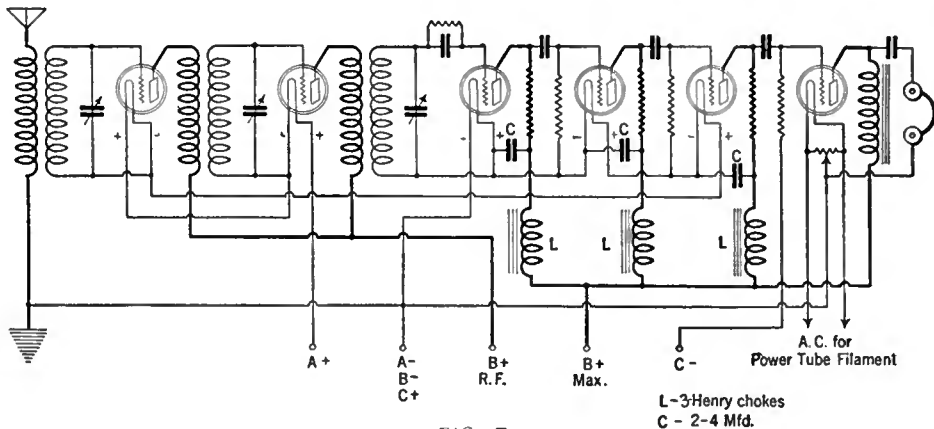

FIG. 7

by a resistance of 4.5×4 , or 18 ohms. This is placed in the circuit as shown in Fig. 8, and the grid return connection is made to point A. These biasing resistors carry the entire filament current, or 0.25 ampere. One convenient form in which they are obtainable is the customary 20-ohm rheostat, which can be inserted in the filament line as shown, and then adjusted to any required value. It is advisable to incorporate bypass condensers in this circuit.

The order in which the tubes are arranged has been discussed to some extent in the first article of this series. The main point to be remembered, of course, is the location of the detector filament nearest the B-minus or ground point. After that may come in order the first a. f. and second a. f. followed by the radio-frequency stages. Aside from the actual effect of a. c. fields on the performance of the receiver, another point to be remembered is the amount of effective plate voltage required in the various stages. It is apparent at once that those radio tubes which are nearest the A-plus terminal have a lower effective plate voltage than those at the negative end of the series. Very frequently increased amplification can be obtained by choosing the location of certain stages, so that they will receive the optimum value of plate potential.

As a matter of general procedure, it is not ordinarily necessary to provide filament shunt resistances for 201-A tubes in series. The writer has used as many as six of these tubes in series without bypass shunts, as a protection from plate-current overload. It was necessary, of course, to limit the plate current in the amplifier

stages to moderate values by the use of proper C-bias voltages. If more than six 201-A tubes are connected in series, or if the total plate current consumed by a receiver of this type is more than, say 35 mA., it will be advisable to use the method described in the preceding article for protecting the last two tubes in the series, which consists of shunting the filaments with resistances of such a value that the current through the filaments is reduced to normal.

The proper value of protective resistance is found by dividing the normal filament voltage by the total plate current of the preceding tubes. For example, if the total plate current at the 6th tube in a series of 8 is found to be 40 mA., it is apparent that the total current in the 7th filament will equal 250 plus 40, or 290 mA. This represents an overload of 40 mA., which must then be bypassed through a resistor across the 7th filament. The value of this resistor will be equal to 5 divided by 0.04, or 125 ohms.

In the next article of this series the constructor will be shown how to build up an A, B, C power unit incorporating the principles previously discussed. It will also include a description of the new Raytheon BA 350-milliampere rectifier, which is a full-wave gaseous rectifier operating without a filament.

The characteristics of this rectifier have made possible the development and construction of an efficient and highly satisfactory power unit for 201-A tubes in series. This unit supplies complete radio power for any type of modern receiver, and several popular circuits will be discussed at some length.

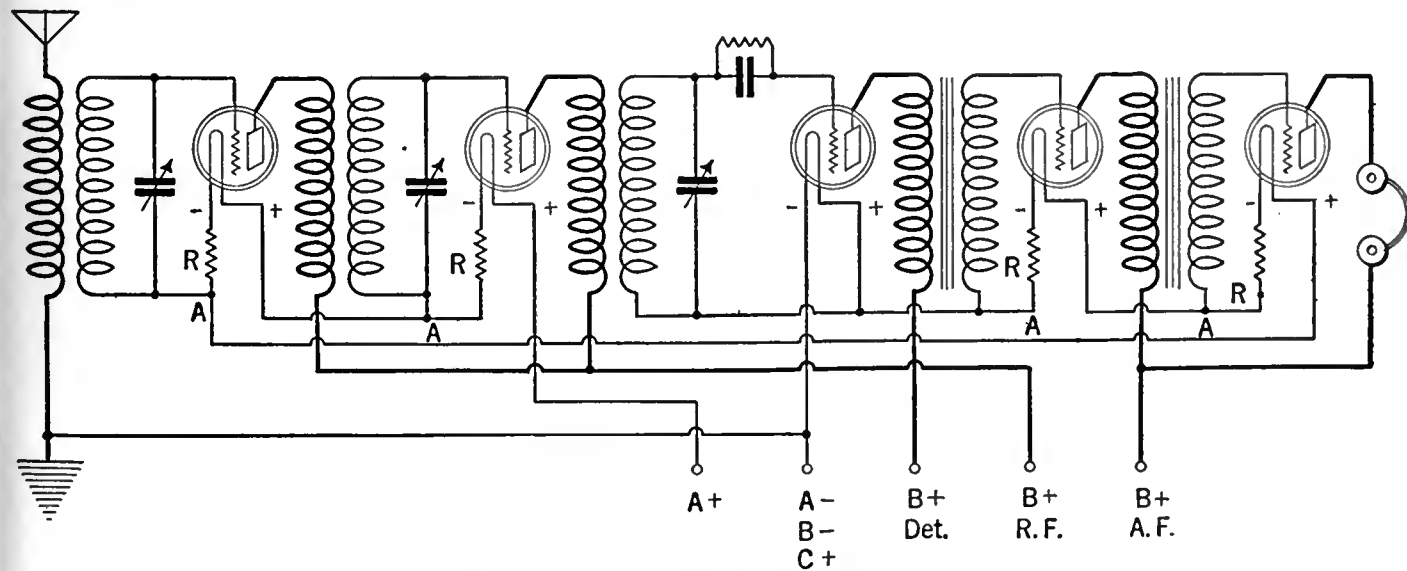

FIG. 8

How to Design a Loop Antenna

Details for Using the Accompanying Chart Which Makes Difficult Mathematical Calculations Unnecessary—Properties Governing Loop Efficiency

By HOMER S. DAVIS

THE loop antenna has been in use for many years and of course needs no introduction. For the broadcast listener it has a number of very desirable characteristics. Being compact and self-contained, it permits the placing of the receiver in any desirable part of the home, whereas the usual antenna and ground connections often make this location fall in a most unseemly place. The inherent selectivity of the loop is contributed to by its directional properties; that is, it receives best from directions parallel to its plane, and very poorly, or not at all, from directions at right angles to it. An interfering station, such as a powerful local, or one on a neighboring wavelength to the desired station, may often be thus eliminated by turning the loop at right angles to it. The loop is also generally regarded to be less susceptible to static and other atmospherics.

The outstanding disadvantage of the loop is that its effectiveness as an antenna is, comparatively speaking, small, usually only a very low percentage of that of the average outdoor type. Its use thus requires a very sensitive multi-tube receiver, such as the super-heterodyne. But this objection seems about to be overcome with the development of high-gain tuned radio-frequency amplifiers, and of many battery eliminators which are making the multi-tube receiver

should be kept as low as possible. This capacity increases with the number of turns, and is at a maximum when the turns are close together, but decreases rapidly as the wires are separated. Spacing the turns not only reduces the distributed capacity but enables a larger number of them to be used for a given inductance, thus adding to the received current. Distributed capacity of a loop is also increased by two factors seldom of importance with small inductance coils. One of these applies to the lead wires to the set, which should be kept short and separated. The other factor is that a loop is an arrangement of wires above the ground, and therefore forms a condenser with the ground, and also with various parts of the receiver. This tends to limit the highest frequency (lowest wavelength) to which the loop will respond, and there is little that the builder can do about it.

Two forms of loops are in common use, the "box," or single-layer square type, Fig. 1, and the "spiral," or flat square type, Fig. 2. The spiral loop is the simplest and cheapest to construct, but is less desirable since the inner turns rapidly become less useful as the area diminishes.

The first step in designing a loop antenna is to decide upon its physical proportions, keeping in mind the factors mentioned in the discussion above. A good idea of present practice may be had in a visit to the retail shops. Having chosen the most desirable size of the loop, and the size of the variable condenser for tuning, the next question is the necessary number of turns of wire to wind upon it. On page 264 of Bureau of Standards *Circular No. 74* is given the formula:

$$L = 0.008 a n^2 [2.303 \log_{10} \frac{a}{b} + 0.726 + 0.2231 \frac{b}{a}] - 0.008 a n [A + B]$$

Even for one having the mathematical ability to use this formula, it is not possible to solve directly for the number of turns. But for use in designing loops for broadcast receivers, a simplified approximate formula has been developed, and the accompanying alignment chart constructed from it.

USING THE CHART

THE drawing of two straight lines with a pencil and ruler is all that is required to use this chart. It consists of four numbered scales. Scale "a" represents the effective side of the square; in the case of the box loop, this is the actual length of a side, as indicated in Fig. 1; for the spiral type, the average length should be used, as in Fig. 2, since the inner turns are shorter. The effective breadth of the winding, scale "b," is a little greater than the actual breadth indicated as "b" in Figs. 1 and 2, overlapping each side by half the space between wires. Scale "c" represents the capacity of the tuning condenser, while scale "n" is the number of turns of wire.

The procedure is best illustrated by working out one or two examples. Suppose a box loop is to be built with 18" sides, for use with a 500-mmfd. (0.0005-mfd.) tuning condenser, and a 6" effective breadth of winding is decided upon. The key at the bottom of the chart indicates

which scales are to be connected together. Draw a line, therefore, from 500 on the "c" scale to 18 on the "a" scale. Then, through the intersection of the first line with the Index Line, draw a second line from 6 on the "b" scale across to the "n" scale, and you will read 16 as the number of turns of wire required. To take another typical example, it may be necessary to know the size of tuning condenser to use with a certain spiral loop of 18 turns, with 20" sides at the rim and an effective breadth of 4". The average length of a side is then 16". According to the key, connect 18 on the "n" scale with 4 on the "b" scale, then draw another line from 16 on the "a" scale through the intersection until it crosses the "c" scale, reading 350 mmfd. (0.00035 mfd.) as the required capacity of the tuning condenser.

Care should be taken always to connect the proper scales as shown by the key. The chart is an approximation of the complicated formula reproduced elsewhere on this page and its accuracy is 5 per cent. or better, when used with a loop whose side is not more than about five times greater than its breadth.

In choosing the size of tuning condenser to use with a loop, it should be borne in mind that the

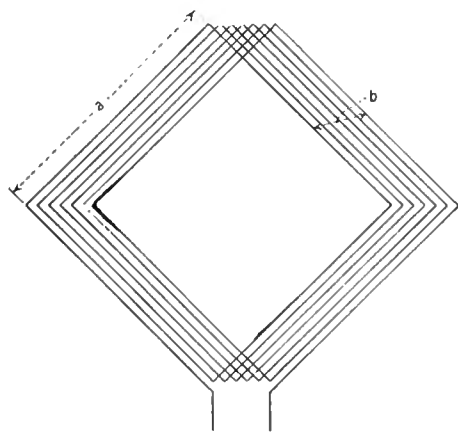

FIG. 1

economical. Thus the popularity of the loop antenna is steadily growing.

The design of a good loop is largely a matter of compromise between a number of variable and often conflicting factors. It has been found that, with all other conditions remaining the same, the received current in a loop is greater, (1) the larger the number of turns of wire used, (2) the larger the area enclosed by the loop, and (3) the greater its inductance. The required inductance of the loop is determined by the capacity of its tuning condenser; the area or physical size is limited by available space, or good appearance in the home. The necessary number of turns of wire to obtain the required inductance depends upon the spacing of the turns.

As in the design of the inductance coils within the receiver, the distributed capacity of the loop

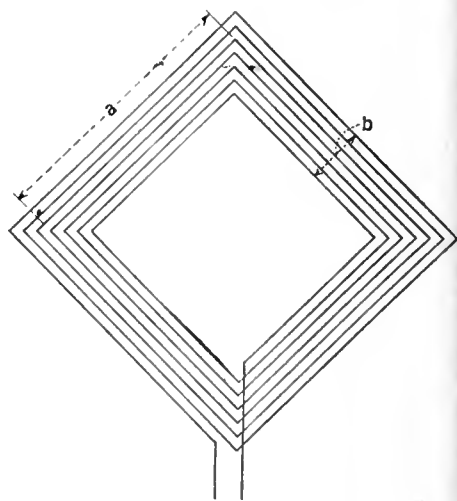

FIG. 2

distributed capacity of the latter will usually be found to be comparatively large, and a large condenser is desirable since it has a greater ratio of maximum to minimum capacity. With the smaller sizes, difficulty is likely to be experienced in reaching the higher frequencies (lower wavelengths). A capacity of 500 mmfd. (0.0005 mfd.) is usually regarded as most satisfactory, and has been adopted as standard by most loop manufacturers.

Rectangular loops of artistic design have recently appeared, but the formula for this type is nearly impossible to chart. If the reader desires to build a rectangular loop, the chart for square loops may be utilized as a guide, first using it for the shorter side, then for the longer. The number of turns actually required will lie somewhere between these limits.

LOOP ANTENNA

DESIGN CHART

For
BROADCAST FREQUENCIES

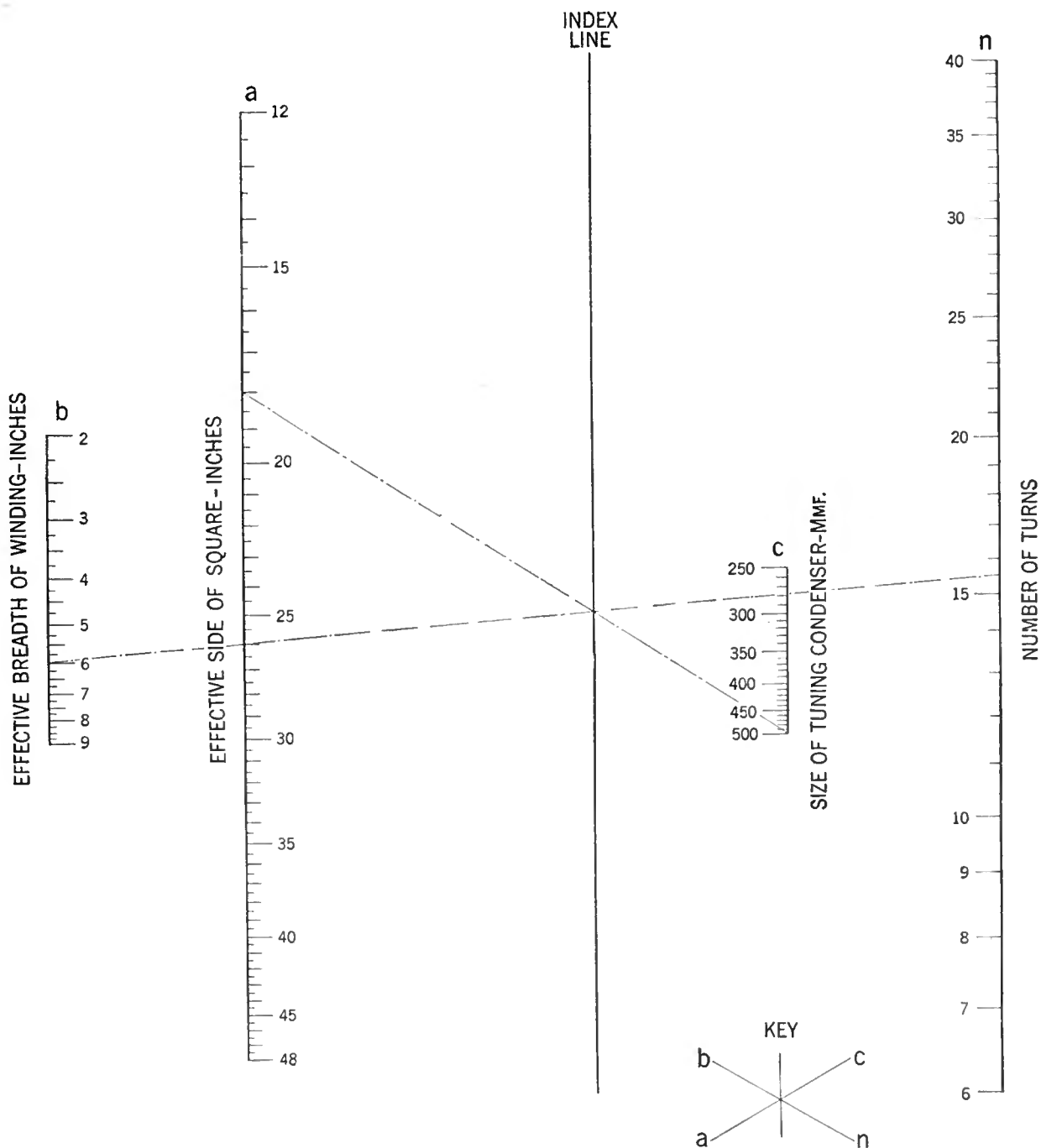

For Best Accuracy, Ratio $\frac{a}{b}$ Should Not Exceed 5

AS THE BROADCASTER SEES IT

by CARL DREHER

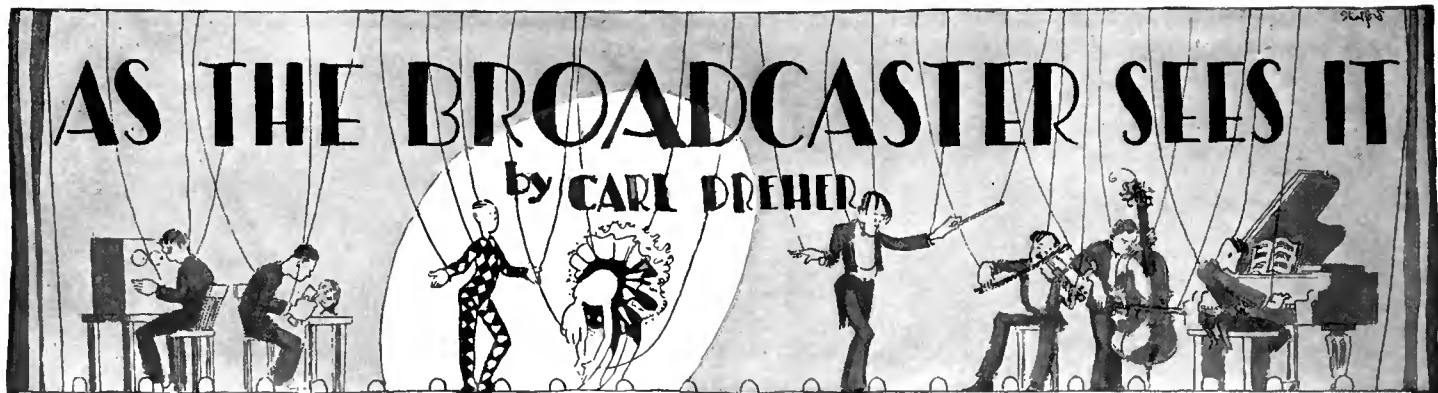

Drawings by Franklyn F. Stratford

The Difficult Business of Running a Broadcasting Station

EVERYBODY wants to run a radio broadcasting station. The general public, not having access to one, must do without this luxury, but among the fortunate beings who happen to be employed in the broadcasting business, from the owners of stations down to the functionaries who have dedicated their lives to folding and unfolding the camp-chairs in the studios—too many want to be broadcast admirals. There are considerable numbers of badly managed stations at which a tug-of-war, more or less violent, is constantly in progress, with the proprietors, program people, and technicians all trying to make final decisions and dominate the works. In general, this condition obtains at the smaller stations.

As a general rule, no one of the above groups is competent to run a broadcast station unaided. If they were, considerable money could be saved. The effects of undue domination by any of the functionaries will now be set down, and the audience is politely requested not to throw pop-

bottles. The owner of a broadcasting station might be thought a safe person to entrust with its fortunes, because of his monetary interest in the establishment, but it does not necessarily work out that way. I could offer in evidence an actual station, and will, in fact, whisper its call letters to any member of the United States Supreme Court or of Mr. Ziegfeld's chorus who will apply in person. My duties led me, recently, to a point within such a short distance of this transmitter that I was able to judge the technical quality of its emissions accurately. It was terrible. The difficulty seemed to be a harrowing loss of the high frequencies, the cut-off, apparently, being lower than that of a commercial telephone circuit. Speech was barely intelligible, and a jazz orchestra sounded like an organ. I thought the set had been built by the local tinsmith, but my informants told me that it was a 1 kw. product of a nationally known manufacturer, practically new, and secured at a cost of something like \$20,000. After a while I got the story. The proprietor of the outfit, it appears, had objected to the microphone hiss—the "blow," as they call it in that neighborhood. The operator thereupon instituted experiments to eliminate this disturbance. His labors culminated in the connection of a 0.5-mfd. condenser across the line between the output of the 5-watt amplifier and the input of the 50-watt

stage, these being 500-ohm circuits. The microphone hiss disappeared as by magic, and so did all other frequencies above 1800 or so. (The reactance of a 0.5-mfd. condenser is about 340 ohms at 1000 cycles; 170 at 2000; 85 at 4000, etc.) The operator had some vague idea of what he was doing, but, as he had got rid of the hiss, he let the owner listen to the results. The owner was pleased. He declared that the music sounded "mellow." So it does; if "mellow" means absence of high frequencies, then this is the mellowest station in the world.

Possibly the proprietor has an ear unusually rich in subjective harmonics, or his receiving set may be so high-pitched that the combination of drummy broadcasting station and tinny receiver is fairly flat. At any rate, the station continues to run with the 0.5-mfd. bypass. The operator, by now, would take it off, but the owner likes it, so it stays on. As a crusader for good broadcasting, I should be pleased to dip owner and operator in a strong saline solution, applying 1000 volts to the operator and 1500 to the owner while they are still wet. The laws forbid this punishment, so between the two of them they continue to ruin their station.

The case cited has no direct bearing on the question of how to arrange the internal relations of a broadcast station so that the best results may be secured on the air. All that it shows is that, if the owner-manager and technician are both nitwits, as far as broadcasting goes, the station will be a peanut-roaster, whether the two work together or cut each other's throats. But, even if there is a considerable amount of brains

in one or the other division, maximum efficiency cannot be attained unless there is a sound division of labor and power between the groups concerned.

In broadcast stations, as in other technical fields, there is frequently more or less of a gap between the technical and non-technical forces. This condition is only partly remediable. The fact is that most technical enterprises are run—and probably it is for the best—by laymen. The specialists and managers start with a totally different training and background. At some stations, they hardly seem to realize that the aim they have in common is to make the business run. It is admittedly difficult for the layman to be patient with the technician in certain situations. Technical development, for example, is tedious, costly, and apt to interfere with operation. Only the man who knows all the obstacles and how they must be overcome, one by one, can judge how well or how badly the job is being done. At a given stage in the evolution of an art only a partial solution may be possible. In 1921, the production of an acoustically excellent broadcast receiver was impossible, because several of the essential elements were still lacking. These components had to be worked out, in several special fields, before they could be combined by still another group of workers. Not only technical facilities were lacking, but also knowledge. It takes time to secure both the material and the immaterial elements. The non-technical manager often travels with the idea that all technology is built up on exact ideas, and that if he could only find the man who had the knowl-

edge required, all would be well. Sometimes this is true, but as a matter of fact every branch of industry is constantly pushing out against a circumference of dubious knowledge, or downright ignorance; this is particularly true of radio communication and the arts of visual and acoustic reproduction. Again, while the modern engineer is forced to specialize, his work frequently carries him into fields where a broader training would stand him in good stead. He may be working out a problem in auditorium acoustics one day and wrestling with hydraulic equations the next. Some motion is lost with each change, but there is no help for that as long as we want to retain our present economic and technological structure. All these things make cooperation between technical and lay workers somewhat difficult, and

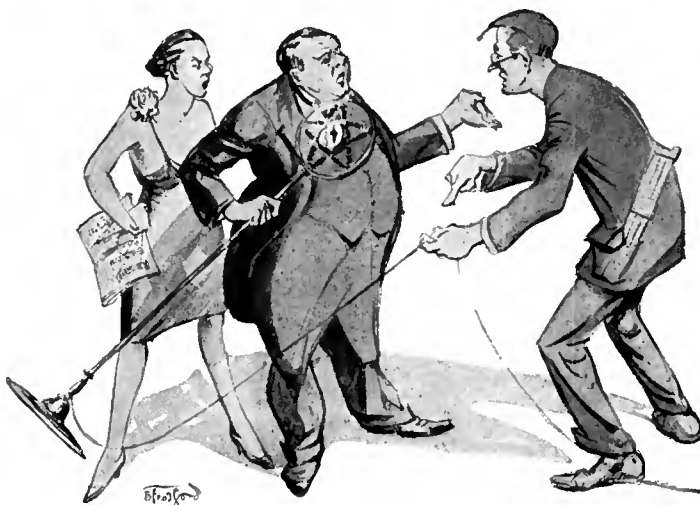

THEY ALL WANT TO BE BROADCAST ADMIRALS

where they are forced into intimate relations, as in a broadcast station, the fur is apt to fly. The managerial or program group presses for results, often unintelligently; the mechanical forces feel oppressed and inarticulate in the face of people who have power over them and do not speak their language. The solution lies in intelligent executive direction. The successful executive gives the engineers a free hand in their operations, within the economic limits of the enterprise, and yet exerts a constant, gentle pressure for results. The greatest weakness of technical men is their penchant for getting lost in the mazes of technical endeavor; they lose sight of the goal which they are paid to work for. At such times they must be firmly grasped by the bridle and led back to the path. But they do not require a check-rein every day of the year, and, as far as broadcasting specifically is concerned, one never sees a station functioning in healthy fashion unless the technical group is given latitude and power in their end of the business. If the special knowledge of the mechanical experts is ignored, the station is always pretty sick.

The program people suffer from similar disabilities. Program managers, like telephone operators and elevator runners, rarely receive praise for their efforts. Everybody thinks he could put on a better show, given the same money to spend. It is sometimes embarrassing when the owner of the establishment thinks so. The owner of a broadcasting station, also, takes a much greater interest in it than he might in some other business. The proprietor of a great merchandising enterprise, for example, will sometimes spend most of his time on his broadcasting station, even though it is a small proposition compared to other divisions of his business. This disproportion arises from the fact that broadcasting is more interesting, and richer in publicity, than other branches of commerce. It is a relatively romantic field of endeavor, and hard-boiled business men have a streak of romance in them, whether they admit it or not. Thus the employees of a broadcasting station, even when the boss is a man of great means and wide interests, generally work very much under his eye. This has advantages and disadvantages. They are subject to all sorts of caprice and unpredictable reaction. The technicians can always find some sort of refuge in their mechanical jargon, but the program people are pitifully exposed. Yet there is some utility in the situation. The object of the station, after all, is to please the public, and the owner is apt to be a pretty good representative of public taste. He may have more money than the average, but his general psychology, prejudices, emotional interest, and fears, are usually basically the same as those of the bulk of the audience. Broadcast entertainment falls within the wide latitude of middle class life, and a successful business man is generally well within the borders of middle class culture. If he owns a broadcasting station, and the programs make his high blood pressure worse, he is probably right in canning the impresario responsible. When the program suit the owner, they will probably suit the Smiths, Joneses, and Robinsons likewise, and that is the purpose for which the amperes chase each other up and down the antenna.

The fundamental difficulty with broadcasting is that it is complicated, very complicated. It is one of the most intricate sectors of the whole tangle of industrial life. Telephone and radio

engineers, musicians, program arrangers, advertising experts, salesmen, publicity men, executives, are thrown together helter-skelter and expected to cooperate in a common endeavor. It is a wonder that they work together as well as they do, and that the results are as good as they are.

Man and Modulation

MODULATION, in broadcasting, is a variation of electric carrier amplitude in accordance with the vibrations of sound. The result is the "intelligence-bearing side band"—one of the most important scientific creations of the twentieth century. But in its broad sense, "modulation" was known long before the days of radio telephony. Before radio phrases got into the vocabulary of the man in the street, modulation was any variation or inflection in tone, as in speech or music. The Greeks knew as much about modulation of sounds, or rather, they could modulate sounds as skilfully, as modern men. But they did not know how to generate or modulate electric waves, the advantage of which is that they can reach out to enormously greater distances than the unaided organs of speech.



"HARD-BOILED BUSINESS MEN HAVE A STREAK OF ROMANCE IN THEM"

Yet, while the purposeful generation of electric oscillations is a very recent invention, periodicity and radiation are among the fundamental processes of the universe. The cosmos is full of waves, short and long. The shortest and fastest of terrestrial origin which we know of now—if no faster ones are discovered in the interval between the writing and printing of this discussion, are the gamma rays of radium, which vibrate no less than 150 quintillion (150×10^{18}) times a second. The wavelength, therefore, must be of the order of 2×10^{-8} meters, or, expressed in the Angstrom units preferred by learned scientists (an Angstrom unit is 10^{-10} meter)—about 200 Angstrom units. Relatively speaking—and we can't speak in any other way—this is quite short. It seems still shorter when compared to the length of the radiation from a 60-cycle circuit, which emits waves 5,000,000 meters, or

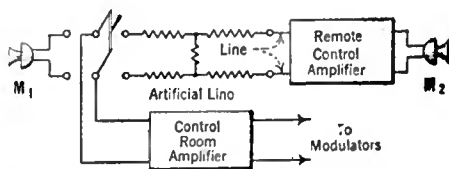

FIG. 1

3100 miles in length. (Inasmuch as radiation varies as the fourth power of the frequency, a 60-cycle circuit emits only feeble waves, but it does radiate. V. Bush has calculated that an antenna which radiates 100 kw. at a radio communication frequency of 30,000 cycles per second, will radiate only 1.6 microwatts if excited to the same potential at 60 cycles.) The ratio between the long wave which we have selected for purposes of illustration (60 cycles— 5×10^6 meters) and the short gamma ray (150×10^{18} cycles— 2×10^{-8} meters) is 2.5×10^{14} , a figure which only an astronomer could gaze at unmoved. And there are waves of all lengths between the shortest and the longest, many existing in nature and others producible by man and therefore also existing in nature.

Man lives not by bread alone, but by radiation as well. Where would he be without the light and heat of the sun? He cannot even live without his share of ultra-violet rays. And recently the great spiral nebulae have been discovered to be sources of extremely short and penetrating X-rays, which, it is speculated, may have something to do with the origin and maintenance of life on the earth. "The primary radiation of the universe," according to Prof. J. H. Jeans, "is not visible light, but short-wave radiation of a hardness which would have seemed incredible at the beginning of the present century."

But, as found in nature, these electric waves carry only their own vibratory energy. It was left for man to generate sustained waves which he could modify intelligently, so that they would bear through space the murmurs of his speech and music, so transient and yet so important to this strange creature endowed with consciousness. The energy of these waves is insignificant. Were it abstracted from the sum total of energy in the universe, or even on this little earth, its absence, as energy, would not be noticeable. It is important only because it is a carrier of human emotion, which, ultimately, in endlessly varying forms, is what man lives for. It would avail him little if the blind energy of the universe, streaming through all living creatures, kept him alive as if he were a plant or a simple, satisfied animal. He would be bored to death. The skill he has developed in the art of modulation is one of his ways of seeking refuge from that fate.

Technical Problem. No. 1

EACH issue hereafter will contain a practical broadcast problem, involving some calculation, on which professional broadcast technicians can test their skill. The question will be stated, and the same issue will contain a full solution, confirming the answer reached by those readers who handled the problem successfully, and showing the others how they should have gone about it. The problem for this month (See Fig. 1) is the following:

A carbon transmitter M_1 , whose output is 30 TU's down, is used in the studio of a broadcasting station, feeding the first stage of a series of amplifiers leading to the modulators. At a point 100 miles distant another transmitter of greater sensitivity, M_2 , its output being only 20 TU's down, feeds a remote control amplifier which has a power amplification of 10,000 times. The line is largely open wire and has a loss of 12 TU's in all. What size of artificial line should be used at the control room termination of the 100-mile circuit to bring it level with the output of

the studio microphone, assuming all impedances to be matched so that the line and studio microphone feed the first control room stage of amplification with equal efficiency?

(Solution on page 109)

Design and Operation of Broadcasting Stations

16. Studio Design

A LARGE part of the material in this discussion is taken from Bureau of Standards Circular No. 300, *Architectural Acoustics*, obtainable from the Superintendent of Documents, Government Printing Office, Washington, D. C., at five cents a copy. This pamphlet in turn leans heavily, as do all works on the subject, on the investigations of the late Wallace Clement Sabine, now being carried on by P. E. Sabine. These studies are concerned with the acoustics of auditoriums, but the results are adaptable to studios of broadcasting stations on the basis that the best reverberation time for electrical reproduction is about half that of an auditorium of the same volume where the performance is intended only for the audience physically present.

The principal acoustic characteristic of a room is its reverberation time, which, as originally defined and measured by Sabine, was the time required for a sound a million times audibility to die down to just audibility, both expressed in power units. In other words, you take a sound of a certain intensity, and let it die down 60 TU (in telephone terminology) in an enclosure, and the time you have to wait is the reverberation time of that enclosure. Actually, reverberation times are generally calculated, and their principal use is comparative and empirical. For example, you have a certain studio whose characteristics have been found to be satisfactory. Then, if you have occasion to design another studio, it is wise to calculate the reverberation time of the first room and duplicate it in the second, or to make such modifications as are indicated by past performance.

Sound may be reflected by the walls, floor, and ceiling of a room, or absorbed, depending on the materials of which the surfaces are composed, the frequency, etc. Generally, there is partial reflection and partial absorption. Open space is taken as the perfect absorbing material; thus, in a room, open windows are perfect absorbing areas. If a square foot of open window is taken as the unit of perfect absorption, various coefficients may be applied to square feet of wall materials to indicate their power of absorption. A few such absorption coefficients are given below:

Brick wall, 18 inches thick	0.032
Carpets and rugs20
Cork tile03
Linoleum03
Hair felt, 1 inch thick, unpainted55
Hair felt, 2 inches thick, unpainted70
Plaster on tile025
Marble01
Varnished wood03
Human beings60
Chenille curtains25
Curtains, in heavy folds	0.5 to 1.00

In many cases these coefficients vary with frequency; theory indicates, in fact, that a flat characteristic for a homogeneous absorbing material is impossible. The coefficients given are supposed to be correct for 512 cycles per second, which is a good mean musical frequency, as 800 cycles per second is a good mean speech frequency for commercial telephone calculations. As would be expected, hard materials like marble, plaster, etc., absorb sound very little, whereas

curtains, felt, human beings, etc. have high absorbing power. This is borne out by practical observation; everyone has noticed the persistence of sound in empty rooms and auditoriums, especially where the walls are hard and unbroken, while when curtains, furniture, and persons are present, reverberation is reduced. As the volume of the enclosure increases, the reverberation time also increases. Given the volume of a room, and the areas and absorption coefficients of the materials used in its construction, the reverberation time may be approximately calculated by the empirical formula:

$$t = \frac{0.05 V}{A} \quad (1)$$

where t is the calculated reverberation time in seconds, V the volume of the room in cubic feet, and A the total absorption. We find A by taking the area of the various materials in the room and multiplying each by its coefficient of absorption, then adding the quantities so obtained. Obviously this assumes that the absorbing power of a surface depends only on its area and acoustic characteristics, and is independent of its position in the room. This is substantially true.

The application of the formula is most readily learned by the actual solution of a problem:

Given a room 20 by 15 by 10 feet, with plaster walls and ceiling, and a varnished hardwood floor, calculate the reverberation time, and apply acoustic treatment to reduce this period to an allowable value for broadcast purposes.

V equals 20 times 15 by 10, or 3000 cubic feet.

Let W represent the wall area, C the ceiling area, and F the floor area. Then we find in the above case that $W=700$ square feet, $C=300$ square feet, and $F=300$ square feet. A may now be calculated for the bare room:

Wall plus ceiling area (1000 sq. ft.) multiplied by the coefficient for plaster (0.025)	25
Floor (300 sq. ft.) multiplied by the coefficient for hardwood (0.03)	9
Total absorption (A)	34

Substituting in Formula (1) above, we have:

$$t = \frac{0.05 (3000)}{34} = 4.4 \text{ seconds}$$

This is much too high for a small room. Sabine found that good musical taste required a reverberation time of slightly over one second, for piano music, in a room of moderate size. Musicians check each other with fair accuracy in such determinations. Even a large concert hall will have an optimum reverberation time of between two and three seconds only. (The allowable reverberation time increases approximately as the first power of the linear dimensions of the room, for the same absorbing materials, since V in the numerator of formula (1) is a cube function of the linear dimensions, while A , in the denominator, varies as the square of the linear dimensions.) Hence it is necessary to apply additional absorption to the room we are considering, in order to reduce the reverberation time to about 0.5 second. This is on the theory that the optimum period would be about 1.0 second, for a room of this size, considering results in the room only, and that this quantity should be halved for purposes of electrical reproduction at a distance.

Suppose, now, that the ceiling of our 20 by 15 by 10 room be covered with some acoustic board material, or hair felt under muslin, with a coefficient of, say, 0.5, and that the floor is carpeted, the walls remaining plaster. The total absorption, A , then becomes:

Ceiling area (300 sq. ft.) multiplied by 0.5	150.
Floor area (300 sq. ft.) multiplied by 0.2	60.
Wall area (700 sq. ft.) multiplied by 0.025	17.5
	227.5

Substituting in (1) above, we now have:

$$t = \frac{0.05 (3000)}{227.5} = 0.66 \text{ seconds}$$

This is nearer a satisfactory value, and may give good results on the air. If, now, one of the 15 by 10 walls of the room, preferably that nearest the contemplated position of the microphone, be covered with curtains having an absorption coefficient of 0.5, the total absorption of the studio becomes 298.7, a value which the reader may readily verify by going through the simple computation himself. The reverberation time is then reduced to 0.5 second. In order to provide margin against reflecting surfaces of the piano, tables, etc., and to allow variation of the period to secure different effects, it might be well to drape two of the walls of the room with curtain material suspended from rods and movable at will, and to have the rug only partly covering the floor. This will permit variation of the reverberation period between, say, 0.3 and 1.2 seconds, which gives sufficient latitude for experiments. Various other combinations are of course possible, and each designer may work out schemes to suit his own requirements or fancies.

In selecting patented sound proofing materials it is well to try to secure a curve showing variation of the absorption coefficient with frequency. The nearer this characteristic approaches to the ideal flatness between 100 and 5000 cycles, the more favorably it should be considered for general use. It is better to choose material with a moderate absorption coefficient which remains fairly constant over the audio range, than a highly selective surface which has high absorption at one or two pitches and reflects badly at other points.

Formula (1) above is not as accurate as a later equation worked out by P. E. Sabine, given by Crandall in his *Theory of Vibrating Systems and Sound* (D. Van Nostrand Co.):

$$t = \frac{0.0083 V (9.1 - \log_{10} A)}{A} \quad (2)$$

Formula (2) gives results for t slightly lower than (1), so that for electrical reproduction it is just as well to use the simpler expression (1), which gives additional margin against excessive reverberation.

Where lively surface materials are used in studio or auditorium design, a protection against echo and objectionable reverberation is to break up flat surfaces by recessing, coffering, etc., thus diffusing the reflected energy.

The circular of the Bureau of Standards referred to at the beginning of this article gives a table of allowable number of instruments in a room of given volume, for best artistic performance. This data should interest musical directors and broadcast technicians who habitually overcrowd their studios:

VOLUME OF ROOM	NUMBER OF INSTRUMENTS
50,000	10
100,000	20
200,000	30
500,000	60

While allowing 5000 cubic feet and over per instrument may be excessive, this table is probably nearer a sensible compromise than the comical broadcast practice of jamming thirty

Public Library
Kansas City

instruments into a room of 6000 cubic feet, allowing about 200 cubic feet per instrument. The greater absorption of broadcast studios certainly does not justify such acoustic atrocities.

Shrapnel from Cleveland

FROM Mr. J. D. Disbrow and Mr. Ross J. Plaisted, of the Engineering Department of WTAM, come separate roars of protest, addressed to the Editor of this journal, regarding my remarks "Concerning B. C. Operators" in the January issue. Mr. Disbrow issues a warning: "Your yearly subscriptions will certainly drop if you continue to print such 'poison' as Mr. Dreher has in his columns this month." He adds: "This article may be correct for some of the operators but it certainly doesn't say very much for the fellows who have spent their life at radio and worked like slaves putting radio where it is to-day. . . . The men behind the scenes get little enough praise as it is, so why rub it in with an unjust article like this one." Mr. Plaisted adopts the *argumentum ad hominem*. "It is entirely possible," he writes, "that the class of operators of Mr. Dreher's station is that of which he speaks, but I must say that the majority of those I have met in the middle-west take their business seriously and spare no effort in learning everything they can about it."

The position of the gentlemen from Cleveland would be tenable, it seems to me, only if all broadcast operators read the literature and took their work seriously. Then the article in question would be uncalled for. But both critics admit that some technical broadcasters are more or less delinquent in these respects. What, then, makes it immoral for me to remonstrate with this minority, on occasion? There was nothing in "Concerning B. C. Operators" which could be taken as an assertion that all, or a majority of technical broadcasters, neglect the intellectual foundation of their profession. Therefore there was no offense. Those whom the shoe does not fit are certainly not forced to put it on. Those whom it does fit might be benefited by wearing it for a time.

As for my general attitude toward my fellow workers, I do not think that anyone who has read even a small portion of my material can accuse me of any desire to disparage the men of my profession. It is true that I am not a habitual dispenser of perfumed vaseline; that rôle I leave to those who have talent for it. I could point to numerous passages in praise of people who deserve recognition, and as for the technical men, I have consistently maintained that their work is the foundation of the art, supporting the whole superstructure of program service and commercial returns. I need not stress this point; let the articles speak for themselves. On the other hand, I do not feel, as apparently Messrs. Disbrow and Plaisted do, that radio men constitute a fraternal organization, existing for mutual praise and support through thick and thin. Radio is a business, with its good features and bad, personnel competent and incompetent, its failures, successes, and hopes. These things I discuss from month to month, as entertainingly as I am able, and instructively when my knowledge permits. I try to learn from what other radio men say and write, and I value criticism insofar as it is based on logical considerations and a desire to get at the facts. That sort of criticism we need badly in radio; we have none too much of it. When it comes to emotional bias we have an ample supply, and it does not help us in any

of our problems, whether the question is a major one like the allocation of frequency bands, or a minor one like what should be printed in "As the Broadcaster Sees It." I invite Messrs. Disbrow and Plaisted to abandon what seems to me a singularly juvenile attitude. But on the basis I have suggested above, their opinions, as that of all other broadcasters and readers, are invariably welcome.

Memoirs of a Radio Engineer:
XVIII

WE HAVE had to interrupt the publication of these yarns for several issues, but we shall now take up the narrative where we left off—with the entrance of the United States into the War, in April, 1917. The ink had scarcely dried on the official signatures to the Congressional resolution declaring war between the United States and Germany when the U. S. Navy, with a yell, clasped all domestic radio activities to its bosom and held them there for two years.



" . . . I MADE NUMEROUS CALCULATIONS "

Also with a yell, my classmates and I, who were receiving the benefits of instruction at the College of the City of New York, escaped from the academic groves, which, in fact, never saw us more. After some negotiation, the Dean of the College offered the five of us in Doctor Goldsmith's radio engineering course credit for the balance of the term, and our degrees, if we would engage in some radio enterprise helpful to the U. S. Navy. This was in May, 1917, and in June we would have graduated anyway—we were Upper Seniors, by now—but there was the opportunity to avoid the final examinations, and, anyway, we wanted to get out. Doctor Goldsmith took charge of the preliminary arrangements, saw us placed, gave us his benediction, and the class scattered. Freed went to the Washington Navy Yard, where, about then, were also gathered Lester Jones (likewise a C. C. N. Y. man), Hazeltine, and Priess, none as yet famous. Buchbinder occupied himself at the Philadelphia Navy Yard, where Forbes, Ballantine, and Commander Lowell were working. Kayser stayed nearest home; the Brooklyn yard was his berth. Marsten and I were allocated to the Aldene factory of the Marconi Wireless Telegraph Company of America, staggering under the weight of government contracts and groaning—so we thought—for our aid.

A comical incident of this period shows the

atmosphere of suspicion which assumed pathological intensity during the war, although in this particular case it was not unreasonable. The story begins in the radio laboratory of the College, before the United States entered the conflict. One of the requirements of the course was the writing of a thesis, which included the complete design of a radio station for a specific service. In my case I had the job of designing a transmitter, receiver, power plant, antenna system, and all auxiliaries for a vessel of the size and type of the SS. *Leviathan*, one of the requirements being that communication with land should be maintained throughout a transatlantic voyage. I made numerous calculations, most of them as mythical as the vessel, and got together a design after some months of work—it took this long because all the component parts had to be individually specified, the high tension transformer, for example, being detailed as to size of core, number of primary and secondary turns, gauge of wire, etc. I addressed a number of inquiries to manufacturers, including one to an antenna insulator factory in Brooklyn.

I do not recollect whether they answered or not. I completed my thesis, and left for the Aldene front. A few months later I received the following letter:

NAVY DEPARTMENT
United States Naval Communication Service.

Office of District Communication Superintendent Third Naval District
Navy Yard, New York, N. Y.
July 26, 1917.

SIR:

1. This office has information that you desire to purchase Radio Antenna Insulators.

2. As all Radio Apparatus has been ordered dismantled by the Executive Order of the President, you are requested to forward to this office reasons why, and for what purpose, you desire insulators.

Respectfully,

J. C. LATHAM
Lieutenant (JG), U. S. Navy,
District Communication Superintendent

I replied with equivalent grandeur, and I presume gave the D. C. S. a laugh.

Solution of Technical Problem No. 1

The amplification of the remote control amplifier fed by the microphone M_2 is given as 10,000 times in power units. The gain in TU given by the formula:

$$TU = 10 \log_{10} \frac{P_1}{P_2}$$

is found to be 40. As M_2 's output is given as minus 20 TU, the output of the amplifier is +20 TU, which, incidentally, is quite a whale of a level to put on a telephone line. This being done, however, and the attenuation along the line being given in the problem as 12 TU, the level reaching the control room is +8 TU. This is to be reduced to the output level of the microphone transmitter M_1 , which is -30 TU. The artificial line required for this purpose will have to drop 8+30 TU, or 38 TU. A 38-TU pad is therefore required.

As an aid in the solution of this problem the reader may consult the following past publications in this department:

Technical Operation of Broadcasting Stations, No. 10. "Calculation of 'Gain.'" September, 1926. Abstract of Technical Article: *The Transmission Unit and Telephone Transmission Reference Systems*, by W. H. Martin, *Journal of the American Institute of Electrical Engineers*, Vol. XLIII, No. 6, June, 1924; October, 1926

Book Reviews

A Scholarly Contribution to the Art of Sound Reproduction—A Comprehensive Radio Dictionary

Not for the Kindergarten

THEORY OF VIBRATING SYSTEMS AND SOUND:
By Irving B. Crandall, Ph.D. Published by
D. Van Nostrand Co., New York City. 272
pages. Price, \$5.00.

ALTHOUGH the reviewer considers this book an extremely valuable contribution to the art of sound reproduction, of which radio broadcasting is a part, it cannot be recommended as indispensable to every owner of a receiving set. Even the most sapient listeners, no matter how many sets they have built, and the most inveterate readers of the semi-technical press, no matter how many articles on flat amplifiers they have digested, will get into difficulties early in the volume. Let them but gaze at the list of symbols on Page 9, and they will recoil in fright from Lagrange's determinant of coefficients of motion, the kinematic viscosity, and Laplace's operator, the last denoted by a triangle standing on its apex, and squared. Doctor Crandall does not deceive them; he begins his preface with the statement: "This treatment of the theory of sound is intended for the student of physics who has given a certain amount of attention to analytical mechanics . . ." The material was first presented in one of the "out-of-hour" courses at the Bell Telephone Laboratories, where, since 1913, the author has specialized in the field of speech and various other phases of sound phenomena; a portion, also, was given as a course at the Massachusetts Institute of Technology during the spring of 1926. In other words, "The Theory of Vibrating Systems and Sound" is a serious work for the scholarly engineer and physicist, who has taken the trouble to arm himself with the requisite tools of analysis, and who realizes that the distinction between "theory" and "practice" is merely a convenient fiction for those who are unwilling or unable to think exactly in physical fundamentals. This book is theoretical and highly practical at the same time. It is not a handbook full of convenient tables which will enable one immediately to design a broadcast studio or a cone loud speaker, but there are problems at the ends of the chapters by which the student may test his progress in acoustic analysis, and one of the appendices consists of an invaluable summary of "Recent Developments in Applied Acoustics," containing references mainly to articles printed since 1922.

The book begins with a review of some of the fundamentals of mechanical theory applied to acoustics, such as the equations of motion of a simple vibrating system, free and forced oscillations, and the vibration of circular membranes in terms of Bessel's functions. Here the going becomes slightly heavy, and the reader who has not kept up with modern mathematical analysis will sink somewhat in his own esteem. He will find little relief in an analysis of air damping, in which the active portion of a condenser transmitter diaphragm is considered as an imaginary "equivalent piston," an assumption valid below the first natural frequency. This chapter is a good preparation for the experimental study of actual telephone diaphragms.

Systems of two degrees of freedom, in natural oscillation and the steady state, are described in considerable detail, references to the classical work of Rayleigh, Lamb, Heaviside, and others, being introduced, as throughout the book, to avoid tedious re-statement. Resonators are treated alone, and then coupled to a diaphragm. There follows the interesting problem of a loaded string—a stretched fibre weighted at equal intervals with equal masses, which is tied in with the highly important technical field of electrical networks.

The properties of the medium and the equations of wave motion carry the treatment into three dimensions, after a view of transmission in tubes and pipes, and resonance in such containers. Point and spherical sources, and the reaction of a viscous medium on a vibrating string, as in the Einthoven galvanometer, are some of the subjects.

In Chapter IV (Radiation and Transmission Problems) there is a brief non-mathematical interlude in the form of an outline of the underwater signalling experiments of Professors Pupin, Wills, and Morecroft, in 1918. It is not generally known that frequencies of the order of 50,000 cycles per second (which would correspond to a wavelength of 6000 meters in electromagnetic radiation) are employed in high-frequency submarine signalling. The analysis proceeds with other forms of radiation from a piston, into conical and exponential horns. Crandall cites Webster, Hanna, Slepian, and others in this section, but disagrees with one of the conclusions of Goldsmith and Minton relative to a comparison between exponential and conical horns. The analysis of the finite exponential horn is not sketchy; it covers eleven pages and a chart.

To a broadcaster, Chapter V, largely on "Architectural Acoustics," is naturally of greatest interest. The work of Wallace Clement Sabine is reviewed, with P. E. Sabine's additions. As it happened, while the reviewer was reading Crandall's book for this outline, he was treated to a swell luncheon by an experienced acoustic engineer. His practical ideas were sound, but when one of my colleagues inquired why some absorbing materials showed marked frequency selection, our host explained that it was because of the resonant action of the equal interstices between the fibres of the structure. I suspected at the time that this theory was not kosher, so to speak, but was too prudent to fight over the sweetbread patty. If you want the real explanation, take a day off and steep yourself in Section 51 and Appendix A of Crandall's book. There you will be led through the conception of the absorbing material as a honeycomb of narrow conduits in which sound waves are dissipated by frictional resistance, the impedance of the mouths of the conduits, the velocity of flow of air particles in the tubes, the resistance coefficients, the esoteric law of Poiseuille, kinetic viscosity, and calculations resulting in values for a certain absorbing wall of the absorption coefficient, showing how it varies with frequency. "If the absorption coefficient is plotted against frequency," writes Crandall, "a very good resonance curve is apparently obtained. This resemblance is evidently accidental, as no resonance

phenomenon has been implied in the problem we are considering." Several other facile assumptions are unobtrusively knocked into cocked hats in Doctor Crandall's text. Space limitations preclude extended comment on the general treatment of reverberation in three dimensions and reaction of the enclosure on the source of sound.

The book is written throughout in elegant and forceful scientific English. The object—to train the properly prepared student in the handling of the mathematical and physical principles involved—is never lost sight of. The reasoning is pellucid from cover to cover. Doctor Crandall has made a worthy contribution to an understanding of the advanced classical literature in his field, and brought the treatment in various subdivisions up to date with distinguished competence.

CARL DREHER.

A Radio Dictionary

THE RADIO ENCYCLOPEDIA: By S. Gernsback.
Published by Sidney Gernsback, New York City.
168 Pages. Price \$2.00.

THE "Radio Encyclopedia" is a comprehensive radio dictionary, clearly printed and, with the exception of the biographies, well illustrated. Messrs. Squier, Goldsmith, and Hogan we know to be much handsomer men than it would appear from their pictures in the encyclopedia, and probably there are others suffering similar injustices at the hands of the photographer, engraver, and printer.

The work will doubtless be useful to experimenters, particularly those who need occasional aid in the interpretation of technical terms used in newspaper and magazine articles on radio subjects. It is not sufficiently detailed for the broadcast or radio engineer and indeed, were it so, the work could hardly be simple enough for the broadcast enthusiast.

Such terms as "gain," "split announcing," "scrambling," "mixing panel," "vernier,"—the kind of thing a broadcast station employee might look up—are not defined, although the popular circuits, usual instruments used in the receiving set, electrical terms applying to broadcasting, etc., are fully and adequately defined. The cross reference notes with each definition are commendably complete and the work is obviously the product of meticulous labor. Since the book is primarily designed for enthusiasts, we regret the absence of definitions for a few words which occurred to us, such as "sound," "tone," "quality," "reproduction," "single-control," "blooper," "radiating receiver," "mike," and "condenser microphone."

A peculiarity of the indexing is that television is described under "television," but "telephotography" is listed neither under that term nor under "photographic transmission" nor "photographs, radio transmission of," but under "transmission of photographs by radio." Perhaps this is an outstanding exception to correct indexing and certainly one of minor importance. This the reviewer cannot judge because a reading of forty pages of material was considered sufficient to determine the general value of the work.

Terms, used in their correct and limited sense, will be found quite complete. The names of almost every conceivable receiving instrument and part, the more popular circuits, such as Cockaday, neutrodyne, Armstrong (Grimes and Roberts are not found under their names), and a scattering number of contemporary and historic biographies are included as the subject matter of Gernsback's dictionary.

EDGAR H. FELIX.

Analyzing the Power Amplifier



How Oscillograms Help to Indicate the Transient Voltages and Currents in the Circuits—A Radio Club of America Paper



By D. E. HARNETT

Engineering Dept., Pacent Electric Company

THE commercial need for high-quality reproduction has lately focused the attention, not only of engineers, but of the whole radio world, on the audio-frequency circuits of radio receivers. Selectivity and sensitivity for a number of years received much attention, but during that time, those engineers who realized how much better broadcast receiver reproduction could be, were trying to persuade the public to recognize good quality and to prefer it. Their efforts have finally met with success. The modern radio set has a much better amplifier than was the case a year and a half ago.

One of the lessons learned from the extensive experimenting on audio circuits is that it is necessary to have the loud speaker driven by a tube which can develop considerably more power than is required from the other tubes in the set. This means that the B-battery supply must furnish much more power to the output tube than was previously thought necessary. As a result, the B socket-power device, which operates from the a. c. house mains, has become very popular. The superiority of this type of socket-power device over the type which operates from some other source, such as a d. c. house-lighting circuit, is that it is possible to maintain the voltage by a suitable transformer at practically any desired value. The limiting factors are the safe operating voltage of the rectifier and the insulation in the device, particularly the insulation in the condensers. These factors are, of course, economic, for it is possible to build rectifying tubes for practically any voltages and to insulate properly for these voltages.

The device under discussion is the "Power-former." It is a combination power amplifier and B socket-power device. The device was developed by a group of engineers under the direction of Mr. L. G. Pacent.

It is desirable to have all that wiring which connects with a high-voltage circuit (such as the plate circuit of the power amplifier tube) confined within a metal case, in order to eliminate danger of injury to the broadcast listener. The rectifier tube is capable of rectifying considerably more current than is required for the power tube. This excess current is supplied to a potentiometer from which the plate potentials for the different tubes in the receiver are drawn. These different plate potentials—of the order of 150 volts, or less—are brought out to binding posts, which connect to the plate circuit of the radio receiver. The audio circuit connects through the jacks. The schematic diagram is shown in Fig. 1.

The operation of the separate parts of this circuit has been studied by a good many engineers and reported before the Radio Club of America and before the Institute of Radio Engineers. When, however, these different units are combined into one circuit, certain complications arise. It has been found that the actual

functioning of the different parts of this circuit is not generally understood.

The principal object of this device is to enable the broadcast listener to have good quality reproduction, with a fair amount of volume. In order to obtain this result, an amplifier tube must be employed which is capable of delivering about one watt without distortion. The audio transformers must be properly designed so that they will not distort the signal. This means that they must have a high primary inductance, a

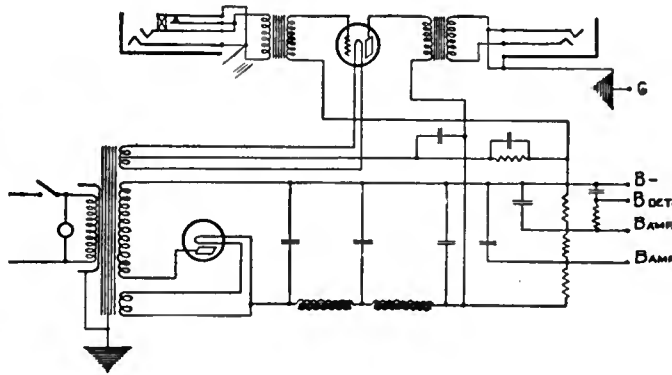

FIG. 1

high mutual impedance, and a ratio which is somewhat lower than was thought best three or four years ago. With the use of ordinary magnetic materials, this necessitates a large core and a winding employing from two to three times the copper used in the average transformer of the past.

Consider first the rectifier circuit—here a 60-

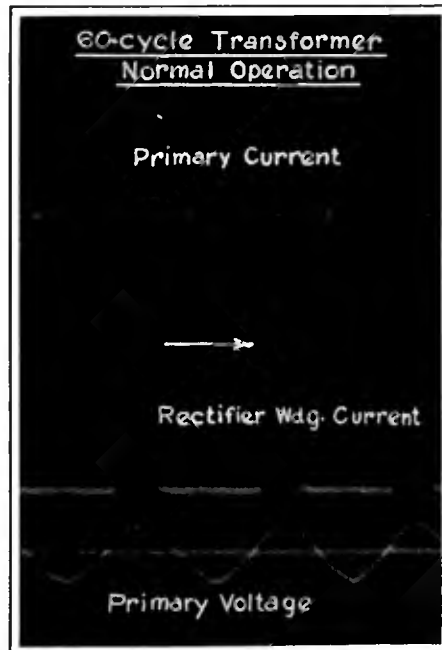

FIG. 2

cycle transformer is operated with the primary on a 110-volt lighting circuit. There are three other windings besides the primary. One of these operates the filament of the rectifier tube; the second, the filament of the amplifier tube; the third supplies the rectifier with high voltage, that is, it supplies the power for operating the plate circuits of the amplifier tube and those of the other tubes of the broadcast receiver. The current and voltages in the transformer are shown in Fig. 2. In Figs. 2 and 3, the arrow indicates the direction of travel in the film. In other words, the head of the arrow indicates an earlier time than the stem of the arrow. In the later photographs, the arrow indicates the direction of time; in other words, the meaning of the arrow is reversed. It will be noticed that the device is supplying the rectified current during approximately one third of the cycle; that is, instead of rectifying during all of the half cycle, which has the proper polarity for rectification, it is rectifying only during the portion of the cycle during which the transformer voltage exceeds the voltage across the first condenser in the filter circuit. Abrupt changes in the impedance of the transformer load introduce a large number of harmonics in the high-voltage winding which are reflected in the primary, giving the wave shape shown at the top of the photograph. Naturally, the direct-current component of this secondary current cannot be reflected through the transformer. This is shown by the fact that the area of the top half of the primary wave is equal to the area of the lower half. The power factor of this device is approximately 70 per cent.

$$\text{Power Factor} = \frac{\text{Power}}{EI}$$

The power is the product of primary voltage, the 60-cycle component of primary current, and the cosine of the angle between them. E is the primary voltage, and I is the r. m. s. value of primary current; that is, r. m. s. value of 60-cycle primary current and all of the harmonic currents. Thus there are two effects tending to decrease the power factor—the phase difference between the primary voltage and current, and the presence of the harmonics in the primary. The current in the other two secondary windings is a sine wave working into a resistive load, that is, into the tube filaments. Approximately two thirds of the power drawn from the transformer is supplied to the rectifying circuit; the remaining one third is used to light the tube filaments. Fig. 3 shows the effect of the rectifier winding on the primary current much more clearly than does Fig. 2. In Fig. 2, the presence of the harmonics appearing in the primary current wave is partially obscured by the presence of the power current which supplies the power to the tube filaments. In Fig. 3 the transformer was operated with the tube filament windings open-circuited, that is, the tube filaments were supplied by a separate transformer. Consequently, the primary current is the sum of the magnetiz-

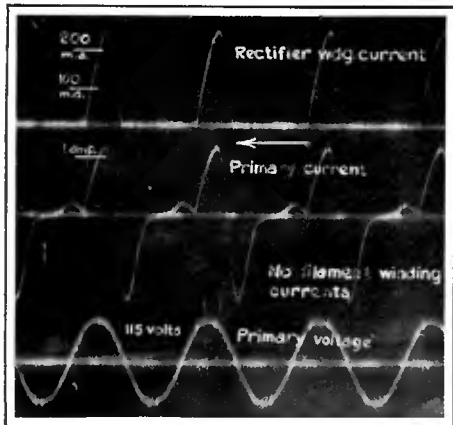

FIG. 3

ing current and the rectifier winding current reflected through the transformer.

THE FILTERING CIRCUIT

THE operation of the filtering circuit is shown in Fig. 4. The lower curve shows the current through the first condenser, and the upper curve shows the current through the first of the two chokes. It has been observed that the ratio of the r. m. s. value of the current of this first condenser to the direct-current rectified output is approximately constant, and lies between 1.8 and 2.2, for normal loads. It is practically independent of the capacity of this first condenser. The current through the second of the two chokes has very little ripple in it.

In a circuit such as this filter circuit, it might seem that the presence of the chokes and condensers would cause rather large transient voltages when the device is connected to or disconnected from the line. Actually, there are probably no transient increases and certainly none which exceed about ten per cent. of the normal voltage. The transient occurring when the switch was shut off is shown in Fig. 5. In this particular case, the switch was shut off during the time interval when the condenser was being charged. This is indicated by the fact that the last charging current peak is lower than the others. Oscillograms which were taken when the switch was turned off during the part of the cycle when the device was not rectifying, do not show this decrease in the last of the charging current peaks. It will be noticed that the current through the condenser drops to zero within approximately one fiftieth of a second after the switch is turned off. During the same time interval, the current through the first choke drops to zero. At the time that the current through this first choke has dropped to zero, there is still a charge on this first condenser. The choke current drops to zero, however, since the charge on the second condenser is still appreciable, and is sufficiently greater than the charge on the first condenser to stop the current. The current through the second choke starts to drop off at about the time when the current through the first choke is reduced to one third of its normal value. This current then drops to approximately zero at the time when the voltage on the third filter condenser is sufficiently greater than the voltage on the second to

stop the current. By this time, the voltage on the second condenser is so low that the remaining charge on the first condenser proceeds to discharge through the choke, giving the slight current through the first choke that is shown in the illustration. A close inspection of the original film will show a slight current through the condenser at this instant. The reason it does not show up in the photograph is due to the fact that the current scale for the choke current is approximately four times that for the condenser current. A very short time after this discharge in current, the charge on the final condenser has been dissipated through the resistance and consequently the remaining charge on the second condenser discharges through the second choke, giving the slight rise shown. These steps in the discharge transient do not, of course, completely discharge the condensers, and very small current can be seen on the original film which repeats the first two slight rises in the choke currents that are plainly distinguished on this film. Several oscillograms of this transient were taken and all of them verify the results shown in this photograph. The right-hand portion of the middle curve on this line shows the amount of ripple in the second choke current before the switch is turned off. Practically all of this ripple is bypassed through the third of the filter condensers. Fig. 6 is another oscillogram taken under the same conditions. The condenser current is not faithfully recorded in this photograph because the oscillograph element was loose. The other two oscillograph elements were working properly,

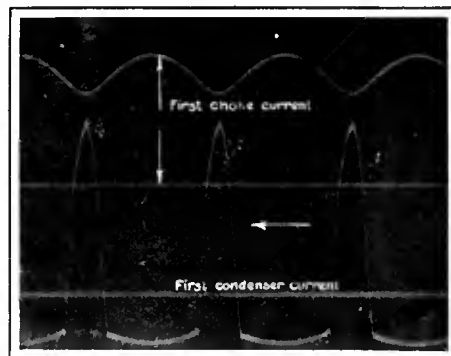

FIG. 4

shown. This decay is shown even more clearly in Fig. 6.

In order that any considerable voltage will be built up across one of the condensers due to the switching transient, it would be necessary that the direction of the flow of energy in the steady state would be, for the moment, reversed. Since none of the photographs give any indication of the reversed current through the chokes, it follows that there can be no high voltage across any of the condensers during the discharging interval.

A moment's consideration of the energy stored in the filter circuit will show that it is very unlikely that a high-voltage transient across one of the condensers will occur. In this filter circuit we have two fifty-henry chokes in series with the high-voltage lead, with three 2-mfd. condensers connected across the line. See Fig. 7. Under normal conditions, the voltages across the condensers are 500, 375, and 350 volts respectively, 50 milliamperes of direct current flowing through each inductance. The energy stored in the first condenser will be $\frac{1}{2} CE^2$, which is 0.25 joules. The other condensers store 0.14 and 0.112 joules. The energy stored in the chokes will be considerably less than this energy stored in the condensers. It is $\frac{1}{2} LI^2$, or 0.0625 joules for each choke. The total stored energy in the circuit is then 0.637 joules. Thus we see that, even though the entire amount of this energy should by chance all pour into one of the condensers at once, the voltage across this condenser would be less than double the normal voltage across the first condenser. The solution is as follows:

$$\frac{1}{2} CE^2 = \frac{1}{2} \times 2 \times 10^{-6} \times E^2 = 0.637$$

Therefore, $E = 800$ volts. But since the oscillogram shows that there is no reverse in the flow of energy, even this cannot occur, and there will be no increase in the voltage across any one of the condensers when the switch is turned off.

The starting transient is shown in Fig. 8. When the transformer is switched on to the line there may be a high secondary voltage transient if it is connected during a particular part of the cycle. In the device under consideration, this will have no effect except on the transformer itself. The reason is that the rectifier filament is cold, so the rectifier tube acts as an open circuit during the first few cycles, and therefore it separates the transformer from the filter. As the tube filament heats up, the tube rectifies and gradually builds up the necessary voltage to maintain the steady state. From the appearance of the

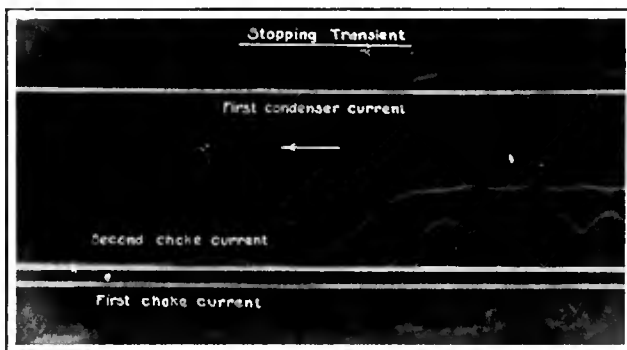

FIG. 5

so that the choke currents are faithfully recorded.

In order to understand why the current drops to zero in pulses, consider the network as two separate circuits. The first is the circuit of the inductances, resistance, transformer, and rectifier in series. Assume the rectifier to act as a resistance. This is a reasonable assumption, since the direction of current flow is correct and the filament will remain hot for several cycles. The current in this circuit will decay logarithmically. The oscillatory discharge of the second circuit, inductances and condensers, will be superimposed on this discharge, giving the characteristics

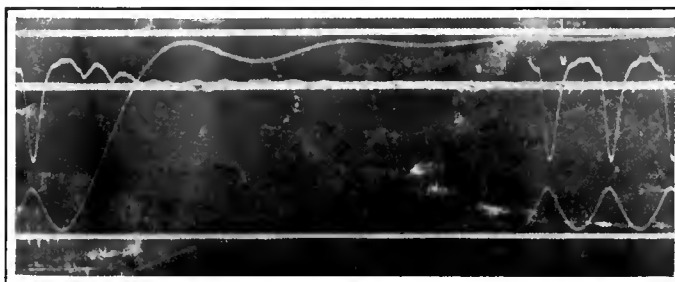

FIG. 6

oscillogram, it is evident that this voltage is built up gradually. If there were a transient voltage exceeding the normal, some of the charging current peaks would be slightly higher than the steady charging peaks. It will be noted that the area of the first few of these charging peaks is greater than the areas under the following discharging alternations of the condenser current. This is the interval during which the first condenser is accumulating its steady charge.

The drop in B voltage supplied by the "Powerformer" is directly proportional to the current drawn. The regulation curve for the high tap slopes down in a straight line from 175 volts, zero current, to zero volts, 37 milliamperes. The socket-power supply will give 20 milliamperes at 90 volts. The characteristic falls rapidly because it is impossible to use more than half the voltage at the output of the filter. The plate-circuit requirements of the power amplifier tube necessitate a high voltage at the filter output. The excess must be absorbed in a resistance. The scheme gives much poorer regulation than can be obtained from a good socket-power device where the voltage output of the filter is correct for the set. The power supply is ample for the usual two-step r. f. amplifier, detector, and one step audio amplifier. The second audio step is in the "Powerformer."

With the natural high impedance of socket-power devices, considerable trouble has been caused by the coupling between the audio plate circuits through the impedance of the socket device circuit. This trouble is entirely eliminated with this scheme. The detector plate circuit is completed through the 2-mfd. bypass condenser. The 30,000-ohm series resistance eliminates the coupling effects between the detector circuit and the two audio circuits.

The 7500-ohm sections of the potentiometer separate the two audio circuits so that each audio current goes through its proper bypassing condensers. Even at as low a frequency as 60 cycles, the condenser path for the audio component of the power amplifier plate current is only one thirtieth that of the potentiometer path.

THE AMPLIFIER

WE NOW consider the amplifier portion of the circuit. If we are to get fair reproduction, it is necessary that the current through the secondary of the output transformer, when connected to a normal load, will have the same wave shape as the signal voltage impressed across the primary of the input transformer. In other

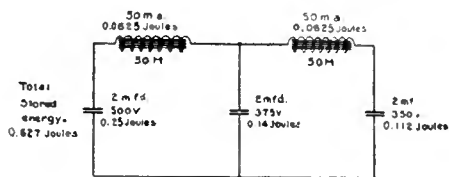

FIG. 7

words, the condition illustrated in Fig. 9 should obtain. The wave forms of the input voltage plate current and output transformer current are shown. The signal voltage is 4.22 volts r. m. s., corresponding to 6 volts peak signal or 18 on the grid through the 3:1 step-up transformer. The bottom curve represents the plate current of the tube. The zero of this current is above the curve

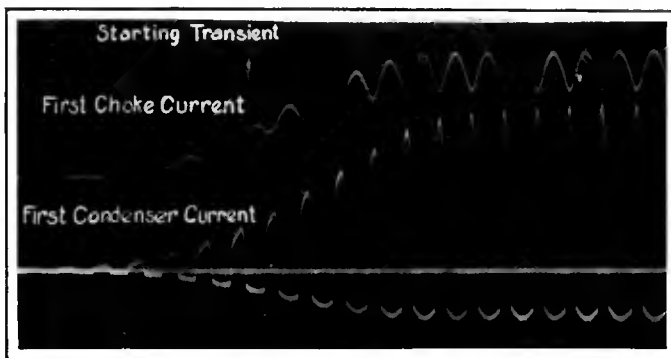

FIG. 8

shown. The center curve shows the current through the secondary of the output transformer working into a 5000-ohm resistive load used to simulate a loud speaker load. It will be noticed that the output current has about the same wave shape as the input signal voltage. The plate voltage was 390 volts; the grid bias 27 volts; the direct-current component of the plate current—34 milliamperes. This, and the succeeding oscillograms, were taken with a 60-cycle signal. The amplifier stage was connected to a more flexible battery supply than the rectifier and filter circuit we have been discussing. We used the separate battery supply so that it could be easily adjusted to illustrate the effect of having improper B and C voltages on the tubes. Fig. 10 shows the effect of using too small a C battery in this circuit. The signal voltage is still approximately 4½ volts. The plate voltage is 400 volts. The C bias has been reduced to 10 volts, giving a plate current of 77 milliamperes. This condition obtains as the grid signal swings positive enough to draw current. The I_r drop of the current flowing through the high impedance of the transformer secondary will absorb practically all of the voltage induced in the secondary winding; consequently, the grid potential will remain approxi-

ately constant during the positive half of the grid signal, as shown in the photograph. When there is no alternating current in the plate circuit, the current through the output transformer secondary will, of course, fall off, just as any current decays when the potential across an inductance is removed and the inductance is discharged through a resistance. This gives the wave form shown in the center curve of the film. It will be noticed that the signal voltage shown at the top of the curve is no longer a sine wave. This is due to the fact that this particular curve was taken at 12:35 A. M. at Columbia University, using the United Service for the alternating current supply. It was noticed during that evening, as well as on other evenings, that the wave shape of the supply was much poorer after midnight than it was earlier in the evening. Fig. 11 is another curve representing approximately the same condition. The difference in this case is that another output transformer was substituted for the standard one. This output transformer has a large step-down ratio of the type which is adaptable to certain of the moving coil type loud speakers. In this case the signal voltage was considerably lower, that is, 2½ volt instead of 4½ volts, accounting for the change in the plate current and the output transformer current. Since the output transformer secondary was much lower in inductance, the current decays more rapidly than in the other case.

The next oscillogram, Fig. 12, shows the amplifier tube operating with too large a C battery. The signal voltage in this case was 4½ volts; B voltage—400 volts; the C voltage—44 volts; 14 milliamperes flowing in the plate circuit. This signal carried the grid so far negative that the curvature on the lower end of the tube characteristic distorted the signal. This distortion which appears both in the plate current curve (the top curve in the photograph), and the output transformer curve (the middle curve), is very similar to the distortion introduced when the grid swings too far positive, where the poor regulation of the high impedance grid circuit causes the peaks of the wave to be cut off. Fig. 13 illustrates the case where the signal voltage is too high, or the B voltage is too low. In this case, the signal voltage was 4½ volts; the plate voltage—175 volts; the C bias—15 volts. This C bias was found to be about the best adjustment for 175 volts B voltage. The plate current was 14 milliamperes. It will be seen that this signal carried the grid down near the cut off point, giving distortion at the lower end, and also carried it sufficiently positive to cause

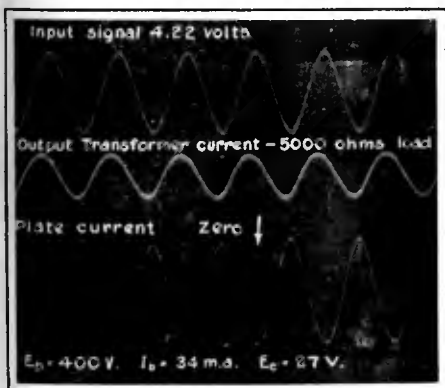

FIG. 9

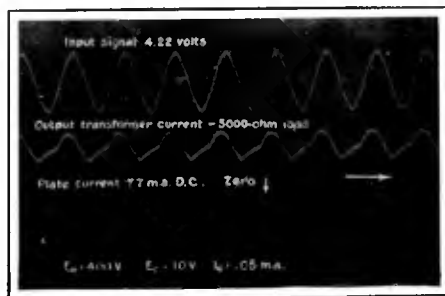

FIG. 10

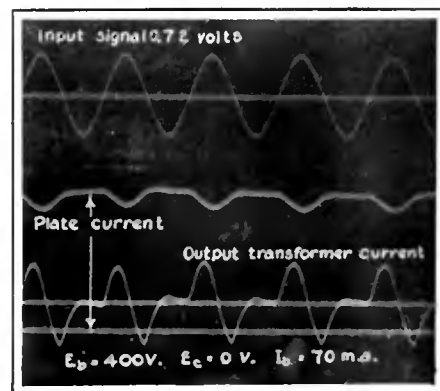

FIG. 11

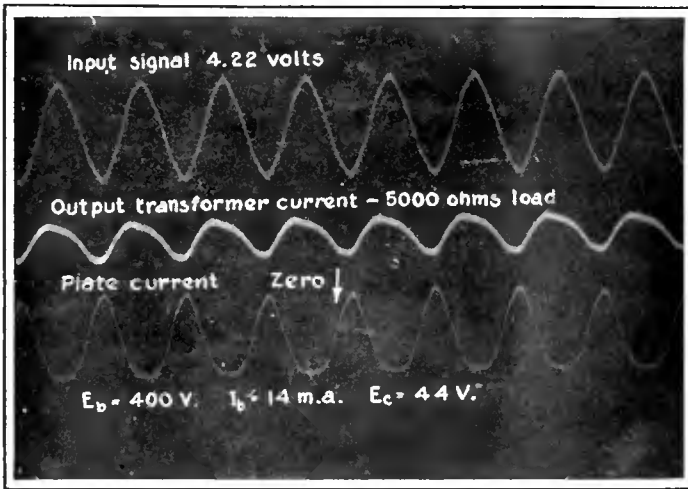

FIG. 12

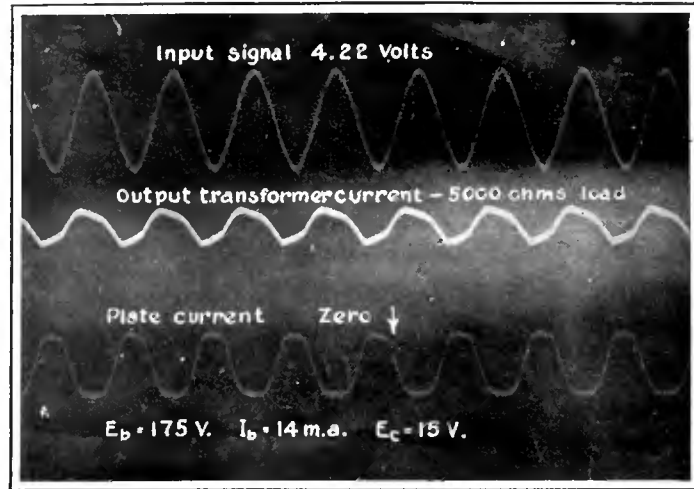

FIG. 13

similar distortion at the positive end of the cycle. This distortion appears in both the plate current curve and in the output transformer current curve.

Observations were made in several homes to find out how much signal voltage the average broadcast listener desires for what he would call normal volume. It was found that 6 volts peak audio-frequency voltage on the primary of the input transformer to the power stage was about the proper value. This corresponds to approximately 150 to 185 volts on the loud speaker. This value of 6 volts would of course be changed were a different transformer ratio to be used, or were a tube having a different amplification factor to be substituted. This power amplifier will take about 8 volts peak signal before the signal will suffer any distortion. It will take up to 12 volts on occasional peaks with such a small amount of distortion that the average broadcast listener will not notice it. If the plate voltage is reduced much below 300 volts, it will be found that the average broadcast listener will tune-in the signal so that there will be very objectionable tube overloading.

There is one other possible source of distortion, namely, the effect of the direct current flowing through the primary of the input transformer in saturating the core and so causing distortion. This form of distortion will not be encountered in the output transformer, since a small air gap is

provided to prevent core saturation. There are two forms of distortion which might be expected from core saturation in the input transformer. One would be that form where the iron is operated so high up on the magnetization curve that the effect of the part of the signal cycle which would tend to carry it a little further up, would not be as effective in changing the flux as the part which tends to reduce the flux in the iron. This would give an unbalanced effect, destroying the symmetry between the two halves of the output voltage. This effect does not exist in the type of amplifier we are considering, for the reason that the signal voltage causes such an extremely small change in the flux density in the iron that the difference in the slope of the magnetization curve in different parts of the cycle is inappreciable. Fig. 14 shows this effect. The smaller of the two curves shows the signal current flowing through the secondary of the output transformer into a 5000-ohm resistive load when a sine wave is impressed on the primary of the first transformer. For the larger of the two curves, the same conditions were repeated with the change that 31 milliamperes of direct current were flowing through the primary of the input transformer. The change in magnitude of the wave is of no significance since it is due to a change in magnitude of the impressed signal voltage. It will be noted that this direct current, 31 milliamperes, is far in excess of any current that would flow through the primary of this transformer in a normal circuit. It will be noticed that the two wave forms are similar, showing that even this large direct current had no effect as far as introducing this particular type of distortion is concerned.

There is still another type of distortion to be considered. When the direct current is flowing through the primary, that is, when the iron is worked higher up on the magnetization curve, the impedance of the transformer primary will be reduced. This acts to reduce the amplification of low frequencies when the signal is impressed through a high series resistance, such as the plate circuit of the tube. Fig. 15 illustrates an exaggerated example of this effect. In the larger of the two curves, the 60-cycle voltage was impressed on the primary of the transformer through a 27,000 ohms. Under these circumstances, the transformer is operating under more

unfavorable conditions than is usually the case. The departure from the sine wave is due to the better amplification of the harmonics of the signal than of the fundamental. The fluctuation in the height of the peaks of the same wave was due to the fluctuation in the B-potential supply. The smaller of the two curves shows the effect of 20 milliamperes flowing through the primary while the signal is impressed across the primary through a 27,000-ohm series resistance. It will be noticed that the magnitude of the output signal has decreased, due to the reduction in the primary impedance. The harmonics are also more pronounced than they are in the upper curve. The conclusion to be drawn from these two photographs is that the effect of the direct current flowing through the primary of the transformer is to tend to cut off the lower frequencies. From experimental data which were taken in addition to these two oscillograms, it seems that a current of 5 milliamperes has very little effect in reducing the effectiveness of the transformer at the lower frequencies.

In conclusion, I wish to thank Dr. S. L. Quimby for his assistance in taking the oscillograms, and for his helpful suggestions. I also wish to thank Mr. Goudy, Mr. Brown, Mr. Corbett, and Mr. Lundahl, of the Pacent Electric Company's engineering department, for making this paper possible.

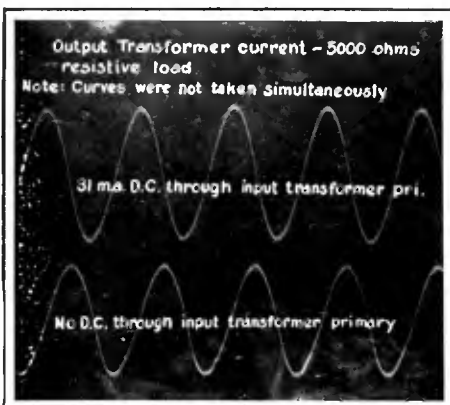

FIG. 14

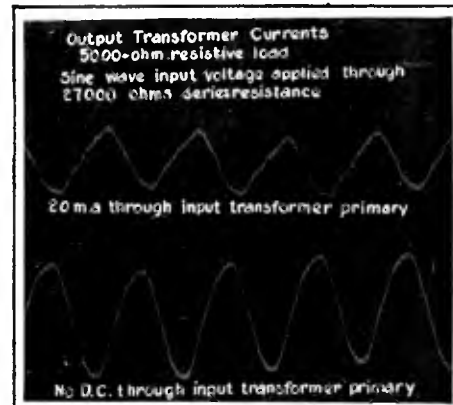

FIG. 15

RADIO BROADCAST is the official publication of the Radio Club of America, through whose courtesy, the foregoing paper has been printed here. RADIO BROADCAST does not, of course, assume responsibility for controversial statements made by authors of these papers. Other Radio Club papers will appear in subsequent numbers of this magazine

Raytheon *Leads*



Raytheon BA
350 m. a.
(Half size)

Raytheon's leadership in the rectifier field is demonstrated again by the announcement of these sensational new rectifiers, worthy to take their places alongside Raytheon Types B and BH.



Raytheon A
2 1/2 amps.
(Actual size)

Light Socket A-B-C Power With One Rectifier

By this amazing rectifier, Raytheon BA-350 m. a., the final great step in the development of radio power is accomplished. Compact, built-in A-B-C power, without accessories, becomes a fact.

Soon a specially selected group of leading radio manufacturers will announce their newest receivers, using Raytheon BA 350 m. a. Standard 201-A tubes are used, and all batteries, chargers, accessories, and outside power equipment are eliminated.

Raytheon BA-350 m. a., the crowning accomplishment of the Raytheon Research Laboratories, has at last given the radio world a practical, proven solution to the problem of simple light socket receiver operation.

A Revolutionary Scientific Achievement

In High Current, Low Voltage Rectification

Raytheon A-2 1/2 amps. is revolutionary in principle, in construction, in performance. It is an unbreakable metal cartridge, compact and simple, without liquids or filaments.

Above all, it is The Efficient Rectifier. Its operating cost over the period of a year, compared with that of other types of rectifiers designed for similar uses, will show a cash saving of many dollars.

Raytheon A-2 1/2 amps. was invented by Monsieur André of La Radio technique in Paris, and developed by the Raytheon Research Laboratories with his cooperation.

Battery chargers and A power units using this remarkable rectifier will bear the same seal of approval that distinguishes all Raytheon-equipped power devices.

RAYTHEON MANUFACTURING COMPANY

Cambridge, Massachusetts



Only manufacturers whose units have been tested and approved by Raytheon may use this seal on their products.

New Prices

- Type B . . . \$4.50
- Type BH . . . 6.00
- Type BA . . . 7.50
- Type A . . . 4.50



The Heart of Reliable Radio Power

Imagine an air-column 48" long

... concealed
in a cabinet
only 18" long

LET that is exactly what has been accomplished in the Amplion Patrician. A 48" air-column amplifier is assembled with the world-famous Amplion unit in a mahogany cabinet 18" x 12" x 9".

That is the reason why this splendid instrument has such a wide range of resonant, natural tone — mellow.

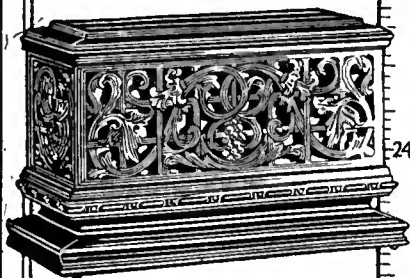

AMPLION PATRICIAN

AA18 \$50

Hand-carved mahogany grille on all four sides, giving a non-directional reproduction.

OTHER AMPLIONS:

Amplion Cone
AC12 \$30

Amplion Grand
AC15 135

Other models as low as \$12

Write for illustrated literature giving full details of the Amplion line.

The Amplion Corporation
of America
Dept. L, 280 Madison Avenue
New York City

The Amplion Corporation
of Canada, Ltd.
Toronto, Ont.

AMPLION

The Radio Broadcast LABORATORY INFORMATION SHEETS

INQUIRIES sent to the Questions and Answers department of RADIO BROADCAST were at one time answered either by letter or in "The Grid." The latter department has been discontinued, and all questions addressed to our technical service department are now answered by mail. In place of "The Grid," appears this series of Laboratory Information Sheets. These sheets contain much the same type of information as formerly appeared in "The Grid," but we believe that the change in the method of presentation and the wider scope of the information in the sheets, will make this section of RADIO BROADCAST of much greater interest to our readers.

The Laboratory Information Sheets cover a wide range of information of value to the experimenter, and they are so arranged that they may be cut from the magazine and preserved for constant reference. We suggest that the series of Sheets appearing in each issue be cut out with a razor blade and pasted on 4" by 6" filing cards, or in a notebook. The cards should be arranged in numerical order. Several times during the year an index to all sheets previously printed will appear in this department. The first index appeared in November.

Those who wish to avail themselves of the service formerly supplied by "The Grid," are requested to send their questions to the Technical Information Service of the Laboratory, using the coupon which appears on page 127 of this issue. Some of the former issues of RADIO BROADCAST, in which appeared the first sets of Laboratory Sheets, may still be obtained from the Subscription Department of Doubleday, Page & Company at Garden City, New York.

No. 97

RADIO BROADCAST Laboratory Information Sheet

June, 1927

Methods of Generating High-Frequency Energy

THE ARC

BEFORE the invention of the three-electrode tube, and its subsequent use as a source of large amounts of high-frequency energy, the arc was a common type of continuous-wave generator.

In the drawing on this Sheet is given the circuit diagram of a simple arc. The ordinary arc light used for street lighting might be used, but much more efficient operation is obtained from an especially designed arc. The elementary theory of the arc is given below.

The drawing indicates the simplest arrangement of the apparatus. "G" is a direct current generator, "r" is a resistance to control the current, L₁ and L₂ are two choke coils to keep the r. f. energy out of the generator and to keep the current practically constant, "K" is the arc, and "C," "L," and "R" are respectively, the capacity, inductance, and resistance of the oscillating circuit.

The arc, which consists of two electrodes, is different from ordinary electrical conductors in one important respect, which is that its resistance is not a constant quantity but a variable one, depending on the current flowing through it. At high current values the resistance is low and at low current the resistance is high. Consequently, an increase in current will produce a decrease in resistance.

Now, when the switch is closed, certain currents flow and the condenser begins to charge, and, therefore, part of the current is diverted from the arc. Since the current through the arc is decreased

by this action, the voltage across the arc must rise, and it continues to rise as long as the condenser continues to charge. As soon as the condenser becomes fully charged, the arc voltage stops rising and the condenser begins to discharge itself through the arc.

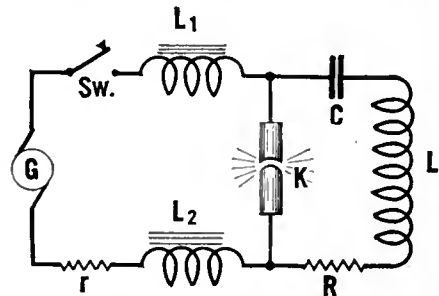

When the discharge is complete, the cycle of charge and discharge repeats itself with a frequency determined by the constants of the inductance L and the capacity C. By carefully choosing these values, large amounts of high-frequency energy can be obtained.

No. 98

RADIO BROADCAST Laboratory Information Sheet

June, 1927

Audio Amplifying Systems

RESISTANCE-COUPLED AMPLIFIERS

A VERY satisfactory method of audio amplification is that employing resistance coupling. The usual resistance-coupled amplifier requires three stages of amplification in order to obtain sufficient overall gain to satisfactorily operate a loud speaker. The introduction, however, of a new tube with a very high amplification constant, makes it possible in some cases to obtain sufficient amplification using only two stages. This new tube is known as the type 240 and data on it will appear on Laboratory Sheet No. 106 (July, 1927).

Several factors must be given attention if satisfactory results are to be obtained from a resistance-coupled amplifier. The mere fact that it is resistance coupled will not insure good quality. A poorly designed resistance-coupled amplifier is capable of creating as much distortion as can be obtained from a poorly designed amplifier of any other type. Some data regarding the constants of a resistance-coupled amplifier were given on Laboratory Sheet No. 74 (March, 1927). The constants given were for an ordinary tube for use in the resistance-coupled amplifier with an amplification constant of about 20. For the new type high- μ tube, however, with an amplification factor of about 30, it is necessary to use somewhat different values of resistance. See Laboratory Sheet No. 106.

The coupling condenser is a very important factor, and it is essential that this condenser have a very high insulation resistance, otherwise some of the B voltage will leak through the condenser to the grid circuit, and the amplifier will no longer function satisfactorily. In building up a resistance-coupled amplifier the best condensers should be used.

It is essential that high-quality plate and grid resistances be used to prevent noise in the amplifier. Also, the plate resistor should be capable of carrying the plate current of the tube without overheating.

Another important point is the amount of plate voltage used. It should be realized that most of the plate voltage supplied to the amplifier is lost in the resistance in series with the plate circuit of the tube. For this reason, it is necessary that fairly high voltages be available in order that there will be sufficient voltage left at the plate of the tube to obtain satisfactory operation. At least 135 volts should be used, and it should preferably be 180. The C-battery voltages should be kept as low as possible. It will generally be found that in an ordinary resistance-coupled amplifier a C-battery voltage of about 3 volts will be necessary on the grid of the tube preceding the last tube, if the latter is of the 171 type. The C voltage on the first tube of the amplifier need not be more than one volt.

Right down the scale!



Type A
\$28.50

Not a note is lost on a

PACENT CONE

—it covers the entire musical range without blurring.

PACENT RADIO CORP.
156 West 16th Street New York

To get the utmost from those new High-Mu tubes

DESIGNED to official specifications for use with the new Radiotron and Cunningham Resistance-coupled High-Mu tubes, the new Lynch Metallized Resistance Coupled Amplifier Kit will give you perfect tone with full volume. May be used with any receiver. At all good dealers' or by mail, prepaid \$9.00. Write for literature.

ARTHUR H. LYNCH, Inc.

Member RMA

250 West 57th St. New York, N. Y.

Why not subscribe to Radio Broadcast? By the year only \$4.00; or two years \$6.00, saving \$2.40. Send direct to Doubleday, Page & Company, Garden City, New York.

CARTER

New Heavy Duty Resistors



Again exemplifying Carter originality of design and quality workmanship. Especially adaptable for A. C. operated receivers and for

"B" eliminators.

Carter again takes the lead in supplying the ideal parts for the latest developments in the industry.

Ask to see them at your dealers.

Dealers: See them at Chicago Radio Trade Show June 13-18.

In Canada: Carter Radio Co., Ltd., Toronto

CARTER RADIO CO.



CHICAGO

Is Your Receiver Up to the 1927 Standard of Tone Quality?

A GREAT many broadcast receiving sets in operation to-day are not up to the 1927 standard of tone quality. Yet, in other respects; such as sensitivity and selectivity they are reasonably efficient. If you are operating a receiver which answers to this description, here are two suggestions for improving your audio amplifier, so that you may enjoy better radio reproduction without buying or building a new receiver:



Type 285
Audio Transformers
285-D (1 to 3)
285-H (1 to 6)
Price \$6.00 each



Type 373
Double Impedance
Coupler
Price \$6.50

1. Replace your old audio amplifier units by two General Radio Type 285 Transformers. A Type 285D (1 to 3) is recommended for the first stage, and a type 285H (1 to 6) for the second:

or, Substitute for your present amplifier a combination consisting of two stages of double impedance coupled and one stage of transformer coupled amplification. This combination requires two General Radio Type 373 Double Impedance Couplers and one Type 285D Transformer.



Type 387-A
Speaker Filter
Price \$6.00



Type 367
Output Transformer
Price \$5.00

2. Use a UX-171 or CX-371 tube in the last audio stage. This tube will effect an improvement in tone quality due to the greater volume it will produce without overloading. When this tube is used, however, a device such as the Type 367 output Transformer or Type 387A Speaker Filter is required to protect the loud-speaker from the flow of direct current.

Diagrams of the above mentioned amplifier circuits and folders fully describing the Type 285 Transformers, Type 373 Double Impedance Coupler, Type 367 Output Transformer, and Type 387A Speaker Filter will be sent upon request.

GENERAL RADIO CO.
CAMBRIDGE, MASS.

GENERAL RADIO

PARTS and ACCESSORIES

The General Radio Company has endeavored to make it possible for the experimenter to obtain its products with minimum of effort. A careful selection of distributors and dealers has been made. They are best suited to serve you. If, however, you are unable to obtain our products in your particular locality, they will be delivered to you, postpaid, direct from the factory upon receipt of list price.



A NEW BOOKLET

36 pages of the latest radio diagrams, parts, circuits and blueprints.

General description and constructional data written in simple style by a Master of radio technique. Truly instructive.

4 wiring diagrams, 4 circuits, 4 blueprints, 47 illustrations, 3 complete pages of parts, 36 pages of radio knowledge.

Send 25 cents for your copy

BRUNO RADIO CORPORATION, Long Island City, N. Y.

A Better Tuning Unit Was Never Devised

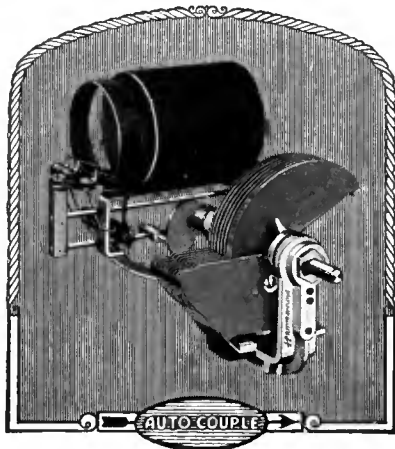

Officially Specified for the Hammarlund —Roberts "Hi-Q" Receiver

THE Hammarlund "Auto-Couple" Unit combines scientifically the Hammarlund "Midline" Condenser with the Hammarlund Spacewound Coil to give automatic variable primary coupling at every condenser setting. This arrangement makes for maximum signal strength and selectivity at all wave-lengths and lessens the tendency of radio-frequency circuits to oscillate at the higher frequencies.

The "Midline" condenser has a full-floating rotor, with removable shaft. A longer shaft permits coupling any number of condensers together for single control.

The Hammarlund "Auto-Couple" Unit (condensers and coils may be purchased separately) is readily adapted to any radio-frequency circuit and when combined with Hammarlund Shields, Equalizers, and Balancing Condensers, will make your receiver the last word in modern radio reception.

Write for folder describing Hammarlund Products officially specified by twenty-eight prominent designers for their newest receivers.

HAMMARLUND MFG. CO.
424-438 W. 33rd Street New York City

For Better Radio
Hammarlund
PRECISION
PRODUCTS

No. 99

RADIO BROADCAST Laboratory Information Sheet

June, 1927

Data on the "Universal" Receiver

PARTS REQUIRED

ON LABORATORY Sheet No. 100 is given the circuit diagram of the new "Universal" receiver which was described in the December, 1926, issue of RADIO BROADCAST. In constructing this receiver, the following parts are necessary:

- L₁—Antenna coil consisting of 13 turns of No. 26 d. s. c. wire wound at one end of a 2 1/4 inch tube.
- L₂—Secondary coil consisting of 50 turns of No. 26 d. s. c. wire wound on the same tube as L₁. The separation between L₁ and L₂ should be 1/4 inch.
- L₃—Primary of interstage coil constructed in same manner as L₁ and tapped at the exact center.
- L₄—Secondary winding constructed in same manner as L₂ and tapped at point No. 9, the 15th turn from that end of L₄ which is nearest to L₃.
- C₁, C₂—Two 0.0005-mfd. variable condensers.
- C₃—Neutralizing condenser, variable, 0.00015 mfd.
- C₄—Regeneration condenser, 0.0005 mfd.
- L₅—R. F. choke coil, made by winding 400 turns of No. 28 wire on an ordinary spool.
- T₁, T₂—Two audio-frequency transformers.

- J₁—Interstage double-circuit jack.
- J₂—Single-circuit filament-control jack.
- R₁—30-ohm rheostat.
- R₂—Fixed filament-control resistance for two 201-A tubes.
- R₃—Fixed filament-control resistance for one power tube. One 0.00025 grid condenser with 3-megohm grid leak.
- Four Sockets.
- Eleven Binding posts.

In operation, condensers C₁ and C₂ will control the tuning, and C₄ will control the amount of regeneration. Various values of voltage should be tried on the plate of the detector tube, and that voltage used which gives smoothest regeneration. Frequently 22 1/2 volts is more satisfactory than 45. Make certain that excessive C-battery voltage is not used on the grid of the r. f. tube, since the amplification obtained will be decreased considerably under such conditions. If there is any tendency toward regeneration or howling in the audio-frequency stages, reverse the connections to the primary of the transformer, T₂.

No. 100

RADIO BROADCAST Laboratory Information Sheet

June, 1927

Circuit Diagram of the "Universal" Receiver

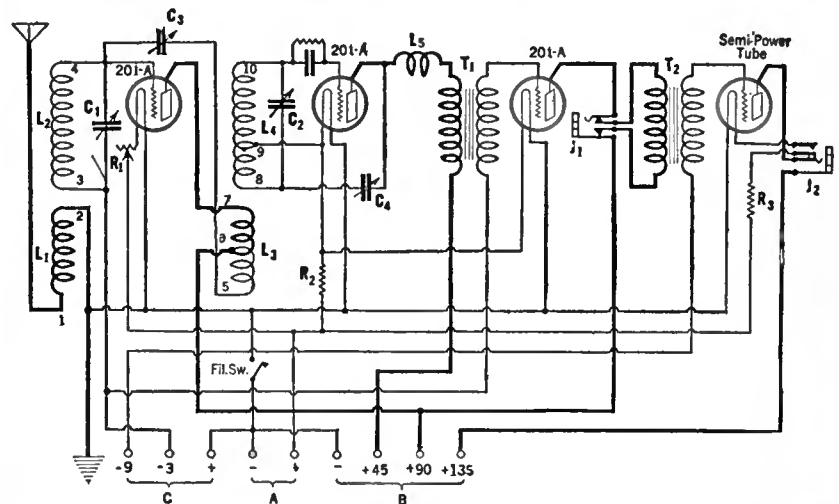

No. 101

RADIO BROADCAST Laboratory Information Sheet

June, 1927

Lightning Arresters

HOW THEY WORK

AN ESSENTIAL part of any radio installation is the lightning arrester, which should be connected in the circuit as indicated in the diagram.

The arrester should preferably be located outside of the building at that point where the antenna lead-in enters the building. One terminal of the lightning arrester connects to the antenna and the other terminal connects to a good ground. A lightning arrester is a very simple device and actually consists of two metal electrodes which are spaced to within about five thousandths of an inch of each other. A radio-frequency current is too weak and too low in voltage to jump across these points which form the gap in the arrester and hence there is no path for the signal except that through the antenna to the receiver and thence to ground. The receiver is therefore actuated by this radio-frequency current and a signal is produced in the telephones, or the loud speaker, as the case may be. Suppose, however, that a high-potential atmospheric electrical discharge takes place near the antenna. Such discharges are always erratic in character and of high frequency. The antenna coil of the set therefore exerts a powerful choking action upon them even though the coil is quite small. For this reason, and also due to the very high voltage of the lightning

discharge, it jumps across the small gap in the arrester and passes to ground without causing any more effect on the set than a loud static crash which will possibly drown out the signal for a moment.

Also, during electrical storms, or while they are

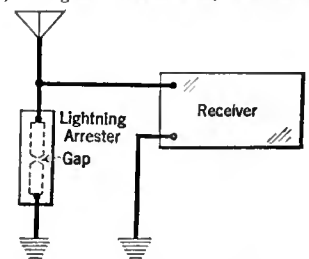

approaching, there is a considerable amount of static electricity present in the atmosphere which tends to accumulate on the antenna system until such time as the voltage is high enough to jump across the small gap in the arrester. This discharge voltage is generally about 500 volts.

No. 102

RADIO BROADCAST Laboratory Information Sheet

June, 1927

Efficiency of Amplifying Systems

ARTICULATION

IN AUDIO-amplifying systems, efficiency must be judged from two standards. One of the standards is, in the terminology of telephone engineers, the "volume efficiency" of the system, which tells us how much increase in loudness of sound is produced by the system. The other standard is known as "articulation efficiency." The "articulation efficiency" of any system is a measure of its effectiveness in the transmission of detached speech sounds. In these tests, sounds are grouped into meaningless monosyllables and the efficiency is measured by the percentage of sounds which are correctly received.

In actual tests on a system the monosyllables are spoken into the input of the system and listeners at the output record what sounds they think were spoken. In very high quality systems it is possible to obtain an articulation efficiency of almost 100 per cent.

The articulation efficiency depends upon the frequency distortion in the system, the amount of noise, and the volume efficiency. On this Sheet is an interesting curve the data for which were taken from a paper by Mr. R. L. Jones in the April, 1927, issue of the *A. I. E. E. Journal*, which shows how articulation varies with variations in intensity of sound. At the zero point the intensity of the received speech is equal to the intensity of the speech as it leaves the mouth and the articulation is about 91

per cent. With an intensity 100 times greater (10^2), the articulation falls to 87 per cent. If the intensity is decreased to a million times less than when it leaves the mouth, (10^{-6}) the articulation is still very

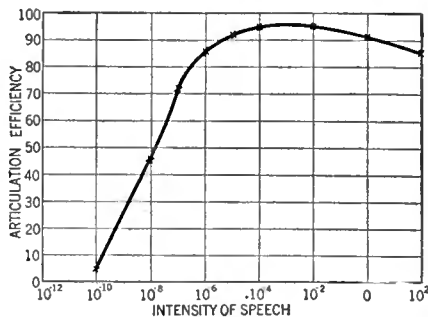

good, being 85 per cent. These tests were made under quiet conditions and, of course, under noisy conditions the results would have been somewhat different.

No. 103

RADIO BROADCAST Laboratory Information Sheet

June, 1927

Audio Transformers

HIGH-IMPEDANCE PRIMARY NEEDED

THIS Sheet will explain why better quality is obtained from transformers with high-impedance primaries.

Drawing A shows how a transformer is connected in the plate circuit of a tube. Now, a voltage, E_g , on the grid of a tube is equivalent to a voltage of μE_g (amplification constant times E_g) in the plate circuit of the tube. Also, the plate circuit of a tube acts like a resistance equal in value to the plate impedance of the tube (12,000 ohms for a 201-A type tube). These two facts were used in drawing the equivalent circuit diagram, B. In this diagram μE_g indicates the voltage acting in the plate circuit and R_p represents the plate impedance of the tube. It is evident that the total voltage, μE_g , available in the circuit, must divide itself between R_p and T , the transformer, and therefore the percentage of the total voltage across the transformer, increases with increased impedance in the transformer. Now, the impedance varies with the frequency, becoming greater as the frequency rises and decreasing as the frequency becomes lower. It is evident, then, that

the percentage of the total voltage across the transformer will also vary with frequency, and if this variation is very great it will be a source of distortion. Practically, the result will be that, at the low frequencies where the transformer impedance is low, very little of the total voltage will be across the transformer, most of it being across the tube. As a result, the low frequencies will not receive as much amplification as do the moderate and high frequencies. The problem then is to so design the transformer that this variation of amplification with frequency is as small as possible consistent with economy of manufacture. The problem evidently comes down to one of designing a transformer to have as large an impedance as possible at the low frequencies, since the impedance increases with frequency, there is no difficulty in obtaining high impedance at other than the low frequencies.

The impedance at low frequencies depends upon the inductance. The larger the inductance the greater the impedance. In order to get a large inductance, a large number of primary turns are required. It is also essential that the core of the transformer be very efficient so that the turns will have as much inductance as possible.

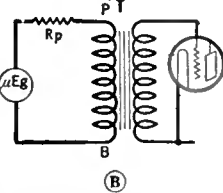
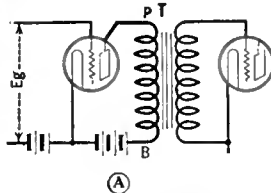

No. 104

RADIO BROADCAST Laboratory Information Sheet

June, 1927

Socket Power Units

VOLTAGE OUTPUT CURVES

AT THE present time, it is common practice in rating B power units, to specify the voltages at various current drains which the unit will deliver from the high-voltage tap. These data are obtained by connecting a variable resistance, in series with a milliammeter, between the negative B and the terminal giving the highest voltage, and then measuring the output voltage with different values of current through the resistance. The data may be collected in the form of a table or a curve may be plotted. It is best to plot a curve for, from it, we can determine the voltage at any current drain. Also, the slope of the curve gives us visually an idea of how constant the voltage is.

If full benefit is to be obtained from such curves, it is essential that we thoroughly understand what they signify. We must first determine the total plate-current drain of our receiver. This information can be obtained by connecting a milliammeter in series with the negative B lead, where it will measure the total plate current. Suppose the reading to be 35 milliamperes. This value of current is now located on the curve and we find that the corresponding plate voltage is (in this particular case) 135 volts. This is the maximum voltage that the socket-power unit will supply at 35 milliamperes. If you require a maximum of 135 volts for your receiver, then the unit is satisfactory. If you cannot use as much as 135 volts and there is no adjustment on the device to lower this voltage, then the unit is not satisfactory; or you might want to use a 171 type tube

with 180 volts and in this case also the unit will be unsatisfactory for it can only deliver 135 volts at the requisite current drain.

The curve tells us nothing concerning the voltages supplied by the other terminals on the power

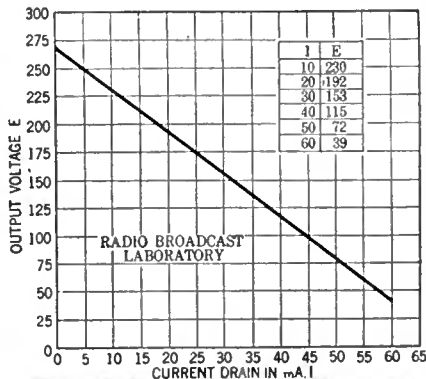

unit. These other voltages are generally controlled by variable resistances so that any voltages from zero to maximum can be obtained.

Here's Work That is Almost ROMANCE!



EARN BIG MONEY in RADIO

Get into the great new BIG-Pay Industry—Radio. If you're earning a penny less than \$50 a week, clip coupon now.

Send for 64-page FREE BOOK. Be a Radio Expert, and draw down big money for this easy, fascinating work. Positions everywhere. Need for Radio Experts in every community. Short hours. BIG PAY. Free book gives all the facts.

Learn Quickly and Easily at Home

Skilled Radio Engineers will show you how to qualify, quickly and easily at home, for Radio's fine jobs. We train you completely and thoroughly. Hundreds of N. R. I. trained men are today holding down good big jobs in the radio field. Hundreds of opportunities now awaiting the trained man. FREE EMPLOYMENT SERVICE. Many other big features. Get the facts—CLIP COUPON.



"My charges for consultation \$2.50 per hour. All success due to you," R. W. Blackhill, Brooklyn



"Radio a gold mine — your course worth thousands." A. K. Herke, Winnipeg



Get This FREE BOOK!

Send coupon below for FREE BOOK—"Rich Rewards in Radio." Read for yourself. No previous experience needed. Common schooling enough. WRITE NOW.

Big Receiving Outfit Furnished

Materials for building up-to-date receiving sets and to construct 50 well-known Radio circuits included to help you learn. An UNEQUALLED OFFER. Other special features now being offered, so Act Quick!

NATIONAL RADIO INSTITUTE
Dept. F-94, Washington, D. C.

MAIL COUPON

National Radio Institute,
Dept. F-94, Washington, D. C.

Without obligating me in any way, please send me your free book, "Rich Rewards in Radio," also complete information on your practical, home study Radio course.

Name.....

Address.....

Town.....State.....

The flux is everything in radio soldering says this Radio Engineer

"In our laboratory we made a thoro analysis of the two groups of fluxes (natural and chemical). We found the natural flux, rosin, the only safe one to use on radio work.

Pure rosin, as in Kester Radio Solder, will not fume, sputter, or creep over large areas, and being a hard, dense substance, rosin will not attract and collect dust (carbon particles), which makes an excellent path for leakages. These are the faults of fluxes containing chloride, be it either in paste, liquid or compound form. Any flux containing chloride will eventually cause heavy leakage. Hence they should be strictly avoided.

We find Kester Radio Solder the most convenient way to solder on radio work, for it has the proper amount of pure rosin right inside the solder itself. In fact, we used it exclusively on all of our work."

There's your guide, radio fans—the approval of an expert radio engineer. Surely there can be no doubt as to what you should use on YOUR SET.



A free Sample write for it now

KESTER Radio SOLDER

the safe solder for radio, requires only heat

CHICAGO SOLDER CO. 4222 Wrightwood Ave. Chicago, U. S. A.

Originators and the World's Largest Manufacturers of Self-fluxing Solder

LYNCH METALLIZED

WARRANTED FIXED RESISTORS

HEAVY-DUTY TYPE

The new Lynch wire-wound heavy duty resistors for eliminator and power work are now ready. These units are ideal for use in Raytheon and all other power circuits.

EQUALIZORS

For perfect filament control use the Lynch Equalizers. There is a type for every type of tube and for any combination of tubes. A Lynch Equalizer will take the place of your filament rheostats. Complete with mounting, \$1.00.

Lynch Suppressors and Low-loss mountings mean better radio.

At All Good Dealers

ARTHUR H. LYNCH, INC. 250 W 57th St New York, N. Y.

Equipment for the Home-Constructor

How to Use Some of the New and Interesting Radio Equipment Which the Market Offers

By THE LABORATORY STAFF

MIDGET CONDENSERS

SMALL midget condensers of a capacity variable between about 15 and 150 mmfd. find many uses in the modern radio receiver. In Fig. 1 are shown several circuit positions where they might quite successfully be applied. For example, one may be connected in the antenna circuit to reduce the electrical length of the antenna without actually removing any wire, as shown at "A." "B" indicates the connection to be used to obtain vernier tuning—almost equivalent to a slow-motion dial—with an ordinary variable condenser. The midget is in this case shunted across its larger brother, and generally should have a maximum capacity of about 50 mmfd.

It should not be overlooked that the presence of a condenser in this latter position will upset somewhat the readings of the main dial so, if the receiver is to be logged accurately, the midget vernier condenser must always be set at approximately the same position before tuning is proceeded with. Midget condensers are frequently used with gang condensers in order to compensate any inequalities between the various stages.

denser is set at the proper value and left in that position.

The last drawing in Fig. 1, "F," shows one of several methods of regeneration control by means of a midget condenser. In this instance, the tickler coil is fixed in relation to the secondary, the amount of radio-frequency current going through it being controlled by the midget condenser.

Of the many possible circuit connections for these small variable condensers, the foregoing paragraphs list only a few of the most common.

The following are some of the manufacturers making midget condensers of capacities varying between 0.000015 and 0.00015 mfd: Hammarlund Manufacturing Company, New York City; Allen D. Cardwell Manufacturing Company, Brooklyn, New York; Silver-Marshall, Incorporated, Chicago, Illinois; Precise Manufacturing Company, Rochester, New York.

PICK-UP DEVICE

REALIZATION that the new phonographs employing electrical reproduction are far ahead of the old type ones using mechanical reproduction, has created a fertile market for

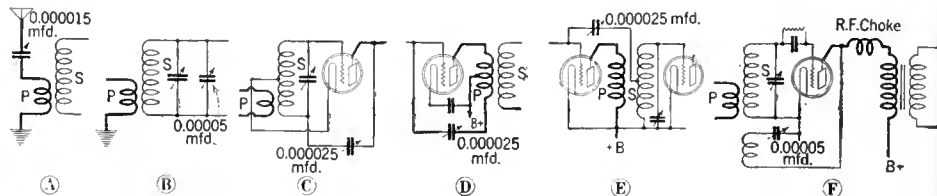

FIG. 1

In a circuit in which the tube capacity must be neutralized a small variable condenser connected in the proper way can be used for stabilization. Either a midget condenser of the type shown in Figs. 2 and 3, or a neutralizing condenser such as shown in Fig. 4, may be used. In the first two types of condenser, the capacity is readily variable by means of a knob, and may be, if desired, mounted on the panel. The latter type is usually mounted at the rear of the sub-panel, and capacity adjustments are made by means of a screw-driver. If the neutralizing condenser is of the midget type it may be used either as an oscillation control or to neutralize the tube capacity, at will. In the first case, the set may be made to regenerate over the full band of frequencies by simply adjusting the capacity so that more or less feedback is obtained. There are many different circuits making use of a small condenser to prevent oscillation (obtain neutralization). In Fig. 1, "C" shows the Rice system of neutralization, "D" the Roberts system, and "E" the Hazeltine method. For neutralization, the con-

equipment which makes possible the conversion of an old phonograph to one of the new type. Generally speaking, such devices consist of an electromagnetic pick-up, volume control, scratch filter, and often an adapter for plugging into the detector tube socket of a radio receiver; thus the audio amplifier of the receiver affords the necessary amplification of the electrical vibrations originating in the pick-up. These vibrations vary in electrical character depending upon the motion of the needle, which, in turn, relies for its minute movements upon the grooves in the rotating phonograph record.

The newest in the pick-up field is the Bosch "Recreator." Judging by the very satisfactory results obtained in our tests on this instrument, its somewhat belated appearance is due to a desire on the part of its manufacturers to produce a really first-rate piece of equipment. Fig. 5 is a diagram showing how the Bosch "Recreator" is used. In this diagram, "A" is the electromagnetic pick-up device; "B" is the swinging arm pivoted to the base "E" by a swivel arrange-



FIG. 2
Precise

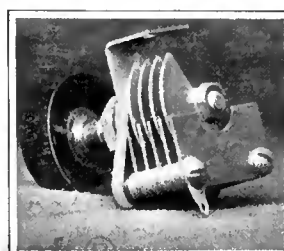

FIG. 3
Silver-Marshall

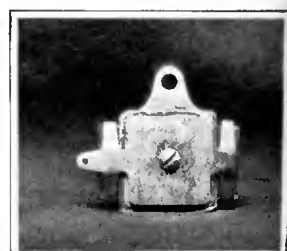

FIG. 4
Hammarlund

RADIO BROADCAST Photograph

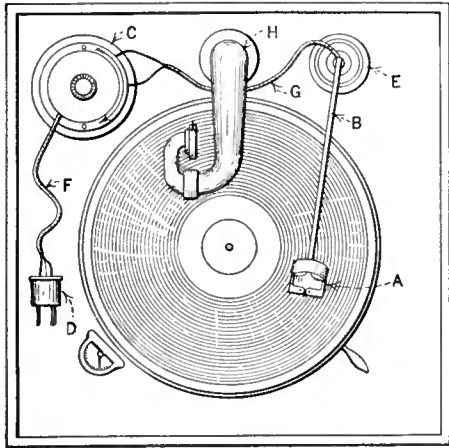

FIG. 5

ment; "G" is a flexible lead with pin jacks which are plugged into the volume control, "C"; "F" is another flexible lead between the volume control and the adapter "D," this latter, of course, being plugged into the detector tube socket of the receiver; "H" in the diagram is the regular tone arm and mechanical pick-up of the phonograph.

It is perhaps irrelevant to emphasize the necessity of employing a high-quality amplifier and loud speaker with this device. The advantages that accrue from the use of electrical reproduction will be forfeited if an amplifier system of satisfactory characteristics is not employed.

The volume obtainable from an outfit employing a Bosch pick-up necessarily depends upon the amplifier utilized. Although commercial electrical phonographs can deliver sufficient volume to make necessary the use of a 210 type tube, a two-stage transformer-coupled amplifier, or its equivalent, employing a 171 type output tube, will give satisfactory volume for average purposes.

Features of this device which are particularly commendable are as follows: (1) The arm between the pick-up and its base is adjustable in length; (2) the base, "D," is small yet sufficiently heavy for satisfactory balance; (3) the flexible leads, "G" and "F," are long, thus making it unnecessary to place the volume control close to the turntable, where generally there is inadequate room for it; (4) the volume control functions as a volume control should, *i. e.*, it satisfactorily and gradually reduces the music to a whisper, or vice versa, as desired; (5) the pick-up is very sensitive; (6) a clamp is supplied so that the electromagnet pick-up may be permanently attached to the existing tone arm of the phonograph if desired, thus doing away with the arm and base supplied.

Manufactured by the American Bosch Magneto Corporation, Springfield, Massachusetts. Price \$20.00, attractively boxed.

TRANSMITTING TUBE

A NEW transmitting tube, particularly adaptable to short-wave work, has recently made its appearance. This is the new UX-852, offered by the Radio Corporation of America.

The UX-852 is of the round bulb design, with three arms or extensions of the glass envelope. The largest or filament arm of the tube is provided with a standard UX base, suitable for use in either the UX or the UV type socket. The socket must be mounted so that the filament of the tube will be in a vertical position. Contrariwise, the horizontal grid and plate arms are not based. Instead, two heavy stranded leads, arranged in parallel, are brought from each of the widely separated stems for connection with grid and plate, respectively. Double grid and double plate leads serve greatly to increase the current-carrying capacity at exceptionally high frequencies, and both leads for each element should be employed at all times so as to carry safely the large circulating currents which flow at very high frequencies.

The fact that inter-electrode capacitance has been reduced to a minimum, permits of operating

the UX-852 at wavelengths below 100 meters (3000 kc.). The tube provides excellent results on the popular 80-, 40-, and 20-meter channels (3750, 7500, and 15,000 kc.), and it has been successfully operated on wavelengths below 5 meters (60000 kc.) and even down to 77 centimeters (0.77 meters), or a frequency of 390,000 kilocycles, which is by no means the limit for the amateur who desires to explore the lowest wavelengths of short-wave radio.

The wiring of the ultra-short-wave transmitter is materially simplified when employing the UX-852 tube, since, with the grid and plate leads coming out of the bulb at different points, all connections do not have to be concentrated at the base, and the wiring can be made proportionately shorter and with wider spacing. The base, while of the UX type with four contact prongs, makes use of only two of the filament connections. Mounted upright in the usual UX push type or UV type socket, the tube has ample air circulation and operates much cooler than the 50-watt UX-203-A and other tubes. The ample cooling capacity is due in large part to the large area of the glass envelope. The new tube will handle plate voltages of 2000 normally, and even up to 3000 with proper precautions, without internal breakdown.

Alternating current should be used to operate the filament when possible. A center tap on the secondary of the filament transformer should be used for the grid and plate circuit returns. Rheostat control should be provided on the power supply side of the transformer. When it is necessary to use direct current to light the filament, the plate and grid return leads should be connected together and to the positive lead. Filament voltmeter leads should always be connected as closely as possible to the socket terminals.

The characteristics of the UX-852 tube are as follows:

Filament Voltage.....	10
Filament Current.....	3.25 amp.
Filament Power.....	32.5 watts
Filament Type.....	Libertated Tungsten
Plate Voltage.....	2000 to 3000
Plate Current (Oscillating).....	0.075 amp.
Input Power.....	150 watts
Maximum Safe Power.....	
Dissipation.....	100 watts
Amplification Constant.....	16
Nominal Output.....	75 watts
Plate Impedance (Eg=0).....	8000 ohms.

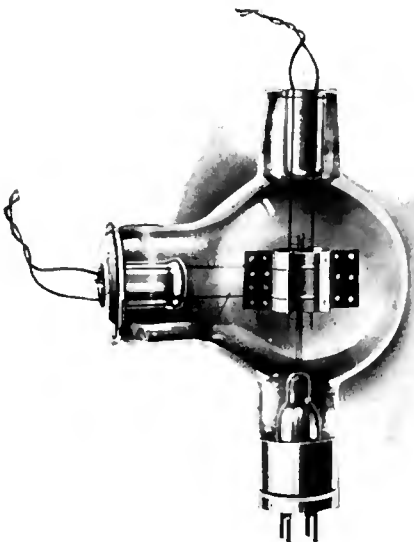

THE UX-852
Transmitting Tube

BROADCAST RECEIVER

THE Ferguson Model 14 broadcast receiver is a ten-tube set employing a loop antenna. Provision is made for connecting an outside antenna, but under ordinary circumstances its use should be unnecessary. The set has six stages of radio frequency, a detector, and three audio stages. The 201-A type tubes are used in all

Bradleystat

PERFECT FILAMENT CONTROL

For noiseless, smooth filament control and maximum range, ask your dealer for the Bradleystat. This well-known

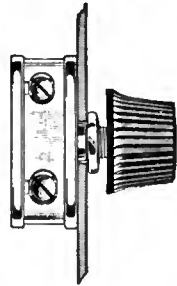

graphite disc rheostat can be used for ALL TUBES, without change of connections. The bakelite knob is removable, if desired. The one-hole mounting makes the Bradleystat easy to install.

Bradleyleak

THE PERFECT GRID LEAK

With a range from 1/4 to 10 megohms, the Bradleyleak offers a variation of adjustment that adapts it to any tube or any circuit. A small grid-condenser can be attached direct to its terminals. One-hole mounting.

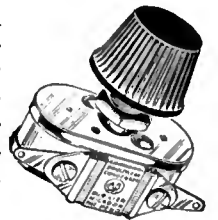

Bradley-Amplifier

Resistance-Coupled
PERFECT AUDIO AMPLIFIER

For perfect tone quality, use resistance coupling, and for convenience and reliability, ask your dealer for a Bradley-Amplifier. Ready to install in your radio set.

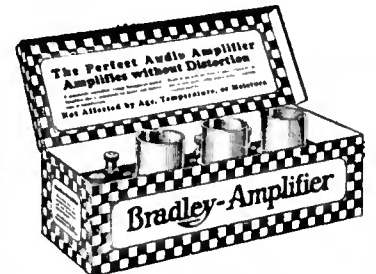

Mail this coupon to

ALLEN-BRADLEY CO.
278 Greenfield Ave., Milwaukee, Wis.

Please send me your folders on Allen-Bradley radio devices, including the Bradley-Amplifier.

Name.....

Address.....

YAXLEY
APPROVED RADIO PRODUCTS

Radio Convenience Outlets

No longer need radio reception be confined to one room—nor need battery wires be a tangled, unsightly mass strewn about the set. With the neat and efficient Yaxley Radio Convenience Outlets you can enjoy your favorite programs in any room in the house. Your batteries can be placed in the basement, closet or any out-of-the-way place and wires brought to set from Convenience Outlet with cable and plug that keeps wires together in an attractive way. Plug cannot be inserted incorrectly. Yaxley Radio Convenience Outlets are easily installed in any standard switch box.

- No. 135—For Loud Speaker. . . . \$1.00
- No. 137—For Battery Connections 2.50
- No. 136—For Aerial and Ground. 1.00

At your dealer's. If he cannot supply you send his name with your order to

Yaxley Mfg. Co.
Dept. B.
9 So. Clinton St.
Chicago, Ill.

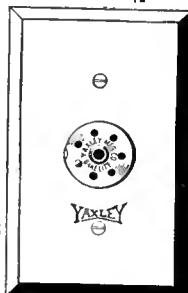

Now you can build the kind of a radio you have always wanted



This BOOK TELLS HOW

No matter whether you want to improve a set you now have or build a new one—get this book first. Tells how to build the latest one, two and three dial receivers—5 to 7 tubes.

10¢ PREPAID
GEARHART-SCHLUETER, Fresno, Cal.

stages except the output, which is designed to take either the 112 or 171 type tube. C-battery connections are provided for use in the power stage. This receiver should not be operated without a power tube otherwise considerable distortion will result, due to overloading.

Only one dial is used for tuning, the condensers being arranged in gang formation. The dial is of the popular window type, and is illuminated from the rear by a small light operated by the battery supply. The dial is marked off directly in wavelengths and is graduated from 200 to 550 meters. During a test in the Laboratory the scale readings were found to check very closely with the wavelength of the stations logged. A volume control is placed directly beneath the tuning knob and consists of a small handle which regulates a rheostat in the filament circuit of the first, third, and fifth radio-frequency tubes. Throwing the lever as far as it will go in a counter clockwise direction turns off all the tubes. The dial is centered on a wooden panel 9 inches high and 20 inches long. The whole receiver is contained in a mahogany finished cabinet 12 inches high, 24 inches wide, and 16 inches deep. A battery cable runs through the cabinet to the rear and affords connections for A, B, and C

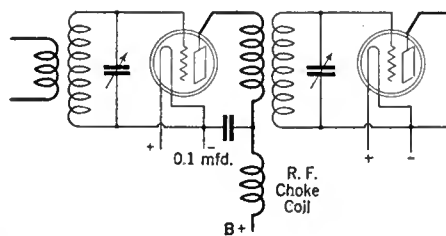

FIG. 6

batteries. The loud speaker jack is also in the rear, as are also the antenna and ground connections.

In spite of the number of tubes employed in the receiver there is a drain of only 30 milliamperes from the B supply. Either heavy-duty dry cells or a socket-power device may be used to supply the B voltage. The A supply is obtained from a storage battery. A photograph of the receiver appears on this page. Manufactured by J. B. Ferguson, Incorporated, Long Island City New York. Price \$235.00 without tubes or accessories.

PLATE POWER-SUPPLY RESISTOR

THIS resistor is used as standard equipment with the Amertran Power Supply Kit to provide the various voltages needed for the receiver. It can easily be applied to any type of plate supply device. The total resistance is 41,000 ohms, taps being taken at 32,000 ohms, 21,000 ohms, 16,500 ohms, 12,500 ohms, and 9000 ohms, as indicated in the accompanying diagram, Fig. 7. No definite values of voltage can be given for the different taps as this is dependent on the amount of current taken and the voltage of the rectifier element. The voltages across the resistances are not hard to calculate, however, and full instructions are given on Laboratory

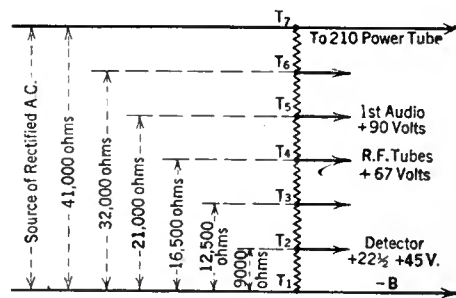
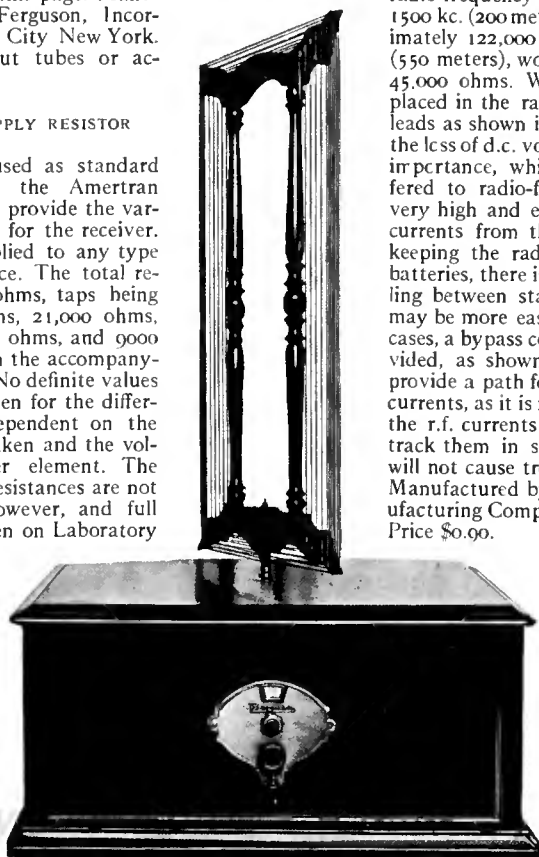

FIG. 7

Information Sheet No. 63 (page 302, January, 1927, RADIO BROADCAST). In the diagram, the taps used in the Amertran device are indicated, together with the tubes they supply. A 210 type is used in the last stage with 400 volts on the plate. The resistors are connected in series and the resistance values are accurate within approximately two per cent. The current-carrying capacity of the unit is 30 milliamperes continuously, which is ample to take care of most of the conditions to which the resistor will be subject in actual service. The resistor is wire-wound and slightly inductive. There are no doubt many uses for this resistor. For instance, it may be used as a potentiometer or as a grid leak at low-power transmitting stations. Manufactured especially for the Amertran Sales Company, Newark, New Jersey. Resistor type 400. Price \$7.50.

RADIO-FREQUENCY CHOKE COIL

THE radio-frequency choke coil is a fairly recent addition to the family of parts which go to make up the refinements of modern receivers. There are many choke coils on the market and most are designed for a specific use, though they may be used by the experimenter in many different positions in the circuit. The inductance of the Bremer-Tully choke coil was found in the Laboratory to be 12.75 millihenries, and the direct current resistance, 83.7 ohms. This means that the voltage drop (d. c.) with a current of 2 mils. would be only about 0.167 volts, or a figure which can be neglected. The impedance to a radio-frequency current, however, of 1500 kc. (200 meters) would be approximately 122,000 ohms, and at 545 kc. (550 meters), would be approximately 45,000 ohms. When such a choke is placed in the radio-frequency battery leads as shown in the diagram, Fig. 6, the less of d.c. voltage is of no practical importance, while the impedance offered to radio-frequency currents is very high and effectually keeps these currents from the battery leads. By keeping the radio currents from the batteries, there is less chance for coupling between stages and the receiver may be more easily neutralized. In all cases, a bypass condenser must be provided, as shown in the diagram, to provide a path for the radio-frequency currents, as it is not the object to stop the r.f. currents entirely but to sidetrack them in such a way that they will not cause trouble in the receiver. Manufactured by Bremer-Tully Manufacturing Company, Chicago, Illinois. Price \$0.90.



THE FERGUSON MODEL 14 RECEIVER

Manufacturers' Booklets

A Varied List of Books Pertaining to Radio and Allied Subjects Obtainable Free With the Accompanying Coupon

AS AN additional service to RADIO BROADCAST readers, we print below a list of booklets on radio subjects issued by various manufacturers. The publications listed below cover a wide range of subjects, and offer interesting reading to the radio enthusiast. The manufacturers issuing these publications have made great effort to collect interesting and accurate information. RADIO BROADCAST hopes, by listing these publications regularly, to keep its readers in touch with what the manufacturers are doing. Every publication listed below is supplied free. In ordering, the coupon printed on page 124 must be used. Order by number only.—THE EDITOR.

1. FILAMENT CONTROL—Problems of filament supply, voltage, regulation, and effect on various circuits. RADIALL COMPANY.
2. HARD RUBBER PANELS—Characteristics and properties of hard rubber as used in radio, with suggestions on how to "work" it. B. F. GOONRICH RUBBER COMPANY.
3. TRANSFORMERS—A booklet giving data on input and output transformers. PACENT ELECTRIC COMPANY.
4. RESISTANCE-COUPLED AMPLIFIERS—A general discussion of resistance coupling with curves and circuit diagrams. COLE RADIO MANUFACTURING COMPANY.
5. CARBORUNDUM IN RADIO—A book giving pertinent data on the crystal as used for detection, with hook-ups, and a section giving information on the use of resistors. THE CARBORUNDUM COMPANY.
6. B-ELIMINATOR CONSTRUCTION—Constructional data on how to build. AMERICAN ELECTRIC COMPANY.
7. TRANSFORMER AND CHOKE-COUPLED AMPLIFICATION—Circuit diagrams and discussion. ALL-AMERICAN RADIO CORPORATION.
8. RESISTANCE UNITS—A data sheet of resistance units and their application. WARD-LEONARD ELECTRIC COMPANY.
9. VOLUME CONTROL—A leaflet showing circuits for distortionless control of volume. CENTRAL RADIO LABORATORIES.
10. VARIABLE RESISTANCE—As used in various circuits. CENTRAL RADIO LABORATORIES.
11. RESISTANCE COUPLING—Resistors and their application to audio amplification, with circuit diagrams. DEJUR PRODUCTS COMPANY.
12. DISTORTION AND WHAT CAUSES IT—Hook-ups of resistance-coupled amplifiers with standard circuits. ALLEN-BRADLEY COMPANY.
13. B-ELIMINATOR AND POWER AMPLIFIER—Instructions for assembly and operation using Raytheon tube. GENERAL RADIO COMPANY.
- 13a. B-ELIMINATOR AND POWER AMPLIFIER—Instructions for assembly and operation using an R. C. A. rectifier. GENERAL RADIO COMPANY.
14. VARIABLE CONDENSERS—A description of the functions and characteristics of variable condensers with curves and specifications for their application to complete receivers. ALLEN D. CARDWELL MANUFACTURING COMPANY.
15. BAKELITE—A description of various uses of bakelite in radio, its manufacture, and its properties. BAKELITE CORPORATION.
16. POWER SUPPLY—A discussion on power supply with particular reference to lamp-socket operation. Theory and constructional data for building power supply devices. ACME APPARATUS COMPANY.
17. AUDIO AMPLIFICATION—A booklet containing data on audio amplification together with hints for the constructor. ALL AMERICAN RADIO CORPORATION.
18. HIGH-FREQUENCY DRIVER AND SHORT-WAVE WAVE-METER—Constructional data and application. BURGESS BATTERY COMPANY.
19. AUDIO-FREQUENCY CHOKES—A pamphlet showing positions in the circuit where audio-frequency chokes may be used. SAMSON ELECTRIC COMPANY.
20. RADIO-FREQUENCY CHOKES—Circuit diagrams illustrating the use of chokes to keep out radio-frequency currents from definite points. SAMSON ELECTRIC COMPANY.
21. TRANSFORMER AND IMPEDANCE DATA—Tables giving the mechanical and electrical characteristics of transformers and impedances, together with a short description of their use in the circuit. SAMSON ELECTRIC COMPANY.
22. BYPASS CONDENSERS—A description of the manufacture of bypass and filter condensers. LESLIE F. MUTER COMPANY.
23. AUDIO MANUAL—Fifty questions which are often asked regarding audio amplification, and their answers. AMERICAN SALES COMPANY, INCORPORATED.
24. SHORT-WAVE RECEIVER—Constructional data on a receiver which, by the substitution of various coils, may be made to tune from a frequency of 16,660 kc. (18 meters) to 1999 kc. (150 meters). SILVER-MARSHALL, INCORPORATED.
25. AUDIO QUALITY—A booklet dealing with audio-frequency amplification of various kinds and the application to well-known circuits. SILVER-MARSHALL, INCORPORATED.
26. VARIABLE CONDENSERS—A bulletin giving an analysis of various condensers together with their characteristics. GENERAL RADIO COMPANY.
27. FILTER DATA—Facts about the filtering of direct current supplied by means of motor-generator outfits used with transmitters. ELECTRIC SPECIALTY COMPANY.
28. RESISTANCE COUPLING—A booklet giving some general information on the subject of radio and the application of resistors to a circuit. DAVEN RADIO CORPORATION.
29. RESISTORS—A pamphlet giving some technical data on resistors which are capable of dissipating considerable energy; also data on the ordinary resistors used in resistance-coupled amplification. THE CRESCENT RADIO SUPPLY COMPANY.

62. RADIO-FREQUENCY AMPLIFICATION—Constructional details of a five-tube receiver using a special design of radio-frequency transformer. CAMFIELD RADIO MANUFACTURING COMPANY.
63. FIVE-TUBE RECEIVER—Constructional data on building a receiver. AERO PRODUCTS, INCORPORATED.
64. AMPLIFICATION WITHOUT DISTORTION—Data and curves illustrating the use of various methods of amplification. ACME APPARATUS COMPANY.
65. RADIO HANDBOOK—A helpful booklet on the functions, selection, and use of radio apparatus for better reception. BENJAMIN ELECTRIC MANUFACTURING COMPANY.
66. SUPER-HETERODYNE—Constructional details of a seven-tube set. G. C. EVANS COMPANY.
70. IMPROVING THE AUDIO AMPLIFIER—Data on the characteristics of audio transformers, with a circuit diagram showing where chokes, resistors, and condensers can be used. AMERICAN TRANSFORMER COMPANY.
71. DISTORTIONLESS AMPLIFICATION—A discussion of the resistance-coupled amplifier used in conjunction with a transformer, impedance, or resistance input stage. Amplifier circuit diagrams and constants are given in detail for the constructor. AMSCO PRODUCTS INCORPORATED.
72. PLATE SUPPLY SYSTEM—A wiring diagram and layout plan for a plate supply system to be used with a power amplifier. Complete directions for wiring are given. AMERICAN SALES COMPANY.
80. FIVE-TUBE RECEIVER—Data are given for the construction of a five-tube tuned radio-frequency receiver. Complete instructions, list of parts, circuit diagram, and template are given. ALL-AMERICAN RADIO CORPORATION.
81. BETTER TUNING—A booklet giving much general information on the subject of radio reception with specific illustrations. Primarily for the non-technical home constructor. BREMER-TULLY MANUFACTURING COMPANY.
82. SIX-TUBE RECEIVER—A booklet containing photographs, instructions, and diagrams for building a six-tube shielded receiver. SILVER-MARSHALL, INCORPORATED.
83. SOCKET POWER DEVICE—A list of parts, diagrams, and templates for the construction and assembly of socket power devices. JEFFERSON ELECTRIC MANUFACTURING COMPANY.
84. FIVE-TUBE EQUAMATIC—Panel layout, circuit diagrams, and instructions for building a five-tube receiver, together with data on the operation of tuned radio-frequency transformers of special design. KARAS ELECTRIC COMPANY.
85. FILTER—Data on a high-capacity electrolytic condenser used in filter circuits in connection with A socket power supply units, are given in a pamphlet. THE ABOX COMPANY.
86. SHORT-WAVE RECEIVER—A booklet containing data on a short-wave receiver as constructed for experimental purposes. THE ALLEN D. CARDWELL MANUFACTURING CORPORATION.
88. SUPER-HETERODYNE CONSTRUCTION—A booklet giving full instructions, together with a blue print and necessary data, for building an eight-tube receiver. THE GEORGE W. WALKER COMPANY.
89. SHORT-WAVE TRANSMITTER—Data and blue prints are given on the construction of a short-wave transmitter, together with operating instructions, methods of keying, and other pertinent data. RADIO ENGINEERING LABORATORIES.
90. IMPEDANCE AMPLIFICATION—The theory and practice of a special type of dual-impedance audio amplification are given. ALDEN MANUFACTURING COMPANY.
93. B-SOCKET POWER—A booklet giving constructional details of a socket-power device using either the BH or 313 type rectifier. NATIONAL COMPANY, INCORPORATED.
94. POWER AMPLIFIER—Constructional data and wiring diagrams of a power amplifier combined with a B-supply unit are given. NATIONAL COMPANY, INCORPORATED.

ACCESSORIES

22. A PRIMER OF ELECTRICITY—Fundamentals of electricity with special reference to the application of dry cells to radio and other uses. Constructional data on buzzers, automatic switches, alarms, etc. NATIONAL CARBON COMPANY.
23. AUTOMATIC RELAY CONNECTIONS—A data sheet showing how a relay may be used to control A and B circuits. YAXLEY MANUFACTURING COMPANY.
25. ELECTROLYTIC RECTIFIER—Technical data on a new type of rectifier with operating curves. KODEL RADIO CORPORATION.
26. DRY CELLS FOR TRANSMITTERS—Actual tests given, well illustrated with curves showing exactly what may be expected of this type of B power. BURGESS BATTERY COMPANY.
27. DRY-CELL BATTERY CAPACITIES FOR RADIO TRANSMITTERS—Characteristic curves and data on discharge tests. BURGESS BATTERY COMPANY.
28. B BATTERY LIFE—Battery life curves with general curves on tube characteristics. BURGESS BATTERY COMPANY.
29. HOW TO MAKE YOUR SET WORK BETTER—A non-technical discussion of general radio subjects with hints on how reception may be bettered by using the right tubes. UNITED RADIO AND ELECTRIC CORPORATION.
30. TUBE CHARACTERISTICS—A data sheet giving constants of tubes. C. E. MANUFACTURING COMPANY.
31. FUNCTIONS OF THE LOUD SPEAKER—A short, non-technical general article on loud speakers. AMPLION CORPORATION OF AMERICA.
32. METERS FOR RADIO—A catalogue of meters used in radio, with connecting diagrams. BURTON-ROGERS COMPANY.
33. SWITCHBOARD AND PORTABLE METERS—A booklet giving dimensions, specifications, and shunts used with various meters. BURTON-ROGERS COMPANY.
34. COST OF B BATTERIES—An interesting discussion of the relative merits of various sources of B supply. HARTFORD BATTERY MANUFACTURING COMPANY.

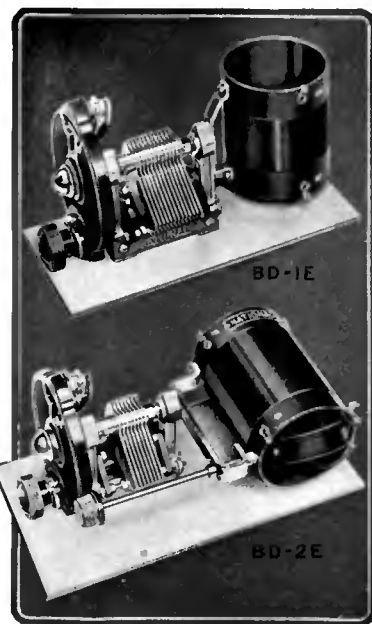

NATIONAL TUNING UNITS

New Type

Designed and Officially Approved by Glenn H. Browning

These new NATIONAL TUNING-UNITS comprise the OFFICIAL BROWNING-DRAKE Coils and R. F. Transformers—mounted on the New NATIONAL EQUITUNE Variable Condensers with their light, rigid Girder-Frames. Each TUNING-UNIT is fitted with a NATIONAL ILLUMINATED VELVET-VERNIER DIAL—Type C, with variable ratio and smoother action. Each tuning unit is packed mounted as shown so that it may be used without change for experimental work or easily installed on a panel.

Price BD-1E, with Genuine BD Antenna Coil and .0005 Condenser \$10.75

Price BD-2E, with Genuine B-D Transformer and .00025 Condenser \$14.25

Deduct 50c each for dials without illumination

NATIONAL Tuning Units are standard for good Radio sets. So are NATIONAL Impedance Transformers for quality audio. NATIONAL Tone-Filters, for power tube output connection.



NATIONAL CO. makes heavy-duty B-Supply Units and 3-stage Power Amplifiers. NATIONAL Company, Inc., Cambridge, Mass. Send for Bulletin 116-B 6.

RADIO PANELS

OF GENUINE BAKELITE

Cut, drilled and engraved to order. Send rough sketch for estimate. Our complete Catalog on Panels, Tubes and Rods—all of genuine Bakelite—made on request.

STARRETT MFG. CO.

521 S. Green Street Chicago, Ill.

This is a good time to subscribe for RADIO BROADCAST Through your dealer or direct, by the year only \$4.00 DOUBLEDAY, PAGE & CO. GARDEN CITY, NEW YORK

SET BUILDERS Get this Book

Set builders, make money and greater profits with the *Camfield Super-Selective Nine*, the receiver of remarkable performance, that has caused a stir from coast to coast.



More Profits

The Citizens Radio Call Book article on *Camfield's Super-Selective Nine* has created a demand so great as to be unparalleled in radio history. Never before has a receiver received such favorable comment. It is truly a wonder circuit and one that every set builder will recognize instantly, once it is set up. Here is a field for more profits, greater satisfaction and really remarkable results. Send 5¢ today for booklet and have the facts before you.

CAMFIELD RADIO MFG. CO. 357-359 E. Ohio St. Dept. XXXX Chicago, Ill.



Your Source of Supply

Manufacturers find the newest approved features—in Audio transformers, B Power and Power Amplifier transformers and chokes—designed by Dongan, builders of radio parts, exclusively.

This is the season to secure the maximum service from our engineering staff.

Complete information on Power Units for the new 350-400 MA Tubes. Several types, mounted or unmounted.

DONGAN ELECTRIC MFG. CO.
2991-3001 Franklin St., Detroit, Michigan



- 35. STORAGE BATTERY OPERATION—An illustrated booklet on the care and operation of the storage battery. GENERAL LEAD BATTERIES COMPANY.
- 36. CHARGING A AND B BATTERIES—Various ways of connecting up batteries for charging purposes. WESTINGHOUSE UNION BATTERY COMPANY.
- 37. CHOOSING THE RIGHT RADIO BATTERY—Advice on what dry cell battery to use; their application to radio, with wiring diagrams. NATIONAL CARBON COMPANY.
- 53. TUBE REACTIVATOR—Information on the care of vacuum tubes, with notes on how and when they should be reactivated. THE STERLING MANUFACTURING COMPANY.
- 54. ARRESTERS—Mechanical details and principles of the vacuum type of arrester. NATIONAL ELECTRIC SPECIALTY COMPANY.
- 55. CAPACITY CONNECTOR—Description of a new device for connecting up the various parts of a receiving set, and at the same time providing bypass condensers between the leads. KURT-KASCH COMPANY.
- 68. CHEMICAL RECTIFIER—Details of assembly, with wiring diagrams, showing how to use a chemical rectifier for charging batteries. CLEVELAND ENGINEERING LABORATORIES COMPANY.
- 69. VACUUM TUBES—A booklet giving the characteristics of the various tube types with a short description of where they may be used in the circuit. RADIO CORPORATION OF AMERICA.
- 77. TUBES—A booklet for the beginner who is interested in vacuum tubes. A non-technical consideration of the various elements in the tube as well as their position in the receiver. CLEARTRON VACUUM TUBE COMPANY.
- 87. TUBE TESTER—A complete description of how to build and how to operate a tube tester. BURTON-ROGERS COMPANY.
- 91. VACUUM TUBES—A booklet giving the characteristics and uses of various types of tubes. This booklet may be obtained in English, Spanish, or Portuguese. DEFOREST RADIO COMPANY.
- 92. RESISTORS FOR A. C. OPERATED RECEIVERS—A booklet giving circuit suggestions for building a c. operated receivers, together with a diagram of the circuit used with the new 400-millampere rectifier tube. CARTER RADIO COMPANY.
- 97. HIGH-RESISTANCE VOLTMETERS—A folder giving information on how to use a high-resistance voltmeter, special consideration being given the voltage measurement of socket-power devices. WESTINGHOUSE ELECTRIC & MANUFACTURING COMPANY.

MISCELLANEOUS

- 38. LOG SHEET—A list of broadcasting stations with columns for marking down dial settings. U. S. L. RADIO, INCORPORATED.
- 41. BABY RADIO TRANSMITTER OF 9XH-9EK—Description and circuit diagrams of dry-cell operated transmitter. BURGESS BATTERY COMPANY.
- 42. ARCTIC RADIO EQUIPMENT—Description and circuit details of short-wave receiver and transmitter used in Arctic exploration. BURGESS BATTERY COMPANY.
- 43. SHORT-WAVE RECEIVER OF 9XH-9EK—Complete directions for assembly and operation of the receiver. BURGESS BATTERY COMPANY.
- 44. ALUMINUM FOR RADIO—A booklet containing much radio information with hook-ups of basic circuits, with inductance-capacity tables and other pertinent data. ALUMINUM COMPANY OF AMERICA.
- 45. SHIELDING—A discussion of the application of shielding in radio circuits with special data on aluminum shields. ALUMINUM COMPANY OF AMERICA.
- 48. HOW TO SELECT A RECEIVER—A commonsense booklet describing what a radio set is, and what you should expect from it, in language that any one can understand. DAY-FAY ELECTRIC COMPANY.
- 67. WEATHER FOR RADIO—A very interesting booklet on the relationship between weather and radio reception, with maps and data on forecasting the probable results. TAYLOR INSTRUMENT COMPANIES.
- 73. RADIO SIMPLIFIED—A non-technical booklet giving pertinent data on various radio subjects. Of especial interest to the beginner and set owner. CROSLY RADIO CORPORATION.
- 74. THE EXPERIMENTER—A monthly publication which gives technical facts, valuable tables, and pertinent information on various radio subjects. Interesting to the experimenter and to the technical radio man. GENERAL RADIO COMPANY.
- 75. FOR THE LISTENER—General suggestions for the selecting, and the care of radio receivers. VALLEY ELECTRIC COMPANY.
- 76. RADIO INSTRUMENTS—A description of various meters used in radio and electrical circuits together with a short discussion of their uses. JEWELL ELECTRICAL INSTRUMENT COMPANY.
- 78. ELECTRICAL TROUBLES—A pamphlet describing the use of electrical testing instruments in automotive work combined with a description of the cadmium test for storage batteries. Of interest to the owner of storage batteries. BURTON ROGERS COMPANY.
- 95. RESISTANCE DATA—Successive bulletins regarding the use of resistors in various parts of the radio circuit. INTERNATIONAL RESISTANCE COMPANY.
- 96. VACUUM TUBE TESTING—A booklet giving pertinent data on how to test vacuum tubes with special reference to a tube testing unit. JEWELL ELECTRICAL INSTRUMENT COMPANY.

Mayolian

"B" SUPPLY

The "B" Without a Buzz

This Non-Motor boating, high-powered unit delivers 50 mls. at 200 volts.

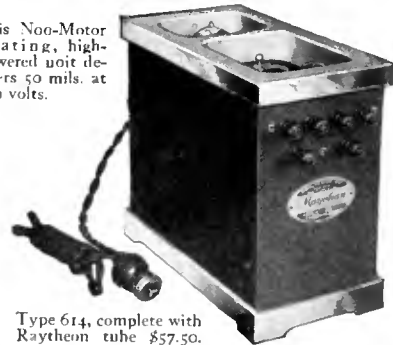

Type 614, complete with Raytheon tube \$57.50.

MAYOLIAN CORPORATION
1668 Webster Ave., New York City

Pioneers in Battery Elimination



The Power of Niagara—
The Quiet of an Arctic Night

USE THIS COUPON

RADIO BROADCAST SERVICE DEPARTMENT
RADIO BROADCAST, Garden City, New York.
Please send me (at no expense) the following booklets indicated by numbers in the published list

Name

Address

(Number) (Street)

(City) (State)

ORDER BY NUMBER ONLY

This coupon must accompany every request. RB 527

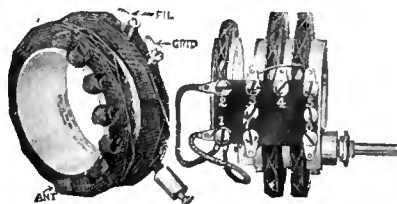

Sickles Coil Set No. 18A for Roberts Circuit

SICKLES

Diamond-Weave Coils

No.	Coil Prices
24 Browning-Drake	\$7.50 set
18A Roberts Circuit	8.00 set
25 Aristocrat Circuit	8.00 set
30 Shielded Transformer	2.00 each

There are Sickles Diamond-Weave Coils for all leading circuits.

THE F. W. SICKLES CO.
132 UNION STREET
SPRINGFIELD :: MASS.

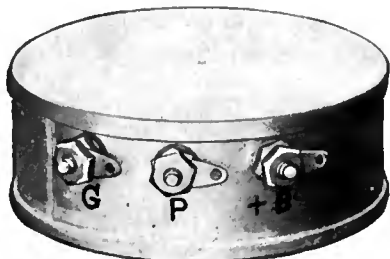

Shielded Tuned Radio Transformer, No. 30

What Kit Shall I Buy?

THE list of kits herewith is printed as an extension of the scope of the Service Department of RADIO BROADCAST. It is our purpose to list here the technical data about kits on which information is available. In some cases, the kit can be purchased from your dealer complete; in others, the descriptive booklet is supplied for a small charge and the parts can be purchased as the buyer likes. The Service Department will not undertake to

X-L Products

MODEL "N"
VARIO
DENSER



Pep Up Your Set!

Tune quickly—adjust accurately—eliminate distracting noises—get correct tube excitation—with X-L VARIO-DENSERS in your circuit. Designers of all latest and best circuits specify and endorse.

MODEL "N"—Capacity range 1.8 to 20 micro-micro farads. Micrometer adjustment assures correct oscillation control in all tuned radio frequency circuits. Neutralize, Roberts 2-tube, Browning-Drake, Silver's Knockout, Interflex circuit, Quadformer, World's Record Super-9, B. T. Power-6, R. B. Lab. Circuit, etc. Price, \$1.00.

MODEL "G"—For Cockaday, Oliver Lodge N. Loftin-White, Nankin Ultra-5 circuits, filter and intermediate frequency tuning in super-heterodyne and positive grid bias in all sets. Capacity range, Model G-1 .00002 to .0001 Mfd. Model G-5 .0001 to .0005 Mfd. Model G-10 .0003 to .001 Mfd. Price each with grid leak clips, \$1.50.

X-L PUSH POST—Push it down with your thumb, insert wire, remove pressure, wire is firmly held. Vibrations will not loosen, releases instantly. Price, 15c. Also in strip of 7 on black panel marked in white. Price, \$1.50.

FREE wiring diagrams showing use of X-L units to the new LOFTIN-WHITE constant coupled radio frequency circuit, and in other popular hook-ups. Send for yours to-day.

X-L RADIO LABORATORIES

2424 Lincoln Ave., Chicago, Ill.

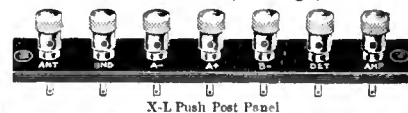

X-L Push Post Panel

handle cash remittances for parts, but when the coupon on page 126 is filled out, all the information requested will be forwarded.

201. SC FOUR-TUBE RECEIVER—Single control. One stage of tuned radio frequency, regenerative detector, and two stages of transformer-coupled audio amplification. Regeneration control is accomplished by means of a variable resistor across the tickler coil. Standard parts; cost approximately \$58.85.

202. SC-II FIVE-TUBE RECEIVER—Two stages of tuned radio frequency, detector, and two stages of transformer-coupled audio. Two tuning controls. Volume control consists of potentiometer grid bias on r.f. tubes. Standard parts cost approximately \$60.35.

203. "HI-Q" KIT—A five-tube tuned radio-frequency set having two radio stages, a detector, and two transformer-coupled audio stages. A special method of coupling in the r.f. stages tends to make the amplification more nearly equal over the entire band. Price \$63.05 without cabinet.

204. R. G. S. KIT—A four-tube inverse reflex circuit, having the equivalent of two tuned radio-frequency stages, detector, and three audio stages. Two controls. Price \$69.70 without cabinet.

205. PIERCE AIRO KIT—A six-tube single-dial receiver; two stages of radio-frequency amplification, detector, and three stages of resistance-coupled audio. Volume control accomplished by variation of filament brilliancy of r.f. tubes or by adjusting compensating condensers. Complete chassis assembled but not wired costs \$42.50.

206. H & H-T. R. F. ASSEMBLY—A five-tube set, three tuning dials, two steps of radio frequency, detector, and 2 transformer-coupled audio stages. Complete except for base-board, panel, screws, wires, and accessories. Price \$35.00.

207. PREMIER FIVE-TUBE ENSEMBLE—Two stages of tuned radio frequency, detector, and two steps of transformer-coupled audio. Three dials. Parts assembled but not wired. Price complete, except for cabinet, \$35.00.

208. "QUADRAFORMER VI"—A six-tube set with two tuning controls. Two stages of tuned radio frequency using specially designed shielded coils, a detector, one stage of transformer-coupled audio, and two stages of resistance-coupled audio. Gain control by means of tapped primaries on the r.f. transformers. Essential kit consists of three shielded double-range "Quadraformer" coils, a selectivity control, and an "Ampitrol," price \$17.50. Complete parts \$70.15.

209. GEN-RAI FIVE-TUBE SET—Two stages of tuned radio frequency, detector, and two transformer-coupled audio stages. Volume is controlled by a resistor in the plate circuit of the r.f. tubes. Uses a special r.f. coil ("Duo-Former") with figure eight winding. Parts mounted but not wired, price \$37.50.

210. BREMER-TULLY POWER-SIX—A six-tube, dual-control set; three stages of neutralized tuned radio frequency, detector, and two transformer-coupled audio stages. Resistances in the grid circuit together with a phase shifting arrangement are used to prevent oscillation. Volume control accomplished by variation of B potential on r.f. tube. Essential kit consists of four r.f. transformers, two dual condensers, three small condensers, three choke coils, one 500,000-ohm resistor, three 1500-ohm resistors, and a set of color charts and diagrams. Price \$41.50.

211. BRUNO DRUM CONTROL RECEIVERS—How to apply a drum tuning unit to such circuits as the three-tube regenerative receiver, four-tube Browning-Drake, five-tube Diamond-of-the-Air, and the "Grand" 6.

212. INFRADYNE AMPLIFIER—A three-tube intermediate-frequency amplifier for the super-heterodyne and other special receivers, tuned to 3400 kc. (86 meters). Price \$25.00.

213. RADIO BROADCAST "LAB" RECEIVER—A four-tube dual-control receiver with one stage of Rice neutralized tuned-radio frequency, regenerative detector (capacity controlled), and two stages of transformer-coupled audio. Approximate price, \$78.15.

214. LC-27—A five-tube set with two stages of tuned-radio frequency, a detector, and two stages of transformer-coupled audio. Special coils and special means of neutralizing are employed. Output device. Price \$85.20 without cabinet.

215. LOFTIN-WHITE—A five-tube set with two stages of radio frequency, especially designed to give equal amplification at all frequencies, a detector, and two stages of transformer-coupled audio. Two controls. Output device. Price \$85.10.

216. K.H.-27—A six-tube receiver with two stages of neutralized tuned radio frequency, a detector, three stages of choke-coupled audio, and an output device. Two controls. Price \$86.00 without cabinet.

217. AERO SHORT-WAVE KIT—Three plug-in coils designed to operate with a regenerative detector circuit and having 2 frequency range of from 19,990 to 2306 kc. (15 to 130 meters). Coils and plug only, price \$12.50.

218. DIAMOND-OF-THE-AIR—A five-tube set having one stage of tuned-radio frequency, a regenerative detector, one stage of transformer-coupled audio, and two stages of resistance-coupled audio. Volume control through regeneration. Two tuning dials.

219. NORDEN-HAUCK SUPER 10—Ten tubes; five stages of tuned radio frequency, detector, and four stages of choke- and transformer-coupled audio frequency. Two controls. Price \$201.40.

220. BROWNING-DRAKE—Five tubes; one stage tuned radio frequency (Rice neutralization), regenerative detector (tickler control), three stages of audio (special combination of resistance- and impedance-coupled audio). Two controls.

221. LR4 ULTRADYNE—Nine-tube super-heterodyne; one stage of tuned radio frequency, one modulator, one oscillator, three intermediate-frequency stages, detector, and two transformer-coupled audio stages.

222. GREIFF MULTIPLEX—Four tubes (equivalent to six tubes); one stage of tuned radio frequency, one stage of transformer-coupled radio frequency, crystal detector, two stages of transformer-coupled audio, and one stage of impedance-coupled audio. Two controls. Price complete parts, \$50.00.

223. PHONOGRAPH AMPLIFIER—A five-tube amplifier device having an oscillator, a detector, one stage of transformer-coupled audio, and two stages of impedance-coupled audio. The phonograph signal is made to modulate the oscillator in much the same manner as an incoming signal from an antenna.



Listed by Underwriters

WHEN you buy any accessory or part for your radio set you like to feel that you have purchased the very best obtainable.



Jewell Lightning Arrester

For lightning protection the Jewell lightning arrester is the best that can be bought. It is listed, as complying with their standards, by Underwriters Laboratory, who check its construction and operation periodically.

The lightning arrester consists of an accurately calibrated air gap inclosed and sealed in a brown glazed porcelain case. It is suitable for either indoor or outdoor installation.

Write for special circular No. 1019.

Jewell Electrical Instrument Co.

1650 Walnut Street, Chicago

"27 Years Making Good Instruments"

This is a good time to subscribe for

RADIO BROADCAST

Through your dealer or direct by the year, only \$4.00

DOUBLEDAY, PAGE & CO.

GARDEN CITY, NEW YORK

Vee Dee

METAL CABINET and CHASSIS (SUB PANEL)

MADE SPECIALLY FOR THE

UNIVERSAL POWER PACK

as featured by
SILVER-MARSHALL

\$6.00 for the complete unit. Includes insulation bushings, washers and all necessary hardware and accessories

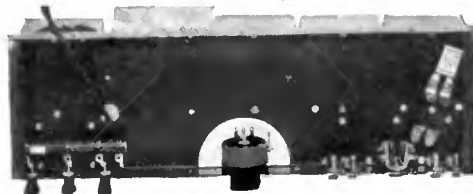
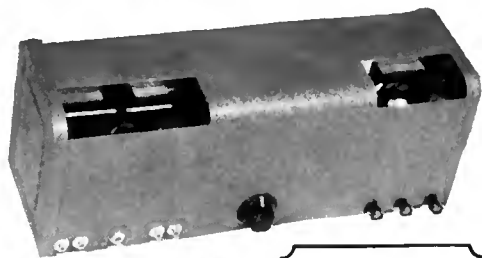

Bottom View

Made of Metal, beautifully finished in a rich neutral tone to harmonize with any radio cabinet. Chassis is completely and precisely drilled according to engineer's specifications. Truly, a most efficient housing for Silver-Marshall's Universal Power Pack. At your dealers' or direct from

THE VAN DOORN COMPANY

160 North La Salle Street Chicago, Illinois
FACTORY, QUINCY, ILLINOIS

Dealers carry Vee Dee metal panels in all standard stock sizes; panels for leading kits; adjustable sub-panels; Special Panel and Sub-Panel for the S. C. 2 Receiver.

Vee Dee Keeps Pace with the Latest and Best

WRITE FOR DETAILS

Centralab
Modu plug



GIVES old receivers the improved tone volume control of latest, best sets. Replaces present speaker plug. Tune in with dials. Then modulate to any degree on Modu Plug alone (between speaker and set). Reduces interfering noises. Attaches without tools. Nothing else like it. Cord or Jack Type, \$2.50 at dealers, or mailed C. O. D. Parts manufacturers for 69 makers of leading standard sets.

Central Radio Laboratories
22 Keefe Ave. Milwaukee, Wis.

Centralab

A KEY TO RECENT RADIO ARTICLES

By E. G. SHALKHAUSER

THIS is the twentieth installment of references to articles which have appeared recently in various radio periodicals. Each separate reference should be cut out and pasted on 4" x 6" cards for filing, or put in a scrap book either alphabetically or numerically. An outline of the Dewey Decimal System (employed here) appeared last in the January RADIO BROADCAST.



R582. TRANSMISSION OF PHOTOGRAPHS. PHOTOGRAPH RADIO BROADCAST, Feb., 1927. Pp. 18-ff. TRANSMISSION. "Radio Photography and Television," Dr. E. F. W. Alexanderson.

The writer gives a brief survey of the problems of telephotography and television, the developments made to date, the research being carried on in the laboratory, and the difficulties that will have to be overcome in order to make television practical.

R342.6. RADIO-FREQUENCY AMPLIFIERS. AMPLIFIER, RADIO, Feb., 1927. Pp. 22-ff. *Infrazyne*. "Infrazyning R. F. Receivers," E. M. Sargent.

Wiring diagrams and data are presented showing how the Infrazyne amplifying principle may be adapted to four well-known circuits, namely, the Browning-Drake, the Hammarlund "Hi-Q," the Bremer-Tully Counterphase, and the Silver-Six.

R334. FOUR-ELECTRODE TUBES. VACUUM TUBES, RADIO, Feb., 1927. Pp. 23-24. *Four-Electrode*. "A Four-Electrode Tube and Circuit," H. de A. Donisthorpe.

Several uses to which four-electrode tubes may be put are outlined. Circuits are given for rectification, for combined radio-frequency amplification, for detection, and for audio-frequency amplification. A circuit is also given where rectification and radio-frequency amplification are accomplished with the use of only one tube.

ROOF.1. UNITED STATES LAWS AND REGULATIONS. LAWS AND REGULATIONS. Public No. 632-60th Congress. H. R. 9071. Feb. 23, 1927. "An Act for the Regulation of Radio Communication, and for Other Purposes."

The new radio law of 1927, enacted by the Senate and the House of Representatives, and signed by the President on the 23rd of February, 1927, is printed in this copy, which may be obtained from the Superintendent of Documents, Government Printing Office, at 5 cents per copy. Other acts and resolutions, previously in effect, are repealed by this act placing all control under the new law.

R582. TRANSMISSION OF PHOTOGRAPHS. PHOTOGRAPH RADIO BROADCAST, March, 1927. Pp. 459-462. TRANSMISSION. "Television: Europe or America First?" MISSION. E. H. Felix.

An account is given of the theoretical and experimental work carried on by Dr. E. F. W. Alexanderson of the General Electric Company, in the field of television and radio photography. The apparatus consists of a source of light, a lens, and a revolving drum carrying a number of reflecting mirrors. It is stated that, in order to make television a success by the method outlined, it will be necessary to transmit something like 300,000 pictures per second, a feat very difficult, if not impossible, to accomplish, unless other major difficulties are first overcome.

R343.7. ALTERNATING CURRENT SUPPLY. ELIMINATORS, RADIO BROADCAST, March, 1927. Pp. 477-479. *B-Battery*. "What You Should Know About B Power-Supply Devices," E. H. Felix.

A general discussion of B battery eliminators is given. The essential elements in such a unit consist of a transformer which steps up the line voltage to an amount determined by the requirements, a rectifier element, a system of inductances and filters to smooth out the pulsating output, and a potentiometer output device to obtain various voltages.

Tests made on a dozen different power-supply devices are shown in graph form. The operation, maintenance, and the causes of trouble are outlined in detail.

R343. Electron-Tube Receiving Sets. RECEIVER, RADIO BROADCAST, March, 1927. Pp. 480-482. *Reflex*. "Building the R. G. S. Inverse-Duplex Receiver. Part. 3," D. Grimes.

This is the third of a series of articles describing the new Inverse-Duplex system of reception, and presents the constructional details for the adaptation of the previously outlined developments to the R. G. S. receiver. Wiring diagrams, a list of parts required, and data on winding the special coils used, are given.

R342.5. POWER AMPLIFIER. AMPLIFIER, RADIO BROADCAST, March, 1927. Pp. 489-492. *Power*. "Constructing an Amplifier-Power Supply Device," James Millen.

Detailed information is given on the construction of a three-stage resistance-coupled power amplifier operated directly from an a.c. source. The data include the winding of the power transformer, choke coils, and output impedance.

R343. ELECTRON-TUBE RECEIVING SET. RECEIVER, RADIO BROADCAST, March, 1927. *Model EA Garod*. Pp. 495-497.

"A. C. as a Filament-Supply Source," B. F. Miessner. Data are given on the operation of a receiver deriving all of its power from the lighting mains. Three 112 type tubes, one 199 type tube for detector, and one 210 type tube for the last stage of power amplification are used in this set. A description of the power conversion unit is given.

Goodrich



Radio Panels

Black, Mahogany and Walnut. Standard thickness 3-16" and 1/4". High softening point prevents warping.

Low free sulphur content prevents discoloration.

Machine easier and are better electrically than any other material in common use.

Your radio dealer has them or will get them for you—if not, write to us and we will see that you are supplied.

Also hard rubber for coils, spaghetti tubing and miscellaneous rubber items for radio manufacturers.

Radio Sales Division

The B. F. Goodrich Rubber Company
Established 1870 Akron, Ohio

USE THIS COUPON

RADIO BROADCAST SERVICE DEPARTMENT
Garden City, New York.

Please send me information about the following kits indicated by number:

.....
.....
.....
.....
.....
Name.....
Address.....
(Number) (Street)
.....
(City) (State)

ORDER BY NUMBER ONLY. This coupon must accompany each order.

RB627

Use Power tubes for good quality at full volume

Simply adapt to your set with Connectoralds

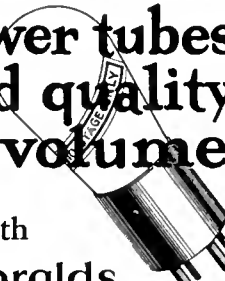

For UX 171 and UX 112 Tubes, Na-Ald 112 Connectoralds are recommended for maximum volume with storage battery sets. These tubes will deliver without distortion several times the volume of the regular 201A.. Price \$1.50

For UX 120 Tubes in UV 201A sockets, the Na-Ald No. 120 Connectorald should be used. To convert a storage battery set to dry batteries with ample loud speaker volume, use a UX 120 tube in the last audio stage with the 120 Connectorald and UX 199 tubes with 419X Adapters in the other sockets. Price \$1.25.

For the UX 120 Tube in UV 199 sockets, ample loud speaker volume without distortion is obtainable from any set equipped for UV 199 tubes by means of the UX 120 or equivalent tube with the Na-Ald No. 920 Connectorald. The tube is raised slightly, but provides for its use in most sets with limited headroom. Price \$1.25.

For UX 120 tubes in the UV 199 sockets of the Radiola Superheterodyne Semi-Portable, and Radiola Super VIII. These excellent Superheterodynes will deliver ample volume for loud speaker operation when equipped with the UX 120 used with the Na-Ald No. 420 Connectorald. Price \$1.25.

ALDEN MANUFACTURING CO.
Dept. B-26 Springfield, Mass.



U. S. Patent, Oct. 12, 1926

Add the new Balkite Combination to your radio set now—with your "A" battery it supplies all radio power automatically from the light socket.

Ask your radio dealer

FANSTEEL PRODUCTS CO., INC.
North Chicago, Ill.

You Can't Carry a Load of Hay on a Wheelbarrow



NEITHER can you obtain good musical performance from your receiver unless your audio amplifier can carry the full load of rich tones and overtones.

Wherever tone quality is paramount you will find Thordarson Amplifying Transformers. Over thirty manufacturers of leading quality receivers use them as standard equipment.

Follow the lead of the leaders. Whether buying or building a receiver—if you enjoy music—insist on Thordarson Amplification.

You don't have to be water boy to the

THORDARSON BATTERY CHARGER

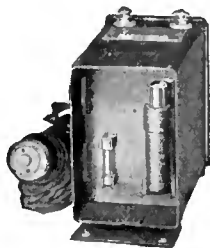

DRY—As dry as they make them. In fact the rectifying element is contained in a moisture-proof cartridge.

SILENT—No vibrating parts. Current is rectified through a patented electro-chemical process.

SAFE—There is no hazard to rugs or wood-work for there is no acid to spill. The tubes of the set are safe, even if turned on when the charger is in operation.

COMPACT—Fits into battery compartment easily. Only 2 3/4" wide, 5 3/4" long and 4 3/4" high, overall.

EFFICIENT—This charger is always ready for service. No overhauling required. Rectifying element is held in spring clips and can be replaced in thirty seconds.

LONG LIFE—The Raytheon rectifying unit used in this charger is guaranteed by its manufacturer for 750 hours of full load operation, or approximately one year's service. The transformer will last indefinitely.

CHARGING RATE—2 amperes.

Price \$12⁵⁰



THORDARSON Power Compact

The only complete foundation unit for home-built power amplifiers. Contains power supply transformer, 2 30-henry choke coils, 2 buffer condensers and center tapped filament supply—all in one compound filled case. Supplied in two types: R-171 for Raytheon rectifier and UX-171 power tube, and R-210 for UX-216 B rectifier and UX-210 power tube.

Type R-171, \$15.00

Type R-210, 20.00



THORDARSON R-200 Amplifying Transformer

A transformer designed for the musical epicure. The large core of finest silicon steel and the high inductance primary winding combine to give this instrument the most perfect transformer reproduction obtainable. Has a remarkably wide range of amplification. Ideal for use with cone type speakers. Designed for both first and second stage amplification. Weight, 2 lbs.

Price \$8.00

THORDARSON

RADIO TRANSFORMERS

Supreme in Musical Performance!

THORDARSON ELECTRIC MANUFACTURING CO.
Transformer specialists since 1895
 WORLD'S OLDEST AND LARGEST EXCLUSIVE TRANSFORMER MAKERS
 Chicago, U.S.A.