

# RADIO BROADCAST

WILLIS K. WING, Editor

APRIL, 1927

KEITH HENNEY  
Director of the Laboratory

JOHN B. BRENNAN  
Technical Editor

Vol. X, No. 6

EDGAR H. FELIX, Contributing Editor

## CONTENTS

Cover Design . . . . .	From a Painting by Fred J. Edgars											
Frontispiece . . . . .	Radio Apparatus Aboard a Transatlantic Liner	550										
With MacMillan to the Arctic . . . . .	Austin G. Cooley	551										
The March of Radio . . . . .	An Editorial Interpretation	555										
<table border="0"> <tr> <td>                     Welcome to the Radio Commission                      Deliver Us from Excess Broadcasting Stations                      Punishment for the Defenseless Ether                      The Network System Grows                      Well Administered Canadian Radio                 </td> <td>                     The Lethargic Radio Industry                      Conflicting Radio Standards                      The Weak Radio Listener "Organization"                      Interesting Field-Intensity Measurements                      The Month in Radio                 </td> </tr> </table>			Welcome to the Radio Commission Deliver Us from Excess Broadcasting Stations Punishment for the Defenseless Ether The Network System Grows Well Administered Canadian Radio	The Lethargic Radio Industry Conflicting Radio Standards The Weak Radio Listener "Organization" Interesting Field-Intensity Measurements The Month in Radio								
Welcome to the Radio Commission Deliver Us from Excess Broadcasting Stations Punishment for the Defenseless Ether The Network System Grows Well Administered Canadian Radio	The Lethargic Radio Industry Conflicting Radio Standards The Weak Radio Listener "Organization" Interesting Field-Intensity Measurements The Month in Radio											
Further Comments on the R. B. "Lab" Receiver	The Laboratory Staff	560										
Have You an Old-Type Freshman "Masterpiece?"	Kingsley Welles	563										
The Listeners' Point of View . . . . .	John Wallace	566										
What Many Listeners Think About Broadcasting	The Super-Condensed Newspaper Radio Program Thumb Nail Reviews											
A 20-40-80-Meter Transmitter . . . . .	Keith Henney	570										
Judging the Tubes You Buy . . . . .	Edgar H. Felix	574										
As the Broadcaster Sees It . . . . .	Carl Dreher	577										
Some Notes on the Morale Among Broadcasters	Abstract of Technical Article. V. The Nature of Language Dummy Microphones											
Constructing a D. C. Amplifier-Power Supply Device	James Millen	580										
Including Some Notes on Trouble Shooting in A. C. Amplifier-Power Supply Devices												
Some "Hi-Q" Improvements . . . . .	John B. Brennan	584										
A Fundamental Analysis of Loud Speakers . . . . .	John F. Nielsen	587										
Radio Broadcast's Laboratory Information Sheets . . . . .		396										
<table border="0"> <tr> <td>No. 81 Ohm's Law</td> <td>No. 86 A Double-Impedance Coupled Amplifier</td> </tr> <tr> <td>No. 82 Oscillation Control</td> <td>No. 87 A Dual-Impedance Coupled Amplifier Circuit Diagram</td> </tr> <tr> <td>No. 83 Mutual Conductance</td> <td>No. 88 Comparisons of Audio Amplifier Systems</td> </tr> <tr> <td>No. 84 The 6X-120 Tube Characteristic Curve</td> <td></td> </tr> <tr> <td>No. 85 C Voltages</td> <td></td> </tr> </table>			No. 81 Ohm's Law	No. 86 A Double-Impedance Coupled Amplifier	No. 82 Oscillation Control	No. 87 A Dual-Impedance Coupled Amplifier Circuit Diagram	No. 83 Mutual Conductance	No. 88 Comparisons of Audio Amplifier Systems	No. 84 The 6X-120 Tube Characteristic Curve		No. 85 C Voltages	
No. 81 Ohm's Law	No. 86 A Double-Impedance Coupled Amplifier											
No. 82 Oscillation Control	No. 87 A Dual-Impedance Coupled Amplifier Circuit Diagram											
No. 83 Mutual Conductance	No. 88 Comparisons of Audio Amplifier Systems											
No. 84 The 6X-120 Tube Characteristic Curve												
No. 85 C Voltages												
Equipment for the Home Constructor . . . . .		604										
A Key to Recent Radio Articles . . . . .	E. G. Shalkhauser	606										
Manufacturers' Booklets Available . . . . .		609										
Book Reviews . . . . .		611										
Letters from Readers . . . . .		613										

## AMONG OTHER THINGS. . .

WITH the signing of the "Radio Act of 1927," by President Coolidge, on February 23, the hopes of the country for an improvement in radio conditions take definite shape. However, there is much to be done. At this writing, the Radio Commissioners are not yet appointed, or confirmed by the Senate—a necessary procedure. And even were the Commissioners functioning this minute, their task is so stupendous that it will take many months to solve the complex problems that are theirs. Everything depends on the character and ability of these Commissioners, for the mere existence of the Radio Act does not mean that conditions will automatically be remedied. Although radio programs have never been so good as they are now, the listener and the entire industry alike have suffered tremendously from the unfortunate interregnum in radio control in this country since last June. The United States has been laughed at by the entire radio world. In Canada especially, that laugh has been a bitter one, for the broadcasters and listeners alike in our sister nation have had to suffer for the sins of our own selfish citizens who clamored to broadcast, willy nilly. The leading editorial on page 555—since it had to go to press before the Bill became a law—perforce reads somewhat inaccurately in its references to the status of the Bill, but it is correct in every other respect.

THIS number of RADIO BROADCAST contains a breadth of subject which gives it a strong appeal to every sort and condition of radio man. The amateur will be interested in Keith Henney's description of an a. c. short-wave transmitter, and in the exclusive story by Austin G. Cooley on his experiences with the MacMillan expedition. The general reader, too, should find Mr. Cooley's narrative fascinating. How the air can be cleared and what it means to the listener is clearly shown by the editorial and accompanying chart on pages 555-6. Additional data from the listeners' questionnaire appear in "The Listeners' Point of View," and more will appear in our May issue. The consumer and dealer alike will find much solid meat in Edgar Felix's article, "Judging the Tubes You Buy," on page 574. Our many readers who have requested data on d. c. socket-power devices will find James Millen's article on page 580 exactly what they have long awaited.

PRINTER'S Ink for February 10th shows that RADIO BROADCAST printed in its February number a total of 23,222 lines of advertising, being exceeded only by Radio News with 26,934 lines. The record of other contemporaries for February is as follows: Popular Radio, 18,089; Radio, 16,597.

AT THE last moment, Ross Gunn's article on coils, announced for April, had to be omitted. It will appear in our May issue. Other features which are coming include: A series of new tube articles by Keith Henney, the first of which deals with modern tubes, how they are measured and what the measurements mean; the first article of a series by Roland F. Beers, dealing with the problems of running tube filaments in series; data on a new type of short-wave receiver; a description of a home-made baffle-board loud speaker; instructions on how to electrify your phonograph, and many other important articles from the Laboratory and from the best writers in the radio field.

—WILLIS K. WING.

Doubleday, Page & Co.  
MAGAZINES  
COUNTRY LIFE  
WORLD'S WORK  
GARDEN & HOME BUILDER  
RADIO BROADCAST  
SHORT STORIES  
EDUCATIONAL REVIEW  
LE PETIT JOURNAL  
EL ECO  
FRONTIER STORIES  
WEST

Doubleday, Page & Co.  
BOOK SHOPS  
(Books of all Publishers)  
NEW YORK { LORD & TAYLOR  
PENNSYLVANIA TERMINAL (2 Shops)  
GRAND CENTRAL TERMINAL  
38 WALL ST. and 520 LEXINGTON AVE.  
838 MADISON AVE. and 166 WEST 32ND ST.  
ST. LOUIS: 223 N. 8TH ST. and 4914 MARYLAND AVE.  
KANSAS CITY: 920 GRAND AVE. and 206 W. 47TH ST.  
CLEVELAND: HIGBEE CO.  
SPRINGFIELD, MASS.: MEEKINS, PACKARD & WHEAT

Doubleday, Page & Co.  
OFFICES  
GARDEN CITY, N. Y.  
NEW YORK: 285 MADISON AVE.  
BOSTON: PARK SQUARE BUILDING  
CHICAGO: PEOPLES GAS BUILDING  
SANTA BARBARA, CAL.  
LONDON: WM. HEINEMANN LTD.  
TORONTO: OXFORD UNIVERSITY PRESS

Doubleday, Page & Co.  
OFFICERS  
F. N. DOUBLEDAY, President  
NELSON DOUBLEDAY, Vice-President  
S. A. EVERITT, Vice-President  
RUSSELL DOUBLEDAY, Secretary  
JOHN J. HESSIAN, Treasurer  
L. A. COMSTOCK, Asst. Secretary  
L. J. McNAUGHTON, Asst. Treasurer

DOUBLEDAY, PAGE & COMPANY, Garden City, New York

Copyright, 1927, in the United States, Newfoundland, Great Britain, Canada, and other countries by Doubleday, Page & Company. All rights reserved.  
TERMS: \$4.00 a year; single copies 35 cents.

## BY AIRPLANE OR MULE-BACK

There's a radio station in Honduras, six thousand feet high, upon a mountain top. They use Radiotrons there, high power Radiotrons, for transmission. More than once in an emergency, the Radiotrons have had to be delivered by airplane. Usually they are carried up the rough mountainside by mule-back.

These great Radiotrons cost a few hundred dollars apiece, and as not many "spares" can be kept on hand at that price, each one must perform exactly to standard—each one must be sturdy of build in spite of its delicate accuracy.

The laboratories that design these high power transmission tubes design the Radiotrons you use. The same factories make them. The same test laboratories test them. RCA produces the tubes for all sorts of high power transmission and learns from these tubes many a lesson of making and testing that gives you a better Radiotron for your receiving set! Benefit from this experience by using only genuine RCA Radiotrons, no matter what *type* of tube you use.



RADIO CORPORATION  
OF AMERICA  
New York Chicago  
San Francisco



## Every tube in your set counts!

Every tube in your set has its "finger in the pie." The faint signal that comes in from the broadcasting station goes through each tube, and it's magnified hundreds of thousands of times before it gets to the loudspeaker.

It's not only important to get the "special" Radiotrons that give you bigger distance and bigger volume. But it's just as important to stick to genuine Radiotrons straight through the set, if you want to keep up its performance. RCA research makes Radiotrons better and better every year!

*Bring your storage battery set up-to-date with  
a power RADIOTRON UX-171 or UX-112  
a detector RADIOTRON UX-200-A  
and RADIOTRONS UX-201-A for all-round quality.*

*Bring your dry battery set up-to-date with  
a power RADIOTRON UX-120  
and RADIOTRONS UX-199 for all-round quality.*

# RCA Radiotron

MADE BY THE MAKERS OF THE RADIOLA

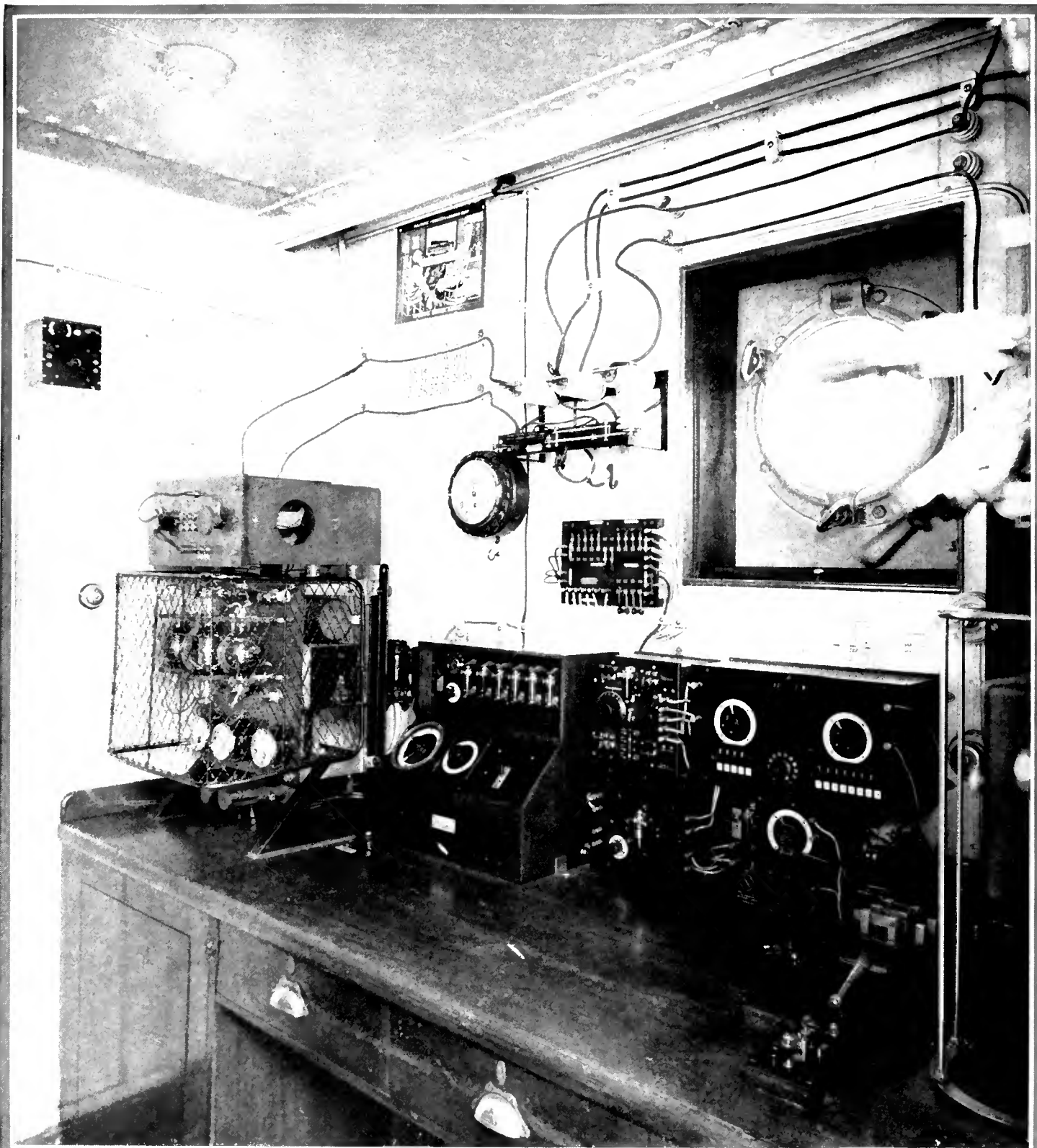

*RADIO APPARATUS ABOARD A TRANSATLANTIC LINER*

*The illustration shows the radio cabin of the SS. "Minnetonka," of the Atlantic Transport Line. At the left is the 750-watt continuous-wave tube transmitter, next is the radio compass, then the main receiver which consists of radio-frequency amplifier, tuner, and local oscillator; to the right is a small emergency transmitter and at the extreme right, not shown in the illustration, is a 500-watt spark transmitter*

# RADIO BROADCAST

VOLUME X



NUMBER 6

APRIL, 1927

## With MacMillan to the Arctic

*Pages from the Diary of the Radio Operator Aboard the Schem of the MacMillan Arctic Expedition—A Triumph for Short Waves*

By AUSTIN C. COOLEY

**M**UCH progress in short-wave radio communication has been due to Commander Donald B. MacMillan who demonstrated from the arctic regions the merits of low-power short-wave equipment before any similar or commercial application of the new science had been made. Every trip this noted explorer makes into the Arctic means added knowledge to the radio art as well as to many other sciences.

The *Bowdoin* and *Schem* were the two schooners to carry the members of the expedition made during the summer of 1926. The former is already famous in connection with the exploration work made under the command of MacMillan, while the *Schem* is a new boat built and fitted especially for the 1926 trip by Commodore Rowe B. Metcalf, a Providence financier. Fitting for the trip included the installation of short-wave radio equipment and the selection of an operator, and Commodore Metcalf put these problems in the hands of RADIO BROADCAST.

As the one chosen for the work, the writer had an interesting time trying to design the radio apparatus to fit the small space allowed by the builder of the vessel. The lack of room on the boat caused many other similar problems, especially in regard to the antenna, so it was necessary to go to the ship and build the radio equipment to fit it. A short-wave receiver for the *Schem* had, however, already been constructed in the Laboratories of RADIO BROADCAST, and a honeycomb-coil receiver by Frank J. Curtin and Wade Marten, students at Columbia University.

Three weeks before sailing date, I arrived at Thomaston, Maine, where the finishing touches were being applied to the *Schem* before leaving the builder's yards. The radio work to be done included the building of the transmitter and a common amplifier for the two receiving sets mentioned above.

In preparing for the trip, there were many diversions from the radio installation work, such as taking a few practical lessons in handling the ship at sea, and working on air compressors for starting the engine. I readily found that handling the sails in a stiff breeze was no ladies' job, especially at a time when we were running on a skeleton crew while the ship was run from Thomaston to Rockland, Maine, for a general cleaning up of the hull.

From Rockland we went to Wiscasset, Maine, where we loaded stores and became acquainted with our shipmates, who kept arriving daily until the full crew of fourteen had reported. Included in the fourteen were three women, Mrs. Rowe B. Metcalf and

two friends, the Misses Maude B. Fisher and Marion Smith. Dr. J. H. C. Martens, geologist, occupied one of the bunks in the forecastle and Novio Bertrand, taxidermist, occupied the bunk below his. Bertrand's was a very unhealthy place because Martens generally had his bunk loaded with rocks to the capacity limit. I had batteries stowed under my mattress, but it was a lower bunk so no one was endangered.

The cabin boy, Henry Sewall, occupied the bunk above mine and the remaining two in the forecastle were selected by Robert Mazet, Jr., the ship's doctor, and Peter Surett, the cook, who had served many years at sea in Gloucester and Nova Scotia fishing schooners. Commodore Metcalf was anxious to get a cook who would not get seasick. Peter had the credentials, for he claimed he had wrung more salt water out of his whiskers than most of us had sailed in!

Just aft of the forecastle is the galley, an unusually large one with a spacious pantry and ice box. Further aft is the saloon, and

then a bath room and two state rooms, one occupied by the Commodore and the other by the three ladies. A water-tight bulkhead separates these rooms from the engine room. A seventy-five horse power, six-cylinder Cummins Diesel engine supplied the driving power and two generators driven by gas engines supply the electrical power for charging a 32-volt bank of batteries. Each generator has a  $2\frac{1}{2}$ -kw. capacity.

Aft of the engine room were quarters to accommodate the remaining four in the crew: Paul B. Warren, Mate; Chas. C. Sewall, Botanist; Egbert Sewall, Chief Engineer; and Captain John



A NATIVE OF THE GREENLAND COAST

One ninth of a native, we should say, for it is well known that eight ninths of an iceberg do not show above the water. This particular one was photographed by the MacMillan Expedition at Godhaven, Disko Island

T. Crowell, of Gloucester, Massachusetts, who proved to be an excellent skipper.

When the radio installation neared completion, tests were carried out daily with radio 2 GY, operated by RADIO BROADCAST Laboratory in Garden City, Long Island. As soon as these tests were begun, a detailed log was kept of all transmission and reception work. In reviewing this log the following entry appears very conspicuously: "G. E. meter resistor, used as grid leak, opens as plate voltage is increased (to 2200 volts)." The entry was made, shortly after the fireworks and smoke cleared up, by "Dynamite", or, G. V. Dillenback, Jr., a friend who had gone through much similar grief with me at radio station 1 XM at the Massachusetts Institute of Technology. We managed to improvise another grid leak for the transmitter after considerable delay and re-established connections with 2 GY.

Grid leak trouble seemed quite important at the time because of the difficulty in obtaining suitable units in New York or Boston. The entry about the grid leak blowing up was made only three days before the sailing date, June 19th.

It was necessary for me to go to Boston and New York before sailing with the expedition, and while I made this trip, "Dynamite" stayed with the ship to clean things up for sailing and do some work tuning up a Conrad antenna (sometimes known as a "Hertz" or a "tuned loop" antenna) which we were experimenting with.

I missed what I imagined to be the best part of the trip—the beginning. At the time of sailing, I was in New York, and could not get away for two days. According to schedule, I was to take the Bar Harbor

Express Monday night, June 21st, and join the expedition at Bar Harbor, Maine.

The Bar Harbor Express does not go quite all the way to Bar Harbor. The trip has to be completed by steamer. There was a strong wind and a moderate sea running Tuesday afternoon when I made this part of the trip. In the distance I could see, from the steamer, what appeared to be two small sailing boats. I could not conceive of any reason for boats of their size being out in such rough weather. As the steamer neared Bar Harbor I could see these two boats coming to anchor in the Harbor. They were the schooners *Bowdoin* and *Sachem*!

"Dynamite's" report on the first leg of the voyage did not seem encouraging. The interference noises on short waves appeared to be very bad when the engines were running, and he found it difficult to work 2 GY while the ship was under way. The movement of any piece of metal on board seemed to cause static on forty meters.

From Bar Harbor to the Arctic and back

again, I had to do the worrying about the static alone, for "Dynamite" left the ship and returned to his home in Albany.

#### THE FIRST THREE DAYS AT SEA

THE next port of call was to be Yarmouth, Nova Scotia. The weather for the first twelve hours out of Bar Harbor was fine—the kind that is too good to last. Before turning to go into Yarmouth, Commander MacMillan radioed the following instructions to us: "Weather so good and night so perfect I think we had better round Cape Sable and go down coast instead of going into Yarmouth. If we become separated. . ."

We rounded Cape Sable, we became separated, and the weather was not so perfect. A moderate sea came up and a thick fog set in. The sea kept getting rougher and the fog thicker. Frequently fishing schooners loomed up through the fog only a short distance away. At times the fog was so thick we could hardly see a hundred feet. We were headed for Sydney, right up at the farthest end of Nova Scotia.

At times we ran as close to shore as we dared so that we could pick up the buoys and fog horns but their significance was none too definite until we obtained the navigating data from the *Bowdoin*. Paul J. McGee, the radio operator on the *Bowdoin*, frequently had to look up these data himself for us because Commander MacMillan and the mate, Ralph P. Robinson, were more than busy handling the ship with an inexperienced crew on watch.

One time, just as I was signing off with WNP, the *Bowdoin*, I heard an unusual commotion on our deck and a general ringing of engine room signals. I went on deck

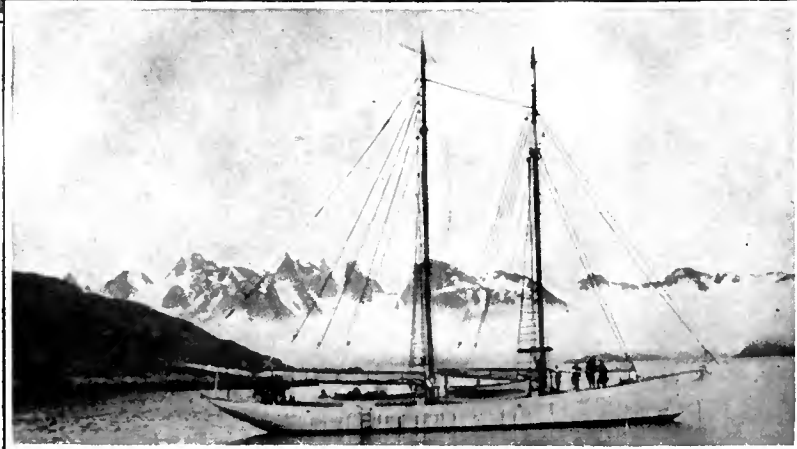
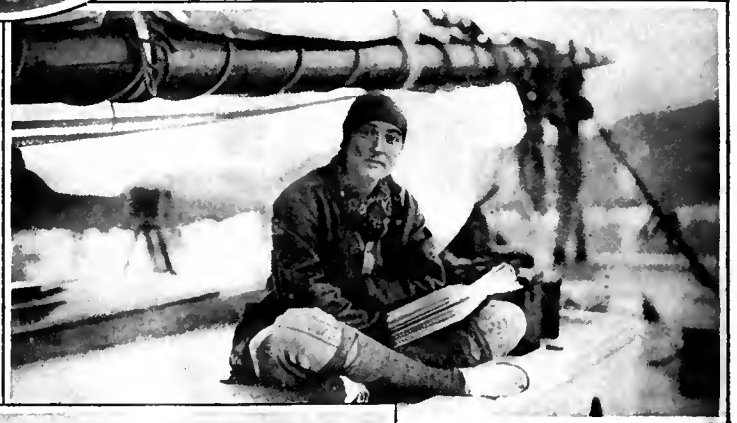

Circle: Commodore Metcalf despite the fact that he was a long way from home at the time of this pose, finds time to indulge in a genial smile. Above, left: One of the most beautiful sights of the trip was supplied by the almost endless panorama of scintillating floes seen at various intervals of the trip

Above, right: Mrs. Metcalf, too, was on the trip—was one of the several women who forsook southern climes in the hope, we suggest, of picking her own sealskin for use in the winter months. Left: This minute craft, not a sister ship to the *Leviathan*, is the *Bowdoin*, anchored near Sukkertoppen. She is a seventy-five tonner

to help with the sails and to satisfy my curiosity. I found that we had almost run on to some rocks. It required a little fast work to keep the ship clear. One of the girls appeared on deck to find out what all the noise was about. "Get those damned women below!" was the order immediately issued by Commodore Metcalf.

Running the radio was not much easier than running the ship. The fog and sea water on the rigging set up a small amount of electrolysis that sounded like a thunderstorm in the receivers. The sails were slapping against the antenna, and the ship was rolling badly, so my signals stood little chance of getting through without swinging. The signals from WNP had a bad swing too, so we even had difficulty working the short distance between us. After the first day of this run I was unable to handle traffic with 2 GY on account of the heavy roar in the receivers. At 2 GY, reports show that our signals could be heard but the swinging was so great that ours were difficult to copy.

Many of our messages to the *Bowdoin* contained information to the effect that we had no charts, that we ran close to the buoy over certain rocks, etc. The operators at 2 GY in Garden City were trying to copy everything but were only able to get occasional words and fragments of sentences. It so happened that what they received tended to indicate we were in danger and had run on to rocks in the thick fog. This naturally caused them considerable anxiety.

After three days of this kind of traveling, we arrived at Sydney. The trip was uncomfortable because of the cold and dampness due to fog, but the ship rode the seas nicely and took very little sea water on deck. Much to my surprise, the motion of the ship in moderate seas did not seem as bad as on a large vessel. There were a few mild cases of seasickness aboard the two boats but nearly everyone was able to stand his watches. I felt rather miserable most of the time and was a little ashamed to admit it because all on the *Sachem* who had not been to sea before failed to get the least bit sick.

The trip north to Battle Harbor, Labrador, was more comfortable and quite enjoyable. On the way up we stopped at Curling, Newfoundland, for a day. We remember this place because we all tried to figure out how the clocks should be set to conform with Newfoundland time. It is known as "John Anderson" time, and is described by Austin H. MacCormick, who made the trip with us to that point, as "sort of a double distilled daylight saving time."

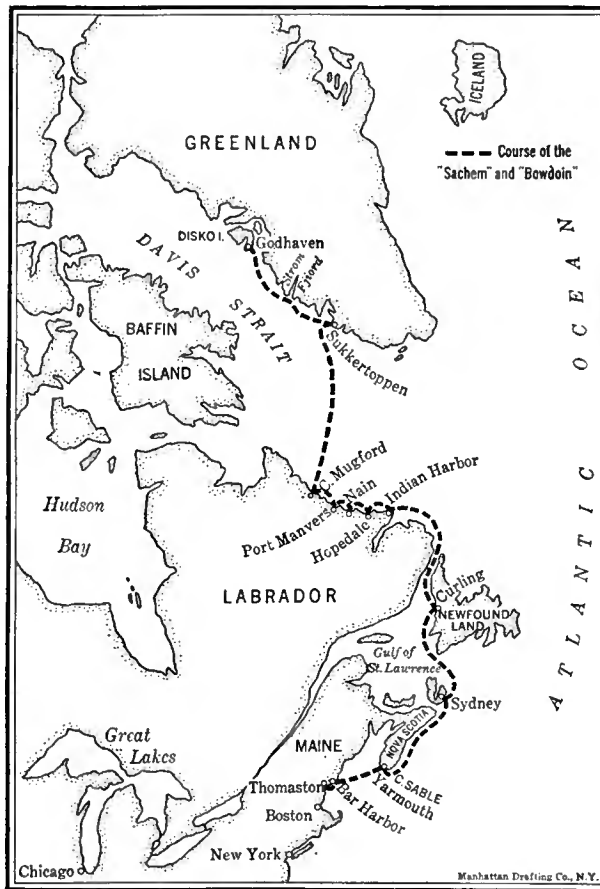

FROM MAINE TO GREENLAND  
The route of the two schooners, *Sachem* and *Bowdoin*, is traced on this map

We passed through fields of large icebergs during the twelve hours preceding our arrival at Battle Harbor on July 3rd. The entrance to the harbor was blocked in places with large 'bergs that had grounded. The weather was clear but cold. Our first glimpse of Labrador was a dismal sight—nothing but hills of solid rock with no trees or shrubbery.

A FEW DETAILS ABOUT THE RADIO

RADIO communication north of Sydney was easier because the rigging was dryer and the ship steadier. At Battle Harbor I made some modifications in the transmitter which helped to steady the wave and improve the signal strength.

At another stop on the Labrador coast—



THREE MODERN MUSKETEERS

A "snap" taken in the North. From left to right we have: Egbert Sewall, engineer; Commodore Metcalf; and Austin Cooley, radio operator, assistant to the engineer, camera man, night watchman, etc.

Indian Harbor—I had time to do considerable experimental work as we were ice-bound there for a week. A slight change in the receiver reduced the ratio of ship static to signal strength to such an extent that I was never seriously bothered again during the trip. The connecting together of many of the cables in the rigging and grounding them also helped considerably in reducing the leaks and electrolysis that had been so bothersome.

Difficulties of a swinging wave were fully anticipated before leaving Maine, so plans were made for a crystal control system. A very good crystal had been presented for the work by Mr. H. S. Shaw, of the General Radio Company. This crystal was ground to oscillate at 1359 kc. (220 meters). To operate on 8154 kc. (36.8 meters), it was necessary to multiply the frequency six times. The plans were to amplify the third harmonic of the crystal then double the frequency in the 250-watt power amplifier.

With only two stages of amplification between the crystal and the 250-watt tube, I was not able to obtain sufficient power to properly control the last stage of amplification. Much time was spent during the entire trip trying to get this working properly but sufficient equipment and space were not available for an additional stage of amplification, which probably would have remedied the matter.

The space available between the two masts for the Conrad antenna was so limited that it was necessary to use considerable loading inductance to bring the natural period of this antenna up to 8154 kc. (36.8 meters). When using only 600 volts on the plate of the 250-watt oscillator tube instead of the rated 2000, it was possible to obtain a current of 2.5 amperes in the Conrad antenna. Every time the plate voltage was increased, the transmitter cabinet resembled a Fourth of July celebration. After considerable effort to operate this antenna properly with full power I compromised by tuning the antenna a little below the 36.8-meter point, and used its feeder as an antenna also. The results were quite satisfactory. This was done to avoid the risk of causing damage to some of the transmitting apparatus.

Regular communication with 2 GY was being maintained on a schedule of three nights a week. Generally we were so close to the *Bowdoin* that it was difficult for one to receive while the other was sending so we divided up the available time for communicating with the States in a way that was proportional to the amount and importance of messages to be handled.

We had no restrictions on the hours of operation during the day so there was an opportunity to carry on some tests with 2 GY on 13,630 kc. (22 meters). While we were on the Labrador Coast, the 22-meter signals could be heard at 2 GY during the day but they were too weak to be used in the handling of messages.

#### WE CONTINUE OUR TRIP UP THE LABRADOR COAST

AFTER an impatient wait at Indian Harbor, we pounded and cut our way through the heaviest ice pack on the Labrador Coast that Commander MacMillan had ever seen. We made a short stop at Hopedale, the most southern Moravian Mission Station, then went on to Jack Lane's Bay to pick up Abe Bromfield, MacMillan's Eskimo interpreter. Plans were to proceed from there across Davis Straits to Greenland but the ice pack off shore appeared so solid that the Commander decided to take us further up along the Labrador Coast through an inside passage hoping we might work to the north of the pack that had been rapidly moving to the southward.

We made two other stops on the Labrador Coast, one at Nain, a Moravian Mission station, and one at Port Manvers where Commander MacMillan and a party made an inspection of some ruins of stone constructed dwellings thought to have been built by Norsemen. From Port Manvers we worked our way up the coast to Cape Mugford, the highest peak on the Labrador Coast, then turned out through the heavy ice fields toward Greenland.

A view from the cross trees of the masts as we sailed through this field of ice offered a sensation impressive enough to appear as one of the outstanding features of the trip. I borrowed Commodore Metcalf's Graflex and took a "shot" from the cross-tree of the mainmast. This was my first attempt at operating a Graflex. As a result, the Commodore assigned me the responsibility of using his Graflex and two movie cameras the rest of the trip. I had practically no experience in the art of photography, so he expected the results that most beginners produce.

In addition to being radio operator and photographer, I was supposed to be Assistant Engineer, but the Chief Engineer was such a hound for work he required very little assistance. On the run between Bar Harbor and Sydney, I stood a couple of watches in the engine room, and I squirted a little oil around the engines on the run to Greenland.

#### OUR ARRIVAL AT GREENLAND

THE trip across to Greenland represented three days of ordinary sea travel. The seas were moderate most of the time and generally there was some fog. This caused us to become separated from the *Bowdoin* after the first day out from the Labrador Coast. After we left the Coast, we encountered no more ice until we came within a hundred miles or so of Greenland.

As we approached the Greenland Coast, a thick fog was encountered.

At twenty minutes after noon, land loomed up off the starboard bow only a few hundred feet away. From here we cautiously sailed south, keeping in sight of land so that we might pick up the beacons marking the entrance to Sukkertoppen. Our chart consisted of a pencil sketch with no scale of miles. After only a short run of twelve miles, we were welcomed by a fleet of kyaks manned by Eskimos who came out to meet us and point out the channel into the harbor.

Commander MacMillan took the *Bowdoin* to the south of Sukkertoppen then anchored and waited a day for the fog to lift so that he could determine his position and then proceed into Sukkertoppen without taking the risk of running through unknown waters full of dangerous rocks and ledges.

The absence of the *Bowdoin* in the Sukkertoppen Harbor the first night of our arrival gave me an opportunity to operate the radio during the entire night and test it out for distance. The evening started off pleasantly by hooking up with 1 AKZ (A. Hurnan, Gardner, Massachusetts). He showed signs of being an excellent operator in the way he took a large file of messages in a very short time. Station 1 AKZ proved to be a very valuable relay station a number of times after that. Before giving the crew of the *Sachem* a rest from the intermittent wail of the radio generator, I worked 9 DMZ (Kansas City, Kansas), 9 A EK (Topeka, Kansas), and 6 VR (San Francisco, California).

In reply to a call from VOQ, the schooner *Morrissey* of the Putnam Expedition, on July 26th, I received the following: "Aground Northumberland Island, Whale Sound, Greenland. If possible tell 2 UO (New York Times Station) or any U. S. station please listen for low-power set." After additional conversation with VOQ, I sent out a QST notifying the Amateur Radio Relay League Stations of VOQ's situation.

Because our wavelength was below the amateur band I had some difficulty in raising anyone in the States who could take a message for the New York Times. Shortly after three A. M., 3 20 (H. A. Beale, Jr., Parkesburg, Pennsylvania) answered my call. It was not long before the signals faded out so we were no longer able to communicate but we were fortunate in getting through the essential news of the condition of the Schooner *Morrissey* and its crew before the fading set in.

Our trip north from Sukkertoppen included a long run into Strom Fjord, which crosses the Arctic Circle. Just as we were approaching this invisible line, the *Bowdoin* went hard aground while running at full speed. A strong wind was blowing down between the mountains that bordered the Fjord so it was difficult to handle the *Sachem* and get a line to the *Bowdoin*. After considerable effort and fast work this was accomplished but, before we could clear the *Bowdoin*, we also went hard aground

on the Arctic Circle. To be a little more exact, we were about three thousand feet from the Arctic Circle. For a while it did not look like a very pleasant situation but after a good struggle both the *Bowdoin* and *Sachem* managed to get clear, and that night we learned that the *Morrissey* had also floated herself off the rocks. In trying to clear ourselves, the great power from the engine was more than the reverse gear could stand, and it gave way.

Resting at anchor almost on the Arctic Circle, and locked in by high mountains except for a narrow opening in the Fjord, we had a very successful night with the radio. The signals were received in the New England States with considerable strength although they were weak in the New York district. The signals from the 50-watt transmitter of 2 GY, at Garden City, came through well enough so that I was able to copy six messages in a row without missing a word.

Our most northern stop was at Godhaven, on the Island of Disko. It was a real surprise to find here an excellent modern radio installation that consisted of a thousand-watt tube transmitter for long waves. The equipment was built up and installed in as neat a manner as will be found in any American broadcast station. Direct communication with Denmark is accomplished daily by this station as well as is contact with a series of other stations in Greenland.

Godhaven has another institution of modern science. It has a terrestrial magnetic observatory operated by the Danish Government. I had the pleasure of a long conversation with Mr. Olsen, who is in charge of the work, and was given the opportunity of helping him in a way by letting him have a few of my spare Ray-O-Vac batteries.

The difficulty of getting signals through to the New York district kept increasing, so a regular schedule with one of the most reliable stations in New England was established. This station was 1 AAY, owned and operated by Kenneth M. Gold, at Holyoke, Massachusetts. The *Bowdoin*, WNP, was using 1 ZK, M. L. MacAdam, at Wollaston, Massachusetts, as a regular relay station although 1 AAY also handled a good portion of WNP's traffic, especially during the first part of the trip. Stations 1 ZK and 1 FL, D. G. Meserve, Hudson, Massachusetts, also handled a number of the messages from KGBB, the *Sachem*.

Press was received regularly from the New York Times Station, 2 UO. His signals came through strong and steady regardless of heavy seas and ship static, and I always found it easy to copy him on my Corona, which had been fitted up with a telegrapher's keyboard.

Our trip home was found to be as much or even more interesting than the outward trip. An account of it, including information on some important observations made of radio phenomena during magnetic storms, will appear in a later issue of RADIO BROADCAST.

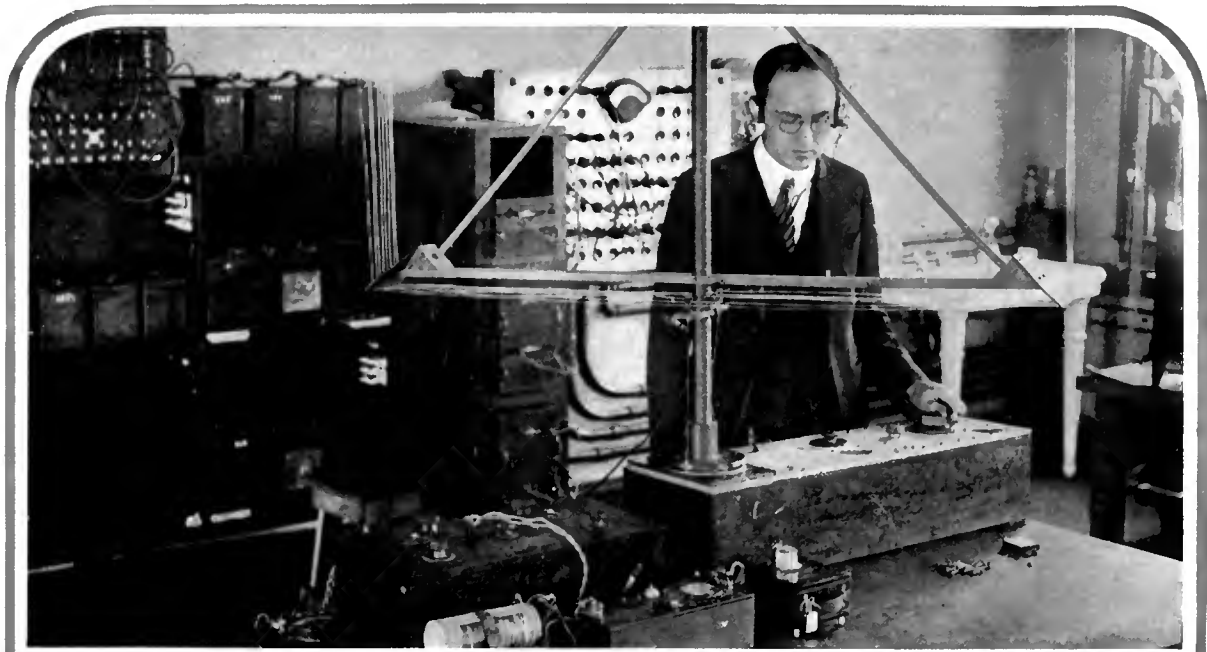

# THE MARCH OF RADIO

*News and Interpretation of Current Radio Events*

## Welcome to the Radio Commission

**A**ROUSING welcome to the new Radio Commission is in order. Although, at this writing, the radio law is not yet passed, we have such definite and reassuring information that the compromise bill will become the law of the land that we do not hesitate to give three cheers of encouragement to speed the Commission to its arduous labors.

The Radio Commission will have full power for one year, during which time it is supposed to undo the present broadcasting knot and to formulate rules and regulations to guide the Department of Commerce's administration of radio matters. At the end of the year, the Commission becomes an appellate body, reviewing the decisions of the Department of Commerce and hearing the appeals of irate broadcasters. The law is, as we predicted, a political compromise between the administration and the opposition radio bills.

Congress having thus, in effect, delegated its legislative powers to a committee of five men, much depends upon their individual and collective qualifications. Indeed, being guided by no principles established in the law, these five men have it in their

power to make or break radio. The entire industry and, more important, broadcast listeners, should rally to their aid.

To solve broadcasting problems effectively, requires more than an ardent spirit of public service and an enthusiastic interest in broadcasting. These qualifications can be easily assumed by any politician out of a job. In addition, every member of the Commission must be sufficiently expert in radio matters to understand the basic principles of frequency allocation and the selectivity limitations of receiving sets. Each must think clearly in terms of "frequency channels," "kilocycles," "service areas," "heterodyning" and "carrier range." Each must forget the misleading term "wavelength" and all the distortion of the situation which its use brings.

The first task of the Commission will be a comprehensive study of the existing situation. How rapidly it will be able to dispose of such dangerous propositions as the pressure to extend the broadcast band downward, brought by short-sighted would-be broadcasters and selfish set manufacturers, seeking to create an artificial market for short-wave receivers; the fatuous claims of the more recently licensed stations to a place in the ether; and the uneconomic proposals to split time on the air rather than eliminate excess stations

wholesale, depends on the background of knowledge and experience which the individual members have in broadcasting matters.

### Deliver Us from Excess Broadcasting Stations

**T**HE principle must be recognized that the fewer broadcasting stations there are on the air, the more stations the listener can enjoy. Freedom of the air does not require that everyone who wishes to impress himself on the radio audience need have his private microphone to do so. Indeed he would be much better served, if he is now operating his own station for that purpose, to combine it with four or five others in order to form a really important unit in the broadcasting system. The leadership in combining stations is a negotiation which is best undertaken by the radio manufacturing industry rather than a political commission. In consolidation of stations lies the only salvation of broadcasting.

We now have about one hundred, high-grade, key stations, which are rendering excellent service and are recognized as favorites by broadcast listeners. We have five hundred additional stations vainly struggling for the position of key stations but, because of their excessive numbers and

The illustration forming the heading this month shows apparatus used at the Bureau of Standards, at Washington, to determine the distance over which radio receivers may be expected to give service under all kinds of conditions  
© Harris & Ewing



congestion, unable to make any material progress in that direction. If each five of these combined to form a single station, it would reduce the number of stations to the point giving the listener the best possible service. Not only would consolidation increase potential audiences of remaining stations fivefold, but actually tenfold, because the elimination of congestion would considerably increase their service ranges. The individual share of maintenance cost of each station sponsor would be reduced by eighty per cent. by combination with four others, thus enabling him to employ talent rivalling the best of stations. Instead of owning a joke of a station of his own, a station sponsor would have an interest in a real, high-power, broadcasting station, with a substantial audience. Under these conditions, the monopoly of good broadcasting now held by the chain system would at last be faced with real and sorely needed competition.

Consolidation and bigger investment in station facilities, however, cannot be hoped for until the individual broadcasting organization is protected in its ether franchise. When the Government faces the problem of dispensing privileges, such as public lands, railway franchises, or ether channels, which can be accorded only to a limited number, private capital is offered it in return for accepting the obligation to perform a public service of a definite standard. In return for the investment, the holders of such franchises are protected from destructive competition. Broadcasting station investments deserve the same protection. If it is not accorded to them, then the risk of capital expenditure in broadcasting becomes too great and the progress of the art is consequently hampered by hesitancy of capital.

Before consideration can be given to the rights of individual stations, the principle of length of service on the wavelength now being used by a station should be established as the basis for determining the claims of rival stations to the same frequency. Station KOKA, for example, has broadcast for about six years on its present wavelength. Had it been one of those stations which upset conditions by shifting their wavelengths upward three or four months ago, its priority to its present wavelength would

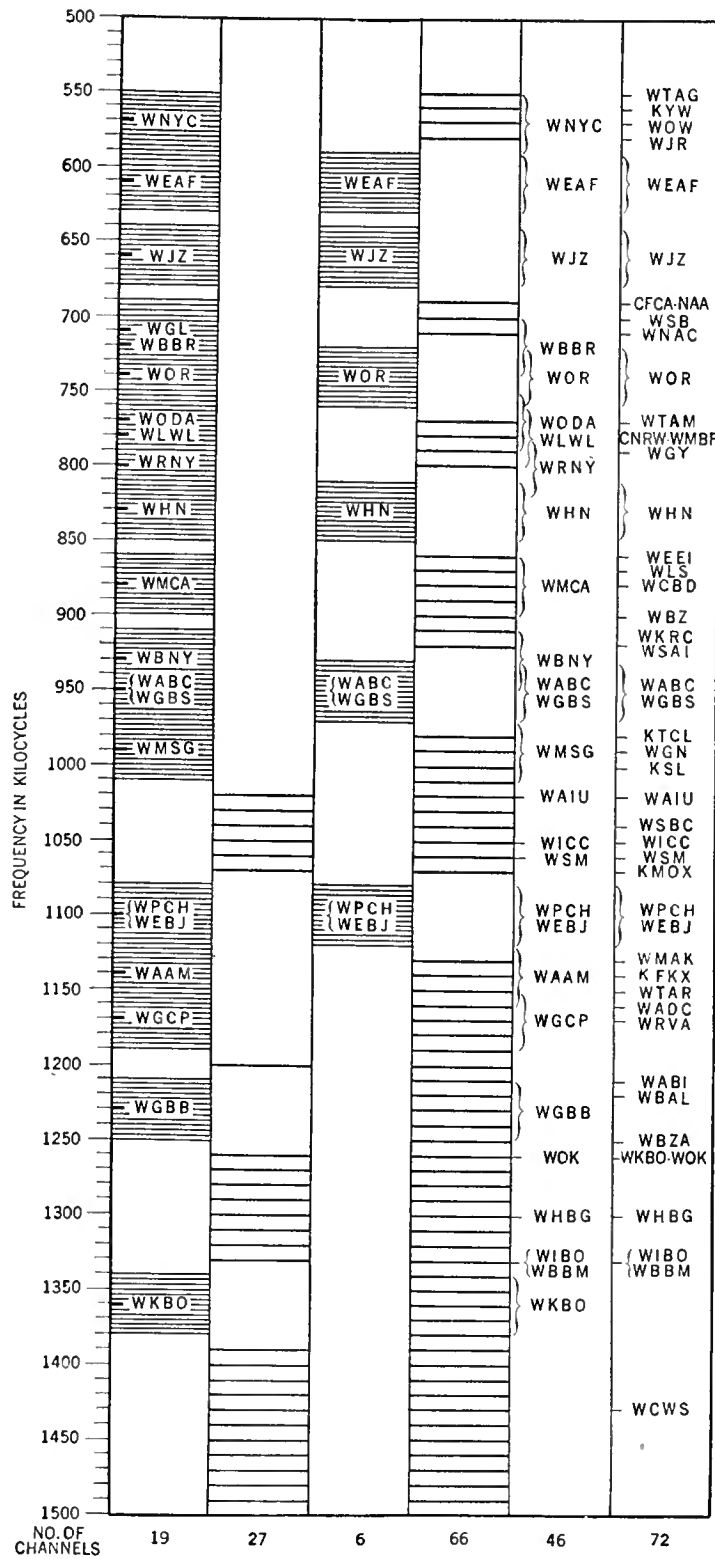

THE EFFECT OF REDUCING NEW YORK LOCAL STATIONS

Reception in the New York City district would be greatly improved by the consolidation into six main stations of the many broadcasters now licensed to operate in that area. This chart, prepared by Edgar Felix, gives a visual indication of the result of such a consolidation. In column No. 1 are listed the more important of the forty odd local stations which may be heard with an average four-or five-tube receiver. Column No. 2 indicates just what outside channels may now be tuned-in through the locals, the assumption being that a local station blankets out stations on two bands above and below its allotted frequency. Column No. 3 shows the proposed consolidated stations, no attempt being made to re-space them equally in the frequency spectrum made available by the discontinuance of the many lesser stations. Column No. 4 shows that the number of outside channels made free by cutting down the locals has been more than doubled. The fifth column is a typical log made in the early evening when all of the locals are on the air, while column No. 6 is an imaginary yet conservative log supposing the suggested consolidation to have gone into effect. An expensive, highly selective receiver is now capable of tuning-in more outside stations than are shown in columns No. 2 and 5, probably to the extent of a dozen or so.

then be, by all sound reasoning, only on the basis of three months of service.

Wavelength jumpers, who abused the broadcasting privilege, should not receive the same consideration as those who rendered faithful and orderly service on their assigned wavelength throughout the broadcasting dark ages, the only course which decency and honor dictated. Stations which pilfered Canadian wavelengths should be forever banned from the ether.

A list of all stations now operating, and their present wavelengths, arranged in the order of date on which these wavelengths were adopted, should be prepared for the Radio Commission. The first hundred stations are the pioneers who advanced broadcasting to its present high standing and they should be given permanent licenses with a minimum of delay.

Naturally, acceptance of the principle of priority will bring loud howls of protest on the part of those who discovered broadcasting in 1926 and invested a few thousand dollars in the face of repeated public warnings that there was no room for them in the ether. Unfortunately, some of these persons have considerable political influence and, by taking advantage of the facilities of the gullible press, they can make loud shouts about discrimination in favor of the interests of huge monopolies. The smallest of these protesting broadcasters has interests just as selfish as those of the most hardened trust. He has some product, carburetors, cartridges, or calliopes, to thrust on the public, which could be exploited more efficiently through a good and established broadcasting station. The duplication of broadcasting facilities is not a public benefit and should not be tolerated to accommodate lusty-lunged publicity seekers who have made no contribution to the advancement of the broadcasting art.

The foundation of the Commission's work should be a basis of frequency allocation which permits every station to be heard without interference to the limit of its service range. Such a basis means that a maximum number of stations can be heard by every receiving set, and this entails reducing the present number of stations by about four hundred.

Whether the Commission will

have the courage, foresight, and backing of the radio public and the radio industry to bring about such a healthy weeding out of stations is doubtful. If the radio industry, however, is to grow to its fullest strength, wholesale station reduction is absolutely necessary. Although the average cost of a radio set is under \$150, there are only one third as many sets in operation as there are pleasure automobiles. The radio industry has sold to only a fourth of its potential customers. The only reason the radio market has not come to its own is because of lamentable broadcasting conditions. The industry could well afford to establish a fund of several million dollars to negotiate and encourage the consolidation of stations; It would be promptly repaid by vastly increased sales.

We offer our concrete suggestions as to how curtailment and consolidation of stations could be worked out—in the New York area, for example. The accompanying chart is calibrated in ten-kilocycle frequency channels. The first column shows a typical list of some of the stations now licensed and in operation within twenty-five miles of New York and which may be received with an average set—and the frequency band which they occupy; the second, the number of out-of-town channels which can now be tuned-in by an average five-tube receiver; the third, the maximum number of stations which should be established in the New York area by combination of three or four existing stations if the rest of the country is to have an adequate number of channels and New York itself interference-free reception; the fourth, the greatly increased number of out-of-town channels which can be tuned-in under the proposed allocation plan; the fifth, the stations now heard with an average receiver operated near New York; and the sixth, some of the stations within reach of New York, which, under good conditions, could be tuned-in by a good five-tube receiver.

A local station usually excludes out-of-town stations on each of the two channels above and below its own frequency as well as those on its assigned channel. A station more than fifty miles away rarely, if ever, covers more than its ten-kilocycle channel, however. Every local station eliminated, therefore, means perhaps five additional stations for the broadcast listener. The chart shows that consolidating the New York stations to six, will, under good conditions, make available sixty-six out-of-town channels through local broadcasting, instead of twenty-seven.

It is not possible to list in the first column every one of the local stations which are heard under all and sundry conditions, but the list, as presented, serves to show the contrast between the present system and that suggested here.

Station WNYC should be discontinued because its program standards are hopelessly below par and will remain so unless the city appropriates a million dollars a year for talent. The station, furthermore, is not being used entirely for broadcasting



FRANK A. ARNOLD

Mr. Arnold recently joined the National Broadcasting Company as director of development. For the past nine years he has been an officer in the Frank Seaman advertising agency. His work in the N. B. C. will present an interesting opportunity to combine his experience with visual mediums with radio—the aural medium

purposes; its point-to-point communication for broadcasting police alarms is misuse of the broadcasting band.

Stations WEAJ and WJZ are the acknowledged leaders in the New York area and both deserve a place in the ultimate line-up of stations. The character of programs of WEAJ and WJZ should, however, be more consistently planned to appeal to different audiences. Two similar programs should not be broadcast at the same time by these two or any other two stations in the same area. If extensive curtailment of stations along the lines suggested herein is carried out, every station in a given area should be compelled to formulate a policy appealing to the taste of a special audience.

Newark's WOR has endeared itself to a large audience, but it should be the only New Jersey representative in the metro-

politan area. It should absorb WNJ, WAAM, WKBO, and WODA, etc., now contributing nothing but congestion to the situation. Each of these stations is struggling under the handicap of interference and lack of prestige. Their absorption by WOR would be most desirable from every standpoint, including that of the persons now paying the bills for their maintenance.

Stations WABC and WGBS now share the same channel and might profitably be combined in a single station. Broadcaster WBJ, or one of the others in that frequency region, could readily assimilate WPCH, WQAO, WMSG, and WBNY, in the hope of making one strong station out of the present conglomeration of radio noise which they now thrust into the ether. Or still better, the whole group might better combine forces with WABC and WGBS so that only five major stations of ample resources would be serving the New York area.

Likewise the many other smaller stations in the New York area. By consolidation with one of the six they would reach a potential audience of undreamed of proportions compared with the paltry few who now, by virtue of the fact that they reside under the shadow of the individual stations' antennas, are forced to listen to so much—well, blather.

There would be no difficulty in securing adequate revenue from commercial broadcasting to make each of these consolidated groups a tip top station. Broadcasting in New York would be so attractive under these improved conditions that the radio audience would double in a year.

### Punishment for the Defenseless Ether

**B**ETWEEN July 1, 1926, and January 15, 1927, 181 new broadcasting stations have been placed in operation, 148 additional stations were under



© Harris & Ewing

#### TESTING AT THE BUREAU OF STANDARDS

The investigator shown in the illustration is making tests to determine the faults in radio battery jars, by means of polarized light. Part of the equipment employed is shown

construction, 280 have announced plans for building stations, 150 increased power, 70 announced plans to increase power, and 104 old stations changed their wavelengths. Only those of the 150 who increased power without changing wavelengths have any real priority rights to their channels.

### The Network System Grows

**P**RESIDENT COOLIDGE'S Washington Birthday speech was well broadcast by thirty-eight stations, including six in New England, eight in the north Atlantic states, one in the south Atlantic, twelve in the central west, three in the south central states, one in the west and seven on the Pacific coast. Three southern stations, WSM, Nashville, WSB, Atlanta, and WHAS, Louisville, have been added to the "blue network," bringing wire programs to a large area heretofore relying on local talent.

On the Pacific Coast, a chain, including KGA, Spokane, KJR, and KEX, Seattle, KYA, San Francisco, and a new station in Los Angeles, is to be placed in operation in the near future. This chain hopes to establish relations with the National Broadcasting chain, although it is unlikely that commercial broadcasters will find it profitable to radiate their programs on a national scale because of the time difference.

Upon the heels of that announcement comes word of the formation of an N. B. C. chain on the coast, including KPO, San Francisco; KGO, Oakland; KFI, Los Angeles; KFOA and KOMO, Seattle; KGW, Portland; and KHQ, Spokane. Perhaps we shall see two rival chains fighting for program superiority. It is unfortunate that there is no such competition in the east, but so long as congestion remains in its present state, that situation is inevitable.

### Well Administered Canadian Radio

**O**UR northern neighbors have succeeded in managing their radio affairs with a competence which is a marked contrast to our own methods. Unfortunately, American wavelength pirates have destroyed the interference-free reception conditions which prevailed in Canada prior to the loss of the WJAZ case in Chicago. The Radio Branch of the Department of Marine and Fisheries provides at

cost, equipment to suppress radiation from electrical apparatus which interferes with broadcast reception. It aids interested persons to locate the sources of interference and advises how to remedy them. The interference suppression service of the Canadian Government is the only one like it in the world and is a remarkable evidence of helpful government cooperation. A total of 134,486 broadcasting receiving stations are licensed at an annual fee of one dollar, this providing the principal revenue for radio regulation. At the time of writing 22,831 bearings have been furnished by radio beacon stations and the average number per month is continually increasing and is now at about 1900 per month. One hundred and forty-five ships, plying from Canadian ports, are equipped with direction finders.

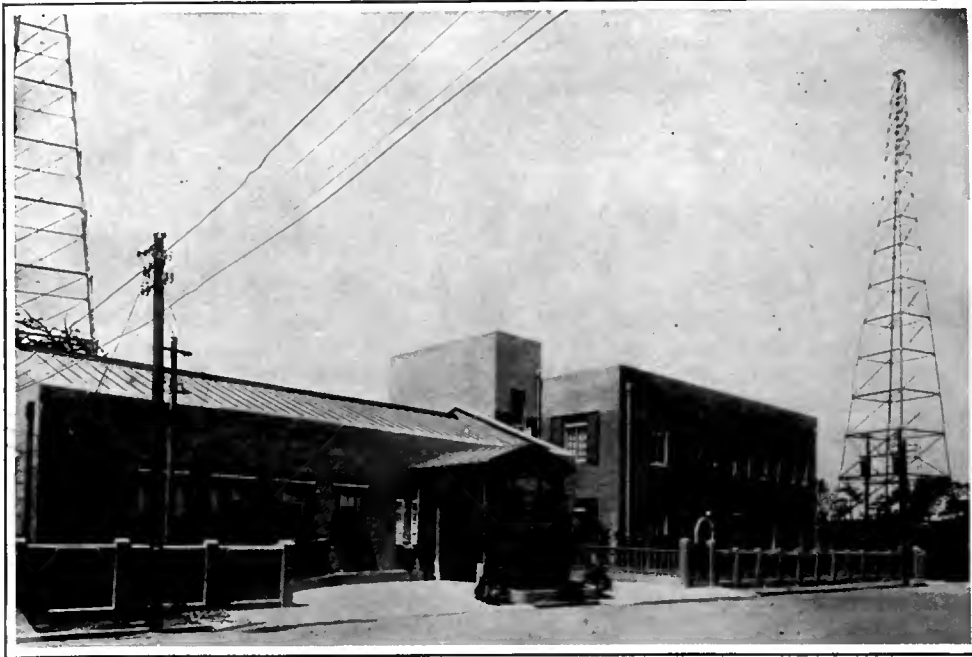

THE EXTERIOR OF A JAPANESE BROADCASTING STATION  
Station jock at Nagoya, Japan. The apparatus is of English manufacture, and six kw. is the power input. The station operates on 832.8 kc. (360 meters)

### The Lethargic Radio Industry

**R**ADIO RETAILING states that 1,750,000 sets were sold during the last season, as compared with two million the year before, a decrease of twelve and a half per cent. The average price, however, has risen from \$83 to \$115 so that gross sales for the year will be larger than last year. Considering, however, that the radio market is only twenty-five per cent. sold and that this year's ether conditions were twice as good as last year's, two and a half million sets should have been distributed this season. The industry's apathy about the broadcasting situation has cost it a pretty penny.

### Conflicting Radio Standards

**T**HE Radio Manufacturers' Association announces that tentative or permanent standards have been adopted by it on fifteen items, including

filament rheostats, sockets, panels, and other small parts. Both the set constructor and the manufacturer will profit by standardized mountings and wiring color codes. It is very unfortunate however, that two competing trade associations are establishing standards and indulging in a stupid war upon each other, thus defeating the usefulness of the work of each of them. This is another demonstration of the radio industry's deplorable lack of foresight.

### The Weak Radio Listener "Organization"

**W**E ARE in receipt of data from the Iowa Radio Listeners' League and several petitions circulated by listeners in various cities of the central west, indicating several attempts at listener organization. The broadcasting situation could be immeasurably helped if listeners themselves raised their voices with a little vigor now and then. Although there have been a few petitions, some of them supporting dangerous proposals, there is not a single person who stands out, except in his own mind, as the representative of large bodies of listeners. One or two men are spokesmen for groups of two or three hundred listeners, but only an infinitesimal proportion of the 20,000,000 enthusiasts has ever given voice to their desires

in matters of broadcasting regulation. We doubt very much if the radio listener can ever be organized. During the last season, he has been faced with the virtual destruction of broadcasting by wanton publicity seekers, with hardly a sound of protest.

### Interesting Field-Intensity Measurements

**A**PAPER by Lloyd Espenschied, of the A. T. & T. Company, supplementing earlier papers on radio broadcast coverage of city areas, appearing in the January *A. I. E. E. Proceedings*, illustrates in a startling and conclusive way the effect of slight changes in location upon signal intensity in different directions. A half-kilowatt broadcast transmitter was installed on a motor truck and field strength measurements were made in all directions from a number of broadcasting station sites. The measurements prove beyond any doubt that to locate a broadcasting station in the



GERALD WENDT  
State College

Dean, School of Chemistry and Physics, The Pennsylvania State College. Especially written for RADIO BROADCAST

*"The most striking phenomenon in America to-day is the flood of returns which are pouring in on the electrical industries from their far-sighted investment in fundamental research, a policy adopted fifteen years ago when many people thought that electricity had already reached the peak of achievement. To-day, no one questions the policy, and other industries are learning the lesson. In August I ventured to predict in The Nation's Business that events would be broadcast by combined radio-telephony and television by 1929. Within a month a man's mobile smile has been transmitted by radio. And now, within four months, Dr. E. F. W. Alexanderson announces that the broadcasting of moving pictures is imminent. It's a swift life nowadays, and the pace is set by the electrical world."*

middle of a city is certain to introduce transmission irregularities of a surprisingly large intensity. Some of the measurements indicate that moving a station ten miles further away from a receiving point within twenty miles of the transmitter may actually increase the signal strength. Commercial broadcasting stations, making claims of coverage to prospective users of the broadcasting medium, must soon be in a position to substantiate their claims by field strength measurement maps, prepared by a disinterested expert body. Recently, we saw a solicitation from a station in Buffalo which demonstrated quite clearly that it thoroughly covered the United States with its five hundred watts, while, as a matter of fact, field strength measurements might well show that there are even some sections of the city of Buffalo which do not hear it with adequate volume.

### The Month In Radio

THERE are now 702 ships in the world equipped with radio direction finders, an increase from 291 in the last two years. Of these, 268 are American ships, 252 are British, and 63 Italian

the rest being distributed among other countries in smaller numbers. We have 30 radio beacons in service, Canada seven, Spain five, Great Britain four and other countries smaller numbers.

Captain Fritz Kruse of the Hamburg American liner *Resolute*, took occasion recently to vent some well deserved wrath upon the indoor sea captains who send out sos calls when they actually need a ship carpenter. He says that younger captains get hysterical upon the slightest provocation and that much of the self-reliance of seamen has been sacrificed by too much dependence on radio. There has been occasional criticism that broadcasting stations do not always stop for distress calls. The abuse of the sos privilege for trivial matters is a sure way to encourage this practice.

EARL R. GLENN and L. A. Herr have prepared a pamphlet of interest to teachers of manual training in the schools, entitled *Curriculum Studies on the Place of Radio in School Science and Industrial Arts*. It gives a thorough study of the author's experience with various types of radio sets suited to schoolroom construction and gives the exact constructional details, including the cabinet work, for a number of practical outfits. The book should be helpful to all manual training teachers.

THE New York State Legislature is having a bill brought before it, introduced by Assemblyman Edwin J. Coughlin, who proposes a censorship of broadcasting programs and an annual fee of \$100 to be paid by each station in the state to maintain this pernicious censorship. Upon a complaint in writing of five or more persons, a clause of his bill reads, that any of the regulations of the bill are being violated or that obscene or indecent programs or messages have been broadcast, a commission is to investigate and may revoke a station's license. Five soreheads with a little political pull could thus close down any station. There has been no complaint about the broadcasting of obscene matter and there is no excuse for this stifling and high handed bill. It is quite evidently a move of small minded politicians who would gather unto themselves power far in excess of their competence. If unnecessary censorship must be devised to hamper broadcasting, at least let its exercise be safeguarded so that it interferes only with real abuses. But why even consider a censorship until we have abuses?

A FORTY-PAGE document, comprising Secretary Hoover's reply in response to Senate resolution No. 149, seeking light on the relations between Major General Squier and the American Telephone & Telegraph Company in wired wireless matters, contains some evidence that the amiable friendship between the two is not being maintained at its fullest ardor. A casual reading of the document leads to the conclusion that the A. T. & T. is getting something for nothing, just as General Squier once seemed to intend when the patents were dedicated to the public. Now he wishes to collect royalties.

There seems to be no question about General Squier's priority in conceiving the transmission of radio-frequency currents over telephone wires which makes possible the utilization of a single wire channel for many services simultaneously, and also that the A. T. & T. has profited greatly from the utilization of the discovery. General Squier contends that he dedicated it to government use only, although he has been unable to convince the courts that the marking on the patent papers dedicating it to the public does not express his original desires in the matter.

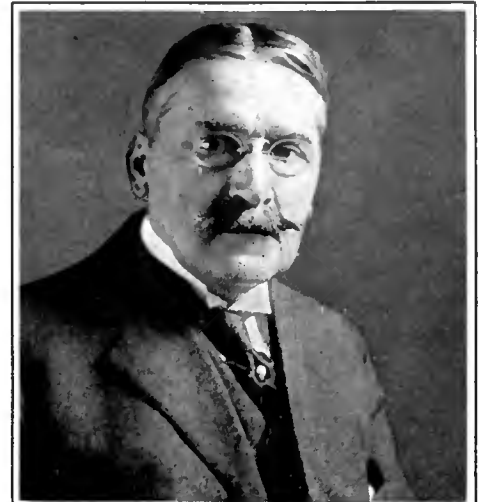

MICHAEL I. PUPIN  
Philadelphia

President, American Association for the Advancement of Science:

*"The most important advance in the art of electrical communications concerns the transmission of magnetic action at a distance." The theory of this transmission was really worked out by the great Scotch scientist, Clerk-Maxwell, and published sixty years ago, but his great theory was not understood by the telegraph and telephone engineers for more than thirty years, and so the art of transmission of electro-magnetic action was not advanced.*

*"That which contributed most to the advancement during the last thirty years was undoubtedly the classical electrical wave experiment by Hertz in 1888 and Marconi's invention of the wireless in 1895.*

*"The Maxwellian theory of electrical transmission was the light that shineth in the darkness and the darkness comprehended it not; but the Hertzian experiment, and Marconi's wireless transmission, were nothing more or less than a simple inference from the Maxwellian experiment. These two achievements helped the telegraph and telephone engineer to comprehend Maxwell's light."*

THE DeForest Radio Corporation successfully defended a suit brought by the General Electric Company which charged that its patents in the use of certain methods of preparing tungsten for use in filaments had been infringed. Federal Judge Morris's opinion held that the ductibility of tungsten was an inherent quality of that metal and therefore unpatentable.

In its original state, tungsten is highly fragile, and methods of making it ductile were disclosed by Doctor Coolidge, who described necessary highly intensive research work and considerable expenditure. The patent law clearly states that properties of materials, however remotely concealed, are not themselves patentable. The discovery of the ductility of tungsten has made the electric light bulb of tremendously increased utility and service.

WCFL in Chicago threatens to increase its power from 600 to 5000 watts. If it radiates that amount of power so that it interferes with WEAf, as it has done in the past, the program value of WEAf will be reduced very nearly to zero. It is unfortunate that about a million innocent listeners would be spattered with the mud of such an asinine ether onslaught.

# Further Comments on the R. B. "Lab" Receiver

*The Substitution of Dry Cell Tubes for the Storage-Battery Type—A. C. Heating of the Power Tube's Filament—Coil Data—The Advantages of Shielding—How to Use a Loop—Some Trouble-Shooting Hints*

By THE LABORATORY STAFF

OF THE many minor changes that can be made to the "Lab" circuit as originally described in RADIO BROADCAST, there are few that are so simple as the substitution of dry cell tubes for the big fellows that require storage batteries. Pity the enthusiast, the farmer for example, far from a source of power by which he can charge batteries or run power tubes. Tubes of the 199 and 12 types are his only chance unless he undergoes the periodic task of hauling a battery to town.

Although there may seem to be something mysterious, something tricky, about this circuit to many readers, there really is no reason why

their life. The 120 draws only 0.125 amperes of filament current, while its filament voltage is the same as that of the 199 tubes. Where it would be impossible to power from one set of dry cells a four-tube set drawing one and a quarter amperes of filament current, it is not impractical to draw from a separate bank of batteries the current required for the single half-ampere tube, such as the 171, and use separate cells for the other tubes.

In substituting dry cell tubes of the 199 and 120 types requiring 3.0 to 3.3 volts on the filament, for those of the 201-A type, it is necessary to change the filament resistances, a simple

storage battery problem with its charger and accessory apparatus, the inclusion of three dry cells to heat the filaments of the first three tubes in the console that houses his radio, need not bother him at all. If in addition to the business of running his 171 power tube from a.c., a device is used to supply high voltages for the plate circuits also from the house lighting system, the user has a receiver that requires almost no attention.

To light the filament of the last tube from a.c. requires only slight changes in the wiring of the set proper. It will be necessary to disconnect the filament wires of this tube from those of the three other tubes and to run a twisted pair of wires outside the set proper to the secondary of a small step-down transformer such as those sold as "bell-ringing" transformers. In Fig. 1 the connections of a receiver of this form are shown.

The method of lighting the filament of the last tube from a.c. has been described several times in RADIO BROADCAST and one should have no difficulty in following the diagram and in making the necessary changes.

There are several methods of returning the grid and plate circuits to the center of the filament transformer. This is usually done by making a center tap on the transformer secondary, but it is not difficult to use a potentiometer of any value for the same purpose. See Fig. 2, A.

If the filament transformer delivers more than the required five volts (which is probable), it will be necessary to reduce the voltage. The rheostat or fixed resistance for this purpose must be connected between the transformer and the potentiometer, as shown in Fig. 2, C. Fig. 2 also shows: A, the method of connecting the potentiometer across the toy transformer's secondary to return the grid and plate circuits to the center of the transformer, and, B, how this same

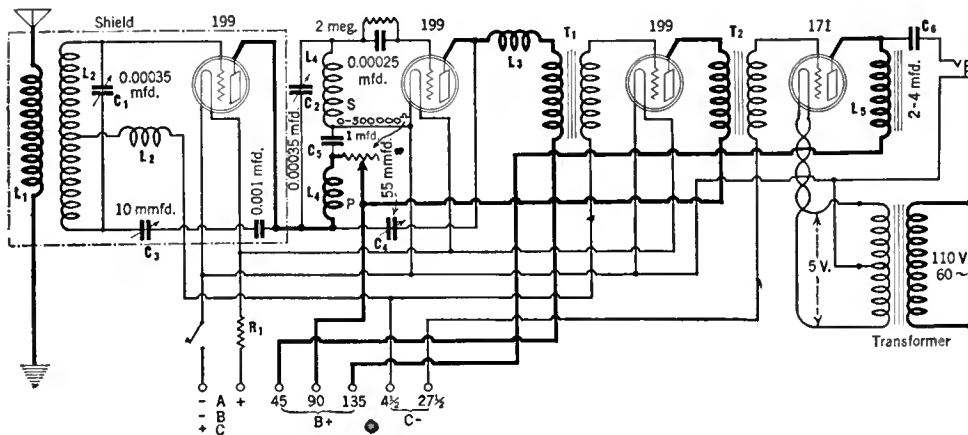

FIG. 1

small dry cell tubes may not be used satisfactorily. In the original article on this interesting circuit, published in June, 1926, the correct ratio of turns between the primary and secondary of the coil connecting the radio-frequency amplifier to the detector, for the different types of tubes used, was given, and for those who build their own the data given elsewhere on this page will be of value.

The mere substitution of a 199 for the 201-A tube in the detector and radio-frequency sockets without the bother of re-tapping the detector inductance, is all that is necessary for the average reader. It is only necessary to change the tap on the coil, which is designed for a 201-A, if the utmost is desired from the receiver. With present-day confusion in the ether, the gain in selectivity and slight loss in volume resulting from the substitution of a higher impedance radio-frequency amplifier tube—a 199 for example—will be worth while.

When it comes to the final stage in the audio amplifier, the 120 is the proper tube for dry cell operation, although a much better one is the 171. The latter requires one-half ampere at five volts, which may be obtained from a bank of dry cells arranged in series-parallel to prolong

matter indeed. It is true that these small tubes do not have the voltage amplifying ability of their larger brethren but it is also true that in a radio-frequency amplifier they are simpler to neutralize and to "hold down," and that, for a given amount of input filament power, they are about ten times as efficient as storage-battery operated tubes. Dry cell tubes also have the disadvantage that they are somewhat more microphonic, but there are simple remedies for this trouble.

An even better—almost ideal—arrangement, is the use of three dry cell tubes and a fourth power tube operated from a.c. This cannot be done by the farmer remote from power lines, but for the city dweller who does not care to face the

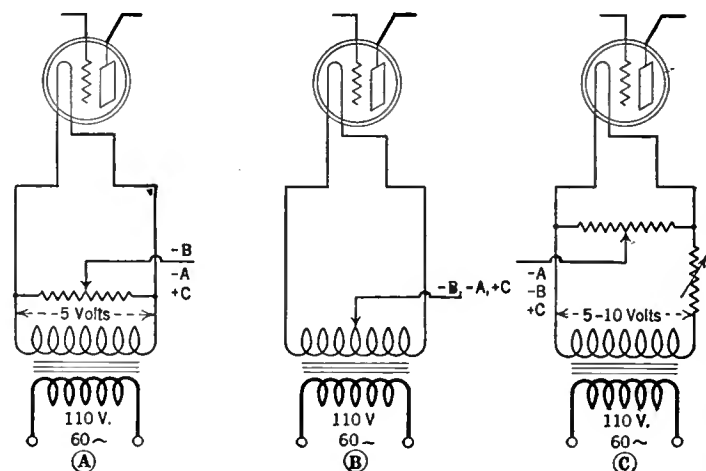

FIG. 2

thing is accomplished by using a mid tap on the secondary of the transformer.

It is worth noting that a power tube drawing one-half ampere in a four-tube storage battery-operated receiver represents forty per cent. of the total current drawn from the storage battery,

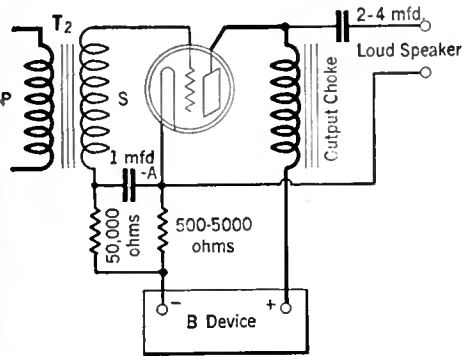

FIG. 3

so that relieving the battery from the final tube current is a distinct advantage from the standpoint of battery economy and care.

COIL DATA

THOSE who desire to use the correct number of plate turns for various tubes will find the following table useful. It is only necessary to divide the total number of turns in the detector coil by the factor given below to determine the place to insert the bypass condenser. Of course the larger part of the coil is the detector input, "S" in Fig 1.

TUBE	TURN RATIO	FACTOR
199	1.57	2.57
12	1.75	2.75
201-A	2.00	3.00
112	3.00	4.00

For example, if the coil has 75 turns and a 199 type tube is to be used, the plate turns, "P", are  $75 \div 2.57 = 29$ , which leaves 46 for the detector input coil, "S".

The matter of taping the coil properly, however, is not extremely important, and those who desire to improve the sharpness of tuning in the detector circuit will do well to decrease the turns in coil P. This will, however, be at the expense of some voltage gain at the lower radio frequencies.

GRID BIAS

MANY readers seem interested in securing C bias for the last tube from the device that supplies the plate voltage for the set when such is employed. It must be remembered that in this case the total voltage obtained by adding the C bias to the plate voltage must be delivered by the B power device. For example, the 171 type of tube requires a bias of 27 volts when 135 volts are used on the plate. This means that the total voltage must be 162, which must be maintained when the set is in operation and probably drawing a total plate current of about 20 milliamperes.

Inasmuch as there are many devices supplying plate voltages now on the market capable of delivering more than 160 volts at a drain of 20 milliamperes, it is easily possible for them to

supply C bias as well. It is only necessary to force the plate current of the last tube to flow through a resistance on its way back to the negative filament lead—or center tap if a.c. is used on the last tube's filament—and to take the drop across this resistance as C bias. Fig. 3 shows in diagrammatic form the method employed and indicates that the resistance should be variable to get the proper bias. For example, if 135 volts are used on the plate of the 171 tube, the plate current will be about 12 milliamperes. The required voltage drop will then be  $0.012 \times R = 27$ , whence  $R = 27 \div 0.012$ , or 2250 ohms. It is well to include a bypass condenser as shown as well as a high resistance in the C lead to the transformer. This condenser-resistance filter will keep any hum out of the grid circuit. If there is no output choke or output transformer, a bypass condenser should be placed across the C bias resistance. Readers interested in this method of obtaining C bias should read Laboratory Information Sheet No. 73, in the March, 1927, RADIO BROADCAST.

DETECTORS

WHEN a C-battery detector is used, it may be found that the regeneration condenser,  $C_4$ , is not large enough to cause oscillation over the entire band. This is often the case with a plate voltage of 45 and a C bias of negative 4.5 volts, and the solution is to increase the plate voltage to about 67.5, or a little under this figure if possible. For freedom from microphonics, and for somewhat better quality, the oxide-coated 112 tubes can be recommended as detectors. They have considerably lower output impedance and, due to their heavier filament, are not so liable to be mechanically noisy.

For the best quality and greatest freedom from line noises when using a B power-supply device, a separate dry B battery for the detector is to be highly recommended. It is only necessary to connect its negative terminal to the negative of the power supply device and to connect the detector B wire from the lower side of the first

this difficulty, and at the same time make the receiver more stable, more easy to control, and eliminate much unwanted "pick-up" from local stations. Another method of decreasing hand capacity is to use a dial that has no metal connecting to the metal parts of the condenser. Yet

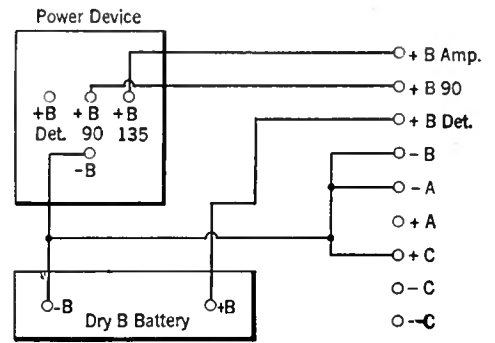

FIG. 4

another is to use a condenser with a shaft made of insulating material or to use an insulated coupling device between the condenser and the shaft that fits into the metallic dial.

USING A LOOP

IN OPERATING the four- or two-tube "Lab" receiver with a loop, several slight alterations must be made so as to allow easy change from antenna to loop connection.

The change is made with the aid of a jack and plug. The jack is of the double-circuit type into which a plug, connected to the loop terminals, is inserted.

The secondary coil of the antenna stage has its end leads connected to the inner terminals of the jack. The tube circuit, that is, the grid and neutralizing condenser points of the circuit, are connected to the upper and lower outside blades of the jack respectively. When the plug is not in the jack, the two inner blades make contact with the outer blades and connect the coil to the radio-frequency tube.

When the plug is inserted, the upper and lower outside blades are sprung away from the inner blades, disconnecting the secondary coil and in its stead connecting the loop to the tube circuit.

Since there is a third contact—the center of the loop—provision is made by means of a single pin jack located on the same insulation support in which is mounted the loop jack, so that a flexible lead from the center point

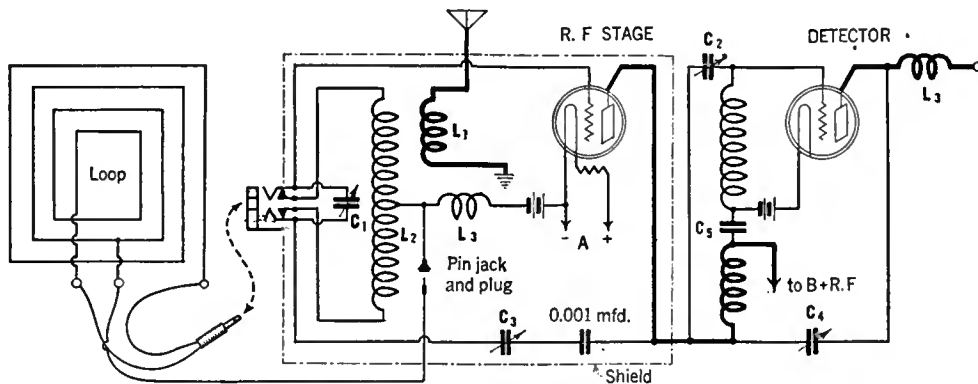

FIG. 5

audio transformer to the positive terminal of the B battery. This is shown in Fig. 4.

With the proper B and C adjustment, the detector should slide into oscillation quietly. With improper adjustments it will go into oscillation with a "whoop," and there will be considerable "hang-over" on the regeneration condenser.

HAND CAPACITY

THE greatest source of trouble with the four-tube receiver is from hand capacity on the antenna or radio-frequency amplifier dial. This is due to the fact that neither rotor nor stator is at ground potential. There are several solutions. In the first place, complete shielding of the radio-frequency amplifier will practically eliminate

of the loop may make contact with the circuit via the pin jack, which is permanently connected to the center tap on the secondary coil.

Reference to Fig. 5 shows the revisions necessary in the circuit to include the loop, while Fig. 6 gives the dimensions of the insulation strip which supports the loop jack and pin jack.

The loop has pronounced directional characteristics, and it will be observed that signals are received loudest when the loop is turned with its plane in a line running between the center of the loop and the station received.

Where hand capacity effects are noticeable in the operation of the loop, this undesirable condition may be eliminated by turning the loop inside out. This is done by connecting together the two

outside ends and using this connecting point as the center tap of the loop. At the original center tap the continuity of the turns of the loop is broken thus providing two leads which may be fastened to the terminals of the plug. Fig. 7 illustrates this point.

SHIELDING

A SET may gain a great deal by partially shielding it.

It is probable that even sticking a metal plate between the coils, or condensers, of a set does some good. At least the inclusion of the plate must distort the field between the apparatus on its two sides in such a manner that some inter-apparatus coupling is eliminated, and therefore it may be argued that the metal plate does some good. It is certain that surrounding the coil, condenser, and tube of the radio-frequency amplifier of the "Lab" circuit with a tightly fitted metal box isolates that circuit from the detector much better than any trick method of placing coils, and that the resultant freedom from unwanted coupling between amplifier and detector is worth every minute of the time involved.

In the Laboratory, such shielding has been made of aluminum, copper, or brass. On one occasion a copper box was made from a single piece of metal and every crack was soldered, so that the amplifier was as totally shielded as possible. Wires came into it through very small holes, and there was provision for grounding the shield, or letting it hang "high and dry," assuming any desired potential with respect to earth.

In every case the shielded receiver had a marked freedom from hand capacity, a much greater freedom from unwanted pickup from strong local stations, and, when, equipped with plate voltage filters consisting of condensers and chokes as shown in Fig. 8, was remarkably stable and easy to operate. With a loop input, the detector unit should be shielded as well as the r. f. amplifier if the best possible results are desired. In this case there will be a minimum of feedback from the detector coil to the loop. A complete metal panel will be much better than a metal plate behind only the antenna tuning condenser.

TROUBLE SHOOTING

THE following paragraphs are not for those unfortunate members of the home constructors society who, like Voltaire's Doctor Pangloss, believe this to be the best of all possible worlds—all because they, personally, never make a mistake. Rather, these few words are for ordinary mortals like ourselves who are occasionally faced with a receiver that is surprisingly silent.

In the first place, one should take courage for, as Edgar Felix recently pointed out in RADIO BROADCAST, a receiver that seems dead may actually be in a state of coma only; like the Sleeping Princess, it may await the wakening hand.

Let us suppose the four-tube receiver has been connected up—properly, of course—and that we have

gone over the connections several times, but that no sounds emanate from the loud speaker. The first thing to do is to test out the audio amplifier. It is a two-stage affair using Amertran De-Luxe transformers, and should have an overall voltage amplification of about 300. To test it,

conditions are correct, shorting the input of the amplifier should also produce a click—which may require a pair of receivers to hear. Speaking into a pair of receivers connected across the input to the amplifier will make it possible to test the amplifier as a whole, the receivers acting as the pick-up device. If the loud speaker indicates that the amplifier reproduces the owner's voice, it proves that the amplifier is working properly. Then the receiver-pickup may be placed in series with the detector tube B-battery lead and again spoken into. This will indicate whether or not the detector gets plate voltage.

If the amplifier works, and the detector has plate current, the next step is to attach the antenna on the plate terminal of the radio-frequency amplifier with that tube out of its socket. The receiver will then be a single-circuit blooper and carrier waves at least should be picked up. If signals are heard it proves that the final three tubes in the set are working properly. The antenna should then be placed on the inductance side of the neutralizing condenser. Signals should now be weak—but if they have the same intensity as before it proves that the neutralizing condenser is shorted, a fact that may not be apparent unless tested in this way. Shorting takes place occasionally in a compression type of neutralizing condenser and causes considerable trouble.

The next step is to place the r. f. tube in its socket and to connect the antenna to the grid of that tube. If signals are now received the antenna may be connected to its proper terminal. With local stations it often happens that signals will be heard even though the r. f. tube is not getting plate voltage. Under these conditions, adjusting the neutralizing condenser will seem to have little effect and signals will be weak since there is no gain in the amplifier tube. It is even possible to receive signals if the detector gets no B battery voltage.

If there is difficulty in neutralizing the amplifier tube, plate voltage filtering will aid. The lower part of the plate inductance should be bypassed back to the amplifier negative filament lead and the B-battery voltage fed through another radio-frequency choke. It is also well to filter the detector plate voltage, thereby making the radio-frequency circuits short and direct, and keeping the r. f. currents where they belong. Fig. 8 shows where these bypass condensers are located. They may be anything from 0.01 to 1 mfd. in capacity, and probably 0.1 mfd. will do all that we can expect. The choke in the 90-volt lead may be a Samson or similar 85 mh. inductance.

If the audio amplifier "rasps" on medium or loud signals of rather high frequency, it is regenerating. This may be due to high-resistance B batteries or plate voltage supply, or to a direct feedback between the input plate lead and the output leads. If the audio amplifier is distinct from the two-tube tuner unit, the input to the amplifier should not be run in cable from the tuner unit.

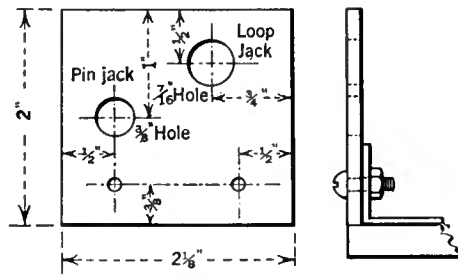

FIG. 6

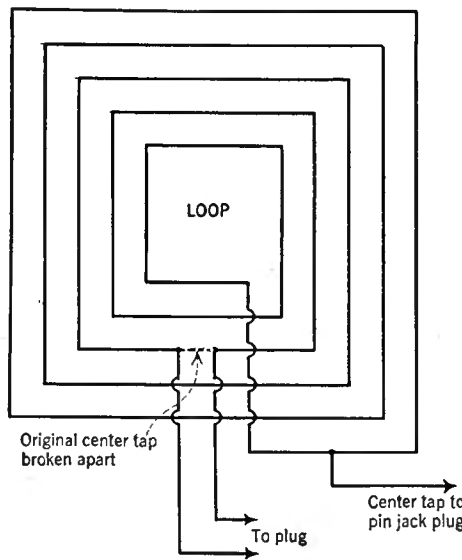

FIG. 7

gently tap the detector tube when a resounding "bong" should come from the loud speaker, or from a pair of phones across the output. If there is no "bong," start from the loud speaker end and make certain that each of the two tubes gets plate voltage.

A sharp click will be heard when the plate voltage is taken from either of the tubes. If the tubes get plate voltage, and if the connec-

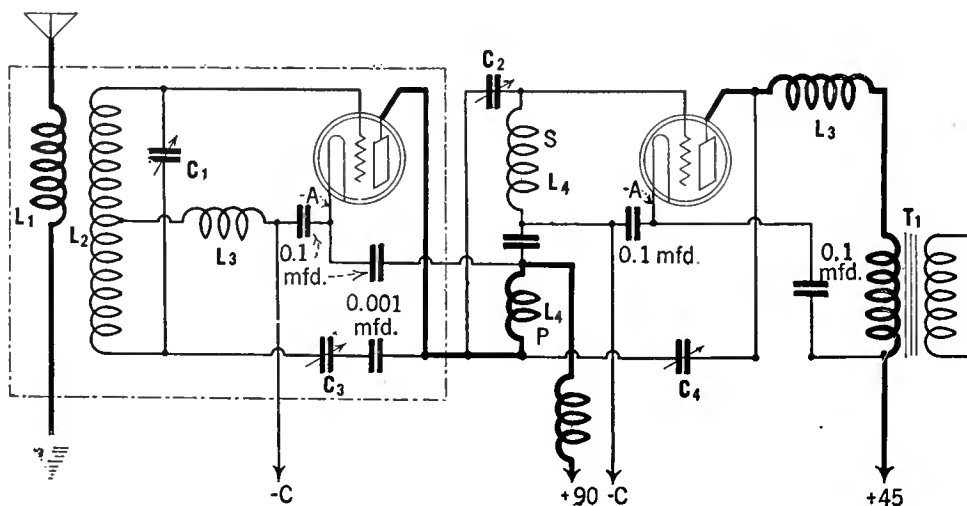

FIG. 8

# Have You an Old-Type Freshman "Masterpiece?"

If Yours Is the Old Model A or B Receiver You Can Improve Its  
Quality by Resorting to Either of the Four Methods Outlined Here

By KINGSLEY WELLES

OWNERS of the old type model A or model B Freshman Masterpiece receivers, or similarly designed tuned radio-frequency sets, are addressed in this article, which explains in detail some simple alterations that can be made to give greatly improved quality. These particular Freshman receivers have now been in use for several years and, during this time, several new power tubes, detector tubes, loud speakers, complete audio-amplifier units, and power amplifiers have been placed on the market. With a few easily made changes many of these new accessories may be used in the Freshman "Masterpiece" and similar receivers.

To improve the quality:

1. We can connect a separate single-stage power amplifier such as the Pacent "Powerformer" or General Radio power amplifier to the output of the first stage and thereby not only improve the quality but also supply, from the amplifier, B potential for the rest of the receiver.

2. We can use a complete new audio amplifier such as the "Truphonic," in place of the amplifier in the receiver. A complete power amplifier, such as the National, may be connected to the detector output.

3. We can use a completely home-constructed power amplifier to replace the audio amplifier in the receiver and also use the power amplifier to supply plate potential for the r. f. and detector tubes; many home-constructed power amplifiers have been described in recent issues of RADIO BROADCAST.

4. We can use a power tube in the last stage with the necessary high C and B battery voltages.

Any of the suggested changes will give considerable improvement although, of course, just using a power tube in the last stage will not effect as marked an improvement as will be obtained if a complete new audio system and power tube are used. The four suggestions have not been arranged according to their desirability but more so according to the ease with which the changes can be made, and we will describe them in the same sequence.

The first suggestion is that a separate power amplifier be used. A single-stage power amplifier which usually also supplies B potential for the whole receiver may be

employed to advantage, for not only is B power supplied to the entire set, but filament power and C voltage for the power tube are also obtained from the power mains. Amplifiers of this kind are of two general types — those employing the 210 power tube, such as the Pacent "Powerformer," and those employing the 171 power tube, such as the General Radio or National units.

To install a power amplifier of the single-stage type, it is merely necessary to plug the input cord of the power amplifier into the jack marked "Phones" on the front panel of the Freshman receiver. When thus connected, the last audio stage in the set is replaced by the power amplifier. The - B, + B Det., and + B Amp. posts on the back of the power unit are connected to the corresponding posts on the receiver sub-panel. The tube should be removed from the last audio socket (left-hand rear socket) in the set. Slightly better results may often be obtained if the set is first removed from the cabinet and the wire marked 4 in Figs. 1 and 2, cut. This is the flexible lead from the plate prong of the first audio socket to the primary of the second audio transformer. The ends of the cut wire should be covered with tape in order to prevent them from touching any other bare wire or metal part, and thus causing a short-circuit.

If the reader is willing to go to the expense and trouble, it is a good idea to replace the first-stage audio transformer in the receiver with one of the new high-inductance primary units, such as the Pacent "Audioformer." To do this, merely cut the four leads from the present first-stage trans-

former and run them to the four terminals of the new transformer, taking the necessary care to see that the various leads are not inter-changed, but connected to the proper transformer terminals. Rather than attempt to mount the new transformer in the space formerly occupied by the older Freshman transformer, it is suggested that it be placed on top of the sub-panel between the detector and first audio tube sockets.

#### WIRING IN A COMPLETE NEW AMPLIFIER

THE second suggestion is that we use a completely new audio amplifier with a power output tube in place of the amplifier already in the receiver. Of the many amplifiers that might be used, the "Truphonic" double-impedance or the Millen resistance-coupled amplifiers will be found eminently satisfactory. To use, for example the "Truphonic," proceed as follows: First remove the two audio tubes from the rear left and center sockets; second, remove the detector tube from the rear right socket, slip the special input lead on the "Truphonic" over the plate prong on the detector tube, and then replace the latter in its socket; third, connect the battery cable on the amplifier to the batteries; fourth, place two 201-A or high-mu tubes in the first two sockets of the "Truphonic" and a power tube in the last socket of the amplifier, making certain that the proper C and B battery voltages are used on the power tube; fifth, connect the loud speaker to the pin jacks. This completes the installation of the amplifier, and the improvement in tone obtained through its use will be very noticeable.

Suggestion number three was that we use a completely home-constructed power amplifier and B supply. In the last few issues of RADIO BROADCAST, James Millen has described the construction and operation of a number of such power units. The use of such a device with the Freshman receiver permits of well nigh perfect audio quality and necessitates only slight changes.

To make the changes it will be necessary to remove the receiver from the cabinet. There are five screws to be removed before the set can be taken from the cabinet. Three are along the back edge of the shelf and one is located at either end of the mahogany strip that runs along the top edge of the front panel. When the set has been

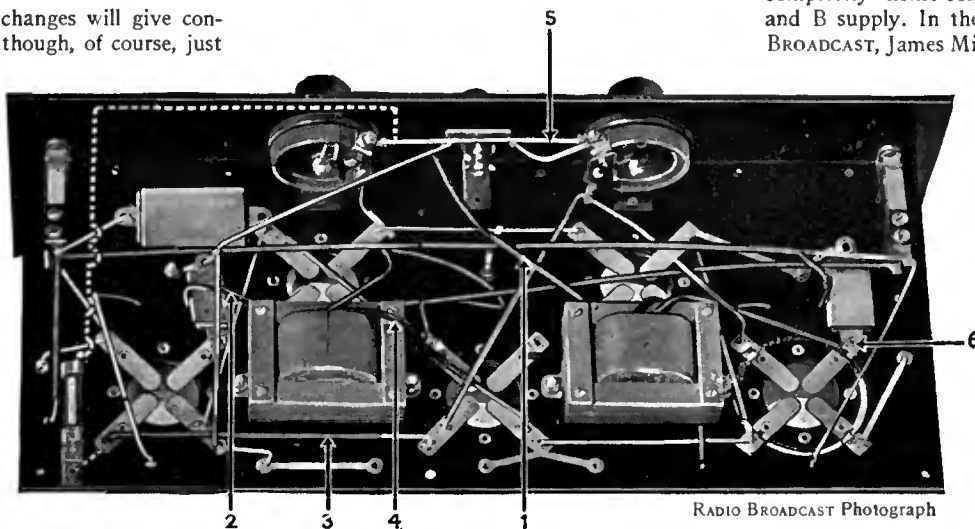

FIG. 1

As much of the wiring in the Freshman receiver is located under the panel, it is necessary to remove the set from the cabinet before making the majority of changes suggested in this article. The arrows indicate places at which new wires are to be attached or old ones cut, as outlined in the text. The dotted lines indicate the connections for an automatic filament control resistance for the power audio tube



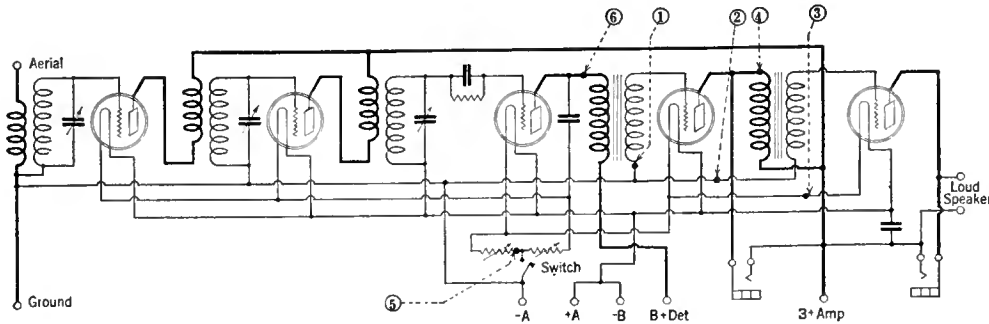

FIG. 2

The circuit diagram of the receiver before any changes are made. The arrows correspond to those in Fig. 1

removed from the cabinet, turn it upside down as shown in Fig. 1. The rear edge of the shelf should be supported so that the set will not rest on the coils.

The necessary changes are to add to the points numbered 5 and 6 in Figs. 1 and 2, leads of flexible rubber-covered wire. These two leads should be left several feet long since they must make connection to the power amplifier.

The complete diagram of connections showing the receiver connected to the power amplifier -B supply device is given in Fig. 3. This layout also includes an automatic relay and trickle charger. With such an arrangement the switch on the panel of the receiver controls the a. c. power, the A power for the amplifier, and the A power for the set. Full details on the operation and adjustment of a suitable amplifier are contained in an article in the January, 1927, issue of RADIO BROADCAST entitled, "A Combined Amplifier and A. C. Operated Power-Supply Unit."

WIRING IN A POWER TUBE

THE fourth suggestion is that a power tube be used in the output in conjunction with the regular audio amplifier in the receiver. This suggestion, which sounds the easiest, really necessitates more changes in the receiver than any of the foregoing suggestions.

Some people have the idea that one of the new power tubes may be substituted for a 201-A type tube in the last audio amplifier socket of any radio set without making any changes whatsoever to the wiring of the set. Such a substitution of tubes is only possible in those cases when the plate potential for the last tube is brought out to a separate binding post and when there is also provision for high value of C battery on the last tube. Power tubes should never be used without proper C batteries or the tube will be ruined and the quality will be little better than that obtained from a 201-A type tube.

In order to use a power tube most advantageously in one of the old "A" or "B" Freshman receivers, the following changes are necessary:

1. The B batteries and loud speaker must be connected in a slightly different manner in order to have a high plate voltage (135 to 180 volts) on the last power tube and only normal voltage on the plates of the other tubes. In the old Freshman "Masterpiece" receiver the r. f. tubes and both audio stages have the same plate potential.
2. The proper C batteries for the new tube must be used. The old Freshman receiver, as manufactured, is equipped with neither C batteries nor C battery terminals.
3. In those cases where a 171 type tube is to be used with more than 135 volts, it will be necessary to use an output device to protect the loud speaker from damage.
4. The audio amplifier rheostat in the old type Freshman receiver is only designed to take care of the current drawn by three 201-A tubes. If a

power tube is substituted for one of the 201-A's, the present rheostat will be overloaded and will soon burn out. The power tube filament must be controlled by a separate rheostat, or a half-ampere filament ballast resistor.

These changes should be made as described below. Do not cut any wires until you are sure that you are cutting the right lead. Also, the leads connecting the transformers into the circuit should be handled carefully since they may easily be broken:

1. The grid return lead from the secondary of the first audio transformer should be cut at the point indicated by arrow No. 1 in Figs. 1 and 2 and a flexible lead soldered to this terminal of the transformer. This lead will supply C battery to the first stage and it is indicated as -C<sub>1</sub> in Figs. 4 and 5.
2. The grid return lead from the secondary of the second audio transformer should be cut at the point indicated by the arrow No. 2, and a flexible lead also soldered to this transformer terminal. This lead supplies C battery to the power tube. It is marked -C<sub>2</sub> in Figs. 4 and 5.
3. Completely remove the lead marked No. 3 in Figs. 1 and 2 by cutting it free at the socket prongs to which it connects.
4. Mount a filament ballast resistor (for a

0.5-ampere tube) and connect as indicated by the dash lines in Fig. 1, to the wire joining the two rheostats.

Replace the set in the cabinet and connect the batteries and loud speaker as shown in Fig. 5. At the right of this drawing is shown an output device which had best be incorporated if a 171 tube is used in the last stage with more than 90 volts (90 volts is sufficient for the 171 tube for average purposes), in which case no output device need be included. Output devices are of two general types. One consists of a choke coil and condenser, while the other is a special transformer resembling in external appearance one of the new large size audio transformers. Either type is satisfactory for use here. Output transformers are made by Silver-Marshall, General Radio, and several other manufacturers. National, Mayolian, General Radio, and others make satisfactory choke-condenser combinations. Space within the set is limited so it will be best to mount the output device on the outside of the cabinet.

The B and C batteries shown in Fig. 4, are of correct value when the last, or power tube is of the 112 type and the other tubes are of the 201-A type. While the 112 is not capable of delivering to the loud speaker anything like the same amount of undistorted energy as the 171 power tube, it is to be recommended in preference to the 171 where B batteries are employed as the source of plate potential. The 171 requires a heavier plate current than the 112 and as a result is not so economical when operated from dry B batteries.

Where a B power-supply unit is to be employed, however, then the 171 is the output tube to use rather than the 112. The correct grid battery voltage for either the 112 or the 171 for different values of plate voltage are as follows:

TUBE	PLATE VOLTAGE		
	135	150	180
UX-112 . . .	9	9	—
UX-171 . . .	27	33	40

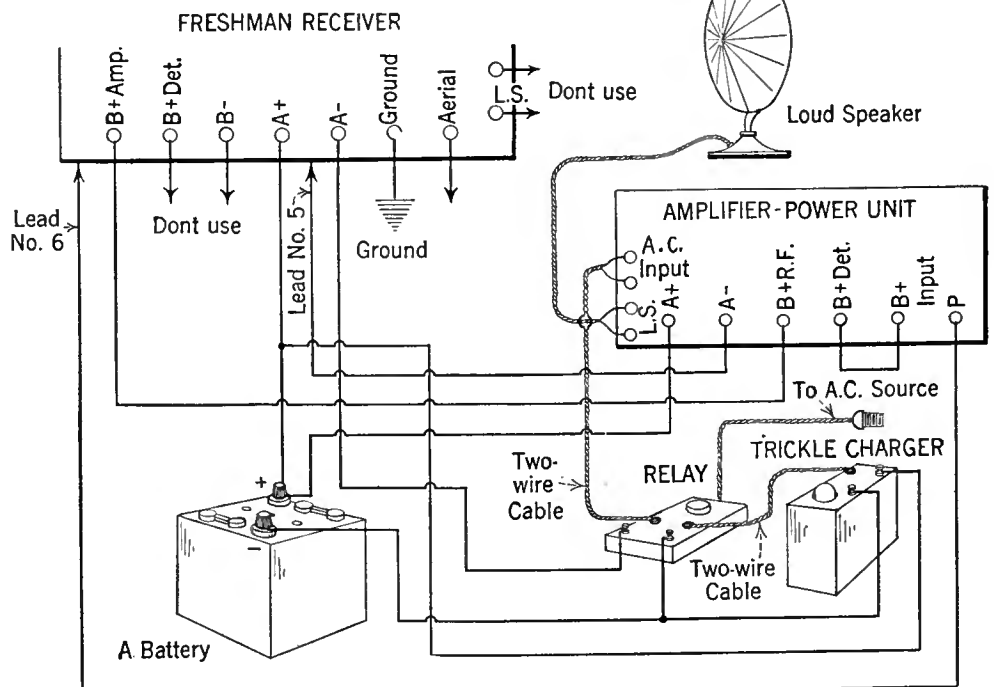

FIG. 3

The Freshman receiver will give very excellent results when used in connection with the complete power amplifier and B supply device described in the January issue of RADIO BROADCAST. In this diagram complete connections for the receiver and amplifier, with an automatic power control relay, are given

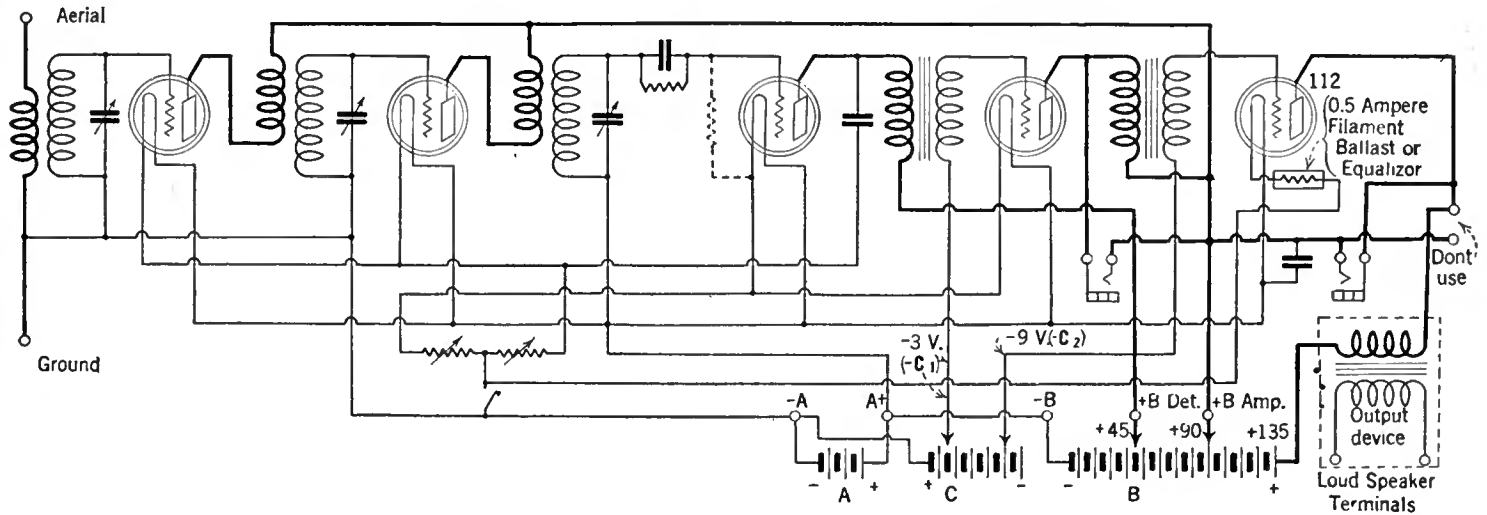

FIG. 4

The circuit diagram of the receiver after the wiring for a power tube has been made. At the right is shown an output transformer which is essential if a 171 tube is used in the output with more than 90 volts but need not necessarily be used in conjunction with a 112 tube. The plate and grid voltages shown are satisfactory for a 112. A table printed on page 564 gives the correct B and C voltages for other tubes. The two C-battery leads, minus C<sub>1</sub> and minus C<sub>2</sub>, should be connected as described in the article. If a 201-A tube is used as a detector, no changes in the detector circuit are necessary, but for a new type detector tube the grid leak should be connected to the negative filament, instead of to the positive filament

The new detector tubes, such as the 200-A type, the CeCo H, etc., will be found very advantageous in a number of cases. On signals of normal strength no difference is noticeable in volume when using one type or the other, but these new detector tubes are more sensitive to weak signals than the 201-A tubes and, as a result, will permit the reception of signals too weak to be understandable with the 201-A. The only change necessary in order to use one of the special detector tubes in the old model Freshman receiver is to increase the detector plate voltage and change the grid leak connection. By referring to Fig 4 the grid leak can be seen in its usual place, while the location of the leak when using a new detector is indicated in dotted lines. The easiest method of making this change is to purchase a grid leak and mount and fasten it to the sub-panel near the detector socket. One end connects to the grid and the other end connects to the negative filament terminal of the detector socket. The optimum plate voltage for a

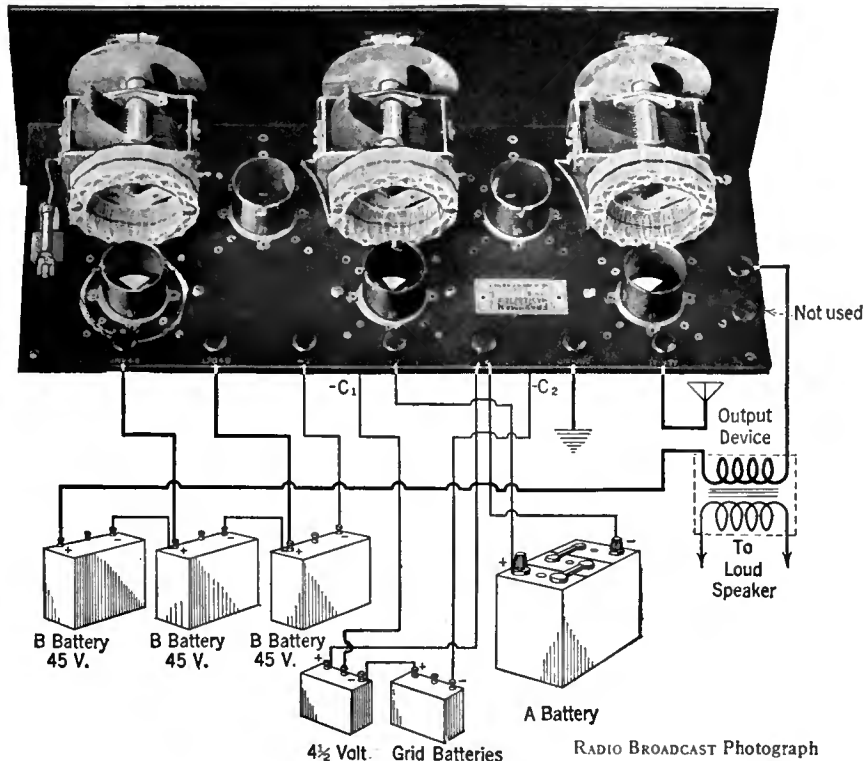

FIG. 5

The batteries and loud speaker are connected to the re-vamped receiver in the manner indicated in this illustration for power tube use. Note that the loud speaker binding posts are not used. The C battery leads are connected to the points indicated in the other diagrams

special detector tube must be found by trial during the reception of signals from a distant station and is frequently higher than that required for the 201-A tube. In the case of the CeCo H detector tube, as much as ninety volts may be necessary for the best results.

When a cone or disc type loud speaker is placed quite close to a set, trouble will frequently be had, especially with the 201-A tubes, due to what is known as mechanical feed-back between the detector tube and the loud speaker, causing an audio-frequency howl to build up until it becomes a roar that completely drowns out the signal. By carefully selecting a detector tube that is not microphonic, by placing the loud speaker some distance from the set, or by using a spring-suspended detector tube socket, the difficulty is readily overcome.

To install a spring suspended detector socket, cut the four brass strips that support the present socket and mount the new socket on a small strip of bakelite just large enough to cover the hole in the base in which the regular socket was located. Connections are made to the four eyelets that held the old socket. Before changing sockets, note which side the slot for the tube pin is on so that the spring socket may be turned the proper way without the necessity of tracing out the wiring.

FIG. 6

The jack on the front panel of the Freshman receiver marked "Phones" is used when a Patent power amplifier of the single-stage variety is used in place of the second stage amplifier in the set. The second audio tube in the receiver should, of course, be removed

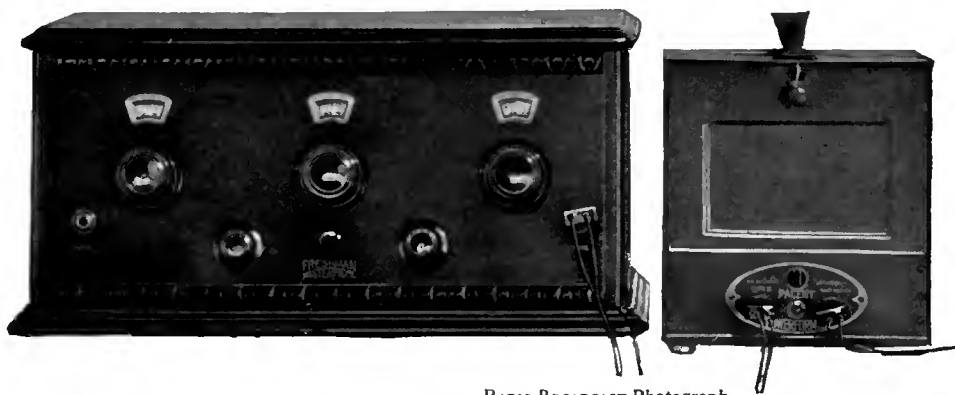

RADIO BROADCAST Photograph

# THE LISTENERS' POINT OF VIEW

Conducted by John Wallace

## What Many Listeners Think About Broadcasting

HEREWITH some of your own opinions, listeners, as culled from supplementary notes accompanying the questionnaire replies, together with diverse comments by ourself:

LINCOLN, NEBRASKA.

SIR:  
Ah! Another questionnaire! I hasten to answer. [Here some bouquets which we blushing delete. *Ed.*] Now as to the questions. You need not apologize for that first one. I am a traveling man and I have been entertained in at least 200 private homes this year. I can not remember a single place in the bunch where the broadcasts were listened to as one would in a show. Even the prayers in the church services were interrupted with bright remarks, and other irresponsible and extraneous material. If I were sure Carl Dreher would get a peek at it I should call it "static", but it wasn't. I'll bet a quart of "snake juice" that there would not be so many church services broadcast if the parsons could sit around the garage stove with some of their audience.

You will have to get some more work in on that "kiddies" nuisance. Note the enclosed clipping from the *Literary Digest*.

The clipping was from a department concerning the correct use of words, entitled "The Lexicographer's Easy Chair" and stated:

kid.—"J. H. C.," Chicago, Ill.—As a common vulgarity for "child," the use of this term can not be too severely condemned, but "kiddy" or "kiddies" are permissible as terms of affection.

What! Must we do battle with the lexicographers as well as with the Uncle Charlies and Auntie Janes?

YONKERS, NEW YORK.

SIR:  
With a large and varied field of entertainment to choose from, I have no quarrel to pick with any of the broadcasters. Each is endeavoring to the best of his ability to attract customers, much in the same manner as the stage purveyors do. To me the element of chance is part of the fun. One night everything off color, the next an

IN THE January and February RADIO BROADCAST, we printed a questionnaire designed to find out what a representative body of listeners really thought about radio stations, radio receiving, and radio programs. The many replies—which are still coming in, by the way—have been extremely informative. Answers have been returned from every section of the United States and Canada, and they have contained a wealth of suggestion which we wish we could hand to every program manager. That is not possible, nor can even a fraction of the results be shared with you. However, this month, Mr. Wallace has chosen excerpts from some answers to the questionnaire which are not only interesting, but represent very well the trend of all the replies. In the May number, we hope to present a final installment of this information which may almost be considered a cross section of radio opinion.

—THE EDITOR.

oriental dream. It's good and soul satisfying philosophy to take the good with the bad and mediocre in alternate doses.

Again I have no quarrel with direct or indirect advertising; at least I am satisfied to know, in a decent way, to whom I am indebted for the privilege of being entertained. I protest the present method adopted by the [New York] *Herald Tribune's* daily program, wherein it prints "Orchestra and Artists" 9:00 P. M. Worthless stuff. If it is the Eveready Hour, I am entitled to know it. I like them and when I see that name, and all others for that matter, I can make my own choice without prejudice, just as I choose rubber tires, perfumes, radio sets or batteries. If this new method on the part of the *Herald Tribune's* is ethics, I call it cheap junk. I commend your magazine which I have read for one year and will continue to read. I find it the best, judged by all standards.

For further remarks on this subject, see the article by Pro Molto Gigolo a few columns on. We quote the following two letters as typical of a great number received:

HARTFORD, CONNECTICUT.

SIR:  
Our radio usually runs most of the time each evening when we are home and reception conditions are good. Dinner music during our evening meal. The local newspaper is scanned for programs of merit and we tune-in on those appealing to us as being most interesting and of best quality.

When any particular event of outstanding interest is advertised we generally plan to invite a few friends and make an evening of it.

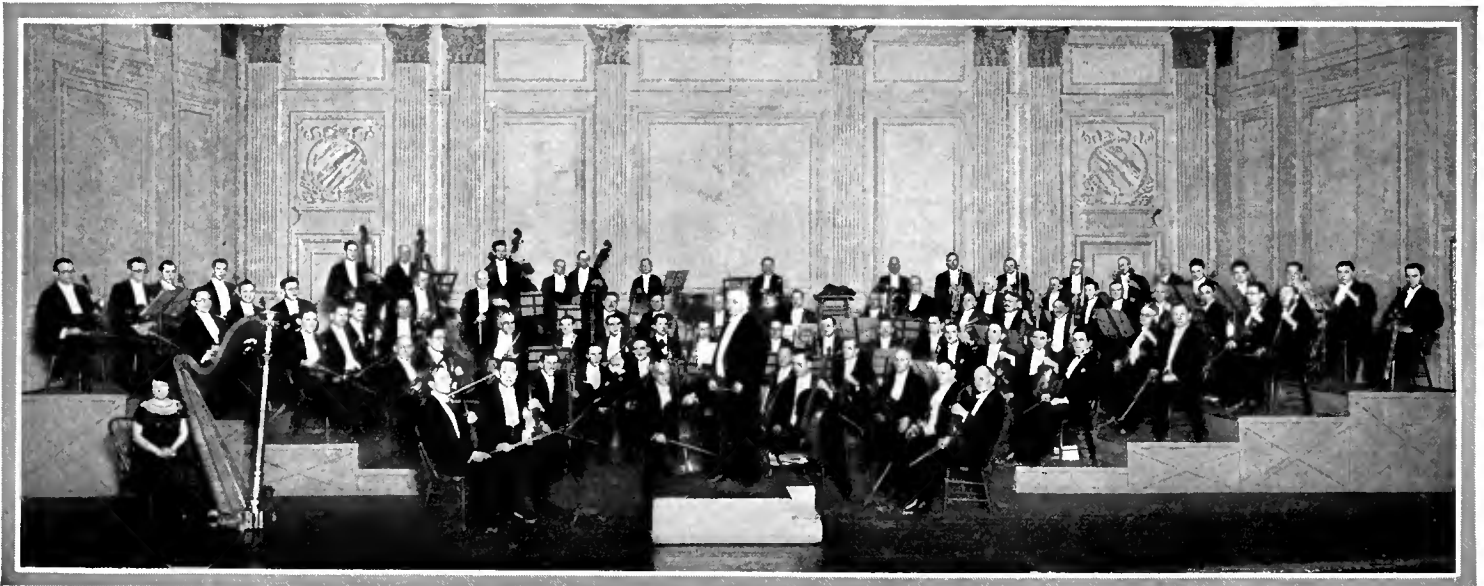

THE BALTIMORE SYMPHONY ORCHESTRA

The Baltimore Symphony Orchestra will go on the air from WBAL on April 24th, presenting as soloist the winner of a municipal violin contest to be held in Baltimore in March. The cantata "Columbus" by David S. Melamet, which won the Saengerfest prize in New York several years ago will be sung by a chorus of 400 male singers assisted by the orchestra.

Our local station is used only when their programs are of a greater merit than we can get from a distance. DX in itself is not sought except when experimenting on a new hook-up or new parts. There is still a thrill in DX and occasionally when coming in late from a party I sit at the dials for 15 to 50 minutes listening to the west. Waiting up for the furnace to draw properly is a good excuse for sitting up late when one knows he ought to go to bed.

POUGHKEEPSIE, NEW YORK.

SIR:

We usually start the radio at 6 P. M. and keep it going while we carry on our other activities. Of course we follow the programs and pick out the numbers which we like best, changing from station to station. It usually takes a concert like the Victor Concert last evening to make us stop our bridge game and give our whole attention to the music. However we seem to hear everything that's going on even while we're concentrating on something else. A jazz concert, however, always means that we tune-in on another station or turn off the radio entirely. Some dance music is all right but most of it sounds like—well, I could make better music by dumping the kitchen utensils on the floor. We enjoy popular music as long as it is music. You may think we are inconsistent but we do enjoy banjo and Hawaiian music. Now as to popular music, it's all right but I wouldn't give up the others for it; and as for radio plays, there are still theaters where we can see the actors act and anything else which is supposed to be seen. So radio plays will have to wait until television is a success. I believe just as you do about speeches. However we do enjoy hearing Vice-President Dawes trying to shatter the filaments in the tubes. As for education, we have had considerable. Besides a lot of static comes along at the wrong time and ruins the most important points of the talk. The miscellaneous novelties aren't worth bothering about.

The Rising Tide of Radio Stations is the subject of a large group of letters. For instance:

BISBEE, ARIZONA

SIR:

Now that you have given your readers an opportunity to tell what they do with their radio receivers, through the medium of your questionnaire, I would like to suggest that you give us another questionnaire to find out what the sentiment is about elimination or muzzling about ninety per cent. of the broadcast stations of the country. I refer particularly to the broadcasters who are dishing out direct advertising and grinding out the most mediocre of programs. Radio is doomed as a source of entertainment unless something is done quickly to remedy the heterodyning nuisance. It is impossible to listen fifteen minutes to a satisfactory program without having the program ruined by some interfering station. With the many thousands of "better, cost less" bloopers, and the heterodyning of interfering stations, radio reception is nothing more than a horrible experience just now. As a partial remedy to the heterodyning trouble why not put all the broadcasters who do direct advertising on one wavelength, reducing their power, and then let them advertise and heterodyne each other to their hearts' content. It would try the patience of Job to try to tune-in a program these nights that did not have its infernal jazz background, or some advertiser dishing out the "dope" on the wares he has to sell. The radio advertiser is a worse offender of decency than the billboard advertiser, whose only offense is to spoil part of the scenery. It is high time for some drastic action to curb these nuisances, and cut out some of the "tank town" broadcasting stations whose only excuse for being on the air is to sell something, or radio is going to pass out as a family entertainer. RADIO BROADCAST, being the outstanding radio publication of the Western Hemisphere, should "take the bull by the horns" and build a good sized fire under him. Otherwise our radio receivers are only fit to look at. Personally, I am just about through with



MYRNA LOY

Who has utterly no connection with radio other than that she acted as guest announcer at KFWB recently. However we liked her picture so you'll have to humor us. It seems she acts in the movies

mine if this messy situation is going to be a regular diet.

Further bits about the superabundance of broadcasters:

ASHTABULA, OHIO.

SIR:

We want to see the total number of stations cut down to about 200 (for the U. S. proper,) these stations to be divided up according to population of territory and allowing, say, two or three apiece for the largest cities, and not over one apiece for states with smaller populations. These few stations to be maintained at the highest possible standards from both the point of entertainers and latest, most efficient equipment.

CAWKER CITY, KANSAS.

SIR:

A good way to remedy the radio business so the DX hound can get a look in, is to limit all the small stations to about one or two hours a week in the evenings between 6 and 10 P. M. And the large station run about two hours every other night. This chain station stuff is all right

but it monopolizes too much air; it should all be on one wavelength. It looks as if they were trying to force the listeners to listen to them or go to bed. The little stations should be left to run as much as they want in the day time especially those located in the middle west in the agriculture country, as some of them are doing a service that is of great value. In the summer time they can all run as old man static will regulate all of them.

And more about the DX hounds:

DETROIT, MICHIGAN.

SIR:

Anent your query about DX—the writer has built quite a number of sets for friends, who wanted "only to listen to the local programs, which are plenty good enough," etc. You know it!

Probably you know the rest; every last one of them has been fishing for DX as soon as he learned how to push the switch. I have about twenty friends who have purchased various manufactured receivers recently. Without even one exception they have all come to me to find out how to get KFI, etc., and find out why they couldn't get every station in the United States every night in the week. Friends with receivers a year and more old are still trying to get DX—though usually more reasonable in expectations.

CATHLAMET, WASHINGTON.

SIR:

Every radio fan likes to fish for DX. If he does not do this for the sake of the program, he does it so he can log the station, and tell his friends about it.

On the Pacific Coast, there is yet another angle to the DX proposition. There are few broadcasting stations in this locality that broadcast good programs night after night. This is principally due to the lack of financial backing, I believe. There are many more stations in the East that are run by large corporations, etc., which can afford better musical talent, better speakers, and the like. Also, in the East, there are many more stations to choose from. For these reasons, the western fan often tries to get Eastern stations.

The following excerpts, having to do with any and all subjects are gleaned from marginal notes on the questionnaire replies:

Radio plays are never tolerated. It is some-



FORD AND GLENN

Formerly of WLS, now of WLW, seeking recreation between times. It's Ford's next move. Thank the powers that be, that no one has taken to broadcasting checker matches!

thing that requires undivided attention. If the phone rings or a neighbor drops in or the baby yells you are bound to lose the thread of the plot and it is thus marred. Likewise it must be tuned-in at the commencement of Act. I

I agree with your views in a recent number of RADIO BROADCAST that educational matter is no good over the radio. If I wish to obtain information on any subject I prefer to look it up at my leisure in some authoritative work and do not want to have it thrust at me through the loud speaker. My radio is for entertainment and entertainment only.

You answer this one, Doctor Wallace. What would the average receiving set be like to-day if there had never been any so called DX hounds?

I certainly agree with you regarding the reading of prepared speeches, especially by the man whose eye cannot travel in advance of his lips and see the periods, semi-colons, and commas. Even Mr. Work the other night in the bridge game, master of the subject though he is, would slide over a period, hesitate and then go back and pick it up.

I do not like radio plays because the performers all speak in a tone of voice that is not natural, which spoils the whole thing for me. I have listened to many plays and it seems that all the various players have assumed the same style of speech, which is a type that no one has

Corporation stations broadcast forever without interference from Congress, bloopers, peanut whistles, static and fading and that *Chicago will not be permitted to have more than 84 1/4 per cent. of the radio stations in this country*

—Simply hate those so-called owls, nighthawks, etc., whose programs seem to mainly consist of a bunch getting together to laugh at their own supposedly funny sayings.

—A suggestion, let each program manager spend two full evenings a week listening-in. Let him note the miserably monotonous duplication of popular numbers. Let him get as sick of the popular stuff as some of the rest of us are. I can enjoy this type of music as well as the better class—but—to hear the same thing night after night, perhaps several times an evening, done by mediocre performers, spoils for me what would otherwise be a perfect type of home entertainment.

The broadcast of actual events is best, such as football, church services, conventions, banquets, etc. The greatest thing about radio is that it brings the world to our home. Our victrola still plays better music, orchestral, vocal, etc. But the radio is something *real, alive, actual,*

the goose that is now laying the Golden Egg. The bum saloons killed their own business.

Further:—I am persuaded that only the *very best* is worth broadcasting, and no good-will publicity is secured by anything short of the best. Indeed I regard certain parties as ill bred pests and purposely avoid them.

—I've been "curing" t.b. here in Saranac Lake for over six years and you can imagine what the radio means to me and the others like me up here. Probably my preference for sports is because I can't indulge in anything more strenuous than a little walking or fishing myself.

—As a subscriber let me ask you not to be too hard on the travelogues. Almost everyone is a potential traveller, and yet the opportunity comes to very few of us. One of the features that I wouldn't miss is the Thomas Cook travelogue from wjz. Maybe the music doesn't fit the location being described but some of us who don't know any better get a kick out of it anyhow.

—Wish I could cast six thousand votes for good music, whether instrumental or vocal, to offset the more numerously expressed votes of the noise lovers.

There is too much striving for highbrow effect, while the average family about the fireside wants to be entertained, not forcibly educated. Even jazz and radio fun is a relief when one is tired. —If the National Broadcasters give me the best



BURR MCINTOSH

KHJ's "Cheerful Philosopher" who reads poems and chats informally with his clientele on Sunday nights

*Compliments of the Season  
from the Officers and Members of  
Victoria Radio Club  
to their twelve most popular stations:*

FEATURES REMARKED	
CNRV . . .	General excellence
KJR . . .	Henri Damski and His Orchestras
KFOA . . .	Afternoon Programmes
KOMO . . .	Power Plant Engineering Co. Programmes
KOWW . . .	Organ Recitals from American Theatre
KGW . . .	Hoot Owls
KPO . . .	Rudy Seiger, Waldemar Lind and Atwater-Kent Programmes
KFI . . .	Simultaneous Broadcast Atwater-Kent Programmes
KGO . . .	Light Operas, Arion Trio and Richard Henry Jackson
KTAB . . .	General excellence
KOA . . .	General excellence
KSL . . .	Male Choir

COLLECTIVE THANKS

The Victoria Radio Club, an organization of some 300 listeners in Victoria, British Columbia, sent the above card to its favorite stations last Christmas. The stations were selected by the officers and directors of the club and only stations or features receiving a unanimous vote were selected. For over two years at each monthly meeting of the club a vote has been taken for the popular station for the preceding month, and the secretary instructed to write the station getting the most votes

bringing great minds, great voices, great personalities, great happenings, great thoughts, great news events, etc. to us all, wherever we are.

All ailing and dying sopranos should be put out of their misery. I prescribe drowning.

I have a lot of other things on my chest. For instance, I do quite a bit of gardening during the summer, but after having been annoyed all winter by station KMA fuzzing up KFI and WJZ I never again expect to be in the mood to buy as much as a nickel's worth of canary bird seed from May or Field. I feel the same way about KOIL and KTNT and numerous others. As local stations they may serve a useful purpose in their community, but they are an irritation to all the rest of the country. Let them reduce power to 100 watts and get back out of the way.

I believe the multiplicity of stations and the general poorness of the programs is going to kill



PAUL STEINDORFF

Conductor of the KGO comic opera company

heard in real life, and I find one that is very hard to understand by radio. To make a thing interesting make it true to life and then every one can understand it.

Why do you not try and get information as to the listeners' attitude towards chain broadcasting, interference, and wave jumping? I myself do not believe in 15 or 20 stations broadcasting the same program simultaneously. I will not make comments on the other two evils other than to say that I am in favor of any radio act that will clear the air without giving the air over to the chain broadcasters, that they may get rich at the public expense.

The three punkest pieces ever written are Handel's "Largo" (he must have written this one Monday A. M. when he had an awful skull on him), "Deep River" by Burleigh, and "Mighty Lak a Rose." Come again.

In our house each number is awaited hopefully—and when one comes bearing that elusive quality that we call 'artistry,' it gets undivided attention. Let's stress this 'artistry' thing! Most anything *can* have it, be it even saxophone, banjo, uke solos, and the like.

Why not have more Gilbert and Sullivan Comic Opera, especially the Mikado. *Less* talk by the announcer and less explanation, which usually takes as long as the music.

Trusting that Congress stops gassing, and gets busy on radio legislation of the proper kind, and hoping that KDKA, WJZ, WEAJ and all Radio

possible programs, I am for them and all the stations they care to hook up. I do not worry in the least about the so called Radio Trust. America is bigger than the biggest trust.

—What is the matter with the English language? The announcer introduces a noted singer—giving the title to a song you would care to hear—and all of a sudden out comes some foreign language and the song is about as interesting as a cat's midnight serenade.

—I do not believe that singers of great rep. get over even as well as some average voices that seem adapted to broadcasting.

—Don't like: Jazz, nor jungle music of any kind; Singers with lumps in their throats; "To a Wild Rose"; Victor Herberts Compositions; Political Talks (They're such liars); Sloppy, mushy songs; Foreign Travel Talks.

In conclusion, I believe that 75 per cent. of the stations now operating are serving no useful purpose, except perhaps to a very limited audience, if any, and the vast majority of listeners would no doubt prefer fewer and better stations.

I appreciate high-grade classical music but I must confess that I listen to it through more or less of a sense of duty when possibly I would rather be tuned-in on the better broadcasters of popular music. Jazz is good when it is not overdone. I am glad to see that there is a tendency to revive some of the older popular music like the Strauss waltzes, Gilbert and Sullivan, etc. The younger generation does not get much of a kick out of these however, as they do things

different now. But anyone that has waltzed round the floor with the girl he adored to the strains of the Beautiful Blue Danube, The Sirens, Illusion, etc., sure will stick out his ears when he hears one of these on the air.

**The Highly Condensed Newspaper Radio Program**

**W**HAT I crave," writes Pro Molto Gigolo, "is the job of the fellow whose daily task it is to make that list of agate lines telling us what to expect to-night from this, that and the other of twenty to fifty radio stations. Such ingenuity! Such a vocabulary! Such a wealth of synonyms, antonyms—all breeds of nym's!

"Look at these examples of the art that is his. Here, for instance, against 7 o'clock, what does his talent dictate should be announced?

7:00 P. M.—Musical program

"Then—look at 7:15! Do you see? Begin to appreciate his tremendous fecundity? Does he repeat himself? Ever? Is it 'musical program' again? No, sir! It is:

7:15 P. M.—Program of music

"But—go down the list. See for yourself. Appreciate for the first time, perhaps, the presence of unpretentious, unannounced genius in your midst—and realize how, at last, newspaper work calls with throbbing gulps to my latent, atrophied abilities—too late, perhaps! Alas, perhaps too late!

"Here! Read—and weep with me:

- 7:25 P. M.—Tea music
- 7:30 P. M.—Dinner music
- 8:45 P. M.—Orchestral
- 9:00 P. M.—Musical ensemble
- 9:15 P. M.—Vocal music
- 9:25 P. M.—Music by voices
- 9:30 P. M.—Male Quartet

"Then, marveling this far, look at this next touch! Genius, I call it!

9:40 P. M.—String

"Now, for suspense, can you better that? All accomplished by one word, too! Can't you picture every one of New York's 1,139,623 radio listeners chaffing at their dials—impatient for 9:40 to tick around—that they may know, at last, what that one word means—whether it refers to beans, Christmas bundle wrappings, or whether it is just the lister's little practical joke.

"Are you convinced? Run down the list—of each station—each with different programs, thereby multiplying the demand upon the ingenious lister to avoid repetition. And this every day! Can he hold up long under it:

- 9:50 P. M.—Concert orchestra
- 9:55 P. M.—Trio
- 10:00 P. M.—Concert
- 10:10 P. M.—Instrumental trio
- 10:20 P. M.—Choral
- 10:30 P. M.—Musical group
- 10:45 P. M.—Ensemble
- 10:55 P. M.—Duets
- 11:00 P. M.—Dance Orchestra
- 11:30 P. M.—Orchestra for dancing
- 12:00 M.—Orchestra program
- 12:30 A. M.—Test program—music
- Early programs to-morrow
- 10:00 A. M.—Program for musical students
- 11:00 A. M.—Talk with music

"To this age's great men, add the first professional program lister! To our newspapers, the gratitude of this one humble aspirant, for devoting their white space at last to a fling in the realm of imaginative service."

**F**ORD and Glenn, formerly of WLS, are now on the staff of WLW. They are on the air at noon, every week day, with a "dinner bell" feature intended especially for the farmers. Every night except Friday, Cincinnati's silent night, they stage their justly renowned "Lullaby Time," at 8:00 Eastern Standard Time. Their Sunday night programs are at 7:20 and 10:00 and they are scheduled further for two afternoon programs a week.

**W**GN is repeating its series of "Old Time Prize Fights." If you did not hear them last year they are well worth watching for. Various championship bouts of the last decade are re-created in the broadcasting studio and Mr. Ryan's announcing effectively puts across the illusion that the battles are actually taking place.

**W**OW is conducting a world's championship laughing contest. The contest is open to all men, women, and children who think they have world-beating laughs. Which strikes us as a swell idea, providing the laughs still sound like laughs after their journey through the ether—which is not always the case.

**W**EAFF was on the air 3834 hours and 45 minutes during 1926, an average of 10½ hours every day during the year.

**THUMB NAIL REVIEWS**

**W**OC—The Moline Plowboys singing nice, sugary harmony—nothing subtle but good straightforward stuff.

**W**BZ—John Charles Thomas singing in a Maxwell Coffee Concert. An excellent baritone voice, and one well adapted to broadcasting.

**W**QJ—Jimmy Maloney and Harry Geise in

yiddish dialect tomfoolery and nonsense songs. First rate comedians. The soulful ditty "By the Side of the Omelette Sea" being especially amusing and worth repeating.

**W**BBM—Lee Sims sitting at piano and rambling from one tune to another with nice modulations between, and fancy variations and improvisations. The station announcer guessing at the titles as the pianist proceeded.

**W**JZ—"Don Amaizo, the Wizard," a new series of broadcasts dealing with a character who is supposed to be mute, answering questions and telling his own story through a violin "gifted with the power of speech." Terrible. Too much talk and not very good violin playing.

**K**FQB—After telling us their telephone number and assuring us that out-of-town listeners could communicate with them by Western Union or Postal Telegraph, and further, after dedicating the next number to some lady in Waco, we were rewarded with a violin soloist playing at "Mother Machree"!

**W**EAFF—(and everywhere else on the dial!) The Chicago Civic Opera broadcasting the "Garden Scene" from its performance of Faust on the stage of the Auditorium Theater. The most ambitious, and so far most successful attempt yet made to broadcast opera from an opera house. A thorough technical preparation was made, fifteen microphones were employed, and wires carried the broadcast to New York City from whence it was distributed as far west as Kansas City and south to WHAS, WSB, and WSM. The orchestra came through in excellent fashion, the singers better than ever before, but still with a trace of the mugginess incidental to all theater broadcasts. It is our pessimistic guess that broadcasts of large bodies of singers in large auditoriums will never be an unqualified success. The studio broadcasts of the same thing, even with a less redoubtable roster of stars, are generally pleasanter to listen to.

PHONE. RECTOR 88

**Phoenix**  
Non-Smut  
**Carbon Papers**

*The Kind the Copy's  
Always Clear*

**E. L. COTTELL, Inc.**  
35 Broadway,  
New York

*Used by the*  
**United Wireless Telegraph Co.**  
ON BOARD THIS STEAMER



**THE  
C. Q. D.  
CALL**

Will always bring a prompt response so long as Robbins and Myers Motor-generators are on duty at the wireless stations.

We make a complete line of direct current motors for every motor use—1-30 to 15 h. p.

Let us tell you how one of them can save you money

**The Robbins  
& Myers Co.**  
Springfield, Ohio.  
145 Chambers St., N. Y.

ADVERTISEMENTS IN A SHIP WIRELESS NEWSPAPER OF 1906  
The *Aerogram* was sold by the operators of the United Wireless Company aboard many of the ocean ships equipped with their system. It was a "wireless" newspaper, but a lot of the material was printed ashore before the vessel left port

# A 20- 40- 80-Meter Transmitter

*How to Make an A. C. Operated Hartley Transmitter for the 15,990, 7496, and 3748-kc. Bands—Two, Three, or Four Tubes May Be Used*

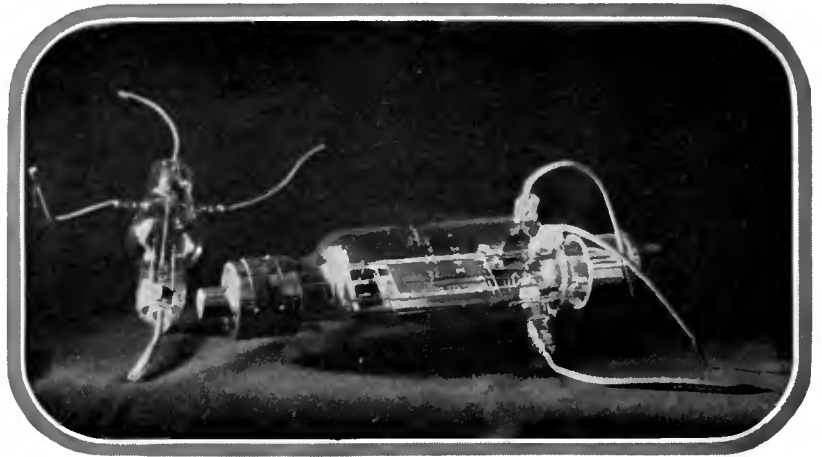

TWO TRANSMITTING TUBES

Among other interesting tubes that DeForest makes are the two transmitting tubes shown above; one is high-powered with an in-put rating of 250 watts, and the other is the H tube with an in-put rating of 150 watts

By **KEITH HENNEY**

*Director of the Laboratory*

IN THE April, 1926, RADIO BROADCAST, there was described a simple short-wave transmitter designed from the standpoint of portability and powered from B batteries. It was with this outfit that 2 GY, the experimental station operated by the Laboratory, made a record of over 26,000 miles per watt power input to the plate, during the winter of 1925. The circuit employed was of the well-known Hartley form, perhaps the simplest of oscillating circuits, and it is shown in Fig. 1. Some additional notes on the operation of this circuit were given in a subsequent article in the November RADIO BROADCAST, and in this latter article the adjustments necessary for maximum output and maximum efficiency were outlined.

So many letters have come to the Laboratory requesting design data for this transmitter and a source of plate and filament power that would do away with the batteries that the following article has resulted.

The complete transmitter, oscillator and rectifier, is on a single baseboard, and no attempt has been made to make the thing a work of art. There is no panel—no unnecessary knobs—and short direct leads prevail throughout. The power enters the equipment at the right and is fed into the antenna at the left. As shown in the photographs, it is a complete transmitting equipment, capable of being set up quickly in any place where alternating current is available.

There is no reason why the tuned-plate tuned-grid circuit could not be used if the amateur desires, but the Hartley requires a minimum of apparatus and has enough variable factors so that the user may find the best adjustment to suit his particular tubes and antenna-counterpoise system.

With the present layout one can manage with only two tubes, one oscillator and one rectifier, thereby reducing the cost somewhat. The transmitter described, however, has four tubes, two paralleled oscillators and two rectifiers. If one wishes, he may start with the two

tubes only and, at some future time, enlarge to three or four as described, this necessitating only a few simple readjustments.

This outfit, with the four tubes, will put about half an ampere into an antenna-counterpoise system consisting of a single wire more or less vertical and with an overall length of about 60 feet. This half-ampere will represent an input

to the plates of the oscillator tubes of about 75 watts. With a half ampere on the forty-meter (7500-kc.) band, one should be able to work across the United States without any difficulty, and reports will show that a good "r. a. c. note" is being received.

## TUBES

WHILE the transmitter illustrated has been used chiefly with tubes of the 210 type, amateurs desiring somewhat greater output may use the DeForest "H" tubes which are attracting considerable attention. These tubes, illustrated in a photograph on page 571, are rated at 150 watts, and will stand 1500 volts easily

The "H" tubes are designed to dissipate considerable heat at the plates and to have an extremely low capacity between elements; this latter feature is essential for very short wavelength work and for efficient circuits. In tubes of large grid-filament capacity, considerable current flows across this reactance so that the grid current (high-frequency) may be the factor limiting the power handling ability of the tube. Wide separation between elements means that high voltages may be used safely. Other tubes that have been successfully used in the Laboratory are of German make, known as Tobe MS-1V. A table giving some data on transmitting tubes is given on page 571.

## THE CIRCUIT

THE Hartley circuit is shown in Fig. 1, and here is adapted for battery operation. When alternating current is used on the filament, a transformer with a center tap is necessary, and, instead of connecting the negative B to one side of the filament, it is connected to this center tap. This is also true of the grid return.

Keying may be accomplished by interrupting the negative B lead, or it is possible to key in the primary of the power transformer in case the

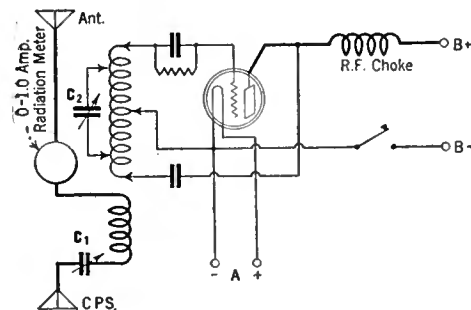

FIG. 1

This is the fundamental Hartley oscillator circuit and is adapted here for battery operation. Note that the antenna counterpoise system is coupled to the oscillator at the plate end of the inductance

## Facts About This Transmitter

Circuit, Hartley  
 Total Cost of Apparatus, About \$100  
 Power Input to Plates, 75 Watts  
 Total Power from Mains, 125 Watts  
 Average Range on 40 Meters (7496 KC.), 1000 Miles

Number of tubes: Four: two UX-210 oscillators and two 216-B rectifiers. One only of each may be used if desired.

This transmitter carries its own filament and plate supply all on one baseboard. Wherever a. c. is available, this outfit may be placed in operation in about five minutes. All that is necessary is an antenna and counterpoise, and someone with a good "fist." A similar transmitter is now in operation at 2 EJ and 2 GY, stations operated by the RADIO BROADCAST Laboratory. It will operate on any of the amateur wave bands. Much of it can be made at home, as described.

filament voltage is derived from another source. In Fig. 2 another scheme of keying is used which on the whole is somewhat better than that shown in Fig. 1. It consists in opening the grid leak, resulting in the grid piling up a negative charge and decreasing the plate current. The key contacts in this case will have practically no power

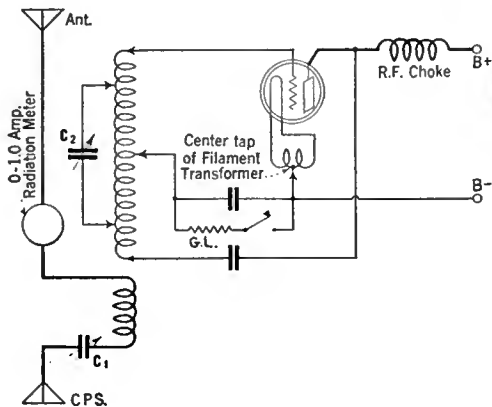

FIG. 2

There are various methods of keying a small transmitter. In Fig. 1 the negative B battery lead was broken. In this diagram the grid leak circuit is opened. This latter method has the advantage that the d.c. voltage across the key is small

to break. Here the grid condenser is placed in the center tap to the inductance so that the key leads will be at comparatively low potentials. If the key is placed at some distance from the set, a choke coil may be inserted in its leads to prevent absorption of energy. Such a choke is included in Fig 5, and is indicated as L<sub>4</sub>. It is not mentioned in the list of parts. It is better to use a simple relay situated near the set itself.

The power supply of this outfit consists of a high-voltage transformer, a rectifier tube (or tubes in this case), and a filter. The transformer can be of any standard make, such as Acme or Thordarson, and for full-wave rectification with two tubes, a center tap must be provided. The secondary voltage each side of the center tap should be about 550 volts for a 210, and up to 1500 volts for an "H" or a 50-watt tube.

Another transformer that can be used is the Amertran PF-52, designed for power amplifiers. This has two windings designed to heat the filaments of 210 and 216-B tubes without using rheostats, and a high-voltage secondary of 525 volts. This transformer cannot be used for full-wave rectification, however, since it has no high-voltage center tap. Other good transformers are the Acme 200 and 300 which have filament windings with terminal voltages of 10 so that resistances must be used to reduce the voltage for 216-B and 210 tubes. The following table gives data on several transformers:

TRANSFORMER	PLATE VOLTS EACH SIDE OF CENTER TAP	FILAMENT VOLTS	PRICE
ACME 200	750, 550	10	\$20.00
ACME 300	1100, 750	10	\$25.00
ACME 600	1500, 1000	12	\$33.00
AMERTRAN PF-52	525 (NO CENTER TAP)	7.5	\$18.00

As indicated in the diagrams, the center of the filament winding of the rectifier tubes forms the high-voltage lead, while the center of the plate winding is the negative lead. A capacity

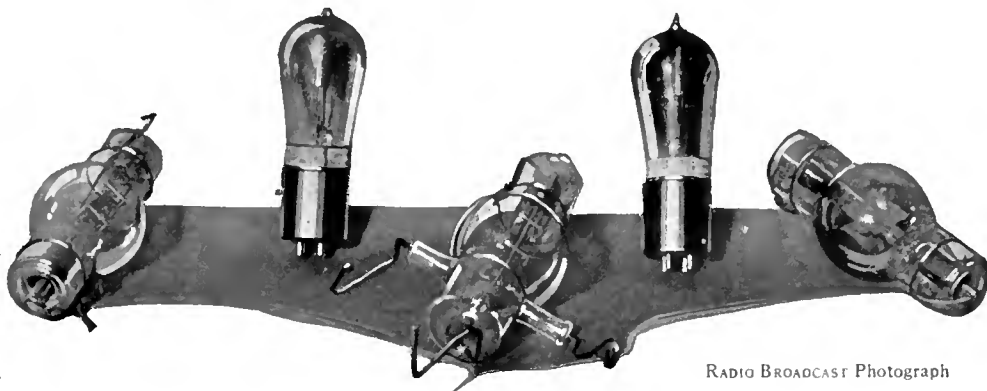

MORE TRANSMITTING TUBES

Among the tubes that have been used successfully as oscillators in the transmitter described are the DeForest H tubes, one of which is shown in the center of this group. The two rectifiers, at the extremes of this photograph, are also of DeForest make and may be used successfully here. The two other tubes shown are German, with an 8-watt rating

of about four microfarads should be placed across the inside of the filter, and of two microfarads across the output, to give a good note. These condensers must stand considerable voltage. Those used in the present transmitter are Sangamo Series B (designed to operate in 500-volt a-c. or 1000-volt d. c. circuits). Other good condensers are Tobe Deutschmann Type 1020 and 2020 for 1000 and 2000 volts respectively, and the American Electric Mansbridge type condensers, rated at 1250 volts. Dubilier

liver about half the power of the full-wave one and will not have so good a note, but will be entirely satisfactory for a low-powered set. At the Laboratory, the Amertran PF-52 transformer circuit with one 216-B and one 210 oscillator has transmitted 1000 miles consistently. With two 216-B's and two 210 oscillators, operating from 750-volt taps on an Acme transformer, such as shown in Fig. 3, A, communication was maintained with a steamer off the Amazon River from station 2 EJ at the

Laboratory. With two DeForest "HR" rectifier tubes and one "H" tube with 1100 volts, 2 EJ worked 1AR at Rio de Janeiro with a report of R5. The input was then 75 watts. With 85 watts input a report of "R6 d.c." was received from 6 RA, Johannesburg, South Africa, on February 14th. Johannesburg is more than 7000 miles away.

There is no particular difficulty with regard to the layout of the apparatus. The photographs give a good idea of where the various parts are placed, while Fig. 5 gives the complete circuit diagram of the transmitter-rectifier. As stated above, the rectifier part of this circuit may be substituted by the circuit in Fig 3, B, using only one rectifier tube.

TUBE	FILAMENT VOLTAGE	FILAMENT CURRENT	PLATE VOLTAGE (MAXIMUM)	PLATE CURRENT MILLIAMPERES	PRICE
210	7.5	1.25	750	65	\$ 9.00
216-B	7.5	1.25	750	65	\$ 7.50
MS-IV	6.0	2.2	800	40	\$ 6.00
DEFOREST "D"	10	2.35	1000	50	\$12.00
DEFOREST "H"	10	2.35	3000	50	\$18.00
DEFOREST 15-WATT	7.5	1.25	750	50	\$ 9.00
DEFOREST "HR"	10	2.35	3000	150	\$16.00

and Faradon condensers are also well-known for this kind of work.

If the Amertran transformer is used, or if the constructor uses only half of the Acme, only one rectifier tube is necessary. Such a circuit is shown in Fig. 3, B.

The single-tube (half-wave) rectifier will de-

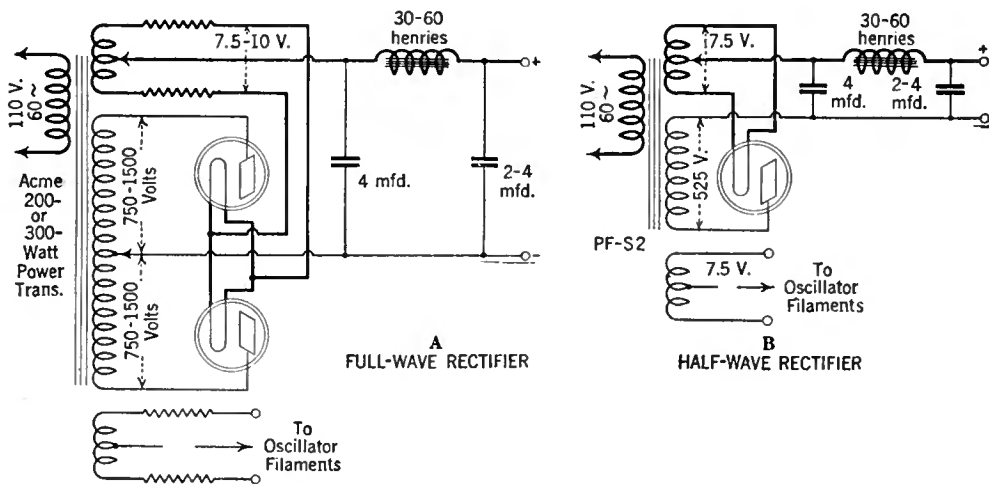

FIG. 3

A full-wave rectifier, as shown at "A," will deliver more power to the oscillator and result in a better note than will be possible from using a half-wave rectifier. The condensers should be as large as the amateur's pocket book will permit. The chokes naturally must have high inductance and low resistance



It must be remembered that the oscillating circuit may have large currents flowing in it. This means that the inductance and leads connecting it to the condenser should be well insulated and of heavy construction. Under the conditions of maximum output, with about 50 watts input, the oscillating current will be well over one ampere. The leads connecting this circuit to the tube are not so important. The tube may be considered as a device which merely places a voltage across the coil-condenser combination. Little current should flow to the tube.

It is a good idea to tune the plate part of the inductance rather than the grid end since the circuit will in general be more stable if this is done. This makes it possible for one side of the condenser to be grounded to the center tap and thereby simplify tuning. To tune to the 7496-kc. (40-meter) band, the maximum capacity will be about 0.00025 mfd. while a 0.00035 mfd. capacity is needed to tune to 3748 kc. (80 meters). In the latter case, the condenser must be placed across the entire coil.

Ordinary variable receiving condensers may be used although the use of double-spaced ones is advisable, especially when higher voltages are placed on the tubes—when using "H" tubes, for example. Double-spaced condensers are regularly made by National, Cardwell, General Radio, Hammarlund, and others.

No trouble has been experienced with small Sangamo fixed condensers when voltages up to 750 have been used, especially when two are connected in series. With higher voltages, condensers such as those made by the Wireless Specialty Apparatus Company and others, are desirable.

The grid leak for 210 tubes in this circuit should be between 5000 and 15,000 ohms, although greater efficiency and a better note seem to result with a high value of leak. The radio-frequency chokes may be of any type, provided they have natural wavelengths in excess of the longest wave to be generated in the oscillator tube, and provided that their distributed capacity is not large. Chokes of 100 to 200 turns of small wire, say No. 30, on a one-inch tube, have been used successfully at 2 GY for L<sub>3</sub> and L<sub>4</sub> in Fig. 5. Some very small and neat chokes are now being made by Cardwell.

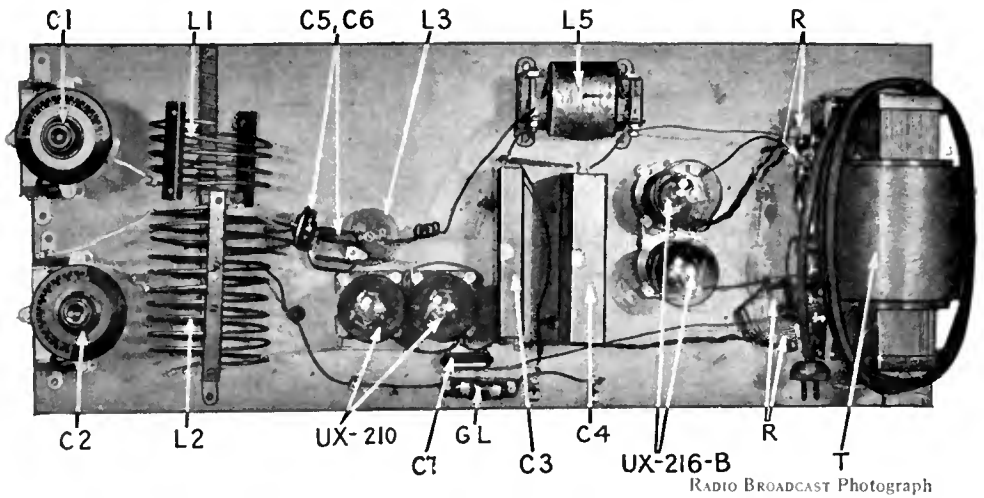

THE LAYOUT OF APPARATUS

This photograph gives a good idea of the layout of a complete transmitter and power supply. For operating on the 40-meter (7496-kc.) band, the present position of the leads to the inductance, L<sub>2</sub>, will be entirely satisfactory. It was with this layout at 2 E<sub>1</sub> that communication was had with a steamer off the Amazon River when the input to the two oscillator tubes was about 75 watts

RADIO BROADCAST Photograph

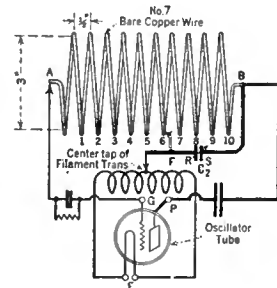

FIG. 4

By following this picture and the small table, amateurs building this transmitter can place it in operation on any desired band without owning a plate meter or an antenna meter, both of which, however, are desirable and necessary if maximum efficiency or power is desired. Note that to cover the 80-meter (3748-kc.) band the tuning condenser must be across the entire coil. If the capacity of C<sub>2</sub> is 0.00025 mfd., the settings as shown in the diagram will be correct for 40 meters (7496 kc.)

Meters	C <sub>2</sub>	G	F
20	0.00015 mfd.	5	7
40	0.00025 mfd.	A	6
80	0.00035 mfd. across entire coil	A	4

FILAMENT RESISTANCES

WHEN operating 7.5-volt filaments from a source supplying a terminal voltage of 110, such as is the case with the Acme transformers, some means of lowering the voltage must be provided. A separate filament lighting transformer has the advantage that a rheostat may be used in the primary as a logical solution. It is not possible, however, to use a rheostat in the primary of the transformers specified here unless the consequent lowering of the plate voltage supply as well as the filament voltage is not considered a handicap.

In the Laboratory, resistances (R in Fig. 5) were provided for each leg of the filament to drop the voltage to 7.5. A Patent six-ohm rheostat was torn apart and the wire straightened. With two tubes drawing 1.25 amperes each, the proper length of wire was found to be about nine inches for each filament lead. Since 210 and 216-B tubes operate anywhere from 6 to 7.5 volts on the filament, the exact length of wire is not important as long as each leg has the same resistance. If 9 inches of a 6-ohm rheostat wire are in each filament lead, the voltage will be not over 7.5 nor less than 6. If only one oscillator or one rectifier is supplied from a 110-volt winding, the wire must be twice as long.

The table in Fig. 4 shows the proper places for the variable connections on the inductance for operation on the various bands, and in case the builder has no plate milliammeter or even an antenna meter, he may follow this illustration with the assurance that his transmitter will work satisfactorily on the bands listed in the table. The grid leak is, as previously mentioned, not critical although higher values increase the negative bias on the grid, lower the grid and plate currents, and increase the efficiency generally. With the connections to the inductance made in accordance with the diagram in Fig. 5, and the accompanying photographs, the transmitter will be set for 40-meter (7496-kc.) work.

The proper place to insert a plate milliammeter is in the negative B lead, as shown in Fig. 5, and with two tubes operating from 750 volts, this meter should be able to read about 150 milliamperes.

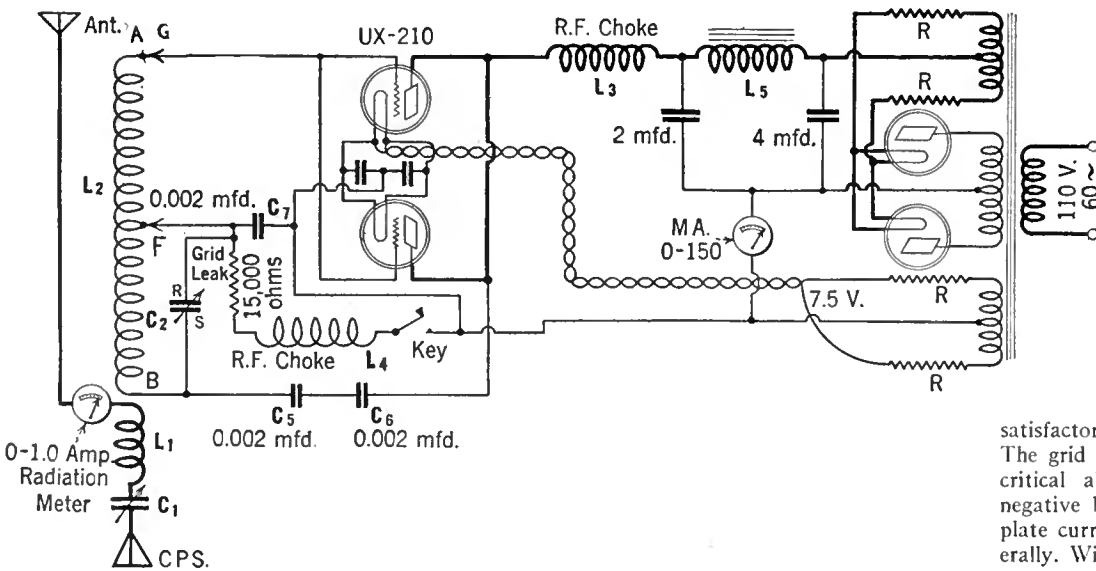

FIG. 5

This is the complete circuit diagram for a full-wave rectifier using 216-B or DeForest "HR" tubes and two oscillators, which may be 210's or DeForest "H" tubes. At 2 GY, with an antenna whose natural wavelength is 47.5 meters, or 6312 kc., communication has been maintained all over the United States and with several foreign countries. The antenna current with this set was as follows: At 42.5 meters (7054 kc.).....0.6 amperes; At 40.0 meters (7496 kc.).....0.50 amperes; At 37.5 meters (7995 kc.).....0.41 amperes; On 40 meters (7496 kc.), the total antenna resistance was approximately 60 ohms

Those who desire may use commercial inductances, such as those of the Radio Engineering Laboratories, with good success. These coils were included in both of the transmitters designed by the Laboratory for the Dyott-Brazil expedition. The coils used in this transmitter, however, were made by winding No. 7 bare copper wire on a three-inch form. The secondary coil in the original set had ten turns, and, with a 0.00035-mfd. condenser across it, it was possible to tune to as high as the 80-meter (3748-kc.) band, as Fig. 4 indicates. The primary coil has four turns of the same wire on a similar diameter. The following list of parts includes several pieces of apparatus that can be made at home, viz. inductances and chokes:

T <sub>1</sub> —Acme Power Transformer, 300 Watts . . . . .	\$ 25.00
4—Sockets . . . . .	4.00
2—UX-210 Tubes . . . . .	18.00
2—UX-216-B Tubes . . . . .	15.00
C <sub>4</sub> —4-Mfd. Sangamo Series B Condenser . . . . .	4.00
C <sub>3</sub> —2-Mfd. Sangamo Series B Condenser . . . . .	2.50
L <sub>5</sub> —Amerchoke . . . . .	6.00
C <sub>5</sub> , C <sub>6</sub> , C <sub>7</sub> —Sangamo 0.002-Mfd. Condensers . . . . .	1.50
C <sub>1</sub> , C <sub>2</sub> —Double-Spaced Cardwell Condensers . . . . .	14.00
L <sub>3</sub> —Radio-Frequency Choke . . . . .	1.00
G. L.—15,000-Ohm Resistance . . . . .	1.00
L <sub>1</sub> , L <sub>2</sub> —Inductances, Radio Engineering Laboratories . . . . .	12.00
R—6-Ohm Rheostat (Dismantled) . . . . .	1.00
Radiation Meter, 0-1.0 Amps. . . . .	7.75
<b>Total</b>	<b>\$112 75</b>

Coupling to the antenna should be loose enough that the tube does not stop oscillating when the antenna is in resonance. This non-

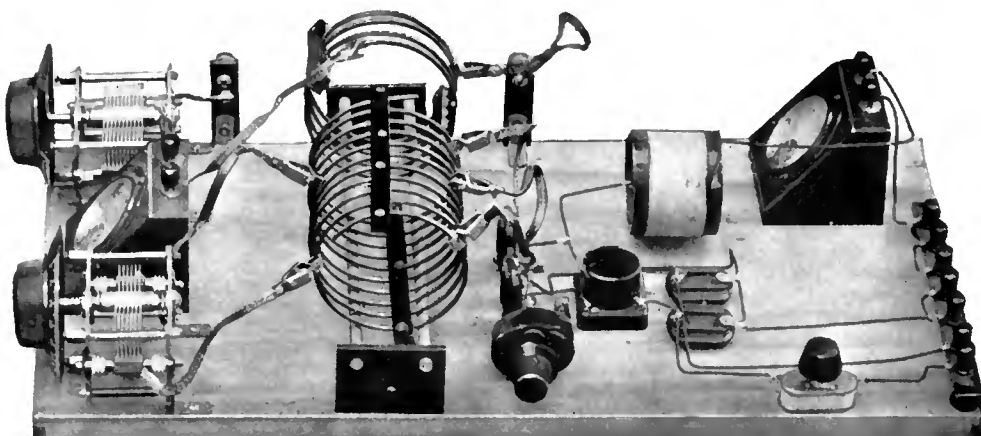

RADIO BROADCAST Photograph

EMPLOYING THE SAME CIRCUIT

An experimental layout used at 2 EJ during the development of the transmitter described in this article

oscillating condition may be evidenced by an audible "sing" in the tube circuit, with undue heating of the plates, and a decided and sudden drop in antenna current. The best adjustment of the coupling will be such that a single resonance peak is observed on the antenna meter—the current increasing slowly at first then rising rapidly to a maximum, and then falling with no sudden breaks. Some care must be exercised in finding this point for, if the coupling is too tight, there will be two resonance peaks more or less close together. It will usually be found that a distant station will report better signals with somewhat loose coupling, due to steadier oscillations. At 2 EJ the coupling is about 2½ inches.

With a plate milliammeter it is possible to estimate the antenna power by the following method: Let us suppose that, with the antenna

disconnected, the plate current is 75 milliamperes at approximately 750 volts. This represents a power input of 750 x .075, or 56.25 watts. Now, with the antenna tuned, suppose the plate current is 100 milliamperes, or an input power of 75 watts. The difference—19 watts—is going into the antenna. This method of calculating the antenna power is not exact though the answer is accurate enough for average purposes. This antenna power, divided by the square of the antenna current, will give the approximate resistance of the radiating system.

This transmitter is flexible enough for any experimenter. At any time larger tubes may be substituted and greater power applied to them. Care must always be exercised, however, to see that the voltage rating of the filter condensers is not exceeded.

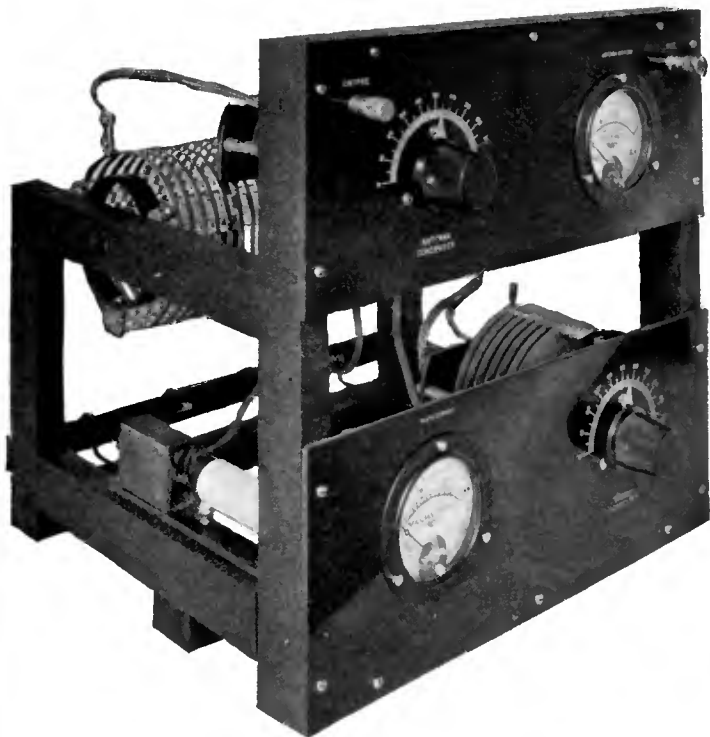

FROM THE RADIO ENGINEERING LABORATORIES

The circuit employed in this transmitter is basically the same as that used in the one described in the article. The R. E. L. equipment shown is eminently satisfactory for short-wave work

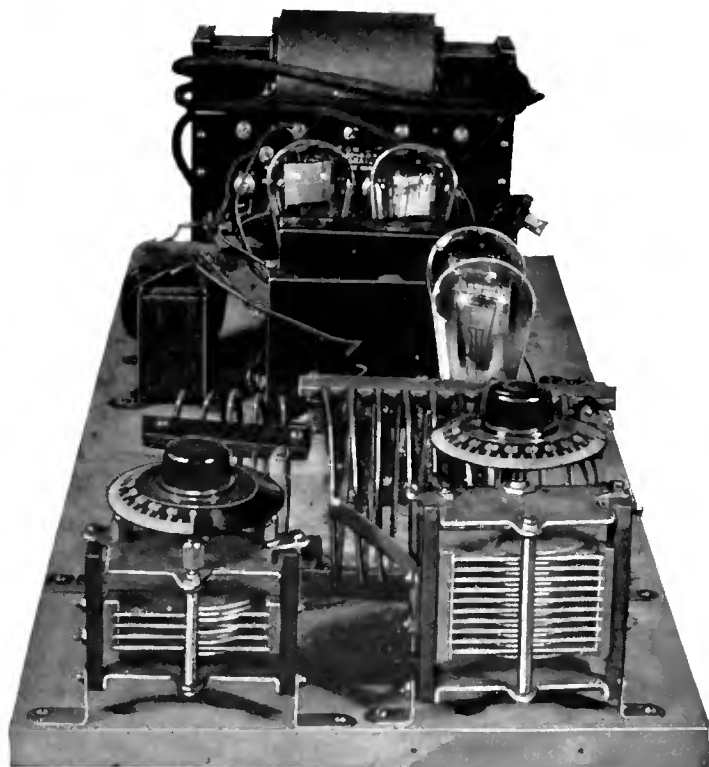

RADIO BROADCAST Photograph

A CLOSE-UP

This is an end view of the transmitter and shows particularly the oscillating and antenna circuits. Note the heavy connection from condenser to inductance

# Judging the Tubes You Buy

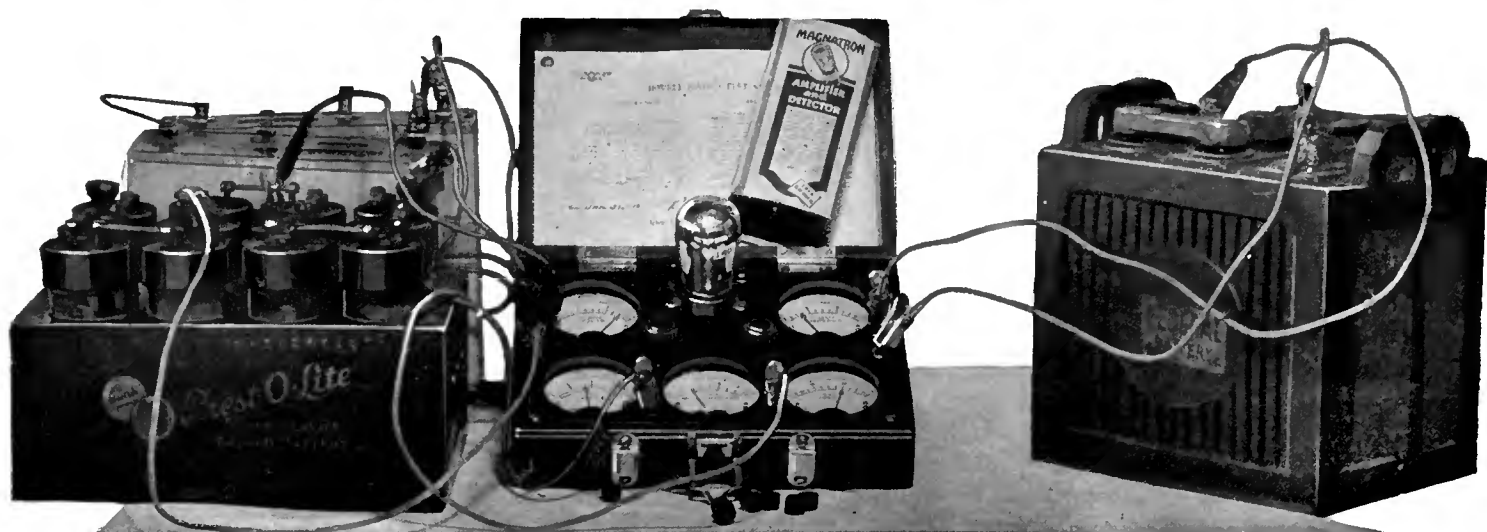

SOME TYPICAL TUBE-TESTING EQUIPMENT

In this set-up a Jewell tube tester has been employed. Although the latter is seemingly considerably more elaborate than the simple one described in this article, it is really not so. The five meters are for reading the plate voltage, filament voltage, filament current, grid voltage, and plate current. In the home-made tester, the first four meters are eliminated, the manufacturers' figures for the batteries and tubes' filament current capacity being accepted as accurate

## *What You Should Know About Vacuum Tubes to Safeguard Yourself When Purchasing Them—Desirable and Undesirable Characteristics: How to Discriminate—A Simple Tube Tester for the Dealer or Fan*

By EDGAR H. FELIX

A RADIO receiver is no better than its vacuum tubes, and they, in turn, function no more efficiently than their power supply permits. The extraordinary rejuvenation which usually follows the renewal of a receiver's tubes bears evidence of their vital influence on quality and volume. A tuner sufficiently sharp to eliminate undesired stations and an amplifier and loud speaker which handle the entire musical range with equal facility, may give unsatisfactory and distorted performance because of the use of the wrong type of tube, of second-rate tubes, or of incorrect grid, plate, or filament voltage supply to one or all of the tubes.

A technical analysis of tube functioning is helpful to the designer of receivers and amplifier units, but it is of little value to the average enthusiast as he goes to a radio store to buy his tubes. There he is dependent on the dealer who is, in part, dependent upon the tube manufacturer. No amount of inspection will reveal whether a tube has adequate emission or whether its plate impedance is precisely that for which a certain receiving set is designed. Only a precision instrument, a tube tester with half a dozen expensive meters, in the hands of a technically qualified person, tells the full truth about a tube. Quite a lot of valuable data as to a tube's condition and characteristics can, however, be obtained with simpler testing equipment.

The most prominent tube manufacturers do not recommend the use of a tube tester by the average dealer because, if improperly operated, or inaccurate, its use is misleading. Only dealers selling a large quantity of tubes are justified in employing the comprehensive measuring equipment necessary to make a conclusive tube test.

Tube manufacturers therefore recommend a performance test, an actual trial of the tubes in the customer's presence, in an operating receiving set.

The buyer of a tube, then, has his choice of: (1) Taking a chance that the dealer will recognize his claim if a tube proves unsatisfactory; (2) of a performance test in a receiver at the radio store; or, (3) of confining his purchases to a dealer of such repute and handling capacity that he can afford to make a scientific tube test with the aid of an efficient instrument. Circumstances, in nine cases out of ten, compel reliance upon the first and most unsatisfactory of these three possibilities because there is no product harder to stand back of than a vacuum tube. When a customer comes to the dealer with a tube in his hand which he states was bought the day before, a suspicious glance is bound to creep into the salesman's eyes. Buyers are not above bringing back a tube which has been paralyzed by an excessive voltage, which has been in use for a period of months, or which has been bought at a cut price because it is a "second," below standard, at another store.

The good way, then, to buy a tube, is to insist upon an informative test before it is accepted. The most conclusive test is made with the aid of a tube tester, which tells, with accurate high-grade measuring instruments, the exact plate, grid, and filament potentials applied to the tube and the resultant plate output current. A chart must be conspicuously in evidence near the tester, giving these essential test specifications for every kind of tube as evidence that the tube tester is being used correctly.

The performance test with a standard receiving set has the drawback that it requires broadcast-

ing of good volume be available at all times of the day, a condition by no means universal. For this reason, the receiving set test is not always possible, however conscientious the dealer whom you select.

Under such circumstances, we are forced to rely upon a tube tester or no test at all. That being the case, an inexpensive tester is needed, which makes an informative test possible. It assures the customer that he is obtaining a tube of accepted characteristics, essential to the efficient and stable operation of most receivers.

### STANDARD TUBE CHARACTERISTICS

THE difficulties encountered in the attainment of uniformity in tube production are simply inconceivable to the lay mind, and it is little wonder that cheap tubes of similar type vary exceedingly in their characteristics. The table on page 576 gives the characteristics of all the different types of tubes that are in general use. Tubes of these types should not vary to any marked degree from the figures given here, especially where their plate current is concerned.

When you, as a customer, hand your dealer the price of a 201-A tube, you should receive a device having a definite plate current output when supplied with its rated filament, grid, and plate voltages. If it fails to measure up to standard, or exceeds established standards, the general belief is that the set in which it is placed merely gives a little greater or less volume. But that is only an incidental result. Indeed, even more than volume, you sacrifice selectivity, stability, and tone quality to a degree dependent upon the deviation of the tube from its supposed characteristics.

Under the circumstances, a really informative tube test is a matter of considerable importance to the purchaser and to the dealer who believes in giving good service. The test made by most dealers for the purchaser is a filament conductivity test. If the tube lights, it is considered satisfactory. This test, however, gives no indication whatever of the way a tube will function in a circuit.

The most conspicuous guide to a tube's efficiency is its plate current output, when the

tube is supplied with its rated filament, grid, and plate potentials, as indicated by an accurate milliammeter. These three supply voltages, however, must be adjusted carefully, if an accurate test is desired. Therefore a separate or combination precision meter, and means of adjustment for each voltage, is needed, in addition to the plate milliammeter. Commercial tube testers, capable of measuring all of these voltages accurately, are beyond the means of a dealer selling only a small quantity of tubes each month.

In the absence of accurate voltmeters to determine filament potential, grid bias, and plate voltage, these voltages may be secured, with some sacrifice of accuracy, from the usual storage A battery through ballast resistances and from dry cell B and C batteries. On this page is shown a circuit diagram of a tube tester equipped with two sockets, sufficient terminals, and switches so that any standard tube may be measured. It can be built by a dealer at a cost of only ten dollars or so. The only indicating instrument required is a milliammeter in the negative B-battery lead, which shows the plate current, no matter what kind of tube is being tested. The accompanying table gives the normal plate current reading for a good tube, the correct socket to use, and the switch setting for every type of standard tube.

An excessively high plate-current reading is as undesirable as a low reading. A tube should give its rated plate current. An excessively high plate current may indicate an exceedingly active filament liberating electrons profusely or, more likely, it indicates a low plate impedance which would cause even a most stable radio-frequency amplifier to oscillate; in an audio-frequency amplifier, it may cause exaggerated resonance points in transformers and loud speakers. A tube showing low emission may be improved by the ordinary reactivation process, but nothing can be done to make a tube giving excessive plate current entirely satisfactory.

Even with the simple tube tester shown, the dealer's salesman can make misleading tests. A UX-201-A for example, should be tested at five volts filament potential, four and a half volts grid bias, ninety volts plate potential, and should, under these conditions, give a two-milliampere reading. If, instead of a four and a half-volt negative bias, the grid return is made to the positive filament lead, the average tube will show a very high plate current. The plate current of power tubes goes up enormously if less than the rated negative bias is applied to the grid. Even in stores doing a large business in New York, the writer has been handed an UX-112 tube with the statement that it is exceptionally good, because it gave nearly twice its rated plate current!

The commercial tube testers are of various types, some having more meters than others. A number of tube testers have a potentiometer for varying the grid bias over a scale of values. By means of a chart, the dealer is supposed to ascertain the change in plate current which should result from this variation in grid voltage.

DATA FOR THE HOME-MADE TUBE TESTER

The following is a list of parts required for the home-made tube tester described in these pages:

1. UX Socket for Dry Cell Tubes
2. UX Socket for Storage Battery Tubes
3. 6-Volt Storage Battery
4. Milliammeter, 1 to 25 Mils.
5. Ballast Resistance, Reducing 6V. to 3V. at 0.06 Amp.
6. Ballast Resistance, Reducing 6V. to 3V. at 0.125 Amp.
7. Ballast Resistance, Reducing 6V. to 5V. at 0.25 Amp.
8. Ballast Resistance, Reducing 6V. to 5V. at 0.5 Amp.
9. Ballast Resistance, Reducing 6V. to 5V. at 1.0 Amp.
10. Grid Potential Switch
11. Filament Potential Switch
12. Filament "On-Off" Switch
13. Plate Potential Switch
14. C Battery, 4.5 volts (Note Special Connections to Obtain 22.5 Volts Bias).
15. B Battery (for C Bias), 22.5 Volts
16. C Battery, 4.5 Volts
- 17, 18, 19. B Batteries, 45-Volt

TUBE	SWITCH POSITIONS			PLATE CURRENT (IN MILS.)
	FILAMENT SWITCH	GRID SWITCH	PLATE SWITCH	
UX-199 . . . . .	F	D	O	AV.
UX-120 . . . . .	G	B	P	2.5
UV-200. . . . .	J	E	M	6.5
UX-200-A . . . . .	H	E	N	1.0
UX-201-A . . . . .	H	D	O	1.5
UX-112 . . . . .	I	C	P	2.0
UX-171 . . . . .	I	A	P	6.0
High-Mu . . . . .	H	E	O	16.0
				1.5

A prominent radio servicing organization in New York, which has more than four thousand regular customers, advised the writer that one of the most frequent causes of trouble is the supplying of incorrect tubes, by dealers, when sets are sold. A careless dealer sometimes gives a customer a power tube to be used with a receiver having no provision for connecting extra grid biasing voltage on the last stage; or he may simply fail to specify sufficiently high B and C battery voltage supply. Such feats of stupid salesmanship may be laid directly at the door of the dealer, but, when a customer purchases a specific tube, he takes full responsibility for its correct utilization. Consequently it is of advantage to know the operating characteristics and the use to which existing tubes are employed to the best advantage. The table on page 576 shows the potential supply which each type requires if it is to function with satisfaction. These should be religiously adhered to.

GENERAL HINTS FOR BUYING TUBES

THE purchaser of vacuum tubes should first satisfy himself that he is using the tubes best adapted to his receiving set; secondly, that he has available a suitable power supply for use with the most desirable tube; third, that he buys the tube from a reputable dealer who will stand back of it. The expression "matching the tube impedance

It is a more complicated test than direct plate-current measurement under fixed conditions and, placing more technical responsibility on the salesman, is less likely to be properly made.

suitable power supply for use with the most desirable tube; third, that he buys the tube from a reputable dealer who will stand back of it. The expression "matching the tube impedance

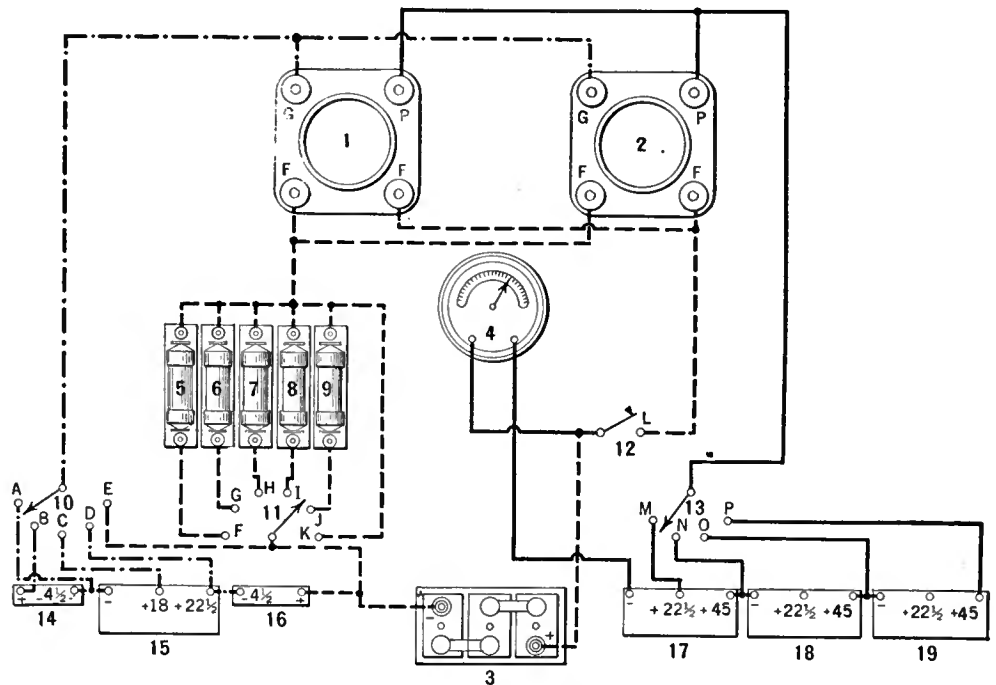

A ONE-METER TUBE TESTER

The 1-25 mil. meter is the only one required for this simple tube tester. The data in the box on this page will help in the construction and operation of this handy tester. The switch positions for the various voltages are as follows: Switch No. 10 (grid bias)—A, minus 27; B, minus 22.5; C, minus 9; D, minus 4.5; E, zero. Switch No. 11 (filament)—F, 3v., 0.06 amp.; G, 3v., 0.125 amp.; H, 5v., 0.25 amp.; I, 5v., 0.5 amp.; J, 5v., 1.0 amp.; K, no resistor in circuit. Switch No. 13 (B battery)—M, 22.5 volts; N, 45.0 volts; O, 90.0 volts; P, 135 volts. It is important that the tube to be tested is not inserted into its socket until all the battery switches have been set correctly, and that the filament switch is left open while changes are made. If this precaution is not followed, blown out tubes, ballast, or meter may result

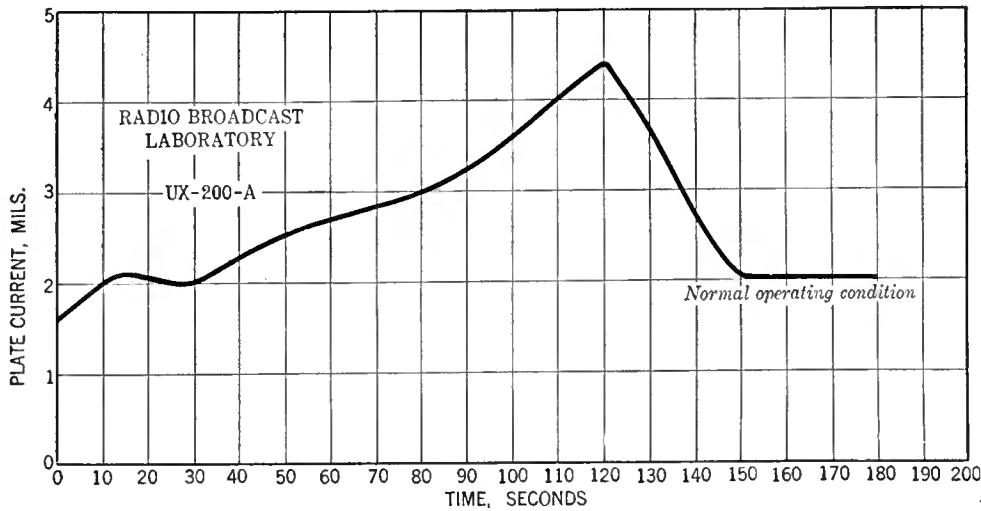

A CURVE FOR A UX-200-A TUBE

Showing how it takes a few seconds after the correct battery potentials have been applied before the tube settles down to normal operating conditions. For two minutes after the set is turned on the plate current gradually increases, after which it drops to its normal value of 2 mils. and stays there

to its output load impedance" is frequently offered as a guide in selecting the correct tube. The fundamental principle behind matching impedance is that any source of power output works best when the load to which it is harnessed is its normal working load. This principle works both ways. A locomotive towing a baby carriage is just as inefficient as a rabbit pulling a freight car. A seesaw works best when the weight on both sides is nicely balanced. When we have unbalance, there is reaction of the load on the power source.

Most radio-frequency amplifiers employ some form of balance for neutralizing the voltages set up through the grid-plate capacity. Whatever method is used to stabilize the receiver, it is dependent for its operation upon the use of tubes of definite and specific plate impedance, amplification factor, and internal capacity. Consequently, the use of a tube which departs from these standards—even a better tube with higher power output—upsets the balance for which the set is engineered. Fortunately, tubes which give normal plate current readings with correct applied voltages are generally normal in their other characteristics. Consequently, the tube purchaser should insist on a tube test which

assures him that his tube is a normal one of standard characteristics.

When excessive plate voltages or incorrect grid voltages are used, the tube impedance changes and conditions for which the set was designed are upset. For example, if a B power-supply device is used which delivers twice the rated plate voltage, the tube impedance is materially reduced, causing the set to howl and squeal. Insufficient grid bias causes a tube to overload easily; excessive bias chokes it and may completely block its output. There is no compromise in the matter of potential supply; it is either correct or else optimum results cannot be obtained.

Tubes which vary greatly from standard, therefore, should not be used, lest there be serious loss in amplification or undue oscillation at the high frequencies. The dealer who hands you a tube and says it is good because it gives an extra large plate current does not know what he is talking about.

One or two other tube characteristics are not identified by measurement tests within the scope of ordinary tube testers. The internal capacity of a tube is determined by the physical proportions and spacing of the tube elements. Unusual

variations from standard, as we have seen, by the use of special types of tubes, upsets any form of neutralization.

One difficulty with tubes is microphonic noises, resulting from physical vibration of the elements. Some control over the frequency at which microphonic noises are experienced is secured by adjustment of filament rheostats. A UX-112 tube used as a detector may sometimes overcome microphonic noise, due to its more rigid filament.

Howling results from a microphonic tube being within close range of the loud speaker. The most effective way to overcome howling due to microphonic tubes is to place the loud speaker at least ten to twenty-five feet from the receiving set, depending on the maximum volume used. The use of sound dampening devices, such as the placing of rubber covers or wooden boxes over the tubes, have been found fairly effective. Set cabinets not tightly assembled are sometimes the real cause of a microphonic tube because they vibrate freely at a certain frequency. The resulting vibration is then passed to the tube elements through the cabinet and socket. Sometimes merely opening the lid of the cabinet stops the trouble.

Another trouble often attributed to the tubes or to defective B batteries is crackling noises similar to static. It is surprising how often that trouble can be remedied by polishing up the A battery leads and carefully tightening all B and C battery connections. A large proportion of the trouble attributed to noisy B batteries and noisy tubes is due to careless set connections made by the set user. When spring clips are fastened on A battery leads, sometimes just squeezing them with the fingers will eliminate set noise. Tube socket prongs and springs should likewise be shined up and inspected occasionally, to make certain of a good connection.

Intelligent tube purchase is therefore a matter of: (1) Selecting the right tube for each purpose; (2) powering the tube with correct grid, filament, and plate voltages; and, (3), purchasing a tested tube which gives normal results as indicated by normal plate current output at its specific operating voltages. The careful purchaser will patronize a dealer who will stand back of the tube after he has purchased it. He will insist upon a tube test of some kind employing, at least, the equivalent of a tester of the type described, or, if possible, a more elaborate and accurate device.

Type	A Battery Volts Supply	Filament Terminal Volts	A Battery Current (Amperes)	B Battery Volts Detector	B Battery Volts, Amplifier	Negative C Battery	Plate Current (Milli-amperes)	Output Resistance (Ohms)	Voltage Amplification Factor	Undistorted Output (Milli-watts)
UX-199	4.5	3.0	.06	45	90	4.5	2.5	16,500	6.25	7
UX-200	6	5	1.0	15 to 25	—	—	—	—	—	—
UX-201-A	6	5	.25	45	90 135	4.5 9.0	2 2.5	12,000 11,000	8 8	15 55
WX-12	1.5	1.1	.25	22½	90	4.5	2.8	15,000	6	7
UX-112	6	5	0.5	45	157 135 112 90	10.5 9.0 7.5 6.0	8 6 3 2.5	4800 5500 8400 8800	8.0 7.9 7.9 7.9	195 120 85 40
UX-120	4.5	3.0	.125	—	135	22.5	6.5	6600	3.3	110
UX-210	8 6	7.5 6.0	1.25 1.1	— —	425 350 250 157	35 27 18 10.5	22 18 12 6.0	5000 5100 5600 7400	7.75 7.65 7.5 7.5	1540 925 340 90
UX-171	6	5	0.5	—	180 135 90	40.5 27 16.5	20 16 10	2000 2200 2500	3.0 3.0 3.0	700 330 130
UX-200-A	6	5	0.25	45	—	—	1.5	—	—	—

# AS THE BROADCASTER SEES IT

by CARL DREHER



Drawings by Franklyn F. Stratford

## Some Notes on Morale Among Broadcasters

**T**HE quality of morale has been much talked of in business and industry since the war. Stanley Hall, the eminent psychologist, wrote a book about it before he died. It may be defined as a state of zest and confidence permeating a body of men engaged in some enterprise. The presence of such a feeling is most essential in war, and its absence is then most serious; but of course all existence is a sort of war, against competitors and obstacles animate and inanimate. In a settled industry morale is important, but where unusual conditions obtain it becomes indispensable. Broadcasting is a case in point.

Broadly speaking, the people engaged in any business may have two attitudes toward the enterprise. They may consider the business simply as a source of income. It consumes their labor and pays for it. A certain proficiency on the part of the employee is required, if he is to hold his job. Beyond that, he does not have to worry. The second attitude involves pride rather than fear. The man who has it is concerned about the whole enterprise, even though he may play only a minor part in its operations. He identifies himself with the institution, and desires its success as he desires his own. This feeling among the body of soldiers in an army, or the mass of employees in a business organization, is what we call good morale. Either attitude is normal, although one is desirable and the other undesirable from the standpoint of efficiency. The men at the top are more apt to feel the urge to work spontaneously than those below. Being in charge, they have more at stake and their responsibility is direct. Their interest

may be taken for granted. What is required is the transmission of this attitude downwards to the levels where the details of relatively small jobs receive attention or neglect. These small jobs, added up, ultimately determine the success or failure of the business.

There are a number of prerequisites which must not be neglected if a state of psychological health is desired in a factory, or a broadcasting station, or what you please. One is equitable treatment of employees. The men who do the best work must receive the largest rewards. If other factors, such as favoritism on the part of someone in authority, enter into the case, a devil-may-care attitude is quickly generated among the men who feel unjustly treated. Adequate tools must be provided. If the men at one broadcasting station have an adequate supply of good microphones, whereas those at a neighboring studio get only enough transmitters to stay on the air, the second group naturally throws up

its hands. They are licked from the start, and they know it. Sound organization is another factor. Everybody must know what he is responsible for, and duties must be clearly defined. Finally, some men will do the work they have agreed to do without being checked up continually, whereas other men *want* supervision, and become slack if the whip is not cracked at them occasionally. The will to get things done is not in them; someone else must supply it for them. It must be supplied, furthermore, not only at the top, but at closer range. It is rarely possible for executives to supervise the details of operation. Each executive requires a group of lieutenants for that specific purpose.

A broadcasting station may be considered as a factory producing entertainment by radio. Morale is important even in a factory. But, as a matter of fact, the broadcaster's work, whether on the technical or program end, contains unique elements. For one thing, the broadcaster does his work in the glare of publicity. In an ordinary factory or business office errors may be made and corrected without other loss than that of time; the end-product and the prestige of the business may remain unaffected. In broadcasting, a slight error, leading to a mix-up on the air, may have grave consequences. Hence, in broadcasting, the tension is greater, and the importance of a healthy psychology among the workers increases in proportion.

For a time it was my belief that on the technical side this element of pitiless publicity would in itself generate a spirit of resolution among the men doing the work. I argued that when a field operator, for example, realized that any difficulties he might have on the job would be heard all



"THEY TALK TO THE CIGARETTE SIREN AT THE RESTAURANT"

over town, he would automatically take care of his connections and his apparatus. The theory is plausible, but wrong. After some years of practice I am convinced that at least half the broadcast technicians now practicing their art in the United States do not take life so seriously. Starting out on a job they will blithely drop a microphone, pick it up, and, seeing no obvious dents in the diaphragm, put it on the air for a concert. When noise develops they are astonished and feel that fate has given them a raw deal. They make connections which a bell-hanger would be ashamed of, forget half the equipment altogether, get to the job ten minutes ahead of the time set for the air, and talk to the cigarette siren at the restaurant while working the gain control. Some of these fellows are hopeless, and the sooner the accident which got them into broadcasting is rectified, the better for all of us. But a majority of them can be utilized quite efficiently, so that they will broadcast with credit to themselves and their stations if some hard-boiled but just and competent technician is placed in authority over them. There must not be so many that he cannot watch them, because watching, at least for a time, is what they need. After they have been trained for a period to protect their microphones from the screw-drivers and pliers thrown into the satchels with the transmitters helter-skelter, and to see to it that the amplifiers do not drop into the gutter while the taxicab is rounding a corner, and to take a few other such precautions, they may get into the habit of being careful, and the station will function as well as can be expected.

These, however, are essentially negative measures. What is desired is a spirit of courage, enterprise, and solidarity among the personnel. This develops spontaneously after a time when the prerequisites are taken care of. The station then turns out a good job. Its reputation mounts accordingly, and likewise its income, whether derived directly or indirectly from its activities on the air. Under these conditions the men feel reasonably happy and confident; they still have their troubles, of course, but they are imbued with the psychology of victory. This holds as much for the program people as for the technicians. It is easy for either group to slip into a rut. When the program force puts on the same stale "features" week after week, without even looking at the newspaper headlines for something new, the station goes downhill as fast as when the operators overload the amplifiers until the plate current could be read on a microammeter. When the announcers start talking before throwing the microphone switch to the "on" position, and get mixed up on their change-overs, the reaction on the operators is bad. The whole station hangs together as a unit. I have never seen a station with a poor program department and an excellent technical division, or vice versa. They are always approximately on a level. The mental or emotional condi-

tion of the workers always plays a great part in determining what that level shall be. The action, furthermore, is a regenerative one; a healthy emotional tone in a business leads to good results, with a resulting increase in personal confidence. The effect of this is again shown in the production of the plant, and so on up to a certain limit. And the same amplification operates downward, so that we find broadcasting stations, as well as other enterprises, afflicted with a general inferiority complex, and turning out a corresponding performance on the air.

As much as anyone, I have jibed at the promoters of specious optimism in business. None has ever found a place on any pay roll with which I had anything to do. But it is important to note that the result they are after is of much consequence, in all truth. The only trouble with the professional boosters is that they deal in hot air, instead of analysis; they cry loudly for good will and courage in business, without taking the essential steps. We have our share of them in broadcasting. They belong on the streets, selling imitation pearl necklaces at fifty cents apiece by the power of eloquence. But the quality of morale, about which these spellbinders talk so much, is really vital in broadcasting, and it will do no harm for station directors to ponder, when the carrier has ceased to bubble and the grid leads are at rest, on ways and means of getting it, and keeping it after it is got.

#### Abstract of Technical Article. V

THE NATURE OF LANGUAGE—A RÉSUMÉ OF RECENT WORK ON THE PHYSICS OF SPEECH AND HEARING, by R. L. Jones, Engineering Dept., Western Electric Co., Inc. *Journal of the A. I. E. E.*, Vol. XLIII, No. 4, April, 1924.

[Continued from March RADIO BROADCAST]

AT SPEECH frequencies, the smallest discernible change in the intensity of a tone is one-tenth of its original value. Thus, for the human ear, the law connecting loudness apperception with sound energy is a logarithmic one. The smallest discernible change is about 1.0 TU, in telephone terminology. Generally 1.0 TU is taken as the smallest significant variation in a telephone system, for this reason. If, for example, the frequency characteristic of a broadcasting station has troughs or elevations of 1.0 TU or less at various points, they may be neglected as imperceptible to the normal human ear.

The law of pitch sensibility is approximately logarithmic also, a fractional change in frequency of about three-thousandths being perceptible over the ordinary musical range. On the above basis of frequency and intensity discrimination, within the normal limits of audition the human ear can separate about 300,000 *pure* tones. The number of complex tones is of course even vaster. This gives one some idea of

the complexity of the job of reproducing speech and music naturally.

In studying sound, for practical results, we must take into account the peculiarities of the ear as much as the physical characteristics of the sound energy itself. Some of these peculiarities arise from the non-linear response of the ear. An intense simple tone impressed on the ear drum gives rise within the ear mechanism to harmonics. A second simple tone will have the same effect, and the harmonics thus generated are capable of giving rise to combination tones and beats within the ear. These effects, while complicating the study of acoustics through the introduction of subjective factors, are sometimes a practical aid. For example, very low pure tones emitted by an instrument, reaching the ear with considerable intensity are heard as complex notes, the harmonics being contributed by the ear mechanism with its non-linear response. Hence, when a radio set and loud speaker deliver a low note, originally pure, in the form largely of harmonics, the ear does not perceive the difference as radically as it would if it were not in the habit of mixing harmonics even with notes that do reach it in their pristine form. This is not an argument for permitting distortion; it simply shows that in some cases this distortion is partially masked through the subjective distortion tendencies of the ear, and these effects are most noticeable at high intensities.

Low tones of great intensity are observed to mask or interfere with relatively weak high notes, but intense high tones do not appear to mask low notes to any degree. This may be due to the action of a loud low note, with its subjective harmonics, in setting up vibrations along a considerable portion of the basilar membrane, interfering with other incoming vibrations of frequencies in the neighborhood of some of the harmonics. But in the case of high-pitched tones only a restricted sector of the membrane responds, and the other nerve terminals are left free to vibrate when a low note is added externally.

In normal speech, frequencies between about 100 and 6000 cycles are used, with the most essential tones between 200 and 2000 cycles at a pressure amplitude of between 1 and 10 dynes R.M.S. In the case of defective hearing there may be a general raising of the threshold of sensation shown in Fig. 2 (March RADIO BROADCAST). Thus certain sounds readily perceived by a person of normal hearing are missed by a listener whose hearing is subnormal, the intensity being below the latter's individual threshold curve at the frequency in question. Evidently by means of amplification some cases may be partially remedied. But amplification is limited by the tendency toward subjective distortion at high intensities. Again, defective hearing may be due to an unusual degree of non-linearity in the response of the ear. The study and relief of deafness is a special field in which research acoustics has been of great help when carefully applied.

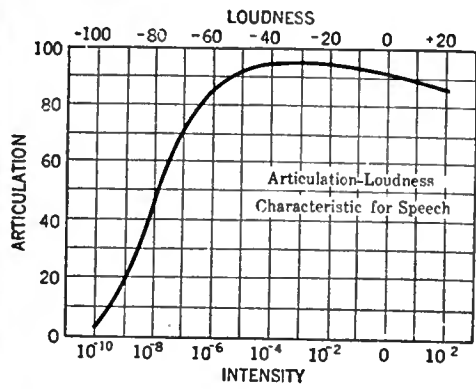

FIG. 1

Electro-acoustic apparatus of the type described in the Abstract of the Crandall-MacKenzie paper on *Analysis of the Energy Distribution in Speech*, given in the January RADIO BROADCAST, may be used in studying the interpretability of speech. This is accomplished by pronouncing detached speech syllables into the transmitter of the experimental system, controlling the volume and distortion at will, and observing the errors in reception at the receiver. The articulation of a telephone system is defined as the per cent. of the total sounds spoken which are correctly received.

With a distortionless experimental system the effect of intensity on interpretability of speech may be studied. The result of such an experiment is shown in Fig. 1, reproduced from Fig. 6 of Jones' paper. The abscissas of the curve represent loudness, expressed as a ratio of the intensity received to the intensity at exit from the mouth. At about one-thousandth of this intensity articulation is at a maximum, although there is no great variation over the range from about 10 down to about  $10^{-5}$ , a ratio of  $10^6$ . With speech of the order of 10 down to  $10^{-2}$ , the loudness is too great for comfortable listening, the ear mechanism being more or less overloaded, with consequent exaggeration of subjective distortion. Below  $10^{-6}$  the curve drops rapidly, the sounds becoming too faint to be interpreted readily; at  $10^{-10}$  inaudibility is reached. These are the results for a quiet room. In a noisy place the peak of articulation would of course occur at a loudness greater than the optimum of  $10^{-3}$  obtained for a quiet room.

The fundamental sounds differ in their articulation over a telephone system at various intensities. In general, diphthongs and vowels are easier to interpret than consonants, and among the consonants the stop class has the advantage in this respect over the fricatives. As speech becomes weak, the consonants drop out first. This is a general rule with some exceptions. The easiest sounds to interpret are the diphthongs *i* (long sound) and *ou*, and the long vowels *ó*, *ō*, and *ā*, which have an average articulation of over 95 and maintain a figure of 84 even when very weak. At the other extreme are the sounds *th*, *f*, *s*, and *v*, whose energy is weak; these

sounds are responsible for about half the errors of interpretation.

By means of high-pass and low-pass filters the effect of frequency distortion on articulation may be studied. Fig. 2, reproduced from Fig. 8 of Jones' paper, shows some results. The ordinates show articulation in percentage of syllables correctly received; the abscissas represent the cut-off frequency of the filter. When a low-pass filter (one passing all the frequencies below a certain marginal value) is used, we note by the curve marked *Articulation L* that when the system transmits only frequencies below 1000 cycles an articulation of 40 per cent. is obtainable. Now looking at the corresponding point for the high-pass filter, on the curve marked *Articulation H*, we observe an articulation of 86 per cent. for a system transmitting only frequencies above 1000 cycles. The dotted curves in Fig. 2 show the per cent. of the total energy of speech transmitted through fil-

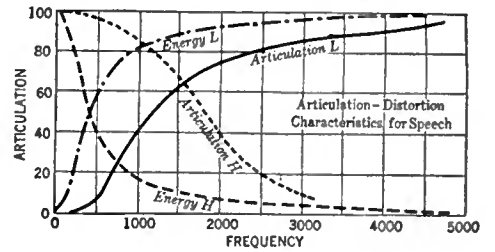

FIG. 2

ond to about 20,000—a range of about ten octaves. Human speech employs frequencies from a little below 100 cycles per second to above 6000 cycles, a range of about six octaves. The intensities and frequencies used most in conversation are those located in the central part of the area of audition. The energy of speech is carried largely by frequencies below 1000, but the characteristics which make it intelligible, largely by frequencies above 1000. Under quiet conditions, good understanding is possible with undistorted speech having an intensity anywhere from one hundred times greater, to a million times less than that at exit from the mouth. On the whole, the sounds *th*, *f*, *s*, and *v* are hardest to hear correctly and they account for over half the mistakes made in interpretation. Failure to perceive them correctly is principally due to their very weak energy although it is also to be noted that they have important components of very high frequency."

A bibliography is appended to the paper.

### Dummy Microphones

I HAVE a suggestion to make to the theatrical outfitters who sell and rent rubber helmets, Roman togas, and tin sabres to the theatrical profession. Let them lay in a supply of microphone stands, stuffed with black paper inside the cage, and with twenty feet of flexible cord attached, so that the outfit looks real from the house side of the footlights. They will do more business with one such contraption than with ten masks of ape-men or complete suits of armor. The fact is

that every broadcaster around New York, at any rate, receives numerous requests for the loan of microphones to be used by vaudeville comedians, banquet stage managers, fraternal organizations, and other ticklers of the public. They don't actually want to broadcast, but merely to kid somebody. This is well enough, but the broadcasters are frying their own bacon, and if they heeded all the requests they would not have enough mike stands left to hold up their own transmitters. I set a harsh example, therefore, by refusing all such prayers hereafter. If John Barrymore asks me to lend him a dummy microphone I may do so, but I shall hang up the telephone receiver on all lesser applicants. I have done my part by pointing out the need, at space rates. Now let the theatrical prop agencies get busy, thus terminating a nuisance for the harassed broadcasters, and enriching themselves.

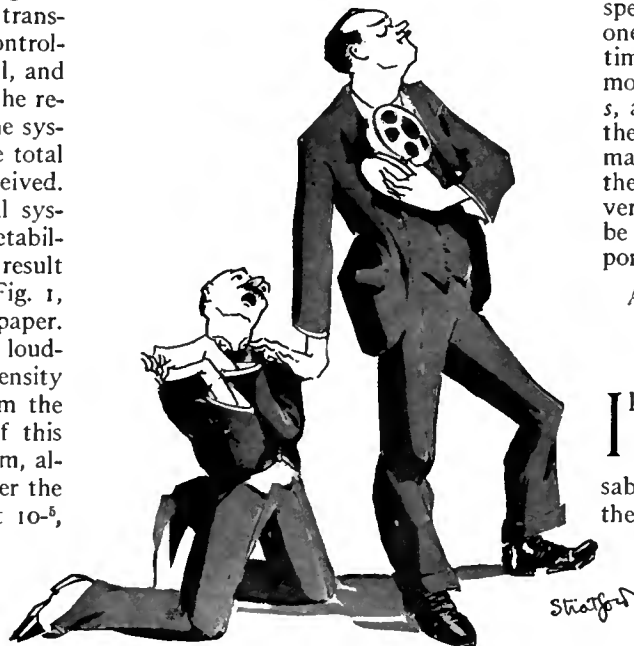

" . . . BY REFUSING ALL SUCH PRAYERS  
HEREAFTER "

ters having the cut-off settings indicated by the abscissas. There we note that, by elimination of all frequencies below 500, 60 per cent. of all the energy is lost, but only 2 per cent. in articulation. On the other hand, by suppressing all the frequencies above 1500, although we lose only 10 per cent. energy, articulation is reduced 35 per cent. But of course, from the standpoint of naturalness of reproduction, which is essential in broadcasting, the low frequencies are as important as the high. "Tinny" speech is more readily interpreted than "drummy" transmission, but neither is natural.

"In conclusion," writes Jones, "we have seen that the ordinary ear is an exquisitely developed organ for sensing minute and rapidly repeated variations in air pressure. It can perceive sound waves ranging in pressure amplitude from less than 0.001 dyne to over 1000 dynes, and in frequency of vibration from about 20 cycles per sec-



# Constructing a D. C. Amplifier-Power Supply Device

*In Which Some Trouble-Shooting Hints Applying to A. C. Power Amplifiers Are Also Presented*

By JAMES MILLEN

**I**N MANY of the older business and residential districts of some cities, the power supply is of the direct current rather than the more common alternating current variety. If the maximum voltages desirable for radio set operation were under 100 or so, then the person living in a district supplied with d. c. would indeed be fortunate, as he would not require an expensive transformer, rectifier, and large-capacity filter condenser in order to construct a plate-supply device. Instead, two small chokes and condensers would completely fill the bill. Unfortunately, however, such is not the case.

With a. c. any desired voltage may be obtained by means of suitable voltage step-up transformers and rectifiers. With d. c., however, the maximum voltage available cannot be stepped up in excess of the line voltage, usually between 110 and 120 volts.

With these facts in mind, the amplifier-power supply unit shown diagrammatically at the foot of this page was designed for d. c. operation. Impedance-coupled amplification was employed in preference to resistance coupling due to the low voltage available. One hundred volts is ample for the first two tubes of an impedance-coupled amplifier, but very inadequate for a resistance-coupled amplifier.

A 6X-171 tube is used in the last audio stage. With 100 volts on the plate, the proper C voltage is about 16.5 volts, which will permit of a fairly loud signal without introducing distortion due

to tube overloading. Where greater volume without overloading is desired, the plate voltage may be raised by inserting a dry or storage B battery at the point marked X in the circuit diagram. To obtain C as well as B voltage from this device is possible but results in a reduction of the maximum available plate voltage, so C batteries are employed in this case rather than to reduce the B voltage further. Although the diagram indicates the use of an A battery or A power unit, the constructor who so desires may find field for interesting experiment by connecting the filaments of the two  $\frac{1}{2}$ -ampere tubes in parallel, and then placing that group in series with the filament of the 171 so as to obtain a series-parallel arrangement of the filaments, drawing a half ampere at 10 volts. A 50-watt lamp in series with this combination permits direct connection of the entire group to the 110-volt line. A small choke coil wound with heavy wire should be placed in series with the line for the purpose of hum reduction. Due to the fact that one side of the 110-volt line is grounded, this arrangement is rather a tricky one, and if care is not exercised, the tubes, and possibly one of the B-supply choke coils, may be burned out.

The layman is advised to use a storage battery in conjunction with the circuit shown.

As one side of the line is always grounded, the ground connection must be removed from the set if it in any way grounds the filament circuit. If in doubt, play safe and disconnect the ground.

If no signals are then heard, re-connect the ground through a 1-mfd. filter condenser.

In connecting to the d. c. lamp socket it will be necessary to insert the plug so that the positive and negative leads are connected as shown in the diagram. If in doubt as to which line is positive and which negative, forget about the matter and insert the plug in the socket first one way and then the other. One way will work and the other will not.

Perhaps some readers may wonder why a filter choke coil is placed in each line instead of the two in one line as in the case of the a. c. operated amplifiers. The reason for this special connection is to eliminate a high pitched "sing" that is heard from the loud speaker in some localities when all the inductance is placed in the one line. The double line arrangement also tends to reduce disturbances due to line noises.

Not so long ago the radio set was judged with the phonograph when a standard of comparison was desired. Since the introduction of high-quality amplifiers and combined power units, such as those designed and described by the author in this and the past few issues of RADIO BROADCAST, conditions have changed considerably, so that now the phonograph is compared with the radio rather than the radio with the phonograph.

In the very near future, the writer will describe in RADIO BROADCAST just how the amplifiers may be used to bring the phonograph up to date.

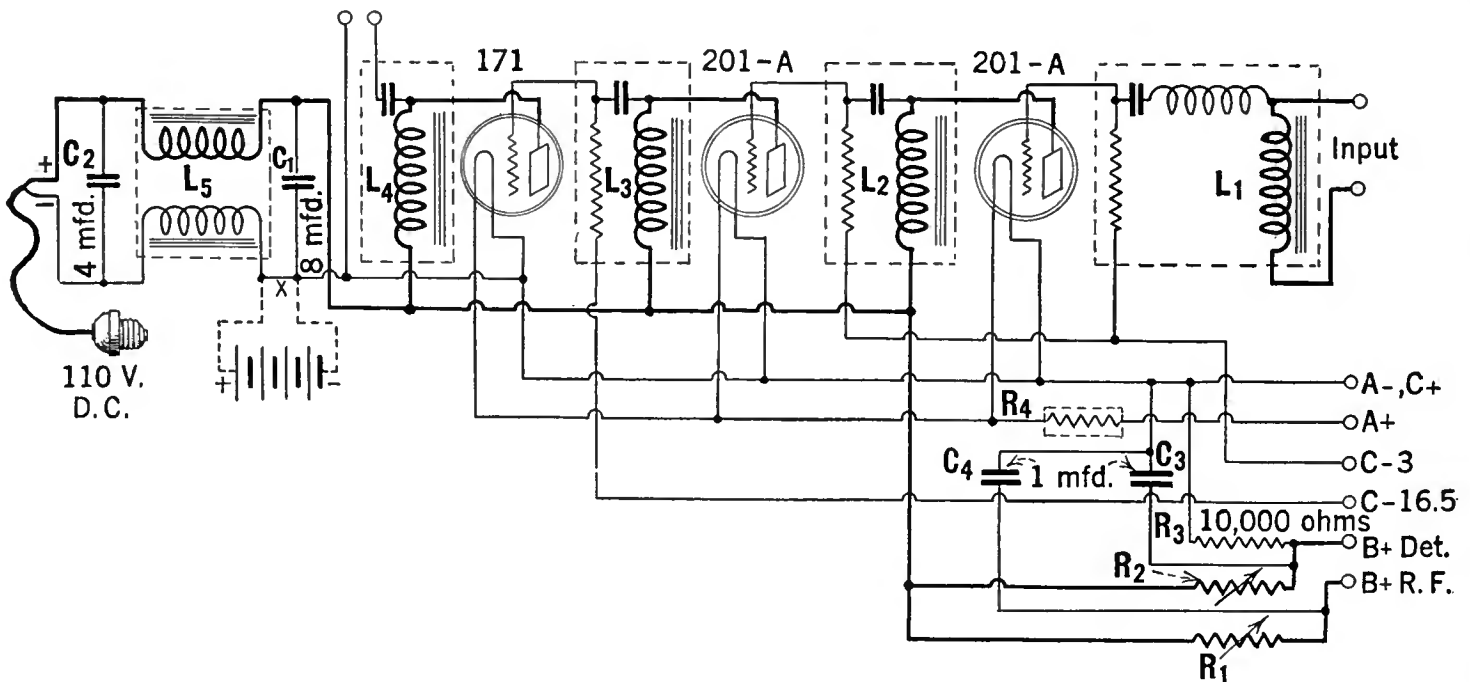

A D.C. OPERATED AMPLIFIER-POWER SUPPLY DEVICE

This is the circuit diagram of the d. c. unit described and illustrated in this article. The B voltage may be boosted by the insertion of a B battery at the point marked "X". No rectifier tube is, of course, necessary

A LIST OF PARTS

THE following list of parts names those products which were used by the author of the article in the construction of the d.c. amplifier power supply device described here:

L <sub>1</sub> , L <sub>2</sub> , L <sub>3</sub> ,—National Impedaformers, 1st, 2nd, and 3rd Stages . . . . .	\$16.50
L <sub>4</sub> —National Tone Filter . . . . .	8.00
L <sub>5</sub> —National Type 35 Filter Choke . . . . .	7.00
C <sub>1</sub> —Electrad 8-Mfd. 200-Volt Filter Condenser . . . . .	5.50
C <sub>2</sub> —Electrad 4-Mfd. 200-Volt Filter Condenser . . . . .	3.25
C <sub>3, 4</sub> —Two Electrad 1-Mfd. 200-Volt Filter Condensers . . . . .	1.80
R <sub>1</sub> —Electrad Royalty Resistor No. 2 . . . . .	1.50
R <sub>2</sub> —Electrad Royalty Resistor No. 3 . . . . .	1.50
R <sub>3</sub> —Lynch 10,000-Ohm Wire-wound Resistor . . . . .	1.50
R <sub>4</sub> —Lynch Equalizer No. 1 and Mount . . . . .	1.00
Three Airgap Sockets . . . . .	1.80
Eight Eby Binding Posts . . . . .	1.20
Base-Board, Wire, Brass, Plug and Receptacle, Etc. . . . .	2.00
Two High-Mu Tubes (or 201-A type) . . . . .	5.00
One UX-171 Type Tube . . . . .	4.50
<b>Total . . . . .</b>	<b>\$62.05</b>

The National Impedaformer used in the first stage should be of the special input type.

supply devices (many of the instruments having several leads attached to each of their terminals) to omit one of the leads, or else run a lead to the wrong terminal. To completely wire and to check the work for accuracy, usually takes a neat worker, constructing his first combination amplifier-power unit, three hours or more.

When an amplifier, correctly wired, fails to operate, the trouble is almost without exception due to a defective piece of apparatus or a poor arrangement of the various parts. Some difficulties likely to be encountered are summarized in the following paragraphs.

PLATE OF RECTIFIER TUBE RED-HOT

A SHORT-circuit in the B-supply line, usually due to failure of the first (nearest the rectifier tube) filter condenser, will cause the elements in the rectifier tube to become red-hot. If a block type of filter condenser is employed, remove the connections from the first terminal of the suspected unit and substitute, externally, a new 2-mfd. condenser. If the first condenser proves to be all right, substitute for each condenser unit in turn. If the filter condensers are all satisfactory, then look for a short-circuit in the wiring. If a metal base is used in the construction of the amplifier, such as in the models shown on pages 383 and 385 of RADIO BROADCAST for

bypass condensers that happen to be available may be used.

Another possible cause of a weak signal is an open grid bias resistor on the last tube. If a variable resistor, such as the Clarostat, is employed, see that it is not adjusted for too high a value of resistance. If a fixed resistor such as a 2000-ohm Tobe Veritas is used, either try another in its place, or else remove the resistor and test it.

DISTORTION ON MODERATE STRENGTH SIGNALS

IF THE variable grid bias control is improperly adjusted, blasting and distortion is bound to result. When this control has been adjusted for best results, however, and distortion due to blasting or tube overloading still continues, then the trouble may be due to improper C voltage on the first two tubes in the case of a resistance- or impedance-coupled amplifier, or on the first tube in the case of a transformer-coupled amplifier. If a change in C voltage does not improve matters, then try different tubes. If the trouble still persists, then an open grid leak is undoubtedly responsible for the difficulty.

If at any time a variation of the grid bias control for the power tube fails to make some marked change, either for better or worse, then it is likely that either the 0.25-megohm

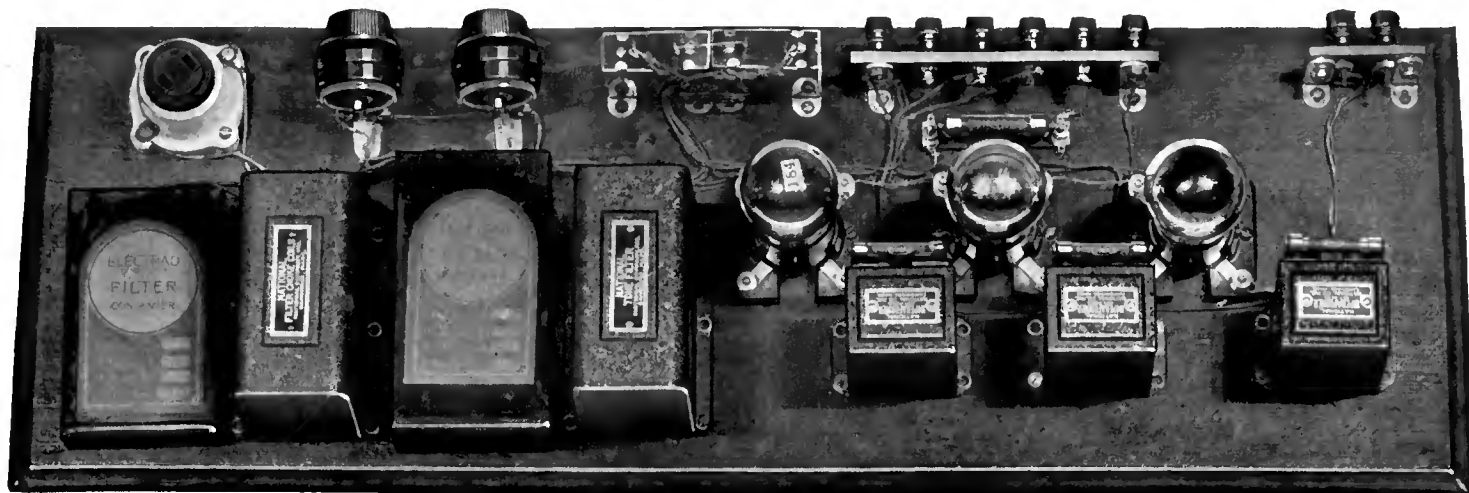

THE LAYOUT FOR THE D.C. AMPLIFIER

Using the units mentioned in the list of parts on this page. Other standard parts of similar electrical characteristics may be substituted. Satisfactory condensers are made by Dubilier, Aerovox, Tobe, Faradon, and others, and the impedance coupling-units may be made up of individual choke coils, 0.1-mfd. coupling condensers, and grid leaks, if the constructor does not desire to purchase Impedaformers

TROUBLE SHOOTING

ALTHOUGH trouble in any one of the amplifier power supply units designed by the writer, and described in the last few issues of RADIO BROADCAST, is not to be expected, no doubt some readers will run against some small snag, the remedy for which, while more or less obvious to the more experienced constructor, may mean all the difference between success and failure for the novice.

First, and most important, the constructor should guard against slovenly workmanship, poor wiring, loose connections, and lack of mechanical rigidity. It should always be kept in mind that the device being constructed is to be directly connected to the house lighting lines, and all connections should be made and all parts mounted so as to prevent any possibility of dangerous short-circuits.

When the unit has been completely wired, but before the wires are bundled together and cabled, all connections should be carefully checked in order that any errors due to carelessness may be located. It is easy for one not familiar with a circuit such as used in power-

February, the trouble will most likely be found where one of the high-voltage B leads, such as those from the rectifier tube, filter chokes, condenser block, or tone filter, pass through the metal base plate. Unless care is used to remove any burrs around the edges of the holes through which the wires are to pass, it is very likely that the insulation on the wires will fail at such points.

WEAK SIGNALS FROM LOCAL STATIONS

AN OPEN or burned-out plate coupling resistor would cause the signals from a strong local station to be barely audible in the loud speaker. Try another resistor in place of each coupling resistor until the defective one is located, or else, if facilities are available, remove the coupling resistors and test each one. Also check the wiring to the resistor mounts in order to be certain that a connection has not been missed.

A short-circuited or an entirely open grid coupling condenser would also result in an extremely weak signal from a local station. Disconnect the coupling condensers and try others in their place. For this test any odd filter or

grid leak, the 0.1-megohm (0.05-megohm in some cases) grid-filter resistor, or both, are defective.

WHEN TUBES DO NOT LIGHT

WHEN the tubes in the first stage, or stages, of the amplifier are known to be good, yet fail to light when in circuit, the trouble may be due to an open filament ballast, or to a poor socket contact. Where the socket is mounted on a metal base, the prongs of some UX type tube sockets, due to an excess of solder on the tube tips, will just touch and short on the metal base when the tube is pressed all the way down. The remedy is simply not to push the tube all of the way down, or else, to remove with a file the excess of solder from the tube prongs.

When an Amperite type of filament ballast is mounted on a metal base, care must be used to see that the heads of the two screws that fasten the mounting clips to the fibre base do not touch the metal. In case of trouble the best way is to take the mount apart and countersink for the heads of the screws. The Lynch Equalizer mount is so constructed as to permit direct mounting upon a metal base without trouble.

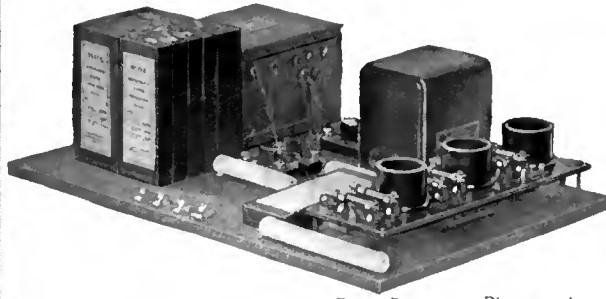

RADIO BROADCAST Photograph

THE LIST OF PARTS

T <sub>1</sub> , L <sub>1</sub> —Dongan Power Compact, No. 3516 . . . . .	\$13.00	R <sub>4</sub> —Lynch Filament Equalizer, No. 2	1.00
C <sub>1</sub> —Muter Condensers		R <sub>5</sub> —Lynch Wire-Wound Resistor, 100,000 Ohms	4.00
Two No. 568, 4-Mfd. . . . .	11.00	R <sub>6</sub> —Metalized-Filament Resistor, 1.0 Megohm	.50
Two No. 566, 2-Mfd. . . . .	4.00	R <sub>7, R<sub>8</sub></sub> —Two Metalized-Filament Resistors, 100,000 Ohms	1.50
Two No. 565, 1-Mfd. . . . .	1.50	R <sub>9</sub> —Metalized-Filament Resistor, 0.5 Megohm	.50
C <sub>2</sub> —Muter Buffer Block No. 595 . . . . .	2.00	R <sub>10</sub> —Metalized-Filament Resistor, 0.25 Megohm	.50
C <sub>3</sub> —Muter Condenser No. 565, 1-Mfd. . . . .	6.00	Lynch Single Mount . . . . .	.35
C <sub>4</sub> , L <sub>2</sub> —General Radio Output Filter No. 387	8.00	Eveready 1½-Volt Flashlight Cell . . . . .	.15
DeJur Resistance-Coupled Amplifier (Includes C <sub>5</sub> , Mountings, Sockets, etc.)	1.20	Raytheon BH Rectifier Tube . . . . .	6.00
Two Airgap Sockets . . . . .		UX-874 Voltage Regulator Tube . . . . .	5.50
R <sub>1</sub> —Lynch Wire-Wound Resistor, 2000 Ohms	1.25	Two High-Mu Tubes . . . . .	5.00
R <sub>2</sub> —Metalized-Filament Resistor, 0.05 Megohm	.75	UX-171 Type Tube . . . . .	4.50
R <sub>3</sub> —Lynch Wire-Wound Resistor, 2000 Ohms . . . . .	1.25	Baseboard, Fahnestock Clips, Wire, etc.	.75
		TOTAL . . . . .	\$86.20

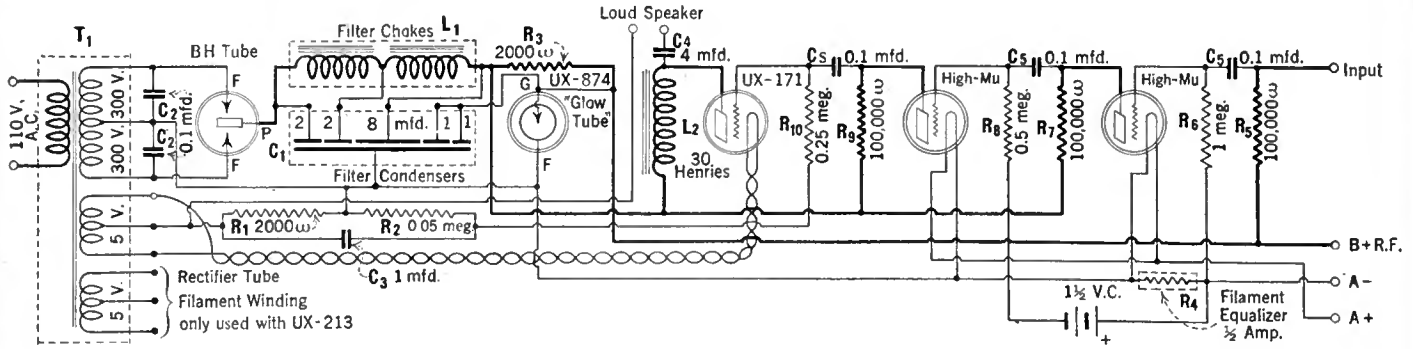

A RESISTANCE-COUPLED AMPLIFIER-POWER SUPPLY DEVICE

The transformer in the Dongan power compact has two five-volt filament windings which permit the use of the UX-213 Rectron in place of the BH Raytheon rectifier tube when so desired. The DeJur amplifier must be partially rewired in order to provide for use of a.c. on the power tube filament. It is recommended that metalized resistors be substituted for the impregnated paper type supplied with the amplifier. A 2000-ohm fixed resistor is used for obtaining the power tube grid bias

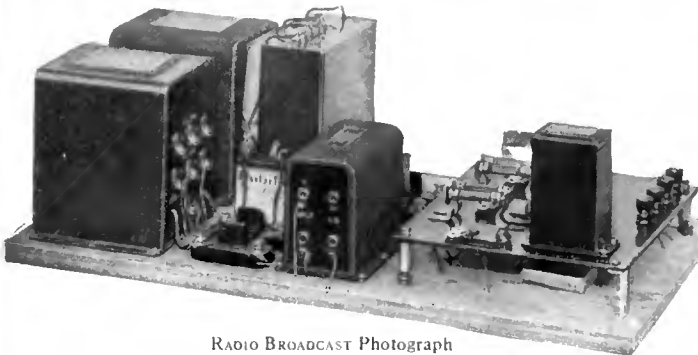

RADIO BROADCAST Photograph

ANOTHER AMPLIFIER-POWER DEVICE USING NATIONAL PARTS

The circuit for this amplifier unit is substantially the same as that for the amplifier at the top of this page, with the exception that a National type A impedance is used in the grid circuit of the last tube instead of the 0.25-meg. resistor. The UX-874 voltage regulation tube is used in these two units to maintain fairly constant r.f. and detector B voltages, regardless of load, thus eliminating controls which would otherwise be necessary. Wire-wound resistors are used in the input circuits of both amplifiers in order to carry safely the heavy plate current drawn by some of the new special detector tubes (6 mA.). C bias for the first high-mu tube is obtained by utilizing the voltage drop across the filament equalizer

THE LIST OF PARTS

T <sub>1</sub> —National Power Transformer . . . . .	\$16.50
L <sub>1</sub> —National Type 80 Filter Choke . . . . .	10.00
L <sub>2</sub> , C <sub>1</sub> —National Tone Filter . . . . .	8.00
C <sub>1</sub> —Dubilier Filter Condenser Block No. PL-90-A . . . . .	9.50
C <sub>2</sub> —Dubilier Buffer Condenser Block No. PL-91 . . . . .	2.00
C <sub>3</sub> —Dubilier 1.0-Mfd. Bypass Condenser No. 901 . . . . .	1.50
C <sub>4</sub> —Three Dubilier 0.1-Mfd. Coupling Condensers . . . . .	1.80
Two Airgap Sockets . . . . .	1.20
R <sub>1</sub> —Claroostat Variable Resistor . . . . .	2.25
R <sub>2</sub> —Metalized-Filament Resistor, 0.05 Megohm . . . . .	.75
R <sub>3</sub> —Lynch Wire-Wound Resistor, 2000 Ohms . . . . .	1.25
R <sub>4</sub> —Lynch Equalizer No. 2 . . . . .	1.00
R <sub>5</sub> —Lynch Wire-Wound Resistor, 100,000 Ohms . . . . .	4.00
R <sub>6</sub> —Metalized-Filament Resistor, 1.0 Megohm . . . . .	.50
R <sub>7, R<sub>8</sub></sub> —Two Metalized-Filament Resistors, 100,000 Ohms . . . . .	1.50
R <sub>9</sub> —Metalized-Filament Resistor, 0.5 Megohm . . . . .	.50
R <sub>10</sub> —National Type A Impedance . . . . .	4.00
Four Eby Binding Posts . . . . .	.60
Bakelite Panel, 6 x 8 x 1/8 Inches with Resistor Clips and Three Sockets . . . . .	4.00
Baseboard, 18 x 10 x 1/2 Inches . . . . .	.50
Rubber Feet, Wire, Screws, etc. . . . .	.50
Eveready 1½-Volt Flashlight Cell . . . . .	.15
UX-874 Voltage Regulator Tube . . . . .	5.50
UX-171 Type Tube . . . . .	4.50
Two High-Mu Tubes . . . . .	5.00
Raytheon BH Tube . . . . .	6.00
TOTAL . . . . .	\$93.00

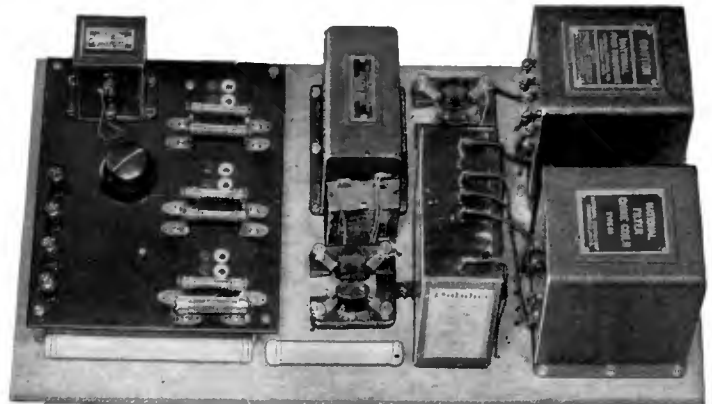

RADIO BROADCAST Photograph

## CRACKLING NOISE IN LOUD SPEAKER

A CRACKLING sound, much like static, frequently is heard when the buffer condensers (used with the Raytheon tube) are either omitted from the circuit or are defective (open-circuited). In either case the remedy is a pair of good buffer condensers. A defective Raytheon tube will also cause this same noise.

## ARCING BETWEEN HIGH-VOLTAGE PRONGS OF RECTIFIER SOCKET

THE a.c. voltage between the two outside leads of the power transformer secondary is equal to twice the normal operating voltage of either half of the secondary which, in the case of the different transformers recommended by the writer in this series of articles, is between 500 and 600 volts. This high voltage is directly impressed across the two adjacent tube socket springs, and to prevent danger of a flash-over, followed by a steady arc, it is extremely important that nothing be done that will impair the quality of the insulation. For instance, just a little soldering flux or paste, between the filament springs of a rectifier tube socket—they are quite close together—is enough to start an arc, which, when once started, is capable of doing considerable damage. For this reason it is important to remove any traces of soldering flux around the terminals and contacts of the rectifier tube socket. Use a cloth dipped in alcohol for this procedure before connecting the complete unit to the electric light lines.

## ARCING IN STEM OF RAYTHEON TUBE

IF A Raytheon tube flashes over and arcs between the two anode leads outside of the "cup," the useful life of the tube is over, as one of the lava insulating tubes has cracked. A new tube is the remedy.

## DETECTOR AND R. F. RESISTOR GET HOT

AS EXPLAINED under another paragraph, care must be used when constructing an amplifier-power supply unit on a metal base to see that the metal does not at any point cut through the insulation on the wire and cause a short circuit. If the wiring is o.k., then look for a defective bypass condenser and replace it.

## FIXED RESISTOR ACROSS THE PLUS-B DETECTOR

IF THE variable resistor controlling the detector plate voltage is turned to a very low value, or entirely short-circuited, the full amplifier B voltage is impressed across the 10,000-ohm resistor. An excessively high current will flow through the unit, and it will get hot. The variable resistor should never be so adjusted as to cause over-heating of the fixed resistor.

## POWER TUBE DOES NOT LIGHT

WHEN the filament of the output power tube fails to light, and there is no doubt as to the tube being in good condition and making perfect contact with the socket prongs, make certain that the a.c. power is on before looking for further trouble. Possibly, the socket to which the amplifier-power unit is connected may be defective, or else the power may be temporarily off. If there is no doubt about the power and the

condition of the tube, then check the wiring for an open or short-circuit. If the difficulty is still undiscovered, then temporarily disconnect one lead from each of the two buffer condensers. Should this latter step correct the trouble, then one or both of the condensers are defective and new ones should be secured. Should, however, the trouble still be present, the probability is that the power transformer is defective.

## MECHANICAL HUM OR VIBRATION

A NOT altogether uncommon fault of some amplifier-power units, which are in other ways very excellent, is a mechanical vibration due to loose lamination in the core of the power transformer. If the transformer is assembled in some sort of frame, frequently all that is necessary to do is to tighten the frame bolts. In other cases, however, where the transformer is enclosed in a metal container sealed with wax, the trouble is more difficult to remedy. If the hum



RADIO BROADCAST Photograph

## COMBINING COMMERCIAL UNITS

This illustration shows how a standard B supply unit, such as the Mayolian may be used with the audio amplifier designed by the author, to obtain a combination amplifier-power unit. The amplifier consists of an impedance-coupled stage and two stages of resistance-coupled amplification and includes an r.f. choke, a grid choke in the power stage to prevent motor-boating, and a tone-filter. Where the power supply is other than 60 cycles a.c., it is often difficult to obtain suitable transformers and chokes for the home construction of a power-supply unit. B supply units for 25- and 40-cycle a.c. are available, however, and when used as here shown, give the equivalent of a combination power amplifier and B supply

is very bad, then perhaps the best procedure is to return the transformer to the manufacturer. If it is only slight, but yet sufficiently annoying, then a simple remedy is to place the amplifier power unit in a closet, the cellar, or some other place sufficiently isolated to do away with the noise, and use cabled leads between it and the set.

## ELECTRICAL HUM IN THE LOUD SPEAKER

AN ELECTRICAL hum in the loud speaker may be due to any one of a dozen, or more, different causes. There is also considerable difference in the hum due to various causes, thus enabling the person experienced in the design and the construction of a.c. operated amplifiers to locate quickly the source or reason for hum. For instance, hum due to an unbalanced filament winding center tap is predominately a third harmonic of the fundamental power-line frequency, while that due to lack of electrostatic

shielding in the transformer, a ninth harmonic, and that due to incomplete filtering of the B supply, a second harmonic. The novice, however, will probably have to go right through the list of possible causes and remedies until the difficulty is located and corrected.

First, and most important, the negative A terminal, either on the amplifier, set, or storage battery, must be grounded. If there are any other ground connections to the receiving set proper, remove them, or, in the case of sets with which the removal of the regular ground connection will interfere with the proper operation of the set, insert a 1-mfd. bypass condenser in series with the ground lead.

Secondly, remove any lamps or other electrical appliances from the vicinity of the set or amplifier. Merely turning off the light, in the case of a lamp, will not do. Either remove the lamp as a whole or else remove the lamp cord plug from the base outlet or socket.

Thirdly, see that the grid-bias voltage control, if variable, is not set at too low a value of resistance. Adjust for best quality, most stable operation, and minimum hum.

Fourth, do not run the a.c. cord from the amplifier near the antenna lead, the set proper, or the input lead from the set to the amplifier. Make the line cord as short and direct as possible without coming close to the set.

Fifth, ground the transformer, choke coils, and condenser cases, or frames.

Sixth, place the amplifier-power unit several feet from the set unless either the set or the power unit, or both, are completely shielded.

Seventh, so place the filter chokes with respect to the power transformer as to prevent any undesirable magnetic coupling.

Eighth, interstage coupling between either the radio or the audio stages, especially if the detector tube is involved, may result in a disagreeable hum. All of the amplifiers illustrated in connection with these articles have been so constructed as to minimize any possibility of such trouble.

If a hum still exists after all other attempts to stop it have failed, then, with the amplifier and the set in operation, pull out the first audio tube. If the hum then stops, it is probably being caused by interstage coupling, due to poor layout of

parts, failure to cable all direct-current leads, failure to use bypass condensers and resistors, as shown in the various circuit diagrams, long grid and plate leads, or magnetic coupling between audio transformers.

Regeneration due to a regenerative detector circuit is confined to one stage and does not produce a hum. Interstage regeneration, due to any of the above causes, does produce a hum. Follow the different layouts described and trouble from this source will not be encountered.

## "MOTOR-BOATING"

THE reason for and the methods of curing "motor-boating" were completely covered by the writer in the article in power amplifiers in the February RADIO BROADCAST. To recapitulate briefly, the two most important points to be watched are the proper adjustment of the grid bias control, and avoiding the use of excessive detector or r.f. voltages.

# Some "Hi-Q" Improvements



RADIO BROADCAST Photograph

## AFTER SOME CHANGES HAVE BEEN MADE

By incorporating the changes in the Hammarlund "Hi-Q" receiver as outlined in the accompanying article, it is possible to operate the receiver with a loop antenna

*Substituting Dry Cell Tubes—How a Loop May Be Used—A Loading Coil to Increase Sensitivity—How to Neutralize This Popular Hammarlund Receiver*

By

**JOHN B. BRENNAN**

*Technical Editor*

**I**T WAS Lincoln who said: "You can fool some of the people all of the time and all of the people some of the time, but you can't fool all the people all of the time."

Before asking oneself what this has to do with radio, and the Hammarlund "Hi-Q" receiver in particular, pause for a moment to hear all of the story.

Of the many receivers which are offered to the home-constructor for home assembly, the Hammarlund Roberts "Hi-Q" enjoys the greatest popularity. Even the fellow who buys a commercial type of receiver has the urge to tinker with the set so that it will fit in with his particular ideas of what a set should be. How much more so this is true of the builder of a receiver such as the Hammarlund-Roberts "Hi-Q" is a question the answer to which is reflected in this article.

Applying the mania for improving, altering, changing, to the quotation above, it might be made to read: "You can satisfy some of the set builders all of the time, and you can satisfy all of the set builders some of the time, but you can't satisfy all of the set builders all of the time."

Pursuing this line of reasoning with respect to the "Hi-Q" receiver results in the bringing out of these salient points:

1. How may dry cell tubes of the 190 type be used with the "Hi-Q" receiver?
2. How may a loop be employed, particularly by the city dweller who requires unusually fine selectivity to tune-in to the locals without experiencing broadness of tuning?
3. How may the sensitivity of the receiver be increased?
4. How may neutralization be made simpler?

At RADIO BROADCAST Laboratory, an investigation into these various problems was instituted with results which are most gratifying.

Whether or not any of the changes as outlined above are seriously considered, it is recommended that at least the simple changes under classification No. 4 be made, thus making for better and more complete neutralization of the receiver.

In the original circuit, no provision was made for a bypass to the negative filament for the r.f. currents. This sets up the possibility and probability of inter-coupling between adjacent tube circuits through the battery leads. When the bypaths are provided, the r.f. currents are kept out of the battery leads and the possibility of inter-coupling is greatly reduced, and in many cases completely eliminated. Two 0.1-mfd. fixed condensers are required to make this addition. The condensers are mounted, one in the second r.f. stage can, and the other in the de-

detector stage can. To mount them, it is only necessary to unscrew one of the rear wood screws of each can which holds the can bottom to the wood base, and insert one of the feet of each condenser under the head of these screws. One contact of the condenser connects to the B-plus terminal of the primary coil in its respective can. The other contact connects to one of the wood screws holding down the can, and thus completes the bypass circuit direct to ground. The circuit diagram for this addition, step No. 4, is shown in Fig. 1.

### USING DRY CELL TUBES

**I**N EXPERIMENTING with dry cell tubes, such as 190's, it has been found advisable to control the filament of each tube with its own Amperite because, when neutralization of the receiver is attempted, disconnecting the filament wire from the first socket applies an over-load to the filament of the second r.f. tube since both the filaments of the first and second r.f. tubes are connected in parallel. Controlling each tube with its own filament ballast will solve this problem. Incidentally, this change might even be applied to receivers employing the 5-volt type of tubes because it is much simpler to remove a ballast from its clips than it is to unsolder a wire from the socket when engaged in the process of neutralizing the receiver.

In the detector and audio-frequency circuits, filament ballasts are already provided, but for dry-cell operation, the value of the ballast differs from the value used for storage-battery tube operation. Type 4V Amperite is satisfactory for all but the last audio stage, wherein a 120 tube is recommended. This tube requires the type No. 120 Amperite.

To incorporate the additional filament ballasts in the circuit, first unsolder the fixed resistance strip

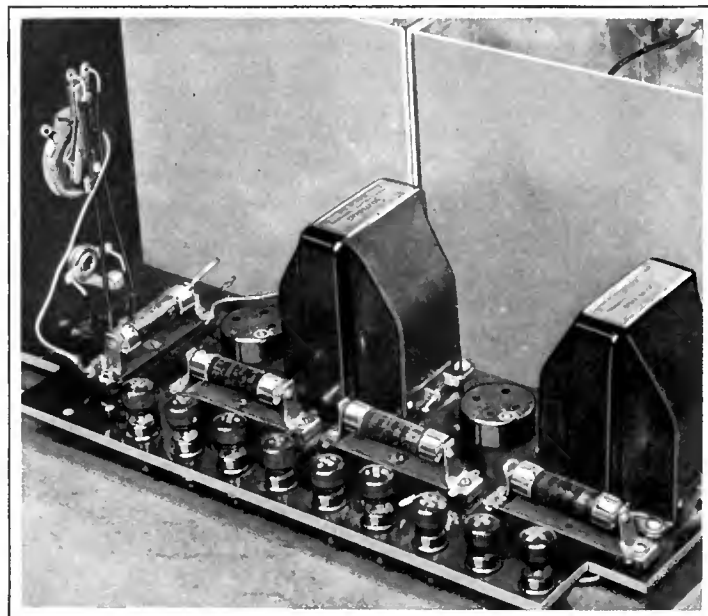

RADIO BROADCAST Photograph

### CHANGES IN THE FILAMENT CIRCUIT

A filament ballast replaces the four-ohm resistance strip which was formerly connected in the first r.f. filament circuit. In this illustration the additional filament ballast is that one at the extreme left of the sub-panel

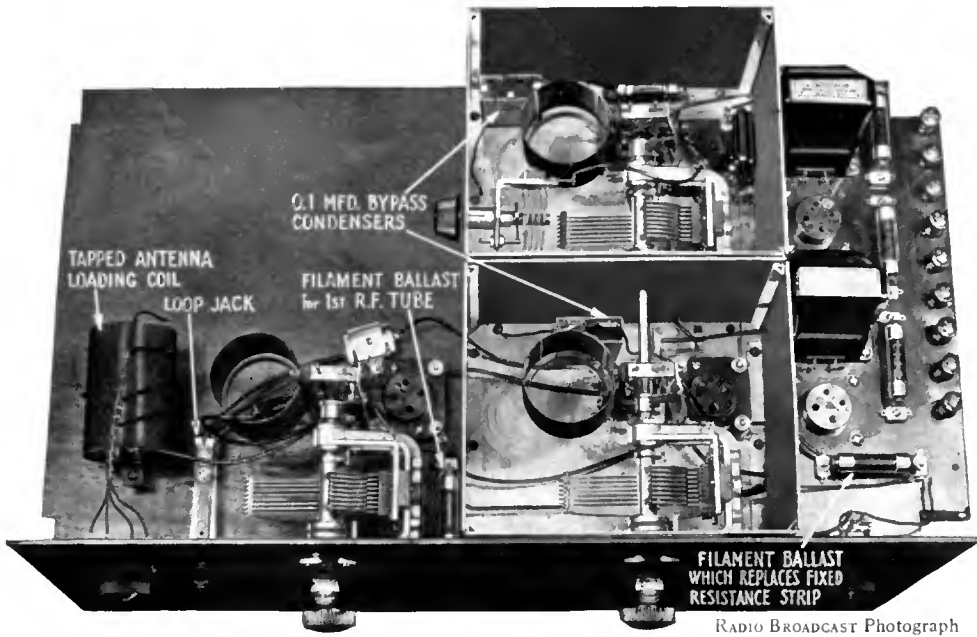

SHOWING THE DISPOSITION OF THE NEW PARTS

All the changes which have been made are clearly depicted in this illustration. Bypass condensers have been included in the r.f. stages, a loading coil has been inserted in the antenna circuit, and each tube is controlled by its own filament ballast. The article also describes other novel features which have been applied to this receiver

close proximity of the interfering station. Such a condition may often be remedied by the use of a loop for local reception. The loop may be substituted for the first secondary coil by means of a plug and jack arrangement as shown in Fig. 3. By means of the loop, sufficient selectivity is obtained so as to insure satisfactory operation without interference on local reception. A loop designed to tune with a 0.00035-mfd. condenser should be used.

Greater sensitivity of the receiver is possible providing several changes are made in the antenna circuit. Here a tapped loading coil may be inserted in series with half of the existing primary coil. Four taps are taken off this loading coil which resonate at approximately 1000 kc., 750 kc., 600 kc., and 545 kc. (300, 400, 500, and 550 meters). This loading coil enables the builder of a "Hi-Q" receiver to tune his antenna circuit roughly to a frequency which approximately equals that of the station he wishes to receive.

This change involves the discarding of the two-point switch mounted at the extreme left of the front panel of the original receiver, and in its place is mounted a Carter 4-point tap switch. The loading coil may be home-made or should consist of 95 turns of a piece of two-inch diameter Hammarlund space-wound coil. Taps are taken

and mount in its place the clip mount of the ballast. Then detach the wire fastened to the positive filament terminal of the first tube socket. In the right front corner of the space set apart by the wall of the can of the second r.f. stage, fasten another filament ballast to the wood base. Connect the wire just unfastened from the socket direct to the end of the ballast nearest the socket. Connect the other end of the ballast to the plus filament socket terminal. Follow through to the other can the wire formerly connected to

FIG. 3

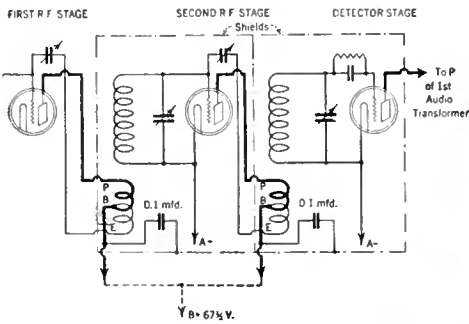
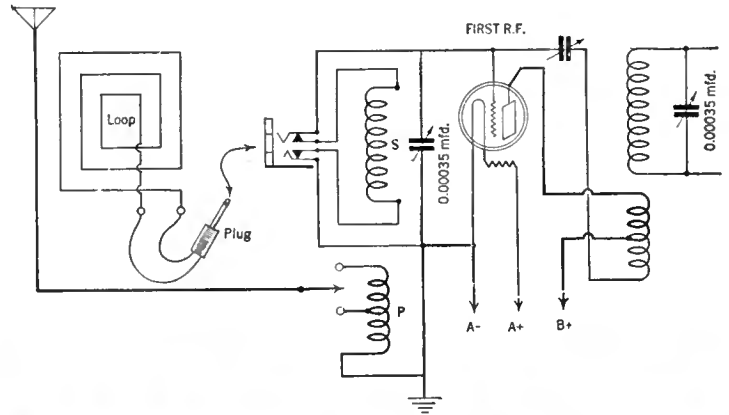

FIG. 1

the fixed resistance strip. Then re-solder it to the wire going to the rheostat which remains in the set. The altered circuit is shown in Fig. 2.

No change in sockets is necessary since the Benjamin sockets originally employed are satisfactory for use with UX-199 tubes.

USING A LOOP, AND SOME COIL CHANGES

OFTEN the owner of a receiver who desires to listen to a local program will experience interference from other local stations due to the

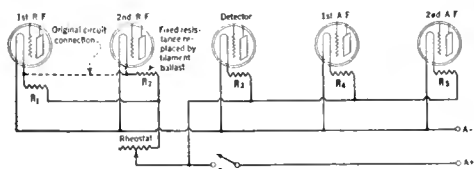
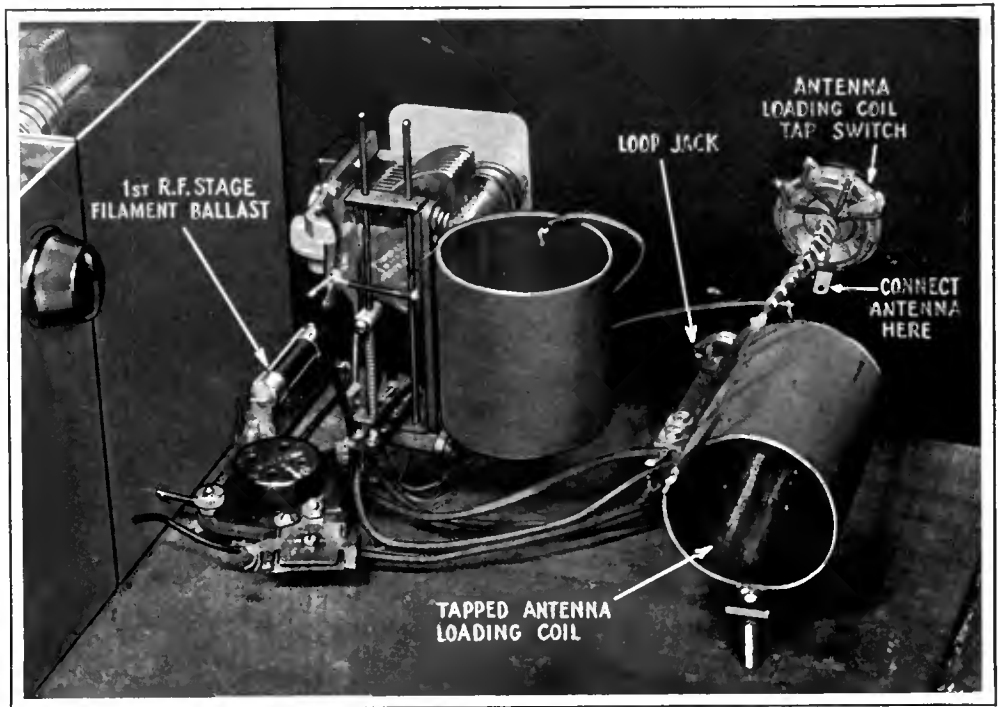

FIG. 2



RADIO BROADCAST Photograph

THE ANTENNA COMPARTMENT

In this view of the antenna tuner circuit compartment the placement of the various new parts is easily seen. A four-point tap switch replaces the two-point switch formerly employed while a double-circuit jack is mounted on the panel for plugging in the loop

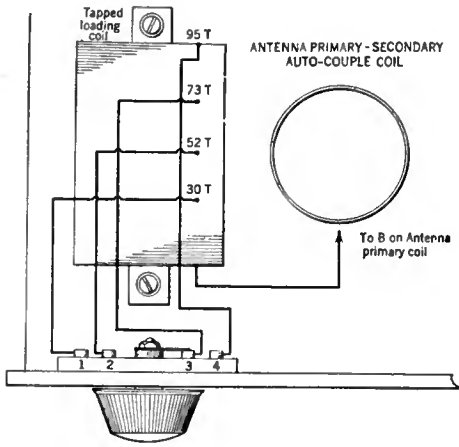

FIG. 4

off at the 30th, 52nd, and 73rd turns, corresponding with the first, second, and third position of the tap switch. The fourth tap switch point includes the entire 95 turns of the loading coil in the antenna circuit. Details of the layout, together with coil specifications, are given in Figs. 4 and 5 respectively.

HOW TO NEUTRALIZE THE RECEIVER

CIRCUITS that are represented to readers as of the non-blooper type due to some scheme of neutralization employed, do not always turn out that way. This is largely due to the indifference of the builder to his job when the time comes to neutralize his receiver. A receiver which is perfectly neutralized is better than one in which neutralization is not complete because, in the latter, oscillation is likely to occur at some point in the broadcast band and at that point reception is spoiled if not completely eliminated.

To neutralize a receiver does not require a great deal of technique and, in the end, the time spent on this important point is more than compensated by the superior results obtained.

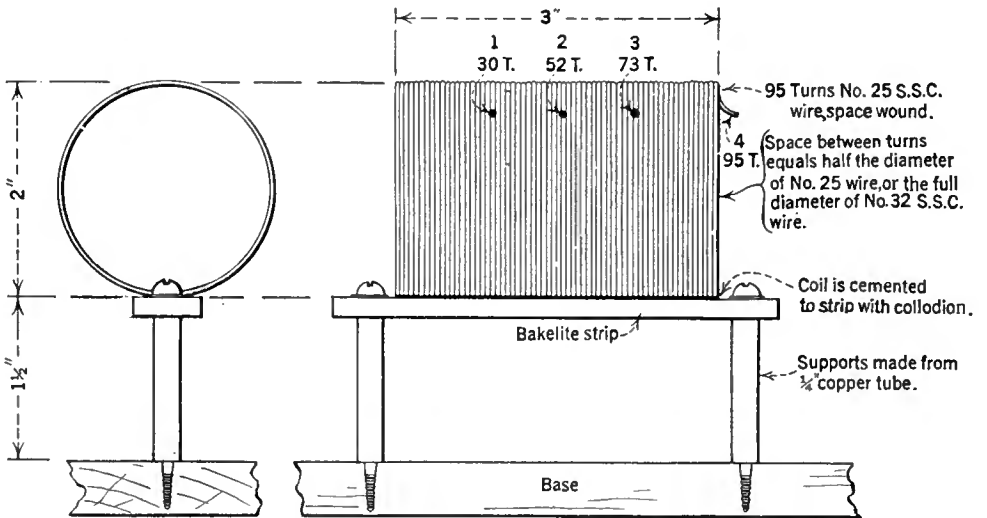

FIG. 5

Where each tube of the "Hi-Q" has been supplied with its own filament ballast, the job is made quite easy. Simply remove the ballast in the first r.f. tube circuit from its clips (after a station has been tuned-in), and, with a stick sharpened to a thin edge, adjust the neutralizing condenser until the signal is reduced to a minimum, or entirely eliminated. It is important to note that while the process goes on it is necessary to re-tune the condenser of the first stage as the neutralizing action usually de-tunes the first condenser circuit slightly.

If the stick of wood doesn't hold out long enough to complete the job, take an ordinary screw driver and wrap the shaft with insulating tape to within a half-inch of the blade. Then if the tape-covered part of this tool inadvertently touches the can walls, no blown-out tubes will result, which would be the case if the screw driver were not insulated.

After the first r.f. stage has been neutralized, the ballast may be replaced in its clips and the

same process duplicated for the second r.f. stage.

A circuit diagram of the receiver incorporating all of the changes outlined in this article is shown in Fig. 6.

The following parts were used in making the changes described. Other makes can of course be employed, if the electrical characteristics of the unit concerned are similar.

1	4-Point Carter Tap Switch, No. 404	\$1.00
1	Loading Coil (See Winding Specifications, Fig. 5)	1.00
2	Bypass Condensers, Sangamo, 0.1-Mfd.	1.60
1	Amperite and Mounting, Type No. 4V (For Use with 3-Volt Tubes)	1.10
3	Amperite Cartridges, Type No. 4V	3.30
1	Amperite, Type No. 120	1.10
1	Carter Double-Circuit Jack, No. 104	1.00
TOTAL		\$10.10

Previous articles on the building of the "Hi-Q" receiver have appeared in RADIO BROADCAST for January and March of this year.

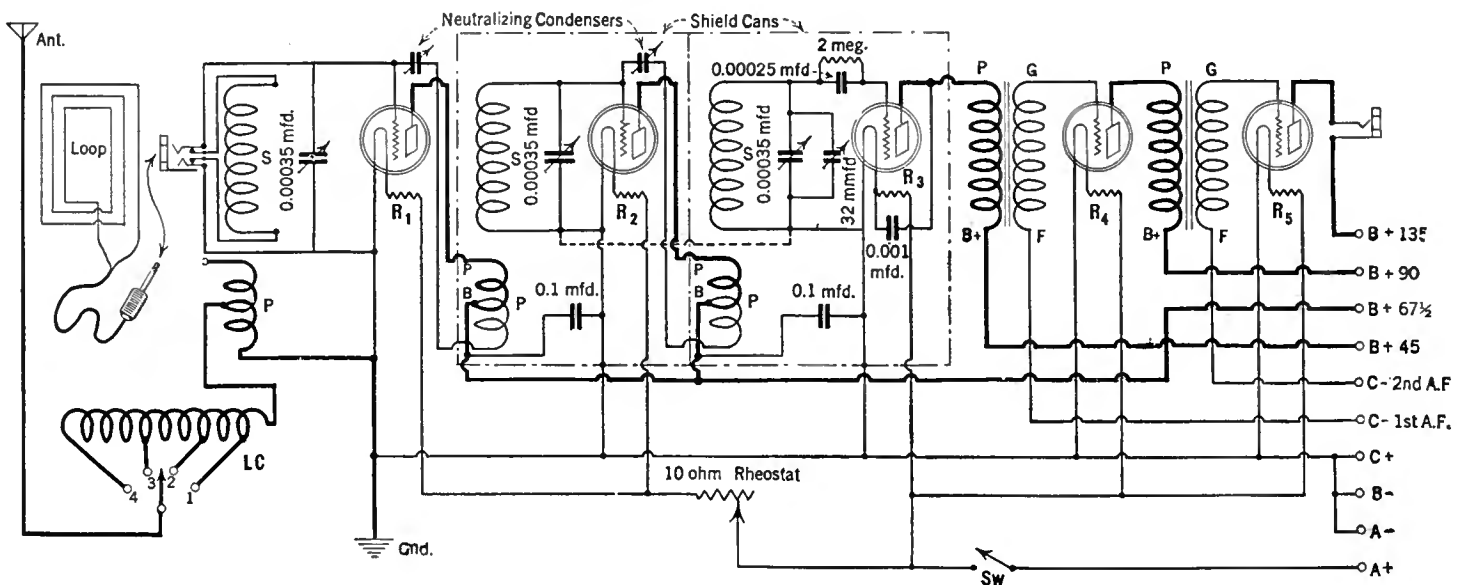

FIG. 6

# A Fundamental Analysis of Loud Speakers



A Radio Club of America Paper Discussing the Signals a Loud Speaker Is Required to Reproduce—Factors Determining the Quality of Output from a Loud Speaker—Some Causes of Distortion in Reproducers



By JOHN F. NIELSEN

Engineering Dept., F. A. D. Andrea, Inc.

CENTURIES before we dreamed of modern loud speaking equipment, the natives of Africa had crude systems of communication in the form of cocoanut shells connected by a taut string, which acted as a medium for transmitting sound vibrations. Outgrowths of these crude systems of communication are our present telephone network and radio systems.

The primary function of any communication system is to transmit intelligence and entertainment. In considering the operation of any such system, the reproduced sounds may be referred

The fact that there is ample opportunity for distortion in those parts of a radio system preceding the loud speaker is apparent from a consideration of the change the speech wave must undergo between studio and loud speaker. Although there is equal opportunity for distortion in the transmitter and receiver, transmitter distortion is generally negligible. The fact that a broadcasting station serves a large volume of receiving sets would point to this state of affairs, since the receiver must be far cheaper than the transmitter. Quality in the receiving set itself is affected by the sharpness of tuning of the radio-frequency stages, by the time constant of the grid leak-condenser combination of the detector circuit, by the characteristic and power capacity of the audio amplifier, and finally, by the loud speaker itself.

Before considering in detail the characteristics of loud speakers, let us digress for the moment and consider the nature of the signal it must reproduce. In general, the loud speaker should reproduce faithfully both speech and music, each of which presents its own peculiar problems.

Speech consists in general of two fundamental types of sound, namely, continuents and stops, and their combinations<sup>1</sup> (see bibliography on page 590). The former are those produced by a continuous flow of air, such as the letters F, S, etc., while the latter consists of those sounds produced by a sudden stoppage of air, such as letters, P, B, and M.

For instance, analyzing the word "Past," we notice, in Fig. 1, that "P" appears as a transient indicated by a high broad peak; "A," a

nearly continuous frequency of approximately 800 cycles varying in amplitude; "S" and "T" are of a high frequency character, of low amplitude, and continuous.

It is readily seen from the nature of the word that, in order to obtain perfect reproduction, the loud speaker must reproduce frequencies of an extreme nature with proper relative amplitude and without time lag. If a loud speaker is inefficient at the upper extreme of its frequency spectrum, it is generally noticed that "S," "T," and other high-frequency combinations, are either missing entirely or are of low relative intensity. In addition, a loud speaker may have resonant peaks at certain frequencies which may so exaggerate some sounds as to completely mask others. Speech energy is distributed over a frequency band of about 50 to 10,000 cycles per second and, in general, has a maximum between

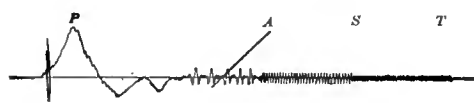

FIG. 1

to as having two properties, i.e., intelligibility and naturalness. In radio broadcasting, the communication system is supplemented by entertainment, and the property of naturalness, therefore, increases in importance in the reproduced speech. Moreover, the transmission of music imposes even more severe requirements upon a communication system because of the wide range of frequencies and intensities required for proper appreciation. It is the purpose of this paper to present in a popular fashion a few of the fundamentals of operation of one link of such a system, namely, the acoustic reproducer.

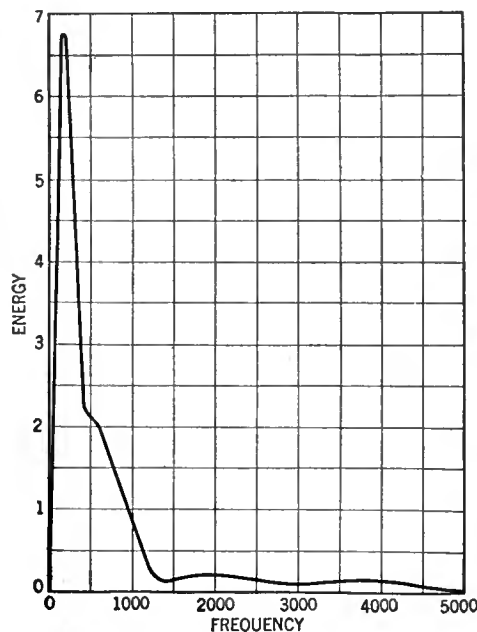
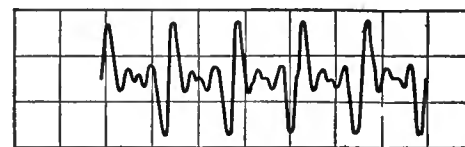
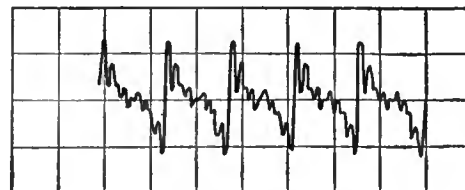

FIG. 2



CELLO ORGAN PIPE "C"



TROMBONE ORGAN PIPE "C"

FIG. 3

150 and 250 cycles. The frequency distribution of speech energy is shown graphically in Fig. 2.

Music is characterized by various harmonics which may be of larger or smaller amplitude than the fundamental. These harmonics distinguish the same note in the same octave as played on different instruments. Fig. 3 shows the difference between a cello organ pipe "C" and a trombone organ pipe "C". It is readily seen that a wide frequency spectrum must be faithfully reproduced to enable the listener to distinguish between different instruments. Musical sounds are characterized by being sustained at definite frequencies for comparatively long periods and by having the change in pitch take place in definite musical intervals called, thirds, fifths, octaves, etc. Musical notes are usually very rich in harmonics; in some instances, as in the case of the cello, the harmonics may even exceed the fundamental frequency in intensity. Musical energy is distributed over a frequency band of from about 16 cycles to something over 10,000 cycles.

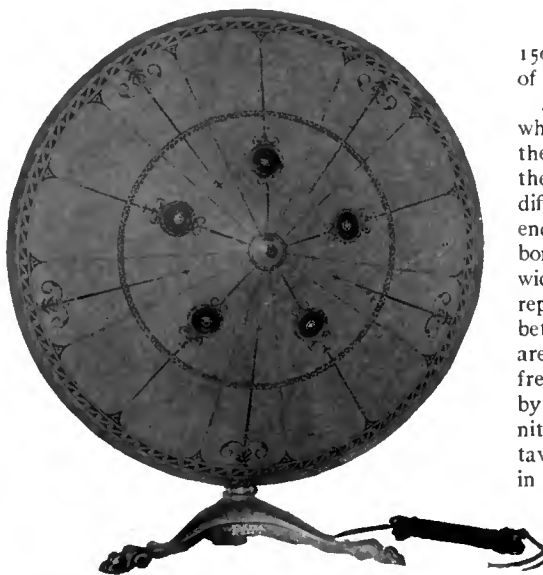

A TYPICAL MODERN CONE LOUD SPEAKER



per second, and usually has its maximum below 1000 cycles. However, it has been found that a frequency range of about 50 to 5000 cycles is tolerable for natural reproduction of both speech and music.<sup>2</sup> (see bibliography on page 590).

Having considered the nature of speech and music, it is evident that the perfect reproducer should give constant response when actuated by constant audio signal impulses, and be free from resonant effects or hangovers of any sort. It is at once apparent that the action of the loud speaker may depend to some extent on the circuit elements used to couple it to the last amplifier tube, since the coupling devices may resonate the loud speaker at some audio frequency.

It has been variously suggested that the quality of reproduced speech and music depends both upon the average response of the sound reproducing element to steady tones, and to the irregularity of the response frequency characteristics. The former serves as a basis for a rough estimate of quality and relative loudness of fundamental notes, while the latter is an index from which it is possible to predetermine the clarity of the reproduced speech and music. That is to say, a response-frequency characteristic obtained by applying steady single frequencies to the loud speaker gives only a general indication of the action of the loud speaker when it is actuated by transient notes, sudden stops, etc. To predict the effect of hangovers which tend to confuse the listener by changing the relative phase displacement of independent notes, it is necessary to know something about the resonant peaks in the response characteristic. Obviously, quality also depends on the nature of the load characteristic of the motor element. Since, as previously pointed out, the energy of both speech and music is more or less concentrated below 1000 cycles per second, the loud speaker, in actual service, must necessarily operate with a wide variation in amplitude. For this reason it is desirable that the efficiency of the loud speaker be approximately constant for all armature excursions commonly met in practice, otherwise, the large amplitude frequency notes, or the smaller amplitude high-frequency notes, will be over-emphasized.

It has been shown elsewhere that musical tones between 200 and 2000 cycles have in general the same average intensity and that the human ear at the intensities generally used in reproduced music or speech has about the same sensitivity over this range.<sup>3</sup> (see bibliography on page 590). Further, it has been shown that departures from faithful reproduction above and below this range are far less noticeable than departures within this range. For example, changes in response at 70 or 6000 cycles are about one tenth as serious as the same changes between 200 and 2000 cycles. As the range of maximum sensitivity is approached, given departures from true reproduction become more serious; thus, at 90 or 4000 cycles, a given departure from the true signal is about half as serious as at 1000 cycles. Consequently, if it is taken for granted that equal departures from the original signal do equal damage at points of equal auditory sensitivity, it is possible to arrive at a basis for determining the maximum departure of response from perfect reproduction allowable for tolerable reproduction. Using this as a basis, a response-frequency characteristic can be drawn which represents approximately the limit beyond which it is unnecessary to go for acceptable reproduction. Such a curve is shown in Fig. 4. From the standpoint of relative loudness, the response-frequency characteristic of any loud speaker which falls within the shaded area is substantially as acceptable as a perfect

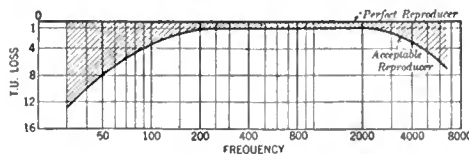

FIG. 4

unit. This, of course, holds only for relatively smooth characteristics, since resonance peaks of relatively large amplitude and sufficient sharpness always introduce sustained vibrations or hangovers, and these constitute an entirely different type of distortion. Representative response characteristics of two commercial cone loud speakers, are shown in Fig. 5.

A comprehensive method of measuring or

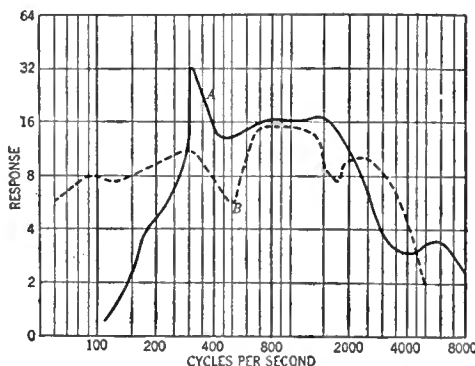

FIG. 5

rating a loud speaker in terms of its resonance peaks is probably as unnecessary as it is difficult. There are, however, a few conclusions that may readily be drawn from a first inspection of the response curve. A broad peak indicates high damping action, and a sharp peak, low damping. Therefore, if the broadness of any resonance peak is rated in terms of multiples or sub-multiples of the geometric mean frequency, the relative

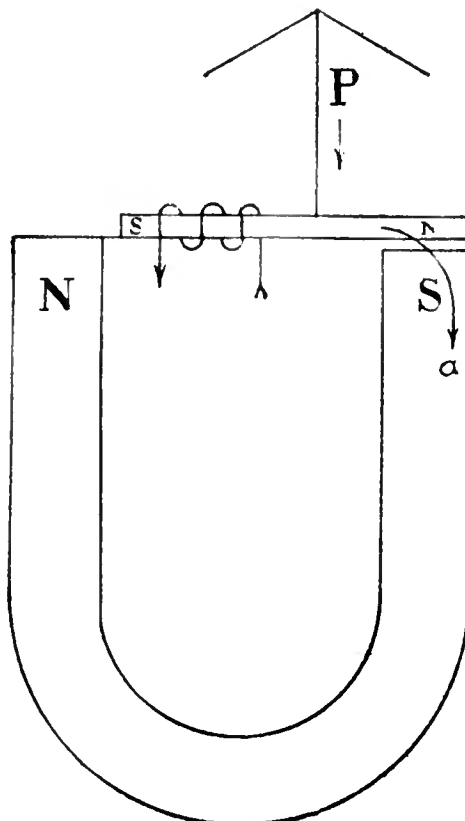

FIG. 6

length of the hangover can be approximately determined. Thus, a resonance peak of unit breadth at, say, seven tenths of its maximum height, will allow vibrations to persist roughly half as long as will one of the same amplitude and half its breadth, and in the former, these vibrations, for a given frequency, are about half as serious. It therefore appears worth while to examine closely the height and breadth of each resonance peak if its amplitude exceeds the average characteristic by 40 to 50 per cent. The absolute height of peaks that may be neglected is more or less a matter of opinion, and therefore, limits can only be fixed by measurement of the undesirable effects produced. Certainly, greatest harm will be produced by peaks falling within the frequency spectrum, most important from the standpoint of auditory sensitivity. Whence it would appear that the harmful effects of peaks can be weighted in accordance with the response curve of Fig. 4.

THE LOUD SPEAKER'S MECHANISM

HAVING considered, in general, the desirable characteristics of loud speakers, let us investigate the mechanism that is to produce these characteristics.

A loud speaker may be considered as made up of three systems:

1. The motor element, which converts the electrical impulses into corresponding mechanical vibrations.
2. The coupling system, which transmits the mechanical vibrations from motor to diaphragm.
3. The diaphragm or loading device, which radiates the mechanical vibrations into the air as waves of sound.

The simplest type of motor element in common use is the vibrating reed type. It consists, in general, of an armature pivoted or hinged at one end and actuated at the other, a magnet to supply a steady uni-directional magnetic flux, and a winding coupled to the magnetic circuit which is capable of superimposing an alternating or pulsating signal flux on the steady flux already present. A schematic diagram of such a unit is shown in Fig. 6. The free end of the armature is normally at rest in a steady uni-directional magnetic field supplied by the permanent magnet. When an alternating or pulsating current is passed through the coil coupled to the armature, the free end of the armature is alternately attracted and repulsed by the remaining pole. Thus, the electrical impulses in the coil are converted into mechanical vibrations which are, in turn, transmitted to a diaphragm through the medium of the driving rod.

A brief inspection of the figure will show that this type of motor is not free from distortion. Let  $\Phi$  represent the steady flux across the air gap;  $\alpha \sin \omega t$ , the flux due to a signal current through the windings, and  $P$  the force acting on the armature.

Then:

$$\begin{aligned}
 P &= K (\phi + \alpha \sin \omega t)^2 \\
 &= 2K \phi \alpha \sin \omega t + K \alpha^2 \sin^2 \omega t + K \phi^2 \\
 &= 2K \phi \alpha \sin \omega t - \frac{K \alpha^2}{2} \cos 2 \omega t + K \frac{(2\phi^2 + \alpha^2)}{2}
 \end{aligned}$$

Obviously, the first term represents a reproduction of the signal impulse, while the second term represents a second harmonic of the signal<sup>4</sup> (see bibliography on page 590). The remainder of the force adds a steady component to the steady pull exerted by the permanent magnet. It would seem, since that part of the coefficient of the second harmonic which is proportional to the signal, appears as a squared term, that the second harmonic could be made neg-

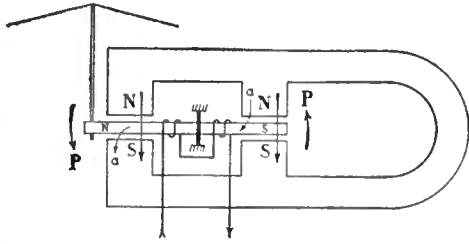

FIG. 7

ligibly small by the simple expedient of keeping the ratio  $\frac{\phi}{\alpha}$  large. Space will hardly permit a discussion of this point. Suffice it to say that good design dictates a limit to this ratio which must necessarily be determined by efficiency, and saturation of armature and pole pieces. Moreover, if a large permanent magnet is used, a stiff armature suspension will be required. Since the reed itself has a resonant period, great care must be exercised to properly fix this period in the frequency spectrum and to provide proper damping. Greatest apparent efficiency will, of course, be obtained by allowing the resonant period of the reed to fall between, say, 800 cycles and 2500 cycles. Best quality can generally be obtained if the resonant period falls near 100 cycles, and is highly damped. It is at once apparent that there are a number of factors which limit both the efficiency and the quality of this type of instrument.

Another type of motor of more recent design, which is very much in favor at present, is the balanced armature type shown in Fig. 7. Among other advantages, this type of structure will take larger loads without producing second harmonics of the signal. Using the same nomenclature as above, we have:

$$\begin{aligned} \text{Force due to one set of poles} &= K (\phi + \alpha \sin \omega t)^2 \\ \text{Force due to the remaining set of poles} &= K (\phi - \alpha \sin \omega t)^2 \end{aligned}$$

The total force acting on the armature is obviously the difference of these two, or:

$$P = K (\phi + \alpha \sin \omega t)^2 - K (\phi - \alpha \sin \omega t)^2 = 4 K \phi \alpha \sin \omega t$$

In this case, the overtone and the additional steady pull, due to the signal, which were present in the output of the reed type motor, vanish. This results, then, in an armature vibration, which is proportional to the signal and which contains no distorting components. It is also a fact that the balanced type of unit will in general reproduce much stronger signals without undue distortion than is the case with the reed type unit. Moreover, if the load contains sufficient damping, the response-frequency characteristic will obviously be more uniform than that of the reed type motor. This type of unit is, of course, not entirely free from resonance, although its fundamental resonant peak is generally not as serious as that of the reed type unit.

Fig. 8 shows the moving coil type of motor. Its operation is, in general, similar to that of the units described above, and lack of space forbids further comment here. This type of instrument may be made very free of mechanical resonant effects, since the mass and stiffness of the armature and its suspension system may be reduced.

CAUSES OF DISTORTION

THERE are numerous causes of distortion in loud speaker motors in addition to those already mentioned. Probably the worst offenders are:

1. Saturation of armature and pole faces.
2. Iron losses, including hysteresis and eddy currents. A detailed discussion of the effects of saturation is beyond the scope of this paper. A simple analysis will, however, serve to point out the general effects to be expected. Saturation occurs in practically all commercial loud speaker motors, at relatively large armature excursions. This particularly applies to reed type motors and balanced armature type motors. It seems reasonable to suspect that the saturation of armature and pole faces in these instruments may

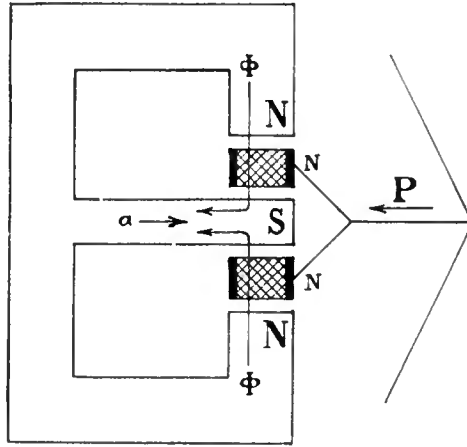

FIG. 8

be due, not to the alternating current in the windings directly, but rather to the permanent magneto-motive force producing large momentary fluxes through the pole faces and armature at large armature excursions. As is often the case, a direct current bias in the windings of a loud speaker, used directly in the plate circuit of an amplifier, may cause armature saturation at very small armature excursions. Be the cause what it may, the effects are the same in that they add odd harmonics of the signal output. Consider

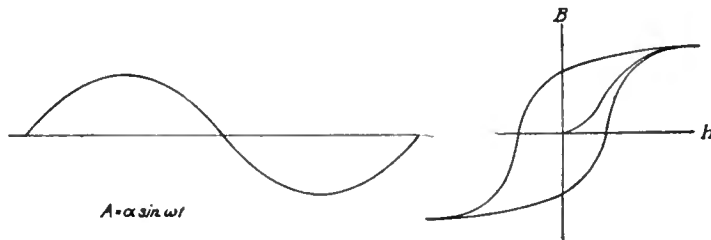

FIG. 9

a sinusoidal signal as shown in Fig. 9, and for simplicity, consider the magnetization curve of the iron involved to be shown in Fig. 10. This, of course, neglects hysteresis and the curvature of the B-H curve, but it is sufficient to illustrate the point. A sine wave signal of sufficient amplitude will produce an armature flux as shown. That is, the peaks of the sine wave will be flattened. Let the signal magneto-motive force be:

$$A = \alpha \sin \omega t.$$

The resulting flux may then be represented as<sup>6</sup> (see bibliography on page 590):

$B = \beta_1 \sin \omega t + \beta_3 \sin 3 \omega t + \beta_5 \sin 5 \omega t$  for the case in hand. In addition, there will also be a series of even harmonics for any practical case. Using the previous nomenclature, we have for the reed type instrument, operating at low flux density\*:

\*A rigorous treatment, would of course, involve even harmonics as well as odd ones since there is always a permanent uni-directional magnetic flux in the armature of the reed type instrument. For simplicity, the shift in axis due to the permanent flux has been neglected.

$$\begin{aligned} P &= K (\phi + \beta_1 \sin \omega t + \beta_3 \sin 3 \omega t + \beta_5 \sin 5 \omega t + \dots)^2 \\ &= K \phi^2 + K \beta_1^2 \sin^2 \omega t + K \beta_3^2 \sin^2 3 \omega t + K \beta_5^2 \sin^2 5 \omega t + \dots \\ &+ 2 K \phi \beta_1 \sin \omega t + 2 K \phi \beta_3 \sin 3 \omega t + 2 K \phi \beta_5 \sin 5 \omega t \\ &+ 2 K \beta_1 \beta_3 \sin \omega t \sin 3 \omega t + 2 K \beta_1 \beta_5 \sin \omega t \sin 5 \omega t \\ &+ 2 K \beta_3 \beta_5 \sin 3 \omega t \sin 5 \omega t + \dots \\ &= \frac{K}{2} (2 \phi^2 + \beta_1^2 + \beta_3^2 + \beta_5^2 + \dots) \\ &+ 2 K \phi (\beta_1 \sin \omega t + \beta_3 \sin 3 \omega t + \beta_5 \sin 5 \omega t + \dots) \\ &- \frac{K}{2} (\beta_1^2 \cos 2 \omega t + \beta_3^2 \cos 6 \omega t + \beta_5^2 \cos 10 \omega t + \dots) \\ &+ K \beta_1 \beta_3 \cos (\omega t - 3 \omega t) - K \beta_1 \beta_3 \cos (\omega t + 3 \omega t) \\ &+ K \beta_1 \beta_5 \cos (\omega t - 5 \omega t) - K \beta_1 \beta_5 \cos (\omega t + 5 \omega t) \\ &+ K \beta_3 \beta_5 \cos (3 \omega t - 5 \omega t) - K \beta_3 \beta_5 \cos (3 \omega t + 5 \omega t) + \dots \\ &= 2 K \phi \beta_1 \sin \omega t + 2 K \phi \beta_3 \sin 3 \omega t + 2 K \phi \beta_5 \sin 5 \omega t + \\ &+ K (\beta_1 \beta_3 + \beta_3 \beta_5 - \frac{\beta_1^2}{2}) \cos 2 \omega t \\ &+ K (\beta_1 \beta_5 - \beta_1 \beta_3) \cos 4 \omega t - K (\beta_1 \beta_5 + \frac{\beta_3^2}{2}) \cos 6 \omega t \\ &- K \beta_3 \beta_5 \cos 8 \omega t - \frac{K \beta_5^2}{2} \cos 10 \omega t + \dots \\ &+ \frac{K}{2} (2 \phi^2 + \beta_1^2 + \beta_3^2 + \beta_5^2 + \dots) \end{aligned}$$

Interpreted, this amounts to a force acting on the armature equivalent to the signal and a number of even and odd harmonics as shown above. It is apparent that the amplitude of the harmonics increases with the degree of saturation.

Similarly, for the balanced armature motor we have:

$$\begin{aligned} P &= K (\phi + \beta_1 \sin \omega t + \beta_3 \sin 3 \omega t + \beta_5 \sin 5 \omega t + \dots)^2 \\ &- K (\phi - \beta_1 \sin \omega t - \beta_3 \sin 3 \omega t - \beta_5 \sin 5 \omega t + \dots)^2 \\ &= 4 K \phi \beta_1 \sin \omega t + 4 K \phi \beta_3 \sin 3 \omega t + 4 K \phi \beta_5 \sin 5 \omega t + \dots \end{aligned}$$

Obviously, the odd harmonics are still present in their original relative amplitudes in the mechanical force acting on the armature. It will be noticed, however, that the conglomeration of added even harmonics present in the vibrating reed type motor, balances out in this case.

In addition to the introduction of harmonics due to saturation, there are present numerous other forms of distortion, even for very minute armature vibrations. Copper losses in general are negligible, but iron losses are responsible for a great deal of distortion at high frequencies.

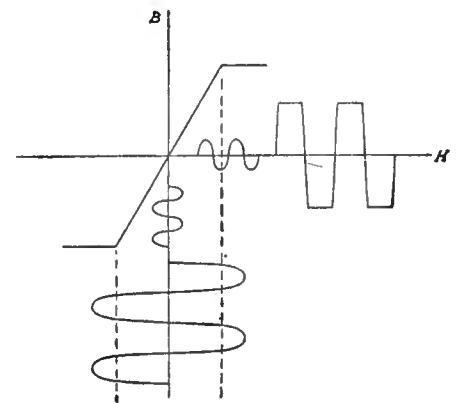

FIG. 10

per second, and usually has its maximum below 1000 cycles. However, it has been found that a frequency range of about 50 to 5000 cycles is tolerable for natural reproduction of both speech and music.<sup>2</sup> (see bibliography on page 590).

Having considered the nature of speech and music, it is evident that the perfect reproducer should give constant response when actuated by constant audio signal impulses, and be free from resonant effects or hangovers of any sort. It is at once apparent that the action of the loud speaker may depend to some extent on the circuit elements used to couple it to the last amplifier tube, since the coupling devices may resonate the loud speaker at some audio frequency.

It has been variously suggested that the quality of reproduced speech and music depends both upon the average response of the sound reproducing element to steady tones, and to the irregularity of the response frequency characteristics. The former serves as a basis for a rough estimate of quality and relative loudness of fundamental notes, while the latter is an index from which it is possible to predetermine the clarity of the reproduced speech and music. That is to say, a response-frequency characteristic obtained by applying steady single frequencies to the loud speaker gives only a general indication of the action of the loud speaker when it is actuated by transient notes, sudden stops, etc. To predict the effect of hangovers which tend to confuse the listener by changing the relative phase displacement of independent notes, it is necessary to know something about the resonant peaks in the response characteristic. Obviously, quality also depends on the nature of the load characteristic of the motor element. Since, as previously pointed out, the energy of both speech and music is more or less concentrated below 1000 cycles per second, the loud speaker, in actual service, must necessarily operate with a wide variation in amplitude. For this reason it is desirable that the efficiency of the loud speaker be approximately constant for all armature excursions commonly met in practice, otherwise, the large amplitude frequency notes, or the smaller amplitude high-frequency notes, will be over-emphasized.

It has been shown elsewhere that musical tones between 200 and 2000 cycles have in general the same average intensity and that the human ear at the intensities generally used in reproduced music or speech has about the same sensitivity over this range.<sup>3</sup> (see bibliography on page 590). Further, it has been shown that departures from faithful reproduction above and below this range are far less noticeable than departures within this range. For example, changes in response at 70 or 6000 cycles are about one tenth as serious as the same changes between 200 and 2000 cycles. As the range of maximum sensitivity is approached, given departures from true reproduction become more serious; thus, at 90 or 4000 cycles, a given departure from the true signal is about half as serious as at 1000 cycles. Consequently, if it is taken for granted that equal departures from the original signal do equal damage at points of equal auditory sensitivity, it is possible to arrive at a basis for determining the maximum departure of response from perfect reproduction allowable for tolerable reproduction. Using this as a basis, a response-frequency characteristic can be drawn which represents approximately the limit beyond which it is unnecessary to go for acceptable reproduction. Such a curve is shown in Fig. 4. From the standpoint of relative loudness, the response-frequency characteristic of any loud speaker which falls within the shaded area is substantially as acceptable as a perfect

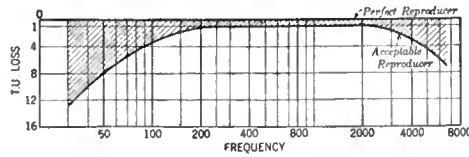

FIG. 4

unit. This, of course, holds only for relatively smooth characteristics, since resonance peaks of relatively large amplitude and sufficient sharpness always introduce sustained vibrations or hangovers, and these constitute an entirely different type of distortion. Representative response characteristics of two commercial cone loud speakers, are shown in Fig. 5.

A comprehensive method of measuring or

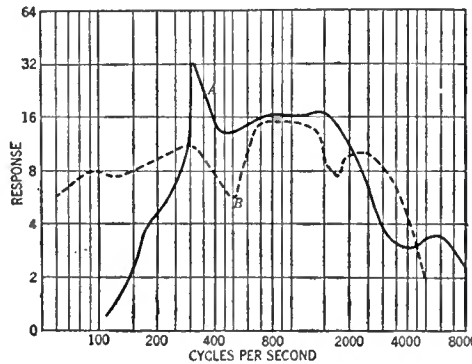

FIG. 5

rating a loud speaker in terms of its resonance peaks is probably as unnecessary as it is difficult. There are, however, a few conclusions that may readily be drawn from a first inspection of the response curve. A broad peak indicates high damping action, and a sharp peak, low damping. Therefore, if the broadness of any resonance peak is rated in terms of multiples or sub-multiples of the geometric mean frequency, the relative

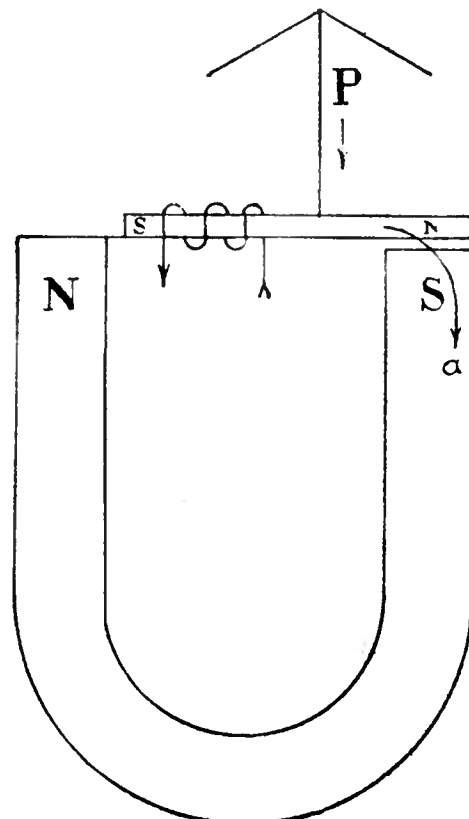

FIG. 6

length of the hangover can be approximately determined. Thus, a resonance peak of unit breadth at, say, seven tenths of its maximum height, will allow vibrations to persist roughly half as long as will one of the same amplitude and half its breadth, and in the former, these vibrations, for a given frequency, are about half as serious. It therefore appears worth while to examine closely the height and breadth of each resonance peak if its amplitude exceeds the average characteristic by 40 to 50 per cent. The absolute height of peaks that may be neglected is more or less a matter of opinion, and therefore, limits can only be fixed by measurement of the undesirable effects produced. Certainly, greatest harm will be produced by peaks falling within the frequency spectrum, most important from the standpoint of auditory sensitivity. Whence it would appear that the harmful effects of peaks can be weighted in accordance with the response curve of Fig. 4.

THE LOUD SPEAKER'S MECHANISM

HAVING considered, in general, the desirable characteristics of loud speakers, let us investigate the mechanism that is to produce these characteristics.

A loud speaker may be considered as made up of three systems:

1. The motor element, which converts the electrical impulses into corresponding mechanical vibrations.
2. The coupling system, which transmits the mechanical vibrations from motor to diaphragm.
3. The diaphragm or loading device, which radiates the mechanical vibrations into the air as waves of sound.

The simplest type of motor element in common use is the vibrating reed type. It consists, in general, of an armature pivoted or hinged at one end and actuated at the other, a magnet to supply a steady uni-directional magnetic flux, and a winding coupled to the magnetic circuit which is capable of superimposing an alternating or pulsating signal flux on the steady flux already present. A schematic diagram of such a unit is shown in Fig. 6. The free end of the armature is normally at rest in a steady uni-directional magnetic field supplied by the permanent magnet. When an alternating or pulsating current is passed through the coil coupled to the armature, the free end of the armature is alternately attracted and repulsed by the remaining pole. Thus, the electrical impulses in the coil are converted into mechanical vibrations which are, in turn, transmitted to a diaphragm through the medium of the driving rod.

A brief inspection of the figure will show that this type of motor is not free from distortion. Let Φ represent the steady flux across the air gap; α sin ωt, the flux due to a signal current through the windings, and P the force acting on the armature.

Then:

$$\begin{aligned}
 P &= K (\phi + \alpha \sin \omega t)^2 \\
 &= 2K \phi \alpha \sin \omega t + K \alpha^2 \sin^2 \omega t + K \phi^2 \\
 &= 2K \phi \alpha \sin \omega t - \frac{K \alpha^2}{2} \cos 2 \omega t + K \frac{(2\phi^2 + \alpha^2)}{2}
 \end{aligned}$$

Obviously, the first term represents a reproduction of the signal impulse, while the second term represents a second harmonic of the signal<sup>4</sup> (see bibliography on page 590). The remainder of the force adds a steady component to the steady pull exerted by the permanent magnet. It would seem, since that part of the coefficient of the second harmonic which is proportional to the signal, appears as a squared term, that the second harmonic could be made neg-

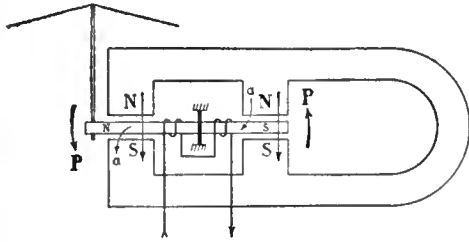

FIG. 7

ligibly small by the simple expedient of keeping the ratio  $\frac{\Phi}{\alpha}$ , large. Space will hardly permit a discussion of this point. Suffice it to say that good design dictates a limit to this ratio which must necessarily be determined by efficiency, and saturation of armature and pole pieces. Moreover, if a large permanent magnet is used, a stiff armature suspension will be required. Since the reed itself has a resonant period, great care must be exercised to properly fix this period in the frequency spectrum and to provide proper damping. Greatest apparent efficiency will, of course, be obtained by allowing the resonant period of the reed to fall between, say, 800 cycles and 2500 cycles. Best quality can generally be obtained if the resonant period falls near 100 cycles, and is highly damped. It is at once apparent that there are a number of factors which limit both the efficiency and the quality of this type of instrument.

Another type of motor of more recent design, which is very much in favor at present, is the balanced armature type shown in Fig. 7. Among other advantages, this type of structure will take larger loads without producing second harmonics of the signal. Using the same nomenclature as above, we have:

$$\begin{aligned} \text{Force due to one set of poles} &= K (\phi + \alpha \sin \omega t)^2 \\ \text{Force due to the remaining set of poles} &= K (\phi - \alpha \sin \omega t)^2 \end{aligned}$$

The total force acting on the armature is obviously the difference of these two, or:

$$P = K (\phi + \alpha \sin \omega t)^2 - K (\phi - \alpha \sin \omega t)^2 = 4 K \phi \alpha \sin \omega t$$

In this case, the overtone and the additional steady pull, due to the signal, which were present in the output of the reed type motor, vanish. This results, then, in an armature vibration, which is proportional to the signal and which contains no distorting components. It is also a fact that the balanced type of unit will in general reproduce much stronger signals without undue distortion than is the case with the reed type unit. Moreover, if the load contains sufficient damping, the response-frequency characteristic will obviously be more uniform than that of the reed type motor. This type of unit is, of course, not entirely free from resonance, although its fundamental resonant peak is generally not as serious as that of the reed type unit.

Fig. 8 shows the moving coil type of motor. Its operation is, in general, similar to that of the units described above, and lack of space forbids further comment here. This type of instrument may be made very free of mechanical resonant effects, since the mass and stiffness of the armature and its suspension system may be reduced.

CAUSES OF DISTORTION

**T**HERE are numerous causes of distortion in loud speaker motors in addition to those already mentioned. Probably the worst offenders are:

1. Saturation of armature and pole faces.
2. Iron losses, including hysteresis and eddy currents. A detailed discussion of the effects of saturation is beyond the scope of this paper. A simple analysis will, however, serve to point out the general effects to be expected. Saturation occurs in practically all commercial loud speaker motors, at relatively large armature excursions. This particularly applies to reed type motors and balanced armature type motors. It seems reasonable to suspect that the saturation of armature and pole faces in these instruments may

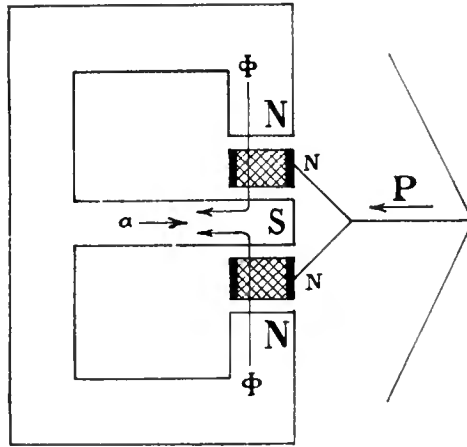

FIG. 8

be due, not to the alternating current in the windings directly, but rather to the permanent magneto-motive force producing large momentary fluxes through the pole faces and armature at large armature excursions. As is often the case, a direct current bias in the windings of a loud speaker, used directly in the plate circuit of an amplifier, may cause armature saturation at very small armature excursions. Be the cause what it may, the effects are the same in that they add odd harmonics of the signal output. Consider

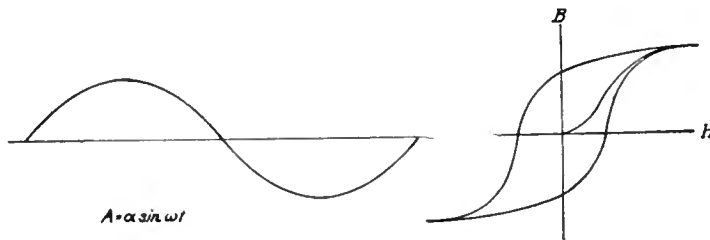

FIG. 9

a sinusoidal signal as shown in Fig. 9, and for simplicity, consider the magnetization curve of the iron involved to be shown in Fig. 10. This, of course, neglects hysteresis and the curvature of the B-H curve, but it is sufficient to illustrate the point. A sine wave signal of sufficient amplitude will produce an armature flux as shown. That is, the peaks of the sine wave will be flattened. Let the signal magneto-motive force be:

$$A = \alpha \sin \omega t.$$

The resulting flux may then be represented as<sup>5</sup> (see bibliography on page 590):

$$B = \beta_1 \sin \omega t + \beta_3 \sin 3 \omega t + \beta_5 \sin 5 \omega t$$

for the case in hand. In addition, there will also be a series of even harmonics for any practical case. Using the previous nomenclature, we have for the reed type instrument, operating at low flux density\*:

\*A rigorous treatment, would of course, involve even harmonics as well as odd ones since there is always a permanent uni-directional magnetic flux in the armature of the reed type instrument. For simplicity, the shift in axis due to the permanent flux has been neglected.

$$\begin{aligned} P &= K (\phi + \beta_1 \sin \omega t + \beta_3 \sin 3 \omega t + \beta_5 \sin 5 \omega t + \dots)^2 \\ &= K \phi^2 + K \beta_1^2 \sin^2 \omega t + K \beta_3^2 \sin^2 3 \omega t + K \beta_5^2 \sin^2 5 \omega t + \dots \\ &+ 2 K \phi \beta_1 \sin \omega t + 2 K \phi \beta_3 \sin 3 \omega t + 2 K \phi \beta_5 \sin 5 \omega t \\ &+ 2 K \beta_1 \beta_3 \sin \omega t \sin 3 \omega t + 2 K \beta_1 \beta_5 \sin \omega t \sin 5 \omega t \\ &+ 2 K \beta_3 \beta_5 \sin 3 \omega t \sin 5 \omega t + \dots \\ &= \frac{K}{2} (2 \phi^2 + \beta_1^2 + \beta_3^2 + \beta_5^2 + \dots) \\ &+ 2 K \phi (\beta_1 \sin \omega t + \beta_3 \sin 3 \omega t + \beta_5 \sin 5 \omega t + \dots) \\ &- \frac{K}{2} (\beta_1^2 \cos 2 \omega t + \beta_3^2 \cos 6 \omega t + \beta_5^2 \cos 10 \omega t + \dots) \\ &+ K \beta_1 \beta_3 \cos (\omega t - 3 \omega t) - K \beta_1 \beta_5 \cos (\omega t + 3 \omega t) \\ &+ K \beta_3 \beta_5 \cos (\omega t - 5 \omega t) - K \beta_1 \beta_5 \cos (\omega t + 5 \omega t) \\ &+ K \beta_3 \beta_5 \cos (3 \omega t - 5 \omega t) - K \beta_3 \beta_5 \cos (3 \omega t + 5 \omega t) + \dots \\ &= 2 K \phi \beta_1 \sin \omega t + 2 K \phi \beta_3 \sin 3 \omega t + 2 K \phi \beta_5 \sin 5 \omega t + \\ &+ K (\beta_1 \beta_3 + \beta_3 \beta_5 - \frac{\beta_1^2}{2}) \cos 2 \omega t \\ &+ K (\beta_1 \beta_5 - \beta_1 \beta_3) \cos 4 \omega t - K (\beta_1 \beta_5 + \frac{\beta_3^2}{2}) \cos 6 \omega t \\ &- K \beta_3 \beta_5 \cos 8 \omega t - \frac{K \beta_5^2}{2} \cos 10 \omega t + \dots \\ &+ \frac{K}{2} (2 \phi^2 + \beta_1^2 + \beta_3^2 + \beta_5^2 + \dots) \end{aligned}$$

Interpreted, this amounts to a force acting on the armature equivalent to the signal and a number of even and odd harmonics as shown above. It is apparent that the amplitude of the harmonics increases with the degree of saturation.

Similarly, for the balanced armature motor we have:

$$\begin{aligned} P &= K (\phi + \beta_1 \sin \omega t + \beta_3 \sin 3 \omega t + \beta_5 \sin 5 \omega t + \dots)^2 \\ &- K (\phi - \beta_1 \sin \omega t - \beta_3 \sin 3 \omega t - \beta_5 \sin 5 \omega t + \dots)^2 \\ &= 4 K \phi \beta_1 \sin \omega t + 4 K \phi \beta_3 \sin 3 \omega t + 4 K \phi \beta_5 \sin 5 \omega t + \dots \end{aligned}$$

Obviously, the odd harmonics are still present in their original relative amplitudes in the mechanical force acting on the armature. It will be noticed, however, that the conglomeration of added even harmonics present in the vibrating reed type motor, balances out in this case.

In addition to the introduction of harmonics due to saturation, there are present numerous other forms of distortion, even for very minute armature vibrations. Copper losses in general are negligible, but iron losses are responsible for a great deal of distortion at high frequencies.

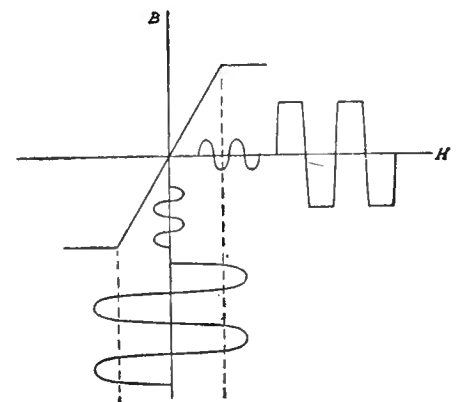

FIG. 10

Iron losses are due to hysteresis and to eddy currents. Hysteretic effect may in general be sufficiently minimized by the use of a good grade of iron, and lamination of that part of the magnetic circuit traversed by the alternating flux appreciably reduces eddy current losses. Eddy currents are due to induction and are induced in the metallic portions of the motor structure by virtue of the changing magnetic flux. Eddy current losses increase as the square of the frequency, and hence tend to reduce the high-frequency response of the motor. Eddy current losses are also dependent on the excursions of the armature and thus may cause amplitude distortion due to their variation over the signal cycle. The frequency distortion due to eddy currents is, however, generally far more serious than the amplitude distortion, and their effect is generally quite apparent in response characteristics.

In order that the armature vibrations be imparted to the air as sound waves, it is necessary to couple a loading device to the motor element. The loading device may consist of a horn together with a small diaphragm and air chamber, or of a large diaphragm which imparts the vibrations directly to the air. The function of either type of loading element is much the same although their action differs somewhat. Properly designed horns apply an almost constant load to a motor element and may thus be made to produce a much smoother response-frequency characteristic than the cone type (large diaphragm) device<sup>6</sup> (see bibliography on this page). The essential difference in the two lies mainly in the fact that the load presented by the horn is almost pure radiation resistance over the operating range, while that supplied by the cone is far from constant, resulting generally in an irregular response characteristic, and is very similar in its action toward the mechanical system to a complex impedance load in an electrical circuit.† Aside from the difference in relative smoothness of their response characteristics the frequency band covered in the two cases is quite different. See Fig. 11. The lowest frequency radiated by a horn is a function of its length. Many horns function in a manner similar to an open organ pipe, in that the lowest frequency transmitted is

$$F = \frac{\text{VEL. OF SOUND IN AIR}}{2 (\text{LENGTH OF HORN})}$$

to a first approximation. This obviously depends on the shape of the horn and the shape of the opening. The lowest frequency efficiently radiated by the cone is, among other factors, de-

†This applies to large flexible diaphragms such as paper cones. With a very stiff diaphragm of small size, plunger action and more uniform response may result.

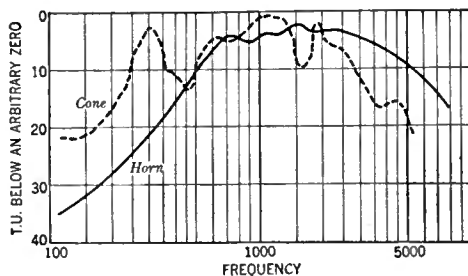

FIG. 11

termined by the size of the structure and the amplitude of motion. In addition, the highest transmitted frequency efficiently radiated by this type of loading device is partly determined by the effective high-frequency mass of the diaphragm. In some diaphragms, at high frequencies, only a small portion of the diaphragm near the driven point is effective as a radiator, the remainder of the device acting in general as a power absorbing network. That is to say, the high-frequency vibrations may travel from apex to edge of the cone as well as being directly radiated from the driven point. The effect of these impulses traveling across the face of the diaphragm is twofold: First, power lost in deformation of the diaphragm face, and, second, out-of-phase radiation. These may frequently occur to such an extent that the radiated sound is much reduced. In addition, the usual diaphragm has many resonant points of its own and thus may present a variable load to the motor.

The efficiency and response-frequency characteristics of a loud speaker depend to a large extent upon the device used to couple the motor to the loading element. In the case of the horn radiator, this device usually consists of a short light driving rod and is, in general, quite efficient and relatively free of distorting effects. In the case of the large diaphragm (cone) loading device, the coupling device must in general include a mechanical transformer, which amounts to a lever or system of levers for increasing the force. In the ideal case the mechanical transformer consists of a frictionless lever of zero mass. In practical cases it may consist of members having appreciable mass and considerable stiffness of suspension, amounting to a complex network, which further complicate the action of the loud speaker as a unit. This particular phase of the subject, however, has been treated in detail elsewhere<sup>7</sup> (see bibliography on this page).

The human ear which in the end is the final judge of quality, is far from a perfect instrument. Its response characteristic is far from linear either with frequency or amplitude<sup>8</sup> (see bibliography on this page). Moreover, the ear is in

itself a modulator, due to the nonlinearity of its characteristics<sup>9</sup> (see bibliography on this page). Such being the case, it is often possible for an observer to apparently hear a fundamental note, when only harmonics of the note actually impinge on the ear drum<sup>10</sup> (see bibliography on this page). Therefore, it may often be permissible to allow a certain amount of distortion to actually take place, and still maintain tolerable quality. Thus, harmonics produced by a loud speaker may often cause a slight apparent increase in efficiency without materially affecting quality. The naturalness of reproduced speech and music depends to a large extent on the energy level at which it is reproduced. That is to say, the psychological reaction of the observer depends on whether or not the signal is delivered at normal intensity. Again, harmonics of the original signal are frequently not detected by the ear until the energy level is such that the harmonic output of the reproducer approaches that of the original signal. Moreover, relatively large irregularities in the response characteristic of an acoustic reproducer are frequently allowable at either end of the frequency spectrum, as previously pointed out. Consequently, a perfect reproducer, having a linear response characteristic, might not appear to have an appreciable advantage over a less perfect device with a reasonably acceptable characteristic.

#### BIBLIOGRAPHY

- 1—"Nature of Language," R. L. Jones. *Electrical Communication*—Vol. 2, No. 1, July, 1923.
- 2—"High Quality Reproduction of Speech and Music," W. H. Martin and H. Fletcher. *Journal A. I. E. E.* Vol. XLII, No. 3, March, 1924.
- 3—"The Relation between the Loudness of a Sound and Its Physical Stimulus," J. C. Steinberg. *Physical Review*, October, 1925.
- 4—"Design of Telephone Receivers for Loud Speaking Purposes," C. R. Hanna. *Proc. I. R. E.* August, 1925. "Theory of Magneto-Mechanical Systems," R. L. Wegel. *Journal A. I. E. E.* October, 1921. "The Electromagnetic Theory of the Telephone Receiver," A. E. Kennelly and H. Nukiyama. *Proc. A. I. E. E.* April, 1919.
- 5—"Fouriers Series and Spherical Harmonics," Byerly.
- 6—"Function and Design of Horns for Loud Speakers," C. R. Hanna and J. Slepian. *Journal A. I. E. E.* February, 1924. "Acoustical Impedance and Theory of Horns and of the Phonograph," A. G. Webster. *Proc. National Academy of Sciences*, 1919, Vol. 5. "Experiments on the Vibration of Air in Conical Horns," A. G. Webster. *Proc. National Academy of Sciences*, 1920, Vol. 6. "Theory of Sound," Lord Rayleigh. Vol. 2. "Performance and Theory of Loud Speaker Horns," Goldsmith and Minton. *Proc. I. R. E.* August, 1924.
- 7—"Methods of High-Quality Recording and Reproducing of Music and Speech Based on Telephone Research," J. P. Maxfield and H. C. Harrison. *Bell System Technical Journal*, July, 1926.
- 8—"Physical Measurements of Audition and Their Bearing on the Theory of Hearing," Harvey Fletcher. *Journal of Franklin Institute*. Vol. 196, No. 3, September, 1923.
- 9—"Auditory Masking and Dynamics of the Inner Ear," R. L. Wegel and C. E. Lane. *Physical Review*, February, 1924.
- 10—"Physical Criteria for Determining the Pitch of a Musical Tone," H. Fletcher. *Physical Review*, September, 1923.

**R**ADIO BROADCAST is the official publication of the Radio Club of America, through whose courtesy, the foregoing paper has been printed here. RADIO BROADCAST does not, of course, assume responsibility for controversial statements made by authors of these papers. Other Radio Club papers will appear in subsequent numbers of this magazine

*“We’ve cut down our come-backs  
with Faradon equipped sets”*

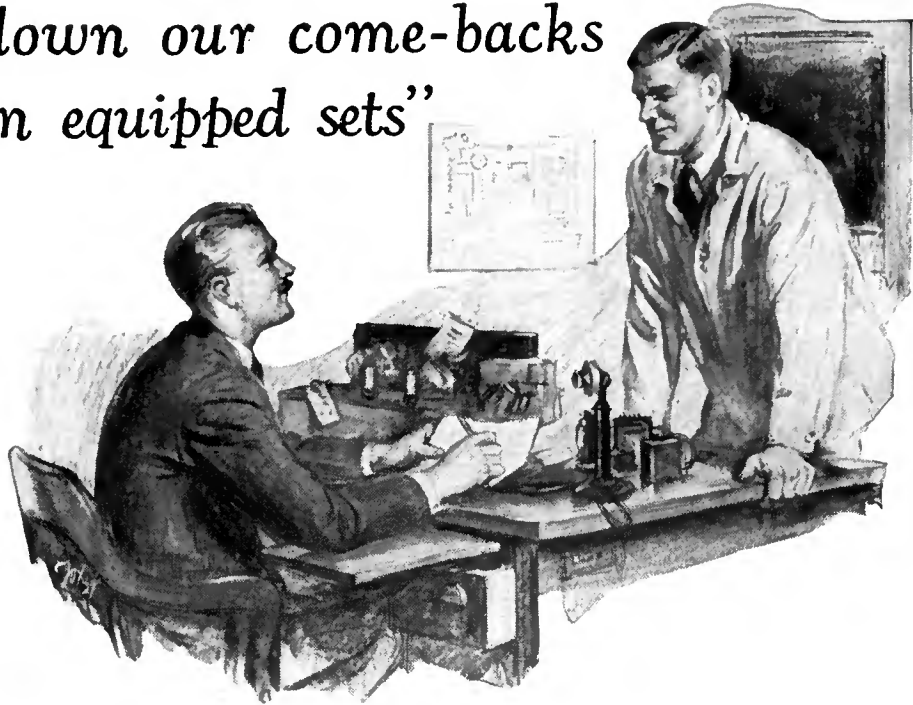

**M**ANUFACTURERS who equip their sets with Faradon Capacitors free themselves from the complaints and returns caused by condensers of lesser durability.

The sheer dependability of Faradons can be best realized by the fact that they have been generally adopted for Automatic Railway Signals, and for Direction Finders at sea—two assignments where condensers must stand up.

For twenty years Faradon experts have combined skill and highest quality materials to make capacitors for each particular need. Faradon engineers are always ready to co-operate with manufacturers having under consideration special equipment which cannot be taken care of by the more than 200 standard Faradon Capacitors ready for prompt delivery.

**WIRELESS SPECIALTY  
APPARATUS COMPANY**  
Jamaica Plain : Boston, Mass., U. S. A.

*Established 1907*

***Faradon***

***Electrostatic condensers for all purposes***

USE THESE COILS  
AND IMPROVE ANY  
RADIO RECEIVER!

**AERO COIL**  
SUPER-SENSITIVE

INDUCTANCE UNITS



**Tuned Radio Frequency Kit**  
\$12.00

The Aero Coil Tuned Radio Frequency Kit illustrated above will positively improve the performance of any receiver. Patented Aero Coil construction eliminates radio frequency losses and brings tremendous improvement in volume, tone and selectivity. Kit consists of three matched units. The antenna coupler has variable primary. Uses .00035 condenser. 8 page color circuit, layout and instruction sheet for building the supersensitive 5 tube Aero-Dyne receiver packed FREE with each kit. Extra copies, 75c each. Instructions include insert showing how to wire up for a power tube if desired.

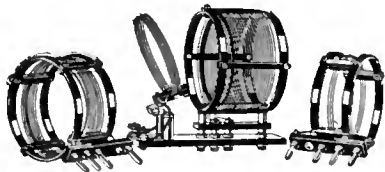

**Low Wave Tuner Kit**  
\$12.50

Completely interchangeable. Adapted by experts and amateurs. Range 15 to 130 meters. Includes three coils and base mounting, covering U. S. bands, 20, 40 and 80 meters. You can increase the range of this short wave tuner by securing coils No. 4 and 5. Combined range of 15 to 550 meters. Both interchangeable coils fit same base supplied with short wave kit and use the same condensers. Coil No. 4, price \$4.00; Coil No. 5 price \$4.00.

Get these coils from your nearest dealer.  
If he should be out of stock order  
direct from the factory

**AERO PRODUCTS, Inc.**

Dept. 109

1772 Wilson Ave. Chicago, Ill.

This is a good time to subscribe for

**RADIO BROADCAST**

Through your dealer or direct, by the year only \$4.00

**RADIO CABINETS**

FOR

**Hammarlund**  
ROBERTS  
HiQ

MODEL "C" CHEST

7 x 21 panel, 12" deep. Shipping charges paid. \$17.50.

Write for illustrated folders showing stock line of radio furniture for all standard panels and kit receivers.

**CORBETT CABINET MFG. COMPANY**  
St. Marys Penna.

# The Radio Broadcast LABORATORY INFORMATION SHEETS

**I**NQUIRIES sent to the Questions and Answers department of RADIO BROADCAST have until recently been answered either by letter or in "The Grid." The latter department has been discontinued, and all questions addressed to our technical service department are now answered by mail. In place of "The Grid," appears this series of Laboratory Information Sheets. These sheets contain much the same type of information as formerly appeared in "The Grid," but we believe that the change in the method of presentation and the wider scope of the information in the sheets, will make this section of RADIO BROADCAST of much greater interest to our readers.

The Laboratory Information Sheets cover a wide range of information of value to the experimenter, and they are so arranged that they may be cut from the magazine and preserved for constant reference. We suggest that the series of Sheets appearing in each issue be cut out with a razor blade and pasted on filing cards, or in a note book. The cards should be arranged in numerical order. Several times during the year, an index to all sheets previously printed will appear in this department. The first index appeared in November.

Those who wish to avail themselves of the service formerly supplied by "The Grid," are requested to send their questions to the Technical Information Service of the Laboratory, using the coupon which appears on page 612 of this issue. Some of the former issues of RADIO BROADCAST, in which appeared the first sets of Laboratory Sheets, may still be obtained from the Subscription Department of Doubleday, Page & Company at Garden City, New York.

No. 81

RADIO BROADCAST Laboratory Information Sheet

April, 1927

## Ohm's Law

SOME EXAMPLES

**I**F A tube's filament has a resistance of 20 ohms and five volts are applied to it, a current of  $\frac{1}{4}$  ampere will flow. If the filament resistance is one half this figure (10 ohms), then the current, for the same applied voltage, will be twice as large, or  $\frac{1}{2}$  ampere.

To determine these currents, we have used a fundamental relationship regarding the current, voltage, and resistance of any circuit, known as Ohm's Law, which states that the current in a circuit is always exactly proportional to the voltage and inversely proportional to the resistance. Therefore, in the above example, halving the resistance doubled the current, and doubling the resistance would have halved the current. Inversely, doubling the voltage doubles the current, and halving it gives half the current.

These facts can be expressed in the form of a simple algebraic equation as follows:—

$$(1). I = \frac{E}{R}$$

in which I is the current in amperes, E the voltage, and R the resistance in ohms.

The equation shows that the current is equal to the voltage divided by the resistance. It can be rearranged so as to make it easy to solve for voltage or resistance as well as current.

To determine an unknown voltage, use the equation in the following form:

$$(2). E = I \times R$$

For determining an unknown resistance:

$$(3). R = \frac{E}{I}$$

Let us take up a few simple examples in which these equations are used.

**EXAMPLE 1:**

A tube's filament has a resistance of 20 ohms, and its rated voltage is 5. What current does it require?

In the problem the voltage and resistance are given and we can substitute in equation number 1 as follows

$$I = \frac{E}{R} \therefore I = \frac{5}{20} = 0.25 \text{ Amperes}$$

**EXAMPLE 2:**

If a 199 tube filament takes 0.06 amperes at 3 volts, what is its resistance?

Using formula No. 3.

$$R = \frac{E}{I} \therefore R = \frac{3}{0.06} = 50 \text{ Ohms}$$

**EXAMPLE 3:**

A filament is designed with a resistance of 4 ohms, and its rated current is 1.25 amperes. What voltage must be placed across the tube to make the rated current flow?

Using formula No. 2, we have:

$$E = I \times R \therefore E = 1.25 \times 4 = 5 \text{ Volts.}$$

No. 82

RADIO BROADCAST Laboratory Information Sheet

April, 1927

## Oscillation Control

A COMPARISON OF TWO COMMON METHODS

**I**T IS the purpose of this Laboratory Sheet to compare two methods commonly used to control oscillations in the radio-frequency amplifiers of receivers.

The first method to be discussed is that using a potentiometer to vary the bias on the grid of the tube. This method is illustrated in Fig. 1, in which P is the potentiometer, and C is a bypass condenser functioning to bypass the radio-frequency energy directly to the negative filament.

When the potentiometer arm is connected to the negative side, the amplifier operates most efficiently and the result is that it oscillates. To prevent the oscillations from occurring, the potentiometer arm is moved toward the positive side and this makes the grid positive, lowers the efficiency of the circuit, and thereby prevents oscillations.

The second method is indicated diagrammatically in Fig. 2, in which case the oscillation control is a variable resistance, R, in the plate circuit of the tube. In this case a bypass condenser is again used to bypass the radio-frequency energy to the negative filament. This oscillation control functions by lowering the value of voltage impressed on the plate of the tube. In this manner the plate impedance of the tube is increased and oscillations prevented.

The second method is to be preferred over the

first since it has several distinct advantages. In the first place the plate current consumption, using the second method, is quite low, whereas, in the first method, in order to prevent oscillations it is necessary to make the grid positive, which causes the plate current to increase to comparatively large values. The second method does not lower the

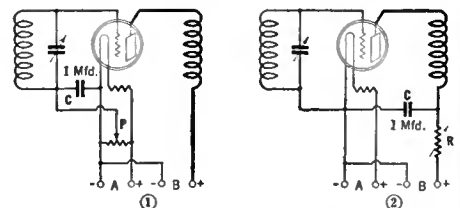

selectivity of the receiver. This is not true of the first method because, when the grid becomes positive, a load is placed on the tuned circuit, and the resistance of the circuit is thereby increased. The result is that it tunes broadly, or, in other words, the selectivity of the receiver is lowered. In practice, the resistance used in Fig. 2 generally has a maximum value of about 500,000 ohms.



THE  
*Magic*  
OF IT!

RECEPTION AT ONE•SPOT ONLY ON THE DIAL  
WITH THE  
**MADISON-MOORE  
ONE•SPOT  
TRANSFORMER**

*Marvelous Selectivity - Accuracy - Distance - Quality!*

ACTUAL EXPERIENCES: Mexico City logged 180 stations, 6 of which were Canadian; Kobe, Japan, from Los Angeles; Buenos Aires, S. A., from Breckenridge, Texas; Pacific Coast from Boston; Atlantic Coast from Los Angeles, Seattle and Portland. *That's distance!*

Chicago received 2 locals and 5 out-of-town stations in 5 degrees. *That's selectivity!*

MADISON-MOORE PRODUCTS ARE MILES AHEAD. EVERY INSTRUMENT IS PRECISION MADE, TESTED WITH SCIENTIFIC LABORATORY APPARATUS. THOROUGHLY GUARANTEED. THEY'RE RIGHT!



A new conception in wave trap design; for loop and antenna sets. Traps the offending station but NOT the adjacent frequencies!

*Sensibly priced*

[ *If your dealer cannot supply  
you, we can. --- Write us.* ]

MADISON-MOORE RADIO CORPORATION  
2524 G Federal Boulevard  
Denver, Colorado - U. S. A.

**MADISON~MOORE**  
*The Finest RADIO APPARATUS in the World!*



# The flux is everything in radio soldering says this Radio Engineer

"In our laboratory we made a thorough analysis of the two groups of fluxes (natural and chemical). We found the natural flux, rosin, the only safe one to use on radio work.

Pure rosin, as in Kester Radio Solder, will not fume, sputter, or creep over large areas, and being a hard, dense substance, rosin will not attract and collect dust (carbon particles), which makes an excellent path for leakages. These are the faults of fluxes containing chloride, be it either in paste, liquid or compound form. Any flux containing chloride will eventually cause heavy leakage. Hence they should be strictly avoided.

We find Kester Radio Solder the most convenient way to solder on radio work, for it has the proper amount of pure rosin right inside the solder itself. In fact, we used it exclusively on all of our work."

There's your guide, radio fans—the approval of an expert radio engineer. Surely there can be no doubt as to what you should use on YOUR SET.



A free Sample write for it now

## KESTER Radio SOLDER

the safe solder for radio, requires only heat

**CHICAGO SOLDER CO.**

4222 Wrightwood Ave. Chicago, U. S. A.

Originators and the World's Largest Manufacturers of Self-fluxing Solder

# LYNCH METALLIZED

## WARRANTED FIXED RESISTORS

THE vital importance of a silent, accurate resistor cannot be over-estimated. Comprising a concentrated metallized deposit one-thousandth of an inch thick, upon a glass core and sealed forever within the tube, each Lynch Resistor is warranted absolutely noiseless, permanently accurate, dependable! Guaranteed accuracy—10%; in production they average 5%. .25; .5; 1; 2; 3; 4; 5; 6; 7; 8; 9; 10 Meg., 50c. .025; .09; .1 Meg., 75c. Single mounting 35c; Double, 50c. If your dealer cannot supply you, send stamps, check or money order. We ship postpaid same day order is received.

Dealers—Get on our mailing list; we keep you posted on new developments. Write us today!

ARTHUR H. LYNCH, INC. MEMBER RMA 426-B 250 W. 57th St. New York, N. Y.

No. 83

RADIO BROADCAST Laboratory Information Sheet

April, 1927

### Tube Characteristics

#### MUTUAL CONDUCTANCE

ON LABORATORY Sheet No. 84 is given a group of curves for a 120 tube, while on this Laboratory Sheet we will calculate the mutual conductance of the 120 tube with the aid of these curves.

The mutual conductance is a measure of the effect of a varying grid voltage on the plate current for a constant plate voltage. Stated as a formula, the mutual conductance equals:—

$$\frac{\text{CHANGE IN PLATE CURRENT (AMPERES)}}{\text{CORRESPONDING CHANGE IN GRID VOLTAGE}}$$

We are giving below some examples that will make simple the calculation of the mutual conductance of any tube provided its characteristic curves are available:

#### EXAMPLE 1

Calculate the mutual conductance of a 120 type tube using the curves given on Laboratory Sheet No. 84. Locate any point on curve No. 3, as for example, that indicated by the cross. This point corresponds to a plate current of 3.4 milliamperes, a plate voltage of 120, and a grid bias ( $E_g$ ) of minus 25 volts. Follow along on the 120-volt line to curve No. 2, and we find that the plate current is 5.4 milliamperes for a grid bias of minus 22½ volts. We now have two values of grid voltage and two values of plate current for the same plate voltage. Chang-

ing the milliamperes to amperes, and substituting in the formula, we have:

$$\frac{(0.005 - 0.0034) \div (25 - 22.5)}{2.5} = \frac{0.0016}{2.5} = 0.00064 \text{ mhos} = 640 \text{ micromhos}$$

#### EXAMPLE 2

Calculate the mutual conductance of the 120 tube for a lower value of plate voltage, say 95. To do this we will locate the point on curve No. 2, corresponding to 95 volts on the plate, and this point, indicated by a cross, gives a plate current of 3.2 milliamperes for a grid bias of minus 22½ volts. This same voltage on curve No. 1 gives a plate current of 4.7 milliamperes for a grid bias of minus 15 volts. Substituting these values in the formula:

$$\frac{(0.0047 - 0.0032) \div (22.5 - 15)}{7.5} = \frac{0.0015}{7.5} = 0.0002 \text{ mhos} = 200 \text{ micromhos}$$

It is evident from these two values of mutual conductance that the 120 give very low values when low plate voltages are used. Practically the only voltages which can be used on the 120 tube with satisfactory results are 135 volts on the plate and minus 22½ on the grid.

Readers interested in calculating the other constants of a tube are referred to Laboratory Sheets No. 67, February, 1927, and No. 80, March, 1927.

No. 84

RADIO BROADCAST Laboratory Information Sheet

April, 1927

### The UX-120 Tube Characteristic Curve

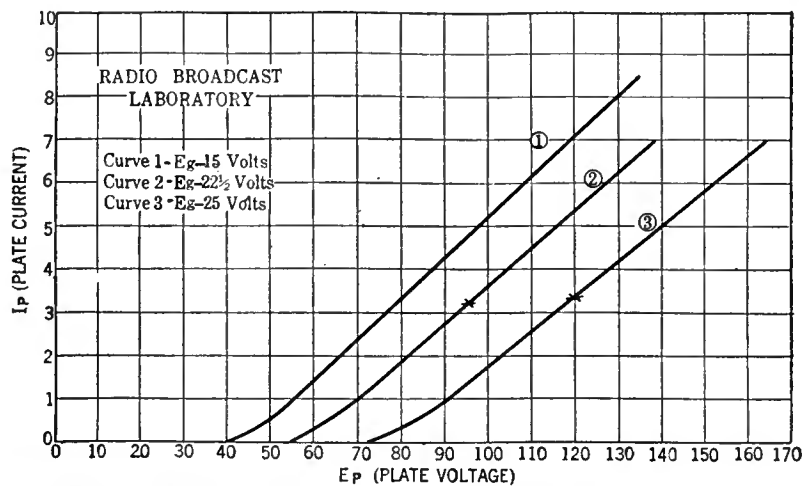

No. 85

RADIO BROADCAST Laboratory Information Sheet

April, 1927

### C Voltages

#### FACTORS DETERMINING VALUE

THE C-battery voltage that can be placed on any tube indicates the amplitude of the signal voltage that the tube can handle without seriously overloading. For example, the 171 tube with 180 volts on the plate requires a 40.5-volt C battery. Any signal can be impressed on this tube, therefore, whose peak value does not exceed 40.5 volts.

Ordinarily we do not talk of the maximum values of alternating current voltages but speak instead of the effective values, which are equal to 0.707 times the maximum or, so called, peak value. In other words, a voltage with a peak value of 40.5 has an effective value of 28.6. If signals greater than this are impressed on the tube, the grid voltage will swing until at times it becomes positive and it will then draw a small amount of grid current, which it does not do when negative. Even very small grid currents flowing through the secondary of a transformer have a very serious effect on their operation. Consequently in amplifier work it is an axiom that the grid voltage must never be permitted to swing an amount exceeding the value of the C battery.

The handling capacity of a tube can be increased

by increasing the grid voltage up to a certain point. Beyond this point an examination of the tube characteristic would indicate that the signals will cause the grid to operate on the lower curved portion of its characteristic. The manufacturers' C-battery ratings are generally the highest that can be used and still operate the tube on the straight portion of the characteristic. As an example, when the 201-A tube is used in an amplifier with 90 volts on the plate it is recommended that the C-battery voltage be 4½, and this can be taken as the value of C-battery which will permit the tube to handle the greatest amount of undistorted power.

The C-battery voltage used on the last tube of an amplifier determines what C battery is required on the other amplifier tubes because it will take a certain definite value of signal voltage on the grid of the preceding tube in order to place the maximum allowable signal voltage on the grid of the last tube. See Laboratory Sheet No. 88. Consequently, the voltage on the grid of the tube preceding the last tube need only be sufficiently great to prevent its grid from going positive on the maximum signal necessary to give maximum voltage on the grid of the second tube.

No. 86

RADIO BROADCAST Laboratory Information Sheet

April, 1927

A Double Impedance-Coupled Amplifier

THE NECESSARY PARTS

A SCHEMATIC diagram of a double-impedance amplifier is shown on Laboratory Sheet No. 87. The material required to build such an amplifier is described below:—

$L_1$ —Impedances designed for use in the plate circuit of an impedance-coupled amplifier. Four of these coils are necessary. They should have an inductance of at least 60 henrys; somewhat better results will be obtained if the inductance is about 100 henrys, however. The exact value of inductance is not very important so long as it be at least 60 henrys. The choke coil in the plate circuit of the power tube,  $T_3$ , must be capable of carrying the plate current drawn by this tube. For a 171 tube with 180 volts, the plate current will be as high as 20 milliamperes.

$L_2$ —Grid impedances. These should have a value of inductance of about 100 henrys. Three of these coils are required.

C—Coupling condensers, having a capacity of 0.1 mfd. These condensers must be well constructed since, if poor units are used, a certain amount of leakage occurs across the condensers. Well-constructed paper condensers are quite satisfactory.

$C_1$ —4-mfd. output condenser.

R—Fixed filament control resistance of a type depending upon the kind of tubes used. It must be

capable of passing the total filament current of the three amplifier tubes.

J—Single-circuit jack.

S—Filament switch.

$T_1, T_2$ —Two high- $\mu$  tubes. Two 201-A's may be used but the amplification will not be as great.

$T_3$ —Power tube of either the 112 or 171 type. The C-battery voltage on the last stage will depend upon the type of tube and the plate voltage that is used.

It will be found that an amplifier of this kind will give excellent quality. It can be used in conjunction with any receiver, it merely being necessary to connect the input of the amplifier circuit to the detector circuit of the receiver. The terminal marked plate on the input connects to the plate of the detector tube and the B plus det. terminal connects to the plus 45-volt B battery terminal. In those receivers using a tickler, the B+ detector terminal would connect to one end of the tickler winding instead of directly to the plate of the detector tube.

People frequently ask if the primaries or secondaries of old audio transformers might not be used as impedances in an amplifier of the type under discussion. This is not feasible, for the characteristics which cause old-style transformers to give poor quality, also make them unsuitable for use as impedances. High inductance windings and well-designed cores are not to be found in old transformers, and it is desirable that an impedance unit have both of these.

No. 87

RADIO BROADCAST Laboratory Information Sheet

April, 1927

A Dual-Impedance Coupled Amplifier

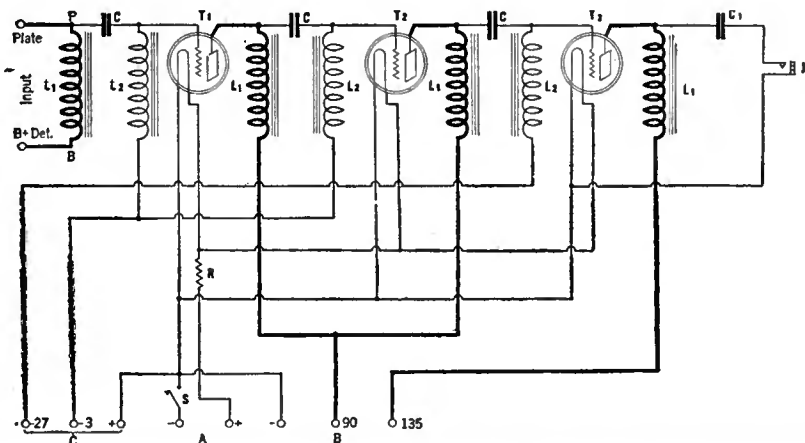

No. 88

RADIO BROADCAST Laboratory Information Sheet

April, 1927

Audio Amplifying Systems

NO. I. TRANSFORMER AMPLIFIERS

THE conventional transformer-coupled amplifier consists of two stages. The over-all amplification of such a system is generally around 300, and this is sufficiently high to give loud speaker reproduction with a moderately strong signal available at the output of the detector. The transformer-coupled system has the advantage that only two stages are required and can, therefore, be made quite compact.

The plate current consumption of such an amplifier is fairly low and only moderately high voltages are necessary on the first stage. The quality of the results obtained depends primarily upon the transformers used and for this reason a certain amount of care is necessary in choosing the transformers that are to be incorporated in such an amplifier.

The transformer feeding out of the detector stage should have a primary impedance that is somewhat higher than is necessary for that transformer used in the second stage. The higher impedance is necessary in the transformer feeding out of the detector tube due to the fact that the detector plate circuit generally has a somewhat higher impedance than the plate circuit of a tube used as an amplifier.

If two transformers of different ratios are to be used, the rule is almost invariably to place the low-

ratio transformer in the first stage and high-ratio transformer in the second stage. For commercial reasons, most manufacturers put a fixed number of turns on the secondaries of their transformers irrespective of the ratio required. The different ratio values are then obtained by winding on the necessary number of primary turns, this latter figure of course varying proportionally with the ratio. Thus, the lower the ratio, the greater the number of primary turns and likewise, the greater the primary impedance.

Proper C battery on the amplifier tubes is absolutely essential if good quality is to be obtained. The C battery voltage on the first stage should not be higher than is necessary to prevent overloading. Placing an unnecessarily high bias on the first tube increases the plate impedance of the tube, and it is essential that the plate impedance be kept low.

If a 171 tube is used in the last stage with a 40 volt C bias, we can impress signals on the grid of this tube which have a peak value up to 40 volts. If the transformer has a ratio of 4:1, the peak value of the voltage in the primary will be 10 volts. If a 201-A tube is used in the interstage, we can obtain the value of peak voltage on its grid by dividing the voltage in the plate circuit, 10, by the amplification constant of the tube, 8, which gives 1 1/4 volts. It follows then, that a C battery bias of 1 1/2 volts on the first tube will be sufficient to prevent overloading.

BRACH Storm King LIGHTNING ARRESTER



Over 2,000,000 Radios are Now Protected by Brach' Arresters

Price Only \$1

Like all Brach Arresters the Storm King is backed by our \$100 INSURANCE GUARANTY

Electrify your Radio with the Wonderful BRACH



CONTROLIT THE HEART OF THE POWER PLANT

Over 75,000 used within First Four Months

L.S. BRACH MFG. CO.



NEWARK, N.J. TORONTO, CAN.

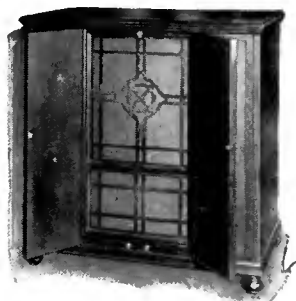

Model AC15

## The Amplion Grand \$135

This remarkable instrument utilizes an entirely new principle in radio reproduction—a combination of soundboard, air-column and cone. This results in a marvelous depth of note—resonance and a fine natural tone.

Every Amplion Grand sold is a laboratory model, personally tested and approved by Amplion's Chief Engineer.

The handsome walnut cabinet 34" x 33" x 18½" is sturdily built—its rich finish will grace the most beautifully appointed room.

Other Amplion Models from \$12 to \$50

**THE AMPLION CORPORATION  
OF AMERICA**

Suite L, 280 Madison Ave., New York City  
The Amplion Corporation of Canada Ltd., Toronto, Ont.

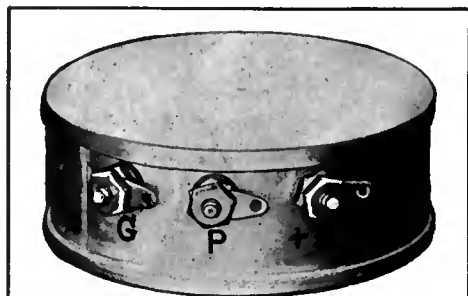

Shielded Tuned Radio Transformer, No. 30

## SICKLES Diamond-Weave Coils

THE new Sickles Shielded Tuned Radio Transformer prevents both outside and local interference. It is remarkably compact, sharp tuning, sturdy.

Sickles Diamond-weave coils have established an enviable reputation for low distributed capacity, low dielectric losses, and large range of frequency with small variable capacity.

The ideal coil for the Naald Localized Control Tuning Unit and for the Tru-phonetic Catacomb Assembly.

There are Sickles Diamond Weave Coils for all Leading Circuits.

**The F. W. Sickles Co.**  
132 Union Street  
SPRINGFIELD, MASS.

**COIL PRICES**

- No. 30 Shielded Transformer... \$2.00 each
- No. 24 Browning-Drake ..... 7.50 Set
- No. 18A Roberts Circuit ..... 8.00 "
- No. 25 Aristocrat Circuit..... 8.00 "

# Equipment for the Home-Constructor

How to Use Some of the New Equipment Tested and Approved by the "Radio Broadcast" Laboratory

By THE LABORATORY STAFF

THE Freed-Eisemann B power-supply device differs in several respects from the average one on the market, and it can be used in connection with almost any type of receiver which does not require more than 135 volts on the highest tap. It operates directly from the 110-volt 60-cycle house current. There are three direct-current voltage taps, 135, 90, and 22½ volts for use, respectively, on the last stage, the r. f. and first audio stages, and the detector stage. Three different C voltages are available; minus 4½, minus 9, and minus 27, which provide the proper grid bias for the various audio tubes. The 4½-volt tap is usually used with the first audio stage, the 9-volt tap when a type 112 tube is used, and the 27 volts when the type 171 is used in the output stage. The rectifying element is a 213 type double-wave rectifying tube which gives ample output capacity for sets using from five to seven tubes. A regulating tube of the 874 type is used to keep the voltage constant at varying loads. This tube is gas filled, and current conduction is accomplished by the ionization of the enclosed gases. When such a tube is connected across the line it has the peculiar property of holding the voltage constant at 90, no matter what load is taken from the line. In this power device, the tube is connected to the 90-volt terminal, and upon test in the Laboratory with a 171 type tube on the 135-volt circuit, the voltage on the 90-volt tap was found to be practically constant for all loads from zero up to approximately 25 milliamperes. This current value is ample to take care of the requirements of nearly every receiver. The regulating tube is connected in circuit in such a way that if the tube is removed during operation, the rectifier will not function. This is a safety feature which prevents excessive voltages from building up, and perhaps causing the filter condensers to be broken down. Another safety feature is that an automatic switch cuts off the line power whenever the cover over the terminal board is opened, thus making it impossible for the operator to get a shock or short-circuit the terminals when wires are to be changed. Manufactured by the Freed-Eisemann Radio Corporation, Brooklyn, New York. Model 16. Price \$45.00 without tubes.

**VARIABLE CONDENSER**

THE Hammarlund Midline condenser can be used in any circuit requiring a variable capacity. As the name "Midline" implies, it is a compromise between the three most common types of variable condensers—the straight wavelength-line, the straight capacity-line, and the straight frequency-line condensers. The tuning graph as shown in Fig. 1 gives the dial readings for different frequencies for the four different types of condensers. With the older straight capacity-line condensers, the station readings were crowded at the lower dial readings. The straight wavelength line condensers were somewhat better in this respect. Later, the straight frequency-line condensers were introduced which reversed the crowding. The "Midline" tends to separate the stations equally over the whole dial.

This condenser is well made mechanically and electrically. The brass plates are soldered firmly into slots. The stator is insulated from the frame by a single strip of bakelite insulation, firmly connected to the frame by a large screw. The frame for holding the stator and rotor is a die-casting of light but strong construction. Screws are provided for mounting the condenser either on the panel or on the baseboard. A screw bushing is also provided at one end to permit single-hole mounting. The adjustable bearings are of the cone type. The tension on the turning movement is provided by a small adjustable felt brake band. Spring connections are provided between the frame and the rotor for carrying the current.

The rotor plates are mounted on a hollow tube

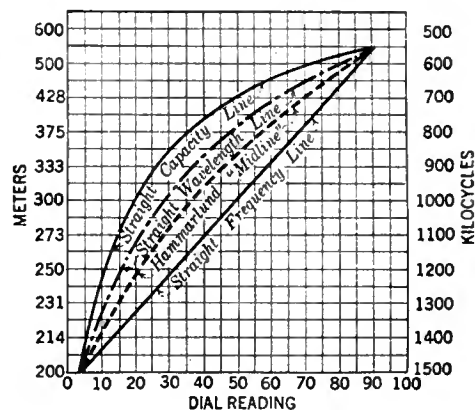

FIG. 1

Showing how the curve of the Hammarlund "Midline" compares with those of other type condensers

a center shaft within it being removable by loosening two screws, making it possible to alter the length of the projecting shaft so that it may be adjusted to fit any type of dial. When the builder must avoid hand capacity, an insulating shaft may be substituted for the metal one. An extension shaft may be provided upon which may be mounted other condensers, rotating coils, cams, gears, or other apparatus. The shaft may be pushed through from either end thus giving a clockwise or counter clockwise movement of the dial. The span of the condenser is four inches which makes it easily adaptable to experimental layouts. These condensers are made up in different capacities with a price range, in the case of the dual units, of from \$7.00 to \$8.50. The price list of the single units is given below. Manufactured by the Hammarlund Manufacturing Company, New York City.

CODE NUMBER	MAXIMUM CAPACITY	PRICES
ML-23	0.0005 Mfd.	\$5.00
ML-17	0.00035 "	\$4.75
ML-13	0.000275 "	\$4.65
ML-11	0.00025 "	\$4.50
ML-5	0.0001 "	\$4.25

B SOCKET-POWER TESTING APPARATUS

WITH the increasing use of power supply devices for operating the radio receiver directly from the lighting circuit comes a new problem in testing. The low-resistance voltmeter which ordinarily served with the dry cell batteries, takes an appreciable load current, and consequently does not give a true reading on a power device. In order to provide a simple instrument for test purposes on a B power device, the Sterling Manufacturing Company, of Cleveland, Ohio, has brought out a small combination testing outfit which has, included in it, a milliammeter with a scale reading of 0—100 milliamperes and a high-resistance voltmeter with a scale reading of 0—300 volts. A rheostat of the proper resistance is provided to form a variable load. The wiring diagram of the tester is given here in Fig. 2, and shows how the meters are connected inside the metal case. Three binding posts are provided for the milliammeter. When the outside two are used, the rheostat is in series with the milliammeter, while if connected to the other two, marked "plus" and "minus," "rheostat out," the meter can be used as a separate unit. The other two posts are connected to the voltmeter so that it may also be used as a separate instrument. When the change-over switch is in the position indicated in the diagram, the two instruments are connected together and the voltage is measured directly across the loading rheostat. It is interesting to note that the

"rheostat in," post with the negative of the power device. Then with the switch in the "meters coupled" position, the rheostat is turned on until the milliammeter reads 30 mils. The voltage which would be obtained is read on the voltmeter. If 150 or more volts are indicated, it shows that that particular power device would be ample for the requirements of the receiver specified.

A plug and cable is also furnished with the test set which can be plugged into the socket of a receiver and the voltage at the socket determined. In this case the leads from the socket would be connected to the plus and minus binding posts of the voltmeter with the switch in the "meters separate" position. Such a test meter should be of great service both to the dealer who is servicing receivers and to the experimenter who wishes to make B power device tests. By taking the voltage readings at different values of current, the data may be placed on a curve sheet and will show the regulatory characteristics of the power device. Manufactured by the Sterling Manufacturing Company, Cleveland, Ohio. Tester R-410. Price \$40.00.

VACUUM TUBES

TWO very interesting tubes have been announced recently. One is from the Van Horne Company, and is patterned after the suggestions of Mr. B. F. Miessner in a recent Radio Club of America paper, published in RADIO

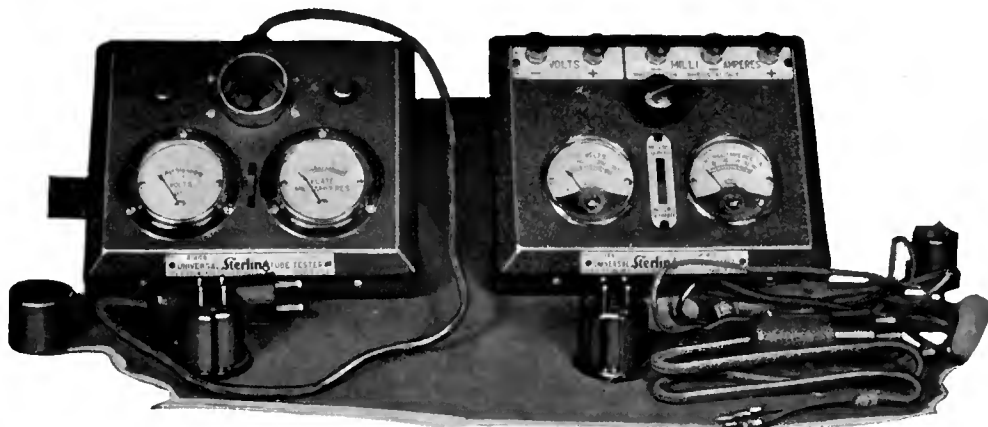

RADIO BROADCAST Photograph

TWO STERLING TESTING INSTRUMENTS

To the left is shown the "Universal" tube tester, the circuit for which is given in Fig. 3 overleaf. The tester to the right is shown diagrammatically in Fig. 2 on this page

small current taken by the voltmeter is also included in the reading of the milliammeter. With the switch in the other position the instruments can be used individually.

It is very important to know, in testing a socket-power device, exactly what voltage will be obtained with any given load. Thus if it were known that a receiver of a given type needed from 25 to 30 milliamperes at 150 volts, a power device which would give only 80 volts at this load would be entirely inadequate. If the tester were at hand it would be a simple matter to tell. Connect the milliammeter plus post with the plus of the power device and the negative,

BROADCAST in February, 1927. This tube operates with a terminal filament voltage of 0.6 volts and consumes 2 amperes. The filament is of the oxide coated type and has a thermal inertia much greater than existing tubes. A tube of this type can be operated from un-rectified a. c. with practical freedom from hum due to its inertia and to the fact that its filament resistance is so low, 0.3 ohms, that a. c. voltages developed across it will be extremely small. This is a very important development in the tube industry and many interesting possibilities are opened up thereby in the realm of a. c. operated receivers.

The other tube is a rectifying tube designed to pass currents as high as 300 milliamperes. With such a tube, together with the necessary chokes and smoothing equipment, it will be possible to run 201-A type tubes with the filaments in series with rectified current supplied by this tube. Up to the present, the maximum rectified current that was available generally was not over 100 milliamperes and since a 201-A type tube requires 250 milliamperes for its operation, it has not been possible to light the filaments with rectified a. c. This important tube is due to the Q. R. S. Music Company and has been announced in the advertising pages of RADIO BROADCAST.

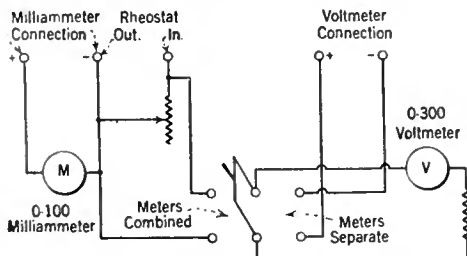
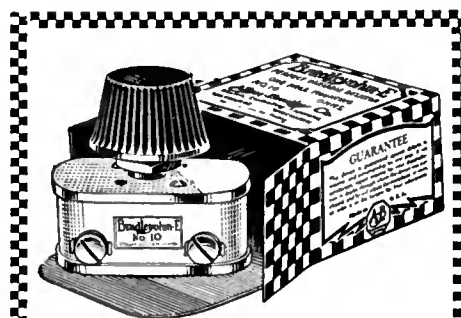

FIG. 2

(Continued on page 608)



**Bradleyohm-E**  
PERFECT VARIABLE RESISTOR

THIS oversize variable resistor is used as standard equipment for accurate plate voltage adjustment in B-eliminators made by the leading manufacturers of the country. The scientifically treated discs provide stepless, noiseless plate voltage control, and the setting will be maintained indefinitely.

Bradleyohm-E is made in several ranges and capacities to suit any radio circuit.

Send for Free Folder  
giving 7 B-eliminator hook-ups

Mail the coupon below for folder describing 7 hook-ups for B-eliminators using well-known kits and parts.

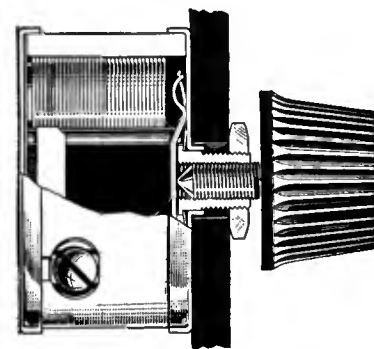

Ask your dealer to include Bradleyohm-E and Bradleyunit-A for variable and fixed resistance units when you build your B-eliminator.

Mail this coupon to

ALLEN-BRADLEY CO.  
278 Greenfield Ave., Milwaukee, Wis.

Please send me your folder giving 7 B-eliminator hook-ups, and also data on all Allen-Bradley radio devices.

Name.....

Address.....

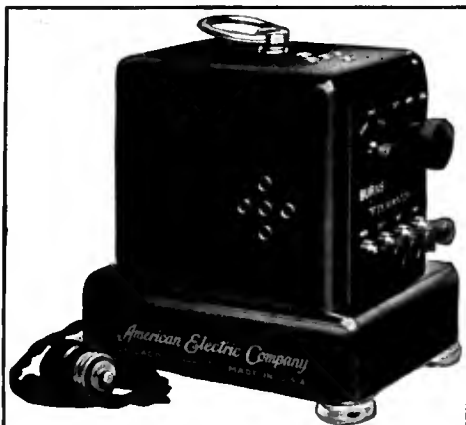

**IT DELIVERS  
FULL "B" VOLTAGE**

**Burns**

**B-Battery Eliminator**

Operates from lighting current like other household appliances. No hum or vibrations. Smooth constant plate supply. Once connected it requires no further attention or adjustment. Remarkable results on local and long distance reception. Pacific Coast List Price \$47.50.

Write for Data

*American Electric Company, Inc.*

State and 64th Streets Chicago, U. S. A.  
Makers of Burns Speakers

**ACME  
ENAMELED  
ANTENNA**

Best outdoor antenna you can buy. 7 strands of enameled copper wire; maximum surface for reception. Prevents corrosion and consequent weak signals.

**The Original Celatsite**

—a tinned, copper bus bar wire with non-inflammable "spaghetti" covering, for hook-ups. 5 colors; 30-inch lengths.

We also offer the highest grade of "spaghetti" tubing for Nos. 10 to 18 wires. 5 colors; 30-inch lengths.

**Flexible Celatsite**

Flexible, stranded wire for point-to-point and sub-panel wiring. Non-inflammable "spaghetti" covering. In black, yellow, green, red and brown; a color for each circuit. Put up in 25-foot coils.

**Celatsite Battery Cable**

—a silk-covered cable of vari-colored Flexible Celatsite wires, for connecting batteries to set. Prevents "blowing" of tubes; gives your set an orderly appearance.

Send for folder

**THE ACME WIRE CO., DEPT. B  
NEW HAVEN, CONN.**

**ACME WIRE  
MAKES BETTER RADIO**

**A KEY TO RECENT  
RADIO ARTICLES**

By E. G. SHALKHAUSER

*THIS is the eighteenth installment of references to articles which have appeared recently in various radio periodicals. Each separate reference should be cut out and pasted on 4" x 6" cards for filing, or pasted in a scrap book either alphabetically or numerically. An outline of the Dewey Decimal System (employed here) appeared last in the January RADIO BROADCAST, and will be reprinted in an early number.*

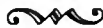

**R325.1. DIRECTION FINDERS. DIRECTION**  
*Bureau of Standards Paper No. 536, Oct., 21, 1926. FINDERS.*  
"A Portable Radio Direction Finder for 90 to 7700 Kilocycles," F. W. Dunmore.

A description of a portable radio direction finder having but two controls (balancing and tuning) and designed to operate over the frequency band from 90 to 7700 kilocycles (3300 to 39 meters), is given. The entire set, with the exception of the direction-finding loop, is contained in an aluminum box.

The receiver is of the super-heterodyne type, employing a standard Signal Corps amplifier. The wide range of frequencies is obtained by using a set of seven interchangeable plug-in direction-finder loops, each with a corresponding heterodyne generator coil. The loops vary in size from 12½ to 24½ inches square, the former having only two turns and the latter sixty turns. A small telescoping brass rod extending vertically through the center of each direction finder loop, and connected to the movable plates of the balancing condenser, serves as an auxiliary antenna for the purpose of sharpening the point of minimum signal strength. Means are provided so that bearings may be taken with respect to the magnetic north.

**R144. HIGH-FREQUENCY RESISTANCE. RESISTANCE,**  
*Bureau of Standards Paper No. 330. High-Frequency.*  
Oct., 27, 1926.

"Resistance of Conductors of Various Types and Sizes as Windings of Single-Layer Coils at 150 to 6000 Kilocycles," E. L. Hall.

Experimental data are presented on the resistance, at frequencies between 150 and 6000 kilocycles (2000 to 50 meters), of single-layer coils wound with various sizes of solid bare copper wire, litz wire, copper tubing, and aluminum ribbon. The measurements were made by the resistance-variation method, and the results are shown on curves, which are directly comparable. These curves are of great value when selecting the size of wire having the least resistance for a given frequency.

**R251.2. THERMO-ELEMENT AMMETER. AMMETER,**  
*Wireless World (London), Nov., 3, 1926. Thermionic.*  
Pp. 611-612.

"Thermionic A-rial Ammeter," G. 2 AB.  
A description of a rather accurate method of measuring small high-frequency currents by the use of a vacuum tube of the proper size in a special circuit arrangement, is given. The method as described is said to have the following distinct advantages: (1) It is cheap; (2) The resistance of the filament may be in the neighborhood of 2 ohms as compared with 12-14 ohms in the case of thermo-couple instruments; (3) The thermo-couple instruments can usually be supplied only in the current-squared calibration, whereas this instrument can be calibrated for direct reading.

**R382. INDUCTORS. INDUCTION**  
*Wireless World (London), Dec., 8, 1926. COILS.*  
Pp. 754-759.

"Designing Low Loss Receiving Coils," S. Butterworth. Data is given on the correct design of low loss receiving coils. Experimental curves are shown which will enable the non-technical man to build coils to specifications.

**R130. ELECTRON TUBES. GRID POTENTIAL,**  
*Wireless World (London), Oct., 6, 1926. Effect of.*  
Pp. 491-493.

"Grid Potentials," C. H. Stephenson.  
Six possible methods of connecting the grid return to a vacuum-tube filament are described. The proper way of connecting the grid will depend upon the characteristics of the tubes, and whether they are used as radio-frequency amplifiers, detectors, or audio amplifiers.

**R344. 3 TRANSMITTING SETS. TRANSMITTER,**  
*Wireless World (London), Oct., 26, 1926. Short-Wave.*  
Pp. 577-579.

"Transmitting on 45 Meters," G. A. Exeter.  
A description of a 6663-kc. (45 meter) transmitter with small input power, and using third harmonic excitation, is given. The Armstrong tuned-grid tuned-plate circuit is used. The radiating system consists of a Hertz antenna with parallel feeders from the coupling coil.

**R376.3. LOUD SPEAKING REPRODUCERS. LOUD SPEAKERS.**  
*Radio News, Dec., 1926, Pp. 642-ff.*  
"Loud Speakers and Their Characteristics," M. L. Muhleman.

The inherent characteristics of loud speakers are compared with the widely different responses of the human ear at different frequencies. What is termed the "response factor" of the human ear to loud speaker reproduction depends on the individual, and it is stated that a change of 10 per cent. in volume is not readily distinguishable.

Horn and cone speakers differ only mechanically, the one causing the diaphragm to move the air through a horn, and the other through an oversized diaphragm. The shape and length of the horn affect the tone, all of the frequencies being audible only when the horn is at least 20 feet long. Cone speakers are said to have better frequency characteristics than horns, although this depends on the size of the diaphragm and other factors. Reference is made to horns and cones of various makes, and these are illustrated.

**R131. GENERAL PROPERTIES OF MICROPHONIC**  
*ELECTRON TUBES. ACTION.*

*Wireless World (London), Oct., 20, 1926, Pp. 553-554.*  
"Microphonic Action," F. E. Henderson.  
An outline of the cause and cure of so-called microphonic noises in vacuum tubes, especially relating to tubes having a fine filament which burns at a cherry red, is presented. Usually the cause is vibration of the filament, and, according to the author, by a suitable mounting, or proper shielding, the effect may be eliminated.

**R582. TRANSMISSION OF PHOTOGRAPHS. PHOTOGRAPHIC**  
*Radio News, Dec., 1926, Pp. 626-ff. TRANSMISSION.*  
"New Television Apparatus," L. Fournier.

The construction and operation of the Belin and Holweck television apparatus is described by the writer. The transmitting apparatus utilizes an arc lamp, a condensing lens, two oscillating mirrors, a transparent screen, and a photo-electric cell. The transmitting and receiving apparatus are synchronized with a 500-cycle current. The Holweck cathode ray oscillograph is used at the receiving end for producing the image. Photographs show the apparatus used.

**R382. INDUCTORS. INDUCTORS,**  
*Radio News, Dec., 1926, Pp. 660-661. Browning-Drake.*  
"Home-Made Coils for the Browning-Drake and Similar Circuits," C. A. Oldroyd.

The writer gives simple constructional data on radio-frequency coils such as are used in the well-known Browning Drake and similar circuits. Mounting devices, and various methods of placing the primary in relation to the secondary, are described at some length.

**R342.2. RESISTANCE COUPLING. COUPLING,**  
*Proc. I. R. E. Dec., 1926, Pp. 759-763. Resistance.*  
"Notes on the Design of Resistance-Capacity Coupled Amplifiers," S. Harris.

An analysis of the coupling in the resistance-capacity coupled amplifier is given, in which the variation of the voltage ratio with frequency is considered. A method is given for determining the values of the resistances and capacities, for which the variation of the voltage ratio over a given frequency range will be a definite and known amount.

**R374.3. BALANCED CRYSTALS. CRYSTALS,**  
*Radio News, Jan., 1927, Pp. 788-ff. Zinctite.*  
"The 'Singing Crystal,'" Dr. J. Pietsch.

The experiments conducted by Doctor Seidl at the University of Vienna with various crystals show that crystals, especially red zinc ore, can be made to oscillate and to give audible sounds. In turn, crystals can be used as microphones. In analyzing the experiments, it is shown that the atmospheric pressure affects the oscillations, as well as the changes in potentials and the pressures applied to the crystal.

**R551. TIME SIGNALS BROADCAST. TIME SIGNALS**  
*Radio News, Jan., 1927, Pp. 790-ff. BROADCAST.*  
"Broadcasting Time Signals," S. R. Winters.

A description is given of the automatic time signalling apparatus used by the Bureau of Standards. An accuracy of 0.1 of 1 per cent. is obtained by employing a standard pendulum swinging between a light source and a photo-electric cell, thus avoiding all actual mechanical contact. The impulses are amplified by means of vacuum-tube apparatus.

**R553. METEOROLOGICAL SIGNALS. WEATHER MAP**  
*Radio News, Jan., 1927, Pp. 791-ff. BROADCASTING.*  
"The Broadcasting of Weather Maps by Radio Accomplished," S. R. Winters.

Using the Jenkins system of photographic transmission, the U. S. Weather Bureau, through the Naval Station at Arlington, is broadcasting weather maps directly to ships at sea. The process is outlined, and a description of the apparatus used is given.

**R334.3. TRANSMITTING SETS. TRANSMITTERS,**  
*QST, Jan., 1927, Pp. 14-18. Crystal-Controlled.*  
"Low-Power Crystal-Controlled Transmitters," J. M. Clayton.

An outline is given of a number of possible circuits that can be used in connection with 160- and 80-meter (1874- and 3748-kc.) crystals. Data are given for the construction of a low-power crystal-controlled transmitter, using two UX-210 tubes, and a.c. for power throughout. The author also gives a circuit using a.c. for the filaments and d.c. for the plate supply. The methods of tuning and making necessary adjustments on each transmitter are outlined in detail.

**R330. ELECTRON-TUBE RELAYS. RELAYS,**  
*QST, Jan., 1927, Pp. 19ff. Radio Tube.*  
"A Direct Radio Control Relay," R. S. Kruse.

A description of a relay tube, with contacts within the vacuum of the tube itself, is given. Use is made of the unequal expansion of two dissimilar metals, which on heating, cause the circuit to close. These relays are said to operate very satisfactorily for: (1) Railway signal and automatic train control purposes; (2) Remote control of lighting circuits; (3) General call signal operation; (4) Demonstrating the dynamic effect of electron bombardment.

**R140. RADIO CIRCUITS. ARMSTRONG AND**  
*QST, Jan., 1927, Pp. 27-31. MIESSNER CIRCUITS.*  
"How Our Tube Circuits Work," R. S. Kruse, Part 2.

Continuing the discussion from a previous article (Dec., 1926, pp. 9-13), two more circuits are taken up—the Miessner and the Armstrong. The former circuit is progressively developed, starting with the plate-tickler circuit of the previous discussion. It is stated that both the Miessner and the Hartley circuits cannot be made to oscillate below a certain wavelength limit, because of inherent circuit difficulties. A Miessner circuit is shown which will operate well at 3748 kc. (80 meters).

The Armstrong circuit has a tuned-grid, tuned-plate circuit arrangement, the tube capacity serving in the feedback circuit to maintain oscillations. A practical transmitting circuit is shown.

**R343. ELECTRON-TUBE RECEIVING SETS. RECEIVER,**  
*QST, Jan., 1927, Pp. 36-39. 5-Meter.*  
"Five-Meter Receivers," R. S. Kruse.

The writer discusses the operation of a 59,960-kc. (5-meter) receiver which was built after trying out various circuits such as the Hartley, the ultra audio, and the Armstrong. Details on tuning and construction are given.

**R134.45. SUPER-REGENERATIVE ACTION. RECEIVER.**  
*QST*, Jan., 1927. Pp. 40-43. *Super-Regenerative.*  
 "A Short-Wave Super-Regenerative Receiver," E. B. Dallin.  
 Reference is made to the difficulty in regenerative tuning just at the point of oscillation where the sensitivity is greatest. In the super-regenerative receiver the following points are worth mentioning: (1) The tuning control has no effect on beat note or sensitivity; (2) The note control has no effect on tuning or sensitivity; (3) Its sensitivity is either controlled automatically or by another dial.  
 It is stated that by varying the grid of the detector at a very high frequency—just at the "oscillation point"—it is possible to obtain great amplification on short waves. The modulator frequency depends directly upon the frequency of the incoming wave. The operation of the circuit is fully described, and complete constructional data are presented.

**R330. ELECTRON TUBES. UX-213 AND UX-874.**  
*QST*, Jan., 1927. Pp. 44-46.  
 "The UX-213 Rectron and the UX-874 Voltage Regulator," O. W. Pike.  
 The UX-213, a full-wave rectifier tube, is described, and performance curves are shown. It is rated as a 440-volt tube and will give 65 milliamperes direct current output at 180 volts.  
 The UX-874 is a regulator tube which is designed to maintain a voltage (90) constant over a certain current range output (10 to 50 milliamperes). The ionized inert gases at low pressure within the tube determine the conduction of current between the electrodes. Constructional data are given for an a.c. operated power-supply device using the above-mentioned tubes.

**R144. HIGH-FREQUENCY RESISTANCE. RESISTANCE.**  
*Popular Radio* Dec., 1926. Pp. 770-ff. *High-Frequency.*  
 "How Circuit Resistance Affects Selectivity," G. H. Browning.  
 The author presents a mathematical and graphical discussion pertaining to the effect of resistance in coils on sharpness of tuning. Six different coils are shown and their characteristics analyzed. The single-layer solenoid coil, space-wound, presents the best all-around characteristics.

**R132. AMPLIFYING ACTION OF ELECTRON AMPLIFIERS.**  
*TUBES. Vacuum Tube.*  
*Proc. I. R. E. Dec., 1926. Pp. 735-757.*  
 "The Output Characteristics of Amplifier Tubes," J. C. Warner and A. V. Loughren.  
 A review is made of the different methods of using amplifier tubes in radio receiving circuits. The small UX-109 type of tube, the UX-201-A type, and the new so-called "power tube," are compared, their amplification factors being discussed, and their characteristic curves of performance being considered from the standpoint of maximum undistorted output. An appended table gives some of the constants of the more commonly used Radiotrons.

**R420. CONTINUOUS-WAVE SYSTEMS. BEAM STATIONS.**  
*RADIO BROADCAST*, Feb., 1927. Pp. 351-355. *Short-Wave.*  
 "Linking Continents with Twenty Kilowatts," K. B. Humphrey.  
 The advantages of the short-wave beam stations now being used by Britain in linking up with her colonies, as compared to the high-power long-wave stations, are said to be: (1) Much lower cost of equipment; (2) More economical operation and maintenance; (3) Greater sending speed is possible.  
 Reflectors are used at both the transmitting and receiving ends. The antenna and the reflector wires are arranged so as to constitute grids parallel to each other, the antenna wires being energized simultaneously from the transmitter at a number of feeder points. The directional effect is said to be a function of the dimensions of the system relative to the wavelength utilized. The receivers used are of the super-heterodyne type with two intermediate step-up amplifier frequencies before detection is affected. The location of the present beam stations, and future installations, are listed.

**R344.4. SHORT-WAVE GENERATORS. SHORT-WAVE TRANSMITTERS.**  
*RADIO BROADCAST*, Feb., 1927. Pp. 361-364.  
 "Some Experiments on One Meter," H. E. Rhodes.  
 The experiments of Mr. J. H. Hallberg with frequencies from 300,000 to 60,000 kilocycles (1 to 5 meters), are described. Details are given explaining how these waves were produced, how they were measured, and what circuits were used in obtaining results. Beam transmission was tried, using different types of reflectors arranged in the form of a parabola. A description is given of the transmitter and receiver, the former being capable of broadcasting microphone-modulated energy.

**R140. RADIO CIRCUITS. GRIMES INVERSE DUPLEX.**  
*RADIO BROADCAST*, Feb., 1927. Pp. 365-367.  
 "Further Notes on the Inverse Duplex System," David Grimes.  
 This second of a series of articles discusses the importance of good audio amplification and the method used in the Inverse Duplex circuit in obtaining it. The three-stage audio amplifier utilizes a resistance-coupled stage between two transformer-coupled units in order to prevent audio regeneration. It is recommended that a low-ratio transformer follow the detector tube, a high-ratio one being better for the last audio stage. The resistance-coupled stage serves as an efficient audio stage, as a filtered radio-frequency feed-back circuit, and as a choking circuit to prevent the modulation howl. A potentiometer across the secondary of the first audio transformer keeps the audio volume below the choking point so that the last tube may not be overloaded. Data are given on the winding of the r.f. coils used in the circuit.

**R142. COUPLED CIRCUITS. COUPLING. Loud-Speaker.**  
*Radio*, Nov., 1926. Pp. 36ff.  
 "Coupling the Loud Speaker," A. Hobart.  
 With the introduction of the new power tubes, which take more plate current, it is necessary to bypass the direct-current component so it will not magnetize the loud speaker beyond its limit. Methods employed are described whereby either a condenser or a transformer may be used. Too much current may also cause burnouts in the windings of the magnet.

**R343.5. HETERODYNE ACTION. HETERODYNE.**  
*Radio*, Nov., 1926. Pp. 35ff.  
 "Additions to the Shielded Super-Heterodyne," G. M. Best.  
 Additional information is presented concerning the construction and simplification of control on the shielded super-heterodyne described in detail in the October, 1926 issue of *Radio*, pp. 19ff.

**R343. ELECTRON-TUBE RECEIVING SETS. RECEIVER, Shielded.**  
*QST*, Dec., 1926. Pp. 27-31.  
 "Devising a Shielded Receiver Kit," M. Silver and K. Clough.  
 A shielded receiver, using Silver parts, is described in detail. It is stated that in a three-stage r. f. receiver, the first stage should be tuned separately, the remaining three circuits then being tuned with one control, the component parts of which can be assembled to test within 2 per cent. Oscillations due to a high coefficient of coupling are prevented by individual shielding, using grid resistances in every stage, and by the use of a third winding coupled to the transformer. The antenna stage, the detector stage, and the audio stages are also discussed at some length.

**R402. SHORT WAVES. SHORT WAVES.**  
*Transmitter*, Nov., 1926. Pp. 10-11. *60,000 kc. (5 meters).*  
 "Experiences on 5 Meters," J. K. K. Grindle.  
 Experiments conducted on 60,000 kc. (5 meters) are discussed, and diagrams of the receiver and transmitter with their constants are shown. It is stated that for best results all measuring instruments should be left out of the transmitter circuit after it is tuned. For an antenna a brass spring was stretched out until the proper length was obtained.

**R070. EDUCATION; TRAINING. EDUCATION.**  
*Radio*, Nov., 1926. Pp. 20ff.  
 "What Radio Means Today," E. W. Stone.  
 Comparing radio engineering with power engineering shows, according to the writer, that much higher requirements are necessary in radio engineering. Commenting on the engineering specifications necessary in designing a radio receiver, the author states that the following points must be considered: (1) Selectivity; (2) Uniform amplification for band between 500 and 1500 kilocycles. (600 and 200 meters); (3) Uniform amplification for the entire audio range.  
 It is pointed out that considerable progress has been made in the application of 60-cycle a. c. toward furnishing power for receivers. Linked with the engineering field are the patent situation, merchandising, and broadcasting, which subjects are treated in a general way.

**R384. 1. WAVEMETERS. WAVEMETER, Oscillator.**  
*Radio*, Nov., 1926. Pp. 29-30.  
 "A Multi-Purpose Oscillator-Wavemeter," W. H. Stirling.  
 An oscillator-wavemeter, for purposes of calibrating condensers, receivers, transmitters, wavelength and capacity of antennas, and other tests relative to resonance, is described. Four sets of plug-in coils cover the range from 3750 to 272 kc. (80 to 1100 meters). Circuit diagrams and operating instructions are given.

**R201.5. SHIELDING AND GROUNDING. SHIELDING.**  
*Radio*, Nov., 1926. Pp. 30-31.  
 "Shielding," H. M. Bishop.  
 When shielding is attempted in receivers to prevent external interference, care must be taken to prevent an increase in effective resistance in the circuit, according to the author. Shielding is used to keep out the external electrical disturbances and to confine electromagnetic fields in the set within definite areas.  
 This paper presents fundamental principles of successful shielding, and gives suggestions as to practical application of the principles outlined.

**R148. 1 DISTORTION. DISTORTION, B Battery.**  
*Radio*, Nov., 1926. Pp. 33ff.  
 "Effect of B-Battery Impedance on Amplification," J. E. Anderson.  
 The high a. c. resistance in the B-battery circuit is said to be the cause of considerable distortion, and the remedy is a reduction in impedance. This conclusion is arrived at by mathematical calculations applied first to the two- and the three-stage resistance-coupled amplifier, and secondly to the two- and three-stage transformer-coupled amplifier. It is pointed out why conditions in a two-stage amplifier, as compared to a three-stage amplifier, are quite different, and what troubles are met with when attempting to use more than two stages. Every equation presented is discussed in detail and applied. The information is very complete.

**R800 (621.383.21) RELAYS. RELAYS.**  
*QST*, Dec., 1926. Pp. 34-36.  
 "A Break-in Relay," M. S. Brainard.  
 A relay, with two contacts, one controlling the motor-generator and the filaments, and the other controlling the oscillatory circuit, is described. Details of the assembly, parts, and its operation, are given.

**R565. NAVAL RADIO. MARINE RADIO SETS.**  
*Radio*, Dec., 1926. Pp. 28ff.  
 "Modern Practice in Marine Radio," D. B. McGown.  
 Several improved transmitting sets, as used on shipboard, are presented. The theory, construction, and operation of the following outfits are given: (1) The converted spark set. (2) The Telefunken system (3) The Federal 2-kw. arc set. Circuit diagrams and photographs of each are shown.

**R343. ELECTRON-TUBE RECEIVING SETS. RECEIVER, Grimes Inverse Duplex.**  
*Radio*, Dec., 1926. Pp. 33ff.  
 "The New Inverse Duplex System," D. Grimes.  
 The author goes into considerable detail concerning the design of the new Inverse Duplex circuit. The present arrangement comprises four tubes with three stages reflexed. A set, completely assembled, is illustrated.



**THE SENIOR SIX**

**ELKAY**

With Truphonic Audio

Renders in true color all the tones of the scale from bass to treble. Brings in the voice in natural, human quality. Complete shielding for quiet tone background. Centralized control, but with fine adjustment for selectivity. Write for complete description.

**NOW READY: new Junior Six ELKAY; an improved T. R. F. receiver designed throughout on Elkay standards, but at a price of \$80.**

*Jobbers: Dealers; Write for Elkay franchise.*

**The Langbein-Kaufman Radio Co.**  
 Dept. R  
 62 Franklin Street. New Haven, Conn.

**demand**

**AEROVOX**

**FILTER CONDENSER BLOCKS**

For Working Voltages of 200, 300, 400, 600 and 1000 Volts D. C.

Flexible leads for connections eliminate all possibilities of leakage from soldering.

AEROVOX WIRELESS CORPORATION  
 60-71 Washington Street  
 Brooklyn, N. Y.

**Employs Q. R. S. Rectifier**

The Greene-Brown B-current supply device employs a Q. R. S. rectifying tube and not a Raytheon, as stated in the February **RADIO BROADCAST**.

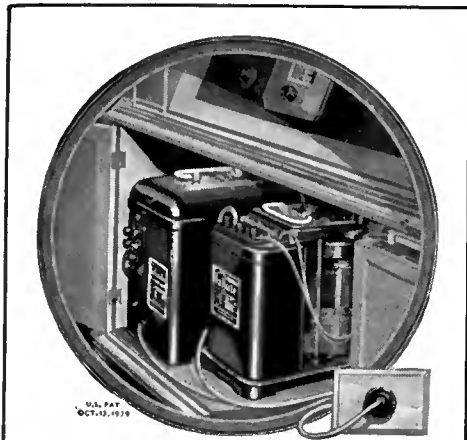

Convert your radio set into a light socket receiver with Balkite "B" and the Balkite Trickle and High-Rate Charger

Ask your radio dealer  
FANSTEEL PRODUCTS CO., INC.  
North Chicago, Ill.

**Big FREE RADIO**  
PARTS, Catalog & Guide  
HOOK-UPS, SETS and KITS  
Send now for this valuable FREE Radio book, 164 pages of newest hook-ups, parts and kits at big savings. A real guide. Shows factory built sets and the new ideas in radio. Send at once. No charge. No obligation. Please include name of radio fan.

**BARAWIK CO.**  
Dept. 74 Chicago, U. S. A.

RADIO FANS, a one-year's subscription to Radio Broadcast will cost you four dollars, two years six dollars. Consider this expenditure as being a necessary investment on your part for the future development of your own knowledge of Radio.

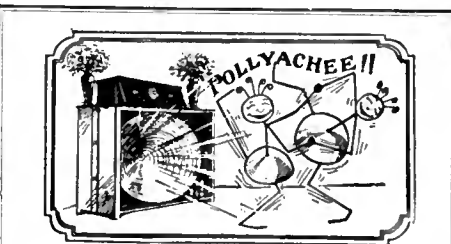

Only \$10 Make Your Own Three Foot Cone Speaker In Less Than An Hour Only \$10

Complete parts furnished in kit form. We guarantee this speaker the equal of any manufactured cone speaker at any price. With this THREE FOOT CONE SPEAKER you hear all the tones. It brings out the true depth and beauty of orchestral and instrumental music. Can be operated softly for living room music or full volume for dancing, and without trace of distortion.

Kit includes famous "ENSCO" cone unit, the only direct-drive, distortionless unit for large cones; Alhambra Fonotex for big cone, with brass apex; two Blue Prints showing cabinet or stand, wall, or roll type construction for cone speaker. All necessary instructions.

Buy this wonderful speaker under our absolute guarantee. Your money back if you are not convinced that it is the finest reproducing medium obtainable at any price. It works on any set, with ordinary Tubes or with Power Output.

SEND NO MONEY!

Write your name plainly as indicated below, then mail and complete kit will be forwarded to you. Just pay postman \$10.00 upon delivery.

Name: \_\_\_\_\_  
Address: \_\_\_\_\_

ENGINEERS' SERVICE CO.  
25 Church St. Desk X New York City

(Continued from page 605)

At the present time, very little data are available concerning either of these important additions to the tubes now supplied radio users, but a great deal may be promised in the near future.

TUBE TESTER

THE "Universal" tube tester is a combination of two meters, suitable switches, and a tube socket mounted on a metal case, for making tests on vacuum tubes and radio receiver circuits. The milliammeter has a scale reading of 0-15 milliamperes and is suitable for measuring the plate current of a tube. The voltmeter has two scales; one 0-7½ for measuring the filament voltage, and one 0-150 for measuring the plate voltage. A plug, connected with a cord to the tester, can be plugged into any socket in the receiver, and a reading thus taken on a tube placed in the test socket. Provision is made for the different style bases on the tubes

by means of adapters. A C battery is incorporated in the tester and this may be connected in series with the grid bias normally on the tube when in the receiver by pushing down the button marked A. This has the effect of increasing the grid bias a definite amount. In testing a tube the milliammeter is first read with the button up giving the regular plate current. The button is then pushed and the milliammeter reading again taken. The difference is noted and then the worth of the tube may be obtained by referring to a table. This table gives figures on the 201-A, 112, 171, 200, 200-A, 109, and 120 type tubes. This is only one of the tests which may be made with this instrument. The plate voltage may be obtained on the tube by means of the voltmeter and if a varying grid voltage is used on the tube, its static characteristic curve may be obtained. In fact any test may be made for which a voltmeter and milliammeter are required. With the plug in the receiver and tube in the test socket, the continuity of the various circuits can be tested. No deflection on the plate voltage instrument would indicate an open circuit either in the B-lead or in the transformer. The voltage readings on the two different scales are obtained by the button to the right marked B in the diagram (up low voltage, and down high voltage). The reversing switch is provided to change over the filament circuit as the receiver may be connected either way.

Here are a few of the tests which can be made on a receiver with the "Universal" tester:

- Tests for plate current taken by any given tube while in the receiver circuit.
- Tests for open grid circuits.
- Voltage test for both A and B batteries.
- Location of defective tube sockets.
- Defects or open circuits in transformers.
- Tests for poorly soldered joints in wiring.
- Tests for contacts throughout the circuit.

Here are a few of the tests which can be made on a receiver with the "Universal" tester:

Tests for plate current taken by any given tube while in the receiver circuit.  
Tests for open grid circuits.  
Voltage test for both A and B batteries.  
Location of defective tube sockets.  
Defects or open circuits in transformers.  
Tests for poorly soldered joints in wiring.  
Tests for contacts throughout the circuit.

All of these various tests are elaborated upon in the directions which come with the tester. Note. In testing power tubes, too much voltage should not be used as the capacity of the milliammeter is only 15 mils. A diagram of the tester is given in Fig. 3.

Manufactured by the Sterling Manufacturing Company, of Cleveland, Ohio. Universal Tube Tester R-408. Price \$22.00.

REGULATOR TUBE

THE model ux-874 Radiotron is a regulating tube used to keep the output of a socket power device at a constant value around 90 volts. It is used in the R. C. A. socket power devices, but may be adapted to almost any socket power device to good advantage where a constant voltage is required over a wide range of loads. The regulator has two elements, an anode and a cathode, surrounded by a mixture of gases. Current conduction is accomplished by the ionization of these gases. The useful property of this tube as a regulator is that, for current through the tube up to maximum of 50 milliamperes, the voltage across it is approximately 90. That is, as the voltage increases, the current through the tube increases in such a way that the voltage is again lowered to the proper point. The device might be likened somewhat to a spillway in which, as the water level increased, the flow increased to such a rate that the level was caused to rise only a very small amount. The cylinder forms the cathode, or negative electrode, and the wire forms the anode, or positive electrode. It should never be operated in the reverse direction, and the amount

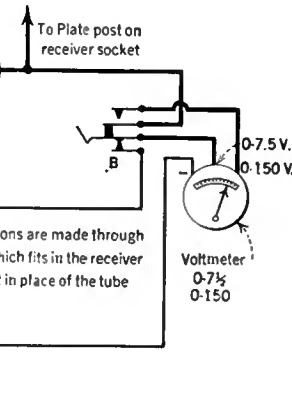

FIG. 3

of current going through it should never exceed 50 milliamperes. A resistance should be included in series with the tube in order to limit the current should the receiving set be turned off. The positive or anode connection to the regulator tube is made to that terminal corresponding to the grid post of the ordinary amplifier tube, and the negative lead is connected to the pin diametrically opposite. The other two

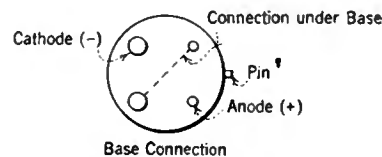
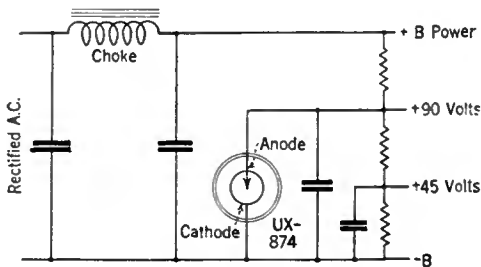

FIG. 4

The connections for an UX-874 voltage regulator tube

pins are connected together through the base, and these two contacts may be connected in the main a. c. line, to open the circuit and prevent a sudden surge in voltage should the regulator tube be removed from the socket. The usual method of connection is shown in the accompanying diagram, Fig. 4. Manufactured by the Radio Corporation of America. Model ux-874. Price \$5.50.

# Manufacturers' Booklets Available

A Varied List of Books Pertaining to Radio and Allied Subjects Which May Be Obtained Free by Using the Accompanying Coupon

AS AN additional service to RADIO BROADCAST readers, we print below a list of booklets on radio subjects issued by various manufacturers. The publications listed below cover a wide range of subjects, and offer interesting reading to the radio enthusiast. The manufacturers issuing these publications have made great effort to collect interesting and accurate information. RADIO BROADCAST hopes, by listing these publications regularly, to keep its readers in touch with what the manufacturers are doing. Every publication listed below is supplied free. In ordering, the coupon printed on page 512 must be used. Order by number only.—THE EDITOR.



PARTS

1. FILAMENT CONTROL—Problems of filament supply, voltage, regulation, and effect on various circuits. RADIALL COMPANY.
2. HARD RUBBER PANELS—Characteristics and properties of hard rubber as used in radio, with suggestions on how to "work" it. B. F. GOODRICH RUBBER COMPANY.
3. TRANSFORMERS—A booklet giving data on input and output transformers. PACENT ELECTRIC COMPANY.
4. RESISTANCE-COUPLED AMPLIFIERS—A general discussion of resistance coupling with curves and circuit diagrams. COLE RADIO MANUFACTURING COMPANY.
5. CARBORUNUM IN RADIO—A book giving pertinent data on the crystal as used for detection, with hook-ups, and a section giving information on the use of resistors. THE CARBORUNUM COMPANY.
6. B-ELIMINATOR CONSTRUCTION—Constructional data on how to build. AMERICAN ELECTRIC COMPANY.
7. TRANSFORMER AND CHOKE-COUPLED AMPLIFICATION—Circuit diagrams and discussion. ALL-AMERICAN RADIO CORPORATION.
8. RESISTANCE UNITS—A data sheet of resistance units and their application. WARD-LEONARD ELECTRIC COMPANY.
9. VOLUME CONTROL—A leaflet showing circuits for distortionless control of volume. CENTRAL RADIO LABORATORIES.
10. VARIABLE RESISTANCES—As used in various circuits. CENTRAL RADIO LABORATORIES.
11. RESISTANCE COUPLING—Resistors and their application to audio amplification, with circuit diagrams. DEJUR PRODUCTS COMPANY.
12. DISTORTION AND WHAT CAUSES IT—Hook-ups of resistance-coupled amplifiers with standard circuits. ALLEN-BRADLEY COMPANY.
15. B-ELIMINATOR AND POWER AMPLIFIER—Instructions for assembly and operation using Raytheon tube. GENERAL RADIO COMPANY.
- 15A. B-ELIMINATOR AND POWER AMPLIFIER—Instructions for assembly and operation using an R. C. A. rectifier. GENERAL RADIO COMPANY.
16. VARIABLE CONDENSERS—A description of the functions and characteristics of variable condensers with curves and specifications for their application to complete receivers. ALLEN D. CARDWELL MANUFACTURING COMPANY.
17. BAKELITE—A description of various uses of bakelite in radio, its manufacture, and its properties. BAKELITE CORPORATION.
19. POWER SUPPLY—A discussion on power supply with particular reference to lamp-socket operation. Theory and constructional data for building power supply devices. ACME APPARATUS COMPANY.
20. AUDIO AMPLIFICATION—A booklet containing data on audio amplification together with hints to the constructor. ALL-AMERICAN RADIO CORPORATION.
21. HIGH-FREQUENCY DRIVER AND SHORT-WAVE WAVEMETER—Constructional data and application. BURGESS BATTERY COMPANY.
46. AUDIO FREQUENCY CHOKES—A pamphlet showing positions in the circuit where audio frequency chokes may be used. SAMSON ELECTRIC COMPANY.
47. RADIO FREQUENCY CHOKES—Circuit diagrams illustrating the use of chokes to keep out radio frequency currents from definite points. SAMSON ELECTRIC COMPANY.
48. TRANSFORMER AND IMPEDANCE DATA—Tables giving the mechanical and electrical characteristics of transformers and impedances, together with a short description of their use in the circuit. SAMSON ELECTRIC COMPANY.
49. BYPASS CONDENSERS—A description of the manufacture of bypass and filter condensers. LESLIE F. MUTER COMPANY.
50. AUDIO MANUAL—Fifty questions which are often asked regarding audio amplification, and their answers. AMERTRAN SALES COMPANY, INCORPORATED.
51. SHORT-WAVE RECEIVER—Constructional data on a receiver which, by the substitution of various coils, may be made to tune from a frequency of 16,660 kc. (18 meters) to 1999 kc. (150 meters). SILVER-MARSHALL, INCORPORATED.
52. AUDIO QUALITY—A booklet dealing with audio-frequency amplification of various kinds and the application to well-known circuits. SILVER-MARSHALL, INCORPORATED.

56. VARIABLE CONDENSERS—A bulletin giving an analysis of various condensers selected with their characteristics. GENERAL RADIO COMPANY.
57. FILTER DATA—Facts about the filtering of direct current supplied by means of motor-generator outfits used with transmitters. ELECTRIC SPECIALITY COMPANY.
59. RESISTANCE COUPLING—A booklet giving some general information on the subject of radio and the application of resistors to a circuit. DAVEN RADIO CORPORATION.
60. RESISTORS—A pamphlet giving some technical data on resistors which are capable of dissipating considerable energy; also data on the ordinary resistors used in resistance-coupled amplification. THE CRESCENT RADIO SUPPLY COMPANY.
62. RADIO-FREQUENCY AMPLIFICATION—Constructional details of a five-tube receiver using a special design of radio-frequency transformer. CAMFIELD RADIO MANUFACTURING COMPANY.
63. FIVE-TUBE RECEIVER—Constructional data on building a receiver. AERO PRODUCTS, INCORPORATED.
64. AMPLIFICATION WITHOUT DISTORTION—Data and curves illustrating the use of various methods of amplification. ACME APPARATUS COMPANY.
65. RADIO HANDBOOK—A helpful booklet on the functions, selection, and use of radio apparatus for better reception. BENJAMIN ELECTRIC MANUFACTURING COMPANY.
66. SUPER-HETERODYNE—Constructional details of a seven-tube set. G. C. EVANS COMPANY.
70. IMPROVING THE AUDIO AMPLIFIER—Data on the characteristics of audio transformers, with a circuit diagram showing where chokes, resistors, and condensers can be used. AMERICAN TRANSFORMER COMPANY.
71. DISTORTIONLESS AMPLIFICATION—A discussion of the resistance-coupled amplifier used in conjunction with a transformer, impedance, or resistance input stage. Amplifier circuit diagrams and constants are given in detail for the constructor. AMSCO PRODUCTS INCORPORATED.
72. PLATE SUPPLY SYSTEM—A wiring diagram and layout plan for a plate supply system to be used with a power amplifier. Complete directions for wiring are given. AMERTRAN SALES COMPANY.
80. FIVE-TUBE RECEIVER—Data are given for the construction of a five-tube tuned radio-frequency receiver. Complete instructions, list of parts, circuit diagram, and template are given. ALL AMERICAN RADIO CORPORATION.
81. BETTER TUNING—A booklet giving much general information on the subject of radio reception with specific illustrations. Primarily for the non-technical home constructor. BREWER-TULLY MANUFACTURING COMPANY.
82. SIX-TUBE RECEIVER—A booklet containing photographs, instructions, and diagrams for building a six-tube shielded receiver. SILVER-MARSHALL, INCORPORATED.
83. SOCKET POWER DEVICE—A list of parts, diagrams, and templates for the construction and assembly of socket power devices. JEFFERSON ELECTRIC MANUFACTURING COMPANY.
84. FIVE-TUBE EQUAMATIC—Panel layout, circuit diagrams, and instructions for building a five tube receiver, together with data on the operation of tuned radio-frequency transformers of special design. KARAS ELECTRIC COMPANY.
85. FILTER—Data on a high capacity electrolytic condenser used in filter circuits in connection with A-socket power supply units, is given in a pamphlet. THE A BOX COMPANY.

ACCESSORIES

22. A PRIMER OF ELECTRICITY—Fundamentals of electricity with special reference to the application of dry cells to radio and other uses. Constructional data on buzzers, automatic switches, alarms, etc. NATIONAL CARBON COMPANY.
23. AUTOMATIC RELAY CONNECTIONS—A data sheet showing how a relay may be used to control A and B circuits. YAXLEY MANUFACTURING COMPANY.
25. ELECTROLYTIC RECTIFIER—Technical data on a new type of rectifier with operating curves. KODEL RADIO CORPORATION.
26. DRY CELLS FOR TRANSMITTERS—Actual tests given, well illustrated with curves showing exactly what may be expected of this type of B power. BURGESS BATTERY COMPANY.
27. DRY-CELL BATTERY CAPACITIES FOR RADIO TRANSMITTERS—Characteristic curves and data on discharge tests. BURGESS BATTERY COMPANY.
28. B BATTERY LIFE—Battery life curves with general curves on tube characteristics. BURGESS BATTERY COMPANY.
29. HOW TO MAKE YOUR SET WORK BETTER—A non-technical discussion of general radio subjects with hints on how reception may be bettered by using the right tubes. UNITED RADIO AND ELECTRIC CORPORATION.
30. TUBE CHARACTERISTICS—A data sheet giving constants of tubes. C. E. MANUFACTURING COMPANY.
31. FUNCTIONS OF THE LOUD SPEAKER—A short, non-technical general article on loud speakers. AMPLION CORPORATION OF AMERICA.
32. METERS FOR RADIO—A catalogue of meters used in radio with connecting diagrams. BURTON-ROGERS COMPANY.
33. SWITCHBOARD AND PORTABLE METERS—A booklet giving dimensions, specifications, and shunts used with various meters. BURTON-ROGERS COMPANY.
34. COST OF B BATTERIES—An interesting discussion of the relative merits of various sources of B supply. HARTFORD BATTERY MANUFACTURING COMPANY.



## Engineering and Mass Production

Those two features are important to you, the manufacturers of sets and eliminators.

Dongan's reputation for being a step ahead in transformer design and a large factory devoted entirely to the production of parts has placed Dongan transformers and chokes as standard equipment in many leading sets and battery-eliminators.

As a source of supply you will find the utmost in cooperation in the Dongan organization.

**DONGAN ELECTRIC MFG. CO.**  
2991-3001 Franklin St., Detroit, Michigan

This is NEW

**Dongan Transformers and Chokes for use with Raytheon BA 350 MA and Q. R. S. 300 MA Rectifying Tubes**

Write for complete details

TRANSFORMERS of MERIT for FIFTEEN YEARS

# Mayolian

B SUPPLY

**Type 612—\$42.50**  
The "B" Without a Buzz

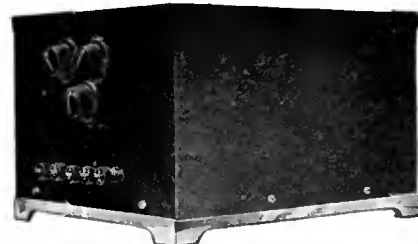

Also—Complete set of parts for home-builders at reasonable prices. Write us.

**MAYOLIAN RADIO CORPORATION**  
1668 Webster Ave., New York, N. Y.

*Pioneers in Battery Elimination*



*The Power of Niagara—  
The Quiet of an Arctic Night*





# Protection



What protection have you provided your set against Lightning? *Jewell Lightning Arrester*

The Jewell lightning arrester gives you the maximum of protection. It is listed as Standard by Underwriter's Laboratories and is regularly inspected by that organization to insure uniform quality in manufacture.

Jewell lightning arresters are easily installed and are suitable for either indoor or outdoor use.

Write for descriptive circular No. 1019.

**Jewell Electrical Instrument Co.**  
1650 Walnut Street, Chicago

"27 YEARS MAKING GOOD INSTRUMENTS"



- 35. STORAGE BATTERY OPERATION—An illustrated booklet on the care and operation of the storage battery. GENERAL LEAD BATTERIES COMPANY.
- 36. CHARGING A AND B BATTERIES—Various ways of connecting up batteries for charging purposes. WESTINGHOUSE UNION BATTERY COMPANY.
- 37. CHOOSING THE RIGHT RADIO BATTERY—Advice on what dry cell battery to use; their application to radio, with wiring diagrams. NATIONAL CARBON COMPANY.
- 53. TUBE REACTIVATOR—Information on the care of vacuum tubes, with notes on how and when they should be reactivated. THE STERLING MANUFACTURING COMPANY.
- 54. ARRESTERS—Mechanical details and principles of the vacuum type of arrester. NATIONAL ELECTRIC SPECIALTY COMPANY.
- 55. CAPACITY CONNECTOR—Description of a new device for connecting up the various parts of a receiving set, and at the same time providing bypass condensers between the leads. KURZ-KASCH COMPANY.
- 61. DRY CELLS—Information on the construction and operation of dry cells with a description of the methods used in testing them. THE CARRON PRODUCTS COMPANY.
- 68. CHEMICAL RECTIFIER—Details of assembly, with wiring diagrams, showing how to use a chemical rectifier for charging batteries. CLEVELAND ENGINEERING LABORATORIES COMPANY.
- 69. VACUUM TUBES—A booklet giving the characteristics of the various tube types with a short description of where they may be used in the circuit. RADIO CORPORATION OF AMERICA.
- 77. TUBES—A booklet for the beginner who is interested in vacuum tubes. A non-technical consideration of the various elements in the tube as well as their position in the receiver. CLEARTRON VACUUM TUBE COMPANY.

MISCELLANEOUS

- 38. LOG SHEET—A list of broadcasting stations with columns for marking down dial settings. U. S. L. RADIO, INCORPORATED.
- 39. BEHIND THE SCENES IN A BROADCASTING STATION—Operation in general, and specific facts about WKRC. KODEL RADIO CORPORATION.
- 40. STATIC—A brief discussion of the disturbances which may cause trouble in a receiver. SUN MANUFACTURING COMPANY.
- 41. BABY RADIO TRANSMITTER OF 9XH-9EK—Description and circuit diagrams of dry-cell operated transmitter. BURGESS BATTERY COMPANY.
- 42. ARCTIC RADIO EQUIPMENT—Description and circuit details of short-wave receiver and transmitter used in Arctic exploration. BURGESS BATTERY COMPANY.
- 43. SHORT-WAVE RECEIVER OF 9XH-9EK—Complete directions for assembly and operation of the receiver. BURGESS BATTERY COMPANY.
- 44. ALUMINUM FOR RADIO—A booklet containing much radio information with hook-ups of basic circuits, with inductance-capacity tables and other pertinent data. ALUMINUM COMPANY OF AMERICA.
- 45. SHIELDING—A discussion on the application of shielding in radio circuits with special data on aluminum shields. ALUMINUM COMPANY OF AMERICA.
- 58. HOW TO SELECT A RECEIVER—A common sense booklet describing what a radio set is, and what you should expect from it, in language that any one can understand. DAY-FAN ELECTRIC COMPANY.
- 67. WEATHER FOR RADIO—A very interesting booklet on the relationship between weather and radio reception, with maps and data on forecasting the probable results. TAYLOR INSTRUMENT COMPANIES.
- 73. RADIO SIMPLIFIED—A non-technical booklet giving pertinent data on various radio subjects. Of especial interest to the beginner and set owner. CROSLY RADIO CORPORATION.
- 74. THE EXPERIMENTER—A monthly publication which gives technical facts, valuable tables, and pertinent information on various radio subjects. Interesting to the experimenter and to the technical radio man. GENERAL RADIO COMPANY.
- 75. FOR THE LISTENER—General suggestions for the selecting, and the care of radio receivers. VALLEY ELECTRIC COMPANY.
- 76. RADIO INSTRUMENTS—A description of various meters used in radio and electrical circuits together with a short discussion of their uses. JEWELL ELECTRICAL INSTRUMENT COMPANY.
- 78. ELECTRICAL TROUBLES—A pamphlet describing the use of electrical testing instruments in automotive work combined with a description of the cadmium test for storage batteries. Of interest to the owner of storage batteries. BURTON ROGERS COMPANY.
- 79. INSULATION—A comprehensive book giving valuable information on all types of insulating material used in electrical work. More for the technical man than for the average set owner. MITCHELL-RAND MANUFACTURING COMPANY.

# FOOL-PROOF Filament Control

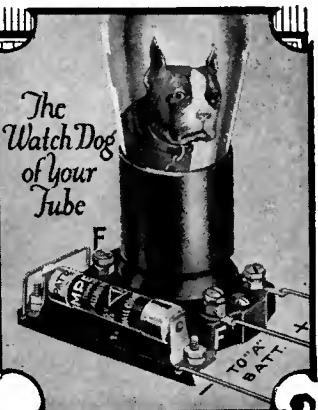

NO guessing. No uncertainty. No meters needed. With Amperite, whether your battery is high or low—while sufficient current is there—each tube receives the exact voltage it requires automatically for perfect performance and long life. Insist upon Amperite. Accept nothing else. Types for all tubes. Eliminates hand rheostats. Simplifies wiring.  
Price \$1.10 mounted (in U.S.A.)  
For sale everywhere.



## Free—Write for Radiall Book.

Explains Amperite, its principle and operation fully. Gives season's most popular Hook-Ups with invaluable construction data. The book is free. Write for it today to Dept RB4

**RADIALL CO.,**  
50 Franklin St.,  
New York

# AMPERITE

REG. U.S. PAT. OFF.

## The "SELF-ADJUSTING" Rheostat

USE THIS COUPON

RADIO BROADCAST SERVICE DEPARTMENT  
RADIO BROADCAST, Garden City, New York.  
Please send me (at no xpense) the following booklets indicated by numbers in the published list

.....

.....

.....

.....

Name: .....

Address: .....

(Number) (Street)

(City) (State)

ORDER BY NUMBER ONLY

This coupon must accompany every request. \* RB 427

## Book Review

### Resistance in Radio

**HOW TO USE RESISTANCE IN RADIO:** Published by the Ward Leonard Electric Company, Mount Vernon, New York. 31 pages. Numerous diagrams. Price 15 cents.

WHEN engineers first began to specify fixed resistance units in radio circuits, considerable trouble was experienced by the radio set manufacturer and home-constructor in obtaining them. The most consistent source of trouble in the earlier types was their low current-carrying capacity, or in other words, their inability to dissipate sufficient energy. This was particularly true of the high-resistance units used in socket power devices. This book takes up the development, the design, the manufacture, and the application of wire-wound "Vitrohm" resistors. These resistors are designed to dissipate the required number of watts without overheating and consequent burn-outs. Circuit diagrams are given showing their uses in socket power units for A, B, and C current, direct-current battery chargers, 32-volt direct-current A supply units, a.c. trickle chargers, and other special units. Methods are given for calculating the correct value of resistor needed for different circuits and of safe carrying capacity. In all, it is an interesting booklet which should be in the hands of every set builder, experimenter and manufacturer who is interested in socket power devices or other apparatus using high resistances.

K. B. H.

### Uses of the Fixed Condenser

**SEVENTEEN WAYS TO IMPROVE YOUR SET:** Published by the Dubilier Condenser Corporation. 32 pages with circuit diagrams. Price 10 cents.

THE small fixed condenser is an indispensable unit in any modern radio receiver. Consequently, an authoritative book which gives information on when, how, where, and why they are used, naturally holds a good deal of interesting material for the experimenter and the home-constructor. Many of us know quite a few uses of the fixed condenser, but it is extremely doubtful if all their uses could be named without hesitation. Among some of the uses given and explained with suitable diagrams are: Tuning a circuit to resonance; blocking direct current; bypassing radio- and audio-frequency currents; smoothing out pulsating currents in filter circuits, and many other uses. Each one of the seventeen points given specifies where the condenser should be placed in the circuit, its value, and its functions. Methods of testing and calculating the values of condensers are also given. This booklet is of especial interest to the non-technical set constructor who wishes to get the best possible results from his radio receiver.

K. B. H.

### The Amateur's Vade Mecum

**RADIO AMATEUR'S HANDBOOK:** By Francis Edward Handy. Published by the American Radio Relay League, Hartford, Connecticut. 178 pages. Fully illustrated. Price, \$1.00.

FOR some time the American Radio Relay League, Incorporated, of Hartford, has been threatening, and promising, to produce a book for the amateur, one that will tell him what, how, and when. At last the book has appeared under the name of the *Radio Amateur's Handbook* and from the pen of Communica-

# Plate Voltage A-plenty For Big or Little Sets

## Type 405 Plate Supply



## Price

With Type BH  
**Raytheon**  
LONG LIFE RECTIFYING TUBE

# \$46

**Type 400  
Power Amplifier  
and Plate Supply  
similar in appear-  
ance to Type 405  
Plate Supply but  
with A. C. operated  
stage of power  
amplification and  
speaker Filter.  
Price \$68**

**Write for descrip-  
tion Booklet 400-B**

The Type 405 Plate Supply delivers ample plate power to permit its use with multi-tube sets where there is a heavy current drain as well as with receivers having small current demands.

The Type 405 Unit operates on 110-volt (60 cycle) A. C. and provides voltages of 45, 90, 130, and 200.

Voltages are readily adapted to plate requirements of all standard tubes in popular use by means of fixed resistances. These resistances are tightly sealed from dust and moisture, thus eliminating bothersome and noisy tendencies of variable resistance voltage controls.

The Unit is contained in a metal case with attractive black crystalline finish and has a conveniently located A. C. switch.

**Power Amplifier  
and Plate Supply  
Kits for home con-  
struction.**

**Type 390 designed  
for Rectron Tube  
\$47.50.**

**Type 395 designed  
for Raytheon Tube  
\$50.**

**Write for folders 390  
and 395 which con-  
tain full instructions  
for assembling**

**Type 405 Plate Supply, with tube, \$46.**

*Ask your dealer to demonstrate this  
unit to you or write for Folder 405-B*

**GENERAL RADIO CO. Cambridge, Mass.**

# GENERAL RADIO

## PARTS and ACCESSORIES

The General Radio Company has endeavored to make it possible for the experimenter to obtain its products with minimum of effort. A careful selection of distributors and dealers has been made. They are best suited to serve you. If, however, you are unable to obtain our products in your particular locality, they will be delivered to you, post paid, direct from the factory upon receipt of list price.

Now is a good time to subscribe for

**RADIO BROADCAST**

*Through your dealer or direct, by the year only \$4.00*

Doubleday, Page & Company

Garden City, New York



The  
"Quality Touch"  
to a Good  
Receiver



## I. C. A. PANELS

For "R. B. Lab." and all Popular Circuits  
Sponsored by Leading Radio Magazines

Don't spoil the appearance of a good set with a poor front panel. You'll be proud to exhibit your receiver to friends when it's fitted with an I. C. A. Panel, in Insuline or Bakelite, beautifully engraved by the exclusive Etch-O-Gravure method. Quickly assembled—drilled ready to set up.

Panels in same materials for over 70 popular circuits. Also sub-panels for practically all well known circuits. A complete I. C. A. Insulating Unit, consisting of front panel, sub-panel, and mounting brackets gives you better reception because of its high dielectric strength.

"Home Set" Builders should have our Free Catalog of many other insulating parts, including tubing, spaghetti tubing, rods, sockets, binding post panels, knife switches, etc.

*If your dealer cannot supply the genuine I. C. A. Products, write us direct. Write to-day for Booklet B-4—It's Free.*

Insulating Co. of America, Inc., 59 Warren St., New York City



## Put Your Set in a Conner Cabinet

THE MOST interesting—the most noticed piece of furniture in your home is your Radio Set—House it in a Conner Convenient Cabinet and it will then be the most attractive. Even the best set, with a makeshift mounting, exposed wiring and batteries, misses much in giving you and your friends the pleasure and satisfaction which it should. A Conner Cabinet lends added class and tone to the finest equipment.

A Conner Cabinet assembles every detail of your receiving set, including batteries and tools in a scientifically convenient arrangement and encloses everything in an exceptionally beautiful piece of period furniture. Radio builders know the name "Conner" means Quality. Leading Radio dealers show Conner Cabinets.

Write today for illustrations of the entire line of Conner Convenient Cabinets and learn how easily you may own and enjoy one of these beautiful cases.

A Period Design for every plan of Decoration

**\$35 to \$99.50**

Jacobean Renaissance Sheraton, etc.

Write today for illustrations and details.

We specialize on Cabinets for Radio Builders.

Get our interesting offer to Radio Dealers in open territory. Write today.

CONNER RADIO CABINET COMPANY ☞ New Albany, Indiana

## LEARN THE CODE AT HOME with the OMNIGRAPH

"Just Listen—The Omnigraph will do the teaching"

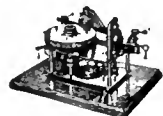

THE OMNIGRAPH Automatic Transmitter will teach you both the Wireless and Morse Codes—right in your own home—quickly, easily and inexpensively. Connected with Buzzer, Buzzer and Phone or to Sounder, it will send you unlimited messages. At any speed, from 5 to 50 words a minute.

THE OMNIGRAPH is not an experiment. For more than 15 years, it has been sold all over the world with a money back guarantee. The OMNIGRAPH is used by several Depts. of the U. S. Govt.—in fact, the Dept. of Commerce uses the OMNIGRAPH to test all applicants applying for a Radio license. The OMNIGRAPH has been successfully adopted by the leading Universities, Colleges and Radio Schools.

Send 6 cents for Catalogue. DO IT TO-DAY.

THE OMNIGRAPH MFG. CO., 13K Hudson St., New York City

If you own a Radio Phone set and don't know the code—you are missing most of the fun

Why not subscribe to Radio Broadcast? By the year only \$4.00; or two years \$6.00, saving \$2.40. Send direct to Doubleday, Page & Company, Garden City, New York.

For plugs, jacks, clips, condenser and transformer parts—

### brass is the logical metal

Used for these screw-machine products, BRASS gives the right electrical conductivity and the mechanical accuracy essential to proper operation of radio sets and parts.

To the manufacturer BRASS means economy in quantity production.

**COPPER & BRASS**  
RESEARCH ASSOCIATION  
25 Broadway, New York

tions Manager Handy. The book should be in every amateur's library.

For the freshmen in this democratic fraternity of brass pounders there are many pages, and for the well initiated owners of keys and tubes there are methods of controlling transmitters by quartz crystals.

The well-known Hartley circuit seems to be the one under the glass case at Hartford, for very little is said about others—especially the "tuned plate-tuned grid," which is reputed to be more efficient than the Hartley. But in spite of this small deficiency, there is dope galore on the code, the communication laws, and a great deal of information that an amateur somehow can't find in other books.

It is to be hoped that Stuart Ballantine's book, *Wireless Telephony for Amateurs*, will some day be brought up to date, for there is technical data here that is difficult to find elsewhere; chiefly because Ballantine used reason in his deductions and not trial-and-error methods that most amateurs follow. But, until this book appears in new form, and with new data on tube circuits and all that is now used in amateur stations, the Handy handbook will be a *vade mecum* for all amateurs.

KEITH HENNEY.

### Non-Technical Radio

THE RADIO KEY BOOK: By E. N. Rauland in collaboration with Harry K. Randall. Published by the author, Chicago, Illinois. 48 pages. Numerous illustrations and diagrams. Price 10 cents.

THE home-constructor who has had some radio experience, and has some idea of the terminology used in the subject, is often up against it for a simple explanation of the various phenomena encountered in this ever fascinating subject. For him especially, and for the person who likes to know the why and wherefore of things, this book can be recommended. Perhaps the best way to give an idea of the contents is to outline the subject matter chapter by chapter. The first chapter takes up the things every listener should know, and outlines just what takes place from the time the signal starts out in the form of sound waves at the broadcasting studio until it is received by the listener in his home. Chapter II takes up the new things in radio, especial attention being given to the quality of the received music or speech. Chapter III gives a list of the parts used in a typical receiver together with an explanation of their functions. Chapter IV is entitled "Hook-Ups and How to Read Them." Chapter V gives some practical hints on servicing and "trouble shooting," together with notes on building receivers and other apparatus. Chapter VI is a review of some outstanding circuits which have been developed lately, together with diagrams, lists of parts, and photographs of the finished receivers.

K. B. H.

#### TECHNICAL INFORMATION INQUIRY BLANK

Technical Service,  
RADIO BROADCAST Laboratory,  
Garden City, New York

GENTLEMEN:

Please give me fullest information on the attached questions. I enclose a stamped addressed envelope.

I am a subscriber to RADIO BROADCAST, and therefore will receive this information free of charge.

I am not a subscriber and enclose \$1 to cover cost of the answer.

Name.....

Address.....

R. B. A.

# WHAT OUR READERS WRITE

## Was Marconi First?

THE letter below disputes with much emphasis the often-made statements to the effect that Marconi should be given full credit for the invention of radio. This is such a touchy question that we would not dare to attempt a verbose argument at this point with so little space available. However, we do think that many readers who have not a copy of the July, 1926, RADIO BROADCAST at hand, will be interested in the following sentences quoted from a letter which appeared in that issue, and which was from the pen of M. E. Packman, vice-president of Dodge's Telegraph, Railway Accounting, and Radio (Wireless) Institute, of Valparaiso, Indiana:

Very recently a claim has been put forward by the Russian Soviet to the effect that Prof. Alexander Popoff was the inventor of wireless telegraphy. In an interview relative to this, Marconi stated, "The Soviet's claim was never once put forward by Professor Popoff himself. When I was in Petrograd in 1902, Popoff sent me a telegram—'Greetings to the father of wireless.'"

The following is the letter championing the cause of Professor Popoff:



PROFESSOR A. S. POPOFF

Editor, RADIO BROADCAST,  
Doubleday, Page & Company,  
Garden City, New York.

SIR:

As a frequent reader of RADIO BROADCAST, may I not correct the impression received by many of your readers from some of your recent articles, namely, that Senatore Marconi is the undisputed father of practical wireless telegraphy.

While it is not generally known, it is nevertheless true that at least several authorities on the history of radio development attribute the honor of being the first inventor of wireless telegraphy to the late Professor A. S. Popoff of Russia, rather than to Senatore Marconi, who, according to the majority of radio historians and the gen-

# STOP!

Use a  
**Belden Fused Radio Battery Cord**

Don't  
Burn Out Tubes  
Discharge Batteries  
Incur Fire Hazard

**MAKE** a neat job of wiring the batteries to your set by using this handy battery cord and get the tremendous advantage of fuse protection for your batteries and tubes. Fuses in the A and B battery circuits of the Belden Fused Radio Battery Cord prevent burned out tubes and damage to batteries due to short circuits.

Crossed wires can neither start fires, ruin batteries, nor burn out tubes if you use a Belden Fused Radio Battery Cord. Fuses are not interchangeable with each other or automobile fuses. You cannot get fuses of incorrect rating in the clips.

Every set needs the protection provided by the Belden Fused Radio Battery Cord. Don't risk operating your set without it. It is cheap insurance.

Fuses are enclosed in a neat bakelite two-piece cover.

Ask your dealer to show you a Belden Fused Radio Battery Cord and explain the protection it provides. Get one today!

**Belden Manufacturing Co.**  
2312A So. Western Ave., Chicago, Ill.

# "Trickle Charge" with a 2 ampere Tungar

When you have a Tungar you have a complete battery charging outfit. It will deliver either a full rate or a trickle charge. Clip it on one post and you will get a full 2 ampere boost, on another, a trickle. It is just the kind of device needed to insure perfect reception at all times. In addition to charging all radio "A" and "B" batteries, Tungar charges auto batteries, too.

This post —  
trickle charge  
to a 6-volt  
battery . . .  
Also charges  
2- or 4-volt  
batteries . . .

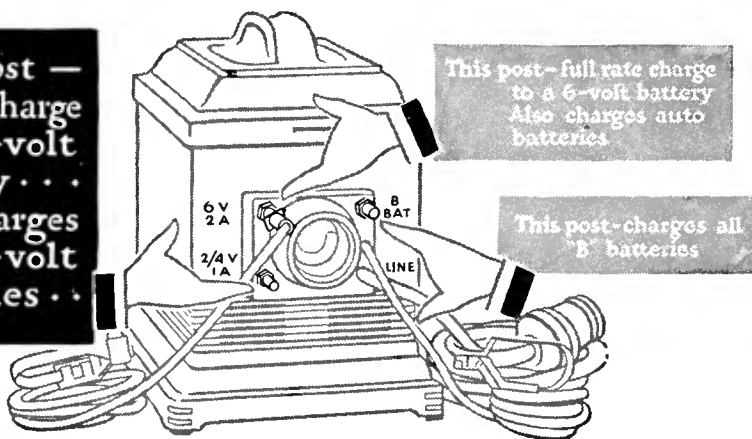

This post—full rate charge  
to a 6-volt battery  
Also charges auto  
batteries

This post—charges all  
"B" batteries

 **Tungar**  
REG. U.S. PAT. OFF.  
**BATTERY CHARGER**

East of the Rockies:

2 ampere Tungar. \$18  
5 ampere Tungar. \$28  
Trickle Charger . \$12

Merchandise Department  
General Electric Company  
Bridgeport, Connecticut

Tungar—a registered trademark—is found only  
on the genuine. Look for it on the name plate.

## GENERAL ELECTRIC

This is a good time to subscribe for

**RADIO BROADCAST**

Through your dealer or direct by the year, only \$4.00

DOUBLEDAY, PAGE & CO.

GARDEN CITY, NEW YORK

### F. D. PITTS COMPANY

INCORPORATED

219-C Columbus Avenue, Boston, Mass., U. S. A.

"Pioneers in the Distribution of Radio"

DEALERS—Send for large and profusely illustrated catalog on the products  
of nationally advertised radio manufacturers.

Wholesale Exclusively

MERCHANDISING RADIO SINCE 1919

eral public, should be given credit for the first practical system of wireless telegraphy.

Popoff started to experiment upon wireless in 1894, sometime after the English physicist Lodge had announced the results of his experiments with the then newly invented coherer. Professor Popoff, in an attempt to repeat certain of Lodge's as well as Hertz's experiments, had struck upon the idea of coupling an antenna and ground to the coherer so that it might be more sensitive to static discharges, since this was the purpose of Popoff's first wireless installations.

According to material recently published in the *Telefonia Telegrafia Bez Pravodov*, a contemporary Russian radio publication, Popoff made public his first wireless installation as early as May 7, 1895. On that date, according to the above publication, in a paper presented before the Russian Physical and Chemical Society, Professor Popoff among other things said: ". . . I want to express my belief that my apparatus, when duly developed and perfected, could be made use of for the transmission of signals at a distance by means of high frequency electromagnetic oscillations, once a source of such oscillations shall have been found."

By March, 1896, Professor Popoff already had found such a source of electromagnetic oscillations, and on the 24th of that month had demonstrated working models of a wireless transmitter and receiver.

Professor Wallson, an eye-witness of the above demonstrations has the following to say: ". . . From your letter I find that you are interested in the details of the meeting of the Russian Physical Society during which A. S. Popoff had first demonstrated his methods of wireless communication. I was present at that meeting and remember all of the attendant details. The transmitter was located in the Chemical Institute of the University, while the receiving arrangement was placed in the auditorium of the old physical laboratory, a distance of about 250 meters. The letters were transmitted according to the Morse code and each signal was plainly audible.

"By the blackboard was standing Professor F. F. Petrushevsky, who was president of the Physical Society. In one hand he held a copy of the Morse code and in the other a piece of chalk. After every transmitted signal he looked into the code paper and then marked upon the blackboard the corresponding letters. These letters he wrote down in the Latin type, and after the demonstration had been finished, we could read the words 'Heinrich Hertz'. It is difficult to describe the enthusiasm of all those present and the ovation that Professor Popoff received when those two words were written. The meeting took place in the beginning of 1896. I do not, however, remember the exact date."

Very truly yours,  
BORIS S. NAIMARK,  
New York City.

### Radio Conditions Forecast

THE time is near at hand, we prophesy, when we shall pick up our paper of a morning with the specific purpose of learning whether or not radio conditions will be favorable enough to ask Smith in this evening to listen to our four-tuber pulling in the dx. Just as of yore we glanced at the weather prophet's prognostications for the day with the object of making a decision regarding the advisability of wearing rubbers to the office, we now shall glance at the radio conditions paragraph to learn whether fading is going to spoil reception from that elusive distant station to-night. Had we picked up a recent copy of the *Milwaukee Journal*, we should have noticed the following in the meteorological department:

*Journal's* radio forecast: Good volume and distance to the East Monday night; poor distance and probably fading

South; probably poor distance West and Southwest.

Apropos this new policy of the *Journal's* to include a radio weather report in its columns, the following letter comes to RADIO BROADCAST:

Editor, RADIO BROADCAST,  
Doubleday, Page & Company,  
Garden City, New York.

SIR:  
Since the first of December, 1926, the Milwaukee *Journal* has been publishing a regular daily forecast of radio weather. The radio forecast is incorporated with the weather report printed on the first page of the daily and Sunday editions.

The reports are based on analysis of the weather map and forecast after the method set forth in Mr. Eugene Van Cleef's article, "How a Low Barometer Affects Radio" and the summary of Mr. Van Cleef's article of May 1925, both of which appeared in the December, 1926 RADIO BROADCAST.

In the five days this service has been in effect (at the time of writing), the prognostications all have been fairly accurate. The *Journal* feels this to be of interest to you, for Mr. Van Cleef's article in your magazine led us to the action, and gives us the information upon which to base our forecasts.

Needless to say, RADIO BROADCAST is the Bible of the *Journal's* radio department.

Very truly yours,  
ANDREW HERTEL, Radio Editor,  
The Milwaukee *Journal*.

*Ware the Cut Rate Wholesaler*

MOST radio retailers, we believe, realize the logic of obtaining their goods from legitimate jobbers or direct from the manufacturers. The "gyp" wholesaler, nevertheless, is still in the market with attractive propositions, tempting discounts, and what not.

THE MERWIN COMPANY  
RADIO LABORATORY BRANCH  
JENSEN, FLORIDA

Editor, RADIO BROADCAST,  
Doubleday, Page & Company,  
Garden City, New York.

SIR:  
I would like to see a paragraph in your magazine protesting against the activities of the cut rate wholesale houses as a warning to retailers who deal with them.

They simply flood the country with catalogues, and sell indiscriminately to private individuals who slip around to the printer for letterheads and call themselves dealers. The legitimate dealer is misled by seeing some standard articles listed along with the trash then sends in an order and gets substitutes "of equally good value." His money is lost, for these unprincipled wholesalers make it impossible to get your money back. It didn't cost us very much to learn this. When we hear of a new piece of apparatus we look for its advertisement in a reliable radio magazine, such as RADIO BROADCAST. If we find the advertisement we write the manufacturer to put us in touch with his distributor. We then play safe. If everybody would do this we would have less "gyp" wholesalers.

We note with pleasure your recent attack on the storage battery situation. The stand you take is splendid.

Very truly yours,  
W. HARVEY MERWIN.

# Norden-Hauck Super-10

## AROUND THE WORLD WITH THE U. S. NAVY

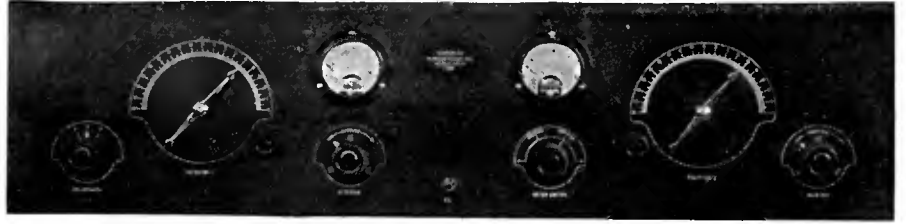

Panel size, 36" x 9" x 1" Super 10-tube Standard Admiralty Model Weight: 55 lbs.

*A SUPER-10 has been installed on board the "U. S. S. Wright," now sailing for Asiatic waters with the U. S. Aircraft squadrons. This receiver will also be used for entertaining civilian representatives at various ports of call.*

### A New and Advanced Model Highest Class Receiver in the World

THE NORDEN-HAUCK SUPER-10 is an entirely new and advanced design of Receiver, representing what we believe to be the finest expression of Modern Radio Research Engineering. It is the product of years of experience devoted exclusively to the attainment of an ideal Broadcast Receiver—regardless of cost.

Results obtained in every respect will upset all your previous ideas of good radio reception. The unusually large number of unsolicited testimonials constantly being received from users—concerns and individuals of international repute—indicates the absolute superiority of the NORDEN-HAUCK SUPER-10.

You, too, may enjoy the advantages of this wonderful receiver at a surprisingly moderate cost. Here are only a few of the host of features that place the NORDEN-HAUCK SUPER-10 far in advance of competition.

- 10 tubes employed to give perfect reproduction with unlimited range and volume power.
- Super selectivity on all wave lengths.
- Built to Navy Standards.
- Wide wave length range without change of coils, 200-550 meters full. (Adaptable 35 meters to 3600 meters if desired.)
- Use Loop or Antenna.
- Simple to operate, having only two major tuning controls.
- No Harmonics. Signals are received only at one Point.
- Special Power Audio Amplifier, operating any loudspeaker and eliminates necessity of external amplifier.
- Can be operated directly from house current with socket power devices.
- Thoroughly shielded at all necessary points.

### Complete Price List for Socket Power Operation

1 Norden-Hauck SUPER-10, completely constructed and laboratory tested	\$307.00
*1 Heavy-Duty 200 V. "B" Eliminator and Tube, 50 60 cycle A/C 110 V.	42.50
1 Automatic "A" Power Supply, complete	29.50
10 Tested Tubes, including Power Tube	22.50
1 Western Electric Cone Speaker, 540AW or Farrand Sr., and Plug	32.60
1 Set Antenna Equipment, complete	5.00
2 "C" Batteries	2.00
<b>TOTAL COST OF ALL ITEMS—NOTHING ELSE REQUIRED</b>	<b>\$441.10</b>
<small>* 25/30 cycle A/C current, \$47.50.</small>	

PROMPT EXPRESS SHIPMENTS NOW BEING MADE

Tear off and mail today

Upon Request complete literature attractively illustrated, will be gladly mailed without charge, or full size constructional blue prints, showing all electrical and mechanical data, will be promptly mailed postpaid upon receipt of \$2.00.

Write, Telegraph or Cable Direct to

**NORDEN-HAUCK**  
Incorporated  
**ENGINEERS**  
MARINE BUILDING  
Philadelphia, U. S. A.

NORDEN-HAUCK, Inc  
Philadelphia, U. S. A.

Gentlemen:

Please send me without cost or obligation on my part, attractive illustrated literature describing the new Norden-Hauck Super-10.

I enclose \$2.00 for which please send me, postpaid, complete full size constructional drawings, and all data for building the Super-10.

Name .....

Address .....

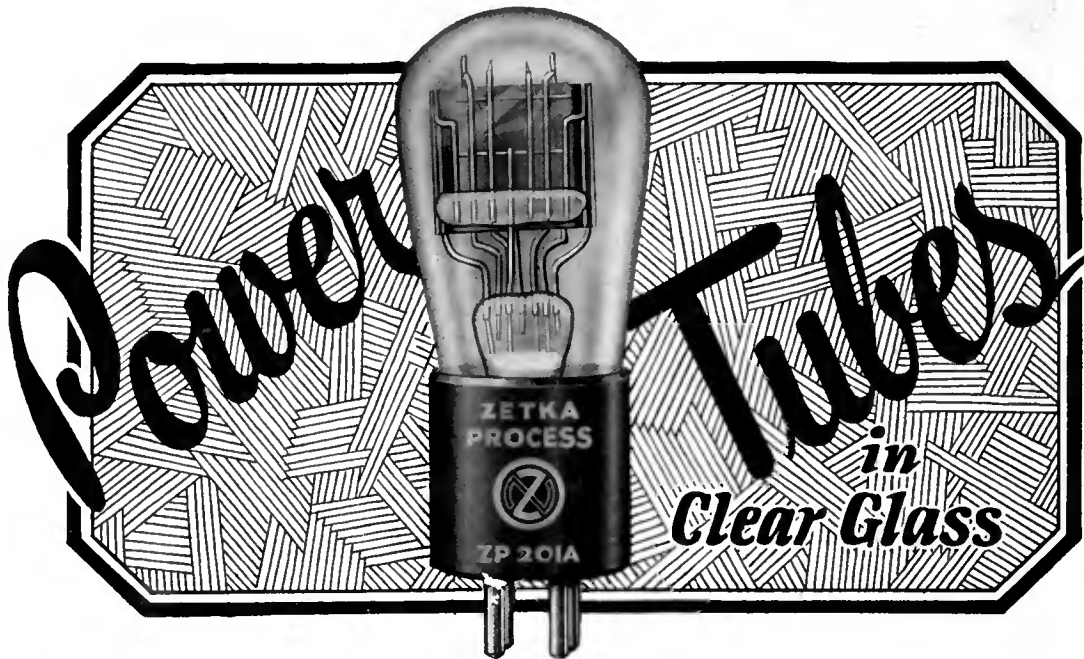

\* Look for the  
Blue and Orange  
Box

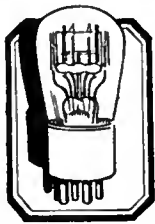

Z 171

A specially designed superior power amplifier. Plate voltage up to 180 volts.

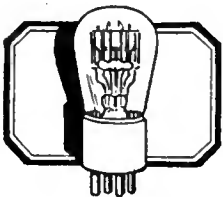

Z 112

Another exceptional power tube for voltages up to 135 volts. Designed for super-power performance.

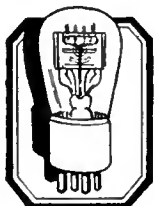

Z 200 A

A super-sensitive  $\frac{1}{4}$  amp. oxide filament detector. Absolutely quiet, extremely sensitive, longer lived.

## Announcing the new ZETKA PROCESS 201A POWER TUBE

Zetka Laboratories announce the creation of one of the most remarkable contributions to radio . . . an oxide coated, quarter ampere *clear glass* 201 A power tube.

This new tube assures almost unbelievable volume, with perfect preservation of natural tone. No bellow or blast. Full, round, accurate recreation. The ZP 201 A was especially designed for use in all stages served by the regular 201 A type tube, giving the unique result of "a power tube in every stage". . . a long-life power tube costing you but \$2.50 instead of \$4.50.

Clear glass \*Zetka Process Tubes, made in all standard types, require no rejuvenation—are "new" tubes during their entire life. See your nearest Zetka dealer about the new ZP 201 A, then hear what a world of difference it really makes . . . how it brings your old set right up to date, and perfection! Clear glass identifies them.

*Your set deserves this finer equipment. Prices no higher.*

# ZETKA

The *Clear Glass* Tube

ZETKA LABORATORIES, Inc.  
73 WINTHROP STREET NEWARK, N. J.

Long prophesied  
Often attempted  
Makeshifts frequently employed  
Here at last!

# CROSLLEY

## Radio Energy

with only a  
switch to snap

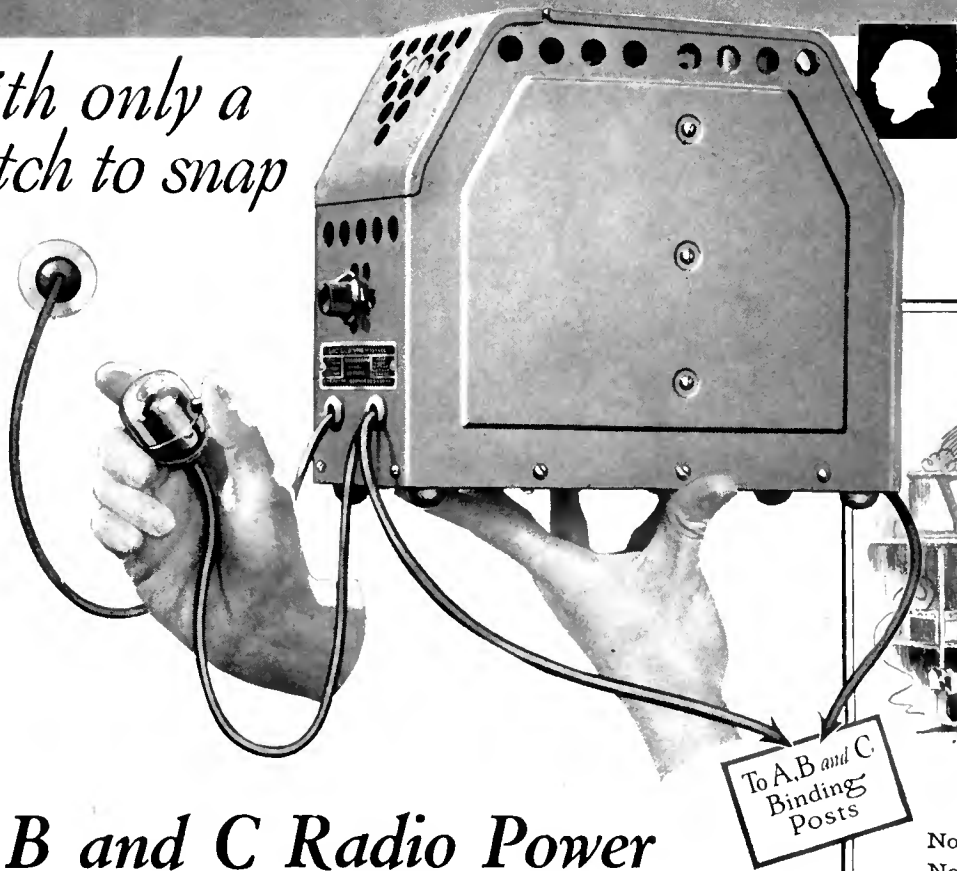

### A B and C Radio Power

from house current outlet direct into the radio with no more attention or thought than you bestow on a vacuum cleaner or your electric iron.

This wonder box weighs only 13 lbs., stands 9 inches high and is 4 inches wide, and is about half the size of an ordinary A storage battery. It is a mechanical device transforming ordinary 110 volt, 60 cycle house power into smooth, quiet radio energy for the new Crosley radios without slightest interfering hum and with the certainty of an electric motor. **PRICE \$50.**

Crosley radios designed for use with this marvelous power supply are the AC-7, a 6-tube table model at \$70, and the AC-7-C, a 6-tube console at \$95. See these wonderful sets at any Crosley dealers, or write Dept. 20 for descriptive literature.

Crosley sets are licensed under Armstrong U. S. Patent No. 1,113,149, or under patent applications of Radio Frequency Laboratories, Inc., and other patents issued and pending. Prices slightly higher west of the Rocky Mountains.

**The CROSLLEY RADIO CORPORATION**

Powel Crosley, Jr., Pres. Cincinnati, O.



- No more batteries to fuss with.
- No more batteries or battery charger to water.
- No failure of the power plant just as you sit down to a fine program.
- No batteries to recharge.
- No batteries to renew.
- No apologies to make to callers because "the batteries must be getting low."
- No upsetting the house to have the radio serviced.
- NO MORE** annoyances from the vital power supply end of the radio. A snap of the switch is the only demand your radio makes upon you from NOW ON.



**NEW!**

*Eveready Layerbilt  
"B" Battery No.  
486, the Heavy-  
Duty battery that  
should be specified  
for all loud-speaker  
sets. Price \$5.00.*

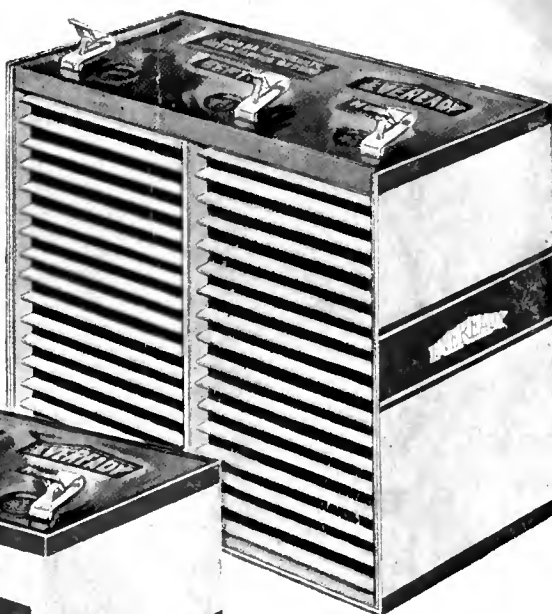

*The Layerbilt pat-  
ented construction  
revealed. Each layer  
is an electrical cell,  
making automatic  
contact with its  
neighbors, and fill-  
ing all available  
space inside the bat-  
tery case.*

**DIFFERENT!**

# Radio is better with *battery* power

RADIO receivers whose quality of reproduction is best always operate on well-made dry cell "B" batteries. What your ear tells you about the performance of battery-run sets is confirmed by laboratory tests that reveal that batteries alone provide steady, noiseless "B" current, taking nothing from and adding nothing to radio reception. Batteries, and batteries alone, provide pure DC (pure Direct Current). Only such current can give you the best results of which your set is capable.

Battery Power is dependable, convenient, and reliable, under your sole control, ever ready to serve you when you turn on your set. As your "B" batteries approach the end of their service,

a slight drop in volume warns you in ample time. You need never miss a single concert if your set is battery-equipped.

Not only in results, convenience and reliability are "B" batteries unequalled, but they are also unapproached in economy, provided, of course, the correct size batteries are used. That means the Heavy-Duty type for all receivers operating loud speakers, as most do nowadays. Smaller batteries are not as economical, though they give you the quality advantages of Battery Power.

For maximum economy, choose the Eveready Layerbilt "B" Battery No. 486. In every test and trial this has proved conclusively to be the longest-lasting "B" battery ever built. Its unique and

patented construction is responsible for its astonishingly long life. It is, we believe, the most economical, as well as the most satisfactory, convenient and reliable source of "B" current available. Just remember this: Radio is better with *Battery Power*, and the Eveready Layerbilt "B" Battery No. 486 offers you that power most economically.

NATIONAL CARBON CO., Inc.  
New York San Francisco  
*Unit of Union Carbide and Carbon Corporation*

Tuesday night is Eveready Hour Night  
—9 P. M., Eastern Standard Time

WJAF—New York	WGN—Chicago
WJAR—Providence	WOC—Davenport
WEEI—Boston	WCCO—Minneapolis
WTAG—Worcester	WSP—St. Paul
WFI—Philadelphia	KSD—St. Louis
WGR—Buffalo	WRC—Washington
WCAE—Pittsburgh	WGY—Schenectady
WSAI—Cincinnati	WHAS—Louisville
WTAM—Cleveland	WSB—Atlanta
WWJ—Detroit	WSM—Nashville
	WMC—Memphis