

RADIO BROADCAST

FEBRUARY, 1927

WILLIS K. WING, Editor

KEITH HENNEY
Director of the Laboratory

JOHN B. BRENNAN
Technical Editor

Vol. X, No. 4

EDGAR H. FELIX, Contributing Editor

CONTENTS

Cover Design	From a Painting by Fred J. Edgars	
Frontispiece	Radio Now Aids the Mariner	350
Linking Continents With Twenty Kilowatts	Kenneth B. Humphrey	351
The March of Radio	An Editorial Interpretation	356
Why Short Waves Should Not Be Opened to Broadcasting	Bringing Classical Music to the People	
Failures in the Broadcasting Tax System	Radio Fills Empty Church Pews	
The Useless Newspaper Radio Program	How the Cable Companies Look on Radio	
The Courts Aid in Radio Tangle	Bureaucratic Meddling with Broadcasting	
Constructive Work by the Bureau of Standards	Why the Poor Engineer Is Poor	
How They Solve Interference Problems Abroad	The Month in Radio	
Some Experiments on One Meter	Howard E. Rhodes	361
Further Notes on the Inverse Duplex System	David Grimes	365
A Four-Tube "Lab" Receiver	John B. Brennan	368
Looking for Trouble?	Edgar H. Felix	372
The Listeners' Point of View	John Wallace	374
Much Sound and Fury About Radio Education	Broadcast Miscellany	
How a Great Symphony Is Broadcast	What Does the Listener Like in Radio Programs?	
Overlapping of First Rate Program Features Should Be Avoided		
Practical Applications of Some New Equipment	The Laboratory Staff	378
A. C. Operated Amplifier-Power Supply Devices	James Millen	381
Notes on the Shielded Dual-Control Receiver	McMurdo Silver	386
As the Broadcaster Sees It	Carl Dreher	389
The Broadcast Program—Pinnacle of Impermanence	Broadcasting and Shows	
The Broadcaster and the Public	Personal Note by the Author	
The SOS Question Again	Technical Operation of Broadcasting Stations	
	2 Studio Field Change-Overs	
A. C. as a Filament Supply Source	B. F. Miessner	393
RADIO BROADCAST's Laboratory Information Sheets		404
No. 65 The Vacuum Tube Voltmeter	No. 69 Sources of Electrons	
No. 66 A Radio-Frequency Oscillator	No. 70 Soldering	
No. 67 171 Tube Characteristics	No. 71 Push-Pull Amplification	
No. 68 Curves for UX-171 Tube	No. 72 Line Power-Supply Devices	
New Equipment		410
Manufacturers' Booklets Available		412
Radio in Turkey	M. Mazloum	416
A Key to Recent Radio Articles	E. G. Shalkhauser	420
The RADIO BROADCAST Technical Information Service		434
Book Reviews		436
Audio Amplification		
Sam N. Henry. Reviewed by John Wallace		

BEHIND EDITORIAL SCENES

IF WE can judge from the correspondence which has been coming into the office recently, radio folk are at present most interested in what steps are to be taken to clear the air and unravel the present serious broadcast tangle. Almost every letter we receive—and our mail man always has a full load—has something strong to say about the present situation and expresses the hope that something may be done. No one can forecast what will happen in Washington where the legislators meditate suitable legislation, but every reader who wants "something to be done" should write his opinions with a plea for action to his Congressman. The people are the Government and letters to our Washington representatives are the best way to make one's feeling felt. It may be that legislation will be passed even before this magazine reaches the hands of the reader, but at present, that happy event seems but distantly possible. The leading editorial in "The March of Radio," dealing with proposals for widening the broadcast band, is worthy of very careful reading.

THE questionnaire in the "Listeners' Point of View" in the January magazine has provoked a large number of extremely interesting replies and it is reprinted on page 376 of this issue for the benefit of those who did not fill out that printed in the January number. It is not possible to acknowledge and thank every reader who sent us the filled out questionnaire, but we greatly appreciate the fine interest and cooperation of the many who went to considerable trouble to reply. The January listing of many excellent booklets published by various radio concerns has attracted wide interest. An extraordinarily large number of readers have returned the coupon requesting some of the booklets, which are sent without charge. A more complete list is published in this number.

QUOTATIONS from Senatore Marconi's description of his new beams system, contained in Mr. Humphrey's leading article, are printed in detail for the first time in this country. Much of the description, too, has not heretofore been released in the United States.

THE second of David Grimes's excellent descriptions of his improvements on his Inverse Duplex System appears in this issue and his third article appears in the March RADIO BROADCAST. Experiments have been taking place in the Laboratory to improve the four-tube R. B. "Lab" receiver. The changes described in the article beginning on page 368 are not extensive but they are important. This model is one of the finest receivers we have ever used and we welcome correspondence from readers detailing their experience with this set. Edgar Felix's article on page 372, "Looking for Trouble?" should offer great help to the "average radio fan" who is called upon to "shoot trouble" in his own outfit or those of his friends. The information there can also be applied with great profit by radio dealers and others who are called upon to put an ailing set in order.

IN MARCH, the second of James Millen's constructional articles on B-power supply units appears, as does a constructional article on the Grimes receiver, a constructional article on adding power supply to the Hammarlund-Roberts "Hi-Q," and many other articles of wide interest.

—WILLIS K. WING.

Doubleday, Page & Co.
MAGAZINES
COUNTRY LIFE
WORLD'S WORK
GARDEN & HOME BUILDER
RADIO BROADCAST
SHORT STORIES
EDUCATIONAL REVIEW
LE PETIT JOURNAL
EL ECO
FRONTIER STORIES
WEST

Doubleday, Page & Co.
BOOK SHOPS
(Books of all Publishers)
LORD & TAYLOR
PENNSYLVANIA TERMINAL (2 Shops)
GRAND CENTRAL TERMINAL
NEW YORK { 38 WALL ST. and 526 LEXINGTON AVE.
838 MADISON AVE. and 166 WEST 32ND ST.
ST. LOUIS: 223 N. 8TH ST. and 4914 MARYLAND AVE.
KANSAS CITY: 920 GRAND AVE. and 206 W. 47TH ST.
CLEVELAND: HIGBEE CO.
SPRINGFIELD, MASS.: MEEKINS, PACKARD & WHEAT

Doubleday, Page & Co.
OFFICES
GARDEN CITY, N. Y.
NEW YORK: 285 MADISON AVE.
BOSTON: PARK SQUARE BUILDING
CHICAGO: PEOPLES GAS BUILDING
SANTA BARBARA, CAL.
LONDON: WM. HEINEMANN LTD.
TORONTO: OXFORD UNIVERSITY PRESS

Doubleday, Page & Co.
OFFICERS
F. N. DOUBLEDAY, President
A. W. PAGE, Vice-President
NELSON DOUBLEDAY, Vice-President
RUSSELL DOUBLEDAY, Secretary
S. A. EVERITT, Treasurer
JOHN J. HESSIAN, Asst. Treasurer

DOUBLEDAY, PAGE & COMPANY, Garden City, New York

Copyright, 1927, in the United States, Newfoundland, Great Britain, Canada, and other countries by Doubleday, Page & Company. All rights reserved.

TERMS: \$4.00 a year; single copies 35 cents.



more distance on the same set

Want more stations on that storage battery set of yours? Want the far-away ones you get now to come in more easily and regularly? The Radiotron laboratories have developed a *super-detector* that slips right into the socket where you have a Radiotron UX-201-A now. Just change that one to a Radiotron UX-200-A.

It makes your set sensitive to fainter signals—reaches out to farther stations—picks up weaker ones you couldn't get before. It makes a big change for a very small cost!

Bring your storage battery set up-to-date with
a power RADIOTRON UX-171 or UX-112
a detector, RADIOTRON UX-200-A
and RADIOTRONS UX-201-A for all-round quality.

Bring your dry battery set up-to-date with
a power RADIOTRON UX-120
and RADIOTRONS UX-199 for all-round quality.

RADIO CORPORATION OF AMERICA
New York Chicago San Francisco

HEATING METAL INSIDE OF GLASS

EVERYONE knows that glass melts easily, and metal requires a high temperature. Yet, at the Radiotron laboratories, the experimenters can put a Radiotron in the coil of a "high frequency furnace" and melt the metal *inside it* without melting the glass. This is done by an electric current that is induced inside the glass bulb, right through the glass.

This extraordinary furnace is not only used for experiment. In manufacture, every single Radiotron goes for a moment through such a furnace, just after the air has been exhausted out of it. The inside metal is heated red hot in the vacuum, and the tiny air bubbles boil right out of the metal and the glass, and are pumped away. Never before could such an exhaust be obtained.

This means *real performance* when the Radiotron gets into your set. And it adds another reason for insisting on a genuine RCA Radiotron with the RCA mark on the base and the glass. There are Radiotrons for every purpose.



RCA Radiotron

MADE BY THE MAKERS OF THE RADIOLA

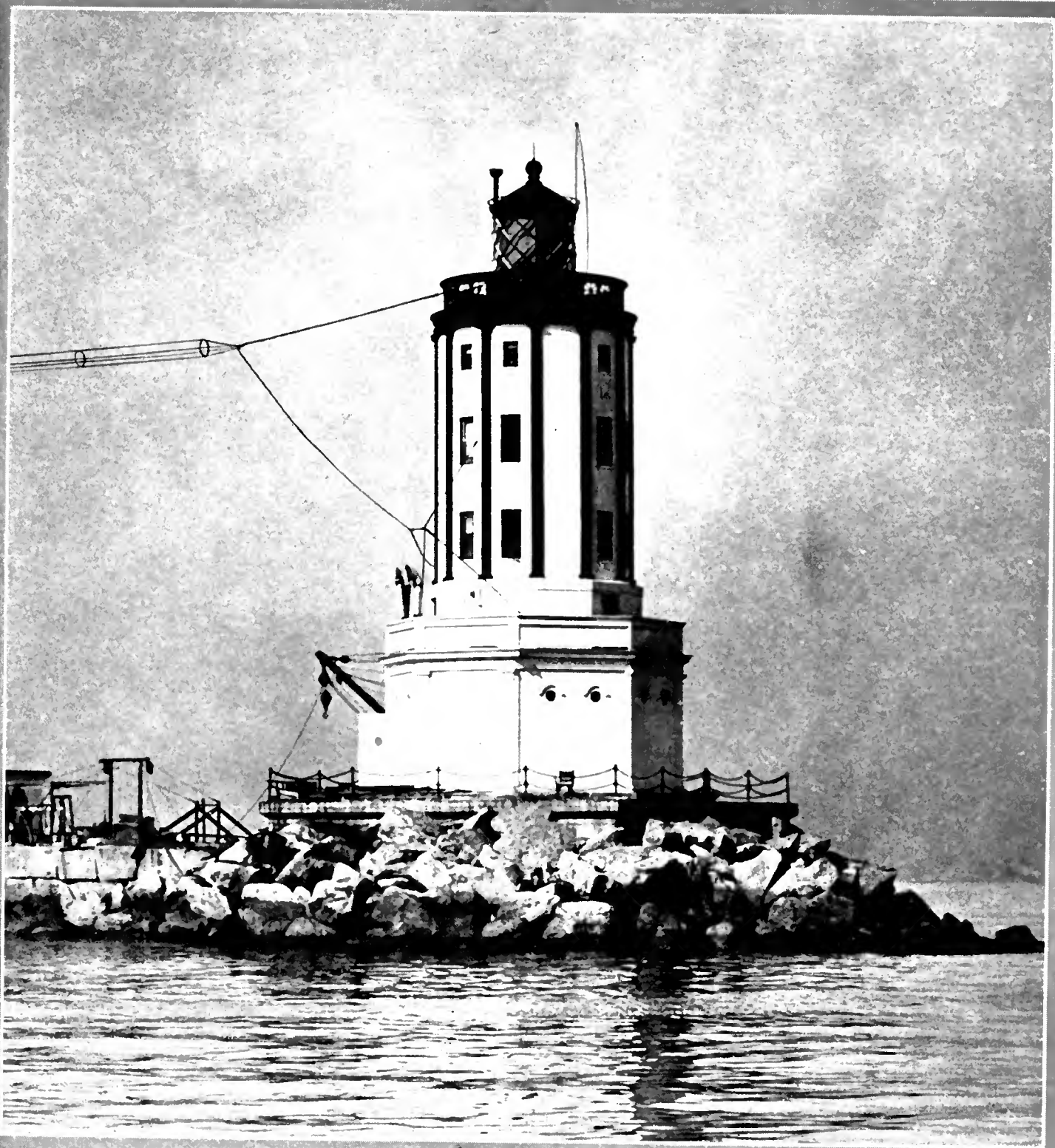

RADIO NOW AIDS THE MARINER

The navigator who peers through thick fog, looking for the beams of a lighthouse no longer has to depend on his sight alone, for the important lights along the coasts have been equipped with automatic radio transmitters which send out predetermined signals, each individual to the location, enabling a ship operator with direction finding equipment to determine his position accurately by radio. This view shows the San Pedro Breakwater Light, just outside the Los Angeles harbor.

RADIO BROADCAST

VOLUME X



NUMBER 4

FEBRUARY, 1927

Linking Continents with Twenty Kilowatts

How Britain Is Linking Up with Her Colonies by Means of the Short-Wave Beam System—New Stations Can Handle Five Times as Much Traffic as Long-Wave Stations and Expense Is Lowered—A Description of a Typical Beam Station and the Principles Involved—What Marconi Thinks of the “Ham’s” Share in Short-Wave Development

By KENNETH B. HUMPHREY

I HAVE always felt,” said Senatore Guglielmo Marconi in the “James Forrest” lecture given before the Institute of Civil Engineers in London recently, “that wireless waves are far too valuable to be continuously scattered and broadcast equally in all directions instead of being concentrated as much as possible on the station with which one desires to communicate.”

“Ten years ago,” he continued, “during the War, I began to consider the possible alternative which might be offered by an exploration of the capabilities for point to point communication of those electric waves which had never yet been used for practical radio telegraphy. I mean waves only a few meters in length, and I was particularly attracted to this line of research because I was well aware that with these waves, and with these waves only, it would be possible to project most of the radiation in a narrow beam in any desired direction, instead of allowing it all to spread in every direction.

“There is no doubt that, generally speaking, radio engineers of four or five years ago thought they knew much more about the subject than we think we know to-day. Laws and formulas were announced and accepted showing which wavelengths were best adapted for various distances, and indicating what amount of power would be necessary in order to be able to communicate any given distance. Unfortunately,

it soon became apparent that the logical application of these laws and formulas brought us to the necessity of employing, for long-distance transmission, such enormous and expensive antenna systems, and

such large amounts of power as to make the method so costly in capital expenditure and operation, that only a very small margin of profit would remain when the system was worked in competition with modern cables and land lines.”

As long ago as 1913 efforts were made to design long-wave stations which could be used for long-distance communication. It was not until 1923, however, that the British Government finally decided definitely to proceed with a plan of linking up the Dominions with the mother country by means of wireless telegraph stations. The Dominions had been asking for such a service for many years, and when the decision was finally reached by the British Government, the Dominion governments immediately made arrangements for the construction of corresponding stations in their own territories to complete the service. Even while negotiations were under way to provide long-wave stations, Senatore Marconi became convinced, as a result of his experiments, that a new system could be developed which would prove to be better both from a standpoint of effectiveness and cost.

Some courage was necessary to propose a system which might easily revolutionize the whole art of long-distance communication. This too, it must be remembered, at a period when larger and larger long-wave stations were being erected in America and at other points, such as the Lafayette station at Bordeaux,

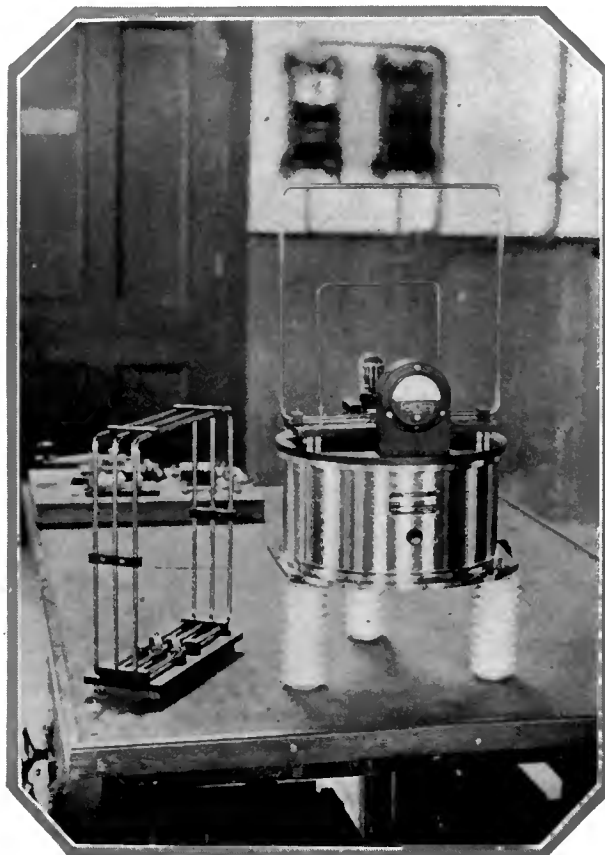

A SHORT-WAVE WAVEMETER

This particular instrument is utilized to keep check on the Bodmin short-wave beam station

France, the station at Nauen, Germany, and others. But in spite of the opinion against him, Senatore Marconi was able to convince the British Government and the Dominions that the beam system of short-wave telegraphy was entirely practical. The early predictions of Marconi have been justified, and the Government has officially accepted the first link in the chain between England and Canada after a rigid seven days' test.

To get some definite conception of what the inauguration of the new beam system will mean, consider the great long-wave stations which have recently been completed, and which may eventually have to give way to the new competitor. Commercial long-distance radio communication has been accomplished previously by stations employing frequencies from 37.48 up to 9.99 kilocycles (8000 to 30,000 meters), and using several hundreds of kilowatts in power at the transmitting station.

One of the latest and largest of these long-wave stations in the United States is located at Rocky Point, Long Island, and is operated by the Radio Corporation of America. Twelve antennas are used to communicate with various points in the world. Each antenna is supported on twelve 440-foot steel towers, and the length of each antenna is in the neighborhood of three miles. From 200 to 400 kilowatts of power are used, and transmission is carried on at two frequencies, 17.15 and 18.22 kilocycles (17,500 and 16,465 meters).

The British Post Office wireless station at Rugby (England) has an antenna 800 feet high supported on 12 masts, and uses about 500 kilowatts of power. The frequency used in transmission is 21.3 kilocycles (14,080 meters).

Buenos Aires, in the Argentine, has an antenna about 680 feet high supported on ten towers, and uses about 800 kilowatts of power. The station normally works on a frequency of from 18.7 to 24.9 kilocycles (16,000 to 12,000 meters). Many other similar stations are operating in Germany, France, Italy, and other countries.

Contrast the above stations with the modern short-wave beam station having five masts 277 feet in height and using a power of only 20 kilowatts, and a transmitting frequency of 11,500 kilocycles (26.09 meters).

Senatore Marconi said that the *average* speed obtained by the long-wave stations was 20 words a minute for a daily average of 18 hours. The beam stations, during the official tests, averaged at least 100 words a minute for 18 hours a day.

The average 20-word speed of the long-wave stations referred to above, is consider-

ably less than maximum speed, which is said to be 100 words a minute. The maximum workable speed for ordinary telegraphic work on the new "Permalloy" cables is said to be about 500 words a minute. During the tests of the new beam station, a speed of 250 words a minute was maintained for several hours at a time without difficulty.

ADVANTAGES OF THE BEAM SYSTEM

THERE are several distinct advantages in using the short-wave beam system over the long-wave system for point to point communication over long distances:

1. The cost of equipment is less.
2. It is more economical to operate and maintain.
3. The speed is greater.

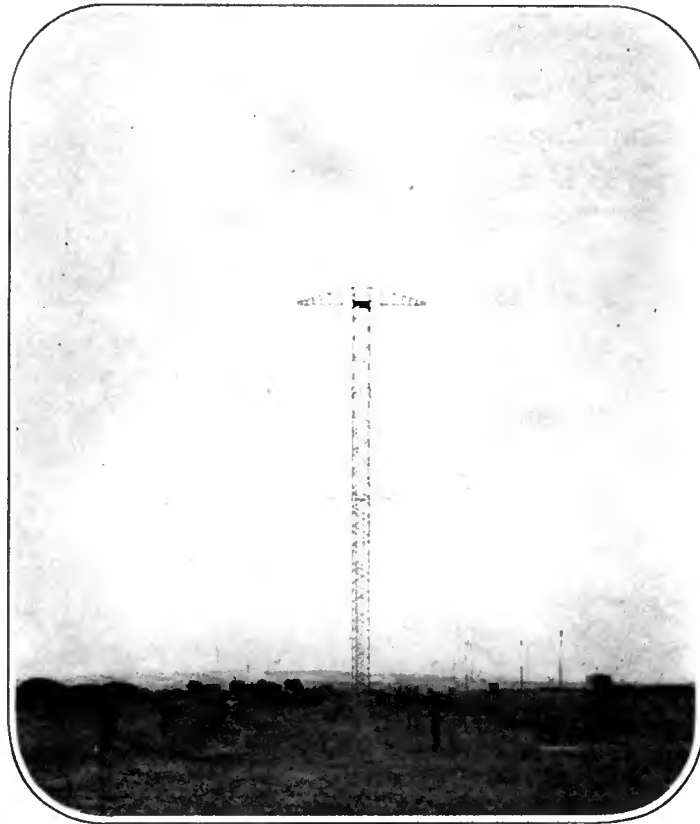

AT THE BODMIN BEAM STATION

The antenna system for the transmission of directional signals to Canada is here shown. There are five masts, providing four spans of horizontal supporting wires from which the vertical antenna and reflector wires are dropped. Canada, looking at this picture, is "way over" to the right, hence the reflector wires are at the left. The antenna coupling boxes, one for each pair of antenna wires, are shown in the picture, as also is a part of the copper-tubing feeder system

Concentrating the radio waves in a beam instead of allowing them to wander to every point on the earth makes it possible to use only 20 kilowatts of power instead of 200 kw. or more (as in long-wave telegraphy). In spite of using less power at the transmitting station, more power is received at the receiving station, and that is the goal that all radio engineers strive for.

Economical operation and maintenance costs are in direct proportion to the amount of power used and the size of the antenna, both of which are less in beam transmission

than for long-wave stations giving the same kind of service.

Another advantage is that the speed in signalling is increased, due to the utilization of short waves. The larger antenna takes an appreciable time to charge and discharge while the smaller antenna takes much less time.

Short waves alone, however, would not accomplish the desired result as far as speed is concerned. It is by the use of reflectors at both sending and receiving ends that the signal is stepped up about a hundred times over that which would be possible with ordinary non-directional sending and receiving. The wave is projected out in a narrow beam and is caught at the receiving station by a similar reflector, and concentrated on the receiving antenna.

It may be calculated, that, to obtain a signal strength of a hundred times that of another signal, the power required would be ten thousand times as large. Considering the ordinary method of signalling without reflectors, the power applied would have to be 20,000 kilowatts instead of the 20 kilowatts actually used in the beam system!

Atmospherics, which have always limited high speed radio sending, do not exist as a serious factor in the new system. Fading is reported to be considerably less in the directional system than in the non-directional system. True, there is still some fading, but because of the increased signal strength, the margin of reliability is increased. During the test week there were only two bad periods where fading was enough to hamper the service. These were during the appearance of very large sun spots, and during an intense display of the aurora borealis in Canada. No interference was experienced on the long waves, but the cables and land lines were seriously affected. It was also noticed that, by changing the wavelength slightly, a path could be found which was practically free from interference.

In the first beam experiments carried out in Italy and in England, the reflectors consisted of

a number of vertical wires parallel to the antenna and spaced around it on a parabolic curve of which the transmitting or receiving antenna constituted the focal line, but in the more modern stations an arrangement devised and patented by Mr. C. S. Franklin has been more advantageously employed.

In this arrangement, the antenna and the reflector wires are disposed so as to constitute grids parallel to each other, the antenna wires being energized simultaneously from the transmitter at a number of feeding-points, through a special feeding-

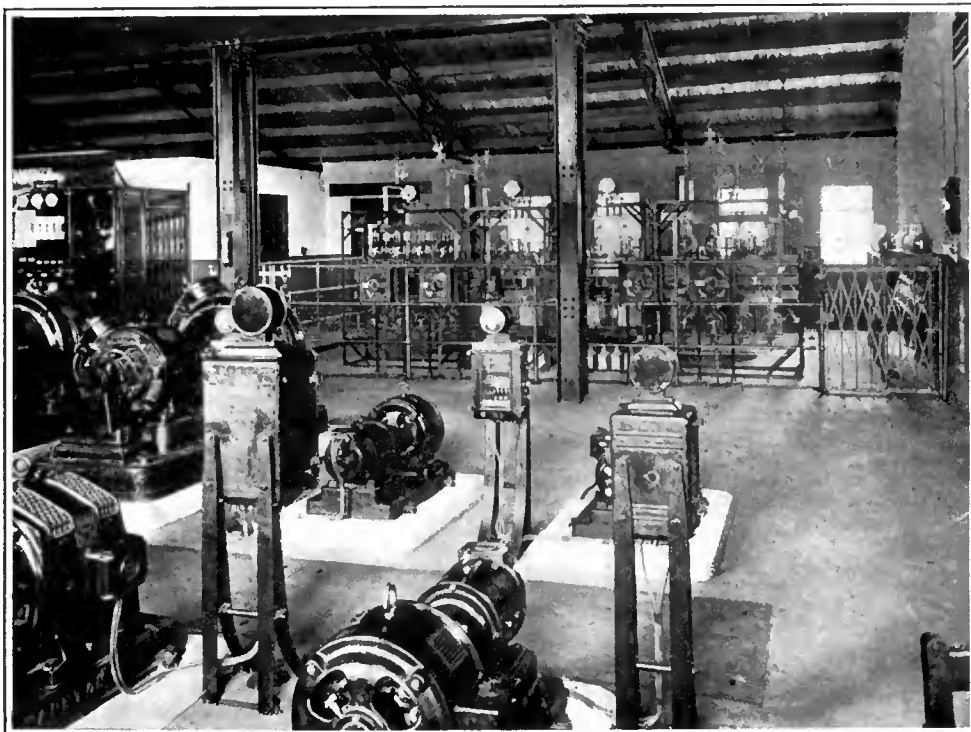

THE MACHINERY HALL IN THE BODMIN STATION

Built by the Marconi Company for the British General Post Office. In the background may be seen the rectifying panels for the Canadian and South African transmitters

system, so as to insure that the phase of the oscillations in all the wires is the same. It has been proved by calculations, and confirmed by experiments, that the directional effect of such an arrangement is a function of its dimensions relative to the wavelengths utilized.

A similar system of antennas and reflecting wires is used at the receiving stations.

THE BEAM ANTENNA SYSTEM

IN A typical short-wave beam station, the Bodmin station, for example, there are five steel lattice masts, each 277 feet high, erected in a straight line at right angles to a line passing through both sending and receiving station. These five masts provide four spans of wire (one between each pair of masts) the sole purpose of which is to support the vertical antenna and reflecting wires. Except as supports, the horizontal spans serve no useful purpose in the actual transmission. At each station there are two distinct transmitters for each point it is intended to communicate with, operating on different frequencies, but whether the second one is to be used as a standby or as a supplementary channel has not as yet been definitely decided. Of the two transmitters, one operates on 11,500 kc. (26.09 meters), while the second will operate on a slightly higher frequency.

Cross-arms at the top of the masts extend for forty-five feet on either side of the vertical, forming a support for the horizontal sustaining wires. For the 11,500-kc. band, there are thirty-two vertical antenna wires, grouped in fours, in a parallel row with which are the reflector wires. There are twice as many reflector wires as antenna wires. The horizontal wire spans between the first second and third masts (two spans)

support the antenna-reflector system for the 11,500-kc. transmitter.

Each of the reflector wires is divided into five complete sections by means of insulators. The reflector wires are placed on that side of the actual antenna wires which is remote from the distant receiving station. Counterweights are attached to the lower ends of both antenna and reflector wires, the object of these being to keep an equal tension on each wire irrespective of changes in wind pressure.

The system of wires which constitutes the connecting link between the transmitter and the antenna is known as the "feeder system." This system consists of two concentric copper tubes, air insulated from each other to avoid loss. The outer tube is grounded and carried on metal standards a short distance above the ground, while the inner tube carries the current to the antenna. In order to insure an equal amount of current for each of the separate antenna wires, the feeder system is arranged so that the distance which the current has to travel through the feeders is exactly the same for each individual wire in the entire antenna system. In order to prevent the presence of reflected waves in the feeder system, which would cause trouble, equalization may be obtained by means of coupling transformers located at each junction box. A check against any reflected wave in the feeder system is provided by three high-frequency thermo-ammeters wired at three different points 32 feet apart. Actually the three meters are located at one point for ease in reading. With no reflected waves in the system, the meters will all register alike.

Each antenna coupling box is grounded by means of metal plates three feet square, arranged in a circle of 50 feet in diameter. This is for the short-wave antenna. For the long-wave antenna the diameter of the circle is 100 feet. Each transmitter is grounded near the building with a galvanized iron plate six feet by three feet connected to a copper tray placed under the transmitter proper by means of heavy copper bars. All masts and guy wires are grounded, as is the support for the feeder system.

The transmitting apparatus follows closely that used in standard practice.



RECEIVING EQUIPMENT AT THE BRIDGEWATER STATION

There are two distinct receivers shown here. That on the left is for South African signals while the right-hand one is for Canadian signals. As two wavelengths may be used for each transmitting station, each receiver may be tuned to receive either of the two wavelengths

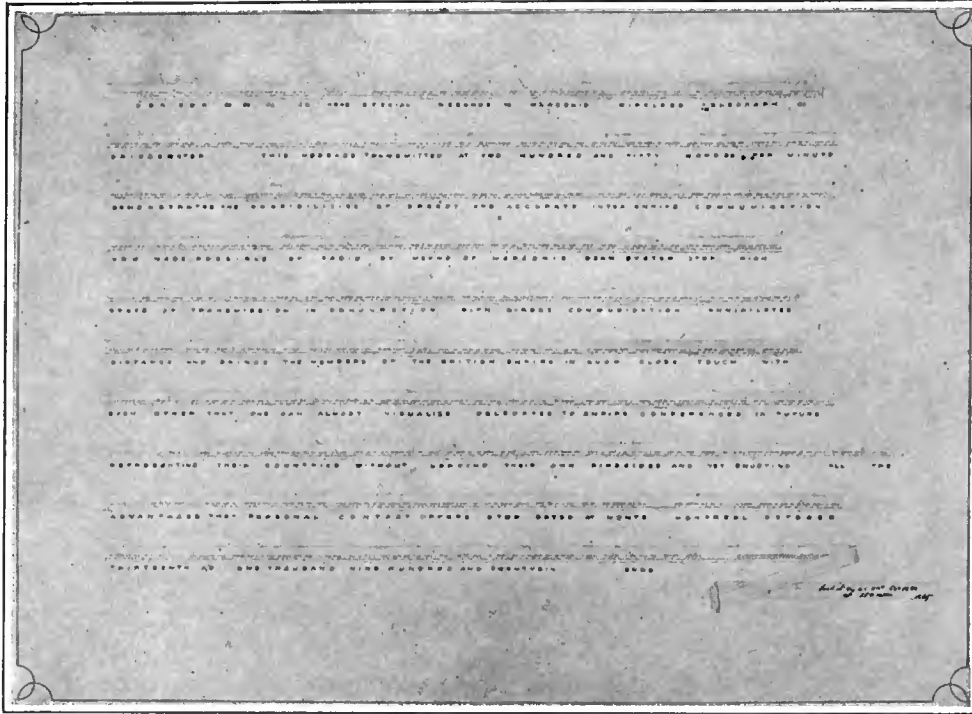

A MESSAGE SENT AT 250 WORDS PER MINUTE

This is an actual record of a message received at a speed of 250 words per minute during official tests of the beam wireless circuit between England and Canada

Many parts, however, had to be designed especially for the work in hand. Vacuum tubes are used throughout for generating the high frequency current. The main power oscillators are cooled by means of oil and are designed particularly to reduce tube capacity and resistance losses. A master oscillator tube is provided which determines the frequency or wavelength at which the main transmitter tubes will oscillate. The voltage used on the tubes has an approximate range of from 8000 to 10,000 volts, which is supplied by special rectifier tubes.

The method used in keying, or interrupting the circuit in order to transmit the dots and dashes of the signals, is of interest. When a signal is being sent, the high frequency current is allowed to go out into the antenna, while, when no signal is being sent, the power is absorbed by an equivalent load made up of resistances placed in a small house near

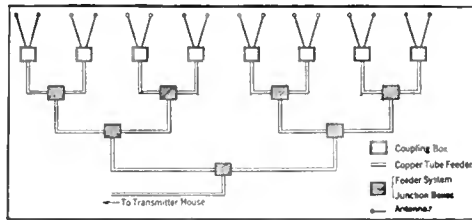

THE FEEDER SYSTEM

This may be studied in conjunction with the pictures on page 352 and at the foot of this page. The antenna wires are taken in pairs to the coupling boxes and thence to the copper-tubing feeder system. The distance from the transmitter to each antenna wire is the same

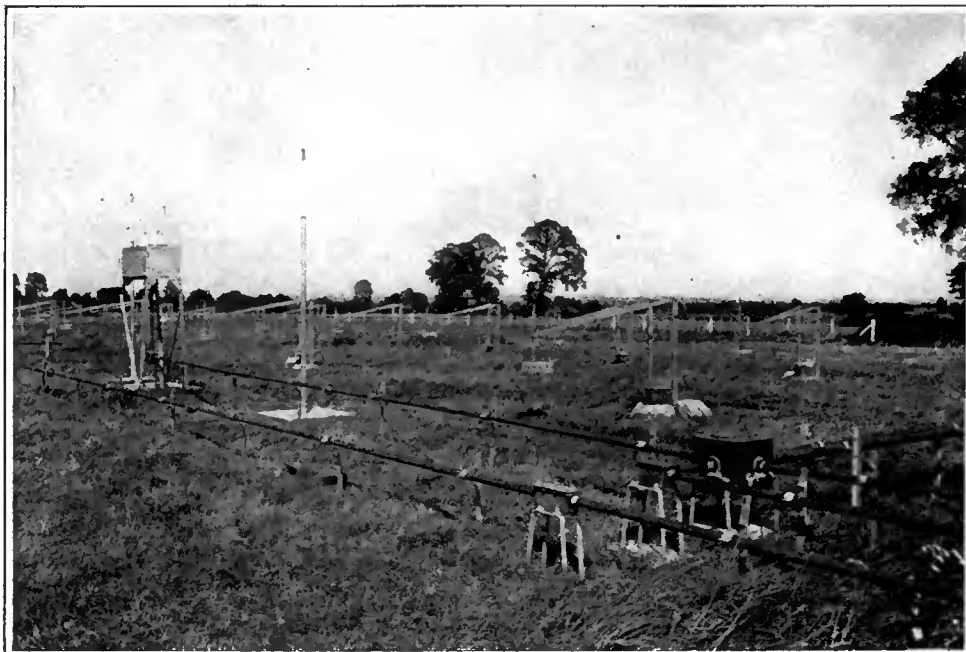

THE FEEDER AND COUNTERWEIGHT SYSTEMS

The copper tubing which constitutes the line between the transmitter and the antenna system, together with one of the junction boxes, is shown in this picture. To the left may be seen one of the antenna coupling boxes to which two of the antenna down leads are taken. The weird wooden structures, which in windy weather are apt to cultivate bobbing propensities, and which may be seen dotted about the field, are the automatic counterweights which provide a certain amount of slack to the antennas when necessary

the transmitter. This makes it possible to keep the load on the transmitting tubes the same at all times.

The absorption system is controlled by means of vacuum tubes the grids of which are thrown positive or negative by the keying relay through other amplifying tubes.

By using vacuum tubes in place of mechanical relays it is possible to speed up the system to a remarkable degree. Only one small mechanical relay is used to tie up the land line with the transmitter.

Everyone who has followed radio to any extent in the last few years knows something about the super-heterodyne system of receiving signals. The English engineers use this idea in a new way. It will be remembered that the super-heterodyne changes over the incoming signal from a short wavelength (high frequency) to a longer wavelength (low frequency) in order that it may be more easily amplified. It is again detected and operates an audio amplifier.

This system is extended for use in the receivers at the beam stations by using two heterodyning systems, or what is practically the equivalent of two super-heterodynes in series. The signal is collected on the antenna, which, being of the reflector type gives a signal of considerable strength, and is fed to the first detector through a very loosely coupled tuned unit. The loose coupling is resorted to in order to cut out interference and reduce the pickup of static and other noises. This first detector is coupled with an oscillator which changes the short wave of 26 meters (11,538 kc.) over to a wavelength of about 1600 meters (187 kc.). The signal then goes through a three-stage amplifier at this frequency and is again detected. At this point another heterodyne

oscillator is provided and the wavelength changed from 1600 meters to 10,000 meters (30 kc.). Again it is amplified through three stages and again detected. This second heterodyne may be tuned to an audible note so that the operator may listen-in and tune the signals as received through the first part of the receiver. The output of the receiver operates a high-speed relay which in turn operates the recording mechanism. Each stage of amplification is of the push-pull type in order to provide distortionless amplification throughout. The output works through a bridge system which insures

that the signal strength is practically the same no matter what the strength of the incoming signal.

MARCONI PRAISES "HAMS'" EFFORTS

IN THE course of his address on the beam system, Senatore Marconi made some interesting remarks relative to the value of the amateurs' share in short-wave development. "The results obtained by amateurs in the field of short-wave endeavor do great credit to them," he said, "especially if we consider that most amateurs possess only limited facilities for experimental work. It should not be forgotten that amateurs were the first to carry out two-way communication with New Zealand for brief periods. Their observations have often been of value in helping us to arrive at a somewhat better understanding of the very complex phenomena involved, but I think it is sometimes dangerous to attach too much importance to all their observations, especially when they concern what I might term 'negative results.' Only the other day I read a statement by an eminent authority that, according to amateurs' observations, the daylight range of a 100-meter (2998-kc.) wave did not exceed 200 miles, and for a 50-meter (5996-kc.) wave 100 miles. I have carried out tests on a 100-meter wavelength for months on end and have never found its daylight range to be below 1000 miles. With a 47-meter (6379-kc.) wave, which is close to 50 meters, we have never observed any skip distance commencing at 100 miles or at anything like so short a distance. It may well be that some of the observers were not particularly skilled, or were using insensitive receivers or that their stations happened to be situated near buildings or structures which unfavorably affected receiving. I therefore think it would be unfortunate if, in consequence of some reports, the theory of skip-distances should become unduly generalized and extended.

"I have found that, for reliable observations and deductions in regard to the behavior of transmissions over varying distances, there is nothing so good as a receiving station installed on a suitable ship."

LOCATION OF THE BEAM STATIONS

THE beam transmitting station in Canada is situated at Drummondville, 30 miles east of Montreal, and the receiving station at Yamachiche, 25 miles north of Drummondville. These stations are linked up by land line to the central office of the Canadian Marconi Company in Montreal in the same way that the English stations are linked to the General Post Office, in London. Beam stations are also being erected in Canada for direct communication with Australia, and corresponding beam stations are being built at Melbourne.

The sites occupied by the beam stations at Bodmin and Bridgwater in England, for communication with Canada, are also utilized for the stations to be used for communication with South Africa. These South African stations are practically com-

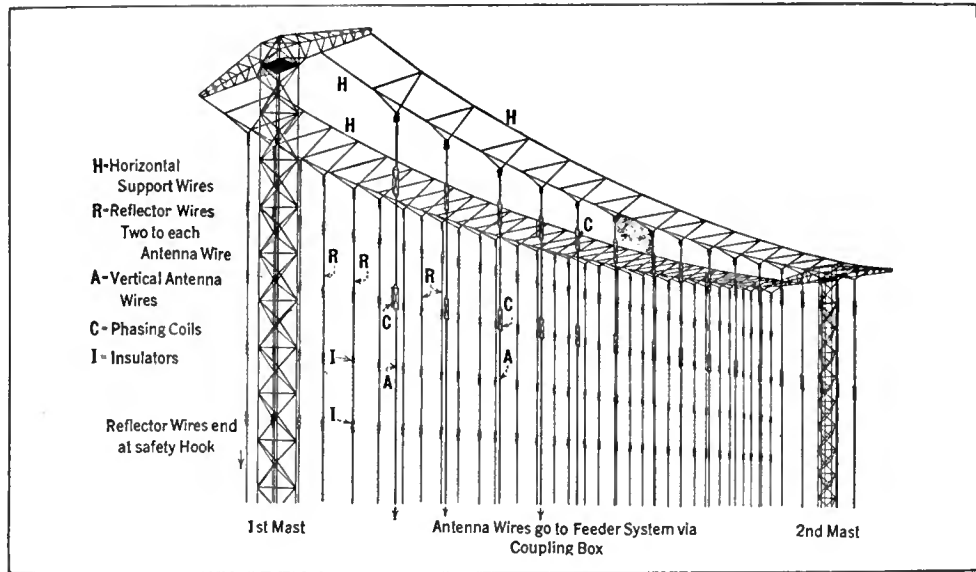

THE BEAM ANTENNA SYSTEM

Showing the position of the antenna and reflector wires in relation to each other. The relative location of the insulators, phasing coils, supporting wires, and towers are also shown. There are sixteen antenna wires and thirty-two reflector wires to each span

plete. Similar stations are being built in England at Tetney, near Grimsby, and at Winthorpe, near Skegness, for communication with Australia and India—the Grimsby stations being transmitting stations and the Skegness stations receiving stations. Corresponding stations are being built in the Dominions near Cape Town, Melbourne, and Bombay. All these stations are in an advanced state of construction, and are expected to be opened within the next few months. This will complete the present Imperial Scheme; but outside of this scheme, the Marconi Company is already engaged

on a considerable development of commercial telegraph services on the beam principle. The Company holds a license from the Post Office to conduct wireless telegraph services with certain continental countries and with all other foreign countries outside Europe. In addition to the wireless stations the Company has been operating on these services for some years, it has a beam station nearly completed at Dorchester for communication with North and South America. A corresponding station is also in process of erection at Rio de Janeiro.

Another important development in which beam stations are included—and these are already under construction—is the Portuguese scheme for linking up Portugal and its colonies. Some time ago the Marconi Company obtained a concession from the Portuguese Government for the establishment of wireless telegraph stations in Portugal and its colonies for the purpose of linking them together and establishing wireless communication with other parts of the world. These stations are now being built in Lisbon, in the Cape Verde Islands, in the Azores, and in East and West Africa. When they are completed, wireless services will be established with England, with the principal continental countries, and with South America.

The beam system is not by any means limited to wireless telegraphy, according to Senatore Marconi. He feels confident that it can be utilized for placing wireless telephony on a much more practical basis than it is on at present, besides helping the systems of picture and facsimile transmission, not to speak of television.

Even for broadcasting he believes it will result in enabling programs and speeches to be transmitted to large portions of the United States, Canada, South Africa, and Australia with much greater strength and accuracy than it is possible to obtain by means of the existing broadcasting systems.

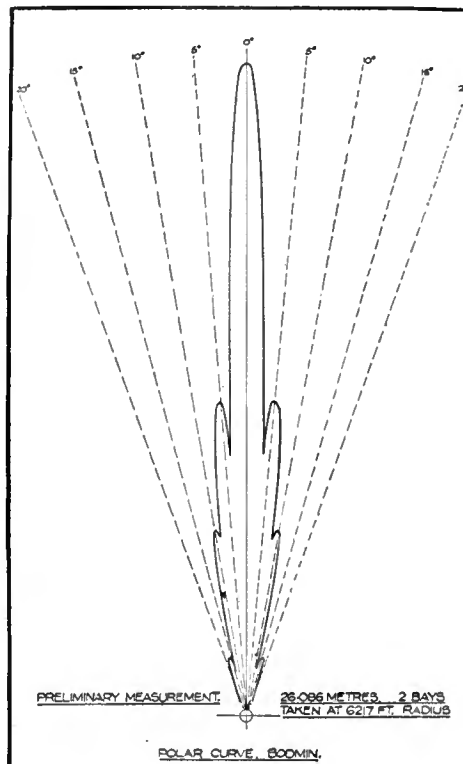

A POLAR CURVE OF A RADIO BEAM Showing how the radio wave travels out from the station in a beam instead of being broadcast in all directions



THE MARCH OF RADIO

News and Interpretation of Current Radio Events

Why Short Waves Should Not Be Opened to Broadcasting

VARIOUS proposals are being brought forward to accommodate the excess broadcasters who insist on infesting the ether with their unnecessary emanations. These are offered principally by pacifists seeking to mollify rejected wavelength-seekers, rather than by those who have the good of broadcasting and the development of radio at heart.

The most tempting and, to the uninformed, the most logical course is to open the higher frequencies, below our present broadcasting wavelengths, to accommodate a host of additional broadcasters. The amateurs have been able defenders of this wavelength territory and, in this respect, they have been highly useful conservers of wavelength space. Were there any real need for additional broadcasters, it is doubtful whether the amateurs and others assigned to short-wave bands, could retain possession of the extensive frequency territory which they now occupy.

The broadcast listener is the principal sufferer if the wavelength territory is extended. To him it means that his present day radio receiver will no longer give him the entire range of programs. To

accommodate an enlarged band, receiving sets must be equipped with tapped inductances and switches making them so complicated and inefficient that only the technically inclined enjoy their use.

In Great Britain, where broadcasting stations have been spread over a wide range of frequencies, receiving sets are either incapable of tuning to all of them or the listener must fuss with a comprehensive lay-out of plug-in coils. Tuning to stations requires reference to a number of charts. Neutralizing such receivers over the entire range is out of the question without a considerable sacrifice in amplification. So discouraging is the tuning process under these conditions that British manufacturers have found it profitable to market receiving sets to disgusted non-technically inclined listeners, adjusted to the wavelength of only one particular station. If stations of any account begin radiating programs on the higher frequencies, the broadcast listener will have excellent reason to complain. Either he must deny himself the pleasure of listening to them or substitute for his simple receiver one of annoying complexity.

The broadcasting station operating on these higher frequencies will not find itself pleasantly situated either. Short-wave programs are subject to a surprising amount of

fading which, varying at different hours of the day and night, will cause him no end of complaint. Heterodyning, by reason of the vagaries of short waves, is not limited to the usual ranges by power, because a short-wave, low power station, hard to pick up at a distance of 25 miles, may be a powerful source of interference at distances of 1000 to 5000 miles.

More important than the consideration of the listener and the broadcaster is the importance of conserving radio frequencies for essential services. The higher frequencies are best adapted to point-to-point communication because little power carries great distances. The higher frequencies alone are adapted to beam transmission and high-speed automatic communication. The transmission of photographs and motion pictures, the coming of which is as certain as commercial aviation, will be seriously handicapped if the numerous Podunk Radio Companies of Four Corners, seeking wavelengths, have their way.

When one examines the list of applicants desiring to broadcast and realizes the remoteness of any chance that they will contribute to the good of broadcasting, one hopes that a way will be found to disregard their clamorings utterly. Recently, we saw an item in an Iowa newspaper which announced that no less than eight

The illustration forming the heading shows the lonely post of Clifford York, fire ranger, atop a 6400-foot mountain in the California National Forest. A radio receiver helps while away the hours of this ranger's lonely watch

new members had joined a local radio club and, encouraged by this substantial increase of membership and evidence of interest, they decided at once to proceed with the erection of a broadcasting station. Moving picture theatres, hotels, radio stores, automobile agencies and ambitious amateurs comprise a large part of the wavelength seekers. Municipalities and religious organizations which ought to know better, have hardly been in the minority when it comes to vandalistic wavelength-jumping and ruination of reception. The character of the applicants for space on the ether is exposed by the ruthlessness with which the meagre allotment of six exclusive wavelengths to our Canadian neighbors was usurped. There is no greater disgrace in the annals of broadcasting than this wanton and ungentlemanly action on the part of stations which have deliberately ruined broadcast reception in Canada. A total of 57 American stations have seized Canadian wavelengths, including WHT, WNAC, WHAP, KSO, WJAZ, WWAE, KFCW, KWDH, KSBA, KTLD, KMMJ, KGDY, KFKB, and KFXE.

There are ample broadcasting facilities for all, if sympathetic interests will combine in the operation of stations, but, if each must use his own station, the future needs of commercial aviation, of short-wave rebroadcasting links, of high speed point-to-point communication, of emergency railroad service and a score of other useful services are menaced by this insistent rabble of the ether.

Why should we accommodate more stations? Simply as a sop to those who must be excluded from the present broadcasting band if there is to be an end to radio chaos. It is an economic waste. If those who apply for stations do not have prospect of an appreciable following, they certainly should not be licensed. If they do, it reduces the audience of existing broadcasting stations. That means less value to their microphones and, in consequence, less attractiveness to better artists and features—in other words, lowered program values. It is hard to see who gains by the insane mania which some people seem to possess to stir up the ether through their own private microphone.

Conserving of radio frequencies is a problem calling for the same foresight as the conservation of forests and the judicious planning of our public highways and railroad grants. Divesting one established on a frequency thoughtlessly assigned today, will be as difficult a generation from now as it would be for the government to regain former public lands, occupied for twenty years by thriving farms, villages, and cities. Many rail at

the lack of foresight of our fathers because of their failure to plan cities, highways and railroads while rights of way were purchasable at low figures. Today we cut up the only remaining airplane landing fields near large cities into real estate developments and we give away broadcast radio frequencies for which there will ultimately be a crying need to promote the safety of aerial travelers and to extend worldwide communication.

Gentlemen, have mercy on your grandchildren!



A GERMAN POLICE MOTORCYCLE, RADIO EQUIPPED

A complete outfit is installed in the armored car at the left, so that the unit may be at all times in communication with headquarters. If any shooting starts, things must be a bit difficult for the unprotected driver

In Great Britain, there are 2,105,000 licensees, but whether listeners are wholly satisfied with their much vaunted broadcasting system is indicated by another item in the same publication:

The British Broadcasting Company carries on remarkably, but many promises and long overdue improvements, such as high power stations and alternative programs, are held up, among other reasons, because of lack of funds.

In view of the fact that of the £2,227,000 received by the Post Office in license fees for the three years ending March 31, 1926, only £1,166,000 has been handed over to the B. B. C., the Wireless Retailers' Association has instituted a campaign to recover the bulk of the balance for the purpose for which it was subscribed.

After outlining the activities of the Wireless Retailers' Association in stimulating the Postmaster General, the article continues: "The Wireless Retailers' Association's activities are far from finished in this connection and dealers throughout the country will undoubtedly do all they can in this endeavor to secure better broadcasting."

A well known New Yorker, a zealous radio follower, is quoted anonymously in the *Times* as follows: "What makes British radio rather dull for an American is the heavy official way in which they run it. Parliament is constantly talking about and laying down rules for it. Every set owner pays a license fee and the really huge sum thus raised does not appear to go back into broadcasting. The general impression one gains is that the government is everything, individual initiative nothing—in radio."

The Useless Newspaper Radio Program

Failures in the Broadcasting Tax System

THOSE who dislike commercial broadcasting in principle always suggest, if they have any constructive idea, the establishment of a taxation system to support broadcasting. The experience of South Africa, as described in *Broadcaster and Wireless Retailer*, a leading British trade publication, is enlightening. In the prosperous South African province, two stations have been given a monopoly, one at Johannesburg and one at Durban, the former now showing a deficit of over \$25,000 and the latter about \$35,000. The magazine complains that there are 20,000 "pirates" in Johannesburg who do not pay their broadcasting fee and incidentally points out that the cost of collecting the \$50,000 revenue from listeners was more than \$2500. The annual license fee is about \$10.50.

EXTENDING still further their policy of disregarding the interests of their radio readers, newspapers are now publishing the radio programs in a manner which makes them totally useless. By leaving out the specific names of commercial features and substituting some asinine generality such as "musical feature" or "entertainers" they have destroyed the news value of the only part of their radio sections which commands general interest. This is done on the ground that commercial features should not be given free publicity, but its only effect has been to make the ambiguous program listings a waste of space.

Perhaps the astute newspaper publishers will discover that their news columns give free publicity on a much larger scale than do the radio programs. Headlines will read, "Famous automobile manufacturer reduces prices," instead of "Ford prices drop," and all news will studiously avoid

mentioning the names of persons and companies engaged in profitable pursuits. Reader interest will of course be greatly enhanced because these readers fall for puzzles so enthusiastically!

Why not cut out the radio programs altogether? Nobody would miss the present-day conundrums anyway.

The Courts Aid in the Radio Tangle

VARIOUS court decisions, recently granted and about to be granted uphold the priority rights to wavelengths. Chicago, where every conceivable broadcasting shortsightedness has been permitted, on an extensive scale, is also in consequence, the most fruitful source of experience and precedents. WJAZ, which precipitated the present broadcasting tangle almost singlehanded, by upsetting the Department of Commerce's regulatory power and which also was the first to disregard the gentleman's agreement with

Canada, is a Chicago station. WGN, a Chicago station, won the first court decision against WGES, establishing legally the priority to an established wavelength. Although won in a court of limited jurisdiction, it establishes a most acceptable precedent. When this decision was announced, WHN retained John F. Hylan, who, it may be remembered, was once mayor of New York, to hail WRNY into court for planting a steady whistle on its programs. By the time this appears in print, there will probably be many other broadcasting suits under way.

Chicago has the doubtful distinction of having the largest number of broadcasting stations of any area, as any long distance fan will testify who almost invariably finds as many Chicago stations operating at a late hour as in the rest of the country put together. A

manifestation of intelligence in Chicago broadcasting circles is both a surprise and a relief. The merger of WEBH and WJJD in the presentation of programs under the direction of the *Chicago Herald and Examiner* may lead to the elimination of one of these two duplicate equipments, a move which will be distinctive in that it is one in the right direction.

Constructive Work by the Bureau of Standards

IN HIS annual report to the Secretary of Commerce, George K. Burgess, Director of the Bureau of Standards, briefly summarizes the comprehensive

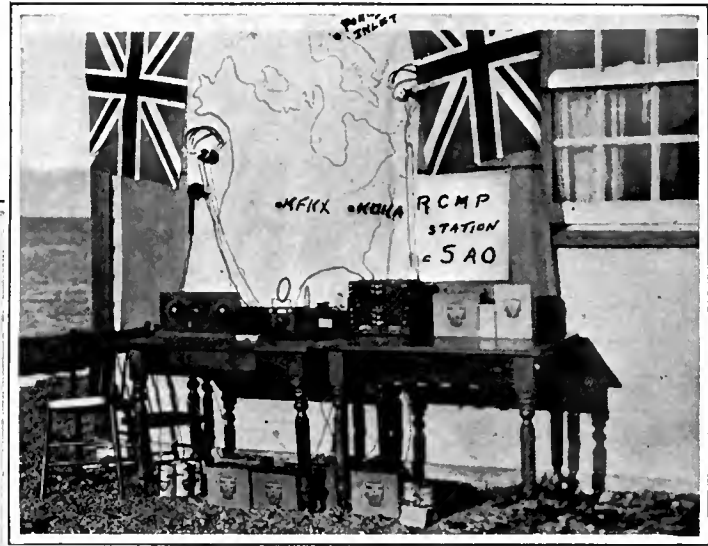

CANADIAN MOUNTED POLICE STATION, POND'S INLET

This station, in northern Baffinland, is one of the "farthest north" radio stations. The call letters are C-5 AO, 7596 kc. (40 meters), and the outfit is operated by Constable Tinsbury, R.C.M.P. The sending set was designed by Robert Foster, former operator aboard the Canadian *C. G. S. Arctic* and the receiver was presented by George C. Wendt of Montreal. Pond's Inlet is five degrees above the Arctic Circle and enjoys four months of perpetual darkness. Those who hear this station should report the fact to Mr. Wendt, P. O. Box 390, Montreal, P. Q.

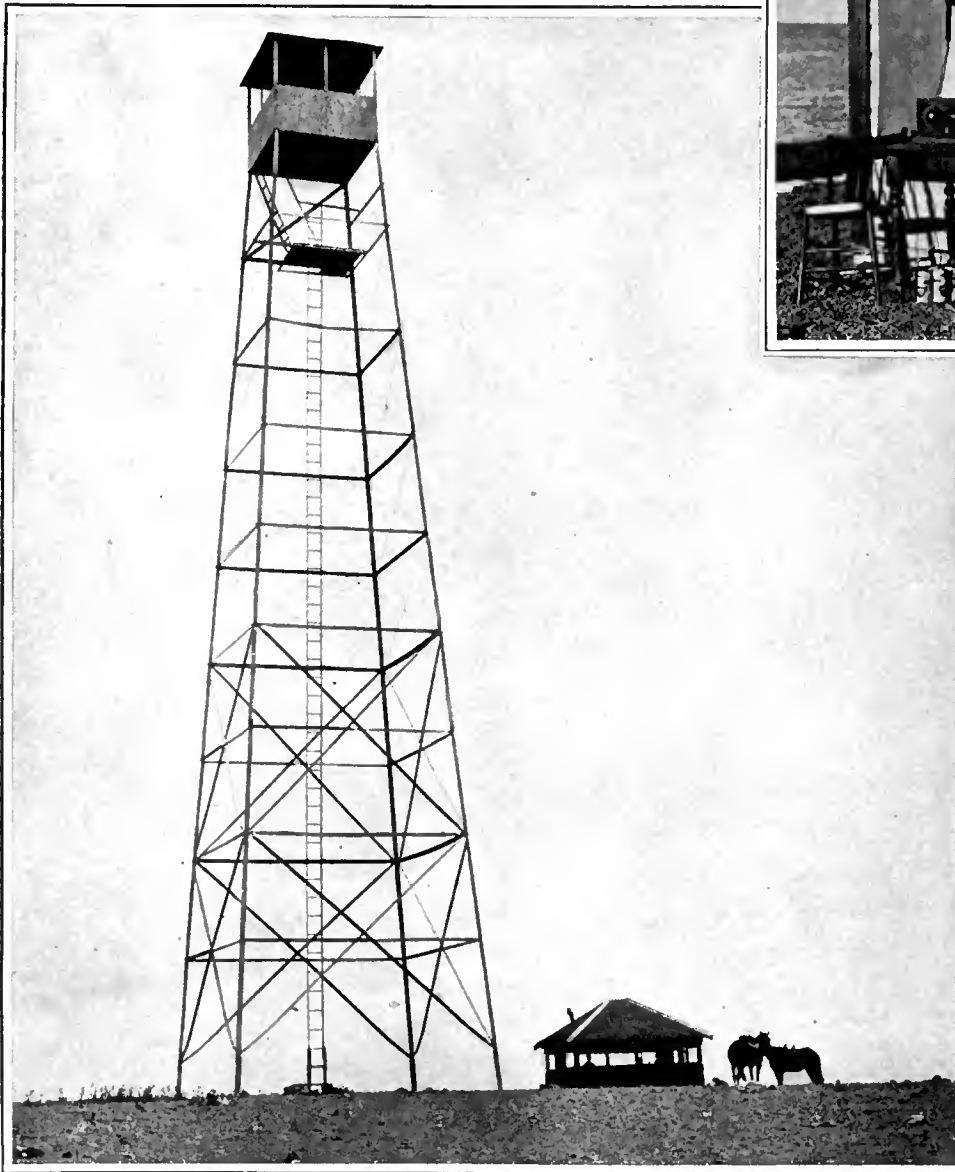

THE LOOKOUT TOWER ON SHEET IRON MOUNTAIN, CALIFORNIA

The life of a forest preserve lookout is lonely by the very nature of things and this post of Clifford York in the California National Forest, Glenn County, California, is at least isolated. During June to October, the season of greatest fire hazard, York is on watch ten and a half hours a day and his radio receiver does much to break the monotony. Note the glassed-in cabin below

activities of the Bureau. In the field of radio, marked progress was made in frequency standards and in the development of instruments for holding broadcasting stations exactly on their assigned frequencies. We wonder if the Bureau is not too late in this discovery. In the broad sense, holding to assigned frequencies has gone quite out of fashion. Several contributions were made to the knowledge of the vagaries of radio wave propagation and the subject is being studied with the coöperation of twenty scattered laboratories. Direction finders of various types were developed for the Coast Guard, the Navy and the Signal Corps and several studies were made into the frequency range of accurate direction finding. The Bureau is frequently asked to test radio apparatus for manufacturers, but its staff and funds do not permit of such investigation. It

would be a valuable service to the industry if a comparison test of the performance of radio equipment could be made by a government body for a fee covering the cost.

How They Solve Interference Problems Abroad

EUROPE has improved its broadcasting conditions by adopting a uniform plan of frequency assignment with the result that long distance hunting has been attacked with renewed interest. Although there were less than thirty broadcasting stations operating in Great Britain, the conferees had the foresight to reduce the number of stations in order to give Europe interference-free reception. At once there was increased demand for sensitive receivers and also for better and easier means of identifying distant stations. A correspondent of *Wireless World* suggests that every station should be identified by a number transmitted in Morse. This suggests the basis for a most intriguing proposal. Supposing all our broadcasting stations were required to transmit license numbers beginning with Number 1 at the high frequency end and ending with 610 or 950, whatever the number is by the time this gets into print. It would be a wonderful game to begin with Number 1 and work all the way to the top of the scale.

Bringing Classical Music to the People

THE day of the concert stage is passing rapidly," says Madame Fritz Kreisler, urging musical artists to forego the concert stage in favor of soloist work at one of the prominent movie palaces. "People are no longer willing to sit through long programs. They want their music in tabloid form."

Radio has contributed a valuable demonstration of the possibility of popularizing classical music by abandoning the hackneyed, impersonal and formal concert hall style of presentation. A worthy ambition, if commercial broadcasting continues to develop, will be fame as a radio star, involving as it does a technique as specialized as that necessary for successful concert or opera performance and a service infinitely more exclusive.

Radio Fills Empty Church Pews

IN VIEW of the complaints of some of the clergy against the inroads of radio, it is illuminating to have confirmed by a questionnaire, circulated

by the Sears Roebuck Agricultural Foundation, that the broadcasting of services by twenty-seven churches has increased their attendance, while it decreased attendance of only two. One rector wrote, "Since we have been broadcasting our service, our attendance has grown so rapidly that it is a problem to know how to take care of the crowds." Another wrote that forty persons had recently joined his church as a result of broadcasting, while a third stated that the gallery pews in his church had been opened up, and dusted for the first time in twenty years, as a result of the increased attendance attributed to broadcasting.

How the Cable Companies Look On Radio

WHILE Marconi announces reduced costs in trans-oceanic communication by reason of short wave beam transmitters and the British Post Office and the A. T. & T. discuss charges for transatlantic telephony, Newcomb Carlton, President of the Western Union Telegraph Company, indulges in some

belittling: "Every few months, an improvement in radio is announced. Each one is revolutionary and each is good for at least a column in any newspaper. Static, of course, was overcome several years ago and has been overcome regularly ever since. However, after allowing for all improvements, including the beam transfer method, I think it would be safe to say that, in respect to international communication, the radio retains a position on the left hind leg."

Twelve days later, substantial reductions in cable rates were announced.

Bureaucratic Meddling with Broadcasting

THE State Athletic Commission of New York State has taken upon itself the privilege of assigning radio announcers to local ring battles. Having heard a few of those in the favor of the Commission assigned to the task of announcing, one gathers that the qualifications of articulation and familiarity with the English language are not considered

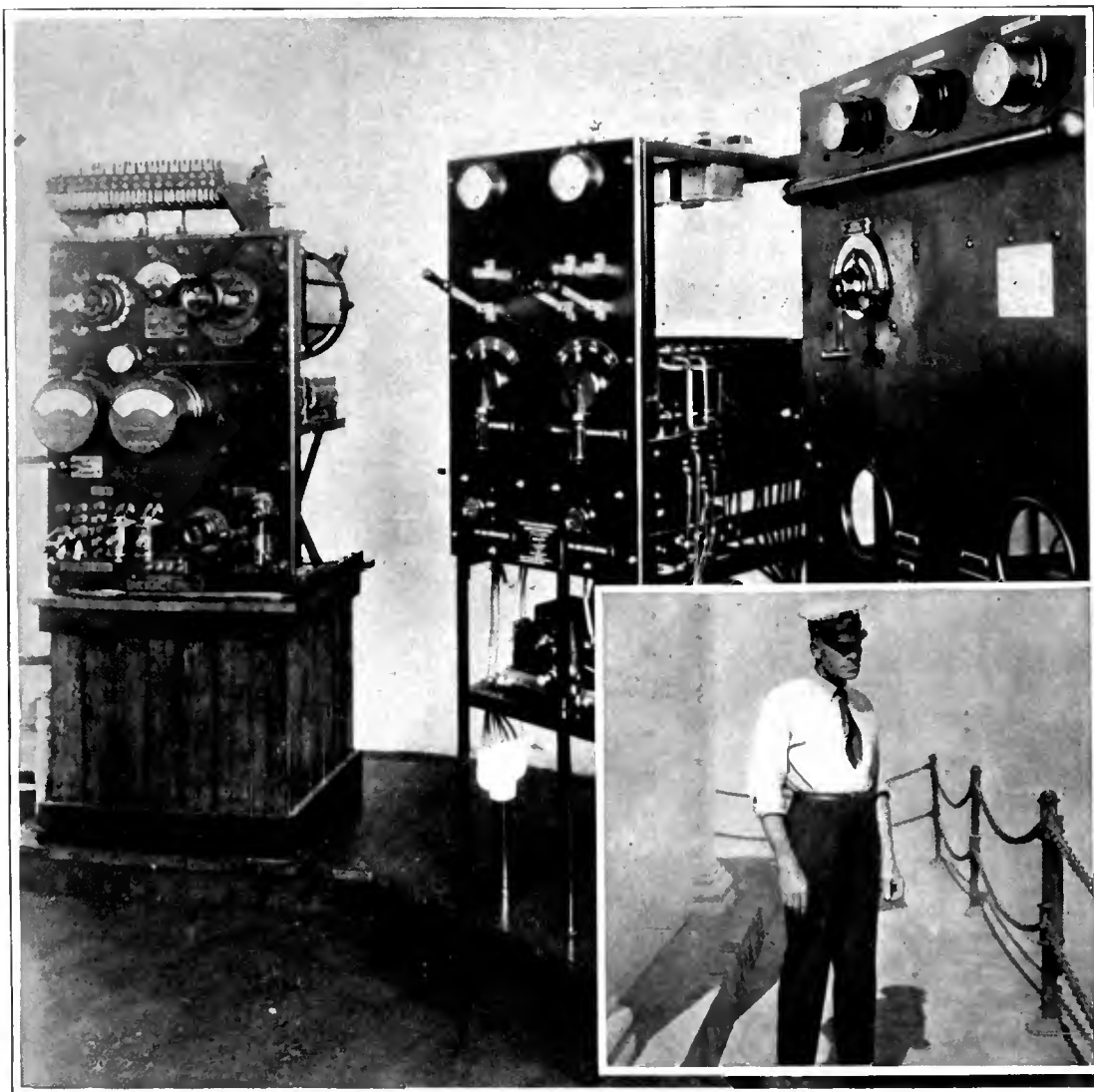

THE RADIO EQUIPMENT OF A LIGHTHOUSE

Automatic radio fog signals are sent out from many lighthouses. The large view shows the transmitting and automatic control apparatus in use at the San Pedro breakwater light, located just outside the breakwater that forms the outer harbor of Los Angeles. Radio beacon signals are sent out on 299.8 kc. (1000 meters). The insert shows one of the light keepers

of paramount importance. Why not select experienced radio announcers who, by training and experience, have learned the art of "getting over" by radio?

Why the Poor Engineer is Poor

THE Board of Investigation and Coördination of the Society for the Promotion of Engineering Education, which has been investigating for three years, urges that a program of sweeping changes be put into effect in all the engineering colleges of the country associated with it. "The development of greater social insight and a large sense of social responsibility should be a definite objective of the engineering profession if it is to gain recognition for more than its technical proficiency," the report declares, and continues: "At the same time, it has need to prove its proficiency in dealing with problems of economy as related to the technical problems of engineering. The ability of the engineer to extend his influence . . . appears to hinge primarily on his attainment of greater competency and greater recognition on the economical and social side of his work."

The unimaginative style of writing of most engineers and their failure to translate their work and achievement in such terms that the public can understand and appreciate it is often mentioned as a primary reason for their small remuneration as measured by their service to the public. Many people assert that they can recognize an engineer when they see one by his introspective and concentrated manner. Development of greater appreciation of his social significance not only means greater recognition to the engineer but better adaptability of his work to commercial and human needs. When chief engineers, engineers, and sales managers get together, there is generally a battle. "Make it cheap enough to sell," says the sales manager. "Make it to today's latest specifications," says the never-satisfied engineer. Better appreciation of sales problems and the economics of industry would make better engineers.



RALPH P. WORDEN
Cleveland

Radio Editor, the Cleveland News. Especially written for RADIO BROADCAST:

"The increasing use of 'mixers,' by means of which the control operator in a broadcasting station can emphasize or subdue various sections of a large orchestra, places on the operator's shoulders a great responsibility. The orchestra may be directed by Damrosch or Stokowski, yet if the operator is anything short of a Damrosch or a Stokowski in his own field it is possible for him to prevent the artistry of the leader from reaching the radio audience. This is said, not in criticism of the leading stations, whose broadcasts have been above reproach at all times, but in explanation of the fact that large orchestras or bands 'on the road' often do not sound as well over various radio stations as they do when featured at the country's leading broadcast studios."

The Month In Radio

E. F. BEMIS, Electrical Division, Department of Commerce, announced the leadership of the United States in the export of radio apparatus. Its 1925 shipments were valued

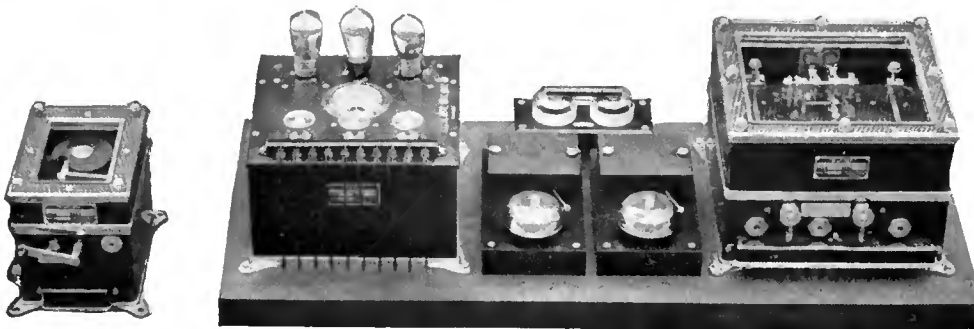

A WIRELESS ALARM FOR SHIPS

This device, supplied by Marconi's Wireless Telegraph Company, Ltd., is designed to respond to a series of three four-second dashes, which is suggested as preparatory to the sending of distress calls. Ships thus equipped would not have to maintain a constant watch for distress calls. On the left is the four-second dash sender, which is connected to the main transmitter of the ship. The mechanism is wound up by the handle. Next is the tube receiver, and on the right, the selector unit for interpreting the signals and putting the alarm bell in circuit

at \$9,903,857, being nearly three and a half millions greater than that of Great Britain. British sales to Europe constituted more than 41 per cent. of the total British radio exports, while American volume is built up largely in Canada and Latin America.

ANOTHER Department of Commerce statement announces a 60.4 per cent. decline in phonograph output in two years, the number of manufacturing establishments dropping from 111 to 68. The principal phonograph companies have gone into the radio business.

AN APPEAL, seeking to upset the rejection of Claims 11, 12 and 13 of R. A. Heising's Patent 1603282 was unsuccessful in a recent Patent Office hearing, and the rejection of these claims was affirmed. An interference in connection with patent 789124, issued to one Ehret, was cited.

IN A decision rendered in a federal court in Pennsylvania, DeForest patent 1507016 and 1507017, for oscillating audion and feedback circuits were held prior in invention to the claims in Armstrong's 1113149 and Claims 1, 2, 3, 5, 8, 9, 12 and 14 to 18 of the latter were held invalid. The suit was between the DeForest and Westinghouse companies. This decision is subject to further appeal to higher courts.

M. C. HOPKINS, whose patents 1275127 and 1275129 have already been battled over with the Western Electric Company through the Lektophone Corporation, has appealed the decision of the Circuit Court of Appeals of September 20, 1926. His company has done likewise in a suit involving the same patents with the Brandes Products Corporation.

AN AVERAGE of 500 letters a day is being received by the Radio Service of the Department of Agriculture which is broadcasting special programs for the farmer through numerous stations. Considering the antipathy which the farmer has toward letter communication, this is indeed a reassuring indication of the remarkable success of these programs

GERMAN radio fans are petitioning the president of the Reichstag to permit the broadcasting of all debates of that body. Gluttons for punishment, these Germans.

TWELVE minutes after the referee's decision in Philadelphia that Gene Tunney was the new World's Heavyweight Boxing Champion, the presses of the *Rand Daily Mail* in Johannesburg were printing papers containing the news. 2XAF, WGY's short-wave little sister, bridged the distance between the two continents. London newspapers published summaries of the announcer's description of the fight as heard by short-wave listeners.

AN EXAMPLE of the value of radio compass bearings is given in an announcement from the Communication Division of the Office of Naval Operations of the Department of the Navy. Two merchant vessels, proceeding in a fog, in the vicinity of Hog Island Light, did not make use of the radio compass group located at the entrance to Chesapeake Bay. One of the vessels grounded and then requested bearings. She was promptly told that she was on the edge of a shoal. The other ship overheard and escaped. Better late than never, but too late is futile.

A DIRECT radio link between Nauen, Germany, and Rio de Janeiro, Brazil, has been established with a rate of 2.75 reichmarks per word.

Some Experiments on One Meter

By HOWARD E.
RHODES

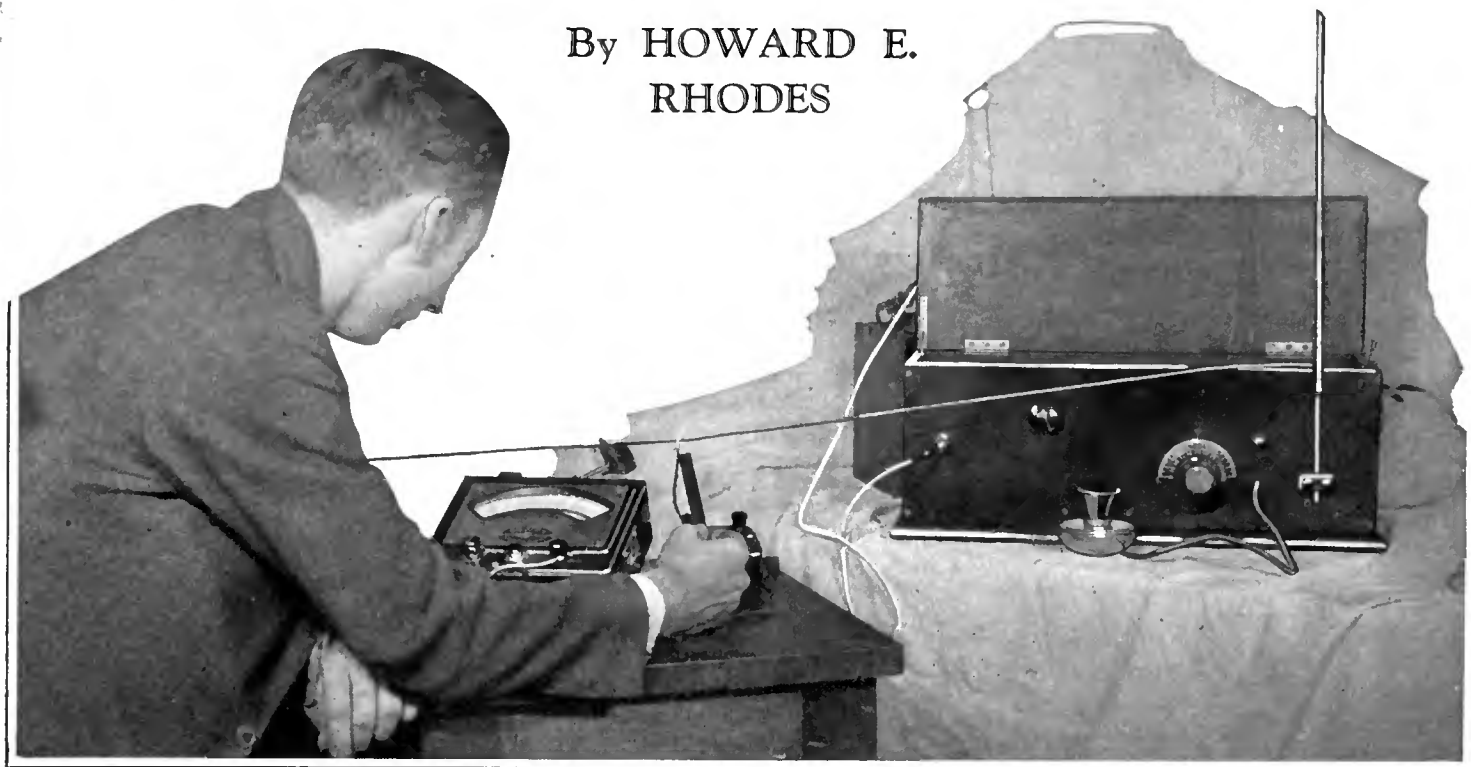

RADIO BROADCAST Photograph

FIG. 1

A special method, perhaps used for the first time by Mr. Hallberg, several years ago, for measuring short wavelengths with a single wire. Two points on the Lecher wire are found where a maximum deflection on the indicating meter is obtained. The distance between these two points is equal to half of the wavelength. The microphone is on the table near the transmitter. The antenna on the transmitter is evident, projecting upward at the right of the picture

Being a Report of the Radiophone Experiments of J. H. Hallberg on One Meter— A Description of a Transmitter and Receiver Used for Work on the 300,000 kc. Band—A Special Form of Lecher Wire Is Used for Measuring the Wave- length—Plenty of Scope for Experiment Is Offered the Interested Amateur

A CONSIDERABLE amount of work has been done during the last one or two years on short waves, between one and five meters (300,000 and 60,000 kc.), and the special purpose of this article is to report on some work of this nature which has been done by Mr. J. H. Hallberg, and which should form a worth while addition to the information available at present. Mr. Hallberg has experimented with short-wave telephony for the last few years, having originally become interested in it through research work which he has done, relative to the measurement of very short wavelengths, and which made necessary the development and calibration of $\frac{3}{4}$ - to 10-meter oscillators and detectors. Most of the work done by other experimenters on ultra short waves was with pure un-modulated c. w., so that these experiments with modulation throw some light on the possibility of using telephony on very short wavelengths. Many experiments of the nature described here can be easily duplicated by readers of this magazine.

It is necessary for those who experiment along these lines to possess an amateur station and operators' license, information on which can be secured from U. S. Radio Inspectors. Those who have concerned themselves with short-wave work, will find sufficient material about their laboratories to make the transmitter and receiver described in this article. It is the cheap-



MR. J. H. HALLBERG

Whose interesting experiments with 1-meter radiophony are described in this article

ness and ease with which these short-wave experiments can be done that counts in part for the interest which they should create.

The transmission experiments outlined here, were made on the sixth floor of a twelve-story steel apartment house, not the best place, by any means, to experiment on wavelengths between 1 and 5 meters. Steel girders, conduits, pipes, fixtures, metal grill work, etc., absorbed the greater part of the power, which, for most of the tests, was only about four watts. With this low power and with so many objects capable of absorption located in the vicinity of the transmitter, it was to be expected that the range would not be very great. With a single-tube receiver (no audio amplification) the voice, music, or the tick of a clock placed close to the microphone on the transmitter, could be heard about one-half mile away. This is not at all bad when it is realized that the per cent. modulation must have been quite low. Beyond about a half a mile the modulation could be heard but was quite weak. If the detector was made to oscillate, signals were increased in strength considerably but at the same time there was much distortion. Sometimes it would be found that the signals could not be heard in one location but that moving the receiver a few feet away would bring them in with good strength. Very likely the signals could have been heard further than half a mile away in certain locations with

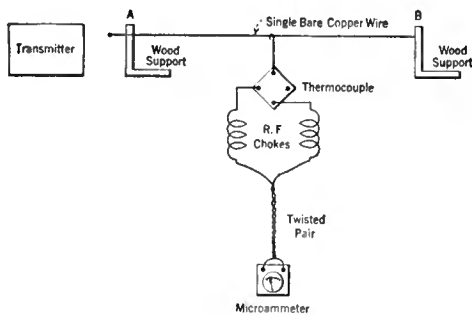

FIG. 2

A diagrammatical sketch showing how the instruments are arranged. The technique of measuring is explained in the article. The lead connecting from the Lecher wire to the thermocouple should be as short as practical, not over 1" long. The twisted leads may be several feet long so as to permit the microammeter to be placed on a table below the Lecher wire. The r.f. chokes are of the same construction as those used in the transmitter and receiver

mA. This gives an input power of 1.3 watts. With this power the signals could be picked up and were sometimes as loud and clear as with a 210 tube, but were not very dependable. For more consistent results a 210 tube was used with 6 volts on the filament and 220 volts on the plate. The plate current varied between about 18 and 30 milliamperes, which corresponds to input powers of 4.4 and 6.5 watts respectively. Some experiments were tried with a plate voltage of 400 and 7.5 volts on the filament but there was no improvement in reception. The fact that results were practically the same with either 400 or 200 volts on the plate of the 210 tube seems to indicate that with 200 volts there is plenty of power available and that the problem lies in suitably utilizing it and preventing any great amount of absorption by surrounding objects. The problem of absorption is one that causes a great deal of trouble when the work must be confined to an apartment or small laboratory. As mentioned above, it is very much better to conduct the experiments in the open.

Lecher wires. It is not necessary to use two wires, and in this work on very short wavelengths Mr. Hallberg has found that the single wire gives better results and that the readings are much more accurate than can be obtained using two wires. After some experimenting, apparatus was set up as illustrated in Fig. 1. Fig. 2 is a diagram of the set-up. The single No. 18 bare copper wire was tightly strung up between the two supports, A and B, the end of the wire at A being brought within about two inches of the oscillator inductance. The end of the wire could have been formed into an open loop to afford more pick-up but it was not found necessary to do this. One terminal for the heater of the thermocouple is hooked over the wire and the other end of the thermocouple is left open. The microammeter is connected to the output terminals of the thermocouple by a pair of twisted leads. In determining the wavelength the hooked wire is slid along the Lecher wire until a maximum deflection is obtained. This point is marked on the wire. The instrument is then slid further

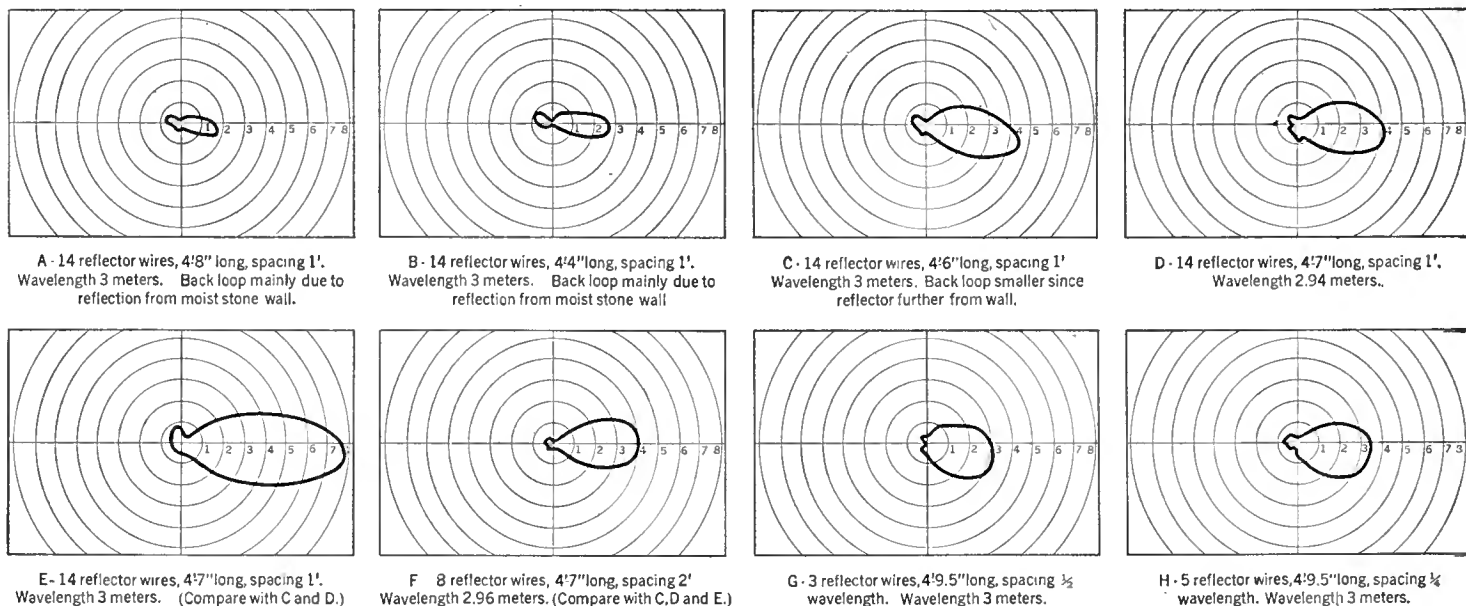

FIG. 3

Eight valuable polar curves reprinted from *QST*, showing the energy distribution from a transmitter when using different reflectors. The reflector wires were in all cases arranged in the form of a parabola, energy being fed to the antenna, located at the focus, by means of an r.f. transmission line

reference to the transmitter, but the experiments were not carried any further. The best place to do experiments of this nature would be in the open country where there are not so many objects capable of energy absorption in the vicinity of the transmitter. The results mentioned above were obtained when a 210 type tube, with a plate voltage of about 220, was being used as an oscillator. The receiver was a portable affair with self-contained batteries. Some care is necessary in selecting the tube for the receiver to be sure to obtain one with a sufficiently low inter-electrode capacity. In the experiments which Mr. Hallberg made, he found the Magnavox tube especially suitable because its grid-plate capacity was in general very much lower than that of the other tubes with which he experimented. A small antenna is used on the transmitter and the construction of this antenna will be described in detail further on in the article. No counterpoise is used on the transmitter. The receiver uses neither antenna nor ground, although they may be used if desired.

Various types of tubes were used in the transmitter with various plate voltages. With a 201-A best results were obtained using a plate voltage of 130 and a plate current of about 10

In ultra short-wave work of this sort it is almost essential that the receiver and transmitter be calibrated together since very slight changes in inductance or capacity will make it impossible to tune the two sets to the same frequency. In one test we had tuned-in the signal at about 50 on the condenser dial of the receiver, but, on shortening the grid inductance 1/8th of an inch it was not possible to pick up the signals. In measuring the wavelength, Mr. Hallberg used a special form of Lecher wire which is very interesting. Perhaps all of our readers are not familiar with the Lecher wire. Lecher wires usually consist of two parallel bare copper wires spaced by about four inches and, at one end, the two wires terminate in a small helix which is coupled to the oscillator. The other ends of the Lecher wires are left open. When energy is induced in these wires, it creates what are termed "standing waves," similar to the effect that would be produced if a rope were to be attached to some fixed support and the other end moved up and down at a certain definite rate. When the rate at which energy is given to the rope is correct, waves start to run along the rope and finally there are created a series of stationary waves similar to those induced electrically in

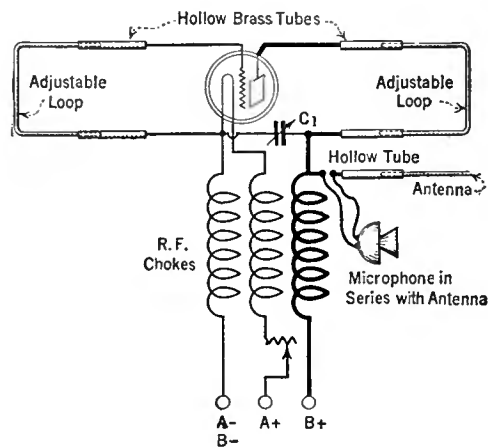
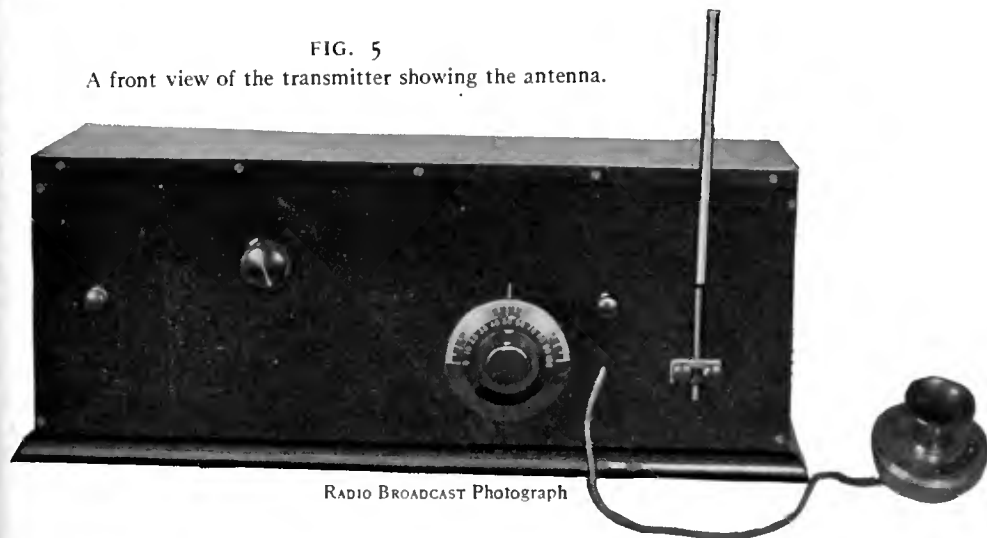

FIG. 4

An ultra short-wave transmitter. The two adjustable loops are the inductors. They are made of hollow brass tubing arranged so that one piece can slide within the other. Details for making the r.f. chokes are given in the text. Variable condenser C_1 has a maximum value of 0.0002 mfd.

FIG. 5

A front view of the transmitter showing the antenna.



RADIO BROADCAST Photograph

along the wire until another point of maximum deflection is obtained. The distance between these two points is then measured, and this distance, in meters, is equal to one-half the wavelength. Therefore, the distance, in meters, between successive maximum deflections, multiplied by two, equals the wavelength at which the transmitter is oscillating. This method of wavelength determination is quite accurate, and Mr. Hallberg's experiments indicate that it gives the shape of the wave as well as its length.

Soon after one begins work of this sort, it becomes evident that one of the most important things is to develop an efficient beam transmitter such as was described in the Bureau of Standards Scientific Paper No. 469. Mr. F. C. Jones, of 6 AJF-6 XM, in his article in the May, 1925, *QST*, described a reflector which he used on a wavelength of about three meters. Several polar diagrams were given showing the reflection with different numbers of wires, spaced various distances apart. These diagrams are valuable, and are reproduced here in Fig. 3. The curves are practically self-explanatory. In A and B there is a considerable back loop, which is due to reflection from a moist stone wall located near the reflector system. These curves show very well that the closer the wires are together, the sharper will be the beam, and also the greater the back leakage. The reflectors were arranged in the form of a parabola and their effect, as can be seen from the curves, is similar to that which is obtained through the use of a reflector in an automobile head light, for the purpose of directing the light along a certain path. The antenna is placed at the focus of the parabola. The reflector wires are one-half wavelength long minus a small amount due to the loading effect of the other nearby wires. For 3 meters, the wires may be 1.5 meters long, for work on the second harmonic. They may also be made 3 meters long if the fundamental is to be used. The antenna should be of the same length, with a single turn at the center to be used for coupling purposes. These curves are given because of their value to the experienced experimenter and will be especially valuable to those who desire to work using such a reflector system fed through an r. f. feeder line. With such reflectors, the received energy can be increased hundreds of times without any change in the input to the transmitter. If an intensive study is to be made, the reflector and antenna systems should be arranged so that many different combinations and sizes might be set up. We hope to do some of this in the Laboratory and the results will be published in a future article. However, a great deal of excellent experimental work can be

carried on by merely using a simple antenna, as described in this article. The designing of a reflector system will be an interesting job after the simple antenna system has been brought up to its maximum efficiency.

WEAF REBROADCAST ON 1 METER

THE tests and experiments that Mr. Hallberg has done to date using a simple antenna have proven very satisfactory, and the editors of

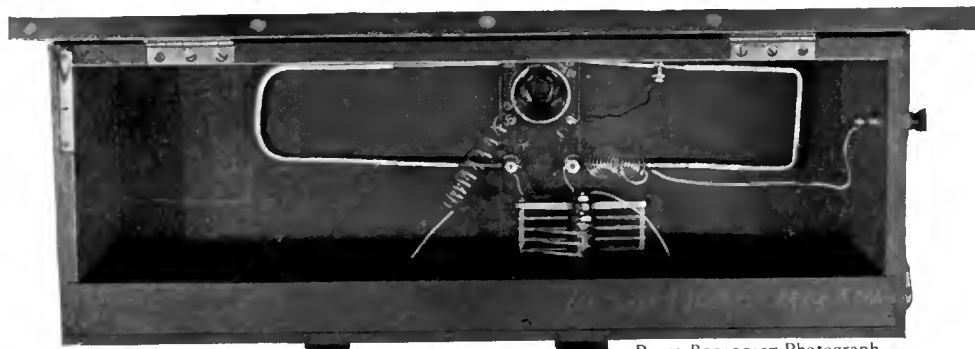

RADIO BROADCAST Photograph

FIG. 6

Looking down on the transmitter. Note how simple is the construction

RADIO BROADCAST witnessed a very nice demonstration of rebroadcasting using a wavelength of 1 to 1½ meters. The signals from WEAF were picked up with an ordinary 610-kc. detector, and the telephones held near the microphone of the short-wave transmitter. The modulation in the transmitter was excellent and clear signals could be picked up with the 1- to 1½-meter receiver without any difficulty.

In these tests no antenna was used on the receiver, the pickup from the transmitter being merely by means of small loops that comprise the coils of the receiving set. On the transmitter an antenna is used, and a part of it can be seen in Fig. 5 accompanying this article. This antenna consists of two brass tubes which telescope one within the other. The length of the antenna is varied until it is brought into resonance with the oscillations in the tube. A great deal of development work on both the transmitter and receiver is necessary. It is possible that results will be better with the antenna coupled to the transmitter in some other manner. The range can be extended considerably if an antenna were to be used in conjunction with the receiver.

The transmitter diagram is shown in Figs. 4, 5, and 6. Fig. 6 is a top view of the transmitter. The construction of the r. f. choke coils can be plainly seen. The two loops, one in the grid

circuit and the other in the plate circuit, are made of hollow brass tubing so arranged that one can slide within the other and in this way the length varied. Fig. 6 shows very well how simple the construction of this transmitter can be made. Amateurs will recognize from the schematic diagram, Fig. 4, the form of modulation as being similar to the so-called "loop modulation," in which a single turn of wire in series with the microphone is placed close to the transmitter inductance. Talking into the microphone causes the amount of power absorbed by the loop to vary in accordance with the sound waves. Fig. 8 illustrates the arrangement of apparatus in the self contained portable receiver, and Fig. 9 is the circuit diagram. The choke coils for use in the receiver are constructed in exactly the same manner as those used in the transmitter. Be sure that the turns are not too close together since it does not require much capacity to produce an effective bypass for these high frequencies.

The transmitter is not at all difficult to make up and practically all the information necessary can be obtained from the accompanying illustrations and diagrams. The grid and plate coils, or loops, should preferably be made up of copper tubing but satisfactory results will be obtained if a large size copper wire is used. The radio frequency choke coils can be seen in Figs. 4 and 6. They consist of about 10 turns of wire. They are easily made up by closely winding approximately this number of turns on a ½" dowel

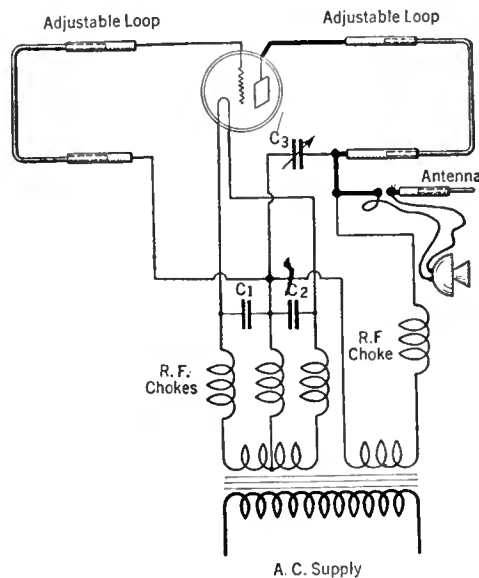
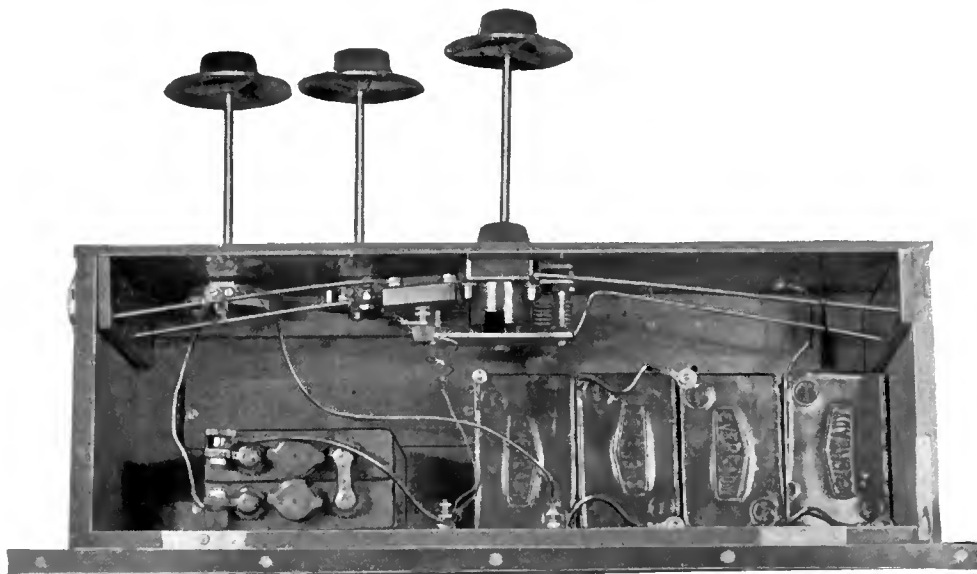

FIG. 7

An a.c. operated transmitter. The signals from this transmitter can be picked up on an ordinary crystal. C₁ and C₂ may be 0.001 mfd. condensers. C₃ has a maximum capacity of 0.0002 mfd. The transformer supplies energy for the filament and plate circuits



RADIO BROADCAST Photograph

FIG. 8

A top view of the receiver, showing the arrangement of batteries. The two adjustable loops can be seen near the front of the set

stick. The coils are then stretched so the turns are spaced about $\frac{1}{2}$ " apart. The size of the loops should be varied until the tube oscillates. When the tube begins to oscillate, the plate current will generally change. Another test for oscillation is to touch the plate terminal with a screwdriver and watch to see if the plate current changes. If a type 210 tube is being used, with, say, 200 volts on the plate, a good size spark can be seen as the screwdriver touches the plate terminal.

The microphone is connected in series with the antenna. See Fig. 4. In the preliminary experiments, it is not necessary that a microphone be used. Perhaps the best method would be to supply the plate and filament directly from the a. c. power lines. The circuit diagrams of a transmitter using alternating current for the filament and plate supply is given in Fig. 7. It is the same as the circuit diagram shown in Fig. 4 with the exception that the energy is supplied through two transformers instead of by batteries. With a. c. on the plate, the transmitter output can be picked up on an ordinary crystal detector since the 60-cycle note will be audible in the telephones. On the other hand, with battery supply for the transmitter, the signal could not be picked up unless an oscillating detector were to be used. In making the first tests it is very much easier to work with a crystal detector rather than with a tube.

A fine little wavemeter can be made as illustrated in Figs. 10 and 11. This wavemeter consists of a single loop of wire, L, connected in series with a midget variable condenser, C, which should have a maximum capacity of 25

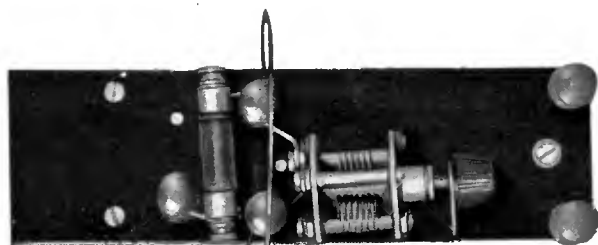

RADIO BROADCAST Photograph

FIG. 10

The wavemeter. A telephone bypass condenser is located under the panel

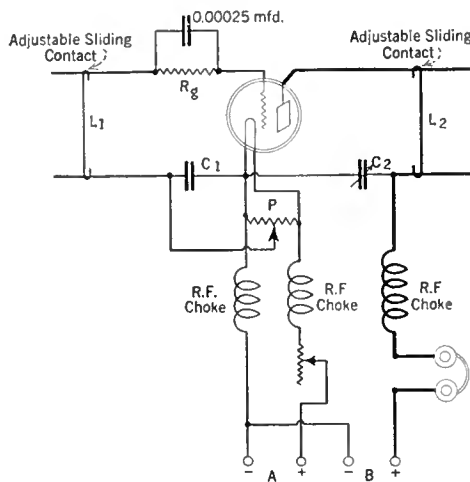

FIG. 9

The circuit diagram of the receiver. The potentiometer, P, is used to control regeneration. C₂ is variable and should have a maximum capacity of 0.0002 mfd. C₁ may be a 0.0001 mfd. fixed condenser. R_g is about 5 megohms. The r.f. choke construction is described in the text

micro-microfarads. The telephones in series with a good tested fixed crystal are placed across the variable condenser. A telephone bypass condenser, C₂, having a capacity around 0.001 mfd., should be placed across the two terminals of the telephones. The whole set of parts may be placed on a small piece of bakelite measuring not more than 2" x 4".

The details concerning the receiver can be obtained from the various diagrams and photographs that are illustrated in this article. See Figs. 8 and 9. The two short-circuiting wires, L₁ and L₂, on the inductances, must be adjusted so as to tune to the same wavelength as the transmitter. The potentiometer controls oscillation. For phone work, the detector should be operated in a non-oscillating condition.

The extension handles are plainly shown in Fig. 8. They are very

essential since the hand capacity is considerable and it will be difficult to hold the signal if the extensions are not used. For the first experimental work it is hardly necessary that the receiver be housed in a cabinet for any other reason other than the fact that it makes it somewhat more portable. A bread board layout could be put together very much simpler and would be just as good insofar as the experiments are concerned.

In starting these experiments, the first thing to do would be to make up a transmitter and be sure that it oscillates. Two simple tests for oscillation were given at the beginning of this article. Now set up the Lecher wire and determine the wavelength. The layout of apparatus used in the Laboratory is shown in Fig. 1. The author is sliding the hooked wire along the Lecher wire and in this way obtaining a maximum deflection on the meter. When a maximum deflection is obtained, this point is marked on the wire and then the whole apparatus is slid along further until another maximum point is obtained. The distance between these two is measured with a meter stick and this distance, multiplied by two, equals the wavelength. All the apparatus should then be left just as it is, and a wavemeter, such as is illustrated in Figs. 10 and 11, coupled to the transmitter, and the resonance point obtained. The process of measuring the wavelength by means of Lecher wires is satisfactory but is too troublesome to bother with every time a wavelength determination is to be made. It will be better to determine the wavelength on which one desires to work and then to adjust the oscillator to this wavelength with the aid of the Lecher wire. This point can then be determined on the wavemeter and any future calibrations can be made using it rather than the Lecher wire.

It is hoped that sufficient interest will be created by this article to cause readers of RADIO BROADCAST to make up apparatus similar to that illustrated in this article. Experiments of all sorts can be made, different types of antennas can be used, and the method of coupling it to the transmitter can be varied. In the transmitter shown in Figs. 1, 3, 4, and 5, the antenna is connected directly to the end of the plate inductance loop in which position it seems to give quite good results. Possibly better results will be obtained if a loosely coupled antenna system is used. Also the antenna used in these experiments was tuned to the fundamental wavelength and radiation on a harmonic frequency might give better results. RADIO BROADCAST will be pleased to receive any reports of experiments that are done on the outside, and it is expected that these reports, together with the experiments that are to be done by the magazine, will be reported in an early issue

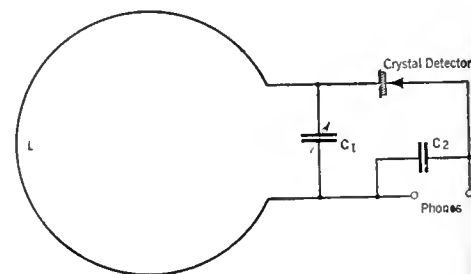

FIG. 11

A piece of wire and a midget condenser comprise the tuned circuit of this wavemeter. C₂ may have a capacity of 0.001 mfd. Be sure to use a good crystal

Further Notes on the Inverse Duplex System

Pertinent Data Respecting the Audio Channel—Why Combining Two Efficient Transformers Will Cause Distortion, and How It Is Eliminated in the Inverse Duplex Circuit—Choosing Correct Transformer Ratios—The Prevention of Overloading

By DAVID GRIMES

IN THE early days of broadcasting, the question of quantity rather than quality completely dominated our desires of achievement. The mere novelty of receiving anything at all without the aid of intervening wires was sufficient to offset completely the fact that those weird sounds emanating from crude loud speakers resembled only in a very minor way the original sounds at the studio. Standard transformer coupling was universally used, but we would blush to glance at the jagged curves of some of these embryonic audio coupling units!

Transformer coupling certainly delivered the volume, and the imperfections in most horn type loud speakers did not disclose the quality limitations. As broadcasting stations improved, and the cone speaker came into use, the transformers were placed aside, and almost every conceivable resistance and impedance coupling arrangement came into existence. Most of these combinations were quite satisfactory from an audio quality standpoint but were considerably lacking in volume output. A three-stage resistance- or impedance-coupled amplifier was usually required to equal even a low-ratio two-stage transformer-coupled amplifier. The resistance and ordinary impedance amplifier also appeared to choke up when required to deliver a great deal of volume so that their high quality was confined to rather modest output.

This last fact caused the return of the transformer, but the new type transformer coupling was a vast improvement over its predecessor. It brought in the bass notes as well as the high tones, and it certainly delivered the volume up to the tube limit without itself choking up. But a rather peculiar thing was noted in the extensive tests conducted by the author on the improved modern transformer. If one stage of transformer amplification only were to be used, the quality was all that could be desired, and the actual results checked with the theory. An amplification curve of such a high-grade one-stage transformer coupling is shown at "A" in Fig. 1. When two such stages are then connected in tandem, or cascade, theory would give curve "B," which would be very desirable. Actual results, however, were more like those presented in curve "C." The transformers themselves were obviously not to blame—it was a circuit trouble.

The distortion and tendency toward "peanut whistling," indicated by the peaks in "C," were found to be due to audio regeneration. The circuit in Fig. 2, consisting of three stages of audio amplification, the first

and third transformer-coupled, with an intermediate resistance-coupled stage, overcame all of the distortion shown in curve "C", Fig. 1, and was very stable in operation. This system is employed in the latest Inverse Duplex circuit.

In addition to its stabilizing influence, the resistance-coupled stage was made to deliver real amplification by employing a 25,000-ohm resistance in the plate circuit, and operating the tube on an impressed potential of 135 volts. The 25,000-ohm value is most efficient as this practically equals the internal impedance of the

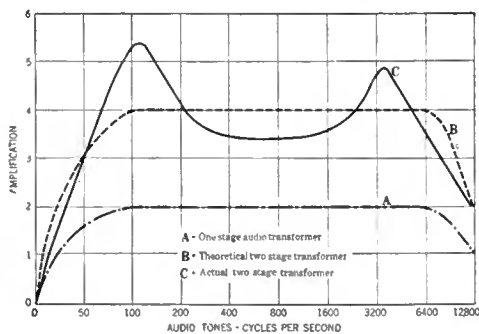

FIG. 1

tube and permits the plate to receive a full 70 volts, which is quite satisfactory for the plate of a first audio tube. The choking of resistance stages before full volume is reached is not present here as the last transformer-coupled audio stage is called upon to deliver the real volume.

This audio circuit now produces excellent quality even under super-selective radio circuit conditions, if good quality is delivered at its

input. Eliminating the relatively few poor quality broadcasting stations from the discussion, still another problem presents itself before good quality reproduction can be obtained from strong local broadcasting stations. This problem arises from the overloading or choking of the detector tube, and the omission of the low bass notes resulting therefrom. A perfect audio amplifier would utterly fail to register the bass notes if the detector grid was being choked by too strong energy from the local station. This has led many engineers to abandon the sensitive grid leak method of detection for the less efficient plate rectification system. But the real answer is found by employing three audio stages for the desired volume without being compelled to force the detector beyond its limit, and then, on local reception, to provide means for reducing the antenna input so that detector choking will not take place. A tapped antenna primary winding arranged according to Fig. 3 has been found to be satisfactory for this means.

The antenna taps are taken off in a geometric manner so that each successive tap doubles the number of primary turns. In this way, not only does this switch act to reduce the input on local stations, but it also tunes the antenna circuit somewhat to the benefit of distant reception. Incidentally, by reducing the antenna coupling, its resistance loss is partially removed from the set and the selectivity is proportionately increased. This antenna switch performs three functions, then, and its proper adjustment is essential for best results. It must be remembered that a change in the position of the antenna tap switch necessitates a re-tuning of the first or left-hand tuning condenser. The tuning condenser will drop below the proper settings on the other two condensers upon an increase in the number of antenna primary turns.

AUDIO TRANSFORMER RATIOS

THE next discussion in order pertains to proper audio transformer ratios for the several stages in the Inverse Duplex Circuit, as there appears to be a great deal of misinformation on this particular subject. The average radio experimenter uses transformer ratios in a rather haphazard manner, tending usually to place the highest ratio right after the detector. A few tests showed this to be absolutely wrong, as was pointed out by Julian Kay in the November, 1924, RADIO BROADCAST. The low ratio should be placed immediately after the detector and the high ratio in the last stage, especially when using the new

—THE EDITOR.

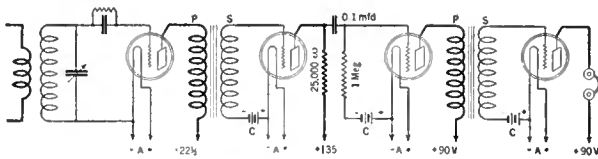

FIG. 2

UX-171 type of power tube. The 2 to 1 transformer usually has a comparatively large number of primary turns because the number of secondary turns is generally a fixed value, for commercial reasons. The low ratio between the two windings in the case of the 2 to 1 transformer is thus obtained by increasing the number of primary turns so that they more nearly approach the number of secondary turns. This high wound primary has, as a result, a rather high impedance, which ideally matches the high internal impedance of the detector tube. The high-ratio transformers, with their smaller primary windings, are much less suited for the detector tube. It is apparent, then, that poor quality may be expected on the low notes from the use of a high-ratio transformer in the first audio stage. A 2 to 1 transformer has therefore been adopted in the first stage in the new Inverse Duplex System.

The word "power," as applied to the new UX-171 tube, is really a misnomer. It has led many to believe that this tube will create tremendous power. As a matter of fact, the amplification of this particular tube is much less than the standard 201-A type tube. The amplification factor is only 3 while that of the 201-A tube is approximately 8. The "power" tube is designed, however, to handle powerful signals without distortion but power must be delivered to the tube if good volume is expected out of it. With this thought in mind, a 6 to 1 ratio audio transformer was installed in the last stage. Its results were very gratifying. A 6 to 1 trans-

former is therefore recommended in this stage. It tends to make up for the decreased amplification of the 171 tube, thus giving more volume on the weak distant station. It must not be forgotten that the impedance of the 201-A tube, in the plate circuit of which is the primary winding of the 6 to 1 ratio transformer, is considerably lower than that of the 200-A detector tube. The primary winding of the first transformer, the 2 to 1 instrument, is in the plate circuit of this detector tube. Even were a 201-A tube to be

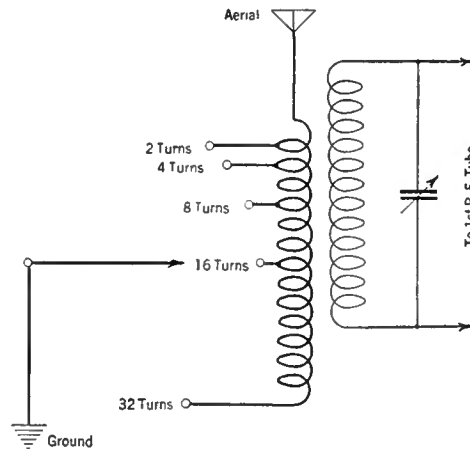

FIG. 3

used in the detector stage it would still be preferable, for matching purposes, to put the low ratio transformer first, *i.e.*, the one with the high primary ratio, for the impedance of the 201-A type tube is higher when used as a detector than when placed in an audio stage.

Although an output device is shown in the

diagram on this page, this may be omitted if an UX-171 tube is employed with a plate potential not in excess of 135 volts. The omission of the output device, consisting of the choke marked on the diagram "Audio Output Choke" and the 1.0-mfd. condenser, is a simple matter. Leave all the other connections as they are but connect together the two leads that are shown leading to the 1.0-mfd. condenser, thus placing the loud speaker directly in the plate circuit of the 171 tube. Also omit the lead to the choke from the plate, and from the choke to the 135-volt terminal.

PREVENTING INHERENT INTERFERENCE

FOR some unknown reason, it is generally believed that radio and audio currents cannot be placed through the same tube simultaneously without interfering with each other. Perhaps the fact that some of the first reflexes did run into trouble accounts for this prejudice.

In order to ascertain this point definitely, a series of extensive tests was run. These tests proved conclusively that no interference took place between the two currents unless the grid potential became "plus" during the operation. In order to prevent this happening, it is merely necessary to operate the duplex tubes with a "minus" bias on the grids. The standard 4 1/2-volt negative bias is used for this purpose. Under these conditions sufficient audio volume can be obtained to completely overload the audio power tube long before the duplex tubes reach that point where modulation takes place. A 250,000-ohm potentiometer is connected in the circuit across the secondary of the first audio transformer as a means of controlling the audio volume. This potentiometer does not affect the grid bias, but permits the gradual reduction of audio volume without impairing the quality. This method of volume control does not affect the distance-getting ability either, as it is not associated with the radio circuits.

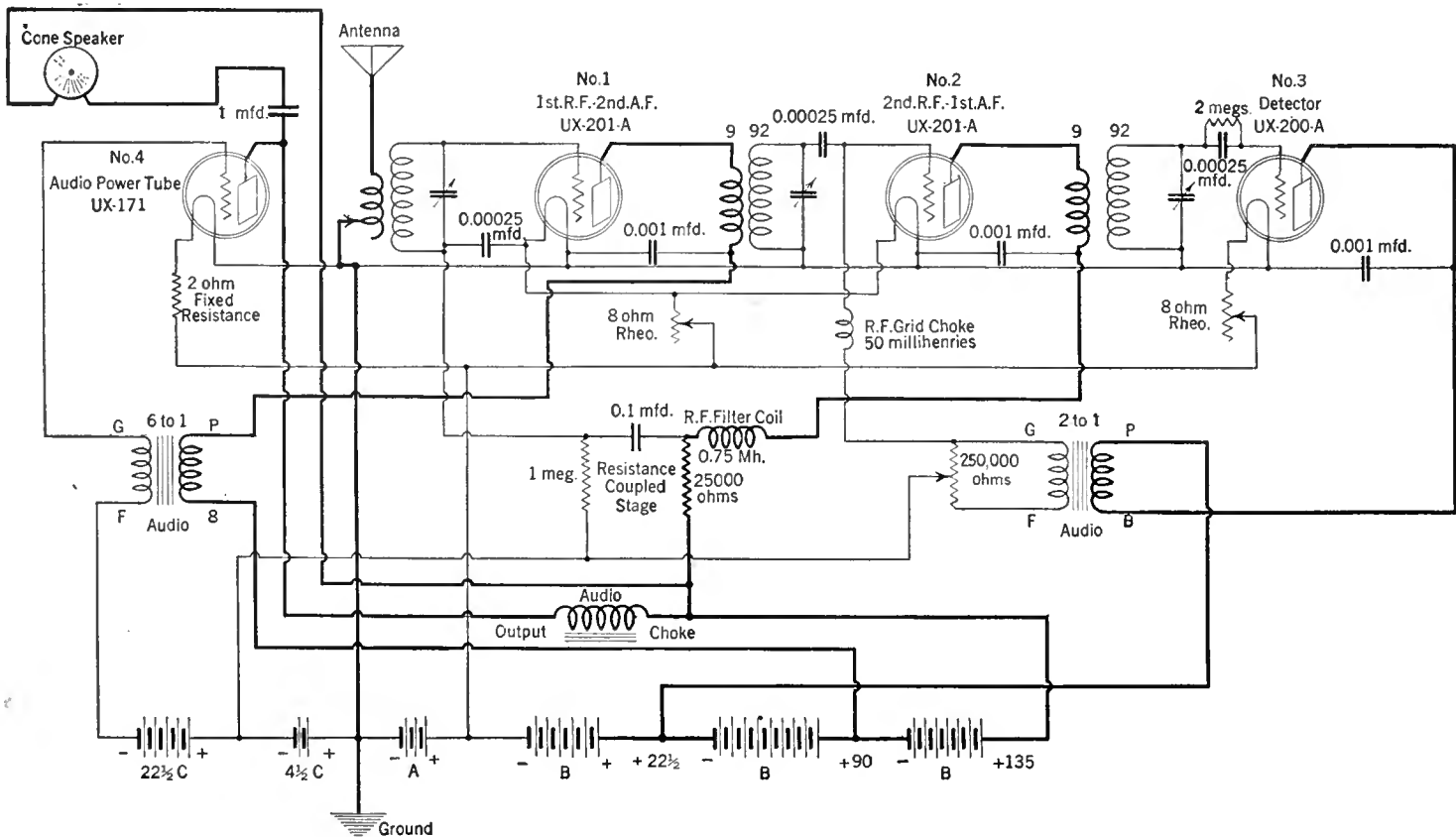

FIG. 4

The potentiometer enables the operator to keep the audio volume below the overload point of the last power tube. If, however, he insists on boosting the audio volume beyond this value, distortion of the signals will first take place in the power tube and then modulation (interference between the radio and audio currents) will occur in the first duplex tube. This modulation was originally referred to as "overload howl" because it resulted in a sustained howl that was quite disagreeable in both volume and pitch. This howl has been overcome in the new Inverse Duplex System arrangement, the resistance-coupled stage being responsible for this improvement. This resistance stage is never called upon, in normal operation, to deliver the volume that would ordinarily choke it. The last audio transformer produces this volume. However, the instant that the grid becomes positive on the No. 1 duplex tube (the condition necessary to cause modulation), a great number of electrons are attracted to it. These flow down into the 0.1-mfd. condenser, completely choking up this tube. This action interrupts the modulation so that only a low pitch choking sound is heard. This serves as warning that too much audio volume is being sent through the tubes. The potentiometer is then dropped back to restore the circuit to its operating condition. This choking causes no damage and is a great improvement over the old modulation howl method. This is the third function of the resistance-coupled stage. It not only serves as an efficient audio coupling and as a filtered r.f. feed-back circuit, but also as a choking circuit to prevent the modulation howl as well. The potentiometer is a necessary part of the new Inverse Duplex System to keep the audio volume below the choking point on strong local broadcasting stations.

The above choking function is somewhat controlled by the audio phases but these phases are easily determined. The action is here described as a matter of information. On a very strong local signal, the grid leak and condenser in the detector tube suddenly choke up, cutting off the plate current in the detector tube. This sudden stoppage of the primary current in the first audio transformer generates an inductive voltage surge, or "kick," in the secondary. This kick is amplified by the No. 2 tube, and appears on the grid of the No. 1 tube where modulation takes place if the surge exceeds the grid bias. Now, this surge is either positive or negative, according to the polarity of the connections on the first audio transformer. A positive surge performs the choking of the resistance stage at the instant modulation occurs. A negative surge creates modulation also but does it by reducing the plate current of the No. 1 tube. This

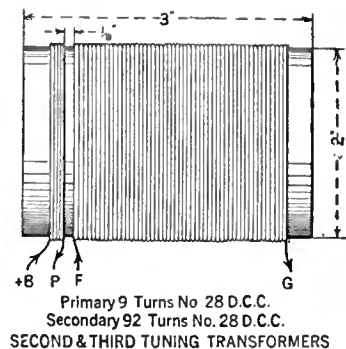
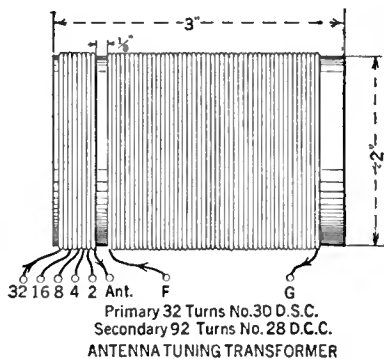

FIG. 5

negative surge does not attract electrons to the grid so no choking of the resistance stage takes place. Under these conditions, the modulated howl is not interrupted, and it becomes an unpleasant note. The proper polarity of the primary of the first audio transformer can therefore be easily determined. If a bad overload howl occurs on local stations when the potentiometer is set too high, merely reverse the connections on the primary of this first transformer and the choking action will be obtained. With the average audio transformer, this primary polarity will be reversed, as shown in Fig. 4, for the choking conditions.

With this first audio polarity determined for least overload, the polarity connections for the primary of the second audio transformer must be ascertained. In this latter case, it is not a question of choking modulation but of reducing any tendency for whistles due to common B battery impedance. The phase or polarity of the primary connections on this second transformer should be such that the loud speaker current flowing through the B battery will be out of phase with the detector plate current flowing through the 22½-volt section of this battery. These connections can be determined experimentally. A steady howl or whistle (with the antenna disconnected and the detector tube fully warmed up) will occur if the connections are wrong. Reversing them will stop the trouble.

This concludes the special duplex considerations and brings this series up to the study of the radio frequency design.

COIL DATA

BECAUSE of the rather efficient operation of the r.f. filter circuit, the rest of the radio frequency apparatus is very simple. One of the

desirable features of the new Inverse Duplex System, from the constructor's point of view, is the feasibility of winding one's own tuning coils if desired. There are no complicated mechanical contraptions or fussy electrical specifications. The second and third tuned r.f. transformers are built alike. The primary of the first, or antenna transformer, is slightly different, but the secondary winding is identical with the other two tuned secondaries.

Reference should here be made to Fig. 5, which shows the mechanical details of the tuned transformers. The coils are designed to cover the wavelength band from 175 to 575 meters (1714 to 521 k.c.) with 0.00035-mfd. variable condensers. Each secondary consists of 92 turns of No. 28 d.c.c. wire. The second and third primary windings each have 9 turns of the same kind of wire as is on the secondaries. It should be noted that the primary and secondary are wound in the same direction of rotation, and that the grid of the tube is connected to the end of the secondary farthest from the primary. The coils are wound on bakelite or micarta tubing having an outside diameter of 2 inches. The primaries of the second and third coils are wound on the same tubing and separated 1/8" from their respective secondaries. The antenna primary may be wound on the same tubing as its secondary and the taps taken off as shown, or it may be wound on a piece of tubing slightly smaller than the secondary tubing so that the primary may be slipped just inside the secondary, at the filament end. The latter arrangement is to be preferred. The three coils should be mounted at right angles where no shielding is employed. A suggested layout for the apparatus is shown in Fig. 6.

The next article in the series will take up in detail the building of an actual receiver giving plans, photographs, operating instructions, and some results obtained when using the receiver in different receiving locations.

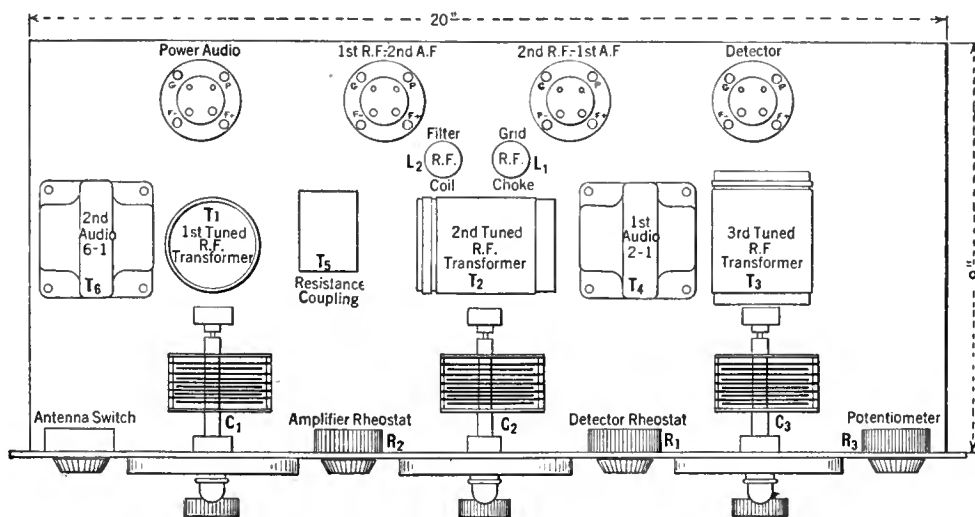

FIG. 6

A Four-Tube "Lab" Receiver



RADIO BROADCAST Photograph
IN ITS CABINET

The R. B. four-tube "Lab" receiver equals in appearance, a factory-made job

By JOHN B. BRENNAN

Technical Editor

AFTER the completion of the construction of the four-tube R. B. "Lab" receiver, which was originally described in the November, 1926, RADIO BROADCAST, the Laboratory Staff felt that for a time it could sit back and rest on its laurels with the satisfaction that comes in doing a job well. However, this resting period was short-lived, due mainly to the many excellent suggestions received from the readers of this magazine.

The two-tube tuner unit, practically a new departure in modern receiver design, was then presented to RADIO BROADCAST readers, in the January issue. This two-tube tuner unit incorporated many novel features of design which it was thought were worth while to apply to the previous four-tube receiver. And, too, during that time which elapsed between the November, 1926, and January, 1927, issues, new material made its appearance, all of which gave rise to the pertinent query "Can the R. B. 'Lab' four-tube receiver be improved?"

Many of the improvements contained in the construction of the two-tube R. B. "Lab" receiver can be made in the four-tube model without much difficulty.

One of the most important of these improvements is the substitution of different coils for the two binocular ones originally employed. Then too, the use of an antenna loading coil permits individual builders to adjust the antenna circuit of their receiver for maximum signal pick-up, making it possible to utilize the antenna at its utmost efficiency.

Hand in hand with the problem of providing the very best volume control is that of supplying a detector circuit capable of handling all the signal energy that can be supplied by a radio-frequency amplifier operating at its peak of efficiency. It was observed, in the operation of the first four-tube R. B. "Lab" receiver, that some distortion took place even though the volume output was reduced by means of the

volume control, because the detector had become overloaded. The first problem then was to employ a detecting circuit which did not tend to overload, even on very strong signals. The solution lies in the use of the C-battery method of detection, as shown in B, Fig. 1. While not as sensitive as the grid leak and condenser method, this C-battery system has virtues which outweigh the point against it of poor sensitivity. The problem of providing a suitable volume control has been solved by placing this volume adjustment in the radio frequency amplifier cir-

cuit—proper enough because, in this position, strong local signals can be reduced to the desired volume and of course no overloading will take place in the detector circuit.

In the four-tube set described in the November issue, the volume control consisted of a 0-500,000-ohm variable resistance unit shunted across the secondary of the first audio transformer. In the model described here, the variable resistance has been re-located in series with the plus-B plate lead going to the r.f. amplifier. Instead of being a 500,000-ohm potentiometer type of volume control having three terminals, this new volume control is the Electrad Royalty, Type L, having a similar resistance range, but it is of the two terminal type. The two volume-control circuits, that formerly used and the one used at present, are shown in A and B respectively, Fig. 2.

As regards the antenna loading coil, it was found, by actual test, that as great as a 4 to 1 increase in signal strength was obtained when the approximately correct inductance was included in the antenna circuit at the particular wavelength to which the receiver was tuned. The loading coil was then provided with taps so that, on the first tap enough inductance was inserted in series with the primary so as to make the circuit function satisfactorily at 250 meters (1200 kc.), the second at 350 meters (857 kc.), the third at 450 meters (666 kc.), and the fourth at 500 meters (600 kc.). For the individual experiment, the placement of these taps to coincide in resonance with these figures is, of course, approximate, since everyone's antenna is not exactly the same. However, not a great difference will result as the loading coil taps are arranged to work with what is considered an average antenna. The complete winding specifications for the new coils are given in Fig. 3.

Where a solenoid coil is used in a tuning circuit it will have an electromagnetic field which, if not taken

The Facts About the Receiver

Name of Receiver	Four-tube R. B. "Lab" Receiver.
Type of Circuit	One stage tuned neutralized radio frequency amplification, regenerative detector, and two stages of transformer-coupled audio frequency amplification, followed by an output device.
Number and Kind of Tubes	Four; 201-A's for r.f. stage, detector, and first audio stage; UX-171 in last audio stage.
Volume Control	A 500,000-ohm variable resistance in series with B battery lead to plate of r.f. tube.
Regeneration	Condenser feedback.
Neutralization	Rice.
Tube Voltages	R. F. and 1st a.f., 90 volts; Detector, 45 volts; last a.f., 135 volts for 112 tube or 180 volts for 171 tube. Filament voltage, 5 volts. C battery voltage, r.f. 4½ volts; detector, 4½ volts; 1st a.f. 4½ volts; last a.f., 9 volts for 112 with 135 B volts, or 40.5 volts for 171 with 180 B volts.

Essentially this four-tube "Lab" Receiver is the same as that described in the November issue. Briefly, the circuit changes consist mainly in the insertion of a loading coil in the antenna circuit, the substitution of a solenoid coil for the binocular in the radio frequency amplifier stage, and the use of C battery detection instead of the grid leak and condenser method. The mechanical changes involve the substitution of a grained aluminum panel for the former insulated one, the addition of an interstage shield, and a tap switch.

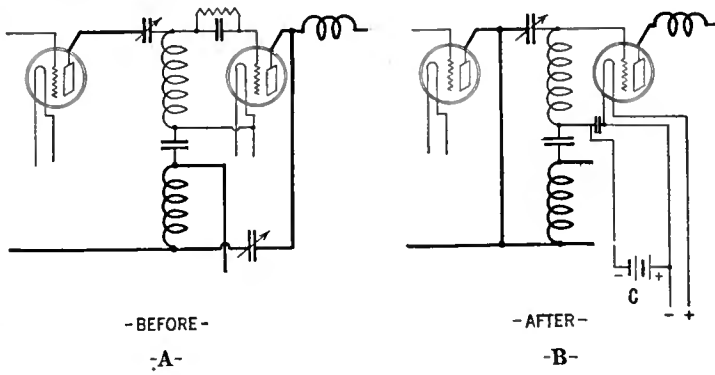

FIG. 1

Originally the grid leak and condenser were used to obtain rectification but in the rebuilt "Lab" receiver the C battery method of detection is employed. Its use insures against overloading of the detector tube. Both systems are shown here

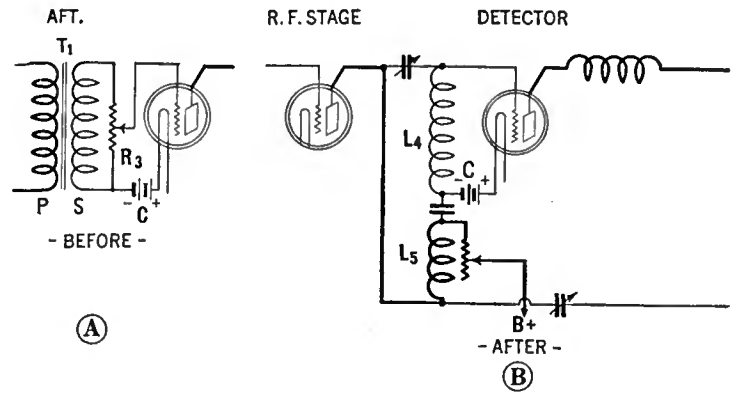
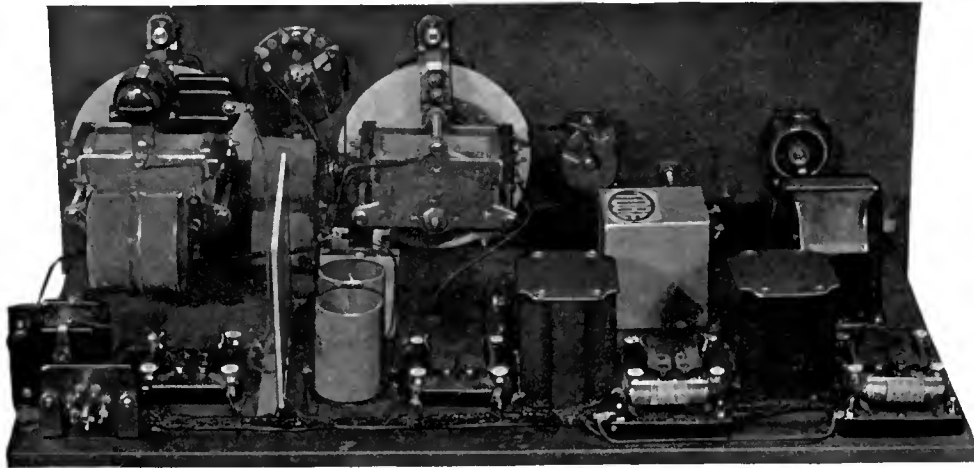

FIG. 2

"Before" shows the original volume control system. "After" shows the system now employed. With the volume control in the latter position, the output of the radio-frequency amplifier stage may be decreased without affecting tone characteristics



RADIO BROADCAST Photograph

THIS REAR VIEW OF THE RECEIVER

Clearly denotes the use of bakelite strips to insulate the volume control and regeneration condenser from the metal panel. The Sangamo condenser which is employed as a protective condenser in series with the regular Precise neutralizing condenser may also be seen. The cabled leads are run along the rear edge of the baseboard and are terminated at the Yaxley plug receptacle

care of, will inter-couple with adjacent tuning circuits so as to cause uncontrollable oscillations. One way to overcome this difficulty is in the use of a type of coil which will not set up such a great field. Coils of the confined field type, such as binoculars and toroids, are satisfactory on this score but are not generally as efficient as solenoids. To employ the solenoid but not experience inter-coupling effects, a sheet of aluminum, if placed between the adjacent interfering coils, will decrease the inter-coupling effects to a negligible minimum. Such a shield has been employed for just this reason in the revamped four-tube set described here. The interstage shields, manufactured by the Aluminum Company of America, fit in to this plan extremely well. See Fig. 4.

The circuit itself is shown in revised form in Fig. 5. Changes, purely of a mechanical nature, have also been considered and, with the circuit changes, were incorporated in the present receiver.

MECHANICAL ALTERATIONS

THE mechanical alterations consisted of substituting one of the new Aluminum Company panels for the insulated panel. These metal panels are to be obtained in several finishes, such as walnut, mahogany, etc., and make the outward appearance of the receiver pleasing indeed.

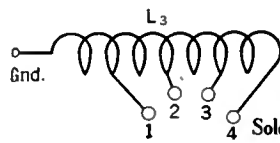
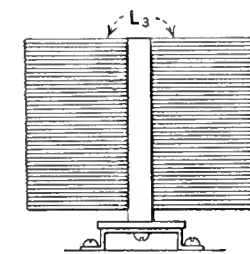

- 1= 26th Turn
- 2= 59th "
- 3= 89th "
- 4= 118th "

Solenoid - 2 1/8" diameter
Binocular - 1 3/8" (each half) diameter

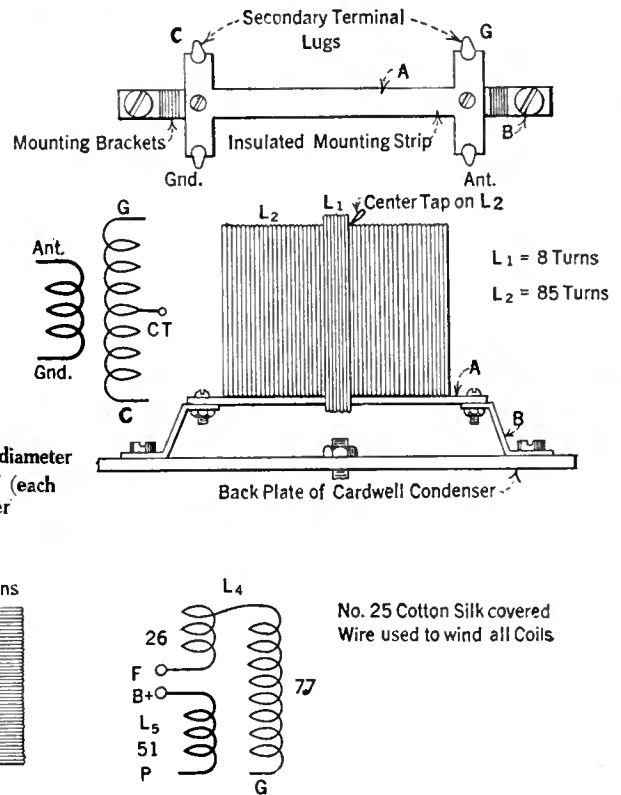
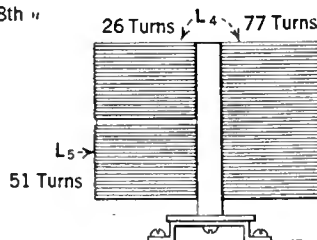

FIG. 3

Complete coil specifications necessary for winding the tuning coils used in the receiver are given here. Three coils, instead of two, are now employed in the "Lab" receiver. The extra coil takes the form of an antenna loading coil

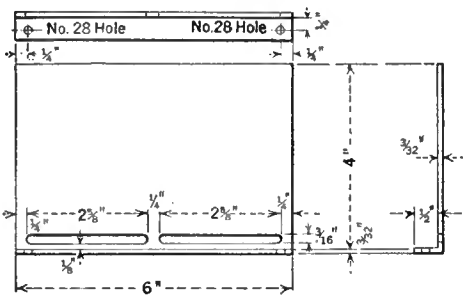

FIG. 4

For those who desire to make their own interstage shield the specifications given here will prove helpful

furnishes, for a small extra charge, a set of insulated bushings designed to fit snugly over the various mounting parts of their dial so that this objectionable feature of contact with metal panels is successfully overcome. Reference to Fig. 6 will show how the bushings are employed to insulate the dial frames from the panel.

In order to simplify the assembly of the output terminals, a single-circuit jack was substituted for the pin jacks formerly used. It is not a difficult matter to make the change since one side of the output circuit returns to the minus A circuit—very easily accomplished by mounting the frame of the jack in the metal panel, which in turn is connected to the minus A-battery circuit.

In Fig. 7 are shown the specifications for the new panel layout, and with few exceptions there is very little difference from the original layout.

In the neutralizer circuit, a 0.01-mfd. fixed

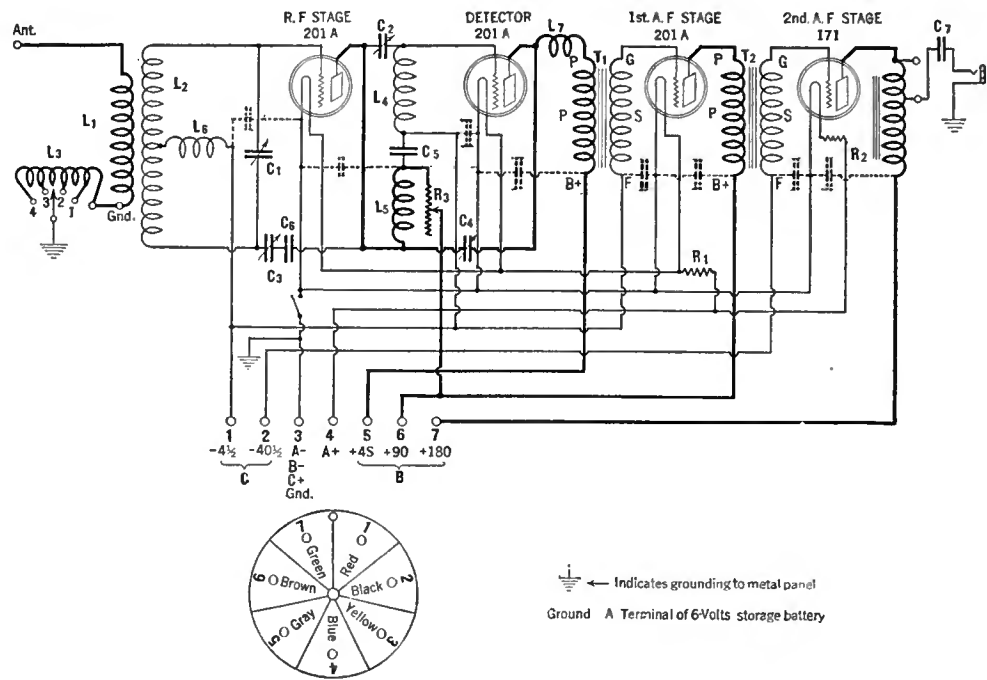

FIG. 5

This is the circuit diagram of the four-tube R. B. "Lab" receiver in its altered form. The 1-mfd. bypass condensers, shown in dotted lines are to be recommended especially where the power supply is obtained from an a. c. operated B power unit. In any event, the inclusion of these condensers tends toward greater stabilization in the operation of the receiver

condenser is connected in series with the regular neutralizing condenser, which has a value of 10 mmfd. In this newer construction the Precise type 940 condenser has taken the place of the mica insulated type of condenser which was formerly employed.

To conserve space and prevent the crowding of parts and wiring, the terminal strip supporting the binding posts has been replaced by a Yaxley receptacle and 7-wire battery cable. There are just enough wires in this cable to make connection to all the batter-

ies. A separate binding post mounted on a strip of bakelite is mounted in a convenient spot as shown in the illustrations, to accommodate the antenna lead-in connection. Since the ground connection can be made direct to the minus post of the A battery, no separate ground terminal in the receiver is necessary. Fig. 8 gives the specifications for the antenna post mount, brackets, and other insulating strips necessary for the assembly of the receiver.

The circuit diagrams and photographs accompanying this article are illustrative of the changes and alterations made, and serve well to guide the constructor in the duplication of these modifications.

The following lists of parts show the apparatus that was used in the original circuit and that specified for the present receiver:

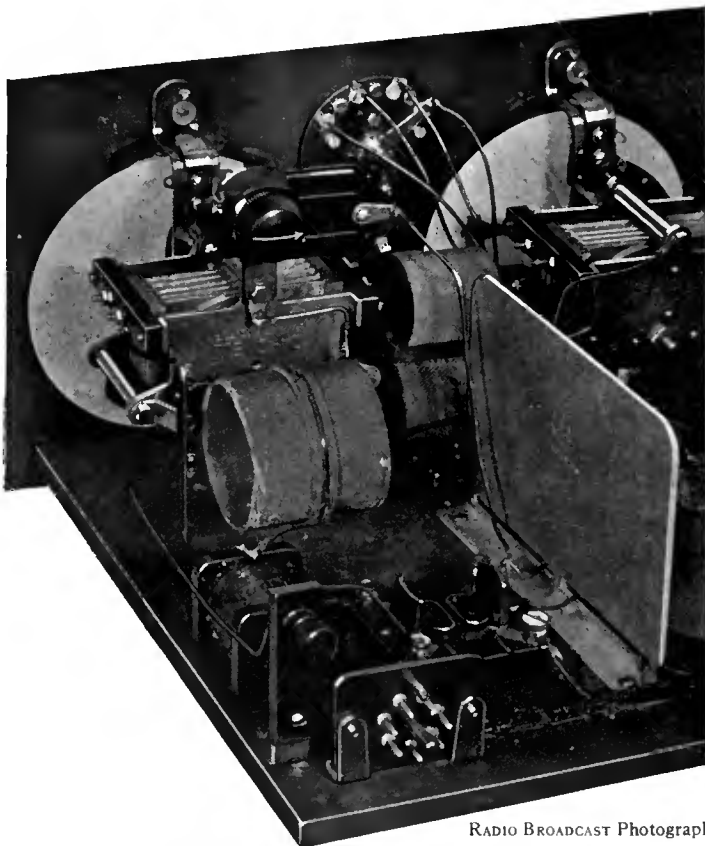

RADIO BROADCAST Photograph

THE RADIO-FREQUENCY AMPLIFIER STAGE

Which comprises the first tuning circuit, amplifier tube, neutralizing condenser, r. f. choke coil, etc., are situated at the extreme right of the base-board as may be seen from the illustration above. The loading coil which is connected in series with the antenna circuit is situated forward of the interstage shield. Practically all of the apparatus employed in the construction of the receiver retains the same position it originally occupied as described in the November, 1926, RADIO BROADCAST

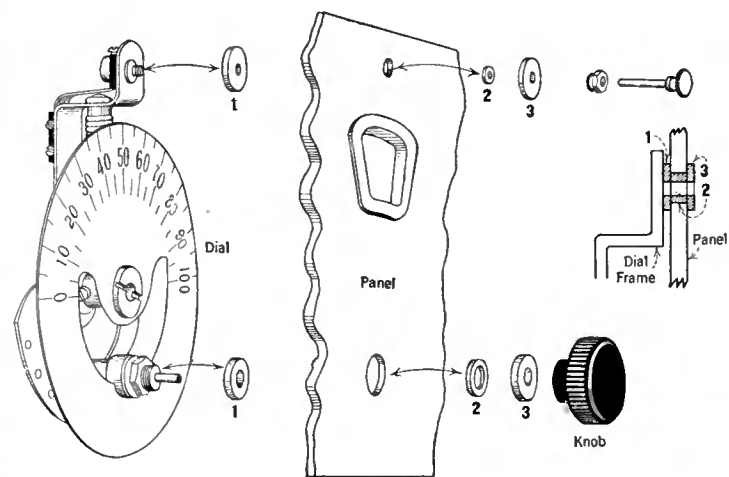
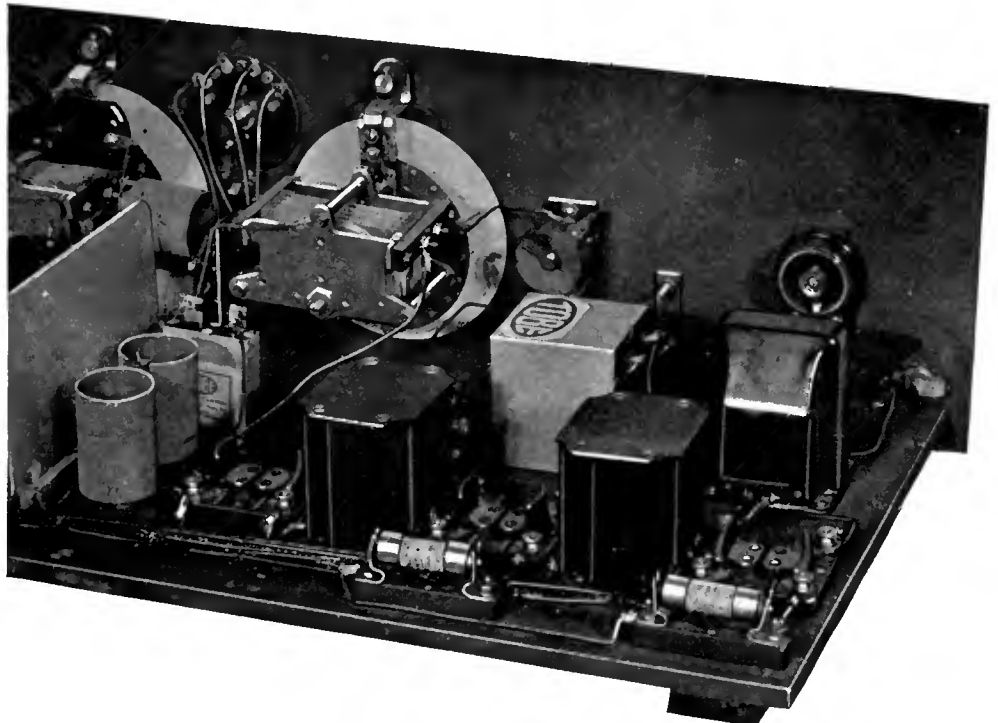

FIG. 6

It is really a simple job to mount the illuminated controls on the metal panel with the aid of the insulated washers. These latter prevent any connection between the dial and the metal panel. The sketch above will clearly indicate the method employed. Explained, it is briefly this: An insulated washer is slipped over the two mounting bushings of the dial and another smaller washer is fitted in the hole in the panel. Then the dial is held to the panel while, on the front, another washer is passed over the mounting bushing. The dial is then securely fastened by means of the metal washers and nuts provided

ORIGINAL FOUR-TUBE R. B. "LAB" RECEIVER MATERIAL LIST

1 Set Gen-Win R. B. "Lab" Coils . . .	5.50
2 Cardwell Taper-plate Condensers, Type 169E, 0.00035 Mfd.	9.50
4 Airgap Sockets	3.00
2 Amertran Deluxe Audio Transformers, 1st and 2nd Stages	20.00
1 Samson Output Impedance	5.00
1 Tobe Output Condenser, 4 Mfd.	3.50
1 Precise 55-mmfd. Regeneration Condenser, Type 940	1.50
1 XL Neutralizing Condenser, Type N	1.00
2 Samson No. 85 R. F. Chokes	4.00
1 Tobe Bypass Condenser, 1 Mfd.90
1 Electrad Royalty Variable Resistance, 0-500,000 Ohms, Type E	2.00
1 Electrad Filament Switch40
1 Electrad Grid Condenser, 0.00025 Mfd.30
1 Electrad Fused Metallic Grid Leak, 4 Megs.60
9 XL Binding Posts	1.35
1 Radion Binding-Post Strip50
2 Marco Illuminated Controls	7.00
2 Frost Pin Jacks30
1 Formica Panel 7" x 21" x $\frac{3}{16}$ "	3.00
2 Brachstats, $\frac{1}{2}$ Amp. and $\frac{3}{4}$ Amp.	2.00
1 5-Wire Fused Belden Battery Cable	2.00
Total	\$73.35



RADIO BROADCAST Photograph

THE DETECTOR AND AUDIO AMPLIFIER STAGES

On the end of the metal panel may be observed a single circuit jack. This jack replaces the two pin jacks which were formerly employed to obtain connection between the set and loud speaker

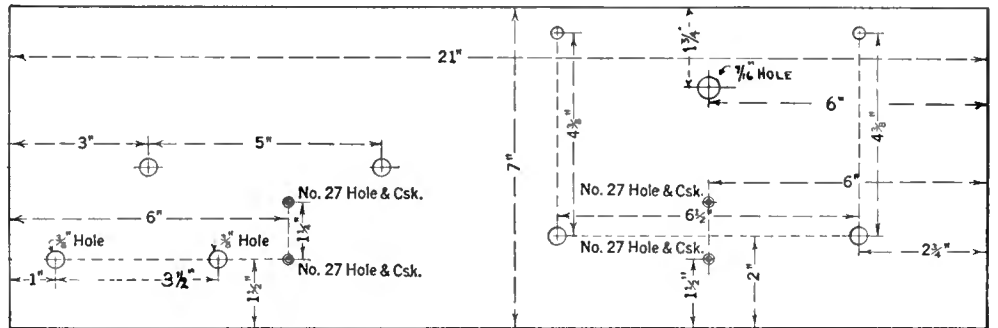

FIG. 7

The metal panel is drilled in accordance with the layout given here. Those holes, the sizes of which are not specified, must be drilled with a small drill first (No. 27) and then enlarged so as to either clear the mounting nut or just take the insulated bushings, as the case may be

an eight-tube super was here examining some remodelling we were doing on his receiver. We were trying out both sets together (super and R. B. 'Lab' receiver). Four feet of antenna wire were used. The R. B. 'Lab' receiver cut circles around the super, for both distance and volume!"

Mr. H. C. Sherer of Montclair, New Jersey, enthusiastically endorses the R. B. "Lab" receiver in the following words: "Your R. B. 'Lab' set is a handsome job. Quality is of the best and it is miraculous for selectivity considering but one stage of r.f. is used. I consider it the equal of any six-tube circuit."

*All the parts starred are retained from the former construction and may be satisfactorily employed in the improved four-tube R. B. "Lab" receiver.

LETTERS ABOUT THE "LAB" RECEIVER

IN COMPLETE justification of our faith in the circuit, letters of praise and commendation have been received testifying to its excellence of performance.

Mr. Harvey Merwin, of Jensen, Florida, built an R. B. "Lab" circuit receiver and among other things says: "I have just been listening to the Yale-Harvard football game through wjz using only four tubes." This at four o'clock in the afternoon, too. A receiver must be good to get through in this location. Mr. Merwin continues, "You folks are living in a radio paradise—ours is dx or nothing."

At another time Mr. Merwin had occasion to write us as follows: "You probably will think I am stretching the truth a bit but the owner of

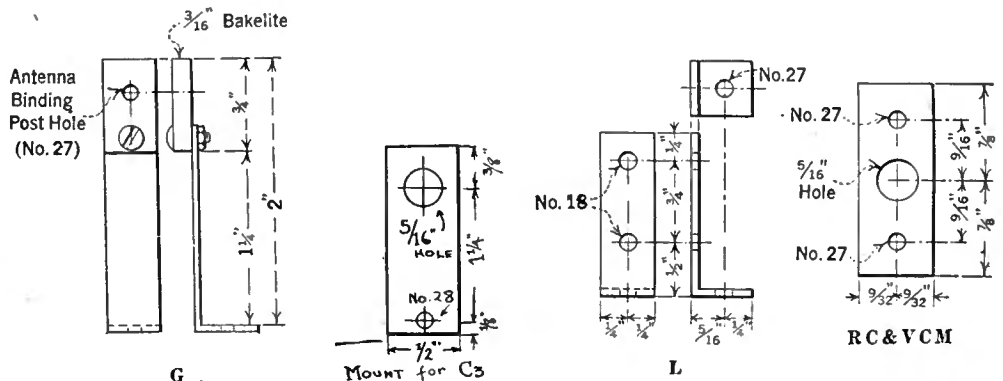

FIG. 8

Here are given the specifications for the various insulated mounts and angle pieces necessary for the assembly of the receiver. RC and VCM, shown at the right, is made of insulating material for preventing connection between the metal panel and the regeneration condenser and volume control. The mount for the condenser C₃ is constructed of brass strip, as is G and L.

Looking for Trouble?

When the Neighbor Calls Upon You to Overhaul a Recalcitrant Radio Receiver, Here Is the Way to Go About It in a Systematic Manner

By EDGAR H. FELIX

EXPERT diagnosticians in analyzing radio troubles are rare. The position of a radio oracle is fraught with danger. Reputations quickly fall by the wayside when friends and neighbors call upon "experts" to repair their sets. They expect that one look at an anemic receiver is sufficient to diagnose the trouble and that one telling flip of the screw driver is all that is necessary to repair it. But radio receivers are often mysterious in their ways. Even service men employed by radio dealers often find themselves stumped by the notorious stubbornness of radio sets out of order.

As an aid to unfortunates who, with or without reason, have attained reputations as radio experts in their circle of acquaintances, the suggestions which follow, for a systematic trouble search, have been prepared. Substituting this procedure for the haphazard hit-and-miss trouble hunt will enable you to maintain your reputation and dignity, and to go about the task of finding what is wrong with a radio receiver in a professional manner.

Briefly, a receiver out of order can be classified in one of the following groups:

1. Totally dead.
2. Signals weak but clear.
3. Signals accompanied by whistling and uniform distortion.
4. Reception accompanied by clicking, crackling noises.

A receiver is often classified as dead when it is merely in a state of coma. When you are unctuously conducted to a receiver reputedly dead, behave as you would in the presence of the dead. Turn on the A-battery switch gently, displaying no emotion or expectation that the tubes will light. If they light, you have already determined that the A battery is functioning and that the tube filament circuit is complete. Be sure that all the tubes light to a normal brilliancy though, before presuming this.

Continue your superficial inspection of the remains by pulling the loud speaker plug in and out. It there is a click as you do so, you may be sure that B battery current is flowing through the last tube circuit at least. If there are separate r. f., detector, and amplifier B battery leads, test the completeness of each of these plate circuits by clicking the leads from the batteries to the binding posts. This should give you healthy clicks if all is well with the A and B battery connections.

Next proceed to test the grid connections by tapping with your moistened finger the grid binding post of each tube, beginning with the last and working forward. If you secure clicks all the way through, it is a

sure indication that the grid-plate circuits are complete throughout. The nearest high-power broadcasting station should then be weakly audible. The clicks are evidence that the slight change in grid circuit capacity caused by your touch is sufficient to affect the output of the receiver.

These tests correspond to those of the physician who first looks at your tongue and then feels your pulse. Sometimes this superficial examination leads to important evidence, confining your trouble hunt to one particular tube circuit. It is hardly necessary to explain what to do if the tubes do not light or if clicking one of the plate potential leads causes no sound in the loud speaker, for this definitely confines your trouble search to the power-supply circuit.

If the superficial inspection yields no conclusive evidence, check up the voltage of the A, B, and C batteries with a meter, and note the polarity of their leads and inter-battery connections. If these prove to be connected correctly and deliver the requisite voltage to the set, but still no signal or receiver noise can be induced from the recalcitrant radio device, it is a good time to remember an important appointment elsewhere and leave the premises forthwith! The chances are that a broken wire or short-circuit has put the receiving set out of business. Professional service men, discovering this to be the case, usually subject the tubes to test and, if they find the tubes are good, take the receiver to the repair shop. Undoubtedly the set requires a tracing of its wiring, a tedious task not likely to be appreciated by an ordinary broadcast listener as a manifestation of expert technical knowledge.

Receivers equipped with a headphone jack give one more point of test before this difficult process or flight must be undertaken. Listen-in with the headphones or, if they are not available, plug the loud speaker in the headphone jack. If good reception is secured through the headphone jack but not through the loud speaker jack, trouble is definitely restricted to that part of the circuit which comes after the first jack. A burned-out transformer, a broken lead, or a defective coupling resistance in the audio ampli-

fication system are then likely causes of the receiver's infirmity. If headphones in the loud speaker jack give a very loud signal on local reception, but the loud speaker does not make a sound in that position, the fault is, by this evidence, confined to the loud speaker, its leads, or the loud speaker plug. Examine the loud speaker wiring, including the flexible cord near the plug and the speaker itself. With sets giving excessive current output, loud speaker windings are sometimes burned out, although sets with moderate power rarely cause loud speaker burn-outs.

With receivers of the neutrodyne or radio frequency type, it is often possible to localize the trouble in a defective r. f. stage to the particular tube circuit out of order. This is accomplished by disconnecting the antenna lead and applying the antenna input direct to the detector circuit. A convenient place to make this connection is at the plate socket terminal of the final radio frequency stage. If signals are now heard, though the receiver is silent with the antenna connected to its regular binding post, it is a sure indication that the trouble lies within the r. f. amplifier circuit. The antenna should next be connected to the plate post of the preceding r. f. tube. If signals are still heard, it is definitely established that the fault is in the 1st r. f. circuit (in a circuit with two r. f. stages). If no signals are heard with the antenna in the latter position (yet they are heard with the antenna on the second r. f. tube plate), the fault is necessarily in either the first or second r. f. amplifier circuits.

The work of tracing the wiring is materially reduced by confining the trouble to a single-tube circuit as outlined above.

If it is necessary to trace the set's wiring, disconnect the set from its power source and antenna system and follow the wiring logically through from circuit to circuit. Begin with the antenna system, the first grid inductance, the plate circuit of the first tube, the input circuit of the second, and so on until the end. A short-circuited grid inductance, for example, does not affect the continuity of any of the circuits (superficially dismissed by the click test) but may completely eliminate signals.

An open in the antenna circuit, with a receiver located far from any broadcasting stations, may manifest itself as a dead receiver so far as signals are concerned and yet show adequate A, B, and C power, and otherwise complete connections. Receivers of a hundred miles range or more reproduce the familiar atmospheric noises even without antenna connected. Consequently, a receiver is not likely to be classed as "dead" when in working order by reason of antenna or lead-in breakage.

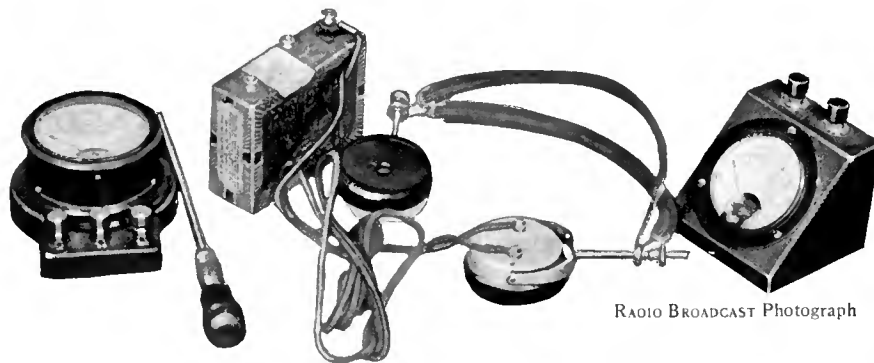

RADIO BROADCAST Photograph

TESTING EQUIPMENT

A few of the pieces of apparatus which come in handy for testing a receiver for faulty operation. The battery and phones are largely employed to test continuity of circuits by the click method. The milliammeter shown at the extreme right, if connected in series with the battery and the circuit to be tested, will give a visual indication. The voltmeter is handy for checking voltages of batteries



RADIO BROADCAST Photograph

TESTING THE R. F. STAGES

You can readily tell whether or not the radio frequency stages of your receiver are supplying noticeable gain over preceding stages by touching the antenna lead to the grids of the various r.f. tubes

A pair of phones and a C battery are valuable equipment for tracing circuits, especially in finding breaks in pigtail connectors and in testing the continuity of inductances. It is advisable not to undertake more than the superficial tests suggested in the set owner's home. Tracing all circuits with the aid of phones and battery, and detailed examination of the set, is a matter for the laboratory or repair shop.

WEAK SIGNALS

PROCEEDING to the receiver with weak signals, the obvious and most frequent possibilities are run down plate power supply or worn out tubes. The only way to test the power supply properly is with a voltmeter of adequate range. Tubes must be tested with a tube tester or else a complete set of borrowed tubes, known to be in good condition, substituted. If substitution remedies the set's weak volume, the cause of trouble has been determined as run down tubes.

But there are other causes. Weak signals caused by a broken ground or antenna lead-in are always accompanied by exceedingly sharp tuning, both because of the removal of antenna circuit resistance and the increased regenerative action therefrom. A break or disconnection in one of the grid circuits, a gang condenser slipped off tune, or a poor contact of a tube grid pin with its spring in the socket, are likely causes of weakened signals.

WHISTLING

WHEN reception is accompanied by a steady whistle, the nature of the whistle should be carefully analyzed before conclusions are reached. Determine first whether the whistle is entirely independent of tuning or whether it occurs only when the receiver is in resonance with an incoming signal. If it occurs all over the dials, a likely cause is a defective grid leak or a reversed or run down C battery. On the other hand, if it occurs only with a certain station, the cause probably lies outside of the receiver. Heard only when in resonance with a station, especially at the lower end of the dial scale, it may be due to the fact that the receiver has become regenerative. Radio frequency receivers of all types depend for absence of regeneration upon some method of balancing out or resisting the tendency toward regeneration. These systems may be upset by large changes in coupling of the plate potential source, whether of the B battery or line supply type. Since the B battery is

common to all plate circuits, they are coupled through it. A run-down B battery, or a softened rectifier tube in a line power-supply device sometimes causes a shrill whistle.

Sometimes a neutralized receiver becomes regenerative even though the plate potential source is in good shape. This may be due to changes in tube characteristics or in the adjustment of neutralizing condensers. By reducing the filament brilliancy gradually when tuned to a near-by high-power station, the signals may become clear although weak after a certain point in filament reduction. This indicates that the receiver needs re-neutralization. A dead C battery sometimes makes a terrifying and omnipresent whistle.

A whistle which discontinues entirely when the detector tube is removed is very possibly caused

by a defective grid leak. Moisture and temperature conditions sometimes cause grid leaks to deteriorate.

Clicks when a receiver is touched or jarred slightly, indicate a loose wire or a defective tube. Observe whether the click has a ringing quality or whether it is fairly regular and sharp. The ringing quality generally indicates a microphonic tube while harsh clicks accompany broken wires or loose connections. When tracing connections examine first the battery leads and loud speaker cord, then remove and restore the tubes one at a time to confine the break to a single tube circuit. If you find the receiver silent when all the tubes are in except one, the chances are your break is in that particular tube circuit. An exception is the output tube of the receiver, the removal of which silences clicking because there is no plate current through the loud speaker circuit. Its functioning can be checked through the phone jack. If reception is quiet and satisfactory through that jack, the break lies in the amplifier or its special power supply.

Steady clicks experienced with mathematical evenness, unaffected by "jiggling" the receiver, are due, most frequently, to defective grid leaks.

When looking for a broken wire, first check the power input connections, antenna lead-in, ground wire, and examine the leads to the rotors of the variable condensers, variometers, and couplers.

A click heard at a certain position of the tuning dial is obviously caused by touching condenser plates or weakened rotor connections at that particular adjustment.

The essential equipment of the trouble hunter includes a voltmeter covering the full range of A and B battery voltages, some means of testing tubes or a set of replacement tubes for comparative purposes, pliers, screw driver, a set of headphones, and a flashlight for examination purposes and its use in supplying a convenient means of testing completeness of circuits with headphones in series with one of the cells.

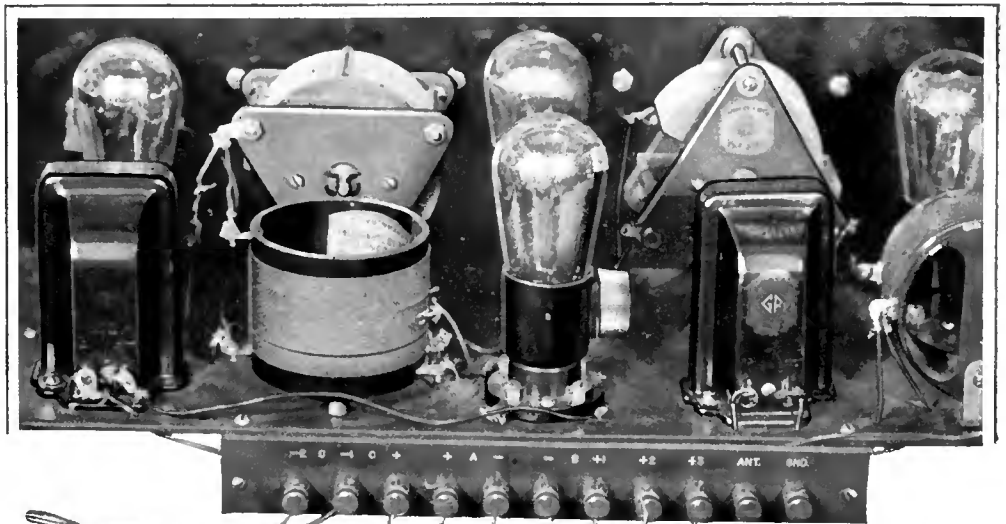

RADIO BROADCAST Photograph

TESTING THE PLATE CIRCUITS

One way to determine whether the various plate circuits of the audio channel are complete is to unfasten one by one the B battery leads from their binding posts and touch them against the posts. If the circuit is complete a click will be heard each time in the loud speaker

THE LISTENERS' POINT OF VIEW

Conducted by John Wallace

Much Sound and Fury About Radio Education

MR. ZEH BOUCK, in his column in the *New York Sun*, "What are the Air Waves Saying?" attacks our attack on radio education in the October number and conclusively proves that several conclusions we did not wish to draw are utterly false and incompatible with even a moron's reason. He did this in such excellent and devastating fashion that we were greatly relieved that we hadn't actually advocated all the things he objected to!

Mr. Bouck took up two statements we made in the article, viz: that an educated man is a disciplined one, and that the well informed man is not necessarily well educated, and informed his readers that "in these two rash assumptions Mr. Wallace has considerably and effectively committed suicide; for the arguments contradict each other and demonstrate the general untenability of his stand. Then Mr. Bouck kindly and considerably did a little suiciding himself by refraining from evidencing wherein the second statement was untenable or how the two were in conflict.

To support his disbelief in "discipline" he rang in the aid of Messrs. Plato and Spencer, with which two eminent gentlemen we do not intend to engage in controversy in a public print. However, towards the end of this article, Mr. Bouck becomes more convincing and very persuasively presents the side of the believers in radio education:

Of course Mr. Wallace is right when he says that broadcasting does not educate, but merely informs. But he might have said the same of books, colleges, and life itself.

Education is something entirely within ourselves, and consists of arranging and rearranging all the information we assimilate into logical interrelations. Education is the process of making philosophy out of knowledge. An education is, therefore, a subjective edifice constructed of objective materials supplied by books, life, radio broadcasting, and academic instructors. In a limited sense, any one of these factors may be considered as educating or educational, with radio by no means placed last in effectiveness.

We particularly emphasize the educational possibilities of broadcasting because of the complete absence of disciplinary imposition. The information imparted by radio comes to us, for the greater part, in the guise of entertainment. Sugar coated, it is assimilated effortlessly by the listener, his mind, in the repose of recreation, highly receptive to thoughts and ideas that strike a sympathetic note in his mental symphony.

It is almost needless to say that the effectiveness of broadcasting as an educational factor depends largely on the broadcasting station; and as yet no station has done more than a partial justice to these possibilities.

Referring to Mr. Bouck's first paragraph, we will gladly say the same thing about "books, colleges, and life itself"—and here it is: they do not educate. Education is the result of the inherent, latent capacity of any given mind to become educated. An individual possessing such a mind will inevitably become educated. He will arrange and rearrange all the information he assimilates into logical interrelations. He will assimilate this information from any and every source, including radio broadcasting. But what of any depth, or subtlety or complexity or real meaty value will he ever hear in a radio lecture?

Moreover—he is a rare bird! There is not more than one of him in every thousand radio listeners. Thus it is ridiculous to claim that lecture broadcasts are "educating" when they are failing to "educate" 999 out of every thousand persons who hearken to them. It would be just as reasonable to claim that a palsied marksman was a "crack shot" because he at one time shattered one clay duck out of eighty.

How a Great Symphony is Broadcast

EIGHT microphones are used in sending out the series of twenty-four Saturday evening concerts which are broadcast by the celebrated Boston Symphony Orchestra through arrangement with W. S. Quinby, of Boston, through wbx and the "blue" chain network, including wjz, wgy, and wrc. While two sets of three microphones each have been installed in the hall for picking up the music, only one set is used during a single broadcast. The second or emergency set of three microphones is installed so that immediate switching may be accomplished in case of trouble with the first set. The other two microphones used in this broadcast are installed in the control room in the wbx broadcasting booth at Symphony Hall where the operators and announcers monitor all the programs.

For picking up the music of the orchestra, two microphones have been suspended from the ceiling on each side of the hall slightly in front of the stage, and another is set up on a stand on the floor of the hall directly in front of the conductor's platform. The emergency set has been installed in the same manner and requires only the throwing of a switch to transfer from one set to the other.

The musicians check for poor musical balance and the operators guard against poor mechanics in the broadcast.

The specially constructed booth containing the amplifying apparatus, announcers' microphones, and associated control instruments is located at the rear of the hall over the stage. This room is soundproof so that good monitoring by the operators may be done. A very small window in the proscenium enables the announcers to watch constantly the orchestra conductor so that special announcements may be made from time to time without interrupting the music.

Two specially constructed wire lines connect Symphony Hall with the central control room of wbx in the Hotel Brunswick. One pair of wires is normally used for the broadcast and the other for the operators to communicate over. Both lines, however, may be used for broadcasting. At wbx, another operator checks the programs thus further reducing the chances of poor broadcasting. The concert is put on the air from wbx and at the same time sent over wire lines to wbx at Springfield. At Springfield it is re-amplified and put on the air from wbx. Additional wire lines with amplifiers at Waterbury, Connecticut, connect the Springfield control room of wbx with the central control room of wjz in New York.



GERTRUDE O'NEILL GANLEY
Impersonator; one of the most popular entertainers heard from wcco, Minneapolis

The program is split at wjz, one pair of wires feeding the music to Schenectady where wgy sends out the concerts and the other line carries the music to Washington, District of Columbia, where it is sent out through wrc.

Nearly two hours before the start of each Saturday evening concert, the engineers of the Westinghouse station test the various broadcast controls. One operator tests the microphone circuits through to the amplifiers. Another tests out the wire lines connecting the stations on the chain for the evening by putting musical tones varying in pitch from low to high frequencies over the lines. All corrections are thus made before the start of the broadcast to assure the desired intensities. A few seconds before the opening symphony announcement is to be made, the operator at the hall signals the various station operators for "the air." Then the control is given to the symphony announcer who has full charge of the chain for the remainder of the broadcast.



BROADCASTING THE BOSTON SYMPHONY THROUGH WBZ

The Symphony Hall studio of wbz, showing the control panels and microphone set-up for the broadcasting of the Boston Symphony Orchestra. Standing, left to right: W. S. Quinby, the public-spirited citizen who sponsors the programs; Alwyn E. Bach, wbz announcer. Seated, foreground: Professor John Patten Marshall, of Boston University, who gives interpretative talks before the selections; D. A. Myer, engineer in charge, wbz, and G. W. Lang, assistant chief operator

Overlapping of First Rate Program Features Should Be Avoided

ENTER Messrs. Alphonse and Gaston! Accompanied by sundry bowings and scrapings, the radio stations are beginning to defer to one another. True they have done so before in matter of lending time to sister stations for some special broadcast where both share a wavelength. But now we find them altering their programs to avoid competition with some particularly good feature offered by a rival station.

Thus it was that WRNY shifted its New York Edison Hour back thirty minutes to avoid overlapping the Eveready Hour of WEAf. And wjz, back in the football season, cancelled its broadcast of the popular Yale-Princeton game upon learning that WEAf was to do the job and made last minute arrangements to broadcast the Army-Notre Dame game instead. Other instances have occurred.

This evidences a noble and magnanimous spirit on the part of broadcasting stations and likewise a very practical one, for it seems reasonably certain that a few really "high-powered" weekly features have built up a reputation that enables them to enjoy a monopoly on a majority of the listeners' ears during their specified hours of broadcast. This must mean that a station offering something new and good during one of these reserved hours is taking a long chance

on having its effort properly recognized. For instance, if we were an eastern station and were about to spring a new and expensive high-brow feature on the Sunday night listeners we should hesitate a long while before billing it for 9:15 P. M. for the Atwater Kent Hour has, we suspect, a monopoly on the high-brow listeners for that period.

This problem of duplication is not a very serious one at present for there aren't so many not-to-be-missed features that they can't all manage to fit themselves nicely into the week without treading on one another's toes. But, if the amazing rush of indirect advertisers to the broadcasting studios, and their profligate handing out of money to first rate artists continues, not many years will go by before we will find ourselves confronted, during certain nights of the week, with more good things than we can hearken to with only one set of ears.

If the broadcasters can be persuaded to spread them out through the whole week and over the less desirable hours it will be so much the better

for us, the listeners. Under such an arrangement, priority should be the arbiter and an advertiser who has uninterruptedly furnished a first-class program over a period of years should not be interfered with. Not only as a matter of polite respect to seniority but as a matter of business: for if several advertisers pick on a highly desirable Sunday night period they will find themselves engaged in terrifically expensive competition; to outshine one another in a scramble for listeners they will be forced to either spend more money than the publicity is worth or drop out of the race.

Broadcast Miscellany

WBMM, bless its heart!, one of the foremost of the low-brow stations, has decided to get itself up in the world and is doing a little cultural climbing. Its efforts, while distressingly sincere, are at times even



THREE RADIO PERSONALITIES

Left to right: Louis Meehan, George Junkin, and Fred Smith. Louis Meehan, unheralded by press agents, slipped on to the vocal staff of KYW in Chicago and we find him one of the three or four best radio tenors. George Junkin is director-manager of KMOX, "The Voice of St. Louis." Fred Smith has again resumed his duties as director of WLW, Cincinnati, after an absence of a year

TELL US WHAT YOU LIKE IN RADIO PROGRAMS

IF YOU have not already sent in your reply to the questionnaire, which was printed in the January RADIO BROADCAST, it is reprinted below. A large number of extremely interesting replies to our questions have already been received and the large mass of material is being tabulated as rapidly as possible.

Many correspondents suggested that space should have been allotted for a list of radio features that are distinctly unpopular with listeners. Expressions of that sort of opinion are always welcome to the conductor of this department. However, it was felt that there was a sufficiently wide range of subject covered in the present list.

While the names of readers of this magazine who are good enough to trouble to reply to these questions will be kept confidential, it will be of considerable assistance if those who reply to this questionnaire will include their name and address.

In replying to question four, please indicate definitely the title of a special part of an evening's broadcast, defining it by the title of the program. Some replies to this question merely indicated the call letters of a favorite station, which is, obviously, pretty indefinite.

The questions below are few, and some of them have the special virtue that they have never been asked before. Please use the space provided for your answers. Tear this sheet from the magazine, and if possible typewrite your replies. If the space provided is not sufficient, attach an additional sheet to this with your remarks. If you are interested in reading the replies—contribute some yourself. Address all questionnaires to

JOHN WALLACE,
RADIO BROADCAST,
Garden City, New York.

Please Answer These Questions

1. Do you listen to your radio evenings as you would to a regular show, or do you simply turn it on and use it as a background to other activities?

(This question may seem silly, but we ask it because we have a growing suspicion that radio programs aren't as reverently listened to as the broadcasters suppose.)

2. Do you regularly tune-in on distant stations or do you regularly rely on your local stations?

(They tell us that the DX hound is a fast-disappearing breed. Is he?)

3. If you had a hundred minutes to listen to all, or any part of the following broadcasts, how would you apportion your time? (Answer in spaces provided in the next column.)

Instrumental Music	} <i>Serious</i> — minutes <i>Light</i> — minutes <i>Popular</i> — minutes	
Vocal Music		— minutes
Radio Play		— minutes
Speech		— minutes
Educational Lecture		— minutes
Miscellaneous Novelties		— minutes
TOTAL		100 minutes

(In answering this question, assume that each of the offerings is the best of its kind, say Coon-Sanders Nighthawks for the jazz, the New York Symphony for classical music, Ford and Glenn for the novelties, and so on.)

4. What are the six best broadcasts you have heard?

(We could refresh your memory with some notable broadcasts, but that might influence your choice. Anything is eligible, from an especially good dog fight broadcast, to a high-powered soprano solo, heard four years ago.)

Please answer these questions briefly and mail them at once to Mr. Wallace, at the editorial offices of RADIO BROADCAST, Garden City, New York. We prefer to have you write your replies on this page. The results of the questionnaire will be announced just as soon as it is possible to compile them.

droll. Witness: Its Tuesday night feature is proclaimed as "An Hour with *Ultra-Modern Composers*," which same "ultra" individuals turn out to be such old standbys as Tschai-kowski, Rachmaninov, and Saint Saens! The announcer was doing his best to give some informative remarks about Ravel (who was evidently about as familiar to him as the Chinese coinage), and assured us that he had once won the "Prix de Rome"—the first word being pronounced as in pins and needles.

WBBM is an excellent station in kind and immensely popular with the mass of listeners around Chicago, but we wish it would be itself. Its sub-title is an ingenious one, easily the best of all the station "slogans." It calls itself WBBM—The Stewart-Warner Air Theatre."

EMASCULATING NEWSPAPER PROGRAMS

AT A recent meeting of the Publishers Association of New York, a set of rules was adopted designed to eliminate free advertising in radio programs. Edwin S. Friendly, business manager of the New York *Sun*, was appointed censor to see that the rules are followed. All names of advertisers or possible advertisers and their trade-marks are to be eliminated from the radio programs published each day in the papers. This step, we suspect, will go far to alienate the general reader of the newspaper and to bring nearer the day when a national radio program paper, sold on subscription, will be widely circulated.

AND NOW THE CLEVELAND SYMPHONY

THE entire winter series of Thursday night symphony concerts by the Cleveland Symphony Orchestra is to be broadcast through WTAM. Those yet to be heard fall on January 13 and 27, March 3 and 31, and April 21. The Cleveland orchestra has never previously been heard in a full symphony program through any broadcasting station. Some four years ago part of a program was broadcast from the Masonic auditorium by WJAX, predecessor of WEAR and WTAM. Since that time, many efforts have been made to arrange for broadcasting of the orchestra's concerts, but until the present contract was made, there had been no broadcasting.

Under the new arrangement, the broadcast is sponsored by the Sandusky Cement Company which places \$1000 to the credit of the orchestra's maintenance for each concert and also a fee to WTAM to compensate for time in the air and telephone line charges in connection with the broadcast. The series, as broadcast, is known as the Medua Concerts. WTAM forwards to its listeners an excellent booklet containing the program and notes shortly before each concert.

WEEKLY RECITALS WORTH HEARING

WORTH your attention is the series of weekly musicales of the Adolph Lewisohn Course in Appreciation of Music broadcast by WNYC from Hunter College on Wednesday evenings at 8:30 (EST). These musicales are under the supervision of Dr. Henry T. Fleck of Hunter College. The works of one or two of the standard composers are discussed at each of the sessions and performed by some chamber music organization.

A GENUINELY BAD "REGULAR FEATURE"

THE Champion Sparker's program broadcast by WJZ, WGY, WRC and WBZ on Tuesday nights bids fair for the honor of being the worst of all the indirect advertiser's programs. This, you may recall, is the feature which affects singing announcements, the which is done by Milton J. Cross. The announcements are not bad, if rather silly, but the band introduced is terrible.

Its ailment we shall not attempt to diagnose; perhaps it's simply loose-jointed. The solos and duets with which the program is interspersed are uneven in quality with only a very occasional good number supplying the necessary crests to the unevenness.

ALL RIGHT FOR THEM AS LIKES IT

ANOTHER wjz offering in which we take a little delight is the Thomas Cook and Son travelogue series. It appeals to us as a grand waste of time. Not that we dislike travelogues; a sure enough travelogue with either "still" or moving picture illustrations may be interesting as well as instructive. But the radio travelogue's method of illustrating the scene under discussion with a tune strikes us as being far fetched. The melody, no matter how well selected, seldom has much connection with the site to which it is attached. There is no guarantee that the associations a particular song has for the arranger of the program are the same for each or any of his listeners. For instance, in our alleged mind, the Song of the Volga Boatman is inseparably associated with—not a winding stream in Russia—but garlic. (Which was the burden of the breath of the person who sat next to us when we first heard it at the *Chauve Souris*.) So the travelogue program resolves itself into two distinct, and in our opinion, unconnected parts: a series of tunes, and a series of episodic descriptions. Why not just the tunes—or just the description? Or preferably neither?

But somebody must like the things or they wouldn't still be going on, so we will cease quarreling with them and merely refrain from listening to them. In fairness to the Cook travelogues, they're not half as dull as the score of lesser imitations to be heard from various stations throughout the country.

ONE of KOKA's regular weekly features is "Teaberry Time," which is to be heard Fridays from 9 to 10 P. M. It is a potpourri of orchestral selections, vocal solos, and quartets and monologues. The whole is alleged to be bound together by a slight yarn. The yarn might just as well be omitted.

FOR the afternoon listener within range of Chicago, the firm of Lyon and Healy offers a series of recitals introducing young local artists at 2:30 in the afternoon of each week day, and they are broadcast by WGN.

WMAQ and WLS of Chicago have got together for the joint presentation of a light opera company recruited from both studios. So far they have presented "The Mikado," "The Pirates of Penzance," "The Bohemian Girl," and "The Chimes of Normandy,"—and all in excellent fashion.

WLS swears up and down that a twenty minute sermon broadcast by one Samuel R. Guard in connection with its "Little Brown Church in the Vale" drew ten thousand three hundred and forty-one (10,341) letters of appreciation! Which leaves us with nothing whatever at all to say.

ANOTHER series of Sunday afternoon concerts is that of the Atlanta Symphony Orchestra as presented by WSB. And in case you can "get" WSB in broad daylight, they are to be heard at 3:30 P. M. Eastern Standard Time.

BROADCASTING of investment talks has been inaugurated by the Cincinnati Better Business Bureau. These talks are five minutes in length and are broadcast from WSAI every Thursday evening at 6:40.



THE HARTT HOUSE STRING QUARTETTE

This quartet is established at Hartt House, the art and recreational center of the University of Toronto. From left to right: Geza de Kresz, first violin; Milton Blackstone, viola, and Harry Adaskin, second violin. These musicians have been together for three seasons and have achieved great success in chamber music. By special arrangements with the syndics of Hartt House and the radio department of the Canadian National Railways, these artists are broadcasting a series of recitals at the various Canadian stations

Practicable Applications of Some New Equipment

An Explanation of the Uses and Functions of Various Pieces of New Apparatus Submitted to the Laboratory for Test

By THE LABORATORY STAFF

IT IS the purpose of this department to explain more fully than is possible in the monthly "New Apparatus" pages the uses and adaptations of some of the equipment illustrated thereon. That these "New Apparatus" pages are received with considerable interest by our readers is attested by the numerous letters received that request more information about the various pieces of apparatus listed. While it is not possible to explain at length the functions and theory of every "gadget" shown, an endeavor is being made here to place before the reader brief yet accurate and lucid information pertaining to that equipment which is likely to attract the greatest interest.

GANG CONDENSERS

THERE have been many requests for information as to how the new ganged tuning condensers, such as those made by the Alden Company, and which are illustrated in Fig. 1, should be connected in a circuit. The questions regarding the use of these gang condensers generally arise from the fact that the grid return to the detector tube must connect directly to either the positive or negative terminals of the detector tube whereas the grid returns of the radio frequency amplifiers quite frequently connect to a C-battery. If then, all the grid returns were connected together to the common shaft of the gang condenser, it would not be possible to obtain different bias on the r.f. tubes than on the detector. In order to overcome this difficulty, a special arrangement is necessary. The necessary circuit can be seen by referring to Fig. 2. It should be noted that the rotor plates of the variable condensers, which in a gang condenser are, of course, all fastened to the common shaft, are connected to the low-potential sides of the various radio-frequency transformer secondaries, with the exception that the low-potential side of the coil connected in the grid circuit of the de-

tor tube does not connect directly to the rotor plates, but is connected to the positive filament, thus obtaining a desirable positive bias. A bypass condenser is incorporated in the circuit so as to make it unnecessary for the radio frequency energy in this circuit to pass through the A and C batteries. The arrangement shown is only one of several possible circuits that might be used. An Alden "four-gang" condenser unit

grid circuit of the tube, for such an impedance has a very low resistance to the flow of direct current although its impedance to the flow of alternating currents is very high. The amplifier is arranged so that it can be easily connected to any receiver, and instructions are enclosed with the unit so that anyone purchasing the device should have no difficulty in obtaining satisfactory operation. The same batteries are used to operate the amplifier as are used to operate the radio receiver. A unit such as the Truphonic is to be recommended since it affords an easy means whereby any home-constructor can add a complete amplifier to his receiver and do it with a minimum of trouble. The amplifier unit is entirely complete and includes the sockets, rheostat, and a special cable for connecting it to the batteries. A power tube should preferably be used in the output stage, with proper B and C batteries. The Truphonic amplifier was listed in the December RADIO BROADCAST "New Apparatus" pages.

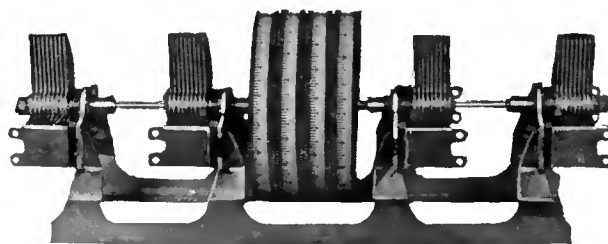

RADIO BROADCAST Photograph
FIG. 1

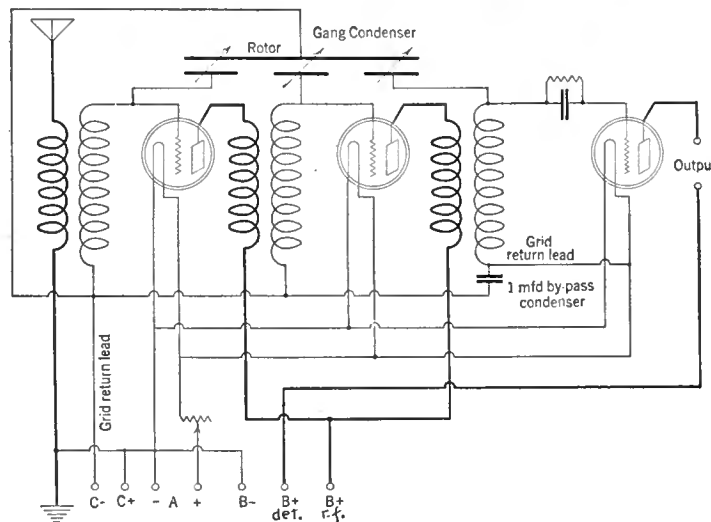

FIG. 2

was listed in the "New Apparatus" pages last month.

THE TRUPHONIC AMPLIFIER

ANOTHER unit made by the Alden Company is the Truphonic amplifier, which is shown in Fig. 3. It consists essentially of a three-stage amplifier similar in design to double-impedance amplifiers, using choke coils in both the plate and grid circuits. This type of amplifier is preferable to one using ordinary grid leaks in the grid circuits in that there is no tendency for the grids to block on strong signals as they would if high-resistance leaks were to be used. The blocking is due to the grid current, which does not have time to leak off through a high-resistance leak. However, the grids cannot block with a properly made impedance in the

THE MILLEN AMPLIFIER

ANOTHER ready-made unit is the Millen resistance-coupled amplifier illustrated in Fig. 4, particulars of which were given in the January "New Apparatus" pages. This unit is also equipped with a cable, and it can, of course be operated from the same batteries that are used for the remainder of the receiver. All types of tubes may be used, it merely being necessary to insert the correct size of filament-control resistance for the tubes being employed. High-Mu tubes should preferably be used in the first two stages. This amplifier will require somewhat higher plate voltages on the first two stages than is required by the Alden Truphonic; 90 volts is sufficient for the Truphonic while 135 is preferable on the resistance amplifier. However, the B-battery current consumption of a resistance amplifier is less generally than that of other types.

The amplifier incorporates several other worth



RADIO BROADCAST Photograph
FIG. 3

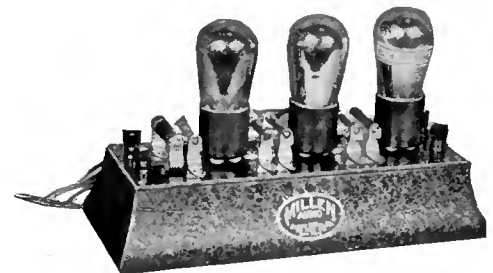

RADIO BROADCAST Photograph
FIG. 4

while features. In the first place, it contains a radio frequency choke in the input circuit to keep the r.f. energy out of the amplifier. This choke, essential in receivers using a condenser to control regeneration, makes the amplifier suitable for use in conjunction with such as the RADIO BROADCAST two-tube "Lab" and the new "Universal" receivers. The first stage is impedance-coupled (we should really call this unit an impedance-resistance amplifier) so as to permit the use of the new 200-A detector tube, the plate current of this tube being too great to pass through an ordinary resistor. Quite fre-



RADIO BROADCAST Photograph
FIG. 5

quently amplifiers of this sort have a tendency to "motor boat" when used with B power-supply devices, and to eliminate this action, a choke coil is connected in the grid circuit of the last tube. And finally, the output circuit includes a condenser-choke circuit so as to permit the use of a 171 tube and high B potential without the necessity of purchasing any extra apparatus to eliminate the direct current from the loud speaker windings. The amplifier is constructed on a cast iron base of very sturdy construction.

REACTIVATING TUBES

MOST of the tubes now in common use are of the thoriated filament type, and it is frequently possible to reactivate these tubes after they have lost their emission qualities. The Jefferson Electric Manufacturing Company has placed on the market the Jefferson radio tube charger with which it is a simple matter to reactivate any type of tube. This instrument was listed in the December RADIO BROADCAST, and is here shown in Fig. 5. If one desires, the terminals on the tube charger may be connected directly to the A-battery terminals on the re-

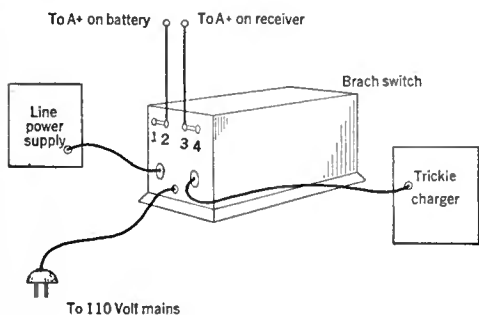

FIG. 6

ceiver, care being taken to disconnect all of the B batteries first. If it is desired to reactivate all of the tubes, they may all be left in their sockets and reactivated at once, or only one tube may be left in the receiver at any one time. There are two sets of terminals, one set marked L and the other set marked S. For storage battery type tubes the L terminals are used, while for dry cell tubes the S terminals are used. There is a small switch on the front of the unit one terminal

of which is marked F and the other B. Throwing the switch on the F terminal places high voltage on the tubes and this high voltage is left on the tubes for 45 seconds. This procedure is called "flashing." The switch is then thrown on to the B terminal and the tubes permitted to "cook" for at least ten minutes. This treatment will generally make old tubes perform very much better. The reactivating process is so easily carried out and is generally so effective that it is always worth while to try reactivating old tubes before discarding them. RADIO BROADCAST Laboratory Sheet No. 21 gave some useful information relative to reactivation, while some actual data on the plate currents of rejuvenated tubes may be found on page 662 of the April, 1926, RADIO BROADCAST.

AN ELECTRICALLY OPERATED SWITCH

The Brach Manufacturing Company's "Controlit" (Fig. 7) is a special switch designed for use in conjunction with a receiver when the set is supplied with plate current from a line power-supply device and a trickle charger is used in conjunction with the storage battery. When the filament switch on the receiver is thrown to the "on" position, this Brach switch functions to turn off the trickle charger and turn on the power-supply device. When the filament switch is thrown off, the power-supply device is auto-



RADIO BROADCAST Photograph
FIG. 7

matically disconnected from the mains and the trickle charger turned on. The connection of the device to a typical installation is shown in Fig. 6. The switch can be adapted to either dry cell or storage battery type receivers by altering the connection to the binding posts on the front.

The device consists of an electro-magnet, to the armature of which is fastened the center blades of a double-pole double-throw switch, as shown in Fig. 8. These two center contacts, fastened by an insulating member to the iron armature, are connected to the a.c. supply. Without any current in the coil, a spring pushes these contacts against the two outer contacts which are connected to the trickle charger, and, of course, the battery will begin to charge. This is the position of the switch when the radio receiver is not being used.

The coil of the electro-magnet is connected in series with the plus A lead so that, when the filament switch is turned on, the filament current for the tubes flows through the coil, energizes the magnet, and the armature is pulled over to the core. This opens the trickle charger circuit and connects the a.c. line to the other two contacts which then supply current to the line supply device connected to them. It is evident that the switch does not require any extra energy to operate it, since the filament current is utilized to supply the coil current.

A switch of this type makes a modern radio installation practically automatic in operation. Filling the storage battery with water when necessary, is all the attention that need be given it.

OUTPUT DEVICES

THE Technical Information Service has answered a great many inquiries as to how an output device should be used in conjunction with a 171 tube if a high plate potential is employed, to eliminate the direct current in the plate circuit from the windings of the loud speaker.

There are two general types of output devices — transformers and choke-condenser combinations.

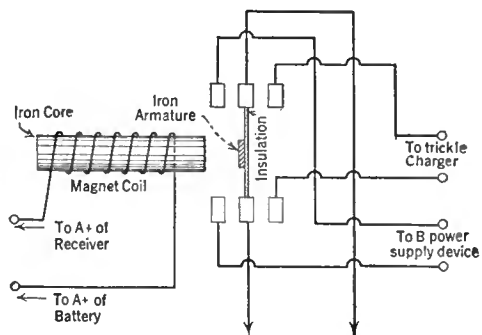

FIG. 8

Until quite recently it was necessary to purchase, separately, a choke and a condenser, and to then place them in circuit as shown in Fig. 9. Now, however, several companies have placed on the market tone filters or speaker filters, as they are sometimes called, which consist of a choke and condenser assembled into a simple unit. The Mayolian tone filter illustrated in Fig. 10 (extreme right) is especially suited to those receivers into which a 171 power tube has been incorporated, with the high value of plate potential, but in which there is no room to place an output device. To install the device it is merely necessary to attach a telephone plug to the extension cord on the filter and to place the plug in the output jack of the receiver. The loud speaker is then connected to two binding posts on the filter. The General Radio Company also puts out an output unit device which is illustrated in Fig. 10 (second from left). It has four terminals, number 1 and 2 being the input and numbers 3 and 4 the output. The National Company's output filter (third from the left in Fig. 10), and the "Orthophone" filter, made by the Amsco Products Incorporated, are also illustrated.

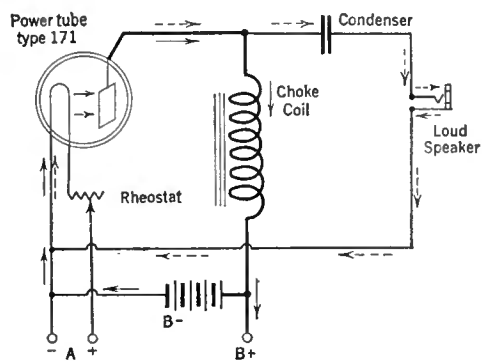

FIG. 9

In Fig. 9 the solid arrows show the path of the direct current and the dotted arrows the path of the alternating or signal currents when an output device is employed. The direct current does not pass through the loud speaker windings but passes from the plate through the choke coil to the battery, whereas the signal current passes from the plate through the condenser and loud speaker back to the filament. The elimination

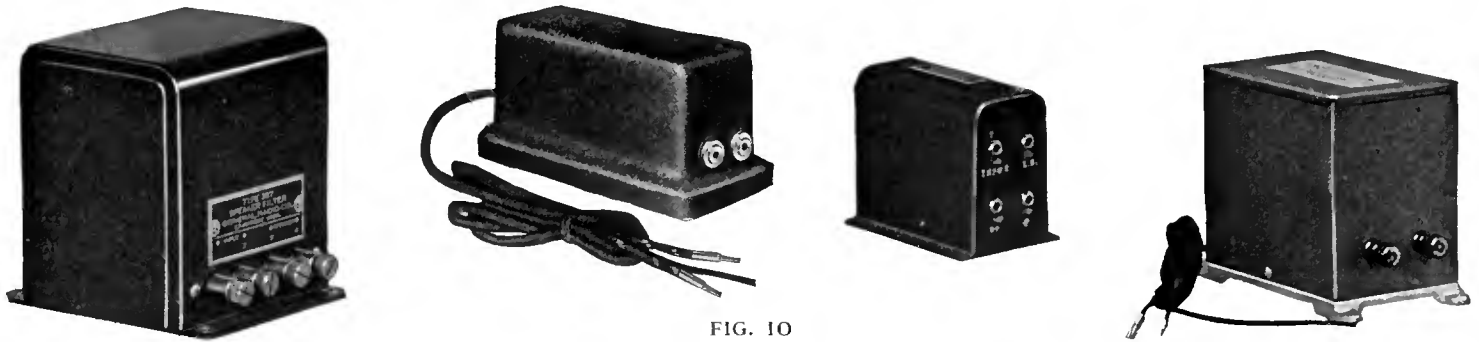

FIG. 10

RADIO BROADCAST Photographs

of the direct plate current from the loud speaker windings is essential when a 171 tube is used with a plate potential of more than 135 volts, since the plate current for this tube is so great as to seriously affect the operation of the speaker if it were permitted to pass through it.

A HIGH-RESISTANCE VOLTMETER

VERY few home-constructors can put together a receiver and its accessories and then leave it alone. Even though the set works perfectly, there is always the itch to get one's fingers inside of the cabinet and try something different. When we do this we begin to feel the need of a few instruments, the most useful of which is the milliammeter, while next in usefulness comes the voltmeter. A milliammeter, in conjunction with a fixed resistance, can be used as a voltmeter (see RADIO BROADCAST Laboratory Information Sheet No. 27, September), but there are many who would prefer to purchase a meter especially suited for the job. Now, as

explained in Laboratory Sheet No. 30 (September) the only type of voltmeter suited for use in measuring the output voltage of a line power-supply device is one having a very high resistance, such as that possessed by the Jewell voltmeter illustrated in Fig. 11. This meter has a 50-volt range and a 250-volt range. Two hundred and fifty volts divided by 1.25 milliamperes, the current this meter requires for full-scale deflection, equals 200,000 ohms internal resistance. This high resistance makes the instrument well suited for voltage measurements of all sorts, including the measurement of the output voltage of line power-supply devices.

A SET TESTER

FOR the Home-Constructor," might have been written on the nameplate of the Hanscom set tester, for it is a bit of apparatus particularly well suited for use in the home-constructor's laboratory. This tester is actually a small oscillator, similar to that described in the Sep-

tember, 1925, RADIO BROADCAST, under the name of a modulated oscillator. It draws all of its energy from the power mains, and it is to be used in hunting trouble in a receiver. It may be placed in one corner of the room and the receiver placed in the other corner, and when the receiver is tuned to the frequency of the oscillator, a low hum about 120 cycles in pitch will be heard in the audio output of the receiver if it is functioning properly. The set tester can be set on any wavelength between about 200 and 550 meters (1500 and 545 kc.). The unit is shown in Fig. 12. It consists of a coil (which may be any type since the losses are of no consideration) placed across a variable condenser, a vacuum-tube socket, and an ordinary electric-light socket. If the device is used in a 110-volt circuit, a 25-watt lamp should be placed in the socket; on a 220-volt circuit a 50-watt lamp should be used. A 201-A tube is used in the tube socket. The circuit of the tester is given in Fig. 13. It was listed in the December RADIO BROADCAST.



FIG. 11



FIG. 12

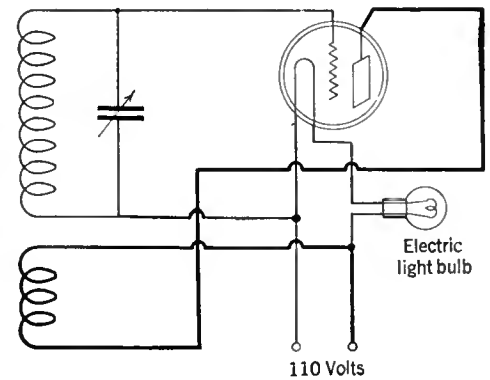
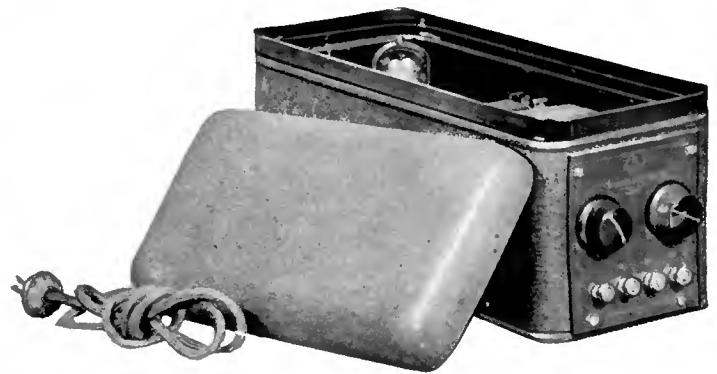

FIG. 13



THE ALL-AMERICAN COMPANY'S B POWER SUPPLY

This unit employs a Raytheon rectifier tube which is located in a protected tube compartment. Suitable controls for adjusting the detector and intermediate amplifier voltages are situated on the front panel, as are the output terminals



RADIO BROADCAST Photographs

ANOTHER B SUPPLY DEVICE

The George Electric Company's B power supply is a compact unit housed in a metal case. Two controls afford regulation of the detector and intermediate tap voltages. A rectifier tube of the Epom type is supplied

A. C. Operated Amplifier-Power Supply Devices

How to Combine the Various Kinds of Audio Amplifiers with Different Power-Supply Systems—Some Typical Combinations—A Comparison of the Different Audio Channels Available—How to Prevent "Motor-Boating"—Choosing Your Rectifier Tube

By JAMES MILLEN

NOT so long ago the criterion of good radio reception was expressed in miles. Quality of reception was given little consideration and was quite beyond the experience of many people.

But today conditions are quite the reverse. Every set owner is now hunting quality instead of the elusive, weak, and distorted signals from across the continent that were once so much discussed on the 8:15 every morning. Now, who boastfully tells his neighbors that he got pwx, Havana, on the loud speaker last evening? No, that same individual today speaks of such things as bass notes, overtones, harmonics, straight frequency line, cone loud speakers, power amplifiers, and what not!

One of the requirements for high quality reception is a well nigh perfect audio amplifier. Such amplifiers require higher plate voltages and currents which can be easily obtained from a power supply device. As a result, a plate supply device is generally incorporated as an integral part of the power amplifier nowadays.

In the first article of this group, which appeared in the January RADIO BROADCAST, the design, assembly, and use of a very fine combined power-supply unit and audio amplifier, now on the market in kit form, was described.

Many readers, no doubt, may already have on hand a B power unit, a pair of good quality audio transformers, or some other of the material essential for the construction of a high quality lamp socket operated audio channel. Or again, perhaps the dimensions of the device described last month were such as not to readily fit in some available space where the constructor might like to place it. Then, there are those readers who have the necessary time and facilities for assembling many of the individual units, such as chokes and transformers, themselves.

For these reasons, a number of amplifier-power supply units have been constructed, and will be described in this and succeeding issues of RADIO BROADCAST. These employ parts of different manufacturers and, in one case, home constructed parts. The circuit in all cases, is fundamentally that shown on page 288 of the January RADIO BROADCAST. Slight variations of circuit, however, have been incorporated in the design of some of the new units. For instance, in some cases, resistance-coupled amplification, and in others, transformer-coupled amplification, has been employed. All of the different arrangements shown are entirely satisfactory and the choice of one in place of another is largely

a matter of individual taste and financial considerations.

As the constructional details of the amplifier-B power unit were described quite completely in the January article, the matter will not be covered again this time, but rather the functions of some of the individual parts, the merits of one system of amplification over another, and some data which should prove helpful on the adjustment and operation of the complete device, will be taken up instead.

THE AUDIO CHANNEL

FIRST, then, let us consider the different types of audio channels available for use in high quality amplifiers to see which will best fit our individual requirements.

Whether the amplifier employs transformer, resistance, impedance, or a combination of resistance-impedance coupling, very fine results can only be obtained by using the very best of parts.

If cheap, or even medium-quality transformers are employed, the result will be noticeably poorer than when the best are used. Likewise, with resistance coupling, unless high-grade resistors and grid coupling condensers are employed, the amplifier is likely to be noisy, is apt to "motor-boat," and may go entirely bad after a few months use. Most resistors of the impregnated paper type enclosed in a small glass tube are entirely unsatisfactory for resistance-coupled amplification. They are noisy and not permanent in ohmic resistance value. The resistors used in the construction of the amplifiers described in this article are of the metalized type, such as are manufactured by several dependable concerns—Durham, Dubilier, Electrad, Lynch, Amsco, etc.

As to difference in cost, the advantage is slightly in favor of resistance-coupled amplification even though an additional coupling socket and tube are required. When a combination of impedance and resistance coupling

is employed, the cost of its components is nearer to that of the transformer coupled amplifier parts.

There will be no noticeable difference in quality output between the various amplifiers described in this article. All of the systems of amplification are fundamentally sound and capable of giving excellent results, provided good units are used. Follow the design data given in this article, use the products of reputable manufacturers and you may be sure that results will be satisfactory.

"MOTOR-BOATING"

MOTOR-boating is a rather accurately descriptive term applied to that condition into which some high quality a. c. operated power amplifiers of both the resistance and impedance variety get when not properly adjusted. A "chug-chug-chug" sound, similar to that of a small motor-boat engine, is heard from the loud speaker. At times the filament of the power tube (if lighted from the same transformer that supplies the B power) will be observed to flicker. The flickering may be explained in the following way: The "chugging" causes the plate current to vary considerably, and this changing load on the transformer makes the voltage applied to the filament rise and fall in synchronism with the "chugs."

The easiest remedy is to use very low-capacity grid condensers, but this is not desirable. Such a remedy is much in the same class as the "successful operation" in which the patient dies. The low-capacity condensers are bound to lead to poor quality audio amplification.

One cause of motor boating may be incorrect C voltage, but, if the grid bias voltage on the first two tubes and the grid bias voltage resistor control on the last tube are properly adjusted, an amplifier should not "motor-boat." No difficulty should be experienced in securing the proper adjustment of this latter resistor, however, as the proper ohmic value is not at all critical—somewhere around 2000 ohms in most cases. In fact, fixed resistors were employed with complete success for this purpose in some of the models made by the writer. If the value of resistance is too low, "motor-boating" results. If too high, the amplifier distorts and lacks volume. In the case of the special Royalty resistor made for this use and marked No. 1 in the Royalty kit, somewhere near the full value of resistance will in most cases result in most stable operation and best quality. The grid

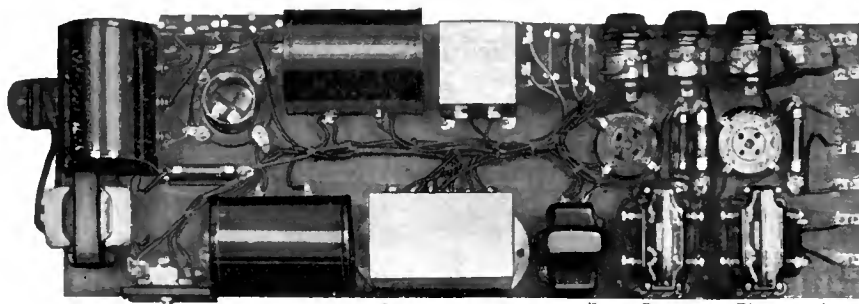

RADIO BROADCAST Photograph

A TYPICAL AMPLIFIER-POWER SUPPLY UNIT

This unit, which is a combination of circuits D and H in the diagram on page 382, consists of a two-tube transformer coupled amplifier with Raytheon power supply. The power tube filament is heated by a separate bell transformer

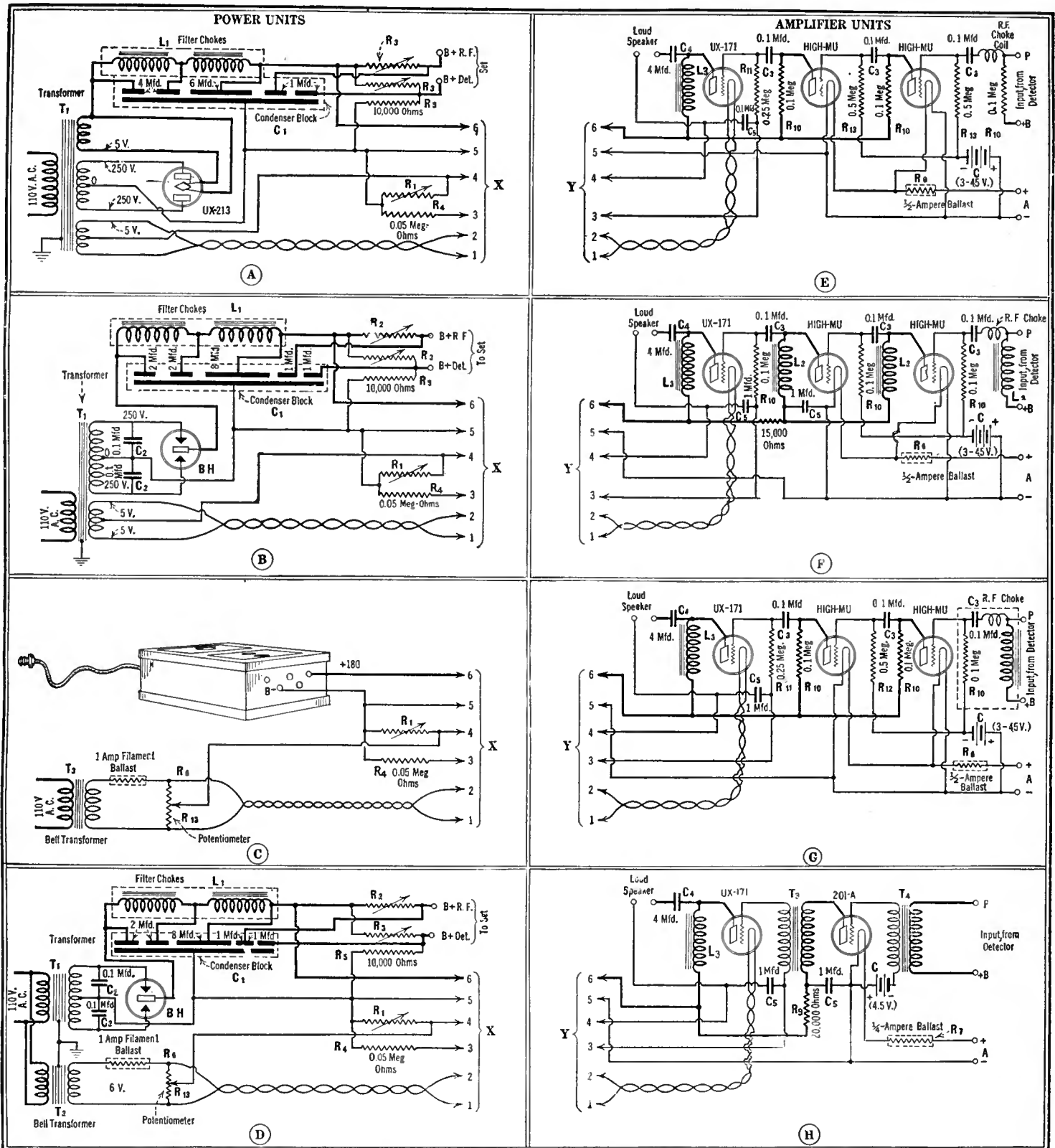

HOW TO COMBINE AMPLIFIERS AND POWER-SUPPLY UNITS

On the left of this diagram are given four power-supply unit diagrams for use in conjunction with the power amplifier circuits shown to the right of the diagram. That lettered "A" is the circuit diagram when a rectifier tube of the Rectron 213 type is employed. With this arrangement it is necessary to employ a power transformer with two filament windings, one to supply the current for the filament of the 213 tube and the other to heat the power tube filament in the amplifier used in conjunction with this power-supply unit. "B" is a power-supply unit employing a Raytheon filamentless rectifier tube. Only one filament wiring is necessary on the power transformer in this circuit—that to light the power-tube filament. "C" shows a standard so-called "B eliminator" with a separate filament-supply transformer as an additional unit. Diagram D shows a Raytheon filamentless tube used in conjunction with a power transformer which has no filament wiring whatsoever. A separate filament transformer is therefore included in the layout to supply the current for the amplifier power tube. Such an arrangement has been resorted to in the unit illustrated on page 381 and 384. All of these circuits, it will be seen, supply B potentials for all of the tubes in a receiver, including the amplifier tubes, grid bias for a power tube, and also filament current for the latter. Filament current and grid bias for the other tubes must be obtained from separate batteries. D, E, F, and G are standard amplifier circuits, each with an output device. The last tube in each case is a power tube, its filament current being pure a.c. Either of these amplifier circuits may be combined with any one of the power units, A, B, C, D, by connecting the set of terminals marked Y with those marked X, joining the correspondingly numbered ones with each other. The lettering on the various parts is explained in the parts list for the amplifier-power units illustrated on other pages of this article. The amplifiers, from top to bottom, are: Resistance-coupled; impedance-coupled; combination impedance-resistance coupled; and transformer coupled

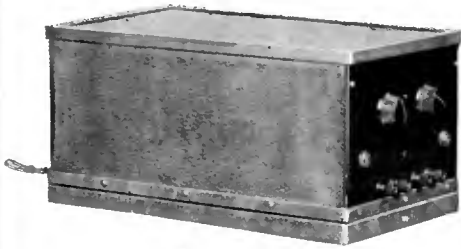

RADIO BROADCAST Photographs

THE LIST OF PARTS

T ₁ —National Power Transformer	\$ 16.50	R ₁₂ —Lynch Fixed Resistor, 0.5 Megohms50
L ₁ —National Filter Choke Unit, Type 35	7.00	R ₅ —Amperite No. 112 Filament Ballast	1.10
C ₁ —National Filter Condenser Bank	17.50	Three Lynch Double Resistor Mountings	1.50
C ₂ —Two Tohe No. 310 Buffer Condensers	1.40	Two Electrad Short Jacks50
C ₃ —Tohe No. 301 Bypass Condenser	1.25	One I-by Socket75
C ₄ —Two Tohe No. 210 Coupling Condensers	1.20	Three General Radio Sockets	1.50
L ₃ , C ₅ —National Tone Filter Unit	7.50	Four Eby Binding Posts60
National Impedaformer	5.50	Eveready No. 703 C Battery35
R ₁ —Clarostat Variable Resistor, Grid Bias	2.25	Brass, Bakelite	5.00
R ₂ —Clarostat Variable Resistor, R. F. Amplifier	2.25	Wire50
R ₃ —Clarostat Variable Resistor, Detector	2.25	Raytheon BH Tube	6.00
R ₅ —Tobe Veritas Fixed Resistor, 10,000 Ohms	1.10	Two High Mu-Tubes	5.00
R ₄ —Lynch Fixed Resistor, 0.05 Megohms75	UX-171	4.50
R ₁₀ —Two Lynch Fixed Resistors, 0.1 Megohms	1.50		
R ₁₁ —Lynch Fixed Resistor, 0.25 Megohms50		
		TOTAL	\$ 96.25

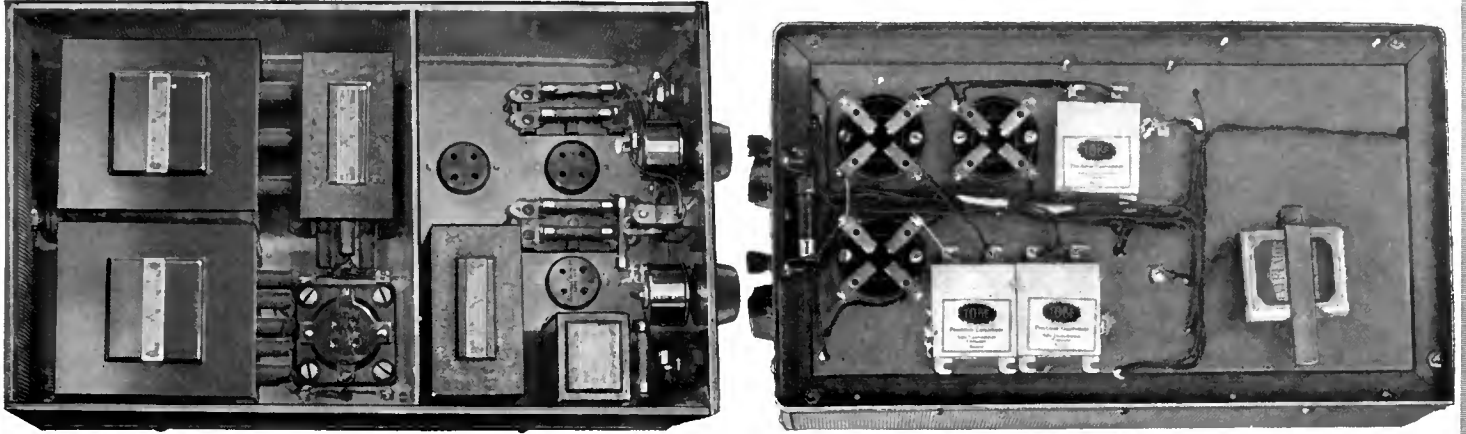

NEATLY CONSTRUCTED AMPLIFIER-POWER UNIT

The form of construction used in this model is less costly than that employing a bakelite panel and a low-priced cabinet. A hack saw, hand drill, an old pair of scissors, and a soldering iron are all the tools necessary. The brass base plate, 10" x 14" x $\frac{1}{8}$ ", is fastened between two frames of angle brass, the lower of these being of $\frac{3}{4}$ " angle brass and the upper $\frac{1}{2}$ " brass. The sides, which are of perforated brass (as also is the top), are six inches high. Brass strip, $\frac{1}{2}$ " x $\frac{1}{8}$ ", is used at the top and bottom to stiffen the perforated material. Note the shield separating the amplifier and power-supply sections of the unit. This device is a combination of circuits G and B in the diagram on page 382. The detector voltage is fixed in this particular model. When the r. f. and detector circuits require more than 10 mA., employ a National type 80 choke in place of the type 35 specified

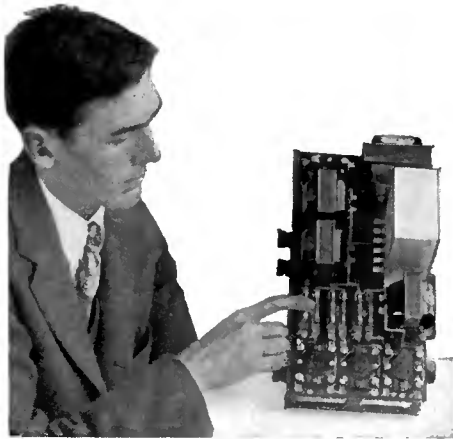

RADIO BROADCAST Photographs

THE LIST OF PARTS

T ₁ —Jefferson Power Transformer	\$ 7.00	R ₁₂ —Two Lynch Fixed Resistors, 0.5 Megohms	1.00
L ₁ —Two Jefferson Filter Chokes	8.00	Four Lynch Double Resistor Mountings	2.00
C ₁ —Tohe No. 760 Filter Condenser	11.00	R ₈ —Electrad Rheostat, 10 Ohms85
C ₂ —Two Tohe No. 310 Buffer Condensers	1.40	Electrad Short Jack25
C ₃ —Tohe No. 301 Bypass Condenser	1.25	Four Eby Sockets	3.00
C ₄ , C ₅ —Mayolian Block Condenser	8.00	Eight Eby Binding Posts	1.20
Samson R. F. Choke No. 85	2.00	Eveready No. 703 C battery35
L ₂ —Jefferson Choke	4.00	Bakelite	3.00
R ₁ —Royalty No. 1 Variable Resistor, Grid Bias	1.50	Garfield-Radion Brackets	1.25
R ₂ —Royalty No. 2 Variable Resistor, R. F. Amplifier	1.50	Wire50
R ₃ —Royalty No. 3 Variable Resistor, Detector	1.50	Raytheon BH Tube	6.00
R ₅ —Tobe Veritas Fixed Resistor, 10,000 Ohms	1.10	Two High-Mu Tubes	5.00
R ₄ —Lynch Fixed Resistor, 0.05 Megohms75	UX-171 Tube	4.50
R ₁₀ —Three Lynch Fixed Resistors, 0.1 Megohms	2.25		
R ₁₁ —Lynch Fixed Resistor, 0.25 Megohms50	TOTAL	\$80.65

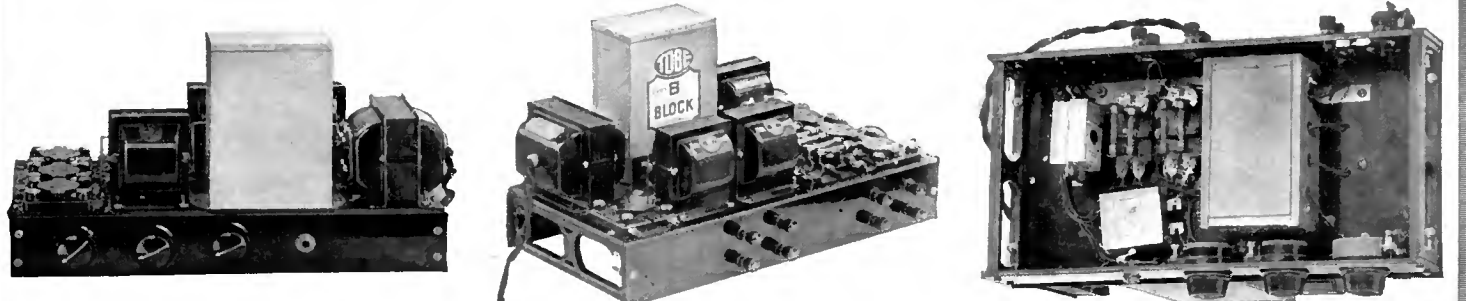

AN AMPLIFIER-POWER SUPPLY DEVICE USING SOME JEFFERSON PARTS

This unit is a combination of those circuits designated as E and B in the diagram on page 382. Three stages of resistance coupling, and a Mayolian coupling condenser block (shown in that photograph of the under-panel view) are employed. The Mayolian coupling condenser block consists of the three amplifier coupling condensers and the 4-mfd. tone filter condenser. Lynch metalized-filament resistors are used for inter-audio coupling purposes. The Jefferson parts include the power transformer and chokes

bias resistor, whether it be the special No. 1 Royalty, a Clarostat, or a fixed resistor, should never be so adjusted or connected that there is less than about 1000 ohms in the circuit as, otherwise, a destructively high plate current will be drawn by the ux-171. In the case of the special Electrad "Royalty" variable resistors, stops are provided so that it is never possible to reduce the value of the resistance below a certain point. Few experimenters realize that a 171 tube will draw approximately 100 mls. of plate current at a plate voltage of 180 when the grid voltage is zero. Of course, where the plate current is obtained from an a. c. operated power-supply device, this full value of plate current will not be obtained due to the regulation of the rectifier-filter system, but the resulting current is, nevertheless, excessively high.

When the proper adjustment of the grid voltages does not stop "motor-boating," the trouble is generally due to a leaky grid condenser. A simple test to determine the value of the condenser (in most instances the one in the last stage causes the trouble) as far as insulation resistance is concerned, is as follows: Connect up the two terminals of the condenser to any high-voltage supply, such as a B battery, or a line power device, of 100 volts or more. Then disconnect the wires and allow the condenser to remain open for three or four minutes. At the end of that time, short-circuit the two terminals, and if the insulation in the condenser is good, a spark should be obtained. If the condenser is leaky, no spark will be obtained. A good condenser will, on a dry day, retain its charge for a considerable time.

Where the insulation resistance of a grid condenser is only poor and not definitely bad, the use of lower value grid resistors will stop "motor-boating." In the case of resistance-coupled amplifiers, or amplifiers in which an impedance is used only in the input circuit, one of the most certain, but yet seldom necessary methods of remedying the difficulty, is by the use of an impedance in place of the non-inductive grid leak in the last or power audio stage. The purpose of this impedance is to change the phase of the grid circuit by approximately ninety degrees. A convenient way in which to apply this remedy is to substitute for the double resistor mount, in the last stage of the resistance-coupled amplifier, a National Impedaformer. They both take up about the same base space. Where space is not a limiting factor, any impedance having an inductance of between 75 and 200 henrys may be used. If the National Impedaformer is used, disregard the markings on the terminal strip and connect the terminal marked P to the grid of the last tube, the terminal marked G to the plate of the next to last tube, the terminal marked plus A to the plus B supply, and the terminal marked plus B to the negative grid bias lead. As a coupling condenser is contained within the Impedaformer, the external one formerly used in connection with the double resistor mount is removed.

THE OUTPUT DEVICE

AN OUTPUT device of one sort or another is essential for the safe and satisfactory operation of a power amplifier. The output device, by keeping the heavy d.c. plate current

from passing through the speaker windings, results in better quality and at the same time removes the possibility of damage to the delicate windings. Still another distinct advantage in using an output device is the elimination of the possibility of anyone receiving a serious shock upon coming in contact with exposed speaker terminals or metal jack parts.

There are two distinct types of output devices—the transformer type and the impedance-capacity unit form. The latter is the more preferable of the two for a. c. operated power amplifiers using the present-day tubes and the Western Electric 540 AW or similar loud speaker.

Perhaps the outstanding advantage of the impedance-capacity unit over the transformer is that the use of the former makes it possible to prevent audio frequency coupling of the plate circuit of the last tube with the plate circuits of the other tubes by means of the

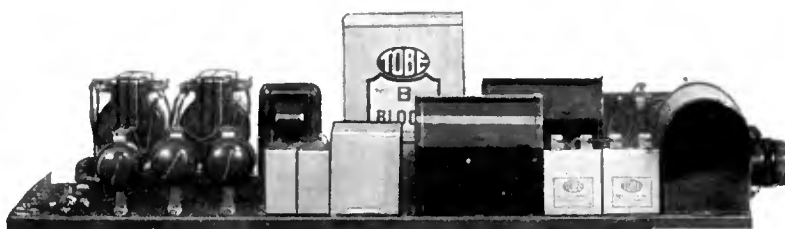

RADIO BROADCAST Photograph

THE AMPLIFIER-POWER UNIT ALSO ILLUSTRATED ON PAGE 381

The following parts are specified for this combination (D and H, page 382): All American power transformer (T₁, \$5.00) and filter chokes (L₁, \$8.00); six-volt bell transformer (T₂, \$1.00); Tobe filter condenser block (C₁, \$11.00); Tobe 4-mfd. condenser (C₄, \$3.50); two Tobe 1.0-mfd. condensers (C₅, \$2.50); two Tobe 0.1-mfd. condensers (C₂, \$1.40); General Radio impedance (L₃, \$5.00); two Ferranti audio transformers (T₃, T₄, \$24.00); three Clarostats (R₁, R₂, R₃, \$6.75); Yaxley jack (\$0.50); Yaxley No. 200 potentiometer (R₁₃, \$1.35); Amsco double resistor mount (\$0.30); three sockets (\$2.50); Electrad 20,000-ohm resistor (R₉, \$1.00); Lynch 0.05 resistor (R₄, \$0.75); Amperite filament ballasts, 0.25 and 1.0 amp. (R₇, R₆, \$2.20); base-board, wire, Fahnestock clips, etc. (\$1.00). The tubes and C battery are considered as extras

otherwise common plate impedance of the B power-supply device.

THE GRID BIAS FILTER

IN CONNECTION with the variable resistor (either a Clarostat or a No. 1 Royalty) used for obtaining the grid biasing voltage for the last tube, will be noticed the use of a 1-mfd. fixed condenser and a fixed resistor having a value anywhere between 0.05 and 0.1 megohms.

These may be noted in "E," "F" and "G" of the combination diagram on page 382. This fixed resistor-condenser combination forms a filter circuit which prevents the passage of audio frequency currents through the grid bias variable resistor. Should the audio frequency current pass through this resistor, a pulsating biasing voltage would be produced having such phase relations with the signal voltage applied to the grid of the last tube as to tend to partially neutralize or buck the signal voltage, and thereby reduce to a considerable extent the amplification which would otherwise be obtained in the last stage.

TUBES

THERE are at present three different double-wave rectifier tubes on the market which have been used with good results by the author. First, there is the 213 type. This is an excellent rectifier tube for use where the a. c. transformer voltage on each side of the high voltage secondary is under 250 volts and preferably about 225 volts. A power-supply circuit employing a 213 rectifier tube is shown in "A," on page 382.

With higher voltages, and currents in excess of 60 milliamperes, the life of the 213 is very materially shortened. The drop in voltage under the same conditions, of the 213 and the Raytheon BH, are almost identical. The difficulty to be encountered, however, in the use of the 213 as a rectifier, is the failure of most transformer manufacturers to provide an additional filament winding on their transformer for lighting the rectifier tube filament in addition to a winding to light a power tube filament, with raw a. c. Thus, except in the cases where the National, General Radio, or another transformer equipped with two filament windings, is used, it is necessary to choose between a filamentless rectifier tube, or an additional filament heating transformer. The Raytheon BH tube (which has no filament) is a fine rectifier and has the additional advantage over the 213 that it may be used with much higher transformer voltages and heavier currents without materially affecting its useful life.

The main difference, electrically, between the B and the BH Raytheon tubes is that the voltage drop across the B tube is considerably more than across the BH tube. The B tube is rated at a maximum current of 60 mls whereas the BH tube is rated at 85 mls.

With Raytheon and similar filamentless tubes, it is necessary, for smooth operation, to use two small buffer condensers across the two sides of the high-voltage transformer secondary. These, in the diagrams on page 382, "B" and "D", are designated as C₂. The purpose of the condensers is to prevent internal tube arcing. If the capacity of these condensers is less than 0.1 mfd., they will not be sufficiently effective, while if they are much larger than 0.1 mfd., they will consume too much power from the line. The condensers must also be so designed as to withstand any high voltage surges to which they may be subjected. For this reason it is generally desirable to use condensers having an a. c. voltage rating of at least 1500 volts. The ux-213 does not require the use of buffer condensers as it functions on a different principle.

In the resistance- and impedance-coupled amplifiers, high- μ tubes will in most cases be found to give the best results. Occasionally, however, when the receiver is located close to a powerful local broadcasting station, and no means of volume control is employed on the r. f. amplifier, it is possible to overload the second high- μ tube. The use of a 201-A in the second stage will overcome the trouble, but a better solution is to reduce the volume slightly by means of some sort of volume control on the r. f. amplifier, preferably a filament rheostat.

When dry-cell tubes are used in the set proper, and it is desired to use dry-cell tubes in the first and second audio stages too, quite good results can be had by using the new CeCo high- μ 199 type tubes. The tube to use in the last stage is the 171 type.

In the case of a transformer-coupled amplifier, a 201-A should be used in the first stage and an ux-171 in the second, or power, stage. It is not advisable to apply the full amplifier voltage (180 or so) to the first tube in a transformer amplifier. A lower voltage may be obtained by means of a fixed resistor, as shown in "H," on page 382 and designated as R₉.



RADIO BROADCAST Photographs

THE LIST OF PARTS

T ₁ —National Power Transformer	\$16.50	R ₉ —Electrad Heavy Duty Fixed Resistor 20,000 Ohms	1.00
L ₁ —Two Amertran Filter Chokes	12.00	R ₄ —Electrad Fixed Resistor, 0.05 Megohms75
C ₁ —Tobe No. 760 Filter Condenser	11.00	R ₇ —Elkav Equalizer No. 475
C ₂ —Two Tobe No. 310 Buffer Condensers	1.40	Muter Double Resistor Mounting50
C ₃ —Two Tobe No. 301 Bypass Condensers	2.50	Yaxley No. 760 Switch	1.20
L ₂ —Samson Choke, Type 0	5.00	Electrad Short Jack25
C ₄ —Tobe No. 304 Condenser	3.50	Three Airgap Sockets	2.25
T ₂ , T ₄ —Two Amertran Audio Transformers	20.00	Seven Binding Posts	1.05
R ₁ —Royalty No. 1 Variable Resistor, Grid Bias	1.50	Eveready No. 703 C Battery35
R ₂ —Royalty No. 2 Variable Resistor, R. F. Amplifier	1.50	Base-Board50
R ₃ —Royalty No. 3 Variable Resistor, Detector	1.50	Bakelite Panel	1.50
R ₅ —Tobe Veritas Fixed Resistor 10,000 Ohms	1.10	Wire50
		Raytheon BH Tube	6.00
		UX-201-A Tube	1.75
		UX-171 Tube	4.50
		TOTAL	\$100.35

A UNIT WITH TRANSFORMER-COUPLED AMPLIFICATION
 Amertran Deluxe transformers, Amertran chokes, Tobe condensers, and a National power transformer have been incorporated in the unit. It is a combination of circuits H and B as shown in the diagram on page 382. A Yaxley No. 760 double-pole single-throw "short jack" type of switch is mounted on the panel so as to control both the 110-volt house current and the storage battery, or A power, unit. This result is accomplished by using one switch lever and its associated stationary contact in the 110-volt line to the transformer and the other lever and contact in the A-power line. The case of the power transformer, the cases of the condensers, and the cores of the chokes, should all be connected together and grounded

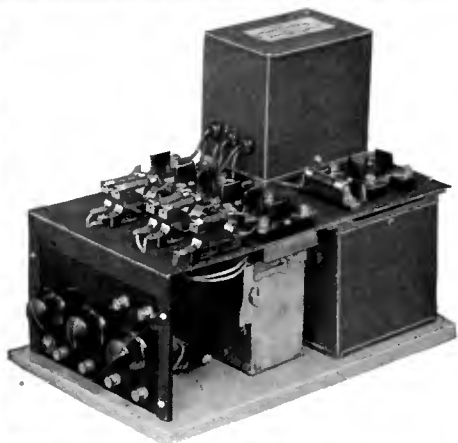
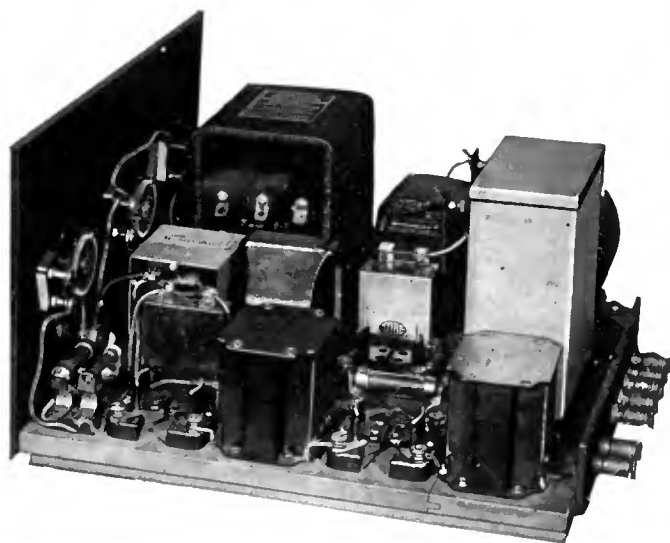

THE LIST OF PARTS

T ₁ —Mayolian Power Transformer	\$ 9.50	R ₁₂ —Lynch Fixed Resistor 0.5 Megohms50
L ₁ —Two Mayolian Filter Chokes	10.00	R ₈ —Amperite No. 112 Filament Ballast	1.10
C ₁ —Tobe No. 760 Filter Condenser	11.00	Lynch Single Resistor Mount35
C ₂ —Two Tobe No. 310 Buffer Condensers	1.40	Four Lynch Double Resistor Mounts	2.00
C ₃ —Tobe No. 301 Bypass Condenser	1.25	Electrad Short Jack25
C ₄ —Three Tobe No. 210 Coupling Condensers	1.80	Four Air-Gap Sockets	3.00
L ₂ —Samson Choke, Type 0	5.00	Six Binding Posts90
C ₄ —Tobe No. 304 Condenser	3.50	Eveready 703 C Battery35
Samson Plate Impedance	5.00	Brass Mounting Material80
Samson R. F. Choke, No 85	2.00	Base-Board35
R ₁ —Clarostat Variable Resistor, Grid Bias	2.25	Bakelite65
R ₂ —Clarostat Variable Resistor, R. F. Amplifier	2.25	Wire50
R ₃ —Clarostat Variable Resistor, Detector	2.25	Raytheon BH Tube	6.00
R ₅ —Tobe Veritas Fixed Resistor, 10,000 Ohms	1.10	Two High-Mu Tubes	5.00
R ₄ —Lynch Fixed Resistor 0.05 Megohms75	UX-171 Tube	4.50
R ₁₀ —Three Lynch Fixed Resistors 0.1 Megohms	2.25		
R ₁₁ —Lynch Fixed Resistor 0.25 Megohms50	TOTAL	\$ 87.55

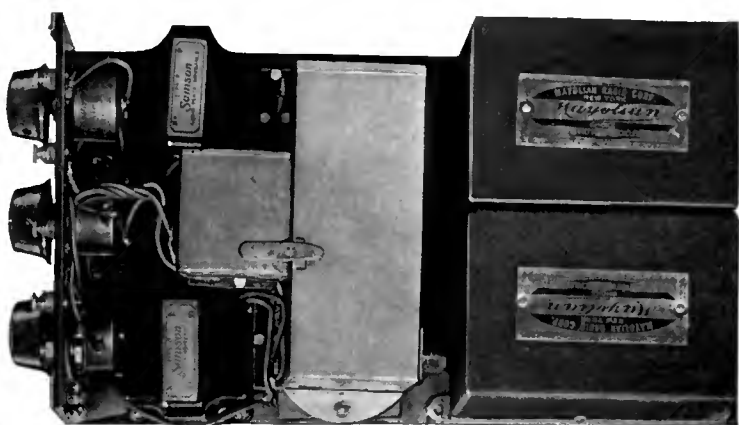
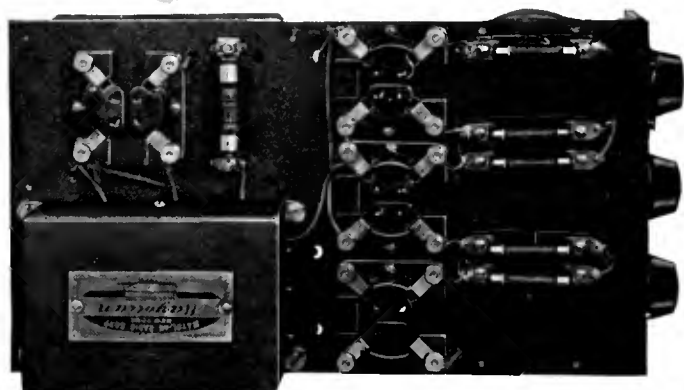

A COMPACT ARRANGEMENT OF APPARATUS

RADIO BROADCAST Photographs

Hollow bases on the Mayolian power units, make it possible to run wires between them and the base. The bend in the 1/8-inch brass base plate can be made by the local tinsmith. This unit is a combination of circuits G and B as shown on page 382. The buffer condensers are located in the space under the transformer base

Notes on the Shielded Dual-Control Receiver

Some Trouble-Shooting Hints on the Receiver Described in the October Issue—How to Distinguish Between the Two Types of Coils Employed—Where to Expect Trouble in the Volume-Control Resistance—What Kind of Antenna to Use

By McMURDO SILVER



GETTING THE "SIX" READY FOR OPERATION

In conjunction with a Balkite trickle charger, a storage battery, a line power-supply device, and a Yaxley automatic switch. "Zero left" dials were specified in the original article, October, 1926, so as to have the dial readings increase with increasing frequency. If the builder prefers to tune by wavelength and have the long wavelength stations tune-in on the upper instead of the lower part of the dial, counter clockwise dials should be procured

THE data presented herewith are intended primarily for those readers of RADIO BROADCAST who have built the receiver described in the October, 1926, issue, under the title of "A Shielded Dual-Control Receiver." This present article deals particularly with methods for insuring that the best operation of the outfit is obtained, and, in a measure, it might very well be termed a symposium, for it presents in condensed form the information and suggestions gleaned from several thousands of builders who have already constructed the "Shielded Six." While some of these home constructors have commented unfavorably on the receiver, the majority has been very satisfied with the results obtained.

The author has one of these receivers, built from standard store parts, in operation in his home in Chicago. This set is situated about two miles from KYW, one and one-half miles from WMAQ, three miles from WEBH and WQJ, a thousand yards from the Moody Bible Institute station WMBI, and, in addition, in the center of the Chicago hotbed of some twenty stations. So situated, it is possible to tune-in Schenectady, Pittsburgh, Detroit, Davenport, Fort Worth, Cincinnati, Denver, and many other stations on almost any evening. Station KFI, Los Angeles, has been heard with a ten-foot wire as an antenna.

One of the first points to come up in connection with the building of the receiver was the fact that the four inductance coils, or radio frequency transformers, look very much alike, and once they have been removed from their cartons

carrying the different type markings, many builders have found it impossible to tell them apart. This is unfortunately a serious condition, for if the coils are improperly inserted in their sockets, that is, if the antenna coil is placed in one of the radio frequency stages, there will be a short-circuit which will burn out one of the windings on the antenna coil. It is very important that the 115A coils be placed in the three right-hand coil sockets of the receiver, as viewed from the front. The 116A coil should be placed in the left-hand (first r. f. stage) or antenna compartment of the receiver. Reference to Fig. 1 will explain how to tell the 115A from the 116A.

THE VOLUME-CONTROL RESISTANCE

IT IS very important that the volume-control resistance, or 25,000-ohm Hi-Pot, be exactly as specified—a Carter 25,000-ohm No. 25. It

should be carefully tested with headphones and battery, and clicks should be obtained on all contacts. It will be found that a comparatively weak click will be gotten between terminals Nos. 1 and 3, whereas a strong click will be obtained between terminals Nos. 1 and 2, if the contact arm is turned around close to terminal No. 1. As the contact arm is turned away from No. 1, and toward No. 3, the strength of the click will decrease. This is correct, and the same condition will apply between terminals Nos. 2 and 3.

Should a 500,000-ohm standard potentiometer be used in the receiver instead of the 25,000-ohm one specified, trouble is bound to develop. The receiver will not be sensitive for distant stations, will be very unstable and prone to oscillate continuously.

Every Carter No. 25 Hi-Pot is supplied with two insulating washers having small projections which fit inside the actual panel and chassis holes intended to receive the shaft bushing of this resistance. One washer should be placed on the inside of the chassis and one on the outside of the panel. If this is done, there is no danger of a short-circuit between the chassis and volume-control resistance, providing also that the three arms of the Hi-Pot carrying the binding posts are bent up and away from the chassis when the resistance is in place in the receiver assembly. In other words, none of the metal parts of the Hi-Pot should touch the chassis or the front panel.

THE 200-OHM BALANCING RESISTANCES

THE 200-ohm balancing resistances, connected between terminals No. 3 of the radio frequency coil sockets and the grid posts of the radio frequency tube sockets, need not be exact in their resistance values, and may vary at least five per cent. either way. These resistances should be tested before the receiver is put in operation with head phones and battery, a click being obtained between the mounting clips when they are touched with the battery lead and phone cord tip. Either Carter or Yaxley resistances can be used in this position, but it is important that they be wire-wound resistances and not graphite, carbon, or deposit types of resistances, for the inductive effect provided by the wire-wound resistances assists in the operation of the receiver.

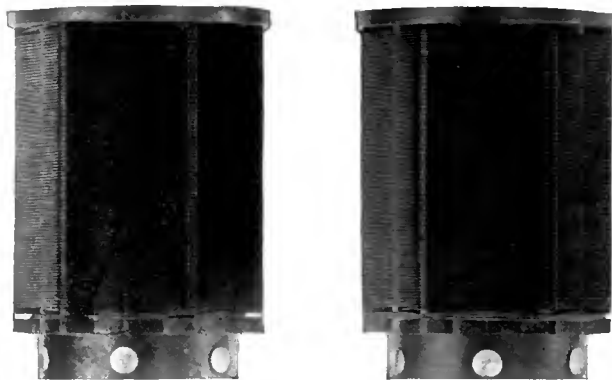

FIG. 1

The difference between the 115A coil at the right and the type 116A coil at the left may easily be told. The differentiating characteristic is the slot at the bottom of the winding form through which light is visible in the left-hand coil, whereas, in the right-hand coil, the slot is completely filled with the wire turns. These coils must not be interchanged in the receiver, for the 116 A coil, if placed in the wrong socket, will cause damage. At the present time, long-wave coils, to adapt the "Shielded Six" for reception between 500 and 3000 meters (600 and 100 kc.), are not obtainable, but the writer will furnish data for such coils to anybody writing for it. The set will not function well below 200 meters (1500 kc.)

ASSEMBLING THE SHIELD TOPS

THERE is a slight trick to fitting the shield tops down over the tubes, coils, and variable condensers, and getting the edges to fall well inside of the edges of the shield pans. One precaution must be observed, and that is to leave at least a $\frac{3}{8}$ to $\frac{1}{4}$ -inch space between the front lock collar of the variable condensers and the lock collars of the link motion, in which space the front edge of the shield body must fit.

If a shield is taken in the right hand and dropped down into its proper pan, this should be done with the front end inclined downward. Thus, the front end of the shield top can very easily be fitted inside the front edge of the shield pan and pushed down, while the rear end of the shield top stands above the edge of the pan. If the hand is then transferred to the back side of the shield and pushed forward slightly toward the panel, it will be found that this rear side may be slipped down very easily inside the up-standing edge of the shield pan.

SELECTIVITY AND QUALITY

IN THE "Shielded Six" every possible endeavor has been made to obtain as perfect quality of reproduction as could be gotten. It is the writer's belief that the design has not

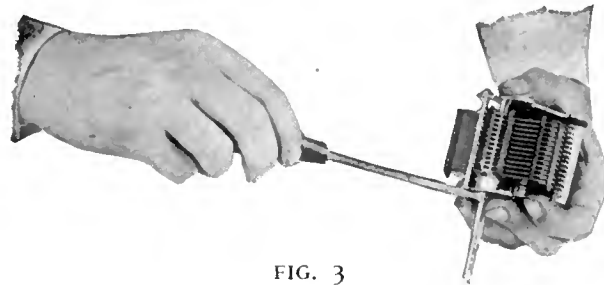

FIG. 3

How to loosen the lock collars on the variable condensers so that the shaft may be re-positioned or the compression on the small spring washer tightened up. Pressure is exerted by the thumb and fingers of the left hand on the rear end of the shaft and on the lock collar respectively

THE ANTENNA

THE use of an antenna much over 70 feet is not recommended with the "Shielded Six." It has been found in Chicago that a ten-foot antenna would give ample volume on local stations, and will allow the reception of some out-of-town stations. A thirty-foot antenna will give very satisfactory results and will frequently bring in West Coast stations with fair loud speaker volume. A seventy-foot antenna will give all that can be desired in the way of results. In practically all cases the antenna switch should be kept turned to the "short" position,

radio frequency amplifier tubes. It is therefore sometimes advisable to connect a condenser made of, let's say, two two-foot lengths of ordinary insulated magnet wire tightly twisted together, between the shield and terminal No. 3 of the detector coil socket in the detector stage compartment. Of course, one end of each wire should be left free and disconnected in order that the capacity formed by the two adjacent wires may not be short-circuited.

CONDENSER ADJUSTMENT

THERE is one factor which will affect the selectivity, and, for that matter, the operation of the entire receiver—the condenser, ganging and adjustment. As

the condensers recommended for the receiver leave the factory, they have all passed mechanical and electrical inspections which insure that, if received by the builder undamaged, their uniformity is such that they will operate in any gang control circuit quite satisfactorily. The possibility of their being slightly strained in transit or in assembly is not remote, although every endeavor was put forth in their design to produce a rigid and substantial mechanical assembly. Upon receipt, the condensers should therefore be carefully examined before being placed in the receiver. The link motion should be slipped over the shafts of the three condensers as shown in the photo-

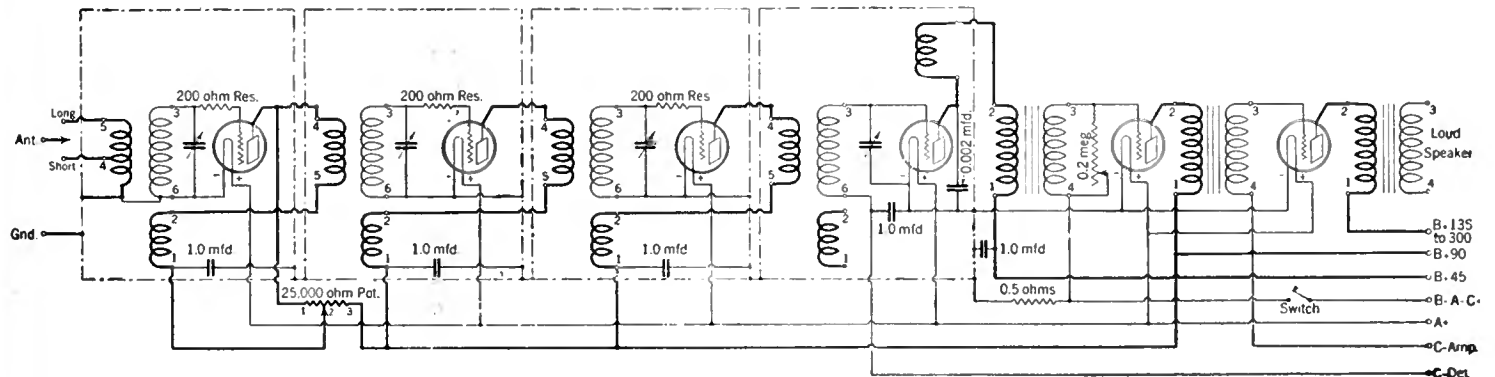

FIG. 2

This is the circuit diagram of the "Shielded Dual-Control Receiver" as described in the October, 1926, RADIO BROADCAST. The shielding is indicated by the dotted lines. The volume-control potentiometer may be seen to the left of the diagram between the first and second tubes. The second, third, and fourth condensers are controlled by one knob

failed in this matter for this belief has been borne out by the enthusiastic comments of builders of the receiver. Nevertheless, in any radio receiver, a certain amount of extreme selectivity must be sacrificed if thoroughly good quality of reproduction is to be obtained. This is because the radio frequency circuits are essentially band selection filters designed to accept and pass a band of frequencies such as would be required for proper transmission of voice and music, and to reject all other frequencies falling outside of the particular band tuned to at the moment.

Obviously, if the receiver is designed to be very selective, the band will be so narrow that the higher frequencies in music will be cut off; while, if the band is too broad, several stations operating at different frequencies will be received. A very considerable amount of time and energy was devoted to this single consideration in the design work, and it is believed that the "Shielded Six," giving selectivity sufficient for the most congested broadcasting centers of the country, should be entirely satisfactory to the average builder irrespective of the locality in which it is used.

which represents loosest coupling between the antenna and receiver, since in this position of the switch, selectivity will be greatest and reception most free from static or other atmospheric noises. The "long" position of the switch should only be used when few local stations are operating or with a very short antenna, say, one from ten to thirty feet long. The "Shielded Six" may be used with an indoor antenna of from ten to fifty feet in length, consisting of a single wire run around the picture moulding or otherwise disposed of to suit the owner. A water-pipe ground may be used, and if it is desired to dispense with an antenna altogether, another piping system other than that used for the ground connection may be used for the antenna. Thus gas and water-pipe systems, or water and steam-pipe systems, would serve nicely for both antenna and ground. An electric light socket antenna plug may be used.

BOOSTING DETECTOR CAPACITY

DUE to the fact that there is no radio frequency load in the plate circuit of the detector, the effective grid to filament capacity is considerably lower than that of the three

graph on page 495 of the October issue, after which they should be adjusted as follows: The rotor plates of all condensers should be inter-

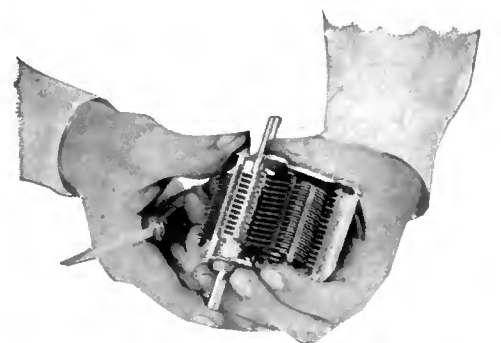

FIG. 4

Pushing the shaft into a new position. Once the shaft has been located as desired, the whole assembly is re-locked by means of the two set screws visible in the rotor shaft collars. Needless to say, if this adjustment is made according to instructions in this article, no change in the capacity characteristics of the condensers will occur

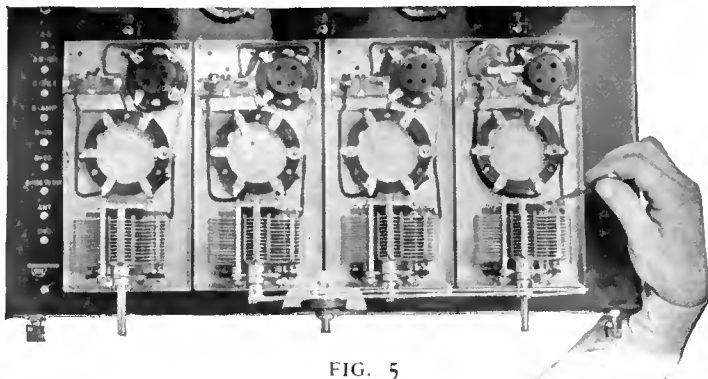

FIG. 5

Note how the bypass condensers have been placed touching both the coil socket and tube socket. Some of the condensers manufactured since this receiver was first described, have mounting lugs that will not exactly match those in the chassis and shield pan. This can be corrected by clipping out whatever parts of the mounting lugs get in the way of the fastening screws. This photograph also shows how a condenser damaged in transit should be adjusted so as to obtain perfect interleaving of the rotor and stator plates

leaved with the stator plates, and carefully examined at each side to see that they interleave centrally. They should then be turned approximately all the way out so that stators and rotors overlap but half an inch along their periphery, and should be re-examined. It is vitally essential that at this point the rotors interleave absolutely centrally with the stator plates. If they don't, a small wrench should be procured—such as will be found with all of the later B type condensers—and the lock nuts on the brass rods, to which the stator plates are soldered, loosened up, as these lock nuts serve to hold the brass stator bars tightly in position in their mounting holes in the bakelite insulating strips on each end plate.

When these nuts are loosened up, the entire stator plate section at one side may be shifted either forward or backward and thus moved to a position where the rotor plates interleave absolutely centrally with the stator plates on this right-hand side. With the two nuts on the rear end of the stator rod left loose, the two nuts at the front end should be tightened up on either side of the bakelite strip until they are quite tight against it, and hold the stator rod definitely in position. If first one nut is tightened half a turn, and then the other tightened likewise, it will be found that the stator plate section can be permanently locked in a position where the rotors will interleave centrally with it. The two nuts on the rear of the tie bar locking on either side of the rear bakelite insulating strip should then be moved up half a turn at a time until they are tight against the rear bakelite insulator, so as not to impose a "thrust" or "pull" between the two insulator strips. This operation is really extremely simple and can be easily accomplished since the condensers are specifically designed to permit of such adjustment by the user should the occasion require. Once the adjustment has been made, let's say, on the right-hand or low side of the condenser, the adjustment may afterwards be made on the left side stator rod so that the rotor plates interleave centrally with the stators when the plate sections are entirely engaged.

As previously remarked, an adjustment of this nature should seldom be necessary, but it is always an excellent idea, after the receiver has been assembled and the link motion put in place, simply to check over each condenser with the small wrench provided, and make absolutely sure that undue strain has not been imposed on the condensers either in transit or in assembly.

Several builders of the "Shielded Six" have

noticed that the length of the condenser shafts may be easily varied. This is a feature of the condensers recommended for the set, and the shafts may be pushed either forward or backward in the condensers to any desired position. This is accomplished very simply by loosening the set screws in the lock collars on the shafts, pushing the shafts into the desired position and then performing the operation illustrated in Figs. 3 and 4. The rotor plate section lock collar should have its screw tightened up on the shaft in the position desired by the builder.

Then, holding the condenser in the left hand, as shown in the photographs, with the thumb upon the rear end of the shaft, and the second and third fingers of the hand pushing the lock collar on the front of the condenser toward the thumb, the set screws in this collar should be locked up

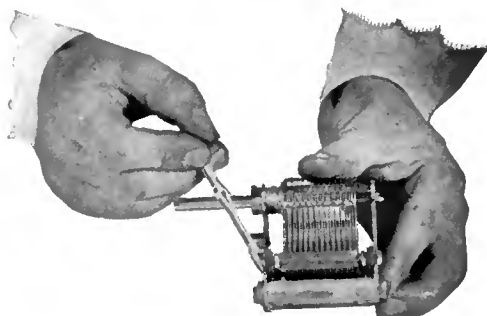

FIG. 6

The details of the plate spacing adjustment. Notice the small wrench, on one of the lock nuts which determine the position of the stator plate assembly

tightly. This will compress the small spring washers between the front lock collar and the frame, and will eliminate entirely any play which might creep in were the hand pressure not exerted. Several photographs (Figs. 5 and 6) accompanying this article indicate how this adjustment may be made.

The ganging of the condensers in the receiver is extremely simple and has been outlined in the previous article. A photograph (Fig. 7) indicates exactly how the builder would view them to arrive at the proper adjustment of each one before the link motion should be locked to the three condenser shafts by means of the set screws in the link motion collars.

Another feature which may come to the builder's attention is the fact that the front edge of each shield pan will have to be pressed forward a fraction of an inch to allow for the bottom mounting studs on the front end plate of each condenser. This is an intentional part of the design, the shields and condensers having been so made that, if necessary, a screw can be put through an ordinary mounting panel into the upper mounting stud of the condenser, which, if tightened up against the front panel, would thus serve to clamp the front edge of the shield pan between the bottom mounting lug, and the front panel.

Should the builder endeavor to operate the "Shielded Six" with a standard B power-supply device (battery eliminator), the connection of a 5-to 15-microfarad condenser across the high-voltage output of the battery eliminator, or possibly across the detector output, will be necessary should there be any tendency for the combination of power-supply device and receiver to howl or produce a "motor-boating" sound in operation. Such noises would be due to the high internal resistance of the eliminator, which, being common to the plate circuits of all the receiver tubes, would serve to couple these plate circuits together and cause audio oscillation. A second caution concerns the purchase of an eliminator with a sufficiently high power output to operate the receiver properly, which requires approximately 25 to 35 milliamperes when a 171 tube is used, with 180 volts plate potential.

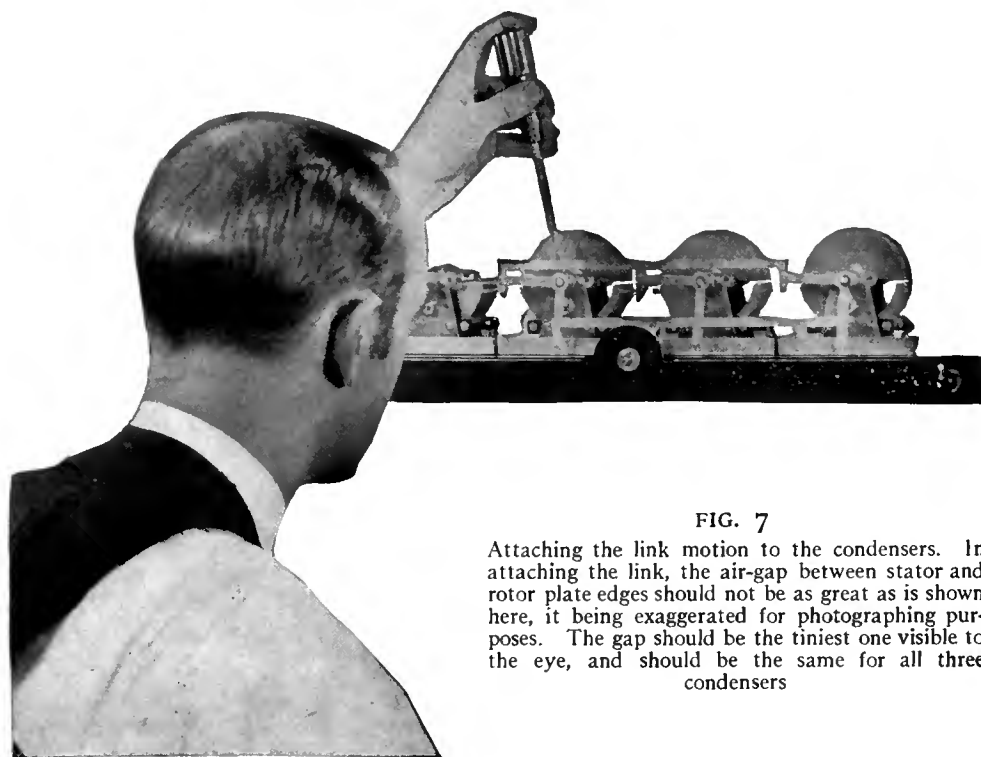

FIG. 7

Attaching the link motion to the condensers. In attaching the link, the air-gap between stator and rotor plate edges should not be as great as is shown here, it being exaggerated for photographing purposes. The gap should be the tiniest one visible to the eye, and should be the same for all three condensers

AS THE BROADCASTER SEES IT

by CARL DREHER



Drawings by Stuart Hay

The Broadcast Program—Pinnacle of Impermanence

IN THE conversation of a group of broadcasters the other day, there bobbed up the sad theme of the transitoriness of radio performance. There are, to be sure, elements of permanence—or what passes for permanence in this dizzy world—even in broadcasting. Artists come and go, announcers appear and vanish, wavelengths change, but the call letters of the station usually stay put, and are chanted, sometimes, year after year, until people know them as well as the streets they live on. Then, also, when a sponsoring concern pays for a program week after week, a type of permanence is attained, on which, of course, the advertising value of such a series is based.

These elements of fixity may be conceded, yet there is about broadcasting something of the nature of spring freshets, young love, and public esteem. Certainly such comparisons do not appear purely literary when one considers the amount of preparation required for a first-rate hour of broadcasting. The actors or artists are engaged, contracts are signed, a continuity is written, the orchestra rehearses, the announcer goes over his lines. A vast number of technical details must be worked out. The work of ten or twenty people may be required for several days, and anything from a few hundred to a good many thousand dollars may be spent. The setting up and testing of the wire network, if a number of stations are broadcasting, is itself an imposing task. Finally the program is sent winging through the air for its brief sixty minutes. A few hundred or a few thousand letters come in. The advertiser who put up the money reaps

the benefit for some time. But what of the "show" itself—where is that? Where are the snows of yesteryear, as the poet asked? Where are the sparks that flew up the chimney last Christmas, where are the rosy cheeks of the pretty girls of the fifteenth century, where is the verdure of the hanging gardens of Babylon? That's where the broadcast hour is—nowhere. The snows, the sparks, the girls, and the gardens went there fast, but nothing ever went faster than a radio performance. It is of the essence of a jazz age, the most intangible, imponderable, evanescent thing that the restless brain of man ever created. The insects that live an hour are not more ephemeral.

But what of it? The 8-9 hour is dead; the 9-10 hour takes the air, and a hundred thousand loud speakers vibrate to its strains. The king is dead, long live the king! Step lively, king!

The Broadcaster and the Public

BROADCASTING is a public service, purveying sweet sounds and interesting noises to the multitude. Professional broadcasters earn their living through the public, and are bound to

preserve a courteous demeanor toward their clients. And, in general, they feel very amiable toward the customers, who in their turn, treat the broadcasters with more than due consideration, and sometimes bestow on them rewards clearly beyond their merits. There are, however, occasional exceptions to these rules. If you have doubts, ask the telephone operator or hostess at any broadcasting station. Some of these girls have, decidedly, more sense and amiability than a lot of the people at the ends of the lines they connect. I am indebted to one of them, Miss Grace McKeivitt, for most of the material in this discussion.

Generally speaking, if a listener calls up a broadcasting station about any matter connected with the material broadcast by that station, his request for service is legitimate enough. For example, when a lady telephones to explain that her baby cried during the station mind telling her whether the spaghetti should be boiled or baked, her request is a reasonable one. The station wants its listeners to get the recipe, and babies will cry.

But it is annoying when people call up one station, or pay it a visit of state, in order to ask questions about another. The feeling between the stations may be amiable enough, but how can one be expected to know the internal and external policies, personnel, and history of the other, and why should it devote time to such matters? It has troubles enough of its own. No one thinks of calling up one shoe-polish firm to ask about the product of a competitor, but in broadcasting an appreciable number



"THE KING IS DEAD. LONG LIVE THE KING!"

of listeners think nothing of consulting one broadcasting station in regard to matters which are purely the concern of some other station. They ask questions about some announcer who once enchanted them with his cooings over the other fellow's carrier wave, and appear astonished and injured when no adequate answers are forthcoming. Their view seems to be that all broadcasting stations are united in one great fellowship for the pleasure of the listeners, and, anyway, broadcasting is so miraculous that ordinary social and business procedures do not apply in its field. As a matter of fact, there is as much rivalry and self-interest, enlightened and unenlightened, in broadcasting as in any other art or industry. Poets, musicians, surgeons, lobster-canners, preachers, and broadcasters all compete for public favor—broadcasters, just as much as the others, aspire for a place in the center ring of the communal circus. The broadcasters, if anything, have a harder time; in a business in which the economic basis is still somewhat unsettled, many of them do the work of two employees cheerfully, and it is unreasonable to load them with extraneous imbecilities.

A great number of listeners appear to have no notion, as yet, that there are such things as service organizations for owners of radio receivers, and that service is a specialized function requiring experienced personnel. In this benighted state, five years behind the times, they can think of nothing better to do, when their receivers get out of order, than to call up their favorite broadcasting station. They are astonished to learn that the engineers there know practically nothing about the Muddle Manufacturing Company's twelve tube set, and can't diagnose its troubles over the wire. Aren't they radio engineers? The idea that no one but the Muddle Company's technical experts knows anything about that receiver (and maybe the Muddle engineers don't know much themselves) does not seem to enter their heads. Of course, there are always the people who know quite well what they are doing, which consists in trying to get something for nothing. A service man will charge \$1.50 for his advice; the broadcast station may do the job for the cost of a telephone call.

The SOS Question Again

ONE of the radio critics commends the practice of a certain broadcasting station coming in on the air at intervals during sos shutdowns with its call letters, and the reason for its silence. I am moved to disagree on this matter.

I have mingled in radio circles many moons, and most of them were in the period before Christian Science, symphonic jazz, and tire advertisements vibrated through the ether. The nefarious dots and dashes which sometimes spoil the pleasure of the BCL's were then the only burden of the wireless waves. It

is my belief—and I call on all the presidents of the Institute of Radio Engineers from R. H. Marriott forward, and all the wireless operators who have leaned on a key since David Sarnoff forsook his, to support and defend me—that such a practice as the one commended by the radio critic *may* work harm to an sos sender.

Almost two years ago I urged, in this department, a revision in the regulations governing sos traffic as far as broadcast stations are concerned. What I proposed was, briefly, that some scientific discrimination be exercised in requiring broadcasters to shut down. Some, whose power is great, who are located near the coast, and whose frequency is near the marine band, may cause interference with sos traffic. They should be required to shut down promptly and to stay that way. Others, situated inland, or with lower power and higher frequency, may not be at all dangerous to sos communication, and they might as well be allowed to remain on the air. Some of the relatively feeble, short-wave telephone stations do transmit right through sos periods, even on the coast; and of course there has never been any general practice of shutting down a few hundred miles inland. I proposed the use of a mathematical formula to differentiate between harmless and potentially dangerous stations, but probably a more low brow method will work out just as well. I recount all this merely to show that I am rather liberal in this matter, and should not be confused with one of the die-hards who cry that if a tug-boat in the harbor of Bangkok sends an sos on a buzzer, the skipper having stubbed his toe, every radio station in the world must shut down for 24 hours. What I say is simply that, if a station does go off the air when an sos is transmitted, it classifies itself as a potential source of interference, and if thereafter it lets out a single peep it may jam a vital call letter or position figure. Either the transmitter should remain on the air with a good conscience, or else it should get off the air in all haste and not move a wheel until the danger is over. There is no compromise.

Broadcasting and Shows

IN BROADCASTING we often speak of a good program as a "fine show," borrowing the term "show" from the theatrical business, where things are seen as well as heard, and, thank heaven, sometimes look better than they sound. Employed in broadcasting, the term is a misnomer, albeit one of those natural ones which may ultimately establish itself in the language, over the objections of the purists. Be that as it may, real "shows" sometimes fall to the lot of the broadcaster; he is required, to put on the air something intended primarily to be seen as well as heard: a theatrical performance, a banquet with musical trimmings, a political meeting, or something else on that order.

The results, from the broadcasting standpoint, are always more or less dubious. No man can serve two masters, according to Scripture. The text was not written about broadcasting, but it holds just the same. The effort to astound and thrill an audience present in the flesh, as well as the larger audience present only with their ears, is always a risk, and frequently a mistake. Broadcasters turn out their best performances—and certainly they are most at their ease, when they are allowed to run things to suit themselves. In a studio, on his own carpet, within his own padded walls, with the microphone where he wants it and the musicians submissive at union rates, the broadcaster is able to work. He can do the job properly, the conditions being under his control. Then he best serves the listeners, and retires to his suburb tired but happy. But think of what he goes through when his enterprise is merely a by-product.

A merry banquet, say, where the anti-Volsteadian sentiments of the diners are given rein, and everybody is happy, ready to laugh at and applaud everything. They have eaten, they have drunk, and now they lean back to listen to a noted soprano, who has also eaten and drunk. Understand me—the lady is in no unseemly condition; she can walk, slap her escort, talk correctly to the pastor of her church, and sing; but she could sing even better if she had fasted for the past three hours. She is ravishingly beautiful, but that doesn't help the radio listeners. Facing a large audience which flatters her with deafening applause (they would probably applaud the ex-Kaiser, Leon Trotsky, or the late Carrie Nation, in the state of happy digestion in which they find themselves), the soprano puts her best leg forward. She has two good ones, and she uses both, in fact. In other words, she acts. This is perfectly natural, but bad for the microphone, which is unable to follow the lady in her prancings. A stationary *Carmen* suits it better. The announcer is also on the platform, and he likewise does his stuff like a fencing master. Goaded by one of the broadcast functionaries listening on the outside and barking his commands over the order pair, one of the technical crew manages to clutch the coat tails of the announcer as he circles near the wings. Half his announcements are not going out, he is told, and the piano-soprano imbalance is such that the station engineer is writing his last letters in preparation for jumping off the towers; two hundred threatening telephone calls have been received. But nothing sounds very bad when one has ten or fifteen cubic centimeters of good ethyl alcohol under one's belt, and Mr. Announcer has at least that. He reforms for about two minutes, and then forgets it. Everybody in the ballroom is happy, and two thousand people clapping their hands, with twenty reinforcing this genteel form of appreciation with loud yells of approbation, somehow impress one far more than fifty thousand disembodied spirits sitting quietly around

the table lamps. Out of sight, out of mind, it is said. But for broadcasters there could hardly be a worse motto. Shows generally lead to it. Hence if they are wise, program managers will go easy on booking great spectacles; they breed grand flops on the air.

Personal Note by the Author

IN HIS scintillating radio column, which vies with the tabloid newspapers in amusing me on Saturday afternoons, Zeh Bouck implied recently that I was not educable, having been in radio eighteen years without showing signs of cultural eminence which would put me on a par with Thomas Aquinas, Spinoza, Upton Sinclair, and the M. Bouck himself.

The observation is correct, but Mr. Bouck is wrong as to the cause. The fact is that recently I had my brain taken out and examined by a committee of distinguished craniologists. Doubts had begun to assail me. The superb confidence which has enabled me to dominate door-openers, women (with exceptions), soda clerks, and radio announcers, began suddenly to waver. I reflected that I was not yet a vice-president of something or other, that several of my classmates at the various institutions of learning from which I have been expelled now live on sweller streets than I do, that I do not possess a Minerva limousine like Bouck's, and have not been nominated for public office. With this inferiority complex gnawing at my lights and liver, I was impelled to have my brain thoroughly tested. Placed in a Riehle machine, it withstood a tension of 24,000 pounds before the frontal lobe broke off. Holes were drilled in the remaining section and the borings analyzed. The quality was found to be much better than that of street-sweepings or orange peel.

"A good brain," was the report of the doctors. "It compares favorably with the bean of a radio columnist. All it needs is a little re-rivetting. This done, you will be competent to teach chiropractic, pretzel varnishing, or broadcasting."

What, then, is wrong? The blame must be cast on radio itself. The harrowing experiences of trying to eliminate static, reading a bug at thirty words a minute, answering the questions of friends whose receivers are out of order, and keeping cockroaches out of the condenser transmitters—such are the real reasons why I am uneducable. I have been beaten over the head too much; my ears, inured to watts and watts pouring from loud speakers, are no longer sensitive to the still, small voice of learning; my eyes, dazzled daily by studio luminaries like Mary Pickford, Queen Marie of Roumania, and the Hon. Norman Brokenshire, can no longer perceive twelve-point type; nor have I the patience to track knowledge, what with split sentence change-overs and modern pauseless programs. I'm a martyr and it is unseemly for my friend Bouck to jibe at me.

Anyway, am I *so* dumb? I have, after all, sense enough left to cadge some free advertising in the eminent journal adorned by the great mocker every week, into whose columns I could break my way, otherwise, only by committing a murder, marrying a lady of sixteen or sixty, or turning Mohammedan.

Technical Operation of Broadcasting Stations

14. Studio-Field Change-overs

THE broadcast listeners hear a "change-over" as the transition from a studio program to one picked up in the field, or vice-versa. One announcer is heard to stop talking, and the other takes up the new program. To the broadcast operator the "change-over" involves a switching operation. There are a number of ways, differing both in program effect and technical methods, of swinging a change-over. The discussion here will deal principally with the technical aspects.

Fig. 1 shows a simple layout for affecting

change-over operations between field and studio. The studio microphone, M_s , feeds its own amplifier, A_s , the output of which is connected to the first of succeeding stages of amplification leading up to the modulators. A line amplifier, A_L , similar to the studio amplifier, but taking its input from a wire line, has its plate tied to that of the studio amplifier, so that the output of either amplifier goes to the modulators. At the far end of the line there is a microphone M_f , a remote control amplifier of from two to six stages, and auxiliary equipment. The object of the field amplifier is to permit riding over line noise, but the audio energy reaching the station is, as a result, much in excess of the output of the studio microphone, so that an artificial line or "pad" is required ahead of the station equipment to cut down the level coming in on the line to the necessary degree. Switching facilities are also required, so that any one of a number of pairs may be connected to the line amplifier stage in the control, but these are represented in Fig. 1 merely by a double-pole double-throw switch between the line and



"RECENTLY I HAD MY BRAIN TAKEN OUT AND EXAMINED"

the pad at the station end. Gain controls, in the diagram, Fig. 1, are represented by diagonal arrows indicating variable amplification of those stages through which they are drawn.

The normal course of a change-over may now be outlined. We start with a performance in the studio. The microphone M_s is feeding the amplifier designed for its output. The studio announcer finishes his program with a prearranged cue sentence, and shuts off his microphone. During or at the end of this sentence, the control operator, who hears everything radiated by means of a monitoring receiver or other facilities, says to the remote control operator, "You're on the air." He does this by means of a telephone set which may be connected, by means of the double-pole double-throw switch, on the blades of which the line terminates, to that line. The field man, talking into the microphone M_f , answers, "Right!" Then, and not until then, the control operator flips the D. P. D. T. switch to the "Air" side, connecting the line to its amplifier. The remote control technician, after his "Right!" has turned the microphone M_f over to his announcer, or has made the announcement himself, if he combines the two functions, as is not unusual in small stations. What is spoken to M_f now goes out on the air, while M_s is dead. The change-over has been accomplished. At the same time, the telephone set, it should be noted, is disconnected, so that if someone talks to it accidentally, the speech will not go out on the air.

The connections and procedure outlined above are of a primitive type compared to the methods actually used in most up-to-date stations. With thirty or forty pairs of wires coming into the control room, the D. P. D. T. switch becomes a regulation telephone switchboard, with keys, jacks, plugs; ringing, talking, and monitoring facilities are there in abundance. The board should preferably be built with two positions, so that one side may be used independently for testing with one outside point while another is on the air, with less of the ever-present danger of creating a mix-up on the air. The single microphone, M_f , provided at the field point, is usually only one of a number, since otherwise there will be a delay while it is transferred from the operator, who must use it to get on the air, to the concert position. The principle of the operation of changing over remains the same, however.

The process of switching back to the studio is simpler than the reverse operation. It is merely necessary for the studio announcer to be given listening facilities, say in the form of a high-impedance headphone paralleling the loud speaker in the control room. When the field announcer finishes up with the cue sentence, the studio announcer switches on his microphone and begins to talk; the control operator, at the same time, disconnects the field point from the air, exchanging a few words of summing-up conversation with the field men before they take down their apparatus and leave for the next job.

It is considered a mark of finesse in broadcasting to make the change-overs "snappy," leaving scarcely a pause between one event and the next. This idea is carried to an extreme in what is known as the "split-sentence change-over," in which one announcer finishes a sentence begun by the preceding announcer. In going back to the studio from the field, the procedure is, on the technical end, the same as outlined above. The sentence must be agreed upon beforehand. For example, it is understood that the field announcer will say, "We shall now return to our studio, where . . ." And there he stops. The studio man, with his microphone already cut-in, remains silent till he hears "where," then, without a pause, finishes the sentence: "The Ritz trio will entertain you for a half hour." The first time one hears this stunt one gets a handsome kick out of it. As far as I know, the credit for introducing it around New York goes to WHN although several other stations have used it since.

It is somewhat more complicated in the other direction (from studio to field). In this case it is necessary to provide listening facilities for the field announcer. This is done readily on a telephone switchboard by sending the monitoring signal to the

field point over the line for some minutes before the end of the studio program, and letting the field announcer listen on a pair of headphones across the line, in parallel with those of the field operator. This monitoring signal may be secured by taking a tap across the loud speaker in the control room, which, however, it is essential to keep going with adequate volume. When the studio announcer comes to the cue word of the split sentence, the control operator flips a key which disconnects the monitoring signal from the line and connects the line to the air. This requires accurate timing, and a slip on the part of the control operator messes up the change-over. He needs to be sober, to be sure. An experienced man, however, will have surprisingly few failures, and a well-conducted station can be run for weeks without making an error on split sentence change-overs.

One other detail must be looked out for, particularly if one essays split-sentence virtuosity—accurate control of field and studio levels, so that the volume of the two announcers is substantially the same. This equality may be attained by providing listening facilities in the outputs of the first-stage amplifiers, A_s and A_L , with means, also, for disconnecting either from the succeeding stages of amplification. With one of the two on the air, the control operator listens in its output, then lets the announcer who is to take the air next say a few words, while a suitable level is set by adjustment of the amplification of the first control stage, or the artificial line (if this is variable) or the output of the remote control amplifier. The control operator listens for this in the output of the first stage, *not* on the air. When the latter is put on the air, some adjustment may be necessary during the first word or two, but if the preliminary setting has been carefully made the inaccuracy will be slight and hardly noticeable.

Split sentence change-overs, while striking and worth trying, have something exhibitionistic about them which makes them unsuitable for dignified or highly artistic events. They are excellent for ordinary and jazzy programs, but one does not introduce a Philharmonic concert with them. In fact, the speed of the switch-over should be somewhat reduced in such a case, not only to lower the risk of a mix-up but because a few seconds of silence add impressiveness to the entrance of a queen, a president, or a \$50,000 radio program.

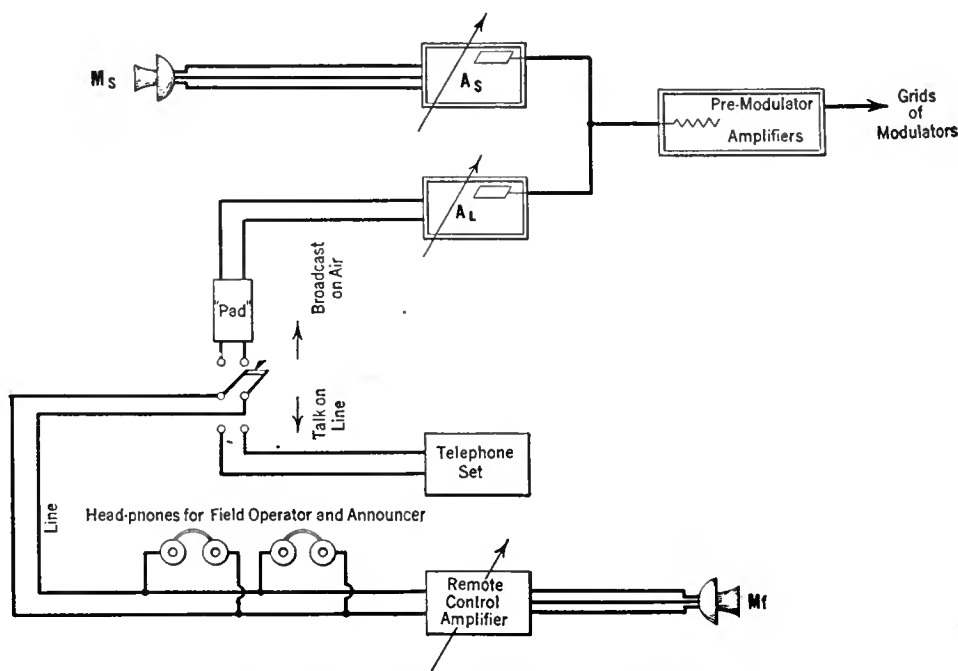

FIG. 1

A. C. As a Filament Supply Source



The Problems of Filament Heating With Alternating Current—Determining the Cause of and Remedying Undesirable Hum—The Best Tubes to Use



By B. F. MIESSNER

Chief Engineer, Genrad Corporation

RADIO receivers and tubes have, since the beginning, been designed and developed for operation on absolutely steady direct current, such as that delivered by batteries. To operate a receiver from machine-generated direct current presents some problems, and to operate it from alternating current presents problems of a much higher order. Because operation from direct-current mains was easier, direct-current receivers of this type were the first to make their appearance in spite of the fact that fully 90 per cent. of electrically wired homes are provided with alternating current, and only between 5 and 10 per cent. with direct current suitable for use with radio receivers, that is, 110-volt current.

With battery operation, it is customary to connect filaments in parallel with a heavy-current A-battery source. When, however, the direct current lighting mains are used it has been found necessary to connect the filaments in series and to add resistance to this series circuit which, when connected across the 110-volt circuit, would provide a current of proper value for the filaments of the tubes. A simplified circuit arrange-

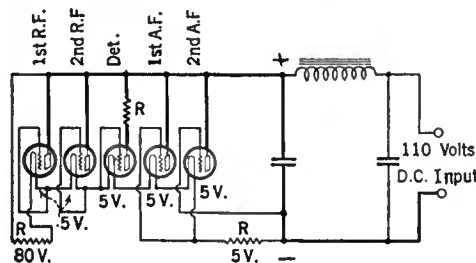

FIG. 1

ment of the general type used for this purpose is shown in Fig. 1.

The next step in electric power receiver development was the substitution, in a circuit of this type, of an a. c. line with a suitable rectifier for supplying the direct current.

In Fig. 2, it will be noted that the vacuum-tube supply circuits are preceded by a filter device, that the vacuum tube filaments are connected in series with a resistance across the rectified current line, and that the grids are biased by voltage drops in filaments more negative than the filament of the tube whose grid requires a negative bias. The first receivers of this type were designed for 201-A tubes requiring 250 milliamperes in the filament and an additional plate load of perhaps 25 milliamperes. To provide this rectified power output of 250 milliamperes at approximately 100 volts, a full-wave rectifier consisting of two Tungar gas type rectifier tubes was used together with a heavy-duty filter, consisting of very large inductances and very large capacities.

With the introduction of 60-milliamper filament tubes and also 60-milliamper rectifier tubes of the Kenotron type, by the Radio Corporation of America, came the possibility of using the same general receiver scheme with such rectifier and radio tubes. This is shown in

Fig. 3. A simplification in the power conversion system was made possible with such a scheme because the output load of the converter was reduced to approximately 30 per cent. of that required by 201-A tubes. Even then, two such rectifier tubes were required to take care of the filament and plate current loads unless a single rectifier tube were to be considerably overloaded.

The ideal scheme for eliminating batteries in receivers is one which will use standard tubes of the larger types, without the necessity of developing rectified current specially for the heating of their filaments, and one which will also provide the large power so necessary for the development of high quality and plenty of volume.

A receiver which will operate satisfactorily with raw a. c. filament supply will require less than half the rectified current required when rectified current is applied throughout. For example, if the small dry-cell tubes are used with filaments in series across the rectified current output, their filament supply will be 60 milliamperes, which is more than the necessary plate supply.

If 201-A type tubes are used, the filament consumption is 250 milliamperes in excess of the plate current load. If still larger tubes, such as the 112, are used, the rectified power must necessarily be still further increased to provide the additional filament heating current. The cost of current-supply devices of this type varies nearly in proportion with the rectified output power for which they are designed; their size, weight, complexity and upkeep cost vary in like proportion.

It will be understood, therefore, that a receiver so designed as to permit the use of standard tubes of proved design with a. c. current excitation of their filaments represents probably the ultimate and ideal type of design for operation from home lighting circuits. The only rectified power required in such a receiver is that used for the plate circuits of the receiver, and the alter-

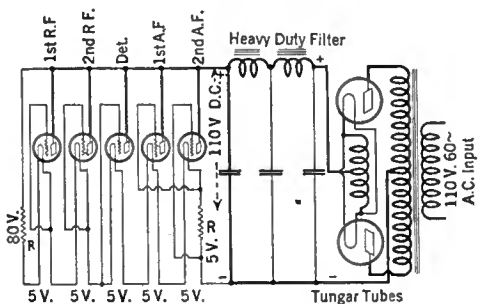

FIG. 2

nating current required for the filament lighting is obtained from a single winding of a few turns of wire on the power transformer used with the B power rectifier. The A power, therefore, requires none of the complex, costly, and bulky elimination apparatus, and the B power requirements are such that the rectifier and filter apparatus is small and inexpensive.

In the author's receiver plan, the filaments of the amplifier tubes are heated by a. c., and the

plate circuits are energized by rectified a. c. The filament of the detector tube is lighted by the B current of all the other tubes which is regulated to the 60 milliamperes required by this filament. By the use of this scheme, therefore, a single 216-B rectifier tube provides ample plate power for all of the tubes, including the powerful 210 second audio tube. The filament power for the detector tube, and the C voltage for all the tubes requiring a grid bias, are also supplied from the 216-B rectifier tube.

AN INTERESTING EXPERIMENT

LET us now consider a two-element vacuum tube connected as shown in Fig. 4. The filament of the tube is excited by a. c. The plate is connected through a telephone or other indicating device to one leg of the filament without any external source of potential included in its path. If we listen at the telephone in this circuit, we will hear a humming noise in which a trained hear can discern a mixture of tone frequencies including 60 cycles, 120 cycles, and

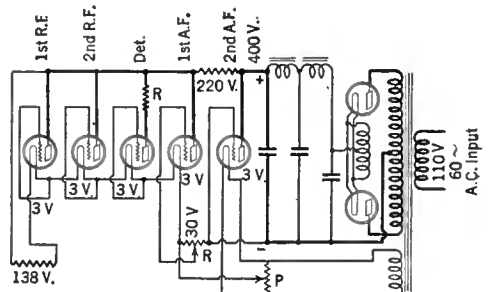

FIG. 3

some other higher harmonic frequencies. This may appear strange, inasmuch as the plate circuit is not provided with any source of potential for attracting the electrons emitted by the filament.

We realize, however, on examination of the diagram, that the plate is connected to the filament at a point of potential variation. The plate itself has at all times the same potential with respect to the rest of the filament as the leg to which it is connected. It is clear that, when the plate and its leg of the filament is positive with respect to the other leg, the plate and this leg both may, by virtue of this positive potential, attract electrons emitted from the negative leg of the filament. In fact, we may conceive of the negative leg as repelling electrons from it while the positive leg is not only holding within it the electrons attempting to escape, by virtue of the releasing effect of the filament temperature, but in addition, this positive leg, along with the plate electrode connected to it, is attracting some of the electrons liberated from the negative leg. Thus we have impressed upon the plate electrode a 60-cycle voltage variation by its connection to the filament circuit, and it functions as a single-wave rectifier under these conditions.

If now we change the connection of the plate

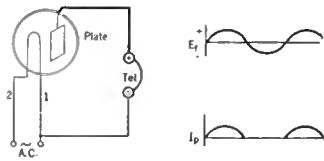

FIG. 4

circuit to the filament circuit as indicated in Fig. 5, so as to reach a point which is neither positive nor negative with respect to the two ends of the filament, the plate will never be positive or negative with respect to the filament as a whole, and it will, therefore, not have the positive potentials applied to it as in the preceding case. If we listen, however, with such an arrangement, we will still hear a humming signal in the telephone. This signal is of a 120-cycle frequency, or in general terms, double that of the exciting frequency. If we include a battery in the plate circuit so connected as to make the plate negative with respect to the filament, we will find that a potential of several volts is required to stop the hum signal. With the 201-A type tube, a negative plate voltage of about 9 volts is necessary to stop this signal. With the 199 type tube, a negative voltage of about 3 volts on the plate will accomplish the same result. One might ask many questions concerning the cause of this phenomenon. It might be due to a bicyclic thermo electromotive force set up between plate and filament by a bicyclic temperature variation of the latter; it might be a bicyclic contact electromotive force; it might be photo-electromotive force, or a magnet electromotive force emanating from the filament current.

Possibly the best explanation is that there is a bicyclic variation in initial emission velocity. We know that when a cathode is heated, it allows a freer swing to the natural vibration of the electrons within it and we know that the higher the temperature of the cathode, the greater the velocity of emergence of the electrons liberated by the heating. If then the temperature of the cathode is varying under the varying heat-producing electric current, the velocity of emergence will vary. Consequently the plate electrode, with no attractive force of its own for these electrons, will receive a mild bombardment of them which varies (in number of electrons striking it) with their emission velocity. We see, therefore, according to this explanation, that electrons reach the plate through no attractive force of its own and with a bicyclic variation following the temperature variations of the filament itself. This temperature effect, along with the effects of the voltage on the plate due to the latter's connection with one side of the filament, as shown in Fig. 4, occur simultaneously. We should not forget in this connection that the positive voltage of one leg of the filament is attempting to equalize the emission reaching the plate by stealing from the negative leg a portion of the excess electrons liberated at the periods of higher temperature. That is, while the negative leg tends to emit more electrons, due both to its

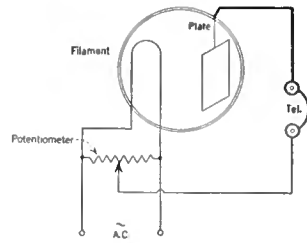

FIG. 5

rising temperature and to its rising repulsive negative potential, the potential of the positive leg is rising also and attracting to it an increasing number of freed electrons. Thus, the effect of the positive leg which we shall call "voltage effect," is in direct opposition to the "temperature effect" and tends therefore to stabilize the electron flow to the plate electrode. These effects are shown in Fig. 6. In this diagram, curve A represents the exciting voltage applied to the filament of the tube. Curve B indicates the temperature of the filament and shows that the temperature variation is bicyclic with reference to the exciting current. Curve C indicates that the plate current also is bicyclic although the definite relation between temperature and emission is not indicated in this curve. Curve D indicates the voltage variation on the positive leg of the filament insofar as its action as a plate electrode is concerned. The numerals 1 and 2 indicate that during the first cycle one leg of the filament is the positive leg and that during the other half cycle the second leg acts as the positive plate electrode, so that, irrespective of the fact that a given leg of the filament is alternately positive and negative, one or the other of the legs is positive during all periods except when the exciting voltage passes through the zero point, and therefore one or the other leg is constantly acting as a plate electrode of variable potential. The effect upon an otherwise steady emission to the plate electrode of the vacuum tube is shown in curve E, which indicates that the voltage effect of the filament causes a periodic decrease in the electron flow to the plate. When the two effects shown in curve C and E are present simultaneously in the same tube, one tending to increase the emission to the plate and the other tending to decrease it, both of these effects are constantly opposed and a neutralization results which has the effect of stabilizing the plate current, as shown in curve F.

While these curves indicate the tendencies toward plate current stabilization, they are not meant to represent exactly the effects found experimentally. To determine exactly the precise amount of hum signal developed in the plate circuit of various types of vacuum tubes under more normal operating conditions, a series of measurements have been made upon different types of tubes under different operating conditions. In order to obtain this information, a

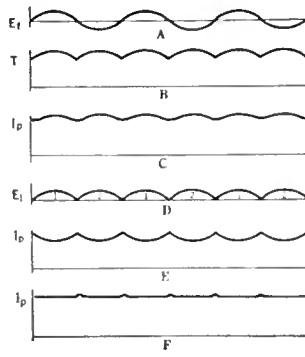

FIG. 6

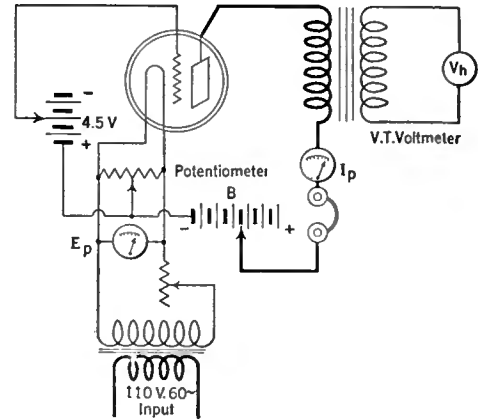

FIG. 7

vacuum tube with direct current plate potential and with steady grid bias was set up for alternating current filament excitation.

FURTHER EXPERIMENTS

IN FIG. 7, the circuit arrangement employed for making these measurements is shown. It will be noticed that the filament of the vacuum tube is energized from a 110-volt 60-cycle lighting circuit through a step-down transformer and controlling resistance. A voltmeter across the terminals of the filament indicates the voltage impressed thereon. A milliammeter in series with the plate circuit indicates the plate current therein, while a telephone in the same circuit serves as an aural indicator of hum signals. An output transformer primary is also connected in this plate circuit and its secondary is connected to the terminals of a vacuum tube voltmeter, whose function it is to measure the peak voltage of the alternating currents produced by hum causes within the vacuum tube. There is no input to the grid circuit other than the grid biasing C battery. The grid- and plate-circuit filament returns are made to the central point of the potentiometer shown connected across the filament terminals. The plan of measurement here is to fix the grid and plate voltages at some definite values and then to vary the filament voltage through definite steps and to measure the hum signal as well as the plate current for each such filament voltage.

Curves are then drawn with the filament voltage as abscissae and the hum signals as ordinates for one curve and the plate current as ordinates for another curve. These two curves are plotted together and various sets of this type are obtained under varying plate and grid voltage conditions. In Fig. 8 are shown two such curves obtained with an UX-112 type tube with a plate voltage of 135 and a grid voltage of 4.5 volts. The filament voltage was varied from approximately two to six volts and the plate current and hum voltage curves were obtained as indicated. We are impressed at once with the unexpected fact that the hum does not increase uniformly with the filament voltage as would a grid impressed signal voltage under the same conditions. There is, strangely, a rather pro-

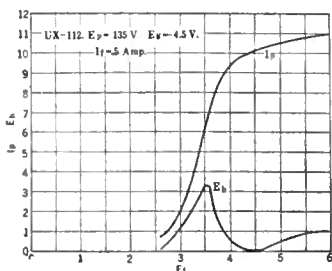

FIG. 8

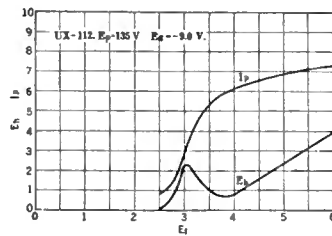

FIG. 9

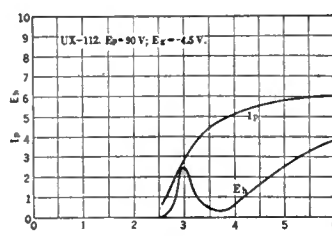

FIG. 10

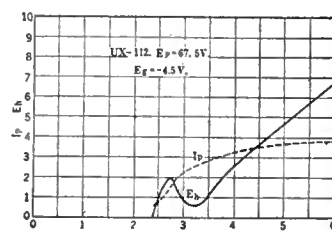

FIG. 11

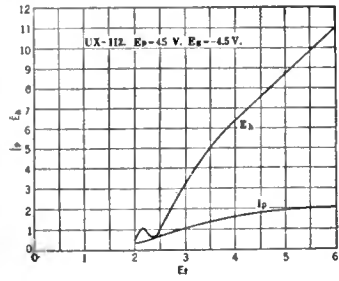

FIG. 12

nounced peak in the hum voltage at a point of about half the normal filament voltage, and there is a very definite minimum at a voltage of about 15 per cent. below the normal voltage of 5 for this tube, and again a definite rise as the normal voltage is approached and exceeded.

If now we change the operating conditions only by doubling the grid voltage, we obtain the curve shown in Fig. 9. Here we note that the hum peak has remained about the same, that the minimum point has risen to a considerable value, and that the upper maximum has increased about four times. If, instead of doubling the grid voltage, we leave the grid voltage at 4.5 volts and decrease the plate voltage to 90, we obtain a curve, shown in Fig. 10, similar to that for the nine-volt grid bias and 135-volt plate voltage. If we now reduce the plate voltage still further, to 67.5 volts (see Fig. 11), we notice a slight decrease in the lower peak, a further rise in the minimum portion, and a decided rise in the maximum portion. Going down to 45 volts we note in Fig. 12 that the lower peak has almost disappeared while the upper maximum has risen to a comparatively high value.

If we now compare the hum curves of Figs. 8, 11, and 12, by drawing them together on one curve sheet, as shown in Fig. 13, we can at once see the general nature of the variation in the curves under the changing plate voltage conditions. With high plate voltage, the hum peak is predominant, and as the plate voltage is lowered, this hum peak decreases in amplitude while the upper maximum steadily increases.

It may be observed in these curves that the peak of the hum curve always coincides with the point of maximum steepness in the filament voltage-plate current curves drawn with them. This appears to identify definitely this hum peak with a temperature variation cause. Since a given amount of filament voltage variation at the steepest point of this static plate-current curve produces the maximum change of plate current, it is quite reasonable to expect that, under dynamic conditions, the complete change from maximum to zero of the filament voltage would produce a periodic change in plate current whose frequency is double that of the filament exciting current frequency. And, since the greatest variation in plate current is produced at this filament voltage, it is obvious that the greatest

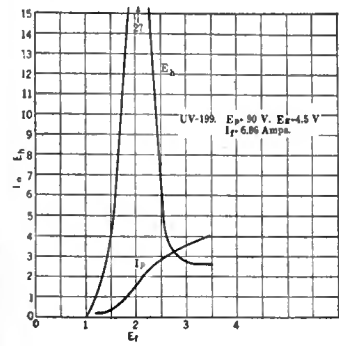

FIG. 16

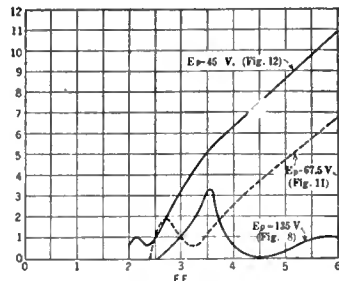

FIG. 13

amount of hum disturbance would occur also at this point. We have, therefore, rather definitely identified the lower voltage peak with the temperature variation of the filament. This identification is still further strengthened by the fact that this hum peak corresponds fairly well in amplitude with the slope of the filament voltage plate-current curve.

The filament voltage of the 201-A type tube is the same as that of the 112, whose characteristics have just been shown. However, its filament is made of thoriated tungsten designed for a 0.25-ampere operating current, while the 112 tube has an oxide coated platinum filament designed for an operating current of 0.5 ampere.

HUM CURVES

IN FIG. 14 are plotted three hum curves of the UV-201-A representing the two extremes and middle conditions as far as plate voltage is concerned. By an inspection of the curves it is easy to visualize very clearly the changes in hum characteristics with variations in plate voltage, and again identify this hum with the filament temperature variation cause. It will also be noticed that the hum peaks are much higher than those obtained for the 112 type of tube. Similar curves for the 120 tube are given in Fig. 15.

Proceeding now to the UV-199 tube with a three-volt filament, taking only 60 milliamperes, we obtain curves such as shown in Fig. 16 and Fig. 17. With 90 volts on the plate and a negative grid voltage of 4.5 (Fig. 16), the plate current characteristic is comparatively flat, while curiously enough the hum peak is very pronounced at the normal operating voltage of the filament. If we decrease the plate voltage to 45 and maintain the same grid voltage as before, we get an extremely flat plate-current characteristic, a very low hum peak, and a definite indication of a minimum point at about 2.5 volts on the filament. See Fig. 17.

Finally, we have two curves for the WD-12 type of tube. This tube has the lowest operating voltage of all, while the filament current is the same as for the 201-A, or 0.25 ampere. It has, however, an oxide-coated platinum filament as has the 112 tube, and operates at comparatively low temperatures. The first curve taken on this tube is shown in Fig. 18, with a plate voltage of 135, and 9 volts negative bias on the grid. The plate current curve is much steeper than any we have yet considered, while the hum peak is

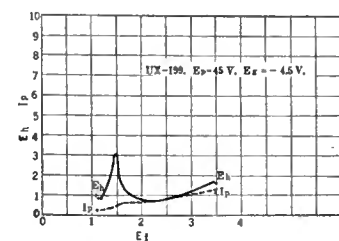

FIG. 17

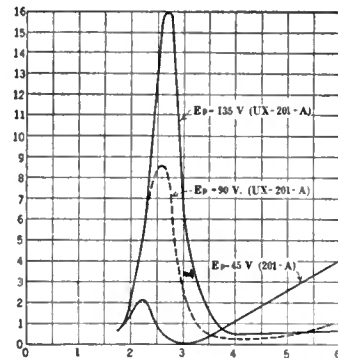

FIG. 14

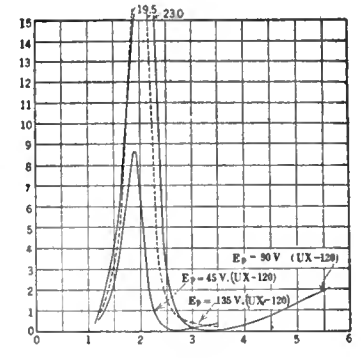

FIG. 15

about the same as for the 201-A. At a point near or beyond the normal filament voltage, the hum curve is still quite high and there is little indication of a minimum point. In Fig. 19 a curve is given with a plate voltage of 90 and a negative grid voltage of 4.5. A reduced hum peak is obtained, but in general the same hum and plate current characteristics are present. Curiously, there is a steep bulge in about the middle of the plate current characteristic that has not been noted on any of the other tubes under discussion.

If we consider the grid and voltage ratings of the filament as indications of the thickness of the filaments, and consider that a thick filament will not fluctuate in temperature so much as a thin filament, we may compare filaments so far as their temperature variation hum characteristics are concerned on a basis which we may call the "thermal inertia" of the filament itself. This is a time temperature factor which is determined by the thermal characteristics of the filament. The cubical contents of the filament, its specific heat, its radiation constant, the conduction effects through lead-in wires, and some other factors, determine the value of this thermal inertia factor for any given filament. With a given material it is, of course, highest for a cylindrical type of filament, as compared for example, with a flat strip type of filament. It is greater for a material with high specific heat than it is for one with a lower value. It is greater for a filament having a surface with low radiation constant than it is for one having high radiation properties. It is greater for a filament of low temperature than it is for one of high temperature, because the radiation factor increases rapidly with high temperatures. If, therefore, we classify the various tubes we have thus far studied with reference to their filaments and select two extremes and a medium, we will have the 112 tube at the one extreme with highest thermal inertia, the 201-A with medium thermal inertia, and the 199 with the smallest thermal inertia.

THERMAL INERTIA

IF WE plot the hum curves of these three tubes for the same plate and grid voltages, that is, 90 volts plate and negative 4.5 grid volts, as shown in Fig. 20, we may compare their hum characteristics directly as a function of the ther-

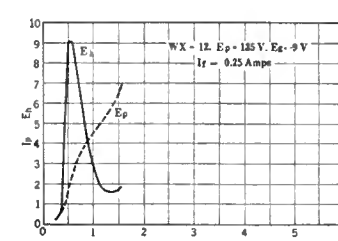

FIG. 18

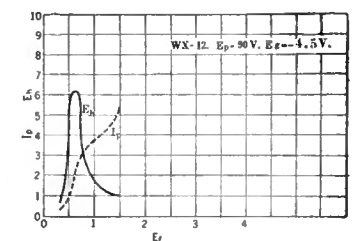

FIG. 19

mal inertia of the filament itself. This comparison indicates very clearly that the hum peak is always found below normal filament voltage, and has a very definite relation in its magnitude to the thickness and thermal characteristics of the filament.

From the preceding data the fact is well established that one very prominent kind of hum in tubes is due to the temperature variation of the filament. It has been further established that there is usually to be found a filament voltage within the operating characteristics of the tube at which the total hum from whatever cause developed by the tube is at a minimum. It has been shown that at voltages near, and in excess of the normal operating voltages, there is usually a considerable rise in hum output of the tube.

We will now endeavor to explain the cause of these phenomena. If we go back to our discussion on the two-element tube, wherein we indicated that there was present within a tube a voltage effect and a temperature effect, which tend to neutralize each other so as to cause a stabilization of the plate current under varying filament emission, the explanation of these hum effects will be made clear.

Let us consider for a moment a tube which, with normal filament, grid, and plate voltages, has a filament sufficiently thick to prevent any appreciable temperature variations due to its high thermal inertia. With such a tube, we will have no hum peak due to temperature variations, but we will have a hum of another type due to the voltage effect previously discussed.

Remembering that the positive leg of the filament is acting as a plate electrode and attracting electrons from the negative leg, we can understand that, irrespective of the fact that the emission from the filament is constant, due to constant temperature, there is still a hum due to the "stealing" effect, which causes a hum of double the frequency of the exciting current, because of this periodic subtraction from the flow to the plate by the periodic flow to the filament legs. With such a tube we will secure a hum characteristic such as that shown in Fig. 21. We can see therefore, that by merely increasing the thickness of the filament we have not eliminated all of the hum causes within a tube.

If now we consider another type of tube in which the filament has a very low thermal inertia and a negligible voltage effect, so that a strong variation of temperature and plate current results, we will obtain a curve of the type shown in Fig. 22, in which the voltage effect is absent.

The 199 type of tube, with but three volts across its filament and the ends far spaced in this straight filament form, is almost a perfect example of this type of tube, as you may remember from the appearance of the hum characteristic which showed a very high temperature peak and no appreciable voltage effect.

In Fig. 22, it will be noted that the hum curve does not drop to zero, at the higher filament voltages, but that it retains a fairly uniform value which, from a comparison of all the curves so far presented, indicates that its value at this point bears a definite relation to the slope of the plate current characteristic in the same filament voltage region. The hum curve, therefore, should never drop to zero unless the plate current curve is parallel to the filament voltage axis.

If we now combine the temperature effect and the voltage effect in a single tube, we may expect a neutralizing action between them, which, under suitable conditions, may make it possible to operate a tube with alternating current on the filament and with a stable plate current. By combining the pure voltage hum characteristic of Fig. 21 with the pure temperature characteristic of Fig. 22, we can understand how this neutralization takes place and what should be the form of the resultant hum curve.

This combination is shown in Fig. 23, wherein the upper curve represents the temperature characteristic and the lower curve the voltage characteristic. The algebraic addition of these two factors, E_{ht} and E_{hv} , gives the resultant curve shown in the dotted line. This dotted curve shows that, at the point where the two neutralizing effects are equal, zero hum results, and that where the temperature effect is predominant, that is, at voltages below this zero point, we have a temperature type of hum, and at voltages above this point, where the voltage effect be-

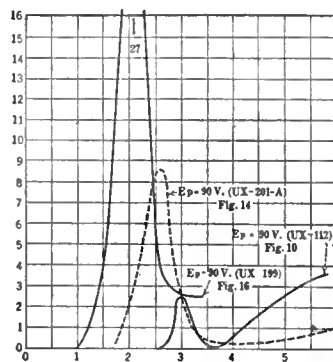

FIG. 20

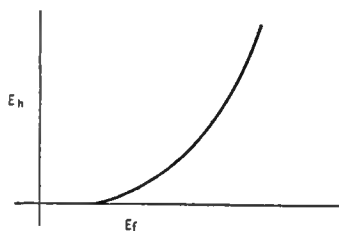

FIG. 21

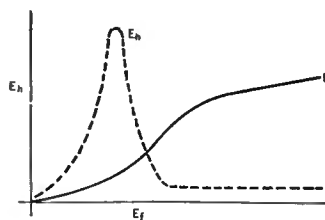

FIG. 22

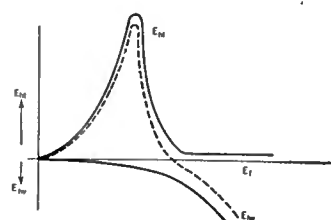

FIG. 23

comes predominant, we have a voltage type of hum.

Of course, in the measuring apparatus used for taking the hum curves previously shown, this reversal in the nature of the two types of hums on the two sides of the minimum point, does not appear, with the result that the portion of the dotted curve below the filament voltage axis turns upward instead of downward in the curves shown. It is necessary to show it as it is indicated in Fig. 23 to arrive at the algebraic sum of the curves, and this form is more exact.

112 TUBE BEST

THE 112 type of tube has been found best for use in audio and radio frequency amplifying circuits because there is more complete neutralization of the two hum causes within this tube than there is in other tubes. Again, while some of the other tubes show quite low minimum hums, at operative filament voltages there are nevertheless, present within the tube, hum causes of the two types of considerable magnitude. These, while they almost completely stabilize the plate current, nevertheless introduce other effects. A tube of the 199 type, while its hum output at about 3.5 volts is quite low, is practically useless for radio frequency ampli-

fication when its filament is excited by alternating current, due to the fact that its filament temperature is varying considerably. The amplification constant of the tube is varying with the temperature variations of the filament irrespective of the fact that the plate current is very nearly stable so that, as a result, a constant amplitude radio frequency voltage impressed upon the grid circuit of such a tube will possess a strong 120-cycle modulation frequency in its plate circuit. A receiver using such tubes may be made to operate very quietly so long as signals are not received, but when signals, especially strong ones, are received, this modulation effect introduces a strong 120-cycle hum which completely ruins reception.

The 112 type of tube, because of its very heavy filament, introduces only a very slight hum of this modulation type and, in addition, its plate current is practically without ripple, due to the very close neutralization of the temperature and voltage effect hums. The ideal type of tube, should have an oxide-coated low-temperature filament of the straight type operating with perhaps one volt and two amperes. The filament should be round so as to provide the greatest thermal inertia with a given mass of filament material. It should be straight, and the voltage across its ends should be low so that the voltage effect is reduced to a negligible factor.

It should be possible, as the writer's experiments with special tubes have shown, to use such tubes indiscriminately for radio frequency amplification, detection, and audio amplification with the introduction of no objectional hum in the loud speaker output.

In receivers deriving filament, plate, and grid voltages from alternating-current sources, there are other forms of hum than those introduced by the filament excitation within the tubes themselves. A certain amount of ripple is always present in B-supply rectifiers, and this will introduce a hum, particularly if any considerable amount of it is present in the detector or first audio stages, with subsequent

amplification behind it. Instead of the usual procedure in bringing the grid and plate circuit returns to the filament at the center of a potentiometer connected across the filament, some of the B ripple hum can be eliminated by introducing a ripple into the grid circuit of one or more of the vacuum tubes in a receiver by displacing the potentiometer from its usual central position. In this way a 60-cycle grid voltage of very small magnitude is made to neutralize a 60-cycle plate voltage variation of larger magnitude.

Another method of eliminating B ripple consists in utilizing, for the grid bias of the vacuum tubes in the receiver, a voltage drop through a resistance carrying some or all of the B current in the receiver. In this way the grid has applied to it a somewhat unsteady biasing voltage with variations of correct phase and amplitude for neutralizing, at least in part, the plate voltage variations from the B supply.

An article in next month's RADIO BROADCAST will give a description of a commercial broadcast receiver in which the principles of hum elimination herein described are employed. This receiver was introduced to the public in May, 1926, and has thus far enjoyed a very successful commercial exploitation.

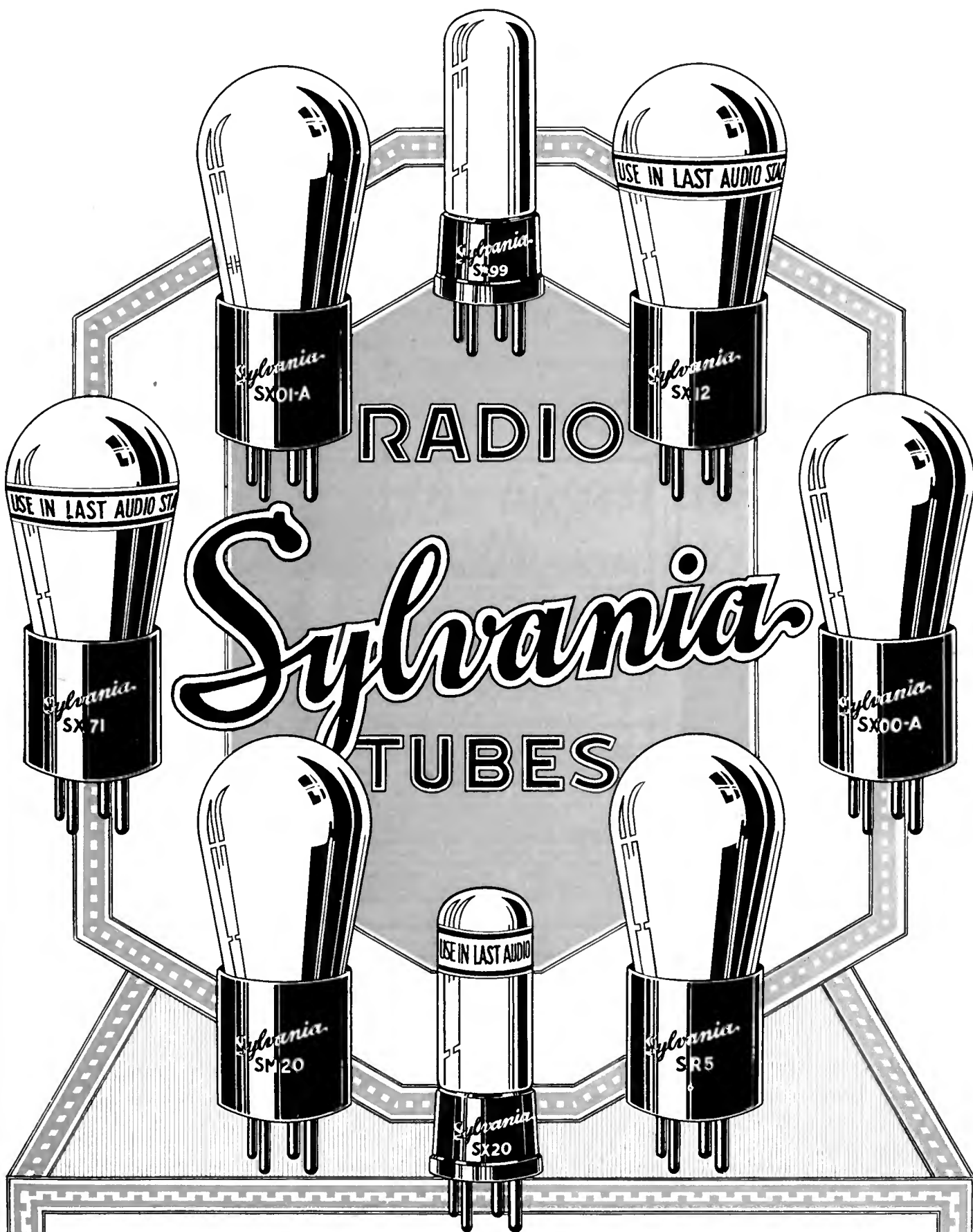

THE tube you want is in this group—the special detector to bring distant stations nearer —power tubes to make near stations more enjoyable. Whatever your set, dry cell or storage battery, Sylvania tubes will bring out the best there is in it.

SYLVANIA PRODUCTS COMPANY · EMPORIUM, PENNA.

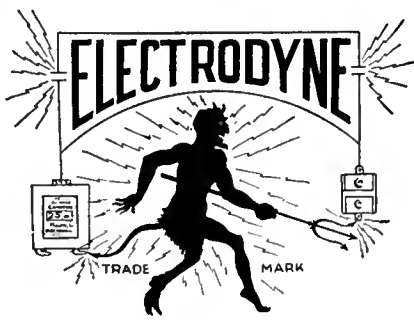

Your Open Fire Is Made Friendly

Picture this. A cold night—a cozy room—an open fire—congenial company and utmost confidence when you turn the dials. A knowledge that your entertainment will be unmolsted because your B-Eliminator has reserve power coming from the "B" BLOCK. The whole atmosphere is more friendly.

Electrodyne engineers guarantee their "B" BLOCK to be absolutely moisture proof. Its condensers are sturdy and made with utmost precision to insure long life. They vary in capacity and price from \$9.00 to \$11.00.

Could you see what was required of your "B" BLOCK, you would buy the best.

ELECTRODYNE "B" BLOCK

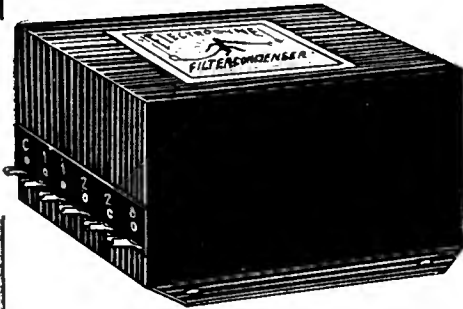

Electrodyne By-Pass and Filter Condensers

Guaranteed to stand 600 and 1000 volts respectively according to our laboratory standard. Electrodyne condensers are guaranteed to hold their charge for days. Prices according to capacity from 60c to \$7.50



Electrodyne Fixed Mica Condensers



Electrodyne fixed mica condensers are sealed in a moisture-proof insulating compound which guarantees absolute freedom from moisture. This means clarity in reception. Prices according to capacity vary from 25c to 95c.

If your nearest dealer cannot supply you write to us direct

Manufacturers write us for our special offer

ELECTRODYNE CO., Inc.
2378 Third Ave., N. Y. C.

The Radio Broadcast LABORATORY INFORMATION SHEETS

INQUIRIES sent to the Questions and Answers department of RADIO BROADCAST have until recently been answered either by letter or in "The Grid." The latter department has been discontinued, and all questions addressed to our technical service department are now answered by mail. In place of "The Grid," appears this series of Laboratory Information Sheets. These sheets contain much the same type of information as formerly appeared in "The Grid," but we believe that the change in the method of presentation and the wider scope of the information in the sheets, will make this section of RADIO BROADCAST of much greater interest to our readers.

The Laboratory Information Sheets cover a wide range of information of value to the experimenter, and they are so arranged that they may be cut from the magazine and preserved for constant reference. We suggest that the series of Sheets appearing in each issue be cut out with a razor blade and pasted on filing cards, or in a note book. The cards should be arranged in numerical order. Several times during the year, an index to all sheets previously printed will appear in this department. The first index appeared in November.

Those who wish to avail themselves of the service formerly supplied by "The Grid," are requested to send their questions to the Technical Information Service of the Laboratory, using the coupon which appears on page 434 of this issue. Some of the former issues of RADIO BROADCAST, in which appeared the first sets of Laboratory Sheets, may still be obtained from the Subscription Department of Doubleday, Page & Company at Garden City, New York.

No. 65

RADIO BROADCAST Laboratory Information Sheet

February, 1927

The Vacuum-Tube Voltmeter

HOW IT FUNCTIONS

THE vacuum-tube voltmeter is a very useful instrument and it finds wide use in an electrical laboratory. The simpler type is not at all difficult to make up, and with it some interesting measurements can be made. For best results it should be calibrated, but even without calibration it is still possible to make many measurements with it that will give a general indication of the comparative merits of different coils, amplifiers, and other units, etc.

The circuit diagram of a vacuum-tube voltmeter is given on this Sheet. The B-battery voltage need not be more than 22½ volts, and the indicating instrument in the plate circuit should have a maximum scale reading of not more than 1½ milliamperes. The C-battery voltage should be adjusted until the meter reads about ½th of a milliampere when the terminals 1 and 2 are short-circuited.

The tube is now being operated on the lower bend of its characteristic curve, similar to the condition under which a C-battery detector operates. Now, if any voltage, whether it be direct or alternating, is impressed across the input terminals, the plate current will change. If a calibration is to be carried out, it is accomplished by impressing various known values of voltage across the input terminals and reading the corresponding deflections of the plate milliammeter. Then, if the input terminals are connected across any unknown voltage it is possible to determine the value of this voltage by noting the

deflection of the plate milliammeter. The actual voltage is obtained from the previously made calibration curve.

As mentioned, even if instruments are not available with which a calibration can be made, it is possible to make comparative tests. For instance, by placing the same input on two amplifiers under test and then connecting the vacuum-tube voltmeter across the output of each, readings may be obtained. Obviously, the amplifier which produces the greatest deflection has the greatest amplification.

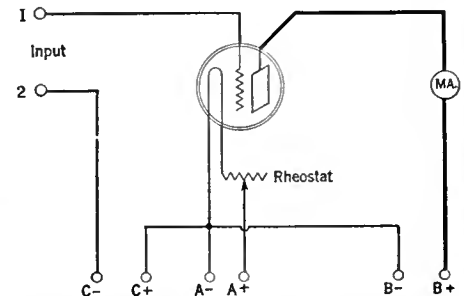

No. 66

RADIO BROADCAST Laboratory Information Sheet

February, 1927

A Radio Frequency Oscillator

ITS USE AND CONSTRUCTION

A DIAGRAM of a simple oscillator that takes all of its energy from the power mains is given on this Laboratory Sheet. A unit such as this is quite useful to the home-constructor in making many tests on receivers. It sends out energy in much the same way as any broadcasting station, and it can be tuned to deliver this energy at any frequency between 500 and 1500 kc. (600 and 200 meters). It makes use of a 201-A tube and will operate on either 110 volts a.c. or d.c. If the latter is used, the device will only function when terminal No. 2 is connected to the positive side of the line.

The coils, L₁ and L₂ may be wound on a single piece of tubing 3½ inches long, having an outside diameter of 2½ inches. L₁ consists of 50 turns of No. 26 d.c.c. wire, and L₂, spaced ¼ inch from L₁, consists of 40 turns of the same size wire. Both coils are wound in the same direction.

The condenser, C, should have a maximum capacity of 0.0005 mfd. An ordinary electric light bulb of 25 watts rating is shown in the circuit. If by any chance the oscillator is to be used on a 220-volt circuit, the electric light bulb should be replaced by one suitable for use on this voltage, and should be rated at 50 watts.

If this oscillator is supplied with alternating current and is placed within a few feet of a receiver, it will be possible to tune-in the signal generated by it if the receiver is in good condition. The note heard will be a low-pitched hum. If the unit is

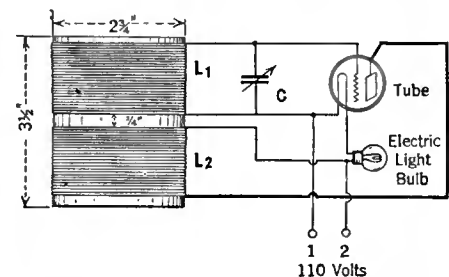

supplied with direct current it will not be directly audible. However, if the receiver is of the regenerative type it will be possible to produce a heterodyne whistle, when the set is oscillating.

Attach this marvelous amplifier



\$25
ready to
attach

to your set
in less than
5 minutes

and get
the biggest thrill out of
radio you have ever had

Any radio set—no matter what type, make, or age—can instantly be transformed to give you such rich and clear and natural reproduction of music and speech that you will be absolutely astounded. You cannot duplicate Truphonic amplification, *no matter how much you can afford to pay*. At the low price of \$25, the Truphonic brings a thrilling new enjoyment of radio within the reach of all.

Truphonic Amplification is not surpassed—at any price

If you want this new thrill in radio, do this:

Get the Truphonic amplifier at your radio dealer's. Place it alongside, or behind your set. Make one simple connection to your set. (A clip goes over one prong of the detector tube—done in 10 seconds). Connect the battery cable. Take the regular standard audio tubes from your set. Insert them in the Truphonic, along with an extra tube (either 201A or power tube). Plug loudspeaker into Truphonic. That is all. The rest is a song of praise from you, and from all of your friends who hear it.

The Truphonic employs an audio coupling system that is definitely superior to transformers, resistance coupling, or impedance. Three stages of this advanced coupling give much greater distortionless volume than is possible by any other method.

A power tube can be used, and in fact is recommended for the very best results, owing to the fact

that for great volume a power tube has a much greater undistorted output capacity than a 201A.

We recommend using a UX 171 tube. (The wiring to extra B and C batteries is provided for in the Truphonic cable). This combination gives exceptional volume, with an unapproached faithfulness. But in any case, whether you use a power tube or not, the Truphonic will vastly improve upon your present reproduction. (Truphonic Amplification is also to be had in single coupler units described on the next page.)

Don't let another night go by without getting all that radio can give in beautiful reproduction. Attach a Truphonic to that set of yours and expect the biggest radio thrill you have ever had.

If your dealer has not yet stocked the Truphonic Amplifier, we will send you one direct C. O. D. on a 5-day money back trial. Be sure to mention your dealer's name and address.

ALDEN MANUFACTURING CO.

Dept. B.22 Springfield, Mass.



TRUPHONIC
POWER by AMPLIFIER



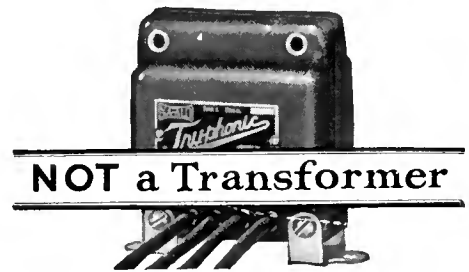

A few points on Truphonic Superiority

We make the statement without reservation—that Truphonic amplification (*not to be confused with dual impedance*) is the most perfect audio coupling so far developed. We further state that using the same tubes in a comparison with any other method of coupling, whether transformer, resistance, or impedance, Truphonic affords the most perfect reproduction obtainable in radio—regardless of the price you pay.

These are strong statements—but they hold out to you the promise of the greatest radio enjoyment you have ever had.

This is good news indeed for radio fans and set-builders, as well as for set manufacturers, for today radio value is measured by radio reproduction.

Convincing Proof

Here are just a few examples of Truphonic superiority:

With 201-A tubes throughout Truphonic is better than any other method in quality and volume.

With Hi-Mu tubes in the first 2 stages, the volume simply steps up, maintaining the same quality. In fact 2 stages of Truphonic with Hi-Mu tubes at 90 volts will give you greater amplification and quality than two transformers using one 201-A and one 171 Power Tube at 180 volts.

With 199 tubes results are noticeably better with Truphonic and you can go so far as to use four stages of Truphonic with 120 in the last stage. This of course could not be done satisfactorily with transformers or resistance.

With 199 tubes in the first two stages and a 210 power tube in the last stage results are obtained which could not be duplicated with other coupling methods.

We give this data to show how universal Truphonic is in its use with various tube combinations, giving in every case results superior to all other coupling methods.

Low in Price

Every set-maker whether amateur or commercial owes it to himself to get full information on Truphonic amplification.

The individual Truphonic Coupler is No. 301 and is priced at \$5.00. If your dealer cannot supply, write direct.

The quick attachable Truphonic Amplifier, No. 304 (fully described elsewhere in this issue) consists of 3 stages of Truphonic coupling and the Output Unit.

The Output Unit No. 300, which has the same exterior appearance as the Truphonic coupler, is designed to protect your speaker from demagnetization and burning out. R. C. A. recommends the use of an Output unit with all power tubes. Price \$5.00.

ALDEN MANUFACTURING CO.
Dept. B-22 Springfield, Mass.

No. 67

RADIO BROADCAST Laboratory Information Sheet February, 1927

171 Tube Characteristics

PLATE IMPEDANCE

THIS Laboratory Sheet will explain how to determine the plate impedance, or output resistance, of a tube by using figures that can be obtained from the static characteristics. Specifically does it deal with the 171 type tube. The plate impedance is equal to the change in plate voltage divided by the corresponding change in plate current. We will calculate the plate impedance of a 171 tube using the static characteristic curves given on Laboratory Sheet No. 68.

EXAMPLES:
No. 1. What is the plate impedance of a 171 tube with 180 volts on the plate and a negative grid bias of 40.5 volts?

See curve 5 on Sheet No. 68. The X indicates that point on the curve corresponding to the condition given in the example (i. e., 180 volts on the plate). The impedance is determined by first of all reading from the curve two different plate currents corresponding to two different plate potentials, with the same grid bias in each case. Any plate voltages may be taken provided we stay on the straight portion of the curve. Therefore, we might take plate voltages of 170 volts and 190 volts, corresponding to plate currents of 15.8 mA. and 26 mA. The change in plate voltage is $190 - 170 = 20$ volts,

and the change in plate current is $26 - 15.8 = 10.2$ mA. Therefore, the plate impedance of the 171 is equal to the change in plate voltage (20), divided by the change in plate current (10.2 mA., or .0102 amperes) which equals 1961 ohms. This value corresponds very closely to that given for the UX-171 (2000 ohms) in Laboratory Sheet No. 58, in the January issue.

No. 2. What is the plate impedance of a 171 tube with 135 volts of B battery and a grid bias of minus 27 volts?

Refer to curve No. 3 and take any two plate voltages in the straight position of the curve, say 130 and 160 volts. The corresponding plate currents are 13.8 mA. and 30.3 mA. The plate-voltage change is $160 - 130 = 30$ volts, and the plate-current change is $30.3 - 13.8 = 16.5$ mA. Therefore, the plate impedance is 30 volts divided by 16.5 mA., or 0.0165 amperes, which gives 1818 ohms as the plate impedance.

Mathematically, it is evident that what we are determining is the reciprocal of the slope of the curve. The plate impedance is constant over the straight position of the curve. It is also apparent from an inspection of the curves that the output resistance or plate impedance is practically the same for all values of plate voltage, the slope of the curves being nearly the same.

No. 68

RADIO BROADCAST Laboratory Information Sheet February, 1927

Curves for the UX-171 Tube

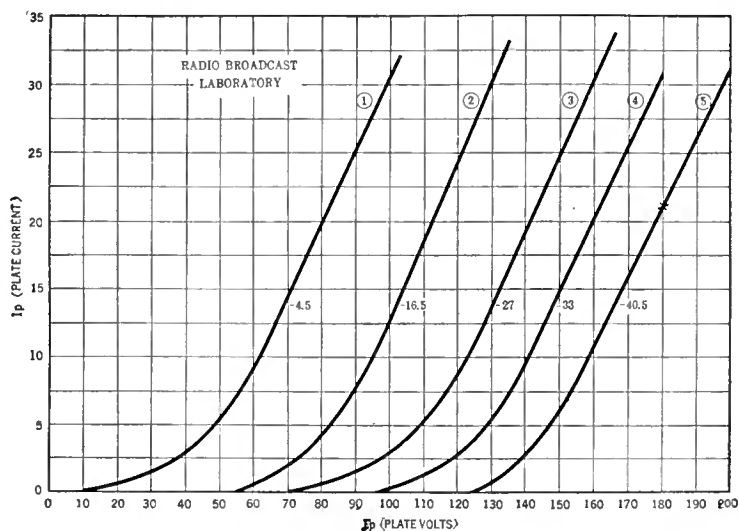

No. 69

RADIO BROADCAST Laboratory Information Sheet February, 1927

Sources of Electrons

THE HEATED FILAMENT

THE commonest source of electrons with which the home-constructor is familiar is the filament of an ordinary vacuum tube. Present theory regarding metals indicates that they are made up of atoms, which are, in turn, composed of electrons. These electrons are in violent motion and it might be expected that some of them would leave the metal, but there is an opposing force which holds them in position at ordinary temperatures. If the metal is made hot, however, the velocity of the electrons increases to a very great extent, and some of them do leave the metal. The easiest way to heat the metal is to make it in the form of a wire and send an electric current through it. This creates an excellent source of electrons. It is unquestionable that, by far the most important way, of obtaining electrons commercially, is through the heating of a wire. This method is used to obtain a source of electrons in vacuum tubes.

The vacuum tube was not a very useful instrument at first until it was found that by placing a metal grid between the filament and the plate, the number of electrons passing to the plate could be controlled. Some years after this first discovery,

it was found that the vacuum tube would act as an amplifier of weak electric impulses, such as telephone currents. The three-element tube, as it is called, has opened up an entirely new field of research and is doubtlessly one of the most important tools in the hands of science.

There are, however, other sources of electrons which are used to a considerable extent in scientific practice. It has been found that some metals will give off electrons if they are placed in a strong light. This is true of zinc, as an example. Under ordinary light zinc does not give off many electrons, but under the influence of light of very short wavelength, such as ultra violet light, it will give off electrons quite rapidly. This effect is known as the photoelectric effect. Other metals, such as potassium, are very sensitive to light in the visible part of the spectrum. Potassium is, therefore, used in some photo-electric cells where its function is to control electric currents in proportion to the amount of light that is permitted to fall on it. The photo-electric cell is one of the most important units used in a picture transmitting system. The effect produced in the cell is of interest to physicists because of the information it can give them regarding the nature of the electron.

BROWNING-DRAKE RADIO



TESTED . . . Then Highly ENDORSED

SINCE its introduction several years ago, Browning-Drake Radio has been TESTED by thousands of radio experts throughout the world . . . then wholeheartedly ENDORSED for dependable radio reception. This unusual endorsement has put Browning-Drake into a hundred thousand homes where Browning-Drake performance is giving permanent satisfaction to its owners.

During the summer of 1923, at Cruft Laboratory of Harvard University, Glenn H. Browning and Frederick H. Drake set a mathematical standard of design for radio frequency transformers. This scientific achievement resulted in the Browning-Drake slot

wound radio frequency transformer. By using one stage of scientifically designed radio frequency, incorporating the Browning-Drake transformer, together with the flexibility of dual-control tuning, a combination was found that has never been surpassed for all around radio reception.

Browning-Drake produces only one model . . . the Browning-Drake Five which is completely assembled at its Brighton laboratories. Every set is unconditionally guaranteed. You will find the price of only \$95.00 as amazing as its performance. Ask the nearest Browning-Drake dealer to demonstrate it for you TODAY.

[DEALERS: No reputable dealer can afford to overlook the Browning-Drake opportunity. Every Browning-Drake dealer has made money and every customer has been permanently pleased. Write or wire TODAY for proposition.]

BROWNING-DRAKE CORPORATION, Brighton, Mass.

Digitized by Microsoft®



Build this
Professional Set
—and know
you have the best

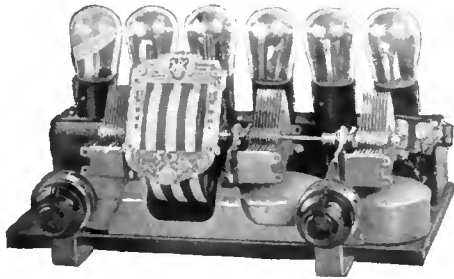

THE professional set shown above, for all its compactness, is a giant in performance. And there are two very definite reasons why this set which may be built for less than \$40 will out-perform sets costing actually 5 times as much!

Truphonic Amplification

The audio end is the now famous Truphonic amplification (fully described on another page.)

Three stages of the superior Truphonic amplification and an output unit to protect your speaker are housed in a steel catacomb. The gang socket panel which neatly covers the catacomb provides for 6 tubes—3 for audio, and 3 for the tuning end of the set. No holes to drill, no apparatus to mount. Can be used in a hundred different circuits. Price 6 tube, \$25. 7 tube, \$27.



Localized Control Tuning Unit

With the Localized Control Tuning Unit all three condensers can be tuned together or separately by the fingers of one hand, giving single dial simplicity with multiple dial efficiency.

When used with shielded coils and the Truphonic Catacomb Assembly you have a set that is ultra professional in efficiency. Rotors grounded to

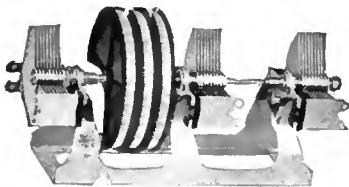

chassis, coil shields grounded to chassis, no grid leads longer than 2 inches, most advanced amplification, output unit—a thoroughly engineered set that you wouldn't trade for a commercial set at 5 times the cost.

Localized Control Tuning Units (including handsome panel plate) are provided in several models. Double (.000375) \$8. Double (.0005) \$10. Triple (.000375) \$10. Quadruple (.000375) \$15. Double with Tickler Control (.000375) \$10.

If your dealer hasn't the Truphonic Catacomb Assembly and Localized Control Tuning Unit, send to us. Be sure to mention your dealer's name and address.

ALDEN MANUFACTURING CO.
Dept. B-22 Springfield, Mass.

No. 70

RADIO BROADCAST Laboratory Information Sheet

February, 1927

Soldering

ESSENTIALS FOR GOOD WORK

IF A receiver is to operate efficiently and quietly it is essential that all of the soldered joints be securely made. Soldering is an exceedingly important operation in wiring a receiver and poor soldering is doubtlessly a frequent cause of trouble.

The ordinary solder consists of a combination of lead and tin, the percentages generally being 50 per cent. lead and 50 per cent. tin. In order to make a good joint, the surfaces to be soldered should be entirely free from oxides. Soldering flux will prevent the formation of oxides while the heat is being applied. The metal parts which are to be soldered should be scraped clean before the flux is applied and, under proper conditions, the solder will flow very easily around the joint when the parts have been heated sufficiently.

If the soldering is correctly done, the solder will appear bright after the joint is made, but a poor joint made with a cold iron will generally leave the solder with a somewhat crystalline structure. Some fluxes should be used very sparingly in making the joint, as they will conduct electric currents and will also have a very detrimental effect on any insulation with which they come in contact. Rosin is a very excellent flux to use, although it is somewhat more difficult to work with than the ordinary soldering

paste. It is standard practice in most large electrical companies to use rosin flux almost exclusively, since it has no bad effects on insulation. When rosin is the flux it is important that a very hot iron be used, otherwise, what is called a rosin joint may be produced, in which case there is a thin layer of rosin left between the two metal surfaces. This makes the electrical conductivity of the joint very poor if it does not completely prevent the flow of current.

As mentioned above, it is essential that the iron be sufficiently hot if a good job is to be done. A hot iron will also, in many cases, prevent other troubles. If soldering is attempted with an iron that is not hot enough, it is necessary to hold the iron on the metal for a long time before the solder becomes sufficiently hot to melt and, during this procedure, much of the heat energy is wasted. With a hot iron, the heat, although more intense, is confined to a smaller space because the job is completed quickly. This is important when we are, as an example, soldering a lead to a lug on a transformer. In such a case it is essential that the job be done quickly so as to prevent heating the lug to such an extent that the lead from the winding which connects internally to the other end of the lug will not come unsoldered and thus cause the circuit to be broken.

No. 71

RADIO BROADCAST Laboratory Information Sheet

February, 1927

Push-Pull Amplification

WHY IT IS USED

TRANSFORMERS are not the only source of loss of quality in audio amplifiers. The tube itself can introduce a certain amount of distortion, although this distortion is generally quite small.

The effect of the curvature of the tube characteristic is to introduce in the plate circuit, for each frequency applied to the grid, a new current of twice that frequency. The relative strength of these double frequency currents must be kept small, otherwise the quality will suffer. In order to keep them small, a large impedance must be used in the plate circuit, which will tend to straighten out the tube characteristic. It is also essential that there be enough C battery always to keep the grid negative, and then again, enough B battery must be used to permit operation on that portion of the characteristic curve which has the least curvature. It should be obvious that, as each successive tube in an amplifier has to handle more current than the one before it, the tubes in the last stage must be rated at, or must be capable of, handling greater power than the earlier stages of amplification.

The effect of the curvature of the plate characteristic can be canceled out by using the so-called push-pull transformers. The sketch on this Sheet indicates the scheme of connections of a push-pull amplifier. Briefly, its usefulness is due to the fact

that the phase relations of the double frequency currents produced by the tube characteristic are such as to cause them to cancel out in the transformer primary and not to appear across the transformer secondary.

The design of a push-pull transformer is impor-

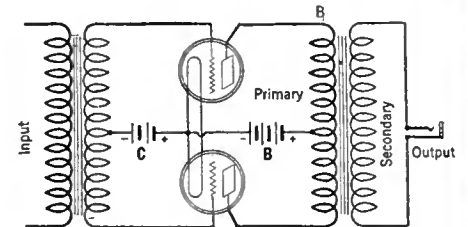

tant, and unless the same care is taken in designing as with an ordinary transformer, the actual results obtained will not make the push-pull arrangement worth while. It is essential that a push-pull transformer have a very high impedance primary and that the frequency characteristic of the transformer be reasonably flat.

No. 72

RADIO BROADCAST Laboratory Information Sheet

February, 1927

A. C. Operated Power-Supply Devices

TROUBLE SHOOTING

THIS Laboratory Sheet will give briefly possible sources of trouble in line power-supply devices (B-battery eliminators).

Quite frequently it is found that a hum is audible in the output of the receiver when it is operated from a power device. This hum need not necessarily indicate poor design, and may be due entirely to mechanical vibration. It can be eliminated by moving the device further from the receiver, or by placing the receiver on top of several layers of soft cloth.

Trouble in the power-supply unit may be the result of breakdown of one of the filter condensers, the breakdown of one of the resistances controlling the intermediate voltage taps, a defective rectifier, or to open connections. In testing the device, a voltmeter is essential. It should be connected between the negative post and the various taps, and if one of the taps gives no reading, the trouble is probably due to a defect in the resistance unit supplying that tap. This is not an uncommon cause of trouble and, therefore, good resistances, capable of carrying the required current without excessive heating, must be used.

Defective resistances are also capable of creating home-made "static." If reception is accompanied by considerable noise when using the power-supply device, the antenna should be disconnected and, if the noise persists, all of the connections and joints should be carefully examined. Be sure that the A-battery terminals are not corroded. If possible,

substitute for the power unit good dry B batteries, and if there is no noise, it is a good indication that the line power-supply device is causing the trouble. Defective resistances are the commonest cause of this noise and they should be carefully examined.

If no voltage readings can be obtained on any terminals, the rectifier tube should be examined. Make sure that the filament has not burned out, or, if the rectifier is of the electrolytic type, be sure that it contains sufficient solution. The filter condensers, if possible, should be tested with phones and B battery to make sure they have not broken down. The same test can also be made on the choke coils to be sure that they have not been burned out, and in this way an open circuit created.

If all the connections appear to be complete and the apparatus in good condition, it will be best to try a new rectifier tube in the correct socket. Rectifiers in which a filament is used are constructed in the same manner as are ordinary receiving tubes, and the fact that they light does not necessarily indicate that they are functioning in a satisfactory manner. Rectifier tubes are counted upon to supply comparatively large currents and must be extremely well made with very sturdy filaments if they are to last any great length of time.

The fact that we are powering our receiver from a line power-supply device does not mean that it does not require attention, or that the parts are going to last forever. The rectifier device may wear out after considerable use, and the condensers will sometimes break down as they become old.

Sign off to sweet dreams



You enjoy radio like a gentleman—if you can get the best out of your set and forget all worry and bother. That's your happy frame of mind when you keep your batteries full of pep with a Rectigon. The most absent-minded dial twister snaps on a Rectigon without a qualm. What if you do tune in while you're still charging your battery? There's no harm done, not the slightest. What if the current does go wrong in the dead of night? Your batteries will not be discharged with a Rectigon attached.

when you keep power in your set with

The Westinghouse Rectigon Battery Charger

©, 1926, W. E. & M. Co.

No noise as it charges—not a bit of fuss. Not even a murmur that would disturb the mildest slumber.



No acids, no chemicals—no moving parts—nothing to spill or burn. No muss, no worry. You'll have no spoiled rugs, no ruined clothing.



Saves its cost in short order—Count the dollars spent in a few trips to the service station and you'll hotfoot it for a Rectigon, for the good it does your pocketbook as well as your batteries.



Snaps on in an instant—Just plug into the light socket, snap on the terminals. Saves service station bother. Spares interruptions caused by absent batteries.



Charges both "A" and "B" batteries—Keeps both packed with power. Bulb is used for "B" battery charging and it is enclosed, like all other parts, in metal, safe from accident. (Rectigon charges automobile batteries, too.)



THE RECTIGON is a superb Westinghouse product. Things you *can't* see, like extra heavy insulation, things you *can* see, like the durably enameled case—all are of highest quality. Westinghouse also manufactures a complete line of radio instruments, and Micarta panels and tubes.

WESTINGHOUSE ELECTRIC & MANUFACTURING CO.
Tune in on KDKA - KYW WBZ - KFKX

*No Storage Battery Radio
is Complete
Without a Rectigon*



Use Power tubes for good quality at full volume
Simply adapt to your set with **Connectoralds**

The use of a Power Tube in the last audio will very greatly improve your tone quality. No change in set wiring is necessary when Connectoralds are used.

For UX 171 and UX 112 Tubes, Na-Ald 112 Connectoralds are recommended for maximum volume with storage battery sets. These tubes will deliver without distortion several times the volume of the regular 201A. Price \$1.50.

For UX 120 Tubes in UV 201A sockets, the Na-Ald No. 120 Connectorald should be used. To convert a storage battery set to dry batteries with ample loud speaker volume, use a UX 120 tube in the last audio stage with the 120 Connectorald and UX 199 tubes with 419X Adapters in the other sockets. Price \$1.25.

For the UX 120 Tube in UV 199 sockets, ample loud speaker volume without distortion is obtainable from any set equipped for UV 199 tubes by means of the UX 120 or equivalent tube with the Na-Ald No. 920 Connectorald. The tube is raised slightly, but provides for its use in most sets with limited headroom. Price \$1.25.

For UX 120 tubes in the UV 199 sockets of the Radiola Superheterodyne Semi-Portable, and Radiola Super VIII. These excellent Superheterodynes will deliver ample volume for loud speaker operation when equipped with the UX 120 tube used with the No. 420 Connectorald \$1.25.

ALDEN MANUFACTURING CO.
Dept. B-22 Springfield, Mass.



AC12 . . . \$30

Amplion Cone
superiority lies in its *clear reproduction of speech*

—this is the supreme test of radio reproducers, especially the Cone Type. The Amplion Cone is enclosed in a handsome mahogany cabinet, 14" x 14" x 9". No matter what set you may use, the Amplion Cone will help it to give you its best performance.

Amplion reproducers range from \$12 to \$50

Have your dealer give you a demonstration or write for illustrated Amplion booklet which describes all models.

The AMPLION CORPORATION of AMERICA

Suite L, 280 Madison Ave., New York City
The Amplion Corporation of Canada Ltd.



NEW APPARATUS

Equipment of the Radio Industry Submitted to the Radio Broadcast Laboratory for Test and Inspection

RADIO BROADCAST Photographs



1. RHEOSTAT: The new Carter Radio Company's combined rheostat and filament switch is a novel addition to the long list of this company's products. The unit retails for \$1.00

2. HYDROMETER: This hydrometer is manufactured by the Chaslym Company of Chicago, Illinois. It retails for 75c.

3. RECEIVER: A ten-tube receiver which consists of five stages of tuned radio frequency amplification, a detector, and four audio stages. The receiver may be obtained in kit form from Norden-Hauk, Incorporated, Philadelphia, Pennsylvania, for \$291.40

4. POWER SUPPLY UNIT: This B power supply employs a Raytheon tube as a rectifier. The detector and intermediate tap voltages are variable. Manufactured in three models by the Grigsby, Grunow, Hinds Company. Price \$32.50, \$35.00, and \$42.50.

5. AMPLIFIER KIT: A complete three-stage resistance-coupled amplifier kit which comprises grid and plate resistance units, bases, isolating condensers, etc. Manufactured by the Polymet Manufacturing Co., New York City and sold for \$5.00.

6. LOUD SPEAKER: The Armstrong Company, Chicago, Illinois, manufactures the Armstrong loud speaker shown above. This instrument sells for \$35.00.

7. RESISTANCE: Hardwick, Field, Leeb, Incorporated, Newark, New Jersey, manufactures the tapped resistor which is a standard piece of apparatus of the Amer-Tran power supply kit. Price \$7.50.

8. LOOP: The Fiat loop, manufactured by the Radio Appliance Corporation, of Chicago, Illinois, is a fine bit of workmanship. Price \$12.50.

9. NEUTRALIZING CONDENSER: The Hammarlund Manufacturing Company, of New York City, manufactures this equalizing condenser which has a maximum capacity of 50 mmfd. The minimum capacity is 2 mmfd. Price 50c.

10. C BATTERY: A new product of the National Carbon Company is the 22½-volt C battery. There are two other taps which provide lower values of C bias. The battery, No. 768, retails for \$1.75.

11. POWER SUPPLY UNIT: Another B power supply employing the Raytheon tube as a rectifier is the Greene-Brown Company unit. Price \$39.50.

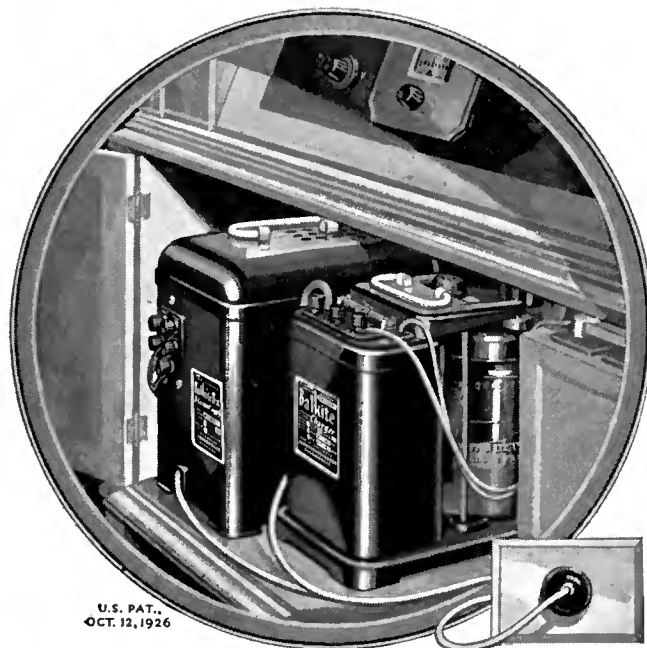

U.S. PAT. OCT. 12, 1926

Make your radio set a light socket receiver now with Balkite "B" and the new Balkite Trickle and High-Rate Charger



Balkite Trickle Charger \$10

With 6-volt "A" batteries can be left on continuous or trickle charge thus automatically keeping the battery at full power. With 4-volt batteries can be used as an intermittent charger. Or as a trickle charger if a resistance is added. Charging rate about .5 ampere. Over 300,000 in use. Price \$10. (West of Rockies \$10.50. In Canada \$15.)

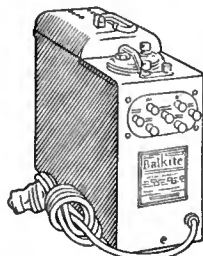

Balkite Combination

Supplies automatic power to both "A" and "B" circuits. Controlled by the filament switch on your set. Entirely automatic in operation. Serves any set now using either 4 or 6-volt "A" batteries and requiring not more than 30 milliamperes at 135 volts of "B" current—practically all sets of up to 8 tubes. Price \$59.50. (In Canada \$83.)

All Balkite Radio Power Units operate from 110-120 volts AC current with models for both 60 and 50 cycles. The new Balkite Charger is also made in a special model for 25-40 cycles.

Now, with the best portion of the radio season before you, make your radio set a light socket receiver by adding Balkite "B" and the new Balkite Charger.

Balkite "B"—the proved "B" power supply—eliminates "B" batteries entirely and supplies "B" current from the light socket. The new Balkite "B"-W serves any set of 5 tubes or less requiring 67 to 90 volts; Balkite "B"-X sets of up to 135 volts and 8 tubes (illustrated); Balkite "B"-Y any standard set. Most owners of even small sets will buy Balkite "B"-X which will take care of nearly any set you buy in the future.

The new Balkite Charger with both high and low charging rates, combines the advantages of both trickle and rapid charging. At the low rate, on trickle charge, it auto-

matically keeps your "A" battery fully charged, and in effect converts it into a light socket "A" power supply. Its high rate provides an ample reserve of power for the largest sets.

Both Balkite "B" and the Balkite Charger are entirely noiseless in operation. Both are permanent pieces of equipment, with no bulbs and nothing to wear out or replace. Other than a slight consumption of household current, their first cost is the last. Both are built to conform with the standards of the Underwriters' Laboratories. Add these two Balkite Units to your receiver now. Then you too will know the pleasure of owning a radio set always ready to operate at peak power. Ask your dealer. *Fansteel Products Company, Inc., North Chicago, Illinois.*

Balkite Charger \$19.50. (West of Rockies \$20. In Canada \$27.50.) Balkite "B"-W \$27.50. "B"-X \$42. "B"-Y \$69. (In Canada "B"-W \$39. "B"-X \$59.50. "B"-Y \$96.)

Walter Damrosch and the New York Symphony on the air Every other Saturday night a symphony concert. On alternate Saturdays one of Mr. Damrosch's famous piano recitals. Over stations: WVEAF, WEEL, WGR, WFI, WCAE, WSAI, WTAM, WWJ, WGN, WCCO, KSD, WDAF, WOC. Balkite Hour 9 P. M. Eastern Standard Time.

FANSTEEL Balkite Radio Power Units





Adapters for all tube and Socket combinations

Na-Ald Adapters are indispensable to the set owner and set builder who wants a simple and instantaneous means of adapting any particular type of tube to the particular type of socket that is used in his set. For instance, if your set is now equipped with standard 201A sockets, and you want to use the small UV 199 type tube, simply insert the Na-Ald Adapter No. 429 into the 201A socket and insert the 199 tube into the adapter.

The various types of Na-Ald Adapters are given below. Specify them for best results:



No. 419X

For adapting small UX 199 and UX 120 tubes to UV 201A sockets, use Na-Ald Adapter No. 419X. Price 35c.

To bring up-to-date and decidedly improve the Radiola III and IIIA and similar sets employing WD 11 Tubes, use UX 199 tubes with Na-Ald Adapter No. 421X. Price 75c.



No. 421X



No. 429

For adapting UV 199 tubes to standard 201A sockets use the Na-Ald No. 429 Adapter. Price 75c.

To adapt all UX tubes and UV 201A tubes to UV 199 sockets use Na-Ald Adapter No. 999. Price \$1.00.



No. 999

Na-Ald Adapters are sold by all good radio stores and carry the Na-Ald unconditional guarantee.

ALDEN MANUFACTURING CO.
Dept. B-22, Springfield, Mass.

How is your radio set working?

A slight fault in the construction of your radio set may be impairing its reception. Why not find out? We are the sole representatives of *Radio Broadcast* and are thoroughly familiar with all the problems that arise in connection with receivers described in this magazine.

For \$2.50 we will inspect and test any radio receiver sent to us by Express Prepaid, and furnish a written report describing the faults we find, together with an estimate of the cost of remedying them. For a Superheterodyne or other highly complicated receiver, a similar service will be rendered for \$5.00.

We have helped hundreds of people to really enjoy their radio sets. Let us do the same for you.

Telephone REctor 2538

Rossiter,
Tyler & McDonell, Inc.
Consulting Radio Engineers
136 Liberty St., New York

R T M RADIO SERVICE

Manufacturers' Booklets Available

A Varied List of Books Pertaining to Radio and Allied Subjects Which May Be Obtained Free by Using the Accompanying Coupon

AS AN additional service to RADIO BROADCAST readers, we print below a list of booklets on radio subjects issued by various manufacturers. With this list appear many additions to that first printed in this magazine for January, 1927. This information supplements the other departments, such as the "Lab," data sheets, and the Periodical surveys, all of which have proved most popular with our readers. The publications listed below cover a wide range of subjects, and offer interesting reading to the radio enthusiast. The manufacturers issuing these publications have made great effort to collect interesting and accurate information. RADIO BROADCAST hopes, by listing these publications regularly, to keep its readers in touch with what the manufacturers are doing. Every publication listed below is supplied free. In ordering, the coupon printed on page 414 must be used. Order by number only.—THE EDITOR.



PARTS

1. FILAMENT CONTROL—Problems of filament supply, voltage, regulation, and effect on various circuits. RADIAL COMPANY.
2. HARD RUBBER PANELS—Characteristics and properties of hard rubber as used in radio, with suggestions on how to "work" it. B. F. GOODRICH RUBBER COMPANY.
3. AUDIO TRANSFORMERS—A booklet giving data on input and output transformers. PACENT ELECTRIC COMPANY.
4. RESISTANCE-COUPLED AMPLIFIERS—A general discussion of resistance coupling with curves and circuit diagrams. COLE RADIO MANUFACTURING COMPANY.
5. CARBORUNDUM IN RADIO—A book giving pertinent data on the crystal as used for detection, with hook-ups, and a section giving information on the use of resistors. THE CARBORUNDUM COMPANY.
6. B-ELIMINATOR CONSTRUCTION—Complete constructional data on how to build. AMERICAN ELECTRIC COMPANY.
7. TRANSFORMER AND CHOKE-COUPLED AMPLIFICATION—Circuit diagrams and discussion. ALL-AMERICAN RADIO CORPORATION.
8. RESISTANCE UNITS—A data sheet of resistance units and their application. WARD-LEONARD ELECTRIC COMPANY.
9. VOLUME CONTROL—A leaflet showing circuits for distortionless control of volume. CENTRAL RADIO LABORATORIES.
10. VARIABLE RESISTANCES—As used in various circuits. CENTRAL RADIO LABORATORIES.
11. RESISTANCE COUPLING—Resistors and their application to audio amplification, with circuit diagrams. DEJUR PRODUCTS COMPANY.
12. DISTORTION AND WHAT CAUSES IT—Hook-ups of resistance-coupled amplifiers with standard circuits. ALLEN-BRADLEY COMPANY.
13. MATERIALS FOR SCREW MACHINE PRODUCTS—Comparative costs of steel and brass with data and actual examples of how to specify. BRIDGEPORT BRASS COMPANY.
14. ORDERING THE RIGHT KIND OF SHEET BRASS—How to specify the proper grades for various purposes. BRIDGEPORT BRASS COMPANY.
15. B-ELIMINATOR AND POWER AMPLIFIER—Instructions for assembly and operation using Raytheon tube. GENERAL RADIO COMPANY.
- 15a. B-ELIMINATOR AND POWER AMPLIFIER—Instructions for assembly and operation using an R. C. A. rectifier. GENERAL RADIO COMPANY.
16. VARIABLE CONDENSERS—An ambitious description of the functions and characteristics of variable condensers with curves and specifications for their application to complete receivers. ALLEN D. CARDWELL MANUFACTURING COMPANY.
17. BAKELITE—A description of various uses of bakelite in radio, its manufacture, and its properties. BAKELITE CORPORATION.
18. BRASS RODS—Details of manufacture together with tests and specifications. BRIDGEPORT BRASS COMPANY.
19. POWER SUPPLY—A discussion on power supply with particular reference to lamp-socket operation. Theory and constructional data for building power supply devices. ACME APPARATUS COMPANY.
20. AUDIO AMPLIFICATION—A booklet containing data on audio amplification together with hints to the constructor; also some general radio information. ALL-AMERICAN RADIO CORPORATION.
21. HIGH-FREQUENCY DRIVER AND SHORT-WAVE WAVEMETER—Constructional data and application. BURGESS BATTERY COMPANY.
46. AUDIO FREQUENCY CHOKES—A pamphlet showing positions in the circuit where audio frequency chokes may be used. SAMSON ELECTRIC COMPANY.
47. RADIO FREQUENCY CHOKES—Circuit diagrams illustrating the use of chokes to keep out radio frequency currents from definite points. SAMSON ELECTRIC COMPANY.
48. TRANSFORMER AND IMPEDANCE DATA—Tables giving the mechanical and electrical characteristics of transformers and impedances, together with a short description of their use in the circuit. SAMSON ELECTRIC COMPANY.
49. BYPASS CONDENSERS—A description of the manufacture of bypass and filter condensers. LESLIE F. MUTER COMPANY.
50. AUDIO MANUAL—Fifty questions which are often asked regarding audio amplification, and their answers. AMERTRAN SALES COMPANY, INCORPORATED.
51. SHORT-WAVE RECEIVER—Constructional data on a receiver which, by the substitution of various coils, may be made to tune from a frequency of 16,660 kc. (18 meters) to 1999 kc. (150 meters). SILVER-MARSHALL, INCORPORATED.
52. AUDIO QUALITY—A booklet dealing with audio-frequency amplification of various kinds and the application to well-known circuits. SILVER-MARSHALL, INCORPORATED.
56. VARIABLE CONDENSERS—A bulletin giving an analysis of various condensers together with their characteristics. GENERAL RADIO COMPANY.
57. FILTER DATA—Facts about the filtering of direct current supplied by means of motor-generator outfits used with transmitters. ELECTRIC SPECIALTY COMPANY.
59. RESISTANCE COUPLING—A booklet giving some general information on the subject of radio and the application of resistors to a circuit. DAVEN RADIO CORPORATION.
60. RESISTORS—A pamphlet giving some technical data on resistors which are capable of dissipating considerable energy; also data on the ordinary resistors used in resistance-coupled amplification. THE CRESCENT RADIO SUPPLY COMPANY.
62. RADIO-FREQUENCY AMPLIFICATION—Constructional details of a five-tube receiver using a special design of radio-frequency transformer. CAMFIELD RADIO MANUFACTURING COMPANY.

YOU CAN BUILD THE NEW SHIELDED HI-Q*

\$63⁰⁵
CABINET
EXTRA

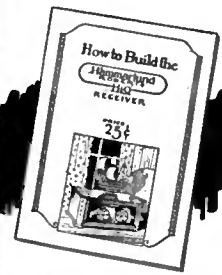
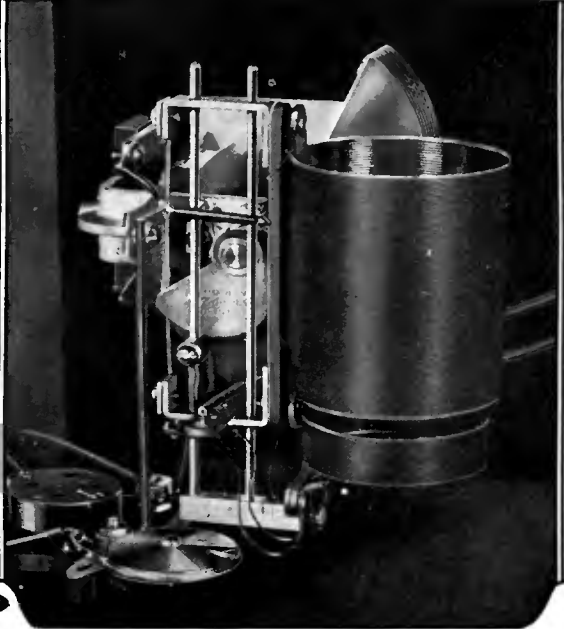
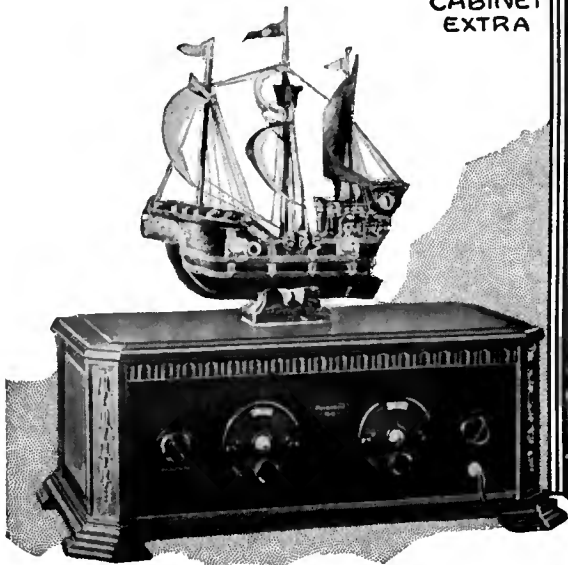

This Book Tells You How
Written under the supervision of ten of America's leading radio engineers, this remarkable book tells you how to build this wonderful modern radio and save \$50 to \$100. From your dealer or by mail
25 Cents

Automatic Variable Coupling—a wonderful new feature through which same control operates tuning condenser and primary coil simultaneously. This gives maximum and equal amplification over entire tuning range.

**Automatic Variable Coupling in the HI-Q
Supplies that Missing "Something"**

The Foundation Unit

In the Hi-Q Foundation Unit, all your thinking has been done for you. Consists of drilled and engraved panel and sub-panel and all the essentials required to start building. Everything plainly marked. Simply put parts together and tune-in. Price complete

\$10.50

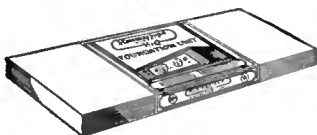

UNTIL the arrival of the Hi-Q Receiver there has always been a missing "Something" in radio, the lack of which has caused distortion of signals and either excessive or minus volume on various wave lengths.

This is only one of the features of this wonderful new receiver. In addition the 1927 Hi-Q Receiver has the newest form of Stage Shielding, a factor which prevents coupling between stages and eliminates oscillation.

These two special features, plus self-adjusting filament control and simplicity of operation makes everyone an expert operator. The perfect matching of highest quality parts produce in this instrument a degree of selectivity even in crowded areas which is nothing short of marvelous. Distant stations come in like magic with full volume, and tone has that natural quality you have always hoped for in radio.

Build It Yourself—Save \$50 to \$100

The wonderful thing about the Hammarlund-Roberts Hi-Q is that, like 70,000 other novices and amateurs, you can build it yourself. Simply get your copy of the "How to Build It" Book and the guaranteed specified parts from your dealer. Follow the crystal-clear instructions and in a few hours have one of the finest receivers available in the radio world.

- Associate Manufacturers**
Benjamin Electric Mfg. Company
Carter Radio Company
Durham Resistors
Eby Manufacturing Company
Hammarlund Mfg. Company
Martin-Copeland Company
Radiall Company (Amperite)
Samson Electric Company
Sangamo Electric Company
Westinghouse Micarta



*Hi-Q: High Ratio of Reactance to Resistance. High Ratio—Great Selectivity—Loud Signals

HAMMARLUND-ROBERTS, Inc. - - - 1182-A Broadway, New York



Note this important Point

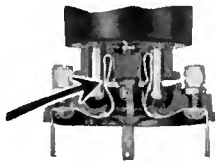

Silencer Socket

There is a difference in radio sockets. Any engineer or radio fan of long standing who has had years of experience with Na-Ald sockets, and with other sockets, will tell you that—very emphatically.

And now to crown the achievements of the pioneer socket designer and manufacturer comes the nation-wide acceptance of the Na-Ald Silencer Socket.

Note how the same continuous strip of phosphor bronze which holds the prongs of the tube in triple-locked, firm embrace and provides connection with the binding posts, gives also the silencing and cushioning effect which renders the tube free from all disturbing microphonic noises more effectively than does any other socket.

Be sure to get nothing less than the Na-Ald Silencer Socket No. 481 XS for the set you build. Owing to great production facilities this socket can be priced at 50c.



Two other Na-Ald sockets are the 481 X—similar to the 481 XS but minus the silencing features—at 35c, and the 400, the heavy duty De Luxe Socket for the high voltage power tubes, priced at 75c.

Na-Ald Sockets are at all good dealers. If out of stock, write to us, mentioning dealer's name and address.

ALDEN MANUFACTURING CO.
Dept. B-22 Springfield, Mass.

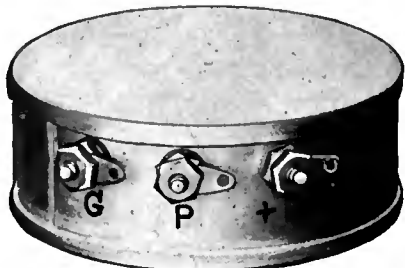

Shielded Tuned Radio Transformer, No. 30

SICKLES Diamond-Weave Coils

The new Sickles Shielded Tuned Radio Transformer prevents both outside and local interference. It is remarkably compact, sharp tuning, sturdy.

Sickles Diamond-weave coils have established an enviable reputation for low distributed capacity, low dielectric losses, and large range of frequency with small variable capacity.

The ideal coil for the Naald Localized Control Tuning Unit and for the Tru-phonic Catacomb Assembly.

There are Sickles Diamond Weave Coils for all Leading Circuits.

The F. W. Sickles Co.
132 Union Street
SPRINGFIELD, MASS.

COIL PRICES

No. 30 Shielded Transformer	... \$2.00 each
No. 24 Browning-Drake 7.50 Set
No. 18A Roberts Circuit 8.00 "
No. 25 Aristocrat Circuit 8.00 "

- 63. FIVE-TUBE RECEIVER—Constructional data on building a receiver. AERO PRODUCTS, INCORPORATED.
- 64. AMPLIFICATION WITHOUT DISTORTION—Data and curves illustrating the use of various methods of amplification. Also data on how to build. ACME APPARATUS COMPANY.
- 65. RADIO HANDBOOK—A helpful booklet on the functions, selection, and use of radio apparatus for better reception. BENJAMIN ELECTRIC MANUFACTURING COMPANY.
- 66. SUPER-HETERODYNE—Constructional details of a seven-tube set. G. C. EVANS COMPANY.

ACCESSORIES

- 22. A PRIMER OF ELECTRICITY—Fundamentals of electricity with special reference to the application of dry cells to radio and other uses. Constructional data on buzzers, automatic switches, alarms, etc. NATIONAL CARBON COMPANY.
- 23. AUTOMATIC RELAY CONNECTIONS—A data sheet showing how a relay may be used to control A and B circuits. YAXLEY MANUFACTURING COMPANY.
- 24. DETECTOR TUBES—A brief outline of tube operation. C. E. MANUFACTURING COMPANY.
- 25. ELECTROLYTIC RECTIFIER—Technical data on a new type of rectifier with operating curves. KODEL RADIO CORPORATION.
- 26. DRY CELLS FOR TRANSMITTERS—Actual tests given, well illustrated with curves showing exactly what may be expected of this type of B power. BURGESS BATTERY COMPANY.
- 27. DRY-CELL BATTERY CAPACITIES FOR RADIO TRANSMITTERS—Characteristic curves and data on discharge tests. BURGESS BATTERY COMPANY.
- 28. B BATTERY LIFE—Battery life curves with general curves on tube characteristics. BURGESS BATTERY COMPANY.
- 29. HOW TO MAKE YOUR SET WORK BETTER—A non-technical discussion of general radio subjects with hints on how reception may be bettered by using the right tubes. UNITED RADIO AND ELECTRIC CORPORATION.
- 30. TUBE CHARACTERISTICS—A data sheet giving constants of tubes. C. E. MANUFACTURING COMPANY.
- 31. FUNCTIONS OF THE LOUD SPEAKER—A short, non-technical general article on loud speakers. AMPLION CORPORATION OF AMERICA.
- 32. METERS FOR RADIO—A catalogue of meters used in radio with connecting diagrams. BURTON-ROGERS COMPANY.
- 33. SWITCHBOARD AND PORTABLE METERS—A booklet giving dimensions, specifications, and shunts used with various meters. BURTON-ROGERS COMPANY.
- 34. COST OF B BATTERIES—An interesting discussion of the relative merits of various sources of B supply. HARTFORD BATTERY MANUFACTURING COMPANY.
- 35. STORAGE BATTERY OPERATION—An illustrated booklet on the care and operation of the storage battery. GENERAL LEAD BATTERIES COMPANY.
- 36. CHARGING A AND B BATTERIES—Various ways of connecting up batteries for charging purposes. WESTINGHOUSE UNION BATTERY COMPANY.
- 37. CHOOSING THE RIGHT RADIO BATTERY—Advice on what dry cell battery to use; their application to radio, with wiring diagrams. NATIONAL CARBON COMPANY.
- 53. TUBE REACTIVATOR—Information on the care of vacuum tubes, with notes on how and when they should be reactivated. THE STERLING MANUFACTURING COMPANY.
- 54. ARRESTERS—Mechanical details and principles of the vacuum type of arrester. NATIONAL ELECTRIC SPECIALTY COMPANY.

- 55. CAPACITY CONNECTOR—A new device which simplifies the connecting up of the various parts of a receiving set, and at the same time provides bypass condensers between the leads. KURZ-KASCH COMPANY.
- 61. DRY CELLS—Information on the construction and operation of dry cells with a description of the methods used in testing them. THE CARBON PRODUCTS COMPANY.
- 68. CHEMICAL RECTIFIER—Details of assembly, with wiring diagrams, showing how to use a chemical rectifier for charging batteries. CLEVELAND ENGINEERING LABORATORIES COMPANY.

MISCELLANEOUS

- 38. LOG SHEET—A list of broadcasting stations with columns for marking down dial settings. U. S. L. RADIO, INCORPORATED.
- 39. BEHIND THE SCENES IN A BROADCASTING STATION—Operation in general, and specific facts about WKRC. KODEL RADIO CORPORATION.
- 40. STATIC—A brief discussion of the disturbances which may cause trouble in a receiver. SUN MANUFACTURING COMPANY.
- 41. BABY RADIO TRANSMITTER OF 9XH-9EK—Description and circuit diagrams of dry-cell operated transmitter. BURGESS BATTERY COMPANY.
- 42. ARCTIC RADIO EQUIPMENT—Description and circuit details of short-wave receiver and transmitter used in Arctic exploration. BURGESS BATTERY COMPANY.
- 43. SHORT-WAVE RECEIVER OF 9XH-9EK—Complete directions for assembly and operation of the receiver. BURGESS BATTERY COMPANY.
- 44. ALUMINUM FOR RADIO—A booklet containing much radio information with hook-ups of basic circuits, with inductance-capacity tables and other pertinent data. ALUMINUM COMPANY OF AMERICA.
- 45. SHIELDING—A discussion on the application of shielding in radio circuits with special data on aluminum shields. ALUMINUM COMPANY OF AMERICA.
- 58. HOW TO SELECT A RECEIVER—A common sense booklet describing what a radio set is, and what you should expect from it, in language that any one can understand. DAY-FAN ELECTRIC COMPANY.
- 67. WEATHER FOR RADIO—A very interesting booklet on the relationship between weather and radio reception, with maps and data on forecasting the probable results. TAYLOR INSTRUMENT COMPANIES.

USE THIS COUPON

RADIO BROADCAST SERVICE DEPARTMENT
RADIO BROADCAST, Garden City, New York.
Please send me (at no expense) the following booklets indicated by numbers in the published list

.....

 Name
 Address
 (Number) (Street)

 (City) (State)

ORDER BY NUMBER ONLY
This coupon must accompany every order.
RB 227



Another Step Forward in Transformer Design Means Better Results for You!

Since The **FIRST** Totally

*Shielded Air Core
Were Designed
Time Ago, We
To Develop This*

*Transformers
By Us Some
Have Continued
Field.*

UNTIL

Now Our **SECOND**, Vastly

*Superior To The
For Those Who
mate Benefits
Obtained From
Research.*

*First, Is Ready
Want The Ulti-
That Have Been
Modern Radio*



Such unbelievable results have been reported from those using our old transformers from all sections of this and other countries, that we do not hesitate to say that *Real Radio Reception Can Be Yours*



The Utmost In Electrical Skill and Mechanical Design Is Embodied In Our New Transformers

- 1—Entirely new principles are utilized in these transformers which give absolute separation of stations, a thing which has for a long time troubled all set owners. As a precaution we have used a special insulator to protect the windings from atmospheric conditions.
- 2—The size has been decreased, with an increase of efficiency so that a cumbersome set is no longer a necessity, the entire set with 2 audio now being easily built behind a 10" x 17" panel—8½" deep.
- 3—More positive contacts in the nature of soldering lugs have taken the place of the inefficient machine screw behind which corrosion always takes place.

Better design and an infallible method of testing these kits has enabled us to reduce the cost so that it comes within the range of most radio users. We guarantee these kits for an indefinite period to retain their efficiency and electrical characteristics.

If you cannot get these from you dealer—order direct from us. Descriptive literature on request



1516 Summer Street

Philadelphia, Pa.

See the World FREE!



Taste Romance and Adventure In the Far Lands of the Earth

How often you've longed to see for yourself the awe of Egypt's pyramids—the beauties of the gorgeous Mediterranean sunset—the squalor of China's ancient cities!

Spend a few years, or the rest of your life, tasting high adventure on the seven seas and in all the world's great ports—roving the earth's highways and byways! You can do it FREE—all your expenses paid—and earn a good salary besides!

Only one profession will carry you around the world at will, travelling like a gentleman, but that's the most interesting and pleasant work there is—Radio Operating! Easily and quickly learned, there's no other profession like it for the man who wants the experiences and pleasures of world-travel. Radio operators are needed—all sea-going ships like the one shown here must carry from one to half a dozen or more.



Take a Look Beyond the Skyline— Without a Penny's Expense

Radio operators aboard ocean liners live luxuriously—they rank as officers of the ship. Meals, a private cabin, all other living needs are furnished free, and besides the operator draws a good salary. You can learn quickly and easily at home in your spare time to be a Radio operator through our practical training methods. Take a look at the FREE BOOK which tells how—mail coupon below.

This U. S. Government recognized school has been training successful operators since 1914. Our graduates are all over the world. We maintain an Employment Department to put you on your own ship. The world-famous NATROMETER, our own patented invention, obtainable only by students of this Institute, is recognized as the best and easiest way to learn the Radio code. A few short months, with the aid of the famous Natrometer and our quick home training, and you too can be a fully qualified Radio operator, sitting in your cabin like the one shown above, bound out for Liverpool or Nagasaki!

Read the Free Book that tells all about this fascinating profession and our practical Government-recognized methods of training you for it. Send coupon TODAY—no obligation. Special tuition offer now on includes world-famous Natrometer free of extra cost with your course. Act at once.

NATIONAL RADIO INSTITUTE
WASHINGTON, D. C.

SPECIAL OFFER COUPON

National Radio Institute,
Dept. BB-94, Washington, D. C.

Gentlemen: Without obligating me in any way send me your free book and information about your special limited offer of Natrometer with course



World-famous
Natrometer

Name
Address



THE HARBOR AT CONSTANTINOPLE

Radio in Turkey

A Short Recital of the Trials and Tribulations Incident to the Birth of Amateur Radio in Constantinople, Which Thrived Through Much Government Interference

By M. MAZLOUM.

ROBERT COLLEGE is an American institution in Turkey. It was founded by Americans and is backed up by American funds. It must be interesting, therefore, to many Americans to know what Robert College has done for radio here in Constantinople.

Early in 1922 Professor Dyke, then head of the physics department, managed to buy some wireless apparatus from a Russian officer, and had it installed in the laboratory. With its help it was possible to receive most of the European stations and under favorable conditions, Arlington. Unfortunately, however, there was no course in radio, and only a very limited number of students had access to the set. This passed the year 1922-23.

In the fall, Henri Moreau, a student of Electrical Engineering, took the set to pieces and built it up anew. This arrangement consisted of two radio frequency stages, one detector and one audio frequency stage. It was a vast improvement over the old hook-up. Let me mention that Mr. Moreau was one of the first amateurs in Constantinople, and had already built a number of reliable sets which could be operated on a loop.

The antenna at the Laboratory was changed to a longer and higher one, and experiments were started, with the result that one day a voice giving a lecture in Berlin was heard over the ether. This started the craze going. Heretofore only the students who actually had sets in their homes took an interest in radio. Now practically everybody was bitten by the bug. It is one thing to hear meaningless "dit-dah-dits" in the phones but quite another to receive intelligible words.

There was a rush for information concerning radio. The library was invaded, but unfortunately the knowledge gained from that source proved inadequate. The books on the subject were few and old, some dating even as far back as the commencement of the century. Finally, the students had to fall back on those who had

had experience of their own. Of course, being amateurs we did our best, but also, being very few, we did not get along very rapidly.

One day in the spring of 1924, when we thought that everything had started to go all right, down came the thunderbolt. The government made an announcement stating that all illegal owners of radio sets would have their apparatus confiscated, and would be, moreover, subjected to a heavy fine, and possibly imprisonment. We could have wept as we saw our work come tottering down. We knew Doctor Gates, the president, too well to think that he would risk getting into difficulties with the government over such an unimportant thing as a radio set. The next day when we came to college the antenna was down and the apparatus had been taken to pieces.

This had exactly the same effect upon us as a bucket of cold water. At first we were shocked but afterwards, when the reaction set in, we glowed all over with impatience, and vowed that since we could not continue working publicly in college, that we would work secretly in our own homes. We used our loops and continued as before in perfect security. There was nothing to attract attention outside the building and therefore nobody ever dreamt of troubling us. Thus passed the year 1923-24.

Professor Tubini, acting dean of the Engineering College, and head of the electrical department, now came to our aid. He was interested in radio, and besides, he was a business man. He went to England, made a special study of radio conditions there, and returned. He brought back a very expensive and modern three-tube set purchased from the Marconi Company. It is one thing, however, to buy a set, and quite another to get it into Constantinople. Professor Tubini went to Angora to get the necessary permission. If I am not mistaken it took him three months to get it, but it was well worth the trouble for he not only got permission to use

**Windsor Wall or Table
Type Cone Speaker
Amazes Radio World**



Model 210
(Pat. Applied For)

The latest model Windsor Cone Loudspeaker has astonished the world of radio. In convenience, quality of reception, and extremely low price, it far surpasses anything yet offered. The cone is 22 inches in diameter and is supported by an easel back. It can be hung up on the wall, as in the picture above, or stood upon any flat surface as shown in the picture below. It contains the famous Windsor loudspeaker unit noted for its extreme clarity and fidelity of reproduction.



Model 210
22-inch Cone Loudspeaker
with easel back

\$15.00

(West of Rockies \$18)
(Pat. Applied For)

Model 302 (Shown below)
With Moulded Composition Horn Loudspeaker and 18-inch Cone Loudspeaker.



(Pat. Applied For)

In this Windsor Console is combined both the Windsor Moulded Composition Horn Loudspeaker and the 18-in. Windsor Cone Loudspeaker. The top is 30 in. x 17 in. and stands 29 in. high. Plenty of battery and equipment space is provided by large shelf in rear. Price, finished in Mahogany or Walnut **\$48.00**
(West of Rockies, \$55)

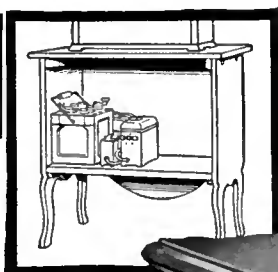

Rear view at left shows large compartment with ample space for batteries, battery charger, or battery eliminator, which are entirely concealed from view. Back is open for ventilation of batteries.

At right is shown the Cone Loudspeaker, with its panel, which is quickly and easily removable, allowing instant access to all batteries, battery charger, battery eliminator or other equipment and wiring.

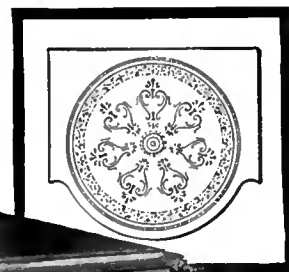

(Pat. Applied For)

Model 200—with 22-inch Cone Loudspeaker

This Windsor Cone Loudspeaker Console is equipped with a 22-inch Windsor Cone Loudspeaker. Its top is 30" x 17" and is 29" high. The battery shelf provides ample space for batteries, charger, battery eliminator and other equipment. Beautifully finished in either Mahogany or Walnut.

Model 200

\$29

Console with Cone Loudspeaker Ready for Set and Batteries (West of Rockies, \$35)

This is the Fastest Selling Line of Loudspeakers and Loudspeaker Consoles in the Radio World Today



Model 100
with Moulded Composition Horn Loudspeaker or 16-inch Cone Loudspeaker
(Pat. Nov. 18, 1924)

Above is shown a beautiful Windsor Loudspeaker Console, finished in either Walnut or Mahogany, which provides ample space on top for any radio set. The battery shelf beneath will accommodate all necessary equipment. Equipped with either Moulded Composition Horn or 16-inch Cone Loudspeaker. Size: 38 in. x 18 in., and 29 in. high. Price **\$40.00**
(West of Rockies, \$42.50)

To the right is shown the newest Windsor Loudspeaker Console. It is equipped with a 22-inch Cone Loudspeaker and cabinet suitable for 7-inch radio panels up to 26 inches in length. Battery shelf provides ample space for all equipment. Beautifully finished in either Walnut or Mahogany. Price (without receiving set) **\$44.00**
(West of Rockies, \$52.00)



(Pat. Applied For)

Model 1000
with 22-inch Cone Loudspeaker

Note to Dealers: Write or wire today for details of the highly profitable Windsor line.

Electrical Department

WINDSOR FURNITURE COMPANY

1412 Carroll Avenue • CHICAGO, ILLINOIS
Los Angeles Branch—917 Maple Avenue

The New

HAMMARLUND-ROBERTS

"Hi-Q" RECEIVER

Embodies the Latest
Hammarlund Developments

The coils and variable condensers specified by the ten nationally-known designer-engineers of the remarkable Hammarlund-Roberts "Hi-Q" Receiver are typical of Hammarlund advanced design and precision manufacturing methods. These instruments are of standard design and may be used with assurance of satisfaction in any other circuit of similar characteristics.

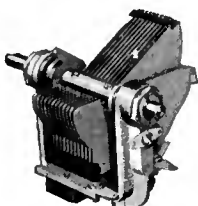

The "MIDLINE" Condenser

Gives better separation of wave lengths than previous types. Has a full-floating rotor with removable shaft, adaptable to any scheme of single control, multiple condenser operation.

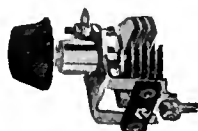

"HAMMARLUND, JR."

A high ratio, shielded midget condenser for use wherever small variable capacities and fine tuning are required. Base-board or one-hole panel mounting. Knob included.

Some Other New Circuits
in Which Hammarlund
Products are Officially
Specified

- COCKADAY "LC27"
- SARGENT "INFRADYNE"
- LACAULT "LR4"
- HENRY-LYFORD
- ST. JAMES SUPER
- VICTOREEN SUPER
- MORRISON "VARION"
- HARKNESS "KH-27"
- CARBORUNDUM SUPER
- PACENT "ULTIMAX"
- BROWNING-DRAKE
- POPULAR SCIENCE
- MONTHLY "POWERFUL"
- LOFTIN & WHITE
- HAYNES "DX-2 MULTI-VALVE"

We shall be glad to refer to the proper authorities any inquiries regarding the above receivers.



The "AUTO-COUPLE"

A scientifically correct tuned radio frequency assembly of Space-Wound Coil, "Midline" Condenser and Aluminum Shield, providing automatic graduated primary coupling at every condenser setting.



EQUALIZER

A compact, efficient variable condenser of small capacity, for neutralizing or balancing radio frequency circuits against undesirable oscillations on the low wave-lengths.

the set, but also to install a laboratory and give courses in radio.

When we heard the glad news we could hardly contain ourselves. There was something doing at last. With the governmental permit in our hands we were established forever, free to carry out our experiments with lots of apparatus and information at our service.

The Marconi set was installed in the chapel, which is our assembly hall, chiefly for recreation purposes. The first night the hall was crowded. Even the cooks and the servants came to hear this wonderful new "voice out of the sky." The people were lucky, indeed, because the program came in beautifully, without a trace of static, which is quite unusual for Constantinople.

Had it not been for the ships in the harbor, which continue until 10:30 p. m., reception might have been said to have been perfect. You should have seen the Russian servants stare when they heard the "International" come booming in through the loud speaker from Moscow. They are all Czarists. Rome and Paris came in very loudly and so did Germany. England, although quite clear, did not have so much volume.

Practically all went home that night interested. Many new devotees to the cause of radio had been made, and when, at the beginning of the second semester, a course in wireless

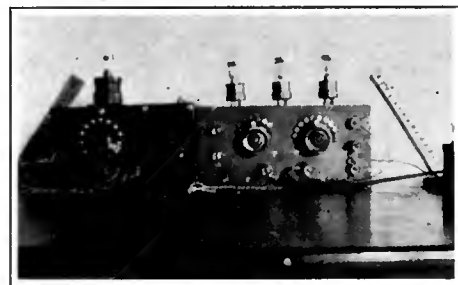

THE AUTHOR'S FIRST VALVE SET

The valves (vacuum tubes) employed are of English manufacture. The pick-up device is a loop antenna nailed to the wall behind the receiver

was started, Professor Tubini did not find an empty class room.

The laboratory equipment was of English make, and was received at the beginning of the second semester just in time for the classes.

Professor Tubini did much to encourage the amateurs. He imported apparatus for them at a very low price, and also arranged it so that goods could be sold in town at a reasonable cost. In short, he facilitated the task of the amateur a great deal. Heretofore the radio fan had to depend on second-class equipment, often unreliable, bought from soldiers or sailors, or else had to import it and this took a considerable time.

It took three years to establish a wireless set in Robert College. It took three years to obtain permission to teach and install a radio laboratory. Had it taken ten years, again I would affirm that the time spent was not in vain. Robert College graduates have a high social position throughout the Near East. Many statesmen and persons of influence have come up from her ranks. To have such men interested in radio means the spreading of the art in their respective countries. It means that the government regulations will become more liberal and that restrictions will no longer exist. It means that everybody will be able to make use of a great art and stretch out into foreign countries and glean information and entertainment which they otherwise could never have afforded. In short, it is the opening of a new world to the war-tired people of the Near East and perhaps is one way of helping to solve the problem of international peace.

HAMMARLUND MANUFACTURING CO.

424-438 W. 33d Street, New York

For Better Radio
Hammarlund
PRECISION
PRODUCTS



Now is a good time to subscribe for

RADIO BROADCAST

Through your dealer or direct, by the year only \$4.00

Doubleday, Page & Company

Garden City, New York

F. D. PITTS COMPANY

INCORPORATED

219-C Columbus Avenue, Boston, Mass., U. S. A.

"Pioneers in the Distribution of Radio"

DEALERS—Send for large and profusely illustrated catalog on the products of nationally advertised radio manufacturers.

Wholesale Exclusively

MERCHANDISING RADIO SINCE 1919

**30
DAYS
FREE
TRIAL**

7 Tube Set Single Dial Radio



The Metrodyne

ONLY ONE DIAL TO TUNE

Retail Price
\$75
Completely Assembled
Big Discounts to Agents and Dealers

Wonderful offer direct from the factory! The world's greatest radio. A perfect working, single dial control, 7 tube receiver. And just to prove our claims, we will ship it to your home for **30 days' free trial**. Test it under all conditions. Test it for distance, volume and tonal quality — and if you are not convinced that it is the best single dial set you ever heard, return it to the factory. We don't want your money unless you are completely satisfied.

BIG PROFITS TO AGENTS AND DEALERS
Our Agents and Dealers make big money selling Metrodyne Sets. You can work all or part time. Demonstrate the superiority of Metrodynes right in your home. Metrodyne Radios have no competition. Lowest wholesale prices. Demonstrating set on 30 days' free trial. Greatest money-making opportunity. Send coupon below—or a letter—for our agent's proposition.

Metrodyne Super-Seven Radio

A single dial control, 7 tube, tuned radio frequency set. Approved by America's leading radio engineers. Designed and built by radio experts. Only the highest quality low loss parts are used. Magnificent, two-tone walnut cabinet. Artistically gilded genuine Bakelite panel, nickeled piano hinge and cover support. All exposed metal parts are beautifully finished in 24-k gold.

Easiest set to operate. Only one small knob tunes in all stations. The dial is electrically lighted so that you can log stations in the dark. The volume control regulates the reception from a faint whisper to thunderous volume, 1,000 to 3,000 miles on loud speaker! The Metrodyne Super-Seven is a beautiful and efficient receiver, and we are so sure that you will be delighted with it, that we make this liberal **30 days' free trial offer**. You to be the judge.

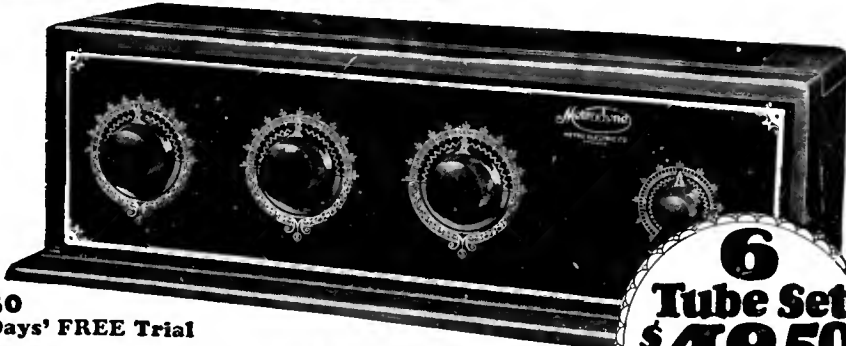

30 Days' FREE Trial

Metrodyne Super-Six

Another triumph in radio. Here's the new 1927 model Metrodyne 6 tube long distance tuned radio frequency receiving set. Approved by leading radio engineers of America. Highest grade low loss parts, completely assembled in a beautiful walnut cabinet. Easy to operate. Dials easily logged. Tune in your favorite station instantly on same dial readings every time. No guessing.

Mr. Howard, of Chicago, said: "While five Chicago broadcasting stations were on the air I tuned in seventeen out-of-town stations, including New York and San Francisco, on my loud speaker horn, very loud and clear, as though they were all in Chicago."

We are one of the pioneers of radio. The success of Metrodyne sets is due to our liberal **30 days' free trial offer**, which gives you the opportunity of trying before buying.

6 Tube Set
\$48.50
RETAIL PRICE
Completely Assembled

MAIL THIS COUPON 
or send a postal or letter. Get our proposition before buying a radio. Deal direct with manufacturer — **Save Money.**

Mail COUPON Below!

Let us send you proof of Metrodyne quality

F. L. Warnock, Greentown, Ind., writes: "I received the Metrodyne in good shape and am more than pleased with it. Got stations 2,000 miles away."

C. J. Walker, Mariposa, Calif., writes: "Received my Metrodyne Single Dial set O. K. I believe that these one-dial sets are going to be excellent sellers. I had no trouble in tuning in stations enough to satisfy anyone, so you will please send me another set."

Roy Bloch, San Francisco, Calif., writes: "Very often we travel from New York to the Hawaiian Islands quickly — from station to station — by means of the little tuning-knob which operates the electrically-lighted dial. The Metrodyne Single Dial Set is much easier to operate than any radio set I've ever seen."

We will send you hundreds of similar letters from owners who acclaim the Metrodyne as the greatest radio set in the world. A postal, letter or the coupon brings complete information, testimonials, wholesale prices, and our liberal **30 days' free trial offer**.

METRO ELECTRIC COMPANY
2161-71 N. California Ave., Dept. 122
Chicago, Illinois

Gentlemen:

Send me full particulars about Metrodyne 6 tube and 7 tube sets and your **30 days' free trial offer**

Name _____

Address _____

If you are interested in AGENT'S proposition, place an "X" in the square

METRO ELECTRIC COMPANY

2161-71 N. California Ave. • Dept. 122 • Chicago, Illinois



Every note .. naturally .. which the ear can hear!

Are you permitting your transformers to censor your reception? Are they cutting out those low base notes of the baseviol or the kettledrum? Are they giving proper amplification to the high notes of the piccolo and the human voice?

Here is an opportunity for you to get every note to which you are naturally entitled. Whether you are using a cone or a diaphragm type speaker, Ferranti Transformers are suitable. Ask your dealer about Ferranti. If he does not handle it, write us and we will let you know who does.

FERRANTI Transformer

Highspots

High amplification ratio with flat curve. Ferranti brings out the fundamental frequency of low tones—none are heard merely by inference from higher harmonics. Every transformer tested ten times—all short-circuit turns eliminated. Built by an established manufacturing company with forty years' experience in the winding of coils of fine wire for electrical instruments and meters. Windings have high impedance. Primary shunted with built-in condenser of correct capacity. Tested to 1000 volts between primary and secondary and between primary and secondary and ground.

For the best available transformer results—Ferranti Audio Frequency Transformer A.F. 3—ratio 3½ to 1—\$12.

For a Transformer far superior to the average, use Ferranti A.F. 4—ratio 3½ to 1—\$8.50.

FERRANTI INC.

130 W. 42nd Street
New York, N. Y.

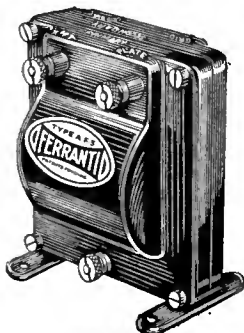

A KEY TO RECENT RADIO ARTICLES

By E. G. SHALKHAUSER

THIS is the sixteenth installment of references to articles which have appeared recently in various radio periodicals. Each separate reference should be cut out and pasted on cards for filing, or pasted in a scrap book either alphabetically or numerically. An outline of the Dewey Decimal System (employed here) appeared last in the January, RADIO BROADCAST, and will be reprinted in an early number.



R343. ELECTRON-TUBE RECEIVING SETS. RECEIVER. *Radio News*, Oct., 1926. Pp. 356-ff. "The Infradyne," H. Green.

The principles upon which this receiver is built are not unlike those of the common and well-known super-heterodyne, differing only in the method in which the intermediate stages deliver the energy to the detector tube. This intermediate stage does not tune to the difference of frequencies of the local oscillator and the incoming signal but to the sum frequency, thus utilizing the very short wavelengths for amplification. This eliminates interference from long-wave stations, stray heterodyning, and all harmonics, so that stations are tuned-in on only one point of the dial setting. A description of this receiver is given in detail.

R347-7. PATENT PRACTICE. PATENTS. *Popular Radio*, Nov., 1926. Pp. 651ff. "How to Patent Your Radio Invention," E. H. Felix.

The writer gives pertinent advice to radio experimenters on the subject of patents and patent practice. Every inventor should ask himself the following questions before applying for a patent:

(1). Does the device perform a service so useful that a sufficient number of people will pay enough for it to yield you a substantial profit?

(2). Is the service performed by the device a new one, or is it accomplished by your device much more economically, efficiently, and satisfactorily than by other existing devices?

(3). Is it sufficiently simple of manufacture to permit it to be made in quantity at a profit?

(4). Does it fill a need sufficiently obvious to its prospective users that it can be sold to them without excessive advertising and promotion cost?

What to patent and what not to patent, how to proceed with a patent application, and the rules of patent practice in general, are discussed.

R553. METEOROLOGICAL SIGNALS. METEOROLOGICAL SIGNALS. *Popular Radio*, Nov., 1926. Pp. 656ff. "Radio Transmits Weather Maps to Ships," S. C. Hooper.

The Jenkins system of picture transmission is described as being used for broadcasting the daily weather maps to ships. A photograph of a transmitted map is shown.

R343. ELECTRON-TUBE RECEIVING SETS. RECEIVERS. *Popular Radio*, Nov., 1926. Pp. 656ff. *Crosley, Murad*, "Inside Information on New Radio Receivers," *Freshman*.

In this third series of articles on new receiving sets, the following receivers are discussed in detail. The New Model Crosley 5-50 receiver; The Murad Super-Six receiver; The New Model Freshman Console.

R281-71. QUARTZ. QUARTZ CRYSTALS. *Radio*, Nov. 1926. Pp. 27ff. "The Operation and Construction of Quartz Crystals," J. B. Dow.

A theoretical discussion on the properties of quartz crystals is presented. A quartz crystal has three axes spoken of as the optical, the electrical, and the third axis. The laws pertaining to such a crystal are determined by applying pressures or stretching forces along these three axes. These laws are explained. The operation of such a crystal, when placed in the grid of a vacuum tube, is to set up continuous oscillations when the plate circuit has the same resonant frequency as the mechanical vibrations of the crystal. Details are given on the relation of a good crystal, the cutting, grinding, and polishing.

R343.7. ALTERNATING-CURRENT SUPPLY. POWER-PACK, *Popular Radio*, Nov., 1926. Pp. 638-642. "How to Build the LC Senior Power Pack," L. M. Cockaday.

A "power pack" unit which supplies the A, B, and C voltages for a 210 tube, B voltage for all the tubes in a receiver, and C voltage, is described. Diagrams on construction and assembly, as well as operating instructions, are given.

R110. RADIO WAVES. WAVES. *Popular Radio*, Nov., 1926. Pp. 643ff. "Waves and Wavelengths," Sir. Oliver Lodge.

A simple explanation of sound and light vibrations, and their effects upon our senses, is given. Sound waves are said to be compressions and rarefactions in the air, whereas light waves are thought of as waves in a subtle medium called the ether. The properties of light waves and their characteristics are presented.

R582. TRANSMISSION OF PHOTOGRAPHS. TELEVISOR. *Popular Radio*, Nov., 1926. Pp. 649ff. "The Televisor," O. E. Dunlap.

The transmission of moving pictures by the Baird system has been perfected to such an extent that licenses have been granted in Great Britain for purposes of transmitting and receiving by this system. The details of the method are clearly outlined, only one photo-electric cell being necessary at the transmitting end.

R582. TRANSMISSION OF PHOTOGRAPHS. TELEVISOR. *Popular Radio*, Nov., 1926. Pp. 649ff. "The Televisor," O. E. Dunlap.

The transmission of moving pictures by the Baird system has been perfected to such an extent that licenses have been granted in Great Britain for purposes of transmitting and receiving by this system. The details of the method are clearly outlined, only one photo-electric cell being necessary at the transmitting end.

(Continued on page 426)

AMSCO

FLOATING SOCKETS

Stop microphonic noises, mechanical feed-back and audio vibration!

AmSCO Floating Sockets make it possible to operate your tubes at highest efficiency. They take all the new type tubes—with the click that guarantees positive contact. Ask your dealer or write for leaflet

AMSCO PRODUCTS, INC.
Broome and Lafayette Streets
New York City

Bradley-Amplifier

Resistance-Coupled
PERFECT AUDIO AMPLIFIER

Provides audio amplification with minimum distortion. Bradlevunit moided resistors used in the Bradley-Amplifier do not vary with age and are not affected by atmospheric conditions. Can be used to replace transformer amplifiers in standard radio sets with decided increase in tone quality.

Allen-Bradley Co.
Electric Controlling Apparatus
278 Greenfield Avenue Milwaukee, Wis.

Pacent Cone

TYPE A
\$28.50

To hear the Pacent Cone is to know what pure tonal quality really means. To own a Pacent Cone is the assuring knowledge that it is worthy of bearing the name of the pioneer radio manufacturer whose name is synonymous with quality.

PACENT RADIO CORP.
156 West 16th Street New York

SM

Build as You Buy!

It goes without saying that you'd like to own the best of radio receivers. You know that the S-M Shielded Six, approved by Radio Broadcast, is just about as good a set as you can buy or build, for it incorporates the very latest engineering ideas you'll find in two to five hundred dollar factory built sets.

Take for example the tone quality, guaranteed to be the most satisfying you've ever heard. Then there's the complete individual shielding of each of the three radio frequency and the detector circuits, so equalized that uniform amplification is obtained at all wavelengths. And you know what the special sensitivity control means—the little knob that lets you go the limit on distance, with only two station selector dials.

You'd like to build the "Six" and feel you had the very best, wouldn't you? And maybe you haven't got \$95.00 for the complete kit handy right after Christmas? All right—S-M has made it possible for you to buy just what you can afford—begin your Shielded Six as a one tube set, a three tubular; or better yet, let your dealer show you how you can commence with four tubes for less than \$53.00, and have a set to start with that will give you volume and quality on local and medium distant stations.

Then as you want to, you can add to your initial investment little by little, knowing that at each step you discard nothing, buy nothing that you won't use when your Shielded Six finally has the last tube installed and you're confident you've got the best of sets.

Ask your dealer about this new "installment building" idea that lets you buy the finest of sets as you can afford to.

Do you know the secret of quality reproduction?

Have you your copy of "The Secret of Quality"? It tells you simply how to get the most out of your audio amplifier—how to get real quality. It contains laboratory data never before available even to many manufacturers. It is the only authoritative treatise of all types of audio amplification written in non-technical language ever published.

It's free! Ask your dealer for a copy.

Prices 10% higher west of the Rockies.

SILVER-MARSHALL, INC.

838 West Jackson Blvd.

Chicago

U. S. A.



The best recommendation of S-M parts is the circuits for which they have been specified. Here are but a few of the more recent ones.

- Infradyne (Improved model) Shielded Six
- Silver-Cockaday
- Best's A. C. Browning Drake
- Best's A. C. Diamond of the Air
- Radio News Batteryless Receiver
- Radio Broadcast Super
- Radio Age Super
- Radio Broadcast Local
- LC-27 Junior Power Pack
- Citizens Call Book Monotune Receiver
- Call Book Power Pack
- Callies Super
- Radio Mechanics "A", "B" and "C" Eliminator
- Radio Engineering "A", "B" and "C" Eliminator
- Radio Mechanics Man-O-War Super
- Lincoln Super
- Best's Short Wave Set
- Hush-Hush II Short Wave Set
- Popular Mechanics Super
- Christian Science Monitor 6 tube Browning-Drake
- Radio Engineering Short Wave Set
- New York Sun "B" and "C" Eliminator for Resistance Amplifier
- Chicago American Short Wave Set
- Chicago Post Power Amplifier
- Best's new Super
- Radio News Power Amplifier
- Loftin-White
- Popular Radio Town and Country Receiver
- Radio News Super



210 Long Wave Transformer \$6.00
211 Filter 6.00

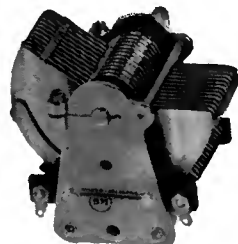

316-A and 316-B Variable Condensers, 00035, \$4.50



220 Audio Transformer \$6.00
221 Output Transformer 6.00

And Now Announcing!

CARBORUNDUM GRID LEAKS AND COUPLING RESISTORS

REG. U. S. PAT. OFF.

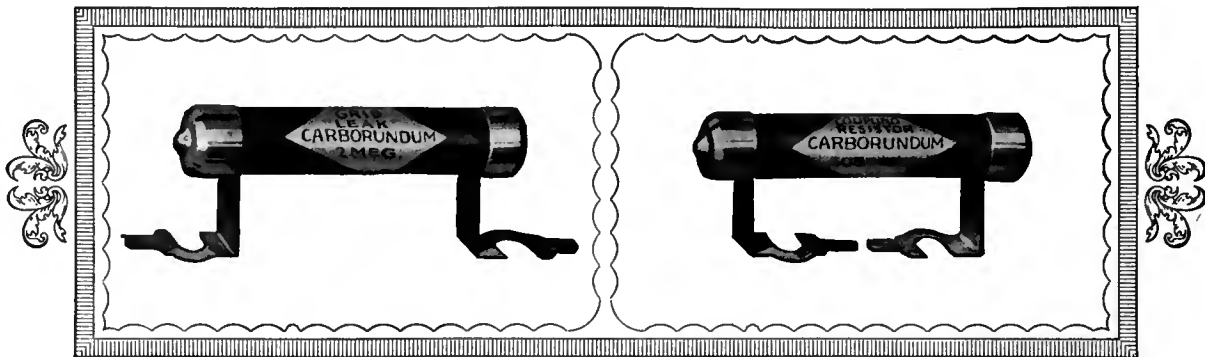

Send for
the new
Carborundum
Hook-Up Book D-2

ABSOLUTELY noiseless—

Do not disintegrate with use or time—

No metallic film but instead a solid rod of dense unbreakable Carborundum—one of the greatest of all electrical resisting materials.

Made in all standard values and tested under actual operating conditions.

Grid Leaks or
Resistors from
your dealer or
direct, 35c. each

IN ORDERING
PLEASE STATE VALUES
REQUIRED

THE CARBORUNDUM COMPANY, NIAGARA FALLS, N. Y.

SALES OFFICES AND WAREHOUSES IN

New York : Chicago : Boston : Philadelphia : Cleveland : Detroit : Cincinnati : Pittsburgh : Milwaukee : Grand Rapids
The Carborundum Co., Ltd., Manchester, Eng.

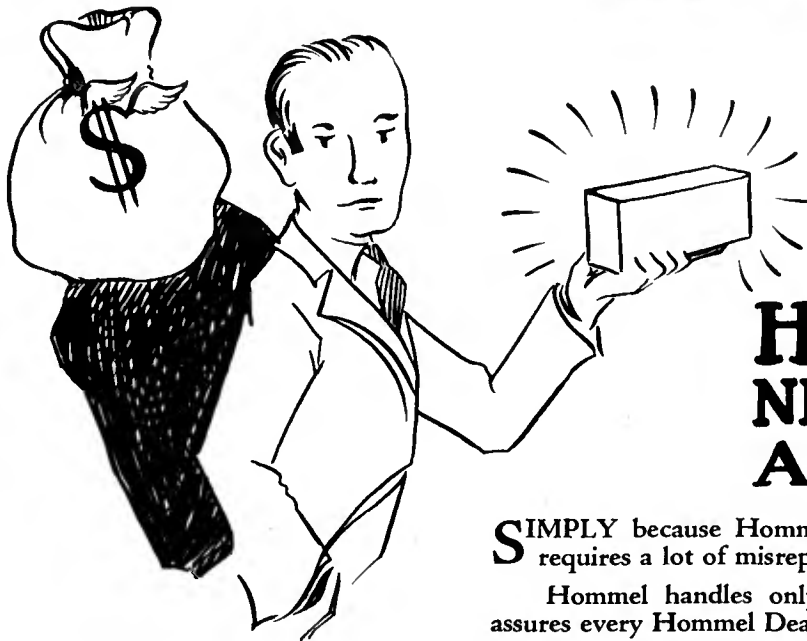

HOMMEL NEVER GOLDBRICKED A DEALER

SIMPLY because Hommel does not buy goldbricked merchandise that requires a lot of misrepresentation to sell.

Hommel handles only the best selling merchandise—the kind that assures every Hommel Dealer a quick turnover.

Hommel's many years of merchandising experience has given him a keen discernment of good and bad selling lines—a good judgment that has built a national reputation for standard and reliable dealer's supplies.

Send for the Hommel Catalogue No. 27-B to-day—and
tie up with Hommel—the wholesaler who never retails

WHOLESALE

EXCLUSIVELY

LUDWIG HOMMEL & CO

929 PENN AVENUE



PITTSBURGH, PA.

from Franklin to Faradon

Compare Franklin's crude Leyden Jar with the compact, efficient Faradon Capacitor of modern radio.

The Wireless Specialty Apparatus Company, established in 1907, manufacturers of Faradon, specializes in electrostatic condensers for all purposes.

For Dependability
insist upon Faradon equipment for your radio set and battery eliminator.



Model WS By-Pass Unit

Made in
½ MFD
1 MFD
and 2 MFD
Units

Wireless Specialty Apparatus Company

Jamaica Plain, Boston, Mass., U. S. A.



Made in
U. S. A.

Price \$10.50

Model WS-3750 "Universal" Filter Capacitor Block

Other models in blocks or individual units with any desired capacities and voltage ratings.

Faradon By-Pass and Filter Capacitors



At
ONE POINT
only
Think of It!



There is no reappearance of stations with the New

MADISON-MOORE ONE • SPOT TRANSFORMER

With this new, improved instrument you log the desired station at ONE particular point on the dial and always bring in that same station at that identical point—not in a half dozen or more places. The intermediate frequency of the MADISON-MOORE One • Spot Transformer is of such high value that reappearance of any station in the entire broadcast range is eliminated.



In addition to this fixed One • Spot reception, you get Positive Selectivity, Higher Quality and Greater Distance. Yet, the price of this latest model is less than for the former one!

To know the joy of exact selectivity without duplication, and to get a world of Radio Satisfaction, install MADISON-MOORE One • Spot TRANSFORMERS.

[If your dealer can't supply you, write us.]

MADISON-MOORE RADIO CORPORATION

2524 E Federal Boulevard

Denver, Colorado, U. S. A.

MADISON~MOORE

The Finest RADIO APPARATUS in the World!

Insist on hearing  *this receiver*

MODERN BROADCAST conditions are a challenge to the radio world. This challenge has never been met in a straight-from-the-shoulder fashion. Now comes the **R.G. S. Receiver** developed by David Grimes, one of the six foremost radio engineers of America. This receiver solves the problems presented by congested broadcast conditions and embodies a new principle that will leave an indelible impression upon all receiver design.

*[The following pages give
you the complete story.]*

BUILT FOR MODERN  **BROADCAST CONDITIONS**

Insist on hearing **R.G.S.** this receiver

42 Stations The R. G. S.

Is YOUR ANSWER to PRESENT

What the Authorities Say:



ARTHUR H. LYNCH
Former Editor
Radio Broadcast
President,
Arthur H. Lynch, Inc.

"For practical all round operation it is difficult to find a Receiver which is in any way superior to the National Grimes which was recently demonstrated to me in my home."

* * *

R. W. COTTON

Designer and Inventor of Cotton Super
Sales Manager Samson Electric Co.

"I have tested the R. G. S. Receiver thoroughly and it has all the attributes of what I consider to be an exceptional receiver. It has tone quality, selectivity, and sensitivity and is one of the few receivers I know of which has been designed for present day broadcast conditions. It will prove particularly satisfactory for broadcast listeners in the Metropolitan areas."

"The R. G. S. Receiver is its own best advertisement."

* * *



VOLNEY HURD
Radio Editor Christian
Science Monitor

"Uncramped by former commercial pressure, David Grimes has brought forth a Receiver which has justified his engineering ability. His radio frequency system gives great sensitivity in addition to selectivity that we have seldom seen equaled with six tube circuits let alone four. In his audio frequency he puts his finger right on the source of most transformer coupled difficulties. Radio has need of a set like this this year. Thank you, Mr. Grimes."



FORTY-TWO STATIONS in 30 minutes—each station as clear as a bell—absolutely no "cross talk"—these are the highlights in a simple test made at Boston a few days ago with an assembled R. G. S. Receiver. During the same time and under identical conditions, a receiver conceded to be one of the finest standard instruments on the market was tried. With difficulty, ten stations were brought in. Even some of these interfered with each other. The R. G. S. Receiver meets the challenge of modern broadcast conditions—conclusively.

MIAMI BEACH AT 5:30 in the afternoon from within one half mile of Station WBBR, New York City. Chicago at 6:15 in the afternoon without an antenna! The chaotic condition of metropolitan area broadcasting is eliminated with one gesture. The R. G. S. embodies a design that insures the ability to pick-up stations without "cross talk" not only on the lower half of the dial but on the upper half with equal ease and facility. And most important of all, the R. G. S. Receiver is not critical at any point on the dial. The irksome task of obtaining extremely critical adjustments is abolished.

THE R. G. S. DOES MORE than raise the standards of selectivity. TONE QUALITY, DISTANCE, SENSITIVITY, VOLUME—they are all there to respond the moment your hand touches the dial.

THE R. G. S. RECEIVER, employing a new application of the Inverse Duplex System, is presented, unassembled. It is offered thus to give the radio world immediate advantage of the startling improvements it effects and also in order

DEALERS: Write for complete merchandising information

BUILT FOR MODERN BROADCAST CONDITIONS



Insist on hearing **R.G.S.** *this receiver*

in 30 Minutes!

RECEIVER

BROADCAST CONDITIONS

to keep the price down to "rock bottom." This kit contains the complete receiver—there is nothing more to buy as far as the instrument itself is concerned. Blueprints and complete instructions for assembling are included.

NO MATTER HOW MUCH advertising is done, the strongest advertisement will be the performance of the instrument itself. The R. G. S. was developed with scientifically selected apparatus. It was not designed to meet a price level, although it is lower in price, with one or two exceptions than any receiver on the market. The R. G. S. was specifically designed, however, to meet (and it does meet) the chaotic conditions that exist in present day broadcast conditions. The new principles of the R. G. S. are not to be found in any other amplifier-receiver equipment.

ALL WE ASK AT PRESENT is that you insist on hearing an R. G. S. Receiver in actual operation. Through our jobbers and dealers we can arrange for a demonstration of an assembled R. G. S. for your particular benefit. Turn the dial of the R. G. S. Receiver with your own fingers, make your own test, draw your own conclusions. As the real authorities in the industry, such as Wing, Cotton, Bouck, Kruse, Lynch, Hurd, etc., have discovered, you will find that every claim we have made is based on real performance. Fill out the coupon below and mail to us.

THE R. G. S. RECEIVER is fully covered and protected by U. S. Patents Nos. 1,517,057 and 1,517,058; by Canadian Patents Nos. 241,602 and 260,787; by British Patents Nos. 204,301 and 225,579; and Australian Patent No. 20,813.

DEALERS: *Write for complete merchandising information*

What the Authorities Say:

WILLIS KINGSLEY WING
Editor of Radio Broadcast

"The new Grimes receiver recommends itself to me because it embodies sound design and some very neat principles. The receiver is 'new' without being 'new and revolutionary' in the unfortunate sense of that term. It is particularly pleasing to see that the excellent and appealingly economic idea of the Inverse Duplex System—deservedly popular for a long time—has been improved and refined, and the result crystallized in this model."

* * *

Robert S. Kruse, Technical Editor of QST, has operated this Receiver in his home for an extended period of time and approves of its performances and selectivity.

* * *



"... I particularly like the idea of reflexing with resistance coupling. We have long lamented the general poor performance of manufactured receivers. It is indeed refreshing to find a designing engineer of commercial equipment, not merely endowed with intelligence himself, but permitted to give full rope to it unhampered by suicidal sales and production departments. Mr. Grimes's new set is several steps in the right direction."



ZEH BOUCK
Consulting Radio Engineer

R. G. S. Sales Division
Grimes Radio Engineering Co., Inc.
285 Madison Ave., New York City

Your R. G. S. Receiver sounds good to me. Please arrange with my dealer, whose address I have given below, for a demonstration at his shop. There is no obligation attached to this demonstration. I am interested in testing for myself if your claims are just claims or if they are founded on fact.

Your Name

Street

City..... State.....

Dealer's Name.....

Dealer's Address.....

BUILT FOR MODERN BROADCAST CONDITIONS



Insist on hearing **RGS** *this receiver*

"My selection of the recommended apparatus in the R. G. S. Receiver was based on the special scientific requirements of the circuit."—DAVID GRIMES.



Samson Transformer

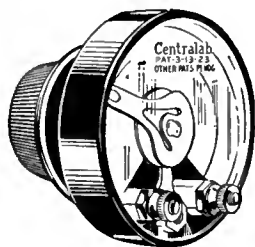

Centralab Potentiometer

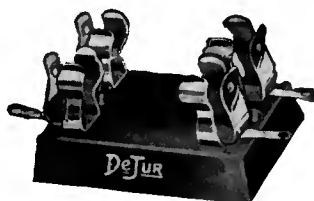

DeJur Resistance Mounting



Grimes R. F. Filter Coil and R. F. Choke



Benjamin Socket

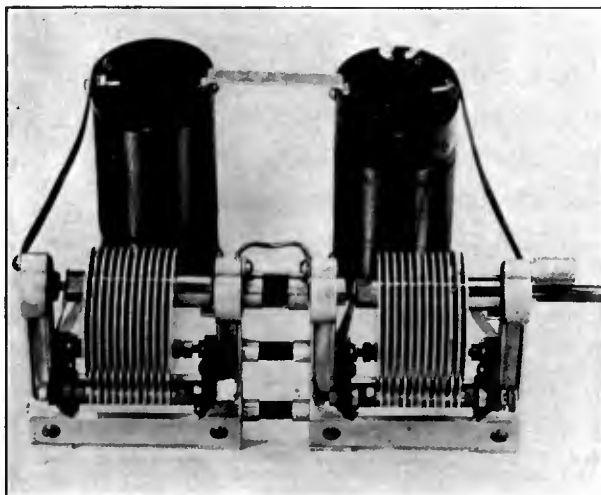

[National-Grimes R. F. Tuning Coils—National Condenser]

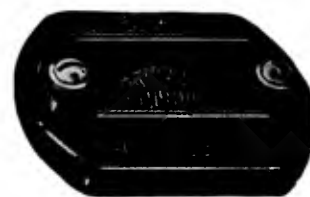

Sangamo Condensers

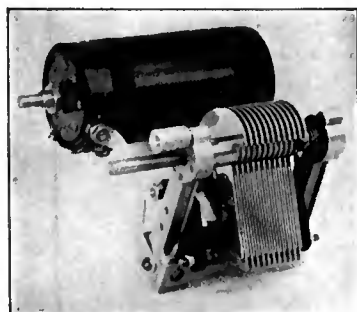

National-Grimes R. F. Tuning Coils
National Condenser



Lynch Resistors

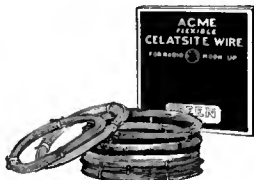

DeJur Variable Resistance

Price
\$69.70

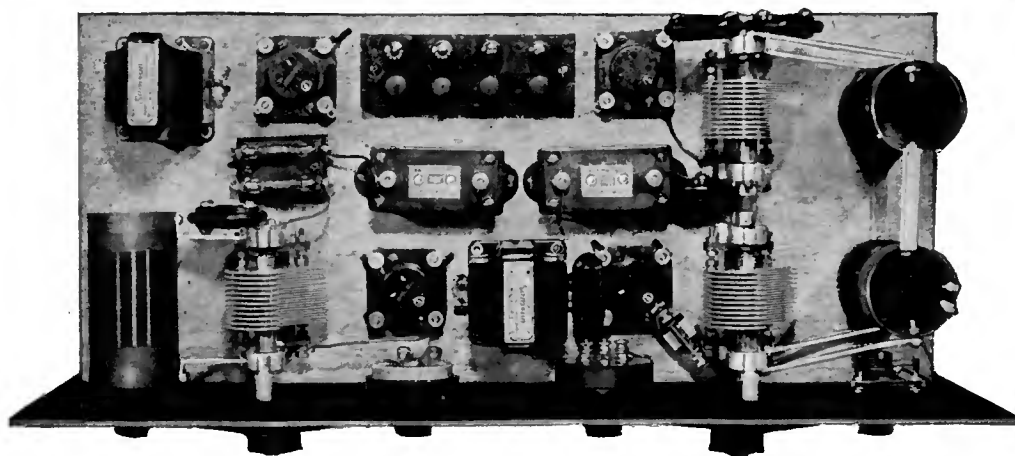

Westinghouse Micarta Panel

Without
Accessories
or
Cabinet

R·G·S RECEIVER

DEALERS: Write for Complete Merchandising Information

BUILT FOR MODERN BROADCAST CONDITIONS



NATIONAL

POWER AMPLIFIER



*Lynch Resistors,
TOBE Condensers
Electrad Royalty
Resistances, all play
their essential part
in the excellence of
the NATIONAL
Power Amplifier*



MOST good Radio sets today are sensitive and selective, but many have lagged behind in audio quality. The NATIONAL Power Amplifier brings your present set up-to-date, and makes its performance an unqualified pleasure. Designed in collaboration with Arthur H. Lynch and James Millen, it omits nothing to give quality reproduction.

This new instrument contains a complete audio amplifier of a design not hitherto offered to the public, which is arranged to be coupled directly to the detector tube of any receiver. The audio tubes are removed from the receiver and in their place the NATIONAL Power Amplifier passes the detected signal to the loud speaker at any desired volume, which may be sufficient to fill a large hall, still without any impairment of tone or quality.

The amplifier uses one stage of impedance and two of resistance coupling, with an impedance leak on the power tube. High-mu tubes are used for the first two stages and a UX-171 semi-power tube for the output, which passes through a NATIONAL Tone Filter to the loudspeaker. Exceptionally good results have been secured with CeCo Tubes in the amplifier, although other standard makes of high-mu and power tubes give excellent performance, providing their characteristics are approximately the same.

In addition to the audio amplifier, this new NATIONAL Power Amplifier has a complete B-supply for the entire set and the C-voltage for the power tube. Once adjusted it requires no further attention and may be placed in a cabinet beneath the Radio set.

The B-supply portion of the NATIONAL Power Amplifier is designed to be used either with filamentless full-wave rectifier tubes, preferably those which will supply from 80 to 85 mls—or the UX-213 or CX-313 fullwave Rectron Tube. All of the parts whether made by NATIONAL COMPANY or other manufacturers, have been selected only after careful investigation—so as to maintain NATIONAL standards of excellence in this sturdy and thoroughly well designed piece of apparatus.

B-POWER SUPPLY KITS

NATIONAL

POWER AMPLIFIER KITS

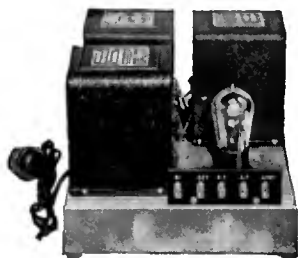

NATIONAL B-Power Unit
Type M



NATIONAL One-Stage Amplifier
Type E-1



NATIONAL Power-Amplifier
Type L-3

In the NATIONAL Power-Amplifier, the Power Units are mounted on a cored and drilled cast metal base with the amplifier. The NATIONAL Power-Transformer carries windings suitable for use either with the new Raytheon BH 80-mil tube or the Rectron UX-213. It also carries a winding for lighting the filament of the power-tube direct from A.C. The Special NATIONAL TOBE B-BLOCK employs extra high-voltage short-path condensers, necessary when so much voltage is being handled. The Filter-Chokes are wound with large wire,—and the iron cores are exceptionally heavy. These power-units will carry 80 mils continuously without heating or damage,—a very high rating. TOBE Buffer Condensers are used. Variable C-voltage for the power tube bias and variable B-voltage for detector and R.F. tubes is supplied at the terminal strip, through Variable Resistances. There is a solidity and excellence of appearance in these B-Supply Units which is a true reflection of the careful engineering design and quality of materials packed within them.

NATIONAL Power Amplifier Kit (Type L-3)

The NATIONAL Power Amplifier is put up in complete kit form by the National Company, except audio tubes. Including the wire and full instructions. The unit may be easily assembled in one evening.

Price—NATIONAL Power Amplifier Type L-3 completely assembled and tested, without tubes; state whether BH type or Rectron 213 type tube is to be used \$89.00
BH type tube extra 6.00
Price, NATIONAL Power Amplifier Type L-3 in kit form with full instructions for assembling, complete with BH tube \$84.00

The NATIONAL B Power-Unit Kit (Type M)

To meet the large demand for a reliable and rugged B-Power Supply unit, free from difficulties associated in so many minds with such devices, National Company also offers a complete kit with Raytheon BH Tube. This is also provided with a cored and drilled metal base, all necessary wire, and can be assembled in a few hours. It employs the same fine units as the NATIONAL Power Amplifier,—Power Transformer, NATIONAL Special TOBE B BLOCK and Filter Chokes.

Price, NATIONAL B-Power Supply Type M, completely assembled and tested, without tubes; state whether BH or UX-213 type rectifier tube is to be used \$60.00
BH Tube extra 6.00

NATIONAL One-Stage Amplifier Kit (Type E-1)

In many cases the Radio owner desires a combined B Eliminator and one-stage power amplifier which can be plugged directly into the output of his present set. The NATIONAL one-stage Power Amplifier meets this need. It contains the same B-Power Units as the NATIONAL B-Power Supply and in addition, one stage of NATIONAL Impedaformer Power Amplification for use with Type 171 Semi-Power Tube,—an adjustable C bias is also included and a NATIONAL Tone Filter.

Price, NATIONAL one-stage Amplifier Type E-1, completely assembled and tested, without tubes; state whether BH or UX-213 type rectifier tube is to be used \$68.00
BH Tube extra 6.00

NATIONAL

B-POWER AND AMPLIFIER KITS

B-POWER SUPPLY KITS **NATIONAL** **POWER AMPLIFIER KITS**

NATIONAL Equipment for B-Eliminators and Power Amplifiers
NATIONAL Power Transformer

This Transformer, for the construction of Power Units, is designed for use with either Raytheon or Rectron Tubes. The secondary carries sufficient voltage to operate the new Raytheon BH 80-mil Tube and the wire is of sufficient size to permit continuous operation for long periods without heating or damage. The transformer has center-tapped 7.5 volt and 5.5 volt secondaries, for heating the filaments of rectifier tubes or of power tubes, whether of the UX-210, UX-112, or UX-171 type. This makes the transformer adaptable without change to a number of different rectifier and amplifier circuits.

The unit is cased in a heavy pressed metal box, attractively finished in black crackle. The terminal panel is of Bakelite with special NATIONAL screw-type terminals.

Dimensions: 4 3/8" wide x 4" deep x 4 3/4" high. Built to NATIONAL standards.
 Price—with Raytheon BH Tube.....\$22.50 each
 Price—without Raytheon BH Tube..... 16.50 each

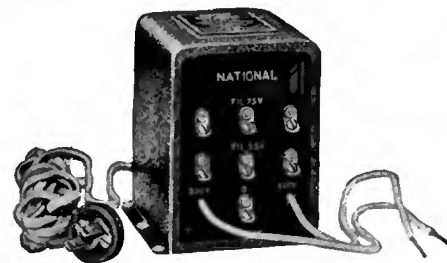

NATIONAL Power Transformer

NATIONAL Filter Chokes (Types No. 35 and No. 80)

These Filter Chokes are made for use in Filter Circuits of plate-supply units. Type No. 35 contains two iron core inductances and is designed for a maximum continuous output of 35 mils. This is sufficient for the average 5 tube set, with or without one power-tube.

Dimensions: 2 5/8" x 4" x 3 1/4", finish and type of case to match the NATIONAL Power Transformer.

Price—Type No. 35.....\$7.00

The NATIONAL Filter Choke Type No. 80 is a larger unit containing two iron core inductances wound with larger wire than the Type No. 35 and with larger cores, and capable of handling up to 80 mils continuously, as with the new Raytheon BH Tube.

Dimension: 4 1/8" x 4" x 4 3/4". Cased to match the NATIONAL Power Transformer.

Price—NATIONAL Filter Choke No. 80.....\$10.00



NATIONAL Filter-Chokes

Tobe Special B Block

built for use with NATIONAL B Eliminators and Amplifiers

This Special TOBE B BLOCK, designed expressly for the NATIONAL B Eliminators and Amplifiers, contains TOBE High-Voltage short-path Type Condensers, suitable for working voltages up to 400-volts D.C. It is not guaranteed for use with UX-210-B tube when more than 400 volts is being rectified with it (a higher voltage condenser block is required for this purpose; prices sent on request).

Dimensions: NATIONAL 4 1/8" x 4" x 4 3/4".

Price—TOBE SPECIAL B BLOCK.....\$17.50 each



NATIONAL Special Tobe B Block

NATIONAL Tone Filter

The plate voltages now required with either the UX-171, UX-112 or UX-210 Power Tubes, for fine quality of reproduction, range from 180 volts upward. The makers of the tubes recommend passing the output to the loud speaker through a Tone Filter. The NATIONAL Tone Filter is designed for this purpose. It contains an impedance of the proper value through which the plate of the Power Tube is supplied, a 2 Mfd. TOBE Filter Condenser, through which the A. C. component of the power tube output passes to the speaker. With this NATIONAL Tone Filter all D.C. is kept out of the speaker windings, thus preventing them from burning out, and at the same time the quality of the output is greatly improved, because no force is exerted on the speaker armature, except that due to the signal. Cased to match the other NATIONAL B-Power units, supplied with 5-foot phone cord, for instant attachment to any existing set.

To install put the tips on the end of the phone-cord plug in speaker jack on the set and insert speaker cord into the two tip-jacks marked LS on the panel of the Tone Filter.

Dimensions: 2 5/8" x 4" x 3 1/4" high.

Price—NATIONAL Tone Filter.....\$8.00 each



NATIONAL Tone Filter

NATIONAL products are built to engineering standards of excellence. Anyone who has ever built a set using NATIONAL BROWNING-DRAKE Coils and Transformers knows what that means. Send for Bulletin 116-RB.



National Co., Inc., Engineers and Manufacturers—W. A. Ready, Pres., Cambridge, Mass., Makers of NATIONAL BROWNING-DRAKE Coils and R. F. Transformers, Impedance Transformers, Condensers, Power Transformers, etc., for Radio.

NATIONAL
B-POWER AND AMPLIFIER UNITS

B-POWER SUPPLY KITS

NATIONAL

POWER AMPLIFIER KITS

CLAROSTAT

Scores again!



Isn't it significant to users of variable resistances that the NATIONAL-LYNCH Power Amplifier and B eliminator—the quality job of the year—is equipped with CLAROSTAT.

CLAROSTAT, the greatest variable resistor, is standard equipment not only in the apparatus of the National Co., but in the products of 90% of the B eliminator manufacturers of the country.

◆◆◆◆◆

Have you sent for your copy of "THE GATEWAY TO BETTER RADIO"? The edition is limited and you can't afford to be without it. 32 pages covering everything. Send 25c to Dept. R. B.

American Mechanical Labs. 285 N. 6th St., B'klyn

Chosen by EXPERTS

JAMES MILLEN, Lawrence M. Cockaday, Gerald M. Best, and many other eminent radio designers use the Lynch Metallized Resistor in their experimental circuits and receivers. These men know radio; they have laboratory and testing equipment with which quickly to make accurate comparisons. There could be no better proof of the true merit of the Lynch Metallized Resistor than the endorsement of these experts.

Comprising a concentrated metallized deposit one-thousandth of an inch thick upon a rigid core, sealed forever within a glass tube, the Lynch Metallized Resistor gives *conductive, non-arcing* resistance that remains silent, accurate!

Guaranteed accuracy—10%; in production they average 5%. .25; 5; 1; 2; 3; 4; 5; 6; 7; 8; 9; 10 Meg., 50c. .025; .09; .1 Meg., 75c. Single mounting 35c; Double, 50c. If your dealer cannot supply you, send stamps, check, or money order. We ship postpaid same day order is received.

PRICES:

.25 to 10 Megohms .50. Above .01 to .24 Megohms .75
.001 to .01 Megohms \$1.00.

Write us for complete list of ranges

Dealers all over the country and abroad are concentrating on dependable Lynch Metallized Resistors—"the line of least resistance," no "grief," and steady turnover—due to adequate advertising.

Get on our mailing list: we keep you posted on new developments. Write us to-day!

ARTHUR H. LYNCH, Inc., Fisk Bldg., Broadway & 57th Street, New York



FIXED RESISTORS

Endorsed by Leading Radio Authorities and Specified by Arthur H. Lynch for the

National Power Amplifier

See Specifications

Two CeCo Type "G"
HIGH MU TUBES

One CeCo Type J-71
POWER AMPLIFIER

Write for Data Sheet

C. E. MFG. CO., Inc.
Providence, R. I.

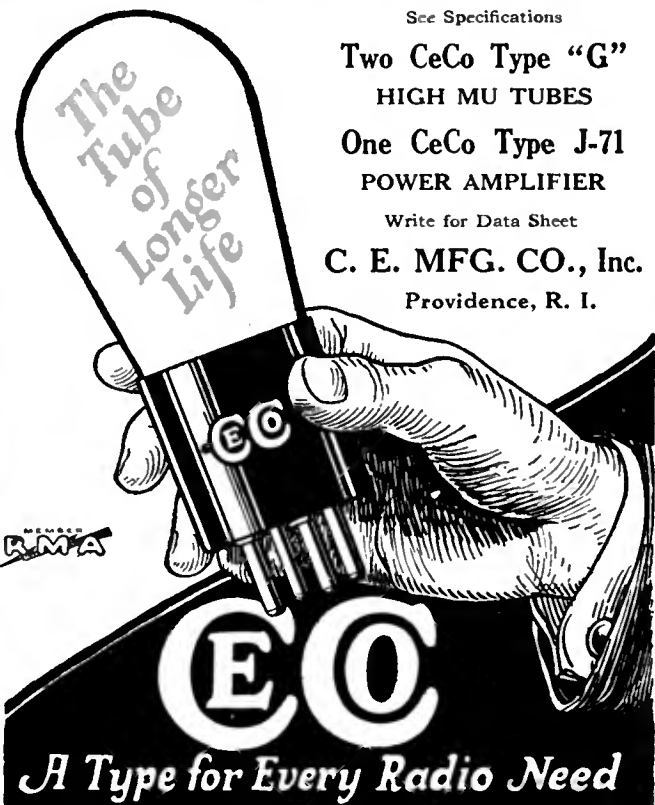

A Special TOBE B-BLOCK with hi-voltage condensers was chosen for use in the NATIONAL POWER AMPLIFIER. TOBE Buffer Condensers are used in the B-Supply Units also, and each audio-coupling condenser is a 0.1 Mfd. TOBE. The NATIONAL Tone-Filter uses a big TOBE, too.

TOBE Condensers are used because they are good condensers. Ask your dealer for TOBES and TOBE B-BLOCKS.

Tobe Deutschmann Co.

Engineers, Manufacturers,
Importers of Technical Apparatus

CAMBRIDGE MASS.



No. 3527
Unit

Increase the Volume of Your Present Set

It is easy now to get much greater undistorted power from your present radio receiver whether it has 2 tubes or 8 tubes. At the same time and at little additional expense you eliminate the need of B-Batteries.

No. 3527 Unit. Full Wave Rectifier for use with one UX 213 tube and power amplifier UX No. 171 tube. This unit includes one No. 2505 transformer and two No. 514 chokes. Full Power and B-Battery Eliminator. No. 3527—\$15.00 List.

No. 3516. Full Wave Rectifier for use with one Raytheon B11 tube and one UX No. 171 tube. This unit includes one No. 2593 transformer and two No. 514 chokes built into substantial metal case. Exceptional power for all purposes. Eliminates B-Batteries. No. 3516—\$13.00 List.

Fans—Send check or money order to factory if your dealer cannot supply you. Deliveries are prompt.

Manufacturers—As exclusive parts manufacturers Dongan offers the receiver and battery eliminator manufacturer a reliable source of supply. Our engineering department will co-operate with you in effecting the proper designs of the latest types for your requirements. Ask for a representative or send your specifications.

DONGAN ELECTRIC MFG. CO.
2991-3001 Franklin St. Detroit, Mich.

TRANSFORMERS of MERIT for FIFTEEN YEARS

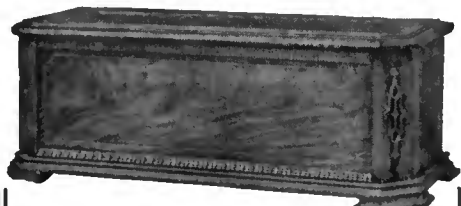

MODEL "C" CHEST

Cabinets in stock—have piano hinge and are 10" deep — grooved front top rail being removable. Illustration shows gold line wood panel to match.

Sizes	Walnut Only	Panel to Match
7x18-10	\$15.00	\$1.26
7x21-10	17.00	1.47
†7x21-12	17.50	
7x24-10	19.00	1.68
*7x26-10	21.00	1.82
7x30-10	23.00	2.10
**7x28-11	23.00	1.96

*For Madison Moore Receiver.

**For Victoreen Receiver.

†For Hammarlund Roberts Hi Q Receiver.

Walnut Infradyne Cabinet
\$2600

LC-27 Cabinets

Mahogany or Walnut with Baseboard

\$1800

The LC-27 cabinets have 25° slope and take 8x26 panel. They are full 10" deep back of the panel. WRITE FOR folder showing complete LC-27 Line, special Infradyne cabinets, and other Radio Furniture.

CORBETT CABINET MFG. COMPANY
St. Marys - - Pennsylvania



Inside Aerial and Loop Wire



Belden Aerial Wire



Lead-In and Ground Wire

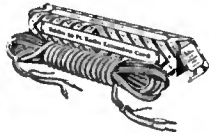

Belden 20-Ft. Radio Extension Cord



Belden Accessories that Improve Your Set

FOR an outdoor aerial, use a Belden enamel Aerial. It cannot corrode or deteriorate. For indoor aeriels, use the Belden Indoor Aerial Wire. And do not forget Belden Lead-In and Ground Wire to finish the job. All of these items are included, if you wish, in the new Belden Superadio Antenna Kit.

The Belden 20-foot Loudspeaker Extension Cord brings the loudspeaker where you want it. For safety to tubes and batteries, and protection against fire, use a Belden Fused Radio Battery Cord.

The Belden Fused Battery Cord provides:

- 1—An A-battery fuse.
- 2—A B-battery fuse.
- 3—A polished bakelite cover for the battery fuses.
- 4—A compact connecting cable that dispenses with loose wires.
- 5—A color-code on each wire for identifying each circuit.
- 6—A time saver, because the cord is quickly connected and easily concealed.

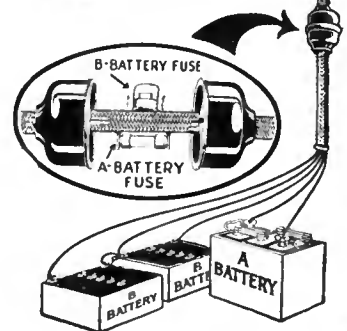

Ask your nearest dealer to explain how Belden Radio Accessories help you get better results from your set.

BELDEN MANUFACTURING COMPANY
2312A South Western Avenue Chicago, Illinois



Have you changed it Lately?

Few people realize what a remarkable improvement they can secure in tone quality by occasionally changing the Resistors in their sets.

Remember that the characteristics of tubes and batteries constantly change. Even when you replace old tubes with new ones there is always a variance.

Changing values within your set require Resistors of proportionately different values if you are to have the harmony and unison of all elements which affect perfect reception.

Most internal Receiver noises are NOT from faulty tubes, "B" batteries or loose connections, but are purely the result of unstable grid Resistors.

Wise radio owners keep several extra Durham Resistors, of various ranges from 1 to 5 megohms on hand and occasionally change them to meet varying conditions. Try it yourself and note the immediate improvement in tone quality.

(500 Ohms to 10 Megohms)

DURHAM METALLIZED RESISTORS

INTERNATIONAL RESISTANCE COMPANY
Dept. D, 1936 Market St. Philadelphia, Pa.

(Continued from page 420)

R 385.5 MICROPHONE. MICROPHONE. RADIO BROADCAST, Dec., 1926, Pp. 183-184. Condenser. "THE CONDENSER TRANSMITTER," A discussion concerning the condenser microphone, its characteristics and peculiarities, is presented. It is compared to the carbon microphone, the latter having certain advantages over the condenser type, although both are used in broadcasting stations.

R582. TRANSMISSION OF PHOTOGRAPHS. TELEVISION. RADIO BROADCAST, Dec., 1926, Pp. 139-143. "And Now, We See by Radio!" A. Dinsdale. A new system of transmission of motion pictures, called the Baird system, is discussed, and details relative to its operation and development are outlined. A comparison is made between the comparative effectiveness of the selenium cell and the photo-electric cell. The system is spoken of in the highest terms and said to be the only real practical system developed to date. Its accuracy in reproducing images and objects is considered to be far greater than that of any other system, this having been shown by actual demonstrations to others. Commercially, it is considered by many to be the only apparatus available at present.

R402. SHORT-WAVE SYSTEMS. SHORT-WAVE TRANSMISSION. "General Electric Short-Wave Test Results," M. L. Prescott. In a summary article, the results of the General Electric Company's short-wave transmissions, covering a period of eighteen months, are closely compared. Six stations were operating at frequencies from 20,000 to 2750 kilocycles, at various times during the intensive test period of April, 1926. Experimenters of the A.R.R.L. made observations and these are shown plotted as audibility curves. The curves show decided variations when comparing day and night transmission.

R132. AMPLIFYING ACTION. AMPLIFICATION. QST, Nov., 1926 Pp. 14-18. R.F. "R. F. Amplification—A Re-Hash," E. B. Lyford. The problem of controlling oscillations in r.f. stages is summed up, four general methods of stabilizing being enumerated. (1) The potentiometer in the grid return, or in the plate circuit. (2) The lossier method in the tube circuits. (3) Hazeltine neutralization method. (4) Reversed tickler method or the bridge compensation method. A variation of the Rice circuit of neutralization is shown and explained. Dimensional data are given for those who desire to experiment with this method of neutralization.

R330. ELECTRON TUBES. RELAYS? QST, Nov., 1926, Pp. 20-21. Electron. "A Sensitive Vacuum-Tube Relay," W. H. Hoffman and F. H. Schnell. A relay used in conjunction with a receiving set to operate sounders, bells, buzzers, etc., is outlined. A signal audibility of R-5, or better, will cause the relay to function. The parts required to build the relay, together with the circuit diagram, serve as a guide to the builder.

R3 4-3. TRANSMITTING SETS. TRANSMITTER, Crystal-controlled. QST, Nov., 1926, Pp. 22-25. "A Shielded Crystal-Controlled Unit," J. M. Clayton. A crystal-controlled transmitter, with separate stages of a three-stage oscillator-amplifier circuit shielded, here described, is said to have solved several difficulties experienced in unshielded sets. Tubes of the UX-210 type are used throughout, a maximum of 500 volts being available for the plate potential. Two tubes operate in parallel in the last stage. Complete data on construction and operation, including the circuit diagram, are given.

R220. CAPACITY. CAPACITY STANDARDS. QST, Nov., 1926, Pp. 28-31. "The Uses of a Calibrated Variable Condenser," R. B. Roof. With a well calibrated variable condenser, seven possible uses for it are described: (1). To find the distributed capacity of a coil. (2). To find the inductance of a coil. (3). To match two dissimilar coils so that they may both be tuned by the sections of the same tandem condenser. (4). To find the capacity of fixed condensers. (5). To calibrate other variable condensers. (6). As a wavemeter in conjunction with an inductance. To measure decrement and r.f. resistance. (7). Various uses in oscillating vacuum-tube circuits. A vacuum-tube driver is needed for the first five uses. In order to indicate resonance several methods, as outlined, may be used.

R113. TRANSMISSION PHENOMENA. TRANSMISSION PHENOMENA. QST, Nov., 1926, Pp. 32-33. "Horizontal Wave Experiments at 2AER," J. M. Hollywood. Data obtained and conclusions arrived at during a series of tests on horizontally and vertically transmitted and received waves on 40 meters (7496 kc.), indicate that a number of theories may be looked upon as supplying information concerning wave propagation. The author speaks of the "pebble in the pond theory," "the radiant ray theory," and the "lines of force theory," all of them being illustrated.

R124. COIL ANTENNAS. LOOP EXPERIMENTS. QST, Nov., 1926, Pp. 36-40. Considerable experimental data obtained with a loop receiver-transmitter using tubes no larger than the UX-210, are presented. The circuit diagram of the set itself is shown, together with constructional and operating data, and photographs. The outfit was used mainly for portable work in cars and planes. A Heising modulating system can be connected to it for phone work, as illustrated.

R120. ANTENNAS. ANTENNAS, Hertz Type. The Transmitter, Oct., 1926, Pp. 7-10. "Hertz Excitation. Something Different," K. M. Ehret. Whether an antenna will operate better when radiating on harmonics or on the fundamental depends on location, says the writer. A theoretical as well as practical discussion, pertaining to the Hertz form of oscillators, follows, wherein facts of current and voltage feed to the radiating system are clearly outlined. A "re-radiating" antenna (inductive coupling of the main antenna to a secondary oscillator) is suggested as giving very good results.

SELECTED FOR R. B. LAB. CIRCUIT ON SHEER MERIT

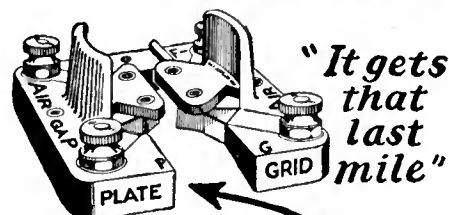

"It gets that last mile"

The AIRGAP SOCKET

RADIO BROADCAST LABORATORY recommend Airgaps for THE R. B. LAB. CIRCUIT (November issue page 36) because, as there stated, they introduce a minimum of GRID-PLATE capacity and aid in preventing objectionable feedback.

At all dealers or direct, postpaid
60c. each

AIRGAP PRODUCTS COMPANY Mfr.
9 Campbell Street
Newark, N. J.

SEE THAT GAP?

Bradleyleak

THE PERFECT GRID LEAK



Provides a noiseless range of grid leak resistance from 1/4 to 10 megohms. Assures most effective grid leak resistance value for all tubes. Small grid condenser (0.00025) is separate. Metal parts nickel plated. One hole mounting.

Allen-Bradley Co.

Electric Controlling Apparatus
278 Greenfield Avenue Milwaukee, Wis.

Mayolian
"B" SUPPLY

Type 612—\$42.50
The "B" Without a Buzz



Also—Complete set of parts for home-builders at reasonable prices. Write us.

MAYOLIAN
RADIO CORPORATION
1668 Webster Ave., New York, N. Y.

Pioneers in Battery Elimination



The Power of Niagara—
The Quiet of an Arctic Night



IT DELIVERS
FULL "B" VOLTAGE

Burns

B-Battery Eliminator

Operates from lighting current like other household appliances. No hum or vibrations. Smooth constant plate supply. Once connected it requires no further attention or adjustment. Remarkable results on local and long distance reception.

Popular Price—Write for Data

American Electric Company

State and 64th Streets Chicago, U. S. A.
Makers of Burns Speakers

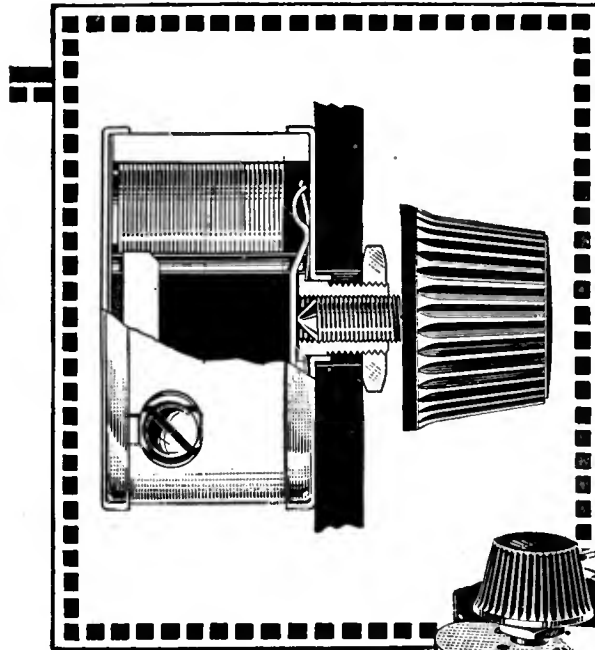

Bradleyohm-E
PERFECT VARIABLE RESISTOR

This new oversize resistor is used as standard equipment by leading B-Eliminator manufacturers such as Acme, All-American, Majestic, Philadelphia Storage Battery and Willard. The scientifically-treated discs provide stepless, noiseless, plate voltage control, and the setting will be maintained indefinitely.

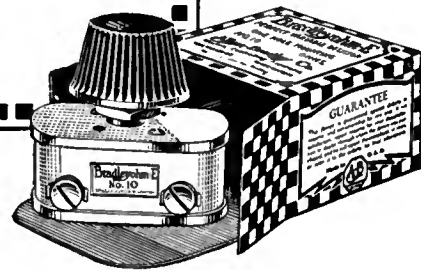

Use Allen-Bradley Resistors for B-Eliminator Hook-Ups

ALLEN-BRADLEY research engineers have developed a series of variable and fixed resistors especially suited for B-Eliminator hookups. The success of their efforts is indicated by the fact that Allen-Bradley resistors, both variable and fixed, are used by more than fifteen B-Eliminator manufacturers, including European as well as the largest American manufacturers.

Bradleyunit-A
PERFECT FIXED RESISTOR

Another triumph of the Allen-Bradley Research Laboratory is Bradleyunit-A, a perfect fixed resistor that contains no glass, requires no hermetic sealing, and can be soldered into place without the use of clip mountings. Bradleyunit-A is not affected by temperature or moisture.

The silent, smooth control of plate voltage so essential in B-Eliminator service is obtained with Bradleyohm-E. For fixed step adjustment of voltage, Bradleyunit-A is recommended.

Do not experiment with make-shift resistors when these Allen-Bradley units have been pronounced the ideal units for B-Eliminator service.

Ask your dealer for them, today!



ALLEN-BRADLEY COMPANY,
278 Greenfield Avenue,
Milwaukee, Wisconsin

Please send me your literature on Allen-Bradley radio devices and B-Eliminator hookups.

Name

Address

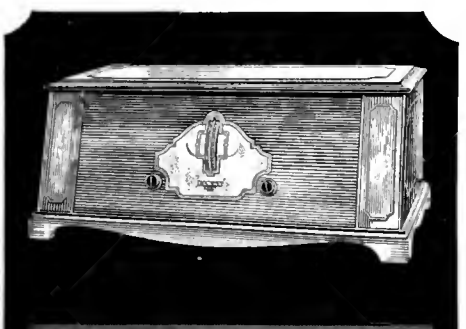

The New 6-Tube

ELKAY
TRADE MARK REG.

With Donle Truphonic
Audio Amplification

which delivers pure tone in any volume over the entire tonal scale, and the patented Elkay Synauto R. F., which smoothes out the tuning over the whole dial from 200 to 580 meters—is a receiver that will be modern for years to come.

Completely shielded. Neat Uni-Control—the flexibility of 3 dials at your finger tips. In brown antique. Duco-finished mahogany, \$125. (Exclusive franchise to the Trade).

The Langbein-Kaufman Radio Co.
Dept. R
62 Franklin Street, New Haven, Conn.

THOUSANDS OF RADIO SET OWNERS need these improvements

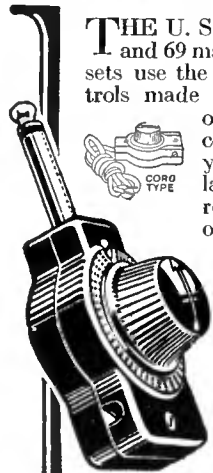

THE U. S. Navy the Signal Corps and 69 makers of leading standard sets use the variable resistance controls made by Central Radio Laboratories. These improved controls should be used on your set if you want the last word in quality for fine reception. Yet, owing to our huge output the cost is no more than for many inferior devices.

Modernize Your Old Set with **Centralab Modu-Plug**

Tone volume is, as you know, the one big improvement in this year's best sets. You can enjoy this improvement with your present receiver for only \$2.50. Modu-Plug is especially for that purpose. It provides full tone volume control from a whisper to maximum, simply by adjusting the small knob on the plug. Matches the speaker impedance to the set. Attaches instantly without tools.

Standard type Modu-Plug replaces present speaker plug. Cord type fits sets not equipped with jacks. Either type, at dealer's, or mailed direct, \$2.50.

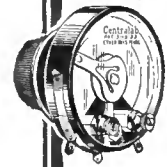

Centralab RheostatM

With "A" Battery Switch

Here is the variable resistance guaranteed always smooth, noiseless and permanent in adjustment. Tapered to control oscillation and volume, it also has a positive, quick acting "A" battery switch. One knob replaces two. Turning knob to right lights tubes, then increases volume. To left decreases volume, then cuts off batteries. Resistance is 0 to 500,000 ohms. You cannot imagine the great improvement until you try it. Adapted to all circuits. At dealer's, or mailed direct, \$2.30.

Centralab RheostatS

Where your old design rheostat overloads, heats up and quickly becomes noisy on new style tubes using increased current, Centralab Ribbon-type Rheostats will operate smoothly and permanently quiet. Insulated metal discs hold rigid a smooth flat resistance surface instead of wires, insuring even regulation and no dead spots.

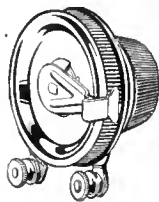

Every set using this rheostat is improved. 2 resistances for 5 to 10 tubes, at dealer's, \$1.25 or mailed direct.

SEND NO MONEY—if your dealer isn't supplied, order direct from us. Send no money. Simply pay postman on delivery, plus few cents postage. Install and test for 10 days. Then if you are not more than pleased and delighted with the wonderful results, return the goods to us and your money will be refunded. **10 DAYS' FREE TRIAL!**

We make variable resistances for both the U.S. Navy and Signal Corps and for 69 makers of leading standard sets

CENTRAL RADIO LABORATORIES

22 Keefe Avenue

Milwaukee, Wis.



R111. ELECTROMAGNETIC THEORY. ETHER WAVES. Popular Radio, Nov., 1926. Pp. 635ff. "Are There 'Ether Waves' After All?" E. E. Free. Experiments conducted by Prof. D. C. Miller, of Cleveland, Ohio, on the problems of the existence of the ether have received considerable attention, due to the claims put forth that a slight ether drift has been detected. The Michelson-Morley experiment showed no ether drift, and Einstein's Theory was based on this evidence. Dr. Miller's experiment consisted in measuring the interference fringes of light passing in different directions. He obtains a variation of speed of light parallel to the axis of the sun of about 6 miles per second, and believes that the whole solar system is falling through space at an actual speed of about 120 miles per second. This coincides remarkably well with astronomical observations.

R120. ANTENNAS. ANTENNAS. Proc. I. R. E. Oct., 1926. Pp. 675-688. Principles of, "Field Distribution and Radiation Resistance of a Straight Vertical Unloaded Antenna Radiating at One of Its Harmonics," S. A. Levin and C. J. Young. The operation at the harmonics of the grounded antenna, and of an ungrounded antenna at any distance above ground, has been considered as far as current, voltage and power distribution, electromagnetic field, and radiation resistance, are concerned. The antenna is always assumed to be a straight vertical wire and unloaded. The ground is supposed to be a perfect conductor.

R140. RADIO CIRCUITS. RADIO CIRCUITS, Proc. I. R. E. Oct., 1926. Pp. 689-693. Calculation of, "A Method for Maximization in Circuit Calculation," W. Van B. Roberts. Having found the expression for a current (or voltage, or power, etc.) in terms of complex quantities representing the constants of a circuit, it is often desired to determine what value of some one of these complexes makes the absolute magnitude of the current (or voltage, etc.) a maximum or a minimum. Rather than reduce the expression to its absolute value first, and then maximize in the usual way, it is often much less tedious to differentiate the expression while in the complex form. The condition for which the absolute value is an extremum is then not that the derivative is equal to zero, but that the derivative multiplied by a small increment of the independent variable gives to the dependent variable an increment which is at right angles to the vector representing the dependent variable itself. The condition of maximum obtained by this method is often in a form that is more compact and that has obvious physical significance. Two examples of the use of the method are given.

R134. SUPER-HETERODYNE. SUPER-HETERODYNE. Proc. I. R. E. Oct., 1926. Pp. 695-698. Origin of, "On the Origin of the Super-Heterodyne Method," W. Schottky. In this discussion the author points out how, in his opinion the super-heterodyne method of ether wave reception was first conceived by himself and others while doing research work in the Siemens Laboratory, Germany, during the war period. This idea was patented in 1917, and another in June, 1918. These are said to be older than the original Armstrong patent, pertaining to the same methods of reception.

R113.4. HEAVISIDE LAYER. HEAVISIDE LAYER. Wireless World (London). Sept. 8, 1926. Pp. 359-360. "Conditions Under Which Short Waves Penetrate the Heaviside Layer," E. V. Appleton. The writer discusses the changes that transmitted wireless waves of various wavelengths undergo when meeting the Heaviside Layer. On the longer waves, it is said, the conductivity of the upper atmosphere is equivalent to that of a sheet of copper one meter in thickness. However, the penetrating powers of the shorter waves, their peculiarities as made manifest by the skipped distances, makes it probable that energy penetrates the Heaviside Layer. Somewhere between one and ten meters all of the transmitted rays are said to leave the earth and escape.

R610. STATION DESCRIPTIONS. STATION. Wireless World (London). Sept. 22, 1926. Pp. 413-416. "KDKA, 309.1 Meter Transmitter." A description of station KDKA, East Pittsburgh, is given. Details relating to construction and the constants of the antenna system, the oscillator, modulator, and amplifier units, the power supply, and the control system, are discussed. Photographs and drawings accompany the article. The station is said to operate at an efficiency of 67 per cent.

R344.5. ALTERNATING CURRENT SUPPLY. RECTIFIER, Wireless World (London). Sept. 22, 1926. Pp. Ruben. 423-424. "The Ruben Rectifier," A. Dinsdale. A solutionless electrolytic rectifier, developed by an American named Ruben, and known as the Elkon rectifier, is described. It is composed of two discs between which a film is formed when connected to the circuit. The principle of operation is not disclosed.

R320. ANTENNAS. ANTENNAS. Wireless World (London). Sept. 29, 1926. Resonance. Pp. 451-453. "Frame Aerial Crystal Reception," W. H. F. Griffiths. The effects produced when tuning a distant antenna to resonance with a broadcast station are outlined. If the currents induced in this way are appreciable, the receiving antenna will radiate and thus increase the signal strength for a neighboring receiving set, which is also tuned to the same wave. A loop antenna was used to obtain the results outlined and graphed.

R343. ELECTRON-TUBE RECEIVING SET. RECEIVER, RADIO BROADCAST, Dec. 1926. New "Universal." Pp. 154-158. "The New 'Universal' Receiver," H. E. Rhodes. This receiver is a revised model of the R.B. "Universal" described in RADIO BROADCAST for Jan., 1926, pp. 331-336, and uses the Roberts system of neutralization, condenser control of regeneration, and a two-stage transformer-coupled audio frequency amplifier. The article presents the diagrams, the assembly information, and data on construction and testing.

GEORGE ELECTRIC COMPANY "B POWER UNIT" TYPE "M"



Complete with Tube \$29.50

Our patented filter circuit is most efficient, delivering absolutely pure direct current, free from any hum or distortion. The Type M Unit is sturdily constructed, and will last as long as the best receiving set.

Variable resistances permit the selection of voltages to make your set work efficiently at all times. You can bring in distant stations with more volume, and your locals with purer tone.

This unit operates on 110 volt, 60 cycle A. C. It will deliver 180 volts, with plenty of current for a ten tube set or sets equipped with power tubes.

FULLY GUARANTEED

Our dealer will be glad to give you a demonstration. Write for further information.

GEORGE ELECTRIC COMPANY
751 Carleton Ave. St. Paul, Minn.
Dealers and Agents!—Write today for attractive agency proposition

Raytheon LONG LIFE RECTIFYING TUBE

This is a good time to subscribe for
RADIO BROADCAST
Through your dealer or direct, by the year only \$4.00

IMPORTANT

The Watch Dog of your Tube

-as the TUBE Itself

Amperite alone can supply automatically, the self-adjusting filament control your tubes require for perfect rheostat regulation under all varying conditions. Insist upon Amperite, and accept nothing else. Simplifies wiring. Eliminates hand rheostats. Specified by leading engineers in every popular circuit. Types for all tubes. Price \$1.10 mounted (in U.S.A.) At all dealers.

Radial Company
60 FRANKLIN ST., NEW YORK

AMPERITE

REG. U.S. PAT. OFF.

The "SELF-ADJUSTING" Rheostat

FREE Write for Hook-ups to Dept. R.B.-2

The Old Way

each time you turned your set on or off you had to operate

3 Switches

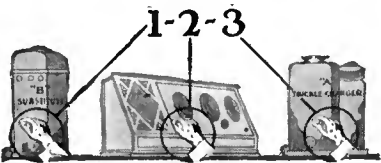

NOW—

you operate everything with **ONE** switch—the SET SWITCH



BRACH

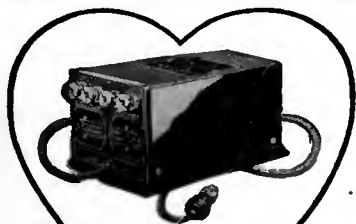

CONTROLIT
DOES IT
—AUTOMATICALLY

Manufactured by the Makers of the Famous **BRACH** LIGHTNING ARRESTERS

L.S. BRACH Mfg. Co.
NEWARK, N. J.
TORONTO, CAN.



February—

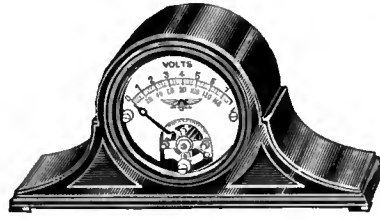

Pattern No. 135-C

Moving parts are silvered. The double range scale has black characters on a silvered background. The movement is of the D'Arsonval moving coil type, equipped with standard zero adjuster. Enclosing case is of polished black bakelite. It is a very beautiful as well as highly accurate instrument.

Broadcast listeners are now enjoying the best reception conditions of the year. Better radio reception, however, can be had by exact regulation of filament voltage.

Pattern No. 135-C "DeLuxe" Radio Voltmeter is ideal for filament control, A-B and C battery testing, circuit checking and all around radio use. It is much more desirable for radio test work than the ordinary voltmeter, as it can be used for portable test purposes, and also perform all tip jack tests. Its two ranges are ample for all radio check and test work.

Send for our descriptive form No. 1016 and also ask for our catalog No. 15-C

Jewell Electrical Instrument Co.
1650 Walnut St. - - - Chicago
"26 Years Making Good Instruments"

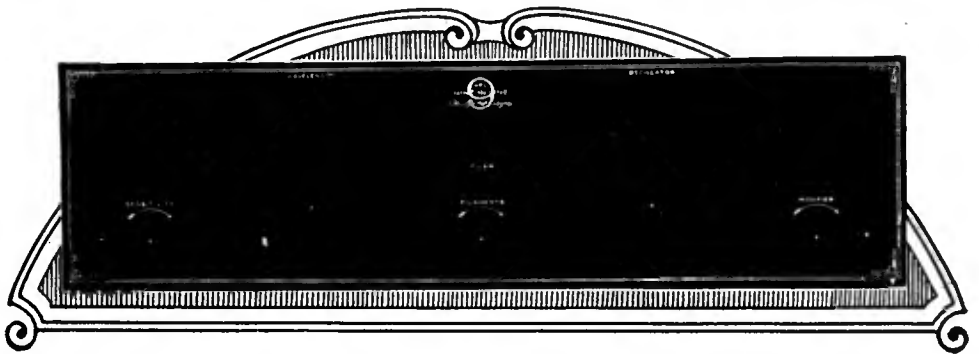

FORMICA KIT PANELS

FROM one end of the country to the other, home set builders are producing handsome radio sets by the use of Veri Chromed Formica panels for the leading kits.

These panels include the Karas Equamatic, Bremer Tully Power Six, H. F. L. Nine-In-Line Superheterodyne with sub panel, Victor-teen single dial and two dial. There is also an Infradyne 7 x 28" and 7 x 30" Aerodyne, St. James 8 Tube, Bremer Tully Counterphase, Browning Drake National, Madison Moore Superheterodyne, Camfield Duoformer. They are sold by the leading jobbers and dealers.

Special Panels cut to size and Formica Tubing are also available for Amateurs

The FORMICA INSULATION COMPANY
4616 SPRING GROVE AVENUE CINCINNATI, OHIO

Hear the FORMICA Orchestra Tuesday 9 to 10 over WLW



Formica has a Complete Service on Insulating Material for Radio Manufacturers

Digitized by

There's money for you in RADIO



Wonderful opportunity for ambitious men to win success in this fast-growing profession

THE Radio industry is expanding so rapidly that trained men are at a premium. There is a constant, urgent demand for operators — factory superintendents — engineers — service men — designers — salesmen.

There is no better way for you to succeed in this fascinating business than to study the Radio Course of the International Correspondence Schools. This course is new and complete. It was written by practical authorities in this field. It is endorsed by leading radio experts and radio manufacturers.

Mr. R. E. Thompson, president of the R. E. Thompson Manufacturing Company (makers of the famous Thompson Neutrodyne Radio Set), says:

"I was once a student of the International Correspondence Schools myself and I am familiar with your methods and texts. I recommend them to any young man who is sincerely seeking to improve himself in position and salary."

Quincy J. Workman, of Scranton, Penna., writes that he has "nearly doubled his salary" since he took up the I. C. S. Radio Course. He is now manager of the Radio Department in a large store.

This same course enabled John M. Paynter, of the U. S. Lighthouse Service, Charleston, S. C., to get a position as Radio Operator and Ship's Electrician. Scores of other men in radio factories, laboratories and stores report similar progress.

You, too, can get in on the ground floor if you act quickly. But don't delay too long. Mark and mail the coupon today and let us tell you all about the I. C. S. Radio Course and what it can do for you.

Mail the Coupon for Free Booklet

International Correspondence Schools
Box 8297-F, Scranton, Penna.

Without cost or obligation, please send me all the facts about the new I. C. S. course in

RADIO

Name.....

Street Address.....

City.....State.....

Bradlexstat

PERFECT FILAMENT CONTROL



Provides complete noiseless filament control for all radio tubes without change of connections. Metal parts are nickel plated. One hole mounting. Self contained switch opens battery circuit when desired.

Allen-Bradley Co.
Electric Controlling Apparatus
278 Greenfield Avenue Milwaukee, Wis.

R156. TRANSFORMERS TRANSFORMERS AND CHOKES. *Wireless World* (London) Sept. 29, 1926. Pp. 455-458. "Magnetic Circuits of Choke Coils and Transformers," S. O. Pearson.

In designing choke coils and transformers for radio circuits, it is important to keep in mind that in many parts of these circuits the coil must carry both d.c. and a.c., says the writer. If the d.c. component saturates the iron, practically no choking effect is produced by the coil. The principle is outlined diagrammatically by curves showing the variation of current taking place in the anode circuit and the magnetic flux density. The use of air gaps is supposed to greatly increase the magnetizing current, but, at the same time, reduces the effective inductance of the coil.

R113.6 REFLECTION IN LOUD SPEAKERS. LOUD SPEAKER REFLECTION. *Wireless World* (London), Oct. 13, 1926. REFLECTION. Pp. 506-508.

"Acoustic Reflection," N. W. McLachlan. The discussion concerns the effect of resonance when loud speakers are located in rooms where echos occur. The reflections produced will determine the proper placing of loud speakers for best results on the low as well as the high frequencies.

R005. EXECUTIVE; ADMINISTRATIVE. PROBLEMS OF RADIO BROADCAST. Dec. 1926. RADIO INDUSTRY. Pp. 144-145.

"What the Future Holds for the Radio Industry," F. Strother.

In discussing the problems of the radio industry, comparison is made between two companies—the National Cash Register Company and the Radio Corporation of America; the former with one aim, one purpose, the latter with a variety of purposes. The RCA is called an artificial organization, because it lacks the natural foundations of a business enterprise, i.e., a purely commercial origin, singleness of purpose, and positiveness of control. The importance of commercial skill, inventive talent, or manufacturing skill, is considered as valuable as the possession of patents. The final analysis is sketched as resolving itself into a problem of "the survival of the fittest."

R115. METEOROLOGICAL. WEATHER AND RADIO. RADIO BROADCAST. Dec. 1926. Pp. 152-153.

"How a Low Barometer Affects Radio," E. Van Cleef. A theory is presented explaining the relation between static formation and atmospheric circulation. In addition to the points discussed by the author in RADIO BROADCAST, May 1925, pp. 90, the following is added: Reception is accompanied by static when transmission crosses any part of a warm humid "low" or when transmission crosses an area adjacent to an intensely developed humid "low" whose surface temperatures are above the freezing point. If the precipitation throughout the "low" is rain, static will be pronounced, while if it be snow or ice, little static will occur. A comparison of the weather conditions for the 1925 season and the 1926 season, when considered with the points mentioned, explains why reception was better in 1925.

R343. ELECTRON-TUBE RECEIVING SET. RECEIVER, RADIO BROADCAST. Dec., 1926. Pp. 169-173. *Single-Tube*. "A Single-Tube Receiver That Won't Radiate," Zeh Bouck.

A single-tube three-circuit regenerative receiver, non-oscillating, is presented, using the King Equamatic system. In the author's opinion, the following are the requirements for a good beginner's receiver: (a). Easily wired and mechanically simple. (b). Inexpensive to construct. (c). Non-oscillating. (d). Should be good enough to keep. Construction and operation details are given for a receiver which fulfills these conditions.

R384.3. FREQUENCY METERS. FREQUENCY METERS. Bureau of Standards. *Letter Circular LC 180*.

"Specifications for Frequency Indicator, Type B, for Use in Radio Transmitting Stations." This circular letter describes in detail the construction of a frequency indicator for use in broadcast transmitting stations, whose frequency falls between the values of 550 and 1500 kilocycles. It consists of a simple capacity and inductance circuit with a thermo-galvanometer coupled inductively to it through one turn. The specifications are very detailed and complete for constructing a precision instrument.

R351. SIMPLE OSCILLATORS. OSCILLATORS. Bureau of Standards. *Letter Circular LC 186*. Piezo.

"Specifications for Portable Piezo Oscillator, Bureau of Standards Type N." A portable piezo-electric oscillator, consisting of a simple electron tube with inductance, shunted by a variable capacity, in the plate circuit, with provision for the crystal in the grid circuit, is described. Together with the drawings, this information is complete concerning construction and operation of a valuable laboratory instrument.

R134. DETECTOR ACTION. DETECTOR ACTION. *Proc. I. R. E.* Oct. 1926. Pp. 649-662.

"Theory of Detection in a High-Vacuum Thermionic Tube," L. P. Smith.

In this paper some new ideas have been presented regarding the detector action by means of the high-vacuum tube in connection with a grid leak and condenser, which show the function of the grid leak and condenser as well as their proper values for best detection. It has been shown that three main sources of distortion exist with this method of detection. They may be briefly stated as follows: Two sources from the curvature of the grid characteristic; one of these is frequency distortion due to the harmonics produced, and the other an amplitude distortion arising from the fact that the rectified grid current does not vary linearly with the input voltage. The remaining distortion is produced by the grid leak and the condenser.

R114. STRAYS. STRAYS. *Proc. I. R. E.* Oct., 1926. Pp. 663-673.

"Long-Distance Radio Receiving Measurements and Atmospheric Disturbances at the Bureau of Standards in 1925," L. W. Austin. The article presents a résumé of the long-distance measurements of long-wave stations made by the Bureau of Standards. Conclusions are drawn regarding the possible explanations of the results.

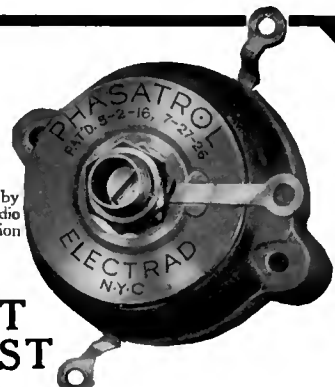

Pat'd
5-2-16
7-27-'26

Licensed by
Rider Radio
Corporation

AT LAST "Phasatrol"

A true balancing device for
radio frequency amplifiers

PHASATROLS are the latest achievement in radio frequency amplification and can be installed in any radio frequency set in a few minutes—no technical knowledge or skill is necessary. PHASATROLS simplify tuning, stop radio frequency oscillations and distortion, enable your tubes to work at maximum efficiency and prevent them from radiating interference to your neighbors.

At your dealers or write direct. Write for
hook-up circular

Price, \$2.75
Dept. 25, 428 Broadway, New York, N.Y.

ELECTRAD

Inc.

This is a good time to subscribe for RADIO BROADCAST Through your dealer or direct, by the year only \$4.00 DOUBLEDAY, PAGE & CO. GARDEN CITY, NEW YORK

YAXLEY

APPROVED RADIO PRODUCTS



Automatic Power Control

No more plugging in sockets and turning switches every time you use your set—no more tinkering with them every time you turn off the set. The Yaxley Automatic Power Control takes care of your B eliminator or trickle charger or both. You know that when you turn on your set, the trickle charger is off, the B eliminator is on. When you turn off your set the Power Control turns off the B eliminator and turns on the trickle charger.

No. 444 Series type—for sets having tubes with a current draw equal to or greater than 6 U. V.-199 types of tubes. - - - Each, \$5.00



Radio Convenience Outlets

Install a Yaxley Radio Convenience Outlet for loud speaker and phone connections in every room. Consists of a wall plate and a wall socket jack with screw terminals. Fits any standard switch box. Easily wired. Wiring diagrams in each package.

No. 135 Radio Convenience Outlet - Each, \$1.00.

Also makers of the famous Air-Cooled Rheostat, Jacks, Jack Switches, Cable Connector, Plugs, etc.

At your dealer's. If he cannot supply you send his name with your order to

YAXLEY MFG. CO.
Dept. B - - 9 So. Clinton St., Chicago, Ill.

Speed

**SUPER-EMISSION
RADIO TUBES**

are the most perfectly
balanced tubes produced



X 200 A

**Super-Sensitive
Power Detector**

Other Types

- 201 A 5 volt detector-amplifier
- X 112 5 " power amplifier
- 199 3 " detector-amplifier
- X 120 3 " power amplifier
- 12 1½ " detector-amplifier

and

SPEED

FULL WAVE
GAS FILLED

RECTIFIER

FOR USE IN STANDARD "B"
BATTERY ELIMINATORS

A FEW FRANCHISES
STILL OPEN FOR FIRST
CLASS DISTRIBUTORS

**Cable
Supply Company
INC.**

Executive Offices

**31 Union Square
New York**

Two Times Two!

"Built Better"—this always has been, and is the policy of AEROVOX.

One year ago the demand for high grade Fixed Mica Condensers, Filter Condensers, Power Supply Condenser Blocks, and Lavite Resistances forced us to double our floor space and equipment.

Today, even though we are now operating on a 24 hour schedule, we are again compelled to double our facilities. With our present plant in full swing—without costing our customers one single production day—we are moving to new quarters at 60-72 Washington St., Brooklyn, N.Y.

"Two times two"—this is our growth for the year just passing. Does the "Built Better" policy pay? AEROVOX thinks so. More than 200 radio manufacturers and thousands of you fans evidently think so, too.

Wherefore, we thank you!



WIRELESS CORP.

60-72 Washington St., Brooklyn, N.Y.

LEARN THE CODE AT HOME with the OMNIGRAPH

"Just Listen—The Omnigraph will do the teaching"

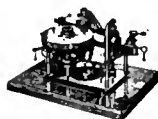

THE OMNIGRAPH Automatic Transmitter will teach you both the Wireless and Morse Codes—right in your own home—quickly, easily and inexpensively. Connected with Buzzer, Buzzer and Phone or to Sounder, it will send you unlimited messages at any speed, from 5 to 50 words a minute.

THE OMNIGRAPH is not an experiment. For more than 15 years, it has been sold all over the world with a money back guarantee. The OMNIGRAPH is used by several Depts. of the U. S. Govt.—in fact, the Dept. of Commerce uses the OMNIGRAPH to test all applicants applying for a Radio license. The OMNIGRAPH has been successfully adopted by the leading Universities, Colleges and Radio Schools.

Send 6 cents for Catalogue describing three models. DO IT TO-DAY.

THE OMNIGRAPH MFG. CO., 13K Hudson St., New York City

If you own a Radio Phone set and don't know the code—you are missing most of the fun

To Radio Dealers Who Would Like

TO SELL RADIO BROADCAST

We invite your consideration of our new plan which offers you greater profit on the sale of each copy of Radio Broadcast.

The year 1927 is going to be one of the biggest years for radio, and Radio Broadcast should be in the hands of every Radio Dealer.

Don't miss an opportunity to associate yourself with Radio Broadcast this year.

Write now for our new plan for 1927 which shows four suggested schedules based on two years' experience of supplying Radio Broadcast to Radio Dealers. One of these four schedules is suitable to your needs, send for further particulars today.

RADIO BROADCAST

Garden City, New York

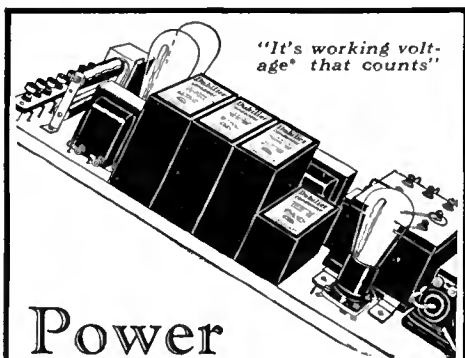

"It's working voltage* that counts"

Power amplification has amazed the world

The amazing results obtained with power amplifiers is the radio sensation of the year. Perfect tone quality and the capacity to handle the full volume of a brass band without distortion, has made power amplification the "last word" in radio.

You, too, can enjoy all these advantages even with your old set, and at a minimum cost, by building a power amplifier with Dubilier Condensers.

Dubilier Condenser Type 903, illustrated, is designed to withstand the high voltage surges which often occur in the filter circuits of power amplifiers. In fact all Dubilier Condensers are built with this high margin of safety, and with an indicated *working voltage** that insures a long life in continuous operation.

Send 10c for our booklet "Seventeen Ways to Improve Your Set." It gives the most recent information on power amplifiers, filters and battery eliminators.



"Working voltage means more than 'test voltage.'" It is the voltage at which a condenser may be safely used in continuous operation.

Dubilier

CONDENSER CORPORATION

4377 BRONX BLVD.

NEW YORK, N. Y.

R213. HARMONIC METHODS OF FREQUENCY MEASUREMENTS. HARMONIC AMPLIFIER

Bureau of Standards Paper No. 530. "Establishment of Radio Standards of Frequency by the Use of a Harmonic Amplifier," C. B. Jolliffe and Grace Hazen.

A harmonic amplifier is described, together with its application in establishing radio standards of frequency from an audio-frequency source. The results of one-frequency meter standardization are summarized briefly. A sonometer, an auxiliary pitch-measuring device, is described, and the method of using the harmonic amplifier with this auxiliary for the standardization of piezo oscillators and comparison of audio frequencies is given.

The work has shown that radio-frequency meters may be standardized with high precision and ease from a fundamental audio frequency by use of a harmonic amplifier. The accuracy of the standardization is limited only by the accuracy of the fundamental frequency source and the precision and accuracy of the frequency meter. The harmonic amplifier is simple and rapid in operation. Fixed frequency generators, such as piezo oscillators and electron-tube driven tuning forks, may also be accurately and rapidly standardized by the use of the harmonic amplifier and the auxiliary sonometer.

R351. SIMPLE OSCILLATORS. OSCILLATOR DRIVER.

Burgess Engineering Circular No. 12, Part I. "A High Frequency Driver," W. H. Hoffman. A vacuum-tube radio frequency oscillator, also called a driver, is described, with detailed constructional information given. It is designed to cover frequencies from 375 kc. (800 meters) to 25,000 kc. (12 meters) for purposes of radio measurements. The indicating instrument used is a milliammeter connected in the grid circuit of the vacuum tube. Five coils cover the frequencies used.

R384.1. WAVEMETERS. WAVEMETERS.

Burgess Engineering Circular No. 12, Part II. "Short-Wave Wavemeters," F. H. Schnell. Two wavemeters, one calibrated in kilocycles and the other in meters, each having a range of 30,000 kc. (10 meters) to 3000 kc. (100 meters), are described. The instruments serve many uses, as outlined. Curves showing the relation between dial settings and either wavelength or frequency readings for Karas and Cardwell condensers in connection with various sizes of coils, are appended.

R800(621.353). BATTERIES, PRIMARY. BATTERIES.

Burgess Engineering Circular No. 11. "Primary. Estimating B Battery Service Life," W. B. Schulte. The paper presents a method of testing B batteries and shows the shelf life, discharge, and capacity characteristics of B, or plate, batteries, classified according to battery weight in pounds. Examples are given showing how approximate service-hours may be computed for all standard combinations of tubes and batteries. Tube plate currents with various grid bias voltages are shown by curves. The effects of the number of tubes, the grid bias voltage, the size of B batteries, and the type of tubes, are clearly shown as a help for the user to figure his own requirements.

R171. INTERFERENCE. INTERFERENCE.

Proc. I. R. E., Oct., 1926. Pp. 575-603

"Reduction of Interference in Broadcast Reception," A. N. Goldsmith. The factors in station interference with broadcast reception, namely signal field strength, receiver selectivity, and psychological reactions of the listeners, are analyzed. Statistical data correlating these factors with interference complaints from listeners in the vicinity of the 50-kilowatt broadcasting transmitter at Bound Brook, New Jersey (WJZ), are then presented, these data being the results of a survey by a special interference reduction staff.

The clearing up of the complaints by this service, using simple methods which are described, indicates the feasibility of high-power broadcasting stations, as well as the necessity for them because of the requirement of reliable broadcasting service over large areas. In the appendix, the construction of a series wave trap is outlined.

R113.7. TRANSMISSION FORMULAS. TRANSMISSION FORMULAS.

Proc. I. R. E., Oct., 1926. Pp. 613-647

"Some Measurements of Short-Wave Principles of Transmission," R. A. Heising, J. C. Schelleng, G. C. Southworth. Quantitative data on field strength and telephonic intelligibility are given for transmission at frequencies between 2.7 megacycles (111 meters) and 18 megacycles (16 meters), and for distances up to 1000 miles, with some data for distances up to 3400 miles. The data are presented in the form of curves and surfaces, the variables being time of day, frequency, and distance. Comparisons are made between transmission over land and over water, between night effects and day effects, and between transmission from horizontal and from vertical antennas. Fading, speech quality, and noise are discussed. The results are briefly interpreted in terms of current short-wave theories.

A Circuit Diagram Correction

AN ERROR crept into the diagram, Fig. 8. on page 288 of the January, 1927, issue. This drawing is a schematic diagram of the power-supply device described by James Millen. A connection between the minus A and the center tap of the transformer filament winding supplying the power tube was shown. This is incorrect. The lead should, instead, be connected from minus A to the center tap of the transformer high-voltage secondary. The ground connection should also be transferred from filament winding to the negative A terminal. The picture diagram given on page 286 is absolutely correct.

DESIGNED to OUTLAST World Storage 'A' Battery

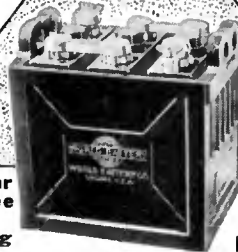

Two-Year Guarantee Bond in Writing

NEW LOW PRICES

Famous the world over for reliable, enduring performance. Solid Rubber Case lasting protection against acid or leakage.

Approved and Listed as Standard by Leading Authorities

Including Radio News Laboratories, Popular Set, Inst. Standards, Pop. Radio Laboratories, Radio Broadcast Laboratories, Radio in the Home and Lefax, Inc.

Send No Money

Just state number wanted and we will ship same day order is received, by express C.O.D. Pay expressman after examining batteries. 5% discount for cash with order. Remember, you save 50% on World Batteries—no send your order today.

WORLD BATTERY COMPANY Dept. 24 1219 S. Wabash Ave., Chicago, Ill.

- Solid Rubber Case Radio Batteries
- 6-Volt, 100-Amperes \$10.00
- 6-Volt, 120-Amperes \$12.00
- 6-Volt, 140-Amperes \$13.00
- Solid Rubber Case Auto Batteries
- 6-Volt, 11-Plate \$10.00
- 6-Volt, 13-Plate \$12.00
- 12-Volt, 7-Plate \$14.80

Set your radiolights 28.2 meters for the World Storage Battery Station WSHC. Verily—new talent—always interesting. Jerry Sullivan, Dir. and Announcer "Chi-GAW-go"



American Radio Now—
50% DISCOUNT ON RADIO!
BIG NEW 1927 CATALOG-FREE

Dealers, Agents, Set Builders—get our big 1927 Catalog—225 nationally advertised lines. Lowest prices in America! Largest, most complete stock. Radio's latest developments. It's FREE—send for your copy now. AMERICAN AUTO & RADIO MFG. CO., Inc. 1427, McGee Street, Kansas City, Mo.

Improve Your Set 100% FERI Lo-Loss Coils!

SHIELDED TUNED RADIO TRANSFORMERS

Features [SELECTIVITY VOLUME QUALITY DISTANCE] \$5.00 Per Set

SPACED-AIR-WOUND TUNED RADIO TRANSFORMERS

Feri Lo-Loss Coils. Low distributed capacity, low dielectric losses and many other features insure unequalled results. Wiring Diagram and instructions supplied with each set of three.

Send for Descriptive Literature on other Feri Products

FERI RADIO MFG. CO.
 1167-A Bedford Ave. Brooklyn, N. Y.

ACME CELATSITE BATTERY CABLE

—a silk-covered cable of vari-colored Flexible Celatsite wires, for connecting batteries to set. Prevents "blowing" of tubes; gives your set an orderly appearance.



Stranded Enameled Antenna

Best outdoor antenna you can buy. 7 strands of enameled copper wire; maximum surface for reception. Prevents corrosion and consequent weak signals.



The Original Celatsite

—a tinned, copper bus bar wire with non-inflammable "spaghetti" covering, for hook-ups. 5 colors; 30-inch lengths. We also offer the highest grade of "spaghetti" tubing for Nos. 10 to 18 wires. 5 colors; 30-inch lengths.



Flexible Celatsite

Flexible, stranded wire for point-to-point and sub-panel wiring. Non-inflammable "spaghetti" covering. In black, yellow, green, red and brown; a color for each circuit. Put up in 25-foot coils.



Send for folder

THE ACME WIRE CO., DEPT. B
NEW HAVEN, CONN.

ACME WIRE MAKES BETTER RADIO

RADIO PANELS

OF GENUINE BAKELITE

Cut, drilled and engraved to order. Send rough sketch for estimate. Our New Catalog on Panels, Tubes and Rods—all of genuine Bakelite—mailed on request.

STARRETT MFG. CO.

521 S. Green Street Chicago, Ill.

RADIO FANS, a one-year's subscription to Radio Broadcast will cost you four dollars, two years six dollars. Consider this expenditure as being a necessary investment on your part for the future development of your own knowledge of Radio.

Fahnestock Clips RADIO'S GREATEST CONVENIENCE

Used by Manufacturers of Standard Sets and Parts—and by Manufacturers of High Grade Wet and Dry Batteries.

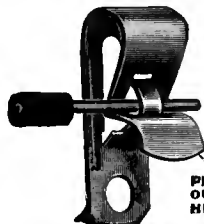

PRESS
DOWN
HERE

ALL GENUINE FAHNESTOCK CLIPS

bear our imprint on the thumb piece of the clip.

WORLD'S LARGEST MAKER OF CLIP TERMINALS

48 different sizes and styles to meet all requirements.

Send for Catalog and Samples

FAHNESTOCK ELECT. CO.
L. I. City New York

\$75.00 A WEEK BUILDING RADIO SETS

—in your spare time

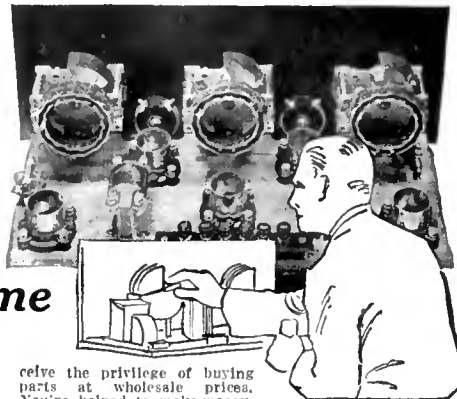

Join the Radio Association of America. Learn how to build and repair radio sets. The Association will train you out in business if you wish. Be the radio "doctor" of your community \$3 an hour upwards easily made. Radio offers you a big money-making opportunity right now.

EARN \$500 IN SPARE HOURS

"I have at last found myself," writes Lyle Follick, Lansing, Michigan, "I have already made over \$500 building radio sets after working hours." Werner Kleber, Rochester, N. Y., writes, "I have made over \$50 a week in my spare time."

Our members are starting radio stores, increasing their salaries, securing better positions, passing radio operator examinations, earning big money for the most enjoyable kind of spare-time work.

WHAT A MEMBERSHIP MEANS

A membership in the radio Association of America gives you the most up-to-date and thorough training in the Science of Radio.

You're taught how to build and repair all kinds of sets. You're given the training you need in preparing for a licensed Radio Operator's examination. You re-

ceive the privilege of buying parts at wholesale prices. You're helped to make money.

JOIN THE ASSOCIATION NOW

If you're interested in Radio for either pleasure or profit, join the Association without delay, because we have a plan whereby your membership may not—need not—cost you a cent. Only a limited number of these memberships are acceptable. Write now for details. Write before it's too late.

This Association has prepared a beautiful book that gives figure-facts regarding the profit possibilities of the Radio Industry, the purpose of the Association, and the details of the Special Membership Plan.

MAIL THIS COUPON

RADIO ASSOCIATION OF AMERICA
Dept. RB-2 4513 Ravenswood Ave., Chicago

Send me your book and details of your Special Membership Plan.

Name

Address

City State

The Next Number of RADIO BROADCAST

Will Contain:

- ☞ A complete description of the new Alexanderson photograph transmission system.
- ☞ The second of James Millen's constructional articles on various models of home-assembled B-power supply devices.
- ☞ How to assemble a B-power supply device for the Hammarlund-Roberts "Hi-Qu" receiver.
- ☞ Another splendid article on the two- and four-tube R. B. "Lab" receiver.
- ☞ Complete constructional details of the new Grimes Inverse Duplex receiver.
- ☞ The March of Radio—the review of current thought, opinion and progress.
- ☞ The Usual Departments—"The Listeners' Point of View"—"As the Broadcaster Sees It"—The Best In Current Periodicals—The R. B. Laboratory Information Sheets.

[March, 1927, RADIO BROADCAST is on sale on the news-stands, February 15th—Four dollars a year by subscription.]

Turn 1 Dial-get stations everywhere:—30 Days Free!



SEND COUPON FOR AMAZING SPECIAL OFFER!
NOTE: This offer is made to prospective buyers by famous big Radio Corporation, one of America's oldest reliable manufacturers of fine sets—seventh successful year. Many satisfied users in every state. Postal or coupon brings testimony of near-by users and proof Miraco's outperform sets costing up to 4 times as much. Very easy to operate.

BEAUTIFUL-BIG-POWERFUL Ultra Selective MIRACO 5

Users report Miraco Radios get programs Coast to Coast, also Canada, Cuba and Mexico, loud and clear on speaker; outperform \$100 to \$200 sets. Some have heard Europe, S. America. Don't confuse Miraco with small cheap sets. Unless trial proves it MOST SELECTIVE, CLEAREST TONED and MOST POWERFUL DISTANCE-GETTER among beautiful big 5-tube sets, don't buy it. Every Miraco comes completely assembled, rigidly tested and fully guaranteed.

Our Factory Prices Save You Up to 1/2!

SEND NO MONEY! Save or make Ultra-5 on sets, speakers, tubes, batteries—write for AMAZING OFFER. Ultra-5 (not illus.) is marvelous value in a big Guaranteed 5-tube, 3-dial set: Retail List \$49.75

MIDWEST RADIO CORPORATION, Pioneer Builders of Sets
405-G Miraco Bldg., Cincinnati, Ohio
WITHOUT OBLIGATION, send free literature, AMAZING SPECIAL OFFER, testimony of users, etc.

NAME:

ADDRESS:

ONE DIAL CONTROL
Only One Dial to turn for all programs.

Seek on 30 Days Free Trial. Enormous demand for Miraco 5's makes possible hosts of costly new refinements and improvements at lower prices than ever: Genuine Bakelite sloping panels, dials beautifully finished in walnut to match cabinets; Coaxial B-Z Battery Cables; features (too numerous to mention) of high-priced sets. Send for Amazing Low "Ultimate" Price!

Beautiful Hand-rubbed Solid Walnut Cabinet
28 in. Long

SPECIAL WHOLESALE PRICES to user-agents who show the set to friends. DEALERS WRITE!

USE THESE COILS
AND IMPROVE ANY
RADIO RECEIVER

AERO COIL
SUPER-SENSITIVE
INDUCTANCE UNITS



Tuned Radio Frequency Kit

\$12.00

Replace your present inductances with this Aero Coil Tuned Radio Frequency Kit. It will positively improve the performance of your receiver. Special patented Aero Coil construction eliminates radio frequency losses. You will notice instantly, a tremendous improvement in volume, tone, and selectivity.

This kit consists of three matched units. The antenna coupler has a variable primary. Uses .00035 condenser. Coils are uniformly air spaced. No dope is used. Consequently they tune into resonance on a "knife's edge."

FREE with Each Kit

Eight-page color circuit, layout and instruction sheet for building the super-sensitive 5-tube Aerodyne Receiver, packed with each kit. Extra copies—75c each. Instructions include insert showing how to wire up for a power tube if desired.

Get these coils from your nearest dealer. If he can't supply you, order direct from the factory

AERO PRODUCTS, Inc.

Dept. 109

1772 Wilson Ave. Chicago, Ill.

Bradleyometer

THE PERFECT POTENTIOMETER

Uses graphite disc resistors which are noiseless and not affected by atmospheric conditions. Metal parts are nickel plated. One hole mounting. Finish and knob match Bradleystat. Made in 200 and 400 ohm ratings.

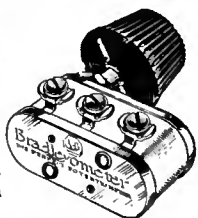

Allen-Bradley Co.

Electric Controlling Apparatus

278 Greenfield Avenue Milwaukee, Wis.

THE
"RADIO BROADCAST"
INFORMATION SERVICE

How to Write for Technical Information—The Scope of This Service

AS WAS announced in the June RADIO BROADCAST, all questions which were formerly sent to "The Grid" will now be handled by the Technical Information Service, RADIO BROADCAST Laboratory. That service is maintained under the following rules:

1. All questions from subscribers to RADIO BROADCAST will be answered free of charge.
2. Non-subscribers to RADIO BROADCAST will be charged a fee of One Dollar for the Laboratory Technical Service.
3. All questions will be answered by mail and none will be published in RADIO BROADCAST. The Technical Information Service of the Laboratory feels that it is important to define the scope of its service to readers. Although the Service is of very general help to our readers, there are certain demands which can not be met.

The Technical Information Service:

1. Cannot make comparisons between various kinds of receivers or manufactured apparatus.
2. Wiring diagrams of manufactured receivers cannot be supplied. This information can be secured from the various manufacturers.
3. Complete information cannot be given about sets described in other publications, but in all cases (wherever possible), inquirers will be referred to a source of information where the data can be obtained. In this connection, the monthly department in RADIO BROADCAST "The Best in Current Radio Publications" should be of great help, and should be consulted. That department records the most important constructional, technical, and general radio articles which appear.
4. Special receivers or circuits cannot be designed by the Technical Service.
5. Those who ask questions which cannot be answered in the scope of a letter will be referred, if possible, to sources where the information can be obtained.

TECHNICAL INFORMATION INQUIRY
BLANK

Technical Service,
RADIO BROADCAST Laboratory,
Garden City, New York

GENTLEMEN:

Please give me fullest information on the attached questions. I enclose a stamped addressed envelope.

I am a subscriber to RADIO BROADCAST, and therefore will receive this information free of charge.

I am not a subscriber and enclose \$1 to cover cost of the answer.

Name.....

Address.....

R. B. F.

"Radio Broadcast" Booklets

HOME constructors who wish to obtain complete blueprints and constructional information on the R. B. Impedance-Coupled Browning-Drake receiver as described in this magazine for September, 1926 can secure a set by forwarding their order, together with remittance for \$1 to RADIO BROADCAST, Booklet department, Garden City, New York. Other blueprint sets which are sold at the same price are those on the four-tube Roberts receiver, and the "Aristocrat" receiver.

Hoyt MODEL 100
TUBE TESTER



The Hoyt Model 100 Tube Tester is still as popular as ever and in use by many thousands of Radio dealers and jobbers. It will give all the usual tests in determining whether tubes are good or not, and with a minimum of time.

List price, with full instructions, \$35.

Send for booklet, "Hoyt Meters for Radio" B-2

Burton-Rogers Company

Sales Dept. for Hoyt Electrical Instrument Co.
Boston Mass.

Save 20 to 50%
FREE RADIO CATALOG



Get the lowest rock-bottom prices on radio parts, sets, kits. New free Radio Catalog and Guide brimful of standard, reliable, guaranteed goods. 164 pages of latest hook-ups and illustrations. Be sure to get this thrifty book before you buy. It puts money in your pocket. Saves you as much as half on a set. Also please include name of radio fan. Send letter or postal NOV for newest 1927 edition.

THE BARAWIK COMPANY

540-549 Monroe St., Chicago, U. S. A.

Why not subscribe to Radio Broadcast? By the year only \$4.00; or two years \$6.00, saving \$2.40. Send direct to Doubleday, Page & Company, Garden City, New York.

WORLD'S FINEST LOUD SPEAKER
GENUINE
"ENSCO" 3" CONE KIT



NO DISTORTION THE SOLUTION OF THE LOUD-SPEAKER PROBLEM PERFECT FIDELITY
The Choice of Leading Engineers

Make Your Own
Three Foot Cone Speaker
In Less Than An Hour

Complete parts furnished in kit form. We guarantee this speaker the equal of any manufactured cone speaker at any price. With this THREE FOOT CONE SPEAKER you hear all the tones. It brings out the true depth and beauty of orchestral and instrumental music. Can be operated softly for living room music or full volume for dancing, and without trace of distortion. Kit includes famous "ENSCO" cone unit, the only direct-drive, distortionless unit for large cones; Alhambra Phonotex for big cone, with brass apex, two Sepia Prints showing cabinet or stand, wall, or roll type construction for cone speaker. All necessary instructions. Buy this wonderful speaker under our absolute guarantee. Your money back if you are not convinced that it is the finest reproducing medium obtainable at any price. It works on any set, with ordinary Tubes or with Power Output.

SEND NO MONEY!

Write your name plainly as indicated below, then mail and complete kit will be forwarded to you. Just pay postman \$10.00 upon delivery.

Name.....
Address.....

ENGINEERS' SERVICE CO.
25 Church St. Desk X New York City

Vee Dee

ART



Metal Panels for Kits and Sets



for
Nationally Famed
Kits—Drilled and
Decorated

- L. M. Cockaday
LC-27, \$3.70
- Browning-Drake
Improved, \$3.05
- Hammerlund-Roberts
lli-Q, \$2.70
- Silver-Cockaday,
Panel and Chassis,
\$4.60
- Keras Equamatic,
\$3.50
- Infradyne-Remler
Type, \$3.75
- Bremer-Tully
Power Six, \$3.05
- Citizens Super, Panel
and Chassis, \$6.60

Write for Discounts

Receivers equipped with Vee Dee metal art panels will yield the utmost in efficiency, accuracy, durability, beauty and economy.

Vee Dee Metal Panels are finished in beautiful wood grains, bronze duotones and high lighted novelty effects. Precisely drilled to the thousandth part of an inch. Every special panel includes vulcanized fibre bushings for best insulation.

Vee Dee Metal Panels are being adopted as standard equipment by prominent manufacturers of kits and sets.

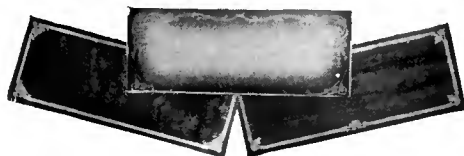

STOCK METAL PANELS

In all standard sizes. Easy to drill. Retail prices range from \$2.15 to \$3.55. Beautifully finished and artistically decorated.

Manufacturers—Jobbers

Save money and improve your sets by adopting Vee Dee Metal Art Panels. We co-operate in working out new panel designs. Lowest prices—liberal terms. Write to

THE VAN DOORN COMPANY

160 North La Salle Street : Chicago, Ill.
Factories, Quincy, Ill.

Order your copy of *Radio Broadcast* from your news dealer or radio store. Make sure that he reserves a copy for you each month. If your favorite radio store does not stock the magazine write us giving name of radio dealer and address

FROST-RADIO

Type 880 Super Variable Resistance

These new non-inductive, variable high resistance units are precision instruments which operate smoothly and noiselessly from zero to maximum rating. Have low temperature coefficient. Lever makes positive rolling contact with resistance element with absolutely no wear. Designed for use as tone and volume control, for resistance coupled amplification, to control regeneration, and as a stabilizer. Furnished in following resistances: 50,000, 100,000, 200,000, and 500,000 ohms. List: \$1.25.



HERBERT H. FROST, Inc.
160 N. La Salle St., Chicago New York City Los Angeles

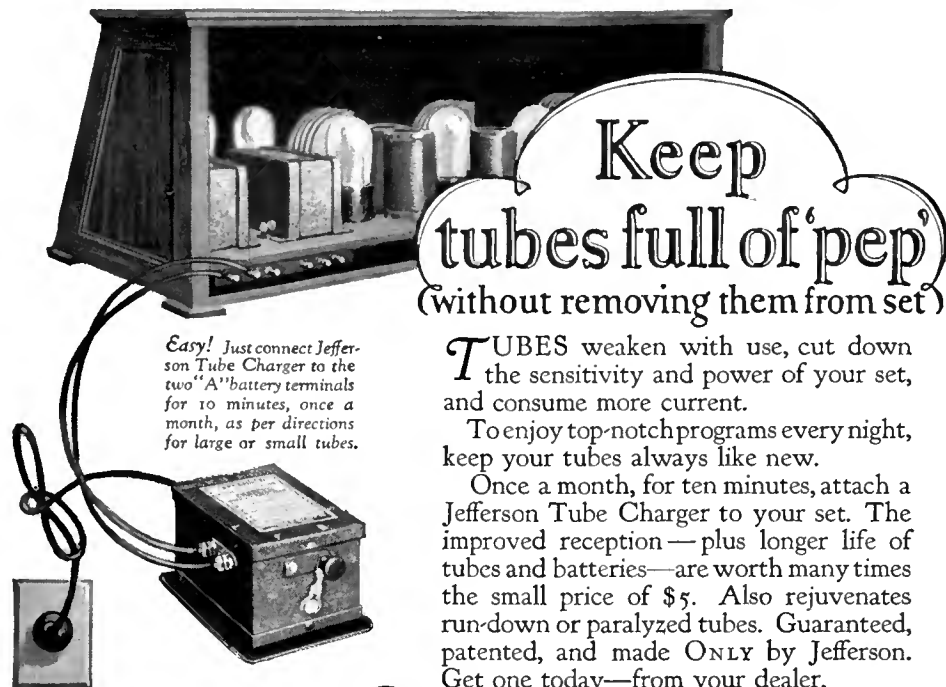

Keep
tubes full of 'pep'
(without removing them from set)

Easy! Just connect Jefferson Tube Charger to the two "A" battery terminals for 10 minutes, once a month, as per directions for large or small tubes.

TUBES weaken with use, cut down the sensitivity and power of your set, and consume more current.

To enjoy top-notch programs every night, keep your tubes always like new.

Once a month, for ten minutes, attach a Jefferson Tube Charger to your set. The improved reception—plus longer life of tubes and batteries—are worth many times the small price of \$5. Also rejuvenates run-down or paralyzed tubes. Guaranteed, patented, and made ONLY by Jefferson. Get one today—from your dealer.

JEFFERSON ELECTRIC MFG. CO.
Largest manufacturers of small transformers
507 So. Green Street, Chicago
[PATENTED]

Jefferson No. 275 Tube Charger



Beautiful Jacobean design by Conner
Finished in Warm Walnut



Put Your Set in a Conner Cabinet

THE MOST interesting—the most noticed piece of furniture in your home is your Radio Set—House it in a Conner Convenient Cabinet and it will then be the most attractive. Even the best set, with a makeshift mounting, exposed wiring and batteries, misses much in giving you and your friends the pleasure and satisfaction which it should. A Conner Cabinet lends added class and tone to the finest equipment.

A Conner Cabinet assembles every detail of your receiving set, including batteries and tools in a scientifically convenient arrangement and encloses everything in an exceptionally beautiful piece of period furniture. Radio builders know the name "Conner" means Quality. Leading Radio dealers show Conner Cabinets.

Write today for illustrations of the entire line of Conner Convenient Cabinets and learn how easily you may own and enjoy one of these beautiful cases.

A Period Design for every plan of Decoration
\$35 to \$99.50

Jacobean
Renaissance
Sheraton, etc.

Write today for illustrations and details. We specialize on Cabinets for Radio Builders. Get our interesting offer to Radio Dealers in open territory. Write today.

CONNER RADIO CABINET COMPANY ☞ New Albany, Indiana

Sheet Copper for Shielding

Shielding

Prevents aerial radiation and feedback.

Insulates against interference from adjoining circuits.

Improves efficiency, selectivity and tone quality.

USE SHEET COPPER because it combines low resistance with easy working qualities.

COPPER & BRASS
RESEARCH ASSOCIATION
25 Broadway — New York

This is a good time to subscribe for

RADIO BROADCAST

Through your dealer or direct, by the year only \$4.00

DOUBLEDAY, PAGE & CO. GARDEN CITY, NEW YORK

FREE HOOK-UPS

AND
BIG
RADIO
GUIDE

Free, 164-page Radio Catalog and Guide brimful of newest 1927 ideas, most advanced hook-ups and illustrations. You make substantial savings on complete sets and parts. Be sure to get this thrifty book before you buy. It puts money in your pocket. Shows standard radio parts; sets, kits, all reliable, guaranteed goods. Please include name of radio fan to whom we may send copy also, write letter or postal note for newest 1927 edition.

THE BARAWIK CO.
548-549 Marne St., Chicago, U.S.A.

Book Reviews

Audio Amplification Data

AUDIO AMPLIFICATION. *Published by the Samson Electric Company, Canton, Massachusetts. 39 pages and 31 illustrations. Price, 25 cents.*

AUDIO AMPLIFICATION" is the title of an excellent booklet written for those desiring the best in radio reproduction. There certainly existed a need for such a booklet, describing, as it does, in a non-technical language, the design and characteristics of the different types of audio amplification systems. The many diagrams included will be found invaluable in building audio amplifiers of all sorts, whether resistance-, transformer-, or impedance-coupled.

Our interest in the book was aroused by glancing at the table of contents, which listed such topics as: "Comparisons of Audio Amplifiers," "Transformer Choice," "Amplifier Stability," "B Eliminators," and "Reproducers." Certainly the book is not merely an advertisement of Samson material, but was prepared in an endeavor to give the home-constructor useful and concrete information. The fundamental facts concerning all amplifiers are carefully explained so that an accurate conception of the entire subject can be had.

We casually opened the book to the chapter on "Transformer Choice" and read:

The question will undoubtedly arise "What transformer should I choose?" This question is no more readily answered than "What automobile should I choose?" All transformers may amplify and all automobiles may run. Many will find just what they want in the cheapest transformer, while others will find what they want in the more expensive one. After one has used a given automobile a while, he is better qualified to judge it and to decide whether his original decision was good or bad. So it is with transformers.

In the first place there is the question of turns ratio. The designation of a transformer by "ratio" is no more complete than the arbitrary designation of an automobile motor's horse power by its cylinder dimensions. Two transformers may have the same ratio of secondary to primary turns, and yet they may be very different in their operation. For illustration, it would be possible to make a transformer of 3-1 ratio with but one turn for the primary and three turns for the secondary. If this transformer were used, it would give no results (assuming an ordinary core such as used in the regular Samson HW-A3, 3-1 were used). In practice, thousands of turns of wire are used as the primary winding, and thousands as the secondary winding. As a rule, the better transformers have a greater number of primary turns than the cheaper ones. Since copper is expensive, it is, of course, cheaper to use as little as possible. As a consequence one 3-1 transformer may give a high amplification of the lower frequencies and another a very low or poor amplification of these frequencies, depending on the quality of the product.

It is sometimes felt that the size and weight of the transformers are direct indications of its quality. This is not necessarily true at all. One transformer might use a poor grade of iron and therefore require a very large coil in order to obtain the same results as another transformer using a better grade of iron. In other words, we might have two transformers very different in size, both of them being equally good. There are other criterions which must be used to judge transformers, and a curve showing how the amplification varies with frequency is the most trustworthy indication of quality.

Who Are You? and Where Are You?

You are a reader of Radio Broadcast!

We want to meet you!

We want to know your name, where you live and what is your occupation.

We are making a miniature census of the readers of Radio Broadcast. We want ten thousand of our readers to fill out the coupon below. In appreciation of your trouble in doing this we will send

FREE, A 36-PAGE BOOKLET containing Radio Broadcast's complete description of the famous Knock-Out Series of Receivers.

Simply fill out coupon below and mail to Radio Broadcast, Garden City, New York and you will receive the 36-page Knock-Out Series Booklet by return mail.

Your Name

Address

City..... State.....

Occupation.....

.....

For Radio Dealers and Employees Only

Kindly fill out this special form if you are a Radio Dealer or are employed by a Radio Dealer or in the radio department of any firm which sells radio

My Name is.....

Name of Firm

Address of Firm.....

City..... State.....

..... I am a subscriber

..... I buy on the Newsstands

Mail this coupon in an envelope to

RADIO BROADCAST
Garden City, N. Y.

FRESHMAN AUTOMATIC CHARGER

Connects Right to Your Light Socket

\$15



NO MORE "A" BATTERY TROUBLES

Sold by Authorized Freshman
Dealers Only

Write for new literature

CHAS. FRESHMAN CO., INC.
Freshman Bldg., New York

Things you should know about Battery Chargers

General Electric presents a complete line of Tungar Battery Chargers having sufficient range to meet the charging requirements of all radio storage batteries—large or small. Tungar is easy to use. It assures fully charged batteries over a long period of years.

Economical and satisfactory operation of your set depends upon the correct selection of Charger as well as battery. Any good dealer will be glad to recommend the proper Tungar. But these few simple facts may be all the guide you need.

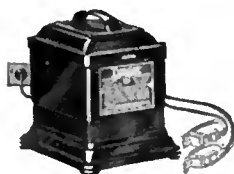

The Two-ampere
Tungar

This size Tungar charges all radio "A" and "B" storage batteries and auto batteries. It is particularly suited to sets having power tubes or using considerable current. It can be permanently connected to the battery and an overnight charge once or twice a week should be sufficient.

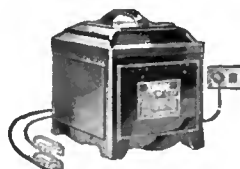

The Five-ampere
Tungar

The five-ampere Tungar also charges all radio and auto batteries. But it has a high charging rate, charges faster and is best for very large batteries.

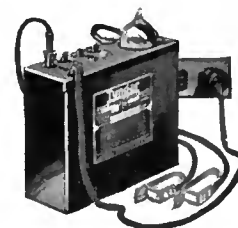

The Tungar
Trickle Charger

This youngest and already popular member of the family should be used with low capacity 4 or 6-volt radio "A" storage batteries. It is usually permanently connected and charges continuously at a low rate.

Tungar—a registered trademark—is found only on the genuine. Look for it on the name plate.



Tungar

REG. U.S. PAT. OFF.

BATTERY CHARGER

Merchandise Department
General Electric Company
Bridgeport, Connecticut

BROWNING-DRAKE BLUE-PRINTS

Full-Sized are now available at

RADIO BROADCAST Magazine

Garden City — Book Dept. — N. Y.

Choose with Confidence

World Radio Storage "B" Battery
12 Cell—24 Volt

Proved value. Thousands of users find reception almost magical. Clear, true power—instantly and unendingly. Wise economy. Sturdy construction—Solid Rubber Case protection. Recharged for almost nothing. Endorsed and listed as standard by famous Radio institutions including Pop. Radio Laboratories, Pop. Sci. Inst. Standards, Radio News Lab., Lefax, Inc., and other Radio authorities. What more need be said? Extra Offer: 4 Batteries in series (96 volts) \$10.50.

Send No Money Just state number wanted and we will ship same day order is received, by express C. O. D. Pay expressman after examining batteries. 5% discount for cash with order. Remember—you save 50% on World Batteries.

WORLD BATTERY COMPANY
1219 So. Wabash Ave. Dept. 78 Chicago, Ill.
Makers of the Famous World Radio "A" Storage Battery
Prices: 6-volt, 100 Amp. \$10.00; 120 Amp. \$12.00; 140 Amp. \$13.00.
All equipped with Solid Rubber Case.

Set your radio dials at 288.5 meters for the World Storage Battery Station WSHC. Variety-New Talent—Always Interesting.
JERRY SULLIVAN—Director and Announcer—"Chi-CAW-go"

GENERAL ELECTRIC

A Two Year Subscription Saves You Two Dollars

It saves you the bother of renewing next year.

It is the most economical way to subscribe. You simply write six dollars instead of four when sending your check or money order. Try it for two years. Form the habit!

RADIO BROADCAST

Garden City, N. Y.

Before You Build a Set
Get Our Catalog of
PANELS and PARTS

FANS! Your set can be made to look and to operate as well as a "factory" set if you build it with I. C. A. Insulation materials. Panels for over 70 popular circuits, including "Radio Broadcast," Universal, Aristocrat, etc., in hi-gloss Insuline or Bakelite, drilled and decorated by the beautiful Etch-O-Gravure Method, all ready to set up. Also plain panels, Insuline or Bakelite, in black and wood finishes, all standard sizes.

I. C. A. Insulation Products also include Mounting Brackets, Sub-Panels, Tubing, Vernier Dials, Pointer Knobs, Switches, etc. Write to-day for Free Booklet B-2.

Don't take substitutes; if your dealer can't supply you send to us direct.

Insulating Co. of America, Inc. 59 Warren St., New York City

The flux is everything in radio soldering says this Radio Engineer

"In our laboratory we made a thoro analysis of the two groups of fluxes (natural and chemical). We found the natural flux, rosin, the only safe one to use on radio work.

Pure rosin, as in Kester Radio Solder, will not fume, spatter, or creep over large areas, and being a hard, dense substance, rosin will not attract and collect dust (carbon particles), which makes an excellent path for leakages. These are the faults of fluxes containing chloride, be it either in paste, liquid or compound form. Any flux containing chloride will eventually cause heavy leakage. Hence they should be strictly avoided.

We find Kester Radio Solder the most convenient way to solder on radio work, for it has the proper amount of pure rosin right inside the solder itself. In fact, we used it exclusively on all of our work."

There's your guide, radio fans—the approval of an expert radio engineer. Surely there can be no doubt as to what you should use on YOUR SET.



A free Sample write for it now

KESTER Radio SOLDER

the safe solder for radio, requires only heat

CHICAGO SOLDER CO.

4222 Wrightwood Ave. Chicago, U. S. A.

Originators and the World's Largest Manufacturers of Self-fluxing Solder

READ RADIO BROADCAST

Famous **MARWOOD** Now Sold on



Easy Terms

1 Dial 6 Tube \$43.85

Get Agents Price—Save 50%
Great news! Now own a famous Marwood at the world's lowest price for real quality—and pay on easy terms. The only Radio sold direct on easy terms—proof that the Marwood MUST be a wonder. A year ahead with 4 big exclusive improvements—Super-Selectivity, Power-Tube Volume, New Easy-Tuning Principle, New Tone Quality. Save half—and get a Radio that can't be beat at ANY price.

Both Models Shipped **Complete With All Accessories**

30 Days Free Trial
We trust you. Prove the Marwood the best buy in America. Don't buy a Radio till you get our Easy Terms. 30 Days' Free Trial, Agent's Confidential Low Price, Free Radio plan, new Complete Radio plan—Make big money.

6 Tube 3 Dial \$36.85

also Agents—Write quick for territory—Make big money. **MARWOOD RADIO CORPORATION** 3747-B-46 Morse Avenue, Chicago, III.

Many home-constructors will want to obtain a copy of this booklet as the information contained in it is of such nature as to be very useful both in choosing the method to use in audio amplification and in actually constructing the amplifier.

H. E. R.

Satire from WGN's "Bummin'ham" Boys

SAM 'N' HENRY. By Correll and Gosden. Published by the Shrewsbury Publishing Company, Chicago, Illinois. 189 pages. Six illustrations. Price \$1.00.

SAM 'n' Henry have compiled and published a book called "Sam 'n' Henry"—and that, to this reviewer's notion, is about all there is to say. The Sam 'n' Henry addicts, once knowing that the book exists, will probably rush out and buy it no matter what our comment; and those who aren't followers of Sam 'n' Henry would never buy it anyway.

Sam and Henry, if you be among the ignorant, are a couple of colored boys from way down "Bummin'ham," Alabama, now working in Chicago, and every night at 10:00 they hold forth over WGN for a large and enthusiastic audience. The rôles were created a year or so ago by Freeman F. Gosden and Charles J. Correll. And the characters are creations, broadly drawn, perhaps, but never out of drawing.

Sam is the ignorant, clinging-vine type, but pathetically anxious to improve himself. Henry is pompous, worldly, and smug, actually quite as dumb as Sam but delightfully unaware of the fact. This every-night program, constituting as it does a sort of radio comic strip, is to be judged like Mutt and Jeff, not on its best or worst days but on its average, the which has been consistently fair.

The book has presumably been compiled from the best performances of the past year, about twenty-five of them, embracing such episodes as "Taking a Ride on the 'L,'" "At the Shooting Gallery," "At the Fortune Teller's," "Initiation at the Jewels of the Crown," "Sam Gets a Letter from Liza," "The Quack Doctor," etc. Several of them constitute rather good satire of an obvious sort—the burlesque on fraternal organizations in the "Initiation" episode, for example.

But of course the best thing about the radio "Sam 'n' Henry" has always been, not what they say, which is frequently dull, but the way they say it. Sam has an amusing, high, piping voice, while Henry's is a beautifully resonant bass, so low that you can almost count the vibrations!

The reader who knows the radio characters well enough to reproduce the dialect and intonation as he reads will doubtless have quite a bit of fun out of a perusal of the volume, and if he is sure enough addict, he will probably indulge in reading it aloud to whomever he can persuade to listen. To him we recommend the book.

JOHN WALLACE.

"How Radio Receivers Work"

HOW Radio Receivers Work" by Walter Van B. Roberts, is obtainable for \$1 from RADIO BROADCAST, Booklet Department, Garden City, New York. Doctor Roberts' book is enjoying a wide sale among radio enthusiasts. It provides the novice in radio with a very complete and easily understood discussion of the basic principles involved in modern radio receivers.

See that Screw

A screw-driver adjusts an X-L in crowded places



X-L VARIO DENSER

RESULTS in easier tuning, more distance, volume and clarity—greater stability. Indorsed by leading authorities.

Model "N" A slight turn obtains correct tube oscillation on all tuned radio frequency circuits. Neutrodyne, Roberts two tube Browning-Drake, McMurdo Silver's Knockout, etc. capacity range 1.8 to 20 micro-micro farads. Price \$1.00

Model "G" With grid clips obtains the proper grid capacity on Cockaday circuits, filter and intermediate frequency tuning in heterodyne and positive grid bias in all sets. Capacity range.

Model G-1—.0002 to .0001 MFD
Model G-5—.0001 to .0005 MFD
Model G-10—.0003 to .001 MFD



Price \$1.50
X-L Push Post. Push it down with your thumb, insert wire, remove pressure and wire is firmly held. Releases instantly. Price 15c.

Push Post Panel permanently marked in white on black rubber. In box including soldering lugs, raising bushings and screws for mounting, etc. Price \$1.50



X-L Radio Laboratories 2424 Lincoln Ave. CHICAGO, ILL.

WE ESTABLISH YOU

Co-operative membership in EIA is establishing an honest and industrious man in each locality, regardless of his handicaps or present occupation, in a successful radio industry of his own. Young married men preferred. Apply by confidential letter to **EQUITABLE INDUSTRIES ASSOCIATION**, Dept. B-27, Tribune Bldg., New York

Why not subscribe to *Radio Broadcast*? By the year only \$4.00; or two years, \$6.00, saving \$2.40. Send direct to Doubleday, Page & Company, Garden City, New York.

"BRUNO" Develops The Adjustable Bracket

You cannot mount upright panels with sloping brackets; neither can you mount sloping panels on upright brackets. You must use one or the other.

With "BRUNO" Adjustable Brackets you can mount either panel, upright or sloping. They are adjustable from 45 to 90 degrees.

Made of diecast aluminum, moulded just so, permitting plenty of leeway for the mounting of any size sub-panel.

Adjustable brackets \$1.25 a pair
Non Adjustable 1.00 a pair

By mail or from your dealer

Booklet of instructions, circuits and blueprints 25 cents by mail

BRUNO RADIO CORPORATION
Long Island City New York



Sylvania TUBES

SYLVANIA Tubes are preferred by the most critical radio users everywhere.

Radio experts with ears that are trained to catch the most minute flaw in radio reception, like the clearer tone and the keener selectivity of Sylvania Tubes.

Sylvania Tubes are made better, yet they cost no more than the ordinary tubes.

For real radio enjoyment, place a Sylvania Tube in every socket of your set and tune in. The result will reveal to you new possibilities in your set.

For
**GREATER VOLUME
 BETTER TONE ~
 KEENER SELECTIVITY
 LONGER LIFE ~**

SYLVANIA PRODUCTS Co.
 — EMPORIUM, PA. —