

# RADIO BROADCAST

WILLIS K. WING, Editor

DECEMBER, 1926

KEITH HENNEY  
Director of the Laboratory

JOHN B. BRENNAN  
Technical Editor

Vol. X, No. 2

## CONTENTS

Cover Design . . . . .	From a Painting by Fred J. Edgars	
Frontispiece . . . . .	Lightning Near WJZ's Towers	138
And Now, We See by Radio . . . . .	A. Dinsdale	139
What the Future Holds for the Radio Industry	French Strother	144
The March of Radio . . . . .	An Editorial Interpretation	146
Why Broadcasting Offers No Competition to the Newspapers	The Dempsey-Tunney Fight—A Dangerous Precedent	
Announcing the National Broadcasting Company	Where Short Waves are Not Needed	
Somebody Should Give Edison a Good Radio Set	The Progress of Radio in Russia	
Where the WEAFA Audience Is Supposed to Be Why Not Hoover as Czar of Radio?	Radio Events in Foreign Lands	
	The Month in Radio	
	Interesting Things Said Interestingly	
How a Low Barometer Affects Radio . . . . .	Eugene Van Cleaf	152
The New "Universal" Receiver . . . . .	Howard E. Rhodes	154
The Listeners' Point of View . . . . .	John Wallace	159
Kind and Unkind Words About Our Friends, the Announcers	The Boston Symphony Orchestra	
The Requirements of a Football Announcer	The Dempsey-Tunney Fight	
WGN's Football Schedule	Something for the Farmers	
	Broadcast Miscellany	
Audio Channels for the Browning-Drake Receiver . . . . .		164
Educate the Masses! . . . . .	J. Andrew White	166
A Single-Tube Receiver That Won't Radiate . . . . .	Zeh Bouck	169
Short Wave Activity at the Laboratory . . . . .	Keith Henney	175
New Apparatus . . . . .		176
Additional Notes on the R. B. "Lab." Receiver	John B. Brennan	178
As the Broadcaster Sees It . . . . .	Carl Dreher	180
The High and Mighty Place of the Announcer	A Louisiana Tragedy	
Taking the Listener Behind the Scenes	The Economic Aspect of Radio Engineering	
Radio Soaks In	Memoirs of a Radio Engineer	
Microphone Symbols	The Condenser Transmitter	
RADIO BROADCAST's Laboratory Information Sheets . . . . .		190
No. 49 Trickle Chargers	No. 53 Shunts	
No. 50 Hard and Soft Vacuum Tubes	No. 54 C Battery Detector	
No. 51 Overtones (Harmonics)	No. 55 Tuning the Antenna Circuit	
No. 52 Frequency Ranges of Musical Instruments	No. 56 Radio Telegraph Transmission	
Epsom Salts Offered as a Storage Battery Panacea . . . . .		196
Book Review . . . . .	Edgar H. Felix	200
"Radio Broadcasting," <i>Encyclopaedia Britannica</i> , Carl Dreher		
Schedule of Time, Weather, and Press Signals . . . . .		202
Converting Wavelength to Frequency . . . . .	Charles F. Filstead	204
Letters from Readers . . . . .		206
A Key to Recent Radio Articles . . . . .	E. G. Shalkhauser	210
The RADIO BROADCAST Technical Information Service . . . . .		218

## BEHIND EDITORIAL SCENES

ALTHOUGH not the first article to appear in the United States on the fascinating subject of "television," A. Dinsdale's article on the experiments and results attained by the remarkable Scotsman, John L. Baird, is by far the most authoritative we have seen. There is certainly no radio subject which excites more interest than "seeing" by radio. Mr. Dinsdale is an English radio experimenter, who is quite close to Mr. Baird. . . . The concluding article in French Strother's provocative series about the problems of the radio industry appears on page 144. The quotation from John K. Barnes's article appended to Mr. Strother's about the manner in which the automobile industry has solved its patent problem is worth the attention of every one who is interested in the business problems of the radio industry.

COULD Hoover solve the perplexing problems of the radio industry? "A nice point," as the Lord Chancellor remarks in *Iolanthe*, and it is suggested on page 148 in the "March of Radio." . . . Few subjects have aroused as much interest as that first discussed by Eugene Van Cleaf, of Ohio State University in the May, 1925, RADIO BROADCAST, "Do Weather Conditions Influence Radio?" . . . Additional conclusions about weather conditions and radio are found in a short and interesting article by Mr. Van Cleaf on page 152. . . . The RADIO BROADCAST Universal Receiver was built last year by uncounted constructors and is daily giving fine service. Howard Rhodes, of the Laboratory staff has devoted several months of work to revising and improving the circuit and a complete constructional article appears on page 154 giving the details of the present model—a remarkably good receiver.

J. ANDREW WHITE in addition to his well known talents as a broadcaster, is a writer of parts; in fact, he is more, he is an editor and for many years edited the *Wireless Age*. There are few so sour-faced as not to get at least one grin out of his fun-poking at broadcasting when it leans toward the uplift.

PRINTERS' INK, the trade publication of advertising men, lists, among the October issues of general and class magazines, RADIO BROADCAST as first among all radio publications with 36,401 lines of advertising. Then, in order, come *Radio News* with 29,972 lines; *Popular Radio*, 28,743; *Radio*, 19,600; and *Radio Age*, 8,166. In the *Printers' Ink* recapitulation of monthly magazines, RADIO BROADCAST is the only radio magazine listed at all, with a ranking of twenty first.

THE January magazine is already presenting a problem, for how to fit in all the good articles we have is no small task. The long-awaited constructional article on a good super-heterodyne embodying the principles laid down by Kendall Clough in the September RADIO BROADCAST is scheduled, as is an extremely interesting two-tube model of the R. B. "Lab." circuit with an extremely fine power amplifier and B supply unit, suitable for either the Raytheon or R. C. A. rectifier tube. The Hammarlund-Roberts "Hi-Q" receiver will be described and there will be a fascinating story of the work done by a New York experimenter with very short waves. A series of articles by David Grimes, describing an extraordinarily fine new receiver employing the inverse duplex principle will also start soon. —WILLIS K. WING

Doubleday, Page & Co.  
MAGAZINES

COUNTRY LIFE  
WORLD'S WORK  
GARDEN & HOME BUILDER  
RADIO BROADCAST  
SHORT STORIES  
EDUCATIONAL REVIEW  
LE PETIT JOURNAL  
EL ECO  
FRONTIER STORIES  
WEST

Doubleday, Page & Co.  
BOOK SHOPS

(Books of all Publishers)  
LORD & TAYLOR  
PENNSYLVANIA TERMINAL (2 Shops)  
NEW YORK: GRAND CENTRAL TERMINAL  
38 WALL ST. and 526 LEXINGTON AVE.  
848 MADISON AVE. and 166 WEST 32ND ST.  
ST. LOUIS: 223 N. 8TH ST. and 4914 MARYLAND AVE.  
KANSAS CITY: 920 GRANO AVE. and 206 W. 47TH ST.  
CLEVELAND: HIGBEE CO.  
SPRINGFIELD, MASS.: MEEKINS, PACKARD & WHEAT

Doubleday, Page & Co.  
OFFICES

GARDEN CITY, N. Y.  
NEW YORK: 285 MADISON AVE.  
BOSTON: PARK SQUARE BUILDING  
CHICAGO: PEOPLES GAS BUILDING  
SANTA BARBARA, CAL.  
LONDON: WM. HEINEMANN LTD.  
TORONTO: OXFORD UNIVERSITY PRESS

Doubleday, Page & Co.  
OFFICERS

F. N. DOUBLEDAY, *President*  
A. W. PAGE, *Vice-President*  
NELSON DOUBLEDAY, *Vice-President*  
RUSSELL DOUBLEDAY, *Secretary*  
S. A. EVERITT, *Treasurer*  
JOHN J. HESSIAN, *Asst. Treasurer*

DOUBLEDAY, PAGE & COMPANY, Garden City, New York

Copyright, 1926, in the United States, Newfoundland, Great Britain, Canada, and other countries by Doubleday, Page & Company. All rights reserved.  
TERMS: \$4.00 a year; single copies 35 cents.

many times  
better than  
in 1921

WITH four times less drain on your "A" batteries than the storage battery tube of five years ago, the filament of a Radiotron UX-201-A throws across to the plate five times as many electrons—a steady stream of tiny electrical charges that carry the song and speech. This is a big increase in efficiency!

And the Radiotron UX-201-A does not burn out—unless you apply a huge, excessive voltage. It does not die gradually, but keeps its efficiency almost to the very end of its life.

These are but a few of the advances in vacuum tube making that have come from the laboratories of RCA and its associates—General Electric and Westinghouse. Unceasing research brings continual improvement in RCA Radiotrons, making possible ever better reception—at lowered cost.

RADIO CORPORATION  
OF AMERICA

New York Chicago  
San Francisco

to get more  
power

put an RCA power Radiotron UX-120, UX-171 or UX-210 in the last audio stage of your set.

to get more  
distance

(on a storage battery set)

—put the new special detector Radiotron UX-200-A in the detector socket.

RCA is not only making Radiotrons steadily better—but is further improving reception with these new special Radiotrons. Keep your set up to date.

★  
RCA Radiotron

MADE BY THE MAKERS OF THE RADIOLA



LIGHTNING NEAR WJZ'S TOWERS

*A remarkable photograph of a lightning discharge, taken at the Bound Brook, New Jersey station of the Radio Corporation, at 4:30 on the afternoon of August 12, 1926. The outline of the WJZ towers can be faintly seen to the left of the discharge*

# RADIO BROADCAST

VOLUME X



NUMBER 2

DECEMBER, 1926

## And Now, We See by Radio!

*How a Canny Scot Turned from Patenting a Waterproof Sock to the Development of Television—Selenium and the Photo-Electric Cell, Their Comparative Effectiveness—The Mechanism Involved in the Transmission and Reception of Pictures of Animate Objects—Commercial Development of the Televisor*

By A. DINSDALE

*Member, Radio Society of Great Britain*

THE last fifty years have seen the development and perfection of many scientific marvels, probably the most outstanding of these being the telephone, the phonograph, the cinematograph, the airplane and airship, and, more recently, radio. All these inventions have come along so rapidly, compared with scientific development for hundreds of years previously, that the world to-day is prepared for the sudden announcement of even more wonderful achievements. Thus, to-day, and without much ado, we are able to announce that the secret of the successful accomplishment of television has been unearthed; a successful television apparatus has been designed and built.

Yet, what is television?

Television is "seeing what is happening at a distance *in the same instant as it happens,*" and the name denotes that this feat is performed by means of a system of electric telegraphy.

Over short distances, provided no other objects intervene, this may be accomplished with the naked eye, and, for greater distances, it can be done with the assistance of a telescope or pair of binoculars. But no telescope or binoculars will enable us to see through brick walls, or, from the comfort of our armchair in, say, San Francisco, see the President of the United States as he makes a speech in Congress. On the other hand, science has pro-

gressed so far that, under such circumstances, we can *hear* his speech as it is delivered.

Science has also so developed that, still in San Francisco, we can open our morning paper and see reproduced therein a photograph of the President in the act of making his speech. That photograph would reach

San Francisco from Washington by wireless or land line telegraphy, and the process is known as photo-telegraphy. It is not television.

For many years, writers of scientific fiction have had no doubts as to what television meant, for in countless stories of this nature the miracle of seeing what is actually happening elsewhere is treated as an accomplished fact, and embodied in the story. Actually, it is only within the last few months that the miracle has become a fact.

The history of television may be said to date from the discovery of the light sensitive properties of selenium. This discovery was made in 1873, by May, one of Willoughby Graham's assistants, and it was not long before the scientists of the day suggested that selenium cells might be made use of to give to the eye what the Bell telephone had already given to the ear. In 1880, Ayrton and Perry actually described a system by means of which this could be done, and it was then confidently predicted that in a very short time it would be possible to see over a telephone line.

It was found, however, that the capabilities of selenium had been greatly overrated. Although a very larger number of workers have been working on television ever since the discovery of selenium, and much ingenious apparatus has been devised, the main



JOHN L. BAIRD

Inventor of the Televisor. He is a Scotsman, the son of a Presbyterian minister, about 35 years of age. After the war, Baird started in business selling a patent waterproof sock of his own invention, but ill health intervened and he had to abandon this project. He then took up television, a subject he had previously dabbled in, and has now produced an instrument which is said to be far ahead of any other inventor's scheme for the transmission of moving pictures

stumbling block encountered by every inventor has been the selenium cell, which, although sensitive, is sluggish in action. When used for television purposes, selenium is called upon to convert into electrical impulses literally hundreds of thousands of light impulses per second, and its sluggishness, or chemical inertia, absolutely precludes such rapid response.

The task which selenium is depended upon to accomplish will be understood when it is pointed out that the human eye sees a whole scene in a single comprehensive glance. This, selenium is totally unable to do, and the suggested alternative was to divide up the scene to be transmitted into innumerable small parts, transmit it section by section to the receiving end, and to achieve this so rapidly as to create the effect of an instantaneous glance.

Thus, if a picture only ten inches square were divided up into sections one tenth of an inch square, 10,000 impulses would have to be transmitted practically instantaneously. To portray movement in a natural manner (i. e., give a moving picture effect), sixteen complete pictures must be transmitted per second, which means that the selenium cell has to transform into electrical impulses 160,000 light impulses per second. As the size of the picture is increased so is the magnitude of the task of the selenium cell increased.

#### THE PHOTO-ELECTRIC CELL

**S**ELENIUM proving a failure, search was made for a substitute, and recently a new device, known as the photo-electric cell, has been tried. Certain metals, such as potassium, sodium, etc., have recently been discovered to possess the ability to generate minute electric currents when exposed to light, and it is this property which is made use of in the photo-electric cell. For television purposes, however, although the response of this new type of cell is instantaneous, and therefore sufficiently rapid for the purpose, the photo-electric cell is not sufficiently sensitive. Its output is of the order of a few micro-amperes only, and such a minute current has to be amplified several million times before it can usefully be employed.

After thus briefly outlining the nature and difficulties of television, we now come to the work of the inventor whose good fortune it has been to provide a practical solution to the various difficulties.

Like Graham Bell, who invented the telephone, John L. Baird is a Scotsman. The son of a Presbyterian minister, he is about 35 years of age, tall, slightly round shouldered, studious in appearance, and possessed of a keen sense of humor of the brand known in Scotland as "pauky." He was trained as an engineer and, on the outbreak of war, was studying at Glasgow University. He immediately offered himself for enlistment, but, on being rejected for active service, served throughout the war as an electrical power station superintendent.

At the conclusion of hostilities, Baird

started in business with a patent sock he had invented, which was designed to keep out the eternal damp for which the west of Scotland is world-famous. Money was plentiful and Baird was on the way to "getting rich quick," but ill-health intervened, in the shape of a complete physical and nervous breakdown, and all business had to be abandoned.

We will not trace his subsequent activities; suffice it to say that they form an interesting record of enterprise and ability, dogged by continual ill-health and recurrent illness.

Throughout the years of an active business life Baird had one hobby—scientific research. In the early days of his training he had endeavored to invent an improved selenium cell, and had devised a system of



AT THE RECEIVING END

This is a photograph of the image obtained at the receiving end during one of Baird's early experiments. Vastly improved likenesses are now obtainable

television. His experiments in the latter subject date from 1912. Thus, when, in 1923, he found himself compelled through ill health to abandon business and lead the life of a recluse, he again took up the threads of the television problem where he had left them so many years previously.

With unlimited time at his disposal, Baird soon began to forge ahead, and after only a few months' work he succeeded in transmitting shadow-graphs. That is, by interposing an opaque object between a source of strong light and a selenium cell, he was able to transmit to the distant receiver, and reproduce on a screen, a shadowy outline of the object at the transmitting end.

So far, so good, but shadowgraphs are not television. Baird soon found, like so

many other investigators in various countries, that successful television is a much more difficult thing. In the case of television, it is not enough to send mere outlines of the object to be transmitted. Not only the contour, but also all the details and gradations of light and shade, together with a lifelike reproduction of all movements, must be transmitted and received.

To achieve this, the arrangement of scene and light source must be reversed. That is to say, the light, instead of shining on the light sensitive cell, must shine *on the scene*, and, under these conditions, the amount of light which actually reaches the cell is that amount which is *reflected* from the scene.

Baird found that the amount of light reflected from the human face is of the order of one candle power only, and when the image of the face is broken up into many small parts for transmission purposes, it will readily be realized that the amount of light which actually falls on the light sensitive cell at any given moment is extremely small indeed.

The full significance of the sluggish response of selenium, and the extremely feeble response of the photo-electric cell, will now be appreciated.

Month after month Baird worked on the problem, using apparatus of the crudest description. The biscuit tins, sealing wax, string, and other makeshifts beloved of the true inventor, and scoffed at by the sterile pedant, were very much in evidence. At last, however, in April, 1925, he had the satisfaction of giving the first public demonstration of television, transmitting outlines between two separate machines. These outlines were not the shadowgraphs referred to above, but were transmitted by reflected light—a most important point, showing an enormous advance over the earlier experiments. They were, however, very rough and flickering, and mere outlines.

The demonstration created considerable stir, but Baird's weird apparatus, old bicycle sprockets, biscuit tins, cardboard discs, and bulls-eye lenses, all tied together with string and sealing wax, failed to impress those who were accustomed to the shining brass and exquisite mechanism of the instrument maker. Also, the scientific world had never heard of Baird. He has no letters after his name, and belongs to no scientific societies and other highbrow institutions. In England, this means that, in the opinion of scientific circles, he could not possibly have achieved anything of scientific importance!

Working feverishly at all hours of the day and night, in the face of diminishing funds, Baird progressed rapidly until, on January 27th, 1926, he gave a successful demonstration before the Royal Institution, one of Britain's leading, and most conservative, scientific institutions. It is typical of the man that, on this occasion, he calmly invited the Institution to come around to his laboratory. About forty members turned up to see the demonstration, and the labo-

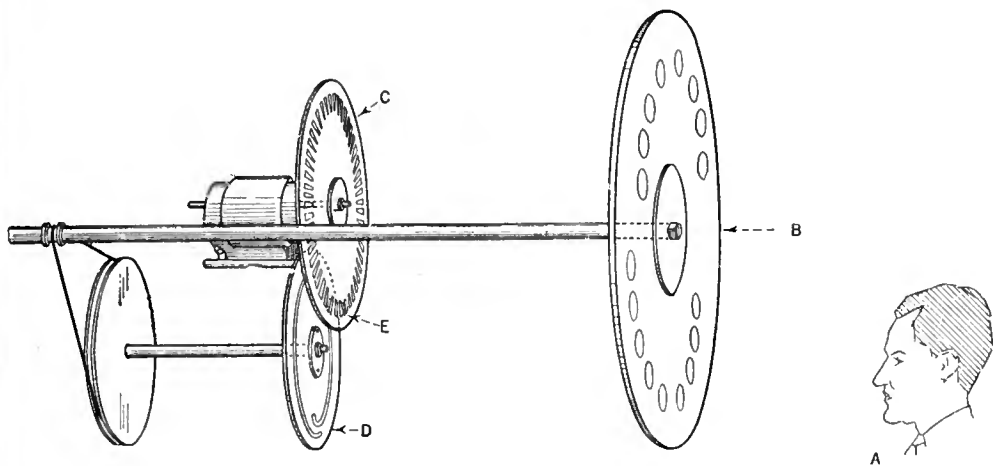

THE SLOTTED DISC EQUIPMENT OF THE BAIRD TELEVISOR

Between the object to be transmitted, and the revolving slotted disc, B, is a light-tight partition in which is contained a special collecting lens. Reflected light from the object to be transmitted passes through the collecting lens and then through the slotted discs B, C, and D, and thence to the light sensitive cell. The discs break up the light to be transmitted into numerous flashes

ratory was only capable of holding five or six at a time. However, by exhibiting to them in relays, all were in turn given a demonstration.

THE APPARATUS USED

THE apparatus used at the demonstration is shown in part in the picture diagram on this page. Between the object to be transmitted, A, and the revolving disc, B, is a light-tight partition. A battery of lights, similar to those in use in a photographic studio, are trained on the object or scene to be transmitted, and the light reflected from the scene is collected by means of a lens set in the partition. This lens acts in a manner similar to the lens of a camera, which collects light reflected from what is before it, and focusses the image of the scene on to the light sensitive cell.

Between the collecting lens and the light sensitive cell, however, are several discs. The first of these, B, carries a series of lenses, which, as the disc revolves, causes a succession of images of the object, A, to pass over the next disc, C. This disc is slotted, as shown, and revolves at high speed. Its task is to interrupt the light reflected from the image, causing it to reach the light sensitive cell in a series of flashes. Before reaching the cell, however, the light flashes have yet to pass through the rotating spiral slots of disc D, which cause a still further subdivision of the image.

E is the aperture through which the light finally passes to the light sensitive cell. The action of the discs, B, C, and D is to cause the light image to fall on the cell in a series of flashes, each flash corresponding to a tiny square of the image.

This, roughly, is the principle and arrangement of the mechanical part of the transmitter. The entire mechanism, called by Baird an optical lever, is the subject of a master patent which will, in all probability, revolutionize certain other branches of optics. An independent authority has characterized the patent as the product of the brain of a genius.

The arrangement of the lenses on the disc B is such that, as the disc revolves, each lens selects a narrow strip of the image as projected through the collecting lens situated between the object to be transmitted and the disc. This portion of the image, by virtue of the rotary action of the disc, is swept across the aperture E. Each succeeding lens is set a little nearer the center of the disc, so that, as the latter revolves, successive strips of the image are dealt with until the entire image has been swept across the aperture.

At the aperture E, the rotary action and perforations of the discs C and D have the effect of chopping up the long image strips into tiny squares. It is as if a piece of paper were first ruled off into parallel strips in one direction, and then ruled off in the other direction to produce squares. Each square, in the television transmission mechanism, represents a small portion of the image, and the intensity of light in

each square depends upon the degree of light and shade reflected from the original object or scene to be transmitted.

The entire mechanism is so designed that first the strips and then the squares just fit together, without an intervening space, and without overlap.

Passing through the aperture E, the light-squares, or flashes, fall on the light sensitive cell, which is the most vital portion of the whole system. The difficulties in connection with it have already been explained, and the design of a suitable cell has caused Baird more trouble than anything else. Working day and night for long weary months, he experimented with every possible variation of every known type of light sensitive device, and eventually invented a cell of his own, the secret of which is still very closely guarded. All that can be said about it is that it is a cell of the colloidal type, that is, made up of extremely finely divided selenium held in suspension in a liquid.

As the light flashes fall upon the light-sensitive cell, the resistance of the latter is altered in exact accordance with the intensity of the light falling upon it. The light impulses are thus transformed into electrical impulses which are then amplified by means of an ordinary a. f. vacuum-tube amplifier and transmitted over a wire circuit to the distant receiver. If it is desired to use wireless transmission, the television impulses are coupled up to the microphone input terminals of an ordinary broadcast transmitter. The carrier wave is then modulated by television impulses instead of speech impulses.

THE TELEVISOR

THE receiving apparatus, or Televisor, as he has christened it, has been reduced by Baird to the simplest possible form, so that, from the users' point of view, it shall be no more complicated than, say,

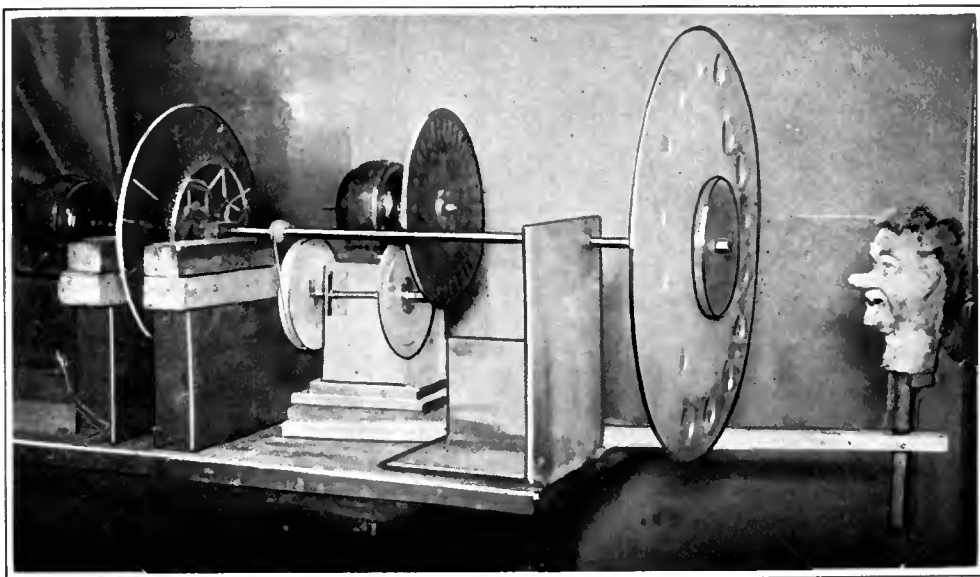

BAIRD'S ORIGINAL TELEVISION TRANSMITTING APPARATUS

This is a photograph of the equipment shown in the drawing at the top of this page. This apparatus has been placed on view at the Science Museum, South Kensington, London. By this act, Baird is officially recognized as a pioneer

a loud speaker. It is so designed, in fact, that it can be coupled up to the loud speaker terminals of any radio receiver, in parallel with the loud speaker, so that both speech and vision can be received simultaneously. If desired, the Televisor, radio receiver, and loud speaker can be incorporated in one instrument, like the self-contained radio receiver of to-day.

Television Limited, the company which has been formed to exploit Mr. Baird's system of television in England, is already making preparations to market such a combined instrument, and a commercialized model has been produced. The instrument is contained in a handsome mahogany case measuring about 24 inches by 20 inches by 18 inches deep. On the left of the front panel of the instrument is a ground glass screen about eight inches square, upon which the television images appear, and along-side this is the grilled opening of a loud speaker horn. A few binding posts at the back, for connecting up to the current supply, antenna, and ground, complete the external features of the instrument, which will probably sell for something like the equivalent of \$250.

#### RECEIVING EQUIPMENT

THE mechanism for the reception of the television impulses is very similar to that used at the transmitting end, only the process may literally be said to be reversed. Instead of the light sensitive cell, a source of light is used in the Televisor, the intensity of which is controlled by the incoming television impulses. Bright flashes falling on the light sensitive cell at the transmitter cause strong currents to flow over

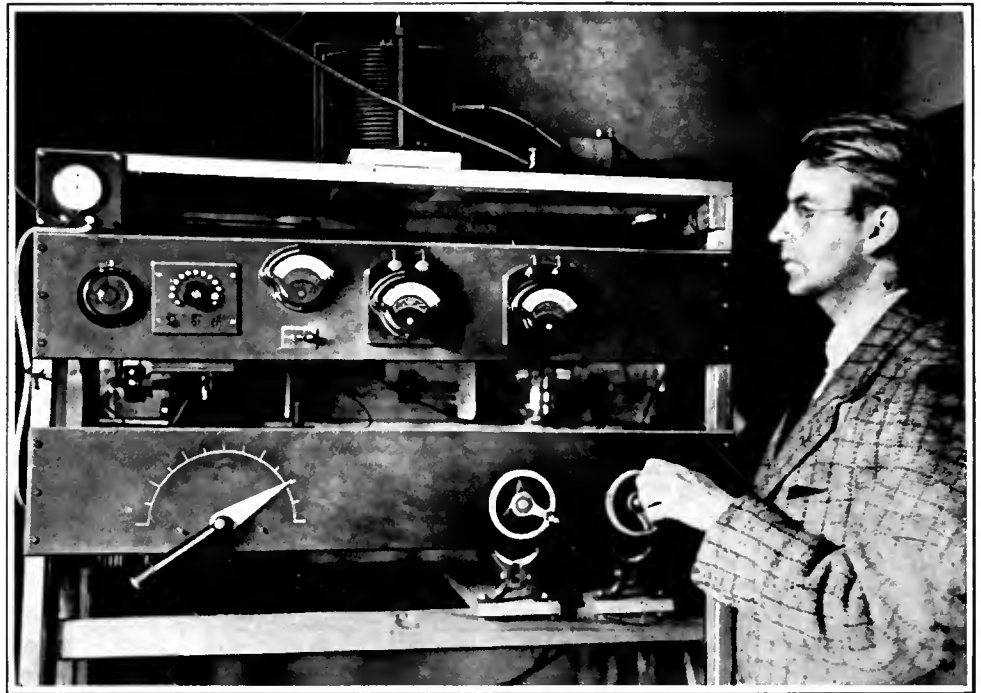

THE TRANSMITTING APPARATUS

Mr. Baird is here shown at the transmitting panel of his television station in London. The carrier wave of the transmitter in London is modulated by television impulses instead of speech impulses. A receiving station has been set up at Harrow, nine miles from London, where the carrier wave is demodulated. Reception is accomplished by somewhat the same process as transmission, only it is reversed

the transmission circuit, be it wire or radio, and these strong currents cause the light source to shine with great brilliance. Conversely, dim flashes at the transmitting end cause dim responses in the degree of brilliance of the light source at the receiving end.

The beam of light from the light source, constantly varying in intensity in accordance with the light and shade of the scene before the transmitter, is focussed, by means of lenses, onto a ground glass screen. If an observer now looked at the screen, he would see a tiny stationary spot of light on it which would be constantly flickering. In that flicker is contained the image, but the light variations must be spread over the entire screen in their proper sequence before the observer can make anything of it. In other words, the various pieces of the jig-saw puzzle must be put together.

This putting together and laying out of the image is performed by a mechanism similar to that shown in the picture diagram on page 141. Each light variation that comes through is passed through the aperture, E, of two discs, and thence on to a disc similar to B. Each lens on this disc selects the appropriate series of flashes which represent a strip of the picture, and sweep them, in the form of a strip of graduated light, across the ground glass screen. The next lens in order selects the next series of flashes and likewise sweeps them across the screen.

In this way the entire screen is finally covered, all the flashes, or squares, and strips fitting together so accurately that there is no noticeable junction. This action has taken quite a long time to describe, but actually it takes place in less than one tenth of a second! Due to the phenomenon known as "retentivity of vision," the observer thus sees, not a spot of light traveling over the screen at an incredible speed (which is what actually happens), but a complete picture, full of smooth gradations



THE CRUDITY OF BAIRD'S EXPERIMENTAL APPARATUS

Is well emphasized by this picture. One of the several discs employed in the transmission of objects may be discerned in the upper left-hand corner

of light and shade, and representing faithfully the scene before the transmitter. Sixteen such complete pictures per second give the effect of smooth animation, as in the case of the motion picture.

As may well be imagined, careful synchronism is necessary between the transmitting and receiving mechanisms. Both are driven by electric motors, and the problem of synchronism depends upon these two motors being kept exactly in step. Baird achieves this by means of small synchronous motors which are used as controllers. An alternating current of a definite frequency (about 60 cycles) is generated at the transmitting end. This serves to regulate the speed of the small synchronous motor which controls the speed of the transmitter driving motor.

This same frequency is superimposed on the carrier wave along with the television impulses, is picked out at the receiver by means of filters, and the receiver output current of that frequency made to drive another small synchronous motor which controls the speed of the Televisor driving motor. Thus, synchronism is entirely dependent upon one thing only, *i. e.*, the a. c. generated at the transmitter, so that any number of distant receivers, or Televisors, are controlled simultaneously and cannot possibly get out of step with the transmitter, unless something goes radically wrong with their mechanism.

From the foregoing, therefore, it is apparent that the carrier wave is made to convey two sets of frequencies, the television impulses and the synchronizing frequency. This latter is audible as a low steady hum, whilst the television impulses depend for their frequencies upon the image being transmitted. For example, the face of an individual looking directly at the transmitter sends out a series of sounds something like "brump, brump, brump," but, when turned sideways, the profile gives out a note like "perahh, perahh, perahh." A hand with fingers extended, if passed in front of the transmitter, will sound like the grating of a very coarse file, and an inanimate object, such as a box, gives a single steady note.

Since his demonstration before the Royal Institution in January of this year, Baird has made phenomenally rapid progress. A few months ago he had to use such powerful lamps at the transmitting end that sitters were almost blinded and burned. Now he has so far improved his apparatus that the light required is little more than is necessary in an ordinary photographic studio, and soon, probably, daylight alone will be found sufficient.

A few months ago, Baird was only able to transmit an object the size of a human face. Now he can take in a complete head and shoulders. Readers may remember

that during the early days of the moving picture, the results on the screen were far from perfect. There was a constant flicker, the focus was often wrong, and there was always the "pouring rain" effect. The images on the screen of Baird's Televisor suffered from very similar effects, but these are rapidly being eliminated, until, at the present time, a highly creditable demonstration can be given.

The writer is able to speak authoritatively on this subject of progress, for he witnessed one of Baird's earliest demonstrations, and has been in close touch with developments ever since. The image seen on the Televisor screen is perfectly clear and unmistakable; the sitter before the transmitter can be recognized without the slightest difficulty, and every detail of his features can be taken in, even to blemishes of the complexion. All movements are faithfully portrayed, just as they would



BAIRD DEMONSTRATES HIS TELEVISOR TO THE FAIR SEX  
A decidedly informal demonstration, one should say. On one occasion forty members of the Royal Institution turned up for a demonstration, and Baird's laboratory was then only large enough to hold six people at a time. By exhibiting to them in relays, he managed to give everybody a view

be on a "movie" screen. Even the smoke from a cigarette can be seen, and its ascending wreaths followed. The results are not yet as perfect as those seen on a motion picture screen, but such rapid progress has been made that the writer has no doubt in his mind that before long absolute perfection will be arrived at.

At present Baird is stepping out of his laboratory as far as the location of his Televisor is concerned, and he is now engaged in broadcasting his television impulses from his laboratory in the heart of London to a receiving station at Harrow, about nine miles distant, using a 250-watt broadcast transmitter operating on 1500 kc. (200 meters). These transmissions are purely of an experimental character and are being conducted nightly after regular broadcasting hours, the object of them being to perfect the technical details of the transmission, from a purely wireless point of view.

At present, as stated above, the television and synchronizing frequencies are within the audio frequency limit, but

Baird aims to raise these frequencies above the audible limit so they can be superimposed on the carrier wave of an ordinary broadcasting station without in any way interfering with music and speech. At the receiving end they will then be picked out by means of filters and, whilst speech and music are rendered audible by means of the usual loud speaker, the scene before the microphone at the broadcasting station will be visible on the screen.

Investigators in many countries have been striving to achieve television for some time, and many have claimed to have solved the problem, but have not been able to back their claims by an actual demonstration. Unheralded by claims, and scoffed at by many skeptical "authorities," Mr. J. L. Baird has arrived with his apparatus, the result of years of patient effort, and has actually given demonstrations innumerable to scientists, press men, and curious visitors. He has proved beyond all question or doubt that he has solved the worst and most troublesome problems of television, and its commercial application is now but a question of development.

Physics, mechanics, and optics have been ruthlessly explored to provide this new method of super-communication, and Baird's success is all the more remarkable and noteworthy because he has, from the very beginning, worked all alone. Even to-day he has no technical assistants, for until recently much of his apparatus was of a secret nature. The secrets of some of it are still possessed by Baird alone, and he is too canny a Scot to allow any one into his confidence. Working under such circumstances, therefore, the magnitude of his task can perhaps be appreciated.

Whenever he enters upon a new phase of development, Baird finds himself in need of expert knowledge of some science of which, perhaps, he is in complete ignorance. In order to progress, therefore, he has only one alternative—to go out to a library and get all the available literature on the subject and proceed to digest it. Truly a difficult task, and one which he has faced many times.

Thus, once again is it demonstrated that, in the field of scientific endeavor, much of the best work of a basic and revolutionary character is done by individuals working alone, without the aid of vast organized laboratories, and small armies of skilled assistants. Most certainly is Baird's developmental work in the television field a true example of individual perseverance, and patience, deserving of the ultimate award which now seems likely to be within this grasp. It is too bad that we cannot all personally see Baird and his remarkable apparatus.



# What the Future Holds for the Radio Industry

*Can We Look for the Emergence of Big Industrial Organizations?—Reasons Why the Radio Corporation Will Not Establish a Monopoly—The Future for the Consumer is Bright*

By FRENCH STROTHER

**R**ADIO is an industry as well as an art. It is doubly "charged with a public interest." The ingenuity of inventors has placed in the hands of millions a new and fascinating form of recreation. The enterprise of hundreds of business men has offered the instruments of this recreation in dozens of models at a wide range of price. Therefore, the public has a profound interest in the radio industry. It is a public concern whether that industry shall be constricted into the hands of a few people, or whether it shall continue to offer the widest possible variety of competition in quality and price.

Many things will enter into the fate of the radio industry. Previous articles in this series have indicated the importance of patents. It was pointed out that one of the possibilities was a series of court decisions that could pretty well put the entire industry into the hands of the Radio Corporation. Having considered that possibility, it may be well to consider alternative possibilities.

In the first place, the Radio Corporation itself is a somewhat artificial and unnatural institution. To indicate just what is meant by this statement, let us sketch briefly the career of another patent-sustained industry that seems to us a perfectly natural type. When the late John H. Patterson went into the cash register business, he went with only one idea, namely, to manufacture and sell cash registers. The cash register was a patented invention, a very crude affair, barely capable of practical use, and offering endless opportunities for patentable improvements. Patterson acquired the basic patent and proceeded at once to manufacture and sell. The expected improvements were made, often by outside inventors. The basic patent was attacked in the courts. Down to the day of his death, Patterson was engaged in endless patent suits, but his business grew until it became one of the wonders of the world.

The essential differences between the National Cash Register Company and the Radio Corporation are several. First, the Cash Register Company had John H. Patterson, a man of business genius and masterful

character. More important, all of Patterson's eggs were in one basket, and that basket was the cash register business. More than once he gambled every dollar he owned and all he could borrow on some daring stroke to increase his business. It was not enough to say that the business was *his*; the business was *him*—to be ungrammatically emphatic—it was the life of his life, and he had no thought nor interest but to make it succeed.

Again, let us emphasize the fact that Patterson primarily wanted to *make and sell* cash registers. Patents were necessary to him, improvements were necessary to him, patent suits were an unavoidable incident of his battle for a free hand to *make and sell* cash registers. He fought patent suits as he fought competitors—to the bitter end. He was out for blood, in the business sense, and he won out.

#### THE RADIO CORPORATION—UNNATURAL ORGANIZATION

**N**OW let us consider the Radio Corporation in the light of this comparison. In the first place, it was founded, not as a business enterprise, but as a patent pool. It was not the creation of a man, but indirectly, the creature of three great corporations, the General Electric Company, the American Telephone & Telegraph Company, and the Westinghouse Electric & Manufacturing Company. These three corporations had, and still have, aggressive managements. They had, and still have, conflicting interests. The conflict of those interests was not removed by the pooling of the radio patents held by the three respectively. On the contrary, the now legally enforced

companionship in that pool rather tends to exasperate that natural conflict. Hence, there are internal strains within the Radio Corporation that could not have existed in the Cash Register Company. Patterson was the "king or nothing" type and he stayed king.

Another striking contrast lies in the absence of a man at the head of the Radio Corporation. This is not meant in the slightest sense as derogating the genius of Owen D. Young, General Harbord, or David Sarnoff. They have business genius, as Patterson had, and in the case of Mr. Young, it is probably of a considerably higher order than Mr. Patterson's. But Mr. Young is not head of the Radio Corporation in the sense that Mr. Patterson was head of the Cash Register Company. In the first place, he has the General Electric Company on his hands, and that is a job big enough to occupy most of any man's time and energy. In the second place, he has not got the financial ownership—not mere control, but ownership—of his company. Patterson could, and did, fire everybody in his company when he wanted to make a quick turn and the others could not turn fast enough to keep up with him. Mr. Young would not use such furious methods if he could, and he could not if he would.

To repeat, then, the Radio Corporation is an artificial institution, in that it lacks the natural foundations of a business enterprise, namely, a purely commercial origin, singleness of purpose, and positiveness of control. Its business is of two wholly unrelated kinds: first, public service in the form of telegraphic communications, and second, the manufacture and sale of articles of merchandise, namely radio sets and parts. These two functions call for quite different types of mind and for quite different types of organization. And in exercising the second of these functions, it is further handicapped by the fact that, while it maintains its own selling force, it must depend for its manufacturing upon two associates, the General Electric and the Westinghouse Electric; with the further complication that while these two companies are nominally its manufacturing sub-

---

*THIS is the third and concluding article in the series by Mr. French Strother, one of the associate editors of WORLD'S WORK. The first of this series of articles proposed to show the course of the inventions and developments in radio which are responsible for the present complex situation. The second, published in RADIO BROADCAST for November, gave an analysis of the radio patent structure and something about who owns the important or key patents. This article discusses the problems of the radio industry in a remarkably sane manner. The hazards ventured here about the future of the industry are not in any sense casual; they are the result of many interviews with those prominent in the business side of radio and an extremely careful study of the probable future course of radio, judged in the light of the experience of other industries. It is comforting and important to note that there need be no serious fears about the future of the radio industry; all signs point toward a sane and proper development.*

---

—THE EDITOR.

sidaries they in reality control the "parent" company, and with the still further complication that these two joint children-parents are in all other respects violent competitors.

#### WHO LEADS THE RADIO INDUSTRY?

THE Radio Corporation at the moment is unquestionably the leader of the radio industry, and it is feared by all other radio companies. This fear is based upon the patent structure of the Radio Corporation, and the possibility that court decisions may so strengthen that position as to make inventive competition practically impossible, and destroy the commercial structures erected upon conflicting patents.

The patent complication is, of course, the reason for the development of astonishing successes such as that of A. Atwater Kent. It is a curious commentary on the idea of a legal patent monopoly that his success, like that of several others in the field, rests upon no patents at all. Here is a man of most unusual business talent, who, unable to acquire patents in a developing art, but perfectly willing to pay tribute to whoever the courts decide owns the patents he uses, refuses to wait until the courts get to that point, and plunges into the business while it is on the flood tide, and makes a spectacular success of sheer commercial skill.

It is idle to say that Atwater Kent is a "pirate." He has qualities that no pirate ever had, and they are qualities that the industry needs. Doubtless, too, they are qualities that the industry will eventually be glad to buy, no matter how the patent situation goes; for selling power of his kind does not grow on every bush, and is worth a high price when it can be commanded. This example is cited to indicate the importance of commerce skill, as well as of patents, in the radio industry.

An example can be chosen in another direction. The Stromberg-Carlson Company has had a generation of experience in the manufacture of telephone apparatus. Essentially, the problems of radio manufacture are much the same as the problems of telephone manufacture. Both call for refinement of design, and, to get real results, for extreme skill in fabrication. In engineering language, a first-rate radio set is now a "precision job," calling for calibration of parts to the thousandth of an inch. Haphazard methods of manufacture were all right while radio was a craze over a new mechanical marvel. But genuine skill in manufacture is increasingly perceptible to the radio public, and in time will be universally demanded. That kind of skill is not created in a day. Stromberg-Carlson have it, and doubtless they too will be welcomed into whatever situation the courts may resolve the radio receiver situation into.

A third example may be cited, in a

third direction. Inventive genius flowers continually, and often in unexpected ways. Companies which, like A. H. Grebe & Company, maintain research laboratories of their own, may at any time develop inventions so valuable that they, too, may be indispensable to whatever powers control the radio field.

#### REQUISITES FOR SUCCESS IN RADIO MANUFACTURING

THERE are, then, at least three other necessary factors besides patents. These are commercial skill, manufacturing skill, and inventive talent.

It is only fair to the Radio Corporation to say that it recognizes these things as clearly as anybody else sees them. The Radio Corporation does not wish to possess a monopoly of the manufacture and sale of radio sets. It is reasonably certain that, even if they got favorable judgments in all their patent suits, they would not try to put all their competitors out of business. It is reasonably certain, on the contrary, that they would ask a number of those competitors to share the field with them, under cross-licensing agreements. Doubtless they would insist that such concerns should possess one or more of the qualifications sketched above, namely, exceptional commercial skill, or exceptional manufacturing skill, or valuable patents or inventive staffs.

These would seem to be not unreasonable requirements, and probably most of the independent companies that have one or

another of these qualifications would be glad to see the present situation cleared up by some such solution. But for the present, the very nature of the patent law and the unadjudicated status of most of the radio patents make it almost inevitable that patent litigation shall be fought to a finish, so that the whole industry may know where it stands. Even the Radio Corporation, strong as its patent structure is, needs this assurance of certainty—perhaps, exactly because of its patent structure, it may need it even more than the independents. The Radio Corporation is run by thoroughly responsible financial interests, has an investment of thirteen million dollars in patents, and the interests of thirty thousand stockholders to protect. As its fundamental assets are primarily in patents, it has got to find out what the courts say those patents are worth.

Another element in the situation tends to eliminate many companies now in existence. This is the progress of invention. In a short span of years, it is quite possible that television by wireless will be a commercial fact, as it is already a laboratory fact. When that time comes, no receiving set will be valued that does not include this feature, by which the home user may see as well as hear the distant speaker or entertainer. The mechanism of television will require "precision" manufacture of an order beyond the powers of many companies now operating. It requires a trained ear to distinguish between good reception of sound and only fair reception, but any child can perceive the difference between good projection of a motion picture and less-than-good projection. To produce that difference calls for technical skill of a high order. The radio manufacturer who cannot supply it will have a hard time.

To recapitulate: The radio art is advancing rapidly, in the direction of refinements of basic inventions, designed to improve the quality of performance. Radio patents are in a state of chaos, owing to the inevitable delays in the Patent Office and the Federal Courts. The radio industry reflects that uncertainty in the rapid rise and fall of radio manufacturing companies. Probably most of the independent manufacturers will disappear, either through the failure of the courts to sustain their patents, or through poor manufacture or poor business management. Probably a few independent complete set manufacturers will survive all vicissitudes, by virtue of excellence of manufacturing staff, exceptional business ability, or unusual inventive talent. Probably a cross-licensing system between these independents and the Radio Corporation will then permit all to use any invention they need. In any event, the public is certain to continue to get a considerable variety of choice in receiving sets, at prices adjusted to suit all classes.

#### The Problems of the Automotive Industry Were Similar to Those Facing Radio Now

IN 1915, practically all the companies in the National Automobile Chamber of Commerce, the successor of all the earlier organizations of manufacturers, which includes all the leading automobile producers, except the Ford Motor Company, agreed to a plan of cross-licensing their patents which permits of their use by every other member free of charge. . . . It was when the committee started work on a definite plan and the difficulties of appraising the value of patents and fixing royalties for their use became apparent, that it was suggested that no charge at all be made. As no manufacturer had patents worth as much as the aggregate value of the patents of all the others, there was a sound basis of fairness in this proposal. It was this argument that finally convinced the automobile manufacturers in the N. A. C. C. and induced them to adopt the plan. Each one had much more to gain from it than he was asked to contribute."

"This cross-licensing agreement does not cover radical patents, for it was felt that any company making inventions of a striking character, involving a radical departure from what is known, should be entitled to special compensation if such inventions proved valuable. . . . Patents, such as improvements on the engine, or on other parts of the car, come under the cross-licensing agreement and can be used by all the parties of this agreement free of charge. There are about eight hundred such patents owned by the members of the N.A.C.C. The practicability of this agreement is clearly evident when one stops to realize that a patent of this kind does not give the holder the right to manufacture a car. If it is an improvement on an engine, for instance, the holder of the patent must get licenses from the holders of all other patents on that engine before he can manufacture it. And none of the holders of other patents could make use of his improvement, which might be highly valuable, until they had gotten the right to do so from him."

—JOHN K. BARNES in *World's Work*, May, 1921.

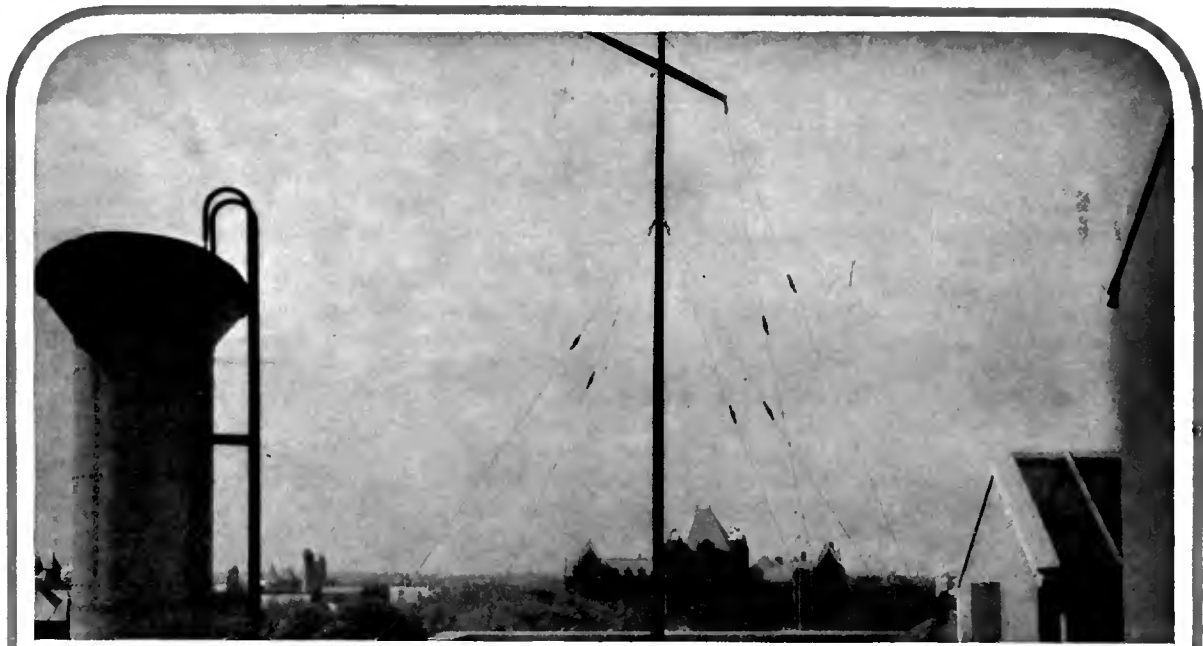

# THE MARCH OF RADIO

*News and Interpretation of Current Radio Events*

## Why Broadcasting Offers no Real Competition to the Newspaper

**E**VERY invention faces the opposition of the service it replaces. Radio broadcasting is afflicted with an unusually large number of opponents because its potentialities have been so greatly exaggerated in the public imagination.

Perhaps no group has better cause to watch the progress of radio broadcasting than newspaper and magazine publishers. The trade papers of those industries overlook no opportunity to point out that radio, which they claim to have "nursed from a failing infant to maturity," may some day slowly engulf them. Radio broadcasting threatens the future of newspapers about as seriously as automobiles threaten the shoe business.

As to radio's alleged debt to the newspapers: when broadcasting spread like wildfire in the first year of the radio boom, newspapers took it up with considerable enthusiasm. They published radio news because it stimulated the sale of newspapers. One New York paper, for example, by publishing a radio supplement, nearly fourfolded its Saturday circulation. Another New York paper has taken in practically a million dollars a year in radio

advertising for several years. Five radio concerns spend a total of a million dollars a year in newspaper advertising alone. Thus, by increases in circulation and by direct revenue from the industry, the work of newspapers in aiding the inevitable success of broadcasting has been repaid in dollars and cents. Radio advertising in newspapers is growing by leaps and bounds and there are few men in the advertising field who would insist that radio advertising will not equal automotive advertising within five years.

The interest of the radio reader is concentrated largely in the announcements of station programs. This interest continues day after day. Hundreds of thousands, if not millions, of newspapers are brought home every evening instead of being left on train or street car because radio programs are referred to in the course of the evening.

There is much wailing and gnashing of teeth in the trade papers of newspaperdom when such events as the Dempsey-Tunney fight are broadcast. Perhaps not as many extras announcing the result are sold as in the past because of radio. Perhaps the few news events which radio handles successfully offer a little competition once in a great while. If this puts fear into the hearts of newspaper publishers, their

hold on public interest must rest on weak foundations. Reader interest in radio, continuing day after day, and the huge expenditure of radio advertisers, counterbalances any loss from this source many times over.

The newspaper has all the news of the world, outside of these very few outstanding events, with which to compete with the radio description. They can bring illustrations and cartoons and opinions of recognized sports writers to the reader, while radio limits itself to a description by a single announcer. Newspapers can outdistance radio in every field of news distribution, even in those few rare events which radio brings to the public effectively. Newspapers, broadcasting an event like the Dempsey-Tunney fight, could popularize their own sports writers and gain attention to their own special way of handling such events, if they used radio to their own advantage as successfully as do other commercial users of broadcasting.

Two fears are constantly in the minds of newspaper publishers: first, that radio broadcasting may become an advertising medium so powerful that it will react on their advertising revenue and, second, that broadcasting may eventually become a disseminator of news rivalling newspapers.

The photograph forming the heading shows the short-wave antenna of the Ontario Hydroelectric Commission at its Toronto station. This station works with a sister station at Cameron Falls, Ontario, near Port Arthur

Both of these fears, experience has already demonstrated, are quite groundless. Radio is established as an entertainment medium and it has demonstrated that it is not an advertising medium. Any one attempting direct advertising by radio insults his audience and is promptly tuned-out. Broadcasting is a valuable good-will medium and may win sympathetic and favorable association with a trade name. It serves as a card of introduction between producers of goods and services and their ultimate consumers. That is a valuable service just as a card of introduction, presenting him to a prospect, is valuable to a salesman, but hardly any salesman would be foolish enough to attach an order blank to a card of introduction.

Printed advertising sells goods. Commercial broadcasting popularizes names. By so doing, it wins sympathetic attention to advertising and consequently makes it more effective. Commercial programs are themselves advertised and it would not be surprising to find, in the course of a few years, that the money spent in advertising commercial broadcasting programs, in order to bring them to the attention of newspaper readers, will actually equal the amount spent on the broadcasting itself.

Differing so in purpose, commercial broadcasting is no rival to the newspaper. And, even if it were a direct rival, it is one of such insignificant proportions that for the newspapers to regard it seriously is no more dignified a spectacle than that of an elephant running for his life at the sight of a mouse.

If the amount spent on commercial broadcasting should ever equal one per cent. of the amount spent on newspaper advertising, commercial broadcasting could well be proud of its tremendous growth. The advertising revenue of many a small town newspaper is greatly in excess of the amount spent on the largest commercial broadcasting chain in the country.

With regard to news competition, aside from such news as has actual entertainment value, such as world series games, prize fights and a few other outstanding sporting events, broadcasting is totally unfitted as a disseminator of the ordinary run of news. Imagine a newspaper printed with invisible ink, which shows up one word at a time for one second, and you have a parallel of how broadcasting handles the news. It would take more than twenty-four hours to broadcast the entire contents of a metropolitan daily. The listener would have no choice of subject matter and no opportunity to refer to or re-read a single line of what he gets by radio. Radio, in no way, threatens the editorial or the advertising purpose of the newspaper.

## Announcing the National Broadcasting Company

THE formation of the National Broadcasting Company, a subsidiary of the Radio Corporation of America, was announced by newspaper advertisements recently, in which the position and policy of the company was set forth. The first few paragraphs are a clear recognition of the fundamentals upon which broadcasting, commercial and non-commercial, is based. The success of radio broadcasting is dependent entirely upon the ingenuity and showmanship skill used in bringing radio events to the public and the degree to which they stimulate and maintain the desire for radio reception.

The statement says that:



THE POWERS BEHIND THE NEW NATIONAL BROADCASTING COMPANY

Photographed in New York with Vice-President Charles G. Dawes. Seated, left to right: General Dawes; Owen D. Young, chairman of the Board, Radio Corporation of America; General James G. Harbord, president, Radio Corporation of America. Standing: David Sarnoff, vice-president, Radio Corporation of America; M. H. Aylesworth, president of the National Broadcasting Company. On January 1st, 1927, the National Broadcasting Company will begin operations on a national scale with such stations as WJZ and WEAJ as part of a chain which can be extended to Denver (KOA) and Oakland (KGO). The National Broadcasting Company is practically a merger of the broadcasting interests of the Radio Corporation, the A. T. & T. Company, the Westinghouse, and the General Electric Companies

The market for receiving sets in the future will be determined largely by the quantity and quality of the programs broadcast.

We say quantity because they must be diversified enough so that some of them will appeal to all possible listeners.

We say quality because each program must be the best of its kind. If that ideal were to be reached, no home in the United States could afford to be without a radio receiving set.

The use of broadcasting by companies seeking the good will of the radio audience must meet these requirements also. The commercial broadcaster who wins the good will of the radio audience is the one who presents it with the finest possible program of its kind. He who endeavors to advertise or to disseminate selfish propaganda alien-

ates the attention of the radio audience and fails in his purpose. Herein lies the protection of the radio audience. Commercial broadcasters will not continue to use the medium if it fail to bring returns in the form of good will. Commercial programs must continue to improve both with respect to the skill of the artists appearing and in the showmanship used in presenting them before the microphone, if they retain the attention of listeners.

## Somebody Should Give Edison A Good Radio Set

WHEN a great American inventive genius declares that radio "is very poor because it is badly distorted" and that "it should not be used for musical purposes," it is an indictment which attracts international attention. As the father of the phonograph, Mr. Edison might be excused for bias, but, as a scientist, there is not the least excuse for statements not based on investigation. The musical production attained by the modern high grade radio set is not to be compared with that of the very inferior products of two and three years ago which the inventor must have used as his standard of comparison.

On a number of occasions, recently, the recording artists of one of the great phonograph companies have been asked to distinguish between phonograph and radio reproduction which they heard from a concealed instrument. None could tell the difference with certainty and he frequently guessed wrong.

The writer recently had demonstrated to him by Dr. Alfred N. Goldsmith two phonograph records of the same selection by the same operatic star. One was the commercial record produced in the phonograph recording studio; the other was a radio program received on a standard commercial receiver and recorded at

Doctor Goldsmith's laboratory. Musical experts have pronounced the radio record better than the other because the artist expressed greater feeling, stimulated by the consciousness of a large and appreciative audience. As to frequency range and fidelity, "quality" experts and curves secured by measurement do not reveal any superiority in phonograph reproduction.

The extraordinary improvement in phonographs during the last year, in fidelity of reproduction and broadening of the reproducing range, is due to the application of radio receiving and transmission apparatus to the phonograph art. The first improvement of any consequence in a decade of phonograph recording was the use of the radio type of microphone in

the broadcast input amplifier for what is termed electric recording. Equipment identical with that used in broadcasting studios has enabled phonograph recording by large musical groups in natural playing position rather than by small orchestras, huddled about an unresponsive megaphone, or singers, shouting at the top of their lungs, endeavoring to make the sluggish needle engrave the wax by sheer power of breath.

Likewise, in the reproduction of phonograph records, the use of amplifiers and loud speakers developed for radio sets has effected extraordinary improvement in phonograph reproduction, resulting in the revival of that once well-nigh forgotten business. For the first time, volume of a phonograph can be regulated, without introducing distortion, to suit the desire of the listener. Tonal quality, by reason of undistorted amplification and the extensive widening of the frequency band handled and the use of radio loud speaker equipment, has restored the phonograph in public confidence.

Mr. Edison would have been much more accurate if he had said that the old fash-

ioned phonograph, before the application of radio inventions to recording and reproducing, was very poor "because it was so badly distorted" and that the application of radio pick-up apparatus in recording and radio amplifiers and loud speakers in reproduction makes the phonograph now equal in quality to the finest radio set.

### Where the WEA F Audience Is Supposed to Be

**A**N ITEM in the *New York Times* furnishes a rather illuminating analysis of the audience of WEA F and the sixteen stations linked with it by wire lines. It estimates that the network reaches 59.5 per cent. of the receiving sets in the country and that 50.1 per cent. of the total population of the country is within the service area of the sixteen stations. 71 per cent. of the listeners live in the city and 29 per cent. are rural.

The number of radio sets reached by each of the stations in the network is estimated as follows: New York 702,000,

Boston 380,000, Philadelphia 265,000, Washington 166,000, Buffalo 125,000, Pittsburgh 208,000, Cleveland 172,000, Detroit 224,000, Cincinnati 187,000, Chicago 354,000, St. Louis 146,000, Minneapolis 73,000, and Davenport 88,000, making a total of 3,090,000. The average number of listeners per set is estimated at five, which corresponds to the number in the average American family.

In most of the cities listed, there are rival high grade stations so that the division of this potential audience is dependent upon program attractiveness. Participation in chain programs gives such stations a marked advantage over their rivals.

### Why Not Hoover as Czar of Radio?

**S**ENATOR DILL, the legislative champion of radio, has announced a change of attitude with respect to the administration of the forthcoming radio law. For a long time, Senator Dill has favored regulation by the Department of Commerce, but he has recently turned in favor of commission rule, a sort of "inter-

### SHORT-WAVE STATIONS FOR COMMERCIAL USES IN CANADA

The transmitting panel, front and rear view, of the Cameron Falls station of the Ontario Hydroelectric Commission, near—

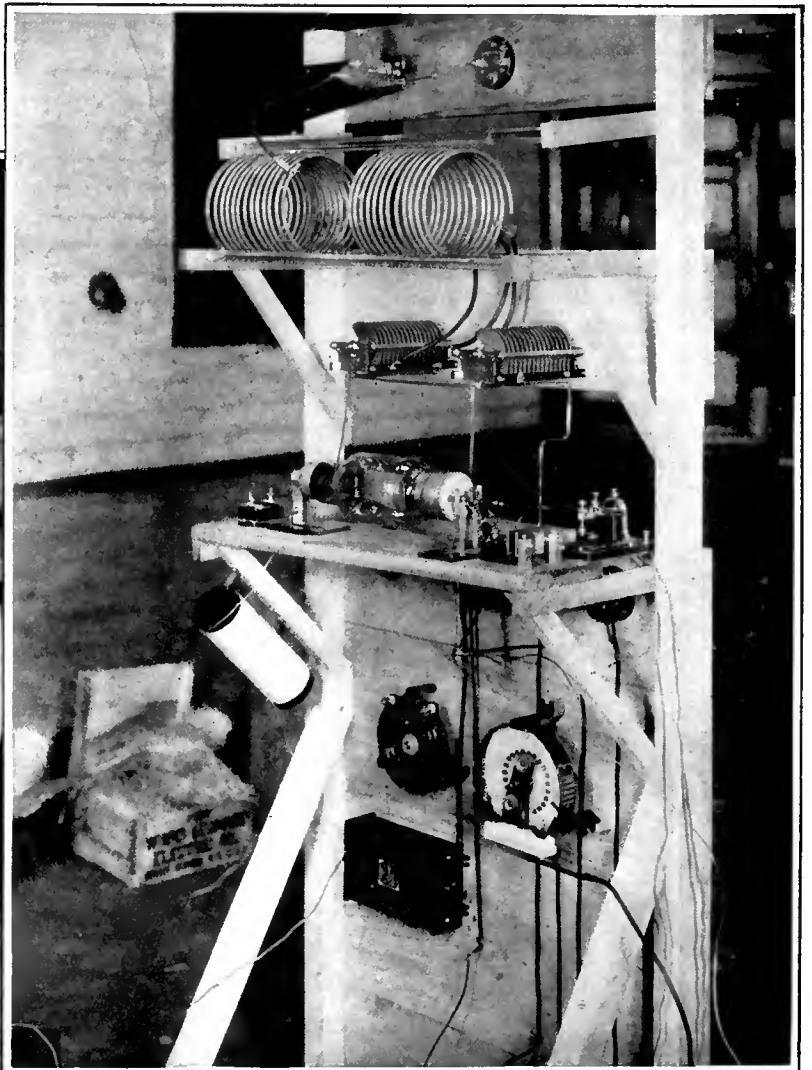
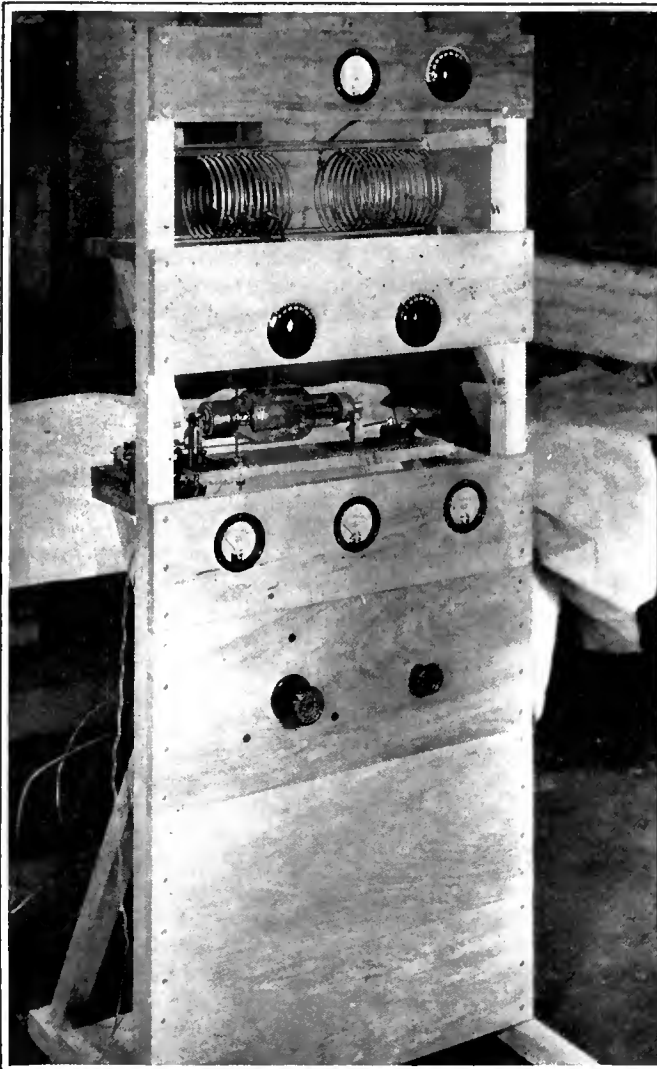

—Port Arthur, Ontario. This 250-watt station (C-9AQ) works with the base station, 600 miles away at Toronto (C-9AI). In daytime a frequency of 10,000 kc. (29.94 meters) is used and at night 5996 kc. (50 meters). The Cameron Falls power station supplies the twin cities of Fort William and Port Arthur with electric power

state commerce commission" for radio, members of which are to be appointed by the President.

It seems unfortunate that Senator Dill has been convinced of the desirability of this proposal. It should aid him materially, however, in getting his bill passed, because a commission with a good number of appointive ten-thousand-dollar jobs is always popular with congressmen and senators in case of reverses at the polls.

Radio is not of sufficient importance to warrant a dignified and pretentious a commission. If it were to consist of real experts, devoted entirely to the good of radio, with fitness to membership determined by a life long study and interest in radio, it might be better than a political group. Even so, ten real experts would do nothing but argue their heads off.

Radio is not sufficiently important nor are its problems so complex that such a magnificent body must be set up to regulate it. One good fifty-thousand-dollar-a-year executive, having the respect of the industry, could clean up radio's troubles by six weeks of hard work. It is too bad that Secretary Hoover has, or is supposed to have, presidential ambitions, because he would be ideal for the job. In fact, the industry could make it a hundred thousand dollars a year for him and profit thereby. Incidentally, Mr. Hoover, it would be a life job, paying more than the presidency and not be nearly so wearing.

In the meanwhile, where is this radio industry which is so boastful of its powers of self-regulation? Its peerless leaders are still busy passing mere resolutions.

### The Dempsey-Tunney Fight —A Dangerous Precedent

THE precedent set by the Royal Typewriter Company in purchasing the broadcasting rights to the Dempsey-Tunney fight at a cost said to be \$35,000, including the expense of broadcasting, is one with dangerous consequences. The payment of large fees for the broadcasting of sporting events, which themselves profit by broadcasting, is both unfair and unwarranted.

The prosperity of boxing has been tremendously helped by the impetus which radio has given it and that it should levy a fee upon those who performed this service for it is ingratitude. If this attitude



AT THE LOS ANGELES RADIO SHOW

Radiola Hall, one of the exhibits. The Radio Corporation of America, among many other exhibitors, had an attractive display, which helped to make the exposition one of the largest and most interesting of any radio show held on the West Coast

becomes general, the public may expect to be deprived of events sponsored by selfish and shortsighted interests. Presenting the Dempsey-Tunney fight was an excellent stroke for the Royal Typewriter Company, but a rather poor one for broadcasting. If the radio audience had been deprived of the fight because no one had been willing to pay this excessive sum, Mr. Rickard might have lost all the good will he has gained through the broadcasting of previous fights.

### Where Short Waves Are Not Needed

THE American Railway Association has announced an experiment in the use of short-wave radio telephony between locomotive cab and caboose on long freight trains. The usual vagaries of short-wave reception were encountered, absorption in the vicinity of steel bridges being especially severe.

In view of the growing ether congestion, it is unfortunate that radio is being considered for a purpose which a wire line, coupled by plugs from car to car as air brake hose is coupled, can accomplish. This method would have the advantage of

enabling the conductor to cut in the line at any car. A break in the car to car chain could actuate an automatic signal, warning the engineer that the cars had uncoupled. At the same time, the wire system would not clutter the ether with radio communication as suitably carried by wire.

### The Progress of Radio In Russia

THE Russian Information Service announces some news of the state of radio communication which shows that country is not as backward as we might have supposed. More than a million radio fans in the Soviet Union listen-in on the programs of the government stations every day, it is claimed. Village libraries in four hundred villages of the Moscow and Leningrad provinces have been equipped with powerful receiving sets and loud speakers, while three hundred workers' clubs in the two cities have been similarly fitted out. The big transmitting stations at Moscow and Leningrad are wired to all the principal theaters, concert and lecture halls, and public meeting places.

When the radio amateur in the Soviet Union wants to hear a bit of foreign transmission by way of variety he tunes-in on one of the big stations in Germany, England, or Denmark and occasionally he can receive from Paris.

In addition to the stations in Moscow and Leningrad, powerful transmitters are now operating at Kharkov, Ivanovo, Bogorodsk, Kiev, Nijni Novgorod, Minsk, Voronesh, Tiflis, Baku, and other cities in the Soviet.

Radio shows are attracting unprecedented audiences, auguring a most successful season. There were 250,000 at the New York show and 100,000 at Los Angeles.

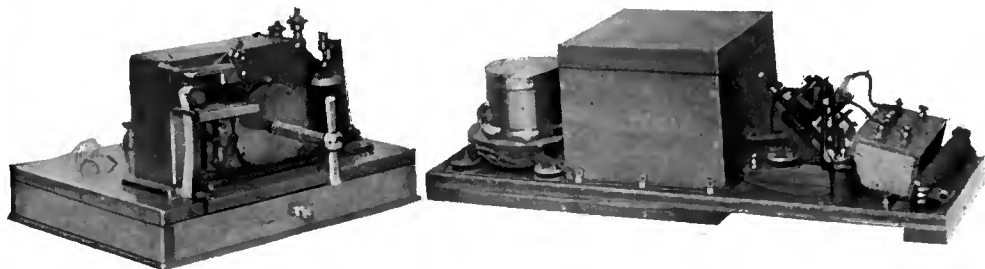

ONE OF MARCONI'S EARLIEST RECEIVING SETS

The outfit used by Marconi when he obtained the first signal ever transmitted across the Atlantic. This set, together with other historical equipment, is on display at Marconi House, London. The twenty-fifth anniversary of this remarkable achievement occurs in December of this year

## Radio Events in Foreign Lands

THE broadcasting interference tangle which has hampered European broadcasting has been solved by a committee of experts. The American standard of ten kilocycles separation has been adopted and the 99 channels available have been divided into two groups, 83 exclusive and 16 non-exclusive channels. Of the exclusive channels, Germany receives 12, Great Britain and France 9, Western Russia, Italy, Spain and Sweden 5, Czechoslovakia and Norway 3, and the remaining countries one or two each. The 16 non-exclusive wavelengths must accommodate 116 stations approximately an average of 7 per common channel. This scheme is quite similar to the suggestions made in the October "March of Radio" for American allocations.

A BROADCASTING station with a maximum power of 9 kilowatts has recently begun operation on a wavelength of 452 meters in Leipsic, Germany. 121,423 listeners are paying monthly fees for the use of their radio receivers, indicating approximately one receiving set for every family in that city.

THE Greek government has prohibited the use of receiving sets tuning to more than two thousand meters. One of the best ways to win listeners on a particular wavelength is to pass a law against listening-in on it.

THE RUSSIAN government, according to a New York *Times* correspondent, has animated a radio war between that country and Rumania by broadcasting revolutionary propaganda on wavelengths assigned to Rumanian stations. By this policy, the Soviet government is demonstrating its total unfitness to regulate radio and, by inference, anything else.

AN UNKNOWN station disturbed the peace of mind of Mexican officials recently by broadcasting anti-government propaganda in the Federal District. The only place that station was easy to find was on the dial of receiving sets.

THE French police are using radio to broadcast, by means of Bélinograph transmitters, fingerprints of wanted persons and criminals. Other countries are planning to join in this effort which will make the job of the international crook somewhat more hazardous.

PRESIDENT DOUMERGUE, vacationing at Rambouillet, spent much of his time with head phones, chasing long distance radio rainbows. According to the dispatches, he has been thoroughly captivated by the radio enthusiasm. His record reception is KDKA, Pittsburgh, "once faintly." If only he knew a few American radio liars! "KDKA? Any time I want it, and on the loud speaker too!"

MR. ALBERT G. LINSIG, foreign representative of the Freed-Eisemann Radio Corporation, estimates that there are 250,000 radio sets in Argentina, 40,000 to 50,000 in Chile, 60,000 in Brazil, 12,000 in Peru, 10,000 to 15,000 in Uruguay, and 5,000 in Ecuador. In

Paraguay, Bolivia, and Venezuela, there are only very few, owing to the stringent governmental restrictions imposed.

### The Month In Radio

A BULLETIN issued by the Department of Commerce estimates the value of radio equipment exports from the United States during 1925 at ten million dollars, an increase of 18 per cent. over 1924 and ten times the figure for 1921. The report points out that the United States is the only important country in the world where no tax is levied upon the radio fan. Fees range from the nominal sum of one franc per year collected by France to \$18 in Salvador and \$13 in Lithuania. Apparently the scale is inversely proportional to the desirability of listening to broadcasting. The British fee is two shillings, Sweden \$2.70, Japan \$.80, South Africa \$1.25.

CANADA was our leading market for radio in 1925, absorbing \$3,682,980 worth, or 27 per cent. of our total exports, Asia second, Europe third, and Latin America fourth.

IN A statement following closely upon the announcement of the National Broadcasting Company, Mr. M. H. Aylesworth, its president, stated that the programs broadcast by the company through the WEAJ and Radio Corporation networks would also be available to other broadcasting stations throughout the country so far as it is practicable.

THE Department of Agriculture announces that more than a quarter of a million farmers have enrolled in its radio farm courses, in which a score or more of broadcasting stations will cooperate. Twenty-four short courses of eight

lessons each are being presented before the microphone. An hour for housekeepers has also been arranged, as well as dramatized versions of informative talks given last year.

A sample of the improved radio showmanship being employed is in the manner in which current farm problems will be discussed. Instead of lectures or discourses, the new method is to have two speakers, one a typical farm county agent and the other a representative farmer who asks questions of the former. The Monday program will be devoted to livestock; Tuesday to crops; Wednesday to poultry; Thursday fruits and vegetables, and Friday dairying.

The improved method of presentation will greatly increase the service value of the Home Department of Agriculture radio efforts. Our congratulations to Mr. Sam Pickard, director of the Department's radio activities.

THE schedule of frequencies assigned to the General Electric Company for experimental work in high frequencies is as follows: 2XAW 100,000 to 15,000 kilocycles (3 to 20 meters); 2XO, 2XAF and 2XAD, 30,000 to 6000 kilocycles (10 to 50 meters); 2XH, 2XK and 2XAC, 6000 to 2000 kilocycles (50 to 150 meters); 2XAK, 2XAZ, 3000 to 1500 kilocycles (100 to 200 meters); 2XAG (50 kilowatts) 790 kilocycles (379.5 meters); 2XAH, 300 to 75 kilocycles (1000 to 4000 meters); 2XI, general experimental license; 2XAM, 2XAE, 2710 kilocycles (110 meters); and WGY, 379.5 meters. 2XAF is now operating on 9150 kilocycles (32.77 meters) and has furnished programs for re-broadcasting throughout the British Broadcasting chain on one or two occasions, as well as to the Johannesburg, South Africa, station on one occasion.

THE Navy Department is contributing to the encouragement of commercial aviation by extending the service of its radio compass stations. It will soon be equipped to furnish bearings to aircraft in the same manner that they are now furnished to ships at sea. Compass stations along the coast are now calibrated for seaward service only and it will be necessary to calibrate them landward as well.

BY THE merger of the Electric Power Club, the Associated Manufacturers of Electric Supplies, and the Electric Manufacturers Council, there was formed the National Electric Manufacturers Association, comprising the 270 leading electrical manufacturers of the country. Included are the General Electric Company, the National Carbon Company, the Radio Corporation of America, the Stromberg-Carlson Telephone Company, the Western Electric Company and the Westinghouse Electric & Manufacturing Company. The president of the organization is Gerard Swope, President of the General Electric Company. Unquestionably this body will wield great influence in the electric industry and its recommendations in legislative matters, including those affecting radio, will doubtless be considered by our legislators with a sensitive ear.

THE largest tube transmitter now operating is the recent 80-kilowatt installation of the Navy Department at San Diego, California.

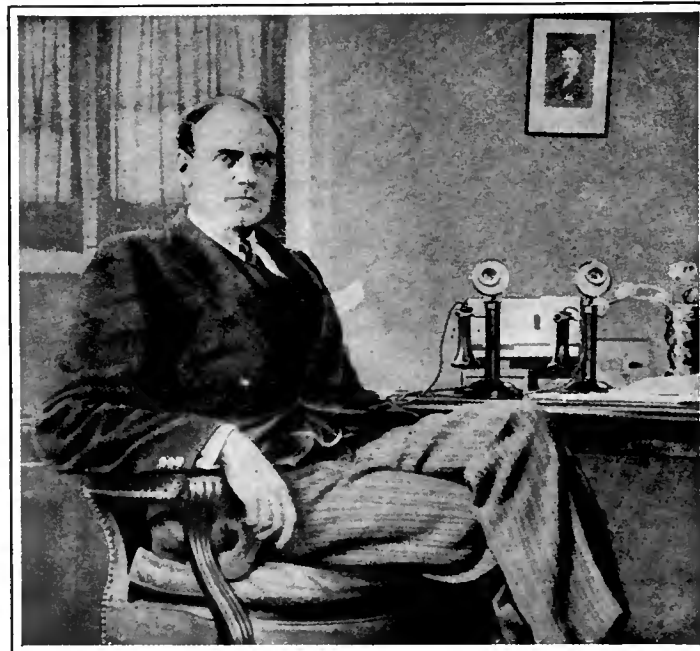

J. C. W. REITH

Managing director of the British Broadcasting Company, the only organization allowed to broadcast in Great Britain. A portion of the government license fee, required of every receiving set owner, is turned over to the B. B. C. for maintenance of its service. This illustration is reproduced from the *Wireless World*, London. It is probable that Mr. Reith will hold an official position in the new British Broadcasting Corporation, Government controlled, which will probably come into existence on January 1st, 1927



C. W. HORN

Pittsburgh

Superintendent of Radio Operations, Westinghouse Electric and Manufacturing Company:

*"Radio, being something new and fantastic, is highly overrated, and dealers and listeners alike must stop exaggerating the truth if the industry is to be stabilized. People expect too much. They have been misguided by false statements and false advertisements and subsequently when they go to buy a radio receiver they expect it to bring in everything from here to Bagdad. Prospective listeners might as well learn now and take heed to the fact that reception with any set depends very largely on the weather. Some sets are more sensitive and selective than others, but even the best of them cannot penetrate atmospheric disturbances which have not been solved by man, and may not be. A slight change in wind direction, coupled with a few other weather freaks, sometimes makes it impossible for, say, Pittsburgh listeners to receive Cleveland even when other stations miles and miles farther away are booming in. It is a mystery. There is no need of any one, dealer or listener, bluffing or exaggerating the merits of radio, because radio itself is a wonderful thing and any broad-minded person in time will come to realize that, regardless of how prejudiced he might be against radio now."*

This replaces the arc set formerly installed at that point. A six-phase vacuum tube rectifier furnishes  $7\frac{1}{2}$  amperes of plate current at 15,000 volts. Only a few years ago, half a dozen flashlight cells, laboriously soldered in series, met the need for the largest plate current requirements then known to the radio art.

**A RESOLUTION** adopted by the Northwest Radio Trade Association with regard to legislation suggests that the new law shall delegate to the power controlling radio

"the authority to issue and revoke licenses, to refuse to issue licenses whenever it appears that the public interest is best served by such refusal"

and also that "the holding of a license prior to the passage of a law shall not constitute a

fixed right to it," thus permitting the cancellation of existing licenses. This comes somewhat nearer to the point than some of the asinine resolutions adopted by other trade organizations to the effect that there is no radio emergency.

**A SURVEY** conducted by the *Detroit News* classifies 290 outlets handling radio in that city as follows: hardware 50, music 44, furniture 32, auto accessories 30, exclusive radio 14, the remaining being divided up among department stores, drug stores, sporting goods stores, etc. It seems unusual that hardware stores should lead the list. Electric stores have the ascendancy in most cities.

**THE** official *Gazette* of the patent office lists a suit brought by the Westinghouse Electric & Manufacturing Company against the Cresley Radio Corporation, citing E. H. Armstrong's patent No. 1,113,149.

Interesting Things Said Interestingly

**PAUL B. KLUGH** (Executive Chairman, National Association of Broadcasters. In the *New York Times*): "Can the Government reverse age-old fundamental laws and assume control of the channels above and below a man's property in order to regulate radio, when heretofore they have been man's inalienable right to control? And what about priority and vested rights? How can the owner of a broadcasting station establish a vested right to a channel of transmission which transgresses the rights of every property owner in every direction so far as the waves of his station are propagated? Yet, on the other hand, how can he be denied such right when, after years of effort and thousands of dollars' expenditure, that station owner by use of a certain transmission channel establishes a public service which public opinion stamps as essential?"

**LOYD K. GRENLIE** and **GEORGE H. JAMES** (Radio Operators of the Byrd Polar Expedition, in the *New York Times*): "Amateur stations in New Zealand and a naval vessel off the coast of Chile reported remarkably steady signals even when the ship was rolling and pitching badly. When using other than the main antenna and ship's ground, reports of 40-meter reception were not so good, because swinging and fading signals were experienced by the receiving operators. There was one night in particular when the operator on watch had extreme difficulty staying with the receiver and the transmitting key due to rolling and pitching of the ship. The operator was experimenting with an American amateur station and was transmitting while the ship was rolling badly. The receiving operator said that it was remarkable how steady the signals were."

**DR. J. H. DELLINGER** (Chief of the Radio Laboratory of the Bureau of Standards. In a statement to the press): "The sun spot cycle is of eleven years, that is, there is a minimum of spots on the sun for a period of time after which they gradually increase and pass through a maximum and return to a minimum, the whole occupying a cycle of 11 years. The last sun spot minimum was in 1922 and it would be inferred, therefore, that radio reception was at its best in 1922, should be progressively worse from 1922 to about 1928, and that, in succeeding years, reception conditions should improve and be at their best again in 1933. It will be interesting to see



© Bachrach

ORRIN E. DUNLAP, JR.

New York

Radio Editor, the *New York Times*:

*"Radio to-day is comparable to a football game—anything may happen at any time. Some research engineer, or an amateur experimenter, of whom there are thousands, may, without warning, plunge through the barriers of science any day with some radical discovery. Nothing of such an exciting nature has happened in radio for several years. Progress since 1922 might be compared with line plunges, resulting in constant gains toward the goal of perfection, but no long runs. It is a question just what this inventor, who skirts the end and evades the tackles Nature places in his path, will place behind the goal posts of achievement, but it is likely to be a revolutionary discovery based upon short wavelengths, a vacuum tube that will do the same work that eight, or nine, tubes can perform to-day, a practical television, a radio motion picture system, or possibly a static eliminator. It is still problematical whether or not broadcasting will be shifted from the present wave band channels to those higher than 3750 kc. (below 80 meters). However, if some laboratory is developing a Red Grange for the ether, a discovery may come which will warrant the change. The coming year may witness the beginning of a startling shift play."*

whether this occurs and whether future observations on sun spots will show a closer correlation with radio reception conditions."

**CARDINAL DUBOIS**, of Paris (interviewed at the Eucharistic Congress): "Radio broadcasting and telephony is a marvelous invention, which attests, perhaps more than all others, the powerful ingenuity of human intelligence. . . . But, like all other material progress, this one too can serve as well both good or evil. The centers from which these mysterious waves go forth are, at will, foyers of either truth or error, virtue or corruption, moral relaxation or wrongful pleasure. They can, across the continents, do the work of life or death, serve noble causes, or collaborate powerfully with social disorder—mislead the spirit and corrupt the heart."



# How a Low Barometer Affects Radio

An Interesting Comparison Between Radio Reception in 1925 and 1926—A Theory Suggesting Why Radio Reception Was Poor From December of Last Year On—The Home Observer Needs a Daily Weather Map and a Receiving Set for His Equipment

By EUGENE VAN CLEEF

Ohio State University

**M**ANY radio listeners who have long been accustomed to many nights with good reception, wondered whether their sets suddenly depreciated during January, February and March and later months of this year. In some instances they requested dealers to refund their money and in other cases tinkered with their sets "either for better or for worse"—often for worse. While complaints of poor reception have been lodged against stations located east of the Rockies and north of the Ohio River, the same listeners have found some consolation in good reception from broadcasting stations located in the south half of the country.

No one knows just why receiving conditions have been so peculiar; but we are convinced that whatever the cause, neither the sets nor the broadcasters can be held responsible. It seems more than likely that our old friend "Weather" must bear the brunt of the blame, although the weather itself probably is the consequence of the vagaries of solar radiation. However, until we have established the exact relation between variation in the atmospheric circulation and the sun's heat, it may be helpful in the final solution of the problem if we succeed in definitely correlating static and atmospheric conditions. We shall therefore first present a theory in explanation of the relation between static formation and the atmospheric circulation, and follow with its application to the unusual conditions during the past winter.

In RADIO BROADCAST for May, 1925, ten points were presented in an article entitled "Do Weather Conditions Influence Radio?" to indicate what atmospheric phenomena affect radio reception as determined by the writer up to that time. To these points an eleventh is now added, which in some respects was implied by the original ten. The new point reads as follows:

11.—Reception is accompanied by static when transmission crosses any part of a warm humid Low or when transmission crosses an area adjacent to an intensely developed humid Low whose surface temperatures are above the freezing point. If the precipitation throughout the Low is rain, static will be pronounced, while if snow or ice, little or no static will occur.

THUNDERSTORMS NOT ESSENTIAL TO STATIC

**T**HE new point implies that if a Low is dry and either warm or cold, or if it is wet and cold, reception across it may be good, although as indicated in point 4 in the series above referred to, transmission across Lows tends to be weaker than across Highs. This statement differs from those of other investigators who have recognized Lows as static breeders, in that thunderstorms are not set up as a requisite for static formation. In an unsigned article in *Tycos-Rochester* for January, 1926, a similar theory is expressed but its author seems to require precipitation, moderately high temperatures and preferably thunderstorms. Point 11 does not include thunderstorms as essential to static development. On the other hand one must not infer that local rains will produce static in sufficiently large quantities to affect radio reception. Precipitation in a Low, so far as it affects transmission or reception must be interpreted in terms of the pressure area as a *unit* and not as a local phenomenon. Still further, we should note that our point does not even require *precipitation* for static building. This will be explained later.

STATIC ELECTRICITY AND CONVECTION

**M**OST meteorologists are agreed that the electrical charges formed in the upper air are the result of convection and consequent condensation of moisture into over-sized drops which are torn asunder when they encounter the strong up-draft of air from the earth. The disruptive action produces positive and negative ions, positive charges collecting upon the larger

drop-fragments and negative charges on the smaller drops. The fine negatively charged particles are carried back into the clouds or even above them, while the large positively charged drops may continue to the earth as rain or they may be carried back to the cloud to form a positive cloud base as opposed to a negative cloud top. It is not essential that the condensed water vapor reach the earth in order that electrical charges be formed. In other words, precipitation, as stated above, as far as the earth's surface is concerned, is not a requirement to static building. When temperatures are such as to condense the water vapor into snow crystals, the same method of potential building applies as to raindrops, but because convection at low temperatures usually is weaker than at high temperatures, and since the flakes offer slight resistance to the air, the breaking up of the snow crystals is not a vigorous process and therefore an inconsequential accumulation of electrical charges takes place.

We must recognize in all this development of a large difference in potential between the earth and the upper atmosphere, that a state of equilibrium exists normally and that the mechanical action of the Low merely induces an excess of charges which we interpret as static electricity

THE WEATHER IN 1925 AND 1926 COMPARED

**A** COMPARISON of the weather maps for January, February, and March of 1926 with those of the corresponding period of 1925, reveals certain differences among the Lows and Highs which, in the light of the above discussion, will account for the differences in reception.

- A—The number of warm humid Lows, that is, areas with much precipitation at temperatures above freezing at the earth's surface, showed a 15 per cent. increase for 1926\* over those for 1925. (\*Reference to 1926 or 1925 hereafter will mean only the months of January to March inclusive and not the whole year.)
- B—The number of Lows in which precipitation was general throughout the area was 32 per cent. greater than in 1925.
- C—In the region east of the Rockies, the Lows in 1926 were more intensely developed than

---

**M**UCH interest has been aroused by the series of articles published by RADIO BROADCAST on how weather conditions affect radio receiving. The first article to appear in any national radio magazine was that from the pen of Mr. Van Cleaf and it appeared in the May, 1925, RADIO BROADCAST. Since that time, we have printed others and the subject has been very generally taken up and discussed. The present article is not an exhaustive examination of a rather large subject. The author tries to show how a positive condition of the weather, attested by the records, may have had some connection with radio reception. The ten points laid down by Mr. Van Cleaf appear on another page, together with the eleventh which he adds with this article. Mr. Van Cleaf is not primarily a radio man, but he brings to radio an specialized knowledge of meteorology which is of great value and lends authority to what he has to say.

—THE EDITOR.

---

in 1925 and the pressure at their centers was, on the average, lower. The number of Lows in 1926 whose pressure was 29.6 inches or below, exceeded that of 1925 by 50 per cent.

The excess of 15 per cent. of warm humid Lows, on the basis of the theory advanced under point 11, favors an increase in the frequency of static formation by the same percentage. This frequency alone, if distributed evenly over the three-month period would mean a reduction of good reception amounting to one day per week, less than normal. If to this be added the effect of an increase in all wet Lows—point B, represented by the difference between 32 per cent. and 15 per cent. or 17 per cent., then there is the possibility of an additional day per week of poor reception. Conservatively, we may reduce the effectiveness of the latter factor to one-half day per week.

The fact that there were 50 per cent. more Lows in 1926 than in 1925 whose pressures were below 29.6 inches at their centers, points to further unsatisfactory atmospheric conditions in the former than in the latter year, for, the more violent the convection, the more favorable the opportunity for the accumulation of electrical charges. Strong convection tends to increase the number and thickness of clouds, and, the stronger the updraft of air into these cloud bases, the more readily will the large globules of water in them be disrupted. A large number of positive and negative charges will concentrate in the cloud layer and play havoc with radio reception.

As previously stated, many listeners have the impression that thunderstorms are basic to the formation of static. Within certain limits this conception is correct, yet a comparison of thunderstorm frequency in 1925 and 1926, brings to light an important exception. In 1925 there were 18 per cent. more days than in 1926, when thunderstorms occurred. If these storms alone were an index of static, then reception in 1925 should have been worse than in 1926, but just the converse was true. The thunderstorm which we recognize by the flash of lightning or the peal of thunder, is only an indicator of the fact that electrical charges have grouped themselves in a position favorable for a discharge. Lightning as a manifestation of a discharge is not a *cause* of static electricity; rather it is a sign of the return of the atmosphere to a state of electrical equilibrium. Equilibrium may be maintained quite as well by numerous small discharges, both invisible and inaudible, and not classifiable as thunderstorms in the popular sense, nor for that matter, as construed by meteorologists. It seems more than likely, that the Lows of the past winter were of the small discharge type and for this reason created trouble for us. There is no reason to suppose that numerous diminutive discharges may not be as effective as a few large discharges. The more intense Lows of 1926 were highly favorable for the development of small discharges and for the building up there-

fore of a substantial difference in potential between the upper atmosphere and the earth's surface. The total adverse effect, measured in days of poor reception, is difficult to determine so far as this phase is concerned. Perhaps a half day per week would not be an exaggeration.

#### SECTIONAL RECEIVING CONDITIONS

THE effect of all the factors cited above as contributors to the difficulties experienced in reception during 1926, totals at least 2 days per week. In a week of 7 days, during which good reception normally might be anticipated 50 per cent. of the time or about 4 days, an incursion of 2 days of bad reception is certainly sufficient to cause consternation among the listeners. Radio reception reduced to two nights per week and sometimes to one night, is not particularly attractive.

In the first part of this discussion, reference was made to the poor reception in the northern and eastern part of the country with respect to the programs broadcast from within the territory. This is exactly what might have been expected, had we known in advance what the paths of the Lows and their frequency of succession would be. The weather maps of the period under consideration show that the number of days of low pressure along the Atlantic seaboard, either over the land or immediately offshore, was 23 per cent. greater in 1926 than in 1925. In other words, the succession of days with low pressure along the Atlantic coast was,

in 1926, far in excess of that during 1925. Here again is reason for disturbed reception. Since low pressure favors static building, and since the static influence may be felt upward of 1000 miles and even 1500 miles from a Low, it follows that the greater the number of days a Low lingers near our station either *en route* toward it or passing beyond it, the more likely are we to experience trouble.

Why should reception from Southern stations have been relatively good during the breakdown in the North? The answer may be found in the set of conditions just described. While the pressure distribution in the North favored an excess of Lows it likewise contributed to the maintenance of high pressure in the Gulf Region. High pressure opposes the formation of static-producing conditions. In Highs, moisture is evaporated by a descending current of air and carried along the earth's surface toward a Low. In place of condensation and cloud building we have evaporation and cloud dissipation. The weather maps of 1926 are impressive for the persistence of high pressure in the south. Hence we should logically expect favorable transmitting and receiving conditions.

The above is offered only as a suggestion of what may have happened and not with the idea that it possesses finality. Since discussion often makes for progress, it is hoped that the writer's theory may serve to stimulate others to further research along similar lines which may lead to a solution of this perplexing but fascinating problem.

### How to Forecast Radio Receiving Conditions

THE list of points below, originally set forth by Mr. Van Cleef in his May, 1925, article in RADIO BROADCAST, show the bases on which he calculates radio receiving conditions. Although other investigators do not grant that these points are final, and dispute some of them, at least they serve a very useful purpose in giving something to the amateur investigator to work with. Many of these points are referred to in the accompanying article.

1. If a line connecting the receiving station with the broadcasting station crosses the intervening isobars at right angles, reception is at its best.
2. The steeper the isobaric gradient (that is, the closer the isobars to each other) the stronger the reception.
3. The more nearly the transmitted waves approach parallelism with the isobars, the weaker the reception. Under these conditions, fading occurs.
4. Reception in a Low pressure area tends to be somewhat weaker than in a High of corresponding intensity.
5. Reception is weaker when the transmitted waves cross from one pressure area into another than when they travel only within one area.
6. The strength of reception for any station is a factor of both its location within a pressure area and its position with respect to the broadcasting station.
7. "Bad weather" does not affect reception, excepting as it may be the index of an unfavorable pressure distribution.
8. Reception can be as good in "bad weather" as in good weather if the pressure distribution is right.
9. Temperature does not influence reception, excepting as it may be the index of pressure distribution as follows:—
  - (a) Reception is better in winter than in summer because the cyclones and anti-cyclones are more intense in the winter period.
  - (b) Reception is better when temperatures are low than when high, because low temperatures usually indicate intensive High pressure areas, that is, areas with steep isobaric gradients.
  - (c) Low temperatures accompanying poorly defined High pressure areas make reception poor.
10. Shallow or flat pressure areas result in much static-noise in the receiver.
11. Reception is accompanied by static when transmission crosses any part of a warm humid low, or when transmission crosses an area adjacent to an intensely developed humid Low whose surface temperatures are above the freezing point. If the precipitation throughout the Low is in the form of rain, static will be pronounced, while if snow or ice, little static will occur.

(An "isobar" is a line which passes through all points whose barometric pressure is the same.)

The author's remarks in this article should not lead one to think that the presence of static is a sign of poor reception. Poor reception may obtain without a trace of static. But Mr. Van Cleef says that if the signals go through a low pressure area, there will be static. During the winter months of this year, reception has not been good in the United States and conditions have been marked by a general diminution of field strength, due to causes as yet positively undetermined.

# The New "Universal" Receiver



RADIO BROADCAST Photograph

## THE "UNIVERSAL" IN A CABINET

Made by the Corbett Cabinet Company. This is the final result of several months of experimenting in RADIO BROADCAST Laboratory. The Trimm cone speaker is of the free edge type

*How the Popular "Universal" Receiver May Be Re-Wired to Include Many New Features—Capacity Controlled Regeneration Permits Smoother Control and Better Quality—Roberts Neutralization System Replaces Rice's—Provision Is Made for Power Amplifier, to Be Described*

By HOWARD E. RHODES

**U**NIVERSAL, many readers will recall, was the name of a receiver described in the January, 1926, issue of RADIO BROADCAST. This name is taken again for the receiver described in this article, not so much because of a resemblance between the two circuits, but rather because many of the same parts are used, which makes it possible to easily change over the old "Universal" into a set identical with the one described herein.

This is the first of two articles, and it will cover the construction of the receiver. The second article, to follow very soon, describes a power amplifier working directly from the a.c. mains. This power amplifier uses a full-wave rectifier to supply plate and grid voltages for the 171 tube which is an integral part of the unit. The filament of the 171 is lighted by raw a.c. The amplifier unit will also supply B-battery voltages for the operation of the receiver.

The receiver illustrated in this article, combined with the power amplifier, will make an excellent all around outfit. All of the power, with the exception of the filament current for the receiver, will be drawn directly from the power mains, and if the storage battery is operated in conjunction with a trickle charger, the set-up will be almost ideal from the operating standpoint, since it will require practically no attention.

It will of course be possible to change over one of the old style "Universal" receivers so as to make it conform with the circuit diagram of the new model by merely rewiring the old set and replacing whatever parts are necessary. However, this is hardly to be recommended, since the receiver will not be as stable in operation as it will be if the parts are relocated in accordance with the diagrams accompanying this article. While a great many home constructors obtained very good results from the original model, there were some who found it difficult to satisfac-

torily neutralize the radio-frequency amplifier and, consequently, in these cases, the operation of the receiver was somewhat unstable so that the point of highest efficiency could not be obtained. This later model has been designed to give perfectly stable operation. The r.f. amplifier, using Roberts neutralization, is very

model is given in Fig. 2, while Fig. 1 is a diagram of the receiver described in this article. Any one desiring to revise his receiver will find it necessary to purchase the following parts:

- 1 Samson Choke Coil, Type 125.
- 1 General Radio Midget, type 368.
- 1 Yaxley Double-Circuit Jack.

### The Facts About This Receiver

Name of Receiver	New "Universal" Receiver.
Type of Circuit	Tuned radio frequency with regeneration in the detector circuit.
Number of Tubes	Four: 201-A in the r. f. stage, 201-A or 200-A in the detector circuit, 201-A in the first audio stage, and a 112 or 171 in the last stage.

This receiver is a revised model of the "Universal" which was originally published in the January, 1926, issue of RADIO BROADCAST. This later model uses Roberts neutralization, condenser control of regeneration, and a two-stage transformer-coupled audio frequency amplifier. The original "Universal" is easily changed over to conform with this new model.

easy to neutralize, and the control of regeneration by means of a variable condenser evidently gives smoother operation than can be obtained using a resistance across the tickler coil. The circuit diagram of the original "Universal"

First, sufficient selectivity to satisfactorily discriminate between the various broadcasting stations; secondly, an r.f. amplifier capable of being accurately neutralized, so as to completely prevent radiation; thirdly, a high quality audio output.

The circuit of this new "Universal" receiver, given in Fig. 1, consists of a regenerative detector preceded by a neutralized radio frequency amplifier, and is capable of a high degree of selectivity sufficient for even the present-day congestion. The r.f. amplifier in this receiver is neutralized by the Roberts method, neutralization being practically complete over the entire broadcast band, so radiation cannot take place. It is thought by some that, provided a regenerative detector is preceded by an r.f. amplifier which does not self-oscillate, radiation will not take place. This is not so, however; a

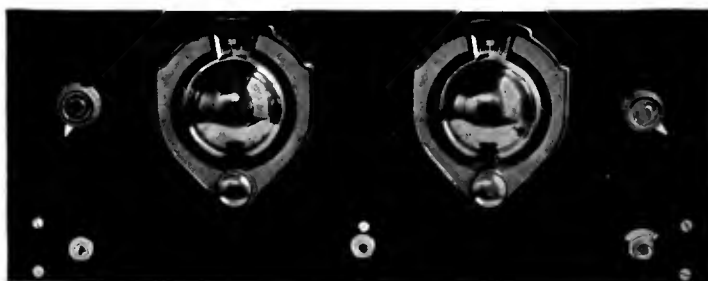

RADIO BROADCAST Photograph

### THE SYMMETRICAL LAYOUT

Of the front panel of the "Universal" gives a very pleasing effect. The center jack is connected in the first audio circuit and the left hand jack is for the loud speaker. The dials are made by the Kurz-Kasch Company

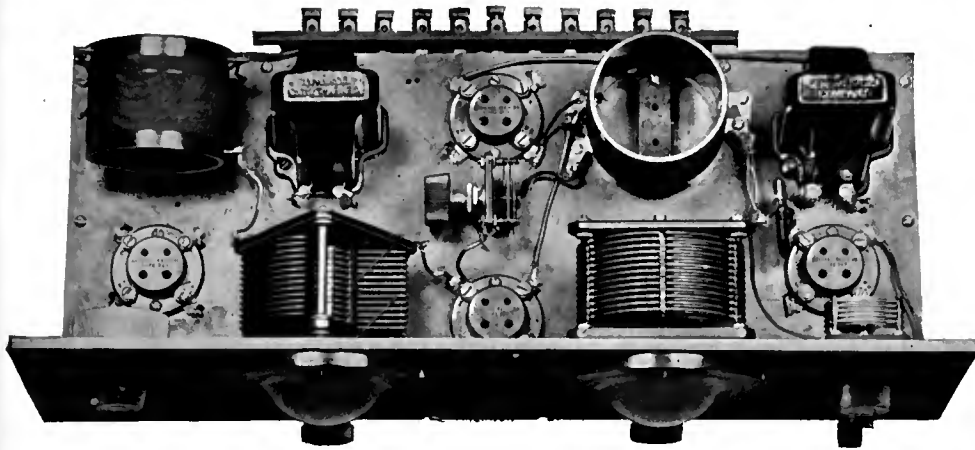

RADIO BROADCAST Photograph

LOOKING DOWN ON THE "UNIVERSAL"

The arrangement of parts as seen from the top. Notice how short are the leads that connect to the neutralizing condensers. Various arrangements of parts were tried before this final layout was decided upon

using the new General Radio type 285D transformers, which have an unusually high primary impedance—about 375,000 ohms at 1000 cycles. If this primary were to be shunted by a 0.001-mfd. condenser with an impedance of only 160,000 ohms at 1000 cycles, a large part of the audio currents would flow through the condenser instead of through the transformer primary. The shunting effect of a 0.001-mfd. bypass condenser is bad enough at 1000 cycles but is very much worse at higher frequencies. However, using a midget condenser for regeneration, no such shunting condenser is necessary. The midget condenser affects the circuit in the same way but, since its value is considerably less than 0.001 mfd., its effect is not as detrimental.

VOLUME CONTROL

THE volume control is a variable rheostat in the radio-frequency amplifier's filament circuit. It modulates the volume very satisfactorily and has practically no effect on the tuning.

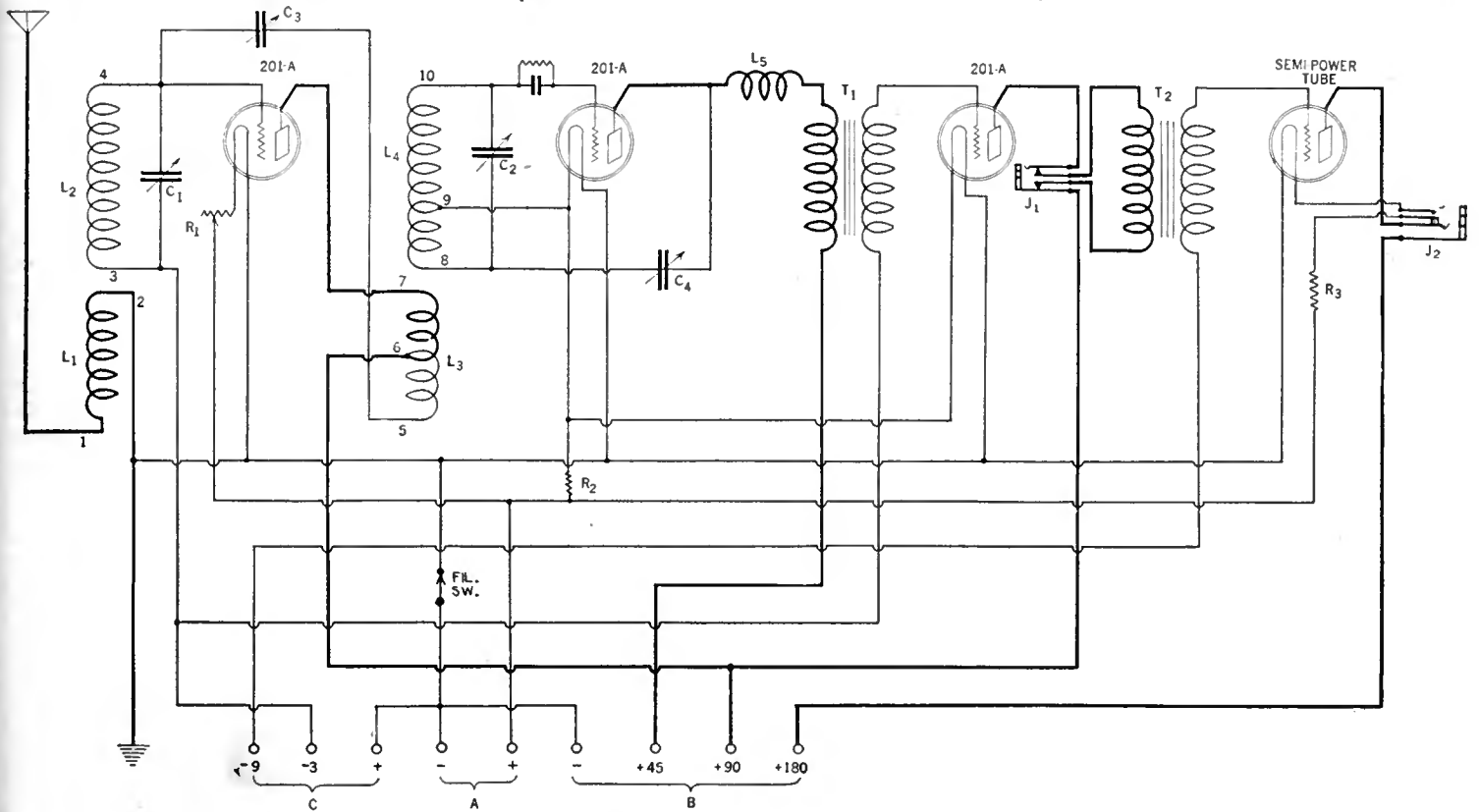
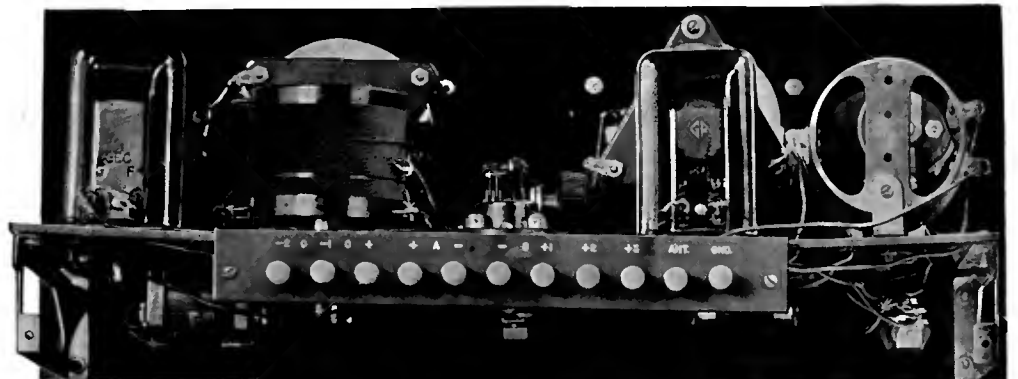

FIG. 1

The circuit diagram of the new "Universal" receiver described in this article. This circuit differs somewhat from that formerly described in RADIO BROADCAST, as will be evident from a study of Fig. 2, but the parts used in the original model are practically the same as employed here

receiver will radiate unless the r.f. amplifier is neutralized. The bridge circuit in a neutralized amplifier prevents the flow of any currents in the grid inductance capable of inducing voltage in the antenna. On the other hand, an unneutralized amplifier may not break into self-oscillation, but it is still capable of allowing currents to flow in the grid inductance that will cause radiation. The importance of a properly neutralized amplifier is quite evident.

Regeneration is controlled by a small variable condenser connecting between the detector plate and the end of the grid coil, in the usual manner. This method of feed-back has two advantages over the old-style movable tickler coil. In the first place the control is very much smoother and, secondly, it tends to somewhat better the quality, by lowering the value of shunt capacity across the first audio transformer. This is a significant point, and is especially important in this receiver,



THE REAR VIEW

RADIO BROADCAST Photograph

Of the "Universal" Receiver, showing the binding post strip and arrangement of the sub-panel brackets. The following B battery voltages should be applied to the terminals: + 1, 45 volts; + 2, 90 volts; + 3, 135 to 180 volts. The C battery voltages are; Minus 3 volts to terminal - 1 and minus 27½ to 40½ volts to terminal minus 2

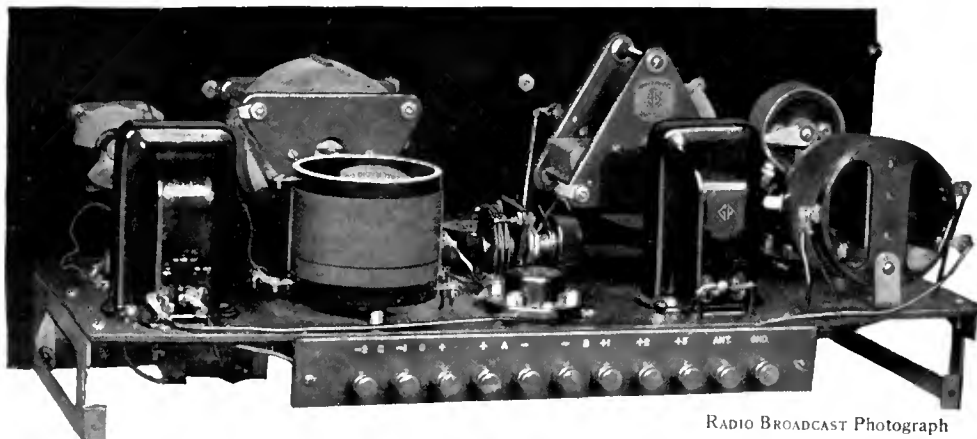

RADIO BROADCAST Photograph

BEHIND THE PANEL

Another view of the "Universal," showing the arrangement of parts as seen from the rear

It is not always possible to use only the regeneration condenser for volume control since it may sometimes be necessary to boost regeneration considerably to obtain sufficient selectivity, and the volume made greater than is desired. In this case it can then be reduced by varying the filament rheostat, still retaining a high degree of selectivity.

The dials used are the product of the Kurz-Kasch Company. They are especially suited to the "Universal" since they are made completely of bakelite. If a metal dial were to be used, there would be noticeable hand capacity when tuning the second condenser, but using a solid bakelite dial, there is no hand capacity at all. The dials are of the vernier type with a friction drive.

There is nothing unusual about the audio amplifier. Both of the transformers are the new General Radio type 285D. A jack is provided

in the output of the first stage. When the switch is turned on, only the first three tubes light. The last tube lights when the plug is placed in the second stage jack. If the receiver is to be operated in conjunction with the power amplifier unit later to be described, the plug is placed in the first stage jack since one stage of audio amplification is incorporated in the power amplifier. In fact, those home constructors who decide to make up both units can put together the receiver with only one stage of audio, entirely omitting the second stage.

In constructing the receiver illustrated in this article, the following parts were used:

- 1 Micarta Panel,  $\frac{3}{8}$ " x 7" x 18".
- 1 Hard Rubber Sub-Base,  $\frac{3}{8}$ " x 7" x 17".
- 2 Kurz-Kasch Dials—Clockwise.
- 2 Benjamin Brackets.
- 1 Yaxley Double-Circuit Jack.
- 1 Yaxley Single-Circuit Filament Control Jack.

- 1 Carter Switch.
- 1 Samson Choke Coil, Type 125.
- 1 Elky Filament Resistance, Type  $\frac{3}{4}$ .
- 1 Elky Filament Resistance, Type 2.
- 1 Micamold Combined 4-megohm Grid Leak and Condenser.
- Coils Celatsite Wire. One coil each of the following colors: Yellow, Red, Black, Green, and Brown.

And the following General Radio parts:

- 2 Type 277D Coils.
- 2 Midget Condensers, Type 368 and 368B.
- 4 Type 156 Sockets.
- 1 30-Ohm Rheostat.
- 2 Type 285D Audio Transformers.
- 1 Type 138A Binding Post Strip.

If it is desired to use home-made coils, they may be made up with the necessary taps in accordance with Fig. 4. If General Radio coils are purchased, it will be necessary to tap the interstage coil at the exact center of the primary winding, and also tap the secondary at the 15th turn from that end of the secondary nearest the primary. Both of these taps are made on the same coil unit. No taps at all are necessary in the coil employed ahead of the first tube.

PREPARATION FOR ASSEMBLY

WHEN the necessary parts have been collected together, the first thing to do is to drill the panel in accordance with Fig. 3. The mounting holes for the condensers have not been shown. Drilling templates are enclosed with the condensers when they are purchased, and it is very much easier to spot the holes using a template.

The next thing to do is to lay the sub-panel flat on the table and place the various parts on it. The location of these parts can easily be determined by reference to the top-view photograph on page 155 and to the picture diagram,

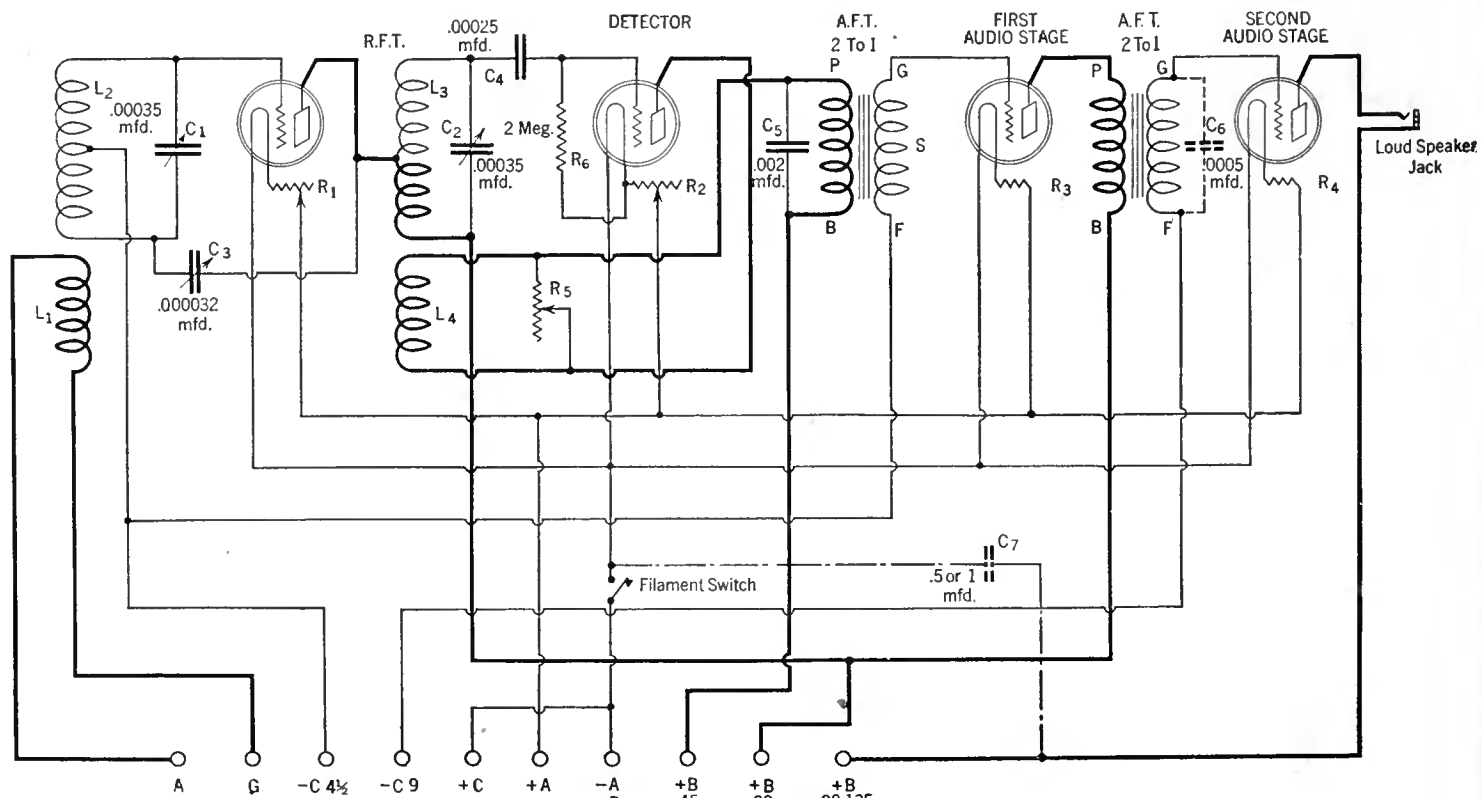

FIG. 2

The original "Universal" receiver circuit diagram, as it was presented in the January, 1926, RADIO BROADCAST. Reference to Fig. 1 will show that several fundamental changes have been made in the new receiver. For example, a different and smoother control of regeneration is used, which may also result in better quality. Also, the Roberts scheme of neutralization has been substituted for the Rice method. Yet, with the changes recommended, it will not be necessary for the owner of one of the old "Universals" to discard any but one or two small pieces of apparatus in rewiring his set to the new circuit

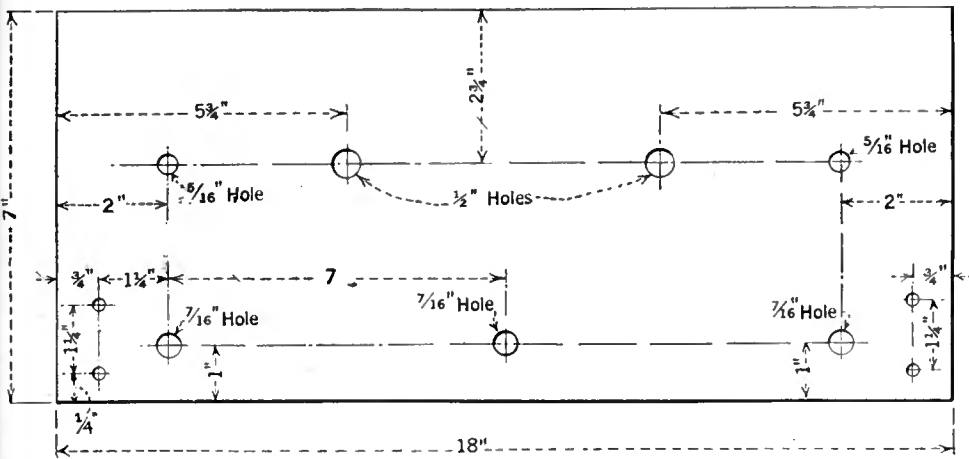

FIG. 3

The holes to be drilled on the front panel are here indicated. The condenser mounting holes are not shown. The drilling template supplied by the manufacturers will supply these data

Fig. 5. One of the coils can be placed vertically, raised off the sub-base by two small brass collars; the other is mounted by means of a small brass bracket. Both coils must be at exact right angles to each other. It is strongly recommended that the apparatus layout as shown, be strictly adhered to. It has been carefully thought out and, when used, results in very short leads in the important parts of the circuit. For instance, examine the picture diagram with reference to the various leads in the plate circuit of the radio frequency tube. Notice how the plate lead goes directly to the coil and how the lead from the other end of the coil passes to the conveniently located neutralizing condenser and hence to the grid. Neutralizing is at best a rather delicate job and an endeavor should always be made to make all the leads that have anything to do with it as short as possible. There are some fairly long audio leads, but they will not be bothersome in the least. These facts were all considered in laying out the parts and the arrangement shown is known to give good results.

The parts having been carefully placed, the various mounting holes are spotted with a prick punch. The parts are then removed and all of the holes drilled with a No. 28 drill. The supporting brackets should also be located and the holes drilled for the fastening screws. Don't forget to mount the binding post strip on two small right angles and spot two holes where it is to be mounted on the sub-base. Mount it far enough back from the sub-base so that when the set is put in a cabinet the strip will project through a slot cut on the back of the cabinet and be just even with the outer surface.

The brackets and parts can then be screwed in place, but these former should not yet be fastened to the front panel. Before this is done, small holes should be drilled in the sub-base at various points so that leads can be brought up through them and soldered to the various terminals on the sockets and other parts. Practically all of the wiring is done under the sub-base so that a lot of exposed leads will not be visible from the top of the panel to detract from the final appearance of the receiver.

Now mount the various parts on the front panel and put the dials in place. In putting on the dials, take care to catch the little friction driving wheel under the dial proper before pushing the mounting screws of the cover into the holes in the panel. Now screw the brackets to the front panel and the first part of the job is done. Next we come to the wiring.

WIRING

IN THE wiring of the receiver we used the insulated flexible wire made by the Acme Wire Company and known as Celatsite. Flexible wiring has several advantages over bus-bar. In the first place, many persons will find it is easier to work with than bus-bar. An example

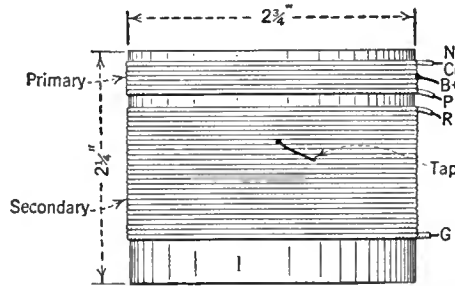

FIG. 4

The taps on a General Radio coil, for use between the r. f. and detector tubes, are indicated here. The secondary consists of 50 turns of d. s. c. No. 26 wire. The primary, spaced 1/8" away, contains a total of 13 turns of the same size wire. The tap on the secondary connects to filament while that connection designated by the letter "R" goes to the regeneration condenser rotor plates.

of a good bus-bar job can be seen by referring to the photos in the September issue of the Browning-Drake receiver. But many fans who would find it difficult to do as good a job with bus-bar will be quite capable of doing a good job with flexible wire. In the second place, with flexible wire, it is possible to cable many of the battery leads. In this way the capacity between certain leads is increased, which is desirable. Also, when leads are twisted, the effect of alternating current flowing in one lead tends to neutralize the effect of current flowing in the other lead in the opposite direction. This helps to stabilize the receiver.

All of the battery leads should be twisted together into one cable; in fact, practically the only leads that cannot be cabled are those connected from the grids and plates of the various tubes to the different pieces of apparatus. In wiring, do not run any leads directly under or close to the neutralizing condenser which is fastened to the sub-panel by means of two small screws. The wiring should be arranged so as to keep all the leads at least one inch from this condenser. Flexible wiring, twisted into cables, has been used for quite a while by a great many large companies, and they have found it essential in obtaining stable operation from high-gain amplifiers.

The actual wiring of the receiver is very simple. It is recommended that the colors of Celatsite be used as follows: Yellow, all positive A-battery leads; Black, all negative A-battery leads, and for connections between negative A and C plus, and B minus and ground; Red, plate leads for the second audio tube, for leads between B-plus terminal to second stage jack, and from jack to plate terminal on the last tube; Green, plate leads for the r. f. and first audio tubes. These leads include those from the B plus terminal to center tap on the General Radio coil, from B plus terminal to interstage jack, from jack to plate, and leads between primary of first audio transformer and jack; Brown, plate circuit of detector tube.

There are no other colors for the C-battery circuits so it is suggested that brown also be used for these. There is one disadvantage in sub-base wiring which is that, in wiring under the base, we are likely to forget what apparatus is mounted just over the wire. In such an accidental manner a lead might be run which would very effectively couple together two parts of the

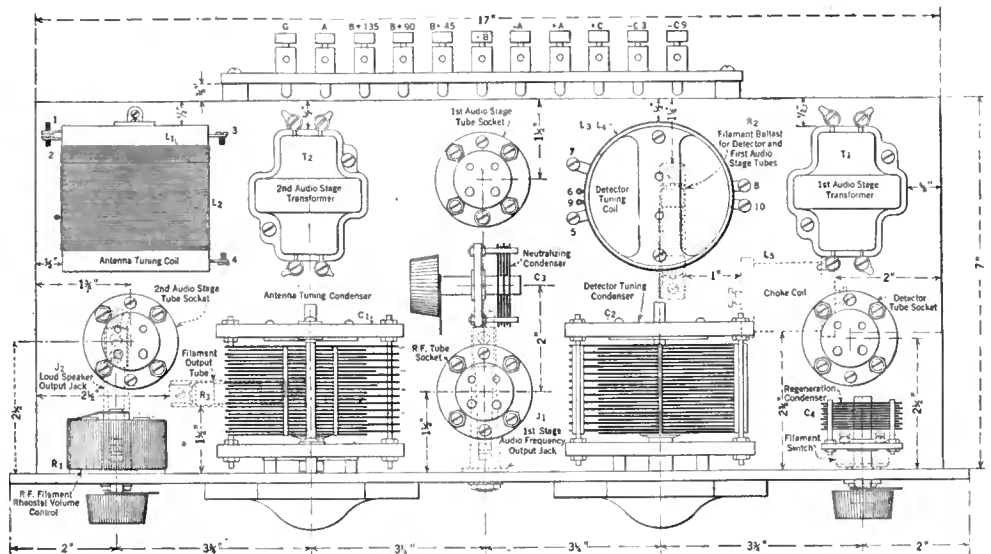

FIG. 5

On the sub-base the apparatus is laid out according to the arrangement here shown. Note that, so that it will protrude sufficiently when the receiver is placed in a cabinet, the binding post strip has been arranged to stand from the sub-base

circuit, and perhaps make it difficult to obtain perfect neutralization.

When the wiring is done (and it won't take very long) the batteries can be connected. The various voltages are marked in Fig. 1. Put the phones or loud speaker in the correct jack and place the regeneration condenser at the maximum position. Now revolve both dials.

Do you hear a squeal? That's fine. Now, as you listen to the squeal, slowly rotate the first dial back and forth. Perhaps the squeal changes in pitch and at one setting it may disappear altogether. This indicates that the set is not properly neutralized. Vary the setting of the neutralizing condenser with one hand as you move the first dial. At one point, you will find that, although the squeal varies in strength, it does not change in pitch. This indicates correct neutralization. Leave the neutralizing condenser as it is and see what other stations you can "pull in."

TROUBLE SHOOTING

PERHAPS you are not so fortunate; possibly, in your case, when you connected the batteries nothing at all

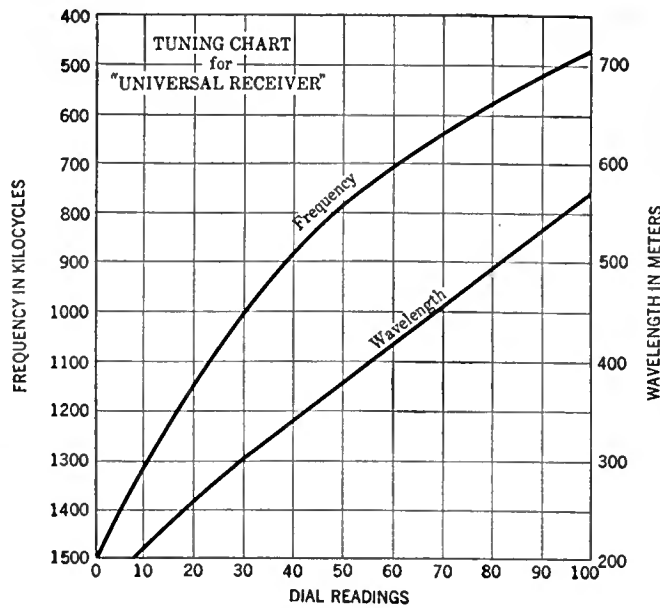

A TUNING CHART FOR THE "UNIVERSAL"

The dial settings are plotted against frequency in kilocycles and wavelength in meters. To approximately set your dials for a certain station, look up its frequency or wavelength, find this point on either the frequency or wavelength curve, and from it drop a perpendicular to the horizontal axis, the point of intersection being the approximate dial setting

about two mils., while a 171 in the last stage, with 135 volts of B battery, will take 10 or 12 mils. If, on inserting one of the tubes in a socket, there is no increase in plate current, check through the plate circuit of that particular tube and find the open circuit.

If, on the other hand, a microphonic ring can be heard in the output when the detector is tapped, the trouble is then to be found in the detector tuning circuit or in the r.f. amplifier circuit. Connect the antenna directly to the plate of the r.f. socket (the r.f. tube being removed) and operate the receiver as you would an ordinary three-circuit affair. If reception is satisfactory with the antenna connected to the plate of the radio frequency tube socket, the r.f. tube should be replaced, and the antenna connected in the normal position. If reception cannot be obtained now, one may be sure that the trouble is in the grid circuit of the first tube, and it should not be very difficult to locate. Look at the various connections very carefully and be sure that all the joints are solidly made.

If, upon turning on the receiver, there is an audio howl, it can often be eliminated by reversing the prim-

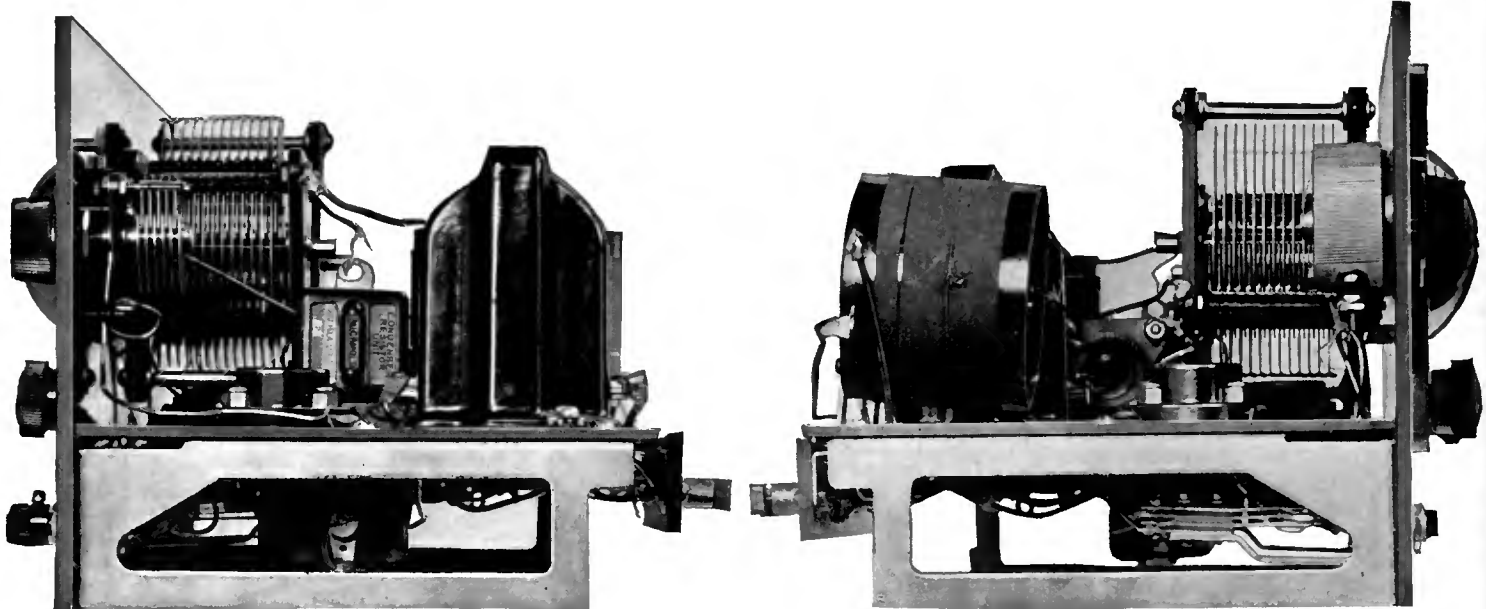

RADIO BROADCAST Photograph

LOOKING EAST—THEN WEST

Two side views of the "Universal." The coil to be seen in the right-hand view is tilted—by mistake. It should be parallel to the sub-panel. These views show clearly how the brackets are mounted. The volume control, a rheostat in the filament circuit of the radio frequency tube, can be seen in the right-hand view. In this view there can be seen the tap on the first coil which should be used if the receiver is to be operated on a short indoor antenna. On a very short indoor antenna, connection should be made directly to the grid of the radio frequency tube

happened, and so we have to begin to "trouble shoot." The first thing to do is to very carefully check over the wiring. Do a thorough job of it, going over the entire receiver. Trouble of this sort is almost invariably due to an incorrect connection and a careful check should show it up. Some simple tests can also be made which will more or less localize the trouble so that the difficulty can be cleared up somewhat easier. A simple test is to connect the loud speaker into the second stage jack and lightly tap the detector, first audio, and

second audio tubes. A microphonic ring should be heard in the loud speaker if the audio amplifier is functioning correctly. The noise should be especially loud when the detector tube is tapped. If no such sound is heard it is indicative of trouble in the audio amplifier. If you have handy a milliammeter, connect it in series with the negative B lead, and then insert the tubes in their sockets one at a time, and be sure that each tube takes plate current. The r.f. and first audio stage tubes should take about 3 milliamperes each. The detector should take

any winding of the second transformer. Also, it is generally best to ground the cases of the transformers. This can be done by soldering connections to the mounting screws on the cases and connecting the lead to the ground binding post.

If the receiver is operated on a short indoor antenna, louder signals will be obtained if the antenna is connected to the center tap on the first coil rather than to the primary winding. The receiver, as designed, is for use on an outdoor antenna about one hundred feet in length.

# The Listeners' Point of View

Conducted by — John Wallace

## Kind and Unkind Words About Our Friends, the Announcers

THERE should be a law forbidding announcers to do any announcing during six months of each year. The law should further stipulate that no announcer should be allowed to so much as cross the threshold of a studio during that period of exile. Announcers should likewise be enjoined to read no syllable concerning radio during this off period and a penalty of a one-year suspension should be invoked for each and every time an announcer is discovered, during his days of retreat, talking to any one having any connection whatsoever with a broadcasting station. In short, the announcer should spend half of every year simmering the poisons of the studio out of his system.

To what profitable use an announcer could put the six months of leisure is a bit uncertain. Some of them might, with great benefit to themselves, spend it at touring in vaudeville, conducting a Lonesome Hearts column in a newspaper, or posing for advertisements of insidious diseases and Stay-Stuck hair preparations.

The benefits to the listener accruing from such an enforced vacation would be very great. It is not at all difficult to understand the dangers of ingrowth to which an announcer submits himself by a too prolonged period in the broadcasting studio. Nor, to be charitable, is it really surprising that his point of view should become horribly warped.

For such is the fact of the case: the announcer, unless he be a bigger man than his job (which a few of them are) soon, from viewing said job too closely, loses all sense of perspective and is unable to subject it to any objective criticism.

His every day association with fellow members of the studio staff and the intimacy resulting therefrom, gives him a grossly distorted and exaggerated view of the staff. When this sorry state has come to pass then we, the listeners begin to be treated to a back yard view of the studio's wash and other lingerie. It is then that we are privileged to glean such highly interesting bits of information from his announcings as:

Well, ladies and gentlemen, Charlie has just come in. Old Charlie Benzing, the smiliest studio manager that ever was. And Oh Boy! is Charlie wet? The water's just dripping off his brand new plush hat. Must be raining pretty fierce outside. And now folks we're going to hear a program of songs from Mabel McGillicudy. Micky's all dressed up so nice and pretty tonight. I just wish you could see her. And for her first number she's going to

sing *If a Rose Had Wings*. And believe me that's a pretty song. We boys in the studio like it better than anything else she sings. All right Micky. . . .

Now let's not be too harsh with such an announcer. He's really interested in the fact that the studio manager came in with water dripping off his hat. For perhaps six or seven hundred nights he has watched Mr. Benzing come in that very same door at that very same time without any drop of water dripping from his hat. Is it any wonder that he is delighted to see him come in for a change, doubling as an over-worked fountain statue? It is an event, a wondrous break in the studio's monotony. And he feels that he is doing his listeners quite a favor in sharing with them this fascinating bit of news.

Of course as a matter of fact, we listeners don't give a whoop whether Mr. Benzing comes into the studio at all. It's really nothing in our lives whether Mr. Benzing even exists or not. But

of such a broad point of view, this sort of announcer is incapable. For him Mr. Benzing is one of the world's outstanding personages. And why? Because his vision has gone out of focus from a too-prolonged stay in the close confines of the studio.

Manifestly, only an idiot would allow his sense of proportion to become so lop-sided. But idiots are not confined to the loud speaker end of the wireless arrangement.

This same weakness, resulting from over-familiarity with the job is to be observed even in the workings of a newspaper. For instance your County Building reporter will come back to the city desk with lengthy stories on some utterly trivial doings of the coroner or the county sheriff. To him they seem news of great import and he is grieved when the city editor cuts them down to five-line mentions. By the time the paper is printed such manifestations of "staleness" are generally absent. Nor does a paper, outside of the village *Bugles*, ever relax its restraint to such an extent as to exhibit to the public the machinery behind the scenes. Even the editorials are anonymous. When the Columnist refers informally to the Copy Reader or to the Man at the Next Desk, it is the very fact that this is a highly indecent procedure that gives it much of its humor.

In general, no matter what be the goods it is purchasing, the dear public is not the slightest bit interested in the personnel behind them. When a leading manufacturer of pickles publishes from vanity or some other absurd motive, a full-page advertisement picturing the handsome visages of himself and his lieutenants with a story concerning how long and efficiently they have been working together toward the goal of bigger and better pickles, we venture to guess that the pulling power of the ad' does not result in the sale of enough pickles to garnish three hot dogs.

It is our conjecture that it is due to staleness, rather than to any malignant wish to inflict pain on listeners, that announcers mingle bad puns with their proclaiming of the titles of a series of dance numbers. This is an offense of widespread prevalence. Stations which otherwise exhibit the utmost reserve and dignity break down completely when it comes to titling their dance selections. An example:

And now maybe some of you listeners take a bath once in a while. And maybe



CHARLES B. POPENOE

It takes more than an announcer to run a broadcasting station, and, too, not only the engineers are the important men behind the scenes. The program manager is responsible for every item of entertainment which courses out over the ether. Mr. Popenoe, program manager of wjz, is one of the pioneers in the broadcasting field, and was attached to that station when it was located in Newark and owned by the Westinghouse Company. As every listener knows, wjz broadcasts regularly some of the best features on the air



some of you don't. Haw! Haw! Haw! But anyway for the next number the boys are going to play "Turkish Towel."

Crimes like that are committed by almost all stations—even up to the mighty WEA. The reason is obvious: the announcer has been ushering in perhaps a couple thousand dance numbers during his past year on duty. It has become a gruesomely monotonous chore. He feels he must break the sameness somehow or go crazy. By some strange process of extension he comes to the conclusion that his listeners feel the same way about it. And this is where he exhibits the distortion of his vision. For to the listeners, the formula type of introduction has not become overly monotonous since no one of them has consciously heard the several thousand dance numbers titled during the past year. The most of them don't pay much attention to the names of the pieces anyway. And this fact the fatuously facetious announcer might learn in the course of a six month's vacation. Hence we advocate the half-year lay-off

### The Requirements of a Football Announcer

THE football season is with us again—and will be by the time this appears in print—and with it, the great annual boom in radio's stock. The great army of non-listeners, whose number is legion, perks up its ears and invites itself to some neighbor's house to listen to that much maligned contraption for which it protests utter disdain the other ten months of the year.

Batteries are brought up to normal, antennas are shaken free of bird nests and branches, an extra dozen camp chairs is set up in the front

parlor, and through the autumn afternoons an additional million or so listeners gathers to feast its ears on the one remnant civilization has left to us of the good old bloody jousts of Roman days.

Football is easily the biggest event in the radio year. It is the great Revival Meeting. The Tabernacle is crowded to the doors with Lost Souls, errant males who own no receiving sets, who pay no tribute to the tube manufacturer, to the battery maker, or to the parts dispenser, Recalcitrant Outsiders who poke fun at the Great God Radio for the most part of the year. Now is the opportune moment for high-powered Evangelism, for the winning into the fold of these Scoffers.

We do not think that it is without justice that football lays claim to being the best item of the whole year on radio's bill of fare. As we have before pointed out, music you can hear on a phonograph, speeches you can read in the newspapers, vaudeville you may find in the humorous magazines, but a football game permits of no such substitution. There is small thrill in reading the account of a football game the Sunday after. However you can't always get to a football game that is being played half way across the continent, nor can you for love or money get a ticket to a game if the last seat has been sold. But an ably reported football game is an awfully close second to the real thing. In fact, if you happen to be possessed of a potent, well exercised imagination, it may occasionally be even more vivid than the actual scene itself—and infinitely cheaper in this day of \$40 seats.

And so we trust that the 1926 season will be—is being—ably broadcast. It is radio's chance to make an impression on the thousands of new listeners. The better the impression the better for radio. The colleges can be relied upon to furnish some interesting games. The only ad-

ditional item necessary is for the broadcasters to furnish interesting announcers. Two or three individuals have already shown themselves capable in this rôle. Sad to relate, the dozen or so others have been thoroughly mediocre in past seasons.

The ideal announcer of football games must be more than reporter, more than an orator, more than a comedian—he must be a football enthusiast. For if an individual listens to a football broadcast he, or she, is by that sign a football enthusiast (as who indeed is not from the wash lady to the button king?) And the dyed-in-the-wool fan can easily detect whether the announcer is really a "fan" himself or simply putting up a bluff.

The great secret of the success of football broadcasts is that the listener does his share, coöperates, puts in real creative effort to make it a success. Your every-day listener seldom if ever goes half way; he really doesn't care much whether he listens-in or not. He demands to be shown. But the football fan listener goes more than half way. He is eager and voracious; he is what the artist on the boards refers to as a "responsive audience." As such he ought to stimulate the announcer to put forth his sincerest efforts, as in truth should the game itself, unless it be a hopelessly dull one.

But if the announcer isn't genuinely an ardent lover of football he will inevitably fail at the simulation. Altogether the situation is a difficult one to fill. The requirements in brief are these: the football announcer must be first a football fan; secondly, intimately acquainted with the complex technique of the game; thirdly, a nimble-eyed reporter; fourthly, an experienced handler of the microphone, and finally, a craftsman of words—which means that he must be able to describe rather than recount.



THE HOTEL BOSSERT ORCHESTRA

Broadcast from that hotel in Brooklyn through WEA during the summer

Evidently no announcer now covering football games comes up to a full hundred per cent. in each of these departments, though several approach it closely. Probably no one will ever receive a perfect rating, but station managers might well be guided by the five suggested requirements in selecting the best man for the position.

**WGN's Football Schedule**

**A** MISFORTUNE, indeed that the scheduled broadcasts of football games from WGN, Chicago, were omitted from the list appearing in this department last month. We made request for a schedule many weeks ago, which drew no trace of reply. We make amends, printing below the games that are yet to go:

- November 20th, Ohio-Illinois, at Champaign.
- November 27th, Army-Navy, at Chicago

**The Boston Symphony Orchestra**

**T**HE event of the winter radio season which this particular listener is looking forward to most eagerly is the series of twenty-four concerts by the Boston Symphony Orchestra. This justly world-famous organization went on the air for the first time in its history on January 23 of this year, in a series of concerts through WEEL. This move, a radical one for such a dignified, conservative old band as that of Boston, was brought about through the efforts of W. S. Quinby, a Boston manufacturer, and WEEL.

The Boston Symphony runs not the remotest risk of losing out in gate receipts because its wares are broadcast, for coveted tickets to Symphony Hall have long been in the class of family heirlooms and are passed down in wills from generation to generation. Another objection the directors originally held forth was that mechanical difficulties might impair the broadcast program. Evidently they have been satisfied that the reproduction is accurate enough or they would not have authorized the present radio season. The loud speaker version of the concerts is, of course, not a perfect reproduction of what is going on in Symphony Hall. Its distortion is particularly acute when the music reaches great crescendos of volume. But since listeners realize the existing shortcomings of broadcasting it does not injure the prestige of the orchestra. Some sort of Boston Symphony concert is better than no Boston Symphony concert at all. Moreover anything as perfect as the results Serge Koussevitzky draws from his 107 musicians can stand a lot of mauling without being entirely shorn of its original beauty. The Venus of Melos is still pretty fair to gaze upon in spite of being dragged over the rough cobble stones by a rope around her neck.

The broadcasting of the present season—the

orchestra's forty-sixth—is being sponsored by wbz with the financial backing of the same Mr. Quinby. Fortunately for us of the Middle West, stations more powerful than wbz are to join occasionally in a hook-up, so the concerts should be generally available to any one east of the Mississippi. wjz, wgy, and wrc will assist in broadcasting fifteen of the twenty-four concerts. For your reference we print the schedule:

*Boston Symphony Orchestra Concerts*

- November 13, 20\*
- December 4\*, 11\*, 18, 25\*

the full orchestra of one hundred and ten men. The concerts are to be given in Carnegie Hall, and are especially designed to fit the needs of the student musician. The entire season's program, which is now being prepared by Mr. Mengelberg, will be built in the form of a musical education, and the history of music will be traced from the days of the early composers down to the latest composers of classical music.

The complete list of dates on which the Student Concerts will be heard is given: November 6th, 13th, and 27th; December 18th; January 1st, and 15th; February 5th, and 12th; March 19th, and 26th; and April 2nd.

With the New York Symphony being heard regularly (in the Balkite Hour at WEAf) as well as the two aforementioned orchestras, prospects look bright for enjoyable Saturday nights in the winter to come.

**The Dempsey-Tunney Fight**

**A**ND, speaking of sports, perhaps we may be permitted, at this our first opportunity, to comment on the broadcasting of the Dempsey-Tunney fight. This broadcast may be reckoned as an outstanding event in radio's young history in that it was heard by countless thousands more of people than ever listened to a sports event before. Some thirty-odd stations were involved in the hook-up. It is our guess that for those forty-five minutes there was listening in the largest audience ever attracted by a single broadcast, which, if you like superlatives, means the largest audience in the history of the world.

What we want to get off our chest first is some untinted praise for J. Andrew White who reported the fracas. His was as perfect a piece of work as we have ever heard over the radio and we hope that every aspiring sports reporter in the country heard it to take a lesson from it. Even the Major's informal remarks before the bout started were effective. For instance, when he laughingly complained that Graham McNamee, his assistant, was using his back as a table to write on, he conveyed a perfect picture of the crowded conditions at the ring side. And from the sounding of the first gong his delineation of the progress of the fight was an almost incredible feat of rapid, intelligible reporting; never a pause, nor a search for words, nor a garbled up sentence. To be sure, we writhed every time he said idea-r-r or jaw-r-r but what was that beside the fact that he employed no more than three "er"s in the whole thirty minutes.

In contrast to Major White's fine job was the miserable exhibition made by McNamee, whose duty it was to handle the mike during the one minute rest periods between rounds. Never has this star announcer been more off form. He hemmed and hawed and blustered about and

THE DAYTON HERALD, THURSDAY, SEPTEMBER 23, 1926

**Everybody Invited! :: Men, Women, Children**

**MEMORIAL HALL TONIGHT**

TO HEAR BY RADIO RETURNS CHAMPIONSHIP FIGHT OF

**DEMPSEY-TUNNEY**

BE THE GUEST OF

**THE DAYTON EVENING HERALD**



**3000 Seats All FREE!**

**"Blow by Blow" From Ringside By Radio**

Every Move by Jack Dempsey and Gene Tunney in Their Fistic Encounter at Philadelphia TONIGHT Will Be Flashed a Second Later to Memorial Hall, Here in Dayton, by the World-Famous Sports Announcer, J. Andrew White, Assisted by Graham McNamee, from Station WEAf, New York.

**4 RCA Loud Speakers Placed So That All May Hear Every Word**  
(ALSO A BRUNSWICK PANATROPE FURNISHED BY THE ANDERSON PIANO CO.)

**OPERATED FROM THREE 7-TUBE DAYTON MADE DAY-FAN RADIO SETS**

Under the Personal Direction of Captain O. E. Marvel, Nationally-Known Radio Engineer of The Day-Fan Electric Co., Dayton, Ohio.

**ALSO PRESS WIRES DIRECT FROM RINGSIDE**

**Better Come Early! Doors Open 6:30 P.M.**  
**Preliminaries Start 7 P.M. Dayton Time**

**HOW THE DEMPSEY-TUNNEY FIGHT GOT TO DAYTON**

Major J. Andrew White was the first ever to broadcast a fight from the ringside to listeners by radio assembled in halls. The occasion was the Dempsey-Carpentier fight. For the more recent Dempsey-Tunney bout, also broadcast by Major White, the Dayton Herald, of Dayton, Ohio, arranged a party in Memorial Hall of that city, and invited the public to hear the announcements, blow by blow. The hall was filled and reports have it that the impersonal loud speakers, giving forth the details of the fight, eight hundred miles away, held the crowd tense

- January 1, 15, 22\*, 29\*
- February 12, 19\*, 26\*
- March 5\*, 19, 26
- April 2, 16\*, 23\*, 30\*

\*Stations, wjz, wgy and wrc will tie in with wbz to broadcast the symphony concerts on these dates.

On the dates not starred, wjz will be broadcasting the student concerts of the New York Philharmonic Orchestra, which we pleasantly recollect as one of the best of radio's offerings last winter. In the twelve Student's Concerts, which will run intermittently throughout the coming winter, the last one coming in the early part of April, Willem Mengelberg, will conduct

got utterly nothing said. This quoted verbatim: "It's still raining. It certainly is raining. Yes it's still raining." Back to the sticks! No sentence he started ever came out right side up and he included such choice breaks as "Ladies and gentlemen of the radio audience and others who may be present . . ." and referred to Dempsey's returning to his wife and family.

The commercial side of the feature was well handled. As you know, the cost of the broadcast was borne by the Royal Typewriter Company (at a rumored figure of \$35,000). The trade name of the machine was worked in a goodly number of times, but probably not too often at that when you consider it was costing about \$1000 per mention. And—surprising and commendable exhibition of restraint—it was never once mentioned during the forty-five minutes of the fight.

### Something for the Farmers

**I**F YOU be not particularly interested in farm broadcasts—and neither are we—you are cordially invited to move on to the next column; for the benefit of the farmers who may be in our "vast invisible audience" we report the following information from the United States Department of Agriculture.

The fall and winter broadcasting schedule of the department's Radio Service includes twenty special program features each week, covering the full range of interests reached by all bureaus of the department. Approximately 100 effective broadcasting stations will lend their facilities regularly for these programs, which are to be brief digests of the mostly timely, pertinent facts woven into story form and adapted to radio presentation.



ALEXANDER MALOOF AND HIS ORIENTAL ORCHESTRA

An orchestra whose programs over WEAJ are as interesting as this photograph of the musicians looks

The United States Radio Farm School, which has already brought requests for a half million enrollment cards will be conducted from twenty-five stations. Lessons take the form of experience talks and imaginary inspection tours. Radio "schoolmasters" at the respective stations will conduct classes. Material furnished by the Department of Agriculture will be dramatized in such form as to attract and maintain interest through the courses. Printed lessons are mailed to all enrolled students.

Another outstanding service to be released

from forty stations, is the noonday flashes. This program will enable a million farmers to listen-in daily to both sides of an intelligent, interesting, telephone conversation between a county agent and farmer who will discuss timely problems.

"Aunt Sammy" will be heard from thirty stations. She is the official radio representative of the Bureau of Home Economics and will divulge all the new wrinkles and fine points in house-keeping.

Special farm features to be scheduled this fall and winter from 50 stations include "A Weekly Letter to Dad," which the son at college writes home telling the folks the high spots in his studies of agriculture which he believes might well be put into practice on the home place; "Autobiographies of Infamous Bugs and Rodents," a ten-minute speciality about "pests that are bothering now," as told by the insects and rodents themselves; "Chats by the Weather Man"; "Primer for Town Farmers"; "An Interview with the Agricultural Economist," and a weekly "Farm News Digest."

Among the stations offering all or part of this government service are: WAPI, WCCO, WDAY, WLBI, WLS, WMC, WOAN, WOS, WRVA, WSB, WCSH, WDAF, WDBO, WGBS, WHK, WOC, WRC, WEAO, WAMD, WAAM, WJD, WHAS, WLW, WKH, WHCC, WBAP, WHB, WMAK, WKAR, WBAK, WEBH, WENR, WFI, WGAL, WGR, WNAC, WOAX, WSMB, WTAM, WEAO, WHO, KOA, KMA, KFAU, KFBB, KFDY, KFJF, KFKX, KFOA, KHQ, KOAC, KOB, KQW, KSL, KTHS, KWWG, RSO, KWCR, KOIL, KPO, KFXF.

### Broadcast Miscellany

**O**N THE occasion of the Third Annual Radio Industries banquet at the Hotel Astor, New York, last September, was heard one of the meatiest evening programs of the late summer season. In the course of about three hours were heard, among others, the Victor Salon Orchestra, WEAJ Opera Companies, Mary Lewis, Reinald Werrenrath, the Happiness Boys, Sam 'n' Henry, the Eveready Mixed Quartet, the Revellers, and the Ipana Troubadors. This event marked the biggest tie-up of broadcasting stations to date. Nearly forty stations carried the program to all parts of the East and Middle West. Vice-President Charles G. Dawes, the principal speaker, was not at all unaware of the



THE TOLLEFSON TRIO

Frequently heard through WEAJ and the chain on the excellent program of "The Vikings" every Tuesday night at 8, eastern standard time

And all the time radio's real mission was so different!

It's educational—There won't be any textbooks a few years from now—that's the impression I get from the enthused and higher-domed-than-me advocates of the University of the Air idea. A great thought.

That slant would have been so useful, interwoven with some of those 1921 lectures into which crept and was fondled the phrase, "broad dissemination of intelligence" by radio, tied up to the notion that broadcasting educated inductively—establishing appreciation of good things in the arts, to say nothing of putting the ruralites hep to public questions through eavesdrop absorption of opinion. The sages who gather at the rostrum and while away after-coffee hours in the banquet hall—it's those serious fellows who do it.

ETHER-WAVING THE "OLOGIES"

**M**ENTAL astigmatism, that's all that conception was. The broader view, as I gather it from the ecstatic intelligentsia, is that the new generation is to have all "ologies" ether-waved. The syllabus is set; it but remains to cram dogma into the waiting cerebrum via the headphones.

Now that's a pretty good idea; a smart fellow thought that one up.

Education will poke itself into every nook and cranny. All evening I have been thinking about that. Great; why, all along the R. F. D. routes, out on ranches in the great open spaces, in lonely cabins on the mountain top, there are seekers after the truth, alone, neglected, uneducated. Here and now, isolation ends! In the land where all men are born free and equal, learnin' shall be free and equal. Free as the air, one might with originality say, and equal to the task of reaching even the remotest places.

Deeply cogitating on the subject, there came to me the vision of the great struggler for enlightenment. Abraham Lincoln, the youth, by the flickering candle light in his cabin of rough hewn logs poring over his one book. The ideal example. It determined me to write this article.

Always, my heart has been wrung at the thought of the Emancipator scrimping and saving his meagre earnings to get together the price of the succession of books that moulded his, later, massive mind. But no more will the boy without opportunities have to struggle for possession of the printed word. Not even a single book will be necessary; the University of the Air aims to relieve both eye-strain and pocketbook. Just a simple receiving set, assembled from parts bought, perhaps, at the five and ten, mental receptiveness, and the education job is begun.

Something worth while, that; I had decided to write this article anyhow; but filled with the spirit of Lincoln and the general seriousness of the subject, it didn't seem right to dash it off without acquiring a background of practicality. What better way to do that than by

actually listening, myself, to contemporaneous broadcasting.

I did. Tuned-in and listened carefully for an hour. The first talk the dial twisting brought was a dissertation on stamp collecting. Which at first blush seemed piffing. But as I listened, the realization dawned that I knew absolutely nothing of this particular intellectual pastime. Ah, this then was just what I wanted; I had never read even a pamphlet on the subject. Exactly in the position of the boy who never had a textbook. I made notes; filled up two pages. It was not wholly satisfactory. But I was persistent; I shifted the verniers around until I picked up a talk on flora and fauna of the tropics; repeated the note-taking process. Here again I was somewhat bewildered by utter ignorance of terms and tendencies. It should have been ideal; but something, too, was wrong; and after careful perusal of the notations made my ardor was appreciably dampened. Finally it was all wet. Three more trys at attempted understanding of subjects on which I was at best but vaguely informed, and I gave it up.

The University of the Air idea seems to have a weakness. That weakness is the lack of visual foundation. That will be a bit of a handicap to the student body.

RADIO GIVES YOU A RESPECT FOR PHONETICS

**A**IR education advocates must have overlooked a consideration you can discover for yourself in ten minutes—if you have never had it before, radio will give you a wholesome respect for phonetics.

The word "intentions" is hard to distinguish from "inventions," for instance;

and "conquering" is liable as not to become "conk herring." The ear is a tricky instrument. Clearest reception on a bang-up receiver and carefully manicured diction on the part of the speaker are rare in combination; but even with these, you get queer results.

To show you how this works out, let's go back to Abe Lincoln. He is chockfull of inspiration for to-day's deserving youths who are log-cabined like he was. Nothing could be finer than to start them off educatively with some of his noble utterances. You know, "That this nation—" and so on. But how would his stuff come over? Figuring they had never seen those same sentiments in print, I'd say from my experience with radio it is wholly possible that they'd be putting down a literal transcription of, say, the consecration of this nation to the Divine Being at the finish of the Gettysburg Address, somewhat after this order:

Vaccination, under guard, shall have a new Bertha Freedman, and come and vamp the people, by the people, for the people, shall not Paris fashions the earth!

A few similar tests will convince you that the more potent the sentiment the easier it phonetically perishes. Educationally, this is a little disturbing.

With Lincoln having always been looked upon as inspirational, it is not wholly comforting to contemplate the risk of having the farm boy or the cattle chaperone appraising him as an utterer of the obvious, because the earphones perhaps gave forth:

A horse divided against itself, cannot stand.

Or to have the plea for faith in right mak-

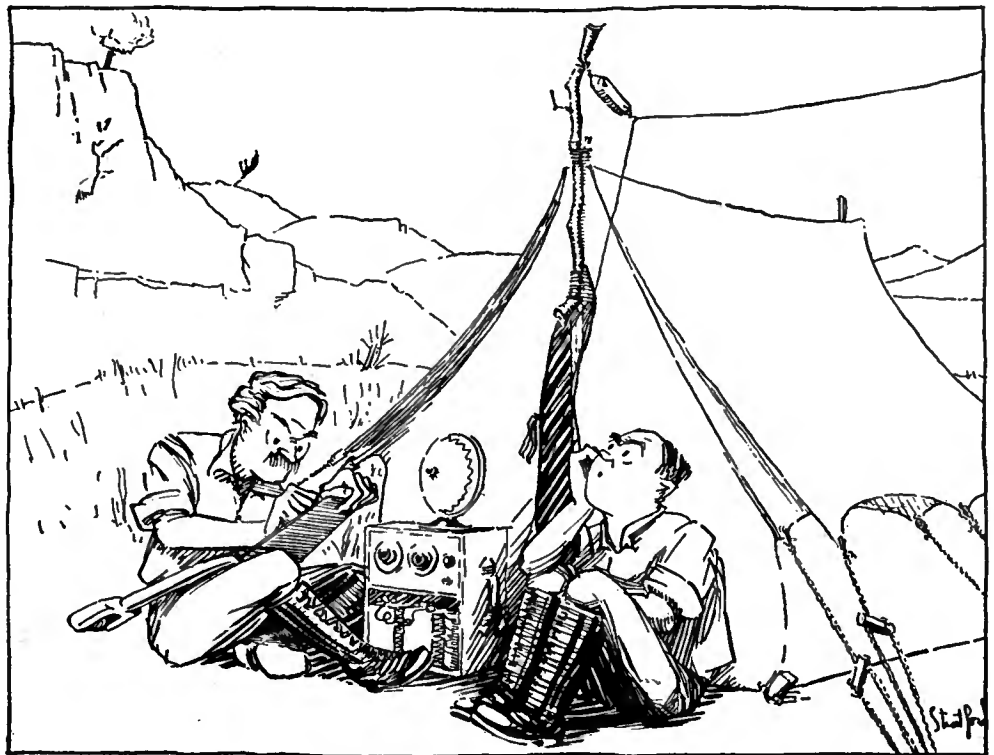

"IN THE GREAT OPEN SPACES, THERE ARE SEEKERS AFTER THE TRUTH—ALONE, NEGLECTED"

ing right, lose some of its kick by coming over:

Lettuce half ate, that Mike makes right!

Nor is it to be expected that the tolerant viewpoint will be materially fostered by the admonition:

Wood mallets toward none, with chair or tea for all.

Difficulties here unquestionably. And examining into the proposition, they appear to multiply inversely as you go down the line.

Now to be fully pedagogic, the little children, bless 'em, certainly have to have theirs. When I was a kid, anyhow, we acquired much of our wisdom and absorbed character-building axioms by speaking pieces. The method, I am informed, has not been abandoned. Wherefore comes consideration of the business of memorizing things. Pictorial illustration was always helpful in committing verse to memory—*Casablanca*, a noble piece, being one of the earliest in my recollection. So let's take that, exclusively from the how-it-sounds position: What, it may be inquired, is to prevent juvenile bewilderment regarding the immature hero of Mrs. Heman's verse as to why he did so nobly stick to the ship should the initial situation phonetically disclose:—

Sea foisted on the boy Ringbeck  
When salt buddie had fled.

The moral effect is of consequence; and irrespective of how quickly we dismiss the detail of childhood's portion there are few reassurances that the adolescents will fare better. It might even be advanced that the phonetics of ether-wave education might materially accelerate flapperish wise-

cracking, with Don Quixote perhaps declaring:

"A man's word is as good as his blonde."

And totally aside from the question of elevation of morals, there might be some biological confusion over:

Summer born great, some sneeze at greatness, and some have great nests thrust upon them.

#### MORE PROBLEMS FOR THE RADIO EDUCATOR

WITH these mere elementary things we appear to be getting beyond our depth. The subtleties to be encountered in even a smattering of science thus may give us pause. What chances for phonetic transcription, I ask you, have the isobaric and isothermal charts of physical geography, to say nothing of the diurnal inequality of the tides?

Yet if I remember correctly the chronological sequence of earnest but futile attempts of teachers to add to my knowledge of things academic, the study of physical geography came early, preceding the sciences. This must be considered in an estimate of a future wherein the young student will be rolling his own from five and ten parts and thus acquiring a new nomenclature and a radio receiver—with the praiseworthy object that other education may come after.

Then through the headphones along comes the physical geography lesson dignifiedly asseverating that the soft mud or ooze at the bottom of the ocean is called, "radiolaria" . . .

A little explanatory straightening out may have to go along with this.

But without further recourse to the foregoing fundamentals of education (although a slow smile accompanies the thought of how the word, "hypothesis"

would come over the air) the broader conception must allow that certain difficulties may be foreseen, and a way found to overcome them. Meanwhile I await with passionate expectancy some advance dope on what disciplinary measures are to be devised to outsmart recalcitrant intelligences on off days. I have not forgotten how the opening of the baseball season, for example, always had a retarding effect on concentration, even under the watchful dominance of an agile-eyed professor. Our future student, as I gather it—or a large percentage of him, at least—will be strictly on his own. Surely he must be dubbed a super-seeker after knowledge who will be able to abide with, say the postulate, the lemma, corollary and scholium on geometry's opening day, when with a turn of the dial he can tune-in the opening game of the World Series.

This generation might have acquired an additional ignoramus or two under that handicap.

Undoubtedly, though, there are many subjects that can be taught quite easily through broadcasting. The favorable aspects must be looked into.

Now for example—

For example. . .

Well, I can't seem to get the inspiration right off. But there must be; just plenty to write about; probably many inspiring addresses on the air right this minute. A radio receiver here at my hand; and the newspaper programs.

It's 9:30 let's see . . . Um, what's this? Paul Whitman's outfit; that means some pretty good symphonized jazz—and Olga Steck, my musical comedy favorite; a few zippy songs. Sounds good. Don't like to miss it.

Perhaps I've written enough, anyhow.

For it can readily be seen how easy it is to educate the Masses. Especially, in the old-fashioned way.

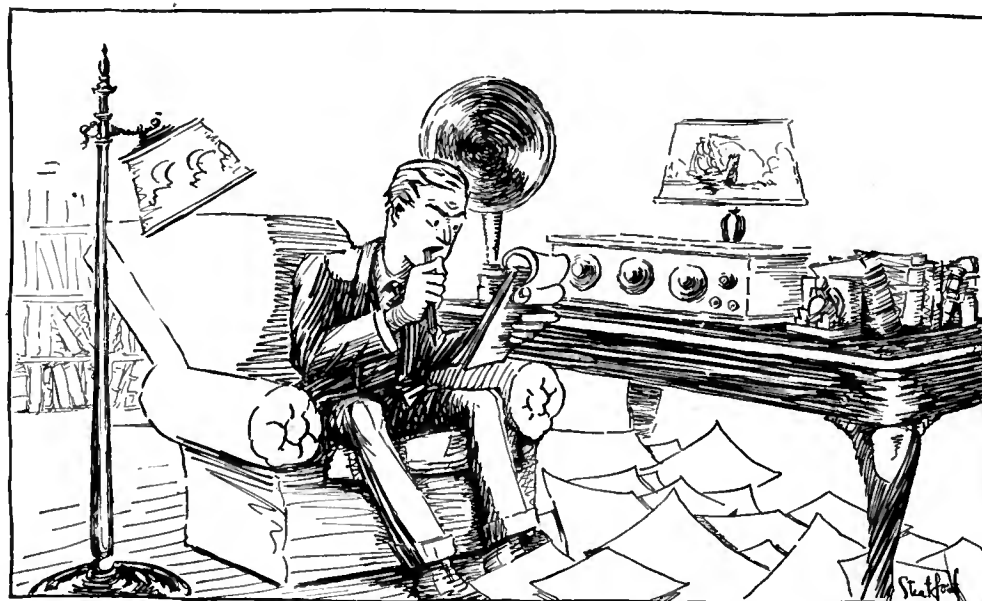

"THE UNIVERSITY OF THE AIR AIMS TO RELIEVE BOTH EYE STRAIN AND POCKETBOOK"

# A Single-Tube Receiver That Won't Radiate



THE PANEL LAYOUT

Of the one-tube non-radiating receiver is well balanced despite its simplicity. The single condenser dial, rheostat knob, filament switch, and jack are the only visible pieces of apparatus on the front of the panel

## Constructional Details for an Ideal Beginners' Receiver Employing the "Equamatic" Principle—Tickler Coil Coupling Is Automatically Varied as Condenser Knob Is Turned—Coil Data Are Presented

By ZEH BOUCK

IT IS the author's experience and belief that there exists a very definite demand for a "perfect" beginners' home-made receiver. Though the last few years have seen many receivers placed on the market which, ultimately, could be purchased far more cheaply than the average enthusiast could build a similar set, these receivers have by no means filled this particular bill. The amazing cheapness of these sets has generally been due to the inability to dispose of them at higher prices in competition with better equipment.

The ideal beginners' receiver for home construction should comply with the following requirements:

1. It should be a simple receiver, particularly in reference to wiring. There is nothing more discouraging to the incipient experimenter than the failure of his first attempt—and ninety per cent. of these unhappy trials are due to wiring complications. Consideration of this recommends a one-tube receiver for the fan's first efforts.

The receiver also should present no great mechanical complications (though this is a less important consideration because the radio beginner is often an experienced mechanic), which postulates the possibility of obtaining the various coils and sundry parts especially prepared for use in the circuit he will employ.

And with final but consistent simplicity, the set should be easily tuned, a factor that favors one-dial control.

2. The receiver should be inexpensive to construct—a condition that runs more or less hand-in-hand with the idea of simplicity.

3. The receiver must be non-oscillating. An oscillating single-tube set (and most multi-tube sets for that matter) radiates interfering signals, which are annoying at all times, yet rendered more so when the offending set is operated by a beginner.

4. The receiver should be a permanent one. It should exhibit such qualities of selectivity and sensitivity that it need never be discarded. When the enthusiast desires more elaborate equipment, he should need only to add an audio amplifier (and perhaps a stage of r.f., if he craves DX) to have a thoroughly satisfactory receiver.

The once very popular three-circuit regenera-

tive tuner filled these requirements with the exception of that very important commandment—"Thou shalt not oscillate"; and these sets were not always so easy to tune. Until recently, the three-circuit tuner was indubitably the most selective and sensitive of one-tube receivers, and it gained wide popularity before propaganda exposed the iniquities of its oscillations. In the last two years, various reflex and other circuits have been offered as substitutes for the three- and single-circuit arrangements. However, while these substitutes were non-radiating, they fell down on one or more of the other points outlined above, and never attained the popularity of the receiver whose place they would usurp.

WILL NOT RADIATE

### The Facts About This Receiver

Name of Receiver	King "Equamatic."
Type of circuit	Single-tube regenerative receiver.
Number of Tubes	One 6V-199; other types of tubes may be used.
Frequency range	545 kc. to 1500 kc. (200 to 550 meters).

This receiver is excellent for local reception. It uses regeneration but if correctly adjusted, cannot oscillate and cause interference. The amount of regeneration is automatically controlled by a movable coil mounted on the shaft of the condenser. In this way the circuit is maintained at a point of high sensitivity throughout the entire broadcast band. It is an ideal single-control receiver.

THE beginners' receiver we have undertaken to describe fulfills every stipulation, above outlined, imposed upon the ideal set. This receiver is nothing more than a three-circuit regenerative tuner that will not radiate, and it is controlled by a single dial (the coupling between the tuning and tickler controls being automatically varied). Regeneration is automatically maintained at close to the optimum degree over the entire tuning range (the optimum degree being that amount of feedback that will give maximum signal strength and selectivity without distur-

tion). This combination is secured by the application of the King "Equamatic" system of coupling variation which was described by the writer in the September and October, 1926, issues of RADIO BROADCAST. This system, briefly, recognizes the necessity of varying the coupling between circuits, as different wavelengths are tuned, in order to maintain maximum efficiency over the entire tuning range, and offers a simple but effective means of automatically securing this correct adjustment, under individual conditions.

The coils employed in this system were designed for use in non-regenerative circuits. However, their efficient application to regenerative arrangements is fairly obvious, and the receiver here illustrated and described was an early and logical by-product of the original King system. This single-tube receiver was designed jointly by Mr. King and the author.

THE COILS

THE beginner may wind the coils for this receiver himself if he possesses the inclination and mechanical ability.

There are three coils in the receiver—the antenna primary,  $L_1$  (in Figs.

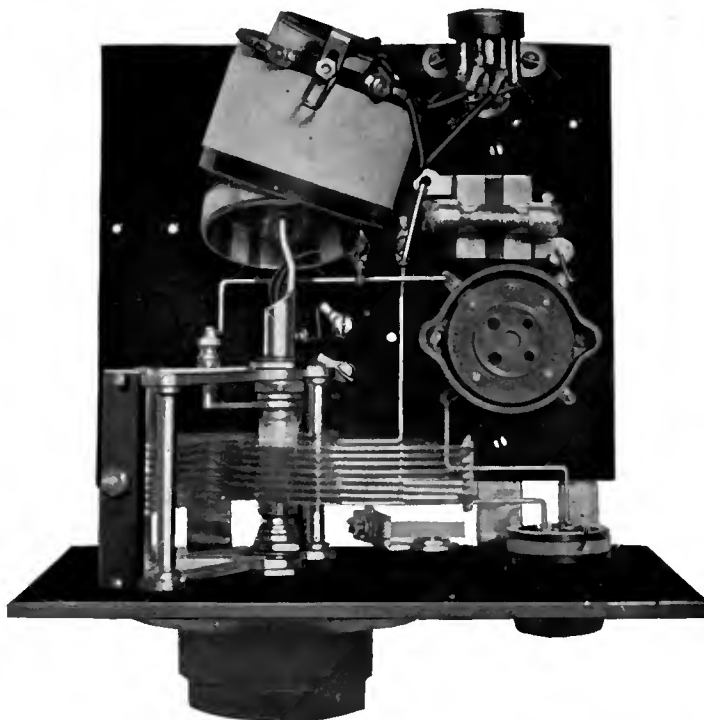

LOOKING DOWN

Behind the front panel of the single-tube receiver described here. An approximate idea of the coil arrangement may be gained from a study of this picture. The support brackets for the sub-panel can be seen in the space between the main and sub-panels

1 and 2), the secondary,  $L_2$ , and the tickler coil,  $L_3$ . The primary coil is hinged to the back of  $L_2$ . The tickler coil is mounted on the extended shaft of the condenser. As the condenser is turned, the coupling between  $L_2$  and  $L_3$  is varied, and in this variation lies the application of the "Equamatic" system.

The various possible motions of the coils, as well as their mechanical construction, are indicated in the chart, Fig. 3. For the sake of clarity,  $L_1$  has been omitted from this drawing. However, the hinged arrangement of  $L_1$  is clearly shown in the photographs.

Coil  $L_1$  is wound on a 2-inch diameter bakelite tube,  $\frac{3}{8}$  inch long, with 14 turns of number 24 double cotton covered wire. Coil  $L_2$  has 60 turns of the same wire on a  $2\frac{1}{2}$  inch tube 2 inches long. The tickler,  $L_3$ , is wound with 12 turns of the same wire on a two-inch tube  $\frac{3}{8}$  inch long. These three coils can be wound with 26 wire, or wire of a different insulation than that specified if more convenient, the same number of turns being used.

A baseboard may be substituted for the subpanel if desired. In this case it will be necessary to raise the bracket supporting the secondary coil with a block of wood so that its axis

(line C in Fig. 3) coincides with the center of the condenser shaft. This centering, as well as the drilling of hole E in Fig. 5, directly under screw I on the condenser shaft (drawing C, Fig. 3) are essential to the correct adjustment of all "Equamatic" receivers.

The mechanics of securing this arrangement are illustrated in Fig. 3. Drawing A shows the dimensional characteristics of the stationary coil mounting. The front panel is designated by "a", the sub-panel by "b"; "c," in all drawings, is a line passing through the center of the condenser shaft; "d" is a machine screw with a square washer holding the coil bracket, e, to the sub-panel; "f" is a bracket of  $\frac{1}{8}$ -inch brass strip, such as a Karas, six inches long, holding the sub-panel to the control panel. Drawing B continues the details of the coil bracket, e, and the manner in which it slides through the swivel screw and washer d, on the sub-panel, b.

Drawing C suggests the moving or tickler coil arrangement. A brass sleeve is fastened to the extended shaft of the condenser G, by screw H. A bakelite or hard rubber strip extends from the brass sleeve, to which the tickler is mounted by a simple L bracket. The coil has been turned slightly to illustrate this idea.

Photographs of several home-made mountings will be found in a preceding article which appeared in the September, 1926, issue of RADIO BROADCAST.

The holes for the condenser, bracket e, and swivel d, are drilled according to the panel and sub-panel layouts. The various hole sizes are indicated in the drilling charts, Figs. 5 and 6.

With the coils either made at home or purchased, and the panels drilled, the assembly of the parts is the next step in the construction of the receiver. The sub-panel should now be joined up with the front panel by means of the two brass brackets, with screws through "A" and "B" in Fig. 6, and through "A," "B," "C" and "D" in Fig. 5. These holes are all counter-sunk. The condenser is then mounted on the front panel at hole C, the rheostat at "D," the filament switch at "E" and the jack at "F."

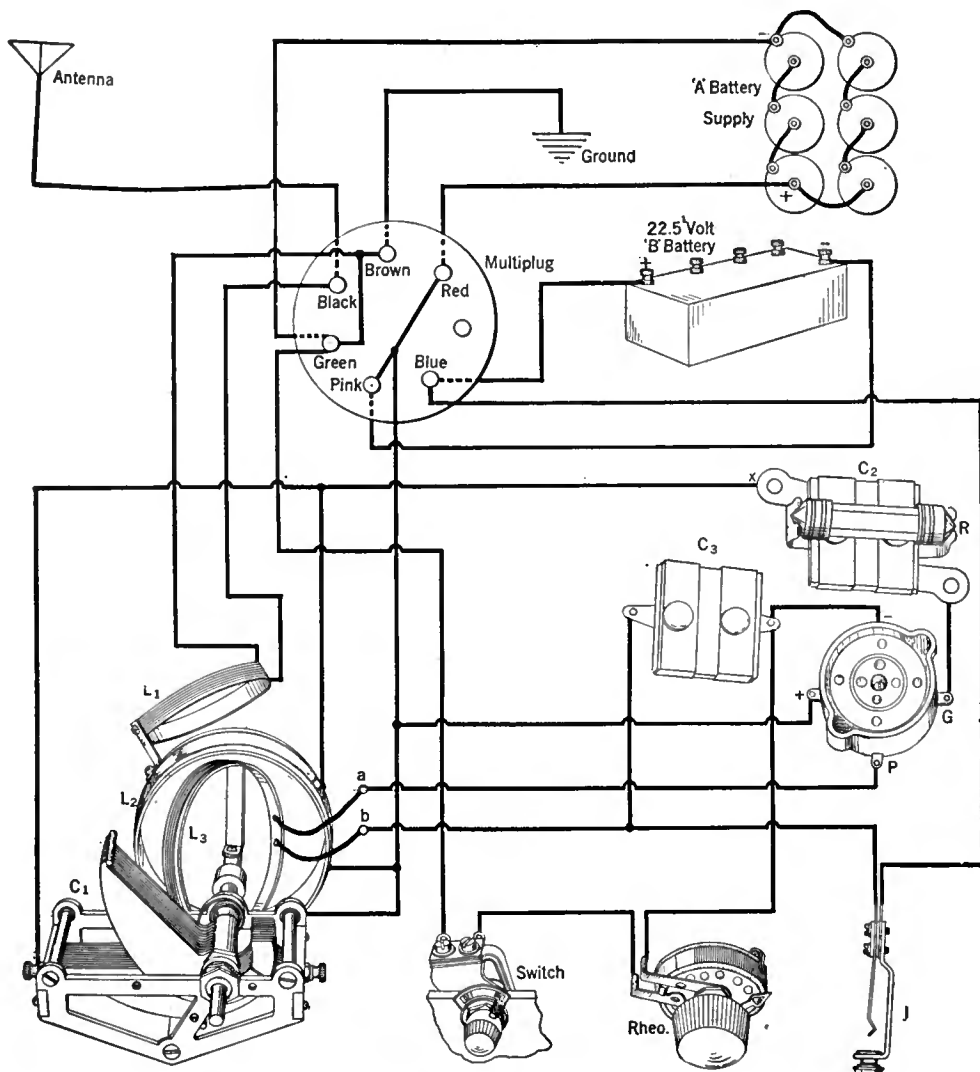

FIG. 1

On the sub-panel, the secondary coil is mounted with a screw through hole E. Holes F, F mount the floating socket; G, G, G mount the Multiplug. Six-thirty-two machine screws, with nuts, pass through holes H, H and I, I, holding firm the flexible leads from the secondary and tickler coils. These details are made plain in the photographs.

PARTS LIST

THE following is a list of the exact parts used in constructing the photographed receiver. Other makes of equal merit and similar design can be substituted with satisfactory results. The letters following the names of the parts refer to the symbols by which they are represented in the wiring charts, Figs. 1 and 2.

1 Karas 370 mmf. (17 plates) Variable Condenser (C <sub>1</sub> ) with Extension Shaft	\$ 7.00
1 Karas "Equamatic" Three - Circuit Tuner (L <sub>1</sub> , L <sub>2</sub> , and L <sub>3</sub> )	4.50
1 Amsco Floating Socket	1.00
1 Electrad Grid Condenser (C <sub>2</sub> )	.40
1 Amsco 1-Megohm Gridgate (R)	.45
1 Electrad 0.002-Mfd. Bypass Condenser (C <sub>3</sub> )	.45
1 Yaxley Open-Circuit Jack (J)	.75
1 Yaxley Filament Switch	.75
1 Amsco Tom Thumb 30-Ohm Rheostat (Rheo.)	.75
2 Karas Sub-Panel Brackets	.50
1 Jones Multiplug and Cord	4.50
1 Karas Micrometric Dial	3.50
1 7" x 8" Bakelite Panel	.80
1 7" x 6" Bakelite Sub-Panel	.70
Necessary Screws, Wire, Etc.,	.50
<b>Total</b>	<b>\$26.55</b>

To the above list should be added extra equipment as follows:

- 1 109 Type Tube
- 6 Dry Cells for A Battery
- 1 22.5-45 Volt B Battery
- 1 Pair Telephone Receivers
- 1 Phone Plug
- Antenna Equipment

Reasonable substitutions may be made in the above list although such may necessitate some deviations from the author's instructions, especially as regards the panel drilling, etc.

THE WIRING

THE receiver is now ready for wiring according to Figs. 1 and 2. Fig. 2 shows the general schematic layout, employing standard symbols, with which it is recommended that the beginner familiarize himself. Fig. 1 is the same circuit in "picture-drawing" style.

The Multiplug is a substitute for binding posts, and connects through a flexible lead with the antenna, ground, and the various batteries. The wires and plug connections are colored or "coded" to facilitate wiring and connections, as designated in Fig. 1.

The antenna or primary coil is wired to antenna and ground. The ground connection is "bridged" across, on the Multiplug, with a short piece of wire, to the minus A battery connection (green). Either connection from L<sub>1</sub> may lead to the antenna.

Coil L<sub>2</sub> is wired as follows: One terminal is wired to the grid condenser and leak. This same terminal is also connected to the stationary plates of the variable condenser, C<sub>1</sub>. The rotor plates are connected to the remaining terminal of the coil, which is also wired to the plus filament post (marked +) on the tube socket. The remaining side of the grid condenser and leak combination is wired to the grid terminal on the socket (marked G).

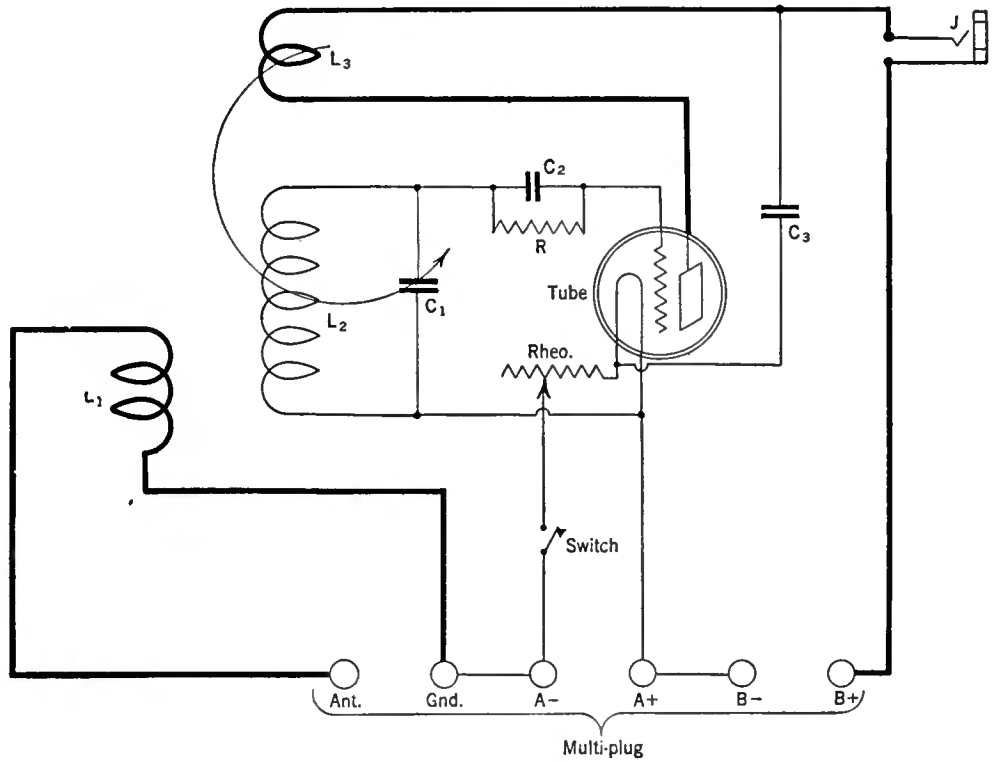

FIG. 2

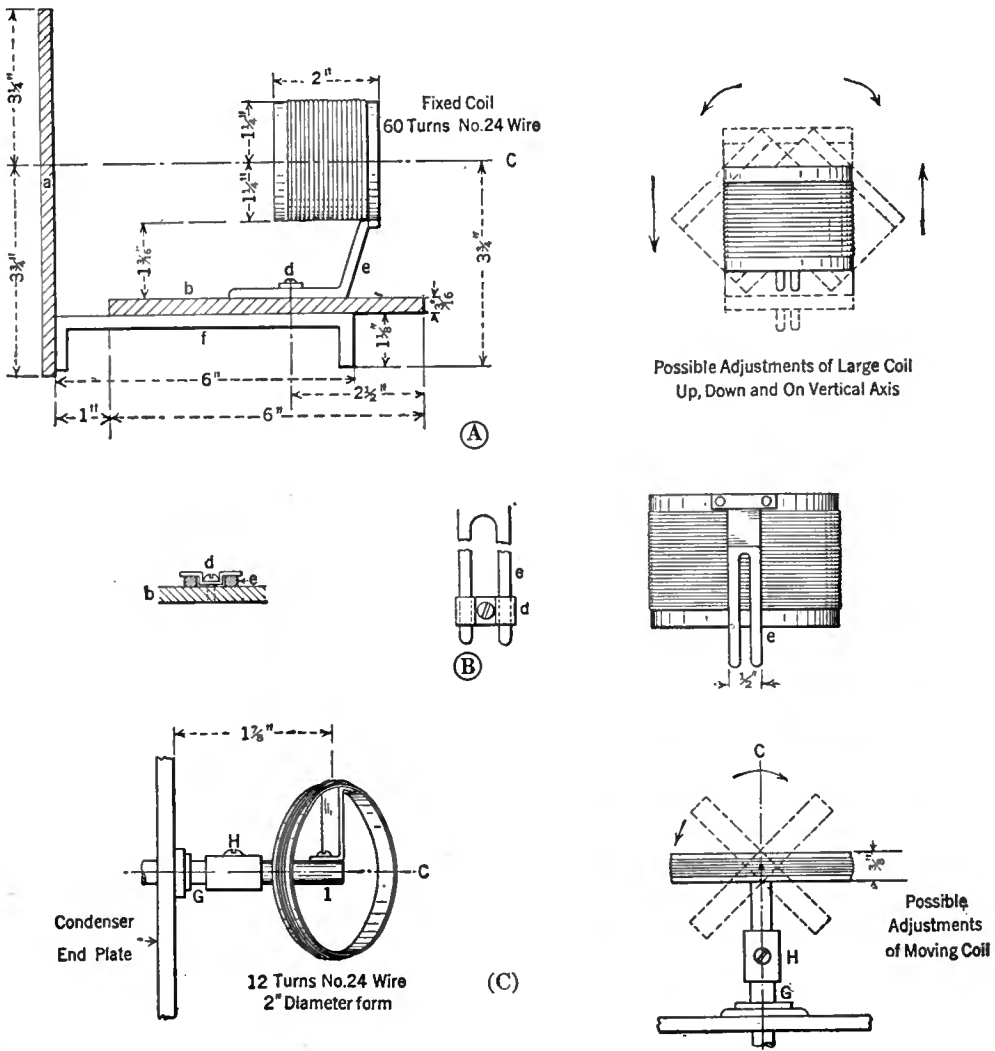

FIG. 3



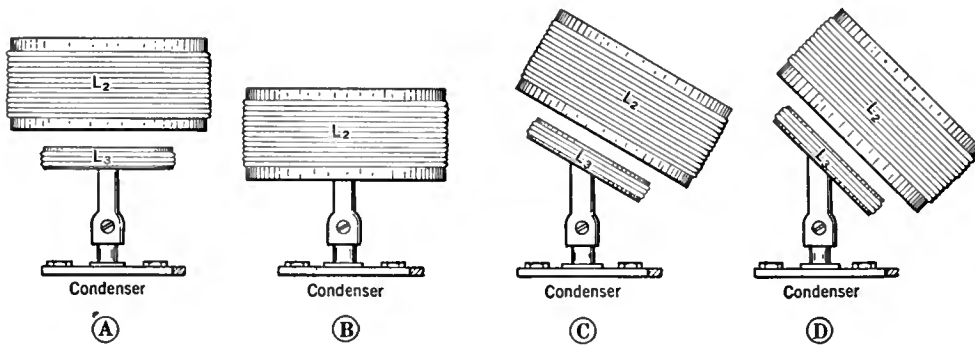

FIG. 4

The plate connection on the socket (P) is led to one side of the tickler coil, while the remaining connection to  $L_3$  is wired to one side of the jack. The bypass condenser,  $C_3$ , is connected from this side of the jack to the minus filament post on the socket.

Only the battery posts now remain to be wired. B battery plus is wired to the free terminal on the jack. The minus B connection on the Multiplug is bridged to the A plus connection which is wired to the A plus post on the tube socket, or to any other wire connecting to that post. From the A minus connection on the Multiplug, connect a wire to the switch, S, and from the switch to the rheostat, and from the remaining post on the rheostat to the minus post on the tube socket. All joints should be soldered. The receiver is now completely wired.

The receiver must, of course, be connected to antenna, ground, and batteries as shown in the picture diagram, Fig. 1. A straight, single wire, 75 feet long, stretched as high and clear as possible, makes an excellent antenna for this receiver. A longer wire may lessen selectivity while a shorter antenna will jeopardize sensitivity. A water pipe or radiator makes an excellent ground.

The A battery must be selected to suit the chosen tube. This receiver will operate with any detector tube. A 199 type tube, with six dry cells, connected as shown in Fig. 1, is recommended by the author. Place the tube in the socket, turn on the switch, and turn the rheostat up slowly. Barring defects in the wiring, parts, or tube, the bulb will light as the rheostat knob is turned from left to right. Turn the rheostat three quarters on, plug in the telephone receivers, and the set is ready to receive.

#### OPERATION AND ADJUSTMENT

AS THE adjustment of the receiver coils consists in so arranging them that the circuit will be slightly below the oscillation point at all wavelengths, it will be well to make clear just how we can tell when the receiver is oscillating. Oscillations will occur when coil  $L_2$  is too close to coil  $L_3$ , *i.e.*, when coupling is too tight. If the grid condenser terminal X, in Fig. 1, is touched with the finger when the circuit is oscillating, a loud, definite click will be heard in the telephone receivers. Also, if a station is tuned-in when the receiver is oscillating, a squeal or whistle will be heard as the station wavelength is approached.

It takes less coupling between  $L_2$  and  $L_3$  to produce oscillations on the short waves than on the long waves. The idea in adjusting these two coils is so to arrange things that the coupling at no time is sufficiently great to make the circuit oscillate, for obviously it is impossible to receive enjoyable signals when the set is in this condition. If the circuit is not actually oscillating, but is very close to the point, signals will still be unsatisfactory, suffering from a muffled distortion.

Fig. 4 shows a series of various coil positions to which we shall refer in our endeavor to make clear the manner of adjusting the coils, which, after all, is really a very simple process.

Move coil  $L_1$  on its hinge until it makes an angle of about 45 degrees with  $L_2$ . This is the right primary coupling for the average antenna.

Turn the condenser all the way in, *i.e.*, so that the rotor plates are completely inside of the stationary plates. Now adjust coil  $L_3$ , by means of the set screw fastening the support to the extended condenser shaft, so that it can be turned on a vertical axis, as shown in the lower right hand illustration in Fig. 3. Tighten the set screw, it need never be touched again. Place  $L_2$  as shown in A, Fig. 4. Now push it down over  $L_3$  as shown in B. The circuit should now oscillate. If it does not oscillate, reverse the connections ("a" and "b" in Fig. 1) to the tickler coil.

Pull coil  $L_2$  away from  $L_3$  until oscillations stop—no further. Now turn  $L_2$  and  $L_3$  slightly to one side as in C, Fig. 4. Turn the condenser out. As the wavelength shortens, the set will probably spill over (oscillate) for coupling has not been sufficiently loosened by the turning of the tickler with the condenser to stabilize the circuit on the shorter wavelengths. This being the case, return the condenser to its long wave position, and turn the coils a little more, say as in D. Go down to a short wave and test for oscillations. As long as the set spills over, return to the long wavelength and decrease the angle between the coils and the panel. The circuit must not oscillate at any wavelength. Always make coil adjustment with the condenser all the way in, at which position the coils  $L_2$  and  $L_3$  should be parallel. Tune-in several stations, and listen for distortion. If signals sound muffled or drummy, pull coil  $L_2$  out an eighth of an inch in its slide, without changing its angular relation to the panel.

Selectivity can be increased by still further loosening the coupling between  $L_1$  and  $L_2$ —moving the former coil up on its hinge.

Once these adjustments are made, the positions of the coils need never again be changed, unless operating conditions, such as antenna, tube, or battery voltages, are altered.

The set will now tune, giving you maximum volume without distortion, with the simple motion of the single dial. The output of this receiver can be inputted into any conventional amplifier. In the writer's laboratory, it is operating into a three-stage resistance-coupled amplifier using a power tube in the last stage, a combination which has been found ideal.

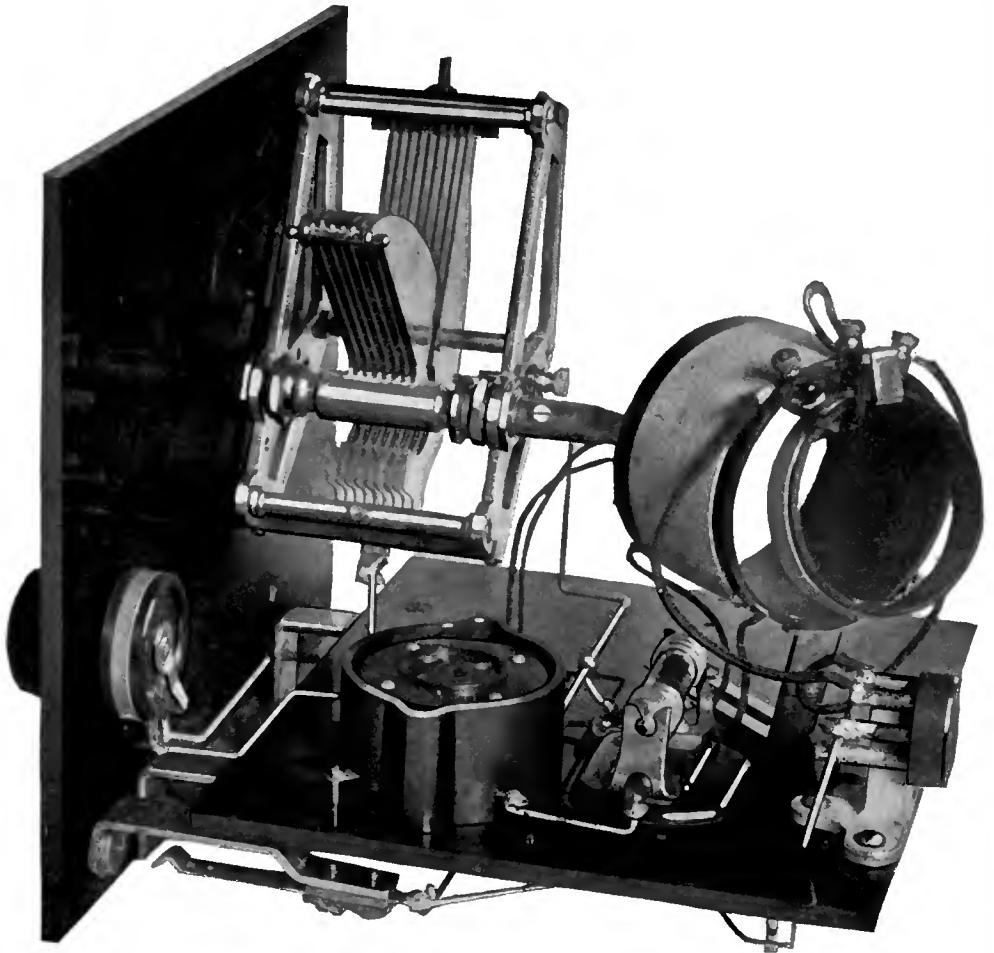

COMPARE THIS WITH FIG. 1

And you will see how simple the receiver is. The primary coil arrangement is clearly shown here

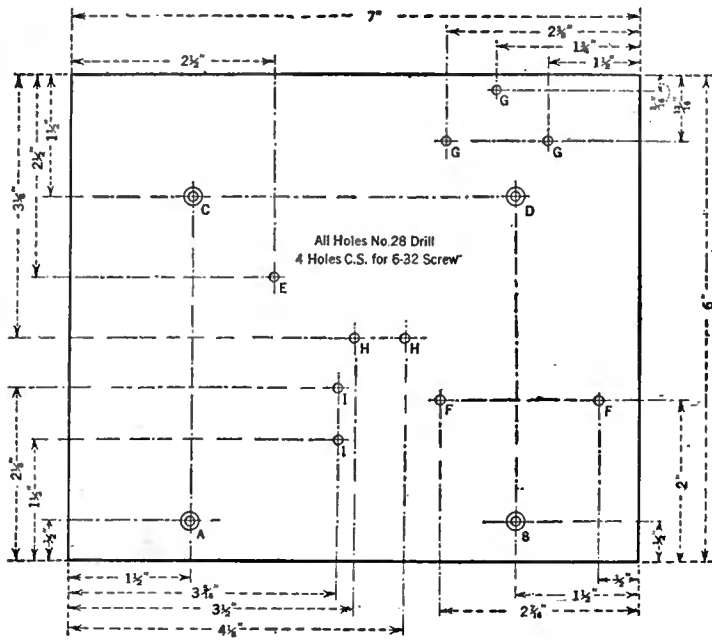

FIG. 5  
The disposition of the holes to be drilled in the sub-panel are indicated. On page 171 the purpose of the various holes is told

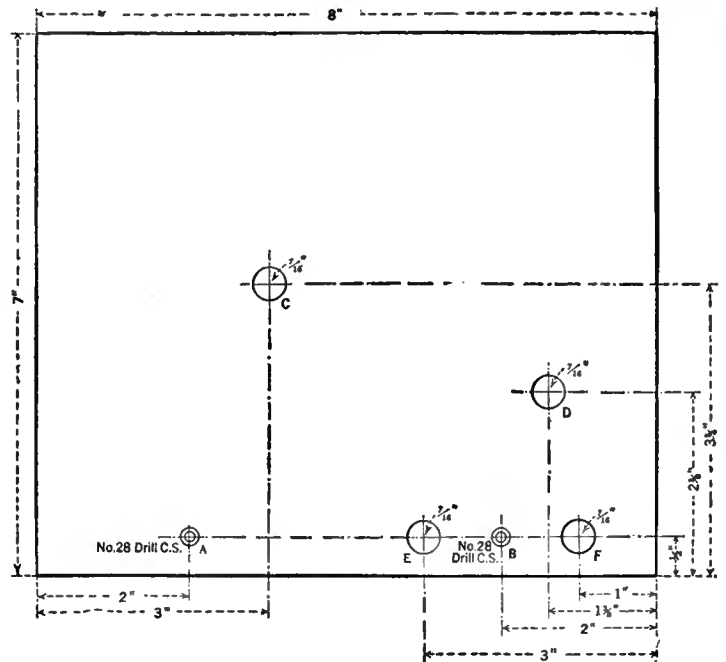
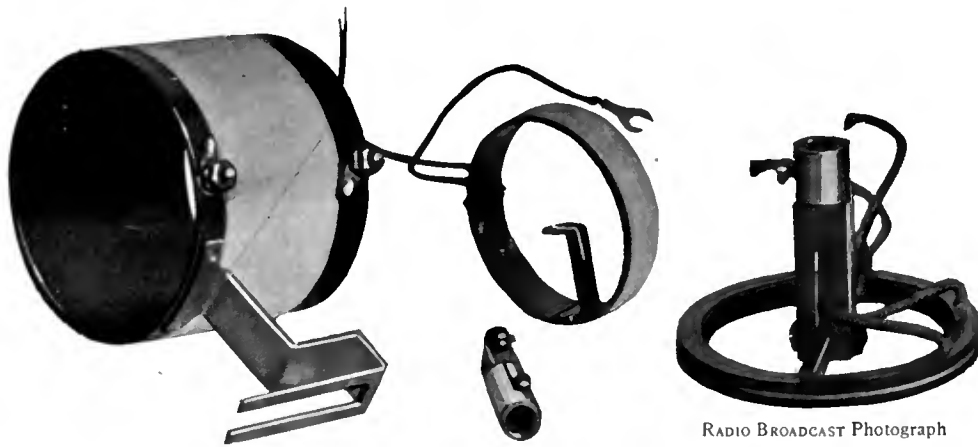
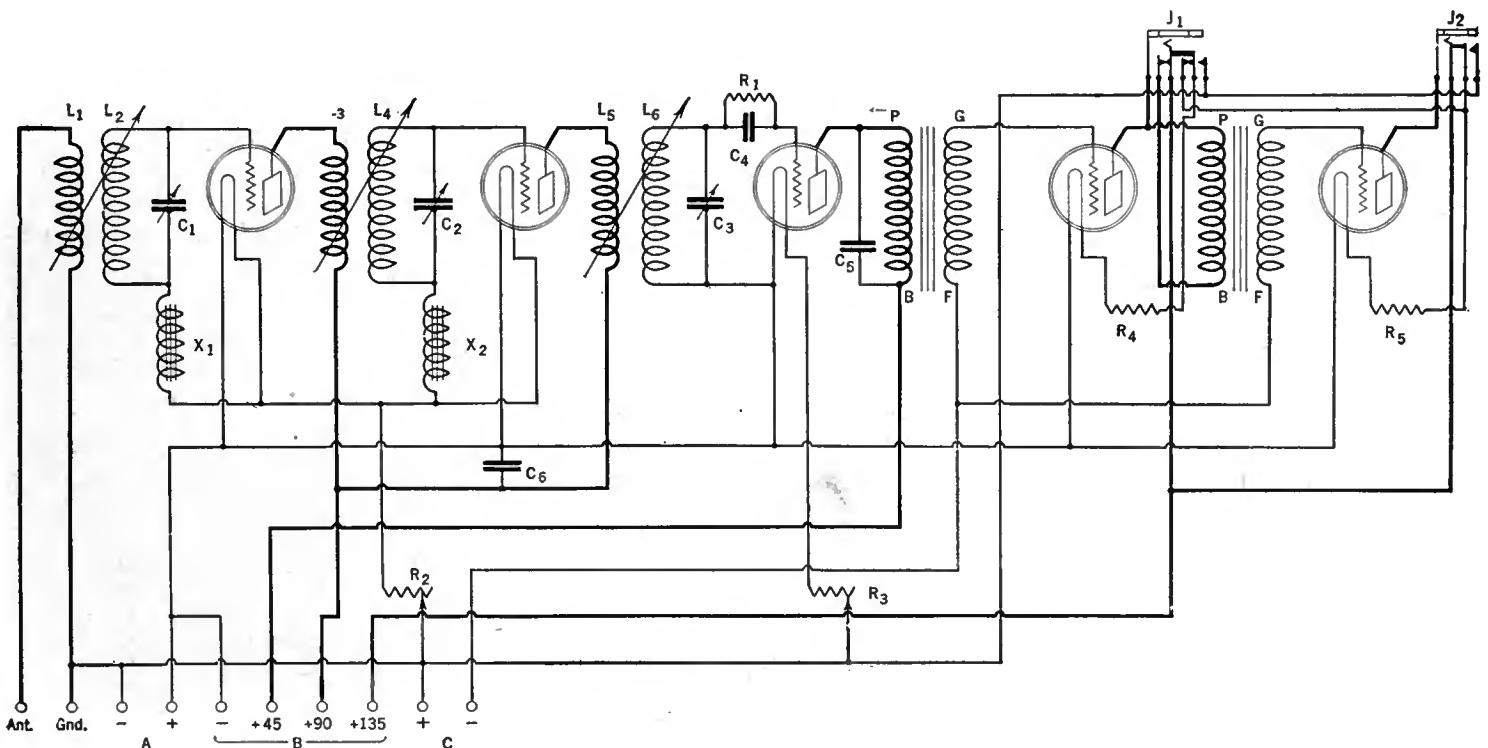

FIG. 6  
This diagram gives the data for the drilling of the main panel of the receiver described here



A COMMERCIALY-MADE COIL UNIT FOR THE "EQUAMATIC RECEIVER"



A FIVE-TUBE CIRCUIT

Employing the system of automatic variable coupling described in this article. Such a receiver was fully described in the October RADIO BROADCAST

# Short-Wave Activity at the Laboratory

How Station 2 GY Maintains Communication With Expeditions—The MacMillan Arctic Expedition—Working With Dyott in Brazil—Reports on 2 GY Signals Are Asked

By KEITH HENNEY

Director, Radio Broadcast Laboratory



COMMANDER DONALD B. MACMILLAN  
At the wheel of the *Bowdoin*

ACTIVITIES at 2 GY, the experimental station of RADIO BROADCAST, working on 7688 kc. (39 meters), for the last few months have been chiefly concerned with the problem of maintaining communication with the various Arctic expeditions, notably the MacMillan expedition to Greenland.

As stated in the October RADIO BROADCAST, the operator on the Schooner *Sachem III*, Mr. Austin C. Cooley, who built and installed the equipment on that ship in cooperation with the technical staff of RADIO BROADCAST Laboratory, was a member of the staff at 2 GY, and naturally the Garden City Station has been most interested in KGBB, the call letters of the *Sachem*. The log at 2 GY is most interesting from the time the expedition left Wiscasset in June until its return to that port about the middle of September. The log reveals nights when communication was impossible due to swinging signals, for example when the schooner crossed from Labrador to Greenland, and when going up the Newfoundland coast. Again there were times when communication was most reliable and messages to and from the vessel were handled at great pace.

Mr. Cooley's equipment consisted of a single 250-watt tube, powered from a motor generator which secured its power in turn from storage batteries charged from the ship's Diesel engine. The wavelength of KGBB was 8103 kc. (37 meters) and 15,000 kc. (20 meters). KGBB's receiver

was constructed in RADIO BROADCAST Laboratory and utilizes a set of Silver-Marshall coils tuning from 18748 kc. to 1499 kc. (16 to 200 meters).

From 2 GY more than 200 private messages were handled with KGBB, not counting service messages to and from the two stations regarding radio matters. Stations 1 AAY and 1 AKZ also handled considerable traffic with KGBB and

when 2 GY was out of communication, relayed messages to the expedition.

During the time the *Sachem* was en route to and from the Arctic a new station was put on the air at 2 GY. It uses two 250-watt tubes in a self-rectified circuit operating from a 500-cycle source of supply. Good signals have been reported in Australia and Brazil and a schedule has been carried out with the Steamer *City of San Francisco*, RXY, running between Pacific ports and South America. The latest contact was on the night of October 7th when she was entering the port of Corinto, Nicaragua—on the Pacific side.

## THE DYOTT EXPEDITION IN BRAZIL

NOW that the Arctic expeditions have all returned safely to the United States, interest among amateur circles—

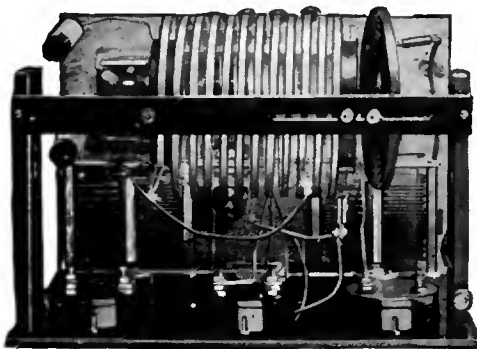

THE DYOTT EXPEDITION'S PORTABLE  
TRANSMITTER

as far as expeditions are concerned—centers about the Dyott venture in Brazil. As mentioned in the October RADIO BROADCAST, this party sailed on the S. S. *Van Dyke* on July 24th to re-explore the River of Doubt originally mapped by Colonel Theodore Roosevelt. Two amateurs of Yonkers, Mr. Arthur Perkins, 2 APQ, and Mr. Eugene Bussey, 2 CIL, are the operators on this trip.

The portable set taken by Mr. Arthur Perkins up the River of Doubt uses the Hartley circuit and the photograph on this page shows clearly the REL inductance, which has secured such favor from amateurs, as well as double spaced Hammarlund condensers for tuning. Mr. Perkins used Sangamo condensers since they are completely enclosed, wherever possible in his set.

The large Cardwell set used at the base station, GMD, uses two 250-watt tubes in a self-rectified circuit which is powered from a 500-cycle generator run from a kerosene engine.

Two contacts have been reported with this expedition. On the voyage to Rio de Janeiro, the portable station with 24 watts input from Eveready B batteries worked stations in the United States until 1700 miles south of Florida, when communication ceased, to conserve batteries. On the night of September 17th, station 1 CMX at Fall River "clicked" with a station in Sao Paulo which purported to be the expedition station. Several messages were taken for the operator's families. It is thought that Brazilian 1 AB handled the Expedition's traffic in this instance for GMD was not then in operation.

The base station signing GMD should be heard in the United States by the time these lines appear, and amateurs are requested to report contact with 2 GY. The station will be located at the head waters of the River Paraguay at San Luiz de Caceres, 16° 30' S, 58° W, and should be able to put good signals into this country. With less power than GMD will use, 2 GY has had good reports from England, Denmark, Chile, Australia, and Brazil. Our station transmits on 7688 kc. (39 meters) nightly to the Dyott expedition at 9 p.m. Eastern Standard Time.

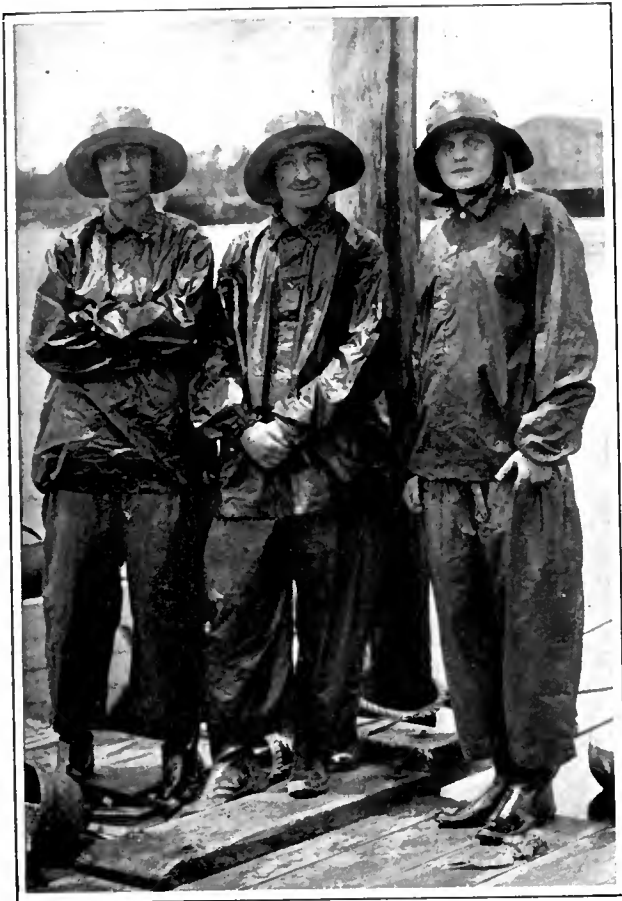

THREE OF THE CREW

Of the schooner *Sachem*. Included in the group is Mrs. Rowe B. Metcalfe, wife of the owner of the Arctic exploring vessel

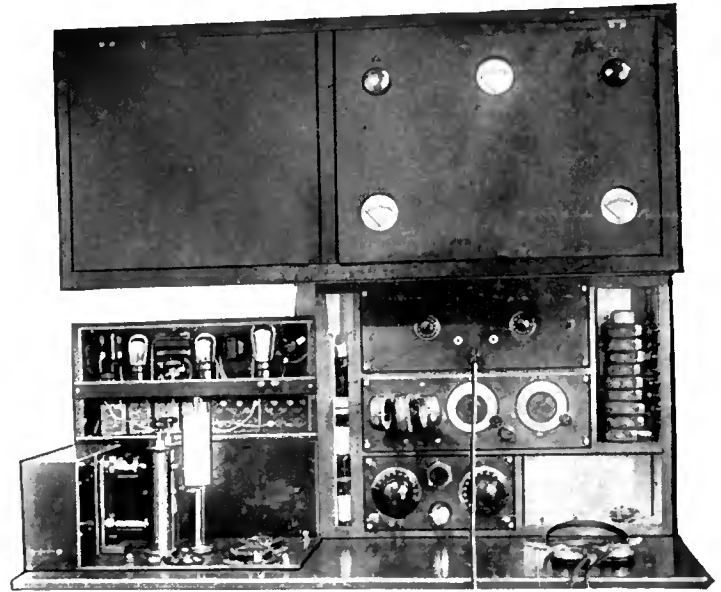

KGBB'S EQUIPMENT

In addition to the short-wave equipment, the radio installation on the *Sachem* included an all-wave tuner for communication with ships, etc.

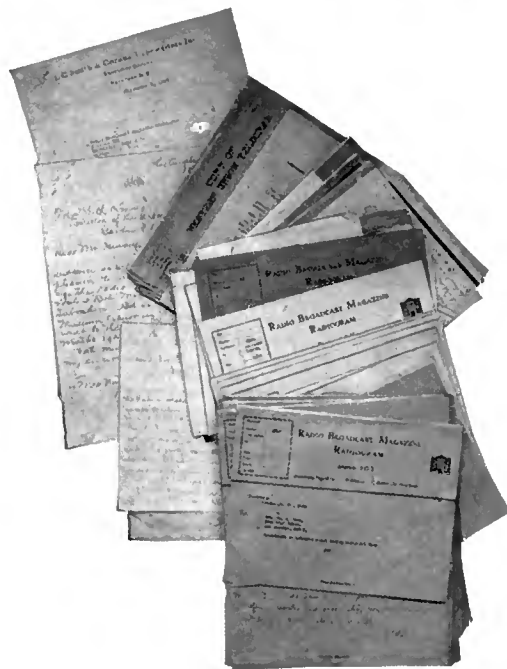

2 GY'S SHARE

Some of the 200 messages transmitted, and received from KGBB by 2 GY at Garden City



EUGENE BUSSEY, 2 CIL

Who will pound brass at the base station of the Dyott Brazil Expedition

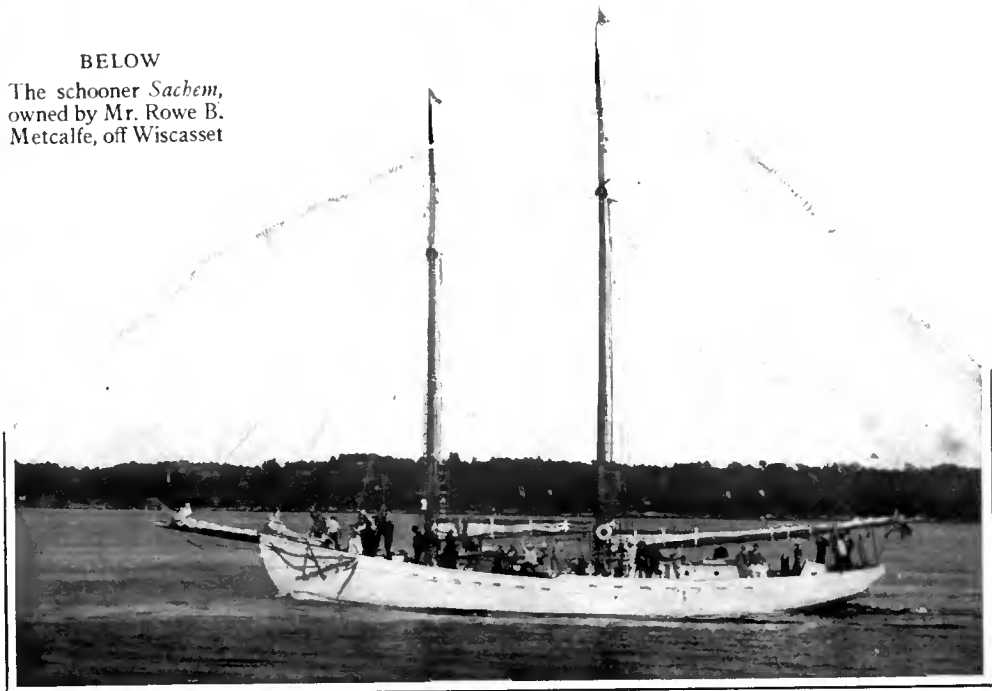

BELOW

The schooner *Sachem*, owned by Mr. Rowe B. Metcalfe, off Wiscasset

# NEW APPARATUS

Equipment of the Radio Industry  
Submitted to the Radio Broadcast  
Laboratory for Test and Approval

RADIO BROADCAST Photographs

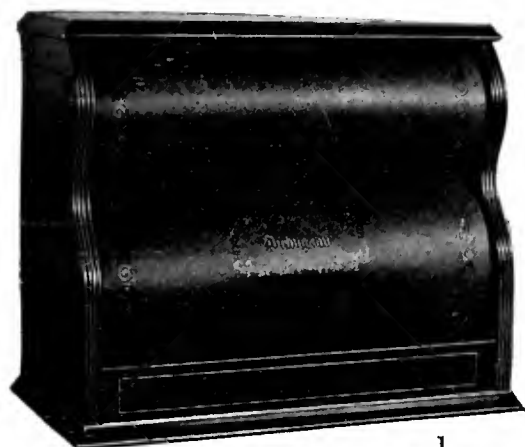

1

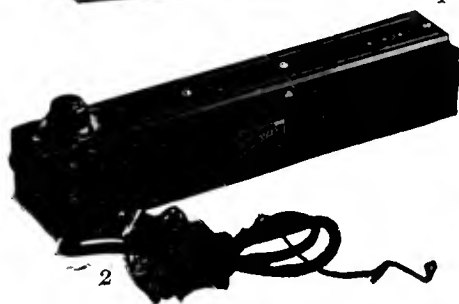

2



3



4



5

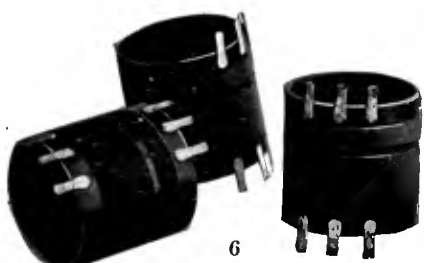

6



7

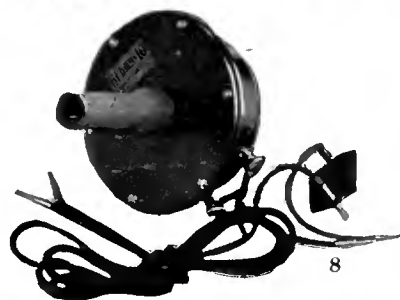

8

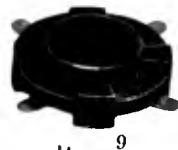

9



10



11

NO.	NAME OF APPARATUS	MANUFACTURER	USE OF PRODUCT	PRICE	REMARKS
1.	Loud Speaker	Dictograph Products Corp., 220 West 42nd Street, N. Y. C.	Sound reproducer for receiving sets.	\$25.00	A loud speaker built under new mechanical principles.
2.	Truphonic Audio Amplifier	Alden Mfg. Co., 52 Willow Street, Springfield, Mass.	Complete three-stage audio amplifier channel.	\$20.00	An interesting three-stage audio amplifier employing dual impedance coupling. The tone quality is good.
3.	Tube Charger	Jefferson Electric & Mfg. Co., 507 South Green Street, Chicago, Ill.	Renews life of vacuum tubes.	\$3.50	A simple device to which tubes may be connected for the purpose of renewing the emission of the filament.
4.	Portable Voltmeter	General Electric Co., Schenectady, N. Y.	Measures voltages of batteries, line supply devices, etc.	\$16.50	This is a double-range type voltmeter, 0-7.5 and 0-150 volts.
5.	Audio Transformer	Benjamin Hughes Co., 298 Lagauchetiere Street, W., Montreal, Canada.	Amplifier of audio frequencies.	\$3.50	An inexpensive audio transformer of good frequency characteristics of Canadian manufacture.
6.	Inductors	The Allen D. Cardwell Mfg. Co., 81 Prospect Street, Brooklyn, N. Y.	Inductances for use in tuning circuits.	Set of 3 \$4.00	Especially intended for use with Cardwell condensers, these inductance units may be very simply mounted on the end plates of the condensers.
7.	Variable Condenser	General Instrument Corp., 477 Broadway, N. Y. C.	Variable capacity element in tuned circuit.	0.0005 Mfd. \$5.50	A ruggedly constructed variable condenser.
8.	Loud Speaker Unit, Hi-Lo	American Electric Co., State & 64th Streets, Chicago, Ill.	Loud speaking attachment for use with horns, phonographs, etc.	\$13.00	This loud speaker unit is of the adjustable type, is excellently constructed, and has good tone characteristics.
9.	Rubber Socket	Moulded Products Corp., 549-551 West 52nd Street, New York City.	Resilient vacuum-tube socket which prevents microphonic noise amplification.	\$0.60	By the use of a shock-proof socket, much noise may be prevented from reaching the loud speaker. The one illustrated has good shock-proof qualities and will not lose its resiliency.
10.	Battery Cable Connector, Acid Proof	De Jur Products Co., 199 Lafayette Street, New York City.	Used in connecting batteries to receiver.	\$1.50	This battery connector is so shielded as to prevent attack by acid.
11.	Six-Tube Receiver	Mu-Rad Radio Corp., Asbury Park, N. J.	Broadcast reception.	5 ft., 5 way \$195.00	An excellent single dial six-tube receiver designed for the use of an UX-112 and similar tubes in the output. Each receiver is individually calibrated.

The correct price of the Burns No. 205-B loud speaker shown in this department last month is \$22.50, and not \$10, as incorrectly listed. The cabinet loud speaker indicated as No. 1 in the "New Apparatus" section last month, is a product of the Musical Products Distributing Company of New York City, and not as listed. It retails at \$65.

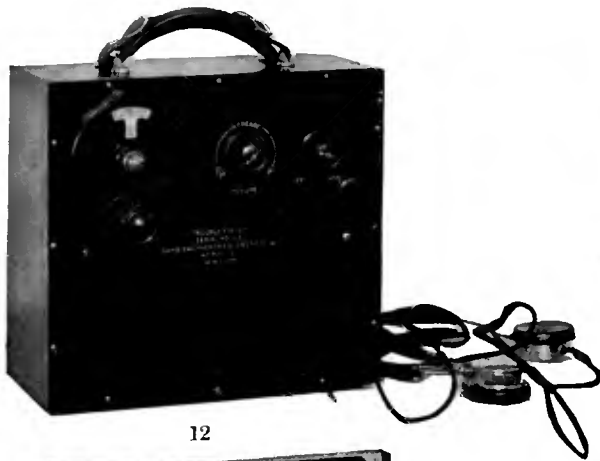

12

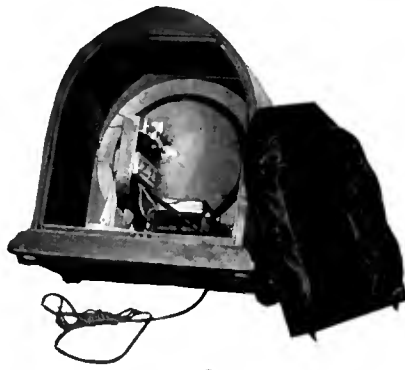

13



14

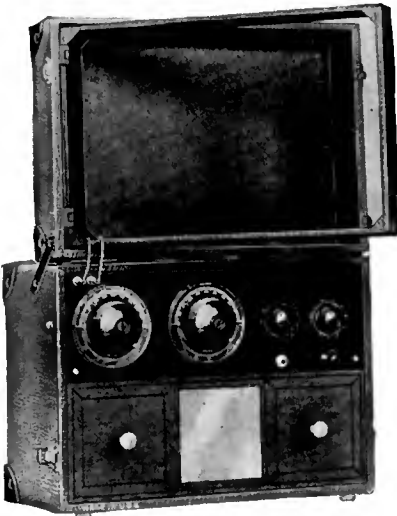

15



16

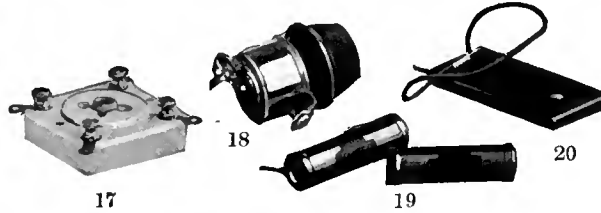

17

18

19

20



21



22



23

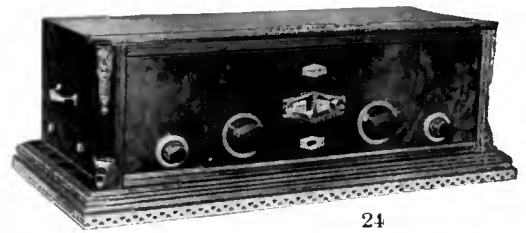

24

No.	NAME OF APPARATUS	MANUFACTURER	USE OF PRODUCT	PRICE	REMARKS
12.	Trouble Finder.	First Aid Specialty Co., Inc., 67 Wall Street, New York City.	Locate interfering and disturbing transmitted noises.	\$100.00	A portable four-tube receiver with built-in loop, excellent for the detection of disturbing noises. Excellent as a portable broadcast receiver.
13. & 14.	Loud Speaker, "Peerless."	United Radio Corp., 15 Caledonia Ave., Rochester, N. Y.	Sound reproducer for use with receiving sets.	\$35.00	A loud speaker employing a heavy wood housing evidently intended as a baffle. The driving mechanism actuates a cone whose edge is supported on leather. The quality produced is fine.
15.	Portable Six-Tube Receiver	Mohawk Corp. of Illinois, Diversy at Logan Blvd., Chicago, Ill.	Broadcast reception	\$135.00	This portable six-tube receiver employs 3-volt tubes. An adjustable loop is contained within the lid. Loud speaker and batteries are self-contained. Three r. f. stages are employed.
16.	Double-Range Voltmeter	Jewell Electrical Instrument Co., Chicago, Ill.	Measure voltages of batteries, line supply devices, etc.	\$10.00	A double-range voltmeter suitably housed in a decorative base.
17.	Porcelain Socket	Hart & Hegeman Mfg. Co., Hartford, Conn.	Receptacle for vacuum tubes.	\$0.50	Especially suitable for short-wave receivers, where good insulation is desirable.
18.	Variable Resistance Unit, Clarostat	American Mechanical Laboratories, Inc., 285 North 6th Street, Brooklyn, N. Y.	Current and voltage regulator in line supply devices, etc., or wherever variable resistance is desired.	\$2.25	An improved variable resistor entirely housed in a metal container. Smooth and permanent in regulation and adjustment.
19.	Fixed Resistance Units Kroblak	C. E. Mountford, 467 Greenwich Street, N. Y. C.	Current and voltage regulator in line supply devices, etc.	\$1.00 (up to 10,000 ohms)	A sealed fixed resistor of the wire-wound type, capable of handling 10 watts. Other values at other prices.
20.	Tube Renewer	Sentinel Co., 504 S. State Street, Chicago, Ill.	Reactivates vacuum tubes.	\$1.50	A handy device for "flashing" tubes to renew filament emission.
21.	Cone Loud Speaker	Trimm Radio Mfg. Co., 24 So. Clinton St., Chicago, Ill.	Sound reproducer for use with receiving sets.	17", \$16.00 14", \$12.00	A cone loud speaker, supplied in two sizes, with good tone characteristics.
22.	Set Tester	Hanscom Radio Devices, Woonsocket, R. I.	Sets up local signal with which to test receiving sets.	\$10.00	With this device it is possible to provide a local signal adjusted to any frequency within the broadcast frequency spectrum for use as a test of receivers.
23.	Tube Tester, Hoyt	Burton-Rogers Co., 26 Brighton Ave., Boston, 34, Mass.	Measures characteristics of vacuum tubes.	\$175.00	A device for measuring amplification constant, plate impedance, and other characteristics of vacuum tubes.
24.	Six-Tube Neutrodyne Receiver	Howard Radio Co., 451 East Ohio Street, Chicago, Ill.	Broadcast reception.	\$200.00	A receiver for broadcast reception contained in a burl walnut cabinet.

# Additional Notes on the R. B. "Lab" Receiver

Hints on the Use of a Metal Panel—Obtaining the Correct Grid Bias for Power Tube Use—How to Provide for Short or Long Antennas—Suggestions for Home Constructors

By JOHN B. BRENNAN

Technical Editor

FOR the benefit of those who may be interested in experimenting with the R. B. "Lab" Receiver, which was described in this magazine for June, September, and November, 1926, the following additional notes on operation, etc., are presented. Especially do these notes refer to the four-tube model

ceiver and so a suitable one was designed in the Laboratory of RADIO BROADCAST, its specifications for home winding being detailed in the November article. Suitable binocular coils, compact, and with confined electromagnetic field, are now available for the "Lab" Receiver from the General Winding Company. They are known as Gen-win R. B. "Lab" set coils.

assembly. This point is made clear by reference to the diagram which shows that after the condenser is mounted on the bakelite, the latter is screwed to the metal panel by means of machine screws.

The sketch to the right in Fig. 1 shows an example of the supporting of a single-hole mounting piece of apparatus. The hole in the metal panel is sufficiently large so that the shaft of the unit mounted will not make contact with the metal. The bakelite has been bevelled to improve its appearance.

Completely drilled and engraved composition (non-metal) panels for the R. B. "Lab" Receiver are obtainable from the Insulating Company of America, New York City.

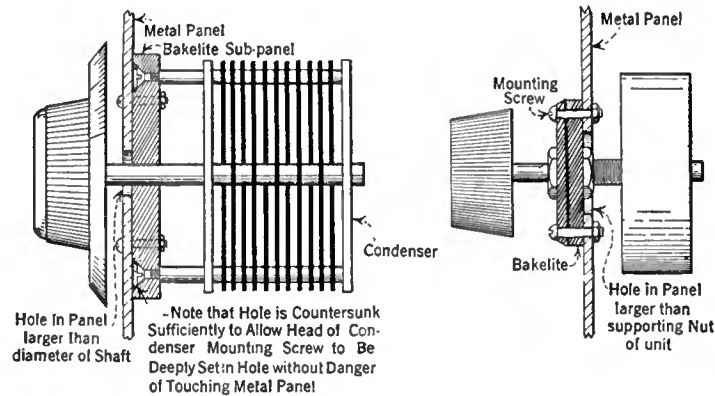

FIG. 1

The use of a metal panel makes necessary the utilization of bushings made of some insulating material to support the instruments mounted on the front panel. This diagram clarifies the method of supporting such instruments

which was described by the author in the November RADIO BROADCAST.

The investigational work leading to the final construction of this receiver was considerable as far as the coils were concerned, many well-known and some obscure forms of winding being tried. Needless to say, perhaps, unshielded solenoids were discarded early in the work; their unconfined fields tended to interact, and thereby upset the balance of the receiver. However, since this type of coil possessed many admirable qualities, its inclusion in the circuit has received more than mere passing attention, and very shortly it is hoped to present to our readers a construction wherein the solenoid type of coil is employed in a completely shielded "Lab" Receiver. Various forms of commercially made binocular coils were tried too, and found wanting. The main fault with these was that the primary coil in the antenna unit was situated at the wrong position with respect to the secondary for best operation in the "Lab" Receiver.

Yet, after considerable experiment, it was decided that the binocular type of coil would give excellent results in this re-

ceiver. The insulating material should be  $\frac{1}{8}$  inch thick.

Fig. 1 shows how the bushings are adap-

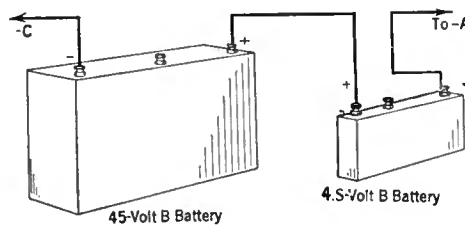

FIG. 2

By bucking together two batteries, one of forty-five volts and the other of 4.5 volts, a resultant 40.5 volts grid bias potential may be obtained

ted to the metal panel. To the left of this diagram is shown the method of mounting a condenser or other instrument not of the single-hole mounting type. Such a condenser is first of all mounted on a suitably sized piece of bakelite in the usual manner, care being taken, though, to see that the screw heads are countersunk well into the material so that they will not come into contact with the metal panel in the final

## TUBES

IN THE matter of tubes, the R. B. "Lab" receiver was designed primarily for use with standard 5-volt tubes in the first four sockets and a 171 or other semi-power tube in the last audio stage. There are a few tube manufacturers who make special tubes for various uses in a receiver; some make radio-frequency amplifier tubes, special detector tubes, high- $\mu$  tubes, etc. The first and second named might very well be employed in the R. B. "Lab" receiver. The number of turns employed in the plate inductance of the r.f. tube will depend upon the plate impedance of the tube, as explained by Keith Henney on page 123 of the June, 1926, RADIO BROADCAST.

If the UX-171 is to be used in the last audio stage with its full rated 180 volts of B battery, the 22- $\frac{1}{2}$  volt C battery must be substituted for one having a total of about 40 $\frac{1}{2}$  volts. Such a battery is obtainable from the Burgess Battery Company. Com-

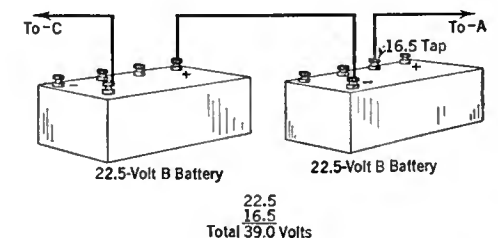

FIG. 3

Two twenty-two and a half-volt batteries, connected in series will no doubt be found satisfactory for use with an UX-171 tube with 180 volts plate potential

binations of several of the new Eveready batteries may also be used to obtain the desired C voltage. It is possible also to obtain this 40½-volt potential by bucking a regular 4½-volt C battery with a light duty

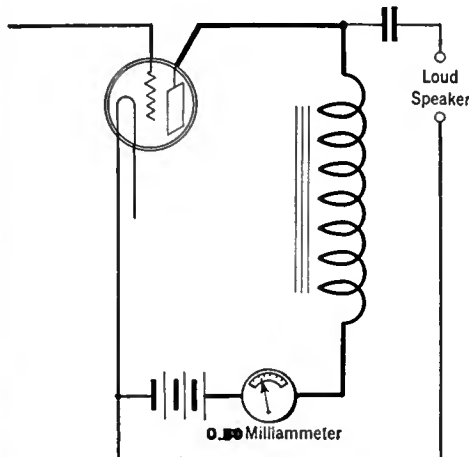

FIG. 4

The connection of a milliammeter in the plate lead of the output tube provides a visible indication as to whether the amplifier is satisfactorily handling the signals or not. Overloading will make itself manifest by a badly fluctuating needle on the meter

45-volt B battery. That is, the positive terminal of the 4½-volt battery connects to the positive terminal of the 45-volt battery. The negative terminal of the large battery connects to the F minus post of the last audio transformer, and the minus terminal of the smaller C battery connects to the minus A lead of the A battery. Fig. 2 illustrates these connections, while Fig. 3 shows how to obtain an approximately correct value by the use of two 22½-volt batteries.

Voltage recommendations are always approximate and, for best results, the home builder should experiment with various voltages. If a milliammeter is obtainable (0-50) it should be connected in the plus B lead to the loud speaker unit. See Fig. 4. Then, when reception is taking place, any distortion which may be present in the receiver will manifest itself in an unsteady, fluctuating reading of the milliammeter. The B and C battery voltages should be adjusted until a minimum fluctuation of the needle from a normal current reading takes place. This normal reading will approximate about 25 mils. It must be remembered, however, that a certain amount of fluctuation can take place before distortion is noticeable. In other words, the fluctuation should be as small as possible, at most not over five milliamperes in twenty-five.

ANTENNAS

WITH a high, long antenna it is not to be expected that the selectivity of this receiver will be as marked as when a shorter antenna is used. The ideal antenna is one of about 75 feet in overall length. Where a longer antenna is used, a fixed condenser of about 0.0001 mfd.,

inserted in series with the antenna and coil, will aid in sharpening the tuning. Naturally too, a long antenna will prevent the dials of the receiver reading similarly for a given station.

It is not to be expected that the receiver, when built according to the constructional specifications outlined in the November RADIO BROADCAST, will immediately fit in with any and all conditions. The R. B. "Lab" receiver was built to meet average conditions, and when it is used under adverse conditions, such as are imposed by the use of an extremely long antenna, some means must be resorted to in counteracting these unfortunate circumstances.

The method employing the fixed condenser, as explained above, is one form of remedy. A variable condenser can be used if desired, and its connections are shown in Fig. 5. To do the job completely, though, the antenna circuit might best be tuned to resonance with the incoming signal, rendering the receiver exceptionally sharp and obtaining a maximum transfer of signal energy from the

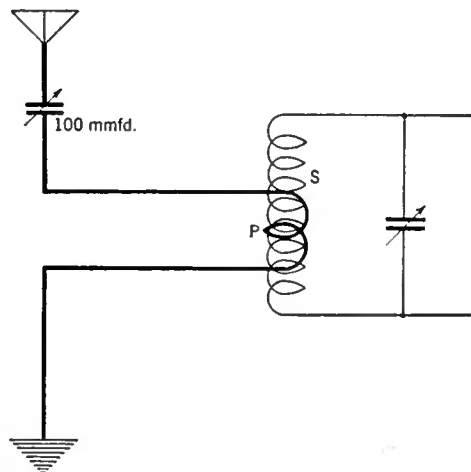

FIG. 5

A condenser (it may be variable) will help to increase the selectivity when a long antenna is used

antenna to the radio-frequency amplifier circuit; even with a small antenna this additional control is worth while from the standpoint of selectivity and volume. The circuit diagram, Fig. 6, shows the additional tuning unit. It consists of an inductance and variable condenser. C<sub>1</sub> is a 0.0005-mfd. variable condenser and the inductance L<sub>1</sub>, may consist of about 80 turns of No. 24 d. c. c. wire wound on a 1½" form. This coil should be placed at right angles to the antenna secondary coil. The coupling coil, P, may be the existing primary coil in the set.

Worth while information relative to the tuning of antenna systems was contained in an article by Harold Jolliffe on page 84 of the November RADIO BROADCAST. It is recommended that this article be closely studied.

Mr. R. S. Danforth, of San Francisco, California, has written a very interesting and informative letter which is here re-

printed in part for experimenters and constructors who have built the R. B. "Lab" circuit.

I have been playing with the so-called Hull or RADIO BROADCAST "Lab" circuit since October, 1925, with very encouraging results. The action of this set was much improved by using an aperiodic antenna primary coil separated about ½" from the secondary, but I found the response and selectivity was greatly improved by using a separate loosely coupled series tuned antenna coil. This antenna coil was about 3" away from the coil ahead of the radio-frequency amplifier tube, and at a slight angle to it, but at the same time kept at right angles to the detector tube coil. I used the Rice System of neutralization and had no trouble in neutralizing the radio frequency tube.

As an audio amplifier, I am using an Amertran De Luxe first stage transformer with two stages of resistance coupling. I employ an UX-200-A detector tube and 201-A amplifier tubes (excepting in the last stage, where I employ a 171) and find this audio combination superior to using all resistances or two transformers. The radio-frequency amplifier tube is a 199.

As regards the efficiency of this circuit, let me state that my present location is very poor yet I can bring in stations that the ordinary set will not get at all, and these with sufficient volume to overload the 171 power tube.

My R. B. "Lab" Receiver is superior in sensitivity to any set which I have ever heard.

The use of the loosely coupled tuned antenna coil, while adding one additional control, shows a very marked increase in volume as well as giving real selectivity.

Our readers are urged to communicate with the author, or with Mr. Keith Henney, director of RADIO BROADCAST Laboratory, relative to their experiences with this circuit.

From time to time the data collected in experimenting with this interesting circuit will be passed along to our readers.

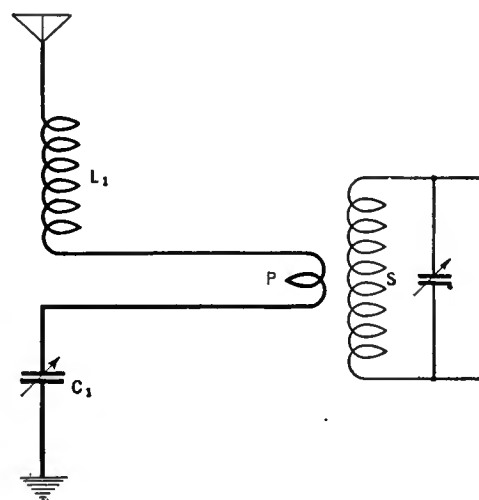

FIG. 6

A better way of increasing the selectivity is to tune the antenna primary circuit. A loading coil and condenser are necessary





Drawings by Stuart Hay

## The High and Mighty Place of the Announcer

THE hope has been expressed in some quarters that our most popular announcers may shortly be raised to the dizzy eminence of movie stars. When the day comes, the announcers will be such god-like figures that to tell the truth about them and their trade will be to incur the risk of prosecution for blasphemy. Therefore let us scrutinize them now and hope that the copy gets into print before the ascension.

Almost every man outside of the deaf and dumb asylum believes in his heart that he can announce, just as everybody thinks that the story of his life would make a thrilling novel, which he would be capable of writing with a little practice. What does an announcer have to do? Just talk? Anybody can do that. When a broadcasting station advertises for an announcer, several hundred candidates usually present themselves. Of these, perhaps ten might be considered for the job, after several months of breaking in. Perhaps one out of the lot can be developed into a capable announcer, not a planet of the first magnitude, but merely a tolerably bright luminary. As for the genuine stars, one comes across them by luck; they occur like pearls in oysters. Possibly if ten thousand superficially qualified college men were weighed in the balance, one by one, a single specimen of the really first-rate, polished and gilded, metropolitan announcer would be discovered. And, if he also possessed brains, he could probably make \$15,000 a year selling bonds; hence he would not be willing to announce for less than a quarter of that sum. The popular idea that the ability to announce or put one's thoughts across in writing are common traits is true to this extent: anybody can so express himself to his own satisfaction. But it is an altogether different job to do it to the satisfaction of the public and get paid for it.

A capable announcer must, obviously, know the language of the country in which he is to pursue his calling well enough to impress the average auditor. This amounts to saying that his solecisms, errors in speech, and misjudgments in choice of words must not be gross or frequent enough to jar any great number of listeners. I speak now of conditions as they are, rather than as they should be. In this country, announcers who speak correct and beautiful English are rare. Any well-educated listener, spending an evening on the air with many of those who pass as good, can jot down six or eight instances of common mistakes in grammar or obviously unesthetic choice of words. I have heard such mutilations as "Those kind of people"

perpetrated in metropolitan stations, without any action being taken against the guilty announcer by either the program manager or the populace. As for some of the small station attachés who take the air, they talk like boot-blacks. Taking them by and large, radio announcers do not treat the language nearly as well as junior public speaking instructors in universities, or even high school teachers in English, although I believe the announcers are better in this respect than the general run of elementary grade teachers. There are no doubt a few announcers in the United States who are impeccable most of the time, but if their number exceeds six, I should like to hear their names. There is room for improvement here, and probably standards will gradually be raised. As matters stand, the beneficial influence which radio might exert in raising the standards of spoken English is being realized only in small part.

In foreign languages, the deficiencies of American announcers, as a class, are even more glaring. In pronouncing French names, the rule seems to be that something midway between the actual French sounds and the English equivalents represents the safest course on the air. The subtle differences in vocalization and articulation which constitute part of the flavor, so to speak, of a foreign tongue, are missed ninety-nine times out of a hundred. Most of the announcers remain totally insensible to them, and the fact that few Americans who pass as well-educated are really at home in French, German, Spanish, and Italian, enables the announcers to get away with their barbarities. Even such relatively elementary considerations as the proper value of a French *u* or an unlauted German vowel are sublimely disregarded. British announcers, I have been told, are much superior to our men in this regard.

I do not wish to lay undue stress on the subject of purity in speech, both domestic and foreign, nor to insist on unremitting correctness, which is an impossibility, whether we insist on it or not. A man may make occasional mistakes, and become conscious of them only after the words are out of his mouth; this no doubt happens to every announcer. I believe that the best of contemporary slang, judiciously employed, adds to the force and gracefulness of language, whether spoken or written. Above all, I should avoid stiffness and affectation; it is better to be casual and natural, with occasional grammatical lapses, than to talk like a pedant. But when all this is conceded, the indifference of the average announcer to the qualities of accuracy

and beauty latent in his language remains a grave fault, toward the removal of which program directors might well devote a little of their surplus energy, if they have any.

It should be noted at this point that in many of the larger stations, particularly those which specialize in toll broadcasting, the announcer is not altogether responsible for what he says. The material is written out for him, as like as not, and all that remains for him is to read it with an air of spontaneity. He should not be blamed for all his bad jokes and circumlocutions; they may hurt him as much as his hearers.

In general, announcers are not prodigies of intellect; they don't need to be, and if they were they would probably be handicapped in their work. I do not mean that, as a class, the announcers are stupid; on the contrary, most of them are facile and clever, and seem to know more than they actually do. Most of them are confident, amiable young fellows, with plenty of brass in their systems and no tendency toward an inferiority complex. They are the greatest pack of publicity-hounds in Christendom. Do you know why? Simply because they get it so readily. Given the same opportunities, most of the rest of us would chase publicity just as avidly. That is the fault of the age, rather than of the announcers, who have not been at work long enough to exert much influence on the *Zeitgeist*, whatever they may do in the future. Let us not be hypocrites; there are few Spinozas or Oliver Heavisides among us. Nevertheless, personal publicity has a harmful effect on some of the announcing boys; they get it too easily, and fail to realize that they have fallen into a disproportionate share, compared to any other class of workers. The magnification of the ego resulting from this misunderstanding is sometimes alarming, and much good announcer material is ruined thereby. The delusions of grandeur burst with a loud report when the victim gets fired and discovers that once he is separated from his carrier wave, nobody pays any attention to him at all.

What constitutes personality in an announcer—that elusive combination of qualities which divides the merely passable announcer from the star with a great popular following? Broadly, it is the knack of transmitting emotions through the voice only, with the skill of the actor or the elocutionist, confined within narrower limits. Yet these emotions originate, to some extent, in the inherent character of the man himself, and an excess of the theatrical element alienates that portion of the audience whose members are sensitive to pretense. The best symphonic

announcer in the East is by no means a facile speaker, but he knows and loves music and possesses a natural dignity which comports with his subject. In other types of broadcasting, theatrical skill and pyrotechnics are more useful, but these qualities must be judiciously handled; the line between entertaining the listeners and enraging all those above the cash-girl level is easily passed over. Genuine wits are few on the air. One thing that is overdone is the "cheerfulness" blather. There is too much insistence on the "happiness" which the next hour will positively generate; one would think that the radio listeners were a mob of melancholiacs.

After all this psychoanalysis and dispensing of advice, I shall probably receive polite inquiries from announcers, or their doting girl friends and mothers, inquiring where I got my dope and whether I have ever faced a microphone myself. I hasten to forestall these comments by admitting that on the one occasion when I wrote an extended piece for presentation via radio I carefully coached one of the young men in my station and let him read it, and if I had to go through with a big good-will feature on the air I should doubtless collapse during the first ten minutes and fall senseless into the condenser transmitter, leaving the mimeograph boy to carry on the great work of the hour.



"I SHALL PROBABLY RECEIVE POLITE INQUIRIES FROM ANNOUNCERS OR THEIR DOTING GIRL FRIENDS"

### Taking the Listeners Behind the Scenes

**I**N THE pursuit of novelties, why doesn't some station put on a "Behind the Scenes" broadcast, giving the radio audience the wire talk, studio conferences, and other preliminaries, before an event is put on the air?

The preparations, sometimes, are more interesting than the actual show. We would hear the command of the control operator to his colleague at the power plant many miles away, "Put on your carrier, Bill, and let's test through"—but the carrier would already be on, and the listeners would enjoy the unwonted intimacy of hearing technical badinage and, if anything went wrong, a damn or two might disturb the calm of an undefiled ether. Next there would be heard the cooing of some beautiful female songster as she entered the studio on the arm of a star announcer, the solicitous inquiries about the health of each by the other, the placing of the microphone, the signal from the control technician to the announcer, and the curtain would rise as usual.

All concerned would know they were on the air, but they would carry on their usual business with as little modification through self-consciousness as they could manage. The audience would like it, I am sure. Everyone likes a peep behind the scenes. If the people in a theater were allowed to go back-stage, in two minutes nobody would be left on the house side of the footlights. As it is, many people who listen to a station night after night, drop in to see the studios and the plant in which their entertainment originates. It is not always possible to accommodate them, for in a busy station the studios, when not in actual use for broadcasting, are generally occupied by orchestras rehearsing for their next performance, artists being put through auditions, piano tuners, and so on. But a little back-stage

show along the lines suggested would inconvenience no one and might intrigue the jaded listeners as much as a hog-calling contest, cooking lessons, or a lecture on fighting the boll weevil.

### Radio Soaks In

**B**ROADCASTING continues to penetrate the arts and sciences. The newspapers are a good index of its progress. Take the Radio Show Section of the *New York Times*, issued in September. Besides the articles by radio specialists, there were discussions by six prominent orchestra conductors: Walter Damrosch, Willem Van Hoogstraten, N. Sokoloff,

John Philip Sousa, Edwin Franko Goldman, and Joseph Knecht. A few years ago these leaders in their respective divisions of musical art never thought of radio except when they wanted to send a wireless message to some passenger on a ship. Now radio concerns them almost as much as the personnel problems of orchestras, the arrangement of programs, interpretations of symphonies, and other matters of direct consequence in their field.

Four metropolitan clergymen, the Rev. Randolph Ray, Dr. S. Parkes Cadman, the Rev. Edwin Keigwin, and Dr. Daniel A. Poling, contribute discussions of radio and its influence on religion to the same issue of the *Times*.

An even more striking item appeared in the *New York Herald Tribune* of August 16th. The music (not radio) critic of the paper, Mr. F. D. Perkins, in reviewing one of the New York Philharmonic Stadium concerts, writes as follows:

Saturday night's concert in the Great Hall brought, for the first time in this series, Saint Saens's "Carnival of the Animals," and Mr. Van Vliet did excellent work in his cello solo in "The Swan" in the Saint-Saens's varied zoo—judging by a hearing of the concert by radio in Schenectady. Schubert's C major symphony, as heard by the same medium, had a praiseworthy and spirited performance under Mr. Van Hoogstraten's direction.

When music critics base their reviews on what comes to their experienced ears out of a loud speaker, the broadcast program managers and engineers begin to listen for the trumpets of the millennium morn.

### Microphone Symbols

**M**R. T. R. DAGG, a broadcast technician of Washington, District of Columbia, objects humorously but not without reason to the symbol for a microphone which appeared on Page 246 of the July issue



"LEAVING THE MIMEOGRAPH BOY TO CARRY ON"

of RADIO BROADCAST. Mr. Dagg concedes that the symbol used is in accordance with the 1926 report of the Committee on Standardization of the Institute of Radio Engineers, but he argues that this picture (repeated here in Fig. 1A), while well enough for the standard transmitter used in commercial telephone practice, does not properly represent broadcast conditions. He proposes the symbol shown in Fig. 1B for a double-button carbon microphone of the type usually found in broadcasting studios.

Brother Dagg's sketch is superior to the I. R. E. symbol in that it shows the two buttons and permits a correct connection, graphically, in the circuit; the fact that we are dealing with a variable resistance is also emphasized. What is less advantageous is that the intersecting arrow is normally used to indicate a manual variation by an operator or user of the instrument in question, rather than the variation of resistance of audio frequency, in accordance with impinging sound waves, which we find in the microphone. Nor does Mr. Dagg's symbol cover electrostatic and electromagnetic transmitters.

Figs. 1C, D, and E show a possible set of symbols for carbon (double-button), electromagnetic, and electrostatic transmitters, respectively. In the first, the two variable buttons, the diaphragm, and the back are shown; the second contains the electromagnet; and the third is obviously a condenser. The variation mark in each case is a wavy diagonal line, to indicate both variation and the generation of an alternating current.

But this is perhaps too complicated to meet the approval of the Committee on Standardization. They might prefer to compromise on something like Fig. 1F, for a double-button carbon microphone, which is simply the standard symbol with the addition of a middle lead; while for electromagnetic and condenser transmitters the original standard symbol would serve, with a printed addition indicating the type. It is a question how far we wish to go in complexity in order to secure a more literal representation, when the primary object of a symbol is to depict by a simple graphical substitute apparatus which is inherently much more complicated, by regarding the principle rather than the machine itself.

### A Louisiana Tragedy

REMONSTRANCE of a listener, unaccustomed to the vagaries of August transmission, addressed from New Freedom, Louisiana to wjz, New York (transmitter at Bound Brook, New Jersey):

I think the programs you give are about the best, and you will realize therefore that I am just a little disappointed when your waves do not



"YOU CAN HEAR THE MUSIC FOR TWO BLOCKS"

come in strong. When it comes in strong you can hear the music for two blocks when the loud speaker is placed on our porch, but now you cannot hear it for more than half a block.

Oral comments of three unfeeling engineers: He seems all broken up about it. Please frame this letter. That's easy. Tell him you have moved the station one and one-half blocks farther away.

### The Economic Aspect of Radio Engineering

AFTER some kind remarks about our article in the September issue, "A Lesson for the Radio Class," in which a comparison was drawn between radio and civil engineering design, Mr. Orrin L. Brodie, a member of the American Society of Civil Engineers, and one of the designing engineers of the Holland vehicular tunnel, adds this observation:

Your novel application of the methods of structural design, especially of the tunnel, to the production of adequate power tubes for radio uses, attracted us also, for some of us are radio fans of a mild order. Nevertheless, the possibility occurs to me that the radio engineer is as his civil and mechanical, etc., colleagues are often confronted in higher and better aspirations with the item of *cost*. What is obviously and logically the best in design is often precluded by inability or unwillingness upon the part of those responsible for the finances to provide the funds, notwithstanding that the best is oftenest

the cheapest, and the cheapest the costliest in the end, for them.

Of course Mr. Brodie is right. Money makes the mare go, and likewise puts amperes in the antenna and pushes forward the shield behind which the tunnel construction takes place. In the particular instance I cited—the production of power tubes for radio receivers—the economic obstacle was not formidable. That step forward was delayed until a copiously emitting filament material had been developed, and the esthetic evils of output tube overloading were sufficiently realized. But in broadcast transmitter practice, the handicap pointed out by Mr. Brodie is all too often in evidence. There are many small stations operating on a shoe string, as they say down in Wall Street, with the owners demanding technical quality and service comparable to those of the large, relatively wealthy stations, but unable to put up the necessary cash. The position of the engineer in such a plant is most unenviable. The labor of Sisyphus would be a vacation for him. Let him emblazon the words of Mr. Brodie on a sheet of vellum and leave it on his employer's desk some fine spring morning.

### Memoirs of a Radio Engineer

XV

IN 1915 and 1916 I took electrical engineering courses at the College of the City of New York under Prof. Charles H. Parmly, at that time a member of the Physics Department. The Department of Electrical Engineering, of which Parmly was the first Professor, was not founded until 1917. Before that date, all technological courses at the College, except for the field of chemistry, were given by Physics professors.

Professor Parmly, at the time I knew him, was a handsome, sparsely built man in his late forties. He had a high forehead, penetrating eyes, and hair and mustache just turning gray. He was an engineer (E. E., Columbia University, '92), and he looked and acted the part. Parmly was the most orderly man I have ever known, bar none, and he knocked some of his regularity and logic into me, among others. He hated messy work and messy thinking, and tolerated neither in his students. We stood in awe of him, because he never pretended to know anything he did not know, and what he did know—and that seemed about everything—he had mastered with almost inhuman thoroughness. There was not the slightest hope of bluffing him in a recitation; if there was any portion of the problem wherein you were hazy, Parmly would find it out, and, on the spot,

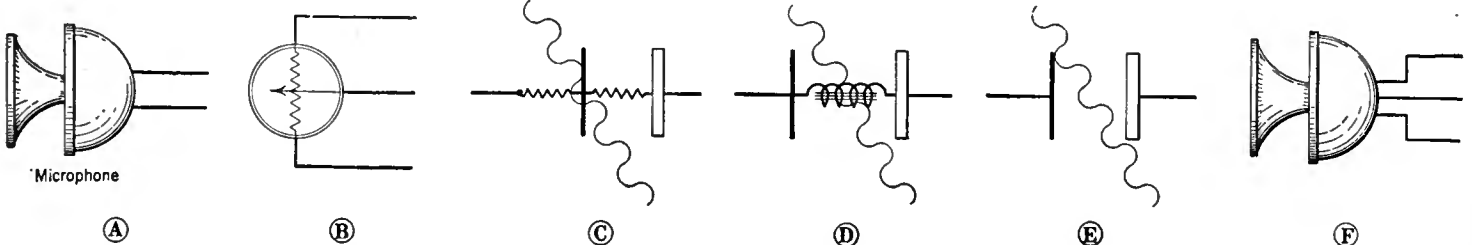

FIG. 1

he would make you clarify your thought, by a method of his own. He never told a student anything, simply in order to get through with the job and on to something else, but, by asking questions in a strictly logical sequence, he would lead him to the correct conclusion. This took time, and when the subject of such a Socratic inquisition happened to be stupid, Parmly would become impatient, but this never impelled him to abandon his method. The only effect was to make him shout his questions in a voice that reverberated through the College halls, while the covering student stammered his replies in barely audible tones. Finally the correct answer would be drawn out, and then the professor's stern face would break into a smile of startling sweetness, under the influence of which the incipient inferiority complex of the sophomore or junior was transformed into a determination to do better next time.

When Parmly spoke, he fairly etched his words. His clarity of diction and articulation expressed his nature. So did his handwriting, the accounts he kept, and his conduct in all the tasks and responsibilities he had at the College. He had, I believe, a feeling like that of Spinoza for the eternal laws of nature, and the exact quantitative relations of electrical phenomena gave joy to his heart. My radio friends who read this, and who never knew him, may form a picture of a severe and rectilinear character unlike the actual man. He was inflexible only insofar as he knew he had to be to turn out good engineers. He impressed us, by his speech, his precepts, and his methods, with that apprehension of undeviating principles in the behavior of physical things which distinguishes the engineer from the mere rule of thumb, hit-or-miss worker. At heart he was kind and gentle, but he did not shirk the task of the surgeon. He could have sent us on with much less than the pains he took. A man of

means and ability, he could have enjoyed an easier and perhaps longer life than the one he chose. After his death, when I was assistant to Professor Goldsmith, I happened to get the task of disposing of some of Parmly's old records. Among other material, there were thousands of inventory cards in his handwriting, in several colors of ink, detailing the apparatus in his charge down to the last screw, with his customary lucidity and order. He did not have to do this. It was simply his way of going about his affairs, without haste, thoroughly, calmly, and efficiently. He made me detest a loose bolt, a poor connection, a sloppy diagram, as an offense, not only against safety and efficiency, but against the esthetic principles of the profession for which he prepared me. Often, in late years, contemplating a dirty shop, or some wretched manufacturing layout, or a test room converted into a shambles, I thought, "Oh for a Parmly, with his determination and his scorn, to tear into this and clean it out, like a wind from the sea!" If you have never seen such a situation in radio, perhaps you have not been in radio long. We have our Augean stables here and there.

The electrical engineering laboratory at C. C. N. Y. in 1916 was not as well-equipped as it is now, but it served the purpose, and a man who could not learn anything from its motors and generators would not be better off at M.I.T. The machines were small, up to perhaps 15

kilowatts, controlled from two main switchboards, with arrangements for stopping and starting individual units by means of clutches in connection with chain drives. We made heat runs on transformers, determined load characteristics of generators, ran Prony brake tests on motors, and went through the whole

smile which was like the sun bursting suddenly through clouds, and pass on to the next squad. Not long after, in September, 1917, he died suddenly. If he teaches now in some other sphere, I hope he has better students, but they will not remember him with more deeply felt gratitude than the men he taught last on earth.

All this is not radio, but to those who think of our work as nothing but frequency characteristics, cost data, and the life of power tubes, I should like to remark that such things are based on much else that is outside of radio—on men, in the last analysis.

## Technical Operation of Broadcasting Stations

### 13. The Condenser Transmitter

THIS article is not intended in the strictly practical sense of previous numbers in the series, for very few stations in the United States employ condenser microphones, and the men at those stations have nothing to learn from my description. Nor will any ambitious broadcaster find it possible to build a usable condenser microphone in his home workshop, unless he is a combination of jeweller, toolmaker, and expert electrician; and if he is all those things, his reasons for remaining in broadcasting are quite beyond me. The object of the present discussion is merely to acquaint technical broadcasters with the general theory and characteristics of a form of telephone transmitter in actual use for broadcast purposes, and second only to the common carbon microphone, in practical importance, not only in broadcasting, but in the allied field of phonograph recording.

A valuable description of the condenser transmitter is found in a paper by E. C. Wente: "The Sensitivity and Precision of the Electrostatic Transmitter for Measuring Sound Intensities," in the *Physical Review*, Second Series, Vol. XIX, No. 5, May, 1922. Wente wrote about the condenser transmitter in the same journal for July, 1917; but the later paper gives more up-to-date data.

The condenser transmitter, according to Wente, consists essentially of a thin metal diaphragm under tension, separated by a small distance from a plane metal plate, the plate and the diaphragm forming the two electrodes of an air condenser. The arrangement of these parts is shown schematically in Fig 2, together with the instrument to the associated amplifier. The thickness of the diaphragm is of the order of 0.001 inch (1 mil), and the spacing between the diaphragm and the back-plate is about the same distance. Obviously this construction requires the finest sort of machine work in the first place, and perfect freedom from foreign particles in the space between diaphragm and plate after assembling. A tiny thread of lint or metal cutting will put the transmitter out of commission.

In the design of condenser transmitters, the natural frequency and damping are controlled, among other factors, by annular grooves cut in the back-plate, facing the diaphragm. The sensitivity to ordinary sounds increases inversely as the natural frequency. For broadcast purposes, the diaphragm is generally stretched to a natural frequency of about 8000 cycles per second, a figure sufficiently above

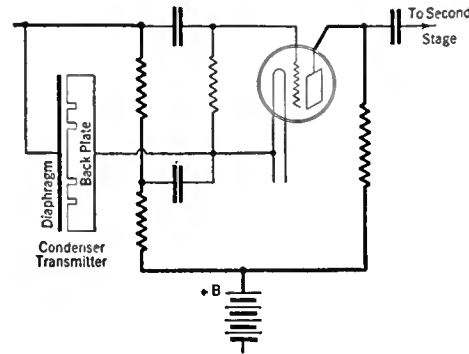
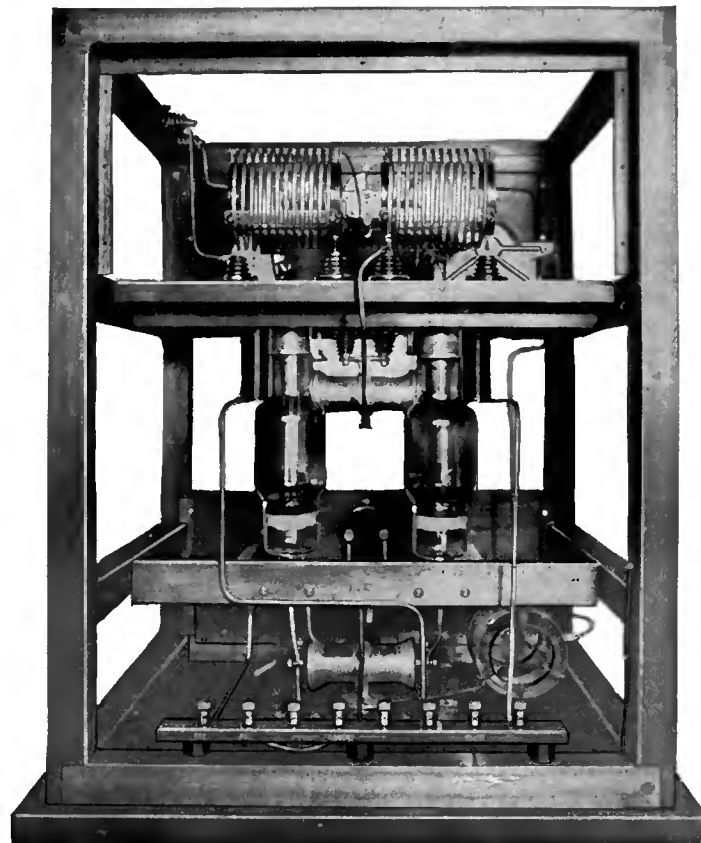

FIG. 2

standard list of experiments designed to prepare the student for the world of industry. At times we mixed up the connections and the breakers would go out with a bang which frightened the men as if they had been so many schoolgirls; it takes years to achieve the non-chalance of the fire-eating engineer who thumbs his nose at an arc and scorns to jump at the crack of the unchained lightnings. Then Parmly would come over and begin catechising us in a gentle and pleasantly sarcastic voice, which gradually rose until it dominated the noise of all the machinery in the building, while we sweated and fumbled for the right replies. When these were at length phrased to his satisfaction, he would look at us for an instant with the bright



GMD, THE CARDWELL TRANSMITTER AT THE BASE STATION OF THE DYOTT BRAZIL EXPEDITION

the audio frequency range normally transmitted to avoid resonance effects. The diaphragm is usually from two to three inches in diameter, which gives a capacity of about 400 microfarads with close spacing between diaphragm and back-plate. This relatively low capacity limits the length of the cable between the transmitter and the input stage of the amplifier system to under 20 feet, and even then it is necessary to devise a special low capacity conductor, since inherently the instrument is a high impedance device, liable to bypassing of the higher sound frequencies if shunted by any considerable capacities. In one form, the transmitter is incorporated in one unit with the first tube, to get around this difficulty. In studio pick-up, however, there is little objection to the more usual arrangement of a compact two-stage amplifier placed on the floor, with a 12-foot length of low-capacity cable running to the transmitter, which is mounted on a concert stand. The vibratory system of the condenser transmitter is essentially the same as that of a high quality carbon transmitter. The latter requires a flow of direct current, in which audio

variations are produced through the changes in resistance consequent on the vibration of the diaphragm. Analogously, the condenser transmitter operates with a constant polarizing voltage, which may be as high as 500 volts, but to reduce insulation difficulties, is more commonly set at about 200 volts, supplied by the amplifier battery through a suitable resistance. The vibration of the diaphragm of the condenser, when affected by sound waves, varies the capacity of the instrument by about one-hundredth of one per cent., which is enough to produce a slight audio ripple on the grid of the first tube. Fig. 2 shows how the polarizing voltage is connected to the transmitter and the audio output tapped off capacitively.

The instrument has a tendency to be two or more times as sensitive at very low and very high frequencies than in the middle range from 1000 to 5000 cycles. This may be corrected in the associated amplifier.

The sensitivity of a condenser transmitter is given by Wentz as 0.35 millivolt per dyne of force exerted by the air wave impinging on each square centimeter of the diaphragm. A high

quality carbon transmitter will produce over 5.0 millivolts for one dyne per square centimeter of sound pressure, across a 200-ohm load. The carbon transmitter is therefore much more sensitive, since it produces more voltage per unit of air pressure across a low impedance than the condenser across a high impedance. Putting it in terms of telephone levels, we may say that a condenser transmitter, with an output of a fraction of 1 microwatt, is 60 TU's down. A high quality carbon transmitter of the usual sensitiveness is only about 30 TU's down. A gain of 30 TU's means about two stages of high quality amplification. We note, therefore, that the condenser is two stages below the push-pull carbon, while the latter is still two stages below zero level, which may be taken as the average commercial telephone power, involving a power of 0.01 watt. The relatively low quality commercial telephone transmitter is from four to five stages better than a condenser in power output. Unfortunately, it does not provide the quality of output required in broadcasting.

Wentz intended the condenser transmitter mainly for reliable measurements in the field of sound, and it continues to be used for this purpose in such highly fruitful measurements as those of Fletcher and Wegel on the sensitivity of the ear, Crandall and MacKenzie on energy distribution in speech, etc. Its more immediate use in broadcasting (a "practical" application, as short-sighted persons would say) provides material for scientific controversy among the more luxurious broadcasters. It is a favorite topic for luncheon arguments among the metropolitan broadcast engineers, second only to analyses of the shortcomings of announcers. The condenser, with its associated amplifier, so placed and padded that it does not pick up microphonically on its own hook, with the best of tubes, and the transmitter itself kept clean and dry, gives a beautiful acoustic output with a practically silent background. The latest and best carbon microphones do substantially the same thing, but expert laboratory maintenance and a large stock to choose from must be available. Some of the early models of condensers were unsuited for broadcast operation, and the troubles to which they gave rise, noised about (*noised* is an unconsciously chosen appropriate word) among the technical brethren, gave the instrument a bad reputation, which, as is usual in such cases, tends to cling to it beyond the proper time. Regarding this, I offer in testimony one condenser transmitter which has given excellent quality without the least disturbance for nine months, although knocked over twice by the studio staff. On the other hand, I should not like to be left without a few good carbons around the station; one sleeps better that way. If Mr. Harry Sadenwater, the champion of condensers among broadcast operating engineers, and Mr. O. B. Hanson, whom I nominate for the same position on behalf of the carbon 373-W and its successors, should care to stage a public debate in Carnegie Hall, I shall be glad to receive a free ticket and to cheer at the ringside. Confidentially, however, I shall continue to flatter both manufacturers with purchase orders, no matter who wins.



DR. L. W. AUSTIN, OF THE BUREAU OF STANDARDS

Doctor Austin is chief of the laboratory for special radio transmission research and the illustration shows him at work in his laboratory, making observations with his double-axis receiving loop which is used in the study of transmission characteristics of radio waves



**CROSLLEY RADIO**  
All prices slightly higher west of Rocky Mts.

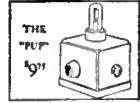

This little double-circuit 1-tube set has made long distance records.



4 tubes. Amazing efficiency, Crescendon equipped



The 4-29 in portable form.



Five tubes, tuned radio frequency. Two stages non-oscillating radio frequency amplification, Crescendon, two stages audio frequency amplification.



5 tubes, I-dial control acuminators, Crescendon, power tube adaptability.

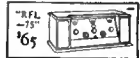

5 tubes. True-cascade amplification; non-oscillating and non-radiating.



In a mahogany console. 5-tube 5-50 receiver, Crosley Musicone speaker, ample compartment for batteries.



Double drum station selector! Musicone and room for batteries and accessories.

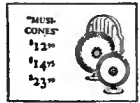

12-inch size, \$12.50. Super Musicone, \$14.75. Musicone Deluxe, \$23.50. Also beautiful Musicone with room for batteries and accessories, as below.



**Crosley Features**  
"CRESCENDON"

When, on ordinary radios, ears must strain to catch a station miles away, a turn of the Crescendon on Crosley radios instantly wells reception to room-fill-



Highly Selective  
**R.F.L. models**

Manufactured under Radio Frequency Laboratory License

Crosley R. F. L. sets represent the highest known development in radio receivers. They will not howl, squeal or re-radiate while tuning—no matter how inexperienced the operator may be.

They are sensitive to a degree rarely attained in tuned radio frequency circuits, cutting out nearby stations with an ease and simplicity that makes them ideal for use in congested broadcasting areas.

Persons technically initiated will instantly understand the perfection of Crosley R. F. L. sets when they realize that true cascade amplification, in addition to absolute balance, is accomplished through the use of Wheatstone bridges in each stage of radio frequency.

To this technical perfection Powel Crosley, Jr. has applied his mass production methods, with the result that nowhere else will the radio buyer find equipment that even approaches Crosley values.

The use of parts in million quantity lots, the simplification of mechanical processes and assembly, and the ownership of wood-working factories which produce exquisite mahogany cabinets at an almost unbelievable low cost, are the means employed by Crosley to make possible the highest type of radio reception at the lowest possible price.

That the public is appreciative of the excellence of Crosley R.F.L. radio sets, as well as the opportunity to enjoy them at small cost, is daily indicated by the tremendous volume of Crosley sales.

Table Model R. F. L.—75

Beautiful two-tone mahogany cabinet—High ratio vernier controlled condensers affording sharp tuning—Recessed dials behind windows—Rich metal trimmings—Power tube adaptability. Appearance and efficiency of this set are out of all proportion to its low cost—the result of Crosley mass production.

\$65

6-Tube Console Model R. F. L.—90

Double drum station selector. Mahogany console finished in two tones. Crosley Musicone built-in. Ample space for all batteries and accessories. Power tube adaptability. Comparable in appearance to the highest priced radios, and in performance it has few equals.

\$90



**THE CROSLLEY RADIO CORPORATION, CINCINNATI—POWEL CROSLLEY, Jr.,**

Crosley manufactures radio receiving sets, which are licensed under Armstrong U. S. Patent No. 1,113,149 or under patent applications of Radio Frequency Laboratories, Inc., and other patents issued and pending. Owning and operating station WLW, first remote control super-power station in America. All prices without accessories.



President  
For Catalogue write Dept. 20

ing volume. An exclusive Crosley feature. ALL-METAL SHIELDED CHASSIS

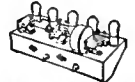

This truly great radio achievement, found in several Crosley sets,

furnishes a substantial frame for mounting elements, produces excellent alignment of condensers, shields the units from each other, prevents interstage, improves the stability of the circuit, increases selectivity and saves costs by standardizing this phase of manufacture.

**THE SINGLE-DIAL STATION SELECTOR**

Nothing in radio equals the joy or the convenience of single dial control. Crosley single drum control enables you to find the stations sought without log book or "tuning"

**"THE ACUMINATORS"**

Crosley Acuminators permit tuning in—loud and clear—weak stations passed over and entirely missed by ordinary single dial radios. In tuning high powered and local stations they are not used.

**USE OF POWER TUBE**

Power tube adaptability marks the Crosley "5-50", "5-75" and "RFL" sets. This feature typifies Crosley provision for best radio reception at moderate cost. This feature is in keeping with all that is most progressive.

HEAD PHONES \$3.00

QUALITY AND BEAUTY IN CABINETS AND CONSOLES



# Aerials have gone out of style

In the old days, when radio was new, the fan was known by crazy festoons of wire that decorated his housetop or yard. These were the old fashioned aerials, and no one has forgotten all the grief they caused.

Modern radio may use the hidden loop, or the short indoor aerial. But there is a better way. The Dubilier Ducon enables you to use the complete wiring system of your house without risk, and with better results than most outdoor aerials give.

You simply screw a Dubilier Ducon into any lamp socket, and connect it with the antenna binding post of your set. You will find that it increases selectivity—especially in crowded neighborhoods, and will reduce “static” in the summertime.

Try a Dubilier Ducon on your set tonight. They are sold by all good dealers on five days’ trial for \$1.50.

**Dubilier** ★  
CONDENSER AND RADIO CORPORATION

## The Radio Broadcast LABORATORY INFORMATION SHEETS

**I**NQUIRIES sent to the Questions and Answers department of RADIO BROADCAST have until recently been answered either by letter or in “The Grid.” The latter department has been discontinued, and all questions addressed to our technical service department are now answered by mail. In place of “The Grid,” appears this series of Laboratory Information Sheets. These sheets contain much the same type of information as formerly appeared in “The Grid,” but we believe that the change in the method of presentation and the wider scope of the information in the sheets, will make this section of RADIO BROADCAST of much greater interest to our readers.

The Laboratory Information Sheets cover a wide range of information of value to the experimenter, and they are so arranged that they may be cut from the magazine and preserved for constant reference. We suggest that the series of Sheets appearing in each issue be cut out with a razor blade and pasted on filing cards, or in a note book. The cards should be arranged in numerical order. Several times during the year, an index to all sheets previously printed will appear in this department. The first index appeared last month.

Those who wish to avail themselves of the service formerly supplied by “The Grid,” are requested to send their questions to the Technical Information Service of the Laboratory, using the coupon which appears on page 218 of this issue. Some of the former issues of RADIO BROADCAST, in which appeared the first sets of Laboratory Sheets, may still be obtained from the Subscription Department of Doubleday, Page & Company at Garden City, New York.

No. 49

RADIO BROADCAST Laboratory Information Sheet December, 1926

### Trickle Chargers

#### DIFFERENT TYPES AVAILABLE

**I**T HAS been customary in general to operate a radio receiver from a storage battery having a very large capacity. However, during the last year or so there has come into rather common use the combination of a storage battery with a trickle charger. This combination consists of a small storage battery which is directly connected to the trickle charger. The trickle charger, connected to the a.c. mains, serves to keep the battery in a constantly charged condition.

There are several types of rectifiers which have been used in trickle chargers. In the bulb type of rectifier, with which we are all familiar, a small vacuum tube is used which rectifies the alternating current and supplies it to the battery. This type is more familiarly known as the Tungar or Rectigon trickle charger, and is very satisfactory and dependable.

The second form of rectifier is the electrolytic type which consists of two electrodes suspended in an electrolyte. It is very simple to construct and works very satisfactorily. It is probably more efficient than the above type since it does not require any energy to light a filament.

The third type, which has only recently come into prominence, uses a crystal. We are all familiar with the crystal detector used in a radio receiver which functions to rectify the small radio frequency

currents, and since the trickle charger need only supply a small current it seems quite possible to use a number of crystal detectors in parallel. Several models using this system are now on the market.

The battery used in conjunction with a trickle charger need not be very large since, under normal operation, it need only be large enough to operate a receiver for one day, after which it may immediately be recharged. However, it is wise to use a fairly good size battery—a unit having a capacity of about 40 ampere hours should give quite satisfactory operation. With such a battery in use, it will be possible to operate the receiver for several days without charging, and in this way preparation is made for any emergencies that might occur.

When the storage battery is operated in conjunction with a trickle charger the only attention required is to see that the water in the battery is kept above the plates. It will be best to examine the battery about once a month. The rate of charge should be adjusted so as to keep the battery fully charged. This means that, when the charger is first purchased, frequent hydrometer readings should be taken to determine the condition of the battery. If the battery begins to run low the rate of charge should be increased; if the battery gases considerably when on charge, it is an indication that the battery is full and it will then be best to reduce the rate at which the trickle charger supplies current, so as to prevent excessive charging.

No. 50

RADIO BROADCAST Laboratory Information Sheet December, 1926

### Hard and Soft Vacuum Tubes

#### SOFT TUBES FOR DETECTOR USE

**I**F A vacuum tube, during manufacture, has left within its bulb a small amount of gas, or if a small amount of gas is introduced into the tube, it is known as a soft tube. If every particle of gas is removed, the tube is known as a hard tube. Soft tubes are particularly suited for use as detectors. They generally require somewhat critical adjustment of the filament and plate voltages but, once these potentials are found, the soft tube makes a very sensitive detector.

Recently some progress has been made in designing sensitive detector tubes, such as the 200-A, which do not require especially accurate adjustment of the operating voltages. The action of a soft tube depends upon the fact that, at certain critical voltages, the gas in the tube is practically in a state of ionization. Then, when a signal is impressed on the tube, the plate current is caused to change, due to the increase in the flow of electrons from filament to plate and due to the increase in the number of ionized gas particles which also flow to the plate. The plate current is therefore increased by these two effects, so that the total change in plate current is greater than it would be if no ionization occurred. When a soft tube is used for a detector, the grid return must connect to the negative end of the filament instead of the positive, as is done when a 201-A tube is used for detection. Therefore, when changing over from a 201-A to a 200-A, be sure to alter the connections so as to have the return connected to the negative filament.

Hard vacuum tubes are generally used as amplifiers, and structurally, are the same as the soft tubes, the only difference being that they have no gas content. Amplifier tubes do not require any criti-

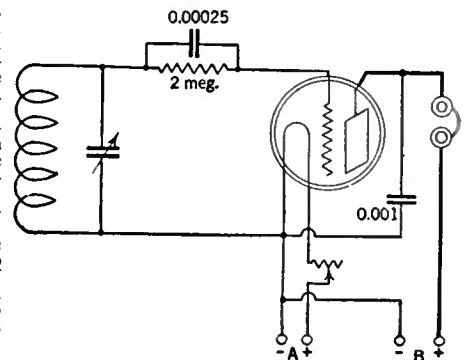

cal adjustment and will operate on from 40 volts up to the maximum that can safely be placed on the tube. A diagram of connections of a 200-A detector tube is given herewith.

# Is actual reproduction possible?

ALTHOUGH it is common to hear such claims as "Perfect Reproduction," "Absolute Perfection," "The Living Artist Brought Right into your Home"—in spite of these claims scientists have never boasted absolute *perfection* in radio reproduction.

Let us look at the facts.

At the broadcasting station the music of the violin, for instance, is changed into a radio wave, and is broadcast. It is then detected in your radio set and changed once more into an electric wave carrying the impulses of the music. This electric wave emerges from the detector tube not altogether perfect. However, it is so nearly perfect that radio science has turned its attention from the *broadcasting* and *detecting* phases of reproduction to the *audio amplifying* of the detector tube output.

*Reproduction by good amplification* has become the most important consideration in the art of radio. The amplifying transformers that were used in radio sets last year are definitely a thing of the past. Almost every set manufacturer has improved upon them. Some have adapted resistance coupling, others large size transformers, and some electric light socket power amplification.

Although these methods of amplification are an improvement, they do not and cannot give *perfect* reproduction, nor do they come as close to perfection as has now been made possible by the recently announced new principle of audio amplification.

## The New Amplification

An entirely new system of amplification known as *Truphonic* has been developed. This system more nearly approaches actuality than any other yet devised. Scientific laboratory tests and tests before both the musically trained and the musically untrained ear establish this fact beyond question.

Unfortunately the *Truphonic* system was not developed in time to be generally used in this fall's production of radio sets—with the exception of a number of the makers of the more expensive sets who have a smaller production, and who were able to incorporate *Truphonic* amplification into their instruments.

But for radio listeners and lovers of fine music who want this most nearly actual of all reproduction *now* and immediately, the *Truphonic* Power Amplifier is provided in the simple, compact form shown below—for *instant attachment, without tools, and with no change whatever in your present radio set.*

Whether you bought or made your set this year, last year or five years ago, the *Truphonic* will give you finer reproduction than you can get in any other way—regardless of how much you can afford to spend.

The *Truphonic* Power Amplifier operates directly from the detector output. No transformers now in the set are utilized. This pure detector music in every note, tone, and shade and in considerably greater volume, is so beautifully and faithfully reproduced that you will find it as difficult to describe as it is for us to attempt to describe it to you.

## The Truphonic with Power Tubes

Besides the fundamentally great improvement in reproduction that the *Truphonic* brings to radio in such a conveniently applied form, there is the added advantage that for those who want extreme volume without overloading the last stage tube, the necessary extra B and C battery connections for the use of power tubes are provided for in the attachment cord.

We have tried in this space to give you some idea of what you may expect from this new principle of audio reproduction that has come to radio. We realize that we have made some strong claims for *Truphonic* amplification, but we have made no claim that you will not find more than backed up when you have tried the *Truphonic* yourself.

We urge you to get the *Truphonic* now—so that you may begin immediately to have an altogether different kind of enjoyment of the splendid programmes that are coming to you over the air.

Your dealer has the *Truphonic*, or will get it for you.



ALDEN MANUFACTURING CO.

Dept. B20

SPRINGFIELD, MASS.

# TRUPHONIC

Power Amplifier \$20

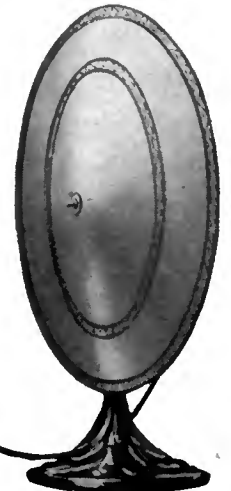
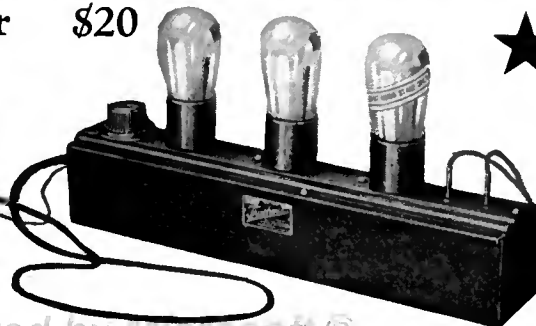

Digitized by Microsoft®

★ Examined and approved by RADIO BROADCAST ★



# Why the **NA-ALD** Silencer Socket is essential to clean-cut reception

In many cases good clean-cut radio reception is decidedly hampered by the disturbing microphonic noises within the radio tubes—particularly the detector tube. These

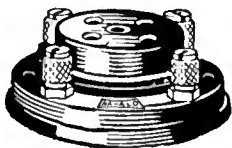

No. 481 XS

disturbing noises are caused by shocks and jars—very often slight—which come from various vibrations such as the vibration of the loud speaker, tapping the radio set itself, walking in the room or even street traffic. These vibrations cause the grid and the plate of the tube to vibrate slightly in respect to one another.

In order to shield the tube against these shocks the Alden Silencer Socket has been designed. With this socket the tube is "cushioned" and "floated" absorbing all shocks in all directions—sidewise, up, down and pivotally. The marvelously balanced phosphor bronze springs which accomplish the "cushioning," form also the contacts for the tube and for the outside connections. This important point, among others, is fully covered by patents.

Contacts press firmly, strongly and flatly against the full length of the tube prongs. Special phosphor bronze, triple-locked contacts are held in constant tension insuring permanent, quiet action. Solder lugs are provided for making connection either above or below the base panel. Or the lugs can be removed and the binding posts used. Round edge permits of mounting in any direction, and makes for a neat mounting on the base panel.

The Silencer Socket (for UV 201A and all UX tubes) is a markedly superior socket which large production enables us to sell for 50¢. At all dealers.

## Other Na-Ald Sockets



No. 481 X

The Na-Ald No. 481X socket is the popular priced universal socket for all UV 201A and all UX tubes. This socket is in great demand for amplifying tubes. The price is 35¢.

The Na-Ald De Luxe Socket is designed for heavy duty service with the big, high voltage, expensive tubes. Triple lamination, dual-wire contacts will carry the heavy current used. The tube prongs and socket contacts can be self cleaned simply by a half turn rotation of the tube in the socket. Alden processed moulding assures the necessary mechanical and electrical strength. The De Luxe Socket is 75¢ at your dealer's.



No. 400

**ALDEN MANUFACTURING CO.**  
Dept. B-20, Springfield, Mass.

### No. 51

RADIO BROADCAST Laboratory Information Sheet December, 1926

#### Overtones (Harmonics)

##### THEIR IMPORTANCE IN RADIO

A GREAT many of the fundamental notes used in speech lie below a frequency of 1000 cycles, but it is the overtones (or harmonics) which determine the quality and timbre of the sound. In order to obtain perfect quality, the characteristics of all the amplifiers and reproducers used in a radio receiving system must be absolutely flat, *i. e.*, they must transmit all frequencies with equal fidelity.

The overtones which were mentioned above are harmonics which are produced by all instruments, including the human voice, and the correct transmission of the harmonic frequencies is essential if the characteristics of the original sound are to be maintained. In many cases it is the prominence of certain harmonics which distinguish the different instruments from others. Quite frequently overtones are confused with octaves. An example will distinguish the difference between these two units. The fundamental sound of, say, 500 cycles has an octave corresponding to 1000 cycles, another octave at 2000 cycles and another one at 4000 cycles, etc.—each octave being double in frequency to the one preceding it. If two octaves are sounded at the same time, it is rather difficult to distinguish between them. On the other hand, the fundamental

note of 500 cycles has overtones, or harmonics, corresponding to 1000, 1500, 2000, 2500 cycles, etc. In this case, the various tones are separated by an amount equal to the fundamental frequency. Whereas the difference between two octaves is rather difficult to detect, it is quite easy to distinguish between various overtones. From the above, it is evident that some octaves are also overtones; for example, the octave at 1000 cycles corresponds to the 2nd overtone of the fundamental note of 500 cycles. However, the next overtone is 1500 cycles, but there is no octave corresponding to this pitch. It is evident that, starting with a certain note, all octaves correspond to certain overtones but that all overtones are not octaves. On Laboratory Sheet No. 52 there is reproduced a diagram showing the fundamental frequency range of various instruments. In the diagram given, it will be noted that an extra octave is shown at the high frequency end of the piano keyboard. As experience has shown that at least one harmonic must be provided for when amplifying a signal near the top of the audible frequency scale, to obtain true fidelity, the extra octave is included to indicate the frequency range requirements of an amplifier to successfully reproduce the highest note of the piano, which has a fundamental of 4096 cycles.

### No. 52

RADIO BROADCAST Laboratory Information Sheet December, 1926

#### Frequency Ranges of Musical Instruments

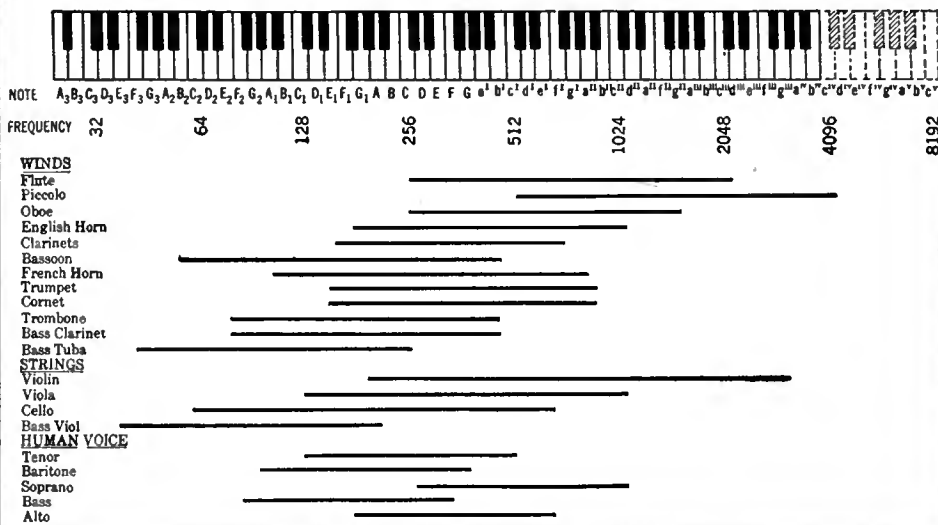

### No. 53

RADIO BROADCAST Laboratory Information Sheet December, 1926

#### Shunts

##### DETERMINING THEIR VALUE

SHUNTS, as used in an electrical laboratory, consist of an electrical conductor placed in parallel with an indicating meter so as to increase the range of currents that can be read with this

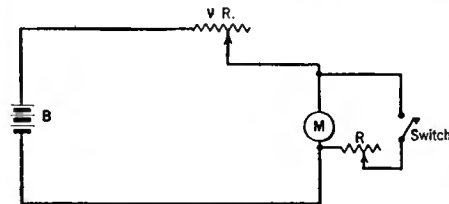

meter. We might have a 10-milliampere meter and desire to read a current of, say, 50 milliamperes; with the aid of a shunt, this can easily be done. The method of calibrating a shunt is indicated in the diagram.

Suppose we desire to calibrate a 10-milliampere meter so that it will read 50 milliamperes. We would connect a battery, B, as indicated on the diagram, in series with a variable resistance, V.R., so as to limit the current passing through the meter (without a shunt) to 10 milliamperes. The resistance would be varied until the meter read exactly 10 milliamperes and then the rheostat R (the shunt) would be switched across the meter and its resistance altered until the meter read two milliamperes. Under such conditions (with the shunt connected), a reading of 2 milliamperes on the meter would mean that 10 milliamperes were flowing through the circuit. Likewise, full scale deflection would indicate a 50-milliampere flow although the needle pointed only to 10 milliamperes. The same procedure would be followed in shunting any instrument, *i. e.*, setting up a circuit which will pass sufficient current to give a maximum deflection on the meter, then shunt the meter and reduce it a definite amount such as one half, one third, or one fifth, then, in order to determine the actual current flowing in the circuit with the shunt connected, it is merely necessary to multiply the meter reading by 2, 3, or 5, depending upon how much the original deflection of the meter was reduced by the shunt.



Eveready's exclusive Layerbilt construction *makes this the most economical of "B" batteries*

IMPROVEMENT on top of improvement has been the history of Eveready Radio Batteries. Here, in the radically different Eveready Layerbilt, is the "B" battery which tops them all. The ability of this battery to give you unrivaled service and economy is due to its unique internal design. Instead of the usual assembly of round cells, it is built of flat layers of current-producing materials pressed firmly together. This construction makes use of the spaces now wasted between the round-type cells and avoids the usual soldered wire connections. Eveready Layerbilt is every inch a

battery. This exclusive Eveready Battery development packs more active chemicals in a given space and enables them to produce more current and give longer life.

This HEAVY-DUTY EVEREADY LAYERBILT BATTERY gives twice the service of the smaller Light-Duty batteries and greatly reduces your "B" battery operating cost.

Use Eveready Layerbilts on any set, and get not only this extra service, but also—the greatest "B" power operating economy—the utmost in "B" power dependability—D. C. (direct current) in its purest form, so necessary for pure tone quality. There is an Eveready dealer nearby.

Manufactured and guaranteed by  
 NATIONAL CARBON CO., INC.  
 New York San Francisco  
 Canadian National Carbon Co., Limited  
 Toronto, Ontario

Tuesday night means Eveready Hour—9 P. M., Eastern Standard Time, through the following stations:

WEAF—New York	WTAM—Cleveland
WJAR—Providence	WWJ—Detroit
WEEL—Boston	WGN—Chicago
WTAG—Worcester	WOO—Davenport
WFI—Philadelphia	WCCO { Minneapolis
WGR—Buffalo	{ St. Paul
WCAE—Pittsburgh	KSD—St. Louis
WSAI—Cincinnati	WRC—Washington

**EVEREADY**  
**Radio Batteries**  
*—they last longer*

# Now you can build a really professional radio set.

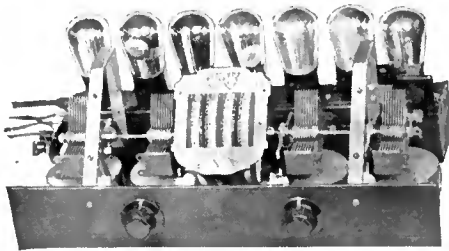

**T**O build a really professional looking and efficiently operating radio set here are two new and important construction units.

The Truphonic Power Amplifier, more fully described on another page of this issue, provides by far the finest type of audio amplification so far developed. For the set builder the Truphonic may be had in a Cat-comb Assembly which gives you a complete unit containing the following: Complete Truphonic audio amplifying system including an output unit to protect the speaker from burning out and demagnetization, sockets with attached leads for the tuning and detector end of the set.

The illustration shows how neatly this Cat-comb Assembly houses all of these elements and how compactly it fits behind the tuning control. No holes to drill, no apparatus to mount. Short, direct leads with a minimum of soldered connections. This unit may be arranged in a hundred different ways to match all the requirements of every circuit and set design. A six foot battery cable is included, in which provision is made for the extra B batteries and C batteries for the use of power tubes.

The Truphonic Assembly is provided in two models, one for 6 tubes, \$20., and one for 7 tubes, \$22.



**Localized Control ★ Tuning Unit**

Trade Mark Reg. U. S. Pat. Off.

The Na-Ald Localized Control Tuning Unit (Quadruple model shown) is a boon to the set builder—a great advance in multiple condenser construction. It can be used with any form of radio frequency coils, and gives you simple control under the fingertips of one hand, enabling

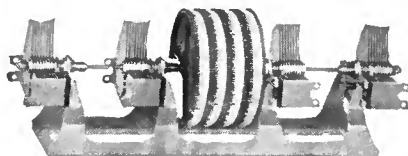

you to tune all the condensers at once, or to tune each one separately and distinctly.

These advanced Na-Ald Localized Control Tuning Units are provided in several models (all are of .000375 capacity unless otherwise indicated). Double \$8., Double (.0005) \$10., Triple \$10., Quadruple \$15., Double with tickler control \$10. With each unit is included the handsome panel plate shown above.

Your dealer has these Na-Ald advanced construction units, or can get them for you.

**ALDEN MANUFACTURING CO.**  
Dept. B-20 Springfield, Mass.

## No. 54

RADIO BROADCAST Laboratory Information Sheet December, 1926

### C Battery Detector

#### FORM OF PLATE CURRENT

**I**N THIS Laboratory Sheet we are going to discuss some points regarding the operation of a C battery type detector. We are going to consider, in particular, the form of the plate current of this detector tube.

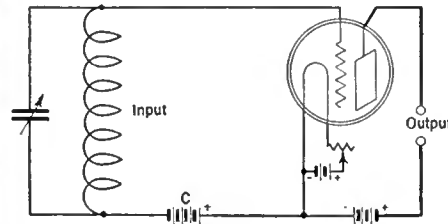

When no signals are being received, the plate current is constant and depends on the adjustment of the C battery. For best operation of a detector of this type, about four volts of C battery should be used on the 201-A when 45 volts are used on the plate. When a signal is received, the plate current varies and is then made up of two compon-

ents; one of these components is the pure d.c. current that flows in the plate circuit when no signals are being received and the other component is an alternating current which is produced by the audio frequency modulation in the carrier-waves that are being received. Although the detector is a rectifier, the current in the plate circuit is not in the form of a pulsating current as might be obtained from such a unit as a B line supply device, which is also a rectifier.

When the signal is being received, the voltage is impressed across the input on the accompanying diagram. This voltage causes the grid to become alternately more positive and then more negative than the voltage due to the C battery. However, the C battery voltage is such that a greater change of plate current takes place when the grid becomes more positive than it does when the grid becomes more negative; therefore, the current variations in the plate circuit increase more than they decrease and the result is that the average current in the plate circuit is higher than when no signal is being received. These current variations in the plate circuit can be detected if they are permitted to pass through a telephone. Also, if a transformer primary is placed in the plate circuit, the current variations will produce a varying flux in the core and will cause corresponding voltages in the transformer secondary, and these, in turn, can be impressed on a further tube and the signal amplified.

## No. 55

RADIO BROADCAST Laboratory Information Sheet December, 1926

### Tuning the Antenna Circuit

#### POSSIBLE METHODS TO USE

**I**N PRACTICALLY all receivers described to-day no tuning is used in the antenna circuit. Generally the antenna circuit is of fairly high resistance and therefore rather broad in tuning and, consequently, it is seldom worth while to accurately tune the circuit. However, some increase in signal strength can be obtained by approximately tuning the circuit to resonance. This tuning can be accomplished in several ways. The simplest method is to use a tapped inductance as shown in sketch A. The taps should be so designed that the antenna circuit is tuned to approximately 1500 kilocycles when the fewest numbers of turns are included in the circuit, and resonant at about 500 kilocycles when the total number of turns are in the circuit.

The antenna circuit may also be tuned with a variometer, as shown in B. The variometer must be capable of being varied in inductance sufficiently to cover the broadcast band of frequencies. The disadvantage of tuning the antenna circuit is that it adds another control when the trend in design is toward the elimination of controls. Evidently, then, the solution is to design an antenna tuning device that can be automatically controlled, perhaps by attaching some device to the shaft of the variable condenser, such as is done in the "Equomatic" system, to vary the coupling of coils between tubes in an r. f. amplifier.

It should be understood that movements of the condenser across the secondary winding has a tuning effect on the antenna circuit if the coupling be-

tween the coils is close. As an example, the coil used in the antenna circuit of a Browning-Drake receiver has a tap at the center for connection to the antenna. Consequently, the antenna capacity (possibly reduced somewhat if a series condenser is used) is across half of the coil and has a decided effect on the tuning of the secondary circuit.

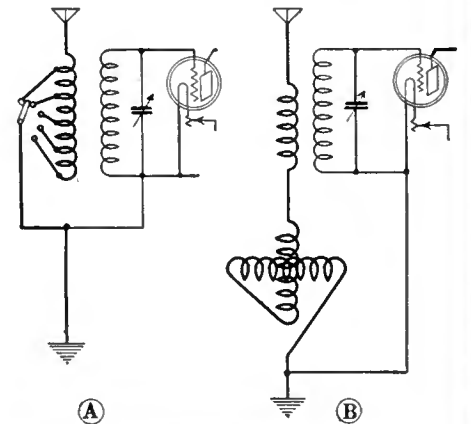

## No. 56

RADIO BROADCAST Laboratory Information Sheet December, 1926

### Radio Telegraph Transmission

#### DIFFERENT TYPES OF WAVES

**I**N TRANSMISSION work by telegraph there are several different types of waves used, these being illustrated in the accompanying drawing.

The drawing A represents the type of wave radiated by a spark transmitter. This form of wave is known as a damped wave since it gradually decreases in amplitude. One of these wave trains is radiated each time that a spark takes place across the electrodes of the spark transmitter. Generally the spark frequency is about 500 per second, so that, if the transmitter was turned on, there would be 500 of these wave trains radiated every second. This type of transmitter is gradually being replaced by apparatus using vacuum tubes for the generation of the high frequency oscillations.

The second form of radiated energy is illustrated in B, and is known as I. C. W., meaning Interrupted Continuous Wave. In this system, the energy is radiated in a series of wave trains similar to the radiations obtained from a spark transmitter, the difference being that the amplitude of the radiated wave is constant and does not decrease as shown in A.

Energy of this form could be obtained by supplying a transmitter from a plate battery in series with which there was arranged some form of interrupter which opened the circuit, say, 500 times per second.

The third type of transmitted wave is known as C. W. or Continuous Wave and in this system,

energy is radiated all the time that the key is pressed and it is not broken up as was shown in the two instances given above. This form of transmission is a very common one and is used by the majority of the high-powered transmitter stations and in amateur work.

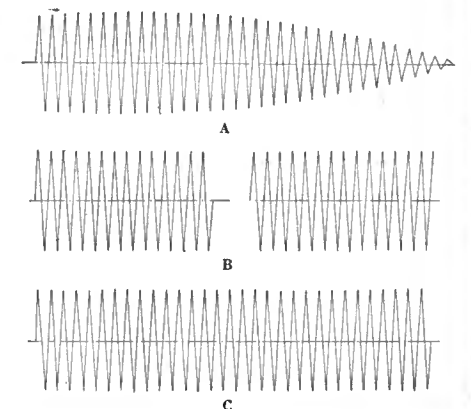

# A Brief Study of Audio Amplification



Type 285

## Audio Transformers

Under average conditions two stages of audio amplification are necessary to produce the desired loudspeaker volume.

Usually a combination of 1 to 2.7 and 1 to 6 ratio transformers proves most satisfactory, with the high ratio preferably in the last stage.

The new General Radio Type 285-D transformer has a ratio of 1 to 2.7 and has been designed specifically for use in the first stage of audio amplification following the new type 200A detector tube. Because of its high input impedance, it produces very noticeably better tone quality than is possible with other transformers having a lower input impedance.

This transformer is particularly adapted, therefore, to use in the first stage of audio amplification and gives excellent results in the second stage as well.

		Price
Type 285	1 to 6	\$6.00
Type 285-D	1 to 2.7	6.00
Type 285-L	1 to 2	6.00

IN the design of any amplifying device for use at audio frequencies, it should be kept in mind that the curve of voltage amplification against frequency should approximate as closely as possible a horizontal line, if true tone quality is to be preserved in the process of intensifying the audible notes.

Since the purpose of amplification is to effect a considerable increase in volume, the curve representing the character of amplification should be as high as possible as well as a straight line running in a horizontal direction.

While it is a comparatively simple task to design a transformer to have a high and even amplification curve over any narrow frequency band, it is considerably more difficult to maintain the same degree of amplification at very low and very high frequencies as in the middle of the range.

In order that a transformer may function efficiently at low frequencies, its input impedance must be high—several times the plate impedance of the tube at 100 cycles. This is accomplished in the General Radio Type 285 transformers by means of a core of large cross-section of high permeability steel and a primary coil of many turns. Proper coil design, avoiding excessive coil capacity and magnetic leakage prevents loss of notes above the middle register.

Careful laboratory measurements of all General Radio Type 285 Audio Transformers show a high and comparatively flat curve over practically the entire section of the audio range covered by the human voice and musical instruments.

It will be remembered by radio experimenters whose interest in the science dates back to the early days of broadcasting, that in 1917 the General Radio Company brought out the first closed core transformer to be sold commercially. This instrument was the type 166. It established a new and higher standard of audio frequency transformer design. Since that time the subject of amplification has been exhaustively studied in the laboratories of the General Radio Company with the result that transformer design has been constantly improved and today the General Radio Company is universally recognized as an outstanding manufacturer of quality transformers.

*Ask your dealer or write for Catalog 925 containing full descriptions of all General Radio Parts*

**GENERAL RADIO CO., Cambridge, Mass.**



Type 369

## Coupling Impedance

While the greater amplification that is obtained by a transformer coupled amplifier has much in its favor, slightly better quality can sometimes be obtained by the use of impedance coupling, if one is willing to dispense with the greater amplification per stage of transformer coupled amplification.

The impedance method of coupling is considerably more efficient than the use of resistances because it allows a much larger proportion of the plate voltage to be impressed on the plate of the amplifier tube.

By using a choke of sufficiently high inductance a quality of reproduction may be obtained, which can not be distinguished from that obtained by the use of resistances and a larger amplification per stage produced.

Type 369 Coupling Impedance Price \$5.00 each

# GENERAL RADIO

## PARTS AND ACCESSORIES

Digitized by Microsoft®

# For Power tubes



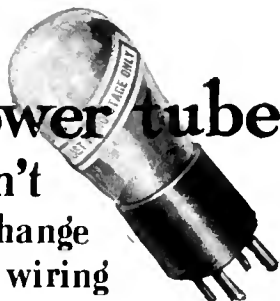

You don't have to change your set wiring



Na-Ald Connectoralds are particularly in demand for the new power tubes, UX 171, UX 112 and UX 120, which greatly increase the undistorted volume that a set will deliver. There is a Connectorald for every type of tube and set. Each type of Connectorald is equipped with cables to connect to the extra B and C batteries, necessary for power tubes. This makes it unnecessary to change the wiring of a set in any way. Except where noted, Connectoralds do not raise the tube in the socket.

## Na-Ald Connectoralds

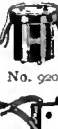
Trade Mark Reg. U. S. Pat. office

-  For UX 171 and UX 112 Tubes, Na-Ald 112 Connectoralds are recommended for maximum volume with storage battery sets. These tubes will deliver without distortion several times the volume of the regular 201A. Price \$1.50.
-  For UX 120 Tubes in UV 201A sockets, the Na-Ald No. 120 Connectorald should be used. To convert a storage battery set to dry batteries with ample loud speaker volume, use a UX 120 tube in the last audio stage with the 120 Connectorald and UX 199 tubes with 419X Adapters in the other sockets. Price \$1.25.
-  For the UX 120 Tube in UV 199 sockets, ample loud speaker volume without distortion is obtainable from any set equipped for UV 199 tubes by means of the UX 120 or equivalent tube, with the Na-Ald No. 920 Connectorald. The tube is raised slightly, but provides for its use in most sets with limited headroom. Price \$1.25.
-  For UX 120 tubes in the UV 199 sockets of the Radiola Superheterodyne Semi-Portable and Radiola Super VIII. These excellent Superheterodynes will deliver ample volume for loud speaker operation when equipped with the UX 120 used with the Na-Ald No. 420 Connectorald. Price \$1.25.

**ALDEN MFG. CO.**  
Dept. B-20  
Springfield, Mass.



TWO CARTONS OF "BATTERY REVIVOR"

The contents of these packages were analyzed by a well known institution and were found to consist essentially of epsom salts. As the retail price was \$1.00 per carton and the market price for the best epsom salts borders on \$2.00 per hundred pounds, it will readily be seen where the profit comes in.

# Epsom Salts Offered As Storage Battery Panacea

A Reprint of a Pamphlet Published by the National Better Business Bureau Indicating Their Analysis of Two Advertised Battery Panaceas

**S**INCE 1887, the storage battery field has experienced periodic epidemics of curative exploitations. It is just now undergoing one of these. Two so-called battery life savers, for which remarkable results are promised, are Sta-Charge and Enrich Battery Saver, marketed respectively by the Kel-Bur Products Company, Salem, Massachusetts, and the Mid-West Sales Corporation, Cincinnati, Ohio. It is claimed that the introduction of these compounds into a lead plate storage battery will correct the majority of ills and troubles to which they may be heir. It is even claimed for one that its use will allow a discharged battery to be fully recharged in from ten to twenty minutes; for the other, that it will keep an automobile battery charged for two years, and for both, that they will double the life of the battery.

In various newspapers, classified advertising like the following has appeared:

Man to Introduce

New, patented process that recharges batteries in 10 minutes, \$20-\$30 daily. Exclusive territory. I. N. Kelbur, Inc., 21 E. 14th St., New York City.

Those responding to such advertisements have received circular letters over the signature of Jack Pansy, Sales Manager of the Kel-Bur Products Company. According to the letterhead, Mr. Pansy's offices are at 21 East 14th Street, New York City. The Company, of which H. E. Burkhart is President, P. J. Kelleher, Secretary and Treasurer, and L. E. Burkhart, General Manager, has its "laboratory and factory" at Salem, Massachusetts, with additional offices at Sanford, Maine, and at 1625 Sydenham Street, Philadelphia, Pennsylvania. We quote portions of Mr. Pansy's letter:

I am glad you are interested in a process that recharges batteries in 10 minutes. It spells "OPPORTUNITY." Salesmen selling STA-CHARGE are making as high as \$40. a day. Sta-Charge is put up in 3-ounce cartons

retailing at \$1.00. We pack 18 cartons to the case. Price to dealers, \$11.00 per case, prepaid. . . . If you say the word, I will ship a case to YOU, charges prepaid, C. O. D. \$7.00 (or for \$6.50 cash with order). Attractive Window Cards, Sales Helps, Pamphlets, Order Blanks, etc. accompany each case. . . . Upon request we will ship a sample carton to you for \$1.00, CASH WITH ORDER.

From another of Mr. Pansy's form letters we glean these statements:

Our Salesmen and Managers in many States are "cleaning up" BIG with STA-CHARGE COMPOUND. It is easy to sell a carton to nearly every Battery Owner—and a case or more to live Dealers.

But—you and I are both losing money, because YOUR territory is not being worked. . . . Once a person puts STA-CHARGE in his Radio Battery, he notices almost IMMEDIATELY how much more CLEARLY he hears the voices; he notices that when the Battery DOES run down it can be charged up fully on the "line" in a fraction of the time required when the old solution ALONE was used. . . . Same way with an Auto Battery Owner—when he sees his lights burning brighter, his Battery "FOOL-PROOF"; the resistance to current so REDUCED (by the STA-CHARGE chemical) that his generator alone keeps the Battery always fully charged—naturally he talks about it.

An interested reader of this advertising purchased a case of Sta-Charge. With it he received the window card reproduced on page 198 and a quantity of sales literature. The following claims are conspicuous in this copy:

- Keeps your Battery ALWAYS fully charged.
- Preserves and lengthens the life of your Battery.
- REMOVES and PREVENTS Sulphation.
- Will recharge any make of Battery.
- Prevents corrosion and shedding of plates.
- Prevents plates warping, cracking, and "buckling."
- Preserves plates and insulators.
- Prevents muddy and soft Positives.
- Gives better lights, better ignition, better starting.



### Approved Parts for

### Eliminators Power Amplifiers

Dongan has perfected transformers and chokes of several types which are used widely with UX, RCA and Raytheon Tubes for both Eliminator and Power Amplifiers.



No. 2568 ABC Power Unit

Designed for use with Raytheon BH tube. Eliminates all batteries. Built into sturdy good-looking black metal case.

List \$17.50

### Power Amplifiers for Home Use

Use Dongan No. 2567 transformer half wave with UX 216 B-tube used in conjunction with UX Power Amplifier tube No. 210. List \$10.00.

Dongan transformers available for all standard types of power Amplifier tubes.

### Fans

Order these and other Dongan parts from your dealer or send to the factory for complete information on constructing eliminator and power amplifier units.

### Manufacturers

For a reliable source of supply on the latest designs Dongan offers quantity production on all approved types. For special requirements our engineering department is at your service.

**DONGAN ELECTRIC MFG. CO.**  
2991-3001 Franklin St. Detroit, Mich.



# FREE This 84 Page WONDER BOOK

Send For It TO-DAY

You must have this latest guide to Radio prices and Radio quality. All of our vast resources and radio experience have been utilized to assemble for you in one gigantic institution, the best and newest things in radio. The Randolph catalog is indeed the radio market place of the world—a masterpiece of merchandising that befits our house—THE LARGEST EXCLUSIVE RADIO MAIL ORDER HOUSE IN THE WORLD.



## Radio Bargains

### OVER 2000 ITEMS

From the most beautiful, fully equipped console radio set, down to the smallest part or tool for the set builder—kits, parts and supplies of every conceivable type and style. 5, 6, 7 and 8 tube sets, with three dial, two dial, and the newest and most popular single simplified control. All sets are assembled in beautiful, genuine mahogany and walnut cabinets in a choice of latest type and designs.

A complete line of "B" batteries, eliminators, including the famous Raytheon Eliminators; latest types loud speakers, cone speakers, "A" power units. Everything in radio at money saving prices.

### RADIO KITS

Includes the following well known circuits, designed and approved by the world's foremost radio engineers: Madison Moore Super; Victoreen Super; Silver Marshal Six; Sargent's Infradyne; Remler Super; Short Wave Kits; 9-in-Line Super; New Acme Reflex; Cockaday; Neutrodyne; Browning-Drake; all classes of radio frequency. Super Heterodyne and every other approved popular circuit.

**Over 2000 -ITEMS- Everything in RADIO**

We Save You Money because we handle radio exclusively and sell a tremendous volume of everything in Radio. Volume purchases regulate prices. We command rock bottom prices from manufacturers, and in many cases we contract for entire factory output of exclusive products. You will benefit by our great volume of purchases and sales, by securing anything you may want in radio at a substantial saving.



### The New Ampliphonic Six The Latest Two-Dial Receiver WITH THE Genuine Amplion Unit

Genuine dark tone and shaded walnut cabinet. Stands 39 in. high. Top measures 27x16 in. Beautifully etched burl walnut panels. Built-in loud speaker with Amplion unit. Large doors open to smaller doors enclosing a large compartment for batteries, chargers, eliminators, etc., everything concealed in this exquisitely designed radio cabinet.

#### 6 Tube Tuned Radio Frequency

6-tube tuned radio frequency two dial control receiver. 3 stages of direct and transformer amplification. Has provision for power tube and an additional tap for increased "B" battery voltage. Very latest construction including solenoid coils, bakelite sockets taking all the latest X-type tubes, modified straight line condensers. Wonderful volume, nothing like it on the market at more than twice the price. **\$79.50** Without Accessories

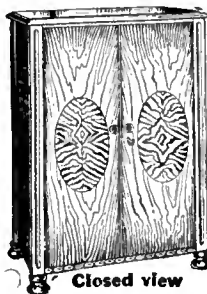

### Symphonic Five

Brown Spanish leatheroid finish cabinet with gold engraved walnut panel to match. Contrasted beautifully with the black fine tuning knobs. Two small knobs control volume and clarity. The volume control is of the finest smooth slow variation type. Roller bearing. Condensers are of the modified straight line frequency type, sub-stantially constructed and of latest design. All is sub-panel mounted, using the new X-type socket. Latest development in solenoid coils. Two stages of low ratio audio amplification with high grade transformer offers the true amplification required for both low and high notes.

**\$24.90**

Without Accessories

The set complete with five type X201A tubes, two 45 volt "B" batteries, one 100 Amp. Hr. storage battery, complete aerial equipment, including cone speaker of the same type as pictured . . . . . **\$54.75**



These sets are typical examples of the bargains in our catalog. You may order direct from this page, sending P. O. money order or draft for full amount. We ship freight or express, charges collect. We guarantee to back up every article with our own, as well as manufacturer's, assurance of quality.

### Columbia Senior Six

Beautiful table set. New localized control. One hand to tune with, three rotating drums easily controlled and easily logged. Dark finish etched panel mahogany finished hand-rubbed cabinet. Size 7x22.

6-tube set, giving tremendous volume, wonderful tone quality, latest straight line condensers, solenoid coils; sub-base mounting and new amplification. Designed to sell for over 100.00. Price, **\$36.50** without accessories

Set complete with two 45 volt "B" batteries, 100 amp. hr. Storage "A" battery, one 4 1/2 volt "C" battery, six type X201A tubes, complete aerial kit, attached battery cable, quality cone speaker or Victor horn type loud speaker. . . . . **\$65.45**



### Columbia Grand 6-Tube Console Set

Here's a sensational bargain in a console radio with built-in loud speaker and adjustable unit. Spacious compartment for all batteries, etc. Very latest type 6 tube tuned radio frequency receiver. Low loss modified straight line frequency condensers. Has three stages of low ratio audio amplification. Designed to accommodate new power tube. Equipped with X-type sockets. Beautiful gold etched panel with handsomely engraved designs. Price of set with accessories . . . . . **\$42.65** This set with all accessories which include 2 45 volt "B" batteries, 100 Amp. Hr. storage "A" battery, 6 201A tubes, aerial and ground equipment—everything complete, nothing else to buy. . . . . **\$65.95**

#### You Must Have This Book

Space limitations here prevent our telling you more about the Randolph Catalog. Simply fill out and mail the coupon—or you may send a postal or letter—and this truly remarkable Radio book will come to you **ABSOLUTELY FREE. MAIL THE COUPON NOW.**



Beautiful hand rubbed, two-toned mahogany finished cabinet, size 18 x 19 x 36. Built-in loud speaker.

### This Coupon Brings the Great RADIO BOOK FREE

RANDOLPH RADIO CORPORATION  
180 N. Union Ave., Dept. 189 Chicago, Illinois

Send me—free—your 84-page, 1927 Radio Book.

Name \_\_\_\_\_  
Street and No. \_\_\_\_\_  
R.F.D. \_\_\_\_\_ Box \_\_\_\_\_  
City \_\_\_\_\_ State \_\_\_\_\_

**Randolph Radio Corporation**  
180 North Union Avenue • Dept. 189 • Chicago, Ill.



## Adapters for all tube and socket combinations

Na-Ald Adapters are indispensable to the set owner and set builder who wants a simple and instantaneous means of adapting any particular type of tube to the particular type of socket that is used in his set. For instance, if your set is now equipped with standard 201A sockets, and you want to use the small UV199 type tube, simply insert the Na-Ald Adapter No. 429 into the 201A socket and insert the 199 tube into the adapter.

The various types of Na-Ald Adapters are given below. Specify them for best results:



For adapting small UX 199 and UX 120 tubes to UV 201A sockets, use Na-Ald Adapter No. 419X. Price 35¢

No. 419X

To bring up-to-date and decidedly improve the Radiola III and IIIA and similar sets employing WD II Tubes, use Na-Ald Adapter No. 421X. Price 75¢.



No. 421X



For adapting UV 199 tubes to standard 201A sockets use the Na-Ald No. 429 Adapter. Price 75¢.

No. 429

To adapt all UX tubes and UV 201A tubes to UV 199 sockets use Na-Ald Adapter No. 999. Price \$1.00.



No. 999

Na-Ald Adapters are sold by all good radio stores and carry the Na-Ald unconditional guarantee.

ALDEN MANUFACTURING CO.  
Dept. B-20 Springfield, Mass.

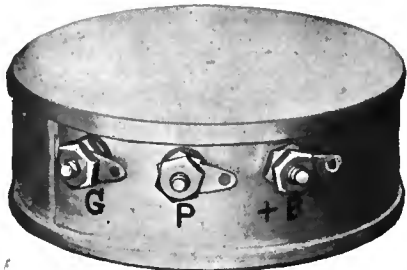

Shielded Tuned Radio Transformer, No. 30

## SICKLES Diamond-Weave Coils

THE new Sickles Shielded Tuned Radio Transformer prevents both outside and local interference. It is remarkably compact, sharp tuning, sturdy.

Sickles Diamond-weave coils have established an enviable reputation for low distributed capacity, low dielectric losses, and large range of frequency with small variable capacity.

The ideal coil for the Naald Localized Control Tuning Unit and for the Tru-phonic Catacomb Assembly.

There are Sickles Diamond Weave Coils for all Leading Circuits.

The F. W. Sickles Co.  
132 Union Street  
SPRINGFIELD, MASS. ★

### COIL PRICES

No. 30 Shielded Transformer.....	\$2.00 each
No. 24 Browning-Drake.....	7.50 Set
No. 18A Roberts Circuit.....	8.00 "
No. 25 Aristocrat Circuit.....	8.00 "

Gives more power.  
Will not over-charge.  
Will not freeze at any temperature.  
Batteries filled with STA-CHARGE need not be stored in winter.  
Will more than double the life of the Battery.

MR. BURKHART EXPLAINS

FOLLOWING inquiries by battery service-station men to whom Sta-Charge had been offered, the National Better Business Bureau wrote the Kel-Bur Products Company and asked how Sta-Charge could perform so many apparent violations of the laws of electrolytic chemistry. The reply, over the signature of L. E. Burkhardt, General Manager, was (verbatim):

"The reason that we make the claims for Sta-Charge that we do, are because those claims are true."

ENRICH BATTERY SAVER

EQUALLY modest are the claims made in advertising by the Mid-West Sales Corporation, formerly at 324 Temple Bar Building, Cincinnati, Ohio, now operating from 3515 Stacey Avenue, Cincinnati, Ohio. Quarter-page newspaper advertisements have carried this message to motorists:

DOUBLE THE LIFE OF YOUR BATTERY

Put ENRICH BATTERY SAVER into your battery and double its life. This newly developed compound will lengthen the life of your battery from two to five years. It does away with sulphation and its accompanying bad effect on the battery plates.

YOUR AUTOMOBILE BATTERY CHARGED FOR TWO YEARS

ENRICH BATTERY SAVER charges your automobile battery for two years, if your generator is working properly. No matter how much current is used for lighting and starting, the generator is able to keep the battery fully charged.

ENRICH BATTERY SAVER IS BATTERY INSURANCE

ENRICH BATTERY SAVER insures you against a host of battery troubles which afflict the battery owner and keep him paying out good money to keep his battery in good condition.

A circular enclosed with form letters issued over the signature of George Henry, Vice-President, contain, among other statements:

Batteries, treated with ENRICH BATTERY SAVER, send a hotter, fatter, spark to the cylinders. The gas is exploded at the proper time, and more power is developed. You get more mileage per gallon of gas. Better combustion prevents the formation of carbon.

ENRICH BATTERY SAVER keeps your automobile battery charged for years, provided your generator is working properly. It doubles the life of automobile and electrolyte batteries—it makes for quicker starting and more effective ignition—it does away with a host of battery troubles.

A small booklet, entitled "Your Storage Battery" advises the battery owner:

"Forget battery troubles—Use ENRICH BATTERY SAVER."

Samples of the two above products were purchased in the open market and analyzed and tested in the laboratories of an institution of national reputation. It was found that Sta-Charge and Enrich Battery Saver are practically the same. They consist essentially of commercial magnesium sulphate (epsom salts) to which some potassium-aluminum sulphate has been added. Undoubtedly, they are made in accordance with the same formula. Several of the Enrich Battery Saver cartons have Sta-Charge labels under the covering which de-

scribes them as "Enrich Battery Saver." Each carton contains 3 ounces of the salt mixture and directions for their use are about the same.

We quote below the recapitulations of the findings submitted by the engineer who conducted tests on these products:

Additions of Sta-Charge or Enrich Battery Saver do *not* make it possible to recharge a lead storage battery any more rapidly than under normal conditions.

Additions of Sta-Charge or Enrich Battery Saver do *not* make it possible for a battery to show an increase in energy after standing idle an hour or so greater than with an ordinary cell.

Additions of Sta-Charge or Enrich Battery Saver do *not* make it possible to recharge a fully discharged battery in ten to twenty minutes.

Additions of Sta-Charge or Enrich Battery Saver do *not* prevent formation of normal sulphate on cell discharge.

Additions of Sta-Charge or Enrich Battery Saver do *not* quickly restore the capacity of a sulphated cell.

Additions of Sta-Charge or Enrich Battery Saver do *not* increase the capacity of a lead cell; on the contrary a slight reduction in capacity may even result.

## STA-CHARGE

Lengthens Life of Battery

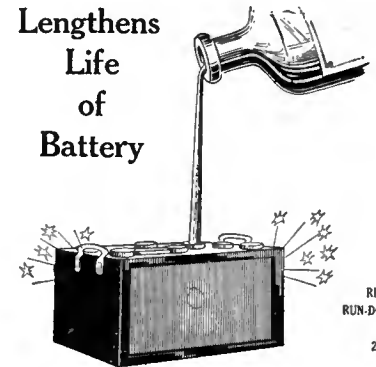

RE-CHARGES RUN-DOWN BATTERIES IN 20 MINUTES

## ASK FOR DEMONSTRATION

A STA-CHARGE WINDOW CARD

Additions of Sta-Charge or Enrich Battery Saver will *not* prevent lead cells from freezing. Additions of Sta-Charge or Enrich Battery Saver do *not* prevent over charge.

Additions of Sta-Charge or Enrich Battery Saver do *not* reduce shedding of active material.

Additions of Sta-Charge or Enrich Battery Saver do *not* prevent buckling or warping of plates.

The fact is that additions of either one of these salt mixtures to the lead cell electrolyte accomplished *no* useful effect whatsoever.

Recent quotations on epsom salts were obtained by the Better Business Bureau. Technical grades are quoted at \$1.20 to \$1.30 per hundred pounds, and United States Pharmacopœia quality is sold at \$1.75 to \$2.00 per hundred. As Sta-Charge and Enrich were sold to their agents at \$6.50 (cash price) for 54 ounces, the margin for these advertisers wasn't so bad. The radio fan or motorist is asked to pay \$1.00 for a substance which is sold under its own name at a small fraction of that amount.

YOUR STORAGE BATTERY

A STORAGE battery is not a black box of mystery. It is a compact and sturdy electrical device which performs in accordance with recognized laws of electro-chemistry, just as an

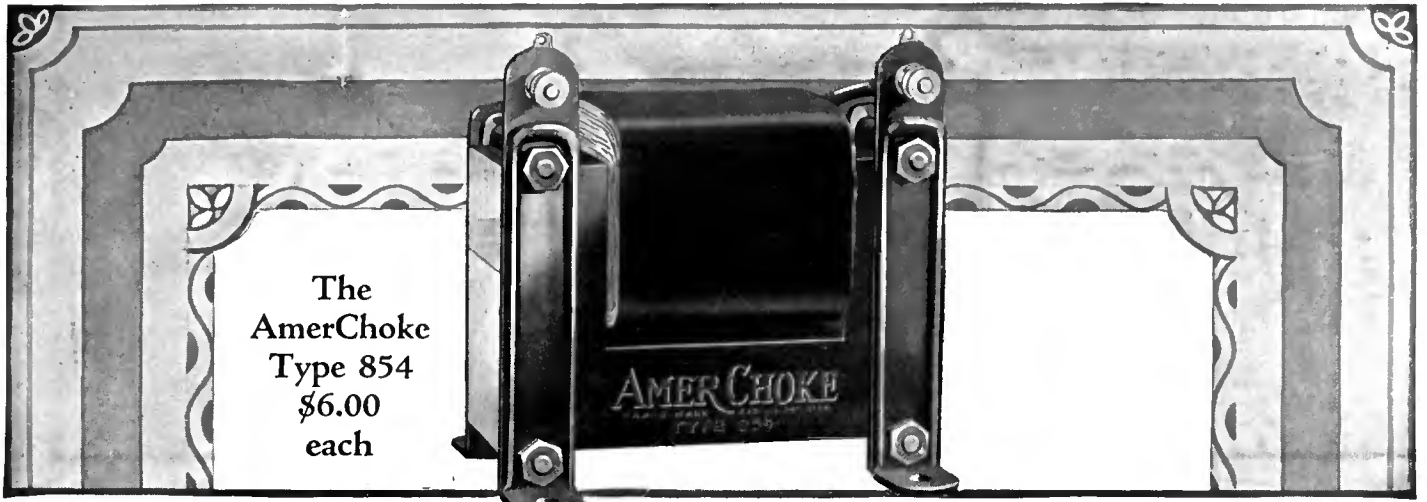

The  
**AmerChoke**  
 Type 854  
 \$6.00  
 each

**AMERCHOKE**

# AMERTRAN RADIO PRODUCTS

## *A Reliable Choke for Filter Circuits*

The AmerChoke Type 854 is a choke coil or impedance designed primarily for use in filter circuits. As an output impedance with a fixed condenser it forms an ideal filter for the loudspeaker, insuring tone quality equal to the average output transformer. And it will be *more* economical. For filter circuits in "B" Eliminators, the AmerChoke will give perfect results due to its scientific design and generous proportions. To obtain even, quiet current supply use the AmerChoke and the AmerTran Power Transformer (described at the left) in the construction of your power amplifier.



The AmerChoke type 854 has a noload inductance of approximately 100 henrys at 60 cycles with average close butt joints. Magnetic saturation from direct current is prevented by two butt joints in the iron core. The AmerChoke shipping weight is about 5 pounds and the price \$6.00 each F. O. B. Newark, N. J., or at any Authorized AmerTran Dealer.

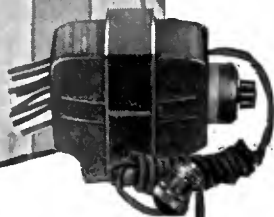

**The AmerTran Power Transformer**  
 Type PF-52

Type PF-52 is intended for use in the best power supply developments. It will convert the standard 110 volt, 60 cycle alternating house lighting current to a higher voltage for plate and low voltage for filament supply. Price \$18.00 Each

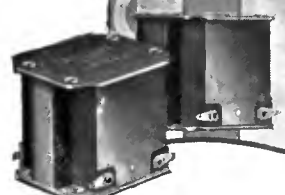

**The AmerTran DeLuxe Audio Transformer**

This new transformer sets an entirely new standard of Audio Amplification. It makes possible a transformer coupled amplifier that excels all other forms of amplifiers. Made in two types for first and second stages—

Price \$10.00 Each

### AMERICAN TRANSFORMER COMPANY

178 Emmet Street

Newark, N. J.

*"Transformer Builders for over Twenty-five Years"*

**Other AmerTran Products:**

- AmerTran Resistor Type 400 \$7.50
- AmerTran Heater Transformer Type H-28 (for A. C. Tubes) \$10.00.

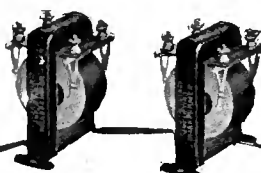

**AmerTran Types AF-7 and AF-6**

AmerTran Audio Transformers, types AF-7 and AF-6, have been considered for years among the leaders in audio amplification. These popular and efficient models are made in two types—AF-7 (ratio 3 3/4:1)—AF-6 (ratio 5:1)

\$5.00 Each

We shall be very glad to send you upon request a copy of our booklet "Improving the Audio Amplifier" together with other interesting constructional data.



# Improved and Simplified Radio Control

The superior control of Centralab variable resistances in radio circuits has been recognized by sixty-nine leading set manufacturers who are now using one or more of these controls on their sets.

The new Switch Type Radiohms and Modulators provide this perfect control of the circuit with simplified panel appearance as there is a variable resistance for all circuit purposes together with an "A" battery switch, both controlled by a single knob. They also lessen cost and trouble in building the set, as the double purpose control costs but little more than one, and there is but a single hole to drill in the panel.

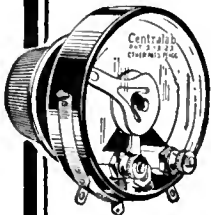

## SWITCH TYPE Centralab Radiohm

Have no sliding contacts carrying current and are both permanent and noiseless in adjustment. A single turn of the knob gives full resistance variation. Provide absolute control of oscillation at all wave lengths in all tuned radio frequency circuits. Resistance variable from zero to 500,000 ohms. Have two terminals.

## SWITCH TYPE Centralab Modulator

The ideal tone volume control for all audio circuits. Have three terminals, maintaining a fixed load of 500,000 ohms to provide even amplification of all tones. Control volume by varying the potential applied to the grid of the tube. A sure cure for overloaded tubes and harsh toned amplifiers.



Centralab Switch Type Radiohms or Modulators sell at \$2.30 each. Centralab Radiohms or Modulators without the "A" battery switch sell at \$2.00 each.

At your dealers, or mailed direct Satisfaction guaranteed by **CENTRAL RADIO LABORATORIES** 22 Keele Avenue Milwaukee, Wis.

Ask your dealer—or write for free literature showing circuits and detailed applications of Centralab controls. Canadian Representative: Irving W. Levine, Montreal. Great Britain Representative: R. A. Rothermel, Ltd., London. Australian Representative: United Distributors, Ltd., Sydney.



electric motor operates in accordance with the laws of electro-dynamics. Neither can be altogether neglected; yet it is a relatively simple matter to correct minor troubles that may arise, and no great amount of technical knowledge is needed. Just as other items in your car need attention now and then—new oil for the crank case, cold water in the radiator, additional air in the tires—so your battery requires its small share of care. In the case of the automobile battery, if no attention is paid, and it is allowed to become under-charged, if it is allowed to run down and then the driver suddenly calls upon it for maximum discharge by holding down the starter, if distilled water is not added now and then to keep the plates covered, if it is subjected to abuse, any battery will give trouble. But such difficulties are easily avoided by proper care, for which there is no chemical substitute. No solution or chemical will take the place of service. You may service your own battery, or patronize a reliable service station, but service it must have, to perform efficiently.

Advertising of battery panaceas is most harm-

ful in that it encourages battery owners to neglect their batteries—to fail to give them the attention they require, and to create the impression that by artificial means a battery may be made to perform in a perfect manner at all times without human aid.

The tendency of the present age is to look for "short cuts," but there is no "short cut" to battery health and battery efficiency, any more than there are short cuts to human health and long life. Just as many chronic invalids are exploited by vendors of worthless medical panaceas so battery owners are periodically exploited by vendors of alleged cure-alls for battery ills. And just as the medical panaceas fail to provide an effective substitute for rational habits of life, so "secret" battery compounds and electrolytes fail to perform such an office for storage batteries—whether for automotive or radio use. Let your service station dealer diagnose and prescribe for your battery ills, as your physician does for your bodily ills. Give your battery a chance to live and perform and render service. Don't dose it.

## BOOK REVIEW

### Dreher Answers "What is Radio Broadcasting?"

RADIO BROADCASTING:  
From the 13th edition of the *Encyclopædia Britannica*, 1926. By Carl Dreher.

THE author of the article on radio broadcasting, appearing in the newly published thirteenth edition of the *Encyclopædia Britannica*, was well fitted by experience to answer the questions most frequently asked by the newly interested radio enthusiast. He did more than merely think of the outstanding features of radio broadcast reception as a subject; he carefully considered just which facts a person would want to know who would look up "Radio Broadcasting" in an encyclopædia.

This task was assigned by the editors of the encyclopædia to Carl Dreher, engineer in charge of wjz, and author of RADIO BROADCAST'S department "As the Broadcaster Sees It." In this exposed situation, Mr. Dreher has had every conceivable kind of question of a technical nature asked of him, ranging from, "What kind of receiver shall I buy?" to, "Is green insulated wire better than blue colored wire for a radio frequency coil?"

In his article, Mr. Dreher first of all takes up the all-important point of selecting a receiver by describing its five principal qualities, which are: Sensitivity, selectivity, quality of reproduction, magnitude of undistorted output, and convenience of operation and maintenance. In the section on selectivity, he quotes four standards for that requirement, suggested by Dr. Alfred N. Goldsmith, which seem to be particularly well founded as a classification for various degrees of selectivity. A receiver which must be tuned 80 kilocycles from the frequency of a nearby station before its signals are inaudible is classified as having "poor selectivity." A receiver of "good selectivity" must eliminate the nearby signal 30 kilocycles off its wave; "very good selectivity," 10 kilocycles off tune; and, "excellent selectivity," when 5 kilocycles off tune.

The article then continues with a brief description of various types of receivers classified as crystal sets, non-regenerative, regenerative, radio frequency, and super-heterodyne receivers. Considering the brevity of each of these sections, it is surprising how much accurate information Mr. Dreher is able to place before the reader. Again the thought recurs that only the an-

swering of thousands of questions of curious enthusiasts has enabled Mr. Dreher to pick so skillfully the bare essentials. He does not omit a brief discussion of the sources of power supply, and he pays his respects to the delicate art of home construction in a manner which will not be obsolete or incomprehensible within the next ten years, the average time between new editions of the encyclopædia in recent decades.

It requires no little courage to write an article on radio to be scrutinized by the curious public from time to time over a period of not less than ten years. Toward the end of that time, Mr. Dreher's illustrations, representing the last word in radio receivers to-day, may look a trifle obsolete and antiquated, just as does the picture of the striking Rolls Royce limousine in the previous edition of the *Encyclopædia* to-day, with its handsome body somewhat along the lines of an ice wagon. Like the motor design of the 1910 Rolls Royce, it is not improbable that the radio frequency end of the radio receiver of ten years hence will be only a refinement of its present-day predecessor, significantly changed outwardly, but still following the general circuit principles now becoming so well established.

EDGAR H. FELIX

### Correction

THE location of the holes for mounting the sub-panel brackets to the main panel of the R. B. Impedance-Coupled Browning Drake Receiver were incorrectly shown in the article in the September RADIO BROADCAST. The upper hole should be located  $1\frac{1}{4}$  inches above the lower hole and *not*  $1\frac{1}{2}$  inches.

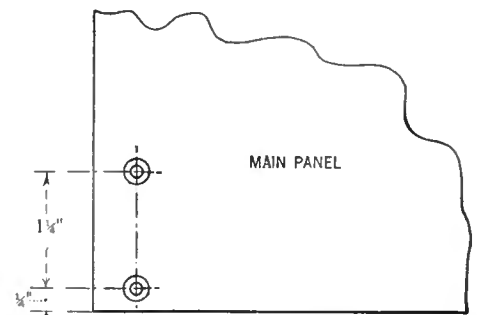



*Coronation Music  
in Reims Cathedral was Never More Majestic*

than the Radio Melody that floods your home till the very walls seem to sway to its rhythm, and each note hushes to enchantment all present as it wells forth full and true. Then the sense of listening ceases and you are in the great artist's presence. This is radio reception from sets made of Samson parts.

Like most fine things this is not an accident but the result of years of painstaking research and manufacturing effort by Samson scientists and engineers.

For supreme quality of reproduction and the elimination of howling, "motor boating" and other disturbing noises, radio and audio frequency currents must be kept where they belong. For this purpose Samson Chokes cannot be approached because their

patented helical winding prevents the choke acting as a by-pass condenser at certain frequencies and reduces distributed capacitance effect to a negligible minimum. These chokes have no pronounced self resonant points. Special bulletins on the uses of these chokes are available.

- No. 85 Samson R. F. Choke ( 85 millihenries)..... \$1.50
- No. 125 Samson R. F. Choke (250 millihenries)..... \$2.00
- No. 3 Samson A. F. Choke (3½ henrys)..... \$3.00

Our book—"Audio Amplification"—already accepted as a manual of audio design by many radio engineers—contains much original information of greatest practical value to those interested in bettering the quality of their reproduction. Sent upon receipt of 25c.

**SAMSON ELECTRIC COMPANY**

Main Office, Canton, Mass.

Factories at Canton and Watertown, Mass.

*Manufacturers  
Since 1882*

★ Examined and approved by RADIO BROADCAST ★



# Cardwell Condensers



**"The  
Standard of  
Comparison"**

THE Sixth Christmas of the Cardwell Condenser finds its popularity undimmed, and during these years it is the only condenser whose basic design has not been radically changed.

During this period the ranks of its friends have been steadily augmented, for no Cardwell user ever deserts.

The Type "C" has the Ideal Tuning Curve, starting at straight frequency and increasing to straight wave length. The Taper Plate Type "E" is midway between straight frequency and wavelength.



Send For Our 36 Page Booklet

**The Allen D. Cardwell  
Manufacturing Corp.**  
81 PROSPECT STREET  
BROOKLYN, N. Y.

Specified for the "R. B. Lab." circuit.

# Press, Weather, and Time Signals

*Times and Wavelengths of Stations in All Parts  
of the World Transmitting the Above Signals*

IN THE accompanying table of transmissions of time, weather, and press intelligence, which we print, with corrections, through the courtesy of our contemporary *The Lightning Jerker*, a Chicago publication, the scheduled times of transmission are given in Greenwich Mean Time, Eastern Standard Time, and

Pacific Standard Time. This list, we feel sure, is as accurate as it is humanly possible to make it, but minor changes are often made at the stations concerned with little or no notice. PX in the last column stands for "Press"; WX for "Weather"; TFC for "Traffic transmissions." The other abbreviations are obvious.

TIME G. M. T.	TIME E. S. T.	TIME P. S. T.	CALL	LOCATION	WAVE IN METERS	FRE- QUENCY KCS.	REMARKS
01:00	8 P. M.	5 P. M.	WHB	New York	2100	142.8	Spark; Press.*
01:30	8:30 P. M.	5:30 P. M.	MPD	Poldhu	2700	111.0	Spark; Press.
02:00	9 P. M.	6 P. M.	NAH	Brooklyn	1500	199.9	Spark; WX, PX.*
02:15	9:15 P. M.	6:15 P. M.	VCE	Cape Race	600	499.7	Spark; Ice Reports, etc.
02:55	9:55 P. M.	6:55 P. M.	NAA	Arlington	2655	112.9	I.C.W.; WX, Time.
02:55	9:55 P. M.	6:55 P. M.	NAR	Key West	1463	205.0	I.C.W.; WX, Time.*
02:55	9:55 P. M.	6:55 P. M.	NSS	Annapolis	16900	17.74	Arc, WX, Time.
03:00	10:00 P. M.	7 P. M.	NPM	Pearl Harbor	1500	199.9	Spark; Press.
03:05	10:05 P. M.	7:05 P. M.	VBT	Cape Race	2700	111.0	C.W.; Press.
03:30	10:30 P. M.	7:30 P. M.	UA	Nantes, Fr.	2400	124.9	Spark; Press.*
03:45	10:45 P. M.	7:45 P. M.	FL	Eiffel Tower	2500	119.9	Spark; Time.*
03:50	10:50 P. M.	7:50 P. M.	WSH	New York	2478	120.9	Arc; Press.
04:30	11:30 P. M.	8:30 P. M.	WNU	New Orleans	3331	90.04	C.W.; WX, TFC, and PX.
05:15	12:15 A. M.	9:15 P. M.	WRQ	New Brunswick	1250	239.9	C.W.; Press.
05:40	12:40 A. M.	9:40 P. M.	NPL	San Diego	13300	22.54	Arc; Press.
06:00	1:00 A. M.	10:00 P. M.	BZL	Demerra	1300	230.6	Spark; Press.†
07:00	2:00 A. M.	11:00 P. M.	GPH	Guayaquil	750	399.8	Spark; Press.†
07:30	2:30 A. M.	11:30 P. M.	BZM	St. Johns, Nfd.	1500	199.9	Spark; Press.
08:00	3:00 A. M.	12 Mid.	YN	Lyons, Fr.	5000	59.96	Arc; Press.
08:00	3:00 A. M.	12 Mid.	VCU	Barrington	1500	199.9	Spark; Press.
08:00	3:00 A. M.	12 Mid.	NPL	San Diego	13300	22.54	Arc. Press.
08:00	3:00 A. M.	12 Mid.	NAH	Brooklyn	1500	199.9	Spark; Press.*
08:00	3:00 A. M.	12 Mid.	BYC	Norsea	4300	69.73	Arc; Press.
08:00	3:00 A. M.	12 Mid.	NBD	Bar Harbor	1900	157.8	Spark; Press.
08:00	3:00 A. M.	Mid.	KPH	San Francisco	2300	130.4	C.W.; Press.
09:30	4:30 A. M.	1:30 A. M.	MPD	Poldhu	2700	111.0	Spark; WX.
09:45	4:45 A. M.	1:45 A. M.	FL	Eiffel Tower	2500	119.9	Spark †
09:55	4:55 A. M.	1:55 A. M.	NAX	Colon	1800	166.6	I.C.W.; Time.*
09:55	4:55 A. M.	1:55 A. M.	NBA	Balboa	7000	42.83	Arc; Time, PX.†
10:30	5:30 A. M.	2:30 A. M.	NBA	Balboa	7000	42.83	Arc.; Press.†
10:44	5:44 A. M.	2:44 A. M.	FL	Eiffel Tower	2500	119.9	Spark; Time.
11:00	6:00 A. M.	3:00 A. M.	GPH	Guayaquil	750	399.8	Spark; Press.
11:30	6:30 A. M.	3:30 A. M.	VMG	Apia, Samoa	2000	149.9	Spark; Press.
12 Nn.	7:00 A. M.	4:00 A. M.	BYC	Horsea	4300	69.73	Arc; Press.
12 Nn.	7:00 A. M.	4:00 A. M.	POZ	Nauen	12000	24.99	Arc; Time.
14:15	9:15 A. M.	6:15 A. M.	VCE	Cape Race	600	499.7	Spark; Ice Reports, etc.
15:00	10:00 A. M.	7:00 A. M.	FL	Eiffel Tower	2000	149.9	Spark; Press.
15:15	10:15 A. M.	7:15 A. M.	BZI	Durban, S. A.	2000	149.9	Spark; Press.
15:30	10:30 A. M.	7:30 A. M.	VIS	Sydney, Aus.	2000	149.9	Spark; Press.
16:00	11:00 A. M.	8:00 A. M.	BYC	Horsea	4300	69.73	Arc; Press.
16:00	11:00 A. M.	8:00 A. M.	FL	Eiffel Tower	2500	119.9	Spark; WX.
16:30	11:30 A. M.	8:30 A. M.	VIP	Perth, Aus.	1500	199.9	Spark; Press.
16:30	11:30 A. M.	8:30 A. M.	WNU	New Orleans	3331	90.04	C.W.; WX, TFC, and PX.
16:55	11:55 A. M.	8:55 A. M.	NAA	Arlington	2400	124.9	C.W.; Time, etc.
16:55	11:55 A. M.	8:55 A. M.	NAR	Key West	1463	205.0	I.C.W.; Time.
16:55	11:55 A. M.	8:55 A. M.	NSS	Annapolis	16900	17.74	Arc; Time.
16:55	11:55 A. M.	8:55 A. M.	NAT	New Orleans	2700	111.0	I.C.W.; Time.
17:00	12 Nn.	9:00 A. M.	NPL	San Diego	13300	22.54	Arc; Press.
17:30	12:30 P. M.	9:30 A. M.	MPD	Poldhu	2700	111.0	Spark; WX.
17:55	12:55 P. M.	9:55 A. M.	NAX	Colon	1800	166.6	I.C.W.; Time.*
17:55	12:55 A. M.	9:55 A. M.	NBA	Balboa	6663	45.02	Arc.; Time.
18:00	1:00 P. M.	10:00 A. M.	VAS	Glace Bay	2700	111.0	Spark; Press.
18:00	1:00 P. M.	10:00 A. M.	VIZ	Rabaul, Aus.	2900	103.4	Spark; Press.
18:30	1:30 P. M.	10:30 A. M.	VID	Darwin, Aus.	850	352.7	Spark; Press.
19:00	2:00 P. M.	11:00 A. M.	XDA	Mexico City	2700	111.0	C.W.; Time, WX.
19:55	2:55 P. M.	11:55 A. M.	NPK	Point Arguelle	1500	199.9	Spark; Time.
19:55	2:55 P. M.	11:55 A. M.	NPL	San Diego	9800	30.59	Arc; Time.
19:55	2:55 P. M.	11:55 A. M.	NPH	San Francisco	4800	62.46	Arc.; Time.
20:00	3:00 P. M.	12 Nn.	BYZ	Rinella	4200	71.39	Arc.; Press.
20:00	3:00 P. M.	12 Nn.	NBA	Balboa	2400	124.9	Spark; Press.
20:00	3:00 P. M.	12 Nn.	BYC	Horsea	4300	69.73	Arc; Press.
20:00	3:00 P. M.	12 Nn.	KAV	Norddeich	1800	166.6	Spark; Press (German).
21:15	4:15 P. M.	1:15 P. M.	BXW	Singapore	2000	149.9	Spark; Press.
21:30	4:30 P. M.	1:30 P. M.	MPD	Poldhu	2700	111.0	Spark; WX.
21:45	4:45 P. M.	1:45 P. M.	BXY	Hong Kong	2000	149.9	Spark; Press.
22:15	5:15 P. M.	2:15 P. M.	IDO	Rome	10000	29.98	Arc; Press.
22:30	5:30 P. M.	2:30 P. M.	BZG	Mauritius	2000	149.9	Spark; Press.
23:45	6:45 P. M.	3:45 P. M.	FL	Eiffel Tower	2500	119.9	Spark; Press.
24:00	7 P. M.	4 P. M.	NPM	Pearl Harbor	11200	26.77	Arc; Time.
24:00	7 P. M.	4 P. M.	BYC	Horsea	4300	69.73	Arc; Press.
24:00	7:00 P. M.	4:00 P. M.	PRG	Prague	9300	32.24	Arc; Press.‡
24:30	7:30 P. M.	4:30 P. M.	YN	Lyons	15100	19.86	Arc; Press.

\*Possibly changed to c.w. May have been discontinued. Uncertain with all marked thus.

†Uncertain of wavelength.

‡This weather sent in code form. Useless unless you have reference code book.

§English press sent on 4100 meters (73.13 kc.)

Practically all of the above stations, it will be seen, transmit on wavelengths too long to be covered by the ordinary broadcast receiver. Experimenters desirous of listening to the above signals might very well employ an ultra-audion circuit for this purpose. RADIO BROADCAST Laboratory Information Sheet No. 19, which was printed in the August, 1926, issue, gives a suitable circuit, together with data for the coils.

# What Really Comes Through Your Transformer?

We know what you want to get out of your set. Everyone wants it. It is clear, pure-toned reception—and you don't want to miss a note from the muffled base of the kettledrum or the profound booming of the baseviol to the shrill "sky-high" tones of the fife and piccolo.)

So much depends on your circuit, so much on your speaker—but even more on your transformers. To render sweet music and to get the full range of orchestral or instrumental performance, the transformer must faithfully reproduce all frequencies.

## The FERRANTI TRANSFORMER Meets Every Condition of Good Audio Reception

It takes two and a half miles of wire for the coils of the A.F. 3 and one and a half for the A.F. 4 plus the many refinements which the genius of Dr. Ferranti has made possible, to create transformers whose amplification curve is almost perfect—almost a straight line. By installing Ferrantis you can modernize your old set or perfect your new one. Ferranti will give you an uncensored message from the sending station.

If you want to make the best of the power tube feeding the loud speaker, use Ferranti.

Ask your dealer for a Ferranti. Don't be satisfied until you have installed one. If he does not carry Ferranti Transformers, write us and we shall tell you where you can get one. No better transformer is available at any price.

For the best available transformer results—Ferranti Audio Frequency Transformer A.F. 3—ratio  $3\frac{1}{2}$  to 1—\$12.

For a transformer far superior to the average, use Ferranti A.F. 4—ratio  $3\frac{1}{2}$  to 1—\$8.50.

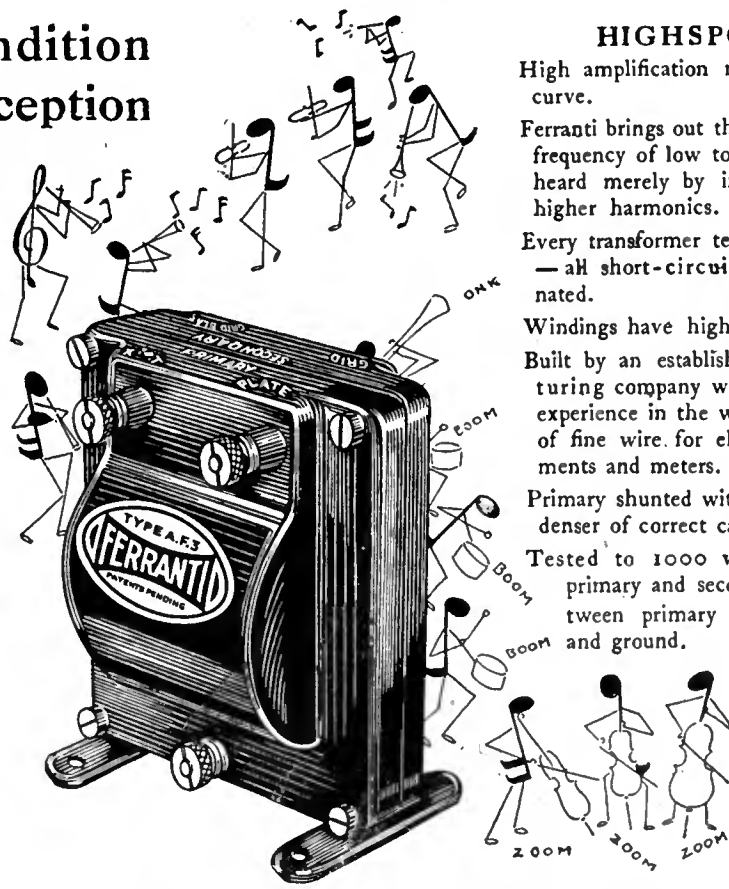

### HIGHSPOTS

High amplification ratio with flat curve.

Ferranti brings out the fundamental frequency of low tones—none are heard merely by inference from higher harmonics.

Every transformer tested ten times—all short-circuit turns eliminated.

Windings have high impedance.

Built by an established manufacturing company with forty years' experience in the winding of coils of fine wire for electrical instruments and meters.

Primary shunted with built-in condenser of correct capacity

Tested to 1000 volts between primary and secondary and between primary and secondary and ground.

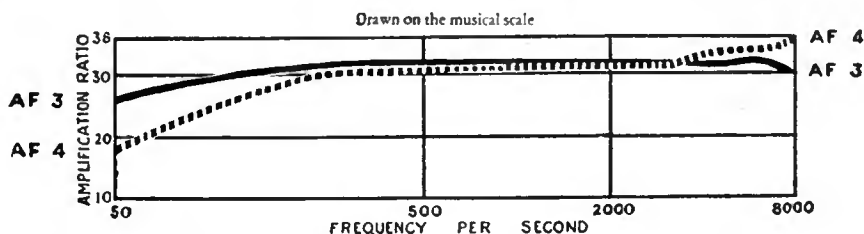

This graph is drawn on a musical scale—the only accurate way of showing the full value of each tone which your set receives. Note that the evenness and fullness of amplification in both the Ferranti A. F. 3 and the A. F. 4 extends throughout the range of the organ, cello and the human voice.

*No Better Transformer Is Available at Any Price*

FERRANTI, INC.  
130 West 42nd Street  
New York, N. Y.

*No Better Transformer Is Available at Any Price*

THE NEARLY PERFECT TRANSFORMER

# The Relation Between Wavelength and Frequency

By CHARLES F. FELSTEAD

**T**HE relation between wavelength and frequency is of a fixed and definite value, and is such a very simple matter when it is once understood that it should offer no confusion to the beginner. A radio wave is an electric wave by means of which radio communication is carried on. Radio, light, heat waves, and X-rays, are all forms of electric waves. The only difference in these waves is their frequency; they all travel at the same speed. The to-and-fro motion of the alternating electric current set up in the antenna and counterpoise (the latter often replaces the ground in a transmitting station) by the transmitting set, produces an alternating electric pressure in the space between this antenna and counterpoise system. This causes a to-and-fro wave motion in the ether that travels out from the radio transmitting station in all directions with the speed of light, just as ripples run out in all directions when a stone is dropped in a pool of water. These electro-magnetic waves travel at the rate of 186,300 miles per second, or 300,000,000 meters per second (to be more exact, they travel at 299,820,000 meters per second). When the electro-magnetic waves sent out by a transmitter reach a receiving antenna, they produce a slight to-and-fro electric current in that antenna, which corresponds in frequency to the frequency of the transmitted electro-magnetic waves. This occurs only when the receiver is tuned to the same frequency as the transmitter. The slight current thus set up in the receiving set is rectified by the detector and changed to a pulsating direct current, which actuates the diaphragms of the head phones, or is amplified by successive audio amplifier stages until it has enough strength to operate a loud speaker.

vided by the number of kilocycles. The result is the corresponding wavelength in meters.

The explanation of this relation between the wavelength in meters and the number of cycles per second follows. As previously mentioned, the velocity of electro-magnetic (radio) waves has been found by experiment to be the same as the velocity of light, which is approximately 300,000,000 meters per second. If a radio transmitter is adjusted—or tuned, as it is called—so that it sends out 100,000 waves per second, that is, 100,000 cycles per second, and since we know that each wave travels 300,000,000 meters in one second, then we know that in one second 100,000 waves have left the transmitting station, and that the first wave is 300,000,000 meters away from the station. Thus, the 100,000 waves are equally spaced over a distance of 300,000,000 meters. By dividing the 300,000,000 by the 100,000, we find that each wave is 3000 meters long. In other words, the frequency which corresponds to 3000 meters wavelength is

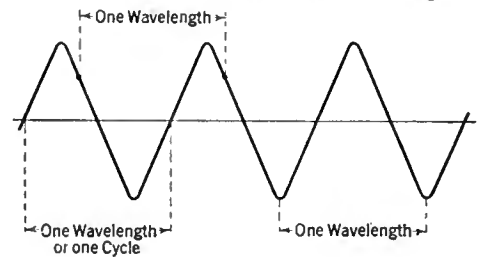

FIG. 1

100,000 cycles, or 100 kilocycles. The shorter the wavelength, the greater the number of waves that will pass a given point in one second; that is to say, the shorter the wavelength, the higher the frequency.

The above is usually put into formula by letting *V* represent the velocity of electric waves, or 300,000,000 meters per second; *N* the frequency of oscillations (cycles); and the symbol  $\lambda$  (the Greek letter "lambda") the wavelength in meters. The formula is now  $V = N \lambda$ . Substituting and dividing we get:

$$\lambda = \frac{300,000,000}{N}, \text{ or } N = \frac{300,000,000}{\lambda}$$

A table of wavelengths, with the corresponding frequency, is given below. It will be seen from an inspection of this table that as the frequency becomes greater, the wavelength becomes shorter, and vice versa.

WAVELENGTH IN METERS	FREQUENCY IN KILOCYCLES
0.5	600,000
1	300,000
4	75,000
5	60,000
10	30,000
50	6000
100	3000
150	2000
200	1500
300	1000
400	750
500	600
600	500
1000	300
2000	150
5000	60
10,000	30
20,000	15

With the advent of congestion in the ether channels allotted for the use of broadcasting stations, it became necessary to decide upon a uniform figure by which stations should be separated. For various reasons a ten-kilocycle separation was chosen, and nowadays it is becoming customary to refer to a station by its frequency instead of its wavelength.

All that is necessary to convert meters to kilocycles (1000 cycles) is to divide the number of meters into 300,000. The reverse is also true; to convert kilocycles to meters, 300,000 is di-

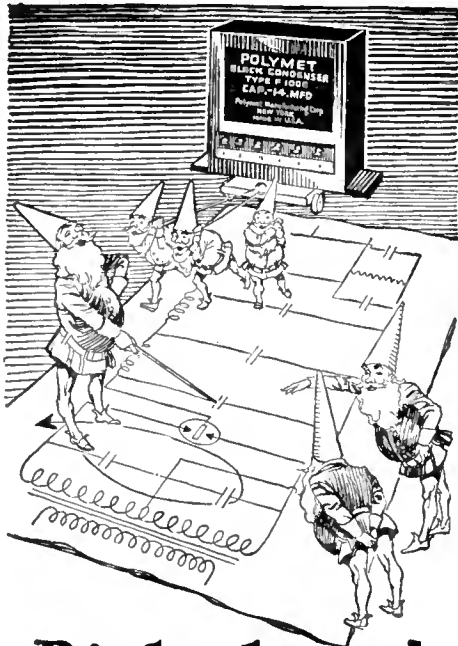

## Right here!

You can't go wrong when you use Polymet High Voltage Condensers in sets or power units. Built to withstand 1,000 volts permanently, and individually tested for this rating, their obvious superiority, both in workmanship and performance, definitely establishes Polymet's leadership as condenser manufacturers.



Polymet condensers incorporate finest insulating paper, best foil and specially prepared impregnating compounds. An exclusive, new and improved process renders them non-inductive, with high dielectric resistance for long life. Obtainable as individual units or in blocks; in cans or unmounted; with fixed or flexible leads.

Capacities .1 to 5. Mfd. • 60c to \$4.50

## Raytheon Circuit Blocks



Tested by the Raytheon Laboratories, they have passed with highest honors and been given an enviable rating.

F1001 .1-C.-1 Mfd. . . . \$2.00  
F1000 14 Mfd. . . . . 9.50

Polymet Products are used by over 125 high grade receiver and power unit manufacturers. There's a reason—Polymet Products have passed their exhaustive tests! Follow the manufacturers—specify Polymet Products—at all good dealers everywhere.

★ Illustrated descriptions sent FREE on request.

Polymet Manufacturing Corporation  
599 B Broadway - New York City

"World's Largest Manufacturers of Radio Essentials"

# POLYMET



# An Amazing New World

## OF RADIO Is Now Yours!



Distance, Quality, Volume, Selectivity --- a new conception of these essentials awaits you with the use of **MADISON - MOORE TRANSFORMERS**

Stations from afar, which even the finest receiving sets have failed to record, come in easily with this instrument. Your dials become the magic key to a new and untouched realm of sound and melody.

Tone is vastly improved and beautified, the most delicate shadings being faithfully reproduced.

Selectivity, always a problem, is no longer difficult. MADISON-MOORE Transformers make every night a radio certainty, for they bring in DX like locals.

Stations which the listener never before brought in, come with loud speaker volume with the use of only a two-foot loop. Quality is immensely improved on all reception.

Every MADISON-MOORE Unit is subjected to most exhaustive laboratory tests before it is approved for use. Every instrument is precision made and is as nearly perfect, electrically and mechanically, as skill and fine apparatus can make it. Radio Engineers and authorities accord it highest praise.

ONLY WHEN YOU INSTALL MADISON-MOORE TRANSFORMERS WILL YOU ENJOY THE UTMOST FROM YOUR SET—WHETHER YOU HAVE THE FINEST YOU CAN BUY OR HAVE BUILT IT YOURSELF.

[ If your dealer cannot supply you, write us ]

MADISON-MOORE RADIO CORPORATION  
2524 Federal Boulevard  
Denver, Colorado - U. S. A.



READ THE GUARANTEE

# MADISON~MOORE

*The Finest RADIO APPARATUS in the World!*

Digitized by Microsoft®

# Speed

**SUPER-EMISSION  
RADIO TUBES**

are the most perfectly  
balanced tubes produced



**X 200 A**  
**Super-Sensitive  
Power Detector**



### Other Types

201 A	5 volt	detector-amplifier
X 112	5 "	power amplifier
199	3 "	detector-amplifier
X 120	3 "	power amplifier
12	1½ "	detector-amplifier

and

## SPEED

FULL WAVE  
GAS FILLED

## RECTIFIER

FOR USE IN STANDARD "B"  
BATTERY ELIMINATORS

A FEW FRANCHISES  
STILL OPEN FOR FIRST  
CLASS DISTRIBUTORS

**Cable**  
**Supply Company**  
**INC.**

Executive Offices

**31 Union Square**  
**New York**

# LETTERS FROM READERS

Contributions from Readers on Various Subjects  
of Radio Interest—An Open Forum for All

*From the Sponsor of the Dill Bill*

PREPARATORY to its appearance in RADIO BROADCAST for November, galley proofs of Carl Dreher's article entitled "A New Plan to Regulate Radio Broadcasting" were sent to Senator C. C. Dill. As all radio fans are well aware, the Dill bill for regulation of radio broadcasting passed the Senate without a record vote on the eve of the adjournment of Congress. Here is the Senator's letter sent after receipt of the galley proofs:

Editor, RADIO BROADCAST,  
Doubleday, Page & Company,  
Garden City, New York.

SIR:

On my arrival here, I find your letter of recent date together with the galley proofs of an article for RADIO BROADCAST for November. I have read this article with much interest and have found it most interesting and instructive, but neither of the bills passed by the House and Senate provides for any such specific method of determining what broadcasting stations shall be allowed to use the air, although I think the language of the Senate Bill is wide enough to permit the Commission to lay down such a basis of deciding between numerous applicants.

I think these suggestions are most excellent to be presented to the Commission that will have charge of carrying out the bill when it is enacted into the law.

It seems to me that the multiplicity of conditions and problems affecting the decision of the question of who shall broadcast in each community, as so well presented in this article, make it all the more necessary to have a Commission that will give its entire time and attention to these problems, such as is provided by the Senate Bill, rather than an appellate body that will give only cursory attention to these questions as presented to it from time to time.

I earnestly hope that the House and Senate conferees will be able to agree on satisfactory legislation early in the coming session.

Thanking you for your letter and the information you sent, I am,

Very truly yours,

C. C. DILL.

Washington, District of Columbia.

### *The R. B. "Lab" Receiver*

THOSE who have already constructed the R. B. "Lab" Receiver, together with the many would-be builders, will be interested in this letter telling of the experiences of one who has already experimented for several weeks with a home-constructed receiver of this type.

Editor, RADIO BROADCAST,  
Doubleday, Page & Company,  
Garden City, New York.

SIR:

I have been working with your R. B. "Lab" circuit for several weeks now and, as you have asked for reports, I will try and tell you of my experiences with this receiver.

I have every issue of RADIO BROADCAST for the last year and a half, and have tried nearly every circuit described therein, from the old original Roberts to the "Aristocrat," but my success with the new R. B. "Lab" circuit exceeds that I have had with any of the others. I have had a very interesting time comparing other sets I have built with the "Lab" set.

We are about three hundred miles from

Chicago and it takes a very good set to bring in any station from that city during the daytime, but I can get KYW on the loud speaker with the "Lab" circuit when the static is not too strong. I have not used the best of parts and the coils are all home made. I use a toroid of 145 turns, cutting off 48 turns for the primary, in the detector circuit. Using a solenoid low loss space-wound coil in the r. f. circuit, with a secondary of 50 turns and a primary of 12 turns, got even better results than with a toroid coil.

I did not have any trouble in getting perfect neutralization so did not resort to the use of the tuned trap you speak of. The tone is all that could be desired, and the volume equals that of any five- or six-tube set. I use a 2:1 transformer in the first stage with one of 3½:1 in the last stage. My opinion is that you have the best four-tube receiver yet presented to the public.

Very truly yours,

E. H. BREWER.

Belmond, Iowa.

### *From a DX Lion*

MR. MOSKOVITA calls himself a DX fan in his letter below. With all due respects, many in the swim of radio matters would preferably dub him a *bound*, of the species DX. Yet we prefer to give him the title of *DX lion*, for it is doubtful whether many can offer proof of reception of so many distant stations as he can:

Editor, RADIO BROADCAST,  
Doubleday, Page & Company,  
Garden City, New York.

SIR:

After reading a letter in the October RADIO BROADCAST about Mr. Harding Gow, of East Sound, Washington, picking up station 3 LO, Melbourne, Australia, I thought I would write to you about my DX reception. I am a veritable DX fan, having tuned-in practically every high-powered station in the United States, and many of low power. Of these latter, especially would I like to mention the reception of CFCQ, Vancouver, British Columbia, a station of only five watts or so. Last winter I used to tune-in this station about four times a week, and this I have had confirmed. In fact, all stations have been verified, both American and foreign.

I have a log book that looks like a Webster's dictionary. Whenever I tune-in a station, I jot down the items being rendered, together with the exact time, and also make note of the dial settings.

My radio is the greatest pleasure I get out of life, and the greatest satisfaction is to tune-in some distant foreign station and have it confirmed. One of the biggest secrets of successful DX reception is patience—and plenty of it too. Many times I will wrestle with an elusive carrier for two hours or more, but I never give up until I have clearly heard a song or some other selection whereby I may have my reception confirmed.

At the present time (the second week in October), the Australian stations are coming in with good loud speaker volume. I get 4 OG, Brisbane, 3 LO, Melbourne, 2 BL, Sydney, and 5 CL, Adelaide. These stations all employ 5000 watts input, I believe. They are heard best at about 3 A. M. Pacific Standard Time.

The Japanese stations are also coming in well. The Tokyo station, JOAK, is the most consistent, while JOCK, Nagoya, and JOBK, also come in with good strength. The Australian stations have excellent programs, composed mostly of classical music, and very little jazz. They are strong for community singing, and there is hardly a night (or, rather, morning) that one or other of

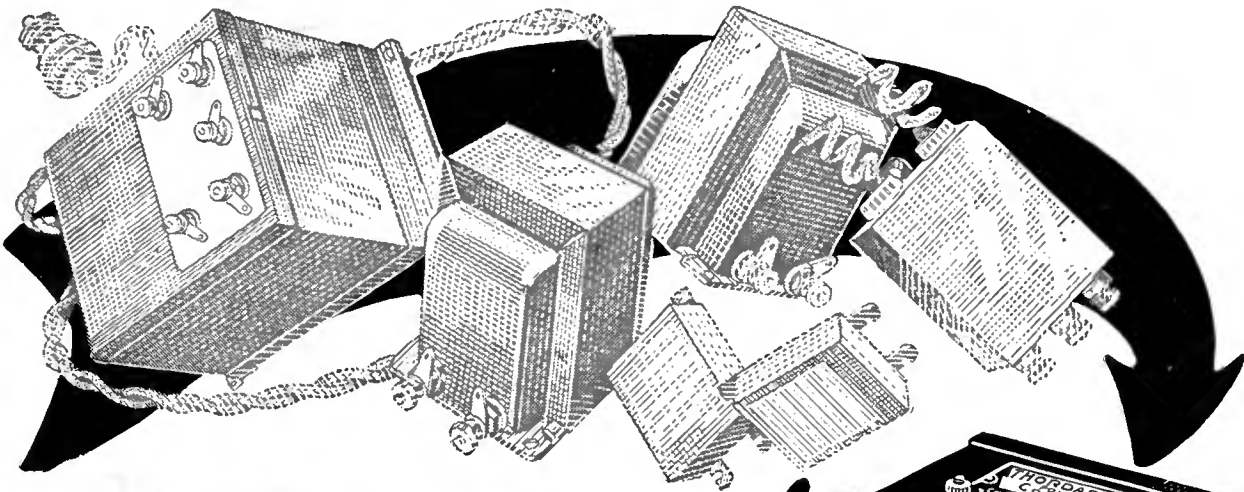

# All in One!

## THORDARSON POWER COMPACT

### TYPE R-171

Contains a power supply transformer for Raytheon BH rectifier, 2 filter chokes, 2 buffer condensers, and a filament supply for UX 171 power amplifying tube.

\$15.00

### TYPE R-210

Contains a power supply transformer for UX 216-B rectifier, 2 filter chokes, and a filament supply of 7½ volts for UX 210 power amplifying tube.

\$20.00

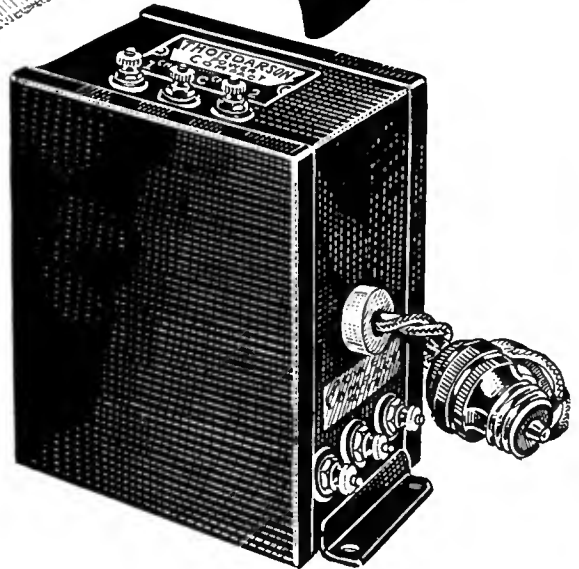

## The Complete Foundation Unit for power amplification and B supply

**Simplified Assembly.** The Power Compact contains within itself the greater part of the complete B supply unit. With the Type R-171, only 14 leads complete the Raytheon assembly. All terminals are carefully located for the greatest ease of assembly.

**Compactness.** The only additional apparatus required to build the B supply are the condenser block (Raytheon type), a Raytheon tube BH, and the resistance units. The complete eliminator occupies a space of but 6 in. x 9 in. without crowding.

**High Efficiency.** The power supply of either Power Compact furnishes the proper current for maximum efficiency of the rectifiers used; the chokes are of sufficient capacity to carry the maximum output. Conservatively rated, will not heat up in continuous service.

**High Voltage Output.** The R-171 Power Compact assembly will deliver a maximum plate voltage output of 300 volts at 30 milliamperes, or 275 volts at 40 milliamperes.

The R-210 type assembly will deliver 400 volts to the plate of the power tube, and in addition, will supply a constant 90 volts to the receiver at any current drain up to 40 milliamperes.

**Silent in Operation.** There is no traceable hum, either mechanical in the compact itself, or electrical through the loudspeaker.

**Complete Supply for Power Amplification.** The Power Compact not only supplies B voltage, but also provides for the filament current and grid bias of the stage of power amplification. *Makes it possible to use power amplification even on sets designed for dry battery operation.*

**Electrically Centered Filament Supply.** The power tube filament supply is tapped at the exact electrical center for grid return. The center tap is taken from the common lead of two perfectly balanced windings—completely obliterating the A. C. hum. (An exclusive Thordarson feature.)

Write for instruction booklets SD-49 and SD-50.

If your dealer cannot supply, order direct from the factory.

**THORDARSON ELECTRIC MANUFACTURING CO.**  
*Transformer Specialists Since 1895*  
**WORLD'S OLDEST AND LARGEST EXCLUSIVE TRANSFORMER MAKERS**  
*Huron and Kingsbury Streets — Chicago, Ill. U.S.A.*

3446

Digitized by Microsoft®



*Accurate Primary  
Coupling at Every  
Condenser Setting  
with the New*

**HAMMARLUND  
"AUTO-COUPLE"**



Specified  
For the New  
Hammarlund-  
Roberts  
Hi-Q Receiver

THE "Auto-Couple"—Hammarlund's latest contribution to radio—is a scientifically correct arrangement of Space-Wound Coil, "Midline" Condenser and Aluminum Shield, which encloses the complete assembly with tube and socket.

It gives automatic, graduated primary coupling, assuring maximum transfer of energy at every broadcast wave-length and controlling undesirable oscillations on the low waves.

The Hammarlund "Auto-Couple" will operate efficiently in any tuned radio frequency circuit.

For the convenience of set-builders coils, condensers and shields are sold separately.

The condenser that should be used with the "Auto-Couple" is the new Hammarlund "Midline" or "S-F-L" .00035 (17 plates), or any other make of condenser of the same capacity and having a back extension shaft.

Ask Your Dealer About the "Auto-Couple." Write for Folder

HAMMARLUND MFG. CO.  
424-438 W. 33rd St., New York

For Better Radio  
**Hammarlund**  
PRECISION  
PRODUCTS

the Australian broadcasters is not sending out this community and choral singing. They also broadcast church services, on Sundays, followed by an hour's selection of band music after the services.

These foreign stations have one weakness in my opinion, and that is their announcing, or lack of it, rather. If you tuned-in on one of the Australian or Japanese stations, you would never complain about the American announcers. Sometimes they play six or more numbers without announcing, and then, when they do announce, it is very hard to catch what they are saying.

The Japanese stations also have very good programs. Mostly classical Japanese music, and occasionally foreign selections, will be heard from these stations. JOAK and JOBK give lessons in English every day for about forty-five minutes.

Very truly yours,  
JACK MOSKOVITA.  
San Pedro, California.

*Critical Hours for the Broadcasting Industry*

UNDER the above heading, the leading editorial in "The March of Radio" in the November RADIO BROADCAST set out to place before the reader a brief summary of the existing status of radio conditions in an unbiased manner. The proverbial ostrich attitude adopted by so many who asseverate that there is little or no cause for alarm, was ignored, and an editorial opinion based upon actual collected data was expounded.

Editor, RADIO BROADCAST  
Doubleday, Page & Company,  
Garden City, New York.

SIR:

The editorial appearing in the November RADIO BROADCAST, "Critical Hours in the Broadcasting Industry," most certainly deserves commendation. I am glad to see one editor displaying the temerity to face facts as they are, rather than resort to the usual ballyhoo. Things are not well with the broadcasting situation, and the more publicity given the matter, the quicker will wrongs be corrected.

I doubt if even you, in your eastern location, have any conception of the interference that has come with wave-jumping. Nineteen heterodyning points, which you mention, is not only a commonplace during the past month, but is far from being the greatest number to be found! The situation now is not one of being able to select the particular program that most pleases one, or is being received to best effect in the old sense, but boils itself down to this: "Where can I find a station that is not being smeared by a half dozen others?"

As matters now stand, our good nights are the bad ones, for, on these latter, reception from one or two stations is made possible because the bad atmospheric conditions have blanketed off the rest of them! The broadcasters are, by wave-jumping, doing more to help the phonograph companies than the latter are able to do for themselves.

I heartily commend your courage in flatly facing matters, for I believe you are the first to do so. The others tell us all is well, trying to foster an improvement by harboring a delusion.

Very truly yours,  
GORDON BALCH NEVIN.  
Johnstown, Pennsylvania

*Mr. Henney's Tube Articles*

TO TELL the good from the bad, by mere external examination, is hardly possible—this apropos tubes. "Every Tube Tested," is by no means an unfamiliar sign bedecking the windows of unprincipled as well as dependable radio dealers. Little does it mean in the formers' case, for, as often as not, the purchased tube is roughly

thrust into the tester's socket, the needles on the meter dials "kick," and all is well. By the time the customer is enabled to grasp the meaning of the multifarious meters, his tubes are wrapped and he is requested to pay at the desk. Mr. Henney's tube articles have been written for the benefit of such customers who are interested, without the necessity of heavy expenditure for apparatus, in testing and measuring the characteristics of their own tubes. Read on:

Editor, RADIO BROADCAST,  
Doubleday, Page & Company,  
Garden City, New York.

SIR:

I have just completed my second reading of Mr. Henney's illuminating series of articles on the uses of vacuum tubes which appeared in the December, 1925, and February and April, 1926, issues of RADIO BROADCAST. They contain so many valuable ideas, clearly stated, that I feel I must tell you of my appreciation.

Nowadays radio magazines are apt to minimize technical explanations of theory to almost the vanishing point. Although the practice of popular radio journals to leave all theoretical discussions to engineering publications may be justifiable to a certain extent, there are many readers of these popular magazines who would like to know not only *how* to do it but *why* to do it. This group of "broadcast amateurs" (to distinguish them from the "hams") lies between the ordinary entertainment-loving listener and the pure scientist, and Mr. Henney's articles appear to have been written for this group. They (the articles) do not stop at telling *where* a particular tube should be used, but go on to say *why* it should be used there.

Another article of this type, that combines theory with practice, was that of Hugh S. Knowles, in the February *Popular Radio*. Let's have more!

Very truly yours  
WILLIS G. HAZARD.  
East Jaffrey,  
New Hampshire.

*Commends Our Laboratory Information Sheets*

WE HAVE received many letters commenting favorably on our substitution of the Laboratory Information Sheets for the former "Grid" Department. A typical one herewith:

Editor, RADIO BROADCAST,  
Doubleday, Page & Company,  
Garden City, New York.

SIR:

Having been a constant reader of your magazine for over two years, I wish to congratulate you on the recent change in its quality, not in the quality of its reading matter, for this has always been far above any other periodical, but in the physical quality and the excellence of the various departments.

I am particularly glad to see the data sheets as their inclusion fills a long-felt want on my part, for what they contain is brief and to the point, exactly what the earnest radio fan, the one who is more than a broadcast listener, needs. Particularly are the circuit data and data on the new tubes to my liking.

I also wish to congratulate Mr. Keith Henney on his laboratory apparatus articles which have been of great value to me. I regret that I have been unable to become a subscriber as my work as field engineer for a well-known radio manufacturer keeps me on the road so much that I have no permanent address, but the highest praise that can be bestowed on your magazine is manifest by the speed with which it disappears from the newsstands the day after publication. My first thought around the 15th when out of town is to tell a local news dealer of the city I am in to hold a copy for me.

Very truly yours,  
B. B. ALCORN.



NATIONAL B-ELIMINATOR COMPONENTS

☞ NATIONAL CO., INC., announces a new line of Components for the construction of B-Eliminators, using the Raytheon BH Tube. ☞ The TRANSFORMER is made to carry the full load without heating and has both five and seven volt filament windings, center-tapped. The 0.1 Mfd, Buffer Condensers are enclosed in this case and connected. ☞ The FILTER CHOKES have heavier covers and windings than usual, and really high

inductance. ☞ The CONDENSER Block employs TOBE High Voltage Condensers and matches the TRANSFORMER and CHOKE Cases. ☞ These units are built to a standard of quality—The NATIONAL Standard. Anyone who has built a set using BROWNING-DRAKE Transformers and NATIONAL Condensers knows what *that* means. ☞ Be sure you get the genuine NATIONAL products. ★

# NATIONAL

## RADIO PRODUCTS

NATIONAL CO., INC., W. A. Ready, Pres. Engineers and Manufacturers Cambridge, Mass.

*Hoyt* PHONE-PLUG MILLIAMMETER



This precision moving-coil instrument is made to plug into the loud speaker lead on your set and enables you to adjust your C battery bias on the power tube, for perfect reproduction. Instantly attached. A necessary accessory if you desire the utmost in quality.

Price \$8.50

**BURTON-ROGERS CO.**  
Boston, Mass. Sales Dept. for Hoyt Electrical Instruments

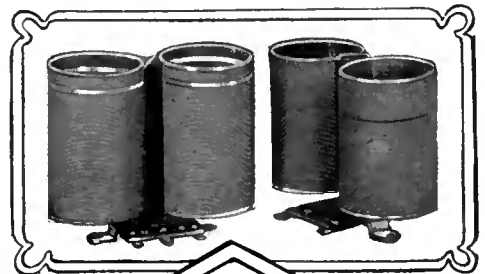

SPECIALLY DESIGNED

FOR R.B. LAB RECEIVER



PATENTS PENDING

There Is No Substitute ★

THE HEART of the new RB Lab Receiver—in fact the heart of any receiver—is the coils. These Genwin Coils were designed to meet the specifications of the engineers who built the RB Lab. Receiver. Patents have been applied for. This is the coil Radio Broadcast prescribes—there is no substitute. As the demand for these coils is taxing our capacity to the utmost, order yours today—don't delay. Then you can build the RB Lab. Receiver and enjoy its marvelous advantages. Like all Genwin products these coils are unconditionally guaranteed.

At Your Dealers or Postpaid **\$5.50** per pair  
**GENERAL WINDING COMPANY, Inc.**  
214 FULTON STREET NEW YORK, N. Y.

# Reliable Noiseless Powerful

KEEPS your set full of live, marvelous energy — banishes its dull, listless moments due to run down batteries. Improves tone, and cuts operating cost to almost nothing. Rigidly tested and fully guaranteed—the greatest "B" Battery Eliminator ever produced.

# Cornell Voltage Supply

("B" Battery Eliminator)

Equipped with long life Raytheon Tube which has no filament to burn out.

Type "B"—137 to 220 volts at 30 milliamps; 150 volts at 60 milliamps. **\$39.50**

Type "CB"—(illustrated below) 142 to 227 volts at 30 milliamps; 155 volts at 60 milliamps. **\$49.00**

(West of Rockies, add \$1.00 to above list prices)

Sold only through authorized CORNELL Dealers



Tested and approved by Raytheon Laboratories

**Beautify your Set**  
With its deeply etched plate, in antique gold finish, this new attractive smooth friction, 9 to 1 vernier dial will beautify your set and make it a 1927 model.  
List Price \$1.50.



CORNELL ELECTRIC MFG. CORP.  
Rawson & Anabelle Sts., Long Island City, N. Y.

Please send full information about your Cornell Voltage Supply; also name of nearest dealer.

Name .....

Address .....

If dealer, check here and receive special dealer proposition.

## A KEY TO RECENT RADIO ARTICLES

By E. G. SHALKHAUSER

THIS is the fourteenth installment of references to articles which have appeared recently in various radio periodicals. Each separate reference should be cut out and pasted on cards for filing, or pasted in a scrap book either alphabetically or numerically. An outline of the Dewey Decimal System (employed here) appeared last in the November, RADIO BROADCAST, and will be reprinted in an early number.



R800 (537.65). PIEZO-ELECTRIC PHENOMENA. QUARTZ CRYSTALS.

QST. Sept., 1926. Pp. 17-19.  
"Luminous Frequency Standards," J. M. C.  
A piezo-electric resonator, not oscillator, to be used as a frequency standard, has been developed by Loewe of Germany, and placed on the market. This resonator consists of a piezo-electric crystal mounted between two plates and placed in a gas-filled tube. When connected inductively to an oscillating circuit, resonance is indicated by the polarizing of the plates from the crystal, and the gas within begins to glow. An accuracy of one fiftieth of one per cent. or better, may be obtained with this device. They are available to cover wavelengths from 35 to 1200 meters (8566 to 250 kc.) at present.

R281.71. QUARTZ. QUARTZ.

QST. Sept., 1926. Pp. 23-25.  
"Examining Quartz for Oscillator Use," L. H. Dawson.  
Information is given on the testing and cutting of quartz crystals. The uncut crystal is first analyzed regarding its optical and electrical axes. Two types of crystals exist, namely, "right-handed" and "left-handed," but either will serve as an oscillator. Sometimes a crystal is found having the double property mentioned above, in which case it cannot be used. An instrument for detecting defects and locating the axes, is described. It can readily be made at home.

R382. INDUCTORS. INDUCTORS.

QST. Sept., 1926. Pp. 26 ff.  
"Easy Tuner Design."  
Charts are presented for the easy calculation and design of tuners and wavemeter circuits using the Hammarlund short-wave coil, which has 10 turns per inch on a three-inch tube. With a given inductance value, and a variable condenser of specific capacity, the shunted circuit obtained will tune over a definite range, as shown. Suggestions are offered as to the best method to employ in the choice of coils for various condensers on the market, and the range these coils will cover when placed in a circuit, is detailed.

R387.1. SHIELDS. SHIELDS.

QST. Sept., 1926. Pp. 29-32.  
"Multi-Purpose Shielded Units," W. M. Henderson.  
Shielded r.f. units, which may be used for a multiplicity of purposes, are discussed, the accompanying curves and photographs showing the method of construction and operation. Claims are made that greater selectivity, stability, elimination of station pickups, decrease of interstage coupling, and the use of a greater number of r. f. stages, are possible with this type of tuner. Of the metals tried (brass, copper, and aluminum), aluminum proved the best as a shield, as is evidenced by the frequency-resistance curve. The Weston method of measuring coil resistance at high frequencies is described in detail, the circuit and hook-up of the apparatus being shown and explained.

R330. ELECTRON TUBES. TUBES, UX-210.

QST. Sept., 1926. Pp. 33-36.  
"Radiotron Model UX-210."  
Detailed information is given concerning the new Radiotron tube, UX-210. Charts and curves show how the tube will function as an oscillator at the various wavelengths. A method of finding plate impedance, amplification constant, and other important characteristics, is explained.

R383. RESISTORS. RESISTORS.

QST. Sept., 1926. Pp. 37 ff.  
"Metallized High Resistance Units," J. Morgan.  
A new type of high resistance unit, which may be used for grid-leaks, coupling units in amplifiers, potentiometers, and in A and B battery devices, has been developed commercially. It consists of a glass filament coated with a very thin film of metal, and sealed within a glass tube. The process of development and manufacture is described, and a table is presented which shows the relation between resistance and current carrying capacity. Normally, the units are said to be accurate to within 5 per cent. when manufactured in large quantities.

R342.15. AMPLIFIER TRANSFORMER. AUDIO AMPLIFIER ACTION

Radio News. Sept., 1926. Pp. 244 ff.  
"Overloading the Audio Amplifier," S. Harris.  
In this fourth of a series of discussions on audio amplifiers, the author takes up the causes of overloading the amplifier; also he discusses the effect of this overloading on the quality of reproduction, and considers the nature of the load as it affects the output of the amplifier coupling device. A theoretical discussion, studying the probable effects of tube capacity, coil capacity, and resistance in the circuit as the apparatus is connected together, is presented. The curves show that several variable quantities may experience considerable variation with frequency input; for instance, the input impedance of the tube may change considerably when the frequency changes. Distortion may therefore be introduced for reasons not commonly suspected.

# DESIGNED to OUTLAST World Storage "A" Battery

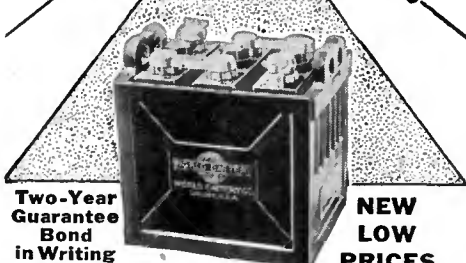

Two-Year  
Guarantee  
Bond  
in Writing

NEW  
LOW  
PRICES

Famous the world over for reliable, enduring performance. Solid Rubber Case lasting protection against acid or leakage.

Approved and Listed as  
Standard by Leading  
Authorities

including Radio News Laboratories, Popular Sci. Inst. Standards, Pop. Radio Laboratories, Radio Broadcast Laboratories, Radio in the Home and Lefax, Inc.

Send No Money

Just state number wanted and we will ship same day order is received, by express C.O.D. Pay expressman after examining batteries. 5% discount for cash with order. Remember, you save 50% on World Batteries—so send your order today.

WORLD BATTERY COMPANY  
Dept. 24  
1219 S. Wabash Ave., Chicago, Ill.

Solid Rubber Case Radio Batteries	
6-Volt, 100-Amperes	\$10.00
6-Volt, 120-Amperes	\$12.00
6-Volt, 140-Amperes	\$13.00
Solid Rubber Case Auto Batteries	
6 - Volt, 11 - Plate	\$10.00
6 - Volt, 13 - Plate	\$12.00
12 - Volt, 7 - Plate	\$14.50

Set your radio dial at 288.3 meters for the World Storage Battery Station WSBC. Variety—new talent—always interesting. Jerry Sullivan, Dir. and Announcer, CHI-CAW-60



IF you like this magazine with its coated paper and enlarged size—then why not subscribe and get it regularly—by the year, \$4.00, Six months, \$2.00.

Doubleday, Page & Co.  
Garden City New York

## Send for Latest RADIO CATALOG and GUIDE

**New 1927 Edition FREE!**  
Fans will be pleased to know that F. J. Maroo, 923, well-known in amateur circles and the engineer who designed the B-T counterphase circuit and the Aero coils, is now directing our amateur department in which is featured a complete line of short-wave receiving and transmitting equipment.  
The 1927 edition of the Barawik Catalog and Guide contains 164 pages of radio's newest developments, everything that a real fan needs, from the complete factory-built set to the smallest screw, including labor-saving devices, tools, power supply units, amplifier equipment; in fact, everything that is necessary in general radio work and amateur work. Standard equipment of the best manufacturers at tremendous savings is listed in abundance. There is also shown a selection of electrical goods, household appliances, auto accessories and articles necessary in the home—all at a big saving in price.

Send the Coupon for Free Copy Today—NOW!  
Also please include name of other fans you know would be interested. Get this guide before you spend another cent.



**BARAWIK CO.**  
540-549A Monroe St.  
Chicago, U. S. A.

Mail This Coupon Now For Free Copy

Name .....

Address .....

Fan .....

Address .....

Increased Selectivity  
Greater Distance  
More Volume

BUT ABOVE ALL—

Quality of Tone

On any set from the modest little Crystal Hook-up to the Super Outfit—you simply install

**THE CARBORUNDUM STABILIZING  
DETECTOR UNIT**

Reg. U. S. Pat. Off.

\$3.50 (in U. S. A.) Dealer or Direct

*Our Hook-up Book tells you how—send for it*

THE CARBORUNDUM COMPANY, NIAGARA FALLS, N. Y.

SALES OFFICES AND WAREHOUSES IN

New York : Chicago : Boston : Philadelphia : Cleveland : Detroit : Cincinnati  
Pittsburgh : Milwaukee : Grand Rapids  
The Carborundum Co., Ltd., Manchester, Eng.

{ Carborundum is the Registered Trade Name used by The Carborundum Company for Silicon Carbide. This Trade Mark is the exclusive property of The Carborundum Company. }

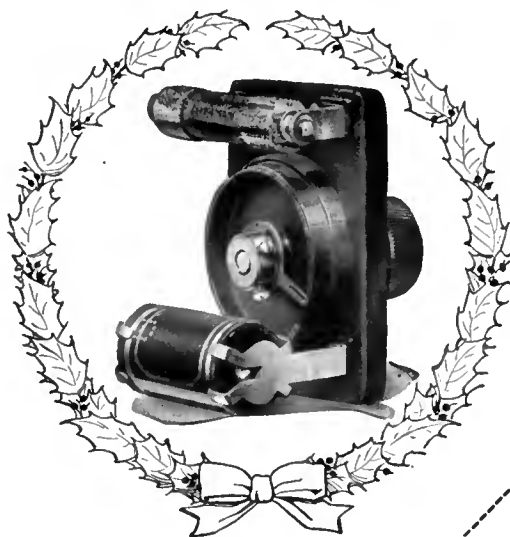

The Carborundum Company  
Niagara Falls, N. Y.

Please send free Hook-Up Book D-2.



Name \_\_\_\_\_

Street \_\_\_\_\_

City \_\_\_\_\_ State \_\_\_\_\_

Let us greatly increase  
the efficiency of your  
receiving set

WE are the sole service representatives of Radio Broadcast, appointed after a thorough investigation of our facilities and experience.

This is our offer: For \$2.50 we will inspect and test any ordinary radio receiver. In addition, we will furnish a written report describing the faults we find, together with an estimate of the cost of remedying them. For a Superheterodyne or other highly complicated receiver, a similar service will be rendered at a slightly higher cost.

Our business is to permanently remedy the faults in radio receivers which are not working satisfactorily. Why not get the benefit of our service? The cost is small, the results will delight you.

Telephone RECTOR 2538

Rossiter,  
Tyler & McDonell, Inc.  
*Consulting Radio Engineers*  
136 Liberty St., New York

**R T M** RADIO SERVICE



INFRADYNE  
BUILDERS:—

here is the quality radio instrument recommended for use with the new Infradyne receiver. It is obtainable in any of the ranges given below, of which the 0-5 volt has been particularly specified for the Infradyne.

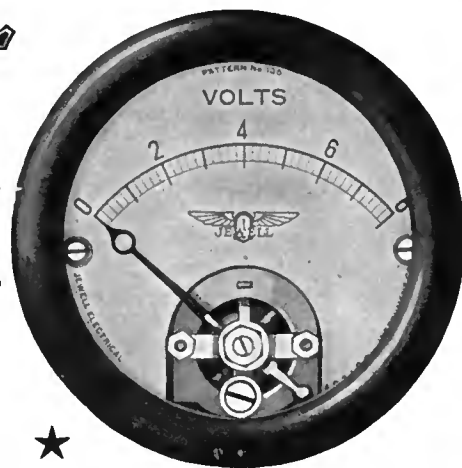

★  
Pattern No. 135 Panel Mounting Voltmeter (actual size) Ranges—  
0-5, 0-8 or 0-10 volts  
0-10, 15, 25, 50 or 100 milliamperes.

Ask your dealer for one of our new radio instrument catalogues, No. 15-C, which describes our many radio instruments in detail, or write to us direct for it.

**JEWELL ELECTRICAL INSTRUMENT CO.**

1650 Walnut Street

Chicago

26 Years Making Good Instruments

# SAIL AWAY AS A RADIO OPERATOR



**T**RAVEL to foreign shores as a radio operator and draw good pay while you see the world.

Radio operating is fascinating work. Excellent quarters and board, the ranking of a ship's officer, and shore leave in foreign ports are among the privileges accorded to the "op". The prominent radio positions held by our 8,000 graduates show the wonderful opportunities for advancement.

## RIA conducted by RCA

Radio Institute of America instruction is not surpassed anywhere. The Institute is conducted by RCA and, in addition to enjoying every advantage of the world's greatest radio organization, it has seventeen years' experience back of it.

## Study at home

A few months of study at home will qualify you to pass the U. S. Government Commercial Amateur or Broadcast License Examination and start on a successful radio career.

Send in the coupon. It will bring you a booklet filled with interesting information on license requirements and opportunities in the radio field. It outlines our courses in detail.

Radio Institute conducts a special technicians' course for radio dealers, jobbers and service men. Write for information.

Send this in

Radio Institute of America  
328 Broadway, New York City

Please send me your free booklet.

I am interested in the radio course which prepares for the Govt. Commercial, Broadcast or Amateur License.

I am interested in the technicians' course for jobbers, dealers and service men.

Name .....

Address .....

Radio Institute of America  
328 Broadway New York City

R325.1. DIRECTION FINDERS. DIRECTION  
*A Scientific Paper, Bureau of Standards, No. 525. FINDERS.*  
"A Uni-Control High-Frequency Radio Direction Finder," F. W. Dunmore.

The paper describes a direction finder, functioning on a 2100-kc. (143 meters) frequency, to be used on ships, especially Coast Guard patrol boats. The direction-finder coil consists of four turns of ignition cable wound on a 20-inch frame. It is installed over the pilot house and rotated from below. A tuning unit and coupling transformer have been designed so that the direction finder coil may be used on the ship's receiving set without changing its tuning adjustments, which are locked in the 2100-kc. position. A special form of automatic balancing condenser, operated by a special cam rotating with the direction-finder shaft, is incorporated in this instrument, whereby a clear minimum may be obtained at all angular positions of the coil without manual operation of the balancing condenser. The controls necessary when taking a bearing are thus reduced to one, i. e., that of rotating the direction finder coil to obtain the minimum signal.

R580. TELEVISION (OTHER APPLICATIONS TELEVISION, OF RADIO.)

*Radio News*, Sept., 1926. Pp. 206 ff.  
"Television, An Accomplished Fact," A. Dinsdale.

After a preliminary discussion covering the historical developments of television and some of its problems, the author describes the Baird System, which transmits images in one tenth of a second. The principle consists in rotating a disc carrying spirally-arranged lenses through which light passes, which, in turn, is collected by a light sensitive cell and converted into electromagnetic waves. The article is illustrated.

R344.5. ALTERNATING CURRENT SUPPLY POWERFORMER. *Radio News*, Sept., 1926. Pp. 240 ff.

"Powerformer Combines B Eliminator and Power Amplifier," D. E. Harnett.

In converting a.c. to d.c. for radio receiving set purposes, two things are needed—a rectifier, and a filter system. Various types of rectifiers may be used. Regarding filters, it must be remembered that d.c. is going through the circuit and this cannot be impeded by condensers in series or high-resistance coils. The load to a line supply device varies considerably, and must be taken into account. The circuit diagram, using a combination B eliminator and power amplifier, is presented and discussed. Detailed constructional information is to follow in a subsequent article.

R090. HISTORY OF RADIO. HISTORY.

*RADIO BROADCAST*, Oct., 1926. Pp. 471-473.  
"Is There a Monopoly in Radio?" F. Strother.

In this article the writer touches upon the various phases of the radio art as it was in the beginning, from the time that the principles of radio were discovered by Hertz and Branly. He continues with a discourse on how this art has carried on during the early period of development. Its rapid growth, and the great interest shown, has brought the inventors and their inventions in this new field into a tangle which, even to-day, is leading to numerous patent suits regarding infringements. It is stated that the conditions in which radio finds itself in Great Britain are vastly different than those here in the United States. In the former country Marconi controls practically the entire industry whereas, in America, the law provides for a patent monopoly but not a monopoly of patents. In subsequent articles the inventors, the inventions, the present patent situation, and also the business side of radio, will be discussed.

R343. ELECTRON-TUBE RECEIVING SETS. RECEIVER, RADIO BROADCAST. Oct., 1926. Pp. 479-482.

"How to Build the 'Equamatic' Five-Tube Receiver," Zeh Bouck.

Complete constructional details are given relative to the "Equamatic" receiver, in this case a five-tube set. With this system, by means of which the coupling between primary and secondary of the inductances is automatically varied when the capacity is changed, it is claimed that the maximum amount of energy is transferred at all frequencies of the receiving range without tube oscillation or distortion. A panel layout, circuit diagrams, and constructional details of the coils, are shown.

R344.5. ALTERNATING CURRENT SUPPLY. ELIMINATOR, RADIO BROADCAST. Oct., 1926. Pp. 485-489. A, B, C.

"An A, B, C Line Supply Device," B. F. Roland, and C. The author describes in detail the construction of an A, B, and C supply unit for connection to the a.c. circuit to be used with sets employing 100 type tubes. This is accomplished by means of the new Raytheon BH type rectifier, and auxiliary apparatus. Up to nine tubes may be supplied with energy from this layout. Voltages and currents furnished are given as follows: A Battery—60 milliamperes, 6 to 30 volts; B Battery—up to 25 milliamperes, 45, 90, and 200 volts; C Battery—from 0 to 50 volts. The parts recommended are standard and are readily obtainable.

R080. COLLECTIONS, TABLES, MISCELLANIES. STATIONS, *Wireless World*, London. Aug. 18, 1926. List of, Pp. 221-222.

"Short-Wave Transmissions."

A list of short-wave transmitting stations of the world, both telegraph and telephone, between 23,076 and 2000 kc. (13 to 150 meters) is given. The information includes call letters and either the owner or location of each station.

R346. RADIO TELEPHONE SETS. TRANSMITTER-RECEIVER, *Wireless World*, London. Aug. 25, 1926. COMBINATION, Pp. 247-248.

"Low-Power Transmitter-Receiver," F. J. Haynes.

A combination transmitter and receiver in one set, is described. The same tubes are used for the two purposes, namely, receiving and transmitting. The grid and the plate connections are switched over in order to make the change. Complete constructional details and the method of operation, are given, together with a panel layout and photographs. The transmitter here described is tuned to 3333 kc. (90 meters), the range being conservatively estimated at from 10 to 20 miles.

## ACME FLEXIBLE CELATSITE

Flexible, stranded wire for point-to-point and sub-panel wiring. Non-inflammable "spaghetti" covering. In black, yellow, green, red and brown; a color for each circuit. Put up in 25-foot coils.



### The Original Celatsite

—a tinned, copper bus bar wire with non-inflammable "spaghetti" covering, for hook-ups. 5 colors; 30-inch lengths.

### Celatsite Battery Cable

—a silk-covered cable of vari-covered Flexible Celatsite wires, for connecting batteries to set.



Prevents "blowing" of tubes; gives your set an orderly appearance.

We also offer the highest grade of "spaghetti" tubing for Nos. 10 to 18 wires. 5 colors; 30-inch lengths.

### Stranded Enameled Antenna

Best outdoor antenna you can buy. 7 strands of enameled copper wire; maximum surface for reception. Prevents corrosion and consequent weak signals.



Send for folder

THE ACME WIRE CO., DEPT. B  
NEW HAVEN, CONN.

## ACME WIRE

MAKES BETTER RADIO



Why  
your set  
needs

## AMPERITE

Because clear reception and long tube life necessitate that delicate and self-adjustable control which only AMPERITE can give.

Eliminates hand rheostats.  
Simplifies set-wiring.

Accepted as the only perfect filament control in every popular construction set.

Price \$1.10 Complete

FREE—Write for "The Radiall Book," containing the latest popular hook-ups and construction data, to Dept. R.B. 12.

Radiall Company

50 FRANKLIN ST., NEW YORK

## AMPERITE

REG. U.S. PAT. OFF.

The "SELF-ADJUSTING" Rheostat

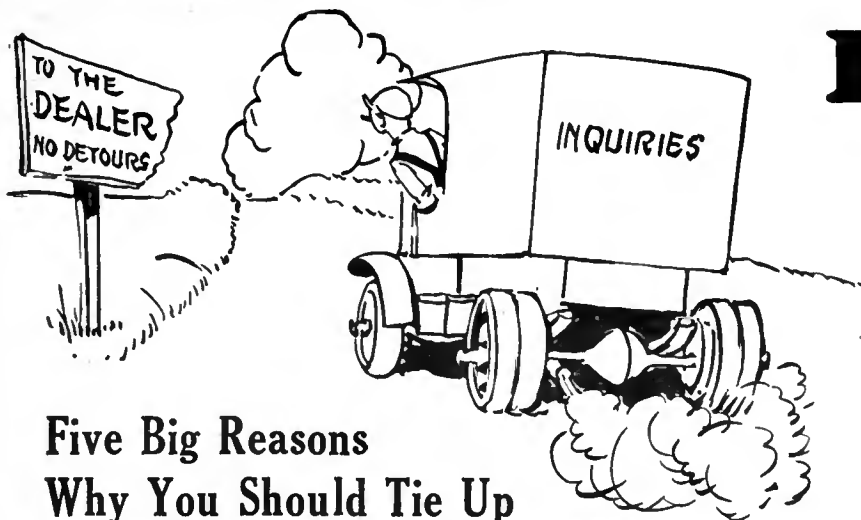

# HOMMEL *never* RETAILS

STRICT adherence to this fundamental Hommel policy over a period of many years has established the "House of Hommel" into the abiding confidence of thousands of radio dealers all over the country.

Hommel's liberal and consistent national advertising acts as a constant sales stimulant that keeps dealers' stocks constantly on the move.

All inquiries, resulting from Hommel's national advertising, are promptly turned over to Hommel dealers—exemplifying the highest type of jobber loyalty and co-operation a dealer can enjoy.

If you like a fair and square jobber connection—tie up with Hommel—the wholesaler who never retails.

Write to-day for the Hommel Catalogue—27-B.

## Five Big Reasons Why You Should Tie Up with "THE HOUSE OF HOMMEL"

1. Unexcelled Dealer co-operation.
2. Ample Stocks at all times.
3. Wholesales Exclusively.
4. Dealers' Repair and Inspection Department.
5. Modern Display Room Facilities.

WHOLESALE

EXCLUSIVELY

# LUDWIG HOMMEL & CO

929 PENN AVENUE



PITTSBURGH, PA.

Improve the Tone  
of Your Set  
with a



## KELFORD 3 Stage Resistance-Coupled AMPLIFIER

Improves Tone \$8.00  
Increases Volume  
Perfects Clarity

Bakelite form with all connections and wiring concealed. Completely equipped with resistances and condensers; all metal parts highly nickel plated. Equipped with the famous Kelford "Cushion" Sockets. Can be used with all circuits to increase volume and clarity.

At Your Dealers

If he cannot supply you, send purchase price and we will forward one postpaid. Money back if not satisfied.

THE AMERICAN SPECIALTY CO.  
Bridgeport Connecticut



IT HOWLS

Now it doesn't!

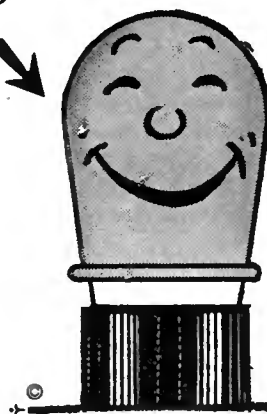

## Mc DONALD HOWL ARRESTER

"It Stops that Howl!"

Slip one of these live rubber jackets over each trouble-making tube . . . and the Howl stops.

Remember the name! You can get it for every size tube. It sells for 75c each. Just ask your dealer, or write.

Sole Selling Agents for the U. S. A.

SPARTAN ELECTRIC CORPORATION  
350 West 34th Street, New York City

Manufactured in the U. S. A., by the  
SCIENTIFIC PRODUCTS CANADA, LTD.

"It Stops that Howl!"





# A New and Advanced Model— Norden-Hauck Super-10 Highest Class Receiver in the World

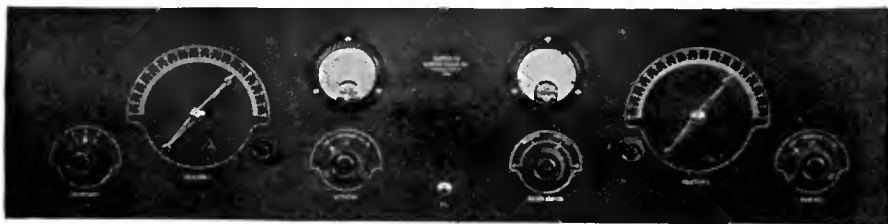

Panel Size: 36" x 9" x 1-4"

Weight: 55 lbs.

**T**HE NORDEN-HAUCK SUPER-10 is an entirely new and advanced design of Receiver, representing what we believe to be the finest expression of Modern Radio Research Engineering. It is the product of years of experience devoted exclusively to the attainment of an ideal Broadcast Receiver—regardless of cost. Results obtained in every respect will upset all your previous ideas of good radio reception. Here are only a few of the host of features that place the NORDEN-HAUCK SUPER-10 far in advance of competition:

- 10 tubes employed to give perfect reproduction with unlimited range and volume power.
- Super selectivity on all wave lengths.
- Built to Navy Standards.
- Wide wave length range without change of coils, etc. (Adaptable 35 meters in 3600 meters if desired.)
- Use Loop or Antenna.
- Simple to operate, having only two major tuning controls.
- No harmonics. Signals are received only at one point.
- Special Power Audio Amplifier, operating any loudspeaker and eliminates necessity of external amplifier.
- Can be operated directly from house current if used with NORDEN-HAUCK POWER UNIT AB-2.

The NORDEN-HAUCK SUPER-10 is available completely constructed and laboratory tested, or we shall be glad to supply the complete engineering data, construction blue prints, etc., for those desiring to build their own receiver.

TEAR OFF AND MAIL TODAY

NORDEN-HAUCK, Inc., Philadelphia, U. S. A.

Gentlemen:—

- Please send me without cost or obligation on my part, attractive illustrated literature describing the new Norden-Hauck Super-10.
- I enclose \$2.00 for which please send me, postpaid, complete full size constructional drawings and all data for building the Super-10.

Name .....

Address .....

**Upon Request** A complete catalog attractively illustrated, will be gladly mailed without charge, or full size constructional blue prints, showing all electrical and mechanical data, will be promptly mailed postpaid upon receipt of \$2.00

Write, Telegraph or Cable Direct to

**NORDEN-HAUCK**

Incorporated

ENGINEERS—MARINE BUILDING  
Philadelphia, U. S. A.

# QUALITY BEYOND BELIEF WITH POWERIZER

Reg.

Combined "B" Eliminator  
and Power Amplifier

POWERIZED radio reception is so true—so faithful, that the radio entertainers are literally transported into your own home. Such remarkable reception up to this time has been offered only in the most expensive new Super-Power sets. Now YOU can have it by merely attaching a Powerizer to your present set, at the cost of a "B" eliminator alone. Ask the nearest Powerizer dealer to demonstrate it TODAY.

RADIO RECEPTOR CO.  
106 Seventh Ave. New York

Price  
\$49.50

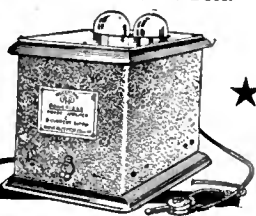

IT DELIVERS  
FULL "B" VOLTAGE

**Burns** ★

B-Battery Eliminator

Operates from lighting current like other household appliances. No hum or vibrations. Smooth constant plate supply. Once connected it requires no further attention or adjustment. Remarkable results on local and long distance reception.

Popular Price—Write for Data

American Electric Company

State and 64th Streets Chicago, U. S. A.  
Makers of Burns Speakers

R131. CHARACTERISTIC CURVES; VACUUM TUBE GENERAL PROPERTIES. CHARACTERISTICS. RADIO BROADCAST Oct., 1926. Pp. 499-503 "How to Measure Your Own Tubes," K. Henney. Information is given on how to find the important constants of various tubes used in receiving sets. A voltmeter and a milliammeter are the only two instruments considered necessary in order to record the data presented in the accompanying charts and the tables.

R148. MODULATION. MODULATION. RADIO BROADCAST. Oct., 1926. Pp. 507-508. "Modulator Plate Current Variation," C. Dreher. In the twelfth article of a series dealing with the operation of broadcasting stations, the question of d.c. plate current variation, when an audio frequency amplifier is used for modulating, is discussed. The author arrives at the conclusion that, if absolute distortionless amplification is to be obtained, it is essential that no variation occur in the d.c. current of the plate circuit of the modulator tube.

R000. HISTORY. HISTORY OF RADIO BROADCAST. Oct., 1926. Pp. 510-513. "He Gave a Lusty Voice to Radio," M. May. STRONG. The history of the regenerative, the super-heterodyne, and the super-regenerative circuits, and of the man who claims to be their discoverer, is interestingly recounted.

R376.3. LOUD SPEAKING REPRODUCERS. LOUD SPEAKERS RADIO BROADCAST. Oct., 1926. Pp. 514-516. "Cone Loud Speakers," C. L. Farrand. This article, presented before the Radio Club of America, tells of the development of the cone type loud speaker. It is stated that three conditions must be met in order to have true conversion of sound energy to electrical energy, or vice versa; namely, provision of a surface in the front of the sound wave which will move in accordance with the sound wave; adaptation of this surface to control an electric or magnetic field; arrangement of the field so it can be utilized for the production of the necessary voice currents. The requirements of a good horn are also mentioned.

R113.5. METEOROLOGICAL. METEOROLOGY. Popular Radio. Sept., 1926. Pp. 415ff. "Foretelling Radio Reception from the Weather Map," B. Dashiell. The problem of trying to predict conditions of radio reception from weather maps and other information, has been one of a guessing nature rather than one of accuracy. However, as explained by the author, some things are known about this important problem and, to some extent, predictions can be made which are fairly reliable. Static, due to atmospheric disturbances in the troposphere, or lower atmosphere, is considered one of the worst disturbers of radio programs. Barometric pressure changes may account for considerable fading of signals. More data concerning "highs" and "lows," together with changes in humidity and location of isobars in connection with variations of radio signals, will undoubtedly aid materially in obtaining definite knowledge concerning many of our present radio troubles.

R342.4. IMPEDANCE COUPLING. AMPLIFIERS, Popular Radio. Sept., 1926. Pp. 418ff. Impedance. "How to Build an Impedance-Coupled Amplifier," L. M. Cockaday. Minute constructional details are presented for a receiver of the impedance-coupled type, using three stages of amplification and a filter choke in the output of the last stage.

R800. (537.65). PIEZO-ELECTRIC PHENOMENA. QUARTZ CRYSTALS. Popular Radio. Sept., 1926. Pp. 421 ff. "A Radiant Crystal Pilot." A new method of using quartz crystals to accurately determine frequencies is found in the glowing crystal tube. The tubes contain a vapor surrounding a quartz crystal and mounting which causes the tube to glow with an orange-red color when exact resonance is established in a circuit which is coupled to it inductively. Several tubes are mounted in a row, each one tuned to a period just a little different from the next.

R383. RESISTORS. FILAMENT RESISTORS. Popular Radio. Sept., 1926. Pp. 424 ff. "How to Simplify Your Set with Automatic Filament Controls," K. Humphrey. A method of measuring the relative characteristics of automatic filament current-control devices, and the results obtained, are outlined. These devices usually consist of some metal which has a positive resistance coefficient to temperature changes, so that when more current than necessary passes through the circuit, the higher temperature of the metal causes the resistance to increase, and this, in turn, decreases the current automatically.

R134.75. SUPER-HETERODYNE ACTION. OSCILLATORS IN RADIO. Sept., 1926. Pp. 33-34. SUPER-HETERODYNES. "Super-Heterodyne Oscillators," G. M. Best. This discussion pertains to the oscillator tube and circuit used in the super-heterodyne receiver. The requirements to be met in a receiver of this type are that the circuit be able to tune over a frequency band from 545 to 1500 kilocycles, be free from harmonics, and have an oscillator condenser which can be controlled without trouble from body capacity effects. Diagrams of the four most popular oscillator circuits are discussed separately. These circuits may be used for other purposes, as stated.

R140. RADIO CIRCUITS. OSCILLATIONS IN TUNED CIRCUITS. Radio. Sept., 1926. Pp. 31 ff. "Tuned Radio Frequency," L. W. Hatry. Several methods employed to control oscillations in a radio-frequency amplifier are analyzed. The lossier methods include the use of the potentiometer in the grid circuit; also the connection of the grid return to the negative filament. The neutrodyne control overcomes oscillations by neutralizing parasitic capacities. Of these, Hazeltine contributed the method shown in Fig. 3A, where voltages are balanced against each other with coupling to the plate coil. The Rice method does the same thing only couples to the grid coil. The Browning-Drake circuit attempts the problem by reducing the effective coupling between the primary and secondary of the transformer.

## There is One Best Way

Jones MULTI-PLUG, the Standard Set Connector, is illustrated below in its various models. To-day the discriminating buyer chooses a set MULTI-PLUG equipped or immediately equips his own set with the MULTI-PLUG because it affords greater simplicity, safety and more convenience than any other method used to connect the radio receiver with the current supply.



Type P. M. is mounted right in the panel. Plug leads go to batteries, ground and aerial. New low price; 4 ft. cable, \$3.00.

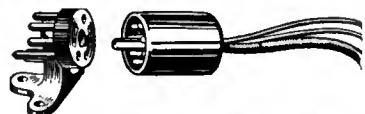

Type B. M. is mounted on the base and wires are soldered to back of socket posts; no binding posts are necessary. 4 ft. cable, \$3.50.

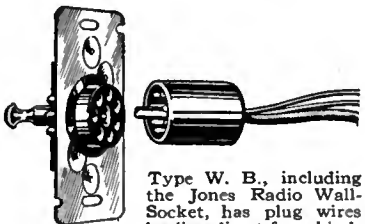

Type W. B., including the Jones Radio Wall-Socket, has plug wires leading direct from binding posts; plug goes into wall socket. Wall socket is connected with hidden batteries, ground and aerial. Adapted to any set. 4 ft. cable, \$3.50.



Type B. P. is adapted to any set. The wires from the socket lead to the binding post, while the wires from the plug lead to the batteries, ground and aerial. 4 ft. cable, \$4.00.



Double Plug Cable is used when both set and current supply are equipped with Jones Sockets. 6½ ft. cable, \$5.00.

Consider the MULTI-PLUG in your Karas Equamatic Set, as specified by the designers

**HOWARD B. JONES**  
618 S. Canal St. Chicago, Ill.

### BROADCASTING FROM THE INSIDE

EVERY month in RADIO BROADCAST appears the department, "As the Broadcaster Sees It," written by Carl Dreher, one of the best known broadcast engineers in the country. Alive with humor, news, apt and searching comment, Mr. Dreher's writings have become one of the most popular features of radio writing anywhere. Are you reading it? Subscribe by the year and make sure of not missing a single issue. Mail your check for \$4.00 to Subscription Department, Doubleday, Page & Co., Garden City, N. Y.

**American RADIO** Now—  
**50% DISCOUNT ON RADIO!**  
BIG NEW 1927 CATALOG-FREE  
Dealers, Agents, Set Builders—get our big 1927 Catalog—225 nationally advertised lines. Lowest prices in America! Largest, most complete stock. Radio's latest developments. It's FREE—send for your copy now.  
**AMERICAN AUTO & RADIO MFG. CO., Inc.**  
1485 McGee Street, Kansas City, Mo.

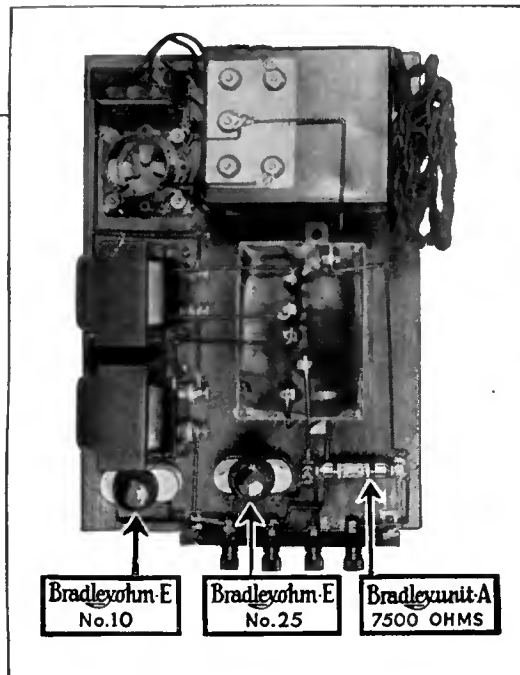

## What a whale of a difference a few Bradleyohms make — in a B-Eliminator!



### Bradleyohm-E

For B-eliminator service requiring wide voltage control, Bradleyohm-E is essential. It is an oversize Bradleyohm with sufficient capacity to handle all normal B-eliminator requirements. Be sure to ask for Bradleyohm-E in the checkered carton. Your dealer can get them for you.



### Bradleyunit-A

This solid, molded, fixed resistor has no glass or hermetic sealing in its construction. It is a solid unit with silver-plated end caps that are not affected by temperature, moisture and age. By all means, use Bradleyunit-A when you need a fixed resistor.

MAGAZINES and newspapers have been publishing circuits and instructions for assembling B-eliminators. Many types of kits have been used, but the outstanding feature has been the almost unanimous recommendation to use Bradleyohm-E for plate voltage control and Bradleyunit-A for the fixed resistor.

The leading manufacturers of B-eliminators have long since adopted Allen-Bradley variable and fixed resistors as standard equipment for their B-eliminators. In fact, the Bradleyohm-E has become almost as universally used in Raytheon tube B-eliminators as the Raytheon tube itself. The scientifically-treated graphite discs in these remarkable units have never been equaled for silent, stepless plate voltage control so essential for the satisfactory operation of a radio set with a B-eliminator.

When you build your B-eliminator, always insist that Bradleyohm-E and Bradleyunit-A are included with kit. You then will be assured of perfect voltage control. Send for folder "How to Build a B-eliminator" describing seven popular hookups.

**ALLEN-BRADLEY CO.**  
278 Greenfield Ave. :: Milwaukee, Wis.

★ Use  
**Allen-Bradley**  
Perfect Radio Devices





## A Beautiful Loop That's Remarkably Efficient

THE current popular requirement for a beautiful, compact loop that is highly efficient is met perfectly by the Bodine De Luxe Loop. The beautifully proportioned hand rubbed walnut frame of this attractive loop improves the most tastefully furnished room. The De Luxe Loop is but 12 x 26 inches over-all, yet its outstanding efficiency is remarkable. By tuning out interferences and reduction of static this efficient loop materially improves tone quality. Designed for loop sets, but can be used with many aerial sets. Price, Bodine De Luxe loop all models \$12.00.

## Bodine Folding Loop

Simple, compact, and very efficient. This remarkable loop is a great favorite with owners of loop sets. Basket weave winding improves efficiency. Wire is especially designed to avoid stretching, and holds its shape under long service. Price, Bodine folding loop \$8.50 to \$10.00.

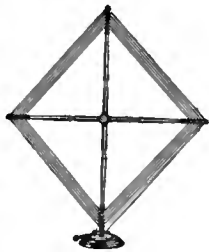

## About Twin-Eight Coils

Reliable Radio Laboratories, Escanaba, Michigan, writes: "We have decided to use Bodine Twin-Eight Coils in our sets for the following reasons:

"They are more uniform than any other. Their actual output of amplification is higher than any of the other coils used in comparative tests. They have practically no interinductance between stages even when placed very close together—in fact at a space where circular coils begin to show interinductance. They handle extremely well in any circuit. They can be used easily in circuits where any other coils—that we know of—will not work at all."



The opinion of Reliable Radio Laboratories is based on extensive comparative tests and should be of great practical value to set builders. Order Twin-Eight Coils from your dealer today. Price, \$2.00 per coil—three matched coils \$6.00.

Mail the Coupon ★

BODINE ELECTRIC COMPANY,  
2246 West Ohio Street,  
Chicago, Illinois.

Kindly mail FREE circular describing:  
Bodine Radio Loops.  
How to use a loop with aerial receiver.  
How to build the Bodine Twin-Eight Receiver.

Name \_\_\_\_\_  
Address \_\_\_\_\_

R343.5. ELECTRON-TUBE RECEIVING SETS. RECEIVER, Radio, Sept., 1926. Pp. 18 ff. *Infradyne.*  
"More About the Infradyne," E. M. Sargent.

As a supplementary discussion on the Infradyne circuit (Aug., 1926. Pp. 11 ff.), reasons are given for selecting the wavelength of 86 meters (a frequency of 3486 kc.) for the amplifier circuit instead of using some lower value. Suggestions are also presented concerning the arrangement of the parts of the set, the circuit of Fig. 1 being given for a more detailed discussion concerning this point. The size of the antenna is supposed to determine selectivity and sensitivity to a great extent.

R321.5. DIRECTION-FINDERS. DIRECTION FINDERS. Radio, Sept., 1926. Pp. 19 ff.  
"An Accurate Direction Finder," W. H. Stirling.

A direction finder which eliminates doubtful minimum bearing, 180-degree ambiguity, and lack of definite indication of bearing, has been developed by the Federal Telegraph Company, for the Chief Radio Supervisor. It covers a range from 90 to 750 meters (3330 to 400 kc.). The circuit arrangement shows the method of hook-up. A discussion on the construction of a similar direction finder, and details for using it, are given.

R132.3. RESISTANCE COUPLING. DISTORTION IN RESISTANCE COUPLING. Radio, Sept., 1926. Pp. 25-26.  
"Distortion in Resistance-Coupled Amplifiers," J. Anderson.

Contrary to much published information on resistance coupling, this method of amplification will introduce distortion if proper selection of parts, such as condensers and resistances, is not made. This happens in the circuit because it is not entirely resistive, but has reactance, due to the coupling condensers. The equivalent circuits and the curves show the distortion effect, a mathematical discussion of the principle involved also being presented.

R380. PARTS OF CIRCUITS: INSTRUMENTS. TESTING INSTRUMENT. Radio, Sept., 1926. Pp. 27-28.  
"A Portable All-Purpose Testing Instrument," E. E. Griffin.

The construction and the use of a special type of test instrument for use with radio receivers in general, is described. It consists of a Weston 0-5 milliammeter, and a Weston bi-polar switch, together with a tube socket, plugs, and resistances, all assembled in a portable case. Instructions for operating the outfit are given, as also is the circuit diagram.

R440. REMOTE CONTROL (BY WIRE). REMOTE CONTROL QST. Sept., 1926. Pp. 9-13. AND BREAK-IN SYSTEM.

"Break-In and Remote Control," J. M. Clayton. For fast and reliable handling of messages, the writer recommends adapting the break-in system, here described, to all amateur c.w. and i.c.w. stations. It is stated that the break-in system can be used on all waves. A separate antenna for transmitter and receiver, the latter not tuned to the transmitter, will guard against burn-outs in the grid leak or the tube. A relay key is described. It is recommended that, in order to avoid key thumps, the circuit be broken both in the grid and in the primary of the plate transformer. This will prevent all oscillations in the transmitter.

Having the transmitter remotely controlled also is of advantage in locating it properly with respect to the aerial, and the receiver can be used continuously. Several methods of remote control, five-wire, three-wire, and two-wire, are outlined.

R351. SIMPLE OSCILLATORS. OSCILLATORS. QST. Aug., 1926, pp. 36-37.  
"A Grid-Meter Driver," W. A. Hoffman.

An oscillator capable of setting up persistent oscillations at all possible adjustments of the constants making up the radio frequency circuit, is shown. The range covered with the five coils described falls between 25,000 and 375 kc. (12 meters to 800 meters). Several applications of this particular driver are appended.

R113.4. IONIZATION; HEAVISIDE LAYER. HEAVISIDE LAYER. Proc. I. R. E. Aug., 1926, pp. 521-540.

"Relation Between the Height of the Kennelly-Heaviside Layer and High Frequency Radio Transmission Phenomena," A. Hoyt Taylor.

The author presents data, accumulated during a long period of observations, relative to skip distances and height of the Kennelly-Heaviside layer when transmitting on very short wavelengths. From the data and the graphs, it would seem that experimental facts coincide with the theoretical calculations published in a previous paper. (*Physical Review*, January, 1926).

R070. EDUCATION; TRAINING. EDUCATION. Proc. I. R. E. Aug., 1926, pp. 431-439.

"Collegiate Training for the Radio Engineering Field," C. M. Jansky, Jr.

Scientific development is classified as: First, that which increases our knowledge of fundamental physical phenomena second, that which applies these phenomena to practical apparatus and equipment. The former falls into the field of physics and the latter into the field of electrical engineering. Again, electrical engineering is divided into: First, power engineering and, second, into communication engineering.

Physics and mathematics are considered fundamental requirements for courses in engineering. This more or less abstract training should be supplemented by drawing practical illustrations and problems from all the various fields of engineering, not primarily from the power field. Thus for a radio engineer, practical problems should be taken from the radio engineering field, he likewise being brought into contact with the problems actually involved. In this way he will become more or less acquainted with the field he desires to specialize in.

## Another Tube Article

Keith Henny is preparing another of his tube articles for publication in an early issue of RADIO BROADCAST. It will be all about special-purpose tubes, such as those now available for r. f., detector, high-Mu, and output stages.

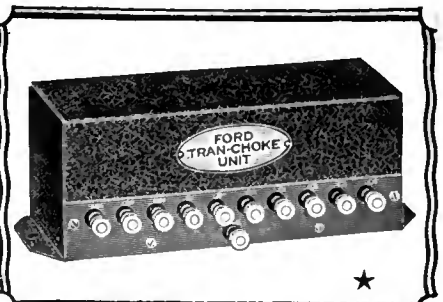

## FORD-TRAN-CHOKE UNIT

A combination of transformer and chokes completely shielded in one unit

For Building The

## RAYTHEON POWER SUPPLY

Each unit is supplied with a Raytheon tube.

Write for Complete Literature

Authorized Distributors

S. D. Darmstadter, Chicago  
E. P. Denham, Seattle, Wash.  
Gray Sales Co., Philadelphia, Pa.  
Jamec C. Pope, Jr., Minneapolis  
Industrial Sales Co., San Francisco

## FORD RADIO & MICA CORP.

111-113 Bleeker St. New York City

## Full-Sized Blue-Prints

of the Browning-Drake Receiver described in the September issue of RADIO BROADCAST makes its construction extremely simple. The receiver combines a stage of tuned, neutralized radio frequency amplification employing a type 100 tube, a regenerative detector and three stages of impedance-coupled audio frequency amplification. High-mu and power tubes are used. This is one of the best receivers of the year. Obtain your copy of the full-sized blue-prints complete with instruction book by mailing remittance of One Dollar to

RADIO BROADCAST Magazine  
Book Dept. Garden City, N. Y.

## Complete parts to build New Improved Impedance Coupled BROWNING-DRAKE RECEIVER

Similar to that described in  
September  
—Radio Broadcast—

Every part finest quality  
obtainable

Price \$56.00

(Not including cabinet)

KELVIN-WHITE CO.  
112 State St. Boston  
Specialists in Browning-Drake Receivers  
Complete particulars on request



# TROUBADOUR



Drum Type \$30.00

just as the amorous nobles of old Spain, France and Italy enraptured a continent with their hauntingly beautiful music and poetry . . . so has the marvelous reproduction of THE TROUBADOUR impressed itself upon the Radio World of to-day.

It is Music and Song and Poetry unaltered, undistorted . . . true. Distinctively artistic in design, body finished in rich walnut brown, base and faces in dull black Morocco leather finish. Troubadour's weight of 11 pounds is absolute assurance against vibration, while Quali-Tone construction along advanced lines results in a new quality of reproduction that amazes listeners by its depth, resonance and purity.

Height 16 1/2". Diameter 13 1/2". Depth 5 1/2".

Send for literature on Quali-Tone's complete line, which includes Junior Speaker \$7.50, Quali-Tone No. 2 Speaker \$10, Quali-Tone No. 3 Speaker \$15, Quali-Tone No. 4 Speaker \$25, Quali-Tone Radio Units \$6 and \$7.50.

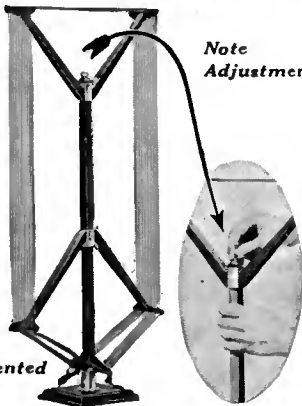

Note Adjustment!

Patented

## 8000 MILE RECORD

The Quali-Tone Loop pictured above holds two World's Records for distant reception, having brought in stations 8000 miles away. Write for verification of these records. Exclusive Thumbscrew Adjustment keeps wires taut always. Guaranteed to improve the performance of any receiver. Price . . . . . \$10

DEALERS—Write for discounts—JOBBER'S  
Send for circulars

DURO METAL PRODUCTS CO. Chicago  
2657 N. Kildare Ave.

### Next Month

A Two-Tube R. B. "Lab" Circuit with Power Amplifier and "B" Supply.  
A New All-Shielded Model of Striking Design and Performance in the January RADIO BROADCAST.

# AUDIO FREE AMPLIFICATION

The four types thoroughly explained in a fully illustrated booklet 9 x 12".  
This booklet will be sent to you absolutely FREE if you will send me six cents in stamps to cover cost of handling and postage.

W. McMANN

64 Church St. Dept. R.B. New York City

# These Automatic Switches at \$2.00 to \$3.75

WITH the completion of the "Convenience Model" of the Reliable Automatic Control Switch, set owners may now have their choice of two types of automatic switches at prices ranging from \$2.00 to \$3.75. It is no longer necessary to pay more for this new radio necessity.

Either type switch will make the A Battery switch on your receiving set, automatically turn on and off, either or both the Trickle Charger and B Eliminator as required.

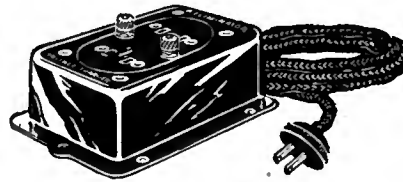

\$3.50

### Convenience Types

**Model 23**—Complete with cord and plug and receptacles for connection with Trickle Charger and B Eliminator. This model is for receiving sets using 3 to 8 type 201-A tubes or their

equivalent in amperage drain. Retail at \$3.50.

**Model 24**—Same construction as Model 23 but is intended for use with sets using from 5 to 10 type 199 tubes or their equivalent in amperage drain. Retail at \$3.75.

### Utility Types

**Model 13**—This model is identical electrically with Model 23 except that it is without cord and plug. Connections are easily made to binding posts. Retail at \$2.00.

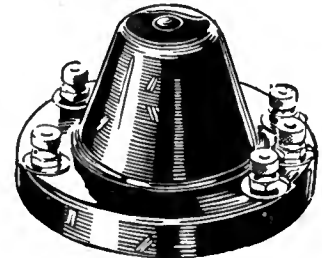

\$2.00

**Model 14**—This model is identical electrically with Model 24 except that it is without cord and plug. Connections easily made to binding posts. Intended for use with sets using from 5 to 10 type 199 tubes or their equivalent. Retail at \$2.50.

Ask the nearest radio dealer to show you these newest necessities of radio, or if he cannot take care of you, order direct, giving dealer's name on the coupon below.

THE RELIABLE PARTS MANUFACTURING CO.  
2831 Prospect Avenue Cleveland, Ohio

# Reliable Automatic Power Control Switch

Reliable Parts Mfg. Co.  
Cleveland, Ohio

I would like to have one of your Reliable Automatic Switches.

\$2.00	\$2.50	\$3.50	\$3.75
No. 13	No. 14	No. 23	No. 24

My Dealer is \_\_\_\_\_

My Name \_\_\_\_\_ My Address \_\_\_\_\_

Fully guaranteed. Money returned if unsatisfactory for any reason. Sent C. O. D. if desired.

More Power!



★  
Type 200A

# POWER DETECTOR

**P**OWER—and more of it—that's the biggest thing in the tube field today! Sonatron's famous power tubes are giving new life to thousands of sets—and new enjoyment to thousands of set owners. The very next thing you should do is to buy this remarkable power detector—and hear the amazing improvement in reception which it brings! It's one of a family of 25 distinct types—the world's largest tube line!

SONATRON-ize your set!

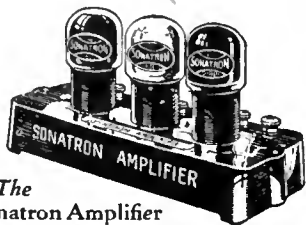

The Sonatron Amplifier with 3 Red, White and Blue Matched Power Tubes

Adds three stages of amplification to any set, even a crystal. One connection, made in a moment, and you have this source of amazing power and tone. Adds beauty to your set, and makes your batteries last longer. For dry-cell or storage battery sets, \$20 complete. At your dealer's.

SONATRON TUBE CO., Chicago, New York, Newark, N. J., Detroit, Windsor, Ont., Canada

# SONATRON

Nationally Advertiser SONATRON Standard Quality Trade Mark

Manufacturers of the WORLD'S LARGEST TUBE LINE

## THE "RADIO BROADCAST" INFORMATION SERVICE

How to Write for Technical Information—The Scope of This Service

**A**S WAS announced in the June RADIO BROADCAST, all questions which were formerly sent to "The Grid" will now be handled by the Technical Information Service, RADIO BROADCAST Laboratory. That service is maintained under the following rules:

1. All questions from subscribers to RADIO BROADCAST will be answered free of charge.
2. Non-subscribers to RADIO BROADCAST will be charged a fee of One Dollar for the Laboratory Technical Service.
3. All questions will be answered by mail and none will be published in RADIO BROADCAST. The Technical Information Service of the Laboratory feels that it is important to define the scope of its service to readers. Although the Service is of very general help to our readers, there are certain demands which can not be met.

The Technical Information Service:

1. Cannot make comparisons between various kinds of receivers or manufactured apparatus.
2. Wiring diagrams of manufactured receivers cannot be supplied. This information can be secured from the various manufacturers.
3. Complete information cannot be given about sets described in other publications, but in all cases (wherever possible), inquirers will be referred to a source of information where the data can be obtained. In this connection, the monthly department in RADIO BROADCAST "The Best in Current Radio Publications" should be of great help, and should be consulted. That department records the most important constructional, technical, and general radio articles which appear.
4. Special receivers or circuits cannot be designed by the Technical Service.
5. Those who ask questions which cannot be answered in the scope of a letter will be referred, if possible, to sources where the information can be obtained.

Readers who help by complying with the simple rules of the Information Service will greatly aid us in sending them a complete, accurate and speedy reply to their questions.

### TECHNICAL INFORMATION INQUIRY BLANK

Technical Service, RADIO BROADCAST Laboratory, Garden City, New York

GENTLEMEN:

Please give me fullest information on the attached questions. I enclose a stamped addressed envelope.

I am a subscriber to RADIO BROADCAST, and therefore will receive this information free of charge.

I am not a subscriber and enclose \$1 to cover cost of the answer.

Name.....

Address.....

R. B. D.

### The Shielded Dual-Control Receiver

**T**HROUGH an unfortunate error, improper TC bias was specified in the article on "A Shielded Dual-Control Receiver" which appeared in the October RADIO BROADCAST. On page 498 it is stated that a small 22½-volt B battery should be used as C bias when the plate voltage is supplied from four 45-volt batteries. This should read three 45-volt B batteries, and, if four are used, the proper bias will be 40.5 volts.

## COMPLETE \$25.00 WITH TUBE



### ★ GEORGE ELECTRIC COMPANY "B POWER UNIT" TYPE "M" ★

Delivers the proper voltage at all times without a trace of a hum. Sturdily constructed to last as long as the best radio set. Its fine appearance will add to the beauty of your receiver.

A full wave rectifier tube is used—no filament to burn out. Three taps with two variable resistances permit complete control of both detector and amplifier voltages up to 180 volts. This gives ample power for any set on the market.

A George Electric Company "B" POWER UNIT will remove all your "B" worries.

### LOWER PRICE HIGHER QUALITY POSITIVE GUARANTEE

Sold direct from the factory to you, or through our authorized representatives. Write for complete information. Shipped prepaid on receipt of \$25.00 or C. O. D. \$25.00 plus postage.

GEORGE ELECTRIC COMPANY  
751 Carleton Ave. St. Paul, Minn.  
Representatives Wanted

Why not subscribe to *Radio Broadcast*? By the year only \$4.00; or two years, \$6.00, saving \$2.40. Send direct to Doubleday, Page & Company, Garden City, New York.

## Potter Condensers

Build the best—

- Socket Power Devices
- A and B Supply Devices
- Power Amplifiers
- Impedance Amplifiers

And are best—

- For Filter Uses
- Rectifiers
- By Pass
- Blocking D. C.

American made of best of materials to full capacity. All sizes and types. ★

POTTER MFG. CO.  
North Chicago, Ill.

**GREATER DISTANCE  
FINER SELECTIVITY  
GREATER POWER**

with

**AERO COIL**  
SUPER-SENSITIVE

INDUCTANCE UNITS

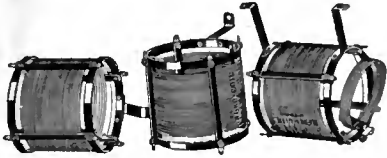

**Tuned Radio Frequency Kit**

\$12.00

The Aero Coil Tuned Radio Frequency Kit illustrated above will positively improve the performance of any receiver. Patented Aero Coil construction eliminates radio frequency losses and brings tremendous improvement in volume, tone and selectivity.

Kit consists of three matched units. The antenna coupler has variable primary. Uses .00035 condenser. 8 page color circuit, layout and instruction sheet for building the supersensitive 5 tube Aero-Dyne receiver packed FREE with each kit. Extra copies, 75c each.

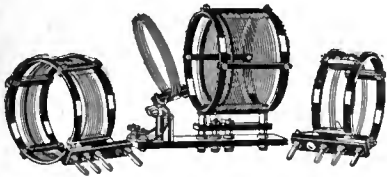

**Low Wave Tuner Kit**

\$12.50

Completely interchangeable. Adapted by experts and amateurs. Range 15 to 130 meters. Includes three coils and base mounting, covering U. S. bands, 20, 40 and 80 meters. You can increase the range of this short wave tuner by securing coils No. 4 and 5. Combined range of 15 to 550 meters. Both interchangeable coils fit same base supplied with short wave kit and use the same condensers. Coil No. 4, price \$4.00; Coil No. 5 price \$4.00.

*These Aero Coils are available at your dealers. Get yours today!*

**AERO PRODUCTS, Inc. ★**

Dept. 109

1772 Wilson Ave.

Chicago, Ill.

**Bradleystat**

PERFECT FILAMENT CONTROL



Provides complete noiseless filament control for all radio tubes without change of connections. Metal parts are nickel plated. One hole mounting. Self contained switch opens battery circuit when desired.

**Allen-Bradley Co.**

Electric Controlling Apparatus

278 Greenfield Avenue Milwaukee, Wis.



*The* **Brach-CONTROLIT**  
A WORTH WHILE GIFT

**R**ADIO devotees will be glad to get a Brach Controlit on Christmas morning. Controlit is new. It's novel. It's different. It is something that will add enormously to the enjoyment of radio.

Adding a Controlit to any set eliminates ALL switches from "B" Battery Substitute and Trickle Charger and places complete automatic control of set and power supply in one switch — the SET SWITCH itself.

It is the gift of gifts to owners of radio sets.

It should go with every new set at Christmas time.

**Price \$6 — in U. S. A.**

**BRACH LightningArrester**



No aerial should be without the protection to radio and home which a Brach Lightning Arrester affords. Good sense demands this protection. The authorities require it.

Every Brach Arrester carries with it a \$100 insurance guarantee.



Prices as low as \$1

**The New Brach TOTEM-POLE ANTENNA**

Here is an aerial antenna that gives most complete reception and unusual clarity to radio. It is the size of a small flag pole, can be readily attached to roof or side or window ledge of house and does away with all unsightly makeshifts.

Totem-Pole Antenna with 100 feet wound wire and fasteners, complete for

Only \$10



**Drip-Proof HYDROMETER**

To the Hydrometer with the famous Chaslyn Balls is combined the Drip-proof feature which insures full protection against battery acid falling on and injuring parquet floors, rugs or clothing.

After testing battery, the Hydrometer can be washed without danger from dripping acid. Something nice to present to a radio fan or to buy for your own use.

Price \$1



**Brach★  
Radio Products**

L. S. BRACH MFG. CO., Newark, N. J.

L. S. BRACH OF CANADA, Ltd., Toronto, Can.

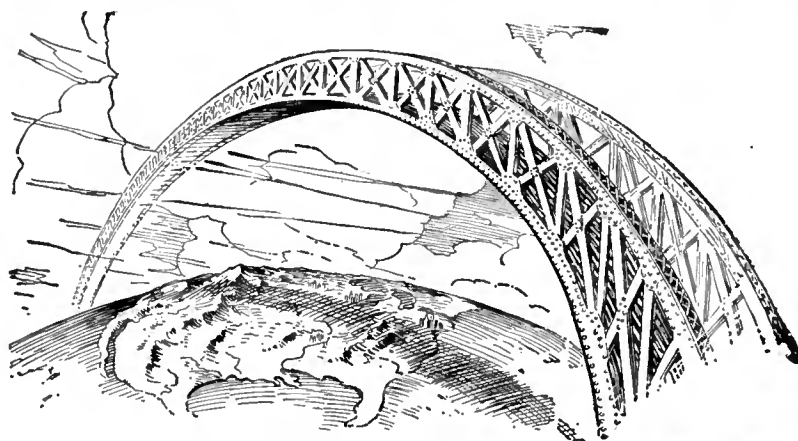

## Bridge great distances

*The new PRIESS "9" NINE brings in remote stations with astounding quality—even when the locals are at the height of their broadcasting*

Deep, sonorous bass notes as well as the faintest sounds of a violin—there are no "squeaks" or "howls"—no background noises. Instead a tone quality to marvel at.

Because of its matchless selectivity the Priess Nine is ideally suited for use in cities and other congested broadcasting districts—it goes through the locals as though they were not there.

Fourteen years of RADIO experience are back of every Priess set. A home demonstration involves no obligation and is a guarantee of your satisfaction. Write for names of dealers.

★ *Priess*  
TRADE MARK  
STRAIGHT 9 NINE

*"Outstanding radio performance and value on the market today—without exception"*

**PRIESS RADIO CORPORATION**  
686 Broadway, New York

*Authorized Priess Dealers show this sign in their windows*



Console \$335

### The one set for city use

Enclosed panel operated loop and built-in loud speaker. A splendid piece of furniture in addition to its radio perfection. NINE TUBES give tremendous power. Single dial control and direct reading wave length. No outside aerial. No lightning hazard. Priess known quality and value.

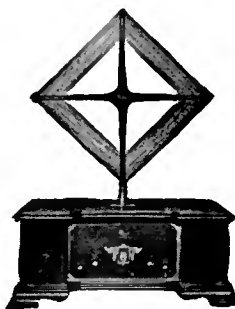
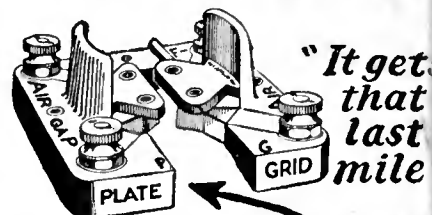

Table model \$195

## Fits All Tubes



## The AIRGAP SOCKET

Mr. Keith Henney, director of Broadcast Laboratory and developer of R. B. Lab. Circuit, and Mr. John B. Brennan, technical editor, recommend Airgaps for that circuit (November issue page 36) because, as there stated, they introduce a minimum of gridplate capacity and aid in preventing objectionable feedback.

At all dealers or direct postpaid 60c. each ★

**AIRGAP PRODUCTS COMPANY Mr.**  
11 Campbell Street  
Newark, N. J.

SEE THAT GAP?



## RADIO PANELS

OF GENUINE BAKELITE

Cut, drilled and engraved to order. Send rough sketch for estimate. Our New Catalog on Panels, Tubes and Rods—all of genuine Bakelite—mailed on request.

**STARRETT MFG. CO.**  
521 S. Green Street Chicago, Ill. ★

**\$75 A WEEK**  
**BUILDING RADIO SETS**  
*In Your Spare Time*

Join the Radio Association of America. Learn how to build and repair sets. The Association will train you—start you out in business, if you wish. Be the radio "doctor" of your community. \$3 an hour upwards easily made.

### EARN \$500 IN SPARE HOURS

"I have at last found myself," writes Lyle Follick, Lansing, Mich. "I have already made over \$500." Werner Eichler, Rochester, N. Y., writes, "... have made over \$50 a week in my spare time." Our members are starting radio stores, increasing their salaries, securing better positions, passing radio operator examinations, earning big money in spare time.

### JOIN ASSOCIATION NOW!

Are you interested in radio for pleasure or profit? Join now because we have a Special Plan whereby your membership need not cost you a cent. Only limited number of these memberships acceptable. Write now for details—before it is too late.

### MAIL THIS COUPON

Radio Association of America,  
Dept. B-12, 4513 Ravenswood Ave., Chicago.  
Send me details of your Special Radio Association Membership Plan.  
Name.....  
Address.....  
City.....State.....

**B**UILD the Browning-Drake Receiver described in the September RADIO BROADCAST with the aid of full-sized Blue-prints. Complete constructional and wiring information together with instruction booklet may be obtained for One Dollar. Send remittances to RADIO BROADCAST Magazine, Book Dept., Garden City, N. Y.

"Rapid" Engraving Machine

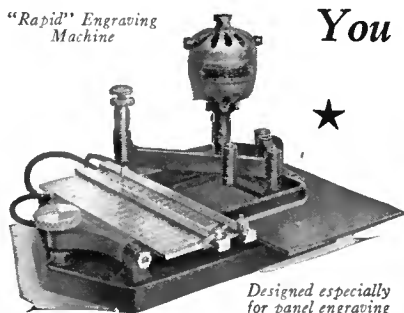

Designed especially for panel engraving

## You can make money Engraving Radio Panels!

★ YOU CAN EARN SEVERAL DOLLARS AN HOUR ENGRAVING PANELS FOR SET BUILDERS

With one of these machines you can engrave panels for amateurs building their own sets or sets for others. Engraves letters, figures, radio symbols, trade-marks, special designs, etc. Will engrave on Bakelite, Celeron, Hard Rubber, Aluminum, Brass and Soft Steel. Complete equipment furnished with machine.

Price \$135.00

**BRANCH TOOL CO., Dept. D., Forestdale, R. I.**

## Sheet Copper for Shielding

### Shielding

*Prevents* aerial radiation and feedback.

*Insulates* against interference from adjoining circuits.

*Improves* efficiency, selectivity and tone quality.

**USE SHEET COPPER** because it combines low resistance with easy working qualities.

**COPPER & BRASS  
RESEARCH ASSOCIATION**  
25 Broadway — New York



### In January—

Working On Ultra-Short Waves. Details of Fascinating High-Frequency Transmission by Voice—with circuit details.

RADIO BROADCAST for January, on sale Dec. 15

## FIVE TUBE RADIO

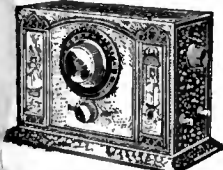

**\$25.00**

**AGENTS  
WANTED  
BIG  
COMMISSION**

Demonstrating agent wanted; every county. Exclusive to right man. Sell what public wants—five tube, long distance, loud speaker radio with single dial control. Price within reach of all, \$25.00 retail; liberal discount to agents. Sell in spare time—evenings. No selling or radio experience necessary. Territory going fast. 100 page Radio Book FREE. Write today—don't delay. **C. P. FISCHER, 122 W. Austin Ave., Chicago**



AMPLION  
CONE  
AC12.....\$30

AMPLION DRAGON  
ARI9.....\$42.50

AMPLION  
PATRICIAN  
AA18.....\$45

# Amplion reproduces the entire musical scale with absolute fidelity

*—no matter what set you have, you  
need an Amplion to bring out its best*

**T**HE Amplion Patrician assembles a 48" air-column with the matchless Amplion reproducing unit in a richly carved mahogany cabinet, 18" x 12" x 9". The Patrician is non-directional and is notable for the pleasant, soft mellowness of its tone.

The Amplion Cone is totally different in principle from any cone type of reproducer. Its especial superiority lies in its clear, clean-cut reproduction of speech.

The Amplion Dragon is used as a standard of comparison in radio experimental laboratories all over the world.

To any radio enthusiast no gift could be more acceptable than an Amplion. Prices range from \$12 to \$45.

*Ask your dealer for a demonstration or write  
to us for interesting Amplion Booklet.*



**THE AMPLION CORPORATION OF AMERICA**

Suite L, 280 Madison Avenue, New York City

*From 1887 . . . . . A path of brilliant achievement . . . . . to 1927*

**AMPLION**

**AROUND THE DIAL**  
with the *Mu-Rad Super-Six Receiver*



*Shining Eyes, Happy Hearts,  
a Resonant Xmas with  
the New Mu-Rad Receiver*

WHEN the gifts are untied, the candles extinguished and the kiddies gather 'round at the close of a happy Christmas Day, the soft sweet tones of MU-RAD will waft their way into your heart. Faithful reproduction, exquisite tonal qualities, simplicity of operation—all this is yours with the new MU-RAD receiver. Ask your nearest dealer for a demonstration. You may exchange your old MU-RAD set for new yearly models.

**MU-RAD**

Radio Corporation

Dept. B Asbury Park ★  
New Jersey

**ACROSS THE CONTINENT**

**HOW TO ORDER BLUEPRINTS FOR THE**

R. B. Impedance-Coupled Browning-Drake. Radio Broadcast "Aristocrat." Four-Tube Roberts Receiver. Send one dollar for each set desired to Booklet Department, Radio Broadcast, Garden City, New York. Each set of blue prints accompanied by full instructions.



**I. C. A. PANELS**

★ For "RADIO BROADCAST" and All Popular Circuits

**"The PANEL OF NO REGRETS"**

Build your set around an I. C. A. Panel of Insuline or Bakelite and make it a Complete success. These standard insulating materials guard you against leakage losses, and also give your set a thoroughly professional appearance. Furnished in Black and Wood finishes, for all popular circuits. Drilled ready to set up. Name, dial markings, etc. by exclusive Etch-O-Gravure process. Write for Free Booklet B-12 describing I. C. A. Panels, Sub-Panels, Mounting Brackets, etc. for "Radio Broadcast" and all popular circuits.

If your dealer can supply you write us direct. Don't take a substitute.  
INSULATING CO. of AMERICA, Inc.  
59 Warren St., New York City



*Mayolian*  
"B" SUPPLY

**Type 612—\$42.50**  
The "B" Without a Buzz

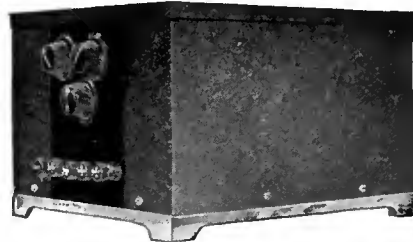

Also—Complete set of parts for home-builders at reasonable prices. Write us.

**MAYOLIAN RADIO CORPORATION**  
1668 Webster Ave., New York, N. Y.

Pioneers in Battery Elimination



The Power of Niagara—  
The Quiet of an Arctic Night

**Bradleyometer**

THE PERFECT POTENTIOMETER

Uses graphite disc resistors which are noiseless and not affected by atmospheric conditions. Metal parts are nickel plated. One hole mounting. Finish and knob match Bradleystat. Made in 200 and 400 ohm ratings.

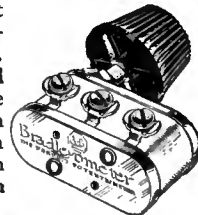

**Allen-Bradley Co. ★**

Electric Controlling Apparatus

278 Greenfield Avenue Milwaukee, Wis.

**Fahnestock Clips**

RADIO'S GREATEST CONVENIENCE

Used by Manufacturers of Standard Sels and Parts—and by Manufacturers of High Grade Wet and Dry Batteries.

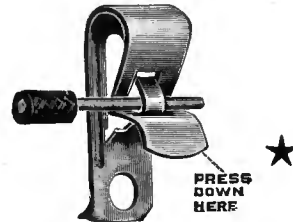

**ALL GENUINE FAHNESTOCK CLIPS**

bear our imprint on the thumb piece of the clip.

WORLD'S LARGEST MAKER OF CLIP TERMINALS

48 different sizes and styles to meet all requirements.

Send for Catalog and Samples

**FAHNESTOCK ELECT. CO.**  
L. I. City New York

# The flux is everything in radio soldering says this Radio Engineer

"In our laboratory we made a thorough analysis of the two groups of fluxes (natural and chemical). We found the natural flux, rosin, the only safe one to use on radio work.

Pure rosin, as in Kester Radio Solder, will not fume, sputter, or creep over large areas, and being a hard, dense substance, rosin will not attract and collect dust (carbon particles), which makes an excellent path for leakages. These are the faults of fluxes containing chloride, be it either in paste, liquid or compound form. Any flux containing chloride will eventually cause heavy leakage. Hence they should be strictly avoided.

We find Kester Radio Solder the most convenient way to solder on radio work, for it has the proper amount of pure rosin right inside the solder itself. In fact, we used it exclusively on all of our work."

There's your guide, radio fans—the approval of an expert radio engineer. Surely there can be no doubt as to what you should use on YOUR SET.



*A free Sample write for it now*

## KESTER Radio SOLDER

*the safe solder for radio, requires only heat*

**CHICAGO SOLDER CO.**

4222 Wrightwood Ave. Chicago, U. S. A.

*Originators and the World's Largest Manufacturers of Self-fluxing Solder*

## LYNCH METALLIZED

WARRANTED FIXED RESISTORS

THE vital importance of a silent, accurate resistor cannot be over-estimated. Comprising a concentrated metallized deposit one-thousandth of an inch thick, upon a glass core and sealed forever within the tube, each Lynch Resistor is warranted absolutely noiseless, permanently accurate, dependable! Guaranteed accuracy—10% in production they average 5%. .25; .5; 1; 2; 3; 4; 5; 6; 7; 8; 9; 10 Meg., 50c. .025; .09; .1 Meg., 75c. Single mounting 35c; Double, 50c. If your dealer cannot supply you, send stamps, check or money order. We ship postpaid same day order is received.

Dealers—Get on our mailing list; we keep you posted on new developments. Write us today!

MEMBER 426-B  
ARTHUR H. RMA 250 W. 57th St.  
LYNCH, INC. New York, N. Y.



# Make Your Set Safe With a Belden Fused Radio Battery Cord

FOR a perfect Radio Christmas, protect the new tubes and batteries, and also avoid fire hazard from crossed wires by hooking up your set with a Belden Fused Radio Battery Cord.

The tiny A and B battery fuses, concealed in the little two-piece bakelite shell, can be easily inspected.

This handy cord also improves the appearance of the set and eliminates all loose wires.

For maximum range and volume, ask your dealer for a Beldenam Aerial. It cannot corrode, even after years of service, and requires no cleaning.

*Ask your dealer for a Belden Fused Battery Cord.*

Belden Manufacturing Co.  
2312A S. Western Ave., Chicago, Illinois



## This is a Radio Christmas

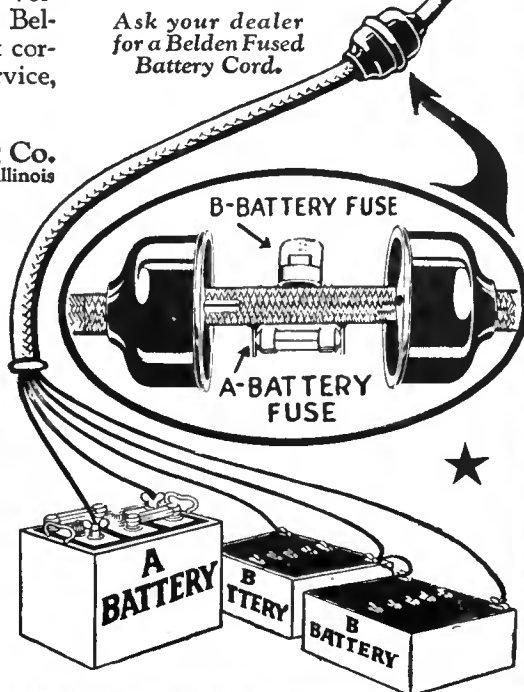



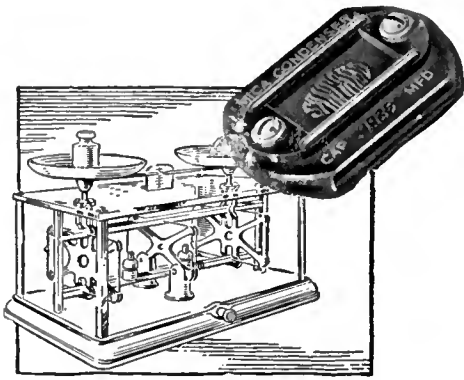

"Weighs out right capacity as accurately as the apothecary weighs out a precious drug."

A.C.L.

**T**ECHNICAL men were quick to appreciate Sangamo condensers in intermediate capacities. One engineer, well known to readers of radio publications—Austin C. Lescarbourea—sends us the following characteristic comment, which is published with his consent:

"In my laboratory we develop new circuits and variations of old circuits, publishing the results in radio magazines. Needless to say, we are using and specifying Sangamo condensers throughout. In my opinion there is no other fixed condenser that can compare with the Sangamo in accuracy, permanent capacity value, neatness and handiness.

"The Sangamo condenser weighs out just the right capacity as the apothecary weighs out a precious drug."

# SANGAMO

## MICA CONDENSERS

are made in 34 sizes, ranging from 0.00004 mfd. to 0.012 mfd. Sangamo Wound Condensers are ready in capacities from 1/10 mfd. to 4 mfd.; Series A guaranteed for continuous operation at 250 volts AC, 400 volts DC; Series B guaranteed at 500 volts AC, 1000 volts DC; also 12 and 14 mfd. blocks.



**Sangamo Electric Company**  
Springfield, Illinois

RADIO DIVISION, 50 Church Street, New York

SALES OFFICES—PRINCIPAL CITIES

6332-10

Build the Browning-Drake Receiver described in the September RADIO BROADCAST with the aid of full-sized Blue-prints. Complete constructional and wiring information together with instruction booklet may be obtained for one dollar. Send remittances to RADIO BROADCAST Magazine, Book Dept., Garden City, N. Y.

# F. D. PITTS COMPANY

INCORPORATED

219-C Columbus Avenue, Boston, Mass., U. S. A.

"Pioneers in the Distribution of Radio"

DEALERS—Send for large and profusely illustrated catalog on the products of nationally advertised radio manufacturers.

Wholesale Exclusively

MERCHANDISING RADIO SINCE 1919

Digitized by Microsoft®



"used in the LC-27"

# AEROVOX

"Built Better"

## FIXED CONDENSERS

are Specified in

**LC-27** by L. M. Cockaday  
*Name of the Air* " Herman Bernard  
*To be announced soon(?)* " John Rider  
 Raytheon "B" Eliminator " Raytheon Mfg. Co.  
 Ultradyne " R. E. Lacault  
*To be announced soon(?)* " R. E. Lacault

AEROVOX fixed condensers have been approved by M. I. T. and Yale Universities.

**AEROVOX WIRELESS CORP.**  
 489-491-493 Broome Street, New York

## RADIO DEALERS

**Get the New 1926-27 Van-Ashe Catalogue**

Shows all the newest parts, circuits and kits—all the hard-to-get items that set builders demand. 12-hours shipments—extra-good discounts. Mail the coupon.



### Dan-Ashe Radio Co.

202 North 10th St. ST. LOUIS, MO.

Send catalogue

Name .....

Address .....

## Choose with Confidence



### World Radio Storage "B" Battery

12 Cell—24 Volt

275

*Proved value. Thousands of users find reception almost magical. Clear, true power—instantly and unpingingly. Wise economy. Sturdy construction—Solid Rubber Case protection. Recharged for almost nothing. Endorsed and listed as standard by famous Radio institutions including Pop Radio Laboratories, Pop Sci. Int. Standards, Radio News Lab., Lefax, Inc., and other Radio authorities. What more need be said? Extra Offer: 4 Batteries in series (96 volts) \$10.50.*

**Send No Money** Just state number wanted and we'll ship same day order is received, by express C. O. D. Pay expressman after examining batteries. 5% discount for cash with order. Remember—you save 50% on World Batteries.

★ **WORLD BATTERY COMPANY**  
 1219 So. Wabash Ave. Dept. 78 Chicago, Ill.  
*Makers of the Famous World Radio "A" Storage Battery*  
 Prices: 6-volt, 100 Amp, \$10.00; 120 Amp, \$12.00; 140 Amp, \$13.00.  
*All equipped with Solid Rubber Case.*

Set your radio dials at 288.8 meters for the World Storage Battery Station W5BC, Variety-New Talent—Always Interesting.  
 JERRY SULLIVAN—Director and Announcer—Chi-CAW-ro

# With Power Amplifier Tubes

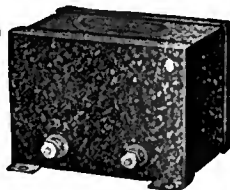
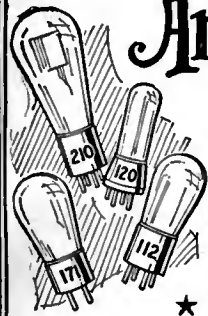

YOU install power tubes in your set to get purer tones and to eliminate distortion.

Concertones have a large enough core and winding to receive the lowest notes from the tubes and to reproduce them without distortion or "blasting." Heavily insulated.

Specified in improved Browning-Drake and other well-known circuits. Ask for free blue print bulletin.

Jefferson Electric Mfg. Co.  
Largest manufacturers of small transformers  
507 S. Green St. - Chicago, Ill.

## JEFFERSON Concertone

(A1-2 SEALED) AUDIO FREQUENCY TRANSFORMERS

Why not subscribe to *Radio Broadcast*? By the year only \$4.00; or two years, \$6.00, saving \$2.40. Send direct to Doubleday, Page & Company, Garden City, New York.

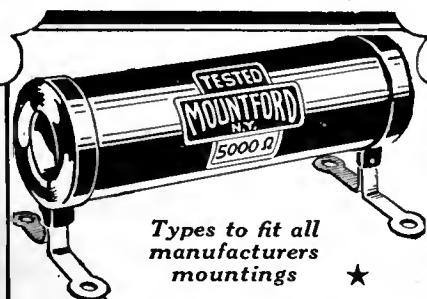

Types to fit all manufacturers mountings ★

### KROBLAK

Wire Wound 10 Watt RESISTANCES for "B" ELIMINATOR and C W TRANSMITTER

Sizes up to 10,000 ohms—\$1, 25,000—\$1.25, 50,000—\$1.50

Also VARIABLE LEAK List Price 50c

Over a Million in Use

Write for Hook-up Booklet

Manufacturers—Write for quotations  
Jobbers and Dealers—Write for discounts.

### C.E. MOUNTFORD

467 Greenwich St.

New York City



Aristocrat EZ TOON Vernier Pointer



# The NEW "Aristocrat" Vernier Port Dial

THE new, improved Aristocrat Vernier Port Dial is the greatest dial value on the market. Despite its many outstanding advantages, the Aristocrat costs no more than ordinary vernier dials.

If you want the finest-looking, finest-tuning vernier dial, be sure you get the Aristocrat. Made of Bakelite. All mechanism and shaft ends are concealed. Calibrations appear in a beveled port with a peaked indicator that makes misreading impossible.

Simple friction action is smooth, sure and quick. No gears, chains or cogs to backlash, wear out or get out of order. It may be installed in a few minutes. The famous Kurz-Kasch Split Bushing fits all condenser shafts—aligns rite, holds tite!

You'll be surprised at the difference a set of Aristocrat Vernier Port Dials will make. In appearance your radio will look better than the season's prettiest models. And, due to the fine, 14 to 1 vernier ratio, you'll enjoy better and clearer tones, more volume, and countless stations you've never before logged.

The Aristocrat Vernier Port Dial is supplied in three attractive finishes to match any radio—black with white markings, mahogany and walnut with gold markings. The price is \$2 each—in the finish you prefer. With a complete set of three Aristocrats, we are making a special limited offer. We are giving away the beautiful, 48-page, authentic Log Book illustrated here. You'll appreciate this gift when you see it. Ask the better radio dealer near you to show it to you.



This marvelous, recently compiled, 48-page Log Book (worth \$1) is given FREE with every set of three Aristocrat Vernier Port Dials. Bound in beautiful, two-tone, Mocotan Leather with embossed cover. Lists every United States and Canadian Radiocast Station of record June 1st, using power of 250 watts or more. Indexed by call letters, wavelengths and location. Also includes the principal foreign stations. Ask your dealer to show you a copy.



THE KURZ-KASCH COMPANY, DAYTON, OHIO ★

Moulders of Plastics

OFFICES: New York, Chicago, San Francisco, Los Angeles, Portland, Spokane, Denver, Toronto

# KURZ KASCH

## Aristocrat Dials and Knobs



**Kit Panels With Gold Decoration**

**F**ORMICA is this year providing amateurs through the leading jobbers and dealers with handsomely decorated gloss black panels with gold decoration for the leading kits: Infradyne, Aerodyne, Bremer Tully Counterphase and Power Six; Browning Drake National; Victoreen Superheterodyne; Victoreen Universal; Madison Moore Superheterodyne; Camfield Duoformer; St. James 8 tube; Karas Equamatic front and sub panels and H. F. L. Nine-in-line Superheterodyne.

Manufacturers are using handsomely decorated Formica panels in dull finish some of them in two colors.

**The FORMICA INSULATION COMPANY**  
4628 SPRING GROVE AVENUE CINCINNATI, OHIO

Hear the FORMICA  
Orchestra Tuesday  
9 to 10  
over WLW



Formica has a  
Complete Service on  
Insulating Material for  
Radio Manufacturers

**Choose Your Cone Materials Carefully**

In Building Your Own

**3 Foot Cone**



MADE especially for cone type speakers, ALHAMBRA FON-O-TEX is used by practically all leading cone type speakers manufacturers. This remarkable material has no grain, hence no resonance point of its own; but resonates uniformly at all frequencies.

Price 75c for a sheet 38 x 38 inches, large enough for a 3 foot cone. Ask your dealer. If he hasn't Alhambra FON-O-TEX we will supply you. To the cost of the number of sheets you need, add \$1 for packing and delivery charges.

The SEYMOUR Co., Desk B  
325 West 16th St. New York City

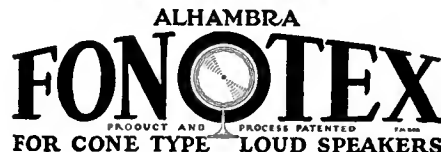

**Bradley-Amplifier**

Resistance-Coupled  
**PERFECT AUDIO AMPLIFIER**

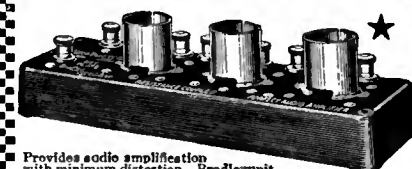

Provides audio amplification with minimum distortion. Bradleyunit molded resistors used in the Bradley-Amplifier do not vary with age and are not affected by atmospheric conditions. Can be used to replace transformer amplifiers in standard radio sets with decided increase in tone quality.

**Allen-Bradley Co.**

Electric Controlling Apparatus  
278 Greenfield Avenue Milwaukee, Wis.

**In a Jiffy-anywhere**  
**PUT UP-CHANGE-OR TAKE DOWN**

**Reel Aerial**

**SATISFACTION GUARANTEED**

**T**AKE your set anywhere—to demonstrate it, entertain friends or experiment—and in a few moments have a 100% efficient OUTSIDE aerial on the job. Simply lead in the Reel Aerial Antenna under or over window or door, which may be closed tight without harm to wire.

Makes a "Reel" Christmas Gift!

Something different and new for your radio friends. An aerial they can use at home, change about for testing and take with them on visits or trips! Note other uses illustrated. Mail coupon if dealer cannot supply you.

HERE'S 100 feet of 1/4 in. wide FLAT bare copper wire, with insulator on outer end, reeled up in a handsomely nickel-plated metal case, 4 1/4 in. diameter. Weighs only 21 ounces. Fits pocket. Unreel as long an aerial as desired, place case on or near set, insert plug on cable in center hole—attach other



Unsurpassed Permanent Aerial! Reel Aerial antenna has same inductance value as stranded copper wire. Being flat, smooth, and easy to take down, it is easily cleaned.

end of cable to set—and tune 'em in. Unused portion in case does not cause dead end losses. When through reel in like a tape measure. No tangling. Provides 100% efficient aerial in a few moments—any time, any place—in-doors, outdoors.

**DEALERS! JOBBERS!**  
Write for attractive proposition. Use Reel Aerials in making trial demonstrations. Sell Reel Aerials for indoor aeri-als, portable sets to travelers and tourists, to experimenters and to people desiring highly efficient permanent aeri-als.

1/2 Size  
Illustration of  
Actual size of  
Case 4 1/4 in. diameter  
**INSULATOR** →

SEND NO MONEY—JUST MAIL COUPON

HAWKEYE RADIO CO., Dept. 1712, Cedar Rapids, Iowa.  
Ship me—on your MONEY BACK GUARANTEE—one Reel Aerial C. O. D. I will pay postman \$5 plus few cents postage (postage prepaid when money accompanies order).

Name.....  
Address.....

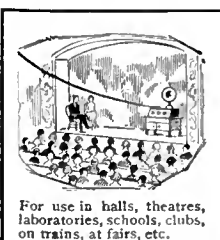
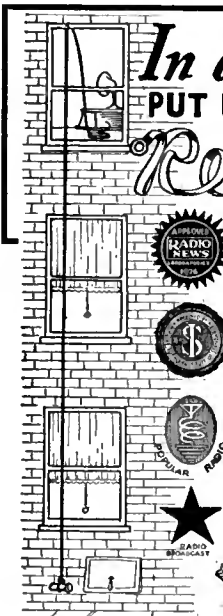

For use in halls, theatres, laboratories, schools, clubs, on trains, at fairs, etc.



Experimenters, Engineers! Attach Reel Aerial insulator to a pole and push pole into ground. Bring antenna into house. By changing distance and location of pole, and reeling antenna in or out, you can vary antenna.

**Build Your Own**

**Big  
3 Foot  
Cone  
Speaker**

Radio Show  
Sensation

Unit developed and speaker designed by Clyde J. Fitch, noted radio engineer. Results guaranteed equal to the finest factory-built speaker or your money back if you wish it. Easily assembled; operates from any receiver that will work a speaker; wonderful tone quality at any volume even with power tubes.

**FREE Blue Print**

Famous Tun-Bar Unit sent prepaid on receipt of \$7.50, or C. O. D. charges collect, if you prefer. Free blue print with each order for unit; blue print alone, \$1.

**Tun-bar  
Cone Speaker  
UNIT**

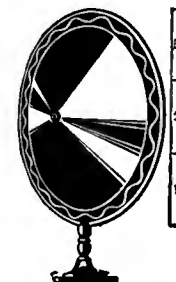

\$7.50 Direct from Maker

**TUNBAR RADIO CO.**  
26 Cortlandt St. Desk "L" New York City

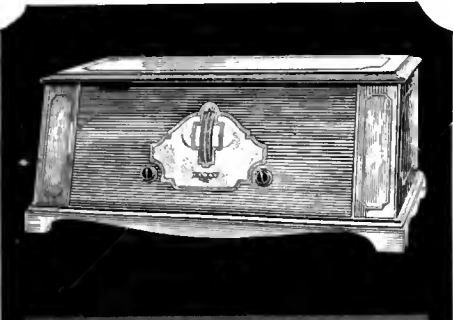

**The New 6-Tube  
ELKAY ★**

**With Donle Truphonic  
Audio Amplification**

which delivers pure tone in any volume over the entire tonal scale, and the patented Elkay Synauto R. F., which smooths out the tuning over the whole dial from 200 to 580 meters—is a receiver that will be modern for years to come.

Completely shielded. Neat Uni-Control—the flexibility of 3 dials at your finger tips. In brown antique, Duco-finished mahogany, \$125. (Exclusive franchise to the Trade).

**The Langbein-Kaufman Radio Co.**  
Dept. R  
62 Franklin Street, New Haven, Conn.

**RADIO AGENTS  
WANTED**

Famous Air King line of 5-Tube T. R. F. receivers. 3 models, retail for only \$49.50 to \$59.50. Solid walnut cabinets. Wonderful tone and power. Liberal discounts to user agents. Write to-day, 20TH CENTURY RADIO CO., 1042 Coca Cola Bldg., Kansas City, Missouri.

**Build a Giant  
3 Foot  
Cone  
Speaker**



**SAVE  
Four-fifths of  
retail cost.  
Equals finest  
speaker made.**

You can build this SENSATION of the Radio Shows at home yourself and make it equal to a factory built one; and save four-fifths of the cost.

Only with a 3 ft. speaker can you get real tone quality—every note of the brass horns in an orchestra, the beats of the bass drum, the low notes of a pipe organ and ALL the in-between tones to the highest note of the violin and the shrill treble of the piccolo. But you must choose your unit with care. It is most important. Insist on a

**Penn Cone Speaker ★  
UNIT**

Designed especially to operate a 3 ft. cone and to work perfectly even with power tube. Adjustable to the audio output of any set and will carry any load a set can give it. Recommended by leading radio engineers. Finest seasoned steel magnet; double pole vibration; shortest, most substantial driving rod on any cone speaker unit. A marvel of design and construction.

Your dealer has or can get the PENN Unit for you. Insist on examining it before you accept any other. Price, \$9.50. If he hasn't the PENN or will not get it for you, we will ship you direct, prepaid, on receipt of price. Parts complete, \$14.15.

\*How to Build a 3 Ft. Cone Speaker for only \$14.15\* sent for 10c. Complete set Blue Prints, \$1.00

**Penn Radio Sales Co.**

104 Fifth Ave. Suite 2009 New York City  
Exclusive Distributors for G. R. Penn Mfg. Co., New York City

**Leadership**

*with Benjamin Radio Products  
in Securing the Best Radio Results*



*All Benjamin Radio Products are of the same high standard as the far-famed Cle-Ra-Tone Sockets—*

You will find that almost every good radio set in the neighborhood has some or all Benjamin Radio Products in it. Radio experts and set makers have proved through long experience that only radio parts conscientiously and painfully made to improve delicate tonal quality, selectivity and volume can bring a leadership in securing the best radio results.

If you would have your set just as good or better than your neighbor's make sure that every component part is reliable and bears the trade mark of a manufacturer in whom you can place your full confidence. The world-wide recommendation of Benjamin Radio Products by radio authorities is the best testimonial for their scientific accuracy and uniformity in securing the best radio results.

**Rewards for Radio Reasoners**

[Awards for novel and original hook-ups, modifications of existing circuits; trade names; slogans; write our nearest office for full details.]

[If your dealer cannot furnish you with Benjamin Radio Products send amount direct to our nearest sales office with his name and we will see that you are promptly supplied.]

**Benjamin Electric Mfg. Co.**

★ 120-128 S. Sangamon St. Chicago  
New York: 247 W. 17th St. San Francisco: 448 Bryant St.

Manufactured in Canada by the Benjamin Electric Mfg. Co. of Canada, Ltd., Toronto, Ontario

**Straight Line Frequency Condensers**

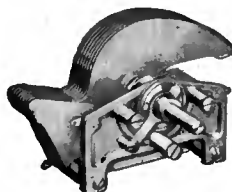

Eliminates bunching of stations. Spreads the log evenly over the dial. Makes tuning easy. Adjustable turning tension. Compact. A beautiful instrument that not only improves reception, but adds to the good appearance of the set.



Plain—70c pair. Adjustable—\$1.25 pair

**Brackets**  
An aid to simplification in set construction. Supports the sub-panel, with room underneath for accessories and wiring.

**Battery Switch**

Quick, positive, clean-cut make and break. When it's "in" it's "off", eliminating danger of wasteful use of battery.



30 cents each

**Improved Tuned Radio  
Frequency Transformers**



Space wound; basket weave; cylindrical; highest practical air dielectric. Proved to give the best results in sharpness of tuning, increase in volume and improvement in quality. Authoritative laboratory tests and practical experience of manufacturers and amateurs shows that this type of coil excels in every important characteristic.

**2 1/4-inch Diameter  
Transformer**

Compact. Especially desirable for crowded assembly. Eliminates interfering "pick-ups."

Set of Three, \$5.75  
Single Transformer, \$2.10

**3-inch Diameter  
Transformer**

Capacity coupling reduced to lowest degree. For use with .00035 Mfd. Condensers.

Set of Three, \$6.00  
Single Transformer, \$2.25

**"Lekeless"  
Transformers**

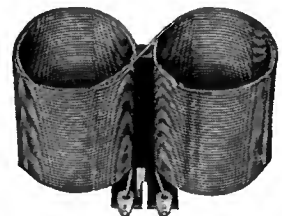

Uniform high inductance, low distributed capacity and low resistance. The external field is so slight that it permits placing coils close together without appreciable interaction.

Single Transformer, \$2.50

**Cle-Ra-Tone Spring  
Supported—Shock-  
Absorbing Sockets**



Spring Supported, Shock-Absorbing, Stop Tube Noises. The greatest aid to non-noisy operation. Contacts always clean.

75 cents each



TRADE MARK

**TOBE B BLOCKS**

The quality of the TOBE B BLOCKS is immediately apparent on sight. The perfection and beauty of their finish is simply a reflection of what is packed inside. The first B BLOCK for B-Eliminator filters—and still in the lead.



**TOBE BH BLOCK**

contains one 6 and two 4 mfd. TOBE Filter Condensers. Especially designed for use with the new Raytheon BH Tube.

Price, \$11.00



**TOBE B BLOCK**  
Type 761

This contains one 8 and two 2 mfd. TOBE Filter Condensers, and is designed for use with electrolytic and D. C. eliminator filters and where separately cased condensers are used on the voltage taps.

Price, \$9.50

**TOBE DEUTSCHMANN CO.**

Cambridge

Massachusetts

FAMOUS **BH** TRANSFORMERS

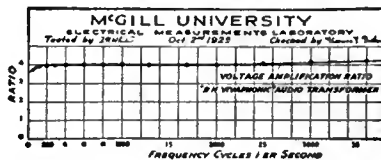

A PERFECT

**AUDIO AMPLIFYING TRANSFORMER**

The BH Vivaphonic is the only transformer having a low loss shield structure (patented.) It is ideal for the Browning-Drake, Universal, Roberts, etc.

**BENJAMIN HUGHES ELECTRIC CO.**  
298 LaGauchetiere West Montreal, Can.  
Transformer Builders Since 1910

**Yale GROUND HOG**  
Perfect Ground  
**DOUBLES POWER AND DISTANCE**

Marvelous newly-invented ground gives incredibly improved reception. Doubles power and distance users say. Reduces leakage. Stops jangling even in mid-summer. Results never before equalled. Satisfaction guaranteed or money back at once. Approved by Highest Radio authorities after exhaustive tests. Proven absolutely essential to clear, powerful distance reception. Draws and holds moisture indefinitely. Highly sensitive to radio energy. **SEND NO MONEY**—To introduce, we offer to those who act at once, regular \$5.00 size for only \$2.00. Send name today and pay \$2.00 plus 17c postage on delivery. Or send only \$2.00 with order and save postage.

**FREE**—Full description of Ground Hog and details of amazing special offer on request—write today.

Yale Specialty Supply Co.  
123 W. 5th St. Kansas City



CAL. 30-40

**KRAG CARBINE STYLE**

22-inch Barrel, 5 shot Box Magazine. The PRICE \$15 choice of hundreds of Big Game Hunters. F.O.B. Barrel slightly used and refinished, other parts NEW. First-class serviceable condition. Shipping Weight 13 lbs.



**HAND GRENADE BAG**

45c POSTAGE Made of fine quality canvas. Size EXTRA 10x10 inches inside. Suitable for School Bag and hundreds of other purposes. Terms strictly Cash. No C. O. D. Shipments  
Catalog Free on request  
**W. STOKES KIRK**  
1627-N.M. North 10th St. Phila., Pa.

**B-Power Supply and Amplifier**

RADIO BROADCAST for January will contain complete constructional information on a new and important power amplifier and B supply, especially interesting to those who have built the R. B. "Lab." circuit. Look for the January issue, on sale December 15th.

**32 Page CATALOG**  
The Little Salesman  
Brings DEALERS BIGGER PROFITS

Matchless bargains in radios and accessories. Full line of Bremer Tully, Balkite, All American G. E. Tugear, Thorola, Majestic, Utah, R. C. A. Tubes, occasionally advertised parts, batteries, chargers, etc. Big opportunity for live dealer to double sales quick. Tell us about your business as we sell wholesale only. Postcard or letter brings catalog and dealer's proposition. Exclusive territories open. Act—NOW!

**NEW ENGLAND MILLS COMPANY**  
Distributors of Nationally Advertised Radio Lines  
Dept. 91A 851-55 Washington Blvd. Chicago, Ill.

**The Best in Radio Programs**

The first to review programs, RADIO BROADCAST, has maintained its interesting department of news and comment about broadcasters and their programs in "The Listeners' Point of View." A regular and lively department, conducted by John Wallace from his "listening-post" in Illinois.

**BLUEPRINTS FOR THE BROWNING-DRAKE**

Complete constructional data and large, clear blueprints can be ordered from the booklet department, Radio Broadcast, Garden City, N. Y. at \$1.00 the set. The efficient Browning-Drake tuner unit with impedance-coupled amplification in a neat and easy-to-build layout.

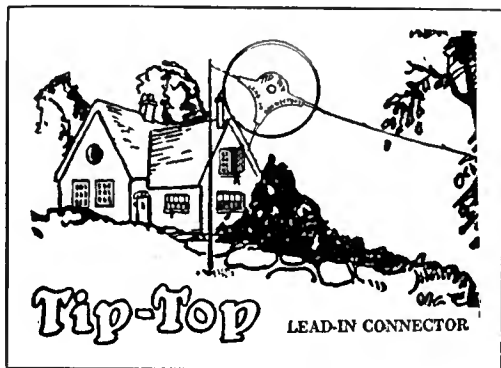

**Tip-Top** LEAD-IN CONNECTOR

A FEW spare moments, a screw driver and you have a sure, perfect connection between your aerial and lead-in wire. No noise, no soldering, no loss of "distance" due to swinging aerial or corrosion. Tip-Top cannot work loose.

★ *Jobbers and Dealers Write Us!*

**JAMES F. DOOLAN MFG. CORP.**  
36-42 West 47th St. New York, N. Y.

*Don't Neglect this Vital Point of Contact!*

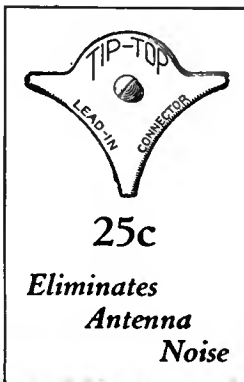

25c

Eliminates Antenna Noise

**Radio Code!**

DO you know you can get code on your radio and read it too? You can get more out of your radio with the Bunnell Buzzplex. It's easy to learn wireless and radio signals with the buzzer, or shift to the lamp for practice in flash or heliographic work.

Used by military schools, boy scout camps and others, wherever code is taught. Instruction book and code chart furnished with each set. Headquarters for transmitting apparatus.

**J. H. BUNNELL & COMPANY, Inc.**  
Manufacturers and Distributors  
32 Park Place, New York  
Phone: Whitehall 5970

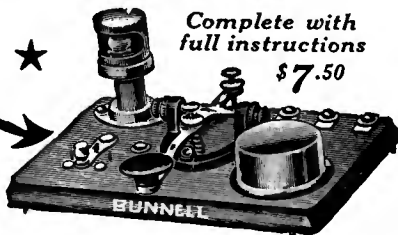

Complete with full instructions \$7.50

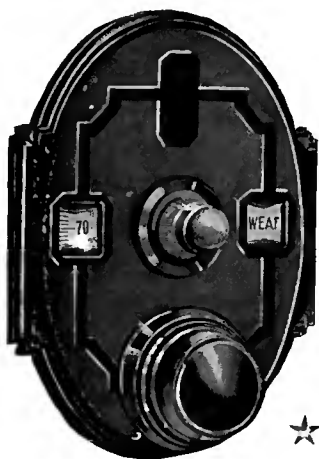

**ACCURATUNE  
Recording Dial**

Its simplicity and efficiency has overwhelmed the real radio fans.

Its positive friction grip insures absolute smooth action.

Graduated from 0 to 100 or reverse. Sold in three ways.

- Recording Dial .....\$2.00  
(Ratio 10 to 1)
- With Micrometer control ..... 2.75  
(Coarse ratio and 200 to 1)
- Illuminated extra..... .50

Sent direct if your Dealer cannot supply you

**MYDAR RADIO COMPANY**  
3 Campbell St. Newark, N. J.  
"Pioneer Mfrs. of Micrometer Dials"

Why not subscribe to *Radio Broadcast*? By the year only \$4.00; or two years, \$6.00, saving \$2.40. Send direct to Doubleday, Page & Company, Garden City, New York.

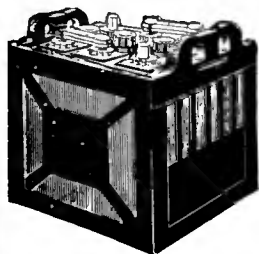

**CHICAGO  
RADIO  
BATTERIES**  
Solid One  
Piece Rubber  
Containers

**★ GUARANTEED FOR 2 YEARS**

**FAMOUS** for unexcelled quality, guaranteed long-lived service and unvarying dependability Chicago Batteries offer the Radio fan an "A" Power that is backed by years of experience and master workmanship with the finest materials available. Endorsed and approved by leading Radio and Automotive authorities. Chicago Batteries in their new non-leak, solid rubber cases represent an amazing value at lowest cost.

**PRICES RADIO BATTERIES  
Solid Rubber Cases**

- 6 volts, 100 amps. ....\$ 8.79
- 6 volts, 120 amps. .... 10.79
- 6 volts, 140 amps. .... 13.50

**SEND NO MONEY**

Buy Chicago Batteries direct from the manufacturer. Batteries shipped same day order is received. Express C O D or 5% discount cash with order.

**MOGUL ELECTRIC LABS.**  
1206 So. Peoria St. Chicago, Ill.

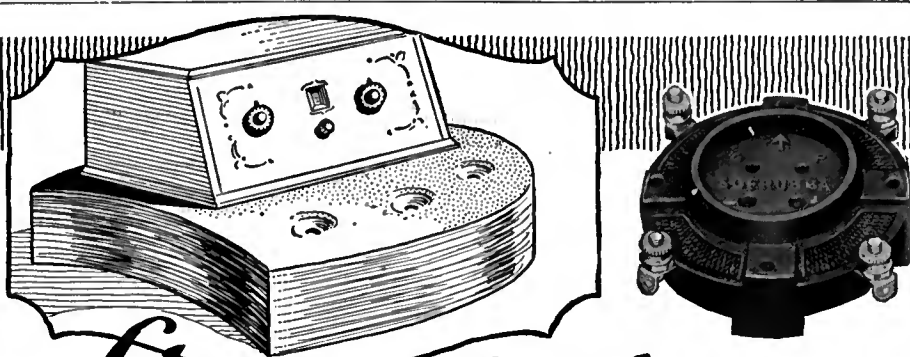

*Like a rubber heel!  
for your radio!*

**ELIMINATES ALL SHOCKS  
AND MICROPHONIC NOISES**

You can remember the first time you tried rubber heels on your shoes. You were surprised in the ease, soft and nerve-soothing difference in your step.

You will be even more surprised when you try a SOFRUBBA socket in your radio set.

You can be assured that every set equipped with SOFRUBBA sockets will be free from shocks and jars that produce microphonic noises.

Whether you use last years' tube or a brand new one with this socket, you can be assured of the most satisfying results.

**Price sixty cents**

Inquire at any reputable dealer, or direct



**MOULDED PRODUCTS CORPORATION**  
549-551 West 52nd Street, New York City

Attention Department C

**S O F R U B B A  
BALLOON SOCKET**



**Full-Sized Blue-Prints**

of the Browning Drake Receiver described in the September issue of RADIO BROADCAST makes its construction extremely simple. The receiver combines a stage of tuned, neutralized radio frequency amplification employing a type 199 tube, a regenerative detector and three stages of impedance-coupled audio frequency amplification. High-mu and power tubes are used. This is one of the best receivers of the year. Obtain your copy of the full-sized blue-prints complete with instruction book by mailing remittance of one dollar to

**RADIO BROADCAST Magazine**

Book Dept. Digitized by Microsoft

Garden City, N. Y.

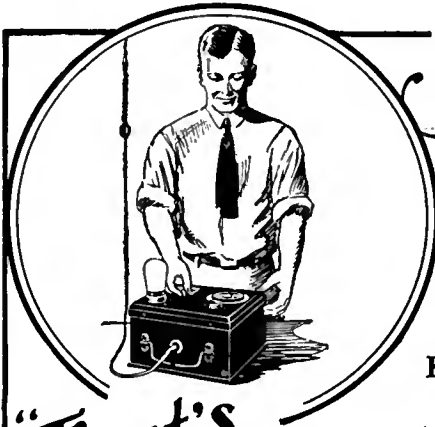

# Your set's no better than the condition of your tubes

Keep them in Shape with a Sterling Reactivator

"That's sure bringing 'em in"

If you want to be sure of good radio. Keep your tubes freshly energized. Do this at home and save money. It takes only a few minutes now and then. The result is equivalent to using new tubes. The Sterling Tube Reactivator, emissionmeter equipped. Tests your tubes and shows you whether reactivation is necessary. It also shows after treatment how vastly improved the tube really is.

PRICE \$12.50

The Sterling "Midget" Tube Reactivator. It costs only \$3.75. (Not meter equipped).

See Your Dealer Now!

Write the factory for 32-page book on up-to-date Radio Reactivators.

THE STERLING MFG. CO. CLEVELAND, OHIO

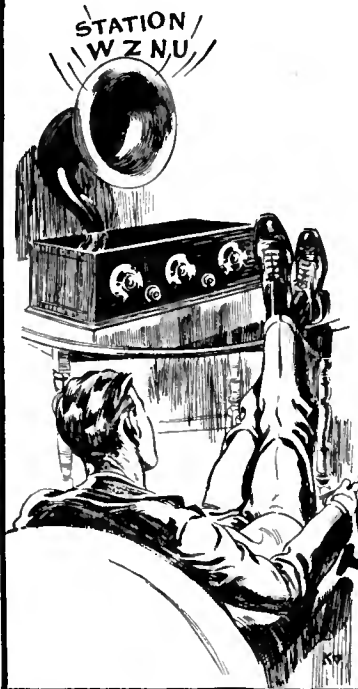

# Sterling TUBE REACTIVATOR

## LEARN THE CODE AT HOME with the OMNIGRAPH

"Just Listen—The Omnigraph will do the teaching!"

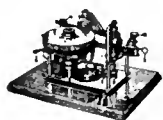

THE OMNIGRAPH Automatic Transmitter will teach you both the Wireless and Morse Codes—right in your own home—quickly, easily and inexpensively. Connected with Buzzer, Buzzer and Phone or to Sounding, it will send you unlimited messages, at any speed, from 5 to 50 words a minute. THE OMNIGRAPH is not an experiment. For more than 15 years, it has been sold all over the world with a money back guarantee. The OMNIGRAPH is used by several Depts. of the U. S. Govt.—in fact, the Dept. of Commerce uses the OMNIGRAPH to test all applicants applying for a Radio License. The OMNIGRAPH has been successfully adopted by the leading Universities, Colleges and Radio Schools. Send for FREE Catalogue describing three models. DO IT TO-DAY.

THE OMNIGRAPH MFG. CO., 13K Hudson St., New York City

If you own a Radio Phone set and don't know the code—you are missing most of the fun

## Enjoy a Big Powerful Radio: 30 Days Free



SEND COUPON FOR AMAZING SPECIAL OFFER!  
NOTE: This offer is made to prospective buyers by famous big Radio Corporation, one of America's oldest & reliable manufacturers of fine sets—seventh successful year. Many satisfied users in every state. Postal or coupon brings testimony of nearly 400,000 users and proves it MOST SELECTIVE, CLEAREST TONED and MOST POWERFUL DISTANCE-GETTER among beautiful big 6-tube sets, don't buy it unless you get it 4 times as much. Very easy to operate

BEAUTIFUL-BIG-POWERFUL  
Ultra Selective **MIRACO** Ultra 5

Users everywhere report it gets programs Coast to Coast, also Canada, Cuba and Mexico, loud and clear on speaker; outperforms \$100 to \$200 sets. Some have heard Europe, So. America. Don't confuse it with small cheap sets. **BEAUTIFUL-BIG-POWERFUL DISTANCE-GETTER** among beautiful big 6-tube sets, don't buy it unless you get it 4 times as much. Very easy to operate

Users everywhere report it gets programs Coast to Coast, also Canada, Cuba and Mexico, loud and clear on speaker; outperforms \$100 to \$200 sets. Some have heard Europe, So. America. Don't confuse it with small cheap sets. **BEAUTIFUL-BIG-POWERFUL DISTANCE-GETTER** among beautiful big 6-tube sets, don't buy it unless you get it 4 times as much. Very easy to operate

Users everywhere report it gets programs Coast to Coast, also Canada, Cuba and Mexico, loud and clear on speaker; outperforms \$100 to \$200 sets. Some have heard Europe, So. America. Don't confuse it with small cheap sets. **BEAUTIFUL-BIG-POWERFUL DISTANCE-GETTER** among beautiful big 6-tube sets, don't buy it unless you get it 4 times as much. Very easy to operate

Built like a \$200 set  
**MIRACO RADIO GETS 'EM COAST to COAST**

Send for Proof!

Our Factory Prices Save You Up to 1/2! SEND NO MONEY! Save or make NOW Only much money \$49.75  
on sets, speakers, tubes, batteries, write or AMAZING OFFER. Radio's most marvelous value in a big FULLY GUARANTEED 6-tube 3-dial set. Retail List \$149.75  
MIDWEST RADIO CORPORATION, Pioneer Builders of Sets  
488-N. Miraco Bldg., Cincinnati, Ohio  
WITHOUT OBLIGATION, send free literature, AMAZING SPECIAL OFFER, testimony of users, etc.

NAME: \_\_\_\_\_  
ADDRESS: \_\_\_\_\_

STATEMENT OF THE OWNERSHIP, MANAGEMENT, CIRCULATION, ETC., required by the Act of Congress of August 24, 1912, of RADIO BROADCAST, published monthly at Garden City, New York for October 1, 1926. State of New York, County of Nassau.

Before me, a Notary Public in and for the State and County aforesaid, personally appeared S. A. Everitt, who, having been duly sworn according to law, deposes and says that he is the treasurer of Doubleday, Page & Company, owners of Radio Broadcast and that the following is, to the best of his knowledge and belief, a true statement of the ownership, management (and if a daily paper, the circulation), etc., of the aforesaid publication for the date shown in the above caption, required by the Act of August 24, 1912, embodied in section 411, Postal Laws and Regulations, printed on the reverse of this form, to wit:

1. That the names and addresses of the publisher, editor, managing editor, and business managers are: *Publisher*, Doubleday, Page & Co., Garden City, N. Y.; *Editor*, Willis Wing, Garden City, N. Y.; *Business Managers*, Doubleday, Page & Co., Garden City, N. Y.

2. That the owner is: (If owned by a corporation, its name and address must be stated and also immediately thereunder the names and addresses of stockholders owning or holding one per cent. or more of total amount of stock. If not owned by a corporation, the names and addresses of the individual owners must be given. If owned by a firm, company, or other unincorporated concern, its name and address, as well as those of each individual member, must be given.) F. N. Doubleday, Garden City, N. Y.; Arthur W. Page, Garden City, N. Y.; S. A. Everitt, Garden City, N. Y.; Russell Doubleday, Garden City, N. Y.; Nelson Doubleday, Garden City, N. Y.; John J. Hessian, Garden City, N. Y.; Dorothy D. Babcock, Oyster Bay, N. Y.; Alice De Graff, Oyster Bay, N. Y.; Florence Van Wyck Doubleday, Oyster Bay, N. Y.; F. N. Doubleday, or Russell Doubleday, Trustee for Florence Van Wyck Doubleday, Garden City, N. Y.; Janet Doubleday, Glen Cove, N. Y.; W. Herbert Eaton, Garden City, N. Y.; S. A. Everitt or John J. Hessian, Trustee for Josephine Everitt, Garden City, N. Y.; W. F. Etherington, 50 E. 42nd Street, N. Y. C.; Henry L. Jones, 285 Madison Avenue, N. Y. C.; William J. Neal, Garden City, N. Y.; Daniel W. Nye, Garden City, N. Y.; Mollie H. Page, Syosset, N. Y.; E. French Strother, Garden City, N. Y.

3. That the known bondholders, mortgagees, and other security holders owning or holding 1 per cent. or more of total amount of bonds, mortgages, or other securities are: (If there are none, so state.) NONE.

4. That the two paragraphs next above, giving the names of the owners, stockholders, and security holders, if any, contain not only the list of stockholders and security holders as they appear upon the books of the company but also, in cases where the stockholder or security holder appears upon the books of the company as trustee or in any other fiduciary relation, the name of the person or corporation for whom such trustee is acting, is given; also that the said two paragraphs contain statements embracing affiant's full knowledge and belief as to the circumstances and conditions under which stockholders and security holders who do not appear upon the books of the company as trustees, hold stock and securities in a capacity other than that of a bona fide owner; and this affiant has no reason to believe that any other person, association, or corporation has any interest direct or indirect in the said stock, bonds, or other securities than as so stated by him.

5. That the average number of copies of each issue of this publication sold or distributed, through the mails or otherwise, to paid subscribers during the six months preceding the date shown above is..... (This information is required from daily publications only.)

(Signed) DOUBLEDAY, PAGE & COMPANY  
S. A. Everitt, Treasurer.

Sworn to and subscribed before me this 16th day of September, 1926.

[SEAL] (signed) Frank O'Sullivan  
My commission expires March 30, 1928.)

### Helpful Technical Information

A regular feature of RADIO BROADCAST is the series of Laboratory Information Sheets, which cover a wide range of information of immediate value to every radio worker, presented in a form making it easy to preserve them. To insure your having every issue, send your check for \$4.00 to

Subscription Department, Doubleday, Page & Co., Garden City, N. Y.

### WORLD'S FINEST

### LOUD-SPEAKER

A three-foot cone speaker—unlike developed by the inventor of the Tropidyne. Easily assembled, saving 80% of the cost. Complete Kit with blue prints sold on rigid money-back guarantee—shipped prepaid or C. O. D. \$10.

Engineers' Service Co.

25 Church Street

New York

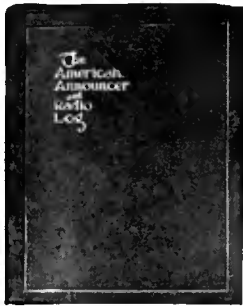

**THE 1926 X-MAS Gift for Every Radio Fan...**

A book 8½" x 11 in., containing large photographs of all the chief announcers of the leading

broadcasting stations in the United States, Canada and Cuba and bubbling over with interesting items regarding their lives, personality and style of announcing. Has six time-divided maps and everything to make it the finest radio log ever published. The book is beautifully bound in red flexible art binding and is put up in loose leaf form, allowing for future additional photographs and sketches. Order quickly to insure Christmas delivery.

SEND CHECK OR MONEY ORDER TO  
**THE AMERICAN ANNOUNCER**  
41 FRANKLIN STREET - - BUFFALO, N. Y.  
Price per copy \$2.50  
DEALERS WANTED EVERYWHERE

# Bradleyleak

THE PERFECT GRID LEAK

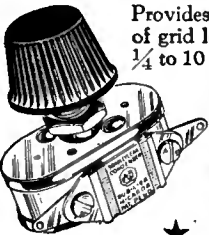

Provides a noiseless range of grid leak resistance from ¼ to 10 megohms. Assures most effective grid leak resistance value for all tubes. Small grid condenser (0.00025) is separate. Metal parts nickel plated. One hole mounting.

**Allen-Bradley Co.**

Electric Controlling Apparatus  
278 Greenfield Avenue Milwaukee, Wis.

## See that Screw

A screw-driver adjusts an X-L in crowded places



**X-L VARIO DENSER**

RESULTS in easier tuning, more distance, volume and clarity—greater stability. Indorsed by leading authorities.

Model "N" A slight turn obtains correct tube oscillation on all tuned radio frequency circuits. Neutrodyne, Roberts two tube Browning-Drake, McMurdo Silver's Knneckout, etc. capacity range 1.8 to 20 micro-micro farads. Price \$1.00

Model "G" With grid clips obtains the proper grid capacity on Cockaday circuits, filter and intermediate frequency tuning in heterodyne and positive grid bias in all sets. Capacity range.

Model G-1—.0002 to .0001 MFD  
Model G-5—.0001 to .0005 MFD  
Model G-10—.0003 to .001 MFD  
Price \$1.50

**X-L Push Post.** Push it down with your thumb, insert wire, remove pressure and wire is firmly held. Releases instantly. Price 15c.

**Push Post Panel** permanently marked in white on black rubber. In box including soldering lugs, raising bushings and screws for mounting, etc. Price \$1.50



**X-L Radio Laboratories** 2424 Lincoln Ave. CHICAGO, ILL.

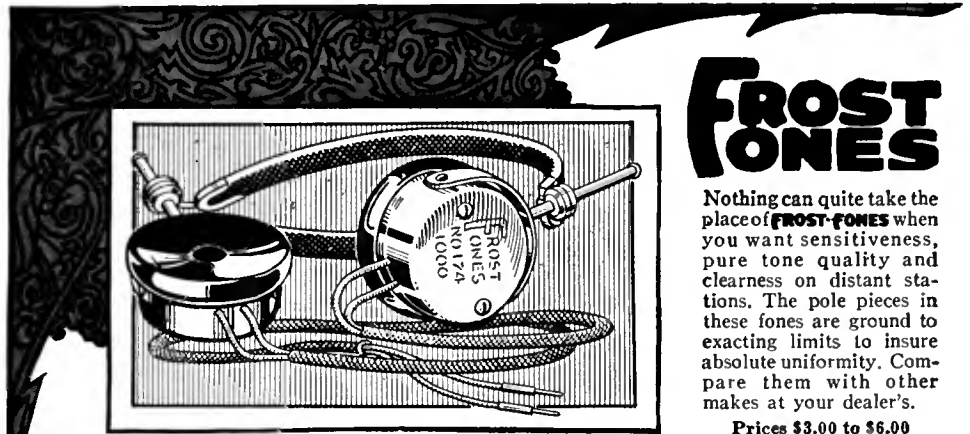

# FROST FONES

Nothing can quite take the place of **FROST FONES** when you want sensitiveness, pure tone quality and clearness on distant stations. The pole pieces in these fones are ground to exacting limits to insure absolute uniformity. Compare them with other makes at your dealer's.

Prices \$3.00 to \$6.00

Type 800, Bakelite Frame

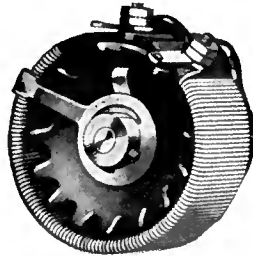

List price, 75c

## The New

# FROST-RADIO RHEOSTATS

**FROST-RADIO** Type 800 Rheostats have a frame cast from genuine Bakelite and designed to allow a free circulation of air around the windings for quick radiation of heat. They operate with a smooth and noiseless action—cannot overheat or vary in resistance. Arranged for single hole mounting; equipped with Bakelite pointer knob. Supplied in twelve resistances, from 2½ to 75 ohms.

**FROST-RADIO** Type 700 Rheostat is simple and rugged in design, being built on a one-piece metal frame that cannot warp or bend. This method of construction makes possible a high grade unit at a very low price. Arranged for single hole mounting; equipped with pointer knob. Supplied in 12 resistances— from 2½ to 75 ohms. See both types at your dealer's.

Type 700, Metal Frame

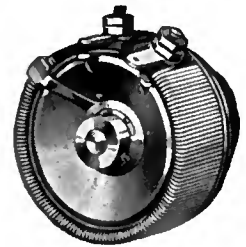

List price, 50c

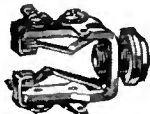

Gem-Jac

A small, sturdy jack projecting only 1 inch behind panel. Its strong, self-cleaning springs are permanently adjusted and have Sterling silver contacts.

Prices 40c to 50c



Pan-Tab

Built to the finest precision standards, the Pan-Tab appeals to the set builder who includes nothing but the best parts. Nickel plated and hand-buffed to a high finish.

Prices 65c to 90c

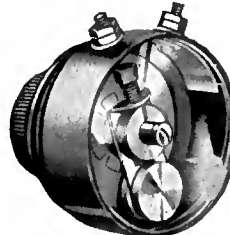

**FROST-RADIO** Super-Variable Resistances

These new **FROST-RADIO** units find a ready use in most of the new circuits. They are non-inductive, smooth and noiseless in operation. As the knob is turned the resistance is graduated continuously without steps or jumps. Type 880 has 2 terminals and Type 890, 3 terminals. Both types - - \$1.25 each

**HERBERT H. FROST, Inc.**

160 N. LaSalle Street  
New York CHICAGO Los Angeles



No. 530 **FROST-RADIO** Socket

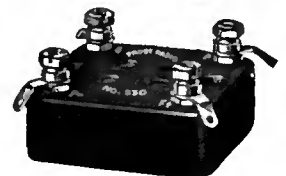

List price, 40c

**FROST-RADIO** Automatic Plug No. 141



List price, 75c

**LOOK FOR THE JANUARY RADIO BROADCAST**  
Five important constructional articles of unusual interest. Details of new receiver circuits—Broadcasting from banquets—The New Hammarlund-Roberts—A New Super-Heterodyne—Many other articles of wide interest—On sale Dec. 15.

# STORAD RADIO POWER SUPPLY

## TYPE 101X—"B POWER"

Raytheon Tube Type Unit with Storad REMOTE CONTROL feature. Place Unit batteries, etc., where you wish. You control them entirely with the Storad REMOTE CONTROL at the set.

100% over capacity work on all sets regardless of size, without hum. Will operate sets using power tube on last stage audio.

Operates on house lighting circuit. Three variable controls from 180 volts down.

Ask your dealer or write for information

**THE STORAD MANUFACTURING CO.** ★

2415 Detroit Ave.

Cleveland, Ohio





# SM

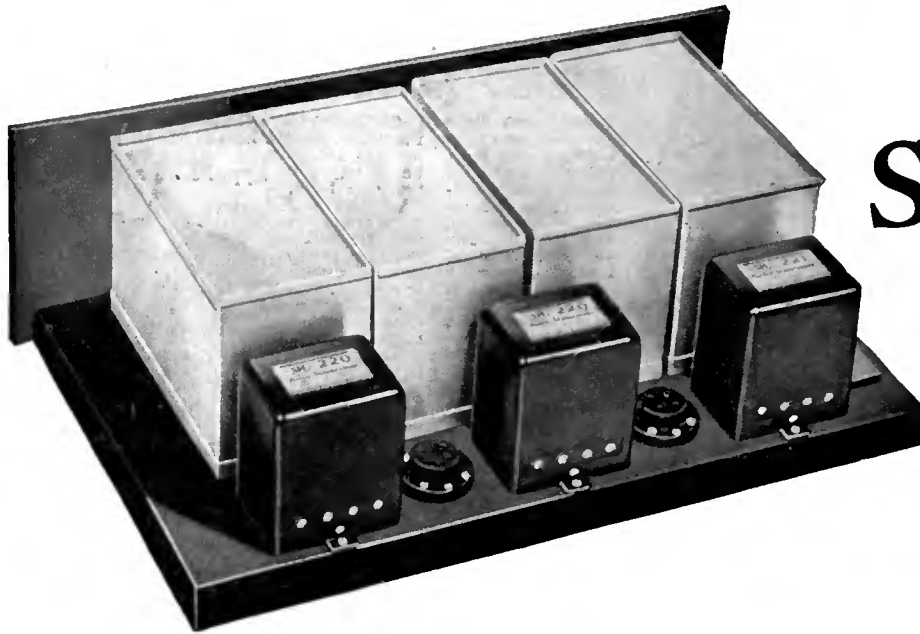

# 630 SILVER SHIELDED SIX

The Radio Broadcast star of approval is on the Shielded Six! In the October issue this remarkable receiver was described at length—approved by the Radio Broadcast laboratory!

The Shielded Six is one of the highest types of broadcast receivers. It embodies complete shielding of all radio frequency and detector circuits. The quality of reproduction is *real*—true to the ear.

Behind the Shielded Six is competent engineering. It is sensitive. Day in and day out it will get distance—on the speaker. It is selective. Local stations in the most crowded area separate completely—yet there are but two dials to tune. These features—its all metal chassis and panel, its ease of assembly and many others, put it in the small class of ultra-fine factory-built sets, priced at several times the Six's cost.

The S-M 630 Shielded Six Kit—including matched and measured parts to build this remarkable receiver—price \$95.00.

The 633 Shielded Six Essential Kit contains four condensers, four radio frequency transformers, four coil sockets, four stage shields and the link motion—all factory matched—price \$45.00.

Clear and complete instructions, prepared by S.M. engineers, go with each kit—or will be mailed separately for 50c.

## 220 & 221 AUDIO TRANSFORMERS



The S-M 220 is the outstanding Audio Transformer that is in demand everywhere and whose popularity has taxed in the severest way the manufacturing facilities of Silver-Marshall, Incorporated. It is the audio amplifying device that has created a new standard by which the merits of audio transformers are measured. It is the first transformer with the rising low note characteristic that means real quality—not theoretic-

ally—but to the human ear. It is a power job—yet this finest of audio amplifying devices is sold with a guarantee for but \$6.00.

The S-M 221 is an Output Transformer that improves low note reproduction in any set. It is for use between the last audio tube and the loud speaker. It eliminates blasting and will increase speaker capacity for handling strong signals without distortion—price \$6.00.

*Prices 10% higher West of the Rockies*

## SILVER-MARSHALL, Inc.

838 W. JACKSON BLVD.

★  
CHICAGO, U. S. A.



# Your program starts with a snap—

It does if your "snap" judgment is good! Because good reception demands lively batteries. And that's what you get when you snap on your Rectigon to do your charging. The time to start bringing in tomorrow's snappy program is tonight—after the last station signs off. You just plug into the light socket and attach the terminals. That keeps your batteries at their peppy best. That saves service station bother. And you'll never be caught with batteries run down, or absent for charging when the week's best program is on the air.

## when you charge 'em at home with

# The Westinghouse Rectigon Battery Charger

©, 1927, W. E. & M. Co.

No noise as it charges—not a bit of fuss. Not even a murmur that would disturb the mildest slumber.



No acids, no chemicals—no moving parts—nothing to spill or burn. No muss, no worry. You'll have no spoiled rugs, no ruined clothing.



Saves its cost in short order—Count the dollars spent in a few trips to the service station and you'll hotfoot it for a Rectigon, for the good it does your pocketbook as well as your batteries.



Charges both "A" and "B" batteries—Keeps both packed with power. Bulb is used for "B" battery charging and is enclosed, like all other parts, in metal, safe from accident. (Rectigon charges automobile batteries, too.)



Perfect safety for your set—If you tune in while you're charging there'll be no harm either to set or batteries. Nor will batteries be discharged if anything happens to the current while your Rectigon's attached.



THE RECTIGON is a superb Westinghouse product. Things you *can't* see, like extra heavy insulation, things you *can* see, like the durably enameled case—all are of highest quality. Westinghouse also manufactures a complete line of radio instruments, and Micarta panels and tubes.

WESTINGHOUSE ELECTRIC & MANUFACTURING CO.

Tune in on KDKA - KYW - WBZ - KFKX

Digitized by Microson

★ Examined and approved by RADIO BROADCAST ★

No Storage Battery Radio is Complete Without a Rectigon