

PUBLIC LIBRARY
GARDEN CITY

RADIO BROADCAST

VOLUME X

NOVEMBER, 1926, to APRIL, 1927



GARDEN CITY NEW YORK

DOUBLEDAY, PAGE & COMPANY

1927

INDEX

(*Illustrated Articles. Editorials in Italics)

PAGE		PAGE		PAGE
<p>* A. C. as a Filament Supply Source (B. F. Miessner) 393, 495 A. C. Filament Lighting, The Problems of (C. T. Burke) 516 * A. C. Operated Amplifier Power Supply Devices (James Millen) 381 * Additional Notes on the R. B. "Lab" Receiver (John B. Brennan) 178 <i>Additional "Talking Mo ies"</i> 256 * Amplifier and A. C. Operated Power-Supply Unit, A Combined (James Millen) 284 * Amplifier for the R. B. "Lab" Receiver A High Quality (John B. Brennan) 467 * Amplifier Power Supply Device, Constructing a (James Millen) 489 * And Now, We See by Radio (A. Dinsdale) 139 <i>Announcing the National Broadcasting Company</i> 147 <i>Another Triumph for Short Waves—The Beam System</i> 256 * Antenna Mast Installation (W. T. Mitthoff) 308 * Apparatus, New 176 * As the Broadcaster Sees It (Carl Dreher) 57, 180, 277, 389, 483, 577 * Atwater Kent Model 20 Receiver, Modernizing the (James Millen) 50 * Audio Channels for the Browning-Drake Receiver 164 <i>Australia, Radio Strides in</i> 25</p> <p>* BATTERY Transmitters, High Efficiency (Keith Henney) 32 * B Power-Supply Devices, What You Should Know About (Edgar H. Felix) 477 * B Supply Device Relay (H. N. Streit) <i>Beam System, The—Another Triumph for Short Waves</i> 256 Book Reviews: <i>American Announcer and Radio Log, The</i> 326 <i>Audio Amplification</i> (H. E. R.) 436 <i>Emil Berliner: Maker of the Microphone</i>, by Frederick William Wile (John Mills) 498 <i>How to Use Resistance in Radio</i> (K. B. H.) 611 <i>Practical Physics</i>, Black & Davis (Edgar H. Felix) 324 <i>Radio Amateur's Handbook</i> (Keith Henney) 611 "Radio Broadcasting," Encyclopoedia Britannica, by Carl Dreher (Edgar H. Felix) 200 <i>Radio Key Book, The</i> (K. B. H.) 612 <i>Sam 'N' Henry</i>, Correll & Gosden (John Wallace) 438 <i>Seventeen Ways to Improve Your Set</i> (K. B. H.) 611 <i>Weather for Radio Listeners, Broadcasters and Others, The</i> by Eugene Van Cleef (Keith Henney) 498 <i>You're On the Air</i>, Graham McNamee 96 <i>Bringing Classical Music to the People</i> 359 <i>British Broadcasting, Changes in the Regulation of</i> 24</p>	<p><i>British Telephone Circuits, "Cross Talk" in</i> 26 <i>Broadcasting Offers No Real Competition to the Newspapers, Why</i> 146 <i>Broadcasting Tax System, Failures in the Broadcasting, The Future of Commercial Broadcasting? Who Will Endow</i> 357, 465, 257 * Browning-Drake Receiver, Audio Channels for the 164 * Building the R. G. S. Inverse-Duplex Receiver (David Grimes) 480 <i>Bureau of Standards, Constructive Work by the</i> 358 <i>Bureaucratic Meddling with Broadcasting</i> 359</p> <p>CABLE Companies Look on Radio, How the 359 <i>Can a Law Prevent News from Being Heard by Radio?</i> 24 <i>Canadian Radio, Well Administered</i> 558 <i>Changes in the Regulation of British Broadcasting</i> 24 * Combined Amplifier and A. C. Operated Power-Supply Unit, A (James Millen) 284 <i>Commercial Broadcasting, The Future of Conflicting Radio Standards</i> 465, 558 * Constructing a D. C. Amplifier Power Supply Device (James Millen) 580 * Constructing an Amplifier Power Supply Device (James Millen) 489 * Constructing the R. B. "Lab" Receiver (John B. Brennan) 35 Constructive Work by the Bureau of Standards 358 * Converting Wavelength to Frequency (Charles F. Felstead) 204 <i>Coolidge Cathode Ray Tube, The Marvels of the</i> 256 <i>Course of Patents in Dispute, The</i> 257 <i>Courts Aid in the Radio Triangle, The Critical Hours for the Broadcasting Industry</i> 23 "Cross Talk" in British Telephone Circuits 26 * Crystals, Piezo-Electric (M. Thornton Dow) 263</p> <p>DANGER of Monopoly in Broadcasting 465 <i>Deliver Us from Excess Broadcasting Stations</i> 555 <i>Dempsey-Tunney Fight, The—A Dangerous Precedent</i> 149 <i>Department of Commerce Should Control Radio, Why the</i> 255</p> <p>* EDUCATE the Masses! (J. Andrew White) 166 * Electrifying the "Hi-Q" Receiver (Leslie G. Biles) 470 * Epsom Salts Offered as a Storage Battery Panacea 196 * Equipment for the Home Constructor (The Laboratory Staff) 493, 604 * Equipment, New 48, 282, 410 <i>Excess Broadcasting Stations, Deliver Us from</i> 555 * Experiments on One Meter, Some (Howard E. Rhodes) 361</p>	<p>FAILURES in the Broadcasting Tax System 357 <i>Field-Intensity Measurements, Interesting</i> 558 Filament Lighting, The Problems of A. C. (C. T. Burke) 516 * Filament Supply Source, A. C. as a (B. F. Miessner) 393, 495 * Filter System for Cone Speaker (W. H. Grasel) 304 * Five-Tube Non-Oscillating Receiver, A (T. H. Nakken) 487 Fixed Condensers, Testing (K. Blaine) 304 <i>Foreign Lands, Radio Events in</i> 150 * Four-Tube "Lab" Receiver, A (John B. Brennan) 368 * Freshman "Masterpiece"? Have You an Old Type (Kingsley Welles) 563 * Fundamental Analysis of Loud Speakers, A (John F. Nielsen) 587 * Further Comments on the R. B. "Lab" Receiver (The Laboratory Staff) 560 * Further Notes on the Inverse Duplex System (David Grimes) 365 <i>Future of Commercial Broadcasting, The</i> 465</p> <p>* GETTING the Most from Your Milliammeter (Homer S. Davis) 304</p> <p>* HANDY Reference Book, A (Ronald W. Klinck) 306 * Have You an Old Type Freshman "Masterpiece"? (Kingsley Welles) 563 * High Efficiency B Battery Transmitters (Keith Henney) 32 * High Quality Amplifier for the R. B. "Lab" Receiver, A (John B. Brennan) 467 * "Hi-Q" Improvements, Some (John B. Brennan) 584 * "Hi-Q" Receiver, Electrifying the (Leslie G. Biles) 470 * "Hi-Q" Receiver, The (Leslie G. Biles) 274 * Home Constructor, Equipment for the (The Laboratory Staff) 493, 604 <i>Hoover As Czar of Radio? Why Not</i> 148 How a Low Barometer Affects Radio (Eugene Van Cleef) 152 <i>How the Cable Companies Look on Radio</i> 359 How the Radio Trade Mark Is Protected (Leo T. Parker) 320 <i>How They Solve Interference Problems Abroad</i> 359 * How to Construct a Two-Tube Shielded "Lab" Receiver (John B. Brennan) 289 * Hundred-Billion-Dollar Vacuum Tube, The (James Stokley) 251</p> <p>ILLINOIS Section Stations Transmitting Weather Reports, Etc. 100 * Increasing Selectivity, A Way of (Harold Jolliffe) 84 <i>Interesting Field-Intensity Measurements Interesting Things Said Interestingly</i> 27, 151, 259 <i>Interesting Naval Radio Tests</i> 25 * Inverse-Duplex Receiver, Building the R. G. S. (David Grimes) 480 * Inverse-Duplex System, Further Notes on the (David Grimes) 365</p>		

INDEX—Continued

	PAGE		PAGE		PAGE
*Inverse-Duplex System, The New (David Grimes).....	266	*Milliammeter, Getting the Most from Your (Homer S. Davis).....	304	<i>Radio Standards, Conflicting</i>	558
*JUDGING the Tubes You Buy (Edgar H. Felix).....	574	*Modernizing the Atwater Kent Model 20 Receiver (James Millen).....	50	<i>Radio Strides in Australia</i>	25
*KEEPING Radio Frequency Currents from the Audio Circuit (H. D. Hatch).....	308	<i>Monopoly in Broadcasting, Danger of Month In Radio, The</i>	464	<i>Reducing Interference in the Ether, Ways of</i>	257
Key to Recent Radio Periodicals, A (E. G. Shalkhauser).....	88, 210, 310, 420, 520, 606	<i>More About Toll Broadcasting</i>	26	<i>Remarkable Short-Wave Transmission Russia, The Progress of Radio in</i>	466
*LAB" Receiver, A Four-Tube (John B. Brennan).....	368	<i>NAVAL Radio Tests, Interesting</i>	25	<i>SCHEDULE of Time, Weather, and Press Signals</i>	202
*Laboratory Information Sheets:		<i>Network System Grows, The</i>	558	*Selectivity, A Way of Increasing (Harold Jolliffe).....	84
A. C. Operated Power Amplifier, An.....	500	*New Apparatus.....	176	*Shielded Dual Control Receiver, Notes on the (McMurdo Silver).....	386
A. C. Operated Power-Supply Devices.....	408	*New Equipment.....	48, 282, 410	*Short Wave Activity at the Laboratory (Keith Henney).....	175
Antenna Power Dissipation ..	302	*New Equipment, Practical Applications of Some (The Laboratory Staff).....	378	*Short-Wave Super-Heterodyne Receiver, A (George J. Eltz, Jr.).....	54
Audio Amplifier Systems.....	603	*New Inverse Duplex System, The (David Grimes).....	266	<i>Short-Wave Transmission, Remarkable Short Waves Are Not Needed, Where ... Should News Be Broadcast?</i>	465
C Battery Detector.....	194	*New "Universal" Receiver, The (Howard E. Rhodes).....	154	<i>Single-Tube Receiver That Won't Radiate</i>	149
C Voltages.....	602	*Non-Oscillating Receiver, A Five-Tube (T. H. Nakken).....	487	<i>Single-Tube Receiver That Won't Radiate</i>	169
Characteristics of Tubes.....	504	*Notes on the Inverse Duplex System, Further (David Grimes).....	361	*Six Tube Super-Heterodyne, A (Kendall Clough).....	260
Curves for the UX-171 Tube.....	406	*Notes on the Shielded Dual Control Receiver (McMurdo Silver).....	386	*Some Experiments on One Meter (Howard E. Rhodes).....	361
Double-Impedance Coupled Amplifier, A.....	603	*Now, I Have Found:.....	304, 306, 308	*Some "Hi-Q" Improvements (John B. Brennan).....	584
Dual-Impedance Coupled Amplifier Circuit Diagram, A.....	603	PATENTS:		<i>Somebody Should Give Edison a Good Radio Set</i>	147
Field Intensity Measurements.....	80	How the Radio Trade Mark is Protected (Leo T. Parker).....	320	*Storage Battery Panacea, Epsom Salts as a.....	196
Filter Circuit Data.....	300	<i>How the Radio Trade Mark is Protected (Leo T. Parker)</i>	320		
Frequency Ranges of Musical Instruments.....	192	<i>Patents in Dispute, The Course of</i>	257	TECHNICAL and Scientific Aspects of Broadcasting, The (Ralph Bown)	63
Gang Condenser, The.....	302	*Radio Patent Structure and What It Means, The (French Strother).....	19	*Television: Europe or America First? (Edgar H. Felix).....	459
Hard and Soft Vacuum Tubes Index.....	82	*What the Future Holds for the Radio Industry (French Strother).....	144	Testing Fixed Condensers (K. Blaine).....	304
Interference Elimination.....	502	*Piezo-Electric Crystals (M. Thornton Dow).....	263	Time, Weather, and Press Signals, Schedule of.....	202
Interference Finder.....	502	*Plan to Regulate Radio Broadcasting, A New (Carl Dreher).....	57	<i>Toll Broadcasting, More About</i>	26
Interference Finder (Circuit Diagram).....	502	Plate Current Burns Out Tubes (R. P. Worden).....	304	*Turkey, Radio in (M. Mazloum).....	416
Intermediate Frequency Amplifier, The.....	300	*Practical Applications of Some New Equipment (The Laboratory Staff).....	378	*20-40-80-Meter Transmitter, A (Keith Henney).....	570
Line Power-Supply Devices.....	302	<i>Praiseworthy Work by the Victoria B. C. Radio Club</i>	26	USELESS Newspaper Radio Program, The	357
Loud Speakers.....	82	Press, Weather, and Times Signals.....	514	Unfortunate Radio Publicity in the Press.....	25
Ohm's Law.....	596	<i>Problems for the Radio Commission</i>	465	*"Universal" Receiver, The New (Howard E. Rhodes).....	154
Oscillating Control.....	596	Problems of A. C. Filament Lighting, The (C. T. Burke).....	516	*WAVELENGTH to Frequency, Converting (Charles F. Felstead).....	204
Overtones (Harmonics).....	192	<i>Progress of Radio in Russia, The</i>	149	*Way of Increasing Selectivity, A (Harold Jolliffe).....	84
Push-Pull Amplification.....	408	<i>Punishment for the Defenseless Ether</i>	557	<i>Ways of Reducing Interference in the Ether</i>	257
R. B. "Local" Receiver, The.....	80	*R. B. "Lab" Receiver, A High Quality Amplifier for the (John B. Brennan).....	467	<i>Weak Radio Listener "Organization," The</i>	558
Radio Frequency Oscillator, A.....	404	*R. B. "Lab" Receiver, Additional Notes on the (John B. Brennan).....	178	<i>Welcome to the Radio Commission</i>	555
Radio Telegraph Transmission.....	194	*R. B. "Lab" Receiver, Constructing the (John B. Brennan).....	35	<i>Well Administered Canadian Radio</i>	558
Regulating Voltage on B Power Supply Device.....	504	*R. B. "Lab" Receiver, Further Comments on the (The Laboratory Staff).....	560	What the Future Holds for the Radio Industry (French Strother).....	144
Resistance-Coupled Amplifiers.....	500	*R. G. S. Inverse-Duplex Receiver, Building the (David Grimes).....	480	*What You Should Know About B Power-Supply Devices (Edgar H. Felix).....	477
Shunts.....	192	"Radio Broadcast" Technical Information Service, The.....	98, 218, 318, 434, 528	<i>Where Short Waves Are Not Needed</i>	149
Sources of Electrons.....	406	"Radio Broadcast's" Laboratory Information Sheets (See Laboratory)	78, 190, 298, 404, 500, 596	<i>Where the WEAFA Audience Is Supposed to Be</i>	148
Super-Heterodyne, The.....	78	<i>Radio Commission, Problems for the</i>	465	<i>Who Can Tell What Is the "Best Radio Set"?</i>	257
Super-Regeneration.....	78	<i>Radio Commission, Welcome to the</i>	555	<i>Who Will Endow Broadcasting?</i>	257
Trickle Chargers.....	190	<i>Radio Events in Foreign Lands</i>	150	<i>Why Broadcasting Offers No Real Competition to the Newspaper</i>	146
Tube Characteristics.....	406, 602	<i>Radio Fills Empty Church Pews</i>	359	<i>Why Not Hoover as Czar of Radio?</i>	148
Tuning the Antenna Circuit.....	194	*Radio in Turkey (M. Mazloum).....	416	<i>Why Short Waves Should Not Be Opened to Broadcasting</i>	356
UX-120 Tube Characteristic Curve, The.....	602	<i>Radio Industry, The Lethargic</i>	558	<i>Why the Department of Commerce Should Control Radio</i>	255
UX-171 and UX-210, The.....	298	Radio Industry, What the Future Holds for the (French Strother).....	144	<i>Why the Poor Engineer is Poor</i>	360
Vacuum Tube Voltmeter, The.....	404	<i>Radio Leads to Another Technical Advance</i>	257	*With MacMillan to the Arctic (Austin G. Cooley).....	551
Volt, Ampere, and Ohm, The.....	504	<i>Radio Listener "Organization," The Weak</i>	558		
What Are Harmonics?.....	300	*Radio Patent Structure and What It Means, The (French Strother).....	19		
What Is Resonance?.....	298	<i>Radio Regulation in the Great Game of Politics</i>	463		
<i>Lethargic Radio Industry, The</i>	558				
Letters from Readers.....	206, 296, 613				
*Linking Continents With Twenty Kilowatts (Kenneth B. Humphrey).....	351				
*Listeners' Point of View, The (John Wallace).....	43, 159, 269, 374, 473, 566				
*Looking Back Over Thirty Years of Radio (Guglielmo Marconi).....	28				
*Looking for Trouble? (Edgar H. Felix).....	372				
*Loud Speakers, A Fundamental Analysis of (John F. Nielsen).....	587				
MANUFACTURERS' Booklets Available	322, 412, 510, 609				
*March of Radio, The.....	23, 146, 255, 356, 463, 555				
<i>Marvels of the Coolidge Cathode Ray Tube, The</i>	256				
*"Masterpiece"? Have You an Old Type Freshman (Kingsley Welles) ..	563				

AUTHORS

Biles, Leslie G.....	274, 470
Blaine, K.....	304

INDEX—Continued

	PAGE		PAGE		PAGE
Bouck, Zeh	169	Shalkhauser, E. G.	88, 210, 310, 420, 520, 606	Ganley, Gertrude O'Neill	374
Bown, Ralph	63	Silver, McMurdo	386	Goldsmith, Alfred N.	278
Brennan, John B.	35, 178, 289, 368, 467, 584	Stokley, James	251	Hallberg, J. H.	361
Burke, C. T.	516	Streit, H. N.	308	*Hedges, William S.	259
Clough, Kendall	260	Strother, French	19, 144	*Horn, C. W.	151
Cooley, Austin G.	551	Van Cleef, Eugene	152	*Jenkins, C. Francis	23
Davis, Homer S.	304	Wallace, John	43, 159, 269, 374, 438, 473, 566	Junkin, George	375
Dinsdale, A.	139	Welles, Kingsley	563	Langmuir, Irving	250
Dow, M. Thornton	263	White, J. Andrew	166	*Lauder, Harry	27
Dreher, Carl	57, 180, 277, 389, 483, 577	Worden, R. P.	304	Loy, Myrna	567
Eltz, George J., Jr.	54			McIntosh, Burr	568
Felix, Edgar H.	200, 324, 372, 459, 477, 574			*Macdonald, J. Ramsey	27
Felstead, Charles F.	204			MacMillan, Donald B.	174
Grasel, W. C.	304			Marconi, Guglielmo	30
Grimes, David	266, 365, 480			Meehan, Louis	375
Hatch, H. D.	308			Metcalf, Rowe B.	552
Henney, Keith	32, 175, 498, 570			Peterson, Alma	271
Humphrey, Kenneth B.	351			Pickford, Mary	163
Jolliffe, Harold	84			Popenoe, Charles B.	159
Klinck, Ronald W.	306			*Pupin, Michael	559
Marconi, Guglielmo	28			Redmond, Aidan	43
Mazlum, M.	416			*Reith, J. C. W.	150
Miessner, B. F.	393, 495			Smith, Fred	375
Millen, James	50, 284, 381, 489, 580			Steindorff, Paul	568
Mills, John	498			Stradtman, William N.	46
Mithoff, W. T.	308			Talmadge, Norma	459
Nakken, T. H.	487			Weinberger, Julius	280
Nielsen, John F.	587			*Wendt, Gerald	559
Parker, Leo T.	320			Whitney, Willis R.	250
Rhodes, Howard E.	154, 361			*Williams, Arthur	466
				*Worden, Ralph P.	360

PORTRAITS

(*Portraits in "The March of Radio")

*Arnold, Frank A.	557
Austin, L. W.	184
Baird, John L.	139, 142, 143
Barthelson, Joy	474
Bernard, Don	474
*Bramwell, William Calvert	464
Browne, Kathryn	271
*Bruck, H. T.	257
*Burgess, George K.	256
*Burton, Charles W.	258
Bussey, Eugene	175
Coolidge, W. D.	250
Crawford, Inga	473
Crookes, William	251
*Davis, George S.	256
*Dellinger, J. H.	256
*Dunlap, Orrin E. Jr.	151

\$29⁰⁰

Console with Cone Loudspeaker Ready for Your Set and Batteries

(West of the Rockies \$35)

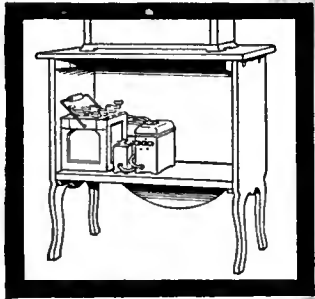

Rear view showing large compartment providing ample space for all batteries, battery charger or battery eliminator. These are entirely concealed from view. The back is open for ventilation of batteries.

MODEL 200 with 22-inch Cone

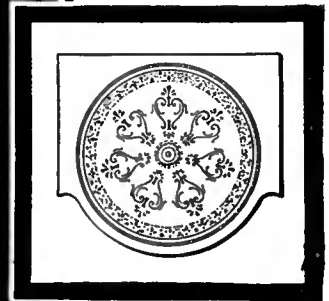

The Cone Loudspeaker, with its Spruce sounding board, is quickly and easily removable, allowing instant access to all batteries, battery eliminator or other equipment a.c. wiring.

MODEL 200 with 22-inch Cone



A Revelation in Radio Reproduction

AT LAST—a cone loudspeaker that reproduces *all* the tones as they are broadcast. From the deep voiced tuba of an orchestra to the softest note of a vocal solo—*every* tone—*every* sound is reproduced in all its beauty, just as it entered the microphone.

* *

This 22-inch Windsor Cone Loudspeaker, with its spruce sounding board, will reproduce the softest crooning lullaby in a softly lighted room, or the full throated march music of a band in an auditorium—both with perfect fidelity of sound and tone.

* *

The Windsor Cone Loudspeaker Console is the greatest value in the

world of radio. When compared with the average cost of cone-type loudspeakers of even smaller size, the cost of the complete Windsor—cone loudspeaker, spruce sounding board, and console—is amazingly low.

* *

As a piece of furniture, the Windsor Cone Loudspeaker Console is of such manifest high quality and attractive design as to be a welcome addition to any home. Finished in Mahogany or Walnut.

* *

The Windsor Cone and Horn Loudspeakers, combined with attractive pieces of furniture in many models, are being demonstrated by recognized dealerseverywhere.

Go to your dealer today and examine this astonishing new Cone Loudspeaker Console. If he happens not to have one, write to us and we will tell you the name of the nearest store at which you can see and hear one.



Note to Dealers Write or wire today for details of the highly profitable Windsor selling franchise

WINDSOR FURNITURE COMPANY
World's Largest Manufacturers and Originators of Loudspeaker Consoles
1412 Carroll Avenue Chicago, Illinois
Los Angeles Branch—917 Maple Avenue

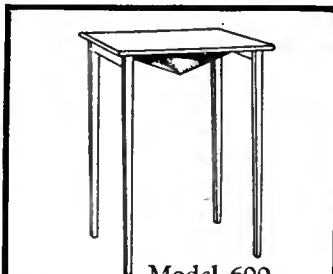

Model 600

With 16-inch Cone (Pat. applied for)
This 20 by 17-inch Cone Loudspeaker Table has suspended from the underside of the top a 16-inch Windsor Cone Loudspeaker. Placed in any part of a room, it fills the room with music just as an inverted electric lamp floods the room with light. Finished in Mahogany \$19 or Walnut. Price (West of Rockies, \$23.00)

WINDSOR FURNITURE COMPANY
Electrical Department
1412 Carroll Avenue, Chicago, Illinois

Send me FREE and without obligation circulars of the Windsor line of Cone and Horn Loudspeakers combined with pieces of furniture, and name of nearest dealer:

Name.....
Address.....
City..... State.....
Dealer's Name

RADIO BROADCAST

WILLIS K. WING, Editor

NOVEMBER, 1926

KEITH HENNEY
Director of the Laboratory

JOHN B. BRENNAN
Technical Editor

Vol. X, No. 1

CONTENTS

Cover Design	From a Painting by Fred J. Edgars	
Frontispiece	A 1914 Model Radio Telephone Transmitter	18
The Radio Patent Structure and What it Means	French Strother	19
The March of Radio	An Editorial Interpretation	23
Looking Back Over Thirty Years of Radio	Guglielmo Marconi	28
High-Efficiency B-Battery Transmitters	Keith Henney	32
Constructing the R. B. "Lab" Receiver	John Brennan	35
The Listeners' Point of View	John Wallace	43
New Equipment		48
Modernizing the Atwater Kent Model 20 Receiver	James Millen	50
A Short-Wave Super-Heterodyne Receiver	George J. Eltz, Jr.	54
A New Plan to Regulate Radio Broadcasting	Carl Dreher	57
"As the Broadcaster Sees It"		
The Technical and Scientific Aspects of Broadcasting	Ralph Bown	63
"RADIO BROADCAST's" Laboratory Information Sheets		78
No. 41. The Super-Heterodyne		
No. 42. Super-Regeneration		
No. 43. Field Intensity Measurements		
No. 44. The R. B. "Local" Receiver		
No. 45. Diagram of the R. B. "Local" Receiver		
No. 46. Loud Speakers		
No. 47. Index		
No. 48. Index		
A Way of Increasing Selectivity	Harold Jolliffe	84
A Key to Recent Radio Articles	E. G. Shalkhauser	88
Book Review		96
You're On The Air, Graham McNamee		
The "Radio Broadcast" Technical Information Service		98
Illinois Section Stations Transmitting Weather Reports, Etc.		100

BEHIND EDITORIAL SCENES

THE October RADIO BROADCAST—the Metropolitan Shows number—was extremely well received at the New York and Boston radio shows and many were the sweet words of praise sung into our editorial ear. In point of content and quality, that issue is one of the most impressive of any radio magazine. And in the present number, there is a fine array of extremely interesting and valuable articles. Perhaps the one which will excite the widest interest is Mr. French Strother's, on the radio patent situation. No effort has been spared to make this series on the radio industry as accurate and correct as possible. More general uncertainty and lack of definite knowledge surrounds the radio patent question than perhaps any other branch of radio. The clarity of this article makes it extremely interesting and valuable.

SENATORE MARCONI sketches in his own words in the article beginning on page 28 how wireless and radio have altered since the day of his earliest experiments. Particularly interesting is what he has to say about the courage it required to recommend the superseding of all the elaborate and expensive long-wave equipment for the short-wave beam. . . . The long awaited constructional article on the R. B. "Lab" circuit begins on page 35 and we are confident that our readers will find here a remarkably complete constructional article on a remarkable receiver. That set we are not hailing as a positive miracle in radio design; that is not either wise or necessary. But the design and operation of the outfit alike speak sufficiently for it. . . . A short-wave super-heterodyne has been the goal of many an amateur's designing efforts. On page 54, George J. Eltz, Jr. describes such an outfit which Major Armstrong said was to his mind about the ultimate in receiver design. The set on a small loop picked up Australian signals and while the world remains what it is, you can't go any farther than that. . . . James Millen has a helpful and complete article on how to modernize the Atwater Kent Model 20 which should interest radio service men and the many owners of that Model.

RADIO BROADCAST for December will feature the third of French Strother's radio industry articles which attempts to indicate whither radio is drifting. Also the first of a series of constructional articles will start, describing a new and completely revised model of that very popular receiver, the RADIO BROADCAST Universal. Many of the old parts can be used in this improved model. Glenn H. Browning, the co-producer of the Browning-Drake circuit, has written a highly interesting article telling something about the various Browning-Drake circuits which have been presented to the set constructing public. He hopes to give the many who are confused as to what model to build, something to guide them, for it must be admitted that some of the claims we have seen for various models of the circuit are a bit confusing. It is going to be a good December number.

—WILLIS K. WING.

Doubleday, Page & Co.
MAGAZINES

COUNTRY LIFE
WORLD'S WORK
GARDEN & HOME BUILDER
RADIO BROADCAST
SHORT STORIES
EDUCATIONAL REVIEW
LE PETIT JOURNAL
EL ECO
THE FRONTIER
WEST

Doubleday, Page & Co.
BOOK SHOPS

(Books of all Publishers)
NEW YORK: { LORD & TAYLOR BOOK SHOP
PENNSYLVANIA TERMINAL (2 SHOPS)
38 WALL ST. AND 166 WEST 32ND ST.
GRAND CENTRAL TERMINAL
ST. LOUIS: { 223 NORTH 8TH STREET
4914 MARYLAND AVENUE
KANSAS CITY: { 920 GRAND AVENUE
206 WEST 47TH STREET
CLEVELAND: HIGBEE CO.
SPRINGFIELD, MASS.: MEEKINS, PACKARD & WHEAT

Doubleday, Page & Co.
OFFICES

GARDEN CITY, N. Y.
NEW YORK: 285 MADISON AVENUE
BOSTON: PARK SQUARE BUILDING
CHICAGO: PEOPLES GAS BUILDING
SANTA BARBARA, CAL.
LONDON: WM. HEINEMANN, LTD.
TORONTO: OXFORD UNIVERSITY PRESS

Doubleday, Page & Co.
OFFICERS

F. N. DOUBLEDAY, *President*
A. W. PAGE, *Vice-President*
NELSON DOUBLEDAY, *Vice-President*
RUSSELL DOUBLEDAY, *Secretary*
S. A. EVERITT, *Treasurer*
JOHN J. HESSIAN, *Asst. Treasurer*

DOUBLEDAY, PAGE & COMPANY, Garden City, New York

Copyright, 1926, in the United States, Newfoundland, Great Britain, Canada, and other countries by Doubleday, Page & Company. All rights reserved.

TERMS: \$4.00 a year; single copies 35 cents.

RADIO BROADCAST

VOLUME X



NUMBER 1

NOVEMBER, 1926

The Radio Patent Structure and What It Means

There Are Twenty-four Hundred Radio Patents on Every Conceivable Subject—Who Owns the Basic Patents and What They Are—Radio Patents Give Non-Technical Jurists Difficulty—Does Control of Basic Patents Mean Monopoly?—The Second of a Series of Articles on the Industry

By FRENCH STROTHER

THE patent situation in radio is almost unbelievably complicated. There are twenty-four hundred American patents in force in this field, and unnumbered applications are still pending in the Patent Office. Everything that the most ingenious inventors have been able to think of to date has been covered; and every new idea, however unimportant it may seem at the moment, is at once made the basis of a new patent application, in the hope that some shift in the current of the radio art will make it more important tomorrow.

Not only are basic elements in radio patented, but the various ways in which these basic elements may be combined are also patented. Physical objects, such as tubes, are patented; methods of using physical objects, such as the various "circuits," are patented; the methods of making the physical objects, such as the ways of exhausting the air in a tube, are patented.

Thus, materials, methods, ideas, combinations of ideas, combinations of methods—all are involved in a maze of conflicting patents, owned by different (often antagonistic) inventors and their licensees or vendees or heirs. On top of this complex condition rests a mountain of patent litigation—hundreds of lawsuits, by almost everybody against almost everybody else.

Nobody in the radio field today can do anything and be sure that he is not violating somebody else's legal rights. Painstaking

investigation is absolutely essential. Not even the Radio Corporation of America can be sure, though it is credited with owning anywhere from 50 per cent. to 90 per cent. of the useful radio patents. A patent does not protect against another patent, which the courts may later decide really covers a certain way of doing a certain thing. No patent is of any certain value until the courts have passed upon it. The Patent Office is a bureau of technically and legally trained men who search the records of the past and certify that, in their opinion, the new device offers either a new method or a new principle. The moment the owner of such a certificate, or patent, tries to make money by operating under it, he comes into the field of the rights of property, in other patents and no property right is finally settled, against an opposing claimant, until the courts have decided which claimant owns it.

The future of radio, therefore, so far as

patents affect it, is in the hands of the courts.

Now nothing that is about to be said about the courts is intended as criticism. Nobody questions for a moment the fact that the hard-working Federal judges have any thought but justice in their minds. Nevertheless, Federal judges are human beings, fallible even in their special field of law; and they are not to be blamed if they are even more likely to err in the field of complicated electrical theory that embraces radio. Thus it has more than once happened that these courts have finally awarded property rights in patents beyond appeal, when the general body of technical electrical experts did not believe these rights belonged to the successful litigant.

There is, therefore, a double uncertainty in the validity of many valuable radio patents. There is first the uncertainty whether one way of doing a thing really involves a difference in electrical theory, from another way of doing the same thing.

And there is the second uncertainty whether the Federal Courts will correctly measure the truth in these cases, where even the electrical experts are still in doubt. A judge, sufficiently versed in the technique of radio to make an unquestionably fair decision would have to be twenty years a radio engineer and would therefore be biased anyhow.

In either event, however, it should be borne in mind that what the courts say will settle the matter practically. As in

TO ATTEMPT to untangle the complexities of the radio patent structure is a task almost impossible of successful accomplishment. Yet, to understand the development and the present situation in radio—particularly in the manufacture of broadcast receiving apparatus—one must have a pretty clear comprehension of who owns the important patents, how they are being used, and how that use is apt to affect the buying and selling of radio apparatus. This second article by Mr. Strother—the first appeared in RADIO BROADCAST for October—contains no information not available to one who makes a careful study of facts open to all; it does, however, recite those facts simply and clearly. In addition, the conclusions which the author draws show whither radio is drifting. The third and concluding article of the series will appear in the December RADIO BROADCAST.

—THE EDITOR.

the famous anecdote, "You may doubt, if you will, whether the church can damn you; but if the judge says hang, you hang." You may doubt, if you will, whether the Langmuir patent on extra-high vacuum in a tube is a true invention at all; but if the United States Circuit Court of Appeals ultimately says that it is, you will thereafter make or sell such a tube at your peril of jail for contempt of court.

ALMOST EVERY PATENT HAS ITS DAY IN COURT

THAT example is only one of the hundreds of possibilities involved in the scores of important patent cases now pending in the Federal courts. Nearly every known method of accomplishing radio reception is patented by at least two rival claimants for the exclusive use of that method; and really every article of apparatus is similarly involved in an undecided lawsuit. Most people suppose that the Armstrong regenerative principle is the most strongly entrenched invention in radio, yet De Forest has recently attacked it head-on in the Federal Courts. De Forest was once almost universally believed to have blanketed the tube situation with his patent of the three-element tube, yet to-day De Forest is in legal difficulties in the manufacture or sale of tubes. A dozen manufacturers are making neutrodyne sets under the Hazeltine patents, yet Hazeltine is being sued by the Armstrong licensees on the theory that his neutrodyne circuit involves regeneration, while, from exactly the opposite direction, he was sued by the Radio Corporation on the theory that his neutrodyne circuit did not involve regeneration and therefore infringes Rice and Hartley's neutralizing methods. This situation is brought about by the technical complexities in the construction and use of the radio-frequency amplifier.

The most complicated patent situation of all surrounds the vacuum tube. There are 256 unexpired patents in this field alone covering everything from the relation of the grid to the plate, on to such details as the use of thorium in the making of a tungsten filament, and the various methods of exhausting the air and gases from the bulb.

It would be hopeless to attempt to review all the important radio patents and their tangles in an article like this. The most condensed available statement of them occupies forty-two closely printed pages of the 1923 report of the Federal Trade Commission on the "Radio Industry"—and that statement gives only one side of the story and nowhere near all the details.

A SUMMARY OF THE "KEY" RADIO PATENTS

FOR present purposes, we shall have to be content with a summary view of half a dozen patents that now seem to be "key" patents, controlling various types of receiving sets.

The tube is "the heart of the set," and perhaps the biggest battles of the hour are raging around the tube. Dr. Irving Lang-

muir, of the General Electric Company, filed an application in the Patent Office thirteen years ago, to cover his claim that he invented the idea of using an exceptionally high vacuum to increase the efficiency and lengthen the life of the tube. H. D. Arnold, of the Western Electric Company, made a similar improvement, and these two conflicting applications have been involved in what the Patent Office calls "interferences" ever since. Independent observers insist that the idea and the practice of high vacuum tubes are as old as the tube itself, and the Western Electric Company claims that it is not an "invention" at all—but,

the life and increases the efficiency of the filament. The Coolidge patent covers a practical method of drawing thoriated tungsten wire, and claims to cover the use of such wire. The General Electric Company, owner of the Coolidge patent, has a test case against De Forest pending in the District Federal Court in Delaware. Here, again, a court decision can put all but one manufacturer out of business.

Passing from the tube to the circuit, we come first upon Armstrong's patent covering regeneration. The courts have decided that this invention dominates the vacuum tube oscillator and the regenerative circuit. Armstrong licensed twenty concerns under this patent before selling it to the Westinghouse Electric Company. This patent is about the most securely adjudicated in the whole radio field, but, as remarked above, De Forest has recently attacked it.

The various forms of grid leaks are covered by patents issued to De Forest, and Langmuir. The last named is broad enough, if sustained by the courts, to control this feature absolutely. It is owned by the General Electric Company.

THE IMPORTANT NEUTRALIZATION PATENTS

NEUTRALIZED circuits are covered by patents issued to Hazeltine, Rice, and Hartley. Fourteen licensees are manufacturing sets under the Hazeltine patent. Rice is a General Electric inventor and Hartley (closely associated with the Western Electric Company) inventor. A battle royal is waging here between Hazeltine, independent, and the Radio Corporation as licensee under all General Electric and Western Electric radio patents. The Radio Corporation sought to affirm the Rice and Hartley patents in a suit against the Twentieth Century Company in the Federal Court for the Eastern District of New York; while Hazeltine sought to affirm his patents in a suit against the Electrical Service Engineering Corporation in the Federal Court for the Southern District of New York. The first action by R. C. A. against the Twentieth Century Company was decided in favor of Hazeltine. The action by Hazeltine and his licensees against the Electric Service Engineering Corporation was also won by Hazeltine. Doubtless these cases will ultimately go to the Federal Circuit Court of Appeals.

The Hazeltine patents are also involved in a suit against A. H. Grebe & Company. Here, again, it is possible that the final court decision could rule out of the field all but one patentee.

There are two or three other patents of great present importance, but enough has been said above for our immediate purpose. First, it should be observed that the critical patents today are not the critical patents of a few years ago. With the rapid advance of the art, the control of a basic idea does not rest in the basic patent, but rests in the patent upon some more recent refinement of

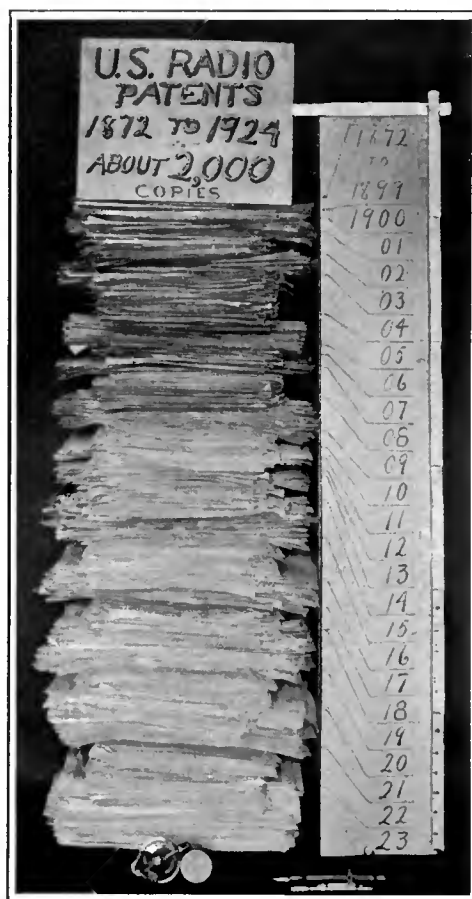

Photograph by R. H. Marriott

U. S. RADIO PATENTS

This stack of patents includes those which have been issued between the years of 1871 and 1924, more than two thousand in all. The picture shows, at the foot of the patents, one of DeForest's first "audions" beside a silver dollar piece. The "audion" has been the cause of some of the costly litigation in radio history. With so many patents, covering every branch of the subject, it is no wonder that decisions concerning patent rights are only arrived at after prolonged legal fray. The stack of patents illustrated is about two feet eight inches high

as noted above, the Circuit Court of Appeals will settle the question some day, and its decision will be law. It could easily put all but one tube manufacturer out of business.

Another tube patent of vital importance is the Coolidge patent, claiming to cover the thoriated tungsten filament. Ordinary tungsten filament soon crystallizes under incandescent heat, and breaks. The addition of thorium considerably lengthens

the basic idea, or upon some new method of manufacturing the device, as in the case of the tube. It thus becomes legally impossible for De Forest to manufacture his own tube unless he has access to the Coolidge method of making the filament. Or it becomes impossible for Armstrong to make a satisfactory regenerative set unless he has access to devices patented by others for controlling the oscillations set up by his system.

The second point to be observed is that, in this process of refinement, the advantage is all on the side of the big corporation as against the small independent company or as against the individual inventor. The reader may here need to be reminded of the systematic method by which invention is stimulated by the large manufacturing corporations whose business depends upon patents. The American Telephone & Telegraph Company, for example, spent nine million dollars last year upon scientific and technical research. The General Electric Company spends several millions yearly. These and similar companies hire inventors almost as they hire book-keepers, and pay them regular salaries. These men are employed to solve definite technical problems as they arise in the course of the company's business. Their work is watched and tabulated with more method and thoroughness than any casual inventor working by himself would be apt to use. Moreover, anything that was patentable would be attended to by the company's patent department, where patent lawyers constantly study the work of the research departments. It may be only a new way

Highlights from this Article

THE future of radio, so far as patents affect it, is in the hands of the courts."

"The most complicated patent situation of all surrounds the vacuum tube. There are 256 unexpired patents in this field alone, covering everything from the relation of the grid to the plate, on to such details as the use of thorium in the making of a tungsten filament, and the various methods of exhausting the air and gases from the bulb."

"The critical radio patents of to-day are not the critical patents of a few years ago. With the rapid advance of the art, the control of a basic idea does not rest in the basic patent, but rests in the patent upon some more recent refinement of the basic idea, or upon some new method of manufacturing the device, as in the case of the tube."

"In the process of refinement, the advantage is all on the side of the big corporation as against the small independent company or as against the individual inventor."

"If patents are the decisive element in the radio situation, the logic of events points to an eventual leadership of the field by the Radio Corporation, with only a possible one or two much smaller groups operating independently under fewer patents. Whether patents are necessarily the decisive element is another question, too broad for discussion here. It will be treated in the next article of this series."

of sealing the glass of a vacuum tube into its socket, or something even less related to radio than that; but this patented refinement may eventually become the commercially decisive thing about radio, either because it may reduce the cost of production vitally or it may produce an article that especially appeals to the public taste.

LITTLE HOPE FOR THE SMALL INVENTOR

IT WILL be deduced, from the foregoing, that the small inventor is scarcely apt to have a controlling power in the present

radio situation. His invention is valuable only as it fits in with one, or perhaps a whole chain, of other inventions controlled by big corporations. He can hardly hope to become an independent manufacturer of anything beyond subsidiary appliances. His market is the corporations already holding numerous other patents. The only exception to this general statement would be the inventor who should devise some method of reception so different in principle from anything now known that he would at once take rank with Hertz plus Marconi or De Forest. Such an invention would revolutionize radio. Also, it should be added, it is extremely unlikely to appear.

Equally to be deduced from what has been said about patent structures, is the fact that even the large independent radio manufacturing companies are at a distinct disadvantage as against the Radio Corporation. Few of the independents have research staffs at all, and none has a staff comparable in size or facilities with those of the main constituent members of the Radio Corporation group, namely, General Electric, American Telephone & Telegraph, Westinghouse, and Wireless Specialty Apparatus Company. As the development of the radio art is now chiefly in the refinement of design and of manufacture of devices already patented, the race for control is a race to invent and patent these refinements. This statement would hold, even if Hazeltine were held by the courts not to infringe Rice and Hartley, for example, or even if De Forest were held not to infringe Armstrong.

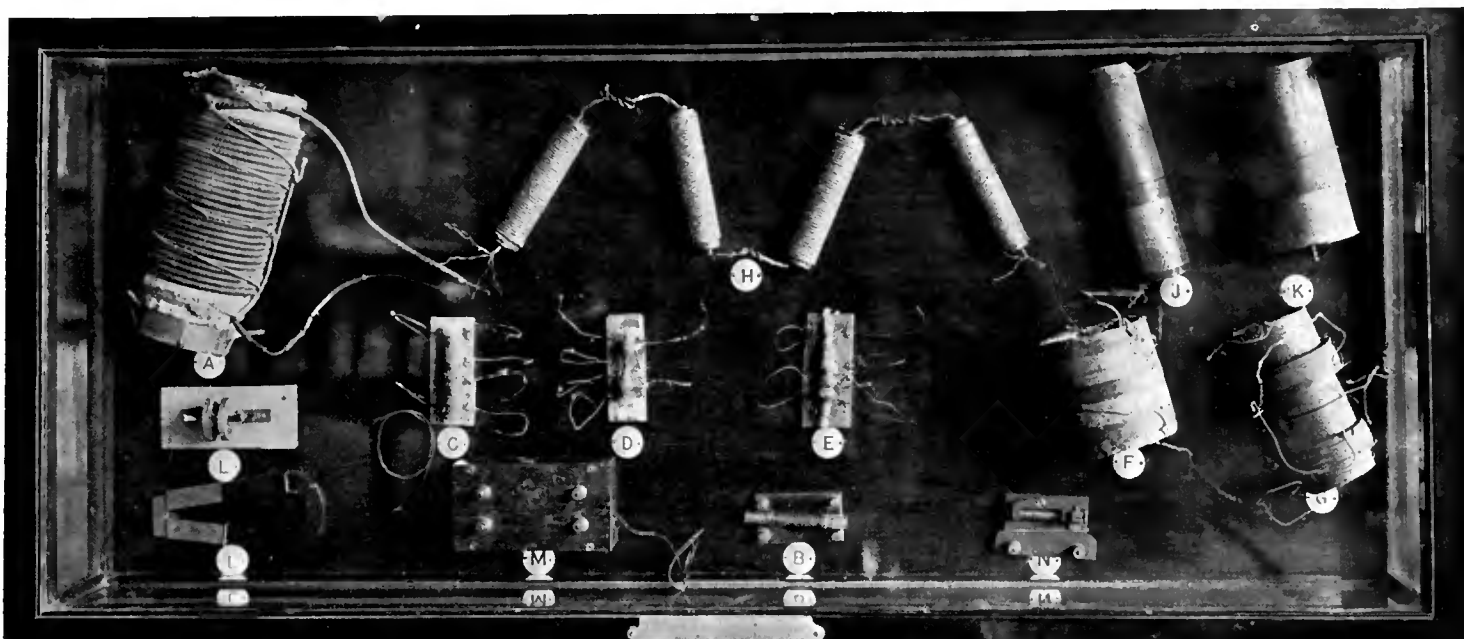

HERE IS SOME OF THE APPARATUS MARCONI PATENTED IN ENGLAND

The various parts in this show case are lettered and identified as follows: (A) Transmitting Jigger, 1900. (B, C, D, E, F, G,) Receiving Jiggers of the years 1898, 1899, 1899, 1900, 1901, various forms. (H) Antenna Tuning Inductance, 1900. (I, J) Aerial Tuning Condensers, 1898. (K) Magnetic Detector, moving magnet, 1902. (L) Magnetic Detector, moving core, 1902. (M) Mercury Iron Detector used for transatlantic reception in Newfoundland, 1901

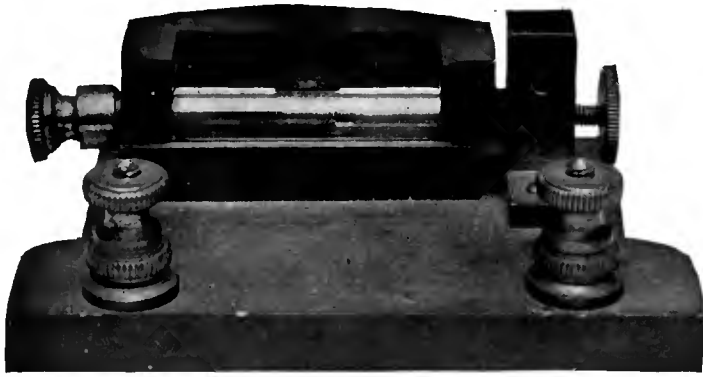

A MARCONI MERCURY AND IRON DETECTOR

Unless, again, that revolutionary new principle of radio reception is discovered. But such a discovery has never been made in any other developing art, so far as the writer can recall. All kinds of steam engines have been devised since Watt first put steam to work, but they all operate on the principle of the expansion of steam. Numerous kinds of internal combustion engines have been devised, but the principle of the expansion of gases is still the key. An art tends to build up from the foundation of the first discovery, and radio has followed the historical precedent of other inventions. It probably will continue to do so.

Finally, it will be observed that the so-called basic patents in radio soon cease to be the controlling factor in the patent structure. Fleming and De Forest are both still living, and their work in tubes made possible everything we mean by the word "radio." The basic De Forest and Fleming patents have expired and yet neither can unrestrictedly manufacture a tube commercially to-day. Two hundred and more patents upon mere details of design and manufacture have taken all commercial value out of their fundamental ideas.

This sapping effect of the smaller patents is at once an aid and an obstacle to monopoly. It tends to monopoly because it gives the advantage to the big corporation with a scientific and legal staff. It tends, on the other hand, to prolong the battle in the Patent Office and the battle in the courts, which must be fought to a finish before property rights are finally established. If smaller companies can set up enough interferences in the Patent Office, they can frequently delay the issue of an opposing patent for a long time; and if the contestants are equally matched, as the General Electric Company and the Western Electric Company, in the Langmuir-Arnold "high vacuum" question, the struggle may be prolonged for half a generation. The battle in the courts is likely to be shorter, though two years is about the minimum for a decision in a district court, and five years is not unusual for the whole course of a case carried on through appeal.

Even at the risk of covering familiar ground, it may be well to locate briefly the control of those patents that at the moment seem to be the most important. The

Westinghouse Electric & Manufacturing Company owns the patents by Armstrong on regeneration and by Fessenden on the heterodyne principle. The Hammond patents on inventions involved in super-heterodyne sets are licensed exclusively to the R. C. A. and the A. T. & T. Company, but Hammond reserved certain rights in military and naval fields as well as the right to license the United States Government.

The Radio Corporation has exclusive licenses under the Telephone Company, Westinghouse, and General Electric patents to sell and use apparatus in certain fields of use, among which is broadcast reception. The apparatus sold by the R. C. A. is made by Westinghouse and General Electric and some by the Wireless Specialty Apparatus Company.

General Electric Company owns the patents by Coolidge and Langmuir on tubes, by Langmuir on the grid leak, and by Rice on neutralization. The American Telephone & Telegraph Company (including Western Electric) owns the patents by Arnold on tubes, Hartley on neutralization, and Lowenstein on the C battery. The West-

Of essential radio patents at the moment, only two are held outside the Radio Corporation. These are Hazeltine's patents on neutralization and Latour's on the common B battery also held in this country by Hazeltine. The R. C. A., however, holds a non-exclusive license under the Latour patents. Perhaps a third might be reckoned in the Schloemilch and Van Bronck (German) patent on the reflex circuit, seized by the Government as alien property during the war and now free to the general public.

From all that has been said above, it seems reasonable to conclude that within five years all the essential patents in radio will have been adjudicated in the courts. Under the law of averages, probably five out of six of them will be vested by court order in the Radio Corporation. And as time goes on, the probabilities are that the unrivalled research facilities of the Radio Corporation's constituent companies will place that group in an unapproachable position so far as technical, unpatented refinements of the essential devices are concerned.

If, then, patents are the decisive element in the radio situation, the logic of events points to an eventual leadership of the field by the Radio Corporation, with only a possible one or two much smaller groups operating independently under fewer patents. Whether patents are necessarily the decisive element is another question, too broad for discussion here. It will be treated in the next, and concluding article of this series.



AN EARLY EXPERIMENTAL TUNED CIRCUIT

Much of the commonly used apparatus of to-day depends in operation on the principles discovered by scientists of many years ago who worked with such crude apparatus as that depicted above. In fact, some people are inclined to believe that many of the comparatively recently granted patents were really covered in all of their essentials by the patents of earlier inventors whose ideas have been somewhat duplicated

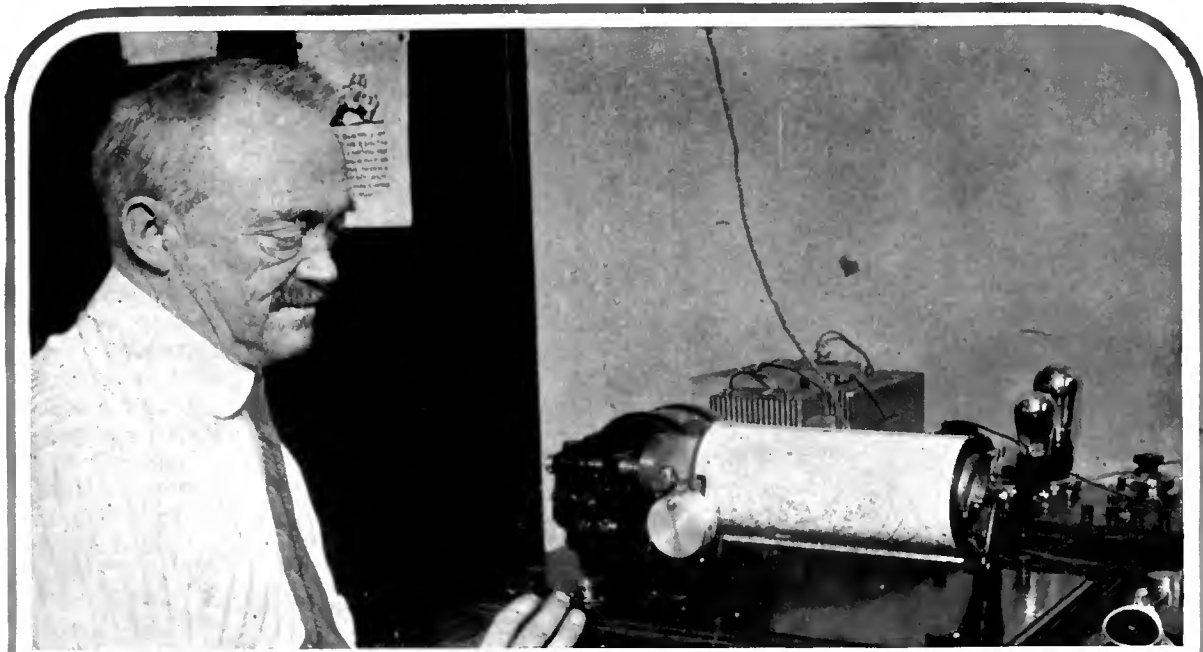

THE MARCH OF RADIO

News and Interpretation of Current Radio Events

Critical Hours for the Broadcasting Industry

BROADCASTING now enters the most critical season of its brief history. It has muddled through many a minor crisis successfully in the past and, undoubtedly, it will be rescued from its present predicament, the outcome of legislative neglect of the last Congress, without any serious mishap.

During the summer, the reception of programs from local stations has not been seriously affected by the offences of wavelength excursionists. The coming of the fall season marks a new phase of the situation. If long distance reception is a factor of any importance in the popularity of radio, the industry is faced by a problem of fairly serious proportions.

At our listening post in one of the ideal receiving locations of the East, we have been able to gain some preview of the kind of receiving conditions which we will face during the early fall season. We have been accustomed for some time to heterodyning of carrier waves at the high frequency end of the broadcast band, but it was of no particular importance so long as the other two thirds of the

band was practically free from that disturbance.

As a result of the procession of self-seeking broadcasters from their proper place in the insignificant end of the band to the heretofore orderly low frequency end, heterodyning has now been distributed over the entire wavelength scale. Although still impeded by summer atmospherics and weak signals from stations more than one thousand miles distant, we found, in a single evening, no less than nineteen points on the dial where heterodyning exists, between 1500 and 500 kilocycles. We may expect a substantial increase of this number as receiving conditions improve. Wavelength jumpers have used some care to avoid interfering with nearby stations, but they have not, in most instances, been able to avoid heterodyning or blanketing distant stations. Fortunately, the enjoyment of local programs is practically unaffected. On the other hand, many favorite long distance stations in all parts of the country are obscured by annoying whistles.

The radio industry at this season of the year makes its annual bid for public favor. Its engineers have, this year, brought forward products of a quality, from the standpoint of selectivity, tone quality, and

simplicity of control, representing great forward strides. These constructive developments are deserving of liberal public support. But, for an industry which boasts of its powers of capable self-government, it has played a lamentably weak hand in dealing with the obstreperous broadcaster. We observe, for instance, a statement issued by the Radio Manufacturers' Association, ridiculing, on the grounds that all is well with radio, a most constructive editorial in *Collier's Weekly*, urging sensible federal legislation and a "Judge Landis" to rule over broadcasting. The R. M. A.'s comment, in its bulletin, is headed "No Cause for Alarm over Broadcasting" and its argument is based upon the philosophy of the proverbial ostrich.

With such an attitude, we cannot hope for much constructive assistance from the quarter which should be most aggressive in remedying the situation. At a meeting in New York on September 15, a "Radio Coördinating Committee" was formed with power to enforce the provisions of a resolution to self-regulate broadcasting until legislation shall be passed. The group represented The National Association of Broadcasters, The American Radio Relay League, The R. M. A., The Federated Radio Trade Association, The

The photograph forming the heading this month shows C. Francis Jenkins who has developed a method of transmitting weather maps to ships at sea, at his transmitter. Signals are being sent on a wave of 8250 meters from NAA to several naval ships as an experiment

American Newspaper Publishers Association, and The National Electrical Manufacturers Association. It is not certain that this impressive group actually will do anything constructive.

High quality local reception is still the paramount factor in broadcasting and this is not seriously threatened by the present situation. But we would lament, with a large percentage of radio's most enthusiastic and valued following, the permanent impairment of long distance reception by continued operation of an excessive number of broadcasting stations.

We have, in these columns, outlined, at some length, the salient features which we believe forthcoming legislation should embody. Included in those recommendations was a suggestion that length of continued service of a station on its assigned frequency should be a paramount consideration in the granting of a license under the new law. This sound principle should be established because it would automatically exclude from the broadcast tangle all those stations which took it upon themselves to select their own channels without regard to the good of broadcasting as a whole. These stations, by abandoning their assigned frequencies when the Department of Commerce's regulatory power was disrupted, also surrendered all priority rights to their original frequencies. More conservative and considerate broadcasters decided to hold to their regular frequencies, however undesirable, rather than confuse the situation. Their commendable policy deserves reward at the expense of more selfish broadcasters. Newly licensed stations do not present a serious problem because they have no priority rights to the frequencies which they have adopted.

No official information is available as to the changes in frequency which have been made during the last two months. From the best sources which we could consult, we have compiled a list of such changes. It is as accurate and complete as we can make it, but here and there, we have found stations which have not carried out announced shifts in frequency. Others have tried shifting for an evening or two, seen the light of reason and had the good sense to return to their proper channels. Perhaps one or two such stations are included in the list which follows:

CALL LETTERS	CITY	ASSIGNED FREQUENCY METERS	KILO-CYCLES	ADOPTED WAVE-LENGTH METERS
WBRR	Rossville, N. Y.	272.6	1100	416.4
WHAP	New York, N. Y.	239.9	1250	431.0
WBNY	New York, N. Y.	212.6	1410	302.8
WMSG	New York, N. Y.	212.6	1410	302.8
WODA	Paterson, N. J.	223.7	1340	390.9
WJAR	Providence, R. I.	303.9	980	485.0
WEAN	Providence, R. I.	270.1	1110	367.0
WTAG	Worcester, Mass.	280.2	1070	430.1
WKBE	Webster, Mass.	230.6	1300	274.1
WIBX	Utica, N. Y.	205.4	1460	234.2
WKBB	Johiet, Ill.	214.2	1400	282.8
WGMA	Culver, Md.	222.1	1350	258.5
WCRW	Chicago, Ill.	239.9	1250	416.4
WSBC	Chicago, Ill.	209.7	1430	288.3

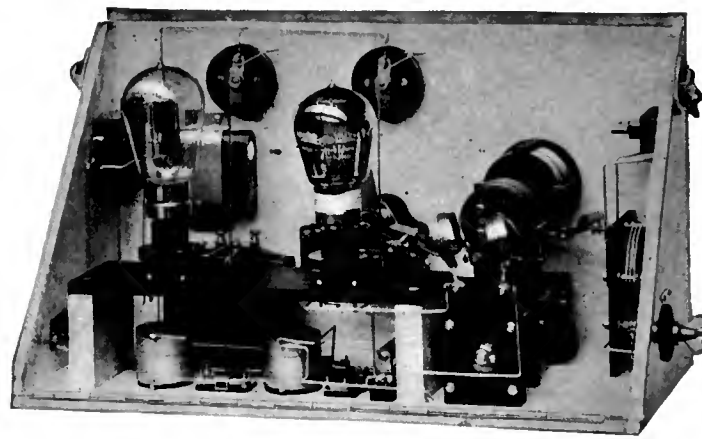

AN ENGLISH SHORT-WAVE RECEIVER

This outfit is made by Marconi's Wireless Telegraph Company, Ltd., London and is designed to receive continuous wave signals from 19,990 to 2998 kc. (15 to 100 meters). Note the openness of construction, a feature of short-wave outfits everywhere

CALL LETTERS	CITY	ASSIGNED FREQUENCY METERS	KILO-CYCLES	ADOPTED WAVE-LENGTH METERS
WAMD	Minneapolis, Minn.	243.8	1230	296.9
WEW	St. Louis, Mo.	247.8	1210	360.0
WQAM	Miami, Fla.	263.0	1140	285.5
KTNT	Muscataine, Ia.	256.3	1170	333.1
KFNF	Shenandoah, Ia.	263.0	1140	461.3
KFDY	Brookins, So. Dak.	272.6	1100	303.9
KFDD	Boise, Idaho.	277.6	1080	275.1
KFBU	Laramie, Wyo.	277.1	1110	374.8
KGY	Lacey, Wash.	245.8	1120	277.6
KOWW	Walla Walla, Wash.	256.3	1170	285.0
KQW	San Jose, Calif.	230.6	1300	333.1

A particularly annoying offense which a number of stations have committed is to adopt frequencies midway between two of the existing ten-kilocycle channels so that they effectively interfere with two or more stations rather than just one.

There has been some noise made about a listeners' boycott of the stations which have jumped their wavelengths. Since so many stations already broadcast without audiences and, seemingly, don't know the difference, this is obviously an ineffective weapon. Broadcast listeners will continue to tune their receiving sets to stations transmitting the programs suited to their individual tastes.

Changes in the Regulation of British Broadcasting

THE British Broadcasting Company will, next year, be replaced by the British Government Broadcasting Commission. Suggestions have been made for a system of inter-Empire broadcasting with the Daventry station in England as its starting point. The first relay station is projected for Moncton, New Brunswick, a distance of 2440 miles. From this point, the programs will be distributed via land lines to Canadian broadcasting stations throughout the Dominion. From Vancouver, a distance of 2300 miles of wire line, the programs would again take the ether route to Australia, a distance of 5000 miles. This offers the greatest distance barrier but, by the use of high power and high frequencies, it is feasible, at least during favorable seasons.

An alternative route would be through a

relay station at the Fanning Islands, 3885 miles from Vancouver and 3710 miles from Sidney, Australia. Sidney would be the distributing center for the Australian continent. At Perth, a radio link would be established with New Zealand and Ceylon and, from the latter point, to Cape Town and India. The jump from Cape Town to Malta would complete the system, involving a total of eight radio relays.

Stupendous as the plan is in its conception, its estimated cost is only three million dollars. Owing to time differences, it would be of practical value only on special occasions of tremendous importance, once the novelty of inter-Empire programs had

worn off. As a feat of radio technique, it would be a wonderful demonstration of radio's possibilities. As for its sociological and political aspects, in uniting the Empire, the plan represents an entirely new development in the application of radio communication.

Can a Law Prevent News From Being Heard by Radio?

AT THE Press Association Conference, recently held at Geneva, under the auspices of the League of Nations, a resolution was adopted, asking the League to induce governments to regulate radio receiving stations. Special emphasis was placed upon the importance of forbidding the listening public to pick up telegrams or messages of press or economic service, directed to paid subscribers and providing further that, if such communications are received by mistake, they must not be reproduced in writing, communicated to a third person nor used for commercial purposes. The use for commercial purposes of news issued by broadcasting stations is to be prohibited.

In other words, broadcast listeners are asked not to listen to news intended for subscribers to news services and, should they violate this request, they are asked not to communicate such news to others or use it in any way—a rather absurd proposition at best. It is perfectly feasible to send private dispatches in code or by secrecy systems which require special knowledge and equipment for interpretation. The use of intercepted private news dispatches can readily be made illegal, but listening to them cannot be stopped by merely writing a law to that effect.

General J. G. Harbord, President of the Radio Corporation of America, called the attention of the conference to the efforts of his company to lower the press rates between Japan and the United States from twenty-seven to ten cents a word. The Japanese Government has refused to sanction this proposal which would do

much to foster better relations between the two countries.

Unfortunate Radio Publicity in the Press

THE press is frequently the victim of publicity exaggerations propagated by zealous radio enthusiasts. Newspaper city editors cannot be expected to be radio engineers. Stories frequently appear in the news sections which a competent radio editor would delegate to the waste basket. We noted, some weeks ago, a front page story in the *New York Times*, urging all broadcast listeners to listen-in carefully for the effect of meteors on radio reception. August is the big month for meteors and scientists have, for the last two

At about the same time, a zealous correspondent in Cumberland, Maryland, reported to his newspaper that a local amateur established communication with the *Bowdoin*, MacMillan's ship in the Arctic, a feat which has been duplicated nightly by many an amateur in all parts of the United States.

The business of editing radio news requires the assistance of specialists. This is particularly obvious when some of the radio items are clipped from small newspapers which do not have radio editors. Frequently they fall for the rawest kind of publicity and free advertising statements, not having the necessary technical qualifications for the selection of items which might enlighten their readers on radio subjects. To counteract this situation, a number of special radio syndicate services are available to smaller newspapers at low cost, the use of which would be a decided improvement over some of the radio items now appearing.

Radio Strides in Australia

RAPID strides are being made in Australia in extending the broadcasting service of that country. A new, high power station, with call letters 2 BL, has recently begun operations in Sidney, using a normal power of five kilo-

which has stimulated the radio business tremendously. KFI, and KGO of our Pacific Coast are frequently heard on the eastern side of Australia. There are still some wavelength difficulties to be adjusted, for some stations, such as 2 FC and 6 WF, are on wavelengths far out of the beaten track—over 1100 meters (272.6 kc.).

Should News be Broadcast?

NEWS gathering agencies, including the Associated Press and the United Press, have been asked by the Publishers' Association of New York City to refrain from broadcasting any but news of transcendent importance, such as the illness of a president or the results of an election.

Newspapers which support the various news services are entitled to this protection. News is a highly perishable product which loses its value by dissemination. Broadcasting has demonstrated that it is, in no sense, a competitor of newspapers, because it is not adapted to the distribution of anything but the most abbreviated kind of news summary. It would require some thirty-six hours to broadcast the contents of a sixteen-page newspaper.

Interesting Naval Radio Tests

THE airship *Los Angeles* has been engaged for a period of weeks in checking the calibration of naval radio compasses along the coast between Boston and Norfolk, Virginia. An airship is much better adapted to doing this work

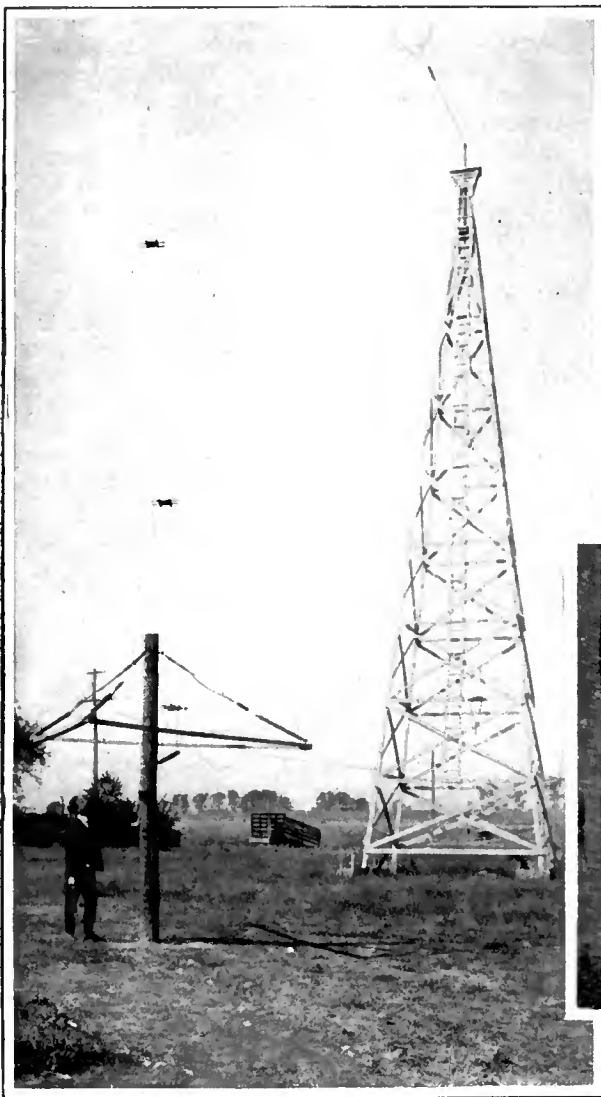

STATION WPSC, PENNSYLVANIA STATE COLLEGE

The illustration at the left shows the antenna lead-ins from an antenna supported from three towers. The buildings of the engineering college are shown in the illustration directly above. The two buildings in the foreground are devoted to the Electrical Engineering department

decades, made observations as to their effect on radio reception. Broadcast listeners were exhorted to listen-in and report any unusual phenomena in reception to Mr. Hugo Gernsback, editor of *Radio News*. The story may have also appeared elsewhere. If the effect of meteors is so obvious as to be easily detected by the average radio listener, it would certainly cast a reflection upon the scientists who have been engaged for twenty years or more in the investigation of radio phenomena.

watts and a maximum of ten. In coöperation with 2 FC, also located in Sydney, it maintains continuous service from 7 A.M. to midnight. 4 QG, at Brisbane, 3 LO, Melbourne, 5 CL, Adelaide, and 6 WF at Perth constitute the balance of the broadcasting stations. These are soon to be supplemented by 3 AR at Melbourne and 7 CM at Hobart, Tasmania. Thus the Australian continent has thorough radio coverage

because of its steadier and slower motion as compared with airplanes. During such tests, the airship flies in a circular course of fifteen miles radius about the compass under test. The transmitter on the airship is operated continuously and an observer at the compass station records the exact time and radio bearing. At the same time, a second observer with magnetic compass and telescope, records its direc-

tion from the compass at regular intervals. By checking the visual and radio observations, the directional errors of the radio compass are recorded for future reference.

Utilizing the picture transmission apparatus developed by C. Francis Jenkins, the naval radio station NAA at Arlington, Virginia, is transmitting weather charts for the use of ships at sea. Two naval vessels have been fitted with the necessary receiving equipment for reproducing the charts. This is the beginning of what will ultimately be an invaluable radio aid to navigation on the sea and in the air.

"Cross Talk" in British Telephone Circuits

IT MUST give British radio listeners considerable distress or amusement to hear their private telephone conversations broadcast as a result of cross talk into circuits furnished the radio stations of the British Broadcasting Company. Judging from newspaper items, this has occurred on a number of occasions.

Cross talk requires most elaborate precautions to avoid, but the radiation of cross talk by a broadcasting system is nothing less than mere carelessness in operation. By constantly monitoring the program of each radio station, broadcasting of cross talk can be prevented by shutting down the radio transmitter until the line is cleared or shifting to another line.

When chain broadcasting was first undertaken in the United States, involving lines many times longer than those used in England, cross talk difficulties were en-

countered but they were avoided by setting up two parallel telephone circuits, offering an alternative path, should one become noisy, without more than an instant's interruption of the program. As routine tests became perfected and the reliability of telephone circuits established by long practice, the necessity for alternate circuits for ordinary interchange of programs has disappeared.

Praiseworthy Work by the Victoria B. C. Radio Club

THE Radio Club of Victoria, British Columbia, we learn from W. J. M. Griffin of that city, has tackled the problem of power line radiation in a most commendable manner. Mercury arc transformers are used to step down the high voltage used in distribution and these, in some districts, cause destructive interference to radio programs. Loyal members of the radio club personally expended some four hundred dollars to equip the transformers with choke coils so as to rid the populace of this pest to radio reception. When radio listeners actually reach into their pockets to alleviate conditions of radiation, they are aided by the cooperation of the power companies and rewarded by a considerable improvement in reception.

More About Toll Broadcasting

WE HAVE received many letters commenting favorably on the article by Austin C. Lescarbourea, "What Does it Cost to Broadcast?" in this

magazine for September, 1926. Every care for accuracy was observed in the preparation and editing of the story, but several inaccurate statements crept in. We have been asked to call attention to several statements which may appear misleading. John Shepard 3rd, of the Shepard Stores of Boston and Providence, writes to say that the two broadcasting stations operated by his company, WNAC at Boston, and WEAN, Providence, have been connected by wire lines for nearly three years. The connection is not occasional as might have been gathered from the phraseology of the article.

In referring to another Connecticut station, WTIC of Hartford was represented as a commercial station in the sense that broadcasting for hire was a practise. In the map of the present WEAJ "chain" appearing on page 368 of RADIO BROADCAST for September, WTIC was shown as one of the links, and the caption conveyed the impression that WTIC accepted payment for commercial programs. Mr. W. G. Cowles, vice-president in charge of broadcasting, of the Travelers Insurance Company informs us that his station has never received a penny of income from any source. The programs from WEAJ, heard through WTIC are the so-called "sustaining programs" such as the Goldman Band concerts, the grand opera hour, and national events of various kinds for which WEAJ is paid by WTIC.

The Month In Radio

LIEUT. E. H. KINCAID, navigator of the Navy transport *Kittery*, succeeded in plotting the course of a West Indian hurricane by observing, with his radio compass, the direction in which the heaviest static was heard. This ingenious observation suggests a new service for the radio compass which may be of value in our meteorological service.

THE Bureau of Standards is conducting experiments at College Park, Maryland, with improved radio beacon systems for the guidance of aircraft. Radio compasses and beacons are used for this purpose on most of the European commercial routes.

THE intensity of radio signals is affected by temperature conditions, according to conclusions reached by Dr. L. W. Austin and Miss Wymore of the Bureau of Standards. In order to eliminate as far as possible the influence of meteorological phenomena, stations between 125 and 190 miles distant were chosen for the experiments. A greater distance would be subject to the influence of other conditions which would complicate the analysis, while a shorter distance, on the other hand, would not show the influence of weather changes to a sufficient degree to make for reliable observation. A study of extensive data reveals that, when the temperature rises along the signal path, there is a tendency for the signal strength to fall and, conversely, a falling temperature produces a stronger signal. It should be recognized, however, that this is only one of the many influences which determine signal strength.



THE FIRST DEMONSTRATION OF WIRED RADIO

A scene in the office of the Chief Signal Officer of the Army when Major General George O. Squier was Chief Signal Officer. Major General Squier has many patents on systems for "wired radio" or "broadcasting" over electric light lines. This photograph was taken on March 24, 1922. In the photograph, left to right: Samuel Isler, assistant radio engineer, Signal Corps; C. E. Bohner, assistant electrical engineer, Signal Corps; R. D. Duncan, Jr., radio engineer, Signal Corps; Louis Cohen, consulting radio engineer; Lieutenant Colonel C. A. Sloane, Signal Corps, U. S. Army; Donald Wilhelm; Major General George O. Squier, Chief Signal Officer of the Army; Sergeant E. D. Latta, Signal Corps; Lieutenant Colonel F. J. Griffin, Signal Corps



SIR HARRY LAUDER
London

From an article by the Scotch comedian in the *Radio Times*, London:

"Let us (the concert and radio program managers) work smoothly together. The importance of maintaining British prestige demands it, because, in the days to come, if broadcasting maintains its present rate of development, other nations will judge us by what they hear as well as by what they see. We must, therefore, take care that what is sent out from our broadcast stations is the very best we have to offer. I think the time has already arrived when we should be making plans with this end in view. The time is coming when Paris, Rome, New York, and other parts of the world will regularly listen to the radio programs of London and Daventry. When that time comes, the London station should have the finest orchestra in the British Isles, no matter what the cost.

"Time will prove the accuracy of my vision. Henceforth, British prestige among the nations will depend largely on how we develop our radio. Let us now make certain that the foundation shall be built on harmony among ourselves."

IN THE second issue of the *Lightning Jerker*, a new publication devoted to the interests of the commercial radio operator, an article describes the activities of the Chicago Federation of Labor in attempting to unionize the technical personnel of broadcasting stations in that city. Considering the fact that engineers and technical men are of an order of skill which does not lend itself readily to standardization of laboring conditions and wage scales, it is unlikely that the result will be successful. It would be unfortunate to force commercial operators on ships to obey the dictates of labor unionism because the temptation to use their essential service as a strike weapon would not long be resisted. It is against the law for an ocean-going ship with a personnel of more than fifty to sail without its proper quota of radio operators. By calling out a few hundred radio men, a complete tie-up of shipping could be effected. A radio operators' union would soon find itself concerned in the bickerings of every class of marine worker, to the discredit of the former and for the benefit of the latter. That enviable prestige for loyalty and self-sacrifice, which heroic radio operators have built up for the

profession, would eventually be clouded, were it to become an accessory to union labor embroilments.

ABOUT 100 broadcasting stations are cooperating with the Department of Agriculture's radio service, according to an announcement by Sam Pickard, its head. The dissemination of farm information by radio has frequently resulted in great profit to farmers. It is interesting to note that several questionnaires on what the farmer most prefers in radio programs place musical entertainment first and information pertaining to his trade second or third. Shop talk is just as tiresome to the farmer as it is to any other kind of worker. By selecting suitable hours for broadcasting farm information, however, so that it does not interfere with entertainment programs, an interested and appreciative audience is assured.

FROM time to time, rumors reach us that various class organizations, such as the American Federation of Labor and the Ku Klux Klan, are considering the erection of broadcasting stations in order to address their members by radio and to disseminate their propaganda. Sooner or later we will recognize that the ether is a universal medium which should be used primarily for broadcasting to the whole public and not for the special interests of any particular group.

Interesting Things Said Interestingly

DAVID SARNOFF (New York; Vice-president, general manager, Radio Corporation of America): "The development of radio sets which dispense with batteries and use house lighting current, together with the fact that radio keeps people at home, is resulting in larger consumption of electricity.

"The types of broadcast receivers which now operate completely from the lighting circuit require up to 200 watts for their operation. The numerous power accessories on the market require from seven to fifty watts. It is reasonable to assume that within the next three to five years, by far the larger percentage of broadcast receivers will draw their local source of energy from the lighting socket. It is estimated that the average of such receivers will consume energy at the rate of eight kilowatt hours per month."

E. H. ANDERSON (New York; director, the New York Public Library): "It is sometimes asserted that the movies, the radio, the automobile, and other diversions, have lessened the reading habit.

"The exact opposite is the truth; the desire for books is constantly increasing in New York. There are many libraries other than the public libraries and many sources of book supply beside the libraries in this city. There is a very large use of books within the buildings of the public libraries, that is to say, a reference use. Over and above all this, the public libraries of Greater New York lent for home use last year 16,781,679 books. The New York Public Library lent 9,018,339; the Brooklyn Public Library, 5,786,774, and the Queens Borough Public Library, 1,976,566 books. This does not wholly represent the demand for books; it merely in-

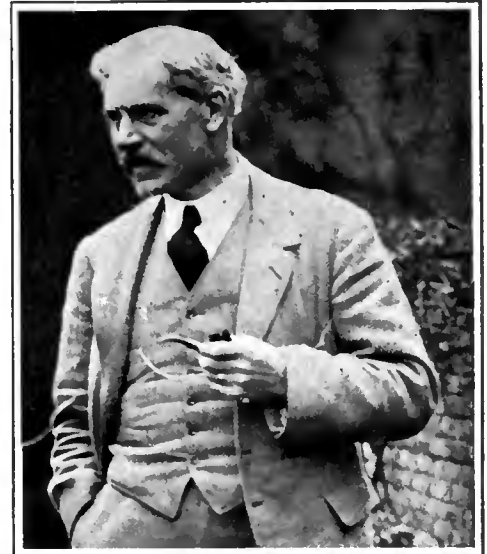

J. RAMSAY MACDONALD, M. P.
London

In a statement he made after listening to the broadcasting of speeches of the Assembly of the League of Nations:

"I doubt if any discovery of our time is more marvelous in its effects, or is destined to have more influence on the human mind than wireless. The broadcasting of Geneva has brought this mighty assembly of the world States into the homes of thousands of our people and of millions like them in other parts of the world. It could not have meant so much to them as it did to me because I have been there, and, consequently, my ears awakened a responsive vision. But to be behind a curtain and to hear, even if seeing be forbidden, the business of such a gathering must enliven interest and quicken intelligence. The League of Nations must be more real to every listener after that morning than ever it was before.

"How appropriate it has been that a landmark has been set in this marvelous development in human contact by the broadcasting of speeches delivered at an Assembly of the League of Nations. I see in it not only a promotion of peace and enlightenment, but a vast extension of the rare opportunities which the mass of mankind have of judging the qualities and the capacities of those set to rule over them.

"Something like a new sense has been added to the citizens of the world."

indicates how far the public libraries were able to satisfy the demand."

ARTHUR BURROWS (Geneva; manager of the International Radiophone Bureau writing in *Popular Wireless*, London):

"Broadcasting is actually changing the outlook in the lives of many persons. Its value to the blind is already so freely recognized that the German Government has not hesitated to pay for 2000 sets of receiving apparatus for the afflicted within its frontiers, and the recent British Governmental Committee has recommended exemption from license fees for the sightless living in the British Isles. I hope that this proposal may be carried a stage further and that all blind persons in Britain without the necessary means will sooner or later be given a suitable receiving set."

Looking Back Over Thirty Years of Radio

How the Vision of a Great Scientist Has Acted to Perfect Radio Communication and to Develop the Art Through Times of Change and Progress—The Swing from Long Waves and High Power to the Short-Wave, Medium-Power "Beam"



AT THE BRIDGWATER, ENGLAND, "SISTEMA A FASCIO" STATION "Sistema a Fascio," as some are well aware, being the Italian for "Beam System." The five masts to the left are for reception from Canada, while the five to the right are for receiving signals from South Africa

NOT since the July, 1925, RADIO BROADCAST have we been privileged to present an article by Senatore Marconi. In the issue referred to, the article, "Will Beam Stations Revolutionize Radio?" described in the great scientist's own words his experiments with beam transmission, and his feeling of the future of radio transmission along these lines. In the present article, which is in part an address delivered by Senatore Marconi in Bologna, Italy, at the commemoration exercises of the thirtieth anniversary of his first patent in wireless telegraphy, Mr. Marconi describes how wireless has progressed since the earliest days and tells more about his own part in the recent development of beam transmission. He pays, it will be noted, graceful tribute to other investigators in this field, to whom much is owing.—THE EDITOR.

By GUGLIELMO MARCONI

from my boyhood, the experimental discovery of electric waves made by Hertz, in confirmation of the mathematical hypothesis of Maxwell regarding the electromagnetic theory of light, and the brilliant pursuit of such researches made by our great Bolognese physicist, Augusto Righi (to whose memory I always bow with devout admiration) had fascinated my mind, and I soon had the idea, I might almost say the intuition, that these waves might in a not distant future furnish mankind with a new and powerful means of communication which could be utilized not only across continents and seas, but also on ships with a vast diminution of the dangers of navigation and with the abolition of the isolation of anyone crossing the sea.

The happy results obtained over noteworthy distances by means of electric waves have been, in my opinion, due in great part to the discovery made by me in 1895 of the effect of the so-called "antennas" or "raised aerials" connected with both transmitting and receiving apparatus.

Such a device was naturally the consequence of a happy inspiration and our mind never forgets, however great the absence, the place where a first happy inspiration was born.

But during my forced absence from Bologna the nostalgia of my native city often invaded my mind; often enough during the eighty-six times I crossed the Atlantic, during the long periods of time spent in the solitudes of Canada and of Ireland, my thoughts which to many seemed fixed on the study of the apparatus which I had before me, flew far away instead, flew to my dear Bologna, to which I am bound by the most sacred affections and the dearest memories.

Since I left Bologna in 1896 and obtained my first Patent of Invention on the 2nd of June in that year, what immense difficulties have had to be surmounted to attain the purpose which I had set myself, and in which my faith was never shaken, even when illustrious scientists had to express the most discouraging opinions!

It had been objected that the curvature

SINCE February, 1896, the date of my departure from Bologna after the first experiments in wireless telegraphy I carried out at the Villa di Pontecchio, my life has been spent far from that city. My absence has been caused by the force of events, which has been greater than that of my will.

Radio telegraphy, which appeared to me destined to connect the thought of all the peoples of the world, required for its development a very great space, and I chose for my first laboratory, the Atlantic Ocean.

From my youth, I would almost say

of the earth would inexorably hinder communications over distances greater than a few tens of kilometres, but I did not believe this and I was soon able to prove by my experiments conducted between the Lizard and the Isle of Wight off the coast of England, across a distance of 300 kilometres, in which the curvature of the earth intervenes rather considerably, that it did not offer any obstacle to radio telegraphic transmission.

LONG DISTANCE "WIRELESS" A DREAM?

IT WAS then affirmed that transmissions over still greater distances were the dream of a visionary but after the experiments which I carried out in December, 1901, between England and Newfoundland in North America, during which I succeeded in communicating for the first time across the Atlantic Ocean, everyone began to be convinced that very probably there would no longer be any distance in the world which could obstruct the propagation of electric waves.

The happy result obtained by those first experiments of mine between Europe and America encouraged me in the prosecution of my studies to face the solution of a difficult problem—commercial radio telegraph communication between Europe and America, and with so many other distant countries where the practical object to be reached would justify the risk of the expenditure of a huge capital for the execution of experiments which, in Italy, were qualified as of rather doubtful success.

In my experiments conducted on the Atlantic during the winter of 1902 I found myself impeded by an unforeseen difficulty caused by the effect of solar light on radio telegraphic transmissions, a phenomenon which I discovered during a voyage made on board the ship *Philadelphia*; on account of the effect of the light, at a distance of more than 700 miles all reception became impossible when the sun rose. But with the increase of the wavelength I found that this difficulty also could be overcome.

Then all students of radio telegraphy devoted themselves to the use of longer and longer waves and thus from those of 1000 and 2000 meters there was a gradual transition to the use of waves which reached the length of over 30 kilometres.

Other difficulties presented themselves as a result of interference between neighboring stations, a difficulty which, it seemed, would cause a very great limitation in the practical applications of radio telegraphy. But with new tuned circuits, which I patented in 1898 and 1900 and experimented with on the south coast of England, such difficulties also disappeared for the greater part. It was then proved for the first time that many neighboring stations among those tuned on different

waves could communicate simultaneously without interfering with each other.

Following my first long-distance experiments over the sea, it was affirmed that communications across mountainous continents would be impossible. But with the wireless telegraph experiments on the Royal Vessel *Carlo Alberto*, which, by the will of H. M. the King of Italy, was placed

development of radio telegraphy was finished; that its employment might be useful at sea for the safety of human life during navigation, but that its employment would be rather limited and rather difficult between distant continents.

It was stated that radio telegraphy would never be in a position to compete with other rapid means of communication over long distances, such as that carried on by cables.

But even in the face of such observations often made officially in the parliaments of great nations, I was never discouraged. We Bolognese often smile in the face of the most difficult situations.

PROGRESS AIDS PROGRESS

IN FACT, by means of the use of thermionic valves—a brilliant conception of Fleming, perfected by DeForest, Langmuir, and Armstrong in America, by Meissner in Germany, and by Round and Franklin in England—and by means of the use of balanced tuned circuits, of electric filters, of power amplifiers and

finally of directional radiators, I succeeded in obtaining results such as to ensure a regular radio telegraphic service by day and night between Europe and America; thus also, in 1918, I could for the first time in history communicate from England to Australia, i. e., almost as far as the antipodes, over a distance of about 20,000 kilometres (12,500 miles).

But to obtain such results, huge and very costly installations were required, based on the use of many hundreds of kilo-

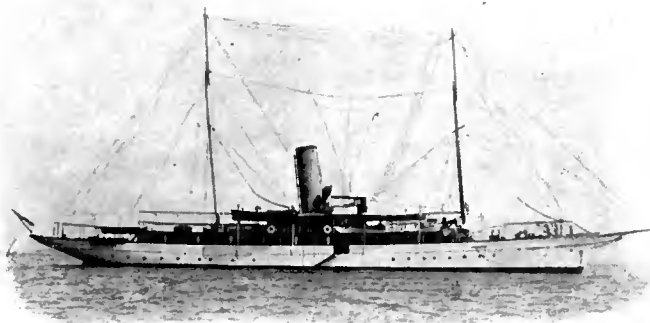

THE "ELETTRA"

Marconi's private radio yacht. Very many of the Senatore's experiments have been carried out from the middle of the ocean aboard the well appointed *Elettra*

at my disposal, I was able to demonstrate that the Alps and Pyrenees were easily surmounted by the electric waves I was using.

But there always remained inexplicable periods of interruption; there also always remained great difficulties occasioned by the low sensitiveness of the receivers then used; there also always remained the enormous obstacles produced by atmospheric electric discharges.

It was then said that at that point the

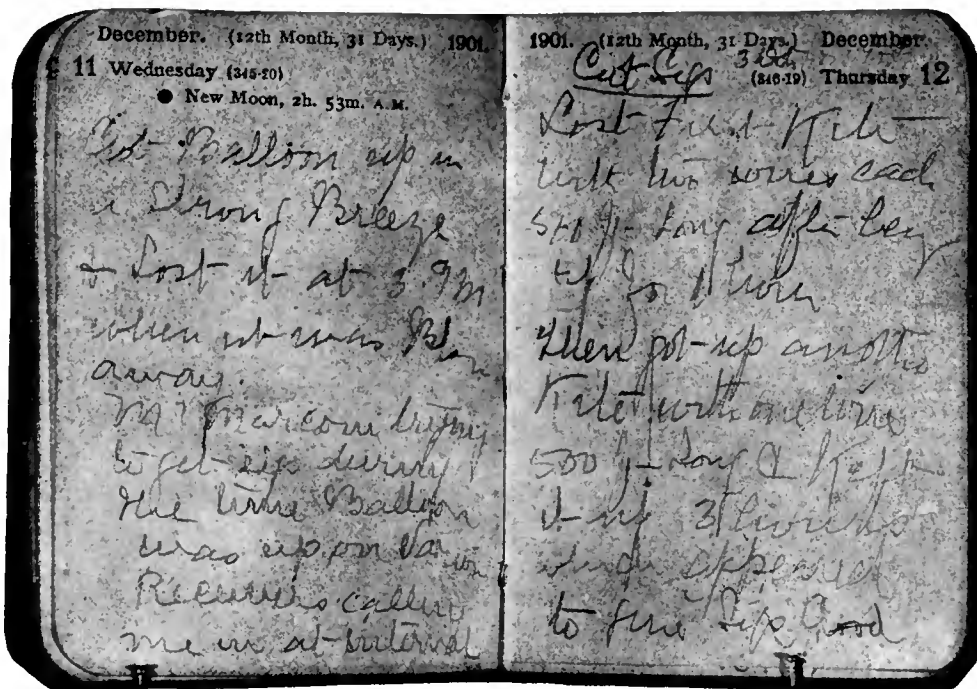

AN HISTORICAL DOCUMENT

Pages from the diary of Mr. S. S. Kemp, Marconi's assistant at Signal Hill, Newfoundland, just about twenty-five years ago (December 12th, 1901), when wireless signals were first transmitted across the Atlantic from Poldhu, England, and received at the Newfoundland station. This was the occasion of the transmission of the famous letter "S"

watts of electrical energy radiated almost circularly; so that the object I had set myself of finding, a means of rapid communication more economical than that afforded by the ordinary wire or cable telegraph, seemed to a great extent frustrated.

I then thought again of my first experiments at Pontecchio. I again remembered all I had then proposed to pursue by means of the radiation of electric waves concentrated in a beam by means of suitable reflectors.

Thus in 1917, at Genoa, where I devoted myself to particular studies for military purposes, I made numerous distance experiments with the first beam (the Italian is "a fascio") apparatus, using short waves, that is of two or three meters length. Yes! "Beam System" ("Sistema a Fascio").

I do not now use any of these words because I am a Fascist and because Fascismo, for the fortunes of Italy, is triumphant. I always claim for myself the honor of having been the first Fascist in radio telegraphy, the first to recognize the desirability of uniting in a beam (*fascio*) the electric rays, as the Honorable Mussolini has first recognized in the political field the necessity of uniting in a "*fascio*" all the best energies of the country for the greater greatness of Italy.

But long waves were no longer suitable owing to the use of my Beam System. This system, instead of radiating the waves in all directions, concentrates them in the desired direction almost like a beam of light projected from a reflector. The British Government has officially decided to use this Beam System on the greatest scale for

direct communications between the most important Dominions and the Mother Country. And yet I was responsible for having caused the expenditure of hundreds of millions on long-wave stations.

A certain courage was therefore necessary to say "Let us turn back."

TURNING BACK PAGES OF RADIO HISTORY

BUT the Bolognese, after building at Bologna one of the highest towers in Italy, did not hesitate to build near it another much lower one.

Near the longest wave stations I was the first to have had constructed, I did not hesitate placing beam stations using very short waves.

In my practical study on the ranges of transmission of such waves, while cruising on the Atlantic for several months aboard my yacht *Elettra* in 1923, I was able to discover some of their very valuable properties unknown to science before that time.

I thus gathered that by using short waves in installations of very low power with a suitable reflector it was possible to

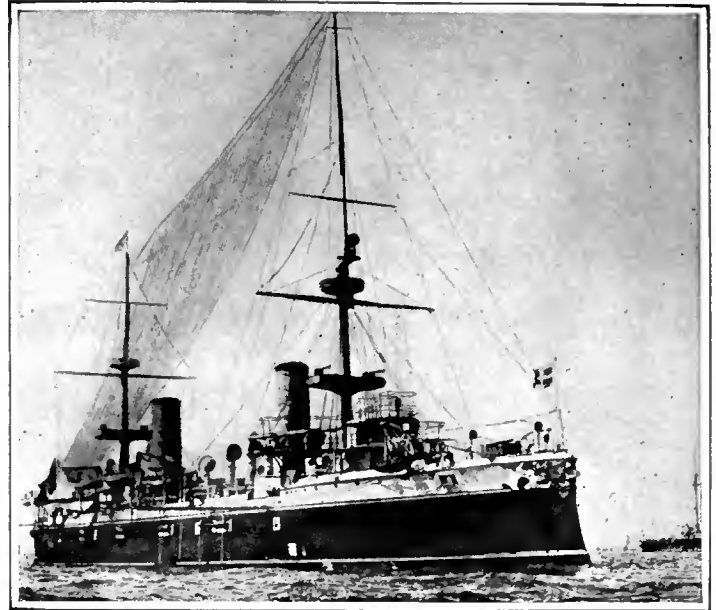

THE ITALIAN WARSHIP "CARLO ALBERTO"

When Senatore Marconi had made his first long-distance experiments across sea, it was generally opined that communication across mountainous country would not be feasible. The King of Italy placed at Marconi's disposal the *Carlo Alberto* from which experiments were conducted, and these proved conclusively that the above supposition was incorrect, for communication across the Alps and Pyrenees was effected without difficulty

carry on the most regular, rapid, and economical service by day and night between the antipodes of the globe, that is between England and Australia.

With such short-wave installations I was able in May, 1924, for the first time in history, to cause the human voice transmitted from England to be heard and understood in distant Australia.

RADIO—ALMOST UNIVERSAL TO-DAY

TO-DAY there are thousands of ships equipped with radio telegraphy for the safety of human life at sea and to maintain alive the daily activity of the countless persons who cross the oceans; to-day radio communications between Europe and America, the Far East and South America handle a huge traffic to the advantage of the growing demands of civilization; to-day millions of radio telephonic receivers scattered in the most distant countries carry on continuous communication with the greatest centers radiating news of everything of interest to mankind; to-day, by means of circular radio telephonic diffusion (so-called "broadcasting"), public opinion can be kept calm during any popular disturbance which interferes with the peace-making work of the press, as was proved on the occasion of the recent general strike in England; to-day many hundreds of thousands of people find occupation, study, and work in the new industry created by radio telegraphy; to-day aërial navigation is possible and safe up to the farthest bounds by means of radio communication, as has been recently demonstrated by the great triumph of Italian boldness and technical training obtained in the glorious *Norge* expedition.

The field of radio transmissions is con-

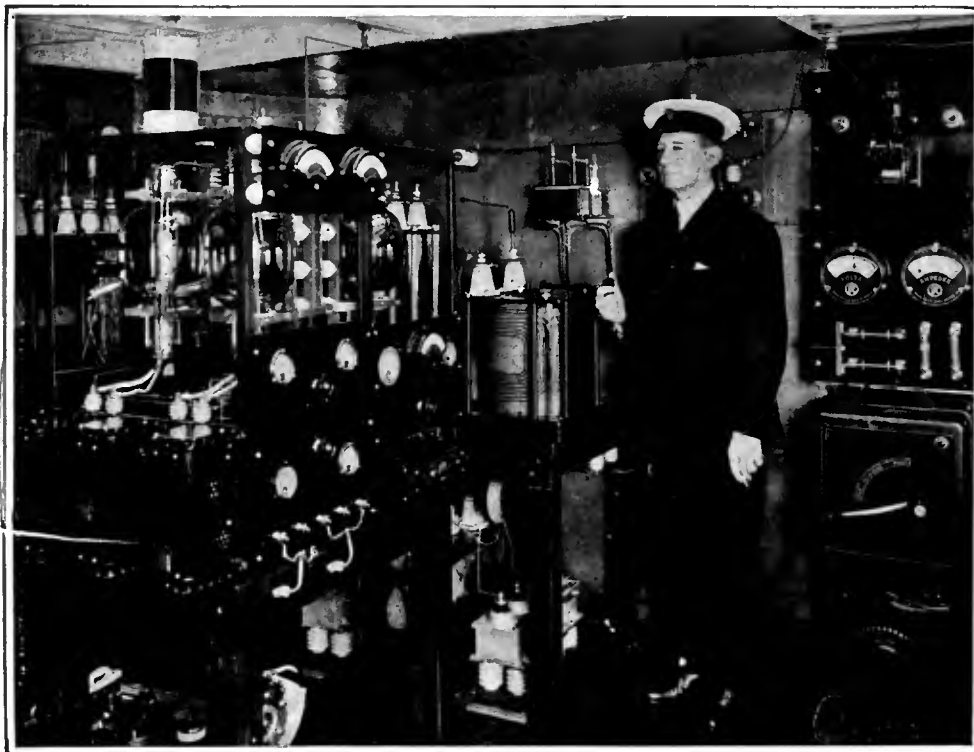

IN HIS SEA-GOING LABORATORY

Senatore Marconi is here shown amongst some of the experimental apparatus on board his famous yacht *Elettra*. He has crossed the Atlantic eighty-six times, many times in his own yacht

tinually getting wider, thus the radio transmission of photographs to a distance is already an accomplished fact and even now the practical solution of the great problem of television is seen to be possible in the near future.

Before concluding, I would like to send a respectful greeting to the numerous band of efficient scientists, seekers after the truth, and humble workers scattered all over the globe whose work has contributed to make possible the progress obtained; I wish once more to record with deep admiration and reverent affection the great figure of Augusto Righi who, with his genius and his indefatigable effort, did so much for the study of electric waves.

The clever and classical work on the Optics of Electrical Oscillations accomplished here at Bologna by Augusto Righi led to results which, from the walls of his laboratory, became the admiration of the students of physical sciences throughout the world.



BEAM STATION EQUIPMENT

"I was responsible for having caused the expenditure of hundreds of millions on long-wave stations. A certain courage was therefore necessary to say let us turn back," says Marconi with reference to the development of the short-wave beam station. The above picture shows the tube rectifier panels of the Bodmin, England, beam station

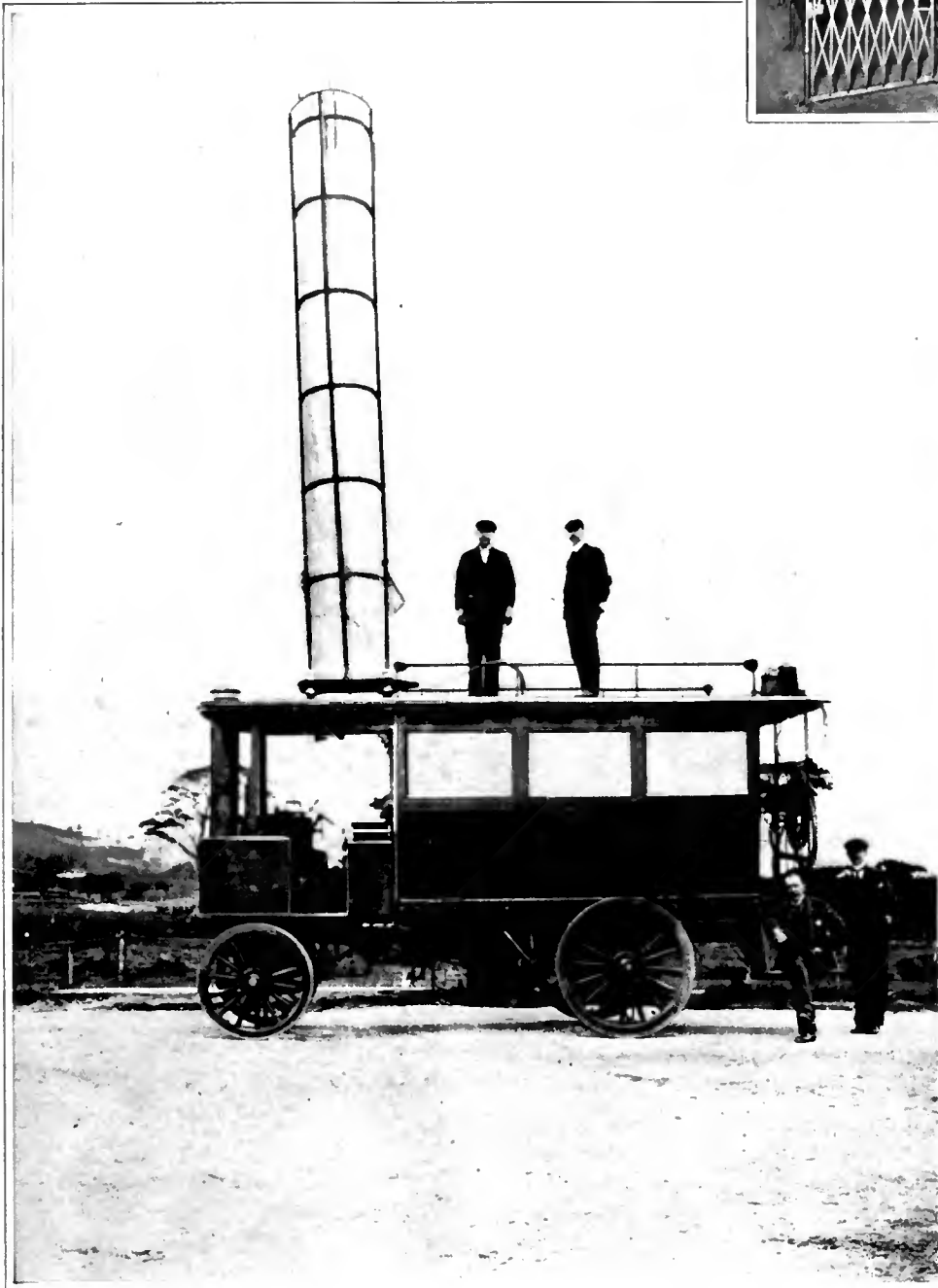

COMPARISON IS ODIIOUS, SO THEY SAY

Yet let us turn to page 39 of the May, 1926, RADIO BROADCAST, and see how Warner Bros. modern 250-watt portable outfit, 6 XBR, compares with the somewhat antiquated mobile affair illustrated above. Those of you who have seen 6 XBR on the road will be in an even better position to contrast, though it is hardly possible that the "puffing billy" depicted will ever be seen on Main Street again. It is a twenty-year old contraption used by Senatore Marconi in one of his first attempts at a portable field station. A cylinder of copper forms the antenna. To the extreme right stands the Senatore

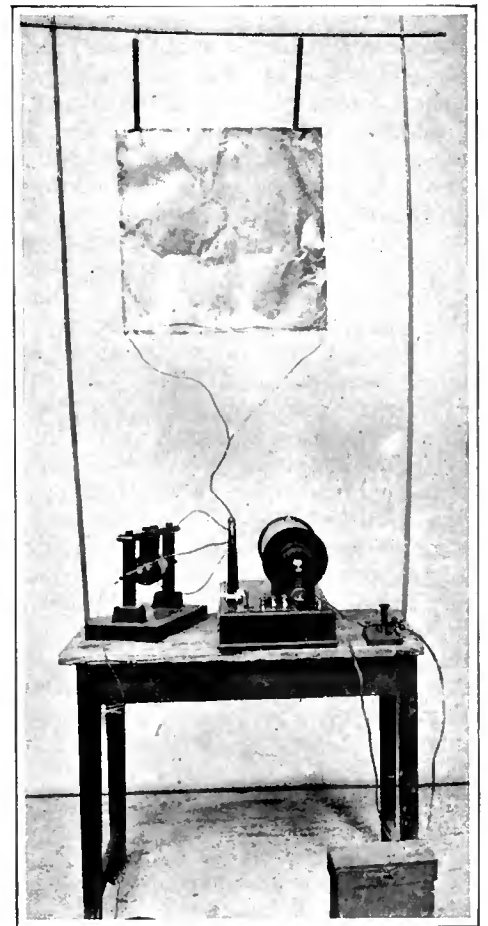

MARCONI'S FIRST TRANSMITTER

Was fashioned after the model in this picture. The apparatus includes the induction coil for obtaining a high voltage with a multiple coil spark gap, one side of which is connected to the antenna, which is in the form of a copper sheet slung, by means of insulators, between two posts. The other side of the spark gap is connected to ground

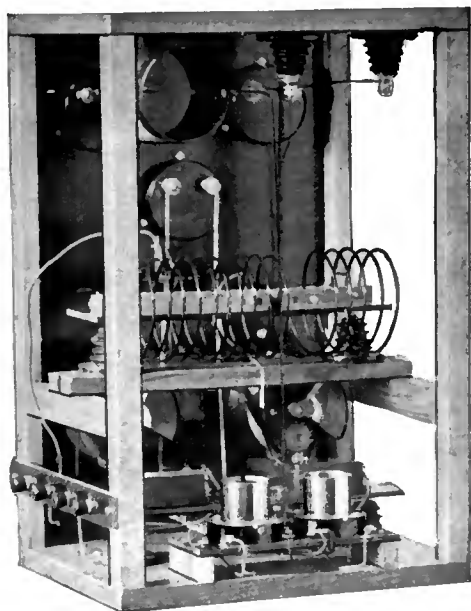

RADIO BROADCAST Photograph

FIG. 1

It is not difficult to see why 1 BD at Plainfield, Vermont, "steps out." Maple boiled in paraffin forms the framework of this efficient transmitter. Note the standard equipment, General Radio condensers and other parts mentioned in this article

IN THE April RADIO BROADCAST was described the portable short-wave transmitter that enabled 2 GY (the experimental short-wave station at the Laboratory of RADIO BROADCAST) to carry on communication with 9 CCQ, 1000 miles away, with a plate input to a 201-A tube of 0.04 watts, a record of 25,000 miles per watt. So many requests have come to the RADIO BROADCAST Laboratory for more complete directions for building this efficient set and so many readers have desired rules for tuning and operating it that the present article has been prepared.

The portable transmitter, however, was one of those "long geared" affairs that, "placed end to end," would reach from the cellar to the garret, and truthfully was not a beautiful object. For transporting about the country in the rear of an automobile—for which it was designed—it was quite the thing, but for one's den, that is a different matter.

Several of the readers of RADIO BROADCAST, however, have made a much better looking job of the small transmitters than that used at 2 GY and some of these are described in this article. For example, Mr. Roy L. Gale of Plainfield, Vermont, 1 BD, wrote:

This is to inform you that I have constructed a dry-battery transmitter after the description of the one in RADIO BROADCAST for April. As a starter I worked Holland, Michigan, Brookville, Ontario, and at 5-45 A.M. day before yesterday I worked Fredonia, Kansas, and a little later, a station at Cambridge, Illinois. I don't think this bad considering that I was using only about 350 volts on a five-watt tube. All report me as "strong and steady." Moreover, I haven't really learned to tune the thing yet, so I am expecting big success with it a little later. Old discarded BCL B batteries work fine on this rig.

High Efficiency B-Battery Transmitters

Several Types of Very Inexpensive Transmitters Using 201-A Tubes Which Are Capable of Long-Range Service—How to Tune Small Transmitters

By KEITH HENNEY

Director, Radio Broadcast Laboratory

Again on April 9, Mr. Gale wrote:

On Easter morning in broad daylight I worked 6 BIL at Pomona, California. My input was about 25 watts to a VT2 so maybe this wasn't a very alarming record considering that I was using quite a bit of power, but there are two fifty watters near here who haven't done any better than this at any time of day or night. I attribute my good results to perfect insulation. Am using Pyrex insulators for the antenna.

Several weeks after his first letter, Mr. Gale sent photographs of his set which appear in Figs. 1 and 2, and a description of his apparatus follows:

The panel is Radion Mahoganite and the layout somewhat resembles that of Mr. Dixon's of Montana, a description of which appeared in RADIO BROADCAST some time ago. You will notice that the coils are well insulated, being supported by maple strips boiled in paraffin, mounted on a hard rubber strip, and this in turn supported by two General Radio insulators. The plate and grid condensers, leak, and sockets, are also supported in the same way. The choke is a Browning-Drake antenna coil. Weston meters are used throughout. General Radio 0.0005-mfd. tuning condensers, and sockets. Dubilier 2000-volt plate and grid condensers, 0.002 mfd. in size. I use a 12 x 24 drilled window pane for lead-in and Pyrex antenna insulators. The antenna is a two-wire inverted L, 60 feet long, the counterpoise being a single wire 60 feet long, both rather high. A single VT 2 is used usually, but I have used two C-301-A's in parallel with good success. Was reported R5 DC in California when using about 25 watts. This in daylight, but not sunlight. I worked 6 BIL at this time for 30 minutes.

With a similar outfit using two 201-A tubes in parallel, Mr. Vincent Fertitta, 5 LE, of New Orleans, has had excellent luck and the accompanying log shows what can be done with small power inputs. Note particularly that with an input of 13.5 watts he worked Italian 1 NO. The average miles per watt of plate power expended for these transmissions is 84.5. Unfortunately Mr. Fertitta's photographs would not reproduce properly but the layout practically duplicates that of Mr. Gale, except that a transformer furnishes plate power instead of Mr. Gale's device of employing discarded B batteries.

A SIMPLE MODEL

JUST to show how simply one can build a similar transmitter, Figs. 3, 4, and the picture on page 34 give an idea of a 201-A transmitter built by Ferdinand Mann, an operator at 2 GY. This outfit, working from a DeWitt LaFrance power supply unit designed for broadcast receivers, and putting out about 200 volts at 30 milliamperes, puts 0.15 amperes into an average 40-meter antenna.

This set, as well as those used by 1BD and 5 LE, use the Hartley circuit loosely coupled to the antenna. Fig. 5 is the circuit diagram of Mr. Mann's affair. The parts used in this small transmitter follow:

- 1 Benjamin Socket
- 2 13-Plate, G. I. Condensers
- 2 Dials



RADIO BROADCAST Photograph

FIG. 2

A front view of Mr. Roy Gale's transmitter which has communicated nearly 3000 miles using about 25 watts input. Mr. Gale operates station 1 BD at Plainfield, Vermont

DATE	TIME	STATION	DISTANCE MILES	WATTS INPUT	MILES PER WATT	AUDI-BILITY
12- 5-25	6:30 P	3 HS	930	12.5	76	R-3
12- 5-25	9:55 P	1 YB	1340	12.5	107.2	R-4
12- 8-25	12:05 P	5 HE	504	13.75	36.7	R-4
12-15-25	11:30 P	3 AUV	1073	15.0	71.5	R-3
12-26-25	12:45 A	8 AFQ	1126	13.75	81.1	R-4
1- 1-26	2:40 A	8 AFM	925	16.25	59.6	R-3
1- 2-26	11:30 P	8 GZ	787	15.0	52.5	R-6
1- 4-26	8:30 P	8 BTH	888	12.0	74.0	R-2
1- 5-26	10:00 P	2 CFT	1075	13.75	78.1	R-5
1- 6-26	12:15 A	2 ACO	1150	15.0	76.6	R-3
1-10-26	12:16 A	1 HJ	1240	15.0	80.2	R-5
1-10-26	2:15 A	2 HH	1155	16.25	71.1	R-7
1-10-26	5:20 A	1 ADI	1430	15.0	95.3	R-4
1-15-26	8:20 A	9 BME	700	13.75	50.9	R-5
1-15-26	10:30 P	8 AH	925	12.5	74.0	R-5
1-17-26	11:45 P	1 UW	1314	13.75	95.5	R-5
1-18-26	12:40 A	1 YB	1340	15.0	89.3	R-6
1-21-26	8:15 P	9 DUD	590	12.5	47.2	R-4
1-25-26	5:40 A	2 AEV	1155	15.0	73.3	R-4
2- 1-26	6:58 A	8 BFH	1000	12.5	80.0	R-6
2- 2-26	5:30 A	1 BKP	1340	13.75	97.4	R-6
2- 2-26	5:53 P	9 DMZ	675	12.5	54.0	R-5
2- 2-26	11:00 P	9 WO	1070	15.0	71.3	R-3
2- 6-26	7:30 P	3 BUV	1083	12.5	86.6	R-5
2- 9-26	12:10 A	8 FP	1075	16.25	66.0	R-5
2- 9-26	11:35 P	2 AMJ	1155	13.75	84.0	R-3
2- 9-26	12:00	8 BQ	1075	13.75	78.0	R-4
2-12-26	11:15 P	2 RM	1155	15.0	77.0	R-4
2-28-26	4:30 A	PR-4 SA	1625	15.0	108.3	R-4
3- 1-26	12:05 A	C-3 QS	1096	13.75	79.0	R-5
3-21-26	4:25 A	8 XE	1073	12.5	85.84	R-6
3-28-26	12:15 A	1-JNO	5291	13.5	391.9	R-2
3-29-26	11:36 P	M-JH	920	13.75	66.9	R-4
4- 5-26	12:30 A	2 KG	1155	15.0	73.3	R-5
4-14-26	10:50 P	M-IN	920	13.75	66.9	R-5

Average miles per watt, 84.5

the tuning condenser across the whole coil, the closed circuit tunes as shown in Fig. 6, from about 15,000 to 5000 kc. (20 to 60 meters). An Ureco 112 tube with 100 volts on the plate was used when taking this data. The antenna was 38 feet long and the counterpoise 24 feet, both consisting of single wires, horizontal and 8 feet apart.

Having determined that both filament and plate circuits are properly connected and operating, it is desirable to know whether the antenna will tune to all frequencies in the amateur band. Fig. 7 shows what happens as the antenna series condenser is varied and the closed circuit retuned for maximum antenna current at each setting of the series condenser. It

shows that the antenna-counterpoise system described above tuned from 29 to 48 meters. It will be noted that the plate current is practically constant through this range.

It must be remembered that antenna current is little indication of how a set "gets out." So much depends upon surrounding physical conditions, upon the relation of the natural wavelength of the antenna to the wavelength actually used, that antenna current is only useful in indicating when the greatest amount of power is being transferred to a given antenna at a given wavelength. It is probable that greater range may be obtained by operating the antenna below its fundamental wavelength, although the current actually pushed into it is less.

Having determined that the given antenna-counterpoise will operate within the amateur band it is only necessary to pick out some wavelength, say 40 meters, and retune both closed and antenna circuits to get the maximum current into the antenna.

Fig. 8 shows the effect of varying the filament tap. When there are five turns in the grid circuit, the greatest efficiency is attained, and when there are four turns, the greatest antenna current results. The figures representing efficiency are antenna current milliamperes divided by plate milliamperes but are not true efficiencies which should be the ratio between output and input power. They do show, however, the adjustment for maximum antenna current consistent with low plate current.

With the closed circuit adjusted for maximum efficiency, the antenna tunes about as Fig. 9 shows.

The final adjustment is to place full power on the tube. All of the data for curves in this article have been with 100 volts on the plate but Fig. 10 shows what happens when higher voltages are used.

A PAGE FROM THE LOG OF MR. VINCENT FERTITTA

- 1 Yaxley Filament Lighting Jack
- 1 General Radio 127A 0-.5 Radiation Meter
- 1 Choke Coil 100 turns, -1 inch diameter No. 28 d.c.c.
- 2 Cardwell Inductances
- 2 Sangamo 0.002 Condensers
- 1 Sangamo 0.001 Condenser
- 1 Lynch 5000-Ohm Resistance
- 1 Elkay Ballast No. 2 with Mounting
- 2 Radion Brackets
- 7 Binding Posts

TUNING THE HARTLEY CIRCUIT

IT IS due to its simplicity that the Hartley gets its popularity. One coil, two condensers, and the tube make up the oscillating circuit. And due to this simplicity, tuning it is not difficult, although there are several processes that must be gone through before one is certain that the circuit is putting out the maximum power with the minimum of input energy.

Once the set is put together, the first thing to do is to test the filament circuit. If it is properly connected, one should then proceed with the plate circuit and if batteries are used for power, about a hundred volts should be used to determine whether the circuit is properly wired. The plate current at 100 volts using a 201-A or a 210 tube will be about ten milliamperes, and as the tuning condenser is varied, the plate current will probably have "bumps" in it due to resonance with the plate choke coil or the antenna circuit.

The filament tap on the tuning inductance should be at about the center of the coil and varying this tap toward the grid end—that is, including more turns in the plate circuit—will decrease the plate current and power drawn from the B batteries. With the tap on the fourth turn from the plate on Mr. Mann's transmitter built at the RADIO BROADCAST Laboratory, and

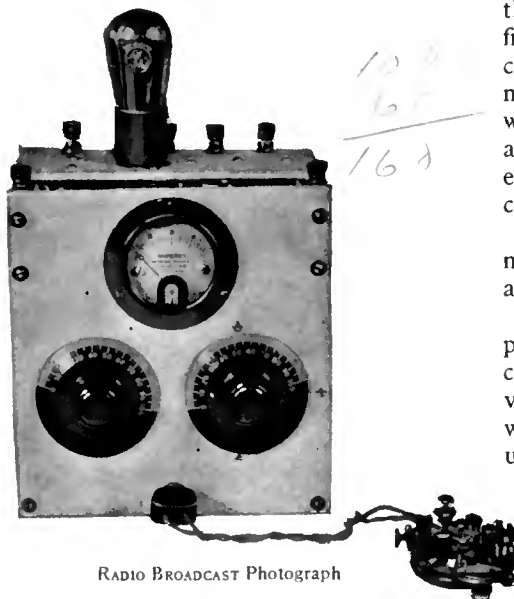

RADIO BROADCAST Photograph

FIG. 3

A front view of one of the transmitting sets operated by batteries and used at 2 GY. Note the extreme simplicity. It uses the Hartley circuit—the same as Mr. Gale's receiver



HERE IS SHOWN

Another view of the 2 GY set. It was made by Ferdinand Mann

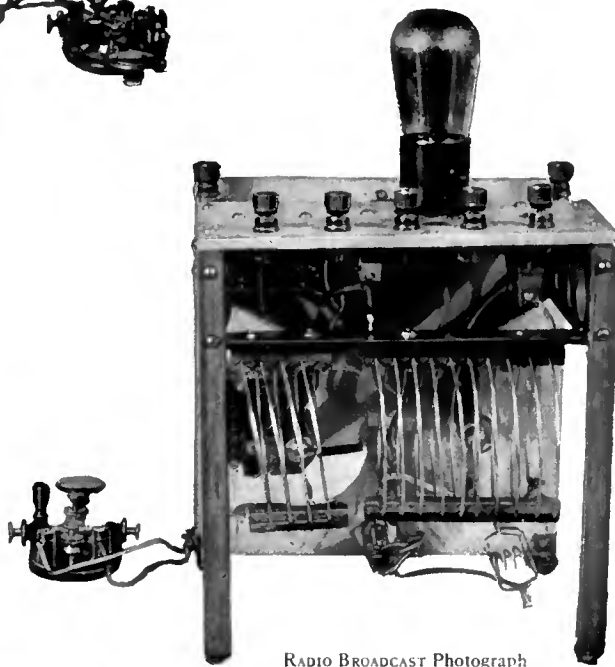

RADIO BROADCAST Photograph

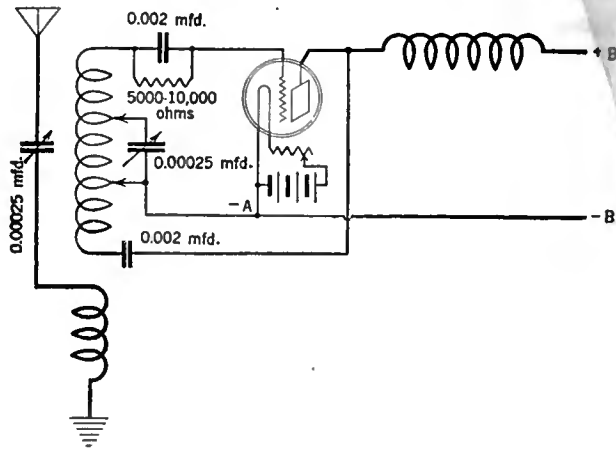

FIG. 5

The well known Hartley circuit. The key may be inserted in the minus B lead. In Mr. Mann's set, the inductance consisted of ten turns of No. 14 gauge antenna wire. The condensers must be well insulated since they have to stand the full d. c. voltage applied to the plate

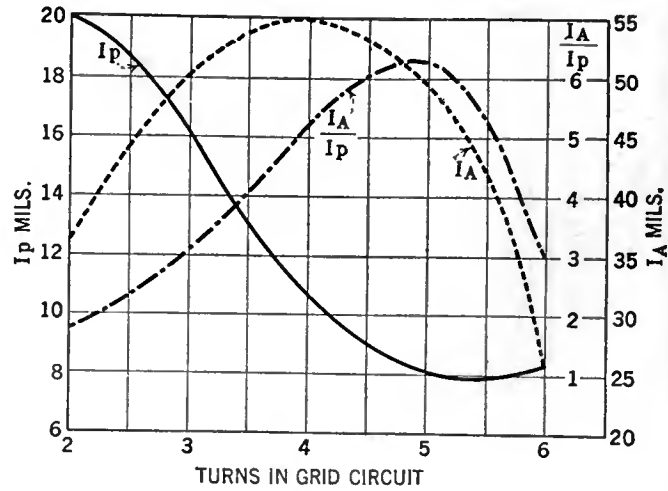

FIG. 8

The effect upon antenna and plate currents of varying the filament tap. The greatest ratio of antenna current to plate current is secured when there are five turns in the grid circuit

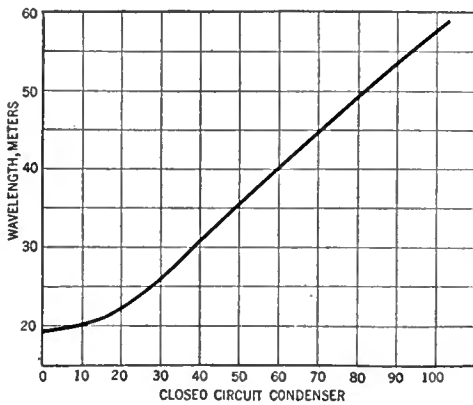
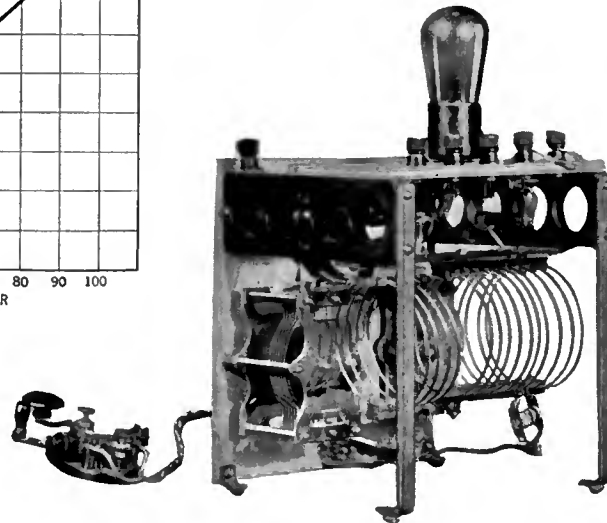

FIG. 6

The closed circuit of the Hartley transmitter at 2 GY tunes from 15,000 to 5260 kc. (20 to 57 meters), as this chart shows



RADIO BROADCAST Photograph

FIG. 4

A side view of the small 2 GY transmitter. It is operated entirely from dry batteries

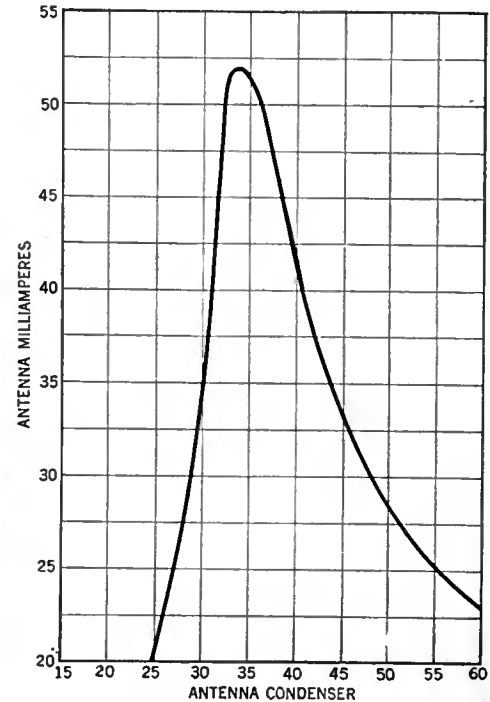

FIG. 9

With the closed circuit adjusted for maximum efficiency, the antenna tunes according to this curve. This is a typical resonance curve. The wavelength is approximately 38.8 meters

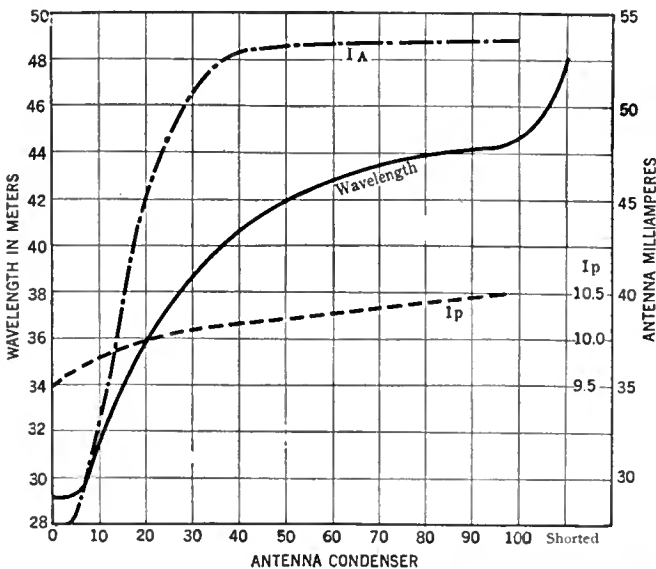

FIG. 7

As the antenna series condenser is varied, the transmitter tunes as this chart shows. It also gives an idea of how the particular antenna tunes to different wavelengths. On the longer waves, the antenna is apparently of lower resistance since more current can be fed into it

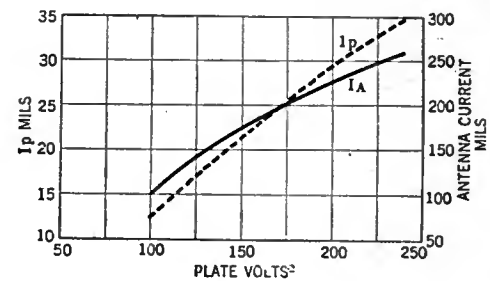
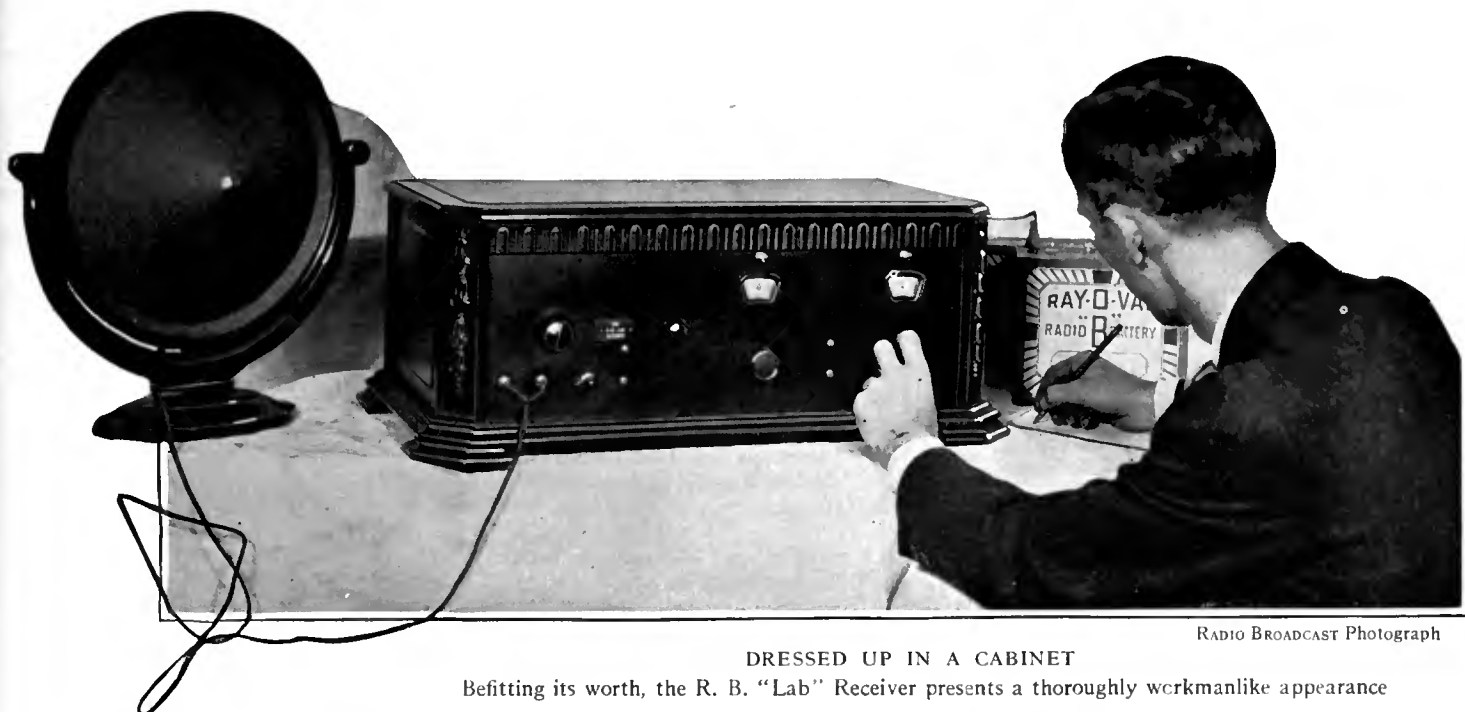

FIG. 10

The relation between power input and antenna current is shown here. The greater the plate voltage the greater the antenna current and naturally the plate current increases too



RADIO BROADCAST Photograph

DRESSED UP IN A CABINET

Befitting its worth, the R. B. "Lab" Receiver presents a thoroughly workmanlike appearance

Constructing the R. B. "Lab" Receiver

Four Tubes, in a Circuit Employing Rice Neutralization, Provide Sufficient Volume for Loud Speaker Operation—Short Leads Made Possible by Novel Layout—Shielded Panel, Output Device, Cabled Wiring, and Illuminated Dials Are Featured

By JOHN B. BRENNAN

Technical Editor, Radio Broadcast

FOLLOWING Keith Henney's articles in the June and September issues of RADIO BROADCAST on the R. B. "Lab" circuit, this third article is published with the intention of placing before the reader constructional data which will enable him to duplicate such a receiver with a minimum of trouble.

The design does not follow orthodox paths but incorporates an unconventional feature not attempted in many receivers. It will be noticed, from both the circuit diagram and panel view photograph accompanying this article, that unlike most receivers, the progression of the signal as it enters the antenna circuit follows from right to left instead of from left to right. In other words, the antenna and detector tuning units are situated at the right-hand end of the receiver instead of, as is more usual, at the left side. There are several good reasons for following this procedure. First, the connections from socket to coil, from socket to transformer, etc., are extremely short; in fact, in the audio channel no wire is used for connecting the sockets and transformers because these units are close enough so that the lugs on the terminals of each may be soldered together. Secondly, practically all of the A, B, and C battery wires are located behind the sockets and at the rear of the base board so that it is possible to arrange these wires in the form of a many-wired cable. Thirdly, the fact that this cabling is

possible insures against feed-back between units comprising the receiver.

The worth of the circuit has been established previously, and this constructional article makes it possible to make use of the circuit at its utmost efficiency, simply because time, energy, and thought have been expended in devising for the circuit the best possible layout.

In the model described here, a panel shield has been used which completely eliminates any hand

capacity effects which ordinarily would be noticed when Rice neutralization is used without any shielding. The photographs show how the home-made shield is installed with cut out places to fit around the apparatus on the panel. A piece of sheet copper, quite thin, is best for the shield.

Neutralization in the Rice circuit is practically independent of frequency, or, said in another way, one adjustment of neutralization will be sufficient no matter whether the receiver is

tuned to the longer or shorter waves within the band covered. This is obviously an advantage because the satisfactory performance and successful operation of a tuned radio-frequency amplifier at its highest point of efficiency depends entirely upon the degree of perfection of neutralization.

The theory governing the proportioning of the inter-stage coil has been dealt with at length by Mr. Henney in his previous articles, and will not be repeated here. Suffice it to say that commercial coils suitable for immediate inclusion in the circuit have been made available. For those who desire to make their own coils, specifications are given in Figs. 2 and 3.

To tune the two coils, Cardwell taper plate type 169E condensers are used. Although the plates are semi-circular in shape, the tuning chart, Fig. 1, shows practically a straight frequency-line characteristic due to the special design of these plates.

The Facts About This Receiver

Name of Receiver Type of circuit	R. B. "Lab" Receiver. One stage tuned neutralized radio frequency amplification, regenerative detector, and two stages of transformer audio frequency amplification, followed by an output device.
Number and Kind of Tubes	Four; 201-A's for i.f. stage, detector, and first audio stage; UV-171 in last audio stage.
Volume control	500,000-ohm variable resistance shunted across the secondary of the first audio transformer.
Regeneration Neutralization	Condenser feedback. Rice.
Utilizing all of the high gain produced by the peculiar inter-stage coupling feature, without waste or undesirable feedback effects, it is possible with the R. B. "Lab" receiver to attain a degree of selectivity and sensitivity hard to approach with other types of circuits. By employing a most efficient audio channel, the tone quality and volume of the loud speaker signal is above reproach.	

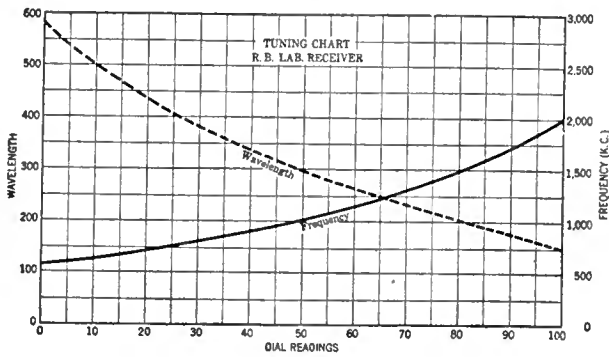

FIG. 1

Both dials of the "Lab" Receiver read alike; should they both read approximately 50 for a certain station, you may be sure that the station is transmitting on about 1000 kc. (300 meters)

be fairly large in capacity—4 mfd.—but not large physically. Furthermore, it must be capable of withstanding approximately 350 volts. The Tobe-Deutschmann 4-mfd. bypass condenser is suitable for this purpose, and is employed in the receiver described.

Wiring throughout the receiver is accomplished with the use of Belden hook-up wire. This wire, consisting of a number of tinned twisted strands of fine copper wire, is well insulated with a rubber covering. It is obtainable in the following colors: Red, blue, green, and gray or natural. The use of this wire greatly simplifies the connecting of the various units of the receiver, and permits the battery leads to be twisted and

denser of 50 mmfd. The Precise is very satisfactory for this work and is used here.

LAYOUT IMPORTANT

TO CONSTRUCT a receiver similar to the one described, detailed layouts, wiring diagrams, and explanatory sketches are furnished so that there need be no great difficulty in this respect.

Only when actual duplication of the layout and wiring of the receiver as herein described is attempted, can successful operation be assured. This point cannot be stressed too greatly. Mr. Henney, in his previous articles, dealt at length with the advisability of placing parts and wiring correctly to prevent objectionable feedback effects. The use of Airgap sockets, which introduce a minimum of grid-plate capacity, aids in reducing this feedback. The receiver described in this article is the result of much experiment, and it is doubtful whether with the apparatus employed a more successful arrangement can be obtained. It is for this reason that constructors are urged to follow closely the design as given.

To begin actual construction of the receiver, the following parts are required:

- 2 Cardwell 0.00035-mfd. Variable Condensers, type 169E.
- 2 "Lab" Circuit Tuning Coils, General Winding.
- 2 Marco Illuminated Dials.
- 4 Sockets, Airgap.
- 2 Amertran Audio Frequency Transformers, 1st and 2nd stages.
- 1 XL Neutralizing Condenser, type N.
- 2 Samson Choke Coils—85 millihenries.
- 1 Samson Output Impedance, type O.
- 1 Tobe-Deutschmann Bypass Condenser, 1-mfd.
- 1 Tobe-Deutschmann Output Condenser, 4-mfd.
- 1 Electrad Royalty Variable Resistance, 500,000 ohms.
- 1 Electrad Filament Switch.
- 1 Electrad Grid Condenser, 0.00025-mfd.
- 1 Electrad Fused Metallic Grid Leak, 4 megohms.
- 2 Brachstats, 1/2-ampere and 1/4-ampere.
- 2 Frost Pin Jacks.
- 1 Precise Microdenser, type 940, 50-mmfd.
- 9 X L Binding Posts.
- 1 Radion Binding Post Strip.
- 1 Panel 7 x 21 x 1/8 inches, Formica.
- 1 5-wire fused Belden battery cable cord.
- 1 Fritz Cabinet.

Choke coils are advantageously employed in both tuned circuits. In the secondary circuit of the antenna stage, an 85 millihenry Samson choke is inserted in series with the lead connected to the center tap leading to the C battery. It is used to prevent oscillation of the circuit at the extremely high frequencies around 3750 kc. (about 80 meters). In the detector stage, a similar choke is employed to prevent the radio frequency currents from passing on through the primary of the first audio frequency transformer and through the B battery to the ground. These currents are more useful when passing through the small Precise variable condensers to cause regeneration.

Another feature—purely a mechanical one—adding to the factory-like appearance of the finished receiver, is in the use of the new Marco illuminated dials. On the front of the panel a small pie-like segment of a bezel is mounted forming the window through which may be seen the white celluloid dial-piece. Behind the dial is located a small lamp which, when lighted by the thumb switch—a part of the dial proper and located above the bezel—illuminates the figures and scale markings so that one may tune the circuit very accurately.

The full volume output of the audio amplifier may be diminished by merely turning the knob on a variable resistance unit which shunts the secondary of the first audio transformer.

OUTPUT DEVICE EMPLOYED

AS IS the custom with the many modern types of receivers, a choke coil and condenser are arranged in the output circuit so that the windings of the loud speaker may be operated free from the excessive drag exerted by the d. c. component of the high B potential on the plate of the last tube. Also, better quality of tone is obtained with this system due to the fact that a Samson tapped output coil is employed, making possible the adjusting of the impedance of the coil to approximately match the particular characteristics of the loud speaker used. The condenser employed in this combination must possess especial qualifications, viz., it must

A, B, and C batted.

So that a power tube may be used in the last audio stage, the filament wiring to this socket includes a separate 1/2-ampere filament ballast,

EVER since Keith Henney's article in RADIO BROADCAST for June describing the fundamentals of the R. B. "Lab" Circuit appeared, a considerable stream of correspondence has come into the office asking when a constructional article would be printed on the circuit. The "Lab" Circuit is not a new circuit in the sense that it is revolutionary; such circuits do not exist. The circuit is not easy to build; it cannot be "thrown" together, but this complete article by John B. Brennan tells how to build a model embodying many features of decided interest to the home constructor who desires to put together a set which uses many circuit refinements brought forward by the manufacturers for the 1927 season. The constructor who builds this set will have a receiver of neat appearance, great sensitivity and selectivity, and one which delivers a signal of high quality—all with four tubes. Development work on the circuit was done over a period of several years, by Keith Henney, director of the RADIO BROADCAST Laboratory. We prophesy that this circuit will enjoy a wide popularity.—THE EDITOR.

such as a Brachstat. The other three tubes are connected with their filaments in parallel and controlled by a single 3/4-ampere filament ballast. Regeneration in the detector circuit is accomplished by means of a small variable con-

stance, 500,000 ohms.

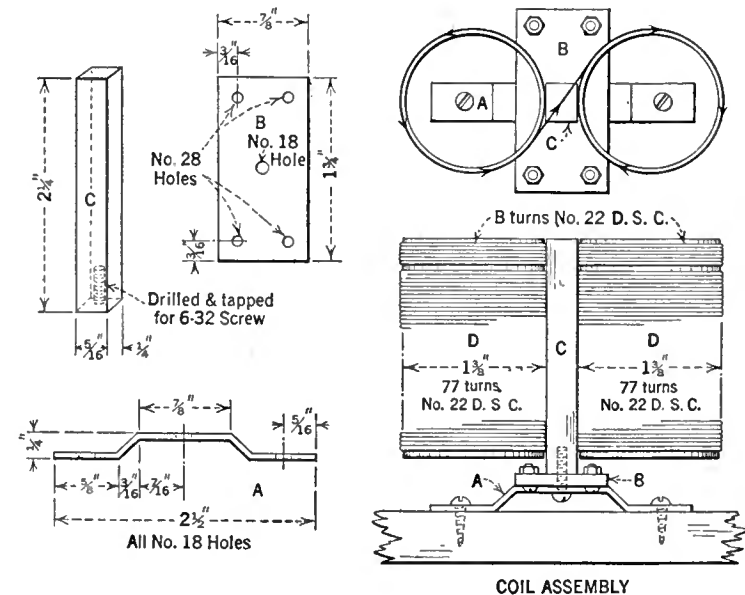

FIG. 2

Data for the construction of the coils and supports are given here. Reference to the text on page 37 and Fig. 3, will simplify the making of the coil units

Having obtained the necessary parts, we now lay out and drill the panel in accordance with the panel sketch, Fig. 4. Each Marco dial is furnished with a steel template which enables the builder to drill the holes in the panel necessary to mount the window.

Now cut and prepare a base board, details of which are shown in Fig. 11. Brackets, to fasten the panel to the base board and the C batteries to the rear wall of the cabinet, are shown in Fig. 10. Brass strip, 1/2-inch wide and 1/8-inch thick is used for this purpose. Also in this diagram are shown the details necessary to prepare the binding post terminal strip.

The next thing to do is to fasten

the metal panel shield to the panel proper by means of four screws which pass through the brass brackets holding the panel in place. The copper should be laid flat on the panel and holes located at the various points where the instruments must project through to the front of the panel. The holes must be made sufficiently large so that no part of the instruments will come in contact with the shield itself.

Assemble the Precise regeneration condenser, Electrad Royalty 500,000-ohm variable resistance, Frost pin jacks, and Electrad filament switch on the panel in their respective mounting holes. Then set the panel aside and assemble the parts on the base board. A layout of these parts is shown in Fig. 5.

Without fastening the panel to the base board, much of the wiring can be done, as shown in Fig. 8. It is better to do the simpler and shorter connections first. For instance, the audio transformers and sockets are close enough together so that with the aid of a lug on the terminal of the socket, direct connection, without the use of wire, can be made from the grid and plate posts of the sockets to their respective grid and plate transformer terminals. After this is done, the filament wiring may receive attention. Here is where cabling of the leads is beneficial. First, with a piece of gray (natural) hook-up wire, connect the minus F terminals of all the sockets together, leaving about $\frac{3}{4}$ -inch of slack wire between the terminals. Next, beginning at the minus A binding post, run a piece of the same colored wire along the

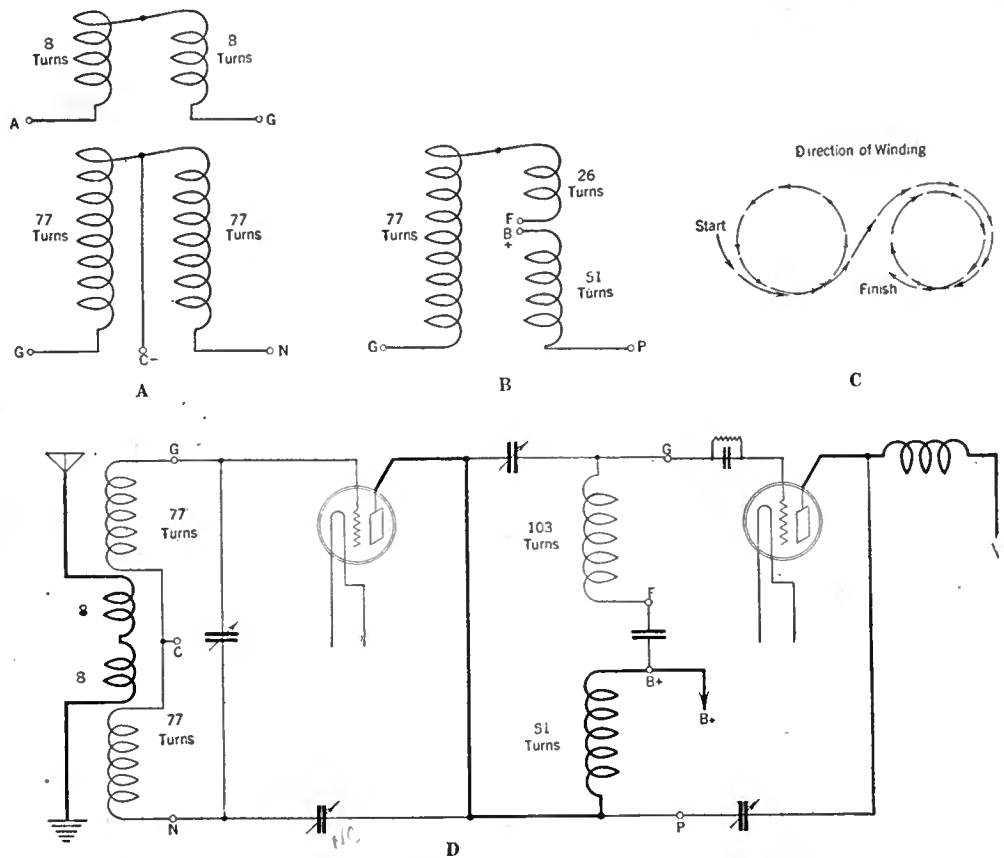

FIG. 3

The diagram above, together with that on page 36 and the text in the article will enable the veriest of home constructors to satisfactorily produce the "Lab" circuit coils. The connections of these coils in the circuit are explained by the diagram given here

amount can be purchased); a piece of $\frac{1}{8}$ -inch bakelite or formica; a strip of $\frac{1}{2} \times \frac{1}{16}$ -inch brass strip; four No. 6 brass round head wood screws; a mailing tube $1\frac{3}{8}$ -inches in diameter, and a sheet of celluloid, such as is used in photography. A strip of bakelite or formica is also required as a coil support. This may be obtained by cutting a strip of the desired width from a sheet of $\frac{3}{16}$ -inch panel material. With this is required one $\frac{1}{2} \times \frac{3}{16}$ inch round head brass machine screw.

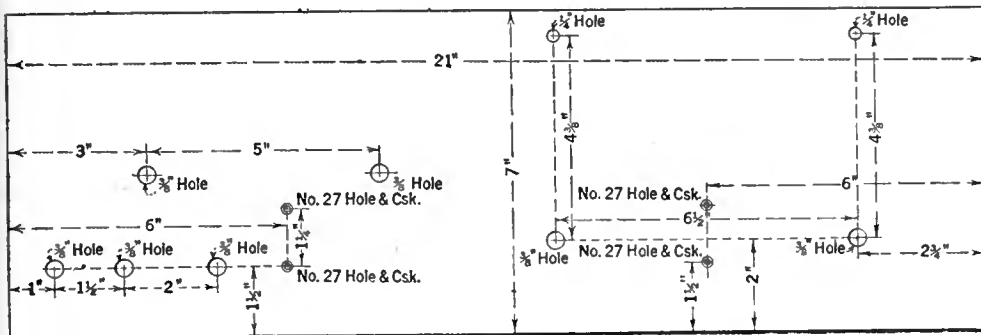

FIG. 4

The panel for the "Lab" receiver should be drilled in accordance with the directions on the diagram above. A steel template furnished with the Marco illuminated dials enables accurate drilling of holes for the windows on the panel to be accomplished

back of the base board and down the left-hand side, and cut it when it is long enough to reach the position the filament switch on the main panel will take. This piece of wire is run parallel to the back edge of the base board and, as it advances, it is wound over the previous socket wiring threading it under and over, etc. From the second approximately estimated position of the contact on the filament switch a similar piece of wire is run back to the minus F post on the last audio socket. It also is twisted with the other lead emanating from the filament switch.

Continuing the filament wiring, a piece of green wire is started from the plus A binding post, wound or twisted around the gray wires, and attaches to the right-hand end of each filament ballast. In the radio frequency, detector, and first audio stages, the plus F posts are connected together with more green wire, which is twisted over the rest of the wires. At this time, it is not well to connect the remaining contacts on the Brachstats to their respective terminals on the sockets because the presence of these wires will impede the completion of the wiring of the B battery and C battery leads. From both audio transformers, connection must be made to the B and C binding posts on the

terminal strip. As these connections are made, the wire is twisted around the mass already forming a formidable cable. The B battery leads are done in red wire, the C battery leads in blue.

COIL DATA

THE tuning coils may be directly wired into place without difficulty.

Winding and assembling the coils for the "Lab" circuit is not as complicated as a first glance at the sketch in Figs. 2 and 3 would make one believe.

First procure the material, namely: A $\frac{1}{4}$ -lb. spool of No. 22 d.s.c. wire (a $\frac{1}{4}$ -lb. spool is too much, but it is doubtful whether a smaller

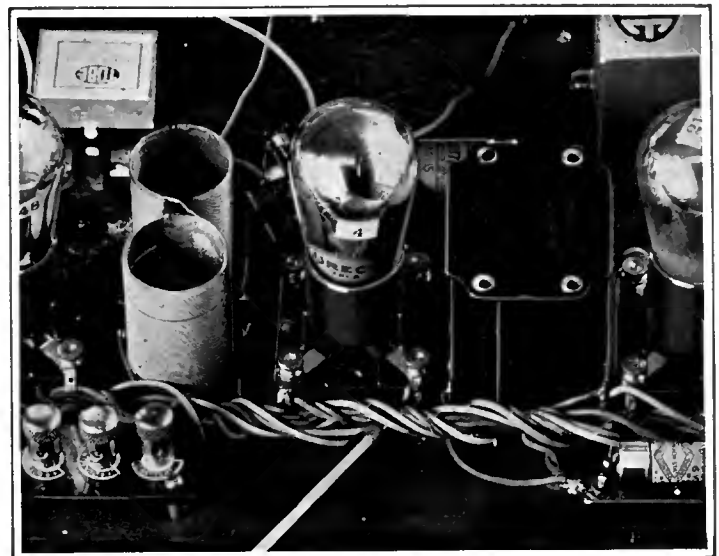

RADIO BROADCAST Photograph

A CLOSE UP OF THE CABLING

Shows how all the wires are formed into one big twist. This is accomplished by threading each wire as it progresses from terminal to terminal under and over those already there

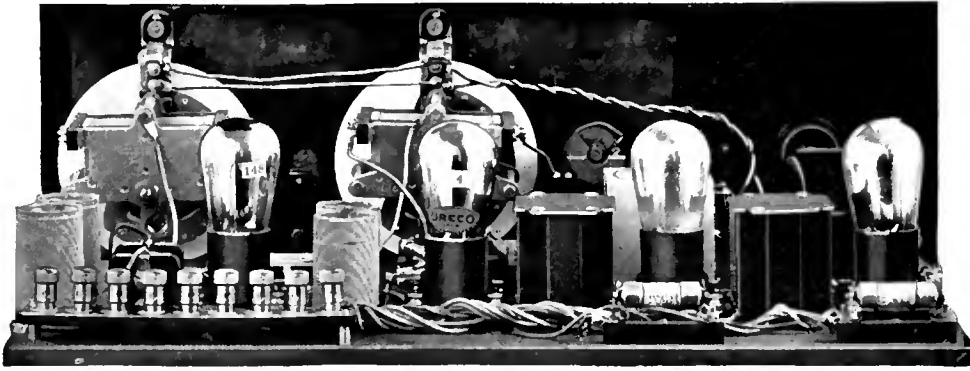

THE SHIELD

Against the rear of the main panel as illustrated here is beneficial since it eliminates the hand capacity effects so detrimental to accurate tuning

RADIO BROADCAST Photograph

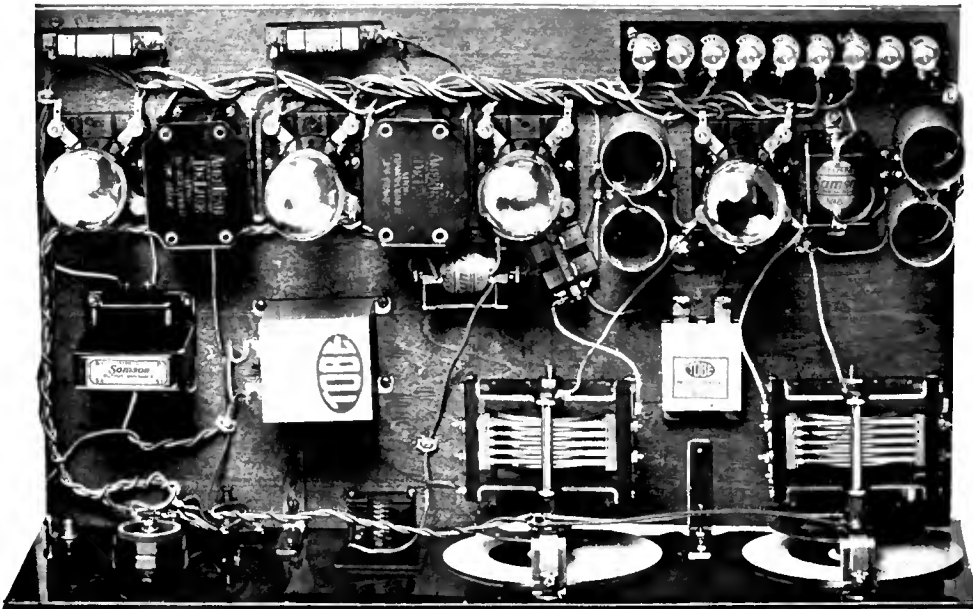

FOR CROSS REFERENCE

This from-above-the-baseboard view should be studied in conjunction with the diagram Fig. 5. This picture shows very clearly how well spaced the various units are, and gives an excellent idea of the cabled filament wiring

RADIO BROADCAST Photograph

Remove the chemical coating from the celluloid film by washing in hot water. Then wrap this sheet around the mailing tube to form just one layer, cutting away the surplus. By applying acetone along the seam formed by the celluloid edges a complete cylinder of celluloid will result.

From this point on it is better if two people do the job, one to turn the cylinder, the other to guide the wire. However, before the wire is started on the form, lightly coat the entire surface of the celluloid with acetone. This will produce a sticky surface in which the wire will find a substantial hold. From time to time as the wire advances along the form, it may be found necessary to refresh the surface by additional coatings of acetone.

Wind about seven inches of wire on the form and set it aside until the celluloid has become hardened again. Then, starting at one end, count seventy-nine turns and lift up the wire at the 79th turn with a knife blade and cut it. Then, unwind back toward the starting point, two turns, so that there are exactly seventy-seven turns in this one section. Beginning again where the wire was cut unwind two more turns. This produces a space four turns wide. Count out ten more turns and cut the wire. Unwind two turns to form a lead, leaving eight turns in the second section. With a pen knife cut the celluloid form at the eighth turn and

you have a coil form upon which are wound two sections, one of seventy-seven turns and one of eight turns. These sections are separated by a space equalling the width of four turns. Now duplicate this process, making another identical coil unit. These two units constitute the antenna circuit inductance.

By dissolving strips of celluloid in acetone, a cement may be made with which the coils may be fastened to the central support, C, as in Fig. 2. The leads from each coil are terminated as shown in Fig. 3.

For the interstage coil system, the procedure is somewhat the same excepting that the first coil unit has a single winding of seventy-seven turns on it. The second coil unit is wound first with twenty-six turns, then a space equal to two turns, and finally a section of fifty-one turns. The correct connections for the interstage form are shown in B, Fig. 3. It is essential that the turns in each form of a completed coil assembly run in the same direction, as in C, Fig. 3. The manner in which the coils fit into the circuit is illustrated in D, Fig. 3.

Returning to the wiring, we note that the grid condenser is mounted directly on the detector socket. This insures the shortest possible connection.

Reference to the wiring diagram and circuit diagram, Figs. 8 and 7, will show that very simple connections are made to the radio frequency choke coils. Also, the neutralizing condenser is so positioned that short leads are all that are necessary to wire it correctly into the circuit.

Three blue wires are twisted together and connected, one to the G post of the first audio transformer, another to the F post of the same transformer, and the third to the G post of the first audio socket. These wires, in the form of a separate cable, are passed along the front of the transformers to the left hand edge of the base board, thence along it to a position at the

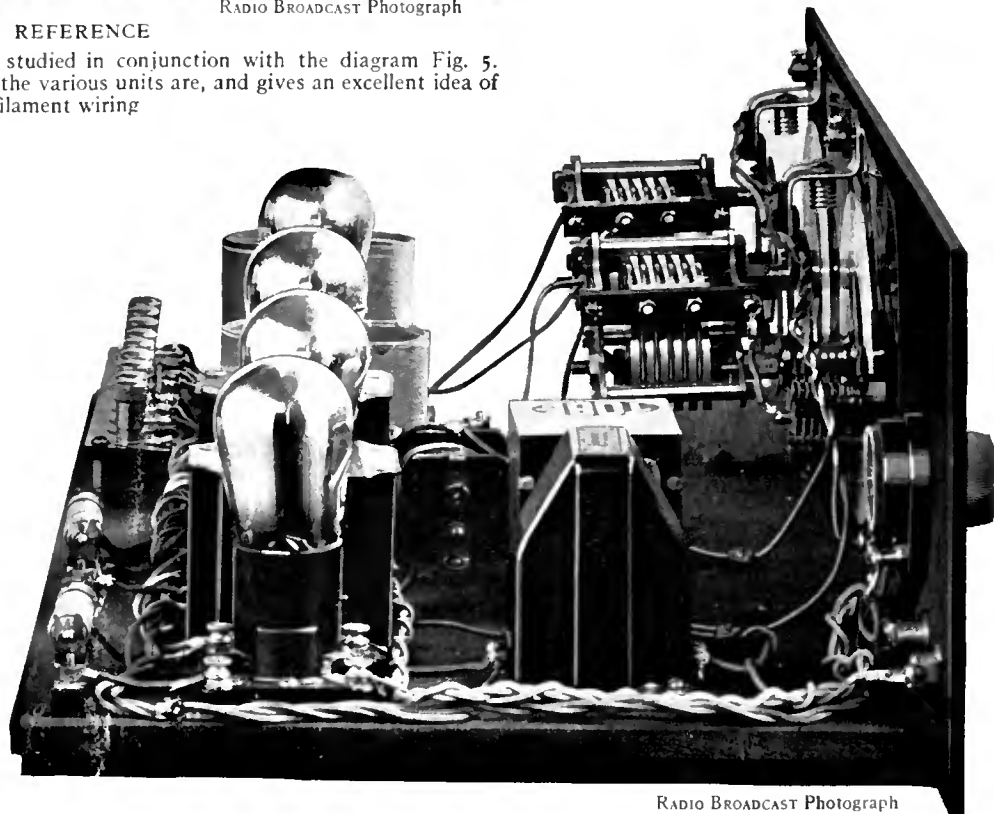

RADIO BROADCAST Photograph

ATTENTION TO THE LAYOUT

Is an important factor that is often overlooked in construction of a new receiver. The wide baseboard of the "Lab" Receiver enables all the apparatus to be placed to best advantage. Note the cabled filament wiring which runs right around the base board to the switch and rheostat

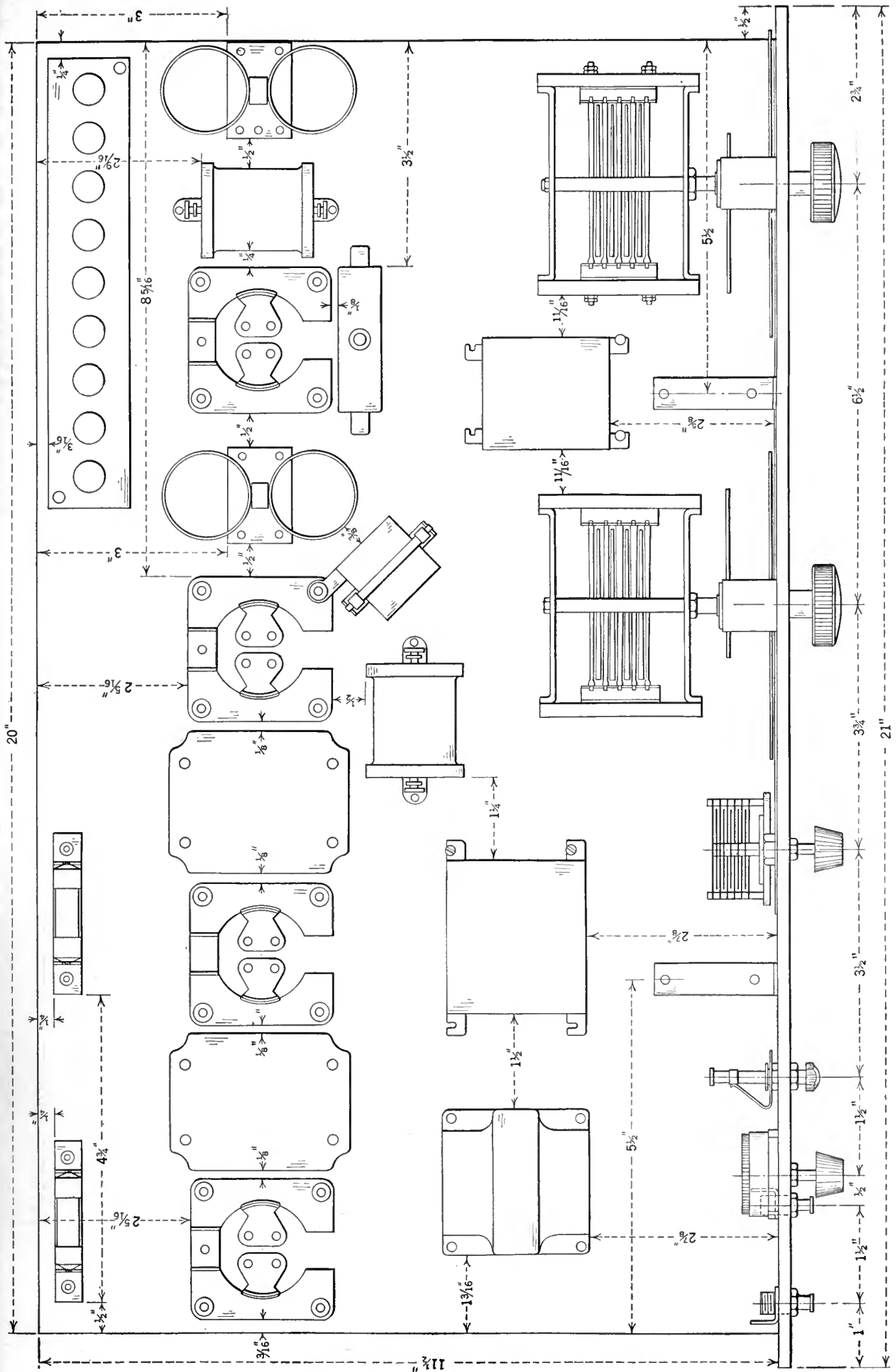
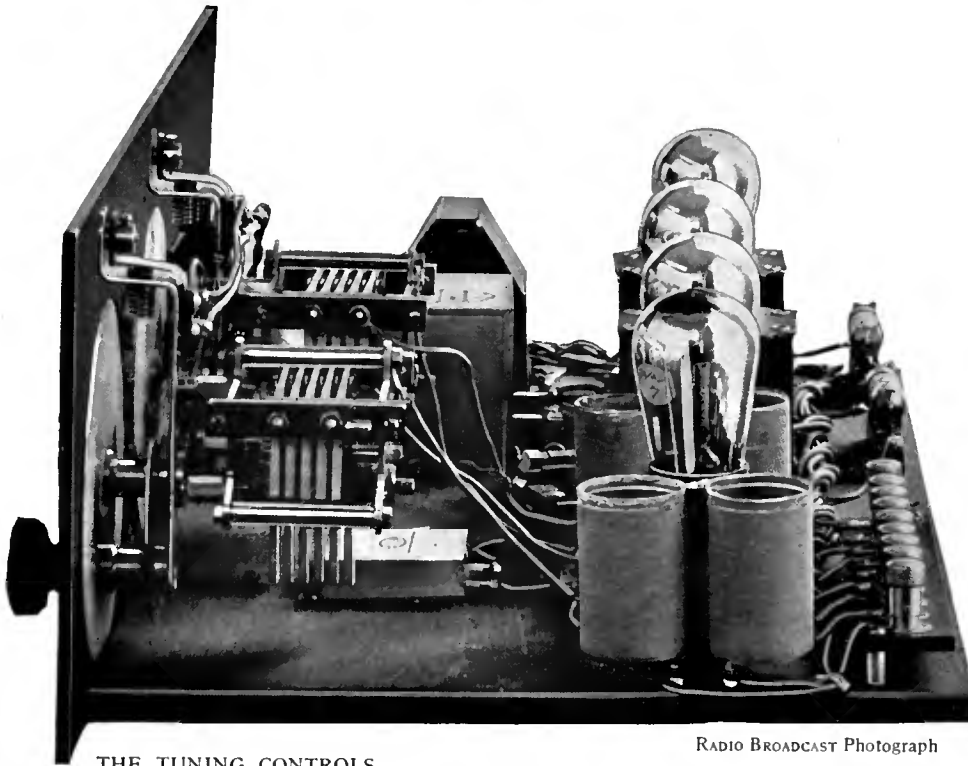

FIG. 5



THE TUNING CONTROLS

RADIO BROADCAST Photograph

Are clearly shown in this side view of the R. B. "Lab" Receiver. The two nearest tubes are the r. f. and detector ones, and not the audio stages, as one would be apt to suppose

front approximately in line with the 500,000-ohm volume control on the panel.

At this point the base board assembly may be laid aside and further work on the panel continued.

First examine the Marco dials; two types are available on the market. The new style is recognized by the fact that the lamp receptacle holding the pilot light is completely isolated from the metal frame of the dial whereas, in the old style, one side of the lamp receptacle was connected to the frame. The new style dials can be used without any alterations, but it will be necessary to change slightly the construction if the old dials have been purchased.

In this latter instance, it is necessary to cut away the upper part of the frame supporting the dial light, removing a 3/8-inch section. By means of a small piece of fibre, rubber, or other insulating material, these two parts are joined together again. The insulating strip insures against short circuits, etc., and, in the circuit employed, prevents blown out tubes. Detailed sketches showing how these changes are made, are contained in Fig. 10.

After the dials have been satisfactorily altered, the condensers are mounted on them, and the whole assembly is mounted on the panel. When this is completed, the panel may be fast-

FIG. 6

To the right a plan of the battery connections to the binding post strip is given. A Belden cable is employed for all but the C battery leads

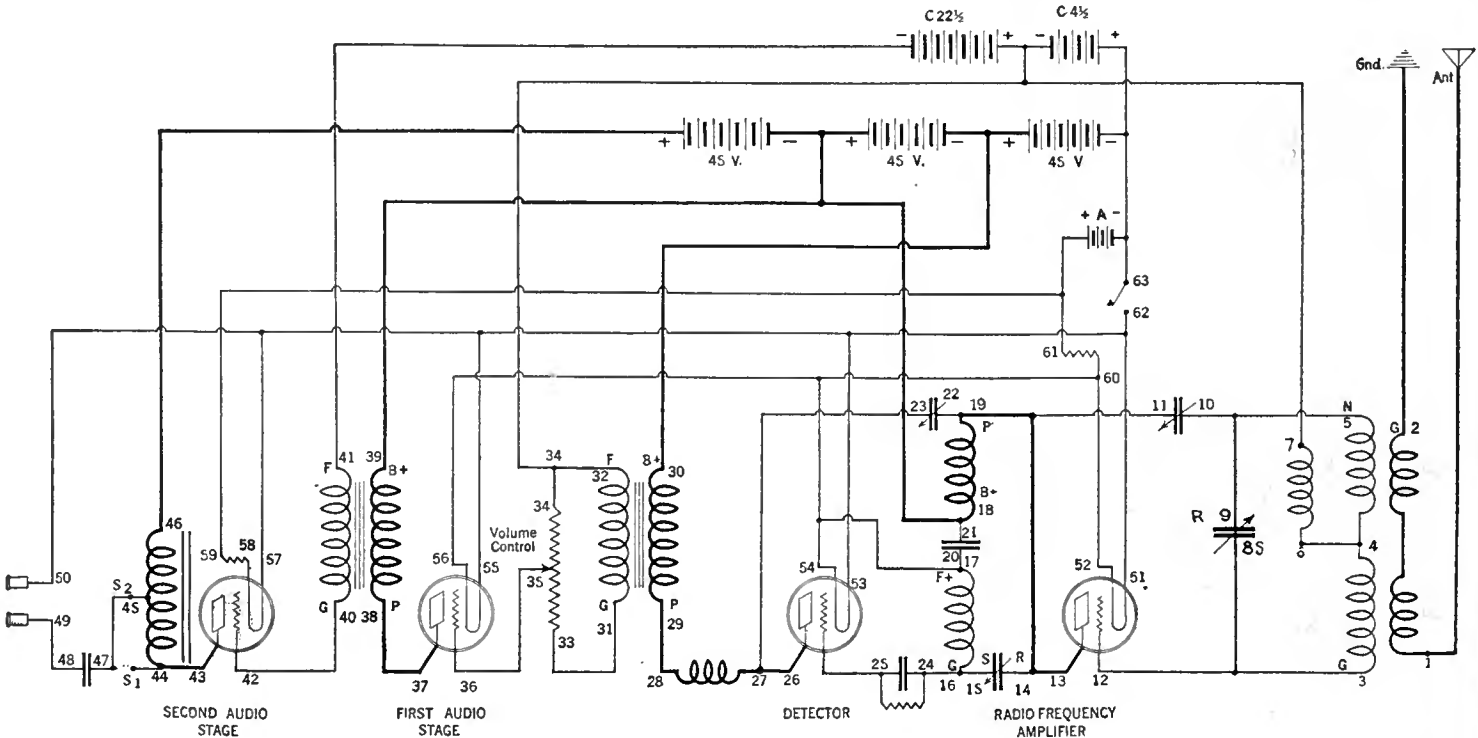
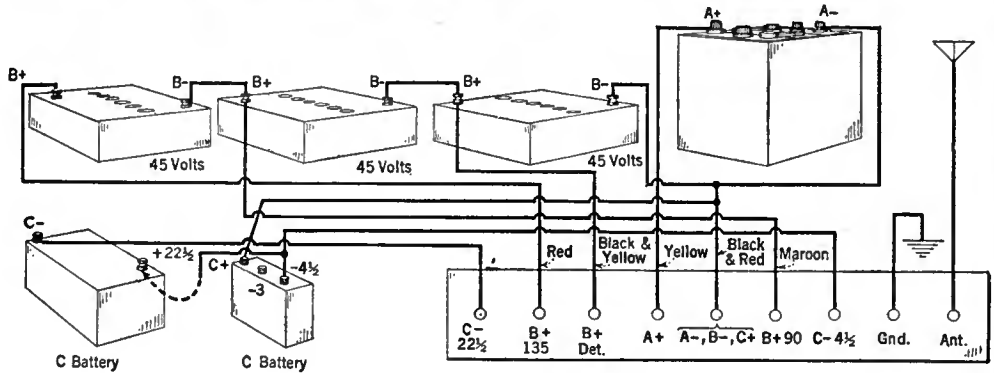

FIG. 7

Here is given the circuit diagram of the four-tube Radio Broadcast "Lab" Receiver. Note that the progress of the incoming signals is from left to right, and not vice versa, as is usually the case. The coil unit at the extreme left, between the terminal numerals 44-46 is a Samson type O audio output impedance coil designed to protect the windings of the loud speaker. Its impedance is variable in two steps which approximately match existing types of loud speakers

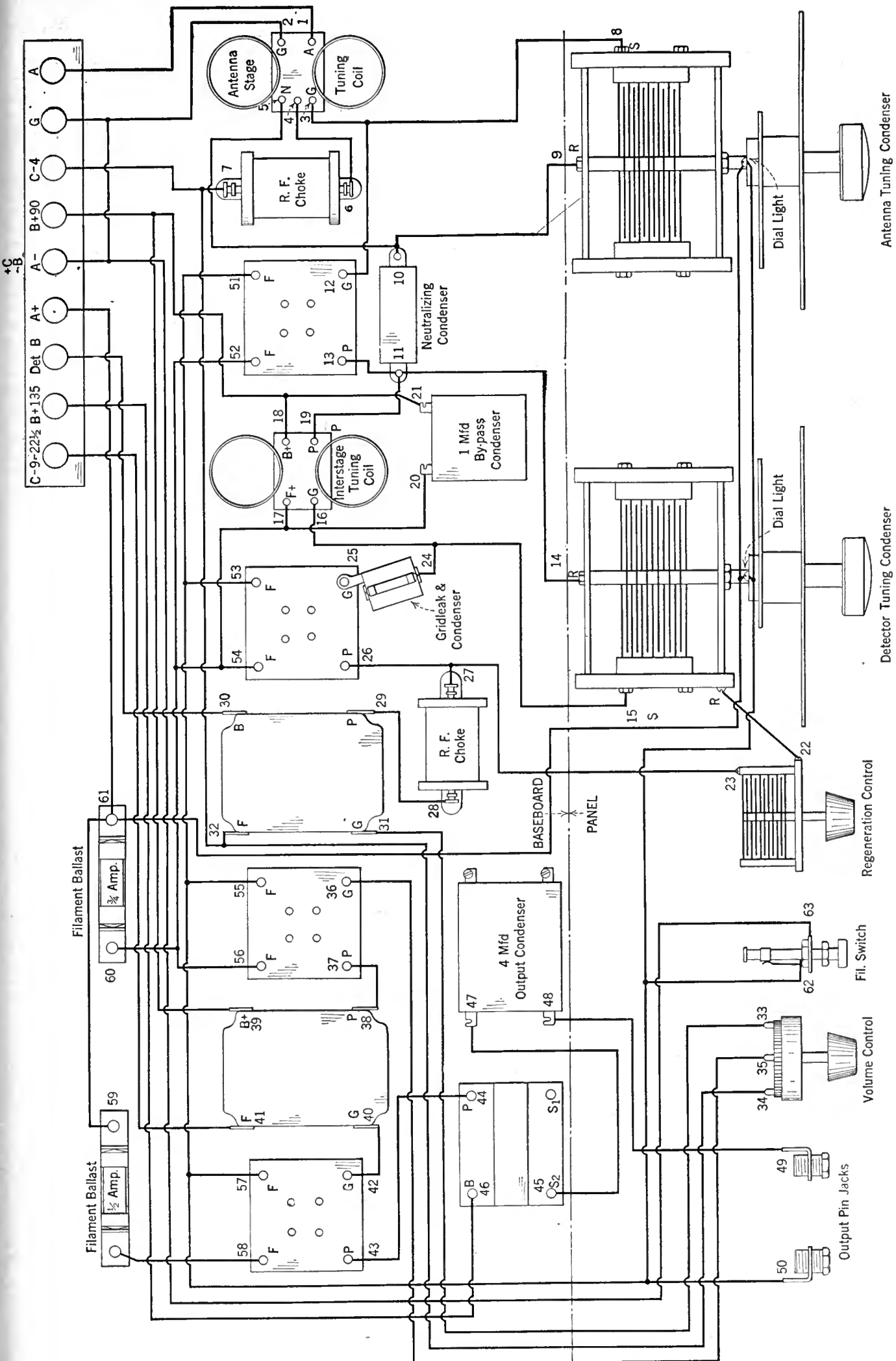

FIG. 8

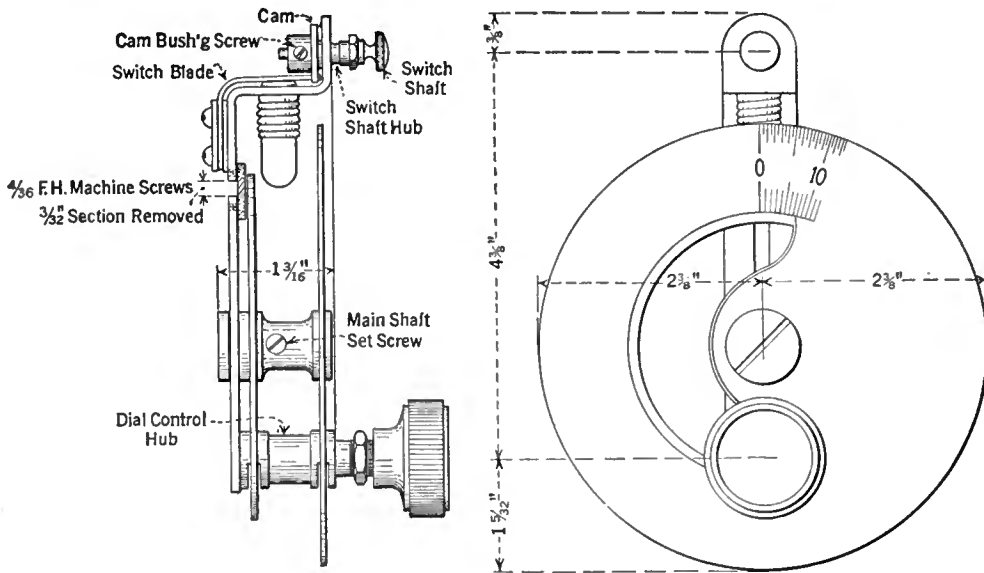

FIG. 9

There are two forms of the Marco illuminated dial on the market. If you have obtained any but the latest models, a slight alteration will have to be made. This alteration, which involves the removal of a section of the frame, is explained elsewhere, and is clearly shown in the above diagram

THE CORRECT TUBES TO USE

THREE 201-A tubes may be used in the first three sockets and a 171 tube in the last audio socket. At 135 volts of B battery, this latter tube requires about 27 volts of C battery.

Now pull out the filament switch. This should light all the tubes. Turn the regeneration condenser so that its movable plates are completely meshed with the stationary plates. Then, with the aid of the tuning chart shown in Fig. 1, set the right-hand dial at an approximate setting for the station it is desired to receive, and slowly turn the knob of the detector condenser, swinging it a few degrees above and below the number on the other condenser. If the station is broadcasting, a regeneration squeal will be heard in the phones or loud speaker. Back off the regeneration condenser setting to diminish the squeal. Then slowly rotate the antenna tuning condenser. If the squeal changes in pitch, the neutralizing condenser should be adjusted until there is no such variation of the squeal pitch. The set is then properly neutralized and may be operated like any other receiver that employs the squeal

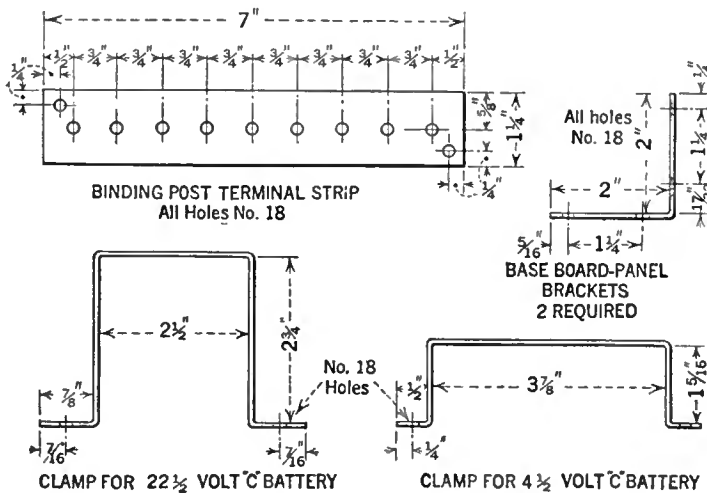

FIG. 10

ened to the base board by means of the brackets, details of which are shown in Fig. 10.

To complete the wiring of the receiver the units on the panel are wired to their correct points on the base board.

By means of a five-wire fused Belden battery cable, the batteries, with the exception of the two C batteries, may be connected to their respective binding posts. The five wires of the Belden cable are colored as follows; red, maroon, yellow, black with red tracer, and black with yellow tracer. These wires are connected to the binding post terminal strip as shown in Fig. 6. The C batteries, since they are contained inside the receiver cabinet, are connected directly to their respective binding posts, as is also shown in the same diagram.

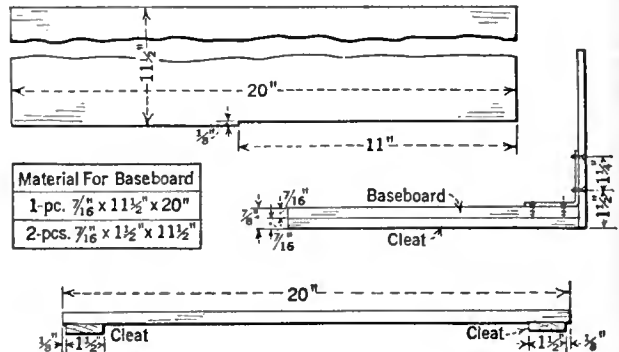

FIG. 11

For the base board it is essential that good wood be employed, thus obviating any possibility of warping. The base board of the "Lab" Receiver is exceptionally wide, and cleats are employed to strengthen it. The base board supports the front panel rather than the front panel supporting the base board, which is generally the case



RADIO BROADCAST Photograph

INSPECTING THE JOB

Right to left, are Willis K. Wing, editor, Keith Henney, Director of the Laboratory, and Howard E. Rhodes of the Technical Staff. Mr. Henney is pointing to the cabled leads which are distributed along the rear and side of the base board

method of tuning. The fact that a squeal can be heard in the loud speaker does not necessarily mean that other neighboring receivers will also pick up this squeal—providing that first you have satisfied yourself as to the proper neutralization of the receiver. This enables you to turn up the regeneration control and then vary the tuning of the detector condenser until the carrier wave of a station is picked up.

Now, from this point onwards, it is only a matter of bringing the antenna condenser setting up to the point where the loudest squeal results and then backing off the regeneration control until the squeal is eliminated. In its place ought to be the music, or speech from the broadcasting station to which the set is tuned.



The Listeners' Point of View

Conducted by John Wallace

Who and Where the Infants Really Are In Radio

WHENEVER we begin to feel too morbid about the headway—or non-headway—that radio is making we are cheered up considerably by a happy thought which we shall make haste to share with you.

We are thoroughly sick of the phrase “in its infancy.” For the last twenty years the movie industry has been assuring us that it is “in its infancy.” So frequently and loudly has this phrase been repeated that it begins to take on the air of a boast rather than a well warranted apology. And, as you well know, the phrase is being constantly applied to radio with the same *double entendre*. So we shall not make ourself an accomplice in the crime by here repeating it ourself—even though it would fit in very nicely.

Instead, we shall say that the men behind the scenes, the *entrepreneurs* of radio, are in their infancy. We do not mean this facetiously but literally. Perhaps it isn't true! If so our pet spark of hope goes a glimmering. But our occasional ventures behind the scenes have disclosed that the usual radio personnel is made up of young men. Generalizing from the few studios we have visited, we guess that the same conditions obtain at the rest of the stations.

Nor is it surprising that radio should be manned principally by youths. The business “broke” all of a sudden. In its humble beginnings there was no hint of the prosperity it was to achieve. To enter the “radio game” was an out and out gamble; and a gamble is not entered into too recklessly by a middle aged, or past middle age, man. Moreover, on the technical side, there were a hundred boys interested in the mechanics of the new invention to the one adult that was similarly engaged in experiment.

The consequence was that back in the early twenties, opportunity-seeking young business men and just-out-of-college boys made a rush to enter the broadcasting profession, and succeeded pretty well in filling up all available seats. And now the older man, the conservative who hesitated to jump at such a long chance, must stick to his banking business or the Governorship, for there's no room for him.

Possibly you have yourself at some time become interested in the resonant, deep and mature voice of some favored announcer. You have pictured him as a kindly, grayed old man with dignified side whiskers. Chance, let us say, brings you to his radio studio. Curiously you ask to have him pointed out. Lo and behold! you are shown a sleek haired youth in twenty-six inch trou'.

Or mayhap you have read in the public prints the comments of Manager Bloopus of WHEW on current radio events and marveled at the paternal sageness of his pronouncements; only to have some disillusioning friend point him out in an ice cream parlor perched boyishly on a high stool guzzling a double choc'lit sundæ with nuts.

Yes, radio as we find it at present is in the hands of the youth of the country: it is a boy's profession. We state this in no spirit of derision but as, we believe, a fact. Far be it from us to hold against the purveyors of radio entertainment their youth. Perhaps we are in a glass house! On the contrary, we think that this factor was in a measure responsible for the wim and wigor of radio's get-away. And supposing radio were operated by a bunch of gray beards; would we be any better off? The answer is no.

For they wouldn't be any better equipped to manage a radio station for having spent forty years in the dry goods business or operating a newspaper. At the time radio came into being no one was any better fitted by previous experience to enter its ranks than anyone else. For radio was, and is, different than any previously

existing sort of “art” or industry. By way of exception, people in the theatrical business had some sort of qualification for the new trade, but not much. Also, the impresarios of the musical world were specially fitted, but unfortunately for us listeners, but few of them abandoned their concert halls and lyceums for the radio studios.

And now to sound the cheerful note which we promised in the opening paragraph of this dissertation. When things look blackest we are consoled by this reassuring thought: what of ten, twenty years from now?

Ah, there you have it—the secret of our ineradicable smile! We, the listeners, will be being served by a flock of veterans. The present staff of each and every radio station, barring assassinations, and acts of God, will still be in existence, *in toto*. We cannot help but believe that this accumulation of experience will mean much. An analogous condition exists in the automobile business to-day. It is the boast of several large concerns that they have almost the identical organization with which they started twenty-odd years ago. Such an organization necessarily becomes closely knit and highly efficient.

Ten or twenty years diligently devoted to an endeavor to discover “what the public wants” should certainly result in some light being cast upon that elusive riddle. The making up of the programs and the doling out of them should by that time be reduced to a formula. The demands of the public will doubtless vary slightly from time to time, but once having determined the general trend of its likings it will be easy to introduce these gradual variations.

Take, for instance, the announcer. Ten or twenty years of announcing (if any of them stick it out that long) should completely exhaust the jests of any announcer and make him a mechanical “announcing machine”—which is just what we would have him. In the course of that time he should have experienced almost every conceivable situation, from connoption fits on the part of the tenor soloist to an explosion in the studio. (And the announcer, lest we fail to give him credit, has plenty of exacting situations to handle.) So in 1936 we may expect him to smooth over any mishap gracefully, and to deliver himself of his routine labors in a very minimum of words.

Of course there is the danger of an inbred organization going stale. But there will inevitably be some changes, some new blood entering the broadcasting profession. And all the while there



AIDAN REDMOND, OF WBZ

A new addition to the announcing staff of the Springfield station. Mr. Redmond officiates usually from the Hotel Brunswick studio of station WBZ, in Boston. Before he came to radio, Mr. Redmond was on the concert stage. He is a native of Cambridge, Massachusetts



THE PENNSYLVANIA RAILROAD "HOUR" ARTISTS

Who are regularly heard through wjz, wgy, and wrc on Tuesday evenings from eight to nine p. m., Eastern Standard Time. The photograph forming this illustration was made in the studio of wjz. At the extreme left is Eddie Smalle, piano; next, a quartette: Franklyn Bauer, tenor; Elliott Shaw, baritone; Lewis James, tenor; Wilfred Glenn, bass. Following the quartette is Norman Brokenshire, erstwhile announcer of wjz, holding the cord of the locomotive bell used to give a realistic touch to the programs. The others in order are, Frank Banta, pianist; Andy Senella, saxophone and guitar; Sam Horman, xylophone; Alvin Simonds, porter at the wjz studio. He adds realism by blowing on the railroad whistle as occasion requires

will be that nucleus of experienced veterans—the boys of today—serving as a stabilizing influence. On the whole the outlook is a happy one!

"Merchants of Glory"

TO INTRODUCE a variation on the above theme, there is one group of individuals connected with the radio business whom we fervently wish would grow up in a hurry, and they are the publicity men. Now you as a listener have little or nothing to do with the publicity men so there's really no reason why we should air our complaints to you. But we, so much the worse, are exposed to them, or rather their products, daily—and it occasions us great ire.

Perhaps you would be interested in being taken behind the scenes and informed as to their deadly activities. Every radio station maintains a publicity man, or if it is big enough, a staff of publicity men, to see that its name is kept prominent in the newspapers—a perfectly legitimate job and not an offensive one if it is done properly. These publicity men set their agile wits to working and send forth about once a week an envelope full of mimeographed drivel, tooting the horn of the station they represent. This parcel of printed matter, together with advance programs, is sent to radio editors throughout the country. It's brought to our desk in baskets.

And if ever you think that the standards of any particular department of radio are low, rest assured that they are nowhere near the rock bottom attained by the radio publicity staffs. Some of these propagandists may be adults, but their prose endeavors certainly read like the work of a backward school-boy. This is no reflection on the profession of publicity as a whole. In the ranks of the publicists are numbered some of the most able journalists in the country. In fact if you run across an especially readable and well written "story" in a newspaper

you may eight times out of ten discover that a good publicity man is behind it.

Radio has simply been unfortunate in not having lured into its camp able and experienced publicity men. The puerility of efforts in this line is borne witness to by an inspection of any newspaper radio section. We find therein column after column of stories containing no whit of interesting information but only a series of wild hurrahs for this or that station and a pack of obviously manufactured yarns.

We could quote you several yards of silly statements that have crossed our desk during the

last month, but fortunately for you we have already emptied our waste basket. We have at hand just one specimen. The publicity man has been touting his station for its high-brow offerings and concludes his article with the remark:

In radio, the child gets a basic training in the better type of music, an acquaintance with the outstanding musicians and operas of the nation. Little children to-day recognize selections from Brahms, Wagner, Beethoven, and others equally popular in musical circles, without trouble. (Italics ours)

No event in the studio is too personal, insignificant, or utterly uninteresting for the publicity man to devote several hundred words to it. If the second cousin of the great aunt of one of the station's artists gives birth to a boy we are promptly informed of its weight, color of eyes, and early remarks.

There are exceptions, of course. Among the five hundred or so stations in the country there are at least ten that send out fair publicity material. And among these ten there are three stations whose publicity is as excellent as could be asked—that is: it is not "publicity" but news, news with thought, research, and painstaking writing behind it.

As for the rest of the publicity men, ten or twenty years of experience (if they stick that long—some of them ought to be fired at once) should result in a marked improvement in their output. We may even come to look forward to our daily publicity mail. Perhaps in thirty years it will be considered Literature!

Men vs. Women as Announcers

ONE of our predecessors in this department threshed out this matter pretty well; but further light has been cast upon the subject by a questionnaire conducted by wjz. A canvass of 5000 listeners resulted in a vote of 100 to 1 in favor of men as announcers. Says Charles B. Popenoe, manager of wjz, anent this vote:

Our previous experience had indicated that listeners preferred men as announcers, but we

Probable Football Broadcasts This Season

Here is a tentative list of scheduled football games to be broadcast during the 1926 season from some of the main stations. It is not improbable that additions and corrections will be made to this list, but such will of course be announced by the stations concerned.

WJZ, WGY

OCTOBER 16, Princeton-Navy, at Princeton.
OCTOBER 23rd, Yale-Brown, at New Haven.
OCTOBER 30, Navy-University of Michigan, at Baltimore.
NOVEMBER 6th, Harvard-Princeton, at Cambridge.
NOVEMBER 13th, Yale-Princeton, at Princeton.
NOVEMBER 20th, Harvard-Yale, at New Haven.
NOVEMBER 25th, Pennsylvania-Cornell, at Philadelphia.

WEAF

AND CHAIN STATIONS

OCTOBER 16th, Dartmouth-Yale, at New Haven.
OCTOBER 23rd, Chicago-Pennsylvania, at Philadelphia.
OCTOBER 30th, Army-Yale, at New Haven.
NOVEMBER 6th, Princeton-Harvard, at Cambridge.
NOVEMBER 13th, Yale-Princeton, at Princeton.
NOVEMBER 20th, Harvard-Yale, at New Haven.
NOVEMBER 25th, Cornell-Pennsylvania, at Philadelphia.

WBZ

OCTOBER 16th, Dartmouth-Yale, at New Haven.
OCTOBER 23rd, Harvard-Dartmouth, at Harvard.
OCTOBER 30th, Yale-Army at New Haven.

NOVEMBER 6th, Harvard-Princeton, at Harvard.
NOVEMBER 13th, Harvard-Brown, at Harvard.
NOVEMBER 20th, Yale-Harvard, at New Haven.
NOVEMBER 27th, Holy Cross-Boston College at Boston.

WCCO

OCTOBER 16th, Michigan-Minnesota, at Ann Arbor.
OCTOBER 23rd, Wabash-Minnesota, at Minneapolis.
OCTOBER 30th, Wisconsin-Minnesota, at Madison.
NOVEMBER 6th, Iowa-Minnesota, at Iowa City.
NOVEMBER 13th, Butler-Minnesota, at Minneapolis.
NOVEMBER 20th, Michigan-Minnesota, at Minneapolis.

WWJ

OCTOBER 16th, Minnesota-Michigan, at Ann Arbor.
OCTOBER 23rd, Illinois-Michigan, at Ann Arbor.
NOVEMBER 6th, Wisconsin-Michigan, at Ann Arbor.

were surprised to find that the preference was so overwhelming.

It is difficult to say why the public should be so unanimous about it. One reason may be that most receiving sets do not reproduce perfectly the higher notes. A man's voice "takes" better. It has more volume. Then, announcers cover sporting events, shows, concerts, operas and big public meetings. Men are naturally better fitted for the average assignment of the broadcast announcer.

Another reason may be that women prefer to hear the voice of a man. If that is true you would expect the converse to be the case. But the vote does not indicate that men prefer to hear women announcers.

Many soprano voices reproduce perfectly. There is no preference for the man over the woman in singing. There is no doubt of the radio popularity of women artists, but they are certainly not in demand as announcers.

But perhaps the best reason suggested for the unpopularity of the woman's voice over the radio is that it usually has too much personality. A voice that is highly individual and full of character is aggravating to the audience that cannot see the face and expression which go with the voice.

We resent a voice that is too intimate on short acquaintance, and the woman announcer has difficulty in repressing her enthusiasm and in maintaining the necessary reserve and objectivity. The bane of the radio voice is a certain patronizing quality which gives the effect of a teacher talking to children or of Columbus instructing the Indians. It is difficult for women to avoid the patronizing note in their effort to speak effectively over the radio.

The struggle to avoid being too patronizing or intimate results in the opposite vice of monotonous colorless delivery, like that of a dead man talking a dead language. Only male announcers, and only a few of them, have been able to strike the right key, equally remote from the majesty of Hamlet's father's ghost and the sweetness of a night club hostess.

Poetry Dept.

YOURS truly reprints a parody contributed to a Chicago colyum—not so much because he thinks it is very droll—but because of the remarkable fact that even his change in words hasn't succeeded in obliterating the musical beauty of the original.

The Listener's Silent Night

(With apologies to Walter De La Mare.)

"Is there anybody there?" said the Listener
Tuning-in the right hand dial
While his left hand twisted the other
By fractional hair's breadths the while;
And a squawk flew up out of the speaker
Over the Listener's head
And he moved the right hand dial another inch,
"Is there anybody there?" he said.
But no jazz band rewarded the Listener;
No voice boomed forth in reply
From the far, great, and open spaces;
"You're listening to KFI."
Only a host of phantom noises,
That dwelt in the ether then,
Taunted in cacophonous chorus
That voice from the world of men;
Cackled in a key coarse and strident
And uniting in shrill caterwaul
Mocked in a mad mélange of moaning
The lonely Listener's call.

They heard his step upon the window sill
And the sound of flesh on stone.
They use the aerial for a clothes line
Now that he is gone.

A Radio Play That Might Have Been

A PLAYWRIGHT acquaintance of ours some time ago showed us a melodramatic little one act-er, in the manner of the Grand Guignol, that ran something as follows:

The curtain rises disclosing a barren, snow covered waste in a remote part of northern Canada. A single, gaunt piece of timber toward back stage is the only object that breaks the monotonous expanse of cold whiteness. In the distant sky a sickly, greenish aurora borealis flickers weirdly. Then there staggers into the scene a lone man, tugging weakly on a pair of long traces. Behind him a gaunt husky shares the pull. A row of empty harnesses show that the other dogs have succumbed. Hardly is the sledge drawn into view when the man falls exhausted. A shrouded form on the sledge discloses itself as the body of his traveling mate.

The survivor struggles to his feet and attempts to carry on, but he is too weak. He talks brokenly to the dog, revealing the situation; he and his companion had undertaken the dangerous task of rushing medical supplies to a remote trading post which was in the grip of an epidemic. They became lost; their supplies gave out. One by one the dogs were killed and fed to the remaining ones. Then his companion had died.

He tries to keep awake, knowing that sleep will mean death. He munches a biscuit, the last of the food. Then he has an idea. He goes to the trailer sledge and, removing several blankets, discloses a radio set equipped with a small loud speaker. With numbed fingers he adjusts the dials, in hope that it will bear him "company" and help him to withstand the "terrible white silence." The audience then hears (from an off-stage phonograph) snatches of music and singing and talking and laughter. And now for the melodrama! The survivor, instead of being heartened by these voices from civilization, is made all the more conscious of his hopeless isolation. He gibbers to himself and laughs hysterically. Gradually we perceive that he is losing his

mind. As he listens, his frenzy relentlessly heightens until he is completely insane. His blind fury is directed at the receiving set. He looks about for a weapon and commences tugging at a piece of timber half frozen in the ice. As, with feverish energy, he pries it loose, the audience (but not the man) hears announcement from the loud speaker that the trail of the lost expedition has been picked up by a rescue party and they should "keep up hope as help would overtake them at any hour." But the maniac had not heard; with a final burst of superhuman strength he brings the huge timber crashing down on the receiving set and falls unconscious into the snow. Curtain. (And spirits of ammonia.)

* * * * *

which has nothing to do with the following true happening except that the scene of both is laid in Canada.

You may recall that WBZ was broadcasting nightly during the early weeks of last November a "life and death" message as follows:

The following message is for Hudson Bay Company at Chesterfield Inlet, Repulse Bay and Wager Inlet:

The company's relief ship failed to reach Southampton Island this season. Consequently that post is insufficiently supplied with provisions. If Chesterfield Inlet or Wager Inlet receives this message, rush special courier to Repulse Bay and have forwarded from there to Southampton two sled loads of staple food, advising Southampton to draw on Repulse Bay where stocks are plentiful for further requirements. Should Repulse Bay receive this message, act on it at once without waiting to hear from Chesterfield Inlet or Wager Inlet.

Though that was almost a year ago, word has only recently been received from lonely Southampton Island, at the extreme northern end of Hudson's Bay, that the messages were successful. Another trading post in the Arctic regions, hundreds of miles away, picked up the call and rushed by dog-sled to the Hudson Bay Company post on Southampton Island the food that enabled the hunters and trappers to live through the winter.



A MILWAUKEE PROGRAM FEATURE, HEARD THROUGH WHAD
George Devine's Orchestra who, in addition to their radio "appearances,"
are feature performers in many theatres in and around Milwaukee

Practically two years had elapsed since anyone had gone in or come out of the Southampton Island post. As this isolated point is not equipped with a radio set, the men stationed there had no idea as to what had become of the supply ship and they were in complete ignorance that the other posts some miles south had been rationed. Chesterfield Inlet chanced to be listening-in when the appeal was broadcast and Brother Pigeon of the Oblate Fathers took down the message.

The Oblate Order labors among the scattered peoples of northern Canada and ordinarily these missionaries have few contacts with more advanced civilization, and such contacts are separated by long intervals of time. From this same Brother Pigeon, CNRO has received a letter, which tells vividly how much radio means to these isolated people:

... Let me tell you now a few words about radio. A charitable person gave us a receiving apparatus so that we can better enjoy our dreadful solitude in these ice deserts. We heartily thank that person who so generously furnished the missionaries with a little bit of the joys of the civilized world. Here are a few results from the radio apparatus. We heard many a time Ottawa and Montreal. What a joy for us all in hearing of our homes. We knew the results of the last Federal elections as soon as you did yourself. We also gathered a message sent to the Hudson Bay Company asking for help for the Eskimos living in Southampton Island who were threatened by a famine because the boat could not reach them with food last summer.

Could we have a few items of news from your locality we would indeed be pleased if you would broadcast them. Since we can pick up your station it is a delightful pleasure to hear "voices from home."

Good News for the Winter Season

THE pooh-poothers of radio, of whom there are still plenty, should have excellent cause to reconsider their poohs when they learn (if they learn!) that radio listeners are to have a special symphony season of their own offered by no less an organization than the New York Symphony Orchestra under the direction of Walter Damrosch.

For if the engineers do a good job of microphone placing and transmitting and the listener has a first rate receiving set the concerts should be very nearly as good as if they were heard in an auditorium. (Providing also that the music is selected with regard to its adaptation to reproduction.) And there will be the added advantage that the radio audience will not be obliged to see the orchestra—which same seeing is more of a detriment to full enjoyment of music than otherwise.

The Fansteel Products Company, manufacturer of Balkite Radio Power Units, is the sponsor of the series. The concerts will be given every Saturday night at 9:00 P. M. Eastern Standard time, over WEAJ, New York; WEEI, Boston; WGR, Buffalo; WFI, Philadelphia; WCAE, Pittsburgh; WSAI, Cincinnati; WTAM, Cleveland; WWJ, Detroit; WGN, Chicago; WCCO, Minneapolis-St. Paul; KSD, St. Louis; WDAF, Kansas City, and WOC, Davenport.

While Mr. Damrosch and his orchestra have been on the air before, this is the first time that any attempt has been made to broadcast a regular series of symphony concerts.

The first concert (October 23rd) will be a full symphony program by Mr. Damrosch and the orchestra. Thereafter the concerts will be arranged as far as possible in pairs. Each symphony program will be preceded by a piano recital by Mr. Damrosch alone. In these recitals he will discuss, explain and play important parts of the programs of the following week. By this method it is expected that the programs can be made not only of the greatest entertainment value, but be made to constitute a liberal education in music as well.

Mr. Damrosch is too well known to require comment. It is not surprising that he should be the pioneer in symphonic broadcasting, for he was one of the pioneer orchestra leaders in the

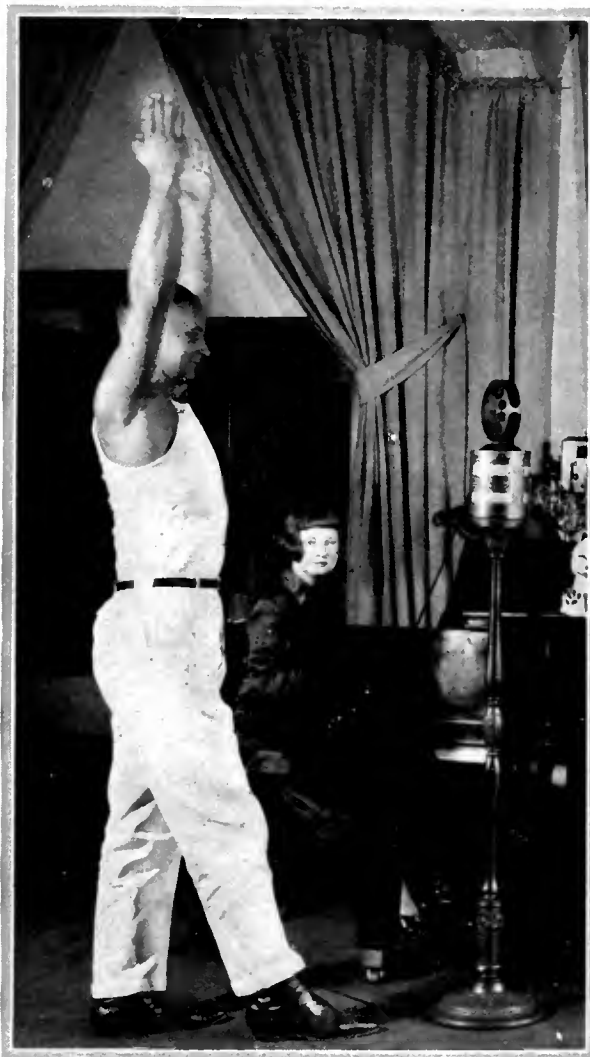

WILLIAM N. STRADTMAN, AT WLW

Mr. Stradtman is the physical director of the Cincinnati Y. M. C. A. For the past two years he has been broadcasting morning exercises at 7:30 through WLW. Eva Carrol Roark gets up in time to play the necessary piano accompaniment for him each morning

country. Perhaps no other person has done as much as he in the development of music in America. He grew up with American music, and to many his name is synonymous with its growth.

While Mr. Damrosch is now enthusiastic about the prospects of broadcasting regularly, this has not always been so. The following story is told about him. He had been approached on several occasions on the subject of going on the air. He was very skeptical and not at all interested, fearing that orchestral music could not be broadcast with any accuracy. He

was afraid it would be distorted beyond recognition, and for a long time refused to consider the proposal. Finally, however, there came an evening when one of the large Eastern symphonies was broadcasting. A member of his family had a radio set put in the room next to Mr. Damrosch's library where he was working. When the concert began the set was tuned-in. For some time Mr. Damrosch paid no attention to it. Then he came into the room to listen. For some time he sat without comment. But after a few minutes the attempt to sit idly by while an orchestra was playing proved entirely too much for him. He got up, took his position in front of the receiver, and proceeded to conduct for the remainder of the entire concert exactly as if he had had the orchestra before him. When it was over he was as spent as by an hour's work on the stage. He was asked whether he thought the music well reproduced, and he was forced to admit that he hadn't noticed, so it must have been well done. From that point his only objection to broadcasting was removed.

Broadcast Miscellany

MR. E. M. TINGLEY, Chicago, Illinois, offers the following information in a letter:

As a bit of radio history, WOR, of Newark, New Jersey, first started to broadcast the time by voice on March 22, 1922. Can any other station claim an earlier date?

It had occurred to me that as the correct time is always new and is always news, especially in the country districts, that it would be particularly suitable for a radio item. I accordingly wrote to KDKA, WJZ, and the Madison, Wisconsin, station asking that they state the time once or twice during each period they were on the air. The idea did not get across, as KDKA replied that their time service from Arlington was satisfactory and the other stations did not answer.

Finally I made a personal call at WOR and their manager and his assistant immediately appreciated the value of the idea and they promised to put it into practice at once.

That same afternoon I heard by the voice of their young lady announcer "the correct Eastern Standard time is now 4:16 P. M., WOR signing off."

In the good old days, all one had to do was to inquire of the telephone operator, then known as "Central," "time please?" Since that service has long been done away with, the radio check-up on the time is an occasional convenience. The trouble is that you generally have to wait for a station to sign off to glean this information. Some one station in each center might make it a point to announce the correct time on every even hour. We don't mean that it should interrupt its program to pipe out with "it is now exactly three P. M." but it could make use of the announcer's interval that nearest approximated the even hour, even though it were a few minutes earlier or later. But let the studio clock be correct itself! Graham McNamee must have made many a commuter miss his favorite train when, one day last summer, he signed WEAJ off at "10:08 Eastern Daylight Time" when it was actually 10:22 in the evening. The catastrophe occurred, he later explained, because in taking

his watch from his pocket he turned the stem wind, which was loose, back several minutes.

AMONG the radio programs we receive regularly is that of the Compagnie Française de Radiophonie, Paris. (The printed program we mean!) Just by way of giving this department a ritzy and cosmopolitan air, here's a typical evening program:

3321 EMISSION

- 20 H. Résultats des courses—cours des cafés du Havre—cours des Matières grasses—cours des farines—des blés de Chicago—cours des sucres—des laines—des cuivres—cours de clôture des cotons de New York—Informations Havas—cours des caout-choucs—du plomb.
- 20 H. 30—Radio concert de Gala, organisé par les Grands Magasins Du Printemps.

The 20:30 o'clock concert is an indirect advertising offering and is sponsored by different organizations on each successive night—such as department stores, theatres, manufacturers, newspapers, magazines, etc.

WCAP having discontinued broadcasting, WRC is now operating at full time on the wavelength it formerly shared with the other Washington station. Wire lines now connect WRC with both WEAJ and WJZ, in New York, and its programs are arranged with features from both of the Metropolitan stations, together with musical and educational events of the Capital.

AN INTERESTING feature of the fall and winter schedule of WBAL will be a series of American Composer programs. The programs will not all be orchestral, but will more frequently feature a solo instrument. Frederick R. Huber, director of the station, aims to enlist the aid of the composer whose work is to be featured, requesting him to supervise the program and to perform certain of his favorite compositions on his own chosen instrument. Among those in the front rank of American musical achievement to whom invitations will be extended are: Charles W. Cadman, Deems Taylor, Henry Hadley, Walter A. Kramer, John Alden Carpenter, and Rudolf Friml.

FACTORS contributing to successful radio broadcasts are outlined in a newly published list of microphone instructions now being distributed to singers, speakers, and piano accompanists at KOA.

Programs start on the minute.

Coughing, sneezing, clearing the throat, scraping the feet and other disturbances in the studios are annoying to listeners. The microphone is so sensitive that the slightest commotion may be transmitted to the unseen audience. Therefore, when the announcer calls, 'quiet everybody!' kindly comply.

Do not begin singing or playing until the announcer gives the signal.

Unless you have memorized your music, be prepared with an extra copy, as you do not stand near the piano when singing.

Do not be perturbed if the announcer motions for you to move nearer the microphone or withdraw, while singing.

Very loud singing or playing is objectionable as it detracts from successful broadcasting, often producing a shattered effect. The best choral effects are obtained when each person sings in a subdued manner.

To pianists: Too much loud pedal spoils the rendition. The top of the piano should be left down as the best broadcasting is accomplished when the instrument is closed.

TOM McNAMARA, former gridiron star, coach, and sports writer is again broadcasting a course of radio football instruction at KOA, Denver—which must mean that last year's series attracted enough interest to justify the continuance. Lessons are broadcast every Monday, Wednesday, and Friday evening at 8:15 o'clock, mountain standard time, and are intended for college and high school players, parents, beginners and athletic instructors. McNamara is head coach of Regis college at Denver.

WBAL has added to its features a dance orchestra which is being heard on Monday and Thursday nights, and which, in keeping with WBAL's policies, is of the slightly high-brow variety. John I. Lederer, its conductor, has some original views on dance music and stoutly maintains that such does not have to be jazzy to be alluring and rhythmic.

"This idea that a lot of noise is necessary to get pep and snap into dance music is a false conception," he says. "The most alluring dance music in the world can be soft and snappy, full of rhythm and syncopation, and yet without any undue noise. I know I get the best results by using the best of the popular dance music, especially those wonderfully syncopated selections from the leading musical comedies. In fact, dance music of this sort I have found to be much more generally liked than the sort that shrieks and wails. Rhythm and syncopation do not necessarily have to be combined with mere noise; in fact, they are far more likely to be found in music that is quietly tuneful and melodious than in any other sort of music."

Mr. Lederer also decries the idea of taking the old masters and arranging their compositions to the popular idea of dance music.

"I think it's a desecration to take the lovely music of, say, 'Faust,' and produce it in dance form. One always connects that sort of music with genius, and with so much dance music being written, it seems almost sacrilegious to rearrange the works of such writers for this

purpose." With his last point we do not find ourself in entire agreement. We admit it is an abuse to lift a "classical" piece in its entirety and simply butcher its time to make a dance piece of it. But we see no great harm done in lifting a theme or two from the classics and bending them to the purposes of jazz. For after all, these themes are as often as not public property, and were originally "stolen" from some previous source by the classic composer. What a jazz composer, and a master such as Brahms, can "say" with the same snatch of tune, constitute two such entirely different things that neither one can conceivably affect the virtue of the other.

THE Hazeltine Corporation reports a profit of \$65,474 during the first half of 1926, after deducting Federal taxes. The total dividend per share for the current year now amounts to one dollar.

Communications

Help! Help! Tell Us Which Is Right? We Aim to Please!

Benton Harbor Michigan.

Rye, New York SIR:

SIR: . . . and why don't you occasionally write something we'd like to read about? You are making the department deader than a doornail and you rarely if ever express an opinion anyone with common sense could agree with.

I have just finished reading your "Listeners Point of View" and I just want to tell you how much I always enjoy this always interesting section of the RADIO BROADCAST. It is more interesting and entertaining with every issue.

BERTRAM WEBER.

N. M. COOKE



HOW THE BASTILE FALLS FOR THE RADIO

A view in an English radio studio, the fall of the Bastille and some of the stirring events of the French Revolution were reproduced. The quaint and curious devices shown here were responsible for the successful illusion of the historic occasion

NEW APPARATUS

New Equipment of the Radio Industry Submitted to the Radio Broadcast Laboratory for Test and Approval



1



2



3

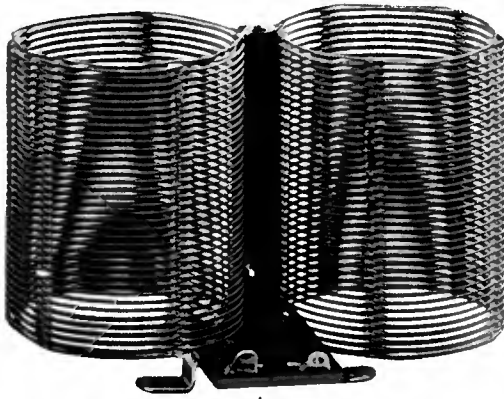

4

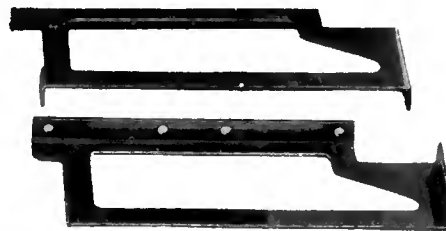

5

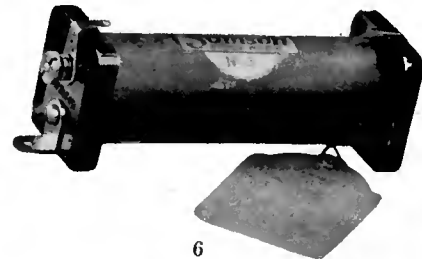

6

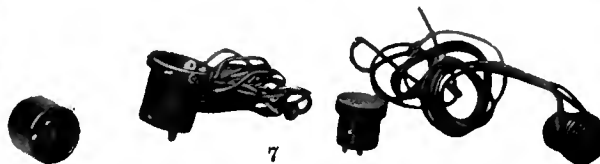

7



8



9

RADIO BROADCAST Photographs

No.	NAME OF APPARATUS	MANUFACTURER	USE OF PRODUCT	PRICE	REMARKS
1.	Cabinet Loud Speaker	Artcraft, Inc.	Sound reproducer for use with receiving sets.	—	The sound producing device in this loud speaker is a Miller unit having a long winding air column. This horn is suitably housed in an artistic cabinet.
2.	Cone Loud Speaker	Selector Company, Seattle, Washington.	Sound reproducer for use with receiving sets.	\$30.00	A cone loud speaking device of the completely free-edge type. Artistically decorated.
3.	Drum Loud Speaker	Telephone Co. of America, 449 W. 42nd St., New York City.	Sound reproducer for use with receiving sets.	\$32.50	Completely constructed of a special wood which aids in amplifying the loud speaking properties of the reproducing unit.
4.	Binocular Tuning Coil	Benjamin Electric Company, 120-28 S. Sagamon Street, Chicago, Illinois; also 247 W. 17th Street, New York City.	A tuning inductance unit for use in receiving sets.	\$2.50	Because of the arrangement of the two halves of the coil in a binocular shape, the field set up by these coils in a receiving circuit is self-confined, thus aiding in preventing oscillations due to inter-coupling effects.
5.	Cardwell Sub-Panel Brackets	Cardwell Company, 81 Prospect St. Brooklyn, New York.	Supports for sub-panel	\$0.75 a pair	Nickel-plated stamped brass panel frames which are fastened to the rear of main panel to support shelves or sub-panels.
6.	Audio Choke Coil, No. 3	Samson Electric Company, Canton, Massachusetts.	An audio frequency choke	\$3.00	The Samson No. 3 choke coil serves the useful purpose of deliberately preventing the audio frequency current in an audio amplifier from passing through B batteries, where inter-coupling effects may be produced. Instead, these audio currents must necessarily return to ground through the by-pass condensers provided for that purpose.
7.	Na-ald Adapters	Alden Mfg. Co., 52 Willow St. Springfield, Massachusetts.	Tube Adapters	\$0.75 to \$1.25	For adapting old tubes to new sockets, etc.
8.	Rubber Socket	Moulded Products Inc., 549 W. 52nd St., New York City.	Receptacle for vacuum tube.	\$0.60	Entirely shock-proof because of the resilient properties of the socket, composed of soft rubber.
9.	Dialite	Carter Radio Co., 300 S. Racine Ave., Chicago, Illinois.	Illuminate dials of receiving sets.	\$1.75	The Dialite may be added to any receiver, where it is desired to illuminate the dial markings. The flash-light bulb with which it is furnished operates direct from a 6-volt source.



10

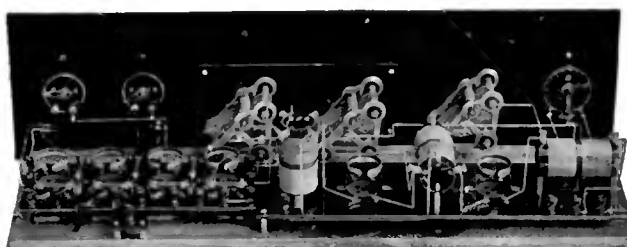

11



15

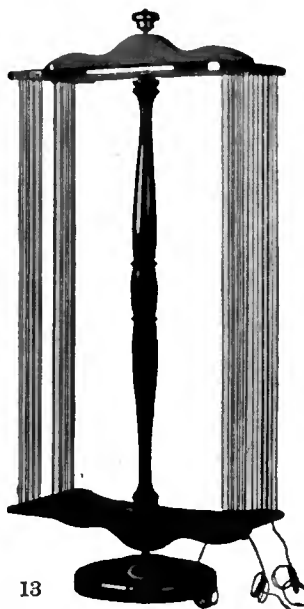

13



14



12



16

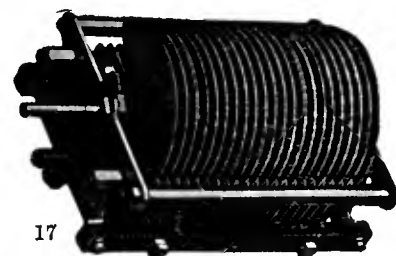

17

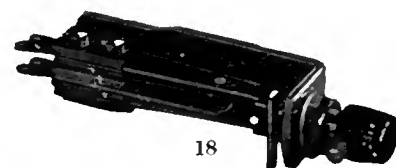

18

RADIO BROADCAST Photographs

No.	NAME OF APPARATUS	MANUFACTURER	USE OF PRODUCT	PRICE	REMARKS
10.	Horn Loud Speaker (Burns)	American Electric Co., State & 64th St., Chicago, Illinois.	Sound reproducer for receiving sets.	\$10.00	A horn loud speaker employing a unit which may be adjusted for maximum sensitivity.
11.	Six-Tube Receiver	Heath Radio & Electric Mfg. Co., 206-10 First St., Newark, New Jersey.	Broadcast reception.	\$69.50	A semi-wired receiver consisting of Heath units. It is easily and simply connected together to form an efficient 6-tube receiver employing 3 stages of Heath resistance-coupled audio frequency amplification.
12.	Cone Loud Speaker.	Tower Mfg. Co., 98 Brookline Ave., Boston, Massachusetts	Sound reproducer for receiving sets.	\$ 9.50	An inexpensive cone loud speaker in the lower-price field.
13.	Loop	W. I. Thomas Company, 217 N. Desplaines St., Chicago, Illinois.	Signal pick-up device.	—	A knock-down loop that may be assembled in a few seconds. To facilitate "pointing" the loop, the frame pivots on a swivel.
14.	Horn Loud Speaker (Wonderphone)	Universal High Power Tel. Co., Carlton and Eddy Sts., Seattle, Washington.	Sound reproducer for use with receiving sets.	—	A typical horn loud speaker having a curved throat and wide-flared mouth.
15.	Pedestal Cone Baffle-Board Loud Speaker	The Rola Co., 45th and Hollis Streets, Oakland, California.	Sound reproducer for use with receiving sets.	\$45.00	This high-quality reproducing unit is a combination of cone and baffle-board speaker. It is substantially and handsomely constructed.
16.	A Battery Eliminator	Davey Electric Corporation, 505 Court St., Brooklyn, New York.	Replaces the usual 6-volt storage battery as a source of vacuum-tube filament supply.	\$47.50 \$52.00	Combining the units of transformer, rectifier, and filter, this A supply furnishes sufficient current to operate up to ten tubes. May be obtained in either 1½-ampere or 2-ampere sizes.
17.	Cardwell Transmitting Condenser	Cardwell Company, 81 Prospect St., Brooklyn, New York.	A tuning device for short-wave transmitters.	Variable \$7.00-\$70.00 Fixed \$4.50-\$15.00	To resist possible breakdown due to high voltages, the plates in this variable tuning condenser are liberally spaced.
18.	Jack Switch	Carter Radio Co., 300 S. Racine Ave., Chicago, Illinois.	For "making" and "breaking" circuit in a receiver.	\$1.00 to \$1.60	This switch is of the panel mounting type. It may be obtained in several models, each for a specific circuit purpose.



THE ATWATER KENT MODEL 20 COMPACT RECEIVER

Instructions are given in the article below which will enable the possessor of an Atwater-Kent Model 20 Receiver to make simple changes to improve the audio channel. Since the Model 20 first appeared, transformers for audio frequency amplification have appeared which are considerably better than those available a year or so ago. A resistance-coupled amplifier, a power amplifier, an output device—all these may easily be adapted to the Model 20

Modernizing the Atwater Kent Model 20 Receiver

Simple Instructions for the Revamping of This Popular Set to Bring It Up to Date—Improving the Quality by Putting in New Transformers, a Resistance-Coupled Amplifier, or Power Amplifier—How an Output Device Is Incorporated

By JAMES MILLEN

DURING recent years, a number of improvements have been made in radio receiving sets. Thus, while the outward appearance of many of the new sets is not greatly different from those sold two or three years ago, the performance is materially better. Perhaps the greatest advance has been made in the direction of better tone quality. A piano now really sounds like a piano; the low notes of the cello and the high notes of the piccolo are now heard just as well as the notes nearer the center of the musical scale.

The improved tone quality, or audio characteristics, of modern radio receiving sets is due to improvements made in several of the small but important component parts and accessories. Very excellent speakers of the disc or cone type are now on the market, as are also improved audio transformers, impedances, and resistors for high-quality audio amplifier construction; output transformers and chokes for keeping direct current out of the speaker; high-voltage B supply units; and a number of new tubes. B batteries have also been improved so that not only are they more economical to use than formerly, but, due to lower inherent resistance, they are no longer as likely to cause audio frequency howls and distortion.

It is quite a simple matter for any one, no matter how inexperienced they may be in handling a screw driver and pair of pliers, to add some or all of these improved accessories to their present receiver so as to bring its performance up to the same high degree of excellence as that of the neighbor's new set.

In this and other articles to follow, data and suggestions will be given on modernizing some of the receivers that in the past have been most popular. This, the first, is devoted to the Atwater-Kent Model 20.

The two-stage tuned radio-frequency amplifier

in this receiver completely covers the present broadcast band, as shown by the chart of approximate dial settings, plotted against wavelength, Fig. 1, so we are able to confine our attention to improving the audio amplifier, which is located, together with the detector tube, on a small bakelite shelf at the right-hand end of the set.

In order to secure better quality audio amplification from this Atwater-Kent receiver, the frequency characteristic of the audio amplifier should be improved; a power tube, with proper C voltage, should be installed in the last audio stage; an output device should be wired in, and one of the new cone speakers may be used.

By improving the frequency characteristics of the amplifier, over amplification of some musical notes and under amplification of others may be avoided, and a natural, round, mellow tone results. The proper use of a power tube will prevent overloading, when the receiver is adjusted for normal volume. There are several good reasons for using an output device, but, in this instance, the main one is to prevent damage to the speaker. As for using a good speaker, it is obvious that no matter how excellently a signal may be amplified, if it is sent into a poor speaker, good quality cannot result.

There are four different ways in which the frequency characteristic (or ability to reproduce the entire musical scale with uniform clarity and intensity) of the Atwater-Kent receiver may be improved. First, we may substitute two of the new type audio transformers for the transformers supplied with the set. Second, we may employ

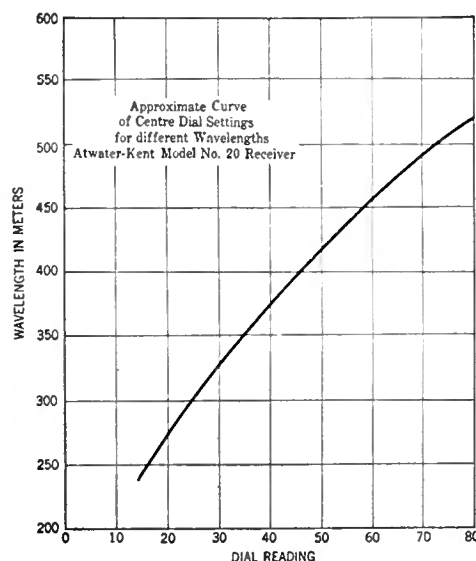

FIG. 1

This is the tuning chart of the Atwater-Kent Model 20 Receiver. The receiver, as will be noted, completely covers the broadcast wavelength band

an external high quality power amplifier in place of the audio amplifier in the set. Third, we may replace the amplifier unit in the set with an equally compact, but infinitely better resistance-coupled amplifier. Fourth, we may replace the amplifier in the set with an impedance-coupled one. All four types of amplifiers will give most excellent results. The first three will be described here.

A TRANSFORMER-COUPLED AMPLIFIER

AS THE amplifier supplied with the set is of the transformer-coupled type, it is very simple to replace the old type transformers with a pair of the new high quality audio transformers and to make provision for the use of a C battery. The Atwater Kent receiver is not equipped with a C battery. As the excellence of an improved amplifier of this type will depend almost entirely upon the transformers used, it is important that good instruments, such as Rauland Lyric, Amertran De Luxe, Jefferson, or the new General Radio 200 A be employed. There are also several other suitable transformers now on the market.

The first step is to remove the set from the cabinet and then take out the six screws that hold the two transformers to the shelf. Turn the set over and cut the four wires, under the shelf, that go to each of the transformers. Then mount the two new audio transformers in the places formerly occupied by the old transformers.

TUBE	PLATE VOLTAGE		
	135	150	180
CECO F . . .	9	15	20
UX-112 . . .	9	9	
UX-171 . . .	27	33	40

GRID BIAS VOLTAGES

This table gives approximate grid bias voltage for three last-stage tubes. Values slightly different than those given may be tried until best results are obtained

Three of the four wires cut from each of the transformers should now be connected to the corresponding terminals of the new instruments by running them through small holes which have been drilled through the brown bakelite shelf near the different new transformer terminals. It will be found necessary to solder extension leads to the different wires in order to make them reach the terminals of the new transformers. The connections of the cut wires are as follows:

- Green wire goes to +B terminal on transformer.
- Yellow wire goes to Plate terminal on transformer.
- Black wire goes to Grid terminal on transformer.
- Red wire is not used. Cover end with tape to prevent short-circuit.

It will be noticed that no connection has been made to the terminal on each transformer marked minus Fil. These terminals are to be used as minus C binding posts, as the Atwater Kent receiver is not provided with C battery binding posts. That on the first transformer should connect to the negative 4½-volt terminal of the

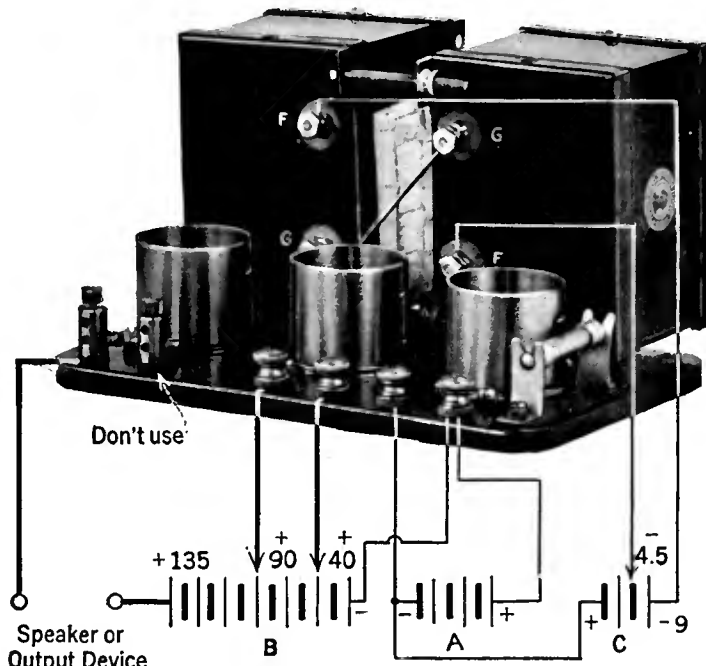

FIG. 2 RADIO BROADCAST Photograph

Having substituted new transformers for those supplied in the receiver, we have a few battery changes to make. This combination picture should make clear the wiring to the A, B, and C batteries. The voltages specified are naturally only approximate

grid bias supply, while that on the second transformer connects to the negative 9-volt tap. We are assuming that a 201-A tube is employed in the first audio stage and a Ceco type F type tube in the second (output) stage. The regular minus A terminal serves the double duty of minus A and +C binding post, as is evident in Fig. 2.

when considerable volume is wanted, and high B voltages (180 or so) are not available, the 171 is a good tube to use. The amplification constant of the 171 is very much less, however, than that of the Ceco type F, for example. Also, while it is desirable to use an output device with any power or semi-power tube in order to keep

There are two good reasons for using a C battery. One is economy (a C battery greatly prolongs the life of the B battery), and the other is audio quality. Without proper C voltages it is impossible to obtain good audio quality, as discussed by George Crom in his article starting on page 745 of RADIO BROADCAST for October, 1925.

We now have an amplifier which, when used with a 201-A tube in the first stage (middle socket) and a power tube, such as the Ceco F in the last stage (end socket), and with batteries connected as shown in Fig. 2, will give exceedingly fine results in connection with a good loud speaker.

It is well to remember that, within certain limits of practicability, the higher the B voltage used on the last tube, the better, as high B voltages permit the use of high C voltages, which decrease the possibility of the amplifier overloading on loud signals.

An accompanying table, on this page, gives approximate B voltages for any value of C voltage for several different power tubes. The UX-171 tube requires very much less B voltage for a given value of C voltage than any of the other tubes. Thus,

FIG. 3 The battery connections to the Model 20, the resistance-coupled amplifier having been added, are as shown here. The output device connections are also given. If this latter is not used, the loud speaker will be connected directly to the P and B posts. The underside of the resistance amplifier panel is shown in Fig. 4 on page 52. The Amperite and fixed condensers are mounted beneath this panel

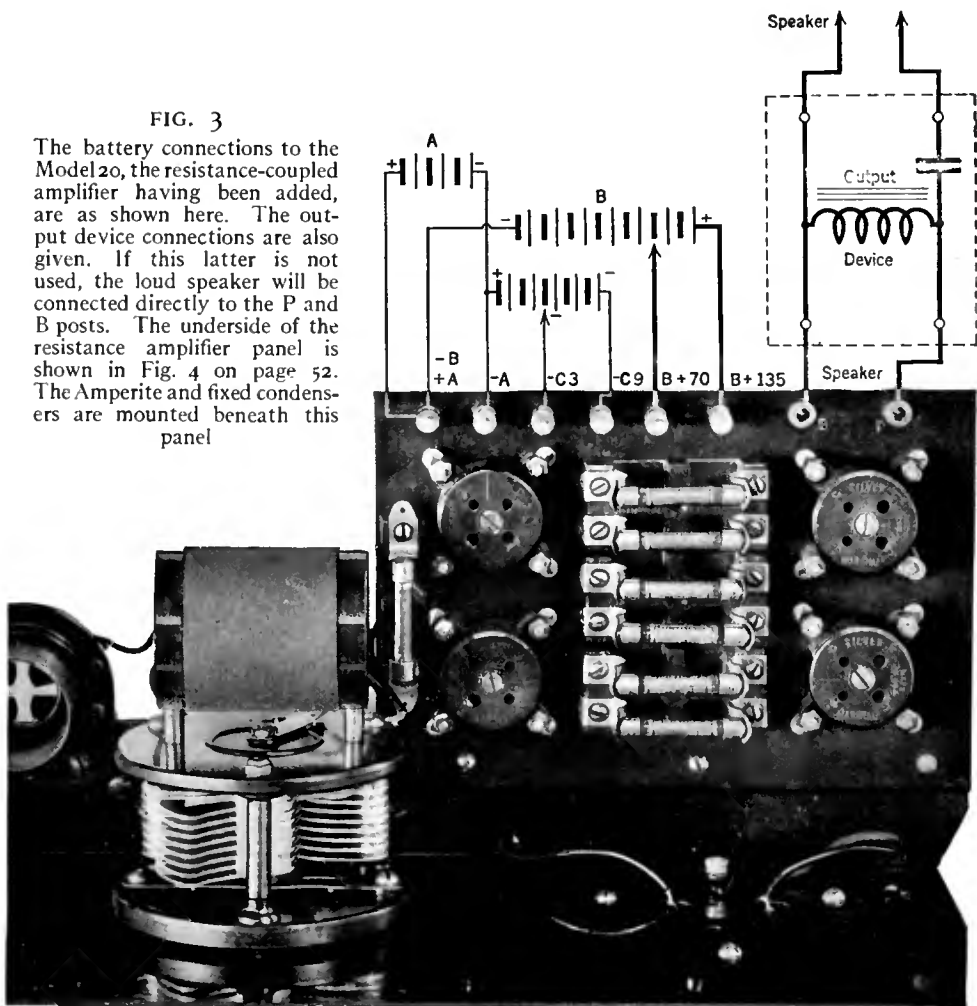

RADIO BROADCAST Photograph

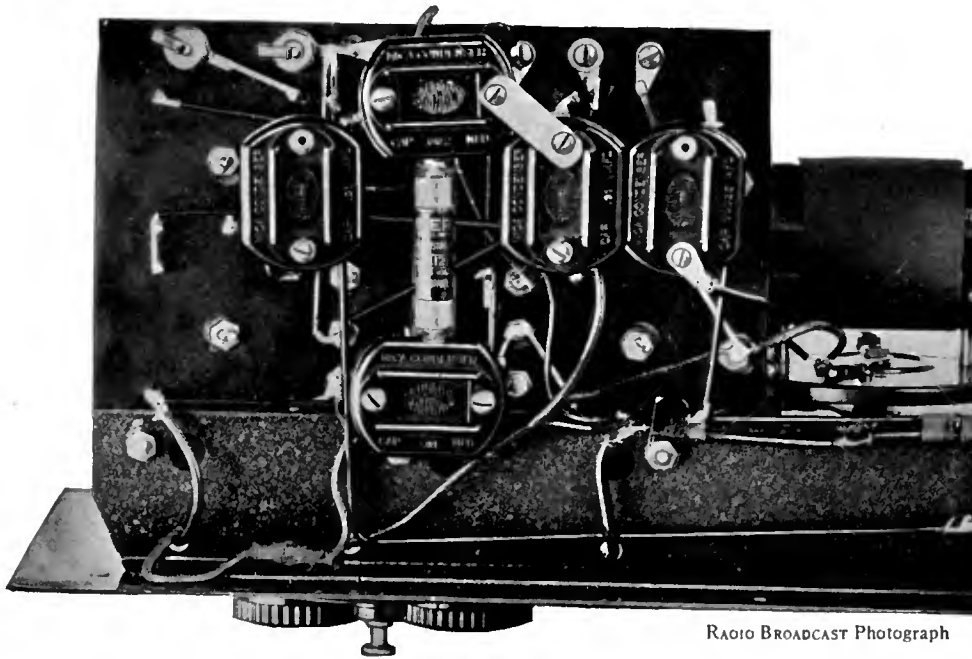

RADIO BROADCAST Photograph

FIG. 4

An under-the-panel view of the resistance-coupled amplifier which may be easily and advantageously substituted for the supplied transformer-coupled one in the Model 20 Receiver

the d. c. component of the plate current out of the speaker windings, it is *essential* to use such a device with the UX-171, due to the high plate current that it draws. The construction of an output device is described in another part of this article. It is very desirable to use a B line supply device with sets using an UX-171 type tube in the last stage of the audio amplifier on account of the large amount of current required by such a tube.

It quite frequently happens with sets using cone speakers that a detector tube that is the least bit microphonic will cause a howl to build up in the loud speaker, due to mechanical oscillation. One of the best cures for such trouble is to locate the loud speaker some distance from the radio set, say on the opposite side of the room. Such an arrangement is also of considerable aid to the person tuning the set as it gives him a very much better idea of just how the set sounds to the others in the room who are not standing right alongside of the loud speaker.

Another solution for mechanical oscillation is to install one of the spring suspension type of tube sockets, such as the new Benjamin. To substitute another socket for the detector socket in the set, remove the brass socket shell (it is just held by two prongs extending through holes

in the shelf), and fasten the new socket in its place. Connections are then made from the terminals on the new socket to the screws that hold the contacts of the old socket.

Another cure for mechanical oscillation is found in wrapping around the detector tube a piece of cloth.

USING A POWER AMPLIFIER

A **SOMEWHAT** more elaborate and costly, but yet perhaps one of the finest ways, especially where great volume with well-nigh perfect quality is desired, to improve the audio end of the Model 20 Atwater Kent receiver, is to construct a power amplifier, such as that described by Arthur H. Lynch on page 224 of RADIO BROADCAST for July, 1926. As will be remembered, this amplifier consists of one stage of transformer- and one stage of resistance-coupled amplification, with A and B power obtained from the lamp socket.

To connect the power amplifier to the receiver in place of the usual amplifier, it is merely necessary to disconnect the + Det. B lead from the binding post on the shelf of the Atwater Kent receiver and fasten it to one of the input (marked +B) posts of the power amplifier. The other input post (marked P) of the power amplifier is connected to the screw that holds the plate

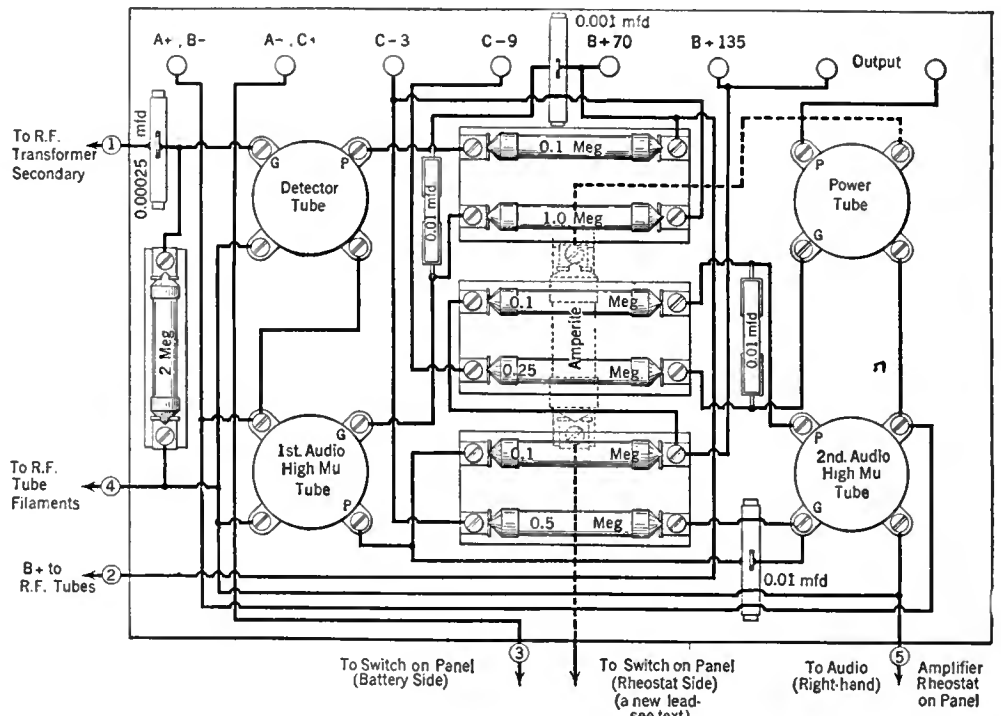

FIG. 5

The wiring diagram of the resistance-coupled amplifier. The values for the condensers and resistances are also given here. Connections to the rest of the receiver (to the r. f. part) are indicated

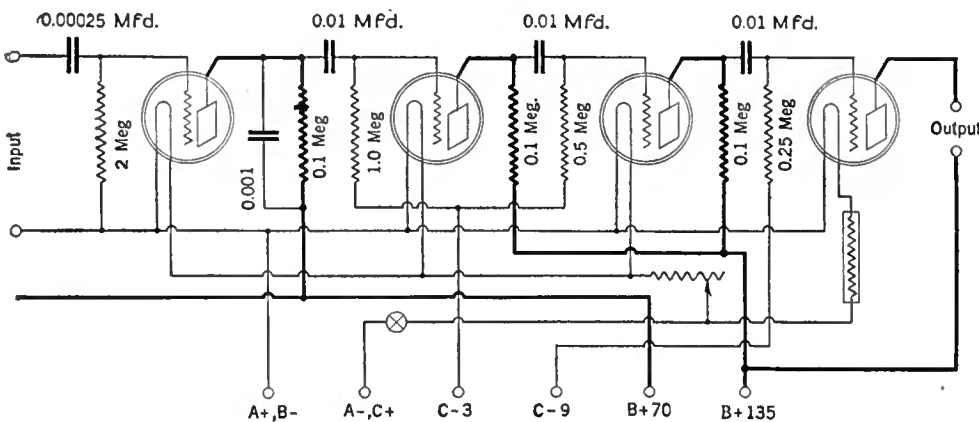

FIG. 6

This is the schematic diagram of the resistance-coupled audio amplifier and detector circuits shown in Fig 5. The input connects to the output of the second r. f. stage in the receiver

prong of the detector tube socket on the shelf of the Atwater Kent receiver (left-hand rear contact of the left-hand socket, looking from front of set). The other connections to the receiver and power amplifier are made in the usual manner, the loud speaker being, of course, plugged into the jack on the amplifier panel, and no tubes being used in the last two sockets of the Atwater Kent receiver.

A RESISTANCE-COUPLED AMPLIFIER

MANY readers may prefer to substitute a new audio amplifier unit of the resistance-coupled type. Such a unit is easily and inex-

pensively constructed from standard parts in a very short time. It may also be quickly and easily substituted for the regular Atwater Kent amplifier.

Figs. 3, 4, 5, 6, and 7 show the construction, wiring diagram, and method of installation of such a resistance-coupled amplifier. Four tube sockets, three double resistor mountings, a single detector grid resistor mounting, and binding posts are mounted on the top of a 5 1/4" x 7 3/4" x 1 3/8" bakelite panel. On the under side of this panel are mounted an Amperite for controlling the filament current of the power tube and the several different fixed condensers, the capacities of which are shown in Figs. 5 and 6. Although four plain UX sockets are shown in the model illustrated, it is preferable to use one of the spring suspended sockets for the detector tube.

To install the completed resistance-coupled amplifier in place of the old, proceed in the following manner:

FIRST STEP: Cut and tag for identification the following leads: Detector grid lead, cut at grid condenser. Plus A lead, cut at binding post. Negative A lead, cut at binding post. Plus B 90 lead, cut at binding post. Negative A lead from rheostats to socket, cut at socket.

SECOND STEP: Remove the Atwater-Kent amplifier shelf and fasten the resistance-coupled amplifier shelf in its place.

THIRD STEP: Solder the leads cut in first step to the new amplifier, as indicated in Fig. 6.

FOURTH STEP: Remove the rheostat disc from the front panel (unfasten the three screws behind the panel) and solder a lead to its battery switch side. Replace the rheostat disc and run the new lead to the Amperite.

Either a type F Ceco or a UX-171 power tube should be used in the last audio stage. High-Mu tubes, such as Cleartron, Ceco, or Daven, should be employed in the first two stages.

The following is a list of parts for the resistance-coupled amplifier.

- 1 Bakelite Panel 5 1/4" x 7 3/4" x 1 3/8" inches.
- 4 UX Sockets, General Radio or Benjammin.
- 3 Double Resistor Mounts (Lynch).
- 1 Single Resistor Mount (Lynch).
- 1 Metalized Filament Resistor Pack (Lynch).

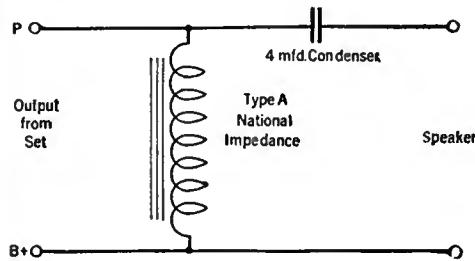
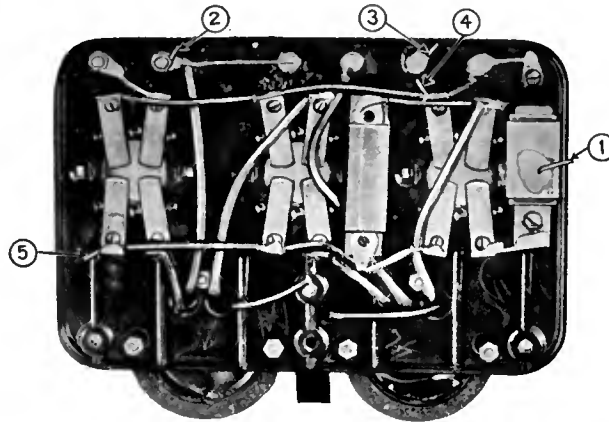

FIG. 9

The wiring connections for the output device. The posts marked P and B plus connect to the set, as indicated in Fig. 3. This output device may be used with any receiver. Mayolian, General Radio, and National make complete output units contained in a single metal case



RADIO BROADCAST Photograph
FIG. 7

The wires to be snipped when removing the amplifier from the original Model 20 Atwater Kent Receiver to substitute a resistance-coupled amplifier, are here indicated. Study this picture in conjunction with Fig. 5, whereon the numbered wires correspond to those numbered in this picture



RADIO BROADCAST Photograph
FIG. 8

The output device mounted on a small piece of board. It consists of a choke and a 4-mfd. fixed condenser

- 1 Type 112 Amperite, Mounted.
- 3 0.01 Mfd. Sangamo Mica Condensers.
- 1 0.001 " " "
- 1 0.00025 " " "
- 8 Binding posts.

PARTS FOR THE OUTPUT DEVICE

- 1 Base, 4 x 5 inches.
- 4 Binding posts.
- 1 Tobe or American Electric 4-mfd. Condenser.
- 1 National Impedance, Type A.

It is important in a resistance-coupled amplifier that only the best of resistors be used, as most of the cheaper grades of the impregnated paper types not only deteriorate after they have been used a short time but are also very noisy. The new metalized filament resistors, such as those of Durham, Dubilier, and Lynch,

now available on the radio market, give exceptionally fine results in amplifiers of this type. The Lynch resistors are also marketed in small boxes containing a complete set of the proper size units for a resistance-coupled amplifier and, in addition, a two-meg. resistor for the detector tube. The proper places in the different mounts for the several different values of resistors is indicated in Fig. 5.

OUTPUT DEVICES

AS PREVIOUSLY mentioned, it is well with any type of output tube to employ an output device for keeping direct current out of the speaker circuit. Direct current in the speaker cord, although perhaps only fifteen or twenty milliamperes in magnitude, is quite capable of starting a fire, especially where long speaker cords of poorly insulated tinsel are employed. Fig. 3 shows how to connect the output device illustrated in Fig. 8, and the necessary batteries, to the resistance-coupled amplifier.

A very satisfactory output device for use with the re-vamped Atwater Kent receiver may be easily constructed from a 4-mfd. fixed condenser and a type A National impedance. The condenser and impedance may be mounted on a small base, as shown in Fig. 8, or else may be directly fastened to the back of the cabinet.

Output transformers are manufactured by Silver-Marshall and General Radio. A circuit diagram for the output device is shown in Fig. 9, while a list of parts is given at the end of the list for the resistance amplifier.

USE B LINE SUPPLY UNITS

REGARDLESS of the type of amplifier employed in the re-vamped Atwater Kent receiver, a B supply unit of either the a. c. or d. c. types will give excellent results. As almost all a. c. B current line supply devices supply voltages well in excess of 100 volts, sufficient voltage for properly operating the power tube in the last audio stage is readily obtainable. With the d. c. variety of B units, however, the maximum voltage obtainable is but about 100 volts. In such a case, it is necessary to add a 45-volt B battery in series with the B supply unit, as shown in Fig. 10.

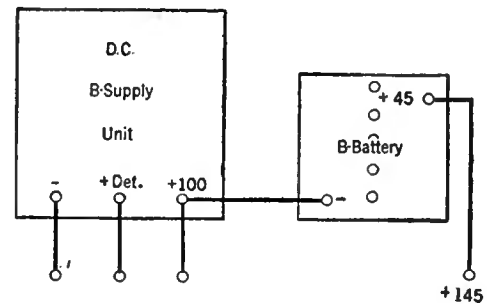

FIG. 10

If you use a line supply device for your B supply, and it does not give you more than one hundred volts or so, an ordinary B battery may be connected in series to make up for the deficiency when power tube operation is required

A Short-Wave Super-Heterodyne Receiver



A Paper Delivered Before the Radio Club of America Showing How a Simple Short-Wave Regenerative Receiver is Converted into a Vastly More Sensitive Short-Wave Super Heterodyne—Constructional and Operating Suggestions



By **GEORGE J. ELTZ, Jr.**

Radio Sales Manager, Manhattan Electrical Supply Company

THE reception of short-wave radio signals, both telephone and telegraph, has been almost universally accomplished by means of the single-circuit regenerative receiver. This type of receiver, while it has been practically abandoned for the reception of longer wavelengths, is excellent in operation on about 3000 kc. (wavelengths of 100 meters, or under). Indeed, so well has the single-circuit receiver operated that perhaps sufficient attention was not given to other methods of reception. With this thought in mind, the author decided to investigate the possibilities of the super-heterodyne method of reception and, as a result, the receiver described was evolved. The receiver was constructed and first operated in October, 1925.

The super-heterodyne used for the reception of short waves differs somewhat from that used for the reception of broadcasting, although of course the general theory is identical.

The super-heterodyne method of reception consists of tuning the incoming frequency, beating with it another frequency, and then amplifying and detecting the beat note. The actual signal listened to has in it none of the original frequency or the frequency which caused the beat note. In the reception of broadcast programs or other signals between 1500 and 600 kc. (200 and 500 meters) the beat note selected is a frequency somewhere between 30 and 80 kilocycles. This relatively high frequency is selected to prevent the introduction of distortion by elimination of the side-band frequencies in the intermediate amplifier and filter.

In the reception of short waves, particularly the reception of c. w., this element of distortion may be disregarded, and such has been the case in this receiver, the assumption being that most of the signals received will be c. w.

The ordinary "super" used for broadcast reception has two tunings: first, the loop or antenna circuit and, second, the oscillator circuit. This short-wave "super" has only one tuning arrangement, in which is combined both the tuning operations indicated above. This method of tuning was selected

because of its simplicity and because it makes possible the construction of what is practically a single-control set.

The intermediate frequency chosen is 22 kilocycles, which, while too low a frequency for good telephone reception, when simple tuned circuits are used, is satisfactory for c. w. or telegraph signals. The selection of this frequency necessitates detuning the set 22 kilocycles from the in-

or "self-heterodyne" type of "super." The beat note of 22 kc. is created in the same manner as in the broadcast set but at a lower frequency. For the reception of short-wave telephone signals, the amplification and detection of the 22-kc. beat note is accomplished in the usual manner. When c. w. signals are to be received, another beat note must be created either by means of another oscillator tube or by a self-heterodyne beat note in the second detector tube. This latter method has been selected, a beat note of 1000 cycles being chosen as the most satisfactory. This detuning of the second detector circuit, while it may appear to be inefficient because of the low intermediate frequency is not so bad as it seems, since the amplification in the intermediate circuit is very great and there is plenty of energy to spare.

To summarize, the action of the entire receiver is as follows:

1. Approximate tuning to the incoming frequency by the first detector tube (which is also an oscillator) and the creation of a 22-kc. beat note.
 2. Amplification of the 22-kc. beat note.
 3. Detection of the beat note with:
 - a. Straight detector for telephone.
 - b. Oscillating detector for c. w.
 4. Amplification at audio frequency.
- The entire action is controlled by one dial.

DESCRIPTION OF THE SET

THE first detector and oscillator circuit may be any of the conventional short-wave receiving circuits. The one chosen is given in Fig. 1. Two variable condensers are shown but all the tuning is done with the one in the grid circuit. The condenser in the plate circuit must be set for each band of frequencies covered; for instance, from 7096 kc. to 6663 kc. (40 to 45 meters), 6663 kc. to 5996 kc. (45 to 50 meters), etc. This setting is not critical, the only requirement being that the tube oscillate strongly but not so violently that it blocks.

The coils, condensers, choke coil,

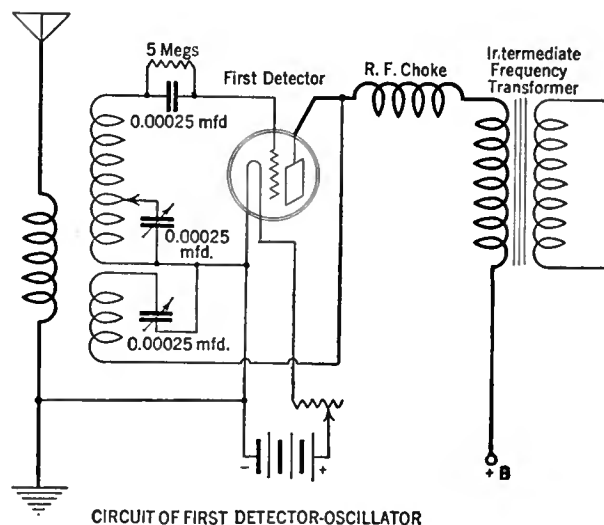

CIRCUIT OF FIRST DETECTOR-OSCILLATOR

FIG. 1

coming signal, but at the frequencies corresponding to wavelengths of 100 meters or under, this detuning is of no importance in decreasing signal strength.

The reader will recognize the description above as applying to the "autodyne"

The Facts About This Receiver

Name of Receiver	Eltz Short-Wave Super-Heterodyne Receiver.
Type of Circuit	Super-heterodyne
Number of Tubes	Five: 1st detector; two intermediate-frequency stages; 2nd detector, and one stage of audio frequency amplification.

Radio-frequency amplifiers at short wavelengths have not generally been found satisfactory, so the accepted short-wave receiver, without r.f. amplification, has remained the stand-by. In such receivers, a detector tube is made to oscillate and beat with the incoming c.w. signal to produce a note of about 1000 cycles. In the Eltz super-heterodyne receiver described here, the same system is employed with the exception that the beat note is caused to be 22 kc. or 22000 cycles, which is inaudible. This is readily amplified by the intermediate-frequency amplifying stages, then again detected or rectified, and finally amplified at audio frequencies.

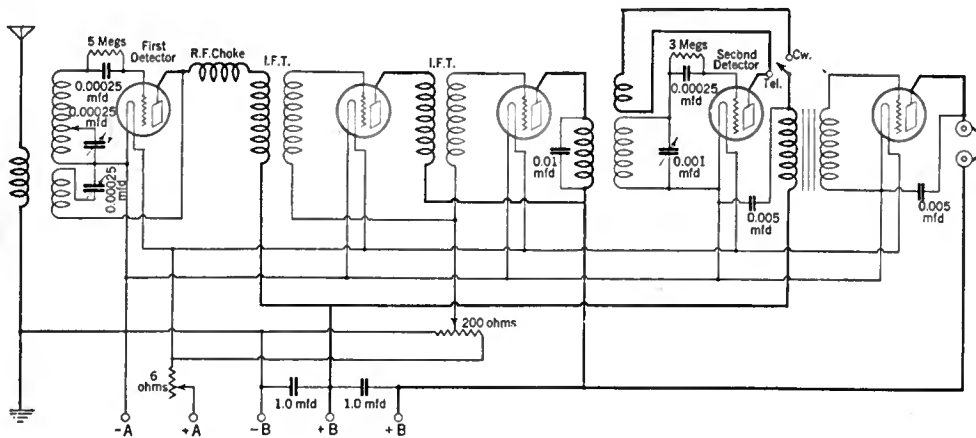

FIG. 2

etc., are identical with those which would be used in the construction of a regenerative set. The variable condenser in the grid circuit must be provided with some means of close adjustment as the setting is rather critical. The plate circuit condenser can be set with an ordinary knob or dial, without trouble.

The choke coil consists of 100 turns wound on a wooden form 1 inch in diameter

and 2 inches long. A honeycomb or similar coil of 150 or 250 turns will also serve very nicely. The intermediate transformer must be one capable of amplifying the rather low frequency of 22 kc. In this set, those manufactured by the General Radio Company were used, but there are probably any number of others which will serve.

The coils used in the antenna, grid, and plate circuits are made by winding bare copper wire of No. 16 gauge over a form on which are placed four narrow strips of celluloid, equally spaced. The wire is spaced with string and, when completely wound, the string is removed and the wire cemented to the strips by means of liquid celluloid. The construction of this type of coil is familiar to any-

one who has followed the development of the short-wave regenerative receiver.

The diameter of the coils is 3 inches for whatever frequency band the coil is designed to cover. Figs. 3 and 4 show the number of turns to be used for each frequency band. Three coils were used by the author to cover the amateur bands.

The figures given for the coils are only approximately correct, as the method of wiring, mounting, etc., all affect the capacity of the coils and, in consequence, the number of turns required to cover a given frequency range.

Where the operator or constructor has a satisfactory regenerative receiver already in operation, there is no need to change, even though the circuit differs from the one shown. The only requirement is that the primary of the first intermediate transformer be free of a capacity shunt greater than 0.00025 mfd.

THE INTERMEDIATE AMPLIFIER

THE complete circuit of the receiver is shown in Fig. 2. By reference to this circuit it will be observed that two untuned intermediate transformers are used and one tuned or filter transformer of special construction. As already mentioned, the intermediate transformers used are those manufactured by the General Radio Company type number 271. These particular transformers have a flat characteristic which permits a considerable gain at 22 kc. Others of different make but of nearly similar characteristic are probably available.

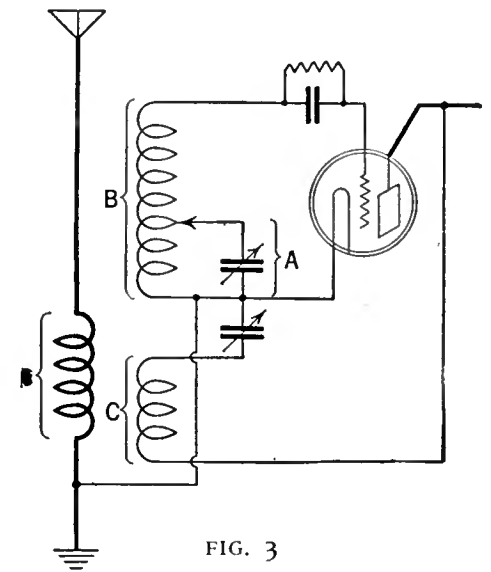
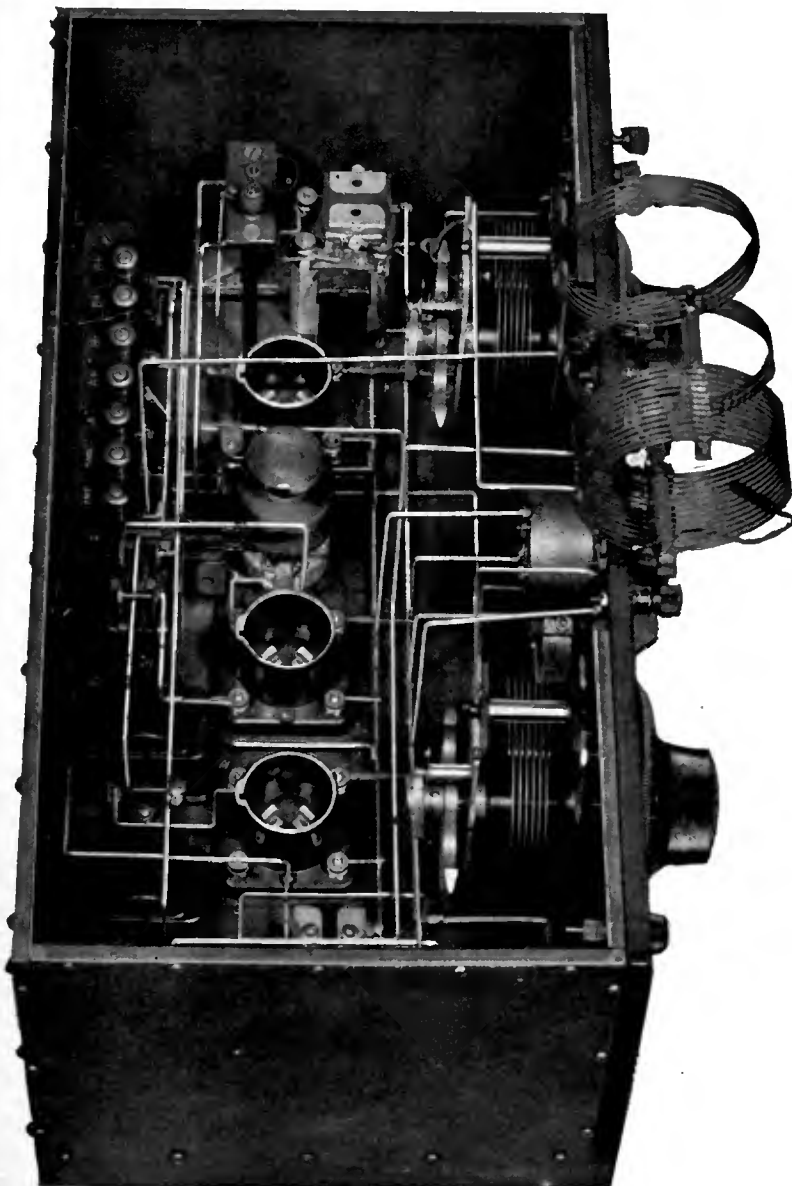

FIG. 3

THE INTERIOR

Of the Eltz five-tube short-wave super-heterodyne is shown in this illustration. The coils, starting at the lower one, are: (1) A-B; (2) C; (3) D. These letters may be explained by reference to Fig. 3 on this page. The flexible lead for tapping A-B may be clearly discerned



RADIO BROADCAST Photograph

No particular description of the intermediate circuit is required. The circuit is a conventional one and the same precautions observed in the construction of any super-heterodyne should be followed. To prevent undue feed-back in the untuned circuits, space the tubes and transformers liberally and keep them in line.

THE FILTER CIRCUIT

BECAUSE of the low intermediate frequency, the filter transformer must be of a special design. By reference

COIL

WAVE BAND	A	B	C	D
40	4	13	3	6
50	6	28	4	6
80	8	28	4	8

FIG. 4

to Fig. 3, it will be also observed that three coils are used. The coil in the plate circuit of the tube preceding the detector and the coil in the grid circuit of the detector comprise the tuning or filter circuit. The coil in the plate circuit of the detector tube is the feed-back coil by means of which the beat note of 1000 cycles is created in the second detector tube.

The specifications of these coils are given in Fig. 5. In winding these coils no particular care need be used, random winding is perfectly satisfactory. Approximately the number of turns specified, however, should be wound, otherwise the frequency of the intermediate circuit will be changed. In Fig. 4, the spacing between coils is shown. No hard and fast rule can be given on the point, as the arrangement of the circuit placing of the coils, etc., will have some effect. Once adjusted, however, there is no need for further change. The coils shown make a rather small assembly. If the space occupied is no factor, honeycomb, duo-lateral, or other form wound coils of similar nature can be used. The coils should be arranged as in Fig. 6. The spacing can be somewhat greater than that specified for the home-made assembly.

The variable condenser shown across the grid coil is of 0.001-mfd. capacity. Because of the rather large space occupied by a 43-plate air condenser of this capacity, a variable mica condenser was chosen. The air condenser is probably better from a standpoint of efficiency. The condenser across the grid coil determines the frequency of the beat note which is heard in the telephone. Keep this frequency as low as possible since the lower the note, the more closely will the primary and secondary circuits be in tune.

If telephone signals are to be received, a switching arrangement should be provided to permit cutting the plate coil of the second detector in and out of the circuit. Radio telephone signals can be received when the second detector is oscillating, but reception is extremely difficult as the "zero beat" method must be used, and the slightest change in frequency at either the receiver or transmitter causes an audio beat.

No particular instructions are required here. Any good audio transformer is satisfactory. If radio telephone signals

are to be received as well as c.w., the transformer should be of good design. For c.w. reception only, a transformer having a high ratio between primary and secondary is best, since, although some distortion may be introduced, the amplification is higher and the distortion is of no importance.

Two fixed condensers are shown in the audio circuit. These condensers are required as a bypass for the 22-kc. frequency, which otherwise would feed back through the head telephones and the body to the input and cause trouble.

GENERAL COMMENTS ON CONSTRUCTION AND OPERATION

THE particular receiver to which the foregoing remarks apply was one with complete shielding of the intermediate, second detector, and audio circuits. The coils comprising the first detector circuit were not shielded but acted as loops for the reception of moderately distant stations.

The principal advantage in the shielding came in the elimination of long-wave inter-

ferences that another station is 44 kc. away from that being tuned, it will also be heard. If this is the only interfering station, it can be eliminated by tuning the oscillator to the other point.

In a section where interference is bad, the widely separated double tuning point unquestionably is a disadvantage, but on the other hand, the same condition also occurs to a certain extent with the regenerative set. Here the interference is measured by the sensitiveness of the ear, the wider the frequency band it is possible for one to hear, the greater the interference. As a matter of fact, the super-heterodyne can effect a separation between two stations impossible with a regenerative set, and yet be less effective than the regenerative set if it so happens that stations are in operation, 44 kc. removed.

While the arguments set forth above appear to place the super-heterodyne at a disadvantage compared to the regenerative set, as a matter of fact, the selectivity is about the same for all practical purposes and the sensitivity of the super-heterodyne superior. Signals which are just about audible on the regenerative set are unpleasantly loud with the super-heterodyne. In a good location for loop reception, the small coils of the first detector circuit are all that are required for ordinary reception over distances comparable with those possible with a regenerative set and a good antenna.

If a good antenna is used, the distance possibilities of the short-wave super-heterodyne are limited only by the static level. For the reception of signals from a certain station, or stations, where it may be possible to remove interference caused by double tuning by changing the transmitting frequency, the super-heterodyne receiver is most satisfactory.

In operation, the plate condenser is set for strong oscillation and all the tuning accomplished with the grid condenser. Here the action differs from the regenerative set with which it is necessary to adjust the plate condenser for each frequency. Because of this single control the manipulation of the receiver is simpler and the possibility of picking up stations increased.

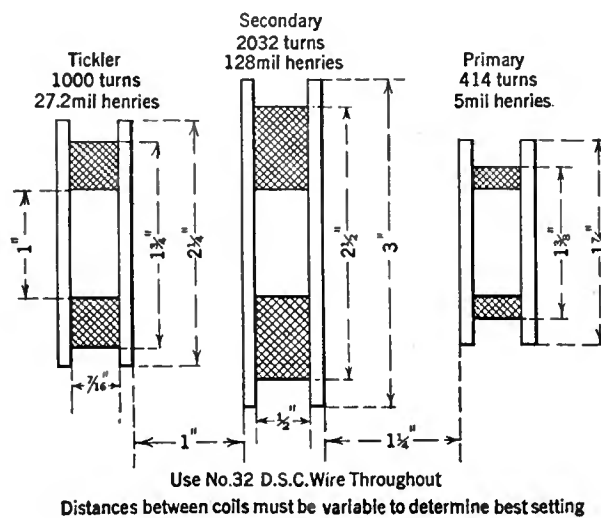

FIG. 5

ference. Subsequently, it was found that by regulation of the amount of regeneration in the untuned intermediate transformers, practically the same result could be obtained, and at no sacrifice in sensitivity. It is recommended that the set first be made unshielded and then the shielding applied if the long-wave c.w. interference is bad. In another model of this same receiver, constructed by Mr. C. R. Runyon, no shielding was used and results were entirely satisfactory.

It is difficult to form a definite opinion of the merits of this receiver over the simple regenerative set. There is absolutely no question of its increased sensitivity, but strange as it may seem, there is some question of its selectivity. The reason for this is the presence of two widely separated tuning points for each station as against the presence of two closely placed tuning points always found with the regenerative set. The selectivity of the super-heterodyne is better than the selectivity of the regenerative set for each point, but if it

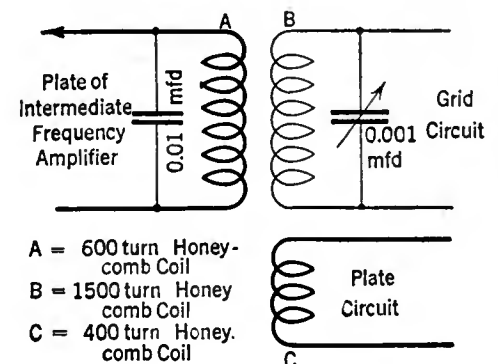

FIG. 6

A New Plan to Regulate Radio Broadcasting

A Keen Analysis of an Extremely Complex Problem—An Original and Operative Scheme Which Takes Into Account All Factors—Among the Broadcasters—Resuscitation After Electrical Shock

“AS THE BROADCASTER SEES IT”

By **CARL DREHER**

Drawings by Stuart Hay

THE number of wavelengths or frequency bands available for broadcasting purposes is limited by the following:

- (1) The needs of other radio communication services as important, if not more so, than broadcasting;
- (2) The design of existing receivers representing a capital investment by the radio listening public, which it is necessary to take into account in any reform schemes;
- (3) Technical considerations arising from the propensity of stations not sufficiently spaced in frequency, to heterodyne and otherwise interfere with one another, as well as acoustic factors involving side-band width required for good quality transmission.

At this writing there are more individual broadcasters than can be properly accommodated in the space available. The number of aspirants is increasing by the week. This condition is responsible for the white hair and stooped shoulders of the United States Supervisors of Radio in congested districts, who are relieved, perhaps, by the recent decision of the Attorney General of the United States that, under existing laws, the Secretary of Commerce has no power to regulate wavelengths and operating hours of broadcast stations.

It is not improbable that the tendency to link up stations will increase, and perhaps technical methods can be developed to stack several transmitters of the same program on a single wavelength. But this is a ray of hope, rather than a solution of a pressing problem. The present situation is that we are issuing licenses, trusting that heaven will provide the wavelengths, in the face of the fact that heaven has yielded up all the wavelengths it has, within the limits of the three conditions above set forth. What, then, is to be done?

When a number of people want something, and there is not enough of the desideratum to go around, some must do without, wholly or partially. Admitting this prin-

ciple, we must further concede the right of organized government to set up a procedure to decide equitably who shall have and who shall not. In other words, a legal mechanism must be set up to mediate between desire and possession. This holds for steam yachts and it should also hold for wavelengths. The problem in regard to wavelengths is by no means appalling, for one does not have to possess a wavelength in order to be happy. Hence, if someone is shut out, he will have little warrant for appealing to the Deity and starting a revolution; it is not as if he were denied the bread of life.

What, then, shall be the method of rationing out wavelengths? The same, it may be suggested, as that used for rationing out steam yachts: competition. If I want a steam yacht I must acquire, in competition with other persons desiring the same thing, the price of the yacht; then, and only then, can I have my desire. Free competition, according to orthodox economic theory, means progress. It has its deprivations and disadvantages, but we believe that it is the best method in the long run. The problem of radio broadcasting today is to work out means, and to prescribe them by law, whereby time on the air will be given to the broadcasters with

the best claim to it, by virtue of merit, in proportion to their merit, as long as the same exists, and no longer. This involves the determination of what constitutes merit in a broadcaster, and how it shall be rated.

With perhaps more temerity than sense, I shall set forth some views on this subject. It should be understood that these ideas are my own, neither the magazine, nor the company with which I am connected, nor any other of my radio associations, is in the slightest degree responsible for them. Furthermore, if I am an advocate of my own system, it is solely for the purpose of stimulating thought, in the hope that some solution, perhaps one compounded out of the ideas of many men, will be found for a technical and social problem which must be faced.

The problem is, of course, a complicated one. How could it be otherwise? It is part of the complication of industrial civilization. We create these Frankenstein monsters, and we must grapple with them. The present job is no more intricate than rate-fixing for public service utilities, and perhaps similar in that quantitative analysis must be the basis of its solution. The principal trouble with this aspect of the radio art is its lack of quantitative data and thinking based thereon.

The social worth of a broadcasting station, under existing conditions, might be rated as about half contingent on program and half on technical factors. If the signal is loud and transmission good, but the program is not worth listening to, the station is as bad as one which presents a brilliant program but hashes it up in transmission, to the point where no one cares to listen to it. If either factor—transmission or program—rates zero, the net result should be zero, which indicates a multiplication process of final calculation. However, as the discussion is of a tentative nature at best, let us sacrifice something for simplicity and use an additive method. We may

D*URING recent months, much attention has been centered on legislative balls at Washington, where Congressman and Senator have been struggling with the problem of enacting a law to regulate radio. It matters little here that, with only a few shining exceptions, a surprisingly small amount of real thought has been devoted to the problem by the legislators. Several proposals now drafted in bill form await the attention of Congress and their provisions for regulating radio, insofar as it relates to other services than broadcasting, is generally thought to be satisfactory. It is our opinion that in practically all of the radio bills, the regulations for broadcasting are not completely thought out, and in any case, were any bill passed, the law would cry for revision in a few years, if indeed the measure would not do irreparable harm to broadcasting while it operated. The fault of both is that the regulatory provisions for broadcasting are by no means flexible enough. Mr. Dreher here presents a scheme for broadcast regulation which takes into account all the interests involved in this complex problem. It is worthy careful reading. While there are many details in the plan to be amplified, we have no hesitancy in saying that we believe Mr. Dreher's intelligent proposals are genuinely calculated to operate for the best interests of all of us concerned in broadcasting. Comments are welcomed.*

—THE EDITOR.

assign 50 per cent. to program; 25 per cent. to power; 25 per cent. to audio-frequency characteristic, freedom from internal (station-generated) noise, etc. On this basis we may proceed to a fairly detailed enumeration of the points of a 100-per-cent. station. However, it is recognized that as time passes, all broadcasting stations remaining on the air will, presumably, attain excellent quality, and there will be no further object in rating them on this factor. The value assigned to such qualities would then be distributed among the other technical and program characteristics of the stations under consideration.

First of all, the power of the transmitter must enable it to be heard over disturbing noises—static, high tension leaks, etc. Grant it one point for each 100 meter-amperes, up to a limit of 25 points. The meter-ampere is the unit of transmission effectiveness: the product of the current in the antenna by the effective (electrical) height. A 500-watt broadcasting station runs with about 10 amperes in the antenna which has an effective height of perhaps 30 meters. That makes 300 meter-amperes, or 3 points in the above scale. The meter-amperes product goes up as the square root of the power; thus a 5000-watt station, such as is not uncommon now, would rate 9 points. A large station with a 50-meter (effective height) antenna, and a transmitter putting 50 amperes into that antenna, would get the maximum of 25 points, and beyond that, increase in power would not bring added consideration. That is, the scales would not be weighted in favor of extreme "super-power," while adequate power capacity would receive proper recognition. Here, as throughout this speculation, we must beware of static concepts in a progressing art. Should high power broadcasting be increasingly desired by the public, the rating might be changed to one point for, say, every 300 meter-amperes, up to the same maximum of 25 points. The rating standards would require periodic revision, to keep up with the advance of the art, to which the system must be a stimulus, not a sedative.

The quality of a broadcasting station, likewise, is no mysterious matter, in as far as it is a function of the apparatus installed. If it transmits impartially all the usual audible frequencies of speech and music, free from distortion due to overloading, transient effects, and a few other technical bugs; and if the operators know their business, it will put out first-rate stuff. If, on the other hand, it loses the lower frequencies, the output will sound "tinny"—metallic or nasal, without natural roundness. Loss of the higher frequencies is even worse; it results in a characteristically muffled output. An expert can estimate, by merely listening to the station, where it "cuts off" at the high and the low end. Better still, with an audio oscillator and

galvanometer, he can take the transmission characteristic of the station, a graph which shows how it treats audio frequencies over the range that matters. If the curve is a sensibly straight line between 50 and 8000 cycles, say, and there are no overloadings anywhere in the system (all matters capable of measurement) the station cannot help sounding good on the air, unless the operators are plumbers. It would be no great feat to express the quality numerically. We shall allow 25 per cent. for a station perfect in these respects in the existing state of the art. If technical measures should be developed to overcome fading, at the transmitter, stations so equipped would be entitled to a higher technical rating, and such an improvement might take over the coefficient released by a common attainment of excellence in such a factor as the audio characteristic discussed above.

So far we have been dealing with things which can readily be expressed quantitatively. But what about program, which

mitter could be fed (overlapping areas not to count), modified by the number of field events per week which the station was willing to sustain, and the money directly or indirectly paid to performing and composing artists. Of course the enterprise of program staffs is an incommensurable factor, but, given the population, wire lines, and money for artists, the main determinants are taken care of. I do not envy the proposed broadcast station appraisers their jobs, but, intricate as these would be, with the setting up of standards, the work would not be impossible of performance.

Of course, the proposed method of rating stations would in no way supersede any existing regulations that have been found serviceable. The present inhibitions on radiation of harmonics, malicious interference, etc., would naturally be included in whatever legislation was passed to meet the needs of the situation. The lid might also be clamped down on the more flagrant and raucous forms of broadcast advertising, without interfering with the milder and more judicious modes.

By the method roughly outlined above every broadcasting station, existing or proposed, would receive an index number. This figure would determine its share of time in the ether in its locality. But first localities would have to be weighted, presumably by population, to decide the number of wavelengths to be allotted to each section. The method here would be substantially the same as that formulated by the First and Second Radio Conferences: division of the country into zones and allocation of channels to as many stations as can be accommodated without excessive interference.

The next step in the plan is the determination of the relative values of the various hours of the day, and the days of the week, for broadcasting purposes. At present the demand is all for the evenings. Everybody wants to broadcast from 6 P. M. on. Without a prohibitive amount of trouble, data could be secured showing the probable number of listeners in any given region during the diurnal cycle. On this basis, values would be assigned to the various hours of each day of the week, somewhat as follows:

	TIME	VALUE
Monday	4-5 P. M.	6
	5-6	10
	6-7	20
	7-8	30
	8-9	30
	9-10	30
	10-11	20
	11-Mid	10
	Mid-1 A. M.	5
	1-2	2

The broadcasting privileges for a limited time may now be handed out. The metropolis of Smithtown has, to the great chagrin of its Chamber of Commerce, been assigned only one wavelength, 324 meters;

A Proposal for an Operative Scheme to Regulate Radio

REDUCED to a brief outline, the scheme for an operative plan to regulate and control broadcasting, proposed by Mr. Dreber, is:

1. Establishment of a suitable commission with power to rate broadcasting stations as to public service value or capacity, and facilities for determining the same.
2. Allocation of wavelengths on a population basis, and with due regard to technical limitations.
3. Evaluation of hours of each day as to relative importance for broadcasting.
4. Distribution of available time and wavelengths to applying stations according to individual ratings and values assigned to hours, exchange of hours to be permitted, subject to ratification by the commission.
5. Modifications as necessary to secure flexibility and optimum service to listeners.
6. Provision for judicial review of major decisions.

has a value of 50 per cent. in this table, a factor full of conflicts of opinion and individual taste, in which one man's opinion is supposed to be as good as another's? Is it not written, *De gustibus non est disputandum*? Then who shall be the arbitrator? To my mind, we can arrive at a result valid at least for the majority of listeners, by an indirect route. The good programs, of whatever sort—jazz, classical, or instructional—are where lots of people are, and most of them must be paid for. Here we have two criteria: Electrical accessibility to centers of population, and expenditures for artists, whether made directly by the station or by a sponsoring advertiser. Reduced to the lowest terms, this means money, for artists and wire lines. Stations with studios in, or lines to, great centers of population, would have the advantage, as they should have if the public is to be properly served. The program capacity of a station could be rated by such a method, taking the index as proportional to the population of a given area around each of the studios from which the trans-

but it has this full time. There are three stations, WAA, WEE, and WXX, and they all want to broadcast six evenings a week from 7 to 11 P. M. Instead of wrangling in the Radio Supervisor's office and splitting time on some nebulous basis, the three disputants submit their stations to the commission and in due time they are assigned percentages as follows: WAA, 60; WEE, 50; WXX, 30. WAA, having the highest rating, gets first choice of daily hours up to the amount of its rating. It takes from 7 to 9 P. M. daily, a requirement of the arbitral commission being that the daily hours must be taken consecutively. WEE, with its 50 points, chooses from 9 to 11 P. M. WXX has to be satisfied with from 5 to 7 P. M., an interval to which its 30 points entitle it on third choice. This is only the first approximation to a final settlement. The management of WAA wants two evenings from 7 straight through to 11, because of program exigencies. They meet the representatives of WEE out of court and patch up a deal involving exchange of program hours. This is presented to the commission and ratified. The standing of the local broadcasters being numerically defined, trading can take place on a perfectly definite basis, as with money. As for WXX, if he isn't satisfied with his time allocation, all he has to do is take the kinks out of his transmission characteristic, smooth out his generator hum, and increase his budget for hiring artists. On the basis of these changes he may apply for a new rating, next year, and upset the layout. Under these conditions no broadcaster is going to sit back on his haunches. If he is unable to keep up with the procession he will have to get out or retire to an inferior place, exactly the same as in business, association football, or amour.

When all time was taken up, no more stations could get in—except by putting up a better station than the worst of those having tenure. This situation is unpleasant, inasmuch as some worthy cause with the desire to broadcast, but with limited resources, may be left out in the silences. But this is a situation not as bad as that tolerated at the present time, when a man may have the desire and the ability to put up a superior broadcasting station, and be unable to get a wavelength simply because some inferior station is already occupying it. He may buy out the latter, but at what price? The weaknesses of the proposed system seem to me preferable to the existing and potential abuses of the present one.

At this point let us examine two of the salient defects of the merit system of time-frequency allocation. An eminent authority with whom the subject was discussed, while commending the motives leading to the formulation of this scheme, pointed out

two grave objections. In the first place, he indicated, the system takes little account of the evils of time division, which is without doubt the cause of some poor broadcasting. If a program director is forced arbitrarily to terminate his performance at a given hour, because the station next in the ranking has the air at that time, it will add a serious restriction to his other troubles. This must be admitted, but after all the best stations would have to divide time least, and, the splitting of time on any one day being a disadvantage, the stations would tend to trade their time so as to minimize this difficulty.

Secondly, the plan as so far advanced disregards the financial interests of broadcasting associations. If a broadcaster invests \$100,000 in a station, securing full



CONTROL EQUIPMENT OF THE PRAGUE, CZECHO-SLOVAKIA STATION

time use of a certain wavelength, any competitor, by spending the same amount, may theoretically obtain equal time division, thereby depreciating the value of the first station's investment perhaps 75 per cent., since the value of a station may be presumed to go up in more than direct proportion to the hours used. In other words, part of the first broadcaster's capital has been confiscated.

We might handle this by providing for a payment covering the unamortized portion of the dispossessed station's investment, by the newcomer, the actual amount to be determined by the regulatory commission, which would have definite schedules subject to judicial review. As broadcast installations are very rapidly amortized under present conditions—the life of an ordinary station is not over four or five

years—these settlements would not run into excessive amounts. A suitable time lag should also be provided, for the sake of reasonable economic stability. In other words, the stations would have ether-franchises of indeterminate duration, but with a certain minimum time to protect each holder. My own feeling is that these two safeguards are sufficient, and that a somewhat uncertain tenure of the communal highways of the ether is a good thing. Perhaps this is too radical, and priority and past services should get more consideration. The balance here depends on one's general political and economic views; the legislators could set it according to the preponderant opinion of the time.

Summing up, the salient points of the proposed scheme for regulating broadcasting are as follows:

1. Establishment of a suitable commission with power to rate broadcasting stations as to public service value or capacity, and facilities for determining the same.
2. Allocation of wavelengths on a population basis and with due regard for technical limitations.
3. Evaluation of hours of each day as to relative importance for broadcasting.
4. Distribution of available time and wavelengths to applying stations according to individual ratings and values assigned to hours, exchange of hours to be permitted, subject to ratification by the commission.
5. Modifications as necessary to secure flexibility and optimum service to listeners.
6. Provision for judicial review of major decisions.

Under (5) there might be included such features as provision for purely local stations of limited power on special wavelengths. There might also be a check on propagandist stations—bodies having some special interest to express directly in the material broadcast, as distinguished from general public service, where the motive in broadcasting is not directly expressed in the material radiated. The quotas of the former class of stations might be reduced by some predetermined ratio. These are matters of detail which would have to be included in the powers of the regulatory commission or its subdivisions.

Fools rush in where angels fear to tread. But they may persuade the angels to follow and do what needs to be done.

AMONG THE BROADCASTERS

Czecho-Slovakia

THE invasion of Czecho-Slovakia by the Western Electric Company is shown in two accompanying photographs of the 5-kw. Prague station's technical equipment. Everything is there, in-

cluding the smoothing-out condensers, the safety gap on the transformer, and the water-cooled tubes. The first picture shows the control equipment, located in the same building in Prague which holds the studios. The power plant is situated in another quarter of the town. It is said to be capable of developing 7.6 kilowatts, but the normal output is 5.2 kw. in the antenna.

The third illustration shows a 500-watt (antenna power) transmitter of French manufacture, used at Brotislova in the same country. At least, that is what the name looks like to us, in our admittedly benighted state regarding Czecho-Slovakian towns and things. Note, in the middle panel, below the tubes, the slide-type variable resistances which are still popular in Europe. Puzzle: What are the three panels, and why do you think so? The one to the right is probably a tank-antenna circuit with coupler and radio-frequency ammeters. The others might be anything: rectifiers, modulators, amplifiers, or oscillators. Having searched without success for the family opera glass, wherewith to read the inscriptions on the meters, I have given it up. Send in your guesses, gentlemen. Czecho-Slovakian and French radio operators are barred from the contest.

WPG

ON MY occasional week-ends in the Catskills, where my antenna swings in a maple grove and a three-tube set, more or less Roberts, with one tube reflexed, keeps me in touch with the dear broadcasters, the new WPG 5-kilowatt Voice of Atlantic City is doing its part in keeping the field strength where it should be. It is holding its own, during August, with all the other aspirants

of the ether, except the 50-kilowatts and such, who are necessarily few. The quality is first-rate, also, and this may be partly due to the master oscillator circuit which, according to a recent issue of the *Western Electric News*, is in use at WPG and other 5-kw. W. E. installations.

It was found by Bown, Martin, and Potter in the United States, as well as by some investigators in England (see "Some Studies in Broadcast Transmission," by the former authors, *Proc. I. R. E.*, Feb., 1926; and A. G. D. West's article on "The Design of a Broadcasting Station," in the *Year Book of Wireless Telegraphy and Telephony*) that a certain type of distortion could be traced to a slight frequency wobble, inherent in the usual method of modulating broadcast transmitters. This rapid variation within the cycle of the modulating frequency manifests itself, by a complex interference ingeniously traced by Bown, Martin, and Potter in their paper, in wave form distortion at the receiver, sounding somewhat like tube overloading only worse. Stabilization of the radio frequency of the carrier and sidebands of the transmitter helps to eliminate this "night distortion," as the British call it. The method employed is to use a "driver" or "master-oscillator" with a 50-watt tube, which may be crystal-controlled. This is isolated from the modulator circuit by

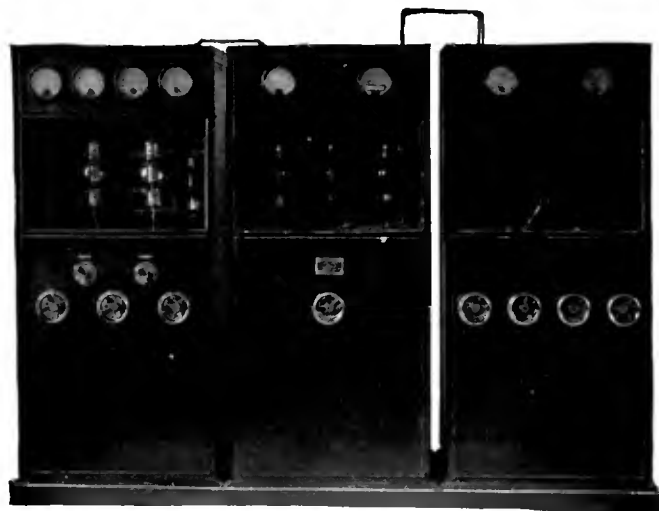

A FRENCH 500-WATT TRANSMITTER
AT BROTISLOVA, CZECHO-SLOVAKIA

means of two stages of radio frequency amplification, resistance-coupled. Care must be taken to shield the driver from the later high power stages. The result of these precautions is that the transmitter holds a constant frequency during modulation. A corollary result is that distortion is reduced to selective fading (with respect to audio frequency), which is apparently due to wave interference, and does not hash up the quality as badly as the frequency wobble aforementioned.

Station WLS of the Sears Roebuck Agricultural Foundation, Chicago, is using a similar frequency stabilizer in its 5-kw. transmitter.

We shall probably have more to say about transmitter frequency stabilizers in subsequent issues.

KPRC

THAT the Southerners may not feel neglected, let us not forget to mention KPRC of the *Post-Dispatch* of Houston, Texas, which has been letting the world (excepting the dead spots) know how it feels, since May 9, 1925.

At KPRC they have two studios on the top floor of the twenty-two story office building of the *Post-Dispatch*. One is a solo studio, intended for single artists (the qualification is purely numerical and mommas and poppas are not barred) but much larger than most studios of this type. The ensemble studio will accommodate an 85-piece band. The solo studio looks like a drawing room, while the larger studio is more of a workshop and contains less in the way of artistic furniture. The walls and ceiling of both rooms are deadened acoustically, monks cloth being draped over the asbestos and hair felt in the large studio, and brocaded damask hangings in the other room.

The technical equipment is the usual Western Electric layout, with mixing panels and all the latest jiggers. The power plant of the station is in the publishing plant of the paper, at some

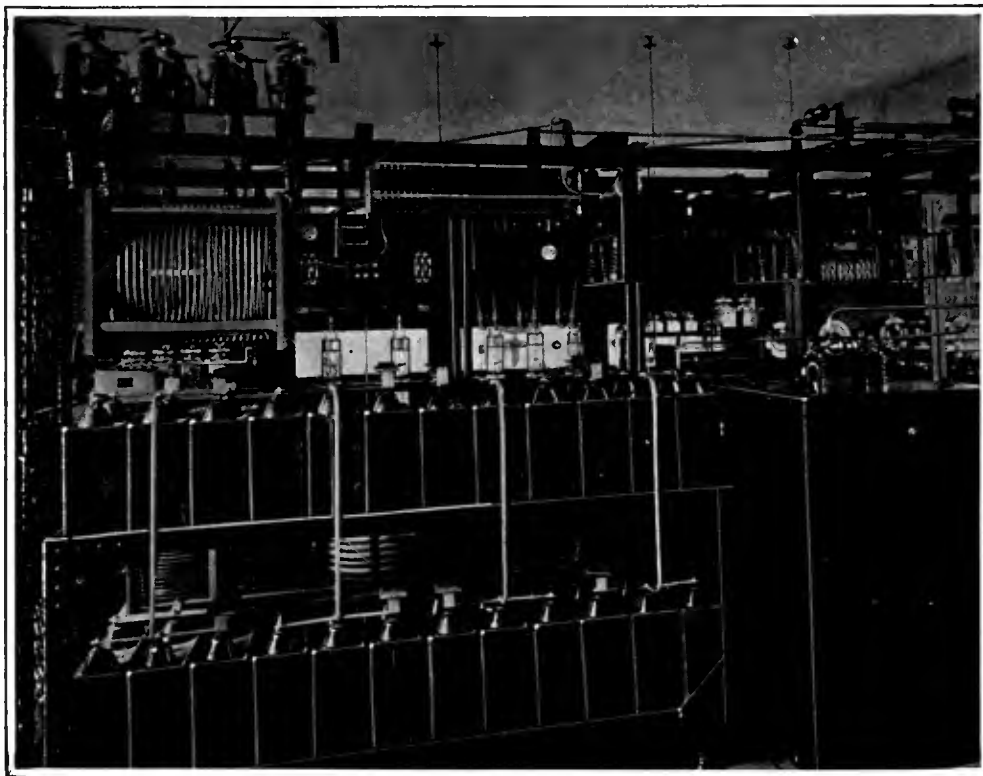

WESTERN ELECTRIC TRANSMITTING APPARATUS AT THE PRAGUE STATION

distance from the studios. The station kicks out lustily and has been heard in Halifax, Nova Scotia, Hawaii, etc.

Mr. G. E. Zimmerman is station Supervisor and Alfred P. Daniel announces. When the control operators are not on duty at the station they pound out dots and dashes on their amateur transmitters.

Resuscitation After Electrical Shock

NOT long ago, a high tension fuse in a mid-Western broadcasting transmitter blew out, while the station was on the air. The operator, a boy nineteen years old, started to put in a new fuse, without shutting down the machine. In



“ . . . KEEPS ME IN TOUCH WITH THE DEAR BROADCASTERS”

his anxiety and hurry he came into contact with the high potential conductor. This cost him his life. He was able to gasp, “I’m not hurt,” when help reached him, but he died a few minutes later.

In another broadcasting station, a month or so before the accident above, one of the technicians took the discharge of a smoothing out condenser, after the set had been shut down. This man also was killed.

At a chemical plant in the East, a conveyor system became charged with 220 volts, a. c., normally not a dangerous voltage. The men who set out to remedy the difficulty, however, had a caustic solution on their hands, which was equivalent to placing them in an electrolytic bath. Four of them were killed, the electrician of the plant first, followed by those who tried to rescue him, heroically, but in the wrong way.

Recently an experienced technician at one of the 50-kw. broadcasting plants told me of a narrow escape he had, partly through luck and partly because the engineer’s powers of observations did not fail him at a critical time. He was testing tubes on 10,000 volts plate. Something arced over in the set. The technician pushed a button which operates a relay to take plate voltage off the transmitter. He did not trouble to open the main breaker manually. The relay opened, but for some reason arced at the contacts, maintaining the circuit with somewhat reduced voltage on the plates. The engineer, unconscious of the danger, started to climb into the set,

over a protective railing surrounding the apparatus. As he touched this railing he felt a tiny spark, the charging current which every object near such a transmitter collects. This warned him that his death warrant, signed and sealed, was being thrust into his hands. He had just time to tumble back from his perilous position. Now he opens the main breaker and clips a short-circuiting lead between the plate bus and ground before he works on the set. A good rule, if one is not tired of life.

Broadcast operating, and electrical work on high tension circuits in general, are not especially dangerous—if one is careful. But not everyone is careful all the time. Now and then a man is caught. When he is taken off, if his heart is good, he may still be saved. The method of resuscitation is presumably familiar to most broadcast operators, but a few may not know the details, and it is certainly worth recounting them on the chance that somewhere a life may be saved.

A man is not dead until he is cold and stiff. But under the impact of a severe electric shock he ceases to breathe, owing to the paralysis of the nerves controlling respiratory action. It is necessary to continue the respiratory function artificially, until the man once more has the power to breathe normally for himself.

Agreement seems to be general at this time that the best method of artificial respiration is that known as the Schaeffer or prone-pressure system. It is exceedingly simple and less tiring to the operator than other methods—an important factor in a job which may have to be continued for hours.

As soon as the man who has sustained the shock is freed from the circuit, he should be laid on his stomach, one arm extended, and the other bent at the elbow, with the head turned to one side and resting on the hand so as to leave the mouth and nose unobstructed. Waste no time in listening for heart action or other tests; all that is irrelevant. If an assistant is available, send him for a physician. In the meantime, artificial respiration should be started without delay, unless to make sure that the man has nothing in his mouth or throat which might interfere with breathing; such a search only takes an instant.

The operator kneels straddling the patient’s hips. He places his hands on the small of the patient’s back, fingers over the lowest ribs, the thumb parallel to the fingers. A man breathes largely in the region of the diaphragm and

lower chest; the object of the movements is to compress and expand this region rhythmically.

At the rate of twelve to fifteen times a minute, the operator presses forcefully but not violently on the lower ribs, keeping his own arms stiff. A count of about two seconds is allowed between pressures, in which the operator rests. The easiest way in which to time the movements is for the operator to synchronize them with his own breathing.

No attempt should be made to administer stimulants. Such measures should be left to the physician, when he arrives. In general, a man stunned by an electric shock needs only air. Artificial respiration should be carried on in a cool, airy place, if one is close at hand; but no time should be wasted carrying the man to such a place, if more than five or ten seconds are involved.

If the patient revives and begins to breathe normally, the operation may be discontinued, but under no conditions should he be permitted to sit up or exert himself. He should be persuaded to lie quietly on his back until the physician judges it safe to move him. There are cases on record where men were revived after over an hour’s work, only to die of heart failure when they got up under the impression that they were all right.

In electrical work, as elsewhere, an ounce of prevention is worth a pound of cure. The best rule is to kill and tag all circuits before working on them, and to short-circuit the plate bus by some simple device which should always be handy for this purpose. When trouble occurs during a program, work as rapidly as possible—but see that the plate current is off before you touch portions of the high tension circuits. Better a thousand times that the dancers should wait a few seconds longer—that an attentive audience be deprived for a few moments of its entertainment, than that a man should lose his life.



“NOBEL PRIZE MAY BE AWARDED TO INTREPID INVESTIGATORS OF MYSTERIES OF GALLON”

RADIO ENGINEERS DETERMINE EXACT NUMBER OF CUBIC INCHES PRESENT IN GALLON

Results to be Given to American Association for Advancement of Science—Nobel Prize may be Awarded to Intrepid Investigators of Mysteries of Gallon

DURING the month of July I paid a visit to my colleague, D. N. Stair, the chief of the brave men who turn sixty cycles a. c. into radio frequency at Bound Brook, New Jersey. Among other things, we discussed the problem of scale deposition on the water-cooled plates of the large tubes, and the feasibility of substituting surface water for the deep-well supply in use. Then, still earning our salaries virtuously by such cogitations, we strolled to a point about a thousand feet from the station building, where a tile pipe emitted a small stream of clear water, the drainage of the nearby fields. Here we sat down, looking at the bright green vegetation in the rivulet, and trying to decide whether the flow was sufficient to fill our cooling system in the allowable time.

"First," I announced, "we must know the number of cubic inches in a gallon. I was taught this figure in school, but of course I have forgotten it. No doubt you can tell me."

"I fear," replied my colleague, "that the figure has also escaped my mind."

"Six hundred and forty acres to the mile," I reflected aloud, "and there are one thousand seven hundred and twenty-eight cubic inches in a cubic foot. But that has nothing to do with the cubic contents of a gallon. Suppose you get your *Electrical Engineers' Handbook*. After mastering the difficulties of the index system, in two or three hours we can find what we want."

"An *E. E. Handbook* is one of the things

we haven't got at this station," replied Mr. Stair, sorrowfully.

"What!" I ejaculated. "Do you mean to tell me that you operate a plant of this size without an *E. E. Handbook* on the premises, if only for the sake of appearances? Well, then, get your slide rule. On the back you will find tables and all sorts of useful facts collected by savants, from Euclid to Einstein."

"No slide rule, either," was the answer. "We use a table of logarithms."

"Then we are driven to using our wits. Now let us see if we can reflect credit on our Alma Maters dear, the test shops at Schenectady, and Aldene, etc. In my mind I have a picture of a certain gallon jug of port wine which, materially, exists at my home, forty miles away. I judge the jug to be about seven inches in diameter and ten inches high. The area of the base is 3.1416 times the square of the diameter, or about one hundred and fifty-four square inches. Multiplying by ten, we arrive at the conclusion that there are one thousand five hundred and forty cubic inches in a gallon, approximately. Does that figure sound familiar?"

"But," protested Mr. Stair, "the area of a circle is 3.1416 times the square of the radius, not the diameter."

"You are right," I assented immediately. "Therefore we must divide the previous result by four. The new answer is three hundred and eighty-five cubic inches to the gallon."



" . . . BY FINDING THE TIME RE-
QUIRED TO FILL THE CAN ONCE"

"It still sounds high," observed my colleague.

"I wish it were higher, when it comes to the port wine," I replied. "The higher the better."

At this point Mr. Stair had an idea. He produced a one-gallon oil can and measured it triumphantly.

"There are two hundred and nineteen cubic inches in one gallon," he trumpeted, after some figuring, "unless the oil merchant is a crook."

"He probably is."

But now, using the empty oil can, we were able to measure the flow of the stream directly, in gallons per minute, by finding the time required to fill the can once. We then returned to the station, where we found Mr. Geer, an engineer of an associated company. Mr. Geer likes to do things himself, and at this moment he was striking a cold chisel with a hammer. I interrupted him.

"Brother Geer," I asked him seriously, "how many cubic inches, to your mind, constitute a gallon?"

"Two hundred and thirty-one," answered Mr. Geer without an instant's hesitation.

"Preposterous," I said, "I have just calculated three hundred eighty-five and Stair finds two hundred and nineteen."

Nevertheless, I felt something hauntingly familiar about the figure Mr. Geer had mentioned. On the train back to New York I suddenly recollected that I carry in my pocket a small souvenir notebook issued by a nationally prominent engineering firm, containing wire tables, weights and measures, etc. Sure enough, there were and are two hundred and thirty one cubic inches in a gallon.

"Oh, well," I reflected, "our scheme of weights and measures is unworthy of a civilized, scientific people. I shall join a society in favor of the adoption of the metric system."

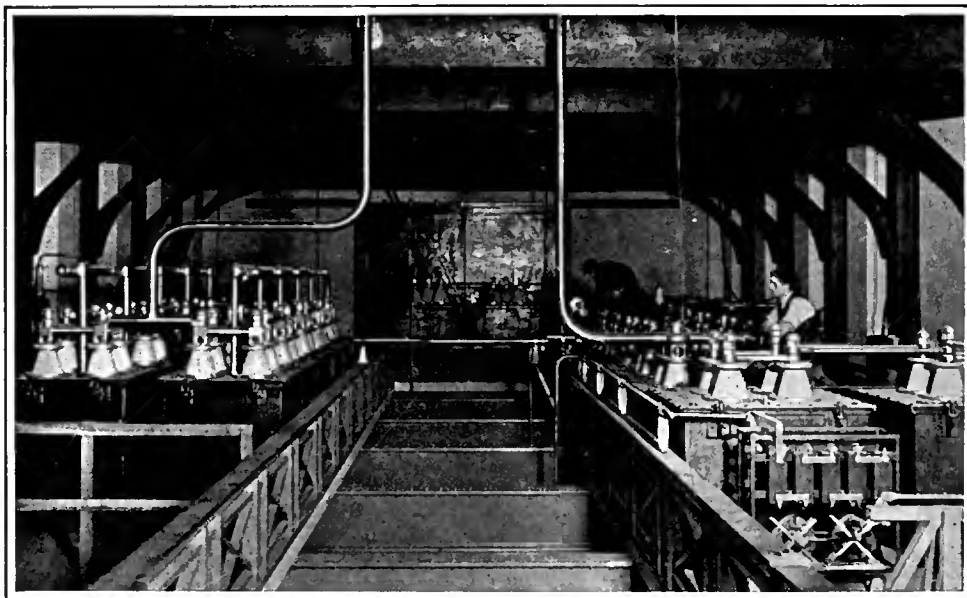

CONDENSERS AT RUGBY, ENGLAND'S NEWEST STATION

The station is so arranged that either short or long waves for telephony or long distance telegraphy can be used for communication with the British colonies or with the United States. The condensers shown are able to withstand 800 amperes at 40,000 volts. The bus bars and lugs are about six inches in diameter and large enough for one's fist to fit inside. Six million sheets of mica, carefully tested and gauged, to the thickness of three-thousandths of an inch were used by the makers, the Dubilier company, into the units which make up the bank

The Technical and Scientific Aspects of Broadcasting

The Processes Involved in the Transmission and Reception of Broadcast Programs—A Simple and Lucid Explanation of the Functions of the Various Units of the Transmitter and Receiver

By RALPH BOWN

Vice President, Institute of Radio Engineers

BROADCASTING differs from other forms of wireless telephony in that the transmission is sent out from one station for the purpose of reaching a large number of receivers scattered over an area, whereas other forms of telephony generally involve two-way transmission between two terminal stations only. Moreover, the apparatus used in broadcasting not only must transmit intelligible speech but must also transmit the subtle intricacies of vocal and instrumental music with the highest degree of faithfulness and freedom from distortion.

Stated briefly, the purpose of a broadcasting system is to pick up air-pressure variations due to sound waves, transport a facsimile of them by radio means to a multitude of receiving points, and reproduce at these points sound waves as nearly as possible like the original ones. The pickup, or input and the reproducing, or output, ends of the system respectively, are comprised of two pieces of apparatus which in principle are essentially like the corresponding parts of the ordinary telephone instrument. At the input end is a telephone transmitter, or microphone, to produce electric current having variations in intensity corresponding to the variations in air pressure on the diaphragm caused by the sound waves. At an output end some form of telephone receiver is used to reproduce from such electric currents the corresponding sound waves. Since the method of transporting the electrical counterpart of the sound waves from the microphone to the telephone receiver is not by electric currents or waves on wires, as in ordinary telephony, but by electromagnetic waves in free space, the mechanisms which intervene in the process are of a distinctive character.

The radio transportation or transmission is accomplished by sending out from the transmitting station electromagnetic or radio waves which vary in intensity in the same manner as do the telephonic currents from the microphone. At receiving stations, these radio waves are intercepted, and their intensity variations converted back into intensity variations of a telephonic current, which actuates the telephone receiver. There are several distinct processes involved:

1. Producing the high-frequency alternating electric current which, when introduced into a radio antenna, causes the radiation of electromagnetic waves. This current is produced by an electrical "oscillator."

2. "Modulating" this current, or causing its intensity to vary in the same manner as does the intensity of the telephone current from the microphone.

3. Radiating the electromagnetic waves by causing the modulated high-frequency current to flow in a radio antenna, or aerial.

4. Intercepting some of the radiated waves' energy by a receiving antenna in which modu-

lated high-frequency currents, similar to those flowing in the transmitting antenna are, thereby, caused to flow.

5. "Detecting," or converting the modulated high-frequency current into telephone currents having the same variations in intensity.

6. At both the transmitting and receiving stations, amplifying the currents to increase their power and to make up for losses in power suffered in transmission through the various parts of the entire system.

The mechanisms involved in items (1), (2), and (3) constitute the Transmitting System, while those involved in items (4) and (5) constitute the Receiving System. In the transit of the

THIS is the second article to be published in RADIO BROADCAST through the courtesy of the Encyclopaedia Britannica, the thirteenth edition of which has just been published. In last month's RADIO BROADCAST, an article on the microphone, by H. J. Round appeared in these pages, and on this occasion we take pleasure in reprinting from the new Britannica an article on broadcasting by Ralph Bown, well known in radio engineering circles in this country and abroad. Mr. Bown is Vice President of the Institute of Radio Engineers. He is in the Department of Development and Research of the American Telegraph and Telephone Company.

—THE EDITOR.

waves through space between these two terminal systems, lies the field of Radio Transmission.

The most important device used in the transmitting and receiving systems is the ubiquitous vacuum tube, or thermionic valve. It is employed in the most modern apparatus for performing many functions, including generation of high-frequency currents, modulation of these currents by telephonic currents, detecting or converting the high-frequency currents to reproduce telephonic currents, and amplifying both high-frequency and audio-frequency (telephonic) currents.

TRANSMITTING SYSTEM: The transmitting system comprises (1) the microphone, which is placed at the studio or theater, and toward which the sound waves of the voice or instrument are projected; (2) the amplifier and control devices, which magnify the electric currents from the microphone by the desired amount; and (3) the radio transmitting station, which sends out radio waves modulated in accordance with the amplified microphone currents.

Highly specialized forms of microphones are necessary in order to respond accurately to the wide range of sound frequencies and intensities of speech or music. The music, for instance, that comes from a symphony orchestra, consists of tones which range from fundamental

bass notes of less than 100 vibrations or cycles per second up to harmonics at 5000 cycles or more. Thus it covers a range of frequencies of at least 5000 cycles or, as it is expressed by the engineer, a band of frequencies at least 5000 cycles wide. One kind of microphone in wide use consists of a tightly stretched duralumin diaphragm having two carbon microphone buttons attached to opposite sides of it at the center. The two buttons are connected with the electrical circuit in such a way that distortion tends to be balanced out. The placing of the microphone with reference to the performers, and the acoustical qualities of the surroundings, are of great importance in achieving the best results. For this reason, where possible, the program is performed in a studio room especially designed for control of placing, sound absorption, and echoes.

Since the range of volume, or loudness, covered by the program may be very large, the amount of amplification applied to the microphone currents before such currents go to the radio transmitter must be adjusted frequently in order that they may neither overload the transmitter, giving rise to distortion, nor fail, through weakness, to actuate the transmitter sufficiently. The amplifier adjustment, therefore, requires to be manipulated by a control operator who is provided with a radio receiver so that he can hear the program exactly as it is heard by the radio audience. To guide his judgment further in manipulating the volume control, the operator is usually provided with

an electrical device called a "volume indicator" which gives him a visual indication of the strength of the telephonic current at the output of the amplifier. The amplifier and control apparatus, and the radio transmitter, as well as the wire telephone circuits between them in cases when they are physically separated, must be carefully designed to transmit the telephone currents without distortion.

The radio transmitters employed in broadcasting are not different in principle from those employed in other forms of radio telephony but are designed with special attention to stability, freedom from distortion, and purity of transmission. In most types, the telephone currents delivered from the control apparatus are amplified and impressed upon the oscillator tubes, which generate high-frequency currents. The output of the oscillator is thus modulated¹ to correspond with the original sound variations. In the smaller power transmitters the modulated high-frequency currents then go directly from the modulating system to the antenna, but in some equipments, amplifiers containing powerful, metallic, water-cooled tubes are interposed. The antenna systems of broadcasting stations resemble those of wireless telegraph installations.

¹See RADIO BROADCAST Laboratory Information Sheet No. 25

FREQUENCY ASSIGNMENT

THE assignment of carrier frequencies to broadcasting stations is an important consideration. When there is no modulation, that is, during the silent intervals of a program, a broadcasting station sends out waves of a single frequency, as in continuous wave (c.w.) radio telegraphy. This frequency is known as the carrier frequency,² and is expressed in kilocycles. When modulation takes place by speech or music, there are also transmitted two "sidebands," or sets of waves which occupy two bands of frequencies, one on either side of the carrier, each about 5000 cycles (half a kilocycle) in width making the total transmission cover a band some 10 kilocycles in width—with the carrier frequency in the middle. The frequency range available for broadcasting is limited, being, in the United States and Canada, for instance, from 550 kilocycles to 1500 kilocycles. Thus there are only 95 non-overlapping 10-kilocycle bands, or channels. Two stations in the same service area cannot occupy the same band or even closely adjacent bands without causing interference to each other, so it is necessary to assign station frequencies in accordance with some form of geographical zoning system, and the total number of stations which can operate simultaneously is definitely limited. In popular usage, the wavelength in meters is commonly used as a measure of the carrier frequency of a station, and in classified lists of stations, both the carrier frequencies and wavelengths are often given. The numerical relation between the two is the same as for any propagated wave motion, either one being equal to the velocity of propagation divided by the other.

RECEIVING SYSTEM: The functions of the receiving system are (a) to collect the radio wave energy in its antenna, in the form of high-frequency currents; (b) to select, to the exclusion of other channels, the currents lying in the band of frequencies occupied by the station to which it is desired to listen and then, (c) to amplify these currents, and (d) to convert them into audio-frequency (telephonic) currents, which are in turn amplified and delivered to the telephone receivers or a loud speaker.

FORMS OF ANTENNAS: Two kinds of antennas are in common use, the one, an elevated wire similar to a transmitting antenna, and the other a loop antenna consisting of a coil of a few turns of wire wound on a frame or other support. The former is electrically more efficient, but the loop being relatively small is often more convenient. The selecting of stations is done by means of tuning circuits having electrical inductances or coils, and electrical capacities or condensers. These are adjustable, so that the circuits may be tuned to respond most strongly to currents in the band of frequencies sent out by the station it is desired to receive. Making these adjustments is known popularly as "tuning-in." In the arrangement and form of the tuning circuits and the vacuum tube amplifiers, receiving sets have a wide variety of differences in detail, but broadly they fall into three main classifications: (1.) Regenerative Sets; (2.) Radio-Frequency Amplifier Type Sets; (3.) Intermediate-Frequency Amplifier (Super-heterodyne) type sets.

In addition to these types, there is a class of much simpler and less sensitive receiving sets known as "crystal sets," which contain no vacuum tubes. A crystal set consists merely of an antenna, the tuning circuits, and a "crystal detector" which serves to convert the modulated high frequency currents into audio-frequency (telephonic) currents. A crystal detector is a

device which utilizes the electrical rectifying properties of certain crystalline minerals. The lead ore galena is one mineral thus commonly employed.

REGENERATIVE SETS: In regenerative³ sets a controllable coupling of some kind is provided between the output and input circuits of the amplifying or detecting tube, or tubes, so that some of the amplified voltage may be fed back into the tubes again and be re-amplified many times. This gives more effective use of a small number of tubes. Such sets, when the "feedback" coupling is wrongly manipulated, will generate continuous high-frequency oscillations which cause waves to be sent out from the antenna as at a transmitting station. These waves may be a troublesome source of interference to other receivers and, for this reason, a decline in the use of regenerative sets is being forced by public opinion.

RADIO-FREQUENCY AMPLIFIERS: In the second type (Radio-Frequency Amplifier) the radio-frequency currents are amplified by a multi-tube amplifier before being impressed on the detector tube, which converts them to audio-frequency currents. If no precautions are taken to avoid coupling between the output and input of the amplifier, this type may also be regenerative. Various expedients are employed in the design and construction of high-frequency amplifier types to guard against regeneration, and to make them stable and non-oscillating.

INTERMEDIATE-FREQUENCY (SUPER-HETERODYNE) TYPE: In this type of receiver⁴, the modulated high-frequency currents from the antenna are combined in a converter tube with continuous high-frequency currents generated by a local oscillator tube circuit. From their interaction in the converter tube there results a modulated intermediate frequency, usually of the order of 50 kilocycles. The intermediate-frequency currents are amplified and passed to a detector tube, which reproduces audio-frequency currents from them. This type of set is stable and easily adjusted. It is, however, usually more complicated and expensive than the other types.

AMPLIFIERS: All types of receiving sets except the simplest, contain, or must be used with, audio-frequency amplifiers which, coming after the detector tube, amplify the audio-frequency currents to a sufficient intensity so that they will operate the telephone receivers or loud speakers which reproduce the sound vibrations.

In order not to distort the high-frequency or audio-frequency currents, it is necessary that the various circuits in the receiving set pass these currents with equal efficiencies for the different frequencies in the band, and that the various tubes, particularly the detector and audio-frequency amplifier tubes, be of sufficient size to transmit the currents without becoming overloaded.

The portions of the receiving system in which distortion is hardest to avoid are the audio-frequency amplifier and loud speaker. The best amplifiers are designed to amplify uniformly all frequencies ranging from 100 cycles, or even less, to 5000 cycles or more, since all these frequencies are important in accurate reproduction of speech and music. In the same way, the transfer efficiency from electric energy to sound energy by the loud speaker should be substantially constant over this range. The load-carrying capacity of the amplifier and loud speaker must be adequate to provide the desired volume, or distortion, due to overloading, will result.

²See RADIO BROADCAST Laboratory Information Sheet No. 1.

³See RADIO BROADCAST Laboratory Information Sheet No. 36.

LOUD SPEAKERS: Loud speakers⁵ are roughly divided into two classes—the horn types and the hornless types. In the horn type, the diaphragm is attached by its edges to the small end of a horn which forms a sort of megaphone to concentrate the sound. In one of the most common hornless types the diaphragm is a shallow cone, one to three feet in diameter, made of paper or cardboard. The cone types have become very popular because they reproduce the lower frequencies, or bass notes, which give rich fullness and naturalness to music, better than do the ordinary horn types. For the higher frequencies, the two types are not so widely different. Horns, if made sufficiently long, are also capable of reproducing the low notes. Such long horns may be looped or coiled to avoid unwieldiness. It is yet too early to say whether the horn or hornless type will ultimately be developed to the greatest perfection.

FORMS OF SETS: In physical form, receiving sets range all the way from an assemblage of the various elements or parts as separate units wired up by the user, to the most pretentious sets in which the entire system, including loud speaker and power supply sources, is housed in an elaborate cabinet designed to be a beautiful piece of furniture. The most common arrangement, however, consists of the receiving set proper (enclosing the tuning and radio-frequency circuits, and very often also the audio-frequency amplifier), the batteries or other power supply sources for the vacuum tubes, and the telephone receivers (or loud speaker). This combination is flexible, and the various parts of it may be purchased separately to suit the owner's preference.

POWER SUPPLY: From the user's standpoint, one of the annoying problems is that of power supply. The power supply for filament current is usually a storage or dry battery called the A battery. Storage battery units have been developed which are simple and convenient for use in the home. They contain, within one box, both the battery and a means of charging it from house electric lighting circuits. Dry batteries, made up in block form and called B batteries, are commonly used to supply the small current at 50 to 150 volts required by the vacuum tube plate circuits. There are also used to a considerable extent so-called B battery eliminators. These are devices in which current from a lighting circuit is used to supply plate-circuit current. In some receiving systems using vacuum tubes that require only a small filament current, this also is obtained by rectification from lighting circuits, and the entire set is operated from an electric-light socket, thus doing away entirely with batteries.

RADIO TRANSMISSION: When the radio waves are thrown out, or radiated, from the antenna at the transmitting station, they tend to spread out in all directions somewhat as do the waves in a pool of water when a stone is dropped into it. As they travel outward in ever-increasing circles, their initial energy is spread over a larger and larger circumference so that the intensity of the waves must correspondingly decrease. If the energy merely spread out in this way, none of it being lost, the wave intensity would change inversely as the distance increased. But, due to the absorption⁶ in the atmosphere, and in the ground, of a part of the wave energy, which is thus dissipated as heat, the falling-off of wave intensity with distance is more rapid. The amounts of absorption caused by various kinds of terrain differ widely, being smallest for

⁵See RADIO BROADCAST Laboratory Information Sheet No. 46.

⁶See RADIO BROADCAST Laboratory Information Sheet No. 2.

(Continued on page 76)

²See RADIO BROADCAST Laboratory Information Sheet No. 16.

Cardwell Condensers

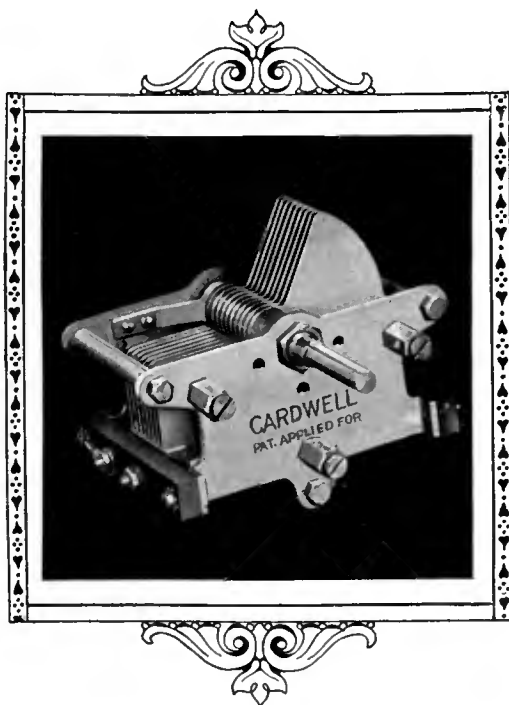

The Type "C" has a tuning characteristic which approaches straight frequency at minimum and straight wavelength at maximum. Priced from \$4.00 up.

The Type "C" Cardwell Condenser is almost the universal selection of Radio Engineers and Editors who want the best. Mr. John B. Brennan used them in the New Radio Broadcast "Lab" circuit. . . . Mr. E. M. Sargent recommends the 317-C as the only condenser for the "Infra-dyne" The "A. C. Varion," which you can build to work direct from the lighting fixtures, uses the 217-C. . . . For Short Wave Reception, Cardwell Condensers have always been accepted as the only practical instrument.

"THE STANDARD OF COMPARISON"

Digitized by Microsoft®

YAXLEY

APPROVED RADIO PRODUCTS

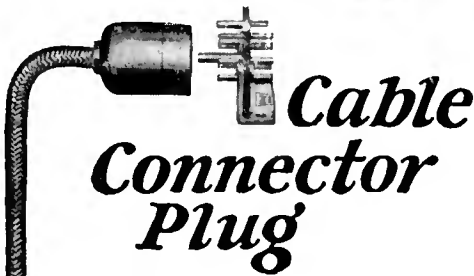

Cable Connector Plug

The very appearance and sure positive action as you put it together will sell you on the new Yaxley Cable Connector Plug.

The Bakelite construction, the phosphor bronze double contact springs, the convenient mounting plate with the permanently attached color guide for wiring tell you the unusual merits of this practical plug for quickly and conveniently connecting battery leads to your set.

The No. 660 is the plug illustrated \$3.50

The No. 670 is the plug for the set with binding posts—no soldering. Just hookup the terminals to your set and batteries and the job is done. \$4.00

Junior Jacks

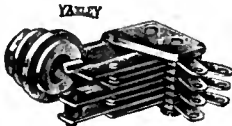

For the set builder who wants a thoroughly dependable jack in the junior size. Absolutely the same in every exclusive feature of design and construction as Yaxley standard jacks. Pure silver, self cleaning contact rivets. All spring combinations from one to seven.

Midget Battery Switch



A neat efficient filament control switch. Never gets out of order.

One nut mounting. Hard rolled phosphor bronze springs. Pure silver contacts. Quick make and break. Furnished complete with "Off" and "On" plate, as illustrated, at 50c.

At your dealer. If he cannot supply you, send his name with your order to

Yaxley Mfg. Co.

9 So. Clinton St.

Dept. B

CHICAGO, ILL.

The Technical and Scientific Aspects of Broadcasting

(Continued from page 64)

transmission over the ocean, or bodies of salt water, and increasingly greater for fresh water and dry land. Since a broadcasting station is usually not surrounded on all sides by a uniform terrain, the efficiency of wave-travel in different directions is not the same. As a result, the received wave intensity may not be the same at all points equidistant from the transmitting station. Mountains and steel-frame building areas of large cities cause particularly heavy absorption, which may amount to almost complete suppression of the waves so that on the far side of such obstructions there is sometimes an area of very low wave intensity called a "dead spot." At such places, or near places where the terrain changes abruptly, as at a coast line, the waves may be deflected somewhat from their course and be thrown across the path of another part of the waves which has not been deflected. This gives rise to wave interference patterns of the same nature as those produced at the edges of shadows by diffraction of light. Since radio waves are millions of times longer than light waves, the patterns are relatively gigantic and one such pattern may cover an area of a hundred square miles or more. Within the area, the wave intensities at points separated from each other by only a fraction of a mile may show wide differences.

INTERFERENCE: If the wave intensity were the only factor in radio reception, it would theoretically be possible to receive from a station at any distance, since, as the waves became weaker, the sensitiveness of the receiving system could be increased by using more amplifiers. However, the atmosphere is nearly always filled with vagrant radio waves which enter the receiving set, producing noises called "interference," which submerge the weak radio signals it is desired to receive. These vagrant waves come from a multitude of sources. The most potent come from the atmosphere itself, and these, in a manner not yet fully understood but commonly thought to be due at least in part to thunderstorms, produce waves which cause in the receiver crackling sounds known as "atmospherics" or, less properly but more popularly, as "static." The various sorts of electrical systems which are a part of every modern community where broadcasting exists are capable of throwing off radio waves when the currents flowing in them change abruptly. These may give rise to clicking, buzzing, and chattering noises.

The vagrant waves are present at all frequencies and therefore cannot be tuned-out by the selectivity of the receiving set. For this reason, satisfactory, noise-free reception from a station can be obtained only in areas where its signal wave intensity is much greater than the intensity of the vagrant waves. The intensity and amount of the "atmospherics" change with the time of day and season of the year, being greater at night and much greater in the summer time. Superimposed on these regular changes are large fortuitous variations. The amount of absorption of radio waves at broadcasting frequencies is influenced markedly by sunlight, being less at night. On account of these two variables, which are not closely related to each other in detail, satisfactory reception from distant broadcasting stations is largely a matter of chance. In densely populated areas, where there also is interference from powerful nearby broadcasting stations, and perhaps from a multitude of regenerative receivers, reception from distant stations becomes well-nigh impossible.

FADING: Another impediment to radio reception at distances of more than one or two hundred miles is an annoying waxing and waning

of the signal intensity, called "fading." The causes of this phenomenon are not fully known, but the problem is being studied actively by many scientific agencies. The evidence so far adduced has led to a theory that at distant points waves from the transmitter arrive by two or more routes, at least one of which is by way of the upper reaches of the earth's atmosphere. At times, these waves, coming by different routes, oppose and nullify each other while, at other times, they add together and assist each other. In going through these two states in progressive alternation they produce fading. The fading may be selective as to frequency so that the different frequencies within the band transmitted by a station are differently affected, and there is distortion of the received speech or music.

INTERCONNECTION OF BROADCASTING STATIONS: The method of achieving widespread distribution of a broadcast program which has been applied most successfully is that of interconnecting a number of stations by telephone wires so that they all simultaneously broadcast the same program. These broadcasting stations, located at strategic points scattered over the area to be served, permit the large majority of listeners to receive the program just as satisfactorily as they receive local programs.

The audio-frequency currents from the microphone which picks up the program, after passing through the control operator's amplifier, are delivered to a system of telephone lines which in many respects resembles an electric power distributing network. Trunk wires go out from the program center to various parts of the country, and from these, at appropriate points, connecting wires branch off to the broadcasting stations. Telephone repeaters are placed in the circuits at suitable points to amplify the currents so that they may reach the broadcasting stations without material loss in volume. As has already been pointed out, distortion of the telephone currents must be very small or the faithfulness of reproduction at receiving points will be spoiled. On this account, the very best kinds of telephone circuits and associated apparatus are employed.

This form of large scale broadcasting has reached its greatest development in the United States and England. In the United States, as many as 29 stations have thus been tied together to broadcast a common program of national importance. On such an occasion, many thousands of miles of land wires are involved, and stations on the Pacific and Atlantic coasts 3000 miles apart, broadcast the same program in unison. In England, as well as in the United States, chains of stations, less widely scattered, are in every-day use.

REFERENCES: Technical development in radio broadcasting has been so rapid and so recent that up-to-date information must be sought in current issues of technical periodicals. Articles on receiving systems are usually confined to one type or to the products of one manufacturer. For transmitting systems and transmission, the following articles are suggested:

"Transmitting Equipment for Radio Telephone Broadcasting," by Edward L. Nelson. *Proceedings of The Institute of Radio Engineers*, Vol. 12, pp. 553.

"Broadcasting Transmitting Stations of the Radio Corporation of America," by Julius Weinberger. *Proceedings of The Institute of Radio Engineers*, Vol. 12, pp. 745.

"Some Studies in Radio Transmission," by Ralph Bown, Deloss K. Martin, and Ralph K. Potter. *Proceedings of The Institute of Radio Engineers*, February, 1926.

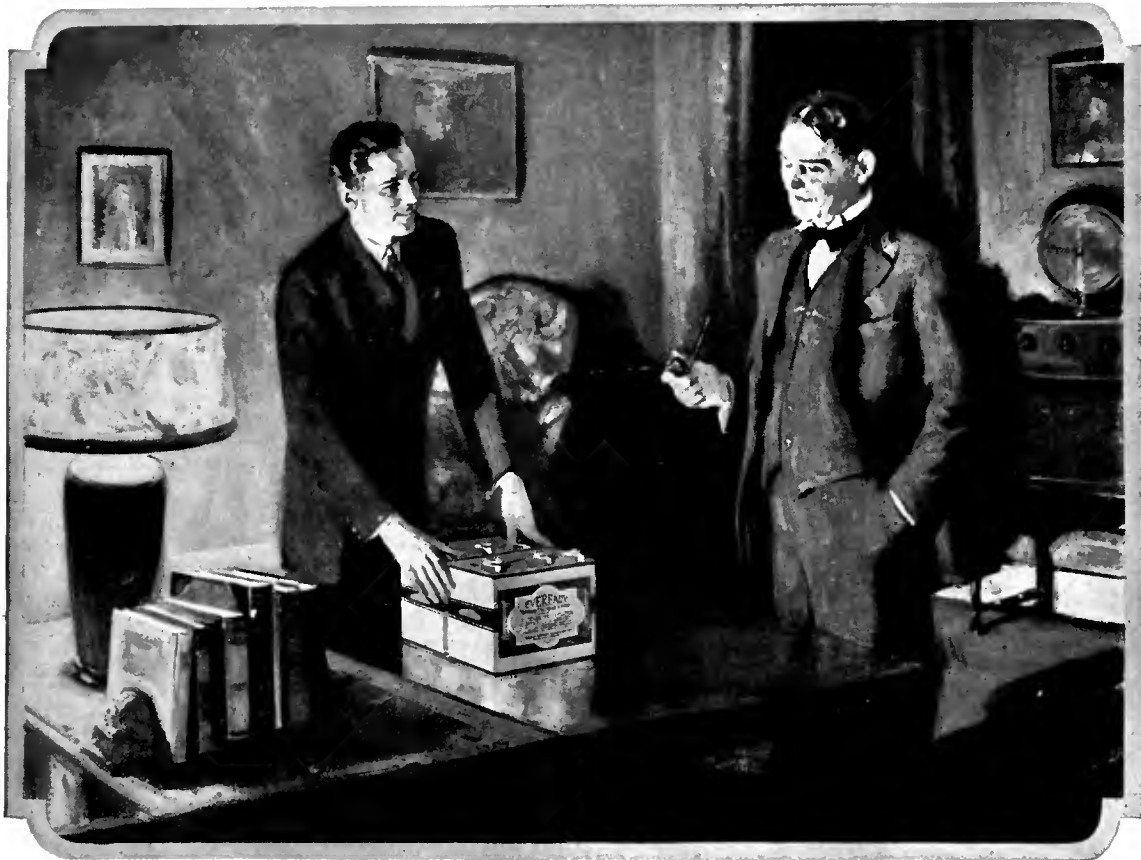

*Here's the most
economical "B" battery ever built
for radio* ★

IN THE production of Heavy-Duty radio "B" batteries Eveready has established a new standard of "B" battery life and economy.

Eveready Heavy-Duty 45-volt "B" Batteries will outlast any Light-Duty 45-volt "B" two to one regardless of the number and kind of tubes used! Moreover, though lasting twice as long, they cost only one-third more!

To cap the climax of "B" battery economy, in Eveready Layerbilt No. 486, Eveready has perfected a Heavy-Duty "B" battery of unequalled endurance and dependability—positively the greatest "B"

battery in service and satisfaction its price can buy.

You can make no mistake in buying Eveready Layerbilt No. 486 for *any* set using normal voltages (45 to 135 volts).

You will be buying the utmost in dependability of "B"

power—the greatest "B" power operating economy—D. C. (direct current) in its purest form, which insures pure tone quality.

With colder evenings at hand, radio reception is vastly improving. Equip your set now with Eveready Layerbilt No. 486, the greatest "B" battery ever built for radio.

Manufactured and guaranteed by
NATIONAL CARBON CO., INC.
New York San Francisco
Canadian National Carbon Co., Limited
Toronto, Ontario



LEFT—Eveready Layerbilt No. 486.

RIGHT—No. 7111 Eveready Dry Cell Radio "A" Battery, 1½ volts.



EVEREADY

Radio Batteries

—they last longer

Tuesday night means Eveready Hour—9 P. M., Eastern Standard Time, through the following stations:

- | | | |
|------------------|-----------------|--------------------|
| WEAT—New York | WGR—Buffalo | WGN—Chicago |
| WJAR—Providence | WCAB—Pittsburgh | WOC—Davenport |
| WEER—Boston | WSAI—Cincinnati | WOOO { Minneapolis |
| WTAG—Worcester | WTAM—Cleveland | WOOO { St. Paul |
| WFI—Philadelphia | WWJ—Detroit | KSD—St. Louis |
| | WDC—Washington | |

Speed

**SUPER-EMISSION
RADIO TUBES**

are the most perfectly
balanced tubes produced



X 200 A
**Super-Sensitive
Power Detector**

Other Types

- 201 A 5 volt detector-amplifier
- X 112 5 " power amplifier
- 199 3 " detector-amplifier
- X 120 3 " power amplifier
- 12 1 1/2 " detector-amplifier

and

**Speed
Gas Filled
Filamentless**

Full Wave Rectifier for use in standard "B" battery supply power units

**Cable
Supply Company**

**INC.
Executive Offices
31 Union Square
New York**

The Radio Broadcast LABORATORY INFORMATION SHEETS

INQUIRIES sent to the Questions and Answers department of RADIO BROADCAST have until recently been answered either by letter or in "The Grid." The latter department has been discontinued, and all questions addressed to our technical service department are now answered by mail. In place of "The Grid," appear now a series of Laboratory Information Sheets. These sheets contain much the same type of information as formerly appeared in "The Grid," but we believe that the change in the method of presentation and the wider scope of the information in the sheets, will make this section of RADIO BROADCAST of much greater interest to our readers.

The Laboratory Information Sheets cover a wide range of information of value to the experimenter, and they are so arranged that they may be cut from the magazine and preserved for constant reference. We suggest that the series of Sheets appearing in each issue be cut out with a razor blade and pasted on filing cards, or in a note book. The cards should be arranged in numerical order. Several times during the year, an index to all sheets previously printed will appear in this department. The first index appears this month.

Those who wish to avail themselves of the service formerly supplied by "The Grid," are requested to send their questions to the Technical Information Service of the Laboratory, using the coupon which appears on page 98 of this issue. Some of the former issues of RADIO BROADCAST, in which appeared the first sets of Laboratory Sheets, may still be obtained from the Subscription Department of Doubleday, Page & Company at Garden City, New York.

No. 41

RADIO BROADCAST Laboratory Information Sheet November, 1926

The Super-Heterodyne

INTERMEDIATE-FREQUENCY AMPLIFIER

IN THE super-heterodyne there is a group of apparatus termed the intermediate-frequency amplifier which functions to amplify the beat notes produced by the action of the first detector and local oscillator (See Laboratory Sheet No. 36). Characteristics which a good intermediate-frequency amplifier must possess are discussed below.

In the first place, all of the transformers used in the amplifier must be resonant at the same frequency. Improperly matched transformers are a cause of poor operation of a super-heterodyne, since the overall efficiency of the entire receiver can be considerably lowered if one of the transformers is slightly different in characteristics from the others. Matching of the transformers is not an easy process since the matching must usually be done with very low voltages in order to make the conditions similar in every way to those found during ordinary operation.

The resonance curve must be sufficiently broad so that all side bands which make up the signal are evenly amplified. On the other hand, if the resonance curve is too broad, the selectivity of the system will not be good enough. No trouble should be met with as regards selectivity in the intermediate amplifier when properly matched air-core transformers are used, but these must be carefully designed to prevent some of the side bands being cut off, due to their (the transformers') sharp peaks. Iron-core transformers are often used in super-heterodynes in conjunction with a filter. Since the

selectivity obtained from the iron-core transformer is not great enough, it is necessary to improve this characteristic by placing, either before or after the amplifier, a tuned circuit, known as the filter, designed to pass only those frequencies for which the transformers give the maximum amplification.

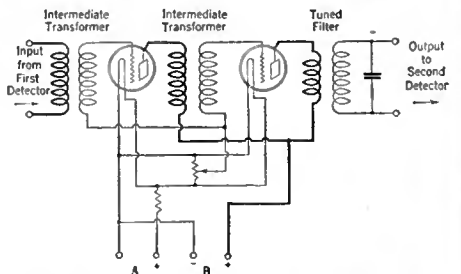

Regeneration in the intermediate-frequency amplifier will considerably improve the selectivity and sensitivity by sharpening the resonance curves of the transformers.

The common method of connecting together intermediate-frequency amplifiers is illustrated in the diagram, in which potentiometer control of regeneration is used.

No. 42

RADIO BROADCAST Laboratory Information Sheet November, 1926

Super-Regeneration

THE THEORY EXPLAINED

WHERE loud signals are required from a loop, and the number of tubes is limited to one or two, super-regeneration can be used. Super-regenerative circuits are not very selective and hence are not very good for working through interference. The principle of super-regeneration is simply explained by a mechanical analogy. Suppose a clock to be wound up and the pendulum placed carefully in its lowest position and left there. The clock will not start itself. But now, suppose strong puffs of air come along at the proper interval to start the pendulum swinging slightly. Once it starts ever so slightly an ideal spring and escapement mechanism would cause its swinging to increase even if the puffs of air stop coming in. The oscillations of the pendulum "build up" and in due time the amplitude of swing reaches a limit determined by friction, air resistance, etc. But if we confine our attention to a sufficiently short period of time after the swing starts to build up, we will find that the amplitude attained during this time is proportional to the strength of the incoming puffs of air. At the end of this period, let the pendulum be stopped and set again at its lowest point so that the whole operation may be repeated. A great deal more swinging is done by the pendulum if the clock is wound up and the puffs of air are playing on it, than if the clock were not wound up, in which case the pendulum would only swing the very small amount caused by the air puffs.

In the electrical sense, in super-regeneration, we have a circuit all set to oscillate, i.e., wound up and balanced, so to speak, so that some incoming ether wave is required to start it oscillating. This is similar to our analogy, in which the puff of air is necessary in order to start the pendulum swinging. In the super-regenerative receiver, the oscillations started by the incoming waves are permitted to build up very rapidly in the same manner that they would be built up in an ordinary regenerative receiver if the coupling was greatly increased beyond that necessary to make the detector oscillate. However, before the circuit can break into continuous oscillation the entire oscillation is automatically extinguished by another oscillation (generally about 10,000 cycles) which opposes the incoming oscillations every 20,000th of a second. This 10,000-cycle oscillation may either be generated in the same tube or in another tube coupled to the detector. During half of each cycle, that is, every 20,000ths of a second, the 10,000-cycle oscillation has no effect upon the incoming signal and during the other half of the cycle its effect is to prevent the production of any high frequency oscillation in the detector circuit.

Consequently the signal energy is very large during half of each 10,000 cycle oscillation, and on the whole there is very much more energy in the detector grid circuit than would be present under ordinary conditions. A comparatively large voltage is therefore impressed on the grid, which makes a correspondingly large amount of energy available in the plate circuit.

SM

630

SILVER SHIELDED SIX

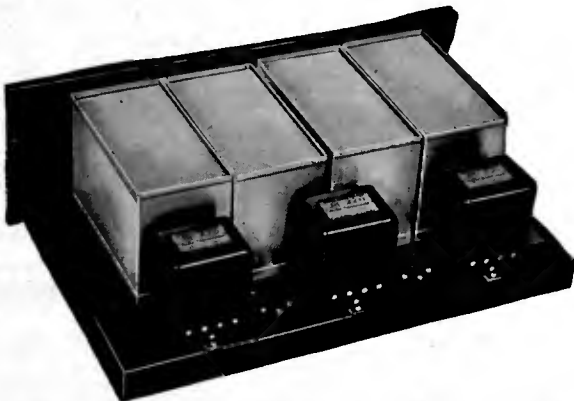

The S-M 630 Shielded Six Kit—including matched and measured parts to build this remarkable receiver—price \$95.00.

The 633 Shielded Six Essential Kit contains four condensers, four radio frequency transformers, four coil sockets, four stage shields and the link motion—all factory matched—price \$45.00.

Clear and complete instructions, prepared by S.M. engineers, go with each kit—or will be mailed separately for 50c.

Prices are 10% higher West of the Rockies

The Radio Broadcast star of approval is on the Shielded Six! In the October issue this remarkable receiver was described at length—approved by the Radio Broadcast laboratory!

The Shielded Six is one of the highest types of broadcast receivers. It embodies complete shielding of all radio frequency and detector circuits. The quality of reproduction is *real*—true to the ear.

Behind the Shielded Six is competent engineering. It is sensitive. Day in and day out it will get distance—on the speaker. It is selective. Local stations in the most crowded area separate completely—yet there are but two dials to tune. These features—its all metal chassis and panel, its ease of assembly and many others, put it in the small class of ultra-fine factory-built sets, priced at several times the Six's cost.

220 & 221 AUDIO TRANSFORMERS



220 Audio Transformer.....\$6.00
221 Output Transformer.....6.00

Prices are 10% higher West of the Rockies

S-M 220—the big, husky audio transformer you hear in the finest sets—the only transformer with the *rising* low note characteristic that means real quality—not only on paper—but when you hear it. It is a power job—yet the finest of audio amplifying devices is sold, with a guarantee for but \$6.00.

The S-M 221 is an output transformer that will bring out the low notes on your present set. It should be used between the last audio tube and the loud speaker—it eliminates blasting and will increase speaker capacity for handling strong signals without distortion, \$6.00.

SILVER-MARSHALL, Inc.

838 W. JACKSON BLVD.

★
CHICAGO, U. S. A.

MICADON 640A
Capacities:
.006 to .02 mfd.
Price
\$1.00 to \$1.95

METALEAK
15,000 ohms to
200,000 ohms
75¢ each
25 meg. to 5 meg.
50¢ each

tone reality
need not be expensive

You don't need an expensive set to get faithful reproduction. Resistance coupling gives even amplification of all tones. And it has the added advantage of costing little, and consuming less "B" battery current.

Micadon 640 A is the Dubilier resistance coupling unit. It is a fixed condenser of the famous Micadon type, designed and patented by Dubilier to provide unvarying capacity with the lowest dielectric loss—so essential for the true reproduction of sound.

Used with the silent Dubilier MetaLeak, Micadon 640 A will give you the foundation for an amplifier unit with all the tone quality found in the best radio sets.

★ Send 10c. for our booklet showing fourteen ways to improve your set with simple applications of fixed condensers

Dubilier
CONDENSER AND RADIO CORPORATION

4377 Bronx Blvd., New York, N. Y.

No. 43

RADIO BROADCAST Laboratory Information Sheet November, 1926

Field Intensity Measurements

DERIVATION OF THE FORMULA

ON LABORATORY Sheet No. 39 were given some data regarding the measurement of the field intensity of broadcasting stations. Further information concerning this subject is given on this sheet, with regard, especially, to the derivation of the formula which was given on the previous Laboratory Sheet.

With the field intensity of some base station known, from actual measurements at a distance of ten miles, it is possible to calculate the field intensity of the base station at any other distance up to about fifty miles, by the formula given below:

$$F_b = \frac{10}{d} F_{10}$$

Where F_b = field intensity of base station at distance d ; d = distance from station in miles; F_{10} = radiation constant of base station.

The field intensity, F , of the station under test, is determined by the relative deflections of a meter in the plate circuit or the detector tube when signals from the base station are being received and when signals from the test station are being received. The two field intensities will be proportional to the meter deflections; the greater the deflection, the greater the field strength. Therefore we can write:

$$F = F_b \frac{I}{I_b}$$

Where F = field intensity of station under test; I =

meter deflection when signals from test station are being received; I_b = meter deflection when signals from base stations are being received.

If the total amplification in the receiver is held constant, the only other factor that would influence the results would be the antenna resistance, and we can take account of it by placing in the formula the ratio of the antenna resistances at the two wavelengths (it is always best to use as a base station one which is transmitting on a wavelength quite close to that being used by the station under test). Putting this ratio in the formula we have:

$$F = F_b \frac{I}{I_b} \times \frac{R}{R_b}$$

which is the same as the formula given in the former Laboratory Sheet.

A great deal of work has been done on this subject and some very interesting data were given in the August, 1926, issue of RADIO BROADCAST by Mr. Albert F. Murray, who recorded the work done by Doctor Pickard. The methods used by Doctor Pickard must be used if the station whose field intensity is to be determined is located at any distance over about fifty miles. For distances less than fifty miles, practically all the energy is received by what is commonly called the ground wave, but for distances very much greater than fifty miles, energy is also received by other paths, so that a formula which only takes into consideration that energy received by the ground wave cannot be used for very great distances.

No. 44

RADIO BROADCAST Laboratory Information Sheet November, 1926

The R. B. "Local" Receiver

NECESSARY EQUIPMENT

IN THE August, 1926, issue of RADIO BROADCAST, there was described a high-quality local receiver by Mr. Kendall Clough. This receiver was designed particularly for local reception and consists of a stage of radio frequency amplification coupled to a non-regenerative detector and the usual audio amplifier. Both of the tuned circuits are contained in shields. The C battery form of detection is used since this method of detection permits the handling of loud signals without distortion. All tuning is accomplished by varying the two condensers. The only other controls are a filament rheostat and a volume control. The following apparatus was used in the original model:

- 1 7 x 18 x 1/2-Inch Bakelite Front Panel.
- 1 7 1/2 x 17 x 1/2-Inch Bakelite Sub-Panel.
- 1 Pair Silver-Marshall 540 Mounting Brackets.
- 1 Yaxley 3-Ohm Rheostat, R_s.
- 1 Yaxley 25-Ohm Rheostat, R_a.
- 1 Yaxley No. 1 Open-Circuit Jack, J₁.
- 1 Yaxley No. 10 Filament Switch.
- 2 Silver-Marshall 316A 0.00035 Condensers, C₁ and C₂.
- 2 Kursch-Kasch 4-inch Dials, Zero Left.
- 2 Silver-Marshall No. 631 Stage Shields.
- 2 Silver-Marshall 515 Coil Sockets.
- 2 No. 115A coils, 1578-545 kc. (190-550 Meters).
- 4 Silver-Marshall No. 511 Sockets.
- 1 Sangamo 1.0 mfd. Condenser, C₃.
- 1 Sangamo 0.002 Condenser, C₄.

- 2 Silver-Marshall 220 Audio Transformers T₁ and T₂.
- 1 Silver-Marshall 221 Output Transformer, T₃.
- 1 Coil Belden Flexible Hook-Up Wire.
- 6 1/2 x 1/2-Inch Lengths Brass Tube for Mounting Coil Sockets.
- 1 Elky Equalizer, Type 35, R₁.
- An Assortment of 3/8" Round Head Screws and Nuts, together with Lugs.

Home-made coils may be made up in accordance with the following specifications:

For the secondaries marked L₂ and L₅ on the diagram, Laboratory Sheet Number 45, wind ninety turns of number 22 d.c.c. wire on a 2-inch tube. The primaries, L₁ and L₄, consist of 13-turn windings wound over the centers of the secondaries. The primary and secondary windings are separated from each other by layers of cambric tape or other insulation. If a 201-A tube is to be used in the r. f. stage, an additional winding is necessary on the first coil. This additional winding, marked L₃ on the diagram, should consist of five turns of number 26 d.c.c. wire. The winding, L₆, can be ignored. It is merely shown since it is to be found on the manufactured coils if they are purchased. It is not, however, connected into the circuit in any way. Shields should preferably be used and are indicated in the diagram by a dot-dash line. The "Xs" of the diagram indicate parts of the circuit that are connected to the shields. The shielding may consist of aluminum cans made to fit over the apparatus. Numbers on the diagram correspond to those to be found on the manufactured coil sockets.

No. 45

RADIO BROADCAST Laboratory Information Sheet November, 1926

The R. B. "Local" Receiver

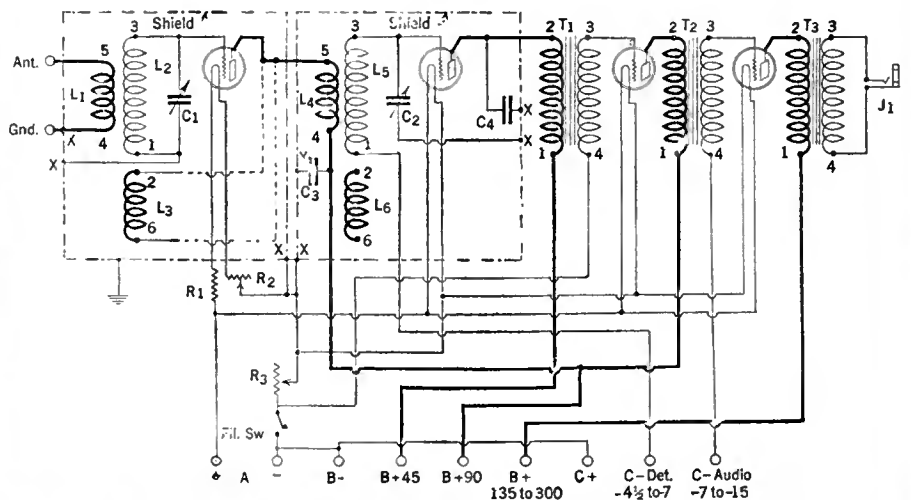

Data on the R. B. "Local" Receiver appears on Sheet No. 44

FREE

This 84 Page
Wonder Book of RADIO Bargains



Send for this guide to Radio prices and Radio quality. All of our vast resources and radio experience have been utilized to assemble for you in one gigantic institution, the best and newest things in radio. The Randolph catalog is indeed the radio market place of the world—a masterpiece of merchandising that befits our house—the largest exclusive radio mail order house in the world.

What Our Catalog Contains

Over 2,000 items—from the most beautiful, fully equipped console model radio set, down to the smallest part or tool for the set builder—kits, parts, and supplies of every conceivable type and style. All beautifully illustrated and interestingly described. And to give this book added value, we have included radio data that makes it an invaluable text book for every lover of today's most fascinating and most wonderful achievement—RADIO.

Radio Sets

In this great radio market place you will find table model sets and console types with built-in loud speakers; the newest ampliphonic console sets; new Spanish period consoles; five, six, seven, and eight tube sets, with three dial, two dial, and the newest and most popular single simplified control. All sets are assembled in beautiful, genuine mahogany and walnut cabinets in a choice of latest types and designs.

5 Tube sets as low as \$24.90
Latest 1927 Models

All Randolph sets are sold at amazingly low prices. No matter what kind of set you want—no matter how little you want to pay—you can select YOUR SET AT YOUR PRICE from the Randolph catalog.

Radio Kits

Includes the following well known circuits, designed and approved by the world's foremost radio engineers: Madison Moore Super; Victrol Super; Silver Marshal Six; Sargent's Infiradine; Remler Super; Short Wave Kits; 9-in-Line Super; New Acme Reflex; Cockaday; Neurodyne; Browning-Drake; all classes of radio frequency, Super Heterodyne and every other approved popular circuit.

YOU MUST HAVE THIS BOOK

Space limitations here prevent our telling you more about the Randolph Catalog. Simply fill out and mail the coupon—or you may send a postal or letter—and this truly remarkable Radio book will come to you **ABSOLUTELY FREE. MAIL THE COUPON NOW.**

Randolph Radio Corporation
 130 North Union Avenue • Dept. 114 • Chicago, Ill.

Radio Parts and Supplies

The Randolph catalog also contains a most complete line of "B" Battery Eliminators, including the famous Raytheon Eliminators; the latest type of Loud Speakers, Cone Speakers, a complete line of quality "A" power units—in fact, you will find listed in this wonder book every part that goes into the construction of a radio set, or any accessories you desire, at prices that mean a substantial saving to you.

Free Radio Service

Everyone has need for radio service. The average man has no time to keep up with the rapid developments of radio. We employ Radio Engineers who have made radio their life work. Their expert advice and helpful suggestions solve every radio problem of our customers.

Our Guarantee

Every article in our catalogs based on careful laboratory analyses and tests. We guarantee to back up every item in our catalog with our own as well as manufacturer's assurance of quality.

Why We Save You Money

Because we handle radio exclusively and sell a tremendous volume of everything in Radio, we can concentrate our buying power for the benefit of our customers.

Volume purchases regulate prices. We command rock bottom prices from manufacturers, and in many cases we contract for entire factory output of exclusive products. You will benefit by our great volume of purchases and sales, by securing anything you may want in radio at a substantial saving.

This Coupon Brings the Great RADIO Book FREE

RANDOLPH RADIO CORPORATION
 180 N. Union Ave., Dept. 114
 Chicago, Illinois

Send me—free—your 84-page, 1927 Radio Book.

Name _____

Street and No. _____

R. F. D. _____ Box _____

City _____ State _____

ASK . . ANY . . RADIO . . ENGINEER



This is the new Burgess Radio "A" Battery

A SPECIALLY designed "A" battery for radio service. There is nothing like it in its field.

Proportioned to permit ease of handling and convenience of cabinet assembly and storage, you may expect this new Burgess creation to give you the length of service and dependability under all conditions for which all products of Burgess are noted.

If you are using the ordinary type of No. 6 "A" battery, we suggest that you learn for yourself from the Burgess Radio "A" the measure of service you have a right to expect.

Ask Any Radio Engineer

BURGESS BATTERY COMPANY
GENERAL SALES OFFICE: CHICAGO

Canadian Factories and Offices:
Niagara Falls and Winnipeg

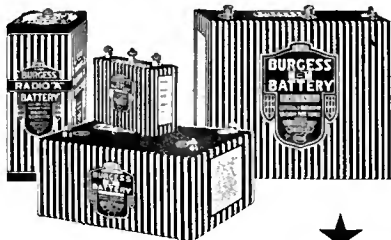

BURGESS RADIO BATTERIES

No. 46

RADIO BROADCAST Laboratory Information Sheet November, 1926

Loud Speakers

SOME GENERAL CONSIDERATIONS

IT IS easy enough to fix a megaphone to a telephone receiver to produce a loud signal, and some loud speakers are merely refinements of this idea. The horn concentrates the sound in one direction, and the tapered column of air within the horn that fills the space about the small receiver diaphragm at the small end, and swells gradually out to join the open air at the flared end, supplies something for the diaphragm to work against. The diaphragm is caused to set more air in motion just as if a bigger diaphragm were used, thus increasing the volume of sound produced. But inasmuch as the best reproducers are only about 2 per cent. efficient (that is, of 100 units of electric energy entering them only about 2 leave in the form of sound energy), only small efficiencies are likely to be obtained even when good horns are coupled to the diaphragm. The great sensitivity of the human ear tends to make up for the inefficiency with which energy is converted from mechanical to acoustical by means of vibrating bodies. In ordinary speech only about one erg (the erg is the physicist's unit of energy) per second is converted into sound energy. How little this is can be seen from the following calculation: Reckoning that the average human being talks the equivalent of two hours steady talking per day, and that the average population of the United States since

the Revolution is forty millions, and that power is worth two cents per kilowatt hour, then, from the energy point of view, all the talking that has been done in the history of our country is only worth \$8.59!

In addition to the low efficiency of the conventional loud speaker, there is also distortion introduced in this method of making radio signals audible by the horn. An excellent method of mitigating this is by the use of two or three separate horns, each with its own diaphragm. In the case where three are used, for example, one is a very long horn that responds well to low tones; the second is an ordinary-sized loud speaker responding fairly well over the middle range; and the third is a very small horn giving the very high-pitched notes. The three horns, all working at once, combine to give a satisfactory uniform response over the whole audible range. The three horns, of course, are combined in a single box. The long horn can be coiled to save space, if necessary.

Another type of loud speaker avoids such distortion as is due to the horn by using no horn at all. This type of speaker usually, but not necessarily, has a large, light, stiff paper cone for a diaphragm, and this alone is sufficient to give it a good "grip" on the air. At present only a few commercial types of loud speakers give any sort of an approach to the goal of quality, which is to have all frequencies transmitted from speaker to listener with equal efficiency.

No. 47

RADIO BROADCAST Laboratory Information Sheet November, 1926

Index

	SHEET NUMBER	MONTH		SHEET NUMBER	MONTH
A Batteries, Dry Cells	14	July, 1926.	Filaments, Series Connection of	34	October, 1926.
Antennas, Theory of Loop	15	July, 1926.	Grid Leak Impedance:	40	October, 1926.
Bias by Voltage Drop	34	October, 1926	<i>Matching Tube and Loud Speaker</i>		
Browning-Drake Receiver	3,4	June, 1926.	Inductance of Solenoid Coils	32	September, 1926.
Bypass Condensers	24	August, 1926.	Intermediate-Frequency Amplifiers	17	August, 1926.
Carrier Wave Analysis	16	July, 1926.	Line Supply Device:	41	November, 1926.
Charging of Storage Batteries on D. C. Code:	13	July, 1926.	<i>Measuring Output Voltage</i>		
<i>Learning to Read Morse Code</i>	19	August, 1926.	Loop Receiver	30	September, 1926.
Coils, Inductance of Single Layer Solenoid Condensers:	20	August, 1926.	Loop, Theory of Loud Speaker:	22	August, 1926.
<i>Dielectrics used in Theory</i>	6	June, 1926.	<i>Matching Impedances of</i>	15	July, 1926.
<i>Bypass</i>	8	June, 1926.	<i>General Considerations</i>	32	September, 1926.
Detection, Analysis of Dielectric Constant	24	August, 1926.	<i>Matching Tube and Loud Speaker Impedance</i>	46	November, 1926.
Distortion in Receivers	40	October, 1926.	Modulation	32	September, 1926.
Field Intensity Measurements	6	June, 1926.	Morse Code	25, 26	September, 1926.
	31	September, 1926.	Neutralization	20	August, 1926.
	39, 43	October, November, 1926.		38	October, 1926.

No. 48

RADIO BROADCAST Laboratory Information Sheet November, 1926

Index

	SHEET NUMBER	MONTH		SHEET NUMBER	MONTH
R. B. "Local" Receiver	44, 45	November, 1926.	Super-Heterodyne:		
Radio-Frequency Transformers	35	October, 1926.	<i>Analysis of Intermediate-Frequency Amplifier</i>	36	October, 1926.
Receivers:			Super-Regeneration	41	November, 1926.
<i>Browning-Drake Loop Type</i>	3, 4	June, 1926.	Transformers:	42	November, 1926.
<i>22, 35</i>		August, 1926.	<i>Primary - Secondary Ratios</i>		
R. B. "Local" Roberts Four-Tube	44, 45	November, 1926.	<i>Radio Frequency Tubes; Special Tubes</i>	5	June, 1926.
Reception, Factors Governing	9, 10	July, 1926.	<i>Characteristics of General Types</i>	35	October, 1926.
Regeneration:	2	June, 1926.	<i>UX-200-A</i>	7	June, 1926.
<i>Method of Control Defined</i>	1	June, 1926.	<i>UX-171</i>	29	September, 1926.
Rejuvenating Tubes	26	September, 1926.	<i>Rejuvenating Uses of UX-200-A, Characteristics of</i>	11	July, 1926.
Resistance of Rheostat	21	August, 1926.	<i>UX-171, Characteristics of</i>	12	July, 1926.
Rheostat, Correct Size	23	August, 1926.	Voltmeter:	21	August, 1926.
Roberts Four-Tube Receiver	23	August, 1926.	<i>How to Make Calibration</i>	26	September, 1926.
Side Bands	9, 10	July, 1926.	Volume Control	11	July, 1926.
Single Control	16	July, 1926.		12	July, 1926.
Single Side-Band Transmission	33	October, 1926.		27	September, 1926.
Storage Batteries, Charging of	37	October, 1926.		28	September, 1926.
	13	July, 1926.		18	August, 1926.

Consistent performance

NINE out of every ten radio fans know Browning-Drake. Since its introduction over two years ago, when Glenn H. Browning and Frederick H. Drake set a mathematical standard of design for radio frequency transformers, a hundred thousand Browning-Drake fans have praised its distinct improvement in radio receiving.

This good-will coupled with the nation-wide publicity following every recognized advance, has given Browning-Drake a place in Radio no dealer can afford to overlook.

One stage of scientifically designed radio frequency, incorporating the Browning-Drake transformer, together with the flexibility of a two-control receiver, has yet to be improved upon for all around satisfactory reception. Constantly improved as new refinements are proved worthy, Browning-Drake has no yearly models to become obsolete.

Browning-Drake produces only one model, built complete at its Brighton laboratories. Sold at the fair price of \$95, steadily maintained, every Browning-Drake dealer has made money, and every Browning-Drake customer has been permanently satisfied.

BROWNING-DRAKE CORPORATION, BRIGHTON, MASS.

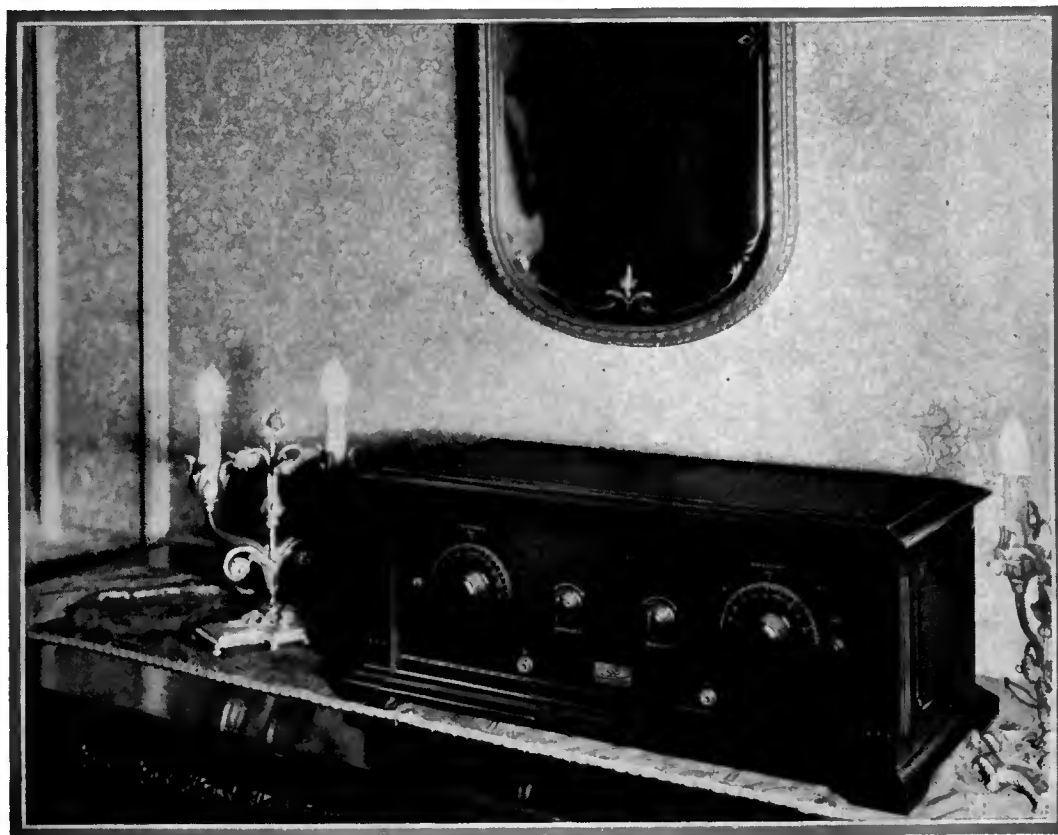

BROWNING-DRAKE



3 reasons for the golden opportunities for radio operators

- 1 Men who need money for college courses learn radio, take an operator's position with good pay, with free board and room. They quit as soon as they save enough for their purposes. *Opportunity for new men.*
- 2 Many operators find that it pays to learn radio for the pleasure of a few ocean voyages to foreign lands. Then they leave for shore jobs. *Opportunity for new men.*
- 3 Bigger and better positions that require technical radio knowledge and experience are constantly calling operators from the ranks. *Opportunity for new men.*

Learn Radio Now

With a few months of Radio Institute of America's expert instruction, you, too, can qualify for your U. S. Government Commercial or Amateur Radio License—and start to see the far corners of the world as a radio operator.

Learn at Home

Radio Institute of America gives the finest radio instruction you can obtain. And you can learn at home. Send coupon for complete information.

SEND THIS IN

Radio Institute of America
328 Broadway, New York City

K

Please send me full information about your Home Study Course of radio instruction.

- I am interested in the complete course including code instruction.
 I am interested in the technical course without code instruction.

Name _____

Address _____

Radio Institute of America

(formerly Marconi Institute)

Established in 1909

328 Broadway

New York City

A Way of Increasing Selectivity

A Higher, More Exposed Antenna Will Improve Sensitivity But Broaden Tuning—How This May Be Remedied—Adapting a "Selectivity Unit" to Any Receiver

By HAROLD JOLLIFFE

HOW many of you fans who are always building and rebuilding your receivers into all manner of trick circuits, buying more tubes, and accessories, and generally striving to pull in more dx, ever pause long enough in your experimenting to reflect that by erecting a long, high antenna you are virtually adding the equivalent of another stage of radio frequency amplification to your set? The distance-getting ability of a large antenna versus a small one may be compared to the difference between a good headset and an insensitive one; the good headset brings in signals from distant stations quite clearly and distinctly, while the poorly-designed phones reproduce them so faintly that you have to strain your ears to find out what it's all about!

And it's analogous with antennas. A long unsheltered antenna will bring in signals from far greater distances than a small, low one can ever hope to pick up; stations heard on the small antenna will come in with a remarkable increase in volume when the set is coupled to a longer, higher antenna. And this simply because the antenna, being high and covering a greater area, is collecting considerably more energy, thereby resulting in a more pronounced radio frequency delivery to the detector. True, indeed, there will be a not-

three-circuit variometer set is an example of a receiver of this type. There are also many receivers which employ the "shock excitation" method of coupling, i. e., the untuned, or aperiodic primary, as in some forms of neutrodyne receivers. Each system has certain advantages. The first, the tuned primary, provides greater signal strength, since the antenna coil may be tuned exactly to the frequency of the desired signal and, in turn, the secondary may be brought into resonance with the received signal. The second, the untuned primary form, makes for greater selectivity at some sacrifice in volume because the primary coil, having a low value and not variable, cannot be tuned to the signal frequency but depends for its operation upon "shocking" the grid coil where the selection of the desired signal is accomplished. The greater the number of turns the broader will be the tuning, with an increase in volume; likewise, as the number of turns is reduced, selectivity is more pronounced, with a decrease in signal strength.

In the course of some experiments with a four-tube Teledyne receiver, the writer found that, by cutting down the antenna coupling coil from ten turns to one, and then loading this one turn with a specially designed loading coil, thereby

making it a combination of the two coupling methods referred to above, the selectivity was as sharp as if the one turn alone were used, while the volume was practically the same as with the ten turns. The antenna used during these tests, and which was subsequently used with great success last winter, was 175 feet long and 115 feet high at the main support—a water tank. The results were so pleasing in this case that the idea was tried with a standard single-circuit receiver; and, in view of the fact that no radio frequency amplification was employed that would aid in boosting the selectivity, the results were eminently satisfactory.

The author therefore decided that it is possible to use a long, high antenna system, with the resulting high energy-intercepting qualities, without sacrificing that degree of selectivity which is generally obtained only by the use of a small antenna, provided that the proper apparatus is employed.

The first thing to do is to build the variable loading unit; the constructional details are

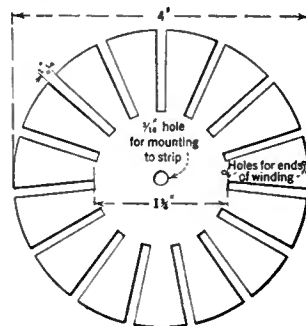

FIG. 1

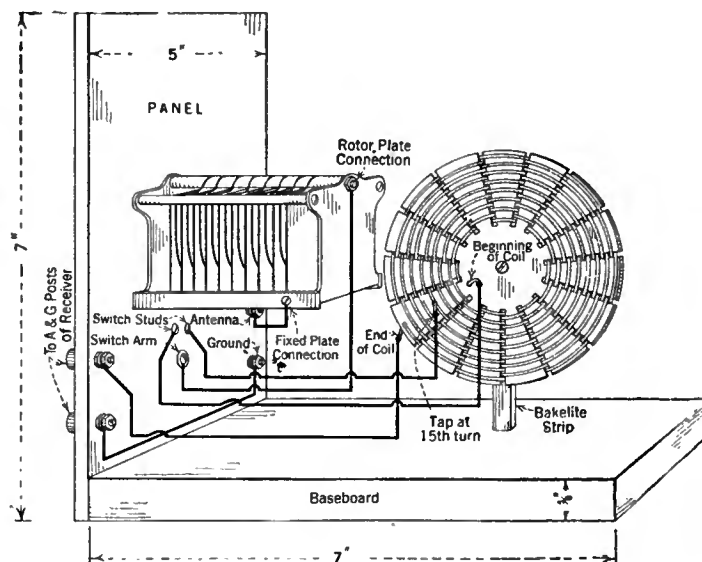

FIG. 2

able decrease in selectivity ordinarily, but we're coming to that now, and it is this factor with which we are concerned in this article.

There are several types of receivers in use to-day which employ a tuned antenna circuit. By this is meant that the primary coil is capable of being tuned to the exact frequency of the incoming signal, either by means of a variable condenser of the proper capacity, a system of taps, or a combination of both. The well-known

BUILT LIKE A VIOLIN



*see it • hear it •
• buy it •*

Oh, it gladdens the eye—does Teletone. It graces any Radio set, any room; for it is the highest development in cabinet making ever designed into a radio-speaker.

Hear Teletone! Voices, as though they were in the very room. Brass bands, as though the sounds were floating over broad beaches.

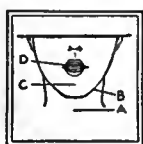
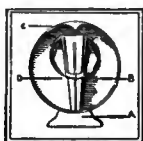

Orchestras, with the completeness of overtones and undertones ordinarily heard only in the concert hall.

Buy Teletone for complete radio-speaker satisfaction. Two charming models to suit your fancy. Two prices to suit your purse—only \$32.50 or \$22.50 for the very most that radio has to offer.

Note that a sound-wave coming from the sound producing unit "A" (the human vocal cords) is amplified through the orifice "B" (the human larynx) until it reaches the conducting area "C" (the back of the throat), whence it is again conducted to the point of greatest amplification "D" (the correctly formed and opened mouth of the singer).



TELETONE CORPORATION of AMERICA

449-453 West 42nd Street, New York City

TELETONE

Radio speaker

Digitized by Microsoft®

★ Examined and approved by RADIO BROADCAST ★

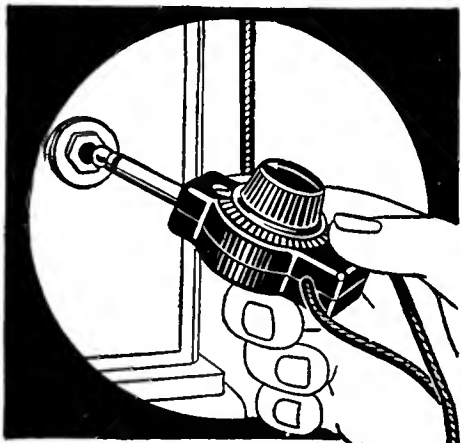

Brings Your Set Up To Date

The only real advance claimed by the makers of this year's best sets is improvement in tone performance. This improvement can be made in your present set by simply adding the Centralab Modu-Plug. This modernizing device makes your reception equal in tone performance to that of the latest high-priced receivers.

Modu-Plug is warranted by Central Radio Laboratories, makers of variable resistances for sixty-nine manufacturers of leading standard sets.

Centralab Modu-Plug replaces the loud speaker plug. Gives any degree of tone volume from a whisper to maximum by simply turning the small knob on the plug, without adjustments of other controls. Modu-Plug matches the speaker impedance to the output impedance of the set. Reduces interfering noises. Clarity and faithful reproduction equal the latest developments in perfected performance.

\$2.50 at your dealer's or mailed direct on receipt of price.

CENTRAL RADIO LABORATORIES

22 Keefe Ave. Milwaukee, Wis.

Australian Representative—United Distributors, Ltd., Sydney
 Canadian Representative—Irving W. Levine, Montreal
 Great Britain Representative—R. A. Rothermel, Ltd., London



Centralab Radiom permits clear, true-tone reception by holding the sensitive regenerative position which immediately precedes the oscillation point, without distortion or loss of selectivity. A standard unit on leading sets. Retail price, \$2.00, at your dealer's or from us.



shown in the accompanying sketches. It consists essentially of a tapped spiderweb coil and a variable condenser. Great care must be observed in the construction of this unit, for, since another piece of apparatus is being added to the receiver proper, it is obvious, if the best results are desired, that the design should be in accordance with the most advanced ideas on low loss efficiency. It is apparent that there would be no use in adding to your receiver an instrument that would effectually block the passage of weak signals, due to the resistance introduced.

The variable air condenser employed should preferably be of the straight frequency-line grounded rotor type, and the requirements of the circuit are such that this condenser should have a maximum capacity of 0.001 mfd. The inductance is of the well-known spiderweb type,

coupling, as in the commercial type of the Browning-Drake receiver, the Teledyne, and any set in which the antenna is connected directly to some point on the grid inductance of the first tube, it will be necessary to remove the two exterior wires which connect with the antenna and ground posts. In their stead is placed a piece of copper wire no smaller than No. 14 and long enough to reach from the antenna terminal, once around the grid coil, and thence to the ground post. In order that this wire will not cut into the finer wire of the grid coil, it should be covered with a good grade of spaghetti. This single turn should also be made very secure so that it will not come loose. This constitutes the coupling coil through which the received energy is transferred from the loading unit to the receiver proper. The output terminals of the

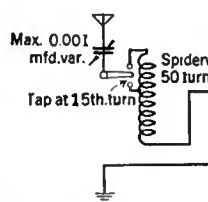

FIG. 3

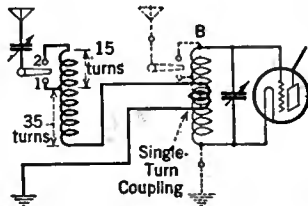

FIG. 4

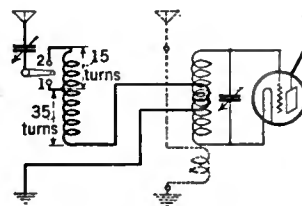

FIG. 5

since such a coil offers a very low resistance to high frequency currents, and is very easy to construct. It consists of fifty turns of No. 22 d.c.c. magnet wire wound in and out of every other slot of the form, and tapped at the fifteenth turn from the beginning. The form may be purchased at a radio dealer's or made at home from heavy cardboard, according to Fig. 1. No shellac, varnish, or other such material is used on this coil. After the coil has been completed, it may be mounted on a baseboard directly behind the condenser by means of a bakelite mounting strip, with a small brass angle. See Fig. 2. It is important that it be placed at right angles to the electrostatic field of the condenser and also that it be out of inductive relation to the first coil of the receiver itself. If any coupling, however slight, exists between the loading unit and the coils of the receiver, the purpose of the one-turn coupling coil will be defeated, as no energy should be transferred except at this point.

In mounting the switch points on the panel, keep them as far apart as the width of the switch blade will permit. It is also in the interest of efficiency to use points with a very low head, not more than 1/8 inch high. Keep the leads to these points at least an inch apart. Observance of these precautions will result in a very low capacity effect at a point where large losses might otherwise be encountered.

All connections should be made with No. 12 or No. 14 copper wire, soldered where necessary, and covered with spaghetti to produce a neat appearance. By connecting the rotary plates of the variable condenser to the ground side of the circuit, all capacity effect from the operator's hands will be entirely eliminated.

When the unit has been completed, it may be housed in a suitable cabinet to match that of the receiver. While the panel specified is seven inches high, this may be varied to correspond with the height of the receiver with which it is to be used, thereby presenting a more harmonious appearance. Fig. 3 is a wiring diagram of the unit.

Now that we have the unit completed and have erected as large an antenna as circumstances will permit, let us see how we can apply the idea to receivers employing various forms of coupling. Assuming that your receiver employs direct

loading unit are connected to the antenna and ground posts of the receiver, and the antenna and ground are then hooked to their respective posts on the unit. How the connections should be when this has been done is shown in Fig. 4, the dotted lines indicating the former connections.

If your set employs aperiodic coupling, as in many modern receivers the changes to be made are very similar. The small coil which is connected between the antenna and ground posts and coupled to the grid inductance is removed and in its place is put the one turn of heavy wire. Fig. 5 illustrates this.

In a set in which the antenna circuit is tuned, such as a vario-coupler set, where the outside winding is connected between the antenna and ground and the rotor is used as the main tuning inductance, the primary will have to be unwound and removed. It is not necessary, of course, to dismantle the coupler, but it would not do to leave the unused primary coil in such close relation to the grid coil. The one turn of heavy copper wire is wrapped around the secondary and connected to the antenna and ground posts as before. See Fig. 6. If a tuning condenser has previously been used in the antenna circuit, it

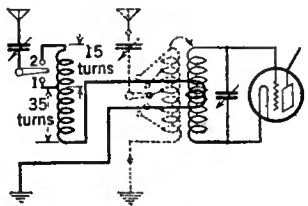
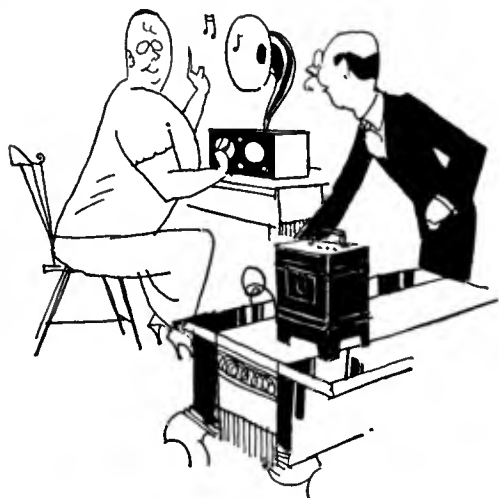

FIG. 6

may be employed in the loading unit, provided it is of the proper capacity.

From the above it is apparent that the one-turn coupling idea may be applied to practically any type of receiver designed for use with an outside antenna. While, in the writer's case, it was used with a long, high antenna, it may also be employed with an ordinary antenna where interference is very marked. If the unit is to be used with a small antenna and a set employing no radio frequency amplification, better results will be secured by the use of a coupling coil composed of two turns instead of one.

The operation of the unit is very simple. For frequencies above 857 kc. (wavelengths below 350 meters), the switch lever is set on the first point so that but thirty-five turns of the loading inductance are included in the antenna circuit. The dials of the receiver are then adjusted to the settings at which a station is known to come in, after which the antenna condenser is varied until signals are heard. The first dial of the receiver will not read exactly the same as formerly.



No tears in these tunes!

Unless, perchance, they're tears of joy. For there's only unalloyed pleasure in a set kept at its lively best with a Rectigon. Your batteries are charged with ease and convenience. But more than solid comfort—there's no costly grief. You'll shed no agonizing tears because of spoiled furnishings, ruined clothes. You can do your charging wherever you wish. There's nothing in a Rectigon to spill or burn. No acids, no chemicals—and no moving parts.

when you do your own charging with

The Westinghouse Rectigon Battery Charger

©, 1926, W. E. & M. Co.

No noise as it charges—not a bit of fuss. Not even a murmur that would disturb the mildest slumber.



Saves its cost in short order—Count the dollars spent in a few trips to the service station and you'll hotfoot it for a Rectigon, for the good it does your pocketbook as well as your batteries.



Snaps on in an instant—Just plug into the light socket, snap on the terminals. Saves service station bother. Spares interruptions caused by absent batteries.



Charges both "A" and "B" batteries—Keeps both packed with power. Bulb is used for "B" battery charging and it is enclosed, like all other parts, in metal, safe from accident. (Rectigon charges automobile batteries, too.)



Perfect safety for your set—If you tune in while you're charging there'll be no harm either to set or batteries. Nor will batteries be discharged if anything happens to the current while your Rectigon's attached.



No Storage Battery Radio is Complete Without a Rectigon



THE RECTIGON'S a superb Westinghouse product. Things you *can't* see, like extra heavy insulation, things you *can* see, like the durably enameled case—all are of highest quality. Westinghouse also manufactures a complete line of radio instruments, and Micarta panels and tubes.

WESTINGHOUSE ELECTRIC & MANUFACTURING CO.

Tune in on KDKA - KYW - WBZ - KFKX

Digitized by Microson

Announcing A New Line That's Different

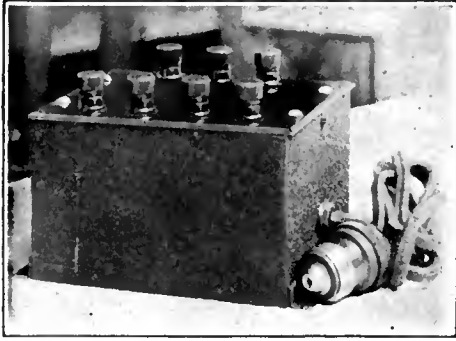

Raytheon Power Pack

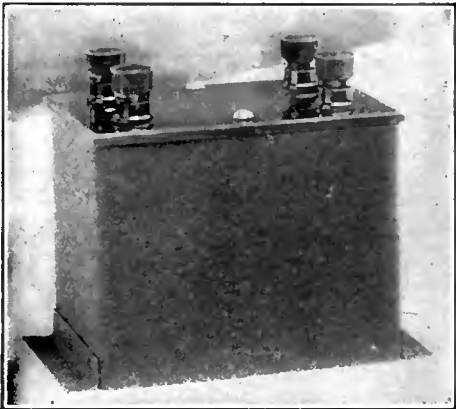

Filter Chokes for any
Eliminator

Ampli Also Announce

1. Transformers for Power Pack.
2. Output Units.
3. Impedance Amplifiers.
4. Wire wound Resistances.
5. Lavite Resistances.
6. Radio Frequency Chokes.

Jobbers and Dealers:—Write for attractive proposition that we wish to outline to you.



Ampli Products Co., Inc.

24 Woorster St. New York City

THE BEST IN CURRENT RADIO PERIODICALS

The Thirteenth Installment of a Useful Classified Survey of Material Appearing in the Radio Press

By E. G. SHALKHAUSER

How This Survey Can Help You

HOW often have you looked for information contained in some article which you recall having read months ago—the description of the Browning-Drake receiver, or the measurement of losses in inductance coils, for example? After looking through probably several issues of a dozen different publications, you either give up or become interested in something altogether different.

When data is wanted on some particular subject, a systematic file of subjects and titles becomes a real radio encyclopedia. Instead of having merely the title of an article given, which often is misleading, a summary of the contents gives all the information. These surveys cover the radio field as gleaned from material in to-day's periodicals. They will always serve as a future reference-guide to all who are interested in the science of radio, whether engineer, manufacturer, dealer, experimenter, or listener.

To be of practical value and easily accessible, these surveys should either be pasted in a scrap book, or, better still, be pasted on individual cards and filed according to numbers, or alphabetically. In the matter of classification of articles, the Bureau of Standards circular No. 138 has been followed. This may be obtained from the Government Printing Office, Washington, District of Columbia, for ten cents. In addition, each abstract has certain key-words placed at the upper right, which may be used for the purpose of filing articles alphabetically.

With this series of surveys we hope to aid our readers and help them through many difficulties which they no doubt have often experienced. The writer is prepared to give information and references to articles previously surveyed upon receipt of a stamped and self-addressed envelope.

Following is the series of headings, made up according to the Dewey Decimal System used in the Bureau of Standards circular No. 138:



R000 RADIO COMMUNICATION IN GENERAL.

Under this heading will appear all subject matter pertaining to laws, regulations, history, publications, etc., which deal with radio in a general way.

R100 PRINCIPLES UNDERLYING RADIO COMMUNICATION.

Here will be given the phenomena of radio waves, their underlying theory of propagation, the principle of antenna and counterpoise, design and characteristics of vacuum tubes and their behavior in circuits, types of circuits, transmitting and receiving apparatus and their principles of operation.

R200 RADIO MEASUREMENTS AND STANDARDIZATION METHODS.

The various known methods which have been used in measuring frequency, wavelength, resonance, capacity, inductance, resistance current, voltage, dielectric constants, and properties of materials, will be mentioned here.

R300 RADIO APPARATUS AND EQUIPMENT.

A description of various types of antennas and their properties, the use of the electron tube in various types of receiving and transmitting sets, other methods of transmission of signals, various detecting devices used in reception, instruments and parts of circuits, come under this heading.

R580. TELEVISION. OTHER APPLICATIONS TELEVISION OF RADIO.

Radio. Aug., 1926, pp. 9ff.
"Some Notes On Television," H. de A. Donisthorpe.
Television, seeing at a distance by telegraphy or radio, as distinct from photo-telegraphy, involves a process whereby light waves impinge on a selenium cell, which, in turn, modulates an electric current. At the receiving end, the modulated current controls a source of light traversing a ground glass screen in exact synchronism with the image at the transmitter, the whole image being recorded in one-tenth of a second. Although only in the experimental stage, this system, known as the Baird system, will probably some day be put to commercial use, as stated.

R343. ELECTRON-TUBE RECEIVING SETS. RECEIVER, INFRADYNE.

This receiver, of the super-heterodyne type, makes use of the sum frequency in the intermediate frequency stages instead of the difference frequency, as is generally the case. In the set described, 3200 kilocycles frequency as the step-up frequency, and small air core transformers, produce the results outlined. A ten-tube circuit is presented, having two stages of radio frequency, first detector, oscillator, three stages of intermediate amplification second detector, and two

R400 RADIO COMMUNICATION SYSTEMS.

The spark, modulated wave and continuous wave systems in transmission, beat and other methods of reception, wired wireless, automatic printing, the buzzerphone and Fullerphone, will be given here.

R500 APPLICATIONS OF RADIO.

To aviation, navigation, commerce, military, private and broadcasting, and the specific information under their headings, are referred to here.

R600 RADIO STATIONS.

The operation, equipment, and management of radio installations, both transmitting and receiving, the testing, the rules and regulations concerning stations, the reports and bulletins issued, will follow under this heading.

R700 RADIO MANUFACTURING.

Data relative to costs and contracts of radio equipment from raw material to finished product including factories, tools, equipment, management, sales and advertising, follow here.

R800 NON-RADIO SUBJECTS.

The matter of patents in general; the mathematics and physics, including chemistry, geology and geography; meters of various kinds; all information not strictly pertaining to radio but correlated to this subject, will be found under this heading.

R900 MISCELLANEOUS MATERIAL.

A Key to Recent Radio Articles

audio frequency stages. Constructional and operating details, including photographs, are given. Special emphasis is placed on the layout and arrangement of parts in the set.

R344.5. ALTERNATING CURRENT SUPPLY. A, B, AND C ELIMINATOR.

Radio. Aug., 1926, pp. 17ff.
"A Complete Socket Power Receiver," G. M. Best.
An A, B, and C battery eliminator, constructed of standard parts and said to be hum-free, is shown. The theory of its operation, parts required for constructing, and practical operating data are presented, thus enabling the experimenter to build his own. A Browning-Drake receiver, described and illustrated, is used in connection with the "power plant."

R132. AMPLIFYING ACTION. AMPLIFYING ACTION.

Radio. Aug., 1926, pp. 24-26.
"How Much Amplification Do You Use?" R. B. Thorpe.
A simple mathematical discussion, accompanied by experimental data and drawings, is presented, relative to voltage amplification of audio frequencies in transformers, resistances, and impedances. The impedances of the various tubes, and their amplification constants in particular are compared in connection with the study of amplification in general.

Stop thief!

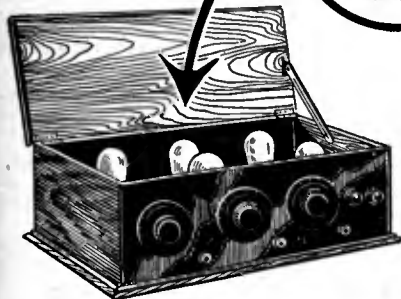
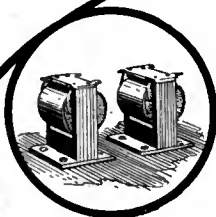

Ordinary amplification is the thief of Tone in radio music—

Your own radio set as it now stands is a perfect reproducing instrument—up to, and including the detector tube. As everyone knows, if you listened with a pair of ear phones to the music from the detector tube you would have perfect reproduction. If that same quality could only be made to come out of your loudspeaker in great volume, then you would have perfect radio enjoyment.

But it cannot—with ordinary amplification. Too much is blurred, too much is weak, too much is lost altogether.

How can we get this pure detector tone with great volume? Can it be had simply by changing the method of amplification? That depends.

Resistance coupled amplification is better, but many of the high notes are frayed and shattered, and the tone breaks down badly on strong volume.

Large size transformers are also better, but too many weak signals are absorbed. The actuality of the base, and the distinction between one musical instrument and another are lacking.

Impedance Coupling is unstable. It shares most of the faults of resistance coupling, and, like transformers, it absorbs the weak signals.

Electric-light-socket power amplifiers are also better, to be sure. But they operate after one of the music-distorting transformers already in the set.

The Truphonic Power Amplifier

An entirely new and different method of amplification has been developed by the eminent radio inventor, Mr. H. P. Donle, and is made by the Alden Manufacturing Company, well known for its Na-ald quality products. It is called the "Truphonic." Already manufacturers of the higher quality sets are endorsing it, and adapting it as the finest type of reproduction. The

Truphonic Power Amplifier is different from any other method of amplification. But what is most important, the results are different. No more need be said than that the Truphonic passes faithfully all notes of broadcast music.

The Truphonic is a small compact instrument (shown below), which when attached in a few minutes to any radio, brings through the loudspeaker with great volume the detector tube music in all of its perfect tonal quality.

What has just been said of the Truphonic can be said of no other method of amplification—regardless of the price you pay.

What Does This Mean to You?

For the price of \$20 and an extra tube (using two of the tubes now in your set and one additional tube, either power or regular) you attach the Truphonic in a few minutes to your present radio and at one stroke convert it into the finest reproducing set that money can buy. A strong statement. But you want strong statements when the product backs them up.

To-day! To-night! Attach the Truphonic Power Amplifier and get all that radio can give.

For the Set Builder

Truphonic amplification is provided in separate Truphonic couplers for the set builder. Three stages not only give the finest quality of reproduction obtainable but also give considerably more volume than two stages of ordinary transformer amplification. Price \$5.00 per stage.

The Truphonic Output Unit protects the speaker against burning out and demagnetization when power tubes are used. (This output is used of course in the complete Truphonic Power Amplifier described above.) Price \$5.00.

The Truphonic Catacomb Assembly is also of great convenience to set builders. A lacquered steel catacomb houses three Truphonic couplers and a Truphonic output unit. A special moulded socket panel with 6 or 7 sockets of special construction which hold either U V 201A or all UX tubes, covers this catacomb. This unit may be arranged in a thousand different ways to meet all the requirements of every circuit and set design. Short direct leads to connected apparatus, with a minimum of soldered connections. No holes to drill, no apparatus to mount. A six-foot battery cable is included. Price 6 tube \$20, 7 tube 22.



ALDEN MANUFACTURING CO.
Dept. B19 Springfield, Mass.

TRUPHONIC Power Amplifier

\$20





The Amplion Patrician encloses a remarkable 48" air column, in a graceful, richly carved mahogany cabinet, 18"x 12"x 9". Acoustically it is non-directional, with a new, softly diffused mellowness of tone that makes this instrument the choice of the connoisseur, wherever heard. AA 18.....\$45.00

The new Amplion Patrician reproduces the very soul of music

—exceptionally rich in those delicate overtones that give to music its temperament, its true character, its tonal color, its sensitive appeal to the spirit.



AMPLION CONE

Artistically, this new Amplion Cabinet Cone graces the most exquisitely appointed room: of two-tone mahogany, 14"x14"x9". Acoustically, it is a time perfected Amplion development.

AC12.....\$30



AMPLION DRAGON

This model is the best known of all the famous "Dragon" type of Amplions, adopted as standard by leading radio engineers wherever broadcasting exists. Notable for acute sensitivity and amazing volume.

AR19.....\$42.50

Other Dragon models from \$12 up

YOU may own the most expensive radio receiving set. You may tune in on the best radio concerts. Yet, if your reproducer is not delicately and accurately constructed, you will lose most of the *fine overtones* that create the true beauty—the very soul—of music.

Since 1887, engineering experts of "The House of Graham"—the creators of Amplions—have been achieving constant improvement in sound-reproducing devices. As the result of this long experience, it is not extraordinary that the Amplion instruments will reproduce more of music's *fine overtones*, and a wider musical range, than other reproducers are able to do.

Write for the interesting "1927-Amplion" Booklet

THE AMPLION CORPORATION OF AMERICA
Suite 2, 280 Madison Avenue, New York City

The Amplion Corporation of Canada Ltd., Toronto

"The House of Graham"—Alfred Graham & Company of London, England—is known throughout the world through its associated companies.



R141.1. RADIO FREQUENCY CIRCUITS. RADIO FREQUENCY RADIO BROADCAST. CIRCUITS.

Sept., 1926, pp. 377-379. "Higher Efficiencies for Radio Frequency Circuits," Part 1. Zeh Bouck.

A system of maintaining the highest efficiency at all frequencies covered by a tuned radio frequency circuit is described. One control governs the capacity variation and the magnetic coupling of a coil attached to the condenser shaft. The system is called the King "Equamatic" system. Details of the circuit, and the arrangement of coils and condensers, are shown.

R134.7. HETERODYNE ACTION. SUPER-HETERODYNE PRINCIPLES.

RADIO BROADCAST. Sept., 1926, pp. 380-383. "How to Get the Most Out of Your Super-Heterodyne." K. Clough.

The component parts of the ordinary super-heterodyne circuit are taken up in detail for the benefit of the homebuilder and experimenter. First, the collector (loop or antenna and coupling coil); second, the first detector; third, the local oscillator; fourth, the intermediate-frequency amplifier; fifth, the second detector; and sixth, the audio amplifier. Upon the principles discussed depend the proper construction and operation of the circuit.

R343. ELECTRON-TUBE RECEIVING SETS. RECEIVER, RADIO BROADCAST. Sept., 1926, pp. 384-387. Short-Wave. "How to Build and Operate the Jones Receiver," F. C. Jones.

Through a short-wave receiver contest, RADIO BROADCAST attempted to find a non-radiating high frequency circuit. In the receiver described, which won first prize, the principle of the Wheatstone Bridge is used in preventing all but a minimum of energy from reaching the antenna. The author discusses the details of construction, assembly, and testing of this receiver.

R385.5. MICROPHONE. MICROPHONE RADIO BROADCAST. Sept., 1926, pp. 394-397. PLACEMENT. "The Importance of Acoustics in Broadcasting," B. F. Messner.

The distortion obtained in radio reception is generally grouped into two classes: First, that due to an overall frequency characteristic of the system which is not flat. That is, the ratio of reproduced intensity to original intensity of sounds is not the same for all frequencies.

Second, that due to an overall amplitude characteristic of the system which is not rectilinear. That is, the ratio of reproduced intensity to original intensity of all sounds is not the same for all intensities.

A third type of distortion, due to directional characteristics of sound receivers and transmitters, also exists. These directional effects vary with frequency, says the writer. Since the microphone should pick up all frequencies without discrimination, it becomes essential that it be placed properly in the studio.

R343. ELECTRON-TUBE RECEIVING SETS. RECEIVER, RADIO BROADCAST. Sept., 1926, pp. 398-404. Browning-Drake. "The R. B. Impedance-Coupled Browning-Drake," J. B. Brennan.

An impedance-coupled Browning-Drake receiver is described. Layouts of panels, a list of parts, and the method of assembly and operation, are given. In this particular arrangement, the author controls the volume of the energy output by the filament current variation in the radio frequency stages.

R342.15. AMPLIFIER TRANSFORMERS. AMPLIFIERS, RADIO BROADCAST. Sept., 1926, pp. 409-412. Audio. "Transformer-Coupled Audio Amplifiers," A. W. Saunders.

An outline is given of the fundamental considerations involved in the design of a specific type of audio amplifier, in which is also shown some of the desirable amplifier characteristics which may be obtained in practice. The difference between an ideal and a real transformer is discussed. In practice, it is impossible to meet all requirements of an ideal transformer, as is shown by results obtained from many types of transformers. Many graphs are presented and explained, data showing how they were obtained being included.

R142.3 INDUCTIVE COUPLING. COUPLING Popular Radio. Aug., 1926, pp. 315 ff. CHART. "A Measurement Chart," R. J. Hoffman.

A chart for calculating the coupling factor for co-axial concentric coils, is shown. Information on how to determine both the coupling factor and the mutual inductance of certain coils is given.

R213. HARMONIC METHOD OF DETERMINING HARMONIC FREQUENCY. FREQUENCY Popular Radio. Aug., 1926, pp. 316ff. DETERMINATION. "A New Method of Using Harmonics for Determining Frequencies," M. L. Strock.

With the aid of a quartz crystal and a vacuum-tube oscillator, a method of determining many accurate frequencies is described by the writer. Harmonic heterodyning enables the experimenter to calibrate a waveweter or to determine the frequency of other circuits. The set up of the apparatus, and its operation, is described.

R343. ELECTRON-TUBE RECEIVING SETS. RECEIVER, Popular Radio. Aug., 1926, pp. 328ff. Browning-Drake. "How to Build the Improved Browning-Drake Receiver," A. H. Lynch.

A Browning-Drake receiver, in which various changes in circuit design have been made, is described in detail. The original conception of Browning and Drake has been altered to include a resistance amplifier. Resistance coupling is used in the audio stages.

R376.3. LOUD SPEAKING REPRODUCERS. LOUD Popular Radio. Aug., 1926, pp. 336-337. SPEAKERS. "How to Pick Out a Loud Speaker," L. M. Cockaday.

The selection of a loud speaker for a radio receiver depends upon many factors, both in type of receiver and kind of horn and reproducer. In order to pick one that is satisfactory a method of hookup to various types of horns is suggested, which determines the choice by actual test.

A Supremely Fine Instrument

No. 78—\$270



"The Mayfair"

Amazing Selectivity—Delightful Tone—Exceptional Volume!

TWO new home delights! First the joy of a supremely fine bit of furniture craftsmanship—a rarely beautiful console to enhance the beauty of your home.

Second the all surpassing joy of true radio entertainment—all the programs of the air brought in with surprising fidelity and beauty of tone. Amazing selectivity that makes radio enjoyable.

The Trinum Circuit makes Oriole Receivers genuinely satisfying in performance. Built with the precision of a fine watch they bring at last to radio that genuine dependability which you have been hoping for. Ask your dealer to show you.



"The Canterbury"

No. 75—\$150

This pleasing console model will grace any home. The six-tube, two dial Oriole Receiver will bring new joy to Radio for you.



"The Warwick"

No. 71—\$125

A table model of exceptional grace and truly unusual power. Everything that radio can give, at a price in reach of all.



Sales Department
THE ZINKE CO.
1323 S. Michigan Ave.
Chicago, Ill.

Manufactured by
W-K ELECTRIC CO.,
Kenosha, Wis.

ORIOLE
RADIO
RECEIVERS
with the Trinum
Circuit

ELECTRAD

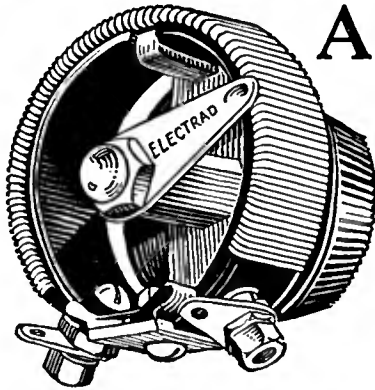

A Better Rheostat

Six Reasons Why

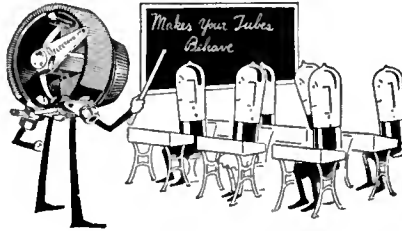

1. Resistance guaranteed within 5%.
2. Milled shaft with squared hole in contact arm insures rigidity—no wobble of shaft.
3. Extra long metallic bearings.
4. Highest grade Bakelite insulation, maximum radiation and mechanical strength.
5. Single hole or three-hole mounting. For three-hole mounting, base is tapped, eliminating needs of nuts behind panel.
6. Phosphor bronze spring contact arm insures contact.

In every respect a better rheostat—6, 10, 20, and 30 ohms. Price 85c., in Canada, \$1.25. Potentiometers—200 and 400 ohms. List 85c., in Canada, \$1.25.

ELECTRAD CERTIFIED JACKS

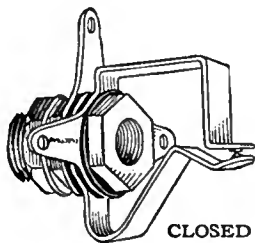

CLOSED

You have never seen the equal of the new Electrad Certified Single Circuit Jacks both open and closed. Requires less than 1" behind panel. Positive acting springs of phosphor bronze. Sterling silver contact points. Insulation of hard rubber. Tinned soldering lugs, so placed that good connections can easily be made. Any good radio store has these jacks or can easily get them for you. Certified and guaranteed electrically



OPEN

and mechanically. U. S. Prices, Open 25c., Closed 35c. Canada Prices, Open 35c., Closed 50c.

ELECTRAD CERTIFIED SWITCHES

—Hear Them Click

No doubt whether you are on or off when you equip your set with the Electrad Certified Switch. You hear it click. Requires less than 1" behind panel. Solid brass construction. Tinned soldering lugs placed to make easy connections. Neatly designed. Genuine Bakelite knob. Adds to the appearance of your set. Certified and guaranteed electrically and mechanically. Price U. S. 40c. Canada 60c.

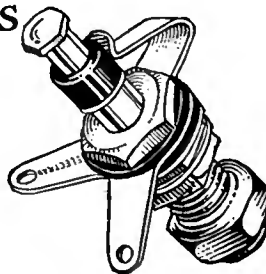

For perfect control of tone and volume use the Electrad 500,000 ohm compensator. For free hook-up write 428 Broadway, New York City.



ELECTRAD

R344.5. ALTERNATING CURRENT SUPPLY. POWER AMPLIFIER. *Radio*. Aug., 1926, pp. 27-28. W. E. 25-B. E. E. Griffin.

"Unfailing B Power From the W. E. Amplifier," The Western Electric type 25-B power amplifier is described for those who may want to own one and know its circuit and operating characteristics. According to the curve, the output voltage drops from a rate value of 350 volts, 2 milliamps. to 265 volts at 43 milliamps. output.

R384.3. FREQUENCY METERS. FREQUENCY METER. *Radio*. Aug., 1926, pp. 38ff. "A Vacuum-Tube Frequency Meter," G. M. Best.

Constructional details of a vacuum-tube frequency meter utilizing a plate current milliammeter as an indicator for resonance, are shown. Coils for the 1500, 7500, and 3750 kc. (20, 40, and 80 meter) band are used across a 0.00035-microfarad condenser. For increased amplification, a direct current amplifier circuit is shown. This makes the meter more sensitive.

R344.3. TRANSMITTING SETS. TRANSMITTER. *Radio*. Aug., 1926, pp. 39ff. "A Low-Powered Master Oscillator Transmitter," F. C. Jones, 6 AJF.

Amateur station 6AJF shows the circuit diagram and list of parts for the construction of a low-powered master oscillator transmitter. Front and rear views are sufficiently clear to show the complete layout.

R113.5. METEOROLOGICAL PHENOMENA. METEOROLOGY. *Radio News*. Aug., 1926, pp. 113 ff. "Radio Weather Good and Bad," E. Van Cleef.

Observations to determine whether any correlation exists between static and the passing high and low pressure areas, are recorded. When waves travel at right angles to the isobars, reception is reported clearest and strongest. When waves pass from one pressure area across another reception is weaker than when they are confined to a single area. Static is most frequent when the isobars are far apart—when waves travel across areas of little difference in air pressure.

When waves travel in a path parallel to the isobars, fading occurs. It is suggested that other stations cooperate in taking observations relative to the above mentioned data to determine the actual cause of static and its behavior.

R130. ELECTRON TUBES. ELECTRON TUBES. *Radio News*. Aug., 1926, pp. 120ff. "Vacuum Tubes and Their Uses," M. L. Muhleman.

The writer presents a non-technical discussion concerning vacuum tubes and then enumerates the characteristics of the new tubes which have recently appeared on the market. A chart showing all the constants of the various tubes, including voltage amplification factor and output resistance values, is of value.

R800. (347.7) PATENT PRACTICE. PATENTS. *Radio News*. Aug., 1926, pp. 124ff. "Making a Business of Inventions," L. T. Parker.

Advice is given concerning the fundamental laws pertaining to patents and patent practice. Questions such as: "What is patentable"; "What records should be kept"; "How to protect a patent," are answered for the benefit of the inexperienced inventor.

R582. TRANSMISSION OF PHOTOGRAPHS. PHOTOGRAPH TRANSMISSION. *Radio News*. Aug., 1926, pp. 126ff. "The Broadcasting of Pictures," Dr. W. Friedel.

The author's method of recording impressions received at the receiving end of a picture transmitting system, is described. It consists essentially of a cylindrical roller with a spiral edge instead of a stylus. This edge records on a continuous roll of paper, making a uniform and clear impression.

R342.15. AMPLIFIER TRANSFORMER. AMPLIFIER ACTION. *Radio News*. Aug., 1926, pp. 142-143. "More About Audio-Frequency Amplifiers," S. Harris.

This third discussion pertaining to audio-frequency amplifiers takes up the question of transformer performance in actual practice, considering the relation between the sound frequencies passing through the audio stages to the sounds we are accustomed to hearing in actual direct reproduction.

With a frequency limit at the low end of the scale of 50 cycles per second the decision is reached, after other sources of distortion are corrected, that a d:op of 5 per cent. in voltage ratio between the maximum and minimum frequency in a two-stage amplifier will produce less distortion than will ordinarily be detected by the human ear.

R391. CONDENSERS. CHEMICAL. *Radio News*. Aug., 1926, pp. 144-145. "Chemical Condensers of Large Capacity," C. J. Fitch.

Constructional and experimental data, relative to the use of aluminum for chemical condensers in A and B battery eliminators, are presented. Although the curves show considerable variation of capacity with formation voltage and kind of solution used, these condensers may be utilized in many ways in the experimental laboratory.

R113.1. FADING. FADING. *Radio News*. Aug., 1926, pp. 146. "Results of Cooperative Measurements of Radio Fading," Bureau of Standards.

A resumé of the findings of the past year and a half on the subject of fading of radio signals, is given. General conclusions arrived at are presented.

R550. BROADCASTING. BROADCASTING. *Radio Broadcast*. Sept., 1926, pp. 367-371. *Who Pays For*

"How Much It Costs to Broadcast," A. C. Lescarboura. The solution of the question "Who Pays for Broadcasting?" seems to solve itself through the broadcasting of so-called "Good-will Programs," as expressed by the author. To-day stations are being used as a medium through which various concerns place their name before the public by means of well chosen musical programs, and the public is satisfied. Chain station hookups make available good concerts for the entire continent. The cost of operating the higher class broadcasting stations, and the charges made to those interested in using the station, varies, as is evident from the tables shown.

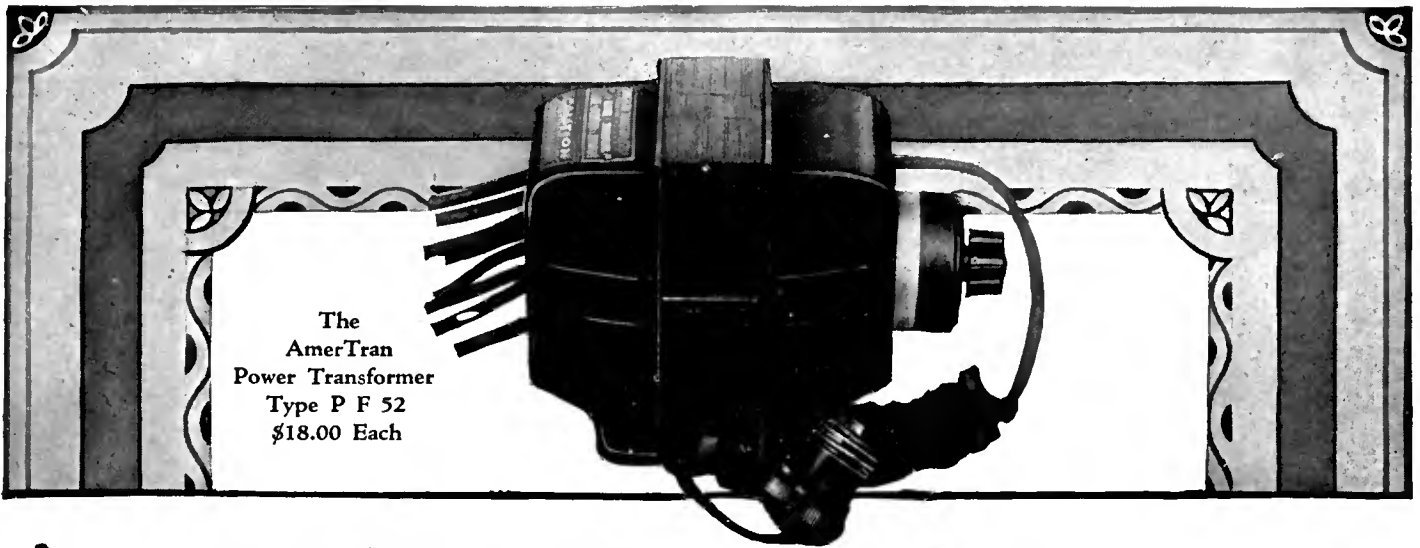

The
AmerTran
Power Transformer
Type P F 52
\$18.00 Each

AMERTRAN RADIO PRODUCTS

A Real Power Transformer

Perfected on the firm foundation of twenty-five years successful experience in transformer building, AmerTran Radio Products enjoy a reputation second to none in their respective fields. Their continued selection by leading engineers and experimenters gives ample proof of their high efficiency and dependable performance.

Of particular interest is the AmerTran Power Transformer Type P F. 52—the transformer for real “honest-to-goodness” power supply. This transformer is intended for use on the standard 110 volt, 60 cycle house-lighting circuit, and can be depended on to give and maintain satisfaction.

It has three separate windings—one for 525 volts and two 8 volt windings for the filament of the Rectifier and power tubes. The windings are enclosed in a strong metal case, provided with mounting feet. There are three primary taps for 110, 118 and 125 volts, connected to a three point snap switch, and a six-foot lamp cord and plug attached to the primary is standard equipment. The shipping weight is approximately 9 pounds and the price is \$18.00 each.

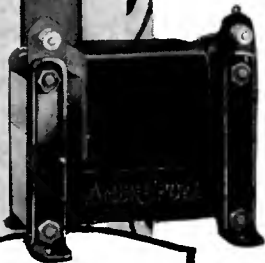

The AmerChoke
Type 854

This is a scientifically designed impedance or choke coil of general utility, designed primarily for use in filter circuits. As an output impedance for by-passing direct current from the loud-speaker it is both efficient and economical.

Price \$6.00 Each

AMERICAN TRANSFORMER COMPANY
178 Emmet Street Newark, N. J.
“Transformer builders for over twenty-five years”

AmerTran Products are Sold only at Authorized
AmerTran Dealers ★

Other AmerTran Products:

- AmerTran Resistor Type 400 \$7.50
- AmerTran Heater Transformer Type H-28 (for A. C. Tubes) \$10.00.

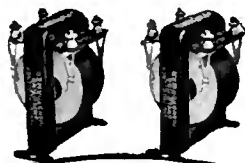

We shall be very glad to send you upon request a copy of our booklet “Improving the Audio Amplifier” together with other interesting and constructional data.



The AmerTran
DeLuxe
Audio Transformer

This new transformer sets an entirely new standard of Audio Amplification. It makes possible a transformer coupled amplifier that excels all other forms of amplifiers. Made in two types for first and second stages—

Price \$10.00 Each

AmerTran Types AF-7 and AF-6

AmerTran Audio Transformers, types AF-7 and AF-6, have been considered for years among the leaders in audio amplification. These popular and efficient models are made in two types—AF-7 (ratio 3½:1)—AF-6 (ratio 5:1)

\$5.00 Each

Buy by the Name

Success in Set Building Begins at the Dealer's Counter

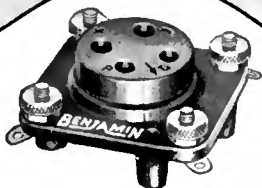

Cle-Ra-Tone
Spring Supported—Shock
Absorbing Sockets
Stop tube noises. Greatest
aid to non-noisy operation.
Contacts always clean.
75 cents each

ALL BENJAMIN RADIO PRODUCTS ARE OF THE SAME HIGH STANDARD AS THE FAR-FAMED CLE-RA-TONE SOCKETS

When you buy your radio parts, buy them right. Everything else being equal, when a name has stood for a quarter of a century's striving toward technical perfection it is practically as safe as a formula as a guide to right buying. When your dealer sells you Benjamin radio products for your set you have already leaped a big hurdle on the way to success.



"Lekeless"

Transformers

Uniform high inductance, low distributed capacity and low resistance. The external field is so slight that it permits placing coils close together without appreciable interaction.

Single Transformers, \$2.50



Brackets

An aid to simplification in set construction. Supports subpanel, with room underneath for accessories and wiring. Plain and adjustable.

Plain, 70 cents per pair
Adjustable, \$1.25 per pair



Battery Switch

Quick, positive, clean-cut make and break. When it's "in" it's "off," eliminating danger of wasteful use of battery.

30 cents each

If your dealer cannot furnish you with Benjamin Radio Products send amount direct to our nearest sales office with his name and we will see that you are promptly supplied

Improved Tuned Radio Frequency Transformers

Proved through exhaustive and comparative tests to be the most efficient coil for modern radio sets. Better in all important features and characteristics. Space wound. Basket weave. Cylindrical. Highest practical air dielectric. Gives wonderful sharpness in tuning, better volume and purer tone quality.



2 1/4" Diameter Transformer

Compact. Especially desirable for crowded assembly. Eliminates interfering "pickup."

Set of three, \$5.75 Single Transformer, \$2.10

3" Diameter Transformer

Capacity coupling reduced to lowest degree. For use with .00035 Mfd. Condensers.

Set of three, \$6.00 Single Transformer, \$2.25

Straight Line Frequency Condensers

No crowding of stations. The broadcast range is spread evenly over the dial. Stations come in without interference, and tuning is much easier. Adjustable turning tension. Low loss characteristics give a definite and distinct radio reception. Beautiful in appearance—a credit to the looks and efficiency of any set. Finished in dull silver. Made in three sizes:

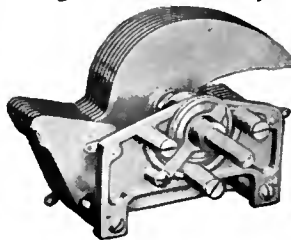

.00025 Mfd. \$5.00

.00035 Mfd. \$5.25 .0005 Mfd. \$5.50

REWARDS FOR RADIO REASONERS

Awards for novel and original hookups, modifications of existing circuits; trade names; slogans. Write our nearest office for full details.

Benjamin Electric Mfg. Co.

New York
247 W. 17th Street

120-128 South Sangamon Street
Chicago

San Francisco
448 Bryant Street

Manufactured in Canada by the Benjamin Electric Mfg. Co. of Canada, Ltd., Toronto, Ontario

R113.6. REFLECTION OF RADIO WAVES. REFLECTION
Popular Radio. Aug., 1926, pp. 319ff. PHENOMENA.
"Does the Human Body Reflect Radio Waves?" Major
J. O. Mauborgne.
The experiments conducted by the writer on frequencies above 3000 kc. (below 100 meters) have netted phenomena hitherto unexplained. The peculiar behavior of the oscillator on waves above 60,000 (below 5 meters), when standing at definite distances from the oscillating antenna, is related in detail, the accompanying photographs showing how the apparatus was set up and how measurements were made.

R800. (537.65) PIEZO-ELECTRIC PHENOMENA. PIEZO-
Proc. I. R. E. Aug., 1926, pp. 447-469. ELECTRIC
"Uses and Possibilities of Piezo-Electric OSCILLATORS.
Oscillators," A. Hund.

The author sums up the contents of his discussion on the piezo-electric effects of quartz as follows: (1.) Experiments with quartz plates have shown that they can be used in an electron-tube circuit for producing radio frequency currents of fixed frequencies bearing a definite relation to the dimensions of the plate. (2.) The piezo-electric oscillator can be used together with an auxiliary generator for standardizing a frequency meter. (3.) As single piezo-electric plate can be employed as a standard for the entire range of frequencies used in radio communication. (4.) By using special arrangements, a small plate can be employed for producing audio frequency currents. (5.) Methods are given for grinding a plate accurately to a given frequency. (6.) Formulas are given for designing plates to a desired frequency to a fair degree of accuracy. (7.) Other miscellaneous applications are described.

R800. (347.7) PATENT PRACTICE. PATENT
Proc. I. R. E. Aug., 1926, pp. 471-477. SAFEGUARDS.
"Safeguards For the Radio Inventor," E. N. Curtis.
Precautions for the radio inventor who is not associated with an organization which includes a patent department, together with explanation why such precautions are necessary, are outlined by the author.

R610. EQUIPMENT; STATION DESCRIPTION. STATION,
Proc. I. R. E. Aug., 1926, pp. 479-506. *KDKA*.
"KDKA," G. Little and R. L. Davis.

In this paper are supplemented several of the previous descriptions of station *KDKA*. The purpose of the paper, as stated, is to bring the history up to date by describing the equipment now in use, both for regular broadcasting and for short-wave international broadcasting, and relay work. The short-wave transmitter, employed for inter-works telegraph service, is also described. The article is well illustrated.

R270. SIGNAL INTENSITY. FIELD-STRENGTH
Proc. I. R. E. Aug., 1926, pp. 507-519. MEASUREMENTS.
"A Radio Field-Strength Measuring System for Frequencies up to Forty Megacycles," H. T. Friis and E. Bruce.

The paper describes field strength measurement sets for frequencies as high as forty megacycles. The apparatus is a double-detection receiving set which is equipped with a calibrated intermediate-frequency attenuator and a local signal comparison oscillator. The local signal is measured by means of the intermediate-frequency detector, which is calibrated as a tube voltmeter.

R800. (621.313.7) RECTIFIERS. MERCURY-ARC
QST. Aug., 1926, pp. 8-11. RECTIFIERS.
"Mercury-Arc Rectifiers," A. B. Goodall.

Three circuit diagrams are shown in which the mercury-arc rectifier is used in supplying the necessary high-voltage B battery supply. To prevent the rectifier from going out during short periods of inactivity, either a lamp or some other device is used to keep a hot spot on the mercury surface. The capacity of the tube is said to be over 6000 volts, and it supplies a rectified current which produces no interference.

R384.1. WAVEMETERS. WAVEMETER.
QST. Aug., 1926, pp. 15-17. *Short-wave*.
"A Shielded Wavemeter for Your Station," F. H. Schnell.

Two shielded wavemeters for short-wave calibration purposes, are described. One of the wavemeters uses a five-plate Karas Orthometric condenser, the other a tapered plate type 167-E Cardwell condenser. Coil data and graphs give the builder all necessary information to construct the instruments.

R344.5. ALTERNATING CURRENT SUPPLY. ELIMINATORS.
QST. Aug., 1926, pp. 25-29. *A Battery*.
"Operating Receiving Filaments Without Batteries,"
R. S. Kruse.

Several methods are proposed and discussed concerning the elimination of the present A batteries and using substitutes of some sort or other. The "Rectrad," an A battery line supply device, makes use of two rectifier tubes, a transformer, chokes, and 54 microfarads of capacity before the output enters the filaments of the tubes. The Davy A-substitute is similar in principle, but does not use condensers in the filter circuit. Circuits of both eliminators are shown.

R127. ANTENNA CONSTANTS. ANTENNA
QST. Aug., 1926, pp. 30-32. CONSTANTS.
"Straightening Out the Antenna," B. J. Melton.

The article is presented with the intention of straightening out our ideas on radiating systems in general, to show why a grounded antenna can only be operated on a so-called "odd harmonic," to suggest that a simple radiating system is probably the best, and to show how to get the juice into the antenna in such a way that the antenna will be given a chance to radiate it most efficiently. Concerning the latter point, the writer discusses various types of antennas and the current and voltage feed systems which may be used.

R344.3. TRANSMITTING SETS. TRANSMITTERS.
QST. Aug., 1926, pp. 33-35. *Short-Wave*.
"A 20-40-80-Meter Crystal-Controlled Transmitter,"
L. B. Root.

A description of a crystal controlled low-powered transmitting set, operating on 15,000, 7500, and 3750 kc. (20-, 40-, and 80-meter band), including complete wiring diagram, parts needed, and the method of operating, is given.



This Clean, Silent "A" Power Unit will never fail you

Use it as a trickle-charger while set is in operation or by merely throwing the switch, use it to fully recharge its built-in battery.

No dirt, no fuss, absolutely silent operation at lowest cost. Only the finest materials are used, including the handsome molded glass "A" battery shown below.

All assembled in a beautiful aluminum cabinet of simple, compact design.

Like the rest of the Universal line of batteries, this unit is designed by leading radio engineers for its special purpose and they have seen to it that only the most suitable materials are employed.

Yet the price of the "A" Power Unit, ready to use, is very reasonable.

Send for full description of this and other "A" and "B" Radio Power Units. We'll also send you a copy of our "Battery Guide" that tells you all about the care and use of batteries for any purpose. Write today. No obligation.

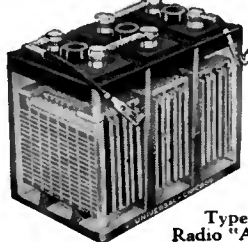

Type GCR
Radio "A" Battery

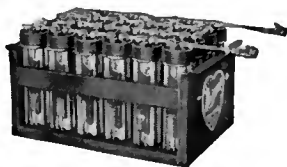

48-Volt
Radio "B" Battery

UNIVERSAL BATTERY COMPANY
3449 South LaSalle Street • Chicago, Illinois

Batteries for every Purse and Purpose
AUTOMOBILE - RADIO - FARM LIGHT
Parts for all makes of Batteries
SHOP EQUIPMENT

★
UNIVERSAL BATTERIES

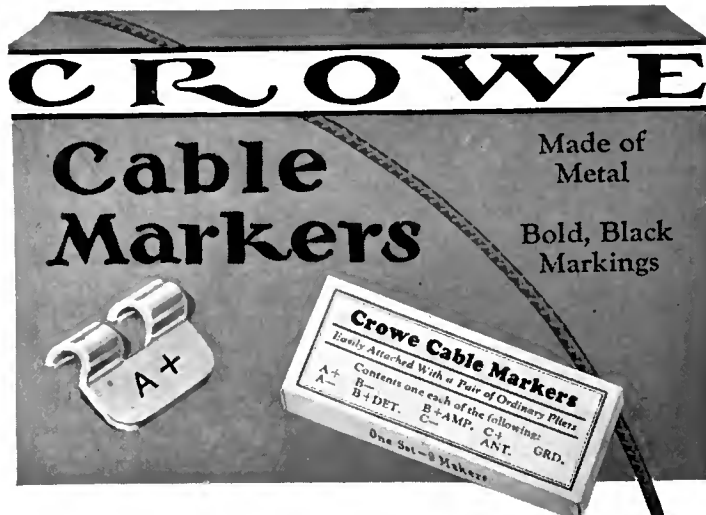

Insure Your Tubes

with these handy metal markers, which identify each cable and prevent costly mistakes.

Crowe markers are durable—will not rub or wear off. Markings permanently etched in bold, black characters, easily read.

Leading dealers carry them.

Crowe
Name Plate & Mfg. Co.
1749 Grace St. Chicago

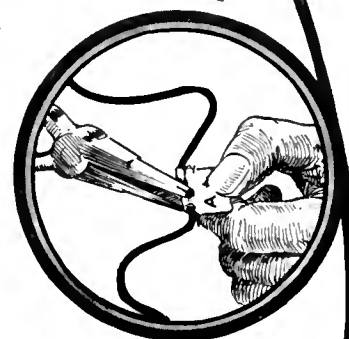

Easily attached with a pair of ordinary pliers

25c
the package

At Your Dealer's

Look for this Display Carton!

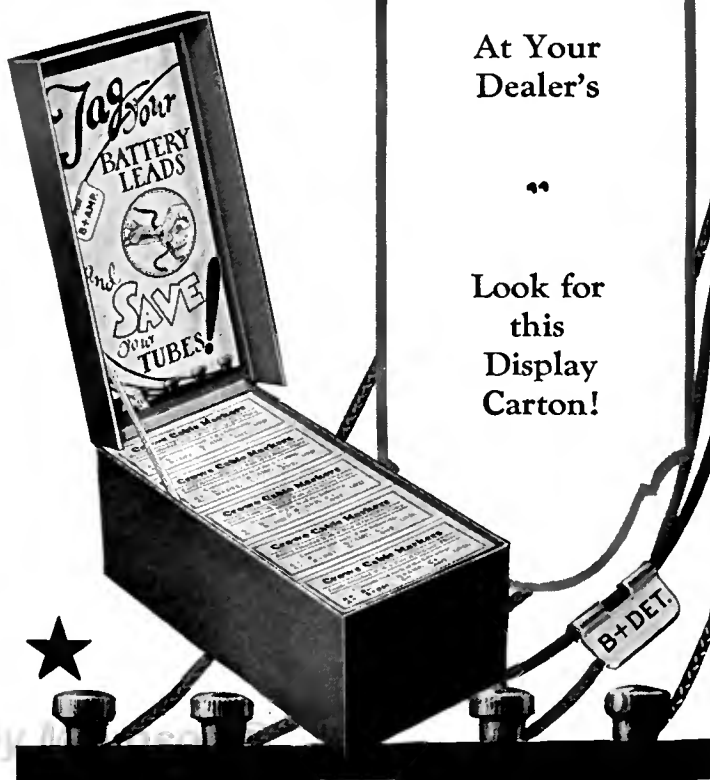

Bradleyohm-E

PERFECT VARIABLE RESISTOR



Endorsed by
PHILCO

PHILADELPHIA, ST. LOUIS, KANSAS CITY, CHICAGO
PHILCO
BATTERIES
THE PHILCO ELECTRIC COMPANY
PHILADELPHIA, PA.
July 14, 1926.

ALLEN-BRADLEY CO.,
Milwaukee, Wisconsin.

The Bradleyohms which we are using
in Philco "B" and "AB" Socket Powers for
voltage adjustment are very satisfactory.

We have tested many variable resistors
but have found no other unit equal to yours.

We shall continue to use Bradleyohms in
Philco Socket Powers during the coming
season.

Yours very truly,
Walter E. Holland
Research Engineer.



The leading manufacturers of B-eliminators are using Bradleyohm-E for voltage control. The number of Bradleyohms in each B-eliminator varies from one to three depending upon the type of eliminator. In all cases, the Bradleyohm-E is the choice of the experienced radio engineer.

EVER since radio broadcasting began, Allen-Bradley Radio Devices have met the demand for silent, stepless current control. Today, Bradleyohm-E, perfect variable resistor, is not only adopted as standard equipment by manufacturers of B-eliminators, but is recommended almost universally by radio engineers and writers as the ideal variable resistor for B-eliminator kits.



For a fixed resistance unit, Bradleyunit-A offers unusual advantages. It is a solid, molded resistor with silver-plated terminal caps that can be soldered without injuring the resistor. Since the Bradleyunit A contains no glass in its construction and does not depend upon hermetic sealing for accuracy, it is unaffected by temperature, moisture or age.

The scientifically-treated graphite discs used in the Bradleyohm-E provide the only means of stepless, noiseless control which does not deteriorate with age. Carbon or metallic powders of various kinds have been used as substitutes by imitators of the Bradleyohm-E, but without permanent success. If you want a variable resistance unit for your B-eliminator which will give perfect service, be sure to ask your dealer for the Bradleyohm-E which is furnished in several ratings. Look for the Bradleyohm-E in the distinctive Allen-Bradley checkered carton.

Bradleyunit-A and Bradleyohm-E can be obtained from your radio dealer in several ratings. Insist on Allen-Bradley Radio Devices for lasting satisfaction.



ALLEN-BRADLEY CO.

MILWAUKEE



278 Greenfield Avenue

WISCONSIN

BOOK REVIEW

An Announcer's Autobiography

YOU'RE ON THE AIR: By *Graham McNamee*.
Published by Harper and Brothers, New York.
210 pages, 40 illustrations. Price \$1.75.

TO SUCCEED (in broadcasting)," says Graham McNamee in his book, *You're On The Air*, recently published by Harper and Brothers, "one must not only possess some artistic skill but also that indispensable quality called personality." It is just that quality that has made McNamee himself succeed to such an extent that he has become the "most popular radio announcer" of many listeners-in. And it is that same quality that will make *You're On The Air* a popular book with the same listeners-in, for, regardless of whether or not it was written by McNamee or by Robert Gordon Anderson, whose name appears on the title page as collaborator, it is an expression of McNamee's personality. If Anderson did the writing, he deserves credit for having done a good piece of reporting.

If you know this genial announcer, nothing more need be said about personality; if you don't, tune-in your set on WEAf some evening and listen for "Good evening ladies and gentlemen of the radio audience." That's McNamee. He may be broadcasting a concert, a fight or a political meeting. There is no limit to his activities and he seems to do everything well (though we may parenthetically remark that personally we prefer his sporting stuff to all the rest). After you have listened to him announcing for an evening or two, read his book and get "the inside story of how he does it," as the tabloids would say.

You're On The Air is written in the first person and starts off with a little of the author's history. It seems that McNamee started out on a musical career, the training for which began early in his life. But he says that in those days he was more interested in the world of sport than in the world of music, and he took an active part in sports. "That experience later proved of help," he says, "for not only did it build up my body, but it has enabled me to report more intelligently the big outdoor sport events." When he was eighteen he came to New York to pursue his musical career, which he did most successfully. It was while here that he drifted into radio work quite by chance, having wandered into WEAf's studio simply out of curiosity to see what a studio was like. When he wandered out it was with his first job as announcer in his pocket.

Sprinkled in with the tale of his personal experiences, McNamee has given many interesting bits of information. He explains how programs are arranged; what happens when an artist is late or doesn't get to the studio at all; how much is charged for time on the air; and what happens when there is trouble on the line. He also tells countless anecdotes about well-known artists who have performed before the microphone. Everyone, the great as well as the small, is nervous the first time he broadcasts.

The book is entertainingly written. Our one objection to it is that it is a little too personal; there are too many anecdotes involving the announcer, too many questions from letters to the studio, too many illustrations reproducing autographed photographs sent to McNamee by the artists that have broadcasted from WEAf; and too little of the cold, hard facts behind broadcasting. But it is McNamee announcing and if you like him you will enjoy *You're On The Air*. Incidentally it's the first good book on broadcasting to be published.

Here's the Answer



THE "I Want To Know" Booklet issued by HOMMEL is now ready for distribution to every radio dealer who wants to put his customers on a familiar footing with every day radio problems.

It's the alpha and omega of useful radio information—the question and answer of many common radio queries—a booklet that every radio customer will be pleased to get.

Every dealer will profit by their distribution, because these booklets contain not only interesting information that customers want, but also will incidentally serve to stimulate every dealer's radio sales.

Write to-day—the supply is limited.

WHOLESALE

EXCLUSIVELY

LUDWIG HOMMEL & CO

929 PENN AVENUE



PITTSBURGH, PA.

For All Popular Makes and Circuits of radio receiving sets

A Constant Plate Voltage Supply Unit with Power Amplification operates on 110 volt (60 cycle) Alternating Current



Provides voltages of 45, 90, 130 for the receiver and also supplies 180 volts for the UX 171 power tube of the Amplifier.

Uses UX-213 Rectron rectifier tube and UX-171 tube in Power Amplifier.

Price, \$ **68.**
(without tubes)

The

GENERAL RADIO ★

Power Amplifier and Plate Supply

Ask your dealer to give you a demonstration, or write for our booklet containing complete information
GENERAL RADIO CO.

Digitized by Microsoft® CAMBRIDGE, MASS., U. S. A.

Radio Time is Here!



Don't Wait!

**Put up your
Beldenamel Aerial
—this week!**

DO you know that a clean, bright aerial wire gets louder volume and longer distance than a corroded, soot-covered aerial? The corroded, tarnished surface of a bare copper aerial wire interferes very seriously with the flow of radio frequency currents from the antenna to the set. That is why the shiny, smooth wires of a Beldenamel Aerial are protected with baked enamel.



If you install a Beldenamel Aerial, now, you will be through with aerial troubles for years to come. Smoke, fumes, and weather cannot affect the Beldenamel coating on a Beldenamel Aerial. That is why so many old, bare copper aeriels are being replaced with Beldenamel Aeriels.



The Belden Supradia Antenna Kit contains a Beldenamel Aerial and other high grade aerial and ground parts.

Ask your nearest dealer to show you a Beldenamel Aerial. It is sold in a distinctive striped black-and-orange carton that protects you against substitutes.

BELDEN MANUFACTURING COMPANY
2312A South Western Avenue Chicago, Illinois

THE "RADIO BROADCAST" INFORMATION SERVICE

How to Write for Technical Information—The Scope of This Service

AS WAS announced in the June RADIO BROADCAST, all questions which were formerly sent to "The Grid" will now be handled by the Technical Information Service, RADIO BROADCAST Laboratory. That service is maintained under the following rules:

1. All questions from subscribers to RADIO BROADCAST will be answered free of charge.
2. Non-subscribers to RADIO BROADCAST will be charged a fee of One Dollar for the Laboratory Technical Service.
3. All questions will be answered by mail and none will be published in RADIO BROADCAST.

The Technical Information Service of the Laboratory feels that it is important to define the scope of its service to readers. Although the Service is of very general help to our readers, there are certain demands which can not be met.

The Technical Information Service:

1. Cannot make comparisons between various kinds of receivers or manufactured apparatus.
2. Wiring diagrams of manufactured receivers cannot be supplied. This information can be secured from the various manufacturers.
3. Complete information cannot be given about sets described in other publications, but in all cases (wherever possible), inquirers will be referred to a source of information where the data can be obtained. In this connection, the monthly department in RADIO BROADCAST "The Best in Current Radio Publications" should be of great help, and should be consulted. That department records the most important constructional, technical, and general radio articles which appear.
4. Special receivers or circuits cannot be designed by the Technical Service.
5. Those who ask questions which cannot be answered in the scope of a letter will be referred, if possible, to sources where the information can be obtained.

In response to many requests, lists of the various groups of apparatus tested and approved by RADIO BROADCAST Laboratory will be mailed to all inquirers without charge.

TECHNICAL INFORMATION INQUIRY BLANK

Technical Service,
RADIO BROADCAST Laboratory,
Garden City, New York

GENTLEMEN:

Please give me fullest information on the attached questions. I enclose a stamped addressed envelope.

I am a subscriber to RADIO BROADCAST, and therefore will receive this information free of charge.

I am not a subscriber and enclose \$1 to cover cost of the answer.

Name.....

Address.....

The "Now I Have Found. . ." Award

SPACE limitations, this month, require that the "Now I Have Found. . ." Department be temporarily omitted. The quarterly award, which is due this month, goes to Mr. H. E. Carlson, of East Saugus, Massachusetts, whose combined rheostat and voltmeter switch was described in the August RADIO BROADCAST.

**Sole Service
Representatives of
Radio Broadcast**

AFTER an inspection of our facilities, and a thorough investigation of our capabilities, the Editors of Radio Broadcast have appointed us their sole service representatives.

We are prepared to undertake an inspection and test of Receiving Sets constructed according to information published in this magazine.

If you have attempted to build a Receiver described in this magazine and have been unable to obtain the expected results, why not pack it carefully and ship it to us? Write us for more detailed information.

Our business is both to install radio sets properly and to inspect those already installed and assist in making them 100% efficient. Why not let us examine your set? We make a charge; but it is very reasonable.

Telephone REctor 2538

**Rossiter,
Tyler & McDonell, Inc.**
Consulting Radio Engineers
136 Liberty St., New York

R T M RADIO SERVICE

Hook-up to
Controlit
for a Merry Christmas



The Heart of the Power Plant

Any radio devotee will be glad to get a Brach Controlit on Christmas. It is new—it is different—it is something that will add enormously to the enjoyment of radio.

Adding a Controlit to any set eliminates all switches from "B" Battery Substitute and Trickle Charger and places complete, automatic control of set and power supply in one switch—the set switch itself.

and protect your Set with the Famous

BRACH Lightning Arrester



No aerial should be without the protection to radio and home which a Brach Lightning Arrester affords. Good sense demands this protection. The authorities require it. Every Brach Arrester carries with it a \$100 insurance guarantee.



Prices as low as \$1

**The New Brach
TOTEM-POLE
ANTENNA**

Here is an aerial antenna that gives most complete reception and unusual clarity to radio. It is the size of a small flag pole, can be readily attached to roof or side or window ledge of house and does away with all unsightly makeshifts.

Totem-Pole Antenna with 100 feet wound wire and fasteners, complete for

Only \$10

**Drip-Proof
HYDROMETER**

To the Hydrometer with the famous Chaslyn Balls is combined the Drip-proof feature which insures full protection against battery acid falling on and injuring parquet floors, rugs or clothing.

After testing battery, the Hydrometer can be washed without danger from dripping acid.

Something nice to present to a radio fan or to buy for your own use.

Price \$1



Brach ★
Radio Products



Volume
With
Clarity

DOUBLE ENJOYMENT
From Any Set With

★ **Burns**

LOUD SPEAKER

Why sacrifice the excellent reproducing qualities of a set by the use of an inferior speaker. With a BURNS it is possible to reproduce with amazing exactness every note of music and inflection of voice that the set can pick up. A trial will convince.

AT YOUR DEALER'S OR WRITE DIRECT

American Electric
COMPANY

State and 64th Sts. Chicago, U. S. A.

Ask About BURNS B-Eliminator

Digitized by L. S. BRACH MFG. CO., Newark, N. J.
L. S. Brach of Canada, Ltd., Toronto, Canada

Metallized!

A glass wire is spun and passed through a chemical, high-temperature process, forming a thin conducting layer of high resistance. Impervious to atmospheric conditions.



Ruggedness!

DURHAM Metallized RESISTORS



Durham Resistor Mounting

Made of moulded insulation of exceptionally high resistance. Has best quality, tension-spring, bronze contacts. The only upright mounting made. Occupies but little space in set.

Single mounting.... 50c.
For condenser..... 65c.

THE maintenance of proper resistance in the grid-resistor is vital to efficient, noiseless reception. Heat, cold, dampness—these are the trouble-makers.

Sturdy as the evergreens of the mountain slopes, the Durham Metallized Resistor is built like them to endure the stress of changing atmospheric conditions.

500 ohms to 10,000 ohms	\$1.00
Above 10,000 ohms to .24 meg.75
.25 meg. to 10 meg.50

DURHAM METALLIZED RESISTORS

International Resistance Co.

Dept. D, Perry Building

Philadelphia, Pa.



Why not subscribe to *Radio Broadcast*? By the year only \$4.00; or two years, \$6.00, saving \$2.40. Send direct to Doubleday, Page & Company, Garden City, New York.

BAKELITE for Radio Parts



The use of Bakelite parts in the set you buy or build, will insure you against inferior reception through defective insulation. Write for booklet 29.



BAKELITE CORPORATION

247 Park Ave., New York, N. Y. Chicago Office: 636 W. 22nd St.
BAKELITE CORP. OF CANADA, LTD., 163 Dufferin Street, Toronto, Ontario, Canada

Weather Forecast Transmissions by Radio

THE following stations in the Illinois section send out regular weather forecasts and reports by radio. With the exception of NAJ and WGO, all reports are in telephony. Amateurs who receive any of these transmissions are requested to write to the Weather Bureau Office, Springfield, Illinois, and report on the quality and service, and say how distinctly the stations are received.

- NAJ, Great Lakes . . . 2270 meters—132 kc.
9.45 A. M. Morning Lake Forecasts.
4.00 P. M. Storm Warnings.
10.00 P. M. Evening Lake Forecasts.
- WGO, Chicago . . . 890 meters—337 kc.
11.00 A. M. and 4.00 P. M. Morning Local and Lake Forecasts.
9.00 P. M. Evening Local and Lake Forecasts.
- WLS, Chicago . . . 344.6 meters—870 kc.
9.00 A. M. Morning Forecasts, Special Warnings
1.00 P. M. Repeated.
Corn and Wheat Region Summary Wednesday.
1.00 P. M. Aviation Forecasts Repeated. Except Sunday.
- KYW, Chicago . . . 536.4 meters—559 kc.
10.00 A. M. Except Sunday†—Morning Forecasts.
4.15 P. M. †Special Warnings.
11.00 P. M. †Except Sunday and Monday—Evening Forecasts.
- WAAF, Chicago . . . 278 meters—1080 kc.
10.30 A. M. Morning Forecasts; Weather-Crop Summaries Wednesday During Crop Season.
12.30 P. M. Repeated. Saturday Gives Weekly Forecast. Except Sunday and Important Holidays.
- WHT, Chicago . . . 400 meters—1260 kc.
12.05 P. M. †Morning Forecasts; Corn and Wheat Region Summary Wednesday.
11.00 P. M. Evening Forecasts. Except Sunday and Monday.
- WEBH, Chicago . . . 370 meters—811 kc.
9.45 P. M. Evening Forecasts, Chicago and Vicinity, and Special Warnings. Except Monday.
- WOC, Davenport . . . 484 meters—620 kc.
1.00 P. M. Except Sunday—Morning Forecasts, General Weather Conditions, Weather-Crop Summaries Wednesday.
9.00 P. M. Evening Forecasts. Monday, Silent Night; Special Warnings Sent as Flashes.
- WEW, St. Louis . . . 360 meters—832.8 kc.
10.00 A. M. Morning Forecasts, General Weather Conditions.
5.00 P. M. Special Warnings. Except Sunday.
- KSD, St. Louis . . . 545.1 meters—550 kc.
10.40 A. M. Morning Forecasts, General Weather Conditions, River Stages.
12.40 P. M., Special Warnings.
1.40 P. M., Repeated.
3.00 P. M. Repeated.
10.00 P. M. Evening Forecasts. Except Sunday.
- KMOX, St. Louis . . . 280.2 meters—1070 kc.
10.00 P. M. Evening Forecasts Except Sunday.

†One hour earlier during Chicago "Daylight Saving."

Sign off to sweet dreams



You enjoy radio like a gentleman—if you can get the best out of your set and forget all worry and bother. That's your happy frame of mind when you keep your batteries full of pep with a Rectigon. The most absent-minded dial twister snaps on a Rectigon without a qualm. What if you do tune in while you're still charging your battery? There's no harm done, not the slightest. What if the current does go wrong in the dead of night? Your batteries will not be discharged with a Rectigon attached.

when you keep power in your set with

No noise as it charges—not a bit of fuss. Not even a murmur that would disturb the mildest slumber.



No acids, no chemicals—no moving parts—nothing to spill or burn. No muss, no worry. You'll have no spoiled rugs, no ruined clothing.



Saves its cost in short order—Count the dollars spent in a few trips to the service station and you'll hotfoot it for a Rectigon, for the good it does your pocketbook as well as your batteries.



Snaps on in an instant—Just plug into the light socket, snap on the terminals. Saves service station bother. Spares interruptions caused by absent batteries.



Charges both "A" and "B" batteries—Keeps both packed with power. Bulb is used for "B" battery charging and it is enclosed, like all other parts, in metal, safe from accident. (Rectigon charges automobile batteries, too.)



**No Storage Battery Radio
is Complete
Without a Rectigon**

The Westinghouse Rectigon Battery Charger

©, 1926, W. E. & M. Co.



★
THE RECTIGON is a superb Westinghouse product. Things you *can't* see, like extra heavy insulation, things you *can* see, like the durably enameled case—all are of highest quality. Westinghouse also manufactures a complete line of radio instruments, and Micarta panels and tubes.

WESTINGHOUSE ELECTRIC & MANUFACTURING CO.

Tune in on KDKA - KYW WBZ - KFKX

Digitized by Microsoft