

RADIO BROADCAST

WILLIS K. WING, Editor

OCTOBER, 1926

KEITH HENNEY
Director of the Laboratory

JOHN B. BRENNAN
Technical Editor

Vol. IX, No. 6

CONTENTS

Cover Design	From a Painting by Fred J. Edgars	
Frontispiece	Radio Aboard a Channel Air Liner	470
Is There a Radio Monopoly?	French Strother	471
The March of Radio	An Editorial Interpretation	474
How to Build the Equamatic Five-Tube Receiver	Zeh Bouck	479
Radio With the Dyott Brazil Expedition		483
An A, B, C Line Supply Device	B. F. Roland	485
The Listeners' Point of View	John Wallace	490
A Shielded Dual-Control Receiver	McMurdo Silver	494
How to Measure Your Own Tubes	Keith Henney	499
Afire at Sea	Walter Meade Williams	504
As the Broadcaster Sees It	Carl Dreher	506
He Gave a Lusty Voice to Radio	Myra May	510
Cone Loud Speakers	C. L. Farrand	514

METROPOLITAN SHOWS SECTION

Bringing the Radio Shows to the Country		517
What's New at the Radio Shows	Edgar H. Felix	518
Parts of Real Quality Dominate the New Season's Lines	Richard Lord	523
How to Select Your 1927 Receiver	Edgar H. Felix	529
Meet Mr. Average Radio Enthusiast	Kingsley Welles	531
"Radio Broadcast's" Laboratory Information Sheets		566
No. 33 Tandem Tuning	No. 37 Single Side Band Transmission	
No. 34 Series Connecting of Filaments	No. 38 Neutralization	
No. 35 Radio Frequency Transformers	No. 39 Field Intensity Measurements	
No. 36 The Super-Heterodyne	No. 40 Analysis of Detection	

Who Is to Control Broadcasting?	Thomas Stevenson	572
Constant Frequency Stations		575
How to Improve Your Neutrodyne	Thorp Hiscock	576
Book Review	Keith Henney	579
<i>Radio Frequency Measurements, E. B. Moullin</i>		
The Microphone	H. J. Round	580
"Now, I Have Found"		582
The "Radio Broadcast" Technical Information Service		585
Letters from Readers		586
The Geneva Plan	Lawrence W. Corbett	588
A Key to Recent Radio Articles	E. G. Shalkhauser	590

BEHIND EDITORIAL SCENES

NOT only is this issue, the Metropolitan Shows Number of RADIO BROADCAST, by far the largest in point of editorial content, but it is certainly the most interesting we have presented our readers in many months. Although a special effort has been made to present in advance of the radio shows as much information as possible about what the visitor will see there and a special section of the magazine has been devoted to the radio shows, no change whatever has been made in the usual number of pages and quality of the regular section of the magazine. . . . Everyone, whether he knows anything about radio technically, or not, should find French Strother's article "Is There a Monopoly in Radio?" of deep interest. Mr. Strother, an associate editor and special writer on the staff of *World's Work*, is nationally known as one of the ablest special writers in the country. We believe that his series of three articles on the radio industry, of which this is the first, will be read with wide and deep interest.

THERE are four articles in this issue of great value to the home set builder. The first is a description by Zeh Bouck of a five-tube tuned r. f. set using the King Equamatic system. The second is constructional data on a fine power supply device, prepared by B. F. Roland, which furnishes A, B, and C potentials to the radio receiver. Many constructors have long awaited a dependable unit and we have no hesitation in saying that this will satisfy their requirements. McMurdo Silver's description of the construction and assembly of a six-tube completely shielded receiver provides the home builder with a set embodying all the latest and approved constructional ideas. And another of Keith Henney's articles on vacuum tubes appears on page 499. This series of tube articles have attracted more attention than almost any of the strictly technical articles ever printed in RADIO BROADCAST.

NOW for the November RADIO BROADCAST. The second of French Strother's articles on the radio industry will appear. Our feature constructional article will tell how to build the RADIO BROADCAST Lab. receiver, which many of our readers have awaited eagerly. George J. Eltz, Jr. has written an extremely interesting description of a short-wave super-heterodyne which works on a small loop extremely well. The short-wave "super" is something the amateur has been attempting to perfect for a long time. This model is not hard to build and should attract wide attention. In addition to these articles of special interest there will be an interesting story by Senatore Marconi and a bookful of other articles which have made so many readers of RADIO BROADCAST say they would never miss a copy.

—WILLIS K. WING.

Doubleday, Page & Co.
MAGAZINES

COUNTRY LIFE
WORLD'S WORK
GARDEN & HOME BUILDER
RADIO BROADCAST
SHORT STORIES
EDUCATIONAL REVIEW
LE PETIT JOURNAL
EL ECO
THE FRONTIER
WEST

Doubleday, Page & Co.

BOOK SHOPS
(Books of all Publishers)

NEW YORK: LORD & TAYLOR BOOK SHOP
PENNSYLVANIA TERMINAL (2 Shops)
38 WALL ST. AND 166 WEST 32ND ST.
GRAND CENTRAL TERMINAL
ST. LOUIS: 223 NORTH 8TH STREET
4914 MARYLAND AVENUE
KANSAS CITY: 920 GRAND AVENUE
206 WEST 47TH STREET
CLEVELAND: HIGBEE CO.
SPRINGFIELD, MASS.: MEEKINS, PACKARD & WHEAT

Doubleday, Page & Co.
OFFICES

GARDEN CITY, N. Y.
NEW YORK: 285 MADISON AVENUE
BOSTON: PARK SQUARE BUILDING
CHICAGO: PEOPLES GAS BUILDING
SANTA BARBARA, CAL.
LONDON: WM. HEINEMANN, LTD.
TORONTO: OXFORD UNIVERSITY PRESS

Doubleday, Page & Co.
OFFICERS

F. N. DOUBLEDAY, *President*
A. W. PAGE, *Vice-President*
NELSON DOUBLEDAY, *Vice-President*
RUSSELL DOUBLEDAY, *Secretary*
S. A. EVERITT, *Treasurer*
JOHN J. HESSIAN, *Asst. Treasurer*

DOUBLEDAY, PAGE & COMPANY, Garden City, New York

Copyright, 1926, in the United States, Newfoundland, Great Britain, Canada, and other countries by Doubleday, Page & Company. All rights reserved.

TERMS: \$4.00 a year; single copies 35 cents.

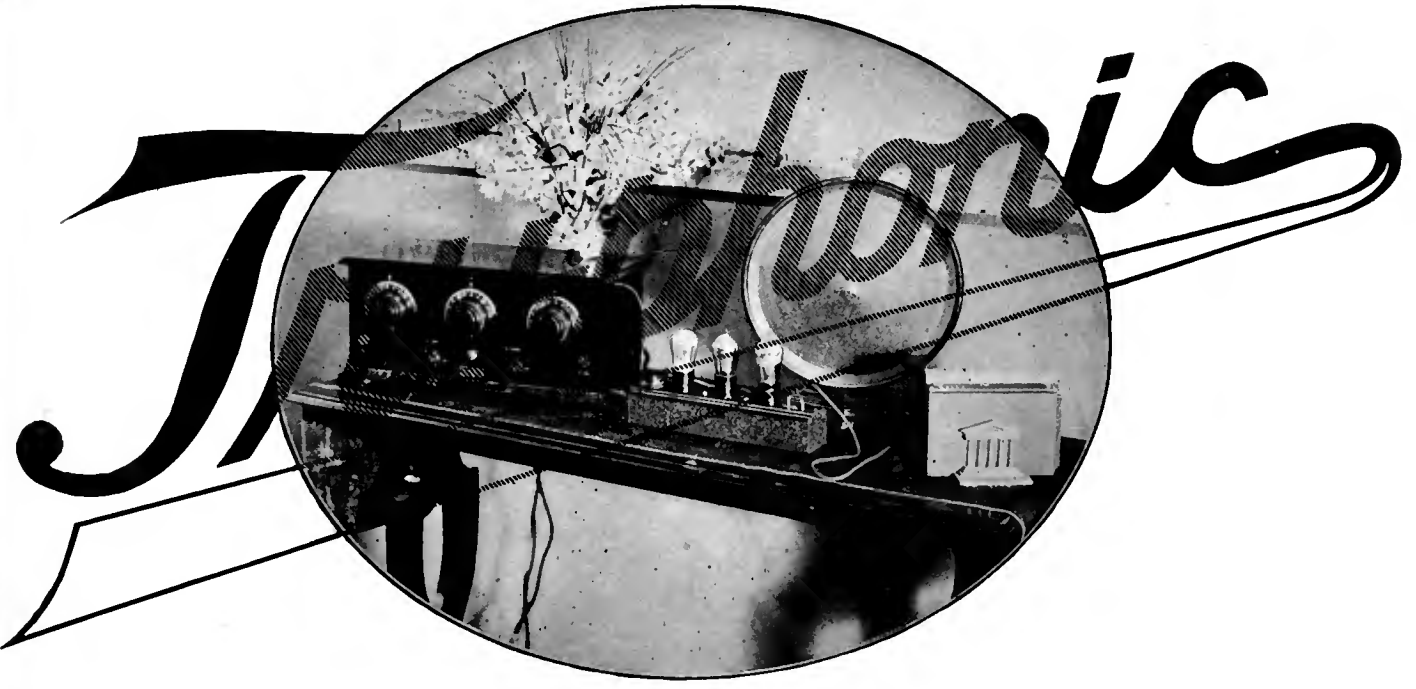

Truphonic Power Amplifier

as the name implies—*True Music*

Improved Amplification and Increased Power

THE most important part of a radio set is the amplification. With the phones on the detector, you get real music. Step to the last stage. You get a muffled roar for applause. The announcer ceases to be clear and understandable.

Attach the Truphonic Amplifier and all this is changed. The same clarity of the detector tube is preserved. You'll be surprised with what you were satisfied with before.

Just try the complete Truphonic Amplifier on any set. Clip the cables to the regular set batteries; shift tubes; plug in adapter and speaker. You'll never take it off.

One extra tube is all you need. If you like, you can use a power tube. Connections are provided. Also, the amplifier includes an output unit for the protection of your speaker. This choke and condenser output unit is recommended by the R. C. A. and others when power tubes are used. You get clearer tone, greater power capacity, and there is no danger of burning out or demagnetizing your speaker.

This Truphonic system is being adopted by many of the higher quality set manufacturers. Their endorsements after the most complete laboratory and practical tests are most wholehearted.

Truphonic amplification so operates as not to absorb weak signals as do heavy audio transformers and impedances. Its amplification is over double that of resistance coupling, with no extra batteries.

Truphonic amplification is a new system, developed by Mr. H. P. Donle. A balanced combination of transformer and impedance action, simultaneously transmitting energy by electromagnetic and electrostatic action exactly coordinates with the characteristics of standard tubes.

Engineers marvel that this compact device maintains such quality and seems impossible to overload.

In addition to the complete amplifier ready to attach to a set, individual couplers in separate iron clad cases are supplied stage by stage. The output unit is also mounted in an identical case. These units have a bracket arrangement that allows the case to be mounted in various positions. This, to-

gether with their compactness, makes it possible for service men to install them permanently in any set. Leads are attached for the convenience of the set builder. Every requirement of set design is fully met.

The greatest boon to the set constructor is the Truphonic Catacomb Assembly. A lacquered steel catacomb, containing three (3) Truphonic couplers and an output unit, is covered by a moulded socket panel of special construction containing six (6) or seven (7) sockets. This socket panel has unique contacts, one piece of metal for all common filament contacts, and continuous metal from plate and grid terminals to connected apparatus. This simplifies construction, and eliminates possible future trouble which can come from each additional soldered joint.

Hear Truphonic now! You will want it for your present set, and for all future sets you buy or build.

- Complete Truphonic Amplifier—No. 304 . . . \$20.00
Ready to attach to set
- Truphonic Catacomb Assembly . . . 20.00
No. 306 with six sockets
No. 307 with seven sockets
- Truphonic Couplers—Individual—No. 301 . . . 5.00 per stage
- Truphonic Output Unit—No. 300 . . . 5.00

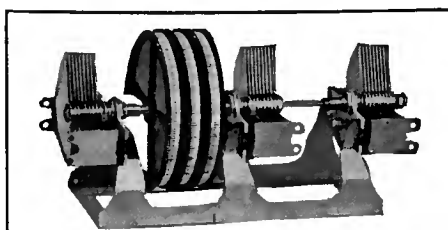

Na-Ald Localized Control Tuning Unit provides simple one-hand tuning without the complications of single control.

- Double, No. 2172 . . . \$ 8.00
- Double, with Tickler Controls
No. 2170 . . . 10.00
- Triple, No. 2173 . . . 10.00
- Quadruple, No. 2174 . . . 15.00

ALDEN MANUFACTURING CO.
Department B-18, Springfield, Mass.

Send me complete information concerning the Na-Ald Truphonic Power Amplifier and the Na-Ald Localized Control Tuning Unit.

Name.....

Street.....

City..... State.....

Dealer's Name.....





RADIO EQUIPMENT ON A BRITISH PASSENGER PLANE

How a standard Marconi 150-watt vacuum tube telegraph and telephone radio transmitter is installed on an Imperial Airways passenger machine operating between London and the Continent. The illustration shows how the apparatus is tucked away in the cockpit of the machine. The pilot operates it from his seat by means of cable controls

RADIO BROADCAST

VOLUME IX



NUMBER 6

OCTOBER, 1926

Is There a Monopoly in Radio?

How the Structure of Invention and Patents Has Grown Up—The Healthy State of Confusion in the Radio Industry—The First of Three Articles Presenting a Study of the Present State and Probable Future of the Radio Industry in the United States

By FRENCH STROTHER

TO GET a broad picture of radio as it is to-day, and of what radio may be to-morrow, is the purpose of this article and the articles to follow it in this series. First, we shall try to present the facts about radio as an evolving art; then the facts about radio patents; and finally the facts about radio as a business. In so brief a space, only the most outstanding things can be noted, but they should give the key to the relative position and importance of the rest.

The present state of radio is the result of a process of evolution. Scientists, searching for pure truth, opened up new principles that could be applied to the transmission of sound. Inventors, building on their work, devised the practical apparatus for doing this. Business men, capitalizing the right to make and sell this apparatus, organized companies to exploit it.

It is important, if we are to understand radio as it is to-day, that we should recognize that these three classes of men work from different motives. The scientist works solely for new knowledge, with no thought of gain. The business man works solely for gain. The inventor works from a combination of the two incentives; if he were not scientific in his bent, he would never master the laborious technical knowledge necessary before he can apply his inventive genius; and if he were not anxious for gain, he would not try to convert his scientific knowledge into practical and saleable devices for general use.

As nearly all the science upon which radio is built was known fifty years ago, we

shall have little concern with scientists in these articles. Taking their work for granted, as the old basis upon which the modern marvel of radio is built, we shall see that radio as we know it to-day is what it is because of three things: (1) the inventors, (2) the business men, and (3) the patent laws.

Nobody "invented radio." The theory of radio was known long before anybody was able to apply it to practice. Numerous inventors were trying to devise apparatus that would make the theory work. For this reason, several different practical systems of wireless telegraphy appeared at about the same time. Marconi had the good fortune to be the first, but he distanced his nearest competitors by only a short time. Indeed, it was only by accident that electrical communication by wire was perfected before electrical communication without wires, for both are implied in the electrical knowledge that preceded both, and inventors were working busily in both fields for many years before anybody in either group succeeded.

The search for a means of wireless communication continued with redoubled zeal the moment that communication by wire was achieved. The basic science upon which wireless is founded is at least as old as Sir Isaac Newton, who wrote to his friend Bentley his scornful opinion of anybody who doubted the existence of what we call the ether. All the great students of electrical phenomena, including Ampère and Faraday, made experiments demonstrating the reality of this medium, which is capable of transmitting undulations which we have always been able to perceive as light, and which, by virtue of the development of radio, we are now able to perceive as sound.

LOOKING BACK TO 1888

MARCONI'S first experiments with wireless telegraphy were made in 1895, but his work was based directly upon the discoveries of Hertz, announced in 1888, and of Branly, announced in 1890. Hertz was the first scientist to set up controlled electric undulations in the ether, by means of a mechanical device called the Hertz radiator, and to receive these undulations, by means of another mechanical device, called the Hertz resonator. Branly of France invented the coherer, or tube containing metal filings loosely packed between metal plugs, which provided the first practical device for "making and breaking" the circuit, at the receiving end—necessary if telegraph messages were to be transmitted by wireless.

Marconi improved upon

FOR many years, Mr. French Strother was Managing Editor of World's Work, and he has long been known to readers of that magazine as a writer of unusual insight and refreshing clarity. RADIO BROADCAST counts it a great privilege indeed to present this article, which is the first of a series of three, devoted to a searching analysis of the radio industry in the United States. One bears much loose talk about monopoly in radio; some have even put their opinions more strongly than that. Mr. Strother, accordingly, set out to analyze the situation in the industry and we are certain that his three articles will not only prove interesting reading, but will furnish material for a great deal of thought—along slightly different lines than has been the case heretofore—for the many who are associated in one way or another with this great industry. In the preparation of these articles, a great number of radio executives were freely consulted, and as freely provided information. No effort has been spared to make these articles as fair and as accurate as possible. The next one of the series will appear in an early issue.—THE EDITOR.

Hertz's method of setting up ether waves, and he improved upon Branly's coherer. Marconi then did a new thing that neither of the others had done, namely, he made a practical combination of his improvements on their two devices, by which he was able to transmit and receive telegraphic signals, over distances measured, not by feet in a laboratory, but by miles over land and sea. Marconi, therefore, properly ranks as a great inventor; but he did not invent radio. He did invent the first practical system of wireless telegraphy.

The next great invention in wireless was the tube. This was invented by an English scientist, J. A. Fleming, who called it a "valve," the name by which tubes are still known in England. Fleming also utilized previous discoveries to make a practical invention. It was known before his day that rarefied gases would conduct electrical currents under certain conditions. Fleming invented a practical device for using this property of rarefied gases in the reception of wireless signals. He confined them in a sealed glass bulb, into which he introduced also the incoming and outgoing ends of a broken electrical circuit. One of these ends, the "filament," he heated by a battery independent of the electrical current he wished to control. The other end was a cold "plate." He observed that the passage of the current through this device could proceed in only one direction—from the hot element to the cold element. Because this action was equivalent to the action of a valve in mechanics, he called his tube an electrical valve. It may be noted, in passing, that Fleming's valve was in a sense only an improvement upon Branly's coherer, although the electrical action of the two devices is vastly different. Fleming substituted rarefied gas for metal filings, and added a means of heating one of the two electrical connections. But these improvements were enormously important, because they made the coherer infinitely more sensitive, wholly automatic, and controlled the direction from which the undulations of the ether should be received.

WHERE THE PATENTS START

THE bearing of all this on the radio art that at present concerns us is this: the scientists, from Newton to Hertz, were interested only in *laws of Nature*. So, too, to be sure, were Marconi and Fleming; but when Marconi assembled a *practical device* for transmitting telegraph messages without wires, he *patented the device*. And when Fleming invented a *valuable device* for improving Marconi's telegraph system, he too, *patented the device*. In other words, the moment pure science had carried an art to the point where there was "money in it," a struggle began to control the instruments which made the practical applications of

the art commercially profitable. That struggle has persisted to this day, with ever-increasing fury, as the increasing practical applications have widened the opportunities for commercial profit.

The present patent tangle in radio will be better understood if we follow the Marconi and Fleming patents one step further. Marconi owned the patent on the (then) only practical system of wireless telegraphy. Fleming owned the patent on the best detector (which was his "valve" or tube) then available. If Marconi wanted to use the best detector in his own invention, he must "do business with" Fleming. If Fleming wanted to get any commercial advantage out of his invention, he must "do business with" Marconi. But if Marconi simply wanted to get the most he could out

NOBODY invented radio. The theory of radio was known long before anybody was able to apply it to practice. Numerous inventors were trying to devise apparatus that would make the theory work. For this reason, several different practical systems of wireless telegraphy appeared at about the same time. Marconi had the good fortune to be first, but he distanced his nearest competitors by only a short time. Indeed, it was only by accident that electrical communication by wire was perfected before electrical communication without wires, for both are implied in the electrical knowledge that preceded both, and inventors were working busily in both fields for many years before anybody in either group succeeded.

"The search for a means of wireless communication continued with redoubled zeal the moment that communication by wire was achieved. The basic science upon which wireless is founded is at least as old as Sir Isaac Newton, who wrote to his friend Bentley his scornful opinion of anybody who doubted the existence of what we call the ether."

of his own inventions, and head off competition, he could refuse to buy rights in Fleming's patent and refuse to allow anybody else to make the other patented elements of his wireless system to which they might add Fleming's improved detector.

This first simple conflict of financial interests in radio was a foretaste and a prophecy of the present enormously complicated conflict. From the day that Marconi took out his first patents it was certain that every subsequent inventor in radio would patent *his* invention. And from the day that Fleming took out his first patent, it was certain that every additional patent would involve a new conflict of financial interest. The reader may imagine for himself what that means to-day, when there are twenty-four hundred unexpired patents on radio subjects in the United States.

HOW THE TANGLE IN RADIO PATENTS BEGAN

ANOTHER suggestion needs to be made at this point, to help understand why the patent situation so bedevils radio.

Science and business differ in a fundamental respect. Science, by its very nature, seeks change and progress. To the scientist, the discovery of a new principle or a new device merely pushes back one step the frontiers of the unknown which he is eager to explore. Hence, one scientific discovery is merely an invitation to the scientist to make the next discovery that lies "up that street." The faster he progresses, the happier is the scientist.

Business, on the other hand, cannot progress so fast. To make a commercial success of even one practical application of science calls for a heavy outlay of money in patent rights, factory, machines to manufacture the device, men to operate the machines, salesmen to sell the device. All this money must be laid out before one dollar of return begins to come back. And the venture is not a success until all the original investment has been recaptured in the form of profits, and something besides gained to pay for the trouble of organizing the enterprise.

Now add this difficulty to the radio situation, and you may imagine how the present semi-chaos came about. No sooner had Marconi started to do business under his patents than a dozen inventors came along with improvements so radical that Marconi either had to control them or be left hopelessly in the rear of the advance of the art. Fleming's "valve" was a better detector than Marconi's. Soon there came along De Forest's Audion, which was vastly better than either. Then along came Fessenden, with his device for producing "continuous wave" emanations instead of alternating oscillations, making radio transmission so flexible that it became possible to transmit

the complex modulations of the human voice or the symphony orchestra. Where did these advances leave Marconi, with his now crude mechanical coherer and his "spark" telegraph circuit? Commercially, where did it leave his financial backers, with their hopes of profit from devices that were antiquated before a dozen of them could be got on the market?

Multiply this dilemma by two thousand, and you may perceive clearly both what and why the present tangle in radio patents is. On the one hand, the joy of scientific discovery urges a thousand scientists and hundreds of thousands of amateurs to try to find new ways of using radio, or better ways of doing the things already discovered. On the other hand, the hope of profits to be earned by exploiting discoveries already made and patented urges business men to try to control every avenue of advance in the art, so that each new device may be used until it has returned its cost and a profit before the next and better device permanently replaces it. The law of the

land largely determines the extent to which the scientific interest or the financial interest shall control the development of the art.

WHAT HAS HAPPENED IN GREAT BRITAIN

FOR this reason, it is worth while briefly to compare the development of radio in Great Britain and the United States. Marconi took his inventions to Great Britain, patented them there, and undertook to exploit them commercially there. Fortunately for him, British law makes any system of communications a Government-controlled monopoly. Radio inventors in Great Britain, desiring to profit by their inventions, have necessarily to deal with Marconi, who, for practical purposes, is the British Government. How soon their inventions shall be used, and to what extent, is determined upon business principles, which demand an orderly commercial development of the whole radio structure, including telegraphic communication, broadcasting, and home reception.

The result in Great Britain has been that most of the subsequent important radio inventions have been made in the United States. Other results have been that the per capita consumption of radio apparatus in Great Britain is incomparably less than in the United States. Both the art and the business of radio have suffered in Great Britain. The one notable exception to this statement is that Marconi has not suffered in a business sense. He, at least, has enjoyed the fruits of monopoly—though it is debatable whether he might not have profited more if he had had competition and consequently a wider market in America.

In the United States, on the other hand, we have laws that provide for a patent monopoly but not for a monopoly of patents. We assure to each inventor a monopoly of the profits to be made from his invention; but we leave to the free play of competitive economic forces the extent to which his monopoly, on his invention, is combined with other monopolies, on other inventions. In this country, therefore, we have business groups that have acquired some of the important radio patents, competing with other business groups that have acquired other important radio patents. No one group has yet been able to corral all the essentials of radio into one lot, and thereby free themselves from the necessity of using every effort, to be more inventive than everybody else, to be more skilful in manufacture than everybody else, and to be more energetic and able in selling their product than everybody else.

IS THERE A RADIO MONOPOLY IN THE UNITED STATES?

THE Radio Corporation of America is very generally charged with trying to occupy that position in radio in the United States. However, the Radio Corporation

does not now distribute as many radio sets as its largest competitor and it has offered to license several competitors under its patents—an offer which was refused. Consequently there is evidence that the Radio Corporation has neither the opportunity nor the desire to become a monopolist in the manufacture and sale of radio sets or parts. This does not mean that the logic of an industry based upon patents as the radio industry is, does not lead to the conception of a concentration of all the patents (which are monopolies) in the field. When that concentration is sufficiently effected so that the rights to use enough patents to make a set are available, who will use them, one concern or many? If there are many, there will be competition.

Competition thus far has justified itself by its fruits. The enormous public interest in broadcast reception has been made possible by the ease with which the listener could secure a receiving set, either by building it himself or by buying his choice of hundreds of ready-made designs. This public interest has created a market of such vast proportions that even a would-be monopolist's share of it is doubtless larger than he could have got by monopolizing the more restricted market which monopoly creates. But, of course, anyone contemplating a monopoly would not be thinking only of the present. He would be thinking of getting a strangle-hold on the future, so that when the industry does become as big as they pre-vision it, he would enjoy all the profits of it.

Let us, then, review the present situation of radio in the United States, to see, if we

can, what likelihood there is that radio will ultimately become the monopoly of one business group. Or, failing that, what the probable development will be.

From what has been said above, it is clear that the answer will not be found in patents alone. Patents are only one of the raw materials upon which a great industry feeds. With them must be put great sums of money, invested in factories and machines. With these must go great manufacturing skill. Added to these must be great skill in salesmanship and the details of commerce. And finally there must be the rare and peculiar type of genius, called, in French, the *entrepreneur*, whom for lack of a single word in English, we call the "captain of industry" or the "statesman of industry"—the man who combines the power to survey a whole field of business enterprise, vision its possibilities, secure capital, organize men of all the diverse kinds involved in invention and manufacture and sale.

The question, therefore, is not only "who invented what" in radio, and who now owns the inventions; but the question also is, who can best make radio apparatus, who can best sell it, and who, if he exists, is the genius that can combine these multiform elements into a stable industry?

These articles are designed to give the reader as many useful facts as possible in answer to these questions, and to suggest some of the possible combinations of these facts as they may tend to determine what radio is coming to in America.

At present, the radio art and the radio patents and the radio industry are in a state of chaos. On the whole, it is a healthy condition, because its very uncertainties stimulate the hopes of inventors, the opportunities of the listening public, and the enterprise of business men. But it is a chaos that cannot last, because inventive possibilities will ultimately become narrower and narrower; economic pressure will force out unskilful manufacturers and unwise commercial adventurers; and the courts will finally award each of the important patents to some one of the numerous claimants. Then the field will be clear for the business statesman to emerge with a practical monopoly in his hands; or, failing that, a group of friendly competitors will survive, as in the automobile field, cultivating various parts of a market big enough for all.

The two articles that follow this will deal separately with the two most important elements in the present radio situation. The first article will discuss the complicated patent situation that surrounds the various essential parts of a radio receiving set—the inventors, and the inventions, and the patents. The second article will deal with the business side of radio—the business men and the business groups and the question of monopoly.

Highlights From This Article

FROM the day that Marconi took out his first patents, it was certain that every subsequent inventor in radio would patent *his* invention. And from the day that Fleming took out his first patent, it was certain that every additional patent would involve a new conflict of financial interest. The reader may imagine what that means to-day, when there are twenty-four hundred unexpired radio patents in the United States."

"In the United States, we have laws that provide for a patent monopoly, but not a monopoly of patents. We assure to each inventor a monopoly of the profits to be made from his invention; but we leave to the free play of competitive economic forces the extent to which his monopoly, on his invention, is combined with other monopolies, on other inventions."

"In this country, we have business groups that have acquired some of the important radio patents, competing with other business groups that have acquired other important radio patents. No one group has yet been able to corral all the essentials of radio into the lot, and thereby free themselves from the necessity of using every effort, both to be more inventive than everybody else and to be more skilful in manufacture than everybody else and to be more energetic and able in selling their product than everybody else."

"The question is not only 'Who invented what' in radio, and who now owns the inventions; but the question also is, Who can best make radio apparatus, who can best sell it, and who, if he exists, is the genius that can combine these multiform elements into a stable industry."

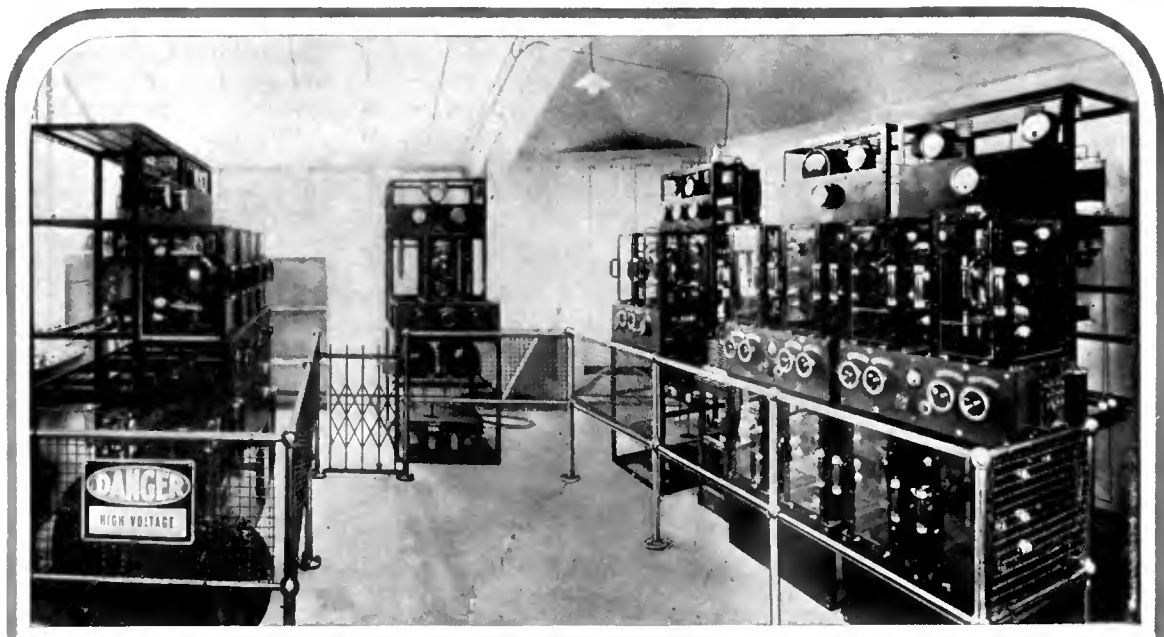

THE MARCH OF RADIO

News and Interpretation of Current Radio Events

The Wages of the "Wavelength Pirate" Is Unpopularity

PESSIMISTS feared that bedlam on the broadcast frequencies would be the inevitable result of the failure of Congress to provide radio legislation. Fortunately, nine out of ten broadcasters have realized the serious consequences arising from a destruction of the delicate wavelength structure which Secretary Hoover and his able assistants have built up during the last few years. At this writing, confusion has been limited to one or two highly congested areas.

Comparatively few stations have taken advantage of the legal loopholes which the Courts and the procrastination of Congress have provided. Few have taken excursions into the lower frequency end of the broadcast band, heretofore reserved for the well-established pioneer stations. So consistently have the "pirates" failed to find these coveted wavelengths free of interference that their reward has been, in almost every instance, nothing less than public contempt. Their incompetence as broadcasters has been accentuated by a continuous heterodyne whistle which accompanies their mediocre programs.

It is a tribute to the Department of Commerce that no real loop holes in the

ether have been found by these self-seeking small boys of broadcasting. Before the summer is over, we may expect about 65 new stations and, in addition, attempts on the part of 48 or so existing stations to shift their wavelength upward. Until court decision, injunction, or legislation restores regulatory power, the listener's patience will be tried by exasperating interference. As a result, the position of the tried and true veterans for broadcasting will be still better established and their would-be imitators discredited. The public is being forcibly convinced of the undesirability of increasing the number of broadcasting stations. Legislation will be all the more drastic in its restrictions because of this distressing spectacle.

The spirit of fair play demands that the case of the "little downtrodden broadcaster" be heard without prejudice. Who are these broadcasters, seeking a place in the wavelength spectrum? Have the moguls of the ether been granted exclusive wavelengths and liberal time on the air at the expense of small deserving stations? Would it not be ideal to give all who wish full opportunity to broadcast when they please?

When broadcasting had its beginnings, some were far quicker than others to perceive its possibilities. These risked capital,

erected stations, gained experience, established listener followings and won their right to a wavelength by rendering service. Others, after seeing the good will return accruing to these far-sighted pioneers, decided to go and do likewise. Many of these belated publicity seekers rushed, madly erecting stations without first ascertaining whether there was room for them on the air.

The situation from which we now suffer is the clamor of these late-comers to get on the air. Their invasion was postponed by the Department of Commerce until the Courts proved it to be without authority to deny them licenses.

These disturbers of the air cannot win the good will they seek. Even though we grant that their motives are no less altruistic than their predecessors, they are unwelcome to the broadcast listener. By interfering with reception from well established favorite stations, they incur only enmity. There is no room for them on the air.

The extent of public antagonism to interference from overlapping broadcasting stations may be gained from reviewing the results of a questionnaire sent by RADIO BROADCAST to 2000 of its readers in all parts of the country. Asked what progressive movements in radio they wished

The illustration forming the heading is a view of the apparatus at the 2 to London station of the British Broadcasting Company atop Selfridge's store. Three kw. is the input to the antenna

supported, 35.5 per cent. urged the elimination of radiating receivers and 32.7 per cent. voted for the discouragement of mediocre stations and relief from overcrowded conditions of the ether. No other question was mentioned by 5 per cent. of those answering the inquiry.

There are 92 channels between 1480 kilocycles (202.6 meters) and 550 kilocycles (545.1 meters). Fourteen of these are required for foreign stations, leaving 78 for American broadcasters. Two thirds of this band, providing 52 channels, is needed for stations of 500 watts power or more, with exclusive channels for stations in the center of the country and those of 5000 watts power or more. This allows for about 75 high grade key stations. On the remaining 26 channels is ample room for small stations, serving only local areas,

treme. Any speaker who has a real message which the public wants to hear has no difficulty in gaining access to the microphone. Program managers are keenly alert to the wishes of their audiences. We would wager if five hundred bona fide uninspired requests were received by *any* broadcasting station for *any* available speaker, he would be promptly invited by its program manager.

The Radio Corporation Rises to Ascendancy in the Broadcasting Field

WITH the forthcoming withdrawal of the American Telephone & Telegraph Company, radio broadcasting loses the most constructive single influence which guided it through its early

lished are adhered to. Its business is wire communication. In that capacity, it will continue to serve broadcasting by supplying high quality transmission circuits for interconnection of stations and the supply of programs from remote points.

One of the principal objections to the A. T. & T. in the broadcasting field was its tremendous size and influence. It made beginners in big business tremble in spite of its helpful and constructive attitude. (We must admit that the leaders in radio to-day are only beginners in big business). Through patent holding it was in a position to exercise a monopoly in commercial broadcasting and did so for a long time. But broadcasting has become too big to be the side line of the largest corporation in the world.

The Radio Corporation of America now

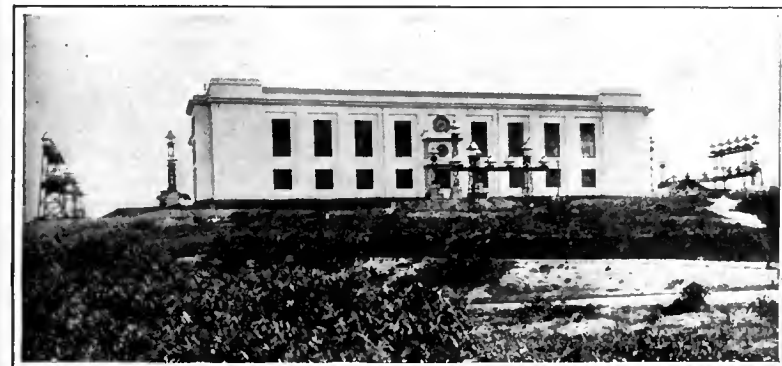

THE HIGH POWER RADIO STATION AT RIO DE JANEIRO

The station is designed to communicate with the United States and Europe and is operated by an international combine of radio interests known as the A. E. F. G. The Radio Corporation of America is one of the interests. The large illustration below shows the 800-foot masts, transmitter building, and staff headquarters. The insert shows a close-up of the transmitter building. On either side are lead-in bridges carrying antenna and counterpoise wires on great heavy insulators

using 250 watts power or less. Five hundred-mile separation can be maintained, giving room for 6 stations per channel, a total of 256 small stations.

The public would be amply served by the three hundred or more stations thus provided. It could ask for no greater boon from Congress than a law forbidding a greater number in the present band.

Is the "Air" Really Free?

FREEDOM of the air" is a most tempting phrase to the professional agitator and persons of liberal tendencies who do not know the ether's limitations. They use the smashing phrase with grand effect, as they describe how great corporations and grasping monopolies have despoiled the people's ether, so that they may spread pernicious propaganda. They plead for a "free ether" which anyone may use to spread his personal opinions at will.

But this picture is much distorted. The other *does* belong to the people, but it cannot be free to anyone who cares to use it. It is a highly circumscribed medium with a definite limit to the number it can accommodate. Its indiscriminate occupation without restriction spells its utter destruction and nullification.

Nevertheless, the ether is not so limited that its use need be denied those who have an appreciable following. There are plenty of stations with liberal views sufficient to entertain all but the most rabid and ex-

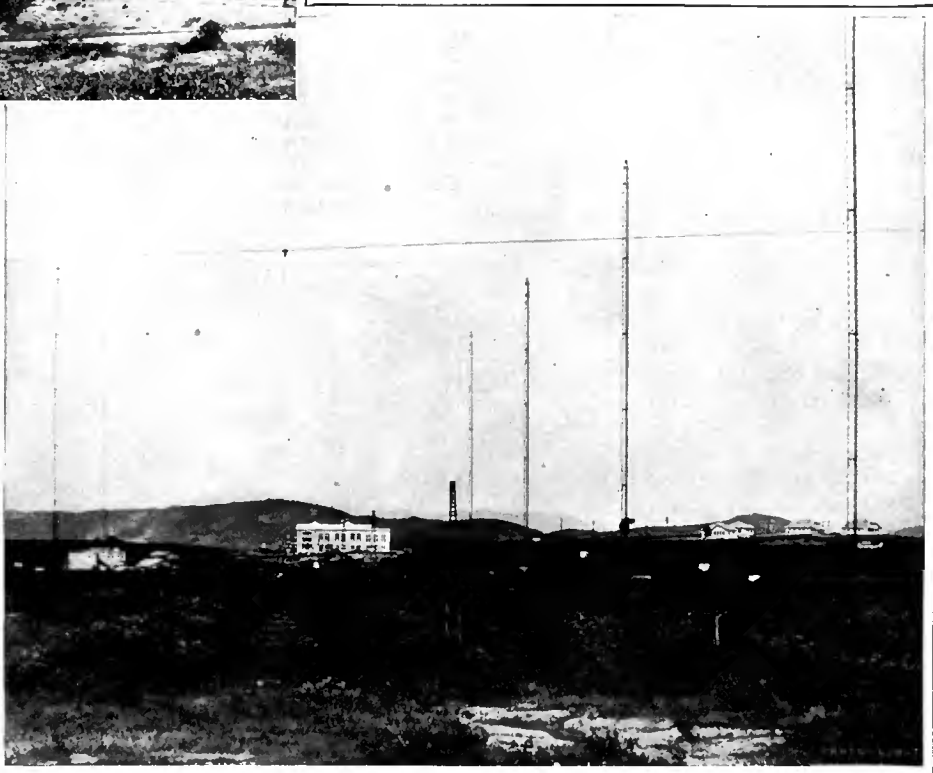

days. WEAF was the pioneer commercial station which not only formulated and established the present method by which the public pays for broadcasting but it created such high standards for commercial programs that it robbed the method of its undesirability. This is a permanent and significant contribution to the foundations of broadcasting.

Nevertheless, few will regret the disappearance of the A. T. & T. from the air, as long as the standards which it estab-

becomes the principal operating company in the broadcasting field. It will control the principal broadcasting chain in the country—the combined Radio Corporation, General Electric, and A. T. & T. group. It is now supreme in broadcasting, in the international radio telegraph business, and the ship to shore communication field.

Its future status in the business of selling receiving sets has not, as yet, been clarified. There are the confirmed rumors afloat to the effect that the Radio Corporation will con-

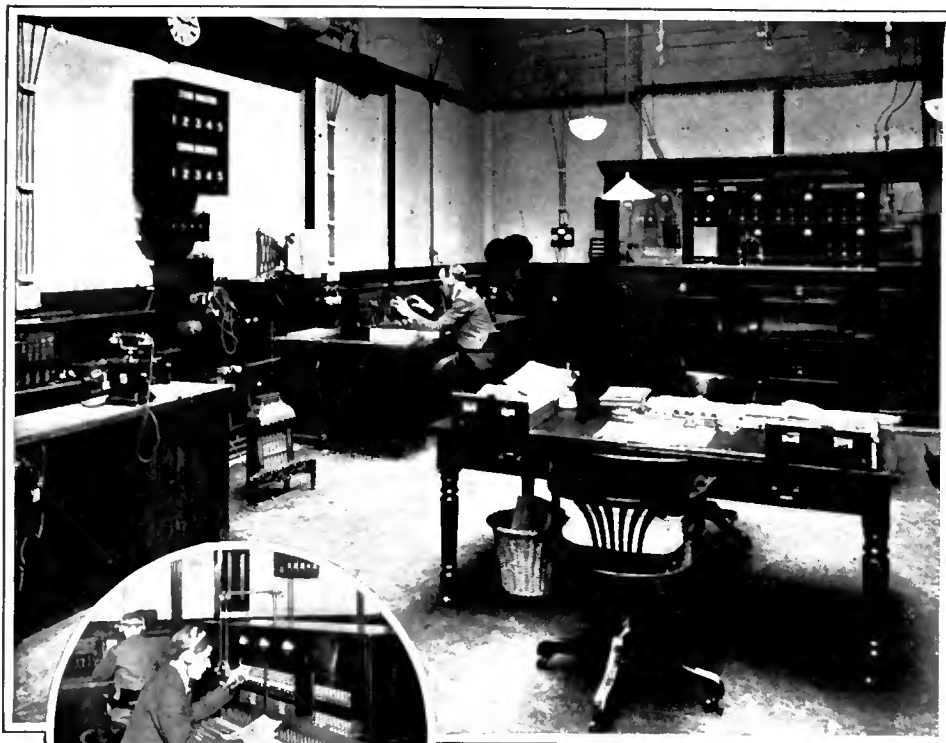

A CORNER IN THE BRITISH BROADCASTING COMPANY'S LONDON STATION

Many of the British programs originate in London and are forwarded by wire to outside stations in the chain. The various switchboards in use are used to supply programs to the provincial stations. The circle shows a close-up of the boards. By means of various distributing points, it is possible to tie up any or all of the twenty-one B. B. C. stations in any combination. The Daventry high power station takes practically all of its material from London

fine itself to these three operating fields and that the General Electric, Westinghouse, and Western Electric will manufacture and market their receiving sets under their own names. The products of the first two mentioned are well known to the public, having been sold to them under the brand name "Radiola," but the Western Electric will be a newcomer to the vacuum tube and receiving set field. Its experience in building high grade telephone equipment, its tremendous research facilities and its knowledge of radio design and construction place it in an enviable position so far as the making of high grade radio equipment is concerned. Most of the best broadcasting stations in this country are W. E. Company products and the excellent "double-detector" (super-heterodyne) receivers which are also a part of such a stations' equipment are made by the Western Electric Company.

Changes in Radio "Big Business"

WHEN the full purport of the negotiations which have been under way for a score of months, leading to a re-allocation of the functions of the various corporations in the Big Five group (General Electric, Westinghouse Electric, Radio Corporation, Western Electric, and Wireless Specialty Apparatus Company) become more generally known there will probably be the customary monopoly talk on the part of those who raise that hue and cry at every opportunity.

But there is every reason to believe that the public will benefit greatly by the contemplated changes.

The augmented Radio Corporation chain will constitute a virtual monopoly of commercial broadcasting in the single sense that it is the only chain that approaches even to a degree national coverage for commercial advertisers. With this improved facility will come even better commercial entertainment programs. The public will benefit by a quality of broadcasting which is not equalled anywhere in the world, the rather definite statements of our British friends to the contrary.

The ability to do a thing better than any one else is a very sound foundation for an unrivalled enterprise. Anyone who wishes to rival this chain, having sufficient capital and brains, will find it possible. Broadcasting stations can be combined and wire lines hired to link them. Commercial broadcasting has not yet developed to the point where two competing chains can be profitably maintained. When that day comes, the rival chain will come into being promptly. Broadcasting monopolies can be retained only by cornering good will with clean and desirable features. On that basis, we may welcome monopolies, real or fancied.

The Progress of Radio Patents in the Courts

IN AN opinion handed by Federal Judge Thomas Thacher recently, the rights of the Hazeltine Corporation and the Independent Radio Manufacturers, Inc.,

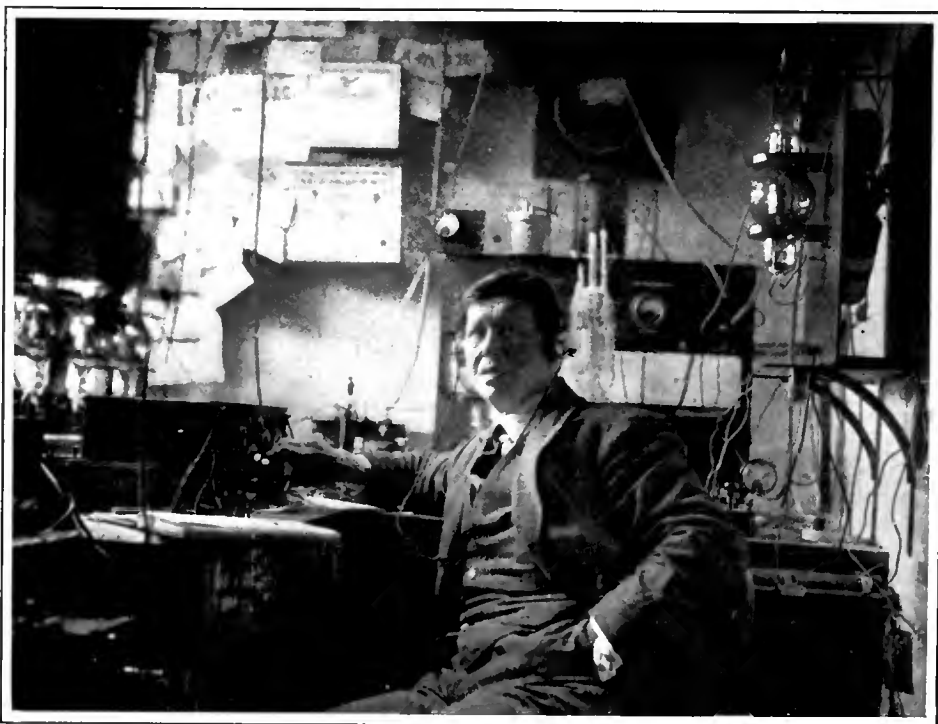

THE MOST FAMOUS BRITISH AMATEUR, GERALD MARCUSE

Using call letters G 2 NM, Mr. Marcuse transmits code and radio telephone signals from his station on 7496 kc. (40 meters) regularly. He has frequently been heard in the Laboratory of RADIO BROADCAST on both code and phone at about 6 P. M. New York time. He works a regular schedule with Canadian 1 AR on 7496 kc. and has often relayed the transmissions of 2 LO, the London broadcasting station of the B. B. C.

to the Hazeltine patents were upheld. The Electric Service Engineering Corporation, against which the Hazeltine interests brought suit, contended, among other things, that the professor had made his inventions while in government service and that, therefore, they were public property. Judge Thacher, in his decision, described the difference between the Rice and Hazeltine patents and asserted that the plaintiff had attained "permanent neutralization for all frequencies, a result never attained before and one which had, as the evidence discloses, an astounding effect upon the entire industry."

Another decision handed down by Federal Judge Inch held that the Hazeltine inventions did not infringe patents owned by the Radio Corporation. The R. C. A. placed its principal hope in the Rice patent.

In Canada, W. W. Grant, maker of regenerative sets, won a case from the Canadian Westinghouse Company which charged infringement of Armstrong patents. Grant has been making regenerative sets since 1919, which is prior to the issuance of the Canadian Armstrong patents. The decision pointed out that the application for Armstrong's patents was made too long after the American patent had been issued to give him exclusive rights in Canada.

A decision very recently rendered by Federal Judge Thompson in the Federal Court of the Eastern District of Pennsylvania supported the claims of the DeForest Radio Telephone & Telegraph Company against the Westinghouse Electric Company. This much litigated patent will probably be the subject of legal battles to the day of its expiration.

Just what the results of this far-reaching decision will be is not yet clear. The Westinghouse Company has collected substantial royalties on the Armstrong patent.

Rushing In Where Angels Are Decidedly Absent

CAPTAIN P. P. ECKERSLEY, Chief Engineer of the British Broadcasting Company, is quoted in *Wireless* (London) as follows:

Broadcasting in America is chaotic. There is no organization in the United States, and advertising through the ether has been the means of its downfall. Broadcasting in America is a private enterprise relying entirely on advertising for its working expenses. There are no listeners' licenses or fees of any kind, and both the broadcasting companies and the listeners regret this.

They now feel that if broadcasting had been one official organization, as it is in England, it would be the most popular entertainment in existence. As it is, it is nothing of the kind. The craze is dying off and the public is getting bored. I might be accused of undue modesty when I say that the broadcasting service of England is undoubtedly the finest of its kind.

Captain Eckersley then went on to say that American broadcasting is now faced with the gigantic task of finding enough money to give the public what it really

wants. And, he claims it can't find the necessary finance.

Continuing, Captain Eckersley contributes a sample of how American broadcasting is conducted:

2 PMS calling. You will now have the pleasure of hearing a group of cowboys singing "The Wild and Woolly West," this item being broadcast from the famous slaughter-houses of Chicago.

Then there is a rousing chorus all about beef on the march, the chase on horseback, the lassoing and the final capture. The housewife who listens in to this is out shopping next morning. The value of this indirect form of advertising is seen when she says: "I want two pounds of bully beef and I want it from the Chicago slaughterhouses!"

This may sound humorous to you, but would the British public stand for it? The answer is an emphatic No. Nor would it like to hear the Savoy Orpheans Band cut off by a strident voice shouting: "Buy Pop's soap! Buy Pop's soap! Buy Pop's soap!"

Then there is the American dramatic sketch as reported by Captain Eckersley:

"George, if you don't come back, I shall kill myself."

"Very well. Use a hypodermic syringe. You can get a really good one at Blank's drug stores on Broadway."

To American listeners, enjoying the extraordinarily high standard of commercial programs, Captain Eckersley's statements certainly sound ludicrous. Evidently the pressure in favor of permitting commercial broadcasting in England is requiring pretty strong counter-propaganda.

We rarely hear any clamor in the United States for a system of taxing listeners directly for the support of an absolutely iron-clad broadcasting monopoly. It is true, under these conditions, that wavelength problems would be lessened and regulation simplified. But we could not conceive of any monopoly which would retain a small proportion of the present enterprise and initiative of our program directors of to-day or one per cent. of the popularity of our present method of paying the broadcast bill.

We cannot understand why Captain Eckersley should draw so heavily on his imagination to invent his description of American broadcasting. Our bread is returning to us, buttered. The American has been criticised for singing the praises of our institutions beyond all reason. But here is Captain Eckersley, straying from his own technical field, to comment in this curiously inaccurate manner about American broadcasting.

The Month In Radio

AN ANNOUNCEMENT from Berlin advises that the passenger aircraft on certain important routes will be equipped with radio telephone apparatus linked with the wire telephone system of the country. While there is nothing new about this feat, it having been accomplished in this and other countries during the war, the German experiment will be the first time that it is done as an ordinary commercial service.

STATIONS 3 LP, 4 ZG, and 5 CL of Melbourne, Brisbane, and Adelaide, Australia, have increased their power to five kilowatts, which makes the chance of hearing them on the Pacific Coast a little less remote.

THE radio show season is not limited to the United States. Radio will be featured in Berlin at the Third Annual Radio Fair, at the Vienna International Fair and at the Leipzig Trade Fair. It is understood that there are several American exhibitors at each of these fairs.

ALTHOUGH there is considerable interest in broadcasting in Spain, 95 per cent. of the receiving sets in that country are said to be imported.

THE Haitian Government Department of Public Works has purchased a one kilowatt broadcasting station for installation at Port-au-Prince in order to disseminate entertainment features, items of public interest and lectures on health and educational matters.

THE Swedish Government has appropriated \$287,500 to build its seventeenth and most powerful broadcasting station. It is to be erected by Marconi's Wireless Telegraph Company and will be of the same design and



ANTENNA SYSTEM OF THE PRAGUE RADIO STATION
This broadcasting station is a standard Western Electric 5 kw. outfit. The antenna is described as an Alexanderson type with three leads



DR. J. A. FLEMING, D. SC., F. R. S.
—London—

From an article by the inventor of the two-element tube in the *Radio Times*, London:

"On the question of remedies (for interference caused by regenerative receivers), it is difficult to prescribe. It might be possible to register possessors of reaction (regenerative) sets or to mark it on their licenses, but it would be difficult to secure accuracy. Any very flagrant or repeated offender, when discovered, should have a warning that his General Post Office wireless receiving license may be cancelled, or a fine imposed. Perhaps the best thing is to bring home to the public generally the full reasons for the trouble, and the cure for it, and to create a widespread feeling that it is not 'playing the game' to allow one's set to oscillate knowingly or unknowingly. The number of deliberate sinners is small."

power as the famous Daventry station. The company controlling broadcasting in Sweden reports a profit of \$55,351 for 1925, after meeting a deficit of a little over \$3000 incurred in 1924.

A SURVEY conducted by the *Dakota Farmer* reports that there are radio sets in 13 per cent of the farm homes of Minnesota, 17 per cent in North Dakota and 12 per cent in South Dakota. In view of the prosperous condition of this group of states, a substantial profit to those handling radio is predicted.

MIDSUMMER radio conferences are being held by the Northwest Radio Trade Association in six cities, scattered through the Ninth Federal Reserve District. About 1500 miles will be covered by rail in special cars and contact will be made with radio dealers serving an area of about 40,000 square miles. About 100 representatives of wholesale houses, manufacturers, and newspaper men will go on the sales boosting tour. This aggressive spirit is a decided contrast to that displayed by some of the trade associations and assures that one section of the country will be served by the best possible sales and servicing methods.

WITH a farm population of well over half a million, there are only slightly in excess of 12,000 farm radio sets in Nebraska, according to a recent survey.

THE latest report of licensed radio listeners in Great Britain shows a total of 2,120,252, according to figures of the British Broadcasting Company.

A HIGH power radio telegraph station will be erected at Manila by the Radio Corporation of America, according to plans recently approved officially. The station will link the Philippines directly with the United States, without recourse to foreign communication systems.

AT THE Atlantic City meeting of the National Electric Light Association, it was disclosed that there are 13,460,000 home consumers of electric current. Only 7.8 per cent of the farms in the country have electric service of any kind. Fortunately radio does not have to wait for power lines, thanks to efficient dry-cell tubes and A and B batteries.

A SHORT-WAVE communication system for emergency use is to be installed by the Chicago, Milwaukee and St. Paul Railroad system, involving transmitting and receiving stations at Chicago, Milwaukee, Minneapolis, Miles City, Butte, Spokane, Seattle, San Francisco, and Omaha.

A SUMMONS read into the microphone of a broadcasting station was considered as a legal serving of process by Supreme Court Justice J. B. M. Stevens of Rochester, New York. Mrs. Lena F. LaPierre thus served notice of suit for divorce upon her husband who left Elmira for Rochester in 1920, utilizing the facilities of WHEC at Rochester for the purpose.

If such a flimsy method of serving summons becomes recognized in law, it will practically nullify the fundamental purpose of the summons. The chance that Mr. LaPierre was listening in to WHEC at the moment that the summons was broadcast is probably less than a million to one.

AN INDICATION of the volume of traffic handled by naval radio telegraph stations is given by the announcement that the naval station at San Francisco sent 159,417 words during the month of June, that at Honolulu, 147,131 and Washington, D. C. 134,737 words.

DR. ALFRED N. GOLDSMITH (New York; Chief Broadcast Engineer, Radio Corporation of America): "This is the fourth summer of broadcasting and it is not stretching the truth to say that broadcasting has finally evolved from a seasonal amusement to an all-year-round service that brings entertainment, enlightenment, and education day in and day out, to the American public.

The radio devotee, during the long indoor season, has grown to know the radio personalities that have come week after week into the home. The sponsored programs, ensuring the periodic appearance of certain radio features, have taken firm grip in the radio audience. The friendly contacts thus established are not to be broken off even though summertime may usher in a new order of things. The public must have its radio program just as it must have its daily newspapers—in summer as well as in winter."

S. W. SMITS, listening in at East Transvaal, South Africa, heard the tiny peep of a short-wave radio station, one night last April. Half way round the world, members of the Wilkins Expedition, mushing their way from Fairbanks to Point Barrow, had stopped to camp



SAM PICKARD

—Washington, D. C.—

Chief of Radio, United States Department of Agriculture:

"The farm fan has two chief criticisms of radio. The one most often voiced is the curse of not getting enough sleep. Most of them admit that they sit up late at night with their sets. Many others say that while they like to be neighborly they tire of the whole community dropping in every winter evening and then forgetting to go home. . . . Radio on the farm is yielding more dollars and cents return on the investment, developing a more prosperous American agriculture, and bringing about a better contented, understanding class of farmers than any other single scientific contribution of the age."

for the night. The radio operator had set up his little portable B battery powered transmitter, in order to report the day's progress to expedition headquarters at Fairbanks and Point Barrow, not more than 250 miles distant. In spite of minute power and distance, Mr. Smits overheard the little transmitter at the ether end of the world.

AMERICAN radio exports in May, 1926, were \$443,981 as compared with \$577,710 in May 1925.

WGY'S programs sent out on a frequency of 9140 kc. (32.79 meters) through station 2 XAF are frequently used for rebroadcasting purposes by the British Broadcasting Company. When especially good conditions prevail, the British report that these programs are equal in quality, if not better, than the transmission of some of their own local dance orchestras.

A RECENT Argentine decree places a limit upon the amount of advertising and mechanical music which a station may broadcast, says a consular report.

ALTHOUGH the number of examiners handling radio applications in the Patent Office has been almost tripled, there are 1850 patents pending as compared with 1594 on January first. The radio division is five months behind in its applications.

How to Build the "Equamatic" Five-Tube Receiver

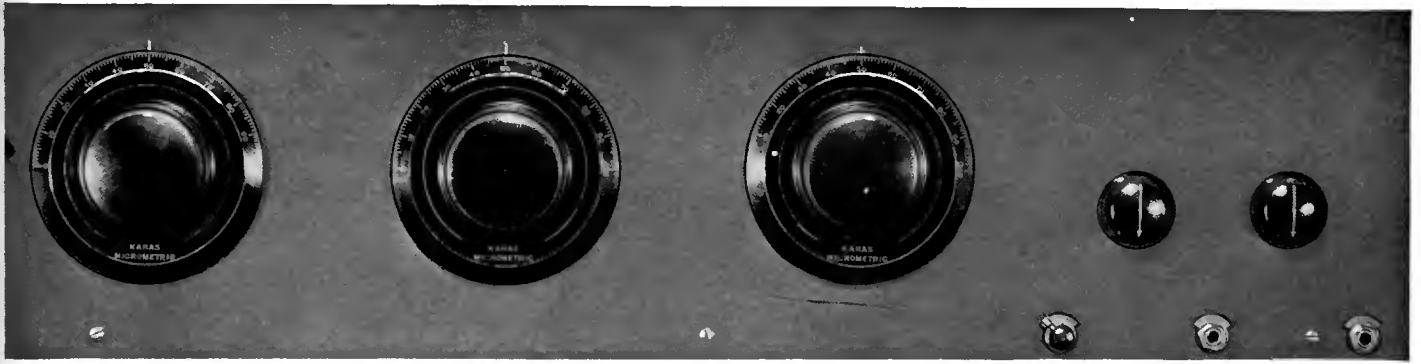

RADIO BROADCAST Photograph

A FRONT VIEW OF THE COMPLETED FIVE-TUBE RECEIVER

The neat layout of the controls is by no means the least important of the "Equamatic's" features. The three condenser dials tune with remarkably consistent correlation

IN THE September RADIO BROADCAST, we discussed the semi-theoretical aspects of the King Equamatic coupling system as applied in general to radio circuits.

In recapitulation, the Equamatic arrangement is a method of varying the coupling between two circuits automatically as the set is tuned, in order that the optimum value of power transfer between the circuits may be maintained at all frequencies. It was demonstrated that this consistent optimum transfer can never be achieved with fixed coupling; and that the efficiency—or, more correctly, the sensitivity and selectivity—of any receiver can be raised by the application of Equamatic tuning.

The automatic variation in coupling is secured by mounting the primary coil on the extended shaft of the tuning variable condenser, the eccentric position of the secondary being adjusted and fixed at best position. The degree of maximum coupling is adjusted by changing the position of the stationary secondary coil in relation to the moving primary, while the acceleration, or degree of coupling change, is determined by the angle of eccentricity.

It has been noted that the Equamatic system can be applied to practically any receiving circuit. However, its practical aspects and advantages are probably most easily demonstrated in a familiar circuit, and the writer has chosen for this purpose a variation of the two-stage tuned r.f. receiver (the almost standardized five-tube set).

The comprehensive idea is best illustrated by reference to the schematic diagram, Fig. 1. Coils L_1 , L_2 , L_3 , L_4 , L_5 , and L_6 are alternately primaries and secondaries of first stage r.f., second stage r.f., and detector circuits. Condensers C_1 , C_2 , and C_3 are 370-micro-microfarad tuning condensers across the secondaries. This arrangement will be recognized as the standard tuned r.f. circuit. The Equamatic innovation lies in the automatic coupling

An Efficient Tuned R. F. Receiver Employing a System for Automatically Varying Transformer Coupling with Frequency—Obtaining the Optimum Practicable Energy Transfer at All Frequencies

By ZEH BOUCK

variations between the primaries and secondaries, L_1 , and L_2 , L_3 and L_4 , L_5 and L_6 .

The primary, L_1 , is mounted on the shaft of the tuning condenser C_1 . Similarly, L_3 is mounted on the extended shaft of C_2 , and L_5 on the shaft of C_3 . As the dials are turned, the coupling between the primaries and secondaries is varied with an acceleration depending upon the angle of mounting. As already mentioned, this angle is adjusted so as to meet the particular requirements of the circuit and tubes, automatically maintaining the optimum energy transfer over the entire tuning range.

COIL DATA

AS WILL be seen in Fig. 2, the primaries are wound with fourteen turns of No. 24 wire on a 2-inch form, and the secondaries with 60 turns, of the same size wire, on $2\frac{1}{2}$ -inch forms. It will be observed that relatively large primaries are made possible in the Equamatic arrangement, insuring adequate transfer of energy

on the low frequencies (long waves). Karas condensers are provided with special extension shafts suitable for the mounting of the primaries.

While, due to the Equamatic principle, the circuit is inherently a stable one, the small retard coils, X_1 and X_2 , are included in the grid returns to render the adjustment of the coils and the operation of the receiver less critical. About 40 turns of No. 36 wire on an iron core having a cross section of one quarter square inch will be about right. The value is not critical.

While the home construction of the coils and retard chokes presents no very great difficulties, inductors and chokes especially designed for operation in Equamatic receivers can be purchased ready made.

The remainder of the circuit presents no unconventional feature, mechanically or electrically. Condenser C_4 is the usual 0.00025-mfd, grid condenser shunted by a two-megohm leak, R_1 . C_5 is a 0.0025-mfd. bypass condenser across the primary of the first audio frequency amplifying transformer, while C_6 is a 1.0-mfd. bypass across the radio frequency plate supply.

R_2 is a ten-ohm rheostat controlling the r.f. filament, and R_3 a twenty-ohm rheostat for the detector tube. The filaments of the audio-frequency amplifier tubes are lighted through $\frac{1}{4}$ -ampere Amperites, R_4 and R_5 . P. G. B., and F refer, of course, to the initialing on the audio frequency transformers.

The Facts About This Receiver

Type of Circuit	Tuned radio frequency.
Number of tubes.	Five. Two stages of r. f. with 201-A tubes; detector, using 201-A or special detector tube; first audio stage, 201-A; second audio stage, 112 or other semi-power tube.
Features	Maximum r. f. gain obtained by use of special automatic variable coupling arrangement.
Frequency range	1500 kc. to 500 kc. (200-600 meters).

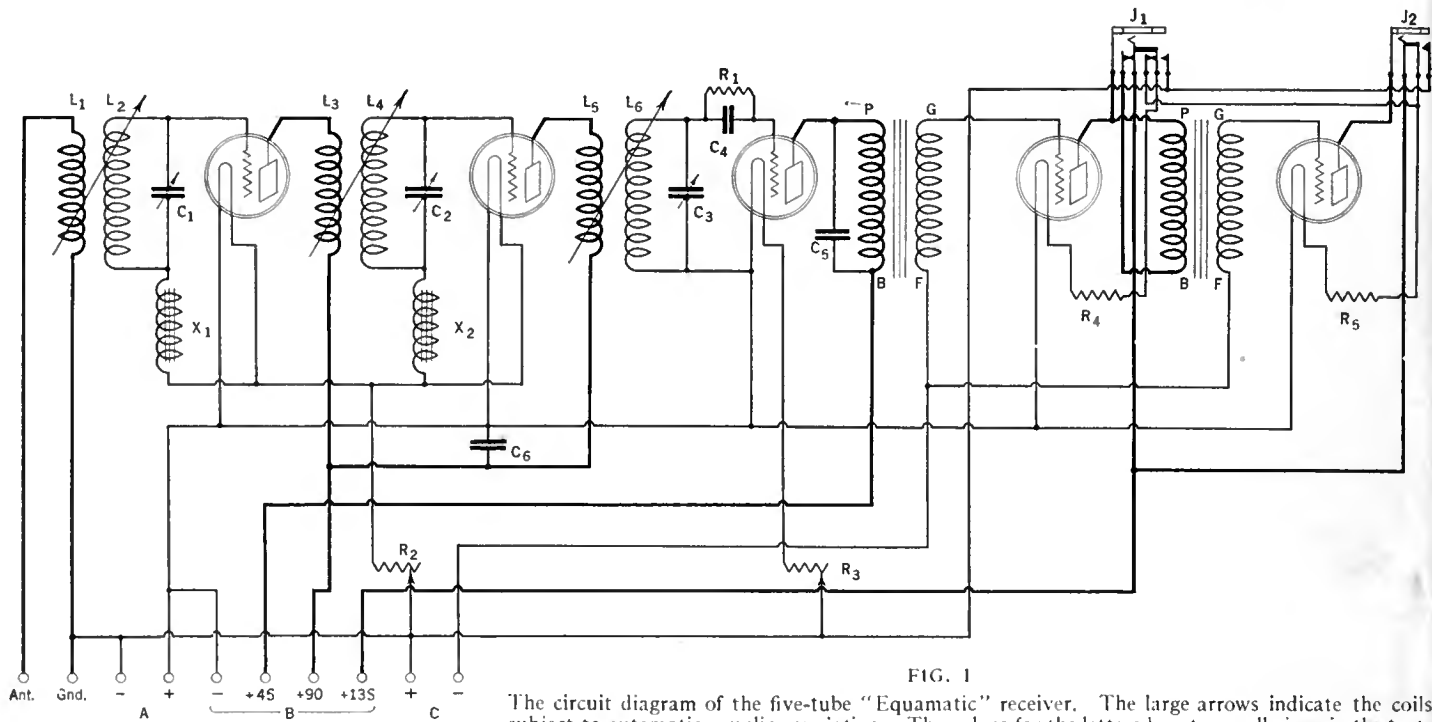

FIG. 1

The circuit diagram of the five-tube "Equamatic" receiver. The large arrows indicate the coils subject to automatic coupling variation. The values for the lettered parts are all given in the text: X₁ and X₂ are retard coils included in the grid returns to render the adjustment of the coils and the operation of the receiver less critical

J₁ and J₂ are respectively first stage and second stage filament control jacks. If desired, for simplicity, the filament control feature can be eliminated.

The following is a list of the exact parts used in the receiver described:

3 Karas Equamatic R. F. Transformers	12.00
3 Karas Orthometric 17-plate 0.00037—mfd, Extended Shaft Condensers	21.00
3 Karas Micrometric Vernier Dials	10.50
2 Karas Harmonik Audio Transformers	14.00
2 Karas Equamatic Retard Coils	2.00
1 Yaxley 10-ohm Rheostat with Gold Dial	1.50
1 Yaxley 20-ohm Rheostat with Gold Dial	1.50
1 Yaxley Gold Interstage Phone Jack	1.05
1 Yaxley Gold Open-Circuit Phone Jack	.75
1 Yaxley Gold Filament Switch	.75
1 Sangamo 0.00025 Fixed Grid Condenser with Clips	.50
1 Amsco 2-Megohm Grid Gate	.45
2 1-A type Amperite 6-Volt Resistors with Mountings	2.20
1 Burgess 4½-volt C Battery	.60
1 Jones Multiplug with Mounting and 8 ft. of Cable	4.50
5 Benjamin ux Cushion Sockets	3.75
1 Electrad 0.0025-Mfd. Fixed Condenser	.40
1 Electrad 1-mfd. Bypass Condenser	.90
1 Formica 7" x 28" Drilled and Engraved panel	6.80
1 Formica 6" x 27" Drilled and Engraved Sub-panel	4.69
3 Karas Sub-Panel Brackets	.70
2 Amsco Binding Posts	.20
Binding Posts, Screws, Spaghetti, Bus Bar, Lugs, etc.	1.00
Total	\$89.79

The above list is given for the benefit of the fan who may wish to construct an Equamatic receiver exactly similar to that described in this article, but there is no reason why substitutions equivalent electrically and mechanically may not be made for any of the parts listed.

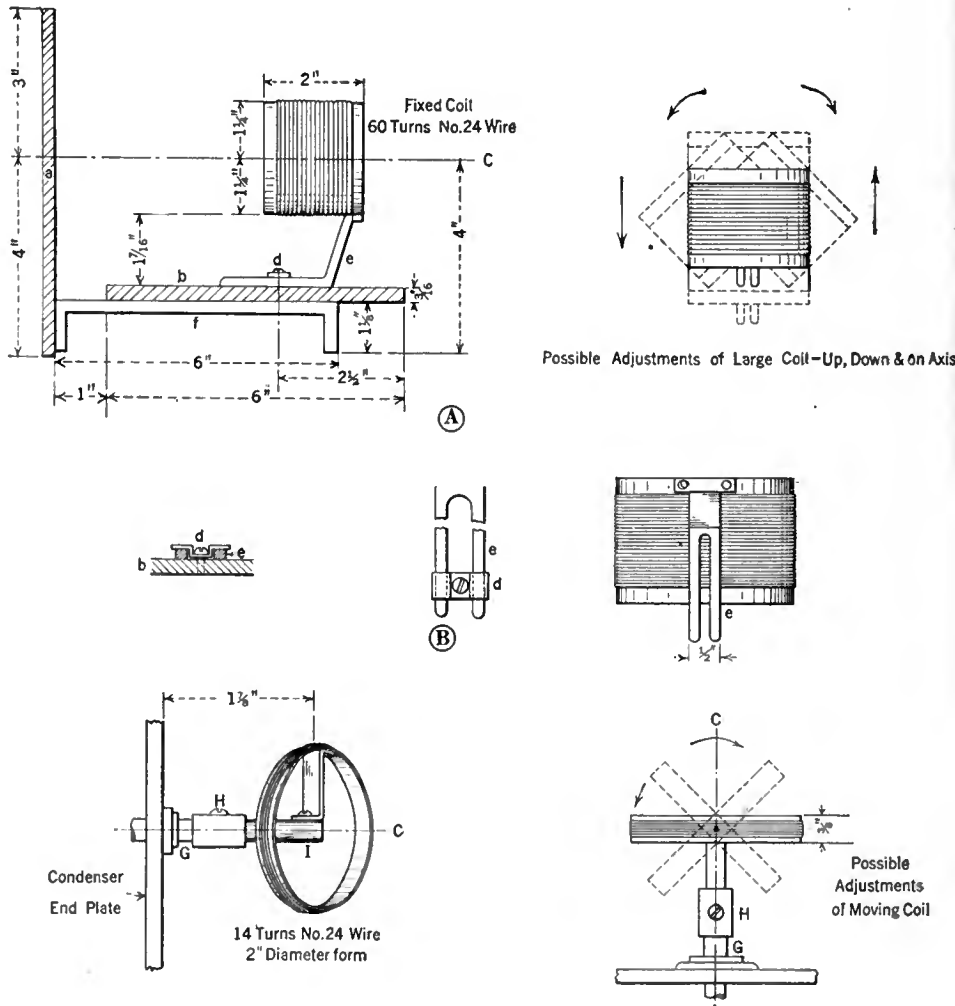

FIG. 2

It is not difficult for the home constructor to make his own coils for the "Equamatic" receiver, and the necessary details are given above. Reference to this diagram begins in column 2, page 479. Data on this system helpful to the home constructor appeared in last month's RADIO BROADCAST

CONSTRUCTIONAL DETAILS

THE constructional details of the Equamatic receiver are suggested in the panel and sub-panel layouts, Figs. 3 and 4 respectively, and in the photographic illustrations. If preferred, a baseboard may be substituted for the sub-panel, striking out four dollars from the complete cost.

Drilled and engraved panels specially designed for the Equamatic receiver are now obtainable. However, the experienced fan is quite capable of working out his own layouts and panels. In such a case, special care need be taken only to insure the perfect alignment of coils and condensers. The stationary or secondary coils should be so mounted that, should they be turned perpendicular to the panel, the axis of the condenser coincides with the axis of the coil. This precaution is important.

The mechanics of securing this arrangement are illustrated in Fig 2. Drawing A shows the dimensional characteristics of the stationary coil mounting. The front panel is designed by a, the sub-panel by b; c, in all drawings, is a line passing through the center of the condenser shaft; d is a machine screw with a square washer holding the coil bracket, e, to the sub-panel; f is a bracket of 1/8" brass strip, 6" long, holding the sub-panel to the control panel. Drawing B continues the details of the coil bracket, e, and the manner in which it slides through the swivel screw and washer d, on the sub-panel, b.

Drawing c suggests the moving or primary coil arrangement. A brass sleeve is fastened to the extended shaft, g, of the condenser by set screw h. A bakelite or hard rubber strip extends from the brass sleeve, to which the primary is mounted by a simple "L" bracket. The coil has been turned slightly to show this idea.

Photographs of several home-made mountings will be found in the preceding article which appeared on page 377-79 of the September, 1926, RADIO BROADCAST.

The holes for the condensers, brackets e, and swivels d, are drilled according to the panel and sub-panel layouts.

The mechanics of mounting the coils are

made clear by reference to Fig. 5. The reader interested in the mechanical construction of home-made mountings is referred to the preceding article, and to the data given in Fig. 2 of this article. The small "pillboxes" to the right of the two right-hand tubes are the retard coils.

While binding posts are suggested in the wiring diagram for the sake of clarity, a Jones Multiplug has been used for all connections to the receiver, with the exception of the C battery.

Figs. 4 and 8 suggest an efficient sub-panel or base-board layout. As will be observed, all coils are connected to associated ap-

ADJUSTING THE COIL ANGLE

THE second and third coils are always adjusted so that coupling is loosened as the frequency increases (as the wave goes down). As a rule, the first coils are similarly adjusted, though unusual antenna conditions, as will be noted later, occasionally reverse this last motion.

The stationary coils should first be placed at slightly above the correct angle, which is in the neighborhood of 58 degrees measured between a side of the coil and the front panel. On the special Karas Equamatic sub-panels, this angle is marked with

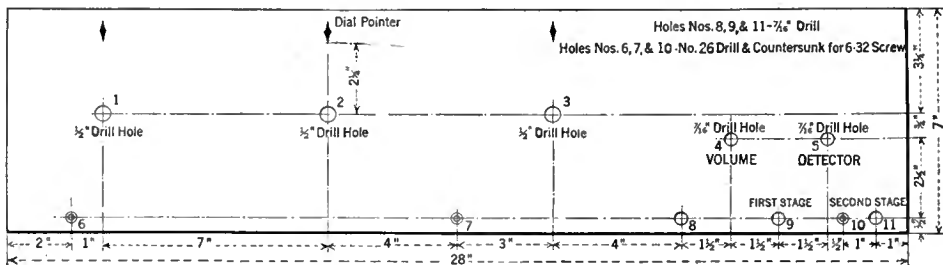

FIG. 3

This diagram shows the main panel layout for the benefit of those constructors who will build the five-tube receiver with the parts as listed by the author on page 480

paratus by flexible leads. It is important that the inductor terminals be wired correctly in respect to outer and inner turns. Assume both coils in a perpendicular position to the panel, i.e., the position in which there would be no coupling change as the circuits are tuned. The two coils will necessarily be parallel. Viewed from the front of the panel, the lead nearest to the observer should be connected to the antenna, in the case of the first primary, and to the plates of the preceding tubes, in cases of the second and third primaries. The secondary lead, nearer to the panel, is led to the negative filament in the first two tubes and to plus filament in the detector tube.

Fig. 6 shows the under-sub-panel wiring, while the photograph at the top of the first page of this article is a front view of the finished set.

a white line. A glance at Fig. 8 will convey a close idea of the correct (final) position. All three condensers are now turned to maximum capacity, and the extension shafts adjusted (by means of the set screw) so that each primary can be turned (on a vertical axis) parallel to the secondary. When this is done, we shall have close coupling between primaries and secondaries. In other words, the primary coils will form the same angle with the front panel, as the secondaries.

In this position, coupling between primaries and secondaries can be tightened by pushing the secondary coil, in its slide mounting, closer to the primary. Coupling can be loosened by reversing the process.

All adjustments of coupling and angle are made in this position, i.e., with the primaries and secondaries parallel—and with the receiver connected to antenna and batteries.

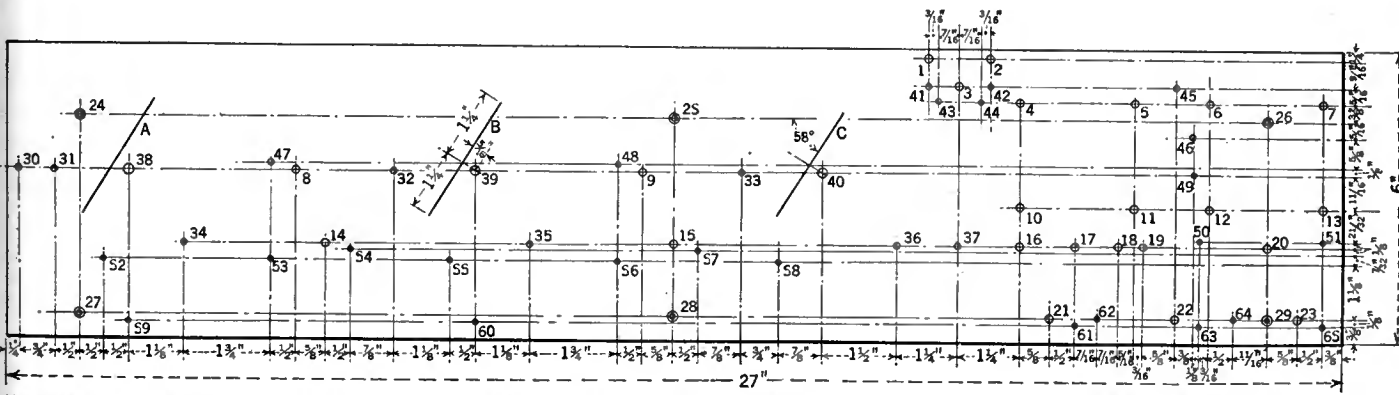

FIG. 4

The sub-panel layout which the author used. If desired, a base-board may be substituted for this panel. On the special panels which are now obtainable for this receiver, the correct angle for the stationary coils is marked clearly with a white line

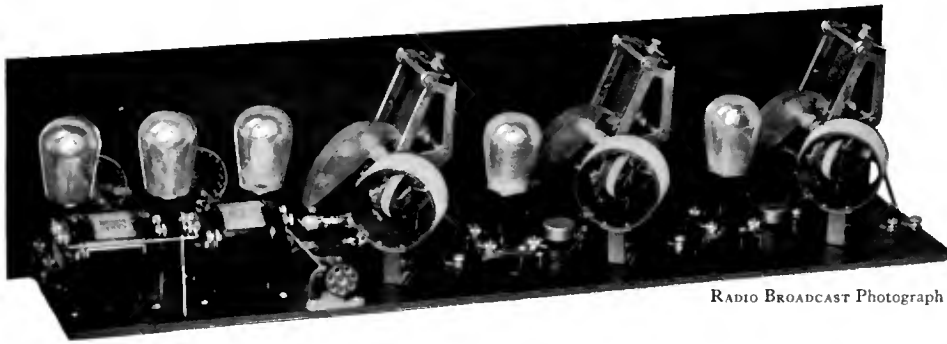
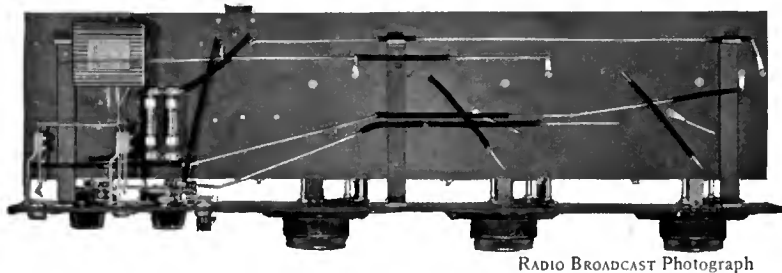

FIG. 5

A behind-the-panel view of the author's receiver, which clearly shows the general arrangement of the coils. The stationary coils may be adjusted in the first case by virtue of the fact that a swivel arrangement, as shown in Fig. 2, is employed

If the coupling between primaries and secondaries is increased beyond certain limits (if the secondary is pushed too far over the primary) the system will become unstable and will oscillate at about 5.2 volts on the filaments (with the rheostats three quarters out). Coupling should be loosened until the circuit is stable at this filament potential. As the coil angle in this first position is purposely high, it will probably be found that, with each condenser tuned to the shortest possible wave, the circuit will again oscillate. The coils are then turned up to close coupling, the

(the normal arrangement, Fig. 8). The loose coupling will raise the resonance point of the antenna circuit to something approaching the wavelength of the tuned station, with a resulting amplified signal. On the longer waves, close coupling will be necessary to secure adequate transfer of energy. However, with an exceptionally long antenna, close coupling on the shorter waves will be desirable in order to lower the inductance of the open circuit. In this latter case, the order of coupling variation will be reversed. Under which of the two possible conditions your receiver works



RADIO BROADCAST Photograph

FIG. 6

There's very little to see from underneath the sub-panel except the filament wiring and the grid battery, etc.

angle slightly decreased (the coils turned in toward the panel), and returned to the short-wave position. If the circuit still oscillates, the angle is further decreased (the adjustment being changed always at maximum coupling) until the circuit is stable over the entire tuning range.

best is easily determined by experiment. To make the coupling loosen as the wavelength increases, it is merely necessary to set the two coils parallel when the condenser is at its lowest capacity. Dependent to a certain degree on the angle of the first coil is the selectivity, while the angles of the other two coils affect stability.

REVERSED COUPLING ON THE FIRST TUBE

AS PREVIOUSLY mentioned, it is occasionally possible that the receiver will function better with a reversed coupling action between the antenna primary and the first secondary, *i.e.*, with the coupling *increasing* as the wavelength is decreased.

There are two antenna conditions, as well as several other interactions, which will determine the direction of coupling movement in this circuit. Whenever two coils are brought close together (the coupling increased) the inductance of these coils is lowered; in other words, they are tuned to a shorter wavelength. This is a simple transformer action. Therefore, when a very short antenna is used, in the average case we will secure best results with loose coupling on the short wavelengths and tight coupling on the long wavelengths

OPERATION

ASIDE from the adjustment of the coils, the operation of the Equamatic five-tube receiver is identically the same

as that of any similar set, such as the conventional neutrodyne. Practically all tubes can be used in this set with the proper A, B, and C voltages. For the indicated potentials, five 201-A type tubes are recommended. If desired, a type 171 tube may be employed in the output socket with increased quality and volume. In this case, a half-ampere Amperite should be used in the filament circuit of the 171 tube, and a separate C battery, of the correct potential, interpolated in the grid return.

The Equamatic receiver tunes with delightful ease, maintaining a remarkably consistent correlation among the three dials over the entire tuning range. The accompanying tuning chart, Fig. 7, will be found reliable on all sets built with the designated parts. Selectivity is perfect, without the knife-edge tuning that causes marked distortion on the short waves, or the broad tuning on the longer waves which characterize the conventional tuned r. f. receiver.

In comparison with a standard neutralized, five-tube tuned radio frequency receiver used in the writer's laboratory, the Equamatic receiver described shows a distinct superiority, particularly on the longer wavelengths.

Articles shortly to follow will describe the application of the Equamatic system to other widely used circuits.

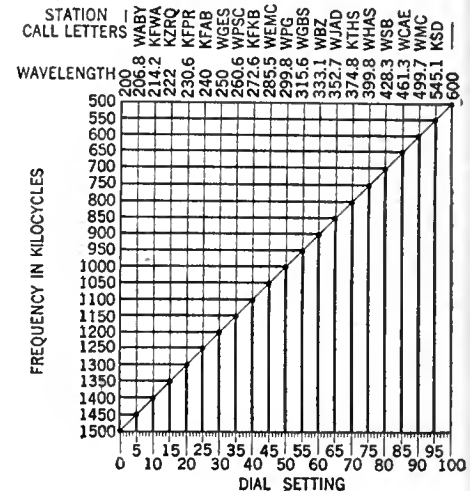
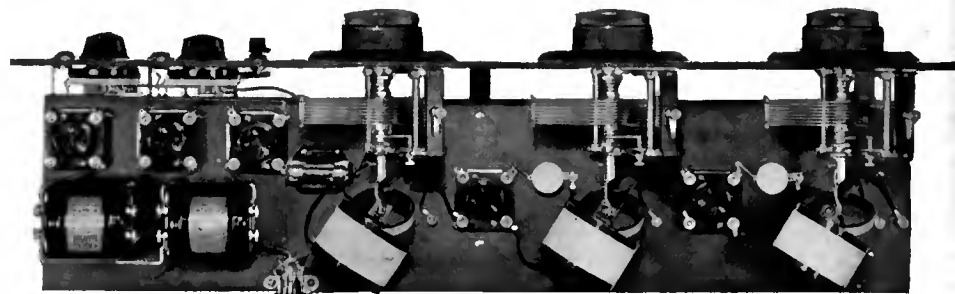

FIG. 7

This tuning chart will be found invaluable by those who build the "Equamatic" exactly to the writer's specifications, for it is surprisingly accurate



RADIO BROADCAST Photograph

FIG. 8

Looking down on the finished receiver. The two pillbox-like "gadgets" behind the two right-hand condensers are the retard coils. The constructional details of these coils are given in the text, but those shown in this picture are factory made

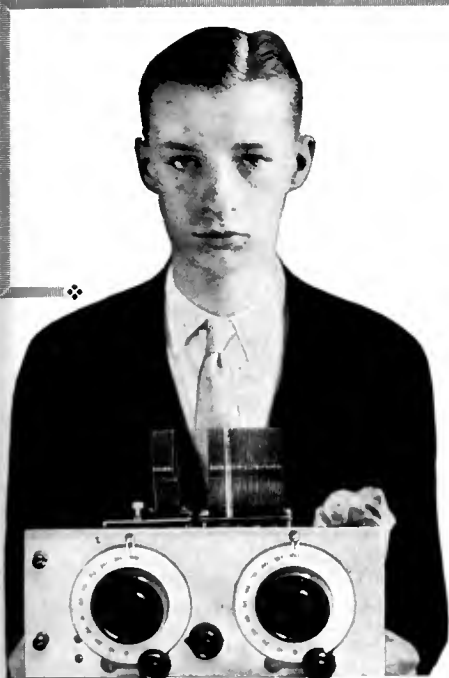

ARTHUR PERKINS (2 APQ)

Who goes with Commander Dyott to the River of Doubt to report by means of a battery operated short-wave transmitter the progress of the expedition. The receiver that will be used by Mr. Perkins is shown in this picture

Radio with the

Dyott Brazil Expedition

The Laboratory of Radio Broadcast Has Supplied Short-Wave Equipment to Three Famous Expeditions, that of Commander Dyott to the "River of Doubt" Being the Most Recent

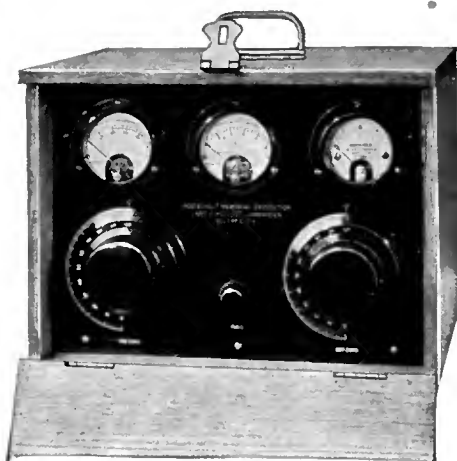

missions of WGY and KDKA while he was in the jungles. We have since heard from this famous explorer that he has been singularly successful in his efforts to listen to the short-wave broadcasts from the outer world and, thanks to the cooperation of the General Electric Company in sending out special time signals, he has regularly been able to ascertain his geographical positions very accurately.

On June 29th, Commander MacMillan sailed for Greenland with two vessels, his own *Bowdoin* and a new schooner, the *Sachem*, built by Rowe Metcalf. On the latter vessel, as radio operator, is Austin C. Cooley who described in RADIO BROADCAST some time ago his experiments in picture transmission by radio. Up to the present time 2 GY has maintained nightly communication with KGBB, the *Sachem*, although she is, as we write these words, in the region of continuous daylight off Greenland. The receiver used by Mr. Cooley was built by the operators at 2 GY. It is similar to the Silver-Marshall set used at the base station of the Dyott Expedition.

WITH the departure of Commander Dyott, of the Roosevelt Memorial Association Expedition, for the River of Doubt, in Brazil, RADIO BROADCAST adds another name to its list of those expeditions which are equipped with short-wave apparatus constructed according to specifications supplied by the Laboratory at Garden City. As generally chronicled in the press, it was on July 24th that the Dyott expedition left New York on its big adventure—to re-explore the River of Doubt, up which Theodore Roosevelt laboriously navigated in 1914, before short-wave radio communication, as it is known to-day, was dreamed of. With Dyott went two complete radio transmitters, a 250-watt short-wave transmitter built for RADIO BROADCAST by the Allan D. Cardwell Corporation, and a small portable set operating from Eveready B batteries. It is intended that the 250-watter, together with a suitable receiver (which was especially built for RADIO BROADCAST), be set up as a base station in a suitably located spot somewhere near the center of Brazil. This station will be under the charge of Eugene Bussey (2 CIL), of Yonkers, while the key of the small portable set, which will advance up the river with the expedition, will be "pounded" by Mr. Arthur Perkins (2 APQ). The equipment used by Mr. Perkins was built by himself to RADIO BROADCAST specifications, with Hammarlund parts.

At the time of writing, little can be told about schedules and wavelengths, as this depends upon restrictions imposed by the Brazilian government. It is probable, however, that the 7500-kc. band (40-meter hand) will be used. The call signals, too, are not yet known, but an endeavor is being made to obtain the use of the calls GMD and 2 GYA for the base station and advance station respectively.

Other expeditions which have been equipped with RADIO BROADCAST apparatus are those of Francis Gow Smith and of Commander MacMillan. Gow Smith sailed many months ago for the wilds of Brazil, seeking more information for the museum of the American Indian. He appealed to 2 GY (the experimental station of RADIO BROADCAST) for a receiver so that he would be able to receive the short-wave trans-



TRANSMITTERS

Which will play an important part during the expedition up the River of Doubt. The small transmitter shown above was built by Mr. Perkins, and will accompany him up the river so that he will be in touch with the base station. To the right is shown the 250-watt transmitter built by Cardwell which will be used to communicate with the outside world from the base station, and with Mr. Perkins up the river

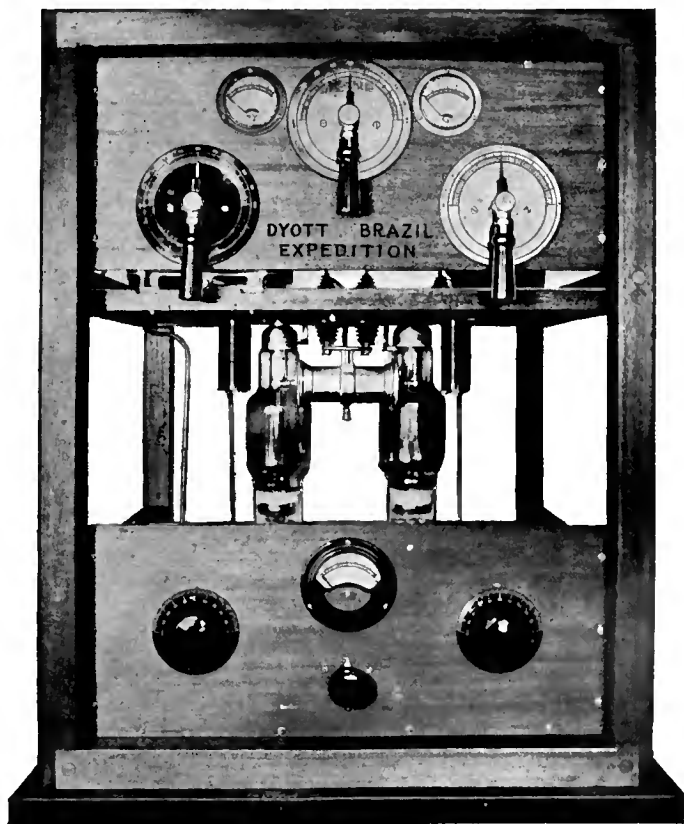

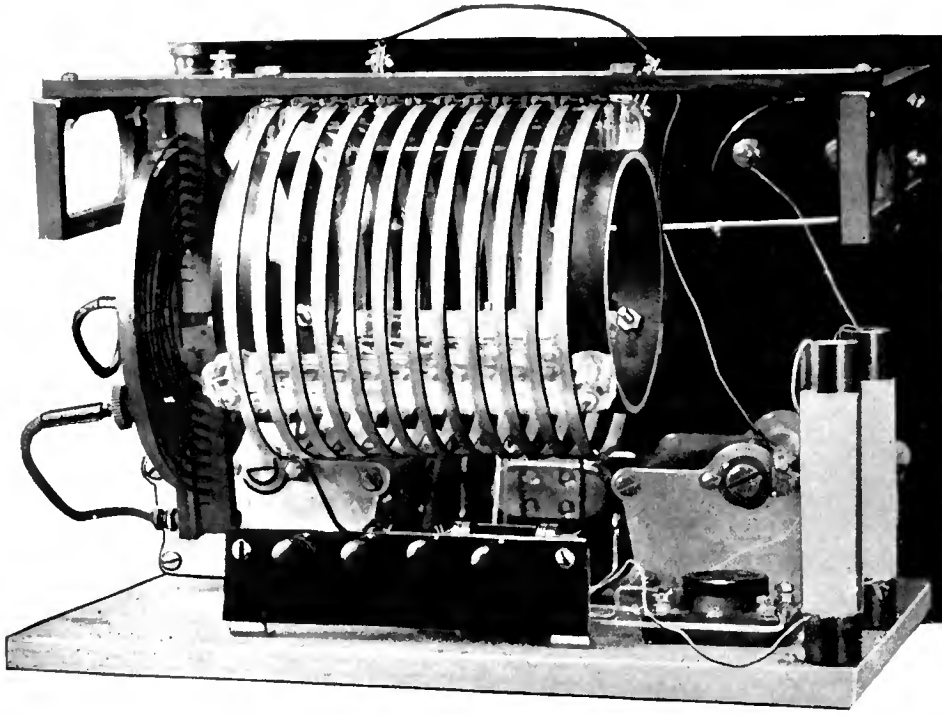

ABOVE

Is shown an interior view of the short-wave portable transmitter which will accompany the expedition up the River of Doubt, and will be operated by Arthur Perkins. Amateurs will recognize the standard short-wave equipment that went into this set. The call 2 GYA may be allotted to this transmitter but definite information concerning this matter is not yet available

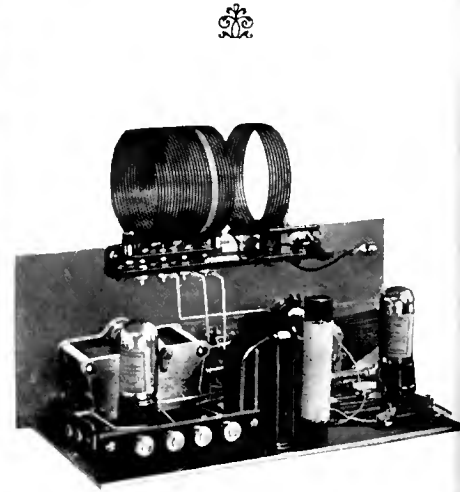

THE ADVANCE SET

An interior view of the receiver which will accompany the expedition up the River of Doubt

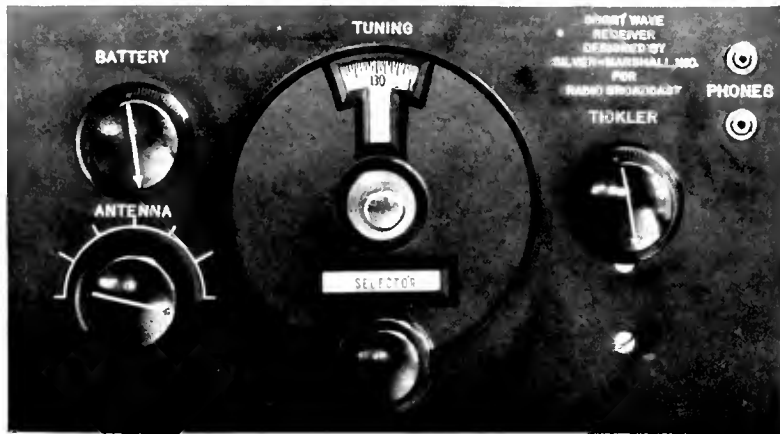

TO THE LEFT

May be seen the short-wave receiver built for RADIO BROADCAST by Silver Marshall to be utilized at the base station of the Dyott expedition. Below: The short-wave receiver built by RADIO BROADCAST for Mr. Gow Smith an explorer now in the very depths of South America. With this receiver he has heard, from the center of Brazil, concerts from WGY and KDKA, and also from London

AT THE BASE STATION

The receiver below will be depended upon for reception of signals from Mr. Perkins and the outside world. This is the rear view of the set built by Silver-Marshall, shown above

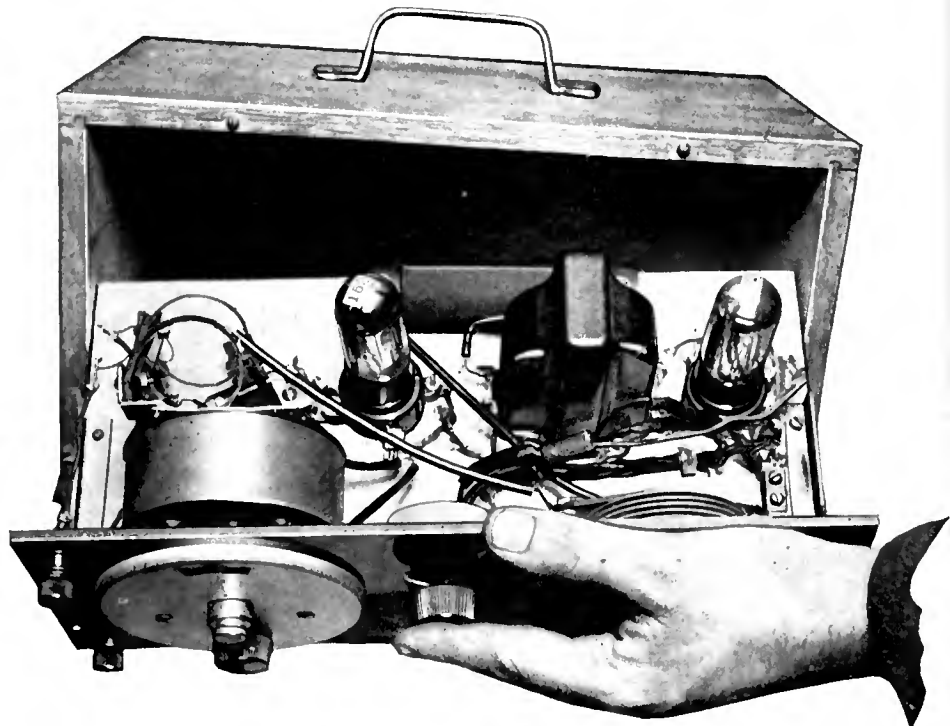

An A, B, C Line Supply Device

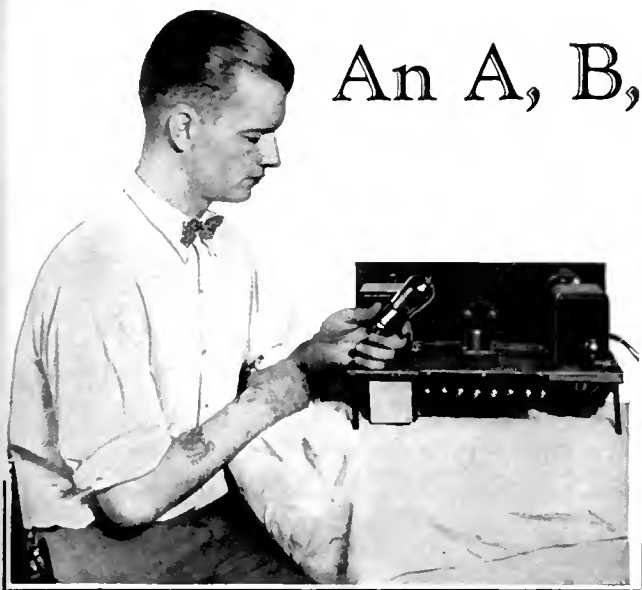

RADIO BROADCAST Photograph

FIG. 1

A rear view of the A, B, C, line supply device shows the simplicity of construction. The operator is examining the new 85-milliamperere Raytheon rectifier tube, the key element to the entire device

RADIO manufacturers everywhere are bending the energies and resources of their development laboratories to an adequate solution of the problem of utilizing the a. c. home supply for radio purposes. It is fairly certain that manufacturers who will place on the market reliable and satisfactory a. c. operated receivers at reasonable prices will enjoy a tremendous sale of these devices. The time is here, if ever, for the presentation of the "light-socket" receiver.

The reasons for the sudden growth of this demand are not obscure. Radio has gradually passed from the experimental stage, in its major aspects, into a state of mature development, requiring the skill and efficiency of trained engineers. The average broadcast listener of today wants reliable performance, high quality reproduction, and ease of control. The keynote of all these virtues is *power*. What better source of power is there than the a. c. light-socket, at an average rate of not more than ten cents per kilowatt hour? Additional advantages offered by the use of a. c. power on radio receivers are the increased reliability, simplicity of maintenance, and ease of control.

Several fundamental differences exist among the various methods in development and in use at the present time, and a brief survey of their respective features will give the reader a perspective of the situation, whereby he can decide for himself the proper method to use in his own radio installation. In the present article, a method will be described in detail for constructing an a. c. operated set at home, using standard parts. The photograph, Fig. 1, shows a power unit designed to supply A, B, and C voltage for receivers employing from three to nine tubes.

Without doubt, the first method employed for operating a radio receiver from a. c. power is that shown in Fig. 2, on the next page. In this circuit, the radio-frequency amplifier tubes, and audio amplifier tubes, are supplied with "raw" a. c. on the filaments. The grid and plate are kept at an average zero potential

A Suitable Unit Which Makes Complete the Elimination of Batteries from the Receiver—A Comparison Between the Costs of A Supply Sources—Adapting the Unit to the Receiver—The New Raytheon Tube

By B. F. ROLAND

from the a. c. filaments by means of potentiometers, which are carefully adjusted to reduce a. c. hum to a minimum. The detector may be a crystal detector as shown, or it may be replaced by a tube detector, operated from a small dry cell. This tube may be

supplied by a separate d. c. filament source, or its energy may come from the plate of the power amplifier tube by placing the filament of this detector in series with the B supply of the power amplifier, as is done in some models appearing on the market this season. Obviously in this case, the detector tube must have a filament requiring not more than the 65 milliamperes current which the plate circuit of the power amplifier can supply. This method of supplying a radio set with a. c. power is very good if it can be properly balanced, but in the hands of any but an expert, it is very hard to eliminate all the hum caused by the a. c. field surrounding the filament leads. If, when using the "raw" a. c., one-volt oxide coated filament tubes are employed, such as the WD-11, WD-12, or Western Electric N type, much better results can be obtained than by the use of standard 201-A type tubes. This was suggested to the writer by Keith Henney of RADIO BROADCAST Laboratory. In either case, the potentiometers must be readjusted every time the filament temperature is changed. If a toy transformer is rewound to have a center tap accurately placed it may be used instead of the potentiometer.

One modern receiver on the market now em-

ploy a method similar to that shown in Fig. 2, using UX-112 tubes for all amplifier stages. Western Electric 216-A or VI-2 tubes will be found to give equally good results. In any arrangement of this type, the last stage audio tube is a power amplifier connected in the usual manner. Proper C batteries must be employed in the various stages to make sure the amplifiers are operating on the straight portion of their characteristic, thus assisting to eliminate the possibility of a. c. hum. The B battery potentials of the receiver in Fig. 2 are obtained from customary sources.

TYPES AND COST OF A POWER SUPPLY

ANOTHER method of supplying A power to radio receivers is by means of the storage battery and "silent" or "trickle" charger. In this arrangement, advantage is taken of the smoothing properties of a storage battery to filter out the ripple in the pulsating d. c. obtained from the battery charger. There are two general types of this class of service, depending upon the choice of rectifiers. The first is the electrolytic, which includes either lead-aluminum cells with borax or ammonium phosphate electrolyte, or the tantalum-lead cell with sulphuric acid as an electrolyte. The normal charging rate of these rectifiers is from 0.25 to 0.50 amperes at 6 volts, and if the trickle charger is operated 24 hours a day, the energy consumed by the average five- or six-tube receiver will just about equal that delivered by the trickle charger. The cost of energy obtained in this manner is approximately seventy cents per kilowatt hour at the receiver, assuming an overall efficiency of 15 per cent. The second type of A power supply

in this class contains a gaseous discharge type of rectifier, and is capable of supplying d. c. to a storage battery up to 2 amperes. On account of the power required to heat the rectifier filaments, the overall efficiency seldom exceeds 8 per cent., and the average cost of power in this instance is approximately \$4.00 per kilowatt hour, including fixed charges and replacement costs on the charger, rectifier, and storage battery. The trickle charger method is probably the most satisfactory plan developed at the present time for the supply of separate A battery power from the light socket. It is economical, reliable, and does not impair the quality of reproduction by a. c. hum as is often the case in supplying raw a. c. to the filaments. The main objection to its universal adoption is the use of the storage battery which often gives off corro-

THIS article describes an easily built device which will supply A, B, and C potential in sufficient quantity for a receiver using up to eight or nine tubes. This supply device, as designed and described here, is applicable for filament supply only with such sets as use the 199 type tubes—connected in series. That means that if this unit is to be used with an existing receiver, the filament circuit must be rewired as directed in these pages and only three-volt tubes can be used. This device will supply: 6 volts a. c. for lighting the filaments of power amplifier tubes, up to 50 volts C potential, up to 200 volts of B potential, and will supply up to 60 mils. of filament current to as many as 9 three-volt tubes in series. Although the unit described here requires the rewiring of the filament circuits to a series connection, this unit should please many radio constructors who are anxious to have a really dependable source of current supply for their sets. This article will serve to introduce the new type BH Raytheon tube whose sphere of usefulness is much larger than the old type B. No critical adjustments are necessary with this unit when the a. c. line voltage changes, and no parts are listed which are not easily had. This model has the approval of the Laboratory of the Raytheon Company and also of RADIO BROADCAST Laboratory.

—THE EDITOR.

sive vapors and needs frequent attention for proper performance.

Neither of the foregoing methods closely follows the general principles of the modern and efficient B-power supply, employing transformer, rectifier, and filter. When the values of current and voltage are considered with reference to A-battery filter circuits, it is not surprising that there has not yet been developed a commercial A power supply along these lines. Dr. Vannevar Bush said at the last Radio Manufacturers Association Convention: "For every microfarad required to produce a certain degree of smoothing at 60 volts, there are required 1000 microfarads for the same degree of smoothing of the same power at 6 volts." The physical dimensions of A filter circuits are, therefore, beyond the scope of economic design. Fairly satisfactory A filters have been built along the lines shown by Fig. 3. Here the customary filter condensers are replaced by resistances. The chokes occupy the usual series position, serving to divert the a. c. through the shunt resistances while allowing the greater part of the d. c. to pass on to the radio receivers. The filtering efficiency of this type of circuit is good if enough current is allowed to pass through the resistances. This current usually attains a value of approximately 30 per cent. of the output current and hence it imposes a large load on the rectifier that does not serve any useful purpose. The overall efficiency of a 6-volt 1.5-ampere device of this type was measured and found to be 6 per cent., making the cost of A power at the receiver approximately \$2.75 per kilowatt hour by this means.

FILAMENTS IN SERIES

A LOGICAL solution to the difficulties of A power filtering is to connect the filaments of the radio tubes in series. Under this condition there are higher voltages available, making it possible to use condensers to advantage, and the current consumed is so small that the filter choke coils are of reasonable proportions.

In Fig. 4 will be found a schematic diagram of the power unit illustrated in Fig. 1. This device will supply voltages and currents as follows:

- A Battery—60 milliamperes—6 to 30 volts.
- B Battery—up to 25 milli-
amperes at $\begin{cases} 200 \text{ volts} \\ 90 \text{ (variable) volts} \\ 45 \text{ (variable) volts} \end{cases}$
- C Battery—From 0 to 30 volts.

The use of the device is, of course, restricted to radio receivers employing tubes similar in characteristics to the UX-199 or DV-3 tubes with filaments wired in series, and under these conditions its performance as a universal power supply is ideal. The device illustrated is adaptable to any type of radio circuit and has been used with success on a three-circuit regenerative set, the Browning Drake, and tuned radio frequency receivers, with variations of each type. Transformer-resistance- or impedance-coupled amplifiers have been employed indiscriminately with equally good success.

In Fig. 4, T₁ is the General Radio power transformer designed for 50 watts, 110 volts, at full load. The high voltage secondary provides 350 volts each side of the tap at the center at no load. The third winding, T₂, provides 5 volts at 5 amperes for the "raw" a. c. filament supply of

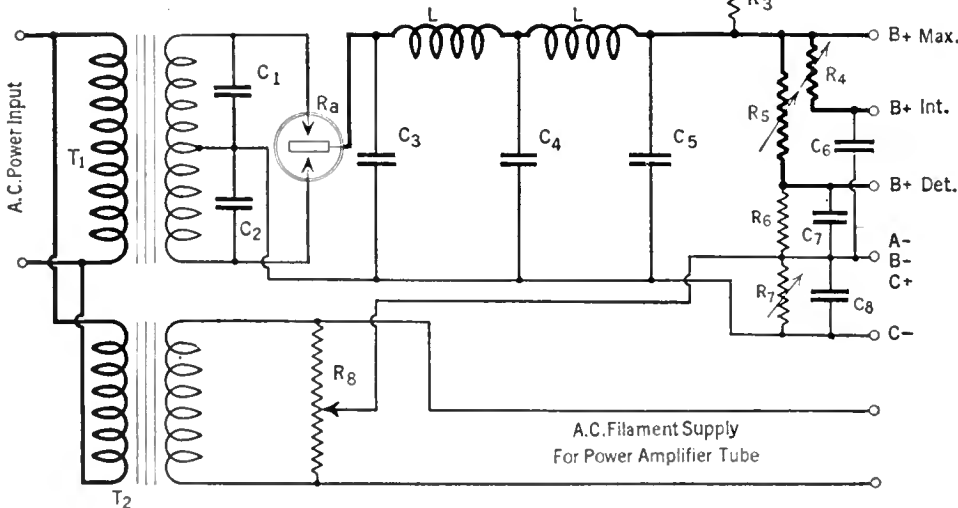

FIG. 4

The complete circuit diagram for the A, B, C line supply device described herewith, is shown above. The parts employed as listed, may be identified as follows: Ra, Raytheon type BH; R₁, Ward Leonard 5000 ohms; R₂, Federal No. 25 Potentiometer; R₃, Ward Leonard 3000 ohms; R₄, Clarostat; R₅, Bradleyohm No. 10; R₆, Ward-Leonard 10,000-ohm fixed resistor; R₇, General Radio No. 214 Potentiometer; R₈, General Radio No. 214 Potentiometer; C₁, 0.1-mfd. condenser; C₂, 0.1-mfd. condenser; C₃, 4.0-mfd. condenser; C₄, 4.0-mfd. condenser; C₅, 6.0-mfd. condenser; C₆, C₇, C₈, 1.0-mfd. condensers (condensers used in this model are Tohe Deutschmann but others with an operating voltage of 350 volts may be used); A, 0 to 75 m.a. milliammeter; L, General Radio type 366 choke, 25 henries at 85 m.a., d.c.; T₁, type 365 General Radio transformer supplying 350 volts per anode; T₂, Brach 8-volt bell transformer supplying 5 volts at ½ ampere

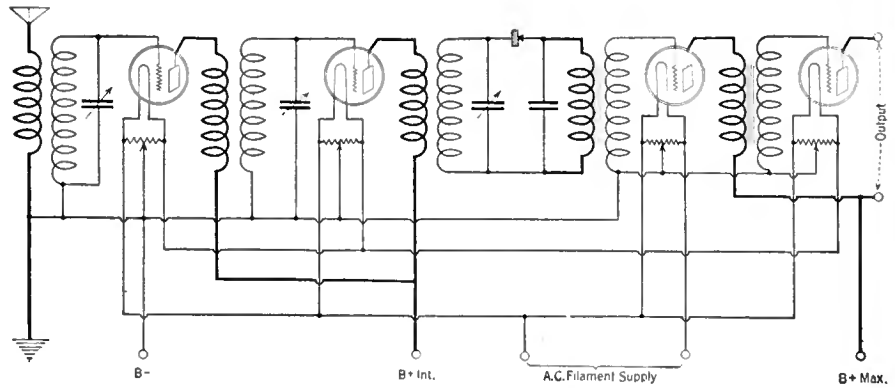

FIG. 2

A four-tube circuit which utilizes merely the stepped-down a.c. for energizing the filaments of the tubes. Since, where a crystal detector is used, the raw a.c. may be applied to the amplifier tubes, there is no need for rectifier or filter

an UX-112 or UX-171 power-amplifier tube. This may be supplied by a separate filament lighting transformer. In this construction, a Brach unit serves the purpose nicely. Across each half of the secondary of T₁ is connected a 0.10-microfarad buffer condenser, c₁ and c₂, of the 1000-volt flash test type. The outer ends of this winding are connected to the filament terminals of a

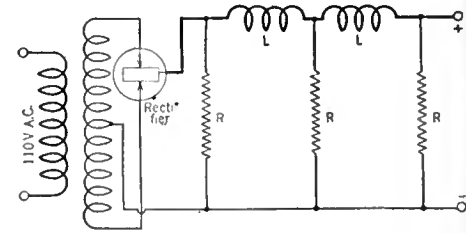

FIG. 3

Line supply devices may employ several systems of filtering the rectified a.c. Here is shown one using resistances instead of bulky bypass condensers

standard ux type socket, into which is plugged the new type BH Raytheon rectifier, Ra. The plate terminal of the socket, corresponding to the cathode of the Raytheon tube, is connected to the plus side of the filter circuit.

The filter circuit of this power unit includes choke coils, L, capable of passing 85 milliamperes direct current without heating, and having a residual inductance of at least 25 henries per choke at this value of direct current. The General Radio type 366 standard B-substitute choke is admirably suited for this service. Others which fulfill the above requirements will probably be equally satisfactory. The filter condensers are arranged in order as shown in Fig. 4.

The voltage-control unit shown at the right-hand end of Fig. 4 has been tried under all conditions, and has given good service. There was some difficulty in obtaining proper values and current-carrying capacities of the various resistors and, after considerable testing, the units specified were adopted. All of the parts in the control unit may be obtained from regular stock of the various manufacturers or their dealers.

For the plate voltage of the power-amplifier tube, the maximum B plus is taken directly from the terminals of the filter circuit, as shown in Fig. 4 as B+Max. amp. This terminal provides approximately 200 volts at full load. A Clarostat, R₄, is used to control the voltage output of the next lower tap (B plus Int.) and will give from 90 to 135 volts approximately at the usual plate-current drain at this voltage. The

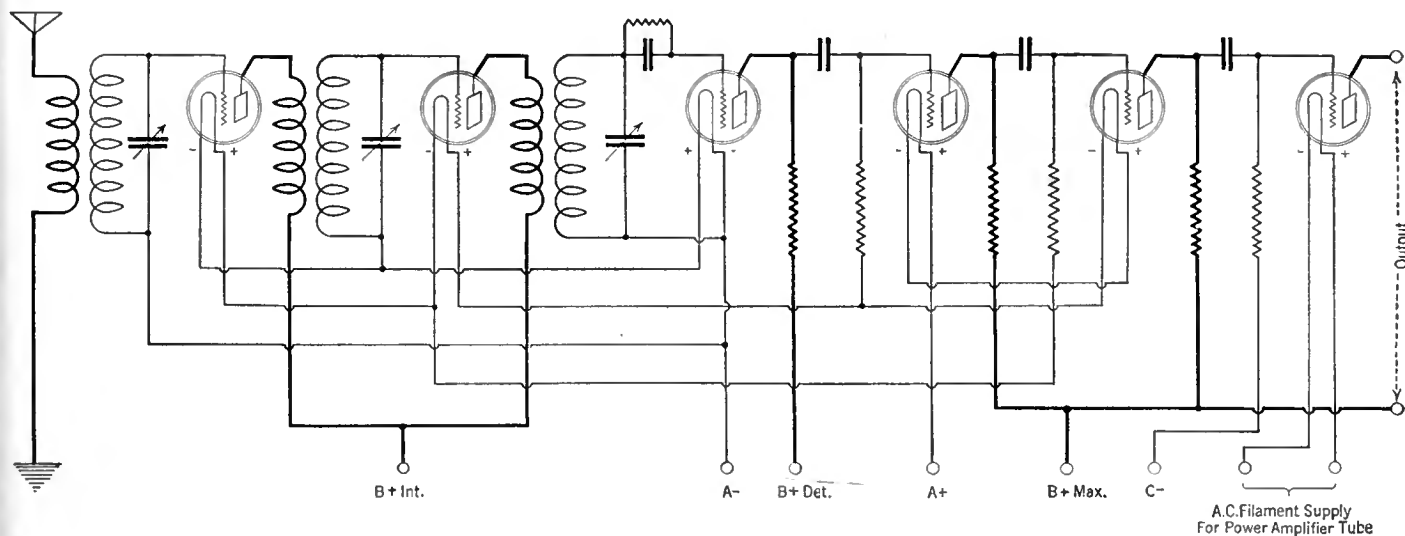

FIG. 5

To employ the line supply device described, the filament circuit of the receiver with which it is to be used must be altered so that all the filaments are connected in series. Then 199, or other 3-volt tubes, replace those formerly used, with the exception of the last stage wherein a power tube, such as the 112 or 171 may be employed. The circuit above is a typical five-tube, tuned radio-frequency receiver employing resistance-coupled audio frequency amplification

B-plus detector tap is obtained through the use of another Clarostat or a Bradleyohm No. 10, R₅; One-microfarad condensers are connected in both of these cases from the B plus variable to B minus to bypass rheostat noises, and to prevent undesirable coupling between the various amplifier stages.

THE C BATTERY SUPPLY

THE C battery is obtained from a wire-wound variable resistance of the proper value. As this resistance carries the full load current of the eliminator, it must be designed to carry from 70 to 85 milliamperes without change of resistance, and without excessive heating. If high C voltages are desired, say up to 60 volts, the Federal No. 25 potentiometer is a good resistance to use here. It has a maximum resistance of 1850 ohms, and will carry the full load current fairly satisfactorily. A General Radio No. 141 potentiometer may be used in this position to supply C voltages up to 34 volts, and does so with much less heating. A 1-mfd. condenser is connected from C plus to C minus to prevent undesirable coupling effects and distortion. If 60 volts C bias are required and 85 milliamperes pass through the resistance

supplying it, the power that must be taken care of is 5.1 watts.

The a. c. filament winding, T₂, may not be available to the average constructor who may have access to a 50-watt transformer having other satisfactory windings. In this case a Thordarson doorbell ringing transformer may be used to light the filament of the power amplifier tube. This transformer will be found to give the proper voltage without a filament rheostat for the UX-171 and UX-112 tubes using the winding marked "6 volts." A 400-ohm potentiometer, R 8, is connected across the 5-volt a. c. supply and the center tap is returned to the B minus terminal of the supply unit. The adjustment of this potentiometer is very critical in order to eliminate all a. c. hum from this source.

The A plus terminal of the power supply is obtained by dropping the B plus max. through a suitable rheostat to the required A-battery voltage. The resistance used in this position should have a range of from 3000 to 5000 ohms, and a current-carrying capacity of 60 milliamperes. As there was no rheostat of these requirements available, the writer used a combination of fixed and variable resistances to achieve

the degree of control required. A fixed Ward Leonard 3000-ohm unit was placed in series with a Ward-Leonard 5000-ohm fixed resistor, around which was shunted a Federal No. 25 potentiometer. With this arrangement, the required degree of current control was attained.

A filament milliammeter having a scale reading of 0-100 mils or better yet 0-75 mils is placed in series with the A-plus lead going to the radio set, and by means of the rheostat and the milliammeter, a constant current of not over 60 milliamperes can be held at all times. If the latter type of meter is not readily available at the local dealer it may be obtained from such companies as the Weston Electrical Instrument Corp, or the Jewel Electrical Instrument Co. An adjustment of the filament current will have to be made when first turning on the receiver and, after the first two or three minutes, no further adjustment need be made. Very wide fluctuations of the 110-volt house supply voltage (i.e., greater than 10 volts) will, of course, affect the value of filament current, but it will be found that setting the milliammeter at 58 milliamperes will give excellent amplification, and make allowance at the same time for those line-voltage variations which come within the usual range.

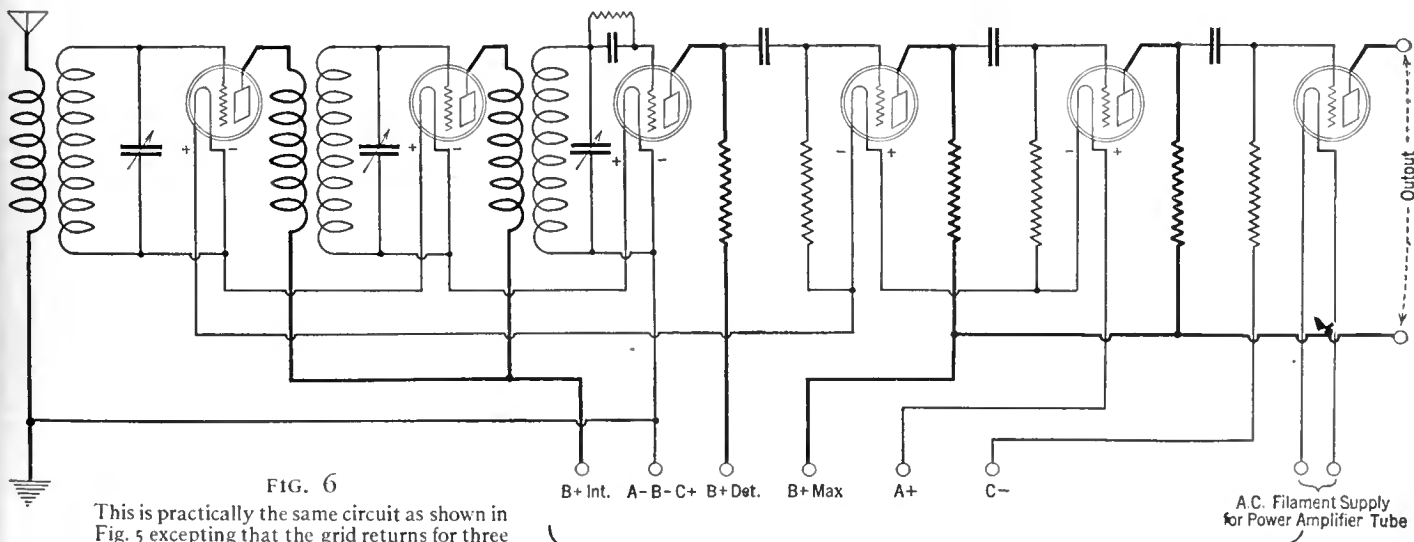
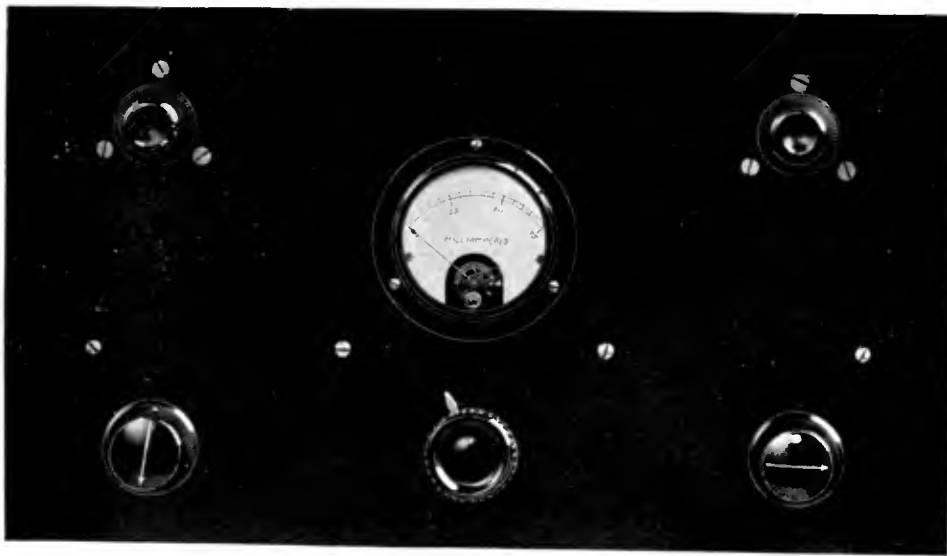

FIG. 6

This is practically the same circuit as shown in Fig. 5 excepting that the grid returns for three of the tubes are connected differently so that other grid bias potentials may be obtained

Terminals corresponding to those of the Raytheon A.B.C. Power Unit



THE FRONT VIEW

RADIO BROADCAST Photograph

Of the line supply device presents a very pleasing appearance. It is suggested that, if the construction of a housing for this device be attempted, perforated sheet brass or just plain sheet brass with vent holes made therein, be employed

The variable arm on the 400-ohm potentiometer is set at such a point that a minimum a.c. hum is heard in the head phones when no signal is being received. It can then be left in this position without further attention. In case it is necessary to reduce the a. c. voltage available from the 5-volt winding by means of a rheostat, it will be necessary to readjust the potentiometer every time a change is made on the rheostat setting.

The experimenter desiring to build the A, B, C line supply device described in this article will find the various drawings and photographs very helpful. The different units should be mounted on the panel and base-board drilled in accordance with the drilling templates shown in Figs. 7 and 8. After mounting the parts, the base-board may be screwed to the panel and the wiring done. It will be wise to follow the exact layouts of wiring that proved to be successful in the model that was made up. The arrangement of wires is evident from the photographs. Cover all the bus bar with spaghetti so as to prevent any accidental short circuits.

Figs. 5 and 6 show conventional radio circuits which have been revised in accordance with the demands imposed by connecting the radio tube filaments in series. Any of the standard radio circuits may be revised and thus adapted to series filament service if the few fundamental features outlined below are observed.

There are, in general, two methods whereby the tube filaments may be successfully operated in series. The first method, employed in some of the Bell System circuits, makes use of the voltage drop in successive filaments as a source of grid bias in certain tubes, thereby raising the maximum value of plate voltage which may be applied to these tubes. This method is acceptable provided the current in the filament circuit is sufficiently uniform and without a. c. ripple, which would introduce a. c. hum and modulation of the radio signals. This method is somewhat more efficient from the standpoint of the amplification obtained and, if care is taken to obtain the proper bias on the various grids, it will undoubtedly serve the constructor in the most desirable manner. See Fig. 5.

The alternative method, which is perhaps simpler from the construction standpoint, is to disregard the various filament drops and connect

the grid return lead of each stage to the negative side of the respective filament. See Fig. 6. It will naturally be necessary in this arrangement to reduce the plate voltage applied to these tubes to normal values consistent without grid bias. If the second method is employed, it is not necessary to provide such a high degree of filtering in the A-current supply. As high as 5 per cent. ripple has been used by the writer in this connection without too noticeable a hum in the speaker.

The power unit described in this article gives a very high degree of filtering, and the filament voltage drop can therefore be used as grid bias if the constructor desires. In this case all of the constants of the circuit must be carefully maintained. For example, the filter chokes must have a residual inductance at 85 ma. d.c. load of not less than 25 henries. The filter condensers should be arranged exactly as shown in Fig. 5, the first condenser having a capacity of 4.0 mfd., the second also 4.0 mfd., and the terminal capacity from 6.0 to 12.0 mfd., in proportion to the quality of reproduction which the builder desires. The bypass condensers placed from the variable B plus terminals to B negative and from C plus to C minus, are necessary to reduce

rheostat noises and to reduce interstage coupling to a reasonable value. Their capacity should therefore be not less than 1.0 mfd. for a margin of safety. The variable C battery, provided for the grid of the power amplifier tube, is controlled by means of the variable resistor R, in Fig. 4. The value of C battery can be roughly calculated from the product of the total load current from the power supply set, and the resistance included in the A-battery rheostat. If exact values are essential, the C voltage may be measured by a high-resistance voltmeter,

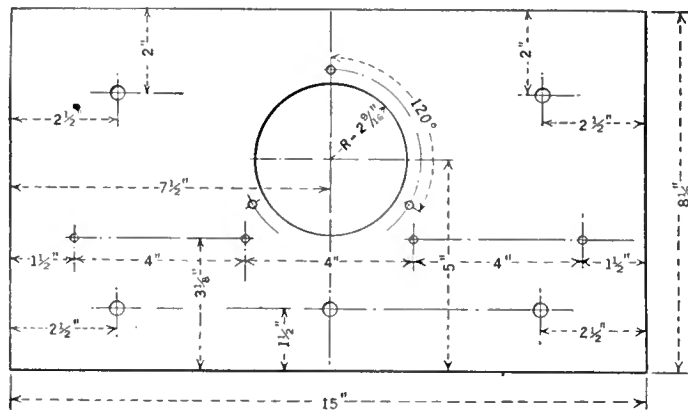
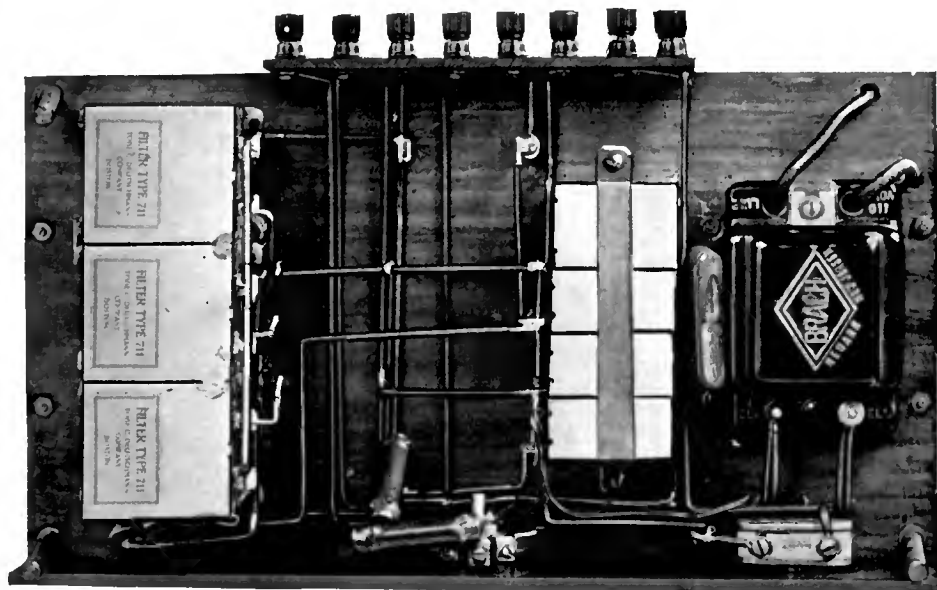

FIG. 7

The panel for the line supply device is not of the standard 7-inch width but is 8 1/2 inches wide. The dimensions shown above enable the constructor to duplicate layout and placement of parts as shown in the accompanying photographs



THE BOTTOM VIEW

RADIO BROADCAST Photograph

Of the "works" assembled underneath the sub-base shows that most of the wiring of the unit is out of sight

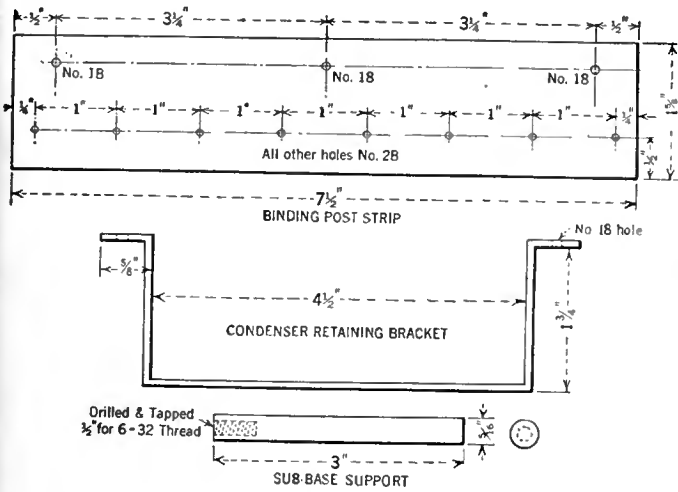

FIG. 8

A binding post strip, condenser bracket and sub-base supports may be laid out as shown here

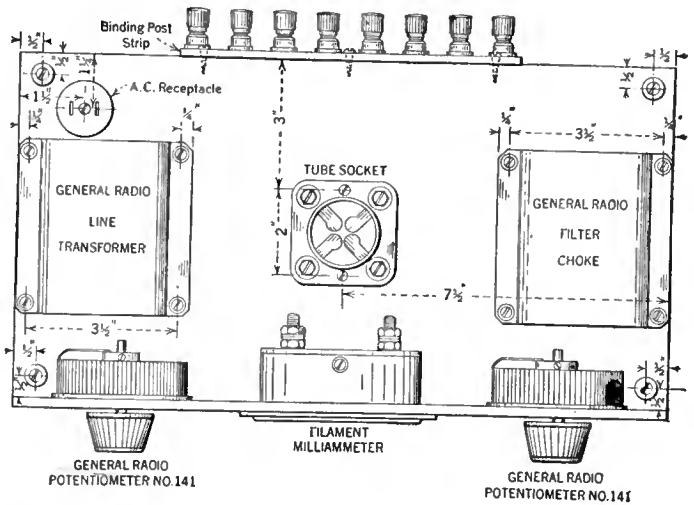

FIG. 9

Upper view of the sub-base layout. Compare this with the top view. Strict adherence to the layout shown is advised for best results

taking into consideration the amount of current drawn by the voltmeter from the power-supply circuit. This determination is not ordinarily necessary, as improper bias on the power tube will very soon become apparent from the distortion produced.

The method of operating a radio receiver with filaments connected in series is perhaps unique to many experimenters who are accustomed to constant voltage control, and for this reason the experiences of the writer may be of benefit. In the first place, it will be noticed that most of the 199 type radio tubes give at least as good service on 58 milliamperes filament current as on 60 milliamperes. Very frequently it is possible to lower this value to 56 milliamperes without lessening the degree of amplification, and in no case should it be

necessary to increase the filament current over 60 milliamperes. The 6V-3 type filaments have a useful range of 60 to 65 milliamperes. In starting up the power unit for use in connection with a radio receiver, first place the rheostat setting at minimum current position, and, if it is known that the minimum current is more than 50 milliamperes, it will be much better to place a 10- or 15-watt 110-volt tungsten lamp in series with the A supply to the radio set. Then, when turning on the 110-volt a.c. supply, take note of the milliammeter reading, to be sure there are no short circuits around the protective resistances. If the milliammeter reads zero, there is possibly an open circuit somewhere in the A circuit, or one of the 199 tubes has a burned-out filament. If the milliammeter reads 50 milliamperes or less,

gradually increase the setting of the A rheostat until the filaments are consuming from 55 to 60 milliamperes. The B supply voltages should now be checked over and adjusted to their proper values. The potentiometer across the a. c. filament of the power-amplifier tube should be

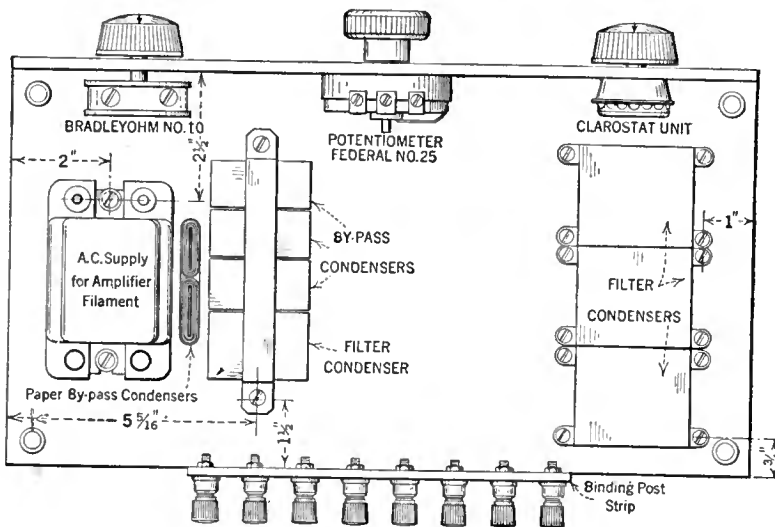
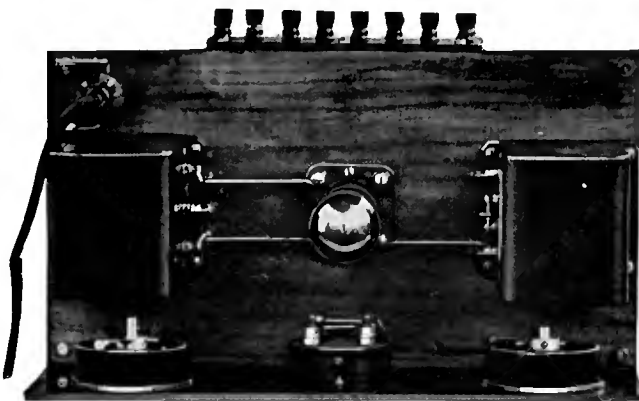

FIG. 10

This picture layout, together with the accompanying photographs, will aid materially in correctly locating the various apparatus employed in the construction. An under view of the sub-base is shown



A TOP VIEW

Of the A, B, C line supply device. The use of the 85-mil. Raytheon tube makes possible the use of this unit as a source of supply for the filaments of 199 or other similar tubes

adjusted very carefully to give minimum a.c. hum when no signal is being received, and then the C voltage on this tube should be adjusted to the proper value. The filament supply may again need adjustment, setting the rheostat to give approximately 58 milliamperes for 199 type

tubes, and 63 milliamperes for 6V-3 type tubes.

The effect of a.c. line voltage variations upon reception will not be noticeable for normal and adequate wiring installations. A setting of 58.5 milliamperes on the filament supply will give a variation of 57 to 60 milliamperes with a line voltage variation from 105 to 120 volts. This variation in voltage is normal, and will not effect any change in volume of reproduction on most radio receivers. When turning off the power unit, it will be found advisable to place the A-supply rheostat at a minimum setting again, in order to offset the harm which might be done by a high line voltage when turning on the power unit again. With a little care, the operator will soon learn to rely upon his filament ammeter and the rheostat as the only elements of his power unit which require frequent attention.

THE NEW RAYTHEON TUBE BH

THE new Raytheon type BH tube is an improvement on the type B tube which supplies the need for an adequate B power supply rectifier. The advances in the design of the type BH tube increase the full-load rating to 85 milliamperes and 200 volts continuous d.c. load. The safe maximum a.c. voltage that may be applied to each anode has been placed at 350 r.m.s. volts a.c.

When the type BH Raytheon is placed in a B-power line supply unit which has been designed for use with the type B Raytheon, there will be an average increase in voltage output of 25 volts for the same radio set. The regulation of the type BH tube is so much that it has a practically constant voltage drop from 15 to 85 milliamperes of rectified current. For this reason, the regulation of B-power line supply units, using the BH type tube, can be made remarkably good.

The Listeners' Point of View

Conducted by — John Wallace

Sad News: Why Radio Cannot Educate

AS THE result of a few random and slightly derogatory remarks made in the June number, concerning the educational possibilities of radio, your humble servant, the above-signed, has been "taken for a ride" by numerous indignant readers. We said at that time that we did not believe that radio could educate. To that statement we added the compromise: "Most of the 'blah' we read about radio as an educational factor is sincere enough and can be made true enough by the simple device of substituting the word 'informational' for 'educational,' wherever the latter appears."

On neither of these points, readers' letters notwithstanding, has our opinion changed. But we confess we were at fault in attempting to dispose of the subject in a couple of paragraphs. For education, from whatever angle you approach it, is a verbose subject and can not be tackled without considerable wordshed. And so the following, by way of elucidating our viewpoint.

The value of radio as an educational force has not been correctly estimated by either the *pro's* or the *con's*. Those individuals who have a personal interest in the matter are inclined to overestimate radio's teaching ability enormously. If you have perused any of the publicity material ladeled out by the radio education fanatics you are acquainted with the extravagance of their claims. Radio, it would seem from their accounts, is a civilizing force of epochal import. Almost overnight it is going to transform a world of yokels into a world of supermen. This contraption—radio—is a personal gift from the gods to them; and they mean to turn it, as far as possible, to their purposes. With it, they aim to place a school "marm" in every home, and breed a race of mental marvels. The purely amusement features of radio, in their opinion, are of secondary importance and only to be tolerated. This is manifestly silly. Radio is first of all an agency for entertainment. Its pedagogical rôle is decidedly of secondary consideration.

We have a deep seated prejudice against that type of mind which demands of every instrument of human devising that it serve the purpose of "uplift"; which insists that every new contrivance justify its existence by showing wherein it is of "Service"; and wherein it makes for progress. If radio is amusing, and it is, that alone is quite enough to justify its being; and it is under no compulsion to apologize for that virtue by doing missionary work on the side.

But if interested parties vastly over-estimate radio's potentialities in this field, it is likewise true that the average person is likely to underestimate greatly the undeniable instructive value that radio does possess. The listener who invariably makes haste to tune-out anything that savours of the lecture hall can have no idea of the scale upon which radio education is being attempted, nor of the success it has, in certain quarters, attained.

When we declare pigheadedly that radio cannot educate, perhaps our principal quarrel is a mere quibbling with words. The phrase "radio education" involves an unhappy choice of words. Substitute the expression "radio instruction" and we acquiesce to most of its claims. "Education," according to Mr. Webster, "implies development and discipline of both the intellectual and moral faculties. 'Instruction' and 'teaching' apply to the communication of knowledge."

The "educated" man and the "informed" man are horses of an entirely different color. In other words, the possession of a vast fund of information does not make a man educated. It is far more likely to make him a bore. Conversely, an individual may be in deplorable ignorance of the principal rivers of Asia or the line of succession to the British throne and yet

possess what Mr. Webster calls "well disciplined moral and intellectual faculties."

For reasons which are easily apparent, radio can in no wise discipline the mind. To cite only one reason, mental discipline is gained almost exclusively from the study of so called "cultural" subjects. But cultural subjects are utterly unbroadcastable. Imagine learning Philosophy or English Composition or Psychology or Calculus or History or Sociology by radio! But radio can inform. For informing is no complicated task; it consists simply in the presentation of facts. As long as radio sticks to the simple presentation of facts, well and good. When it aspires to the teaching of such lofty and controversial subjects as Sociology or History, pooh to it!

The instructive value of radio may be considered from two points of view; first, that not consciously intended as instructive; and, second, that which is deliberately planned because it is instructive. Under the first point of view the value of radio is by no means negligible. The listener who is entertained at first by cheap music, partly because of the novelty of the radio experience, soon grows tired of hearing the same thing over and over again. He wishes something better just as he wishes an improved receiving set. Hence, the stations are requested to

present a better class of music. And, as the listener becomes critical of music, he also comes to demand more of speakers. They must say something worth while and say it in a clear and convincing manner. The more speeches he hears the more comparisons he makes, and the more critical he becomes. This means a demand for better speakers. And so in this way, gradually and slowly and surely, public taste and judgment are improved.

Radio programs which are deliberately planned for instruction can be roughly divided into three sorts; first, those which are broadcast by universities to supplement their extension courses; second, those which are broadcast especially for reception in the class rooms of secondary schools; third, the miscellaneous and occasional lectures broadcast by any old station for whoever cares to listen.

The Kansas State Agricultural College (KSAC) was one of the first of the universities to make systematic use of radio in connection with its work. From the beginning of the school year in September until late in the following spring, a regular schedule of lectures is broadcast to hundreds of listeners who are registered for these courses. In addition to those



LEADER OF THE ANGLO-PERSIANS

Louis Katzman, who conducts the orchestra "Whittall Anglo-Persian" heard through WEAJ and "the chain" every Friday evening from 10 to 10:30 p. m.

who are registered, correspondence received at the college indicates that several times as many listen-in more or less regularly on the educational talks. The lectures cover a wide variety of topics, such as crop and livestock production, dairying, poultry raising, foods and nutrition, household economics, English, chemistry, botany, zoölogy, and the several major engineering fields.

These radio lectures constitute a sort of glorified correspondence course, in that those who are taking the course have the added opportunity to hear the voice and thus have, in a measure, the personal contact with the teacher which heretofore has been limited to the classroom. After each lecture is given, mimeographed copies, with such additional tabular and illustrative matter as may be desirable, are mailed to the registered listeners-in. At the end of the course an examination is given, and those who show evidence of proficiency are given a certificate. In some institutions, definite

An interesting feature of the programs of several of these institutions is the half-hour of opening exercises which they are broadcasting for schools. The State University of Iowa broadcasts opening exercises for high schools which are received by some 200 of these schools. The Kansas State Agricultural College broadcasts exercises for rural schools and, in one or two states, plans are under way for broadcasting messages to schools by the state departments of public instruction.

"Educational" broadcasts which are picked up by receiving sets in grammar or high school classrooms are, at present the most provocative of results, for teacher is present to see that Willie and Mary get the most good out of it—if there is any good to be got. At present writing an experiment along this line is being conducted in the Chicago schools, which we shall watch with interest.

"Educational" broadcasts which emanate from commercial stations at irregular intervals

and are picked up quite accidentally by an altogether casual listener are, we believe, absolutely worthless. The stuff goes in one ear and out the other.

But it is the "educational" broadcast which is offered by some University in conjunction with its regular correspondence courses that possesses the greatest possibilities and demands the greatest respect. For here, we enthusiastically concede, radio has a chance to be of undeniable service. Given an ambitious youth with a thirst for knowledge, who is, for some reason, unable to go to a college—if he is enrolled in a correspondence school his zeal to learn cannot be doubted. And if he has zeal to learn he can turn to good advantage any opportunity along that line—even radio instruction! It is to the assisting of such individuals that directors of "educational" broadcasts should turn their best effort. And they are going to have to expend considerable effort to make these radio courses worth while.

An Effective Use of the Phonograph in Broadcasting

THE use of phonographic records for material hearkens back to the earliest days of broadcasting. However, WGN managed to revive this ancient method in an interesting manner, making use of the same idea that prompted their series of "Old Time Prize Fights." Four former Presidents, Theodore Roosevelt, Warren G. Harding, Woodrow Wilson and William Howard Taft were the speakers on the program. The speeches were recorded many years ago by the Victor company.

Listeners were asked to imagine themselves on the moonlit steps of the Capitol in Washington on the evening of July 4. The great military bands of the country furnished a realistic background of music (also by means of records).



B. A. ROLFE AND HIS PALAIS D'OR ORCHESTRA

A splendid dance orchestra, especially interesting because of the unusual use made of brass in the orchestrations. The group is heard through WEAf every Monday, Wednesday, and Friday from 12:15 to 1:15 p. m., and every Monday evening from 11 to 12 p. m., etc.

credit toward a college degree is given for satisfactory completion of radio courses.

Registration for the radio courses given by the Kansas State Agricultural College during the college year 1924-25 included 1771 individuals registered for a total of 11,431 courses. While the major portion of these individuals resided in Kansas, there were registrants from more than 30 states, from several of the provinces of Canada, and from Mexico. The growing popularity of the courses is indicated by the fact that the total registration was nearly double that of the previous year while the average number of courses for which each individual registered increased from 2.5 to 6.8.

We have gone thus fully into the radio courses presented by the Kansas State Agricultural College because this institution was one of the pioneers in the field and its faculty is exceedingly enthusiastic about its possibilities. Kansas State University, the State University of Iowa, Iowa State College, Ohio State University, University of Pittsburgh, Michigan Agricultural College, Oregon Agricultural College, and a score of other institutions, are giving regular courses of instruction over the radio.



THE WBAL TRIO

A new addition to the regular features from this excellent Baltimore station. From left to right, Celia Brace, violinist, Florence Walton Otley, pianist, and Helene Broemer, 'cellist. The trio is heard Monday and Thursday nights from 8 to 9 p. m.

The cheers of the multitude, presumably gathered about the Capitol steps, could be heard. Then passed in ghostly review the three departed statesmen. Roosevelt gave his famous address on "The Farmer and the Business Man," in the forceful, staccato, hoarse-voiced manner that made him famous. Next, President Wilson, with his perfect enunciation and thoughtful deep-voiced tone, delivered an "Address to the Farmers." The slow, leisurely voice of the late Warren Harding was heard in his famous "Address at Hoboken on the Return for Burial of 5212 American soldiers, sailors, marines and nurses," given on May 23, 1921. The one living ex-president, William Howard Taft, repeated his "Labor and Capital" address, given originally in September, 1912.

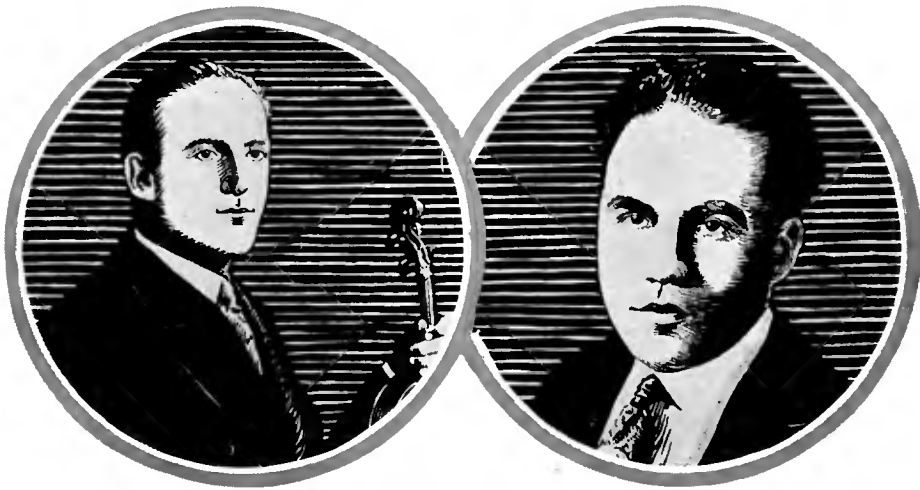

DAVID ROBINSON AND JOSEPH BONIME

Artists on the New York Edison Hour, heard through WRNY, New York. David Robinson was formerly concert master with the Berlin Symphony Orchestra and assists Mr. Bonime, pianist-director of the Edison Hour

Jazz, Olden and Modern

A RECENT Royal Hour (WJZ, WRC, WGY, WCAD) which we listened to offered a program of popular music of five years back, revealing the songs which were on the lips of everyone in the early post war period. Such an exhumation is greatly to our liking, and we should like to see some weekly program furnish specialize in reviving a different year's popular music every week. The grouping of several contemporary numbers together greatly strengthens the associations each conveys. In this particular program by the Royal Ensemble, were heard such juicy melodies of '21 as "Japanese Sandman," "Lazy," "Hot Lips," "Linger Awhile," "It Had to be You," "How Come You Do Me Like You Do," "Blowing Bubbles," "I'll Build a Stairway to Heaven," and the delectable "Wang Wang Blues."

It should be interesting, and provocative of communications, for some station to broadcast a series of such programs, one for each year, from as far back as about 1905, and then solicit a vote from its listeners as to which year was the most productive of good popular tunes. We are inclined to suspect that such a vote would result in a very low rating for the past three or four years.

We will probably be told that a series of programs exactly coinciding with our suggestion has already been broadcast by some station or other. If that be the case we are not at all perturbed; we urge that it be done again.

Germany and America Compared

AN EXPLANATION of the difference between broadcasting in America and Germany, which may be of interest to our clientele, was given in a talk by one David L. Loewe of Berlin, recently heard through WPG.

"The radio audience in Germany," according to Mr. Loewe, "is licensed to receive by the Post Office Department, and a fee of fifty cents a month is charged for all receiving licenses. This is collected by the postal carriers. It is unlawful to maintain a receiving set without such a license. The customary procedure is for the new owner of a receiving set to notify the officials that he has acquired such a set, and his name is listed. This list now includes more than 1,260,000 people.

"Broadcasting stations are managed by private interests under licenses from the Post Office Department. In addition to this, the Post Office owns the majority of shares in the broadcasting company. Furthermore, the wavelengths are determined by the Post Office.

"In order to prevent interference, these stations have cooperated in a general movement throughout Europe for the adjustment of wave-

lengths so that their reception difficulties may be reduced to a minimum. In the past, there was a great deal of interference but by such cooperation the situation has been materially improved.

"The stations in Germany are operating on wavelengths that are used by American stations. In addition, some of them go up to materially higher wavelengths, which fact necessitates the use of receivers different than those employed by a vast majority of Americans.

"There are a number of large stations in Berlin but they are all operated from a central studio in the Vox Haus, where finely equipped studios can house three programs going on simultaneously. One of the studios is large enough to accommodate an orchestra of 150 members. Every modern device for the reproduction of music and speech is provided in these studios.

"The remote control system is not approved of in Germany. Theatrical and operatic performances are put on at the studios.

"All those who appear before the microphone to entertain the public are paid, a considerable part of the fund derived from the licenses being devoted to this purpose. Even lecturers from the Universities are compensated for their time.

"DX reception is the exception rather than the rule; this does not mean that the people of Germany do not enjoy foreign programs; on the contrary, they get them exceedingly well by a happy process of re-broadcasting. Programs from Rome, London, Paris, Stockholm, Geneva, etc., are received on special apparatus located outside of Berlin, for instance, and rebroadcast through the big German stations on the local wavelengths. Thus, several millions of German listeners may hear with loud speaker strength, programs from practically every section of Europe."



[By permission of the proprietors of the London "Star."]

HOW THE ENGLISH LOOKED AT BROADCASTING DURING THE STRIKE

Broadcast Miscellany

STATION WLS has done its share towards improving summer broadcasting by inaugurating a series of Friday night concerts last July, which is to continue to September 24. On every second Friday, the Little Symphony Orchestra of Chicago has been heard in concert. The intervening weeks have provided soloists of considerable importance, among them being Charles Marshall, Helen Freund, and Cyrena Van Gordon.

AN UNUSUAL request for broadcasting service received by KGO was by a bass fisherman who asked that the time of high and low tides be broadcast daily with the weather report. Bass, it seems, are caught in incoming tides.

THE Municipal station at Atlantic City, WPG, is now operating with the first of the new Western Electric 5000-watt broadcast transmitters. This station, however, is not authorized to use full power, although an application is on file with the Department of Commerce. The new set is designed to operate on any wavelength from 200 to 600 meters, but is adjusted to send on 299.8 meters (1000 kc). From the new summer studio on the Steel Pier, sixteen remote control stations are handled, permitting the picking up of many orchestras and bands.

necessary in so popular an entertainment. The whole organization is worthy of applause.

"If wireless had only been made an official monopoly in America, it would be a great deal more successful than it is.

"I still think that music is the most popular item in the modern broadcasting program, and jazz music, or symphonized syncopation, the best for broadcasting purposes.

"Jazz has reached such an art that one accepts the fact that there are classics in this type of music just as there are in straight symphony.

"As a matter of fact, a great number of the acknowledged classics have an added power when rendered in symphonized syncopation."

was argued by Bronislaw Malinowski and Grafton Elliot Smith. The debates are broadcast under the personal supervision of Henry Goddard Leach, editor of *The Forum*. They are later published in full in the magazine.

THE three-hundred foot antenna towers of WJZ's transmission plant at Bound Brook have a new function. In addition to supporting the six-wire "T" type cage antenna used in broadcasting, they also serve as towers of light to guide the United States Air Mail Flyers to their landing field. To make the towers visible at night, since it was impractical to wire them, red reflectors have been placed in such a manner on each tower to reflect the beam of searchlights located on the ground.

BELIEVING that radio concerts have now reached the stage where a definite audience can be counted on each week, and programs ar-



THE DAVIS SAXOPHONE OCTET

Who present an indirect advertising program through the WJAZ chain for a commercial company. Their programs, like all others of this type, are presented without objectionable "sales talk" on the part of the advertiser. The name of the sponsor and the product manufactured is announced and the rest left unsaid

THE Crosley Radio Corporation, has placed an order for the first fifty-kilowatt broadcasting equipment which Western Electric will manufacture for a few concerns. This new transmitter will cost, with the new special fire-proof building to be erected near the present 5000-watt WLW transmitting station, near Harrison, Ohio, about \$250,000.

POPULAR group in the weekly indirect advertising broadcasts is the Maxwell House Coffee Hour, being presented Monday nights through WJZ. A good orchestra, which, we are told, is a prominent recording orchestra playing anonymously, is heard in a varied program of dance and ballad selections, interspersed with instrumental and vocal solos. A sample program is likely to run like this: "Blue Danube Waltz," "Nightmare Blues," "Waters of Minnetonka"—Flute Solo, "Swing Along," "Valse Poetica," Excerpts from Gershwin's "Rhapsody in Blue," "Mighty Lak a Rose," . . . and so forth. And if it be to your liking, help yourself Monday nights.

PAUL WHITEMAN, recently on tour of England with his band, had this to say to a representative of *Popular Wireless*, London, before he left for New York:

"I like the way the B. B. C. chooses its programs. There is variety, and that is what is

EASILY one of the best of the bands heard lately is that of Ben Bernie, who, at the time of writing is playing in the Berkeley-Carteret, Asbury Park, and heard through WOR. However, by the time this appears in print, Bernie may have temporarily deserted WOR for England, where he hopes to make his London debut at the Kit Kat Club, some time in September. Associated with Bernie on the Asbury Park programs through the summer was the justly celebrated Arthur Pryor Band. WOR now has a one link "chain," its Wednesday and Saturday night programs being relayed by telephone lines to WMAF at South Dartmouth, Massachusetts.

A. N. GOLDSMITH, Chief Broadcast Engineer of the Radio Corporation of America, recently conducted an experiment (by means of switching secretly from phonograph to radio, and back again) which proved that radio broadcast quality of transmission has become so perfect that an average audience could not distinguish it from modern faultless phonographic reproduction.

A NEW monthly feature was inaugurated at WGBS in July when the first of a series of debates conducted under the auspices of *The Forum* was broadcast. The subject of the first debate was "Is Civilization Contagious?" It

ranged long in advance, just as in the case of the regular symphony orchestras, the New York Edison Company arranged a series of nine concerts comprising a "world tour in the realm of music."

The series was presented from July 6 to August 31 during the Edison Hour—a Tuesday night feature of WRNY. The Edison Ensemble, under Josef Bonime, specialized, in each succeeding program, on the music of some one country, including America, England, Russia, Germany, France, Italy, Spain, Ireland, and the Orient.

The music was of high quality, as that of the Edison Hour has always been. The programs were popular in make-up, selection being made from the best of the well-known classics.

The unique feature of the series was the elaborate printed program which was furnished to WRNY's listeners in advance of the series. We have a copy of the syllabus, a 28-page booklet, at hand. Besides the complete programs for the series of concerts, it contains thumbnail sketches of the lives of the composers, and the story of each selection played. To the listener not already familiar with the selections played, or with the composers, this booklet must have greatly stimulated interest and doubled the pleasure in the performance. The preparation and distribution of the syllabus must have been a considerable expense, but in our opinion was well worth it, both to the listener and to the sponsor of the program.

A Shielded Dual-Control Receiver

How to build a Modern Shielded Receiver which is Remarkably Stable and Sensitive in Operation

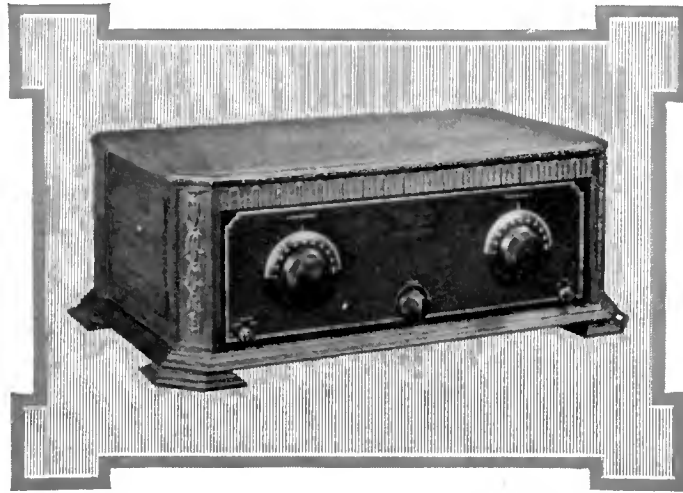

A Six-Tube Receiver with Three Stages of Tuned Radio Frequency Amplification and Only Two Controls

COMPLETE, IN AN ATTRACTIVE WALNUT CABINET

The receiver described in this article is simplicity itself to control, as is evident from this picture from in front the metal control panel

FOR several years past, very few important basic changes have been made in radio receiver design, the difference between the first neutrodyne and the latest type tuned r.f. receiver being due primarily to gradual developments and improvements rather than to any radical basic changes in operating principle. Thus we find that the tuned r.f. receiver of this season resembles very closely similar types of receivers of last year and the year before.

It is the purpose of this article to describe an interesting late-vintage receiver embodying many recently developed improvements in the art. This receiver is illustrated in the accompanying photographs, but before going into a detailed description of the functioning of the system as a whole, it might be well to consider exactly just what these improvements are.

Of the developments which have occurred, the adaptation of shielding to receivers is one of the most important. The reason for shielding can be summed up as a gain in selectivity and stability.

A tuned r.f. amplifier performs essentially two functions. In the first case it amplifies a very weak received signal up to a point where it will satisfactorily actuate a detector tube which may, in turn, supply sufficient power for the operation of a loud speaker. Aside from the amplification requirements, the tuned r.f. amplifier is called upon to provide a sufficient degree of selectivity so that a number of stations will

By McMURDO SILVER

not be heard all at once, but may be separated and only one received at a time. Thus we find in a tuned r.f. amplifier a succession of stages, each stage comprising a tube and its associated tuned transformer circuits. The design of the transformers is generally such as to provide a certain amount of voltage amplification, and the tube itself provides additional amplification. Each tuned transformer represents a filter circuit designed to eliminate all but one narrow band of frequencies (one station) at a time. Thus, the amplifier may be likened to a series of cascaded filters, each one designed to provide a little more selectivity and thus eliminate progressively the unwanted signals collected indiscriminately by the antenna system.

If a receiver is located close to a powerful broadcasting station, or several of them, energy will not only be picked up on the antenna system, but upon the coils and wiring of the receiver. Thus the very purpose of the successive selective circuits in an r.f. amplifier is defeated, for, instead of the signal being passed through successive stages of filtration, it impinges upon each

individual circuit, and the selectivity of the receiver is no better than that of the ordinary single-circuit regenerative set. The obvious remedy lies in the prevention of energy pick-up

by the individual circuits and in the forced feeding of the signal energy it is desired to amplify and reproduce through each tuned circuit successively.

Exactly as energy may be picked up by coils and wiring, so may it be radiated by the same means. Thus, in an extremely sensitive tuned r.f. receiver, the energy fed from one circuit to another, due to the close positioning of the various instruments and wiring, is sufficient to cause the circuit to break into continuous oscillation, with consequent uncontrollable squealing and inability satisfactorily to receive and amplify signals.

The simplest method of preventing this sort of interaction is to build an insensitive receiver. This means is employed in many a cheap tuned r.f. receiver where, because of inability to eliminate oscillation at some point throughout the range of the outfit, it is rendered so inefficient over its entire range that it will not oscillate at any wavelength at all, and the result, unless extremely good engineering has been involved, is a very poor receiver so far as sensitivity is concerned.

A simple solution of both of these difficulties lies in shielding. It has been found that the old

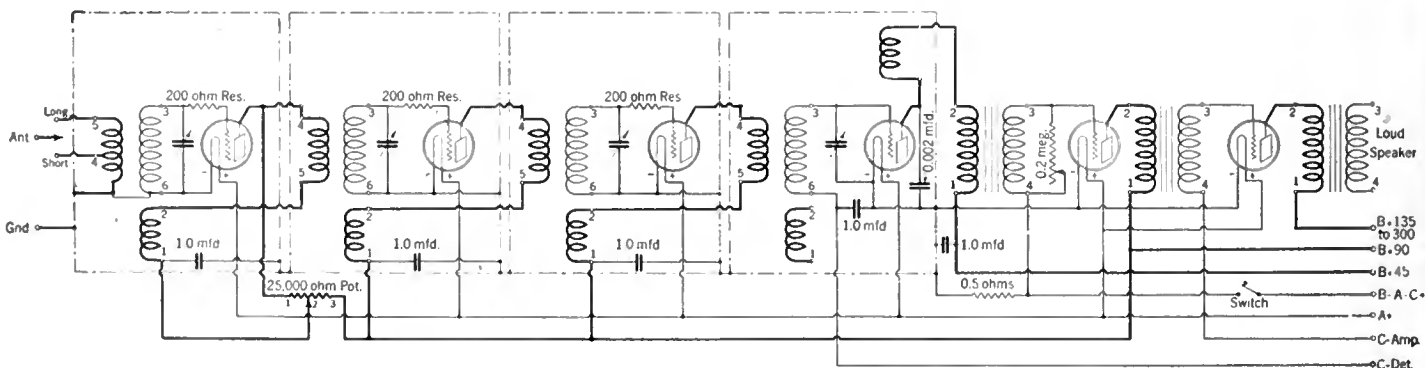

THE CIRCUIT DIAGRAM OF THE RECEIVER

The shielding used is indicated on the diagram by dotted lines. Note how bypass condensers are used in the plate circuits of all the radio frequency stages to eliminate feedback. Two antenna connections provide for either a long or short antenna. The direct current is eliminated from the windings of the loud speaker by the use of an output transformer. The 25,000-ohm potentiometer shown in the lower left hand corner of the diagram is a sensitivity control and functions to unbalance slightly the first tube. In this way a certain amount of regenerative amplification can be obtained with a considerable increase in volume. The receiver uses only two controls; the second, third, and fourth condensers being attached to a special lever arrangement which makes it possible to tune these three condensers by means of a single dial

idea that a piece of metal near an inductance increased its resistance to a simply unthinkable value, was entirely fallacious. In its place has been substituted the realization that metal near a coil will actually lower the resistance of the tuned circuit under certain conditions. It has been found that, particularly in r.f. amplifier design, metal shielding actually improves the over-all amplification of an amplifier even if it is used for no other purpose than to increase the coil resistance at certain wavelengths and perhaps decrease it at other wavelengths.

The particular advantage of such an arrangement will be appreciated when it is realized that the principal difficulty in building a satisfactory r.f. amplifier is in the maintenance of uniform amplification throughout the entire wavelength range. An ordinary r.f. amplifier will be most efficient at the lower end of its wavelength range and that its efficiency will fall off rapidly as the wavelength to which the system is tuned increases. The method of overcoming this deficiency is to introduce some device into the circuit the tendency of which will be to oppose increasing regeneration and, consequently, oscillation, as the received frequency increases (as the wavelength decreases). Shielding located close to an inductance may be made to have precisely this effect, for it can increase circuit resistance at short wavelengths, thereby stabilizing the system nicely, and decrease resistance in many cases at the longer wavelengths. This is very interesting as for several years past, it has been considered necessary to locate shields several feet away from the coils, not merely a matter of inches away from them.

It is thus evident that shielding serves two purposes, in that it enforces the filtering action necessary to get the required degree of selectivity, and it prevents inter-stage coupling, which results in oscillation. In accomplishing both of these ends it does something more; it allows each r.f. amplifying stage to be built to operate at almost peak efficiency, and it becomes unnecessary to render the whole system inefficient to overcome inter-stage coupling. There is still another end accomplished, *i. e.*, the possibility of adding one or more additional radio amplifying stages which will really amplify.

This leads to what is, in the present day, termed a cascade amplifier—one in which regeneration is almost entirely absent. Considering a five-tube unshielded receiver, we find that the coupling between stages is so great that a sixth tube, in the form of an additional r.f. stage, could not be added, for the inter-stage coupling would increase and cause continuous oscillation. This could be overcome only by rendering the whole system less efficient, which would in turn make the third r.f. stage of practically no value.

While shielding may not be considered the panacea for all evil, yet it eliminates, in a large measure, many undesirable conditions, and allows the construction of an r.f. amplifier embodying a third stage—each stage operating at an efficiency in excess of that obtained from last year's unshielded amplifiers.

The Facts About This Receiver

Type of circuit	Three stages of tuned radio frequency amplification, detector, and two stages of transformer-coupled audio amplification.
Number of tubes	Six. All 201-A's except the second audio tube which should be either a 112 or 171.
Features	The receiver uses four variable condensers. The second, third, and fourth are ganged together so that only two controls are necessary. All of the r.f. stages are carefully shielded to prevent unwanted interstage coupling and to improve selectivity. Negative feedback is used in all the stages to prevent oscillation. Bypass condensers are used at all points to advantage. The volume control is a variable resistance across the secondary of the first audio transformer, and the sensitivity control is a variable resistance in the plate circuit of the first r. f. tube.
Frequency range	500 to 1500 kc. (200-550 meters).

TANDEM TUNING

AT THE same time that these strides toward increased receiver efficiency have been made, attention has been concentrated upon the control problem. It has been found possible to produce one- and two-control receivers quite successfully, though the one-control receivers often have an auxiliary compensating adjustment, or require a tube performing no other useful function than to permit of realization of the single-control feature. This is fully explained in Laboratory Information Sheet No. 33 in this issue of RADIO BROADCAST.

In the receiver described, the first r.f. stage is tuned separately, for its characteristics depend in a measure upon the type of antenna used. The second and third r.f. stages, together with the detector stage, operating into and out of practically identical circuit conditions, are tuned by a single control, the tuning condensers being ganged together. Several factors permit this. The first is that the circuits work into and out of similar tube impedances. The second is that in a three-stage receiver the tuning of each individual stage is necessarily broad in order to preserve quality. It is made slightly broader than

in a two-stage r.f. amplifier and, as a result, the three stages can be easily controlled together, as individual circuit variations can be tolerated which would have been prohibitive in a two-stage receiver giving the same degree of selectivity. The mechanical design of coils and condensers permits of the ganging together of two or three individual circuits quite successfully.

With the advent of shielding comes what has heretofore been a tendency evident to critical observers—the gradual advent of the all-metal receiver. In the original of the receiver described in this article, a steel sub-base is used with a brass panel. Insulating material is employed only where it is necessary. As a result, the rigidity of the receiver, and its durability, are tremendously increased. Years from now the all-metal receiver will still be in thoroughly satisfactory operating condition.

The audio amplifier employed in the shielded six-tube receiver described here is of the transformer-coupled type, employing a pair of extremely sturdy audio transformers, which feed into an output transformer.

The output transformer is designed to prevent saturation of the loud speaker by the direct plate current of a power tube. Such a transformer allows the full handling capacity of the loud speaker to be devoted to the handling of signal energy, to the exclusion of the direct plate current required by the tube for its operation. The common method of accomplishing this same end is through the use of a choke coil and large condenser. This arrangement has the same frequency characteristic as a loud speaker, its efficiency decreasing as the frequency becomes less, thus introducing a certain amount of distortion in the wrong direction. The output transformer employed in the model described gives greater amplification of, and ample handling capacity for low notes.

THE CIRCUIT

A SCHEMATIC diagram of the circuit described in this article is reproduced on page 494, and the functions of the various parts can be very easily explained by reference to it. The antenna is connected to the central arm of a two-point switch. One contact of this switch

connects to a tap on the primary of the first r.f. transformer. The other contact connects to the extreme end of this coil. These taps are labeled "short" and "long," so that a long antenna may be used with only a small portion of the primary in circuit, and a short antenna with all of the primary in circuit. The ground connection goes directly to the metal shield, the metal sub-base of the receiver and all the shields being grounded together, taking the place of the A minus and B minus wiring of the set. The secondary of the first r.f. transformer is shunted by a tuning condenser, and is connected to the input circuit of the first vacuum tube. The output circuit of this tube goes into the primary of the second r.f. transformer in the second stage shield. The wiring then leads out and back to a small tickler winding on the coil form of the

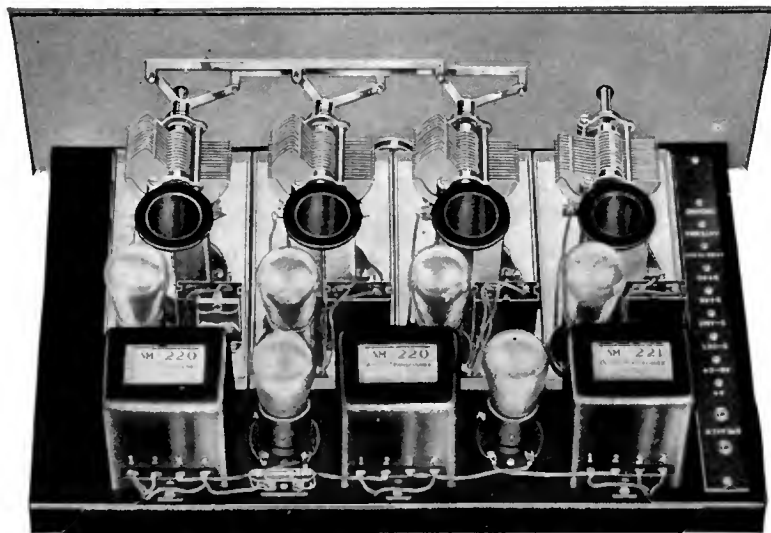

WIRED, WITH LINK-MOTION IN PLACE

The wiring above the sub-panel is all short and direct. The two shielded transformers to the left are for audio coupling purposes while that to the right is an output transformer

first r.f. transformer. The purpose of this tickler in the first stage is to aid regeneration. The low potential end of this tickler is connected through a bypass condenser directly to the shield although the B battery lead comes out from it to the volume control resistance and then on to the B battery wiring.

The volume control is connected in an unusual fashion. It consists of a 25,000-ohm especially tapered resistance, shunting both the tickler and the r.f. transformer primary of the second stage. As it is adjusted to decrease volume, resistance is added in series with the B battery but, at the same time, is decreased in shunt with the transformer primary and tickler. Thus two ends are served—the volume is effectively controlled and, simultaneously, the stability of the following r.f. stages is not impaired, and they operate in a substantially uniformly sensitive condition at all times.

This volume control also serves as a sensitivity control over the first r.f. stage only, and thus, in the hands of an experienced operator, it allows the receiver to be operated at the absolute limit of sensitivity; yet it is only a semi-critical adjustment. In the hands of an inexperienced operator, the volume control is never advanced beyond the point of instability, and is used in a retarded position to control volume. It prevents overloading in the detector or audio amplifier circuits which might cause distortion, yet does not appreciably affect tuning.

The next r.f. circuits are practically identical with the first. Fixed ticklers are again employed so that the receiver is extremely sensitive on long waves, and will oscillate satisfactorily on short waves. Excessive oscillation on the short waves is counteracted by the placing of the shielding with respect to the coils, and by small 200-ohm resistances connected in series with the grid circuits, and so arranged that they do not broaden tuning. These resistances are designed so that their impedance increases with increasing frequency, and thus, as the wavelength of the receiver goes down, they operate to control oscillation increasingly. The overall results of these arrangements is that the tendency of the receiver to oscillate at any wavelength to which it is tuned is offset and compensated, first by the tickler action which maintains efficiency at long wavelengths, and secondly, by the various resistances which operate increasingly to stabilize the receiver as the wavelength is decreased. An extremely fine balance has been arrived at which provides a sensitive system for the entire broadcast wavelength band.

Due to the design of the r.f. transformers employed in this model an extremely high value of magnetic coupling is obtained by an exceptionally large primary, and yet, due to the spacing between primary and secondary, the capacitive coupling is kept quite low. Thus the successive stages cascade very well, and the

desired filtering action of the tuned circuits is not defeated by capacity bypass from stage to stage.

In the detector compartment, the small tickler coil has been ignored and is not used at all. A choke coil is employed to prevent any of the r.f. energy getting out into the audio amplifier, which would result in a certain amount of distortion and instability. A C-battery detector is employed as the handling capacity of such an arrangement is much greater than were a grid condenser and leak utilized. Furthermore, the similarity of the second, third, and detector stage ganged circuits is maintained quite uniform by the elimination of the condenser and leak.

The audio amplifier is arranged along the back of the receiver behind the individually shielded r.f. circuits. The transformers are shielded in heavy metal housings which ground to the steel base. The first audio amplifier operates with a negative grid bias obtained from the voltage drop across the filament resistance of one-half ohm. The bias for the second tube must be provided by a C battery, and will vary with the type of

- 4 S-M 631 Stage Shields
 - 2 S-M 316A Condensers
 - 2 S-M 316B Condensers
 - 4 S-M 515 Coil Sockets
 - 3 S-M 115A Coils
 - 1 S-M 116A Coil
 - 3 Carter 200-ohm Resistances
 - 2 Kurz-Kash Zero Left 4-inch Dials
 - 1 S-M 275 Choke Coil
 - 6 S-M 511 Tube Sockets
 - 2 S-M 220 Audio Transformers
 - 1 S-M 221 Output Transformer
 - 1 Polymet 0.002-mfd. Condenser
 - 5 Polymet 1.0-mfd. Condensers
 - 1 S-M 632 Link-Motion
 - 2 Carter Tip Jacks
 - 1 Terminal Strip with Terminals
 - 1 Crowe Metal Panel, Pierced
 - 1 Steel Base, Pierced
 - 1 Yaxley 10 Switch
 - 1 Yaxley Special Antenna Switch
 - 1 Carter 25,000-ohm "Hipot"
 - 1 Carter 0.5-ohm Resistor
 - 1 Polymet 0.2 meg. Resistance
 - 1 Polymet Resistance Mounting
 - 1 Coil Belden or similar Hook-up Wire
- Assortment Miscellaneous Screws, Nuts, and Lugs

THE ASSEMBLY

IN ASSEMBLING a receiver, there are certain progressive steps which may be very easily followed, and, if followed, will result in a most simple assembly. The photograph looking straight down upon the mounted sub-base, should be very carefully examined.

The first step is to put the volume control resistance in place. The one specified in the list of parts is accompanied by a pair of punched fiber washers. The lock nut should be unscrewed from the bushing and one washer slipped over the bushing so that the ridge on its inner surface projects away from the resistance itself

and toward the sub-base, when it is assembled. The three extensions holding the binding posts should be carefully bent so that when the resistance is in place they will not short upon the shield. In order to hold it temporarily in position, the lock nut is then put back upon the bushing on the outside of the sub-base. Were this not done, it would be impossible to get the resistance into place after the shield pans were fastened down.

The next step will be to fasten the tip jacks on the terminal strip in such a fashion that when the terminal strip is placed in position neither the tip jacks nor the lugs attached to the various binding posts will touch the metal sub-base at any point. Next, take all of the stage shield bottoms and lay them down toward the front of the sub-base so that the holes in them will coincide with the holes in the sub-base. This having been done, the tube sockets should be put in each pan and two machine screws put through the holes found in each socket, through the shield pans, through the sub-base, and into nuts on the underside of the sub-base. The position of these sockets is clearly illustrated in the

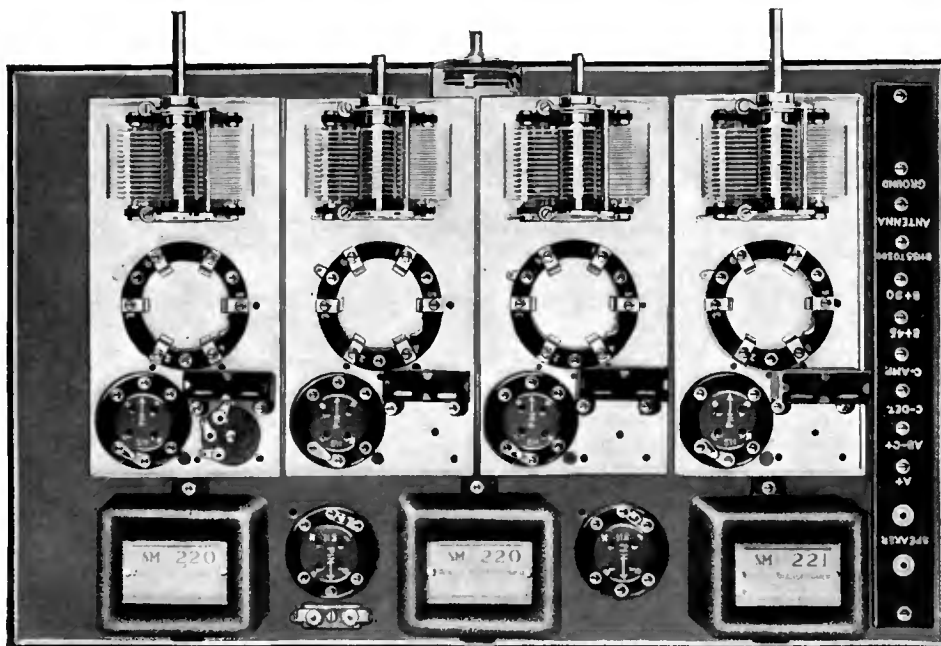

READY FOR WIRING

All the parts have been mounted and we are now ready to start on the wiring. All parts are fastened down with $\frac{3}{8}$ machine screws and nuts

tube employed, which might be either an UX-112 or an UX-171 type tube. A grid leak is connected across the secondary of the first audio stage to provide a load into which the transformer may work (more necessary at this point than in the second stage). All bypass condensers have one side grounded to the shielding or metal base, as have all tuning condensers.

A fixed filament resistance is used, for it has been found that, with UX-201-A, UX-112, or UX-171 tubes, the filament voltage is uncritical throughout the useful charge life of a standard six-volt battery.

The construction of the receiver is absurdly simple because standard parts are available which fit together very nicely, so simply that only a screw driver and a pair of pliers are needed to assemble the whole set. A list of the necessary parts is given below, and it is suggested that, while substitution may be indulged in, no effort be made to alter the arrangement, layout, or type of equipment used in the r.f. portions of the circuit, as the entire operation of the receiver depends upon even such small matters as spacing and wiring arrangement in these sections.

photographs. It will be noticed that the mounting screw between the filament terminals serves as the negative filament connection to the shield by means of a lug under its head soldered to another lug under the head of the binding post screw of the negative filament terminal of each tube socket. The two tube sockets for the audio amplifier may also be put in place, together with the grid leak mount, which falls, as shown in the photograph, behind the first audio socket.

The next step is to mount the coil sockets with their terminals falling as shown in the photographs. All of these sockets, except that in the detector compartment, have a lug placed between the bakelite ring and the shield through which the mounting screw falling between terminals three and six passes. A wire is then soldered to this lug and, in turn, to a lug on terminal 6 of these coil sockets. At the detector stage, terminal 6 connects to one lug of the bypass condenser and then goes out through the shield and to the binding post marked "C minus detector" on the terminal strip. The four bypass condensers may be put in place in their pans, the bottom of their mounting feet being carefully scraped so that they will make good metallic contact with the shield where the screws pass through them. The four variable condensers are fastened as shown in the photographs, the two with the extra long shafts going in the two end shield pans. When these condensers are properly mounted, the shafts of the two central ones should not project beyond the edge of the sub-base. If they do, they should be moved backwards by loosening the set screws holding the lock collar and rotor plate assembly to the shaft, re-locating the shafts further back.

The condensers must be very carefully examined to see that when the rotor plates are turned they interleave between the stator plates in the center of the intervening spaces. Should any stress be imposed upon them, this may be compensated by moving the stator plate sections either forward or back. This adjustment is made by means of the nuts upon the tie-bars anchored in the bakelite strips. Such an adjustment will probably be unnecessary, but it is well to be familiar with it in case the equipment has been roughly handled in transit.

The audio transformers and output transformer may be placed on the sub-base, as shown in the photographs, with their terminals projecting toward the rear. On the bottom of the sub-base it is necessary to mount the one-half ohm filament resistance, using one of the mounting screws of the receiver, which will hold one end tight to the sub-base, and allow the other end to be soldered to one of the contacts of the "On-Off" switch. The condenser between the 45-volt terminal and negative A is fastened in position on the underside of the sub-base also using conveniently accessible mounting screws. In every case where a mounting screw is used to carry a circuit, as would be the case with this resistance or some of the tube socket mounting screws, it is essential that the sub-base be scraped clean of enamel at the place where the nuts or

screw heads come in contact with it. The same applies to some portion of the space under each shield pan on the sub-base in order that there may be positive contact between each shield pan and the metal sub-base.

The wiring of the receiver is done by means of flexible Belden hook-up wire. This wire is composed of a number of fine tinned strands, insulated by a rubber covering. It should be cut to the required lengths and soldered either to the lugs on the instruments themselves or to lugs placed

antenna switch outside contacts, while the inside contact of this switch goes to the antenna binding post. The ground binding post connects directly to the shield. One side of each 1.0-mfd. bypass condenser goes directly to the shield, the lead preferably ending at the soldered joint between the two lugs linking the negative terminal of the stage tube socket to the mounting screw going through the sub-base. In the detector stage, the plate terminal of the tube socket is connected to one extreme lug of the choke coil and also to one side of the 0.002-mfd. condenser, the other side of which is soldered to the lug of the 1.0-mfd. condenser which is grounded. The center contact of the choke coil is ignored, the other extreme lug being connected to a wire going out through the battery-lead hole to terminal No. 2 of the first audio transformer. In connecting the volume resistance in circuit, the right-hand post viewed from the rear runs through a wire to a splice, beneath the sub-base, in the lead connecting the plate of the antenna stage r.f. amplifier tube and terminal No. 4 of the coil socket in the next r.f. amplifier stage. The center arm of the resistance goes to terminal No. 1 of the coil socket through the battery-lead in the first stage compartment joining to one side of the 1.0-mfd. bypass condenser. The other end post of the volume resistance eventually terminates in the "B plus 90" post on the terminal strip.

The whole wiring is an extremely simple matter and can be very easily effected by a novice unfamiliar with circuit diagram reading by simply following the numeral designations in the schematic diagram, the photographs, and on the parts themselves. No actual knowledge of symbols is required whatsoever, though, by the time the builder has wired the receiver, he will have a fair working knowledge of schematic diagram reading, if not before.

All wiring having been done and the antenna and battery switch having been previously temporarily fastened in place on the sub-base in their regular positions, the locking nuts are now removed from them as well as the lock nut on the volume control resistance. The front panel is then put in place and the nuts screwed up tight again upon the antenna and "On-Off" switch. The second of the fibre washers is placed over the bushing of the volume control

with its central circular projection extending inward, so that the metal bushing and lock nut of this resistance do not actually come in contact with the metal sub-base at any point. It is vitally important that the volume resistance make no metallic contact with the sub-base in any way, and if the insulating washers are properly used, no trouble will be experienced.

GANGING THE CONDENSERS

THE ganging of the condensers is the next operation. The set-screws in the link-motion shaft collars should be loosened and the shaft collars slipped over the three right-hand condenser shafts (viewed from the front). The condensers should then be turned so that their plates are just ready to interleave. This can only be determined by



BENEATH THE SUB-BASE

All battery wiring is carried well away from the three groups of two leads that run from one stage to the next, and which appear along the center line of the base. A splice is visible in one lead running to the volume control resistance, and its position in the wiring is quite important

under the terminal screws of the various instruments. If preferred, a sufficient portion of the wire may be scraped to allow it to go under the heads of the terminal screws and no soldering will be needed at such connections. The small 200-ohm resistances should be used as the connecting lead between the grid terminal of each of the r.f. amplifier tube sockets and terminal No. 3 of the coil socket. A wire then leads from terminal No. 3 of the coil socket to the nearest lug locked by a nut to one of the condenser stator bars anchored in the bakelite insulating strip. In the three r.f. stages, terminal No. 6 goes to the shield as previously mentioned, while in the detector circuit it goes to the 1.0-mfd. bypass condenser, and then out to the "C minus-detector" terminal on the terminal strip. In the antenna stage, terminals 4 and 5 run to the

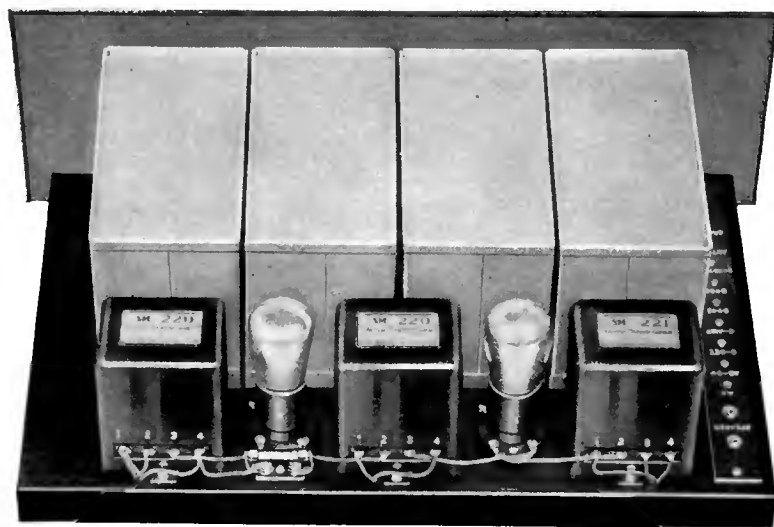

A GENERAL REAR VIEW OF THE RECEIVER

The individual stage covers are in place here. The two visible tubes are the audio stages

very careful sighting through the space between plate edges. The link-motion should then be turned around so that the builder will get an idea of its operation, it being remembered that when it is locked to the shafts, the condensers must move together from the "all out" to the "all in" position. With the condenser plate edges lined up as suggested, the link motion is locked in place by means of the set screws in the shaft collars. This being done, and the position of the plates checked immediately afterwards to make sure they have not changed in the operation, it should be possible to rotate all three condensers simultaneously and with a comparatively smooth even movement. The stiffness of the movement may be adjusted by loosening the lock collar on the condenser shafts and moving them to or away from the frame, which varies the compression on the spring tension washers. The compression bearings adjusted by screws (there are two on each condenser) should not be tampered with unless a pronounced side play is felt in the bearings, these being provided only for take-up. After this operation is completed, the link-motion should occupy a position on the condenser shafts which will allow the panel to be fastened up against the edge of the sub-base without the link-motion scraping it, and also so that there will be plenty of space between the link-motion shaft collars and the condenser shaft lock collars in which space the edge of the stage shields will have to come.

The receiver is now completed, but before being put into operation, the wiring should be most carefully checked to make sure that no errors have been made in it. The volume control knob is so adjusted on the shaft that when the contact arm is all the way to the right, the knob arrow will point directly upward. The dials on the control condenser shafts are so adjusted that they will read zero against their indicating marks when the condensers are entirely interleaving. The three type 115-A coils are put in all coil sockets except the antenna stage. In the antenna coil socket, the type 116-A coil should be placed.

Five 201-A type tubes should be inserted in the r.f., detector, and first audio tube sockets, and either an UX-112 or UX-171 in the second audio stage socket between the 221 and one of the 220 audio transformers. The 0.25-megohm resistance is placed in the resistance clip behind the first audio tube designed to take it.

Through a seven-lead Belden battery cable, all battery connections will be made. The A battery should be a six-volt 80- to 100-ampere hour type. The detector C battery may be a standard four and one-half volt one, and the amplifier C battery will be either three of these four and one-half volt batteries for a 112 type power tube or a small twenty-two and one-half volt B battery for a 171 type power tube. The B batteries consist of four large size forty-five volt batteries of the heavy duty type, or a good standard B supply device. The plus connections of all C batteries will come to the minus connection of the A battery and the minus of the B battery supply.

Before the B and C batteries are actually connected, if the A circuit be completed and the "On-Off" switch turned on, the tubes should light. This would indicate correct wiring, and the plus A-battery lead should then be touched successively to every other binding post on the terminal strip. As this is done the tubes should not light. If they do, it indicates an improper connection, or grounding of the volume control resistance to the metal frame of the receiver. This condition must be corrected before proceeding further, as the tubes should only light with the A battery connected to the proper posts.

Assuming all to be well, and all batteries hooked up, the tips of a loud speaker cord should be pushed into the tip jacks and the ground binding post of the receiver run through a wire to some suitable ground system. The antenna lead-in goes to the antenna binding post, the antenna itself preferably being a single wire affair from thirty to sixty or seventy feet long, and preferably an outdoor one.

The receiver is now ready for operation, assuming all tubes to light and the previous tests to have been gone through. The stage shield covers are put in place with the slots in their ends falling over the condenser shafts. Care should be taken to see that their edges fall well inside the edges of the bottom pans and that they fit in place snugly.

The operation of the receiver is very simple, and hardly merits description. With the antenna switch thrown in the "Long" position, the "On-Off" switch, "On," the two large dials should be rotated slowly down their scales, holding approximately the same dial settings. Stations should be heard, and their dial readings may be written down for future reference. The selectivity of the receiver will be affected by the position of the antenna switch. If the leads from the first coil socket to the switch are correct, the receiver will be most selective and signals weakest in the "Short" position, while they will be louder and the receiver less selective with the switch in the "Long" position. As the volume control is turned right, a click will probably be heard as the two tuning dials come into resonance, and if a slight squeal is remedied by turning the volume control knob to the left until

the squeal disappears and the receiver may be then tuned without resorting to this knob except that it may be retarded further to the left to lower the volume of the received signal. In hunting for extremely weak stations, the volume knob should be kept just to the left of the point where the clicking or squealing is heard, as the receiver is then in its most sensitive condition.

There are a few precautions to be offered with respect to the outfit. In the construction, care should be taken to keep all leads in the stage shields short and direct. In operation, the loud speaker should not be located too close to, or on, the receiver cabinet, as a continuous low pitched howling may result. If this trouble is experienced, wrapping the detector tube in cloth, to prevent vibration, should eliminate it. With the receiver in a cabinet, it is a good plan to lay some old soft cloth drapes over the aluminum stage shields in order to prevent them vibrating mechanically, as a result of the loud speaker vibrations, and communicating these on to the tubes. This is a very important fact, but is seldom encountered except in receivers giving very good low note reproduction and having individual metallic stage shields close to the detector tube, which may vibrate mechanically.

One very important caution is the use of nothing but the best B and C batteries. If a line supply device is used, it must be checked to see that its voltage is ample for the operation of the set, as many such devices are not capable of supplying an outfit of this type. If any difficulty is experienced with poor quality when using line supply device, or from howling, it can be eliminated by the addition of, say four 1.0-mfd. condensers across the output of the eliminator, or across the B battery terminals of the receiver.

A final caution is in the matter of tubes. None but thoroughly good tested tubes should be used in the r.f. amplifier and detector stages. An UX-200 tube can be used for the detector, but it is not recommended by the author. Either an UX-201-A or an UX-112 type tube may be used for the first stage, the latter being recommended as giving better quality of reproduction. An UX-112 or an UX-171 type tube may be used for the last stage; under no circumstances use an UX-201-A as it will be sadly overloaded in practically all cases.

There is no critical balancing adjustment in the receiver with the exception of a single one which may be completely ignored unless the builder wants the absolute limit from the outfit. If this is the case, then two twelve-inch lengths of hook-up wire should be very tightly twisted together with their ends insulated from each other. One end of each wire is then scraped clean. These two pieces of wire form a condenser, one side terminating on the shield of the detector compartment and the other terminating on the grid post of the detector tube socket. This wire condenser may be rolled up in a small lump so that it will fit inside of the stage shield without being closer than one-quarter inch to the inductance coil of the detector circuit. It is well to remember that this precaution increases the sensitivity of the receiver very slightly, but is not worth while unless the builder wishes to get a very small additional gain from the whole system.

The ganging of the condensers specified will be accurate if it is done in the manner outlined, for each individual condenser is carefully measured before leaving the factory. If the essential parts are procured in kits, they will inter-change with each other as their characteristics are identical, laboratory measurements having assured a far greater degree of uniformity than is actually required.

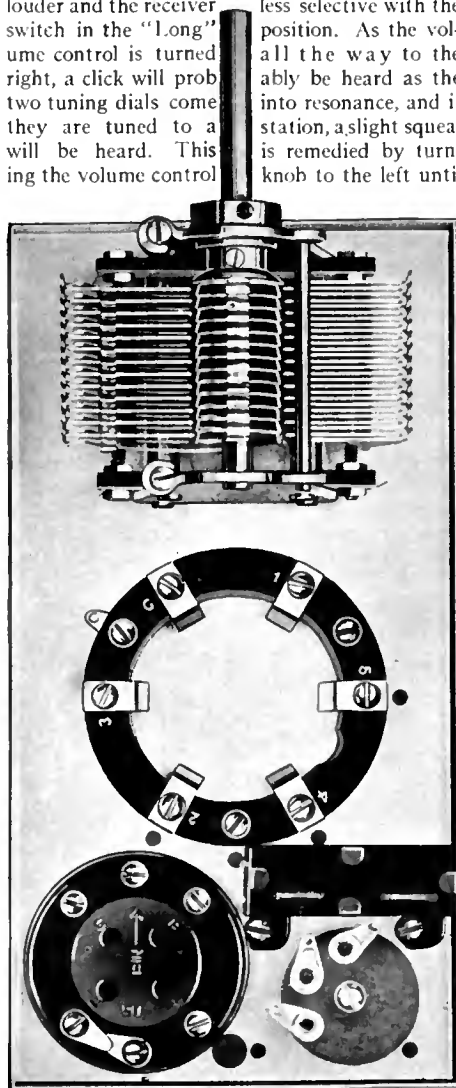

AN INDIVIDUAL STAGE ASSEMBLY

The small choke-coil spool is used only in the detector stage. The large hole is used for battery wiring; the smaller holes around the coil socket for other connections

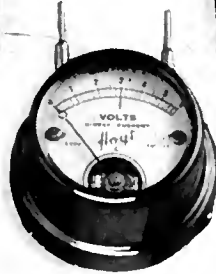
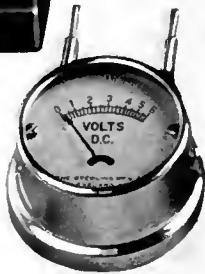
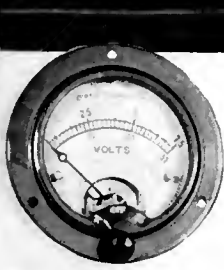
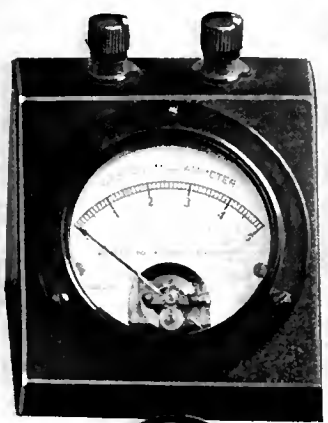
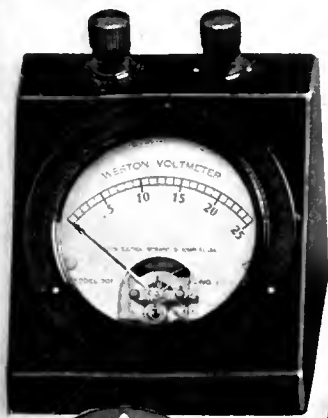

RADIO BROADCAST Photograph

INSTRUMENTS VALUABLE IN MEASURING TUBE CHARACTERISTICS

The above photograph illustrates a few of the essential electrical instruments used in obtaining the data given in this article. In the lower left hand corner is shown the DeWitt La France tube tester. In the interest of more satisfactory operation of dry-cell operated tubes, voltmeters are available in which the 3-volt setting is marked on the scale by a red line. Such meters are illustrated in the above group

How to Measure Your Own Tubes

The Electrical Standards by Which Tubes Are Judged and How the Home Experimenter May Collect His Own Data on Tubes With Simple and Inexpensive Equipment—Another Article in the Series for the Home Laboratory Worker

By KEITH HENNEY

Director, Radio Broadcast Laboratory

WERE we to sit down and mentally review the important events in radio for the last twelvemonth, not the least of our considerations would be the tremendous forward strides taken by the vacuum tube industry. It was not so long ago that we would pay less attention to the tubes when installing a new receiver than we would to the bulbs in the lamps when purchasing an automobile. Nowadays, however, we are accustomed to believe that there is a tube for every purpose, and the impeccably equipped receiver will often be found to be wired for practically as many volts grid bias alone as were the receivers of yore for plate potential! Tubes specially adapted for r.f. amplification, others for detecting, and still others for the

various audio stages, have been produced, and it is due to no mere idle prattle on the part of the manufacturers that they have sprung into instant popularity.

Now that the radio listener can procure special purpose tubes, he naturally wants to know what tube to use, and how, and when. Then he wants to know why such and such a tube fills a particular need. And finally, if he is a born experimenter, as most radio enthusiasts are, he wants to know how he can tell whether such and such a tube is the one he needs for a particular purpose.

Now there are any number of ways by which one can get tube information. For example, there is the printed sheet that comes with the

tube when you buy it, which gives the proper voltages to use. These latter, thanks to the tube manufacturers, are practically always the same for similar types of tubes from different manufacturers. For example, five volts is the customary filament voltage of storage battery tubes, with about 45 volts on the plate of the detectors and from 90 to 180 for the amplifiers. For each plate voltage there is a certain C voltage that should be used, and it is a pity that more people do not pay attention to this point.

But on the carton, and on the directions slip within the carton, there is little information about such things as plate impedance, or amplification factor. Some enterprising manufacturers enclose characteristic curves with the

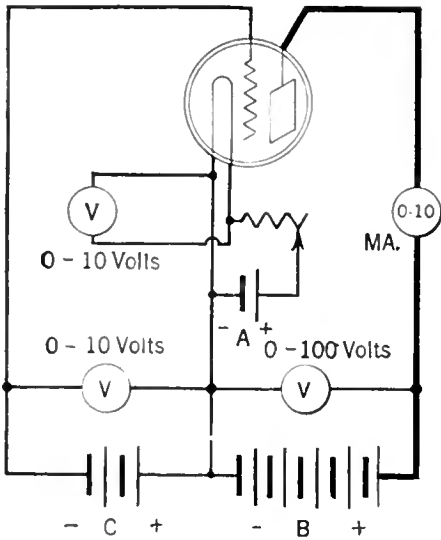
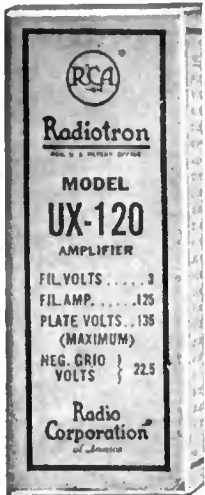

FIG. 1

The connections for the various instruments to be used in measuring tube constants are shown in this diagram



A TYPICAL TUBE CARTON

A certain amount of data is given on the tube cartons themselves

necessary data but there are few indeed in this category.

One can get information from the manufacturers by writing; for most of them know all about their own tubes. Again, magazines and newspapers have published articles on tubes, giving much important data. But these data are general, and usually apply to 199 or 201-A tubes as a class, and do not tell one what happens when the tube gets old, when the various voltages are changed, or when any one of a number of other variables are "monkeyed" with.

HOW ONE MAY FIND OUT ABOUT HIS OWN TUBES

AND, while there are any number of people who are content to take information and advice that is handed out by others there are quite a few who prefer to get the information for themselves. And not all of these people live in Missouri, either!

RADIO BROADCAST has already published considerable data on tubes, data which have come from experiments in the Laboratory. For example, in December, 1925, something was said about the new power tubes, how much power was obtainable, and how much was necessary for satisfactory reproduction. In February, 1926, data were published on the proper uses of tubes and, in April, was described the effect of adding resistance loads to tubes, as well as a discussion of the several methods of coupling loud speakers to power tubes.

In the present article, we shall show how remarkably simple is the apparatus necessary to experiment and measure the important constants of tubes. The main apparatus, outside of the tubes themselves, consists of two meters, a voltmeter and a milliammeter. As a matter of fact, one meter will do, provided one has the means at hand for calibrating a milliammeter as a voltmeter; this was described in the Laboratory Information sheets in the September RADIO BROADCAST.

The voltmeter should be a double range affair, such as the Jewell Model 55, or Weston Model 506, or the Hoyt Rotary meter (which is both milliammeter and voltmeter, so that one has several meters in one.)

With such a voltmeter, one may first adjust the filament voltage properly and then use the instrument to measure or adjust the grid and plate voltages.

The milliammeter must be capable of measuring both large and small currents, which is a lot to ask of any one meter. The Hoyt meter will do this without trouble since it has a 7.5-milliampere scale as well as one for 75 milliamperes, and two voltmeter scales as well. It is a simple matter, however, to adjust an ordinary meter so that it will read accurately the plate current of a small receiving tube—say one milliampere—or the output of a power tube, which may be thirty or more milliamperes. The answer lies in a sensitive meter combined with several shunts.

With a shunt, a meter that ordinarily reads ten milliamperes, a hundredth of an ampere, full scale, will read twice, four times, or any number of times that amount, depending upon the resistance of the shunt employed. Thus, with a shunt included, when the needle points to, say, ten mils., it really means that twenty, forty, or perhaps one hundred, etc., are actually flowing in the circuit. In making up a shunt, it is very easy to find the correct resistance by the "cut and try" method. For practically all meters a 6-ohm rheostat will serve as a satisfactory resistance. If we have a 5-milliampere meter and desire to read 50 milliamperes, we

first connect the meter in circuit and read the deflection. The rheostat is then connected in parallel and varied until the meter deflection is only one-tenth as great. (The total current in the circuit should be held constant). Now, when the meter reads 5 milliamperes, the total current in the circuit will be 50 milliamperes.

The important thing is to procure as accurate a meter as the pocketbook will permit. Weston Model 301 meters are ideal for the home laboratory, and similar types by other manufacturers are eminently desirable. The meter for the purpose of measuring tubes may have a full scale reading of five, ten, and not over twenty-five milliamperes.

HOW TO MEASURE TUBES

HAVING equipped ourselves with a meter that will read 0 to 10 volts and from 0 to 100 volts, and a suitable milliammeter, let us proceed with the all-important business of measuring tubes.

Suppose we start with a 201-A, the most popu-

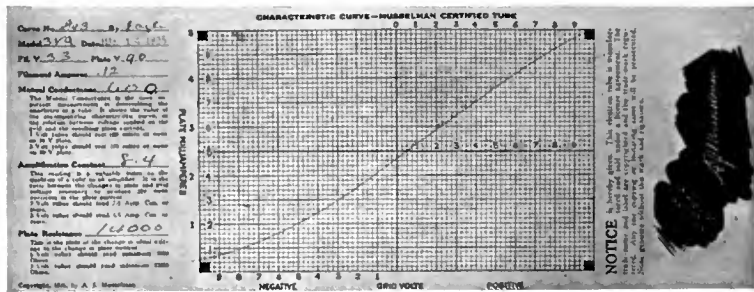

CURVES

Are included within the cartons by some progressive tube manufacturers. This particular one includes individual tube data which some manufacturers do not go to the trouble to give

lar type of tube used in America. The important things we wish to know are the effect of grid voltage and plate voltage on the plate current, the amplification factor, the plate impedance, and the mutual conductance in case we feel that this latter is the criterion by which to judge the worth of tubes.

The first thing to do is to set up our apparatus according to Fig. 1. The voltmeter enables us to set the voltage across the filament at 5.0. Then we connect the voltmeter across the B battery and measure this voltage, afterwards connecting it between the grid and the negative filament lead to read the C bias voltage.

Here a few words of caution are apropos. If the C bias is to be continuously variable, a potentiometer across a battery is necessary. If the C battery is the customary 4.5-volt block and the potentiometer is one of 400 ohms resistance, Ohms' Law tells us that 10 milliamperes are flowing—which is not good for the battery. It is better to use a storage battery or bank of dry cells so that the bias may be varied in steps of 2 or 1.5 volts respectively, which is close enough for all ordinary measurements. We have now:

1. Set the filament voltage at 5.0.
2. Read the B battery voltage.

and the next step is:

3. Adjust the C bias until the plate current is zero.

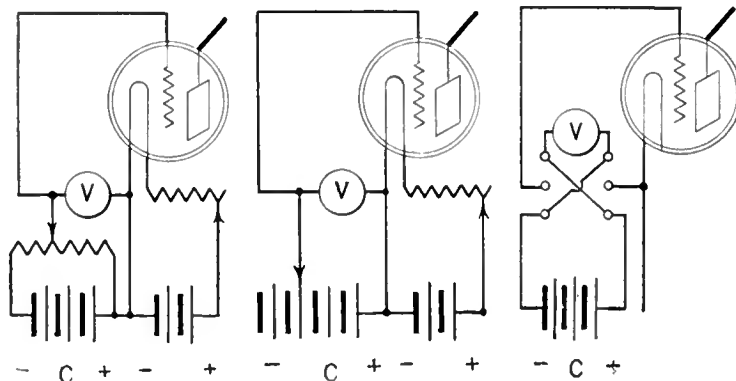
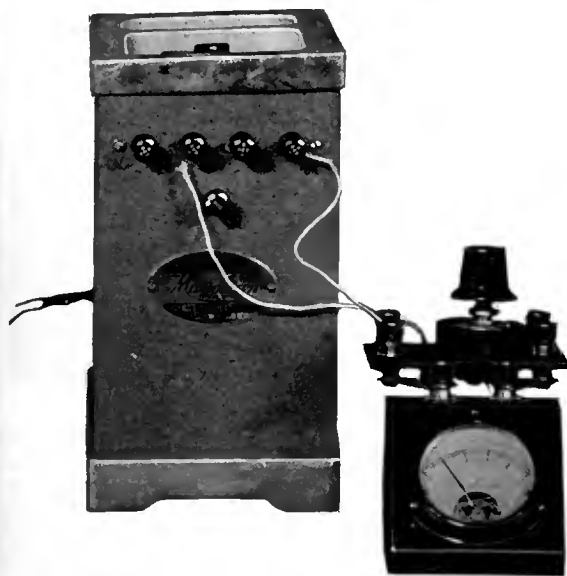

FIG. 2

Two methods of getting bias voltages for the grid are shown in this diagram. That using the potentiometer is bad for the batteries but permits of close regulation. A double-pole double-throw switch is wired as shown in the right-hand diagram for changing from a negative to a positive potential



RADIO BROADCAST Photograph

A SHUNT IN USE

Although the needle on this 5-milliampere meter points to 1 mil., by virtue of the fact that a shunt is included, it is really passing 10 mils. The shunt shown has a resistance of a very few ohms. The voltage source here is a "Mayolian," and a Clarostat is employed to regulate the amount of current.

4. Reduce the negative C bias in small steps and read the plate current.
5. Continue until the grid is about 10 volts positive.

Fig. 2 shows a simple method of reversing the C battery to get positive bias. The plate current will be zero at about 2.5 negative voltage on the grid if the plate voltage is about 22.5, and will be about 4 milliamperes with positive 5 volts on the grid. Now:

6. Increase the B voltage and repeat step 4.

When we have 90 volts on the plate and get the C bias to about positive 2.5, the plate current will be about 10 mils. and, if we have a ten-mil. meter, we shall have to worry about the shunt already mentioned. If the meter only reads 5 milliamperes, we shall have been in trouble before this.

The problem is to make our meter indicate a flow of greater currents without damage to it. We proceed as follows: We set the C bias until the plate current is some value near 5 mils on a 10-mil. meter. Any value that we can read accurately will do. Now we connect an ordinary low resistance rheostat across the meter terminals and adjust it until the meter reads one fifth —i.e., 1 mil. if it reads 5 mils. without the shunt. The meter with the rheostat now indicates only one fifth of the current actually owing, so we must multiply what the meter says by five.

The accompanying photographs on this page show how this shunt is made.

What we want is a series of curves showing how the plate current varies as we change the C voltage while we maintain the B voltage constant. Such curves are known as I_p-E_g curves, I_p standing for plate current and E_g for grid voltage. Specimen curves are shown in Fig. 3. We may plot these curves as we take the data and record them in a book too. The curve should be a smooth one, otherwise an incorrect reading has been taken.

EFFECT OF PLATE VOLTAGE

THE next thing is to observe the effect of varying the plate voltage while we maintain the C bias at given values, say negative 9, 7.5,

4.5, 3, 0, and several positive values. The plate voltage may be varied in 22.5-volt steps, or less.

Now, from these two sets of data, all of the important tube factors may be found, viz., amplification factor, plate impedance, mutual conductance, d.c. resistance, power amplification, and voltage amplification.

We may see from an inspection of the curves obtained that increasing the plate voltage increases the plate current, and that changes in the grid voltage also produce variations in the plate current. In other words, there are two factors that control the plate current—the plate voltage and the grid voltage. For a number of reasons, the grid voltage is more effective, and it is by virtue of this fact that the tube performs its multitudinous functions.

The amplification factor of a tube, usually designated as "Mu," is a measure of the relative effect of changing the grid voltage compared to changes in the plate voltage. It varies from about 3

We have varied the grid voltage about a mean or average value of zero, that is, five volts below and five volts above zero. Looking at the E_p-I_p curves in Fig. 4, pick out the one which was made at zero grid voltage, and put down the data as follows:

Plate voltage	Plate current
126	13
48	3
78 volts change	10 mils. change

Now we are able to arrive at the amplification factor (Mu) from the following formula:

$$\text{Mu} = \frac{\text{change in plate voltage}}{\text{change in grid voltage}} = \frac{78}{10} = 7.8$$

From the data above we may calculate all of the other important factors. For example, the plate impedance is defined as follows:

$$R_p = \frac{\text{change in plate voltage}}{\text{change in plate current}}$$

Remembering that a milliampere is one thousandth of an ampere, and that we must use volts, amperes, and ohms when calculating, we get:

$$R_p = \frac{78}{.010} = 7800 \text{ ohms}$$

The d.c. resistance of the tube is altogether different from this value since, by Ohm's Law, it is simply the ratio of the voltage and the current reading at a particular point. Thus, from Fig. 5:

$$R, \text{ d.c.} = \frac{126}{.0124} = 10,150 \text{ ohms}$$

The a.c. resistance is found out by the following formula:

$$R, \text{ a.c.} = \frac{126 - 30}{.0124} = 7,730 \text{ ohms}$$

The d.c. resistance is not indicative of what the tube will prove to be, either as an amplifier, a detector, or an oscillator. It merely proves that the filament still has a supply of electrons, and that the elements are properly connected to their respective lead-in wires.



RADIO BROADCAST Photograph

THE SIMPLICITY OF THE SHUNT

Is clearly shown in this illustration. It consists of a small resistance suitably mounted for connection to the meter terminals

for a 171 tube to about 30 for a Western Electric V tube. Its actual numerical value depends upon the construction of the tube and is practically constant over wide variations in plate or grid voltages.

To calculate the amplification factor from the curves showing how the plate and grid voltages control plate current, is not difficult. We note in Fig. 3 that, with 90 volts on the plate E_p-90 , changing the grid from negative 5 to positive 5 changes the plate current from 3 to 13 mils. We put down our data thus:

Grid voltage	Plate current
-5	3
+5	13
10 volts change	10 mils. change

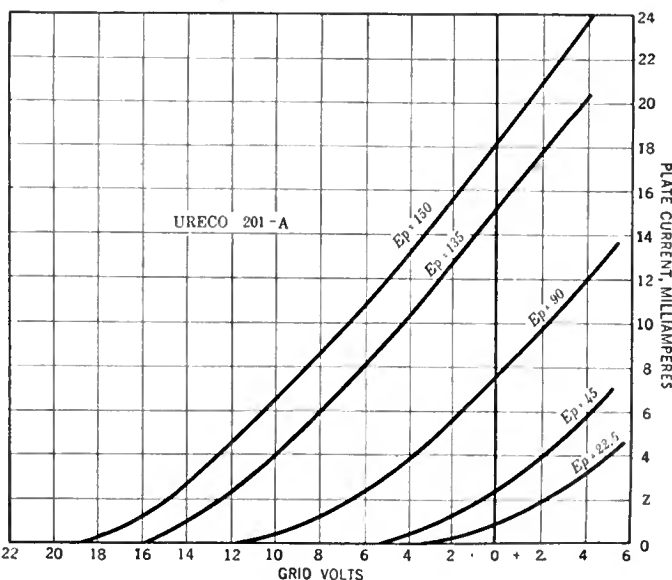

FIG. 3

These curves are from a 201-A tube and are what is known as " E_g-I_p " curves, that is, "grid-voltage plate-current" curves. They indicate how the plate current varies with changes in grid voltage

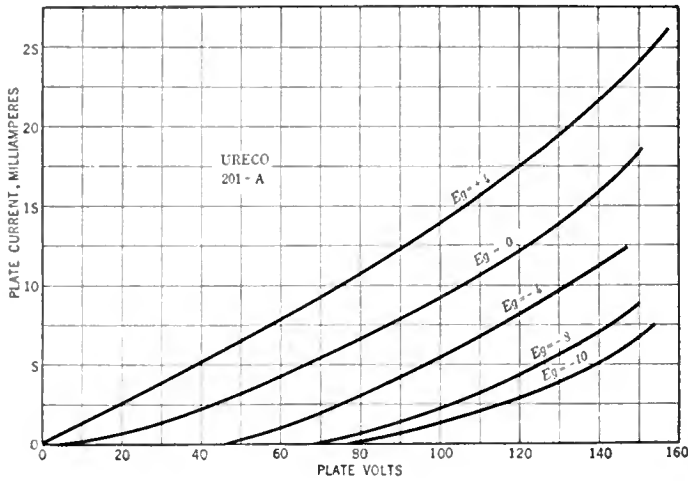

FIG. 4

Plate-voltage plate-current curves, or, as the tube technician would say "E_p-I_p" curves. From the data plotted here and in Fig. 3, all of the important tube constant may be calculated

MUTUAL CONDUCTANCE CALCULATION

THE mutual conductance of a tube is an expression for the effectiveness of the grid voltage in controlling the plate current. It may be obtained from the E_g-I_p curves since this factor is defined as:

$$G_m = \frac{\text{plate current change}}{\text{grid voltage change}}$$

and since, in the case above, we found that ten milliamperes change resulted from shifting the grid voltage ten volts, we have:

$$G_m = \frac{.010}{10} = .001 \text{ mho, or } 1000 \text{ micromhos}$$

The following table will aid in keeping the units straight for the above series of calculations:

.1 milliamperes	=	.0001 ampere
1.0 "	=	.001 "
10.0 milliamperes	=	.01 "
100.0 "	=	.1 "
1000.0 "	=	1. "

Now let us assemble our data and see if we cannot work out a system by which we may arrive at the important factors quickly. Our procedure in which any other values of plate and grid voltages may be used may be as follows:

1. Set plate voltage at 90.
2. Read plate current at E_g = positive 3.
3. Set E_g = negative 3 and read plate current.
4. Divide plate current change by grid voltage change (here it is 6 volts). This gives the mutual conductance at an average of zero grid voltage.
5. Bring plate current back to what we read at positive 3 by increasing the plate voltage.
6. Divide the plate voltage change by the plate current change. This is the plate impedance.
7. Divide the plate voltage change by the grid voltage change (6 again). This is the amplification factor.

There is an important relation between the amplification factor and the plate impedance. From our expressions given above but here set down in our short hand language,

$$\mu = \frac{E_p}{E_g} \cdot R_p = \frac{E_p}{I_p} : G_m = \frac{I_p}{E_g}$$

we may operate by simple algebra. Let us

divide the amplification factor by the plate impedance:

$$\frac{\mu}{R_p} = \frac{E_p}{E_g} \div \frac{E_p}{I_p} = \frac{E_p}{E_g} \times \frac{I_p}{E_p} = \frac{I_p}{E_g} = G_m$$

whence we see that the mutual conductance is the ratio between the amplification factor and the plate impedance. Within the limits of error in measuring the respective currents and voltage—and providing one only uses values on the

straight parts of curves—the value obtained by this division will check that obtained from the curves.

There are several important points to be considered in measuring tube constants. It must be remembered that the factors vary at each point on the various curves. For each value of grid voltage and plate voltage, there is a value of plate impedance, and amplification constant, although the latter does not change



SOME DELICATE WESTON METERS

These are standard meters and naturally are more expensive than those used by the average radio fan. These meters, although of the d. c. type, may be used for a. c. by using them in conjunction with thermo-couples, two of which are shown in front of the meters

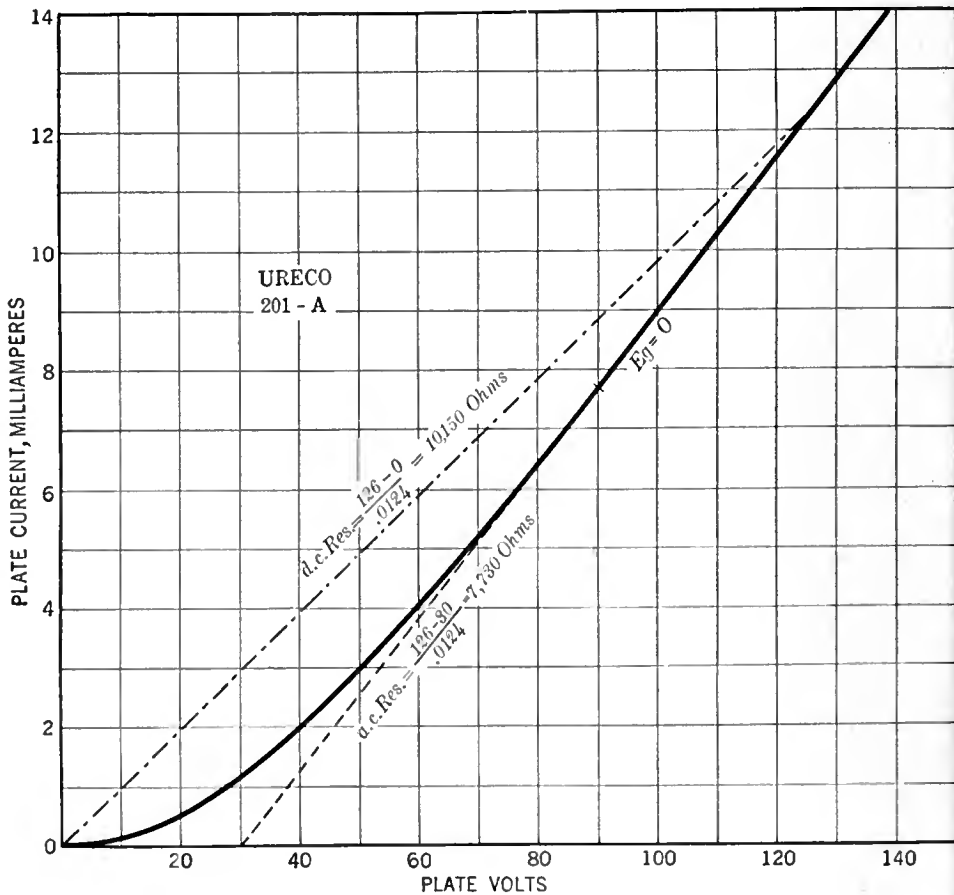

FIG. 5

This diagram of an "E_p-I_p" curve shows the difference between the a. c. "impedance" and the d. c. "resistance." The d. c. resistance is merely the plate voltage divided by the plate current, and may be represented by the reciprocal of the line joining the origin and the point under consideration. The a. c. impedance is the reciprocal of the slope of the curve

much. This means that the mutual conductance varies with each change in voltage, and to state that a tube has a mutual conductance of 1000 means nothing whatever unless the conditions are given.

TYPE	EP	EG	A. C. RP	IP	D. C. RP	WHERE D. C.=A. C.	K
199	90	-4.5	18,500	2.4	37,500	90 $E_p+3 E_g$	2.0
201-A	90	-4.5	11,000	3.0	30,000	90 $E_p+2 E_g$	2.7
112	135	-9.0	5,500	6.3	21,400	135 $E_p-6 E_g$	3.9

TYPE	AVERAGE K.	MAX. K	MIN. K	TUBES TESTED
199	2.0	2.14	1.93	5
201-A	2.7	2.9	2.61	3
112	3.9	4.5	3.23	5

The question naturally arises under what conditions tubes should be measured.

There seems to be great divergence of opinion on this subject and each manufacturer of tubes and of tube testers seems to have his own ideas. At the present moment it is worth while to state that the R. C. A. and the Bell Telephone Laboratories measure tubes under the conditions at which they ordinarily work, e.g., 199 and 201-A tubes with 90 volts on the plate and negative 4.5 volts on the grid.

There is another interesting point. We have shown that the d.c. resistance and the impedance differ. Now, if they differed by a constant amount, we could rig up a meter that would read plate current and at a given plate voltage would give us the impedance directly. Fig. 5 shows the geometrical relation between the impedance and the resistance.

It is true that for any value of impedance there is a set of conditions—grid and plate voltage—that will give a d.c. resistance equal to it, and over a certain

range of conditions the d.c. resistance may be divided by a constant to give the impedance. For all practical purposes, i.e., to tell a good tube from a bad one, and to actually measure the factors to a certain degree of accuracy, this method is entirely satisfactory. For example, the values in the accompanying table will be found to hold approximately. The actual variations from these values are also given.

Whatever the methods of testing, it must be borne in mind that the computations outlined in this article are correct only over limited sections of the curves. This implies that small changes in grid and plate voltages are to be used to get plate impedance, amplification factor, and mutual conductance. In the Laboratory a 1000-cycle note is used on the grid with a maximum voltage swing of 0.8 volts, and the impedance is measured exactly as any other impedance, i.e., in a bridge circuit.

The fact remains, however, that with a volt-meter and a milliammeter one can measure all of the important tube constants. It can be ascertained how the impedance of tubes varies with conditions so that one may engineer his other equipment accordingly, and using the formulas given in the April RADIO BROADCAST, one can calculate the power output in watts obtainable from tubes as well as the gain in voltage in both radio- and audio-frequency amplifiers.

Those who wish tube curves may plot the data obtained from the table on this page which represents typical data on tubes now obtainable.

DATA FOR CURVES FOR VARIOUS TYPES OF TUBES OBTAINED IN THE RADIO BROADCAST LABORATORY

199 (R. C. A. UX-199)

E_p	I_p @ -8 E_g	I_p @ -4 E_g	I_p @ 0 E_g	I_p @ +4 E_g
22.5	0	0	.5	1.4
45	0	.5	1.5	2.7
67.5	.55	1.5	2.68	3.8
90	1.5	2.64	3.7	4.3

201-A (Ureco UV-201-A)

E_p	I_p @ -10 E_g	I_p @ -8 E_g	I_p @ -4 E_g	I_p @ 0 E_g	I_p @ +4 E_g
22.5	0	0	0	-.72	3.2
45	0	0	.5	2.5	5.8
90	.55	1.3	4.0	7.7	11.9
135	4.3	6.2	10.3	14.8	20.5
150	6.5	8.6	13.0	18.5	24.0

112 (CeCo UX-112)

E_p	I_p @ -25 E_g	I_p @ -15 E_g	I_p @ -10 E_g	I_p @ -5 E_g
45	0	0	0	.12
90	0	0	.5	4.3
135	0	.9	4.9	13.4
150	.1	2.2	8.2	19.0
180	.1	4.4	11.8	23.0

210 (R. C. A. UX-210)

E_p	I_p @ -25 E_g	I_p @ -15 E_g	I_p @ -10 E_g	I_p @ 0 E_g
90	—	—	—	7
135	—	—	—	15
150	.1	1.1	4.1	19
190	.6	6.0	11.0	28
252	4.5	16.0	24.0	42

171 (R. C. A. UX-171)

E_p	I_p @ -40.5 E_g	I_p @ -33 E_g	I_p @ -16.5 E_g	I_p @ -4.5 E_g	I_p @ -27 E_g
45	—	—	—	4	—
65	—	—	—	12	—
75	—	—	3	—	—
90	—	—	—	25	—
100	—	—	12.5	31	3
115	—	2	—	—	—
135	1.5	7	33.0	—	16.5
150	6.0	15	—	—	25.0
180	19.0	31	—	—	41.0
200	31.5	—	—	—	—



RADIO BROADCAST Photograph

ANOTHER TUBE TESTER WHICH IS ON THE MARKET

The eight meters included are as follows: Filament voltmeter; plate voltmeter; d. c. grid voltmeter; a. c. grid voltmeter; filament milliammeter; plate milliammeter; a. c. milliammeter; grid microammeter. The instrument is manufactured by the Hickok Electrical Instrument Company, Cleveland, Ohio

Afire At Sea

A Short Chapter From War History—The Chronology of an SOS Call Which Brought Help to the Crew of a Blazing Merchant Vessel

By WALTER MEADE WILLIAMS

THE important part that radio played in the conduct and successful termination of the last war has long been recognized, and many are the stories that have been told of the experiences of the radio men who were active in this branch of the service during those years. Among these is my own story of the destruction by fire of the steamship *City of Wilmington* off Nova Scotia, on April 13, 1918. At that time I was senior operator of the *Wilmington* and on the particular occasion of which I write, we were just starting out from this country with an inflammable cargo for France, escorted by the usual convoy.

There was little premonition of danger in my mind as we picked our way out of the harbor at Wilmington, North Carolina, for I am not superstitious, and I stubbornly refused to sympathize with many of the forty men who comprised our crew when they expressed a vague fear that the boiler trouble, which had suddenly set in, was in some way connected with the date—the thirteenth. However, the boiler trouble did become so severe that the captain of the convoy ordered us to "make" Halifax rather than pass through the war zone in a disabled condition, and so we left the convoy and turned our bow back toward the American shore. In a short time I was in communication with the radio station at Halifax advising them of our return for repairs, little realizing as I pounded at my key, that before many hours were up I should be starting the ether with an sos call.

About eight o'clock, as I sat reading in the operators' cabin, I heard the fire bells ringing but little thought that there was anything seriously amiss. I woke up one of the gun crew who was asleep in the radio room and told him that the bell had just been rung for fire drill. He soon disappeared and I settled myself down comfortably to read again. Suddenly the

door was thrown open and the second operator informed me that the ship had caught fire. "Hurry," he said, "there won't be much left of this ship in a few minutes." Considering the nature of our cargo, this latter statement seems to me now to have been fully justified.

I jumped to my key, and seeing the captain approaching with our bearings scribbled down on a rough piece of paper, I shouted to the other operator to fetch my life belt and overcoat.

"Send out an sos," shouted the captain, "bearings 42°, 38' N; 58°, 18' W. Tell them we're ablaze," he added.

Sooner done than said almost, and in a very short time I received three answers. The nearest was from Sable Island. An-

ordered to the boats and the commander of the armed guard informed me that he too was about to abandon ship. "We will pick you up when you jump overboard if you won't come now," he told me.

After reporting to the captain, I again communicated with the operator on the cruiser, telling him of our condition and begging him to hurry.

By this time the deck was beginning to get really hot underfoot and smoke was pouring into my cabin. I looked anxiously outside and noted that all of the lifeboats had now been lowered and that only the captain remained on board. The flames were leaping skyward, and to anybody watching they would have formed a majestic spectacle, for tongues of flame now nearly reached the top of the foremast. Fire was sweeping both fore and aft and the heat was becoming more and more oppressive.

I called the Danish vessel and the cruiser once again. Both of them were coming now, but there was little consolation to be derived from my conversation except that they were hurrying toward us under forced steam.

A loud voice, that of the captain's, boomed down my ear. "It's no use staying aboard any longer. Abandon



SURVIVORS ABOARD THE "MILLAIS" AFTER THE RESCUE

other from a United States cruiser, while the third came from a Danish ship. They all persisted in sending at once and time was lost in getting matters straightened out so that one should answer at a time.

"How long will it take you to reach us," I asked the Danish vessel. "We are a hundred miles away and probably will not reach you until three o'clock in the morning," was the cheerful reply. I found that the other ships were just as far away so our position was not altogether a bright one.

The captain told me that the fire was rapidly creeping toward the supply of fuel oil and that when it reached this point we could not last much longer.

By this time most of the crew had been

ship," he ordered.

The radio room was just about unbearable by this time and I was only too glad to take the captain's advice. Once again I gave our position to the hurrying rescuers and wishing them a cheery "good night," we left the ship together, not before I had signalled, "me for the nearest boat," though, and then ran for it.

ADRIFT

WE SLID down ropes to a waiting boat and we were adrift, with the nearest help a hundred miles away.

It is not the most agreeable of pastimes to be cast adrift in a small boat, nor is it pleasing to watch the destruction of a fine

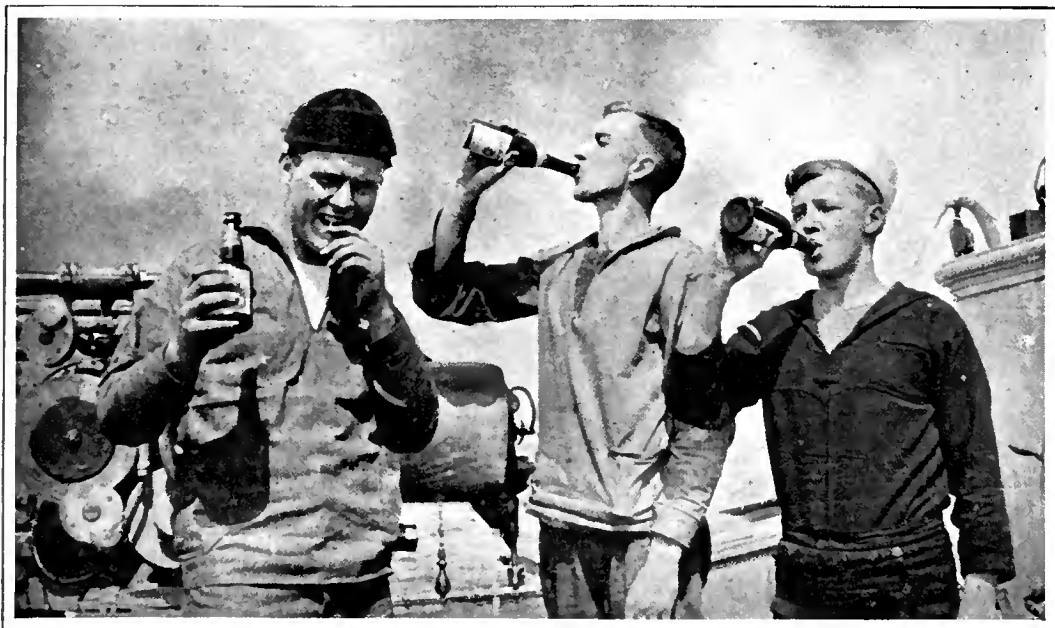

YO HO HO AND A BOTTLE OF NEAR BEER
Aboard the ill-fated *Wilmington* the afternoon before she was burned

A little before dawn the captain proposed that we go back on board the ship as the flames had somewhat subsided, and fire the forward gun to attract the ships that were looking for us, as they were already overdue. It did not take us long to get back and we were able to find a few shells that had not exploded. The naval gun crew set to, and before long we were making enough noise to attract any ship within a considerable radius. Soon we heard an answering siren, followed by the dim outline of a vessel. Those aboard had heard our shots and were looking for us.

A cheer rent the air as we summoned up all the strength that remained to us to give it. The rescuer turned out to be the *Millais*, a Lamport and Holt boat—a Britisher—and no time

vessel, especially if that vessel be one's home, so we were not in the best of spirits as we pulled away to a position perhaps a mile from the burning ship and lay watching the flames. As I watched, I saw the flames sweep aft and envelop the radio cabin. Then the shells, which we carried on board, started to make their presence known, and fragments of shrapnel tore through the air over our heads. We maneuvered our boats until they were out of range of the exploding shells, and as we did so I reflected somewhat dubiously on my possible chances of escape had I remained aboard for a few minutes more, not forgetting that the box of ammunition just behind the radio cabin would not have improved any such chances.

The water was smooth but there was a cold penetrating wind blowing and only the exploding shells prevented our drawing close to the conflagration to keep ourselves warm. The captain passed around

cigars which he had saved at the last moment, and these were instrumental in cheering us up a great deal. At about two o'clock the next morning a ship's whistle was heard and we made every effort to attract her attention. We fired pistols in the air, we lit torches and shouted as loudly as we possibly could, but all to no avail, for the siren grew fainter and fainter and finally became inaudible. A fog had gathered during the night and we began to wonder how long it would take our rescuers to find us in this obscurity.

was lost on our part in transferring.

As we took a parting look at the *Wilmington*, a shell was fired into her hull by the *Millais*, and we watched her sink to a watery grave, for floating wrecks are a menace to shipping and the *City of Wilmington* was too damaged to take in tow.

The Britisher was bound for Gibraltar and we were aboard her for ten days before we touched dry land. At Gibraltar we reported to the American Naval base and about a month later we sailed for home.

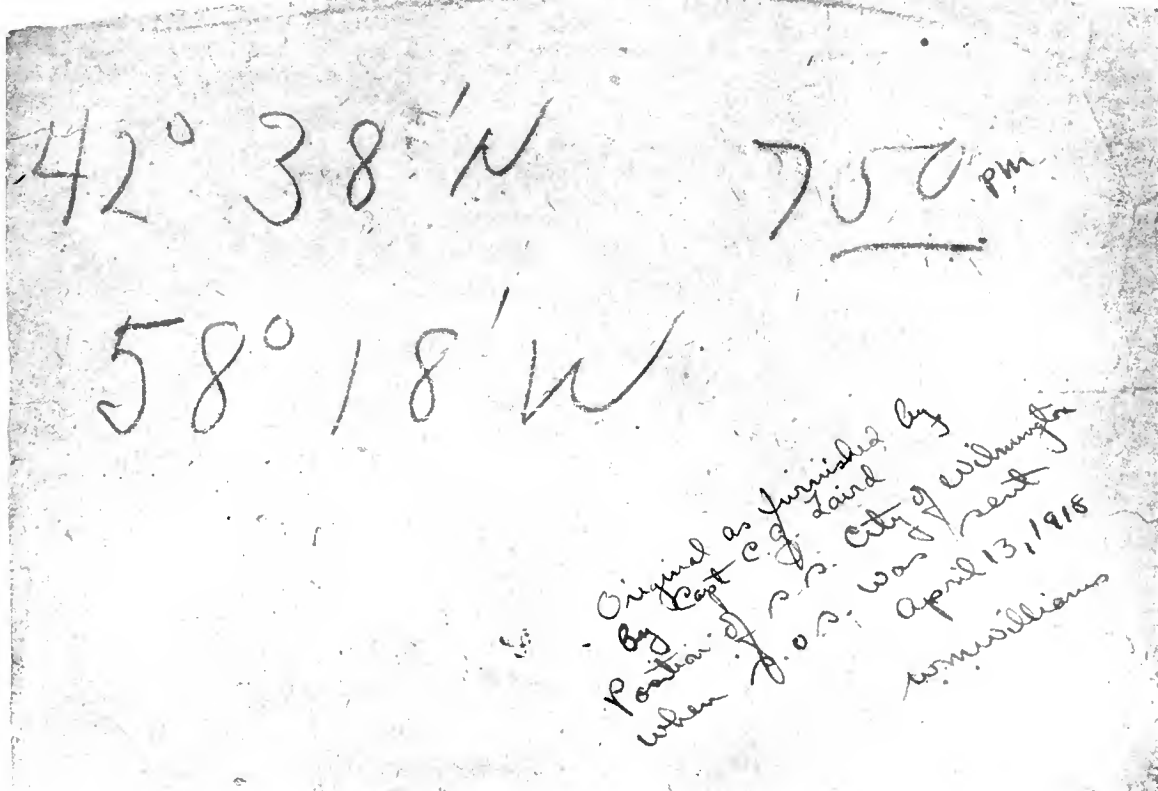

A REAL SOS

The bearings as they were handed to the author by the captain of the *Wilmington* when the SOS was sent out. The message was scrawled on a piece of brown wrapping paper

AS THE BROADCASTER SEES IT

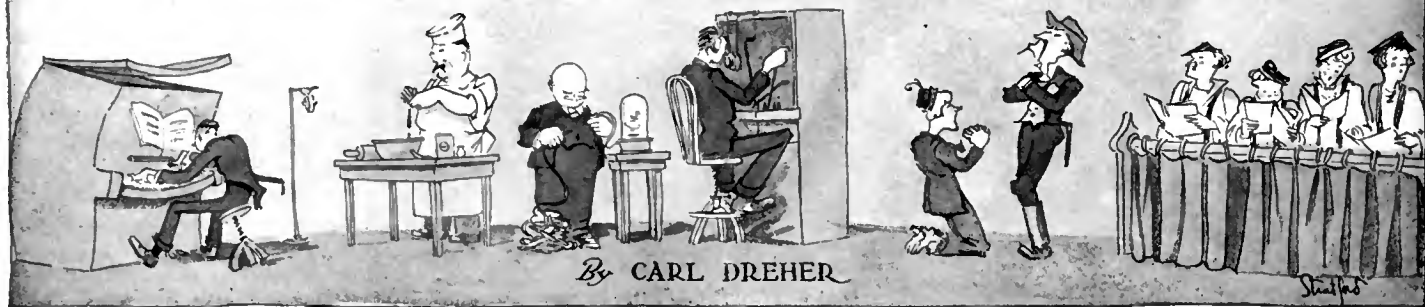

Drawings by Stuart Hay

Are Regular Features Good For Broadcasting?

AMONG the program managers who rule and sometimes ruin broadcasting in the U. S. A. and other countries bathed in the luminiferous ether, and, further, among the radio critics who harry and scourge the program directors aforementioned, some odium appears to attach to what are known as "regular features" on the air. The term as generally used is, of course, a misnomer. A feature is something important, outstanding. In broadcasting, the word is used to denote what would be an "act" in vaudeville, without regard to whether it is extraordinary or commonplace; the Blankety-Blank jazz orchestra broadcasting from the Hotel Inebriate, and the Philharmonic playing a Brahms symphony, are both "features" or "events." But, on this occasion, I am not seated at the typewriter for the purpose of cavilling at terminology. I desire to conduct a fair appraisal of "regular" or periodic broadcasts—those which recur every week at a certain time, and to distinguish between the good and the bad that is in them.

As I said above, some critics seem to object to these series as such. They would like to see a brand new program and program policy every week, one stunt following another with breathless variety. Such a project is impossible, and the prejudice against regularity is indiscriminating. What is objectionable is the recurrence of bad broadcasts, not of good and bad alike. We can stand the good ones every week, the

bad are bad even once, although repetition, no doubt, aggravates the injury.

The public does not mind repetition of good things. I am not referring, now, to the considerable number of "hours" which have been on the air for years—the Eveready is an example—in which a definite effort is made to vary the program from week to week over a wide range. The principal elements of repetition in such cases are the name of the sponsor, the general nature of the program in such points as popular or special appeal, and the broadcasting character or personality of the stock company which puts the show on. But, the material itself being changed, the gravitational attraction which tends to draw all forms of entertainment down to monotony, is successfully resisted. Yet some dinner music programs show a similar longevity, although little attempt is made to shake them up, and the public appears to listen to them with pleasure. It is not an ecstatic pleasure, presumably, but then ecstasy interferes with digestion. In short, the purpose of the broadcast must be taken into account. If the purpose is unexciting, a certain degree of monotony is allowable.

To the broadcaster, "regular features" are life-savers. They are his guides and anchorages, the elements of stability in an all too uncertain existence. An orchestra is booked for every Tuesday night, after negotiations, and then the program rustlers know that, barring a strike or

an earthquake, they have that hour filled for a while, anyway. The engineers, also, do not mind recurring "features" at all. Contrary to the general impression, a broadcaster does not walk into a hall, sniff the air, clap his hands twice, and walk out again in possession of all the facts concerning the acoustic characteristics of the place, down to all the details which the late Professor Sabine of Harvard University investigated so painstakingly. Preliminary surveys and tests are useful, but one still learns after the first time, and frequently gradual improvements in transmission are made over a period of months on a particular job. Then there is the factor of coöperation between the musicians and the technicians. Sometimes they fight more as they become better acquainted, but as a rule, an orchestra leader will do things, in the way of moving his men and modifying their playing, for operators he knows, that he would not do for strangers coming in with the same amplifiers and microphones. Sometimes this is carried so far that a conductor will demand that some particular operator or squad of operators, in whom he has confidence, be regularly assigned to his broadcasts, on the ground that he cannot conduct properly if the wrong man (wrong for that particular leader) is at the gain control. We may safely conclude that frequent broadcasts of the same material are beneficial technically, and hence somewhat more satisfactory to the public in that respect.

The argument that regular events make the work of the broadcaster easier is rather a weak one, inasmuch as the station is run for the public, not the staff. A more pertinent point is that a degree of regularity is inherent in nature, including the art of broadcasting. People expect it, as they expect the sun at dawn, the daily newspaper a few hours later, and a sermon on Sunday. For aeons, I, personally, have been listening to hotel orchestras play "My Heart at Thy Sweet Voice," from *Samson and Delilah*, and baritones intoning "The Road to Mandalay" and "Rolling Down to Rio." At least, it seems that long. And do you blame broadcasting for that? If you do, you are wrong; hotel orchestras and common baritones were plugging those pieces long before a grid, plate, and filament were stuck into a vacuum. Originality is rare, and the number of suitable tuneful pieces is limited. If we take to pushing regularity off the sidewalk, the banks will close, husbands will run away from their wives as one



"THEY FIGHT MORE AS THEY BECOME BETTER ACQUAINTED"



“PEOPLE EXPECT IT AS THEY EXPECT A SERMON ON SUNDAY”

man, the baseball schedule will be dislocated; it will be a job for the National Security League.

Well, let's be serious. Originality, we said, is rare. It is also precious. I am in sympathy with anyone who yells for it. But it must be the real thing, not one of the countless substitutes. The sort of variety and originality represented by broadcasting rattlesnakes, running a station twenty-four hours without a break, or reading the Bible from cover to cover on the air—may the patron saint of 1-B transmitters preserve us from it! I would a thousand times rather hear a good symphony orchestra on the air three times a week, even though it did play “*Tod und Verklärung*” twice in the season. When anything really interesting, astounding, or brilliant emerges from the sandy waste of mediocrities, I hope no one will try to shove it back under the surface if it happens to interfere with some solemn nonsense which was booked in 1921. I am not satisfied with radio, and I hope nobody else is. If we become satisfied, I trust better men will come along and boot us out of our jobs. But at the present stage it is not regularity that we must fight so much as aridity.

Technical Operation of Broadcasting Stations

II. The Heising Choke

SEVERAL alarmed broadcasters have inquired whether our statement in the July issue that 100 henrys is the right value for the voice choke in a telephone transmitter modulated by the Heising method, represents an invariable rule. The answer is that it does not. We will go into the matter in more detail.

As the article on *Modulation* (July), was supposed to cover all sizes of transmitters, I gave a value for this reactance high enough to suit the smaller sets. In general, the larger the transmitter, the smaller the choke required. If the low frequencies are not to be lost, the Heising choke must have a reactance, at low speech frequencies, which is high in comparison to the impedance of the modulator and oscillator banks. The latter figure is small for big sets and large for little ones. Hence the inverse relationship of transmitter power and size of modulator

choke. Now, to take some numerical instances, suppose you have a transmitter with an UX-210 tube as modulator. The tube impedance is near 5000 ohms. An 100-henry choke, considered as a pure inductance, will present a reactance, at 50 cycles, of about 30,000 ohms ($X = \omega L = 2\pi nL$, where X is the inductive reactance, and ω the angular velocity of the alternating current, which is equal to 2π , or about 6 times, the frequency n). Now suppose you have a 50-kw. set, or something on that order. There may be ten modulators in parallel, each with an impedance of 2000 ohms; together they represent only 200 ohms. If the choke is 10 henrys, the reactance at 50 cycles will be 3000 ohms, or 15 times that of the tube bank. In the case of the little set, the 100-henry choke has 6 times the impedance of the modulating tube, so that the margin is really better, with only a tenth of the inductance, in the case of the big set. It is a good idea to allow at least five times as much reactance in the choke

as the joint impedance of the modulator tubes. That means around 100 henrys for the small transmitters, down to about 10 for the big ones, where, owing to the large current carrying capacity required, every added henry means money.

12. Modulator Plate Current Variation

MR. A. R. MARCY of WMAC, at Cazenovia, New York, writes us at length, giving suggestions as to what he would like to see in this department, which is exactly what we want to get from the professional broadcasters who read these articles. Mr. Marcy makes one point which invites further discussion. He says:

Your article on “*Modulation*” is really the one which inspired this writing. There seem to be real and concrete discrepancies between the opinions of radio eminentists as to just what happens (visibly) when the transmitter is being modulated. By this I mean the action of the modulator plate current meter. In July RADIO BROADCAST (page 246) you say that a d. c. meter in the modulator plate supply will not fluctuate. Now it is common knowledge that the modulator plate current meter of the WE 1-B

transmitter varies continuously and is a rough check of the volume level. Mr. E. L. Nelson of the Bell Laboratories says in his article entitled, “*Transmitting Equipment for Radio Telephone Broadcasting*” (*Proc. I. R. E.*, October, 1924, p. 572): “When the equipment is in operation, the needle of the modulator plate meter swings at syllable frequency and affords a convenient although somewhat rough means of adjusting the input amplifier to give the proper volume level.” Who is right? In my experience I've seen just one station where the modulator plate meter needle seemed inclined to make an effort to stay constant. The rest act similar to the needle of the volume indicator meter. Can we have some further information along this line?

This is a grave situation, since neither Mr. Nelson nor I can afford to lose our positions as “radio eminentists.” But, as a matter of fact, we can both survive. We are not talking of the same things. My statement, it should be noted, was made in an illustrative paragraph, in an endeavor to differentiate clearly between the reading of a direct current instrument in the plate circuit of a modulator or amplifier, and the indication of an instrument like an oscillograph, capable of following the audio-frequency variations in the same circuit. That this distinction is not clear to all broadcasters and experts on electrical reproduction, is shown by the absurd controversy a few months ago about high quality amplifiers “modulating up” or “modulating down,” i. e., whether a d. c. milliammeter in the plate of an ostensibly non-distorting tube should read higher or lower with audio input to the amplifier. The answer is, of course, that in a distortionless amplifier the plate milliammeters will remain nailed, fluctuating not at all while the modulation changes. Any change in the reading of these instruments spells distortion, and the more the pointers swing the worse the distortion will be. Whether they go up or down, when the output is loud, depends solely on whether the swing off the linear portion of the characteristic is at the low or the high end of the curve.

But, although I did not intend to oppose the ideal to the reality with the zeal of the reformer, Mr. Marcy has asked a shrewd and pertinent question, and we will discuss the problem from the practical standpoint. If *all* distortion is to be avoided, the modulators must fulfill the conditions of distortionless amplification, and the d. c. ammeter in the modulator plate feed will not vary at all with modulation. Such a

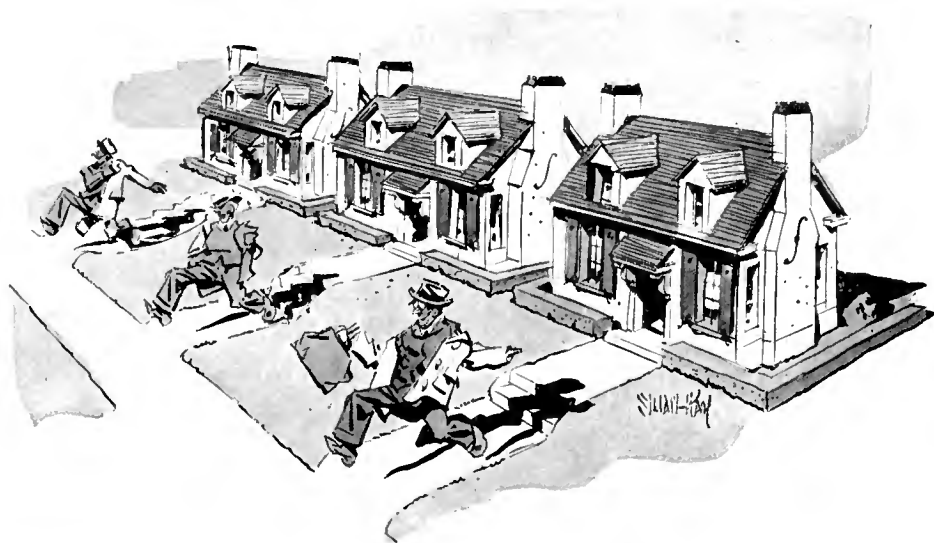

“HUSBANDS WILL RUN AWAY FROM THEIR WIVES AS ONE MAN”

transmitter would possess unusual modulator capacity, and would cost considerably more money than the usual commercial set of its size. Mr. Nelson was writing about a very good, economically practicable set with two oscillators and two modulators, run with approximately equal energy supplied to each hank. Some fluctuation—just how much Mr. Nelson does not state—is considered allowable in the reading of the modulator plate meter. In other words, a compromise is made between quality and cost, which is rational enough, since the human ear does not detect slight distortion and, besides, few perfect receiving sets are as yet abstracting energy from the ether. The question is, Where shall the line be drawn? Kellogg, quoted in the article on *Modulation* which gave rise to the present discussion, evidently believes that the time has come to consider quality more, and cost of modulation, in tubes and power, less. Besides Kellogg and his associates, Conrad, Little, Weinberger, and other prominent broadcast transmitter engineers appear to be favoring ample modulator capacity in their latest installations. Theoretically, this trend is sound, for the progress of broadcasting on the technical side consists in reciprocal improvements in transmitters and receivers. As the receivers become better the transmitters must be improved, and then the receivers are further jacked up to take advantage of the progress in transmitter output. With the advent of power output tubes in receivers, an advance in transmitter modulation technique is a logical step. I should like to disclaim any marked originality in my discussion of *Modulation* in the July number. I have merely tried to sum up the latest results of the design engineers; like other active broadcasters, I am an operating engineer, but intelligent operation requires acquaintance with the problems and solutions of the development and design group in one's field. Like our correspondent, I have yet to see a broadcast transmitter in which the modulator plate meter remains absolutely constant, but I would add this: I have been connected with the job of running several transmitters, and the fluctuation of that meter has become progressively less from the earliest to the latest. Perhaps we should set an allowable limit of swing at syllable frequency—say 20 per cent. of the full reading of the meter, in the present state of the art. To me even this figure seems high, and I know of stations (on earth, not in heaven) where the swing is usually just appreciable when one looks closely at the needle of the plate modulator ammeter, and around 5 per cent. on normal peaks. If I were a listener with the musical ear of a Paderewski and a \$500. receiver, I should be inclined to favor one of these products of the immaculate modulation, in voting for my favorite station, rather than those in which the modulator plate ammeter oscillates giddily all night long.

Abstracts of Technical Articles

II.

IN THIS department for September, under "Technical Operation of Broadcasting Stations," No. 10, there appeared an article on "Calculation of 'Gain,'" in which the rela-

tion between the mile of standard cable and the numerical voltage amplification was discussed. This treatment was not quite complete, inasmuch as the mile of standard cable is not the only reference standard of transmission efficiency used in wire telephony, and is in fact being supplanted in commercial telephone practice by a new unit, called the "Transmission Unit," or T. U. The new unit differs only slightly from the mile of standard cable. To show the advantages of the T. U. system, we present the following abstract of:

"THE TRANSMISSION UNIT AND TELEPHONE TRANSMISSION REFERENCE SYSTEMS,"

by W. H. Martin, of the Department of Development and Research, American Telephone & Telegraph Co., *Journal of the American Institute of Electrical Engineers*, Vol. XLIII, No. 6, June, 1924.

For some twenty years, the "mile of standard cable" has been used in telephone engineering in this country and abroad, for expressing the transmission efficiency of telephone circuits and equipment. With the advance of the art this unit has not been found entirely suitable, and the engineers of the Bell System have replaced it by a new standard, the "Transmission Unit." In comparing the two units, some consideration of methods of determining telephone efficiencies is first necessary.

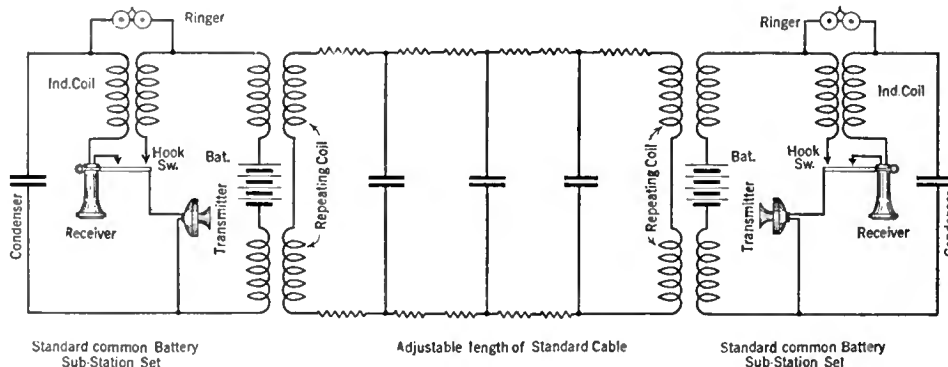

FIG. 1

A telephone system takes in sound energy at one terminal and reproduces it at the other terminal. Its efficiency as a transmission system may be expressed as the ratio of the sound power output to the sound power input. In commercial circuits this ratio is normally of the order of 0.0001 to 0.01.

The actual transmission, of course, is electrical in nature. The effect of any portion of the electrical circuit or the equipment therein may be expressed in terms of the variation which it produces in the ratio of the sound output of the system to the sound input. The over-all effect, and not merely the effect in a limited portion of the circuit, is what must be considered. Each portion of the circuit may be given an index expressing its effect on the sound output of the system. The effect of a number of such elements would then be found by multiplying the indices of the several elements. In practice, this is found to be a cumbersome method. But if the indices are expressed, instead, in terms of a logarithmic function of a ratio selected as a unit, then these indices may be added to give the resultant effect on the power ratio of the system. The "mile of standard cable" is such a logarithmic function, so in this respect the T. U., which is likewise a logarithmic function, merely meets a condition formerly recognized as essential.

The "transmission unit" is of such magnitude that two amounts of power differ by one trans-

mission unit when they are in the ratio of 10^1 . Any two amounts of power differ by N units when they are in the ratio of 10^N . Hence we may write that the number of transmission units corresponding to the ratio of any two powers, P_1 and P_2 , is

$$N = 10 \log_{10} \frac{P_1}{P_2} \quad (1)$$

Equation (1) is the expression for the number of transmission units in terms of electrical power ratio.

Fig. 1 shows the "standard reference circuit" of telephone practice. The cable is an artificial line with resistance of 88 ohms and capacity of 0.054 microfarad per loop mile. Obviously with an increase in the amount of cable, the ratio of the sound output of the system to the input would decrease. Thus this circuit became the reference standard of the telephone plant. The reproduction obtained with a cable length of twenty miles was found practicable for local exchange service, within a city, and that corresponding to thirty miles for toll or inter-city service. Various changes in circuits under test were equated to miles of standard cable.

There then follows a mathematical demonstration showing that the attenuation of standard cable, per unit length, varies as the square root of the

frequency of the current flowing in the circuit. Hence the "unit of standard cable" is unsuitable for use as a measure of efficiency in circuits whose behavior with respect to frequency differs markedly from that of standard cable. The new unit is independent of frequency. This makes it more general and constitutes one of its advantages. As it is based on a simple and universal mathematical relation, its use may be

extended to fields allied to the telephone art, such as sound investigation. It is logarithmic in character, which is desirable in computation, as has been pointed out, and conforms also to the observation that the sensation of loudness in the ear is a logarithmic function of the energy of the sound. Finally, there is nothing revolutionary about the new unit, in that it differs by only about 6 per cent. from the "mile." The minimum sound power change detectable by the ear is of the order of one "mile" or transmission unit.

From *Transmission Circuits for Telephone Communication*, by K. S. Johnson (D. Van Nostrand Co.):

Multiply miles by 0.947 to obtain T. U.
Multiply T. U. " " " " miles

I would add the comment that for radio broadcast work, with the present uncontrollable variations in the ether path, the two units may be considered equivalent, but it is just as well to know something of adjustments in telephone standards such as that discussed in Mr. Martin's paper.

Memoirs of a Radio Engineer XV.

ADVERTISEMENTS give the picture of an era better, sometimes, than many words. For some months I have been trying to describe the radio scene as it appeared to an amateur in the years before 1915. But the

difference between that time and the present will probably show up more strikingly if we go back to some of the advertisements in the radio magazines of pre-broadcast days, and compare them with the ornate and opulent output of the agencies to-day. Quite at random, I have picked up an issue of *Modern Electrics*, that of July, 1913. Look through the advertising pages with me.

Then as now, the I. C. S. was threatening to raise your salary. Not, however, through radio. Clapp-Eastham was advertising a rotary spark gap, "The Blitzen." Why "Blitzen"? From the German, perhaps, meaning "lightning"? Quite possibly; it was before the war. Thordarson was selling "Junior Bell-Ringing Transformers." The Wm. J. Murdock Co. was an aristocratic radio supply house of the time. It advertised a loose coupler for the stupendous sum of \$15.00. Most of the poor amateurs would have sold their entire stations for that sum. *Modern Electrics* was offering premiums with a subscription. For \$1.50 you got the magazine and your choice of a "Little Hustler" motor, a "Tesla" magneto finished in red enamel, a Bleriot monoplane, or a medical coil. A 3-inch spark coil could be had for \$13.15, from Hunt and McCree, who also offered \$7.50 loose couplers for \$1.93. The price cutter you shall have with you always. Wallace & Co. were selling a valve detector, later, I believe, adjudged an infringement on the De Forest audition, for \$12.00, or \$17.00 with storage battery. C. Brandes, Inc. was already selling head receivers at 111 Broadway. There were the usual number of schools urging young men to learn wireless telegraphy and see the world. There were also a great number of patent lawyers' advertisements. Then, as now, the lawyers made more money than the inventors. The Electro Importing Company spread itself over a full page. They had a "Commercial" detector stand for \$3.75—Italian marble base, patent rotary sliding cup, felt bottom. What grandeur! But for the proletarians there was a "Universal" stand for \$1.50, which the wretches no doubt neglected in order to build their own for 75 cents.

In the "Apparatus Exchange" department there were some comical items. An Iowan wanted to exchange "a new revolver, with 3-, inch barrel, 22 cal. break down, nickel plated, for Brandes 2000-ohm head set or 2-inch coil." The pleasures of slaughter had palled, evidently. Another hopeful offered to exchange 10 copies of Schnell's astronomy for key and sounder. Cameras, rifles, drawing outfits, musical instruments, and bound volumes of *Modern Electrics* were all in the market. Some had printing presses, scroll saws, phonographs, lathes, and post card collections, for which they wanted wireless apparatus. One fellow started off, "Will exchange good mail order business, paying 90 per cent. profit"—for anything you have. Some of the brethren, alas, appeared to have been robbing the local public service companies; a suspicious number of wattmeters and telephone ringers were being offered. Everything was "good" and "new"; nothing bad or old was on the market. Safety razors jostled Penzel B-Flat high pitched clarinets, which in turn bumped into "The Boy's Book of Model Aeroplanes," powerful toy motors, peroxide of lead detectors, acetylene post card projectors, and giant sounders. But the prize of the collection is the poor devil who advertised, "Will trade 1 artificial leg, cost \$125, used very little, for any kind of electrical goods."

I'm not trying to spoof the readers; the ad is on page 429 of the July, 1913, issue of *Modern Electrics*.

Among the Broadcasters

WKRC

THE near-by photograph, ladies and gentlemen, is not a hotel lobby, but merely the reception room of WKRC, of the Kodel Radio Corporation. Although it isn't the lobby, it is in a hotel—the Alms of Cincinnati, and it is stated to occupy one half of the north wing on its floor. This reception room faces the solo studio, the orchestral studio, director's control room, and director's office of the station, so that visitors can see everything going on, through the windows. On the opening night, between six o'clock in the evening and six in the morning, when breakfast was served, five thousand visitors passed through the room and saw what there was to see, which is quite an expanse, as no one will deny. The two fellows standing looking into the studio are six feet tall, the representative of WKRC informs us, so that will give you an idea of the size of the room. (One of the gentlemen is also about three feet wide, apparently.)

If it were not for the Italian fresco wall finish, the studio staff could play indoor tennis in the reception room. That, it should be added, is our own bright comment, for which the publicity department of the station is not to blame.

WGY

AMONG other things, WGY is noted for its contemptuous treatment of the dear old carbon microphone. As far as the General Electric Schenectady station is concerned, carbon transmitters are passé. The WGY technicians would no more think of using carbon in their microphones than arsenic in their coffee, and presumably the same thing holds for their brethren at KOL and KGO. When it comes to microphones, they believe in nothing more solid than air—between the plates of a condenser transmitter. At WJZ, now, they are all for condensers in the studio, but when it comes to outside jobs they hem and haw, and take the freight elevator with carbon mikes in their hip pockets. The heroes at WGY go the whole hog. Occasionally, it appears, they pick up a church

service of the Episcopalian persuasion, and have to use as many as eight microphones to do the job properly. And they use condensers, each with its two-stage amplifier. Three transmitters are mounted in the chancel, for the organ and choir, the latter being on both sides of the chancel. There is one at the altar and one at the lectern, for the rector conducts part of the service at these points, as well as one in the pulpit. Then a microphone is required in the auditorium or body of the church to pick up the congregational singing, and the chimes in the belfry get Number Eight. The remote control operator swings in the various transmitters according to his best judgment, as the service proceeds.

I suggest that Messrs. Sadenwater and Purcell, the engineering fellows in charge, endow a home for superannuated broadcasters and name it after the inventor of the condenser telephone transmitter.

WTAM-WEAR

BY PURCHASING station WEAR of the Goodyear Tire and Rubber Company, and combining it with its station WTAM, the Willard Storage Battery Company has secured full time on the 770.7-kc. (389-meter) wave in Cleveland. The program and operating staffs have been consolidated and the studio headquarters moved to the former WEAR offices in the Union Trust Building.

The manager of the combined stations is H. K. Carpenter; L. W. Zimmerman is program director, and S. E. Leonard runs the operating end.

ALASKA

ACCORDING to Mr. F. W. Fickle, of Seattle, Alaska, a territory so far without the local blessings of broadcasting, is to have a station of its own. It will be located in Ketchikan, and the studios will be in the Hotel Sunset Manor. Five hundred watts will be radiated on a wavelength as yet unassigned. Since Alaska is virgin territory for broadcasting, no trouble should be encountered getting a wavelength. This should be a great comfort to the six hundred odd applicants for broadcast licenses in the States.



THE PALATIAL RECEPTION ROOM OF WKRC, CINCINNATI

He Gave a Lusty Voice to Radio

"The Regenerative Circuit Was Not an Invention, it Was a Discovery," says Edwin H. Armstrong. The Story of the Man Who Was Responsible for Regeneration, the Super-Heterodyne, and Super-Regeneration, Three of the Most Important Contributions to Radio Science

By MYRA MAY

IF YOU were asked to name the ten men who have contributed most to the progress of the twentieth century, you would unhesitatingly include the name of E. H. Armstrong in your list. To him is due the credit for having taken the feeble, piping voice of radio and transforming it into a lusty tenor that can be heard all over the world. Under his care the adolescent wireless grew to manhood and developed from a raw recruit into a grand opera singer.

At the age of twelve, Armstrong started out with the ambition to train the untamed radio, and so well has he realized his objective that at thirty-four, he is famous as the inventor of the regenerative, the super-heterodyne, and the super-regenerative circuits.

In appearance, he is tall with mild blue eyes, a bald head and the erect carriage of an army officer. He is ready to talk on anything but himself. To elicit such personal facts, you must consult the "old" members of the Radio Club who knew "Howard" when he was at college and was struggling to establish his claim to his regenerative circuit.

"I knew Howard back in 1911 when he first began his experiments," says George Eltz, head of the radio department of the Manhattan Electrical Supply Company and one of his cronies. "He never spoke of what he was doing and none of us presumed to try to find out. He had made so much more progress in radio than any of the rest of us, that we followed him blindly. What he did was right as far as we were concerned, and he was our arbiter on all questions of wireless. He was a senior at college the year I transferred from Stevens to Columbia, but although we rarely saw each other at school, we often met at the Club.

"I remember going to Howard's home in Yonkers, one day—I think it was about 1912—and having the greatest thrill of my life, for I heard Little Glace Bay station in Nova Scotia. Most of our spark sets were unable to exceed the record of fifty miles some one else had set, so I felt that I was present at an epoch-making event to hear that distance. At that time, long antennas were fashionable; the longer the antennas, the better we thought we could hear. Armstrong's antenna, therefore, was strung along an embankment one mile in each direction, and we used to gaze in mute envy at the thousands of feet of wire.

"We had still another reason for envy. Howard was the only boy in the club who had more than one tube. The rest of us were proud to own even one, but Howard had quite a collection with which he constantly experimented.

"At the top of the house, he had his radio room which is as full of junk to-day as it was in those college days when we used to stand over him, and wide-eyed, watch his experiments. To support his antenna, he built the tall mast which still stands in front of the house. That mast was a wonderful vantage point from which to see fires. When the alarm sounded in Yonkers,

Howard would make a rush for his mast. He always was a remarkable climber and could hoist himself up its length in double quick time.

"He had a better understanding of wireless than any of the members, and all of us in the Radio Club of America were aware that he was far ahead of science, in his knowledge of the audion. The rest of us looked upon radio as a fascinating diversion to which we gave as much time as we could spare, but Howard devoted his whole life to it. Day and night he spent in the little room at the top of the house, where he experimented with his tubes and gadgets."

As a boy he was chiefly interested in reading.

"We couldn't make him go out and play with the other boys," his mother says. "He was always curled up, his head bent over some book. Someone gave him a copy of Marconi's treatises on wireless when he was about eleven, and after that Howard was a hopeless radio fan. He borrowed every volume on electricity the town libraries had, and he transformed his bedroom into a laboratory."

When I called on Mrs. Armstrong in Yonkers, she showed me the laboratory on the third floor. The room is undisturbed

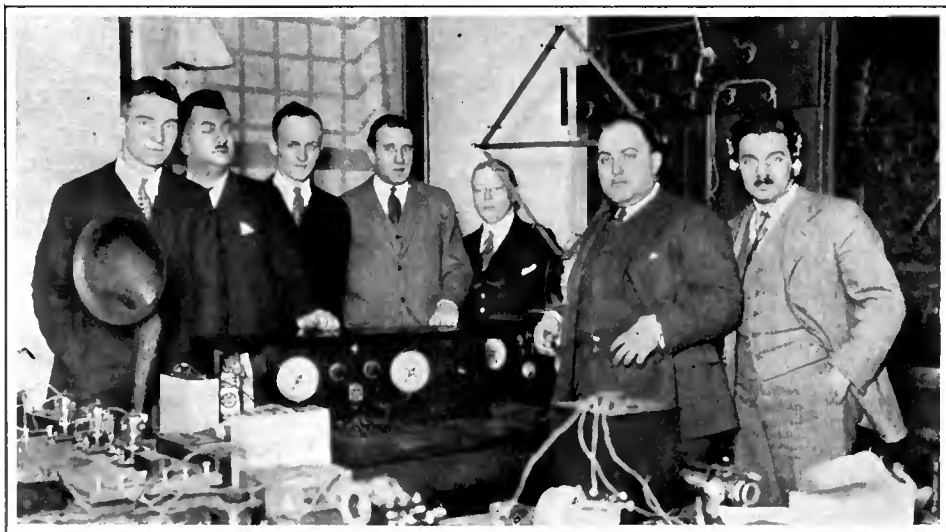

A RADIO CLUB GROUP

Armstrong was closely associated with the Radio Club of America members when still at college, and when struggling to establish his regeneration claim. George J. Eltz, jr., one of the oldest members of the Radio Club, and now a director, says that in the old days the members were all jealous of Armstrong, for he was the only member of the club who possessed more than one tube. The above picture is a recent one of some of the Radio Club members. The gentleman with his left-hand thumb in a vest pocket is Louis Gerard Pacent, a director and committee member. To his immediate right is Thomas J. Styles, while to his right is George E. Burghard. Edwin H. Armstrong is a director of the Radio Club of America

and just as it was when the boy used to make his experiments. A beautiful old secretary is piled high with weighty text books, a work table before the window is covered with early sets, variometers and bits of wire; even the floor is strewn with radio parts. In another corner, there is a heap of worn, discarded electric light bulbs while on the other side of the room, old storage batteries still stand guard over the models of armatures young Armstrong made when he was first in the grip of the electrical fever. "By the time Howard was ready

for high school," his mother continues, "he had read all the available English texts on wireless. At that time the German books were considered the finest so he elected German at school. It was no easy matter for a thirteen-year-old boy to master a new language and understand the technical features which are difficult even in a native tongue, but he persevered. He reached the stage when he could read the German as simply as the English. Whenever he has a plan he wants to carry out, he goes through with it, no matter how many obstacles may stand in his way.

"I remember when he was about thirteen, his little sister wanted a doll's house so he took some old boards and constructed the frame work of a cottage. He didn't know anything about carpentry but he worked until he had made a satisfactory job. Then he cut in the doors, windows, and even the stairway. After the little house was built, he added the crowning touch by putting in electric lights. Every room had its fixtures, which were controlled by switches.

HE ERECTS HIS FIRST ANTENNA

BY THE time he had progressed far enough into radio to want his own antenna, several years had elapsed. His sister, however, was still mindful of the doll's house so she helped construct the mast. Her part in the building operations was to send up on a pulley whatever tools Howard needed. That mast was about 170 feet high, but Howard climbed up and down with the utmost ease. The neighbors used to phone me to request that I keep my son away from the mast as it made them nervous to see him at such a perilous height.

"Howard was just out of college when he made his first invention. He used to stay up late into the night testing his discoveries. The policeman on our block says that the light shining from the third floor windows was his friendly signal when he used to patrol his beat. Since his marriage Howard no longer lives at home, but he still uses his laboratory and comes once or twice a week to work in it."

When Armstrong was twelve years old, Marconi sent the famous letter "S" across the Atlantic and the school boy up in Yonkers immediately evinced a keen interest. He



LEE DE FOREST TWENTY ONE YEARS AGO
This snap of Dr. Lee DeForest was taken long before anybody had thought of regeneration. It dates back to 1905, and was taken before the Boulder, Colorado, station. The names of Armstrong and De Forest are always mentioned when one begins to list those who made great contributions to radio

had been playing with electricity for more than a year but from that time on his future was all mapped out. He devoted his spare minutes from school to radio just as thousands of other boys were doing, but unlike these others, he was driven on by his determination to understand the miracles of radio. For the next eight years he continued studying his beloved subject with unabated zeal. It had become the biggest thing in his life.

By chance he secured a De Forest audion tube. Nobody understood its mechanism but young Armstrong made up his mind that he was going to discover the laws that governed its operation. Hitherto he had been mastering the theory of wireless in a general way; now he had a definite task to accomplish. As a means to an end, he threw himself wholeheartedly into his college course of electric engineering. At home he experimented with his audion and tried out new ideas which were beginning to occur to him. It was not until three years later that he felt he understood his subject thoroughly and at that time, Professor Pupin declared that Armstrong knew more about the audion than any one else in the world.

He had simply put his mind on what he wanted and gone after it.

"The regenerative circuit," he explains, "was not an invention, it was a discovery. While I was working with the De Forest audion, I found in the plate circuit high frequency oscillations of perhaps 500,000 cycles where I had expected spark tone of only 1000 cycles to the second. According to our text books, these high-frequency oscillations should not have been there. Much excited, I tuned up the rest of the circuit so that it would be resonant with those waves. I was amazed at my discovery. Whereas a moment before the signals had come in faint and barely audible, they were now clear and strong and could be heard all over the house.

"As I listened in, I heard San Francisco and Honolulu faintly, signaling to each other. The two stations were about two thousand miles apart, but they were compelled to repeat their messages frequently while I, more than 5000 miles away, could clearly hear the whole proceedings. I did not, however, jump to any immediate conclusions. For the next couple of months, I checked up my discovery until I was very certain that it was genuine."

Then Armstrong invited his teacher, Professor Pupin, to hear the new circuit in operation. Astonished at what his pupil had done, Pupin told the chief engineer at the American Telephone and Telegraph Company about the boy's exploit. The engineer could not grasp the magnitude of the discovery and it was not until the next year that he



FAR FROM THE MADDING CROWD

Yet unwilling to divorce himself from radio altogether for even his vacation period. Major and Mrs. Armstrong, on the sands at Palm Beach, listen to what the Florida ether has to offer with one of Mr. Armstrong's own "supers"

came to investigate just what this boy Armstrong had really done. He found the boy had made good his claims, and realized at once what this revolutionary thing would mean for radio.

Armstrong hooked up the set and let his father hear Ireland and Honolulu. Then he asked for the money to take out a patent, but his father refused on the ground that inventions would interfere with his son's studies. The boy, however, believed that he had a really valuable discovery and applied to an uncle for the money to establish his exclusive rights to his circuit.

The uncle, instead, gave his nephew some advice which in later years proved more valuable than any amount of money could have been. He told the boy to make a drawing of his invention and have it witnessed and dated by a notary public.

DE FOREST OPPOSES PATENT RIGHTS

WHILE the patents for the discovery were pending, Armstrong became involved in a long tedious law suit. De Forest claimed that the regenerative circuit which was based on his audition, was an infringement of his patent. The boy, fresh from college, found himself in expensive litigation that cost thousands of dollars, dragged over six years, and that left him at its conclusion, a weary man.

The drawing of the circuit which his uncle had advised, figured largely in the case. In the interim, between the witnessing of the sketch and the trial, the notary had died. The other side brought signatures of the notary which were ornamented with fancy flourishes and curleycues whereas the signature on Armstrong's document was a plain simple piece of writing. Ugly rumors of forgery began to circulate, but Armstrong finally saved the day when he produced witnesses who proved that the notary had two signatures. The plain one which appeared on the circuit drawing, was the notary's ordinary handwriting and the highly ornate one was reserved for special occasions. The notary had evidently so lightly regarded the signing of the school boy's drawing that he had used the regular unembellished signature.

After that point had been cleared in Armstrong's favor, there yet remained the more important matter of priority. De Forest, the plaintiff, claimed that he had

preceded Armstrong, whereupon the defendant brought his college friends into court and they testified to his having told them of the discovery. One boy even submitted a diary which in the year of 1912, bore the entry, "Armstrong told me he had a connection for intensifying sound."

To strengthen the case further, moreover, Armstrong rigged up a radio set which he brought into court and which he explained in simple, non-technical terms. During

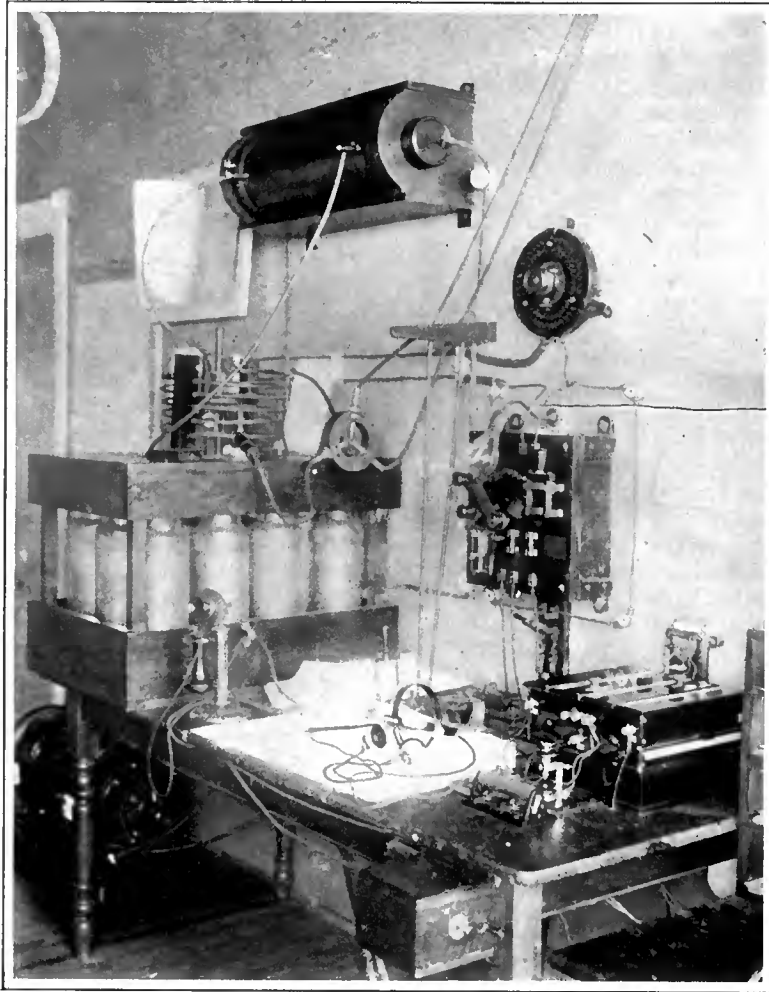

AN EFFICIENT INSTALLATION, OLD STYLE

It is a standard United Wireless station. The receiver consisted of a crystal detector in conjunction with an "efficient" three-slide solenoid inductance. The transmitter was powered from a 10-inch spark coil. The discovery of regeneration played no little part in making obsolete such installations as that pictured. It is surprising, though, how much some persevering operators used to get from their sets before the advent of the tube

the day, he was engaged in the law suit while at night he constructed the sets with which he hoped to substantiate his claims. He was laboring under an immense financial, mental, and physical strain. No company was willing to buy his invention while the patent was opposed or until he had proven his rights, so he struggled on alone, finding the way more and more thorny. The case dragged on and then the United States entered the war. Armstrong's reputation was already established, so when he offered his services to the government, he was given the rank of captain and sent overseas as head of Radio Communication. His was the most

important wireless work in the A. E. F. At first he was in England and later he was transferred to France where he associated with the biggest scientific figures in Europe, and was made a Chevalier of the Legion of Honor in recognition of his second invention, the super-heterodyne. During the war it was found that the Germans, who had radio stations about a mile or two apart, sent signals which our wireless operators were unable to pick up. These signals were no longer audible when our stations, ten miles away, tried to receive them. Of course it was of the utmost importance for this country to be able to intercept enemy messages, but their transmissions were on very short waves, somewhere in the neighborhood of 3,000,000 cycles a second. Armstrong's problem was to amplify these high frequency oscillations so that they could be heard in the American stations ten miles back.

The vacuum tubes constructed in the United States failed to solve this outstanding difficulty that confronted the A.E.F.," he relates. "We were unable to receive extremely weak signals of frequencies varying from about 500,000 to 3,000,000 cycles with an absolute minimum of adjustments to enable rapid change of wavelength. Round in England and Latour in France had produced aperiodic radio frequency amplifiers covering the band from 500,000 to 2,000,000 cycles. Their results had been accomplished by the use of vacuum tubes and transformers of minimum capacity.

NECESSITY THE MOTHER OF INVENTION

WHEN the United States entered the war, the fact that it was necessary to produce extremely sensitive receivers for short wavelengths, and that tube capacity would prove a bar to a straightforward solution of the problem, was not known in this country. As a result, no attention was paid to the capacity in the type of the vacuum tube which was adopted, and while it met the requirements of the lower frequencies admirably, it was impossible to use it effectively for the frequencies of importance in the direction-finding service.

During the early part of 1918, through the courtesy and energy of General Ferrié and his staff, the Americans were supplied with apparatus of French manufacture.

During the early part of 1918, through the courtesy and energy of General Ferrié and his staff, the Americans were supplied with apparatus of French manufacture.

It was apparent, however, that this source of supply could not be a permanent one and a solution of the problem became essential.

After much experimenting, the super-heterodyne was made for direction finding. It was Armstrong's first invention born of bitter need; the regenerative circuit had been the result of an amateur wireless operator's love of his work. The super-heterodyne was this wireless operator's reaction to necessity.

Harry Houck, who was Armstrong's sergeant in France, tells this story:

"The first super-heterodyne was developed under shell fire. They (Big Berthas) were bombing Paris and every few minutes another terrible explosion would shake our laboratory and add zest to our experiments. I had been working under a captain by the name of Armstrong for the past three months, and, while we conducted our research to the tune of exploding shells, I chatted with a mechanic about what a fine, straightforward chap this Armstrong was.

"You know who he is?", the mechanic asked.

"Then for the first time, I learned that my superior officer was the Armstrong of regenerative circuit fame, the man who had been my secret idol since I was twelve years old. I could not believe that this unassuming Captain Armstrong was the famous man about whose inventions I had read so much. I had to be reassured by the men in the laboratory before I was convinced.

"The first set we made was a combination of parts from every type of radio in existence. We used old German apparatus that had been captured and sent to us for observation and we picked to pieces some of the American products also. Thus we gradually evolved our trial set. We sent it up to the front where it was an immediate success. From that time on, we intercepted German messages without difficulty. Every day brought new confirmation of the power of the super-heterodyne. We would hear that the Germans expected to attack a certain sector; we would decode a message from their air force; we would learn where they were massing their forces. Daily our set performed miracles, each of

which was an exciting chapter in the story of the American Expeditionary Forces. Captures that formerly would have been outstanding events became such regular occurrences that we ceased to comment on them."

THE PHANTOM ZEPPELIN

CAPTAIN Armstrong became Major Armstrong, and he was made a Chevalier of the Legion of Honor, but he continued with unabated zeal to head the radio branch of the A.E.F. Part of his duties brought him in contact with airplane radio. He had to go up in the American planes that he might intercept the German messages which were sent between their Zeppelins and their ground stations.

On one occasion while Major Armstrong was up in the air, cruising around Paris, he and his pilot were startled by the sight of exploding shells dropping on the city below them. He was not equipped for aerial battle so he tried to locate the Zeppelins so that he could inform the American gunners below of their exact location. In vain he and the pilot sought some clue as to the whereabouts of the enemy machines.

"Those smart Germans must have made an invisible airship," the pilot said.

The invisible airship was wreaking more and more havoc. Buildings toppled, sirens whistled, shells exploded, and the Major could find no trace of the death-dealing "ship". It was not until Armstrong and his pilot returned to the hangar, that they learned the "invisible airship" was "Big Bertha" bombing Paris.

After the Armistice, American headquarters were moved to Spa, Belgium, to a house formerly occupied by Von Hindenburg. To keep in touch with the outside world, Major Armstrong set up a radio station in the cellar. He made a workable set out of the parts of a number of small damaged outfits. The very day that the new Spa station was in order, it was inaugurated by a message from the radio operator in Paris who explained that a cable for the Major had just arrived, and if he so desired, it could be transmitted by radio. The gist of the news was that the De Forest interests had reopened the legal fight in New York.

Armstrong was three thousand miles from home and his life's work was at stake. He reached home as soon as possible and resumed the long-fought battle. It dragged on until March, 1922, when a verdict in Armstrong's favor was at last handed down. Since then there have been additional

legal engagements between the holders of the Armstrong patent and the De Forest interests. It is not, however, within the province of this article to go into the vagaries of the decisions and legal points involved.

During the experiments in court, with which he proved his case, he noticed the phenomena that led to the discovery of his super-regenerative circuit. It magnified sound enormously.

All three of his inventions, Armstrong sold to a large radio and electrical concern.

"Don't let the thought of money engross you; throw yourself into your work," he advises. "The best pay you can get is the satisfaction of a job well done, but society is so arranged that the man who has contributed happiness or comforts usually gets financially rewarded besides. Money comes to those who think little about the actual earning of the dollars and cents."

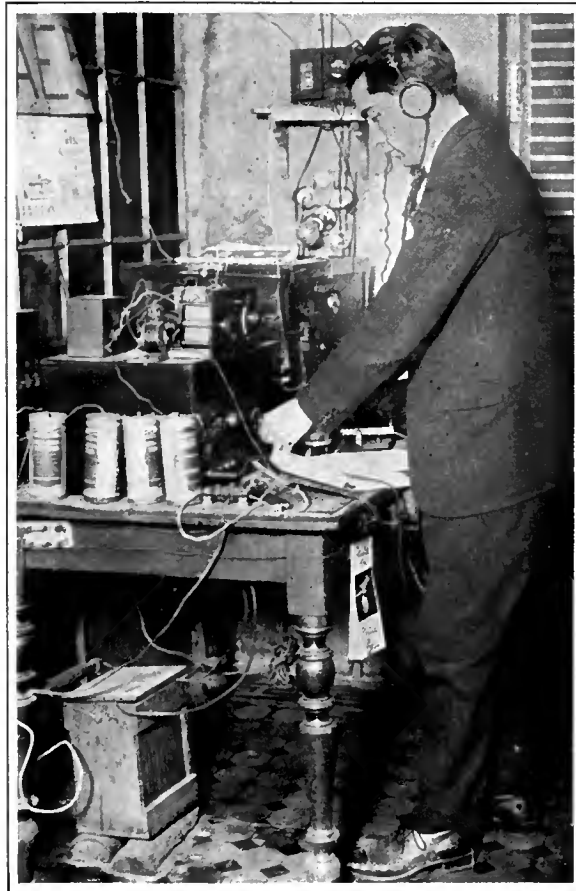

NORTH, SOUTH, EAST, WEST

Wherever radio has been taken up, the regeneration discoveries have been incorporated in amateur constructed receivers. This picture shows an Argentinian amateur operating his home-made receiver. The gentleman is Mr. D. S. P. Acuna, one of the best known of Argentinian radio enthusiasts.

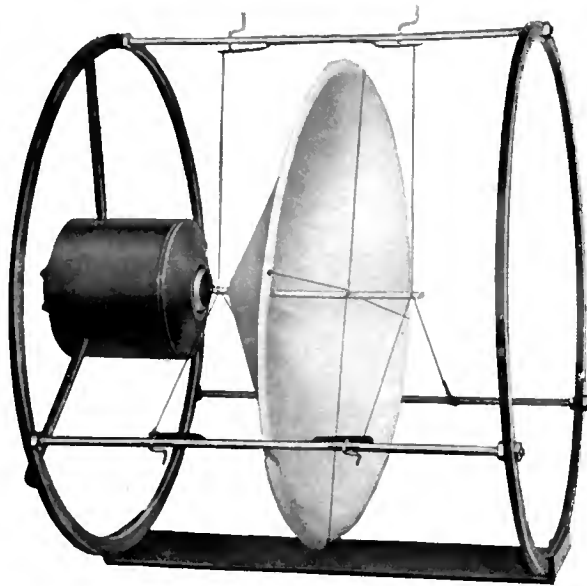

A FREE EDGE CONE DEVICE

In this instance the cone was mounted on a paper straw, and reinforced by silk threads from the straw to its periphery. Bobbin motions as large as one-eighth of an inch were sometimes noticed with this instrument

DEVICES used in the process of converting sound into electrical energy cannot always be used for the reverse process—to convert electrical energy into sound, that is. This is especially true in the case of the common carbon microphone. However, the condenser microphone, to cite one concrete example, is a very satisfactory converter of electrical energy into sound, provided the energy is not considerable. If an attempt be made with this device to obtain the same amplitude of sound as the original input (into the transmitter of a broadcasting station, for example), an electrical rupture will occur. This is due to the low efficiency of the device, and to the low insulation resistance made necessary by the very close spacing of the opposite plates of the condenser microphone. The conversion efficiency of these devices is very low, the electrical output being very small.

Certain types of microphones (better styled "pickups") may be reversed, providing the amplitude is already within the working limits.

For the true conversion of sound into electrical energy, or vice versa, three conditions are necessary. First, we must provide a surface in the wave front of the sound wave which will move in accordance with the sound wave; second, adapt this surface to actuate or control an electric or magnetic field; third, arrange the field so it can be utilized for the production of the necessary voice currents.

The construction of the field and its associated circuit presents but a small problem, while the construction of the moving surface and its supports presents many mechanical difficulties. A disc, secured at its edge, as in the form of the present day telephone, has the disadvantages of stresses in the metal permitting the center portion to deflect a relatively large amount while the edge is stationary. This gives rise to mechanical period in the diaphragm itself, which is ultimately imparted to the associated electrical system. In the development of the telephone it became evident that it would be desirable to have the surface of the diaphragm move integrally from its center to its edge, so a diaphragm of conical shape was resorted to.

The conical shape gives extreme rigidity to axial motion and provides a surface which moves as a plunger, and which is of small weight.

air in the sound box by flexing. The usual difficulties of sound box resonance were present, and the addition of the horn added certain resonant periods.

THE REQUIREMENTS OF A GOOD HORN

MUCH time and effort have been applied to the development of horn loud speakers for phonograph and radio purposes. Horns of small size have been made which cover only a small portion of the frequency range. A horn, to reproduce music successfully, should cover a frequency range of 50 cycles to 6000 or 8000 cycles. This can be partially accomplished by a horn of large size, *i. e.*, 6 or 8 feet in diameter and of about the same length. Horns of smaller size generally cover the upper range or the middle range, and depend upon internal resonance to develop the lower notes.

In order to approximate a reasonable range, several horns can sometimes be used in combination. One horn would be designed for the upper range while one or two horns would be designed to cover the middle and lower ranges. The results obtained from devices of this kind have been only partially satisfactory, as a great many resonant periods occur, which tend to accentuate or blur certain tones.

The conical diaphragm, when used in telephone sound boxes, presented different problems than when it was freely exposed to the surrounding air. Hopkins made a large step in this direction by evolving a practical conical diaphragm of sufficient size to produce a sound wave of magnitude comparable to the original sound, without the use of a horn. This was successfully used with a phonograph. Large diaphragms of this character will produce a sound wave of magnitude of a normal speaking voice with a small amplitude of motion. To produce the same magnitude of sound with a small diaphragm and horn, requires a much larger amplitude of motion and higher amplitude sound wave in the sound box. This high amplitude sound wave is passed out through the narrow neck-like opening of the horn and expanded along its walls and, as the area constantly increases, the amplitude of the wave decreases and ultimately passes to free air at approxi-

Cone Loud Speakers

A Radio Club of America Paper Which Tells of the Development of the Cone Type Loud Speaker—The Requirements of a Cone to Reproduce Equally the Whole Audio Frequency Range—Where to Look for Distortion When It Occurs

By C. L. FARRAND

President, Farrand Mfg. Co., Inc.

mately the same amplitude as the wave produced by the large diaphragm.

The author, while searching for a suitable loud speaker in connection with talking picture work and wireless telephone systems, and wishing to avoid the distortion of the horn, happened upon the Hopkins conical diaphragm, and combined it with suitable actuating electrical telephone mechanisms. The advantages of a diaphragm of this type for use as a loud speaker were investigated and developed. A conical diaphragm can be constructed so that it moves substantially as a plunger at sound frequencies. By so moving, it acts upon a large area and volume of air, and produces a high power sound wave of large amplitude, with slight motion.

It may be generally stated that the cone moves as a plunger at sound frequency. This, however, is not exactly the case. A cone of a given size will move as a plunger only if the frequency is sufficiently low. As the frequency is increased, the outer portion of the cone will tend to remain stationary, and, at extremely high frequencies, only the inner portion of the cone will move. If a cone is built several feet in diameter, the center portion of the cone will act at the higher frequencies, around 3000 to 5000 cycles, while, as the frequency is lowered, the active area of the cone will progressively increase. That is, at the lower tones, a larger portion of the cone will function. It was noticed in the use of larger cones that there was a greater tendency to reproduce the lower frequencies, or bass notes, and it seemed that there was a relation between the diameter of the cone and the length of the wave. It is not unreasonable to expect that a 10-foot sound wave can be better produced by a plunger which approximates that diameter than by one only a small fraction of that size. Such a diaphragm may be likened to an antenna, and acts as a radiator. With suitable proportion, it may approach an aperiodic radiator. By reducing the mass of the diaphragm and the elasticity of the suspension, and disassociating it from other mechanical portions of the system, it will approach the true conditions of aperiodicity. It is essential that the associated telephone movement does not upset this condition by having undue mass or elasticity. The mass and elasticity should be so proportioned that they do not appreciably reduce the natural damping of the diaphragm. A diaphragm of this character has an extremely large resistance to motion, which is due to the actual production of sound waves, and corresponds to the radiation resistance of an antenna system.

The relation between the size of the cone and the length of the sound wave corresponds somewhat to the relation between the size of the antenna and the length of the wave to be pro-



duced, that is, for efficient radiation, it is desirable to have an antenna length which is an appreciable fraction of the maximum wavelength to be radiated from the antenna system.

THE MOVING COIL SYSTEM

THE moving coil telephone is ideal for the purpose of producing a highly damped radiator, as the mass of the coil can be made very low, and the elasticity is only that of the diaphragm, which is extremely small.

The next in choice is the balanced armature telephone. The latter generally requires a reduction lever to reduce the amplitude motion of the armature to a lower motion for application to the apex of the conical diaphragm. A reduction ratio between 0.8 and 0.4 to 1.0 is generally satisfactory.

The moving coil system, with a large conical diaphragm, was developed commercially by the author in the form of the Phonetron of 1921, and used for both loud speaker and pickup purposes.

Fig. 3 is a photograph of one of the original Phonetrans, while Fig. 1 shows its constructional details. The conical diaphragm was supported at its edge by two clamping rings. To these two clamping rings, and located on the axis of the cone, was secured an electro-magnet, by means of a spider-like support. The electro-magnet was pot-like in shape, made of cast iron or steel with a central core of Norway iron, and provided with a field winding of No. 18 B. & S. wire (suitable for 6-volt operation), and thus produced a uni-directional annular field. A cylindrical bobbin of hard rubber was supported from the apex of the cone so as to move freely in the annular field without touching the metal portions of the magnet. This bobbin was wound with 0.002-inch diameter enameled wire, about 4500 turns, for use directly in the plate circuit of a vacuum tube. Fewer turns, together with a transformer, were sometimes used. The apex of the cone was stiffened by means of thin conical metal reinforcements. When used as a pickup, the construction was similar. The Phonetron pickups were installed in the original wjz station in Newark, New Jersey, and were

used there during the spring of 1922 with excellent results. Unfortunately the receiving equipment at that time did not permit the broadcast listener to appreciate the quality of transmission. A receiver utilizing a practically distortionless amplifier and Phonetron loud speaker was installed in the office of John V. L. Hogan in New York City. Tests were made between this receiving station and wjz of Newark, and various comparisons of pickups and loud speakers were made. The amplifier used in connection with this early work was a resistance-coupled audio-frequency amplifier wherein only the alternating potential of the plate is supplied to the succeeding grid by means of a balancing battery, which balances the d. c. potential of the plate. This circuit is shown in Fig. 2. This amplifier, I believe, is due to Arnold of the Western Electric Company. It is very satisfactory for experimental purposes where it is desired to have distortionless amplification of all sound frequencies. Four resistance-coupled stages will give an amplification equivalent to about two stages of efficient transformer coupling. The new Radio Corporation and Cunningham power tubes, ux and cx 112, are satisfactory for this type amplifier. The purpose of making the resistance of the first stages larger is to decrease the operating voltage on the tube and to permit a smaller balancing battery which balances the operating voltage of the tube to be used. An amplifier of this kind will amplify from zero cycles to 25,000 cycles without distortion, there being no reactance, either capacitative or inductive, to introduce a frequency function. Figs. 4 and 6 are photographs of a battery balanced amplifier of this type built for laboratory purposes.

CHOOSING PAPER FOR A CONE

IN THE development of the cone loud speaker, many different types of construction were tried. Various materials, including hard rubber, celluloid, wood, metals, paper, etc., were tried for the cone. A fibrous paper, not highly calendered, operates satisfactorily, and presents a good commercial solution. The thickness of the paper should be approximately one mil (.001") for each inch of diameter, providing a soft finish paper is used; the thickness should be less if the paper is hard finish. The harder the finish of the paper, the greater will be found the tendency to depart from the cone shape, and undue stress will be set up in the paper, which will give rise to rattles, due to "tin-can" actions. The proportion of the altitude of the cone to its base can be gauged by the angle of the side of the cone to its axis. This should range between 30 degrees and 60 degrees. These values are approximate, and depend upon the size of the cone, and may be deviated from without affecting operation to any large extent.

The freedom of movement, of course, is hindered somewhat by the flexing of the paper at the edge. This flexing involves a loss of power which can be compared to hysteretic losses.

Experiments were conducted to determine the amount of these losses and to lessen them. Sandpapering an annular portion at the edge of the cone, or substituting light flexible paper or other material, and castellating the paper edge, were tried. Where heavy paper was used, the above experiments improved the results, and were manifested by an increased clarity of treble. Complete freedom of the edge was obtained by suspension of the cone on silk thread. The photograph at the top of page 514 is of the free cone device. The cone was mounted on a paper straw, and reinforced by silk threads from the straw to its periphery. On one end of the straw was mounted a bobbin which floated in the annular field produced by the electro-magnet. The complete assembly was supported by threads. There was nothing to retard the axial motion of the bobbin; it floated freely in the sound wave, and motions as large as 1/8th of an inch were sometimes noticed when used.

As this was done, it was found that the edge of the cone, due to the slowness of curvature, was not inclined to move integrally with the rest of the cone. This was overcome by making a circular trough-like portion at the edge, which reinforced it, and retained the circular form of the cone. A method nearly as effective is to reverse a small portion of the cone at the edge, making a V shape trough instead of the circular trough. The advantages of freeing the edge of the cone are so slight that operation can be equaled by suitable proportion, while the mechanical advantage of a supporting ring at the edge of the paper are apparent. The outer portion of the cone can be conveniently turned inward and the mass of the supporting rings and its supports materially reduced without affecting its operation.

Fig. 5 shows a photograph of a large cone speaker built in experimental form. The mechanism is substantially the same as that of the Phonetron, shown in Fig. 1, and consists of a floating coil supported from the apex of the cone and which floats in the annular, uni-directional magnetic field. The cone of this model was about four feet in diameter, and was made of pieces of wood cemented together. The

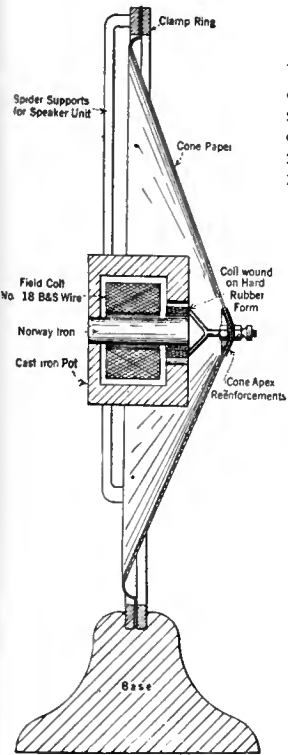

FIG. 1
The construction of the Phonetron, shown at the other lower corner of this page, is made clear by this diagram

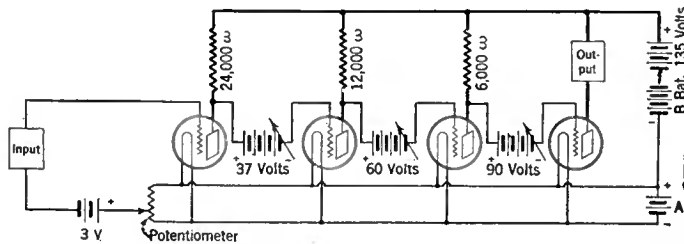

FIG. 2
This is the circuit diagram of the resistance-coupled amplifier used in a New York City location to pick up the signals from the old wjz at Newark when comparisons of pickups and loud speakers were made in 1922

FIG. 3
In 1921, a moving coil system, with a large conical diaphragm, was developed. It was known as the Phonetron



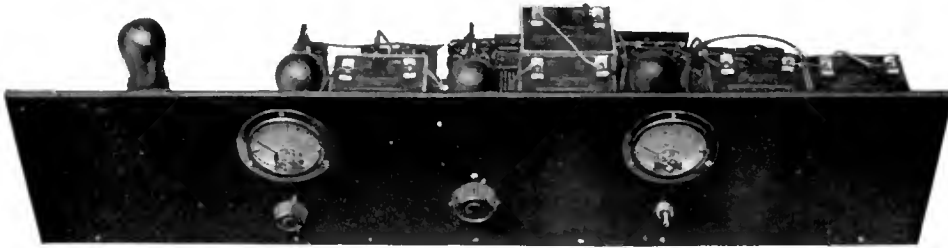

FIG. 4

A battery balanced amplifier as used in the experiments between New York and WJZ of Newark in 1922. It is a resistance-coupled affair wherein only the alternating potential of the plate is supplied to the succeeding grid by means of a balancing battery, which balances the d.c. potential of the plate

periphery of the cone was cemented to a ring of canvas which in turn was cemented to a square plywood board. The action of this device, as in the case of the Phonetron cone speaker, is as follows: The armature coil is drawn inward toward the field magnet when the voice current is in one direction, and forced outward from the magnet when the voice current reverses to the opposite direction. In this way, the force is applied between the apex of the cone and the heavy magnet pot without a system of mechanical levers.

The loud speaker, being the device which produces the sound, is generally blamed for all the deficiencies of the receiving system, including those due to poor receiver, vacuum tubes, batteries, and at times, even the deficiencies of the broadcasting.

The better grade of receiver of to-day contains good audio transformers and is capable of producing good quality music with sufficient bass. It is, however, necessary that the batteries have voltage to supply sufficient power to the vacuum tubes. It is also necessary that the vacuum tubes have sufficient power capacity, *i. e.*, sufficient filament emission and normal filament brilliancy. The type UV-201-A and C-301-A tubes, when new and used with a 90-volt B battery, have sufficient emission and, therefore, power capacity, to permit faithful reproduction at only very moderate intensity. However, when the volume is increased with this combination, an accentuation of harmonics occurs, which are evidenced in a faithful speaker by nasal or rattling tones. An unfaithful reproducer will, however,

FIG. 5
A large cone speaker built in experimental form. Its mechanism is not unlike that of the Phonetron shown on the previous page. The cone of this model was about four feet in diameter



smooth these "rough edges" of the sound and give a more pleasing tone; this deceives the listener into believing that the more faithful speaker is faulty, whereas the facts are that the speaker is faithfully reproducing the voice which has been distorted by the vacuum tubes. This condition can be improved by an increase of plate

voltage, which will lower the impedance of the tube and affect a greater transfer of the lower frequencies (when used with a transformer of given inductance), and will also permit the increased amplitude of the lower tones to be passed without distortion.

Super-heterodynes and sets of tuned radio frequency type utilizing regeneration have a tendency to change the tonal characteristics of the music or speech, when tuned. As the receiver is tuned to the maximum volume, an accentuation of the bass will be observed. This may cause all tones to become somewhat drum-like in nature with, at times, a complete loss of the treble. The tuning of a receiver should not change the tonal characteristics of the reception excepting that there is, however, a tendency of the human ear to respond more readily to louder sounds. In practically all radio reception of today, the magnitude of the treble is greater than the bass. This must not, however, be confused with the accentuation of bass due to regeneration as referred to above, when a partial or complete loss of treble occurs at the tuning point of maximum volume. A good receiver and speaker will reproduce throughout its tuning range the true relative value of bass and treble, the reduced bass on either side of the peak tuning point being due to the failure of the ear to notice the bass until it is sufficiently loud. The intensity of treble will not lessen at the tuning point of maximum volume, but the bass will sound louder.

FIG. 6

Below is shown another view of the balanced amplifier shown at the top of this page, and schematically in Fig. 2

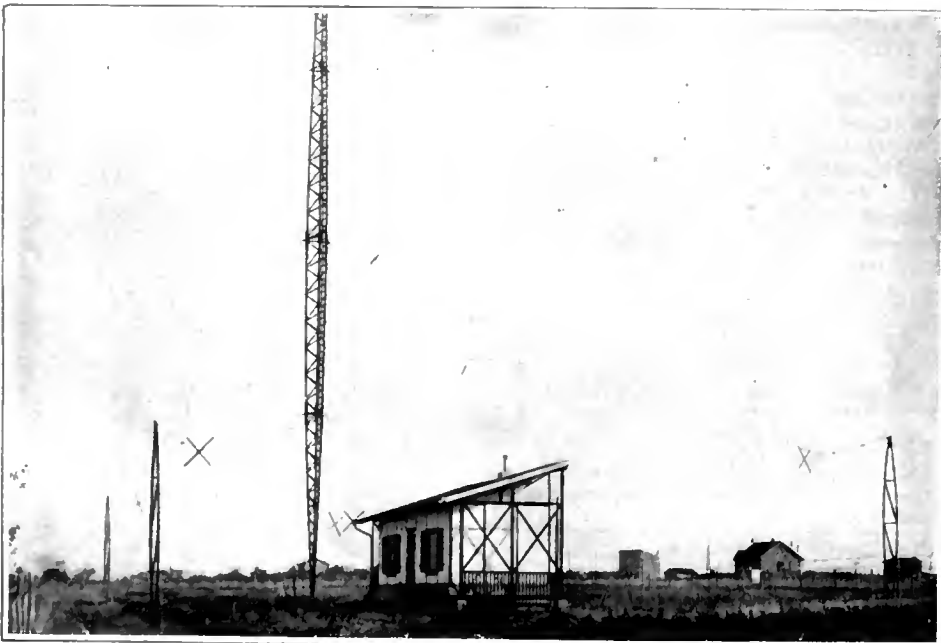
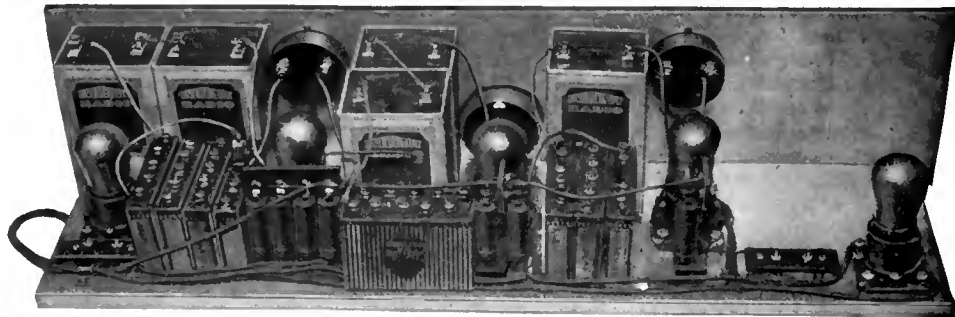

A FRENCH AMATEUR SHORT WAVE STATION

Owned by *La T. S. F. Moderne*, a Parisian radio magazine. Its call is 8AE and when this station was erected, was using 1764-1499 kc. (180-200 meters). This view shows the antenna and counterpoise

RADIO BROADCAST

Metropolitan Shows Section

VOLUME IX



NUMBER 6

OCTOBER, 1926

A Special Section of Sixteen Pages, Devoted to a Presentation of the Advances in Complete Radio Receivers, Parts for the Set Constructor, and Accessories Which Can be Well Applied to Radio Sets Old and New, Together with an Article on How to Select Your 1927 Receiver.

Bringing the Radio Shows to the Country

THE offerings of the radio industry to the public for the 1927 season represent the soundest progress in the technical advancement of the art and the most substantial improvement in convenience and beauty of radio equipment of any year in the history of the industry. Visitors to the radio shows will marvel at the great simplification and refinement which is evidenced in the products of practically every manufacturer. To record this progress in lasting form, we devote this special section of the magazine. Prepared so far in advance, it is necessarily incomplete but we are grateful for the hearty cooperation of the industry which has made it possible.

While no printed description can hope to convey the show to its readers with the vividness of an actual visit to any one of the many shows to be held in all sections of the country during the next few months, we present the high lights of all the shows in a manner to be helpful to the set buyer. The special section which follows is an interpretative summary, not a catalog, of the progress of the art, as recorded by the show exhibits.

The two outstanding shows will naturally be those held at our two largest cities—the Third Annual Radio World's Fair, at Madison Square Garden, New York City, September 13th to 18th and the Fifth Annual Chicago Radio Show, Coliseum, October 11-17th, but enthusiasts in all sections of the country will be favored by comprehensive radio shows. The various show managements have so arranged their schedules that all the prominent manufacturers are enabled to ship their New York exhibits to each of the important shows in the country, assuring representative expositions in nearly a score of cities.

The principal shows scheduled are as follows: Akron

Radio Show, September 15-18; Boston Radio Exposition, Mechanics Building, September 27-October 2; Third Annual Brooklyn Radio Exposition, 23rd Regiment Armory, October 30-November 6; Cleveland Radio Industries Exposition, Public Auditorium, September 20-26; Detroit Radio Show, Convention Hall, October 25-31; Second Annual Indianapolis Radio Exposition, State Fair Grounds, October 25-30; Los Angeles Radio Exposition, Ambassador Auditorium, September 5-11; Fourth Wisconsin Radio Exposition, Auditorium, Milwaukee, September 25-29; Northwest Radio Exposition, Kenwood Coliseum, September 27-October 2; Pittsburgh Radio Show, October 4-9; Pacific Northwest Radio Exposition, Public Auditorium, Portland, Oregon, September 20-25; Rochester Radio Show, Convention Hall, October 11-16; Second Southwest National Radio Show, New Coliseum, St. Louis, October 18-23; Pacific Radio Exposition, Civic Auditorium, San Francisco, August 21-28; Sioux Falls Radio Show, Coliseum, October 26-29; Omaha Radio Show, Auditorium, September 6-11.

It will be noted in the pages which follow that radio has at last progressed to the stage where each step forward is no longer heralded by a fanfare of excessive exaggeration. We now enter upon an era of sound improvement and steady refinement; the day of the revolutionary advance is a thing of the past. In our summary of what is presented at the radio shows, we describe the general trend of improvements which the show visitor will observe and how these improvements make for his greatly increased enjoyment of radio broadcast reception.

—THE EDITOR.



BEAUTY AND UTILITY COMBINED

The new Bosch "Cruiser" receiver, displayed in an unusual domestic setting. This is a two-control model with concentric knob for one-hand manipulation and typifies the sort of receiver offered the 1927 purchaser

NO MATTER what special features the visitor to the radio show may seek, he will find receivers which, apparently, have been designed to fit his particular needs.

The broadcast listener, who uses his radio for the musical entertainment and pleasure it gives him, will appreciate particularly the improvements in fidelity of reproduction attained by better audio coupling methods, shielding and power tubes, the flexible volume controls which do not introduce distortion, the many convenient single- and dual-tuning control receivers and the better power supply devices which reduce his maintenance duties to a minimum.

The long distance enthusiast will find his requirements met by a large selection of highly sensitive and selective receivers with as many as four stages of radio-frequency amplification, so precisely synchronized that single- and dual-control is feasible.

In deference to the lady of the house, manufacturers have incorporated significant advances in ease of control, beauty of appearance and simplicity of maintenance. Several makers are showing receivers having a single tuning control with an illuminated indicator, calibrated by stations or wavelengths, taking the guesswork and uncertainty out of tuning. She will also be pleased with the advances made in appearance, not only of the set cabinet itself, but in the complete sweep which has been made of unsightly accessories, such as B batteries, storage batteries, chargers, and loud speakers. In the better grade re-

What's New at the Radio Shows

A Pre-View of the New Receivers, Showing How the Radio Set, While Not Radically Different in Fundamental Circuit, Has Been Greatly Improved in a Hundred Little, Important Ways

BY EDGAR H. FELIX

ceivers, there is adequate space for every element necessary to the operation of the set.

The engineer, visiting the radio shows, will sigh with relief at the disappearance of the "revolutionary circuit" fairy tales which, in past years, have circulated at the beginning of each season. 1927 ushers in design improvements instead of discoveries in circuit design which are claimed to be millennial. The industry has finally settled down to making its product a better performer by painstaking design and workmanship rather than seeking the attainment of the impossible by a mere rearrangement of parts in new combinations.

RECEIVER DESIGN AND WORKMANSHIP HAVE IMPROVED

THE technical expert finds the 1927 receiver a real advance in refinement of design and workmanship. Thoroughly shielded radio-frequency stages improve selectivity and stabilize operation. Precisely calibrated radio-frequency tuning represents a degree of precision manufacture entirely new to the industry. Adequate power tubes with a choice of effective coupling methods between stages have provided the 1927 purchaser with audio-frequency amplification of remarkable fidelity and flexibility. Loud speakers, combined in self-contained sets, are greatly improved and contrast pleasingly with the cramped, inadequately small sound projectors of earlier vintages.

So much for generalities as to the year's improvements. We will consider the products of various manufacturers and how they have incorporated these and other improvements. We regret that mention of many meritorious products is necessarily omitted because data was not received in time to be incorporated in this article.

Single tuning-control receivers are considered first only because they represent

the most striking, if not the most important tendency of the season. Although the future predominance of the single-control receiver is by no means established, many manufacturers are building at least one model of that kind. A few which have come to our attention are the All-American, Apex, Atwater Kent, Bosch, Cardinola, Chelsea, Crosley, A. C. Dayton, Diva, Distantone, Elkay, Federal, Freed-Eisemann, Ferguson, Franklin, Garod, Hunt, International, Kodel, Kolster, Magnatone, Magnavox, Mazda, Melodyne, Metro, Midwest, Mohawk, Morton, Murad, Okay, Operadio, Penna, Perlesz, Pfanstiehl, Priess, Radiola, Ray Isler, Rodgers, Showers, Simplex, Splitdorf, Shamrock, Stewart-Warner, United, Wilcox, and Windsor.

From the foregoing, one should not conclude that these single-control sets predominate at the shows. In fact, it is probable that there are more two-control receivers than one-control being offered to the public. Having two hands, the user is expected to be able to manipulate both controls simultaneously and in synchrony. In so doing, these manufacturers contend, they obtain greater efficiency because the radio-frequency circuits are thereby more accurately tuned than they would be if operated by a single control. Stromberg-Carlson, for instance, the pioneers in quantity manufacture of multi-stage, shielded radio-frequency receivers, is concentrating its output upon two-control re-



THE PFANSTIEHL MODEL 20

An excellent single-dial receiver, calibrated directly in wavelengths. The dial is illuminated from the rear. Utter simplicity marks this handsome model. Price \$125.

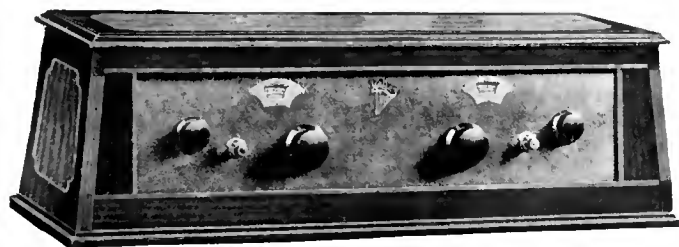
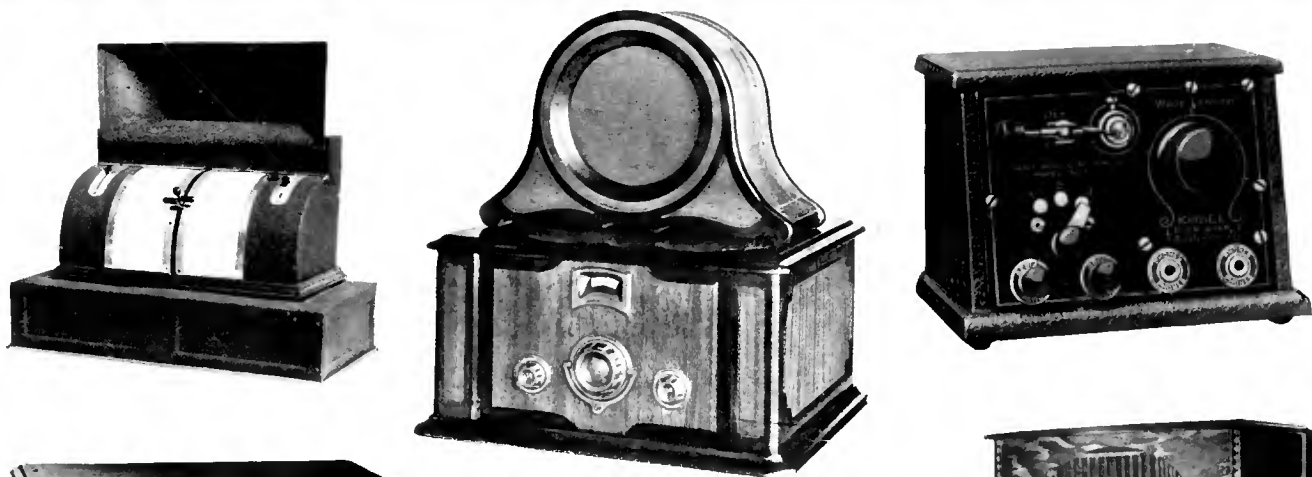

FIVE NEW RECEIVERS

The interesting looking receiver at the upper left is the new Dunn, with three controls easily grasped as one and space for marking in stations; below it the Kodol "Unitrol, with main control tuning all circuits and verniers on either side for more accurate tuning; immediately above is the Magnavox calibrated to wavelengths and with the new Magnavox loud speaker fitting neatly atop the cabinet; a reminder of crystal set days is shown in the Kodol crystal set, upper right, while the fine looking cabinet model at the right is the Workrite neutrodyne with ample cabinet space for all essential accessories

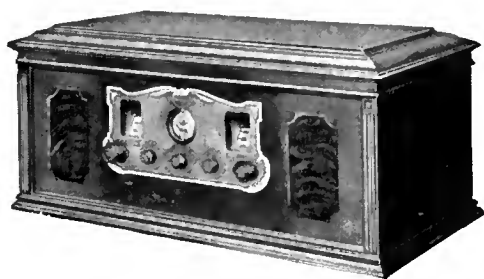
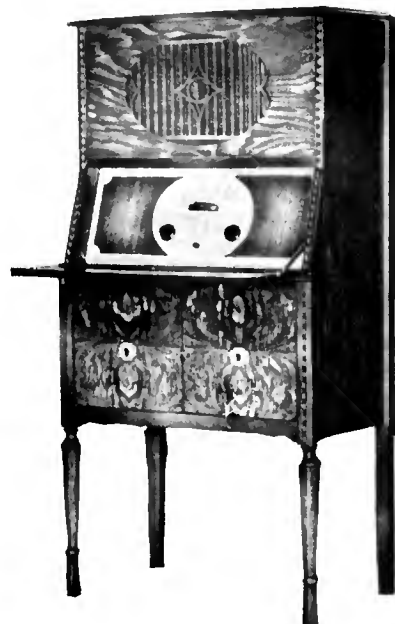

MODELS OF DUAL CONTROL SETS

The long, narrow receiver with the two controls at the center left is the Valley; below it the two-control Gilfillan neutrodyne; at the bottom left is the six-tube Bosworth, with two knurled knob controls which may be manipulated by two fingers of one hand. The Fada receiving set above utilizes four stages of radio-frequency amplification, permitting of loop operation, while careful shielding reduces inter-stage effects to a minimum

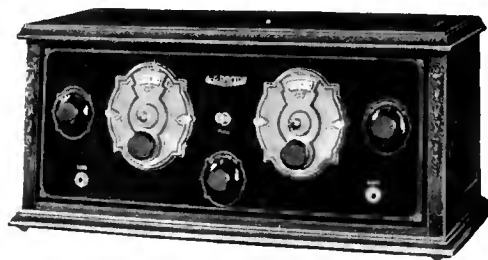
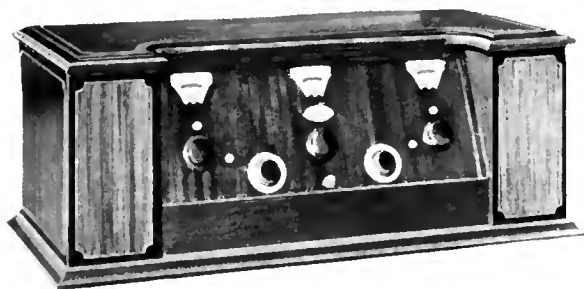
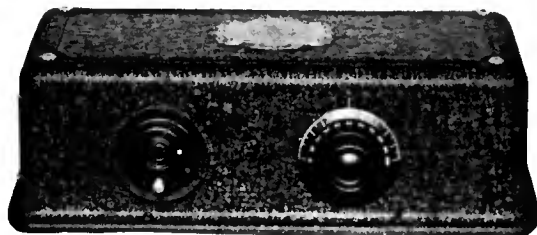
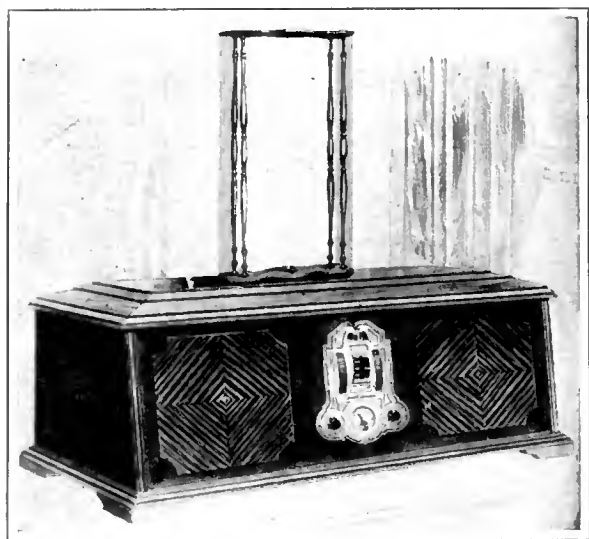

SOME SETS OF THE 1926-1927 SEASON

Four shielded stages of radio frequency amplification make the Freed-Eisemann receiver, at the upper left, sufficiently sensitive for loop pick-up; the Apex, below it, has its tuning control calibrated in wavelengths for the benefit of unskilful operators; the Crosley three-control set is mounted in a handsome cabinet with ample battery compartment space; note the well built Grebe Syncrophase, which may be operated as a single- or three-control set at the will of the operator; below it is the new Atwater Kent single-control with resistance-coupled amplification; the A-C Dayton, just below it, has two controls for rough tuning and two additional for ultra-fine adjustment

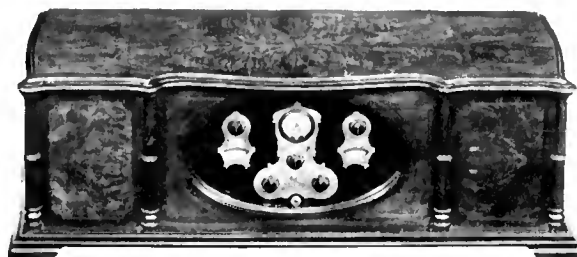
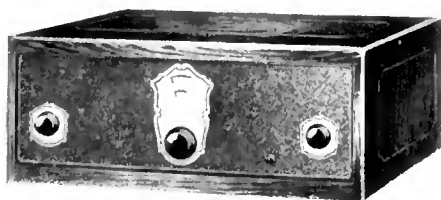

COMPACT AND INTERESTING RECEIVERS

Everything fits in the Blair console, including charger, storage battery, eliminator or B batteries and its three closely adjacent knurled controls can be manipulated with one hand; the simple and neat set to its right, above, is the new Stewart-Warner; below is the Argus, with voltmeter to best advantage operation of tubes to best advantage

ceivers. Among others making two control receivers are All-American, Argus, Bosch, Bosworth, Bremer-Tully, Case, Gilfillan, Stewart-Warner, Valley, Workside and the A-C Dayton, the latter employing two additional controls, used only when very precise tuning is attempted.

All single-control receivers are not alike. Among them are represented several degrees of convenience and perfection in design. Some sets have a single master control, combined with extra compensating controls to take care of slight variations in the calibration of the circuits. Other receivers are made with such accuracy and so expertly calibrated under laboratory conditions that no compensating adjustments are needed. Still others are equipped with frictionally coupled or closely spaced controls so that they may be used singly or in unison at the will of the operator. Included in these two groups are models from Bosch, Bosworth, Dunn, Grebe, Radiola, and others.

THE GRAND CALIBRATED DIAL

ANOTHER feature which distinguishes these various single-control receivers is the method used in calibrating the indicator. Some are so accurately built that the tuning dial is marked, by the maker, in wavelengths or even by the call letters of the principal stations. Others have drums upon which the user himself indicates the stations, when the receiver is installed in its permanent location. Still others are marked in arbitrary units, such as 1 to 100. Obviously it is a great advantage to the novice to be able to set the receiver to a desired wavelength, according to dial markings. This feature has been incorporated in the products of the Apex, Bosch, Fada, Freed-Eisemann, Kolster, Magnavox, Pfanstiehl, Priess, Shamrock, Stewart Warner, and a number of others.

The receiving set may be divided into



THE PERLESZ SINGLE-CONTROL RECEIVER

An unusual eight-tube new model presented for this season. The attractive cabinet contains a built-in speaker and space for current supply

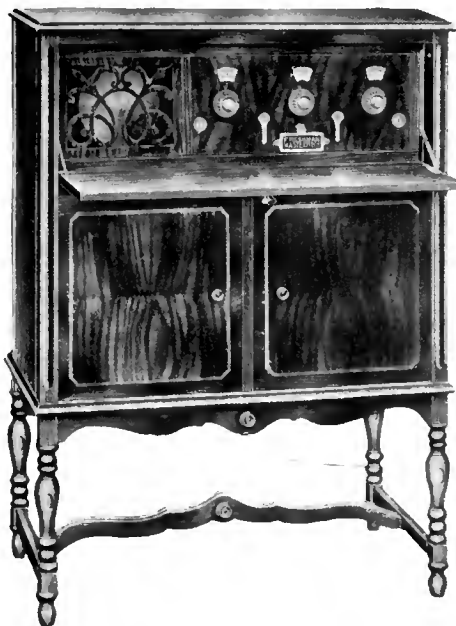

THE FRESHMAN MASTERPIECE CONSOLE MODEL

Freshman continues his three-control receiver, thus helping to maintain the proportion of three-control to the other types. A built-in speaker is a feature of this moderately priced set

three parts, (1) The radio-frequency amplifier, (2) the detector circuit and (3) the audio-frequency amplifier. The engineers designing 1927 products have given considerable attention to the importance of properly dividing the work among these three departments of the receiver. To accomplish this, many have completely shielded each tube circuit so that it would not affect its neighbor in doing its work. By using several stages of radio-frequency amplification, sufficient energy is delivered to the detector, even with loop pick-up, to operate the detector tube without introducing distortion. Overloading the detector, when listening to near-by, high power stations, or using a long antenna, is avoided by the use of a volume control, reducing the amplification of one radio-frequency tube. The functioning of the detector tube has been aided materially by such design because the tube no longer must deal altogether with signals of greatly varied strength.

The audio-frequency channel also gains by the new balance of functioning introduced by these methods. An audio-frequency amplifier, regardless of type, works with minimum distortion if the tubes are passing normal plate current. If the filament emission is reduced by means of a rheostat, to avoid overloading, the tonal quality is seriously thinned. Likewise, too strong a signal produces the all-too-familiar blasting. The use of a volume control in an early radio-frequency stage, used for several years in the Radiola super-heterodyne, has been adopted by many manufacturers this year.

Another feature which makes for good tonal quality is the operation of vacuum tubes with the correct filament

and plate potentials. No matter how skillfully a manufacturer makes his set, its tone output in the hands of the user is not good unless the proper A, B, and C voltages are applied to the vacuum tubes. This problem is aggravated by the fact that many socket power devices deliver different voltages under different load conditions, making it difficult to be certain of the voltage applied. B, and C batteries likewise suffer a gradual fall in voltage as they are used. Distortion sometimes creeps in so gradually that the regular user is not aware of change in quality. Many manufacturers have incorporated voltmeters in their sets or have provided pin jacks so that voltmeters can be installed easily at the option of the purchaser. These meters enable the set user to maintain his tube filaments at the proper voltage.

An interesting feature of the Freed-Eisemann receiver is a switching mechanism by which the plate voltage applied to each tube on the set may be read instantly, as well as that of the A battery at its terminals (giving warning that the battery needs recharging), at the filament terminals (permitting the prolongation of tube life to the maximum by the use of correct voltage) and the various C battery voltages in the audio amplifier.

The Radiola super-heterodyne loop receiver has been long established in the field, but with 1927 come several worthy competitors. By successfully coupling four



THE CROSLY 5-75

A new model in the Crosley line. Like many of this year's models, the set has a single station selector, with space for writing in stations heard. The set has a built-in reproducer and ample room for batteries. Price \$75.



A SEVEN-TUBE RECEIVER

The Rauland "Lorraine" houses a seven-tube receiver and loud speaker in its fine walnut cabinet and offers adequate space for the concealment of all accessories. It retails for \$335

stages of radio-frequency amplification with a loop receiver, reception down to the noise level is claimed by several makers of such sets. Precision manufacture in the production of inductances and capacities and the use of effective shielding has made possible the use of four stages of radio-frequency amplification, manipulated by a single or dual control. Freed-Eisemann, Bosch, and Priess have brought forward such models, while Fada has a two-control receiver with such a powerful radio-frequency amplifier. Three stages of radio-frequency with single-control tuning has

been brought forward by All-American, A-C Dayton, and Perlesz.

The five-tube receiver which held the dominant place in the field last year finds strong rivalry from the six-, seven-, and eight-tube receiver, but there are still a large number of well established manufacturers, realizing the satisfaction which the five-tube receivers have given, who have stuck to their lasts and continued with five-tube, three-control sets. They have improved the appearance of their receivers and revised the audio-frequency amplification system to permit of the use of power tubes and a better quality of reproduction. A newcomer in this field is the Sparks-Withington Company, known in the automobile accessory field. Other manufacturers, presenting C models in this field, are the Blair, Freshman, and Splittdorf.

The general appearance of receiving sets has undergone marked changes. The power house, switchboard type of receiver is practically a thing of the past. Neatly illuminated dials have at last replaced the "pie plates" of olden days. A few manufacturers have taken to ornate decoration so that the option of the buyer ranges from an appearance of utmost simplicity and dignity to the last word in new-art, fancy scroll work.

The combination of loud speaker with set is no longer accompanied by sacrifice of quality of reproduction. Earlier attempts in this direction were all too frequently made at the sacrifice of true quality because small loud speaker openings and cramped, thin-necked horns were used in connection with high grade receivers.

Microphonic effects, when extremely large volume is attained with the loud speaker too close to the receiver, have maintained the popularity of the two unit systems, in which the radio receiver and preliminary audio-frequency amplification is incorporated in one unit and the loud

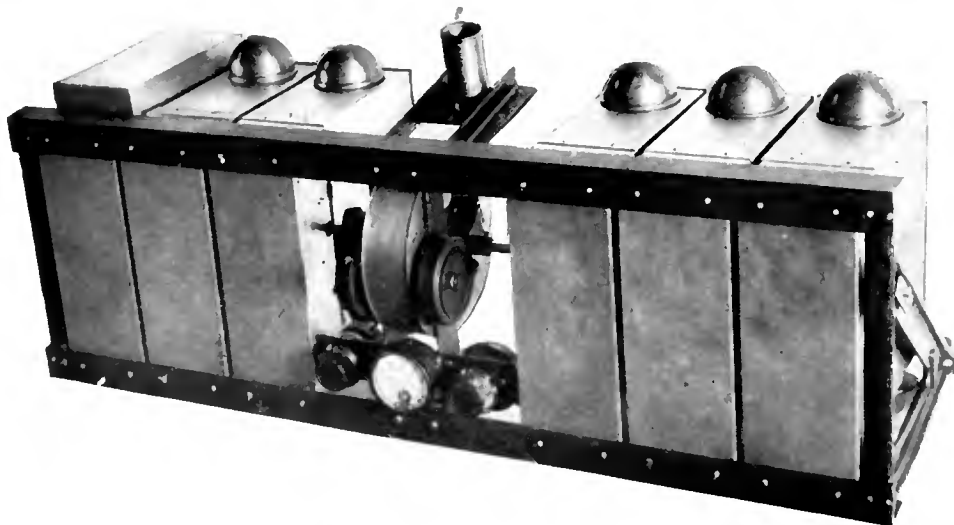

A COMPLETELY SHIELDED RECEIVER

The chassis of the new Freed-Eisemann "800" neutrodyne. Copper shielding is used for radio-frequency stages and detector tubes. The audio stages are shielded in a steel compartment. The set is loop-operated and uses eight tubes



SIMPLICITY AND BEAUTY

Tuning this Ferguson receiver is simply a matter of setting the dial to the wavelength of the desired station. A volume control varies the output to the wishes of its listeners

speaker and power amplifier in a second. The power unit is arranged so it can be placed sufficiently distant from the first to subdue microphonic effects. The familiar Radiola with the type 104 loud speaker is only one example where this system is employed.

THE MARRIAGE OF RADIO AND THE PHONOGRAPH

ANOTHER group in the field is the combination phonograph and radio outfit. Since the audio-frequency end of a receiver, comprising preliminary and power amplification and high grade sound reproducing devices, is useful in connection with electric phonographs, it has been a natural development to have this end of the receiver serve a double purpose. We find both Brunswick and Victor in comprehensive lines, involving Radiola receivers and power amplification systems combined with their phonographs.

While the outstanding feature of the show and the general trend of the industry is indicated by a consideration of the higher priced receivers, the manufacturers have by no means neglected the needs of those who wish to make a modest investment. The improvement in the lower priced merchandise is just as marked as that in the higher field. Many of the lower priced sets have been remarkably improved in appearance and convenience. Even a most cursory examination of the illustrations in this section of the magazine will bring this fact forcibly to the reader's attention.

Parts of Real Quality Dominate the New Season's Lines

A Glance Over the Offerings of Manufacturers Which Are Seen at the Fall Radio Shows—Valuable Improvements for Existing Receivers and a Wealth of Parts for Those Who Are Building New Sets

By RICHARD LORD

AS THE value of mechanical and electrical precision has become better appreciated in every branch of the radio art, parts built with watchmaker's precision have become the rule rather than the exception. The days of touching condenser plates, transformers which might better be called low-frequency filters and rheostats with self-removing resistance windings have practically disappeared. The 1927 offerings of parts manufacturers represent new standards in accuracy and soundness of construction and present the experimenter with opportunity to make the most advanced type of receiving equipment.

Parts may be considered in two general groups:

(1) those which may be used for the improvement of existing receivers, such as trickle chargers, automatic power supply switches, socket power supply devices, audio-frequency and power amplifier systems, loud speaker and console cabinets; and

(2) elements which go into the receiving set itself, such as variable condensers, transformers, dials and a vast array of miscellaneous small parts.

The performance and convenience of existing sets can be greatly improved by the installation of some of these various new devices. The storage A battery, for instance, need no longer engage the constant attention of the broadcast listener and experimenter if he equips it with a device like the Apco Full Automatic Converter. By plugging the proper terminal into the light socket, connecting the storage battery to another pair of terminals and the filament supply leads from the set to a third, the storage battery may thereafter be practically

forgotten. The converter automatically places the battery on charge when the set is not in use and it also disconnects the charging device when the charging process is complete. Kodol has brought out a Chargometer which automatically disconnects the charging device when the battery is fully charged. Another convenience is the Brach Controlit which permits of the installation of the storage battery and charger at a point remote from the set. When the set switch is turned on, the charger is disconnected and the B battery circuit automatically switched in. When the set is switched off, the Brach device turns on the trickle charger which maintains the A battery at full charge. The National lead battery people have brought out a trickle A charger and battery unit and also a 2-ampere Tungar outfit.

Willard and Philco present their A battery trickle charge outfits, having a constantly visible hydrometer to show the battery's condition of charge.

There is a wide range of charging devices which meet every possible condition with which the radio user may be faced. For those having only 110 volt d. c. available, there is the Ward-Leonard Trickle charger. The Unitron electrolytic charger, offering three different charging rates, selected by a switch, is available in styles suitable for 25, 40, and 60 cycle power supply. Other excellent chargers are offered under the trade name of France, Kodol, Liberty, Valley, Westinghouse, and numerous others.

In the field of B battery substitutes are so many meritorious products that it is quite impossible to so much as list them in this brief review of what may be seen at the

shows. They vary from outfits like the smaller Apco and All-American devices, with a fixed amplifier output and variable detector voltage, to the Sterling, with its three variable outputs for low, intermediate and high voltage, sufficient to power any standard type of tube, including the ux-210 and supplying also two ranges of C battery voltage, one of 3 to 9 volts and the other of 40 volts. All sorts of intermediate combinations, most of which are equipped with variable detector voltage, one or more fixed or variable amplifier voltages, are available to the user. The manufacturers making several models include such popular names as Acme, Apco, Grigsby-Grunow-Hinds, Kodol, Majestic, Glenn L. Martin, Mayolian, Timmons, and others too numerous to mention.

In the field of the chemical rectifier, B battery substitute devices may be mentioned the Balkite in various models, delivering 90, 135, or 150 volts maximum, according to the need of the user, and some also combined with A battery power supply units. In this field also is the Willard storage B battery, combined with their previously mentioned A battery unit. Another device along these lines is the Philco, which has enjoyed very wide sale.

For those desiring to construct their own B battery substitutes, the necessary chokes and transformers, or complete kits ready for assembly, are exhibited by Thordarson, Pacent, Ward Leonard, Silver-Marshall, Apco, Acme, and others.

Lest it be concluded from the foregoing that the B battery is a thing of the past, attention is called to the strides made in B battery construction in the past few

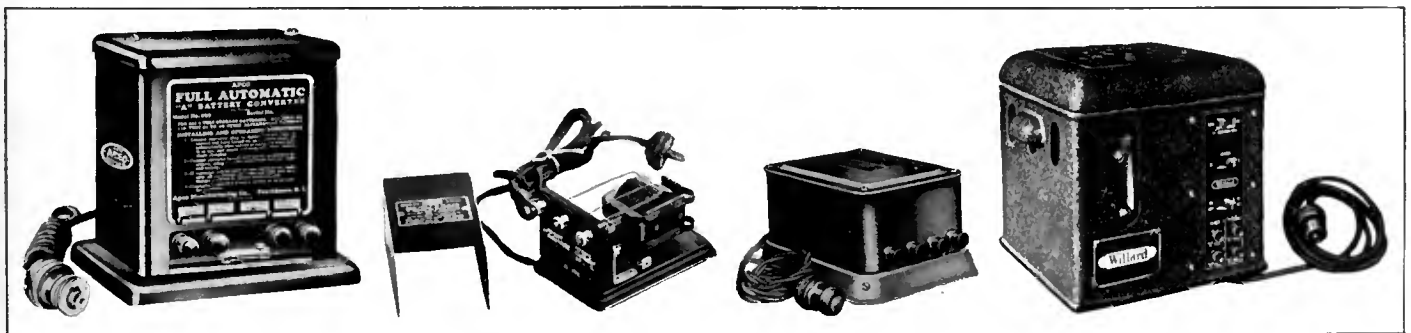

AUTOMATIC DEVICES FOR CONTROLLING THE A BATTERY

Four devices from Apco, Brach, Kodol, and Willard. The Apco arrangement is designed to keep the A battery at maximum charge automatically. The Brach "Controlit" enables the switch of any set to control automatically the operation of B substitute and battery charger. The Kodol "Radio Chargometer" is an automatic switch which disconnects the battery when it is fully charged. Price \$10. The Willard Power Unit charges the A battery automatically and also controls B battery charging



**FOR THE HOME CON-
STRUCTOR**

The Marco illuminated dial is shown above; notice the rotary contact, which is a feature of the Frost potentiometer; the Benjamin inductance is self supporting with primary and secondary terminals properly marked

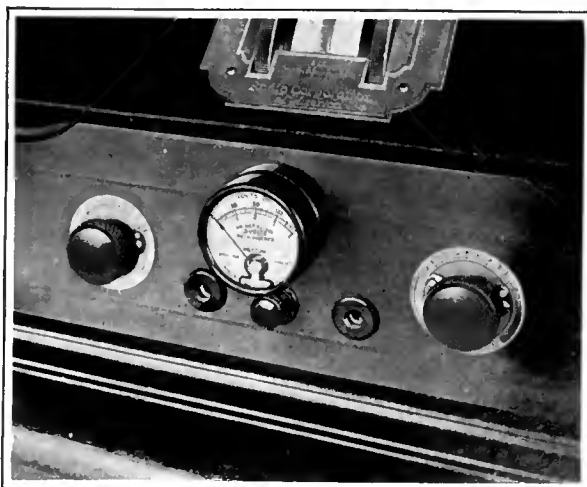
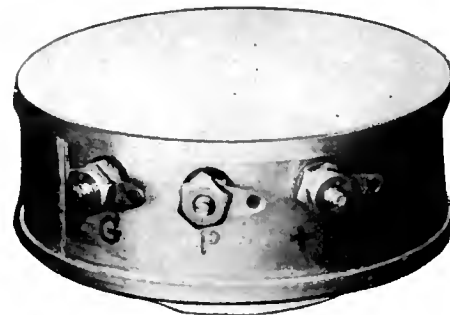
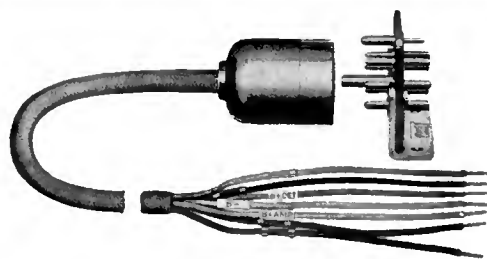
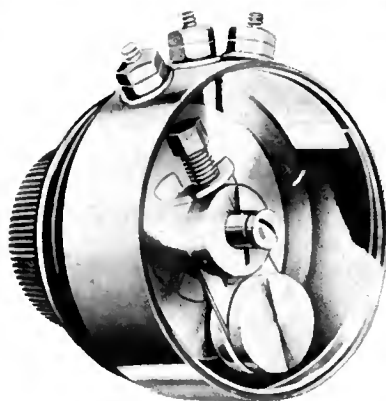

**TO REPRODUCE
PHONOGRAPH
RECORDS ON
YOUR RADIO**

With the aid of the Bristol device at the left, you can reproduce your phonograph records with the radio set's amplifier and loud speaker

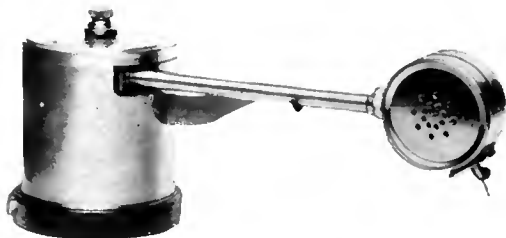

**NEW PARTS OF WIDE
ADAPTABILITY**

At the top is the Yaxley cord and plug which instantly connects and disconnects antenna, ground, and power supply from the set; below it the Sickles shielded radio-frequency inductance just right for the broadcast frequencies; below it the Weston pin-jack meter fitted to a Radiola

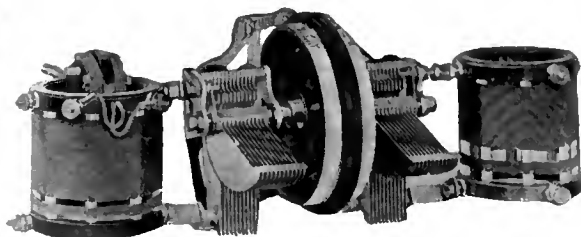

NEW OFFERINGS TO BE SEEN

No microphonic effects trouble the owner of the Detroit Woodwork's loudspeaker cabinet, because it is easily placed at a distance from the set; above is the new Bruno Unitrol, controlling two condensers with two adjacent knurled knobs, according to the latest practice and may be purchased with inductances covering the broadcast band; at the right, we have the giant Pacent 36" auditorium volume cone, capable of handling the output of the largest amplifiers

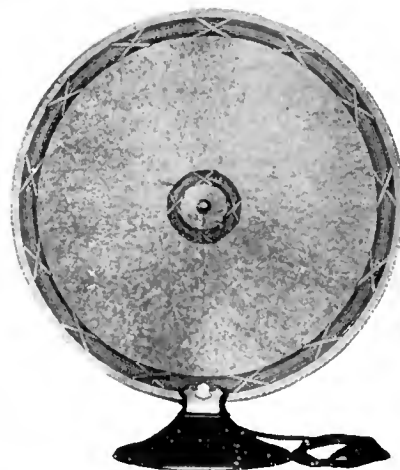

years. Better construction in much larger units give longer life and ample current capacity for economical sets which require up to 155 volts plate potential. Some of these larger batteries power such receivers for as much as nine months to even a year without renewal. The most novel advance in the B battery field is the National Carbon Company's Layerbilt battery, constructed of flat cell units somewhat on the order of the Voltaic pile. The French Battery Company also has a fine new radio battery, classed as "pitchless," for which very long life is promised.

Another concern new to the radio field, is announcing the "Tab" rechargeable B battery for the chemically inclined who may renew the mix in the battery when the first batch is exhausted.

BETTER AUDIO AMPLIFICATION

THOSE desiring better quality of reproduction from their receiving sets, as well as those building new receivers, have at their disposal a choice of amplifier systems by which this objective may be attained. Among those in the resistance amplifier field are the Allen Bradley, Daven, DeJur, and Heath each making three-stage units with or without filament rheostats. Some of these are designed for power tubes in the last stage, having provision for the installation of a C battery.

The resistance amplifier finds rivalling it, various combinations of impedance and transformer-amplification. The well-known Thordarson line includes the essential parts for a high grade, impedance amplifier, while Rauland-Lyric calls attention to its "trio," consisting of one transformer stage and two impedance stages. And then there is the Na-Ald Trufonic amplifier, a three stage device, built after the design of H. P. Donle. The National Company supplies "Impedafomers" for those desiring to build an impedance amplifier.

In the field of power amplification are various units which may be plugged-in the detector or first amplifier stage of receiving sets, subjecting its output to one stage of

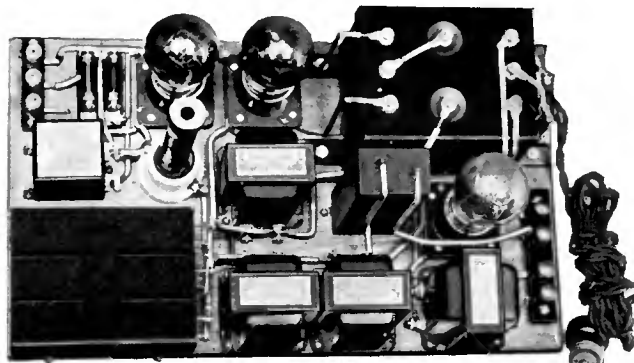

THORDARSON'S AMPLIFIER AND B POWER SUPPLY

power amplification as well as furnishing A and B power for the amplifier tube and also supplying the radio set itself with the necessary plate potential. Thus we have the combination of B battery substitute and power amplifier converting the usual receiving set into one capable of delivering substantial undistorted volume to the loud speaker. These cover a wide price range and furnish B voltage of various ranges, beginning with the neat Radio Receptor device and ranging in price up to models by such experienced makers as Pacent, Farrand, Timmons, and General Radio. The last named, for instance, offers three B battery voltages and one stage of power amplification, using the UX-171 tube.

NEW LOUD SPEAKERS

TO MENTION by name the numerous types of loud speakers available to the public would be almost a hopeless task. They range in size from the little Tower cone at a price within range of the most modest buyer to the Pacent auditorium volume 36-inch cone. Magnavox has announced a new and neat model, while Acme, already well known in this field, has produced a new type cone with a base so shaped that the cone may be placed within a cabinet. A newcomer in the field is the Sparton, automobile horn maker, with several types of free-edge cones, while the Utah line combines a variety of unique shapes and styles for those preferring something not along the conventional lines. Owners of receiving sets, having high grade power amplifiers,

may, by using a Bristol electric tone-arm, play phonograph records and use their radio amplifying system to reproduce them. This device performs a function just the reverse of a phonograph adaptor.

Another method of improving a set is to eliminate unsightly accessories. Console cabinets, combined with loud speakers and having an ample battery compartment are exhibited in numerous styles by such makers as Pooley, Detroit Woodcraft, and others.

An economy measure and an essential in checking the condition of A and B batteries are various meters manufactured by Weston, Roller Smith, Hoyt, and Jewell. The first concern is exhibiting a dual range voltmeter with pin jacks, provision for the installation of which is made on such well known manufactured sets as the Radiola super-heterodyne and some of the receivers in the Bosch line.

The set constructor who has examined some of the latest manufactured receiving sets is likely to feel that he can no longer hope to make a radio receiver which approaches the precision and quality of some of the more expensive manufactured sets. Of course, this cannot be literally true, because every manufactured set had its hand-made predecessor which served as a model. Some parts manufacturers have gone a long way to help the constructor in making a receiver at least comparable to some of the better manufactured sets.

SPECIAL NEW PARTS FOR THE SET BUILDER

THE Alden localized control gang condensers, for example, offer the convenience of one control for two, three or four tuned circuits. The condenser shafts are mounted parallel instead of at right angles to the panel and are separately controlled by closely adjacent, knurled knobs, all of which may be moved simultaneously with the aid of two fingers of one hand, or separately at the will of the user. The Bruno device, built along the same lines, controls two condensers and may be purchased with inductances attached, covering the broadcast band. The Bruno



NEW UNITS FOR SUPPLYING B POWER

The Valley B Power, using Raytheon tube; the Balkite Combination Radio Power Unit, which, when connected to the A battery furnishes power both to A and B circuits. It is controlled by the filament switch on the set and is automatic. Price \$59.50. Next is the General Radio Power Amplifier and B supply. Finally, the All-American "Constant B" using a Raytheon tube, which sells for \$37.50

NEW ACCESSORIES FOR THE SET OWNER

At the left is the new Sparton cone loud speaker; below it the Samson output transformer, which prevents the B potential from flowing through the loud speaker windings; underneath it is a cutaway illustration of the Eveready Layerbilt B battery, which gives great capacity in a small space, inter-cell waste being eliminated; at the bottom left is the Hammarlund variable condenser which combines the advantages of straight frequency line at the high frequencies and straight capacity line at the low end

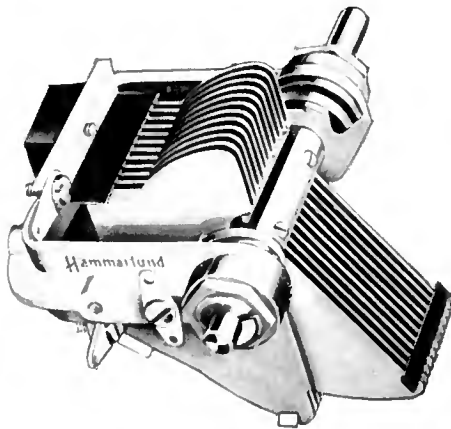

TWO NEW RADIO DEVICES

The Air-Gap socket eliminates socket losses between grid and plate terminals by its cutaway construction; the National Radio A power unit combines a trickle charger with an A battery; while below is the Bodine loop

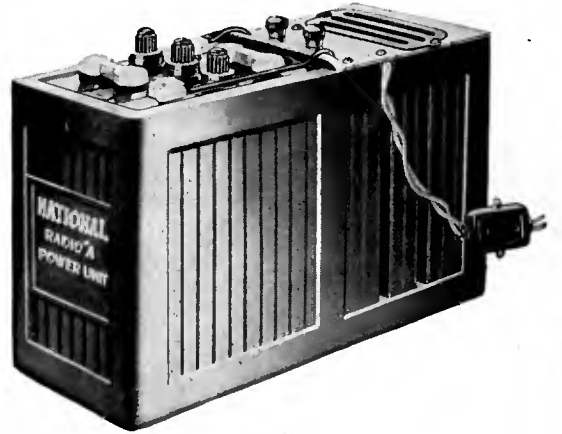
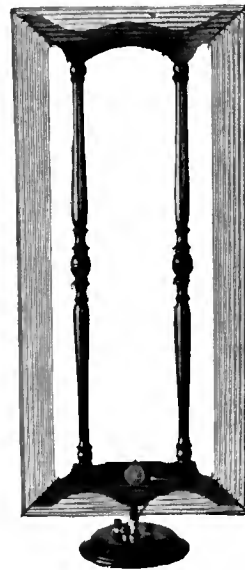

A BATTERY CHARGER AND ASSEMBLED KIT

At the right is the Valley charger, equipped with a meter to show the charging rate; below is a Pierce-Airo kit assembled. The set is tuned by a triple gang condenser

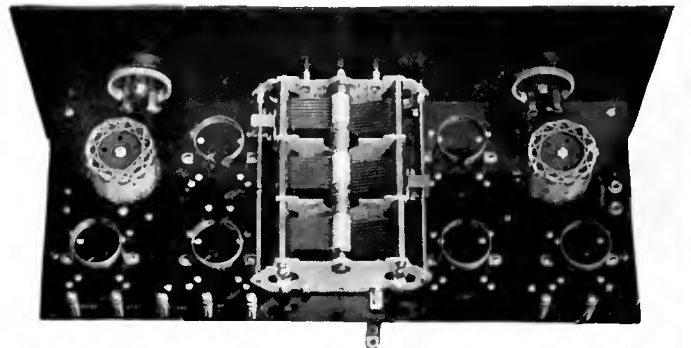

control is designed so as to engage the neighboring knurled knob after the other has been turned single for more than 10°. It is equipped with a bakelite shaft, reducing losses occasioned by long metallic shafts.

The conventional gang condensers, controlled from a single shaft, maintain their sway, following the design of previous years.

There are a number of innovations in the variable condenser field. Considering the innocent appearance of the variable condenser, it has been subjected to rather sensational publicity in the past two or three years, first by the discovery of the phrase "low loss" and then by the straight-line frequency hys-

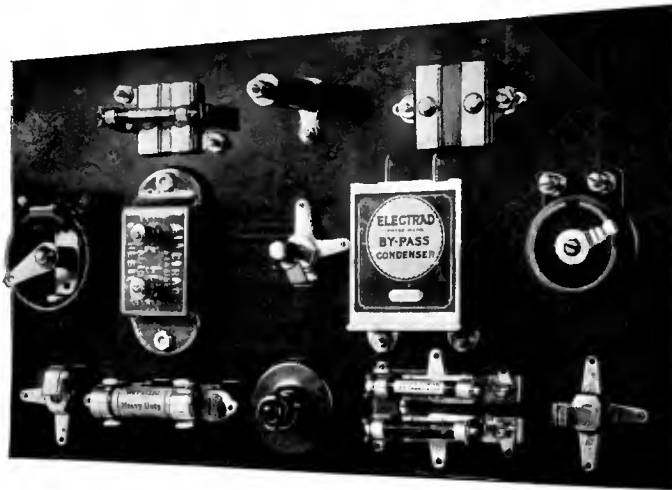

THE ELECTRAD LINE OF PARTS

Electrad makes a comprehensive line of small parts which contribute so much to the efficiency of the home built receiver

Although the subject of audio-frequency transformers has already been partly covered in the section on audio-frequency systems, several manufacturers have already announced new transformers, involving improvement over their predecessors. The Samson model, for instance, is completely enclosed in a metal shield, reducing stray effects. The Ferranti, imported from London, shows a most promising calibration curve, for which the user pays a rather handsome price.

In the field of small parts, such as sockets, dials, switches, resistances and rheostats, are many ingenious improvements. By utilizing the Marco illuminated dial, the ambitious



THE WARD LEONARD D. C. CHARGER

nounced a compromise between these two types so that stations are aligned along the dials in such a way that the relative congestion of different parts of the broadcast band is taken into account. Another departure in condenser construction is the Furnell which substitutes for flat, interleaving plates, a conical type with a worm drive for adjustment, covering a range of 360° from minimum to maximum.

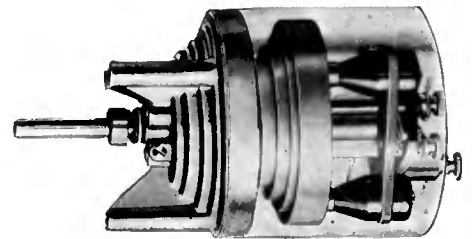

THE INTERESTING FURNELL CONDENSER

teria. This year, in which there have been some very real advances in condenser design, there is not, however, the fanfare of excessive publicity.

One trend is indicated by the new Hammarlund, the General Instrument Metralign, and Silver-Marshall variable condensers. It has been discovered that just as the straight capacity line condenser crowded the short wavelength stations too closely so the straight frequency line condensers spread the long stations too far apart. These manufacturers have an-

ADVANCES IN SHIELDING

The tendency toward shielding is recognized in the General Instrument shielded radio-frequency unit, offering coil, condenser and socket in a completely shielded can. Silver-Marshall offers a similar outfit in kit form, while Sickles has produced a radio-frequency transformer coil completely shielded in a can only 1 1/8" thick and 3" in diameter, the enclosed inductance covering the broadcast band with a condenser of 0.00035-mfd. capacity.

home constructor, with the aid of its rigid metal template, may equip his homemade receiver with a very fine, illuminated dial. In the comprehensive Carter line of jacks, switches, rheostats, and dials are such interesting products as the Dialite, which not only illuminates the panel but indicates whether the A battery is on or off, and jack switches permitting of substantial circuit changes

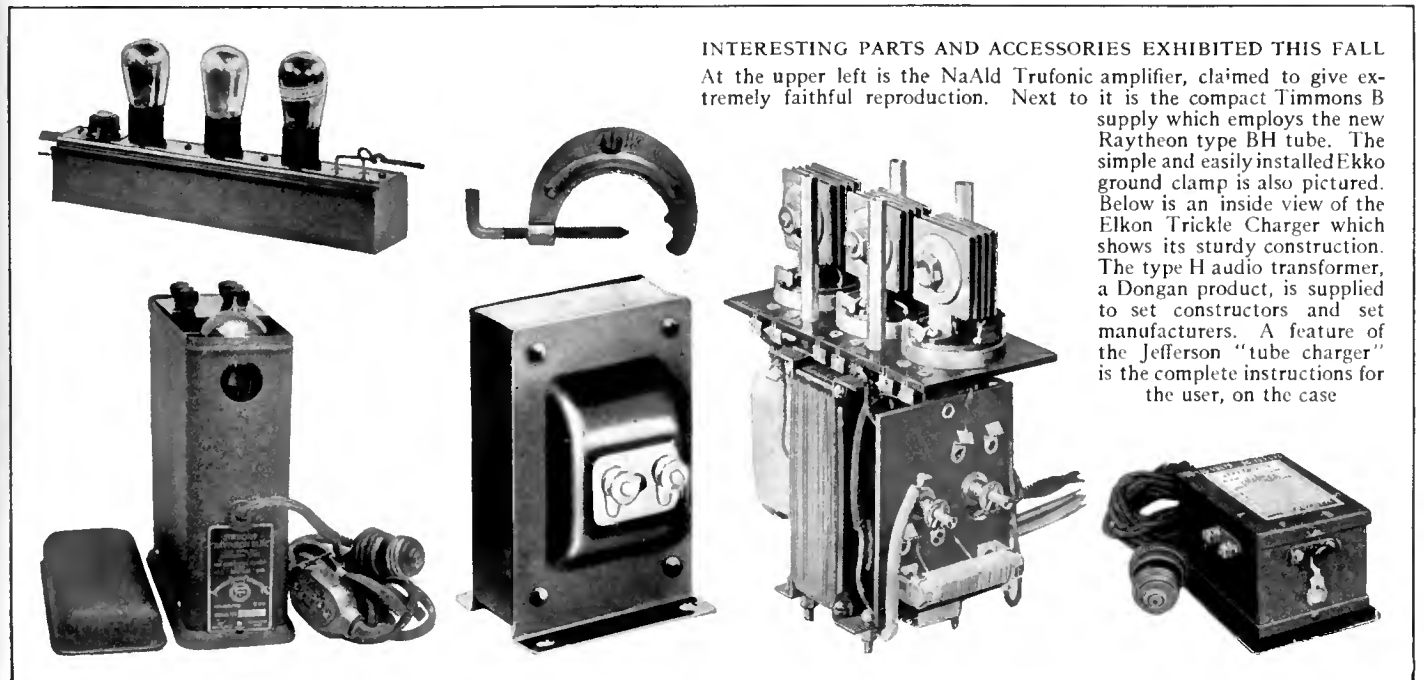

INTERESTING PARTS AND ACCESSORIES EXHIBITED THIS FALL

At the upper left is the NaAld Trufonic amplifier, claimed to give extremely faithful reproduction. Next to it is the compact Timmons B supply which employs the new Raytheon type BH tube. The simple and easily installed Ekko ground clamp is also pictured. Below is an inside view of the Elkon Trickle Charger which shows its sturdy construction. The type H audio transformer, a Dongan product, is supplied to set constructors and set manufacturers. A feature of the Jefferson "tube charger" is the complete instructions for the user, on the case

through the adjustment of a small, inconspicuous, single hole, mounted switch. Centralab, in its extensive line, features the Modu-plug, which combines a high resistance volume control with the conventional loud speaker plug. Alden has a line of sockets and adaptors fitting every conceivable combination of requirements so that any set may be adapted to the use of any standard tube. A new socket, known as the "Air Gap" separates by an air space the grid and plate terminals, reducing such losses as might occur there to an absolute minimum. Sofruba, as its name indicates, attempts to meet the problem of microphonic tubes by a socket made of spongy material. Eby has succeeded in applying ingenuity to the socket problem by designing a new kind of terminal, making the soldering of bus bar or wire simple, effective and quick. Clarostat seems to have the record in variable resistances, its unit covering from 0 to 5,000,000 ohms, while their Clarotuner is a fixed tickler with regeneration controlled by a similar unit. Arthur Lynch presents a fixed resistor mounted in a glass tube, claimed to be absolutely impervious to moisture and weather conditions, in sizes to meet every radio need for fixed resistances. Electrad presents a line of variable resistances of low and high resistance, fixed units in glass tubes and

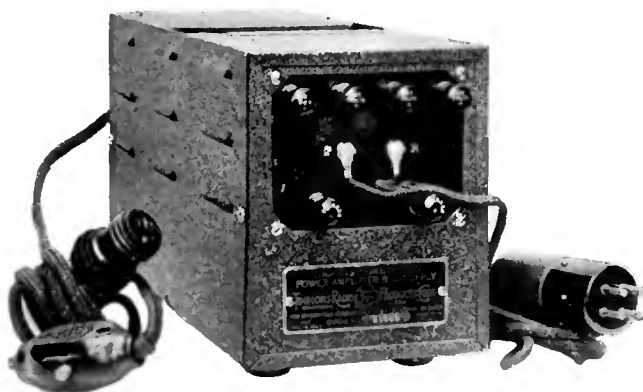

A POWER AMPLIFIER AND B CURRENT SUPPLY

This Timmons product combines one stage of power amplification with a B battery eliminator

numerous other well made small parts of wide service to the home set builder.

Finally, in the vacuum tube, we find the new, highly sensitive Radiotron 200-A detector tube, which should appeal to the DX fan. A similar tube is made by Donle-Bristol. Raytheon has improved its rectifier tube so widely used in B battery substitutes by increasing its output capacity to 85 mils, its rating to 200 volts and its voltage regulation so that there is practically no fluctuation through current drains ranging from 10 to 85 milliamperes. Apco harks back to pre-war days in tube construction by offering a tube with two filaments, thus doubling its useful life. Daven makes specially high-mu tubes for resistance amplifiers. Ceco features a

detector tube of special characteristics, while Supertron calls attention to its isolantite member which assures absolute rigidity of plate, grid and filament in its vacuum tube. Perryman, Ken Rad, and Cleartron show tubes both small and large with conventional characteristics.

This rather abbreviated sketch of what may be seen at the shows calls attention to only a few of the interesting highlights, but it serves to indicate the year's progress.

For those who do not wish to go to the trouble of selecting parts for their receivers, there is a variety of kits which may be successfully assembled by fairly inexperienced constructors. The Pierce-Airo, for instance, is a receiver having two stages of tuned radio-frequency, detector and three stages of resistance amplification, controlled by a single dial with two verniers. Bruno presents a receiver of one stage of tuned radio-frequency with a regenerative detector and three stages of resistance-coupled amplification. Silver-Marshall offer a similar outfit, as well as their "Shielded Six," consisting of three stages of radio frequency, detector and audio-frequency amplifier with each stage mounted in an enclosed can, preventing inter-coupling effects. A six tube tuned radio frequency receiver with a three-stage resistance amplifier is being shown by the Heath Radio and Electric Company.

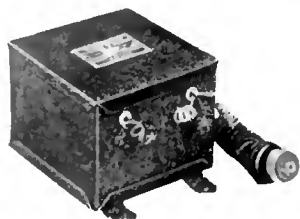
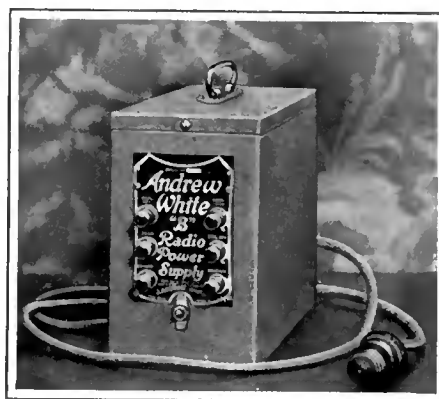

NEW OFFERINGS FOR THE RADIO PURCHASER

Two reproducers are shown, on the left, the Rauland "Lorel" cone type speaker and on the extreme right, the Acme cone which has a base of such form that it is easily mounted within a set cabinet. Two B supply power units are shown, the Majestic, and the J. Andrew White. The Majestic is from Grigshy-Grunow-Hinds and has two variable voltage outputs as well as a high and low amplifier output control, suiting it for use with any standard tube. The Andrew White unit has several output taps with 135 volts as its maximum

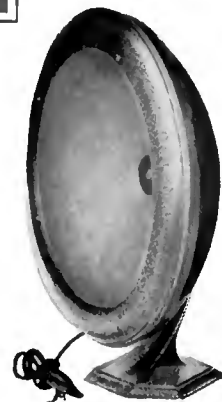

How to Select Your 1927 Receiver

Five Main Requirements Which a Receiver Must Satisfy—Direct Help for the Prospective Purchaser, Confused by a Maze of Claims—How to Judge the Necessary Accessories

By EDGAR H. FELIX

A TINY urchin, appraising the stock of a confectionery store, with two pennies clenched in his hand, is naturally hesitant. His bewildered mind attempts to make the wisest expenditure of his hard earned accumulation of capital, but, with so many good things to choose from, his indecision is distressing to behold.

No less confused is the mind of the novice radio buyer, after a tour of inspection at one of the great radio shows. Hundreds of attractive models have lured his eye; claims and counter-claims have raised havoc with his preconceived opinions and his lack of technical knowledge has taken from him the courage to make a confident selection.

By adopting a systematic plan of selecting a receiver, it is possible for the most uninformed person to find the product which is best suited to his needs and his pocketbook. If you know definitely what qualities you wish your receiver to possess and know how to determine whether it possesses them, selection is not difficult.

We have reduced the fundamental qualities of the radio receiver to five and they are listed in the order of their importance from the standpoint of the entertainment value of the receiver. These five cardinal qualities are:

1. Fidelity of tonal reproduction at the maximum volume you desire;
2. Adequate selectivity to meet your receiving conditions;
3. Simplicity of control and maintenance, to make operation a pleasure for every member of the family;
4. Sensitiveness sufficient to bring in the stations you wish to hear; and
5. Appearance, to fit the receiver to its surroundings in the home.

Fidelity of reproduction is, without doubt, the most important essential quality of a receiving set intended for entertainment purposes. The outstanding developments of the past year in this direction have been the improved transformers, resistance- and impedance-coupling devices and power tubes which make possible truthful reproduction at any volume which a user may desire.

The volume which a receiver can handle without overloading is limited by the capacity of the last vacuum tube used. You must decide between small tubes, such as the UX-201-A and the UX-199 types; semi-power tubes of the UX-171, UX-120, and UX-112 type; and large power tubes, such as the powerful UX-210.

The small tubes, of the UX-201-A and UX-199 type, are capable of handling only relatively small output. With a good loud speaker and a powerful signal, small tubes can fill a moderately sized room with music of good quality, provided outside noises, such as heavy motor traffic or many people moving about, do not interfere. But, should you de-

sire to flood a good sized living room with radio music so that five or six may enjoy it without being compelled to refrain from conversation, the semi-power tubes are recommended. Most receivers are equipped so that you have your choice between small or semi-power tubes in the last stage. Even those who must depend upon dry cells for filament current have semi-power tubes at their disposal.

The semi-power tubes do not really give greater volume than the small tubes, but they have the important ability of giving clear, undistorted music with very satisfactory volume. The small tubes, on the other hand, are likely to give scratchy and raucous reproduction if pressed to give their maximum output.

The large power tubes, such as the UX-210 require 110-volt alternating power supply to furnish the necessary high plate potential and filament current which they use. Do not consider a large power tube unless you have electric lights in your home. Large power tubes deliver sufficient volume to furnish dance music for a dozen couples in a large living room.

THE FIRST STEP IN SELECTION

MAKE your first step in selection the decision whether you require only a small tube, a semi-power tube or a large power tube in the last stage of amplification of your receiver. This decision rests on conditions which may differ in every home—whether rooms are large or small, the number of members of the family and the existence of disturbing outside noises.

The tonal quality of a receiver is the product of the audio-frequency amplifier, the plate voltage supplying it, and the loud speaker. Each of these units must be designed to work together

properly to give you good results. Your ear tells you if they perform to your satisfaction. You need no technical knowledge for that. But assure yourself, when a receiving set is demonstrated to you, that it is equipped with the same loud speaker and the same power supply—whether B batteries or B substitute—that you intend to install at home. A test with a different brand of loud speaker or different power source certainly does not tell you positively how the device will work with other accessories in use.

The loud speaker which converts the electric output of the receiving set into sound waves requires as much care in selection as the receiving set itself. In a general way, cone types rightly are greatly increasing in popularity and there are many high grade cones available to the set buyer. Some are low pitched; others are high pitched. If music sounds too low and throaty, ask for a higher pitched cone. When cone or horn is a part of the receiving set, a ringing effect is sometimes heard, arising from the vibration of the tube elements. When such a receiver is demonstrated, listen critically for this undesirable effect, particularly with loud music, lest you purchase a receiver in which it has not been completely overcome.

To test the quality of reproduction of a radio set, ask the salesman to tune-in a near-by, high power station, with the exact equipment which you intend to install in your home. Listen carefully with moderate volume to the music. Then slowly and gradually have the volume increased, listening for any change in the fidelity of the music. When it begins to sound rough and scratchy, you have reached the volume limit of faithful reproduction. Be sure that the volume before this point is reached is adequate for the purpose for which you desire to use your radio set.

Listen carefully for low tones. A receiver which fails to reproduce low tones accentuates the melody part of an orchestra's playing in the upper registers and fails to give adequate emphasis to the rich, booming, low tones upon which lies the burden of carrying the rhythm. An organ program is a particularly effective test for the efficiency of a receiver in reproducing low notes. A good receiver makes the organ sound majestic and powerful; a receiver producing only the high frequencies efficiently gives a thin and flute-like reproduction of the organ. The soprano voice and the piano demonstrate the reproduction of high tones, the voice sounds thin and nasal and the piano tinny and twangy, if the upper registers are not well reproduced. Remember that fidelity of reproduction is the paramount criterion to receiver selection and that, consequently, it merits most careful demonstration.

Selectivity is of great importance in congested districts such as New

FIVE MAIN QUALITIES OF A RECEIVER

WHEN the various qualities of a radio receiver are really reduced to their lowest terms, the points one looks for are not many. With the requirements so simplified, picking out an outfit to meet one's individual needs is not difficult. The points:

1. Fidelity of tonal reproduction at the maximum volume you desire
2. Adequate selectivity to meet your receiving conditions
3. Simplicity of control and maintenance, to make operation a pleasure for every member of the family
4. Sensitiveness sufficient to bring in the stations you wish to hear
5. Appearance, to fit the receiver to its surroundings in the home.

This article gives, in as much detail as possible, information on how to apply tests on all five points before you buy. It is probable that most purchasers, even those who "know nothing about radio," unconsciously consider most of these points, with the exception of points 1 and 2. The new receivers on the market this year, in the main, are especially satisfactory on these two counts.

York, Chicago, and Los Angeles and other cities where numerous broadcasting stations operate on closely adjacent wavelengths. A local high power station sets up such great energy in the antenna system, that it is heard over a somewhat wider span on the tuning dials than are the signals from distant stations of equal power. Overlapping of stations occurs in crowded areas unless the receiver is selective.

TESTING A SET FOR SELECTIVITY

IT IS not difficult to test a receiver for selectivity. Have the receiver tuned to the nearest, local, high power station. With the program coming in at full volume, have the tuning dials turned one degree off the maximum point at which the station comes in. Note carefully if there is any drop in signal strength as a result of this manipulation. If a one-degree swing of the dial in each direction from the maximum point weakens the signal, you may be quite sure that the receiver is highly selective. If a two-degree swing causes the volume to fall off markedly, it is satisfactory for use in congested districts. On the other hand, if a three-degree swing of the dials in each direction does not weaken the signal considerably, the set is not adequately selective to cope with congested conditions.

No one circuit can rightfully claim the monopoly of selectivity. There are many circuits which, if utilized in well designed receivers, are adequately selective. On the other hand, the most efficient circuit may be so unscientifically applied in the receiver design that it is not selective. So look to the demonstration of performance rather than to any wordy argument about circuit superiority for the proof that a receiver is selective.

Simplicity divides itself into two classes: simplicity in tuning and adjustment, and simplicity in maintenance. The greatest convenience in tuning is found in those receivers which have a single, calibrated dial, marked in wavelengths or frequencies, so that you can set the dial to the station which you desire to hear, provided you know its wavelength or frequency. The only other essential control devices are a means of controlling the volume and a switch to turn the set on and off.

At the other extreme is the receiver which has three or more tuning controls, several filament rheostats, separate switches for power supply devices and directional loops which must be turned toward the desired station.

Receivers of years ago had almost more controls than are found in a railway signal tower. The tendency in the last year toward simplification has been marked. Now there are many models with but one tuning control. Other manufacturers

support the two control set, claiming greater selectivity. When more than two controls must be manipulated to tune in a station, it becomes difficult for one pair of hands to do the work. But the three-control set has advantages too, because its less expensive design and manufacture permit of a lower selling price.

MAINTENANCE—ANOTHER IMPORTANT POINT

CONVENIENCE in maintenance is determined by the means used to obtain filament and plate current. Where power lines are not available, dry-cell tubes are usually used because a storage battery is an unhandy article to take out and have charged every two or three weeks. So long as the receiver has only five or six dry-cell tubes, it is not necessary to renew the dry cells so often that it becomes annoying. Where power is at hand, storage battery tubes are usually preferred because they give greater amplification and better signal volume.

If you select the storage battery type, consider a storage battery charger an essential part of the receiving set. Include it in the first cost because it is necessary to reliable reception. A storage battery receiver, without means of charging, is as helpless as a motorist in a desert. Both need outside help, if the fuel supply becomes exhausted.

To those who must rely on dry-cell A batteries, the number of tubes in the receiver is quite important. The use of more than five or six dry-cell tubes results in such heavy current drain that the dry-cells must be quite frequently renewed.

Plate potential may be secured from the power line or from B batteries. Much attention has been given in the public press to the development of devices for securing plate potential from the power line. Many of these devices are practical and convenient; others operate with a certain amount of hum and require frequent tube renewal. On the other hand, it must be said, in all fairness, that B batteries have also been greatly improved in the last few years, with respect to economy and length of life. If large batteries, made by reputable manufacturers are used, they power most five- or six-tube receivers for six to nine and sometimes even twelve months without replacement. High grade B battery

substitutes have proved very satisfactory but some inferior, low priced, poorly constructed devices cause so much hum that they are far inferior to B batteries.

If you plan to purchase a B battery substitute, be sure, when having the receiver tested for fidelity of reproduction, that the device which you plan to buy is demonstrated with your receiver. If the hum is disagreeable, try a different make which gives less hum or install B batteries.

THE SENSITIVITY TEST

THE fourth quality to which you must give attention, when selecting a receiver, is its sensitiveness. If the radio receiver is purchased for musical entertainment and not for chasing long distance ether rainbows, sensitiveness is a minor factor. There is a thrill in long distance reception akin to that of speeding in an automobile. But the receiver which is stressed as the king of distance getters does not always possess the more important factors of tonal quality and simplicity already discussed. As the true musical value of radio reception has become apparent and the grade of programs available through near-by stations has substantially improved, the inferior tonal quality of reception from long distance has made distant programs of decreasing interest. Still there are a few who would rather hear a sneeze from Honolulu than a symphony concert from a local station. To these few, the radio frequency end of the receiver is of utmost importance. The greater the number of efficient stages of radio-frequency amplification, the more sensitive the receiver.

The average receiving set owner needs sensitiveness only sufficient to receive stations within 150 to 250 miles with adequate volume and high quality. A daylight range of 100 miles indicates a receiver sensitive enough to bring in all the stations within range of good quality reception. For instance, if a dealer can demonstrate the reception of Philadelphia stations in New York City by daylight, with good quality, he has proved a degree of sensitiveness which will meet the demand of practically every listener.

Little need be said on the subject of appearance because your own eye is a quick and sound judge, although your pocketbook is often the only limitation in your choice. In judging

appearance, the receiver should be considered completely installed, with all batteries, power supply equipment, charging device, auxiliary amplifiers and loud speaker connected. A neat looking cabinet does not always mean a neat installation because provision is not always made for inconspicuous placement of associated equipment. On the other hand, some receivers have a place for everything so that every accessory is neatly concealed.

HOW TO LOOK FOR THE FIVE POINTS IN JUDGING A SET

BRIEFLY stated, the five points indicated in this article to enable the prospective purchaser to judge a receiver he is considering can be presented thus:

1. Quality of Reproduction
 - (a) Small, semi-power, or power tubes in last audio stage.
 - (b) Reproduction with loud speaker and power supply of type to be used with the receiver.
 - (c) Demonstration for reproduction of low and high tones.
2. Selectivity

Test by observing over how many degrees of the dial near-by stations are heard.
3. Simplicity
 - (a) Number of controls used in tuning.
 - (b) Ease with which filament and plate potential is maintained.
4. Sensitiveness

Ability to receive over moderate range by daylight with good quality.
5. Appearance

Fitness of receiver, with all accessories connected, to be installed in your home.

Meet Mr. Average Radio Enthusiast

The Extremely Interesting Results of a Comprehensive Survey Made of "Radio Broadcast" Readers—Who They Are and What They Want in Radio—The Future of the Parts Business

By KINGSLEY WELLES

Drawings by Franklyn F. Stratford

COMPOSITE photographs, made by stacking a number of negatives and printing them together as one picture, are sometimes used to show the average type of a group. Several years ago, such a composite photograph of the five leading candidates of one political party was compared by an astute publicity man with a similar photograph of five of the opposition, to prove what a lot of ruthless, hard-boiled, political crooks were opposing the mild mannered reformers of his party.

RADIO BROADCAST has just completed a composite photograph of the average radio enthusiast. There is room in every home for this picture, over the radio set. More than two thousand readers were asked to cooperate in making the picture; more than seven hundred responded. There is every reason to believe our picture is really true to type.

Perhaps you have formed your own conception of Mr. Radio Enthusiast. You may have imagined him to be a learned type, poring over a calculus through heavy, bow rimmed glasses, or a long-legged youth in short trousers, drilling holes in a panel clamped to the library table. Perhaps you have pictured a knowing genius, cramped in an attic, building magnificent supermastodon receivers, surrounded, like Socrates, by admiring satellites.

Shatter these picturesque illusions. Mr. Radio Enthusiast is none of these. He is a successful business man who knows how to make a good living. Statistics prove it. 39.2 per cent. of those who responded to RADIO BROADCAST's questions are engaged in the radio business or allied industries, which tend to interest them in radio. This leading group includes electrical engineers, mechanical engineers, telephone engineers, electricians, scientists and research engineers, as well as radio engineers, jobbers, dealers and manufacturers.

Skilled workers—draftsmen, carpenters, tool makers, engravers, expert mechanics and the like—came next with a representation of 12.4 per cent. Close on their heels came independent merchants, representing 11.9 per cent. of the total, with druggists, jewelers, bakers, opticians, contractors, and realtors forming the bulk of the classification.

The professional men, with 11.8 per cent. representation, were nosed out at the last minute by the independent merchants, just as the final

returns came in. Dentists, surgeons, librarians, lawyers, writers, ministers, architects, and a score of other learned professions were represented in this group.

If you think there is anything lowly in caste about Mr. Average Enthusiast, revise your opinion. Executives—the patricians of industry and commerce—bankers, manufacturers, railroad officials, exporters and importers—men who own their motor cars and have actually paid for them—formed a group comprising 11.5 per cent. of the total answering the questionnaire! Now you know who buys the \$9.00 transformers.

Office workers (such as clerks, accountants, salesmen, agents, customs inspectors, and what-not) wearing clean white collars, in spite of addiction to radio as a hobby, came through with 10.2 per cent. of the vote.

The remaining 7.8 per cent. were divided among students (5 per cent.), sailors, army and navy officers, coal heavers (a total of one), housewives and miscellaneous other defenders of the home.

Friend reader, when you are chided that your addiction to radio is disgraceful, that it is the hobby of small boys and lunatics, quote these figures. Arise in righteous wrath and defend the dignity of the followers of radio!

HOW LONG HAVE YOU BEEN INTERESTED IN RADIO?

BUT this is not the only revelation deduced from these questionnaires. How long does radio hold its following? I venture to recall the early days when my case of radio infection first became really serious. Twelve years ago, I sat with headphones clamped to my ears. Behind me there was a whispered family conference. I overheard. "He'll get over it soon," said a voice. "Yes, that's our only hope," said another. "Time will restore his sanity," followed a third. No cure was found. And no cure has been found for the virus radio.

The questionnaires yielded the surprising fact that 89.8 per cent. of RADIO BROADCAST's readers have been interested in radio for more than three years; 30 per cent. for more than six years and 26.1 per cent. for more than ten years. So, if you are one of the newly infected recruits, do not think that time will effect a serious moderation in your enthusiasm; rather realize that you will be gripped more and more firmly. We assume, of course, that you are like Mr. Average Radio Enthusiast.

You swell with pride when friends consult you about the purchase of radio sets. It is flattering to be recognized as a radio authority in the community. But is not the experience and knowledge you have gained by building sets and by long study of authoritative publications ample justification for the deference with which you are consulted?

THE READER ADVISES WHAT TO BUY IN RADIO

IF YOUR wife is proud of you because the iceman, the baker, the butcher, the boys at the club and all the in-laws consult you before buying their radio sets, do not let her see this

copy of RADIO BROADCAST. Of course, she always struggles to get hold of it, even before you have had a chance to read it. But she must not be permitted to learn that no less than 79.2 per cent. of RADIO BROADCAST's readers have been consulted as experts in the selection of sets. A scattering of experts in the radio art have been consulted by as many as a hundred and more friends, seeking the benefit of their thorough radio knowledge. By totalling up the number of sets which each has advised upon, we find that these 575 oracles were consulted in the purchase of 10,827 sets. Since 727 is only $8\frac{1}{3}$ per cent. of RADIO BROADCAST's total circulation, we come to the conclusion that over 125,000 radio sets have been purchased on RADIO BROADCAST readers' recommendations.

These oracles recommend an entirely different kind of set for their friends than they make for themselves. Although 16 per cent. of those who replied had made one form or another of the Roberts receiver, this popular type by no means was recommended most frequently to inquiring friends, who were probably those in the market for a factory-built outfit. These radio enthusiasts realize that a beginner does not get good results with a receiver requiring more than average skill to operate. 34.6 per cent. recommended the super-heterodyne to their friends, 29.5 per cent. tuned radio-frequency receivers, and 17.2 per cent. neutrodyne receivers.

Take another look at Mr. Average Listener. Notice those keen, searching eyes, those little wrinkles just over the nose. Any physiognomist will tell you that these indicate concentration and an insatiable appetite for knowledge. This characteristic is almost uniform among radio enthusiasts. They want RADIO BROADCAST's Laboratory to work day and night finding out things for them that they want to know. You would guess, of course, that they ask for the development of a lot of new circuits to play with. But that is not altogether the right guess. The request most frequently made in the answers to the questionnaire was for technical investigations and laboratory reports regarding the qualities of radio sets and parts. What they want is performance data so that, when they are consulted, they really know what they are talking about. They want to be able to say that the "Cream Puff receiver has 25 per cent. greater amplification in the radio-frequency amplifier than the Stuffed Doughnut receiver, but the latter has a much better audio-frequency

Oh, Mr. Goofer, your radio's so wonderful. Do tell us what to buy!



"THEY ASK READERS FOR RADIO ADVICE"

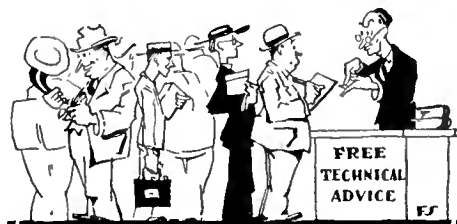

"FANS FLOCK TO THE GOOD RADIO STORE"

amplifier, maintaining, as it does, practically a straight-line characteristic between 32 and 5300 cycles."

Fourteen and two-tenths per cent. want information about the construction of accessories such as A and B battery eliminators, loud speakers and other elements which improve existing sets; 13.2 per cent. on the fundamentals of set and circuit operation; 11.8 per cent., more information on specific kinds of circuits with the super-heterodyne as the leader receiving 4.9 per cent of the vote in this section. Ten and one-tenth per cent. asked for more short-wave experiments, radio pictures, and beam transmission. Eight and one-tenth per cent. asked advice on how to make sets with specific qualities such as simple tuning, one-control, more sensitive sets.

Seven and seven tenths per cent. of those replying to the questionnaire were interested in transmission phenomena, investigation of fading, causes and cures for static and power line interference.

THEY WANT FORWARD STEPS IN RADIO

THERE was no such diversity of interest however in regard to the problems of radio which they wanted the magazine to fight for.

Let the blooper beware! We find his life is seriously endangered. Thirty-five and five tenths per cent. favor capital punishment in various forms for the blooper, ranging from gentle dynamiting to "something lingering, with boiling oil in it." We do not publish some of the phrases used by irate enemies of bloopers, lest suspicion be attached to them, should there be any mysterious disappearances.

Sharing almost equally with the bloopers in the contempt of radio enthusiasts are those little, willful broadcasting stations which insist on inflicting themselves upon the overburdened ether, regardless of the wishes of the radio audience or the good of the broadcasting art. Thirty-two and seven tenths per cent. asked

for the wholesale elimination of mediocre stations. Many were specially acrimonious in alluding to some of the newer stations which have filled the ether bands to overflowing. If the owners of such stations believe that they are gaining goodwill, they have certainly made a terrible mistake.

Ten and five tenths per cent. made suggestions for better broadcasting, asking for the encouragement of better programs, less prolific announcing, better pronunciation in announcing, less jazz, and better quality in transmission. The other program movements favored received only a scattering vote. It is notable in this respect that there were practically no protests against commercial broadcasting.

GOOD PARTS WILL STILL BE MADE AND SOLD

IN ORDER to further aid and enlighten the troubled radio industry, this magazine also questioned parts manufacturers and dealers as to their opinion on the future of the parts business. Radio enthusiasts are often surprised to learn from their dealers that they are giving up the parts business because it is more trouble than it is worth; at the same time, they find the business in the really active and enthusiastic parts store bigger and better than ever. What is the true situation? Is the number of retail outlets for parts gradually becoming comparable in number to those existing for steam calliopes or ostrich harnesses?

The figures obtained by RADIO BROADCAST indicate a very pleasing and definite trend in the parts business. Thirteen and nine tenths per cent. of the dealers handling parts last year are or have given it up during the coming season. Yet 24 per cent. reported substantial increases in parts sales during the last season. It was necessary to study the individual questionnaires in order to get at the root of the situation. In every case that a dealer indicated that he was interested and enthusiastic about set construc-

tion, about the handling of parts and sympathetic with the experimenter, and stated that he equipped his store so as to handle parts to advantage, including in his staff, technical men capable of advising and helping enthusiasts, the parts business grew and grew. Fans are quite evidently flocking to the man who caters to them by helpful service and neglecting him who stocks parts as an evil necessity.

All the manufacturers who developed and actively marketed new devices specially adapted to making the latest and most advanced types of sets found the parts business profitable and growing. This included 75 per cent. of those answering the questionnaire. But those who rested on their laurels and did not contribute to the advancement of home set building did not find their coffers flooded as the result of an insistent demand for their products.

It is obvious from the foregoing that set building has gradually consolidated its following in what, by all evidence it is possible for us to gather into a group of serious and persistent experimenters and that only those catering to their special interests—whether dealers or manufacturers—can gain their liberal patronage. But if he makes or markets products which enable the constructor to make the best and latest there is in radio, his ingenuity and progressiveness will be rewarded with profit.

From our study of the replies returned from the leading parts manufacturers, it is certain that the interested home constructor, whose numbers still remain legion, may continue to expect an ever improving selection of parts and that there will be constantly improved components for his favorite model of receiver, B power supply and all the other essential parts and accessories. There is no question whatever that progressive designs put forward by manufacturers known to all in the field will be widely purchased by the discriminating set building enthusiast.



TWO INTERESTING RECEIVERS SHOWN IN THE FALL EXHIBITS

On the left is an interesting Erla model using the circuit developed by the Radio Frequency Laboratories. The model below, from F. A. D. Andrea, New York, is a three-control long-wave neutrodyne receiver, especially developed for the British and Continental market. The set, as will be noted has anti-capacity telephone switches for changing from short to long waves. The set will tune well above 2000 meters

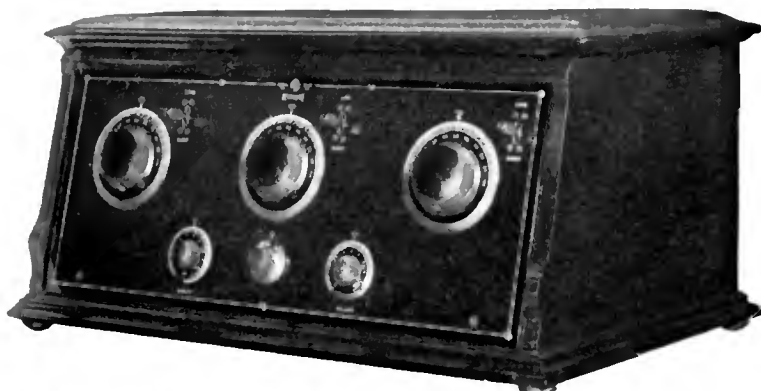

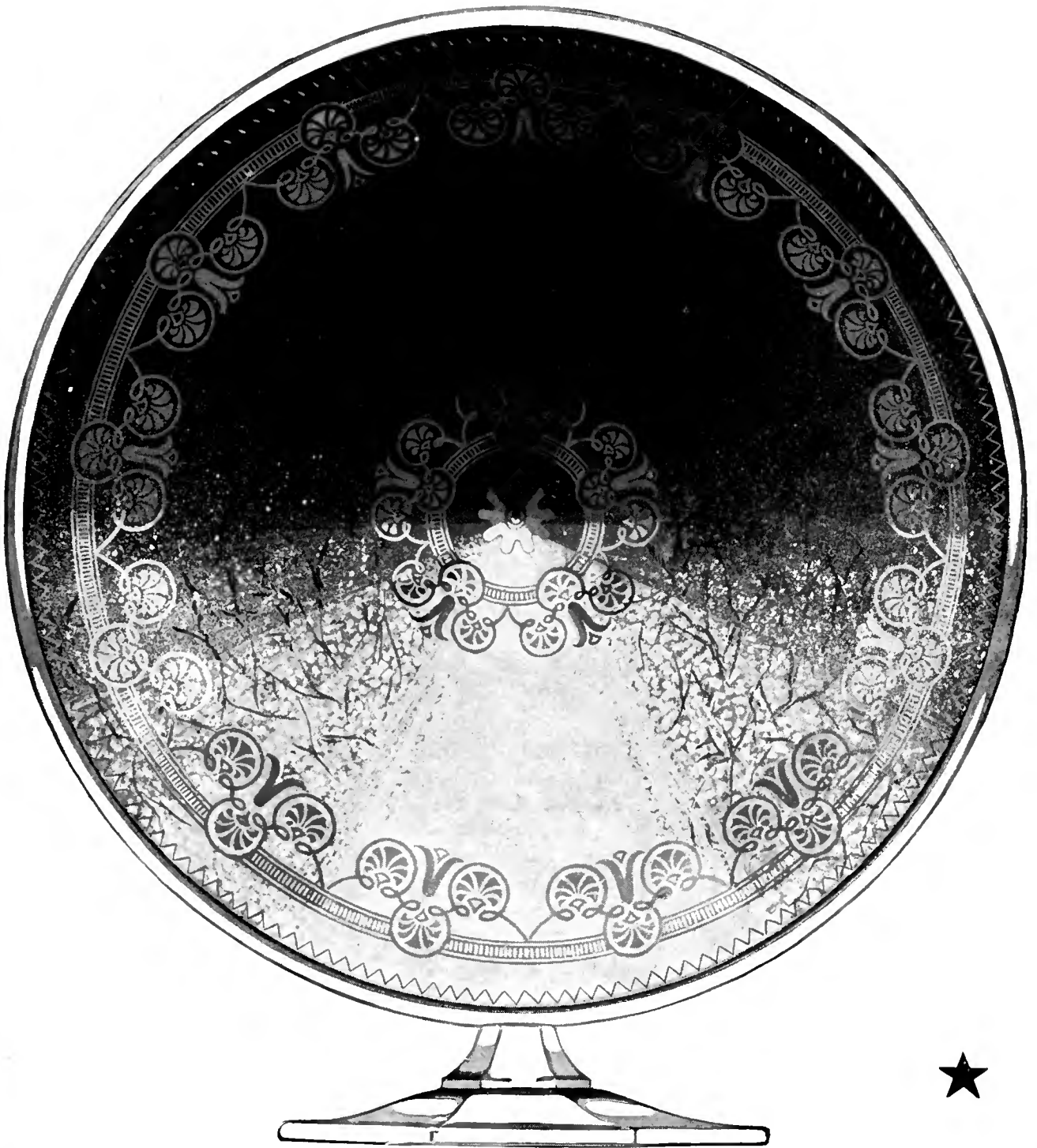

 The Crosley Musicone, announced little more than a year ago, introduced a revolutionary speaker principle and took the radio loud speaker market by storm.

Its overwhelming popularity, which has involved the replacement of hun-

dreds of thousands of old type loud speakers, establishes beyond challenge the Musicone's superiority.

And now Powel Crosley, Jr., announces ... the Crosley Super Musicone!

This larger 16-inch cone utilizes the same Crosley patented actuating unit

as the smaller Musicone ... and this, not the cone shape, is the secret of Musicone excellence.

It offers, by virtue of its larger proportions, still more superb volume. It produces, especially in the bass, still richer resonance!

The 12-inch Musicone has been reduced to \$12.50. Also at \$32 in the form of a beautiful Console, in which both receiver and batteries may be placed.

THE CROSLEY RADIO CORPORATION, CINCINNATI, OHIO ... POWEL CROSLEY, Jr., President.

CROSLEY *Super* MUSICONE

BETTER •  COSTS LESS

Write Dept. 20 for illustrated booklet

All prices slightly higher West of the Rockies

★ Tested and approved by RADIO BROADCAST ★

more power to you~ and perfect tone too!



Power detector tube to replace Type 200 and 201-A. Doubles volume and distance.

A

SONATRON for EVERY PURPOSE

Ask your dealer to show you the world's largest line of tubes. SONATRON'S 25 distinct types offer a tube for every purpose. Get maximum efficiency from your set with SONATRON tubes.

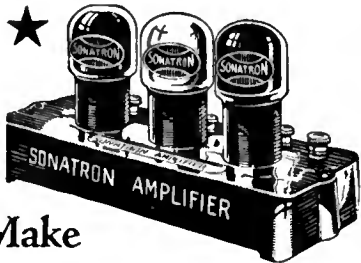

Make Your Set a 1927 Model

SONATRON Red, White and Blue Matched Power Tubes Amplifier—complete as above—\$20. Attached to any set in one minute. Can be used on dry-cell sets. One year guarantee for greater tone, distance and fidelity of reproduction.

Product of **SONATRON TUBE CO.**

Chicago, New York, Newark, Detroit and Windsor, Ont., Canada.

Visit us at Chicago Radio Show, Booth 19, main floor Coliseum, Oct. 11-17 inc.

SONATRON TUBES and AMPLIFIERS

The Radio Broadcast LABORATORY INFORMATION SHEETS

INQUIRIES sent to the Questions and Answers department of RADIO BROADCAST have until recently been answered either by letter or in "The Grid." The latter department has now been discontinued, and all questions addressed to our technical service department are now answered by mail. In place of "The Grid," we present herewith a series of Laboratory Information Sheets. These sheets contain much the same type of information as has appeared in "The Grid," but we believe that the change in the method of presentation and the wider scope of the information in the sheets, will make this section of RADIO BROADCAST of much greater interest to our readers.

The Laboratory Information Sheets cover a wide range of information of value to the experimenter, and they are so arranged that they may be cut from the magazine and preserved for constant reference. We suggest that the series of Sheets appearing in each issue be cut out with a razor blade and pasted on filing cards, or in a note book. The cards should be arranged in numerical order. Several times during the year, an index to all sheets previously printed will appear in this department.

Those who wish to avail themselves of the service formerly supplied by "The Grid," are requested to send their questions to the Technical Information Service of the Laboratory, using the coupon which appears on page 585 of this issue. Some of the former issues of RADIO BROADCAST, in which appeared the first sets of Laboratory Sheets, may still be obtained from the Subscription Department of Doubleday, Page & Company at Garden City, New York.

No. 33

RADIO BROADCAST Laboratory Information Sheet

October, 1926

Tandem Tuning

EQUALIZING THE CIRCUITS

TANDEM tuning of condensers, to decrease the number of separate controls, has become quite common. There are some fundamental facts concerning tandem tuning which must be considered if satisfactory results are to be obtained.

The output and input characteristics in which the tuned circuits work must be the same in each stage. In A of the accompanying diagram, the tuned circuit No. 2 works out of the plate circuit of one tube and into the grid circuit of the following tube. The same thing is true of circuit No. 3. Therefore, if the coils and condensers are exactly similar, the two condensers in these circuits may be coupled together and operated from a single control. The tuned circuit No. 1, however, is coupled to an antenna, and for this reason its condenser will not tune in exact step with the other two condensers and, therefore, it cannot be "ganged" with the other two circuits even though the coil and condenser have the same characteristics.

One method which will permit the ganging of all three condensers is shown in B. Here, tuned circuit No. 1 has been coupled to the plate circuit of an additional tube. It is now similar to the other two tuned circuits, and the three can be all tied together. The antenna then feeds through a resistance coupled directly to the grid of the additional tube.

It is, of course, possible to so construct circuit A so as to permit ganging of all three units without an

additional tube. It would require, however, very accurate cutting of the condenser plates so as to compensate any effect of the antenna circuit. This is a difficult job and it is preferable to either retain two controls or to use an extra tube.

Many so-called single-control receivers are equipped with some compensating device which

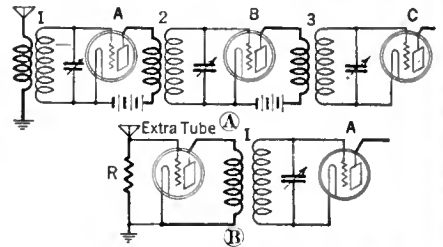

permits exact tuning of each circuit to resonance. In some cases this device consists of a small midget condenser connected in parallel with one of the main tuning elements; sometimes the stationary plates of one of the condensers are mounted on a pivot so as to permit more accurate tuning. But no receiver that has such an adjustable feature can accurately be called a single-control set.

No. 34

RADIO BROADCAST Laboratory Information Sheet

October, 1926

Series Connection of Filaments

BIAS FROM VOLTAGE DROP

ALTHOUGH the practice of connecting filaments in series has been common in telephone work for some time, it has only lately come into use among radio set builders.

When filaments are in parallel, the battery voltage must be the voltage that one tube requires. For a 201-A type tube this is five volts. When the tubes are in series the battery voltage must be the sum of the voltages, that is, for five 201-A type tubes, 25 volts is required. In the parallel case, the total current is the sum of that taken by each tube; in the series case, the current is that taken by one of the tubes.

In the diagram are four 199 tubes in series with a 12-volt battery to supply them with current. There is a three-volt drop in each filament and, taken from the positive end of the battery, the total drop increases in three-volt steps. This voltage drop can be used as a negative bias for amplifier tubes. It is only necessary to connect the grid return of the amplifier in question to the place along the line where the voltage—with respect to the negative side of the amplifier filament—is that required for proper bias.

For example, in the diagram, tube No. 1 has its grid return connected to the negative side of the filament. This represents zero bias. Tube No. 2 is also connected to the same place, but between the

negative side of the filament of tube No. 2 and the point where its grid return is connected, is a three-volt drop caused by the preceding tube. In the same manner, tube No. 3 has its grid biased positively three volts since in this case there is a difference of voltage of three between the positive and negative sides of this filament. Tube No. 4 has a

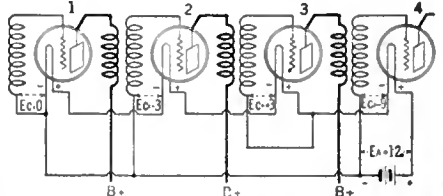

negative bias of 9 since between its negative filament lead and the point where its grid return is connected is the voltage drop caused by three preceding tubes. In the diagram, Ec represents grid volts. In the article entitled "An A. B. C. Line Supply Device" in the October, 1926, RADIO BROADCAST, diagrams are given of receivers with filaments in series.

FREE

This 84 Page Wonder Book of RADIO Bargains



Send for this guide to Radio prices and Radio quality. All of our vast resources and radio experience have been utilized to assemble for you in one gigantic institution, the best and newest things in radio. The Randolph catalog is indeed the radio market place of the world—a masterpiece of merchandising that befits our house—the largest exclusive radio mail order house in the world.

What Our Catalog Contains

Over 2,000 items—from the most beautiful, fully equipped console model radio set, down to the smallest part or tool for the set builder—kits, parts, and supplies of every conceivable type and style. All beautifully illustrated and interestingly described. And to give this book added value, we have included radio data that makes it an invaluable text book for every lover of today's most fascinating and most wonderful achievement—RADIO.

Radio Sets

In this great radio market place you will find table model sets and console types with built-in loud speakers; the newest amphiphonic console sets; new Spanish period consoles; five, six, seven, and eight tube sets, with three dial, two dial, and the newest and most popular single simplified control. All sets are assembled in beautiful, genuine mahogany and walnut cabinets in a choice of latest types and designs.

**5 Tube sets as low as \$24.90
Latest 1927 Models**

All Randolph sets are sold at amazingly low prices. No matter what kind of set you want—no matter how little you want to pay—you can select YOUR SET AT YOUR PRICE from the Randolph catalog.

Radio Kits

Includes the following well known circuits, designed and approved by the world's foremost radio engineers: Madison Moore Super; Victor-ten Super; Silver Marshal Six; Sargent's In-fradyne; Remler Super; Short Wave Kits; 9-in-Line Super; New Acme Reflex; Cockaday; Neutrodyne; Browning-Drake; all classes of radio frequency, Super Heterodyne and every other approved popular circuit.

YOU MUST HAVE THIS BOOK

Space limitations here prevent our telling you more about the Randolph Catalog. Simply fill out and mail the coupon—or you may send a postal or letter—and this truly remarkable Radio book will come to you **ABSOLUTELY FREE. MAIL THE COUPON NOW.**

Randolph Radio Corporation
180 North Union Avenue • Dept. 14 • Chicago, Ill.

Radio Parts and Supplies

The Randolph catalog also contains a most complete line of "B" Battery Eliminators, including the famous Raytheon Eliminators; the latest type of Loud Speakers, Cone Speakers, a complete line of quality "A" power units—in fact, you will find listed in this wonder book every part that goes into the construction of a radio set, or any accessories you desire, at prices that mean a substantial saving to you.

Free Radio Service

Everyone has need for radio service. The average man has no time to keep up with the rapid developments of radio. We employ Radio Engineers who have made radio their life work. Their expert advice and helpful suggestions solve every radio problem of our customers.

Our Guarantee

Every article in our catalog is based on careful laboratory analyses and tests. We guarantee to back up every item in our catalog with our own as well as manufacturer's assurance of quality.

Why We Save You Money

Because we handle radio exclusively and sell a tremendous volume of everything in Radio, we can concentrate our buying power for the benefit of our customers.

Volume purchases regulate prices. We command rock bottom prices from manufacturers, and in many cases we contract for entire factory output of exclusive products. You will benefit by our great volume of purchases and sales, by securing anything you may want in radio at a substantial saving.

This Coupon Brings the Great RADIO Book FREE

RANDOLPH RADIO CORPORATION
180 N. Union Ave., Dept. 14
Chicago, Illinois

Send me—free—your 84-page, 1927 Radio Book.

Name _____

Street and No. _____

R. F. D. _____ Box _____

City _____ State _____

New Centralab Rheostats

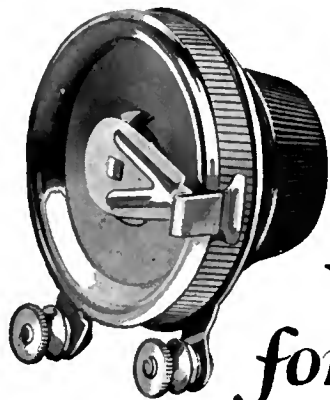

for Noiseless Control

New circuits using one rheostat to control several tubes, and new tubes using increased current, overload the older designs of rheostats which overheat and quickly become noisy in service.

The new Centralab Rheostats are especially for these conditions. They operate smoothly and noiselessly. The resistance element is firmly clamped between insulated metal discs so that it cannot move or warp, and by this means, uniform spacing is maintained between the windings, giving even regulation, and eliminating dead spots. The large area of metal aids in cooling, and they carry unusually heavy current for their size.

NEW RIBBON TYPE For Heavy Duty

The Centralab Ribbon Wound Type is an important improvement in heavy duty rheostat construction. Wound with flat ribbon in place of wire, it gives heavy current capacity that will handle from 5 to 10 tubes and give noiseless control.

All metal parts are brass or spring bronze, nickel plated. Diameter 2 in. Bakelite knob. Single hole mounting.

Ribbon Type, 3 ohms for 5 to 7 tubes, or 2 ohms for 7 to 10 tubes ... **\$1.25**
Wire Wound Type, 4 models for 1, 2, 3, 4 or 5 tubes ... **\$1.00**

At your dealer's, or mailed direct on receipt of price.

CENTRAL RADIO LABORATORIES
 22 Keefe Ave. Milwaukee, Wis.

The Centralab Modulator is used in the popular Henry Lyford Circuit.



No. 35

RADIO BROADCAST Laboratory Information Sheet

October, 1926

Radio Frequency Transformers

TUNED AND UNTUNED

RADIO frequency transformers are classified as "tuned" or "untuned." A tuned transformer must be tuned to the frequency that is to be amplified. Thus, for a particular setting of the condensers, the amplification would be great for a narrow band of frequencies but negligible for frequencies even slightly outside of this band. Untuned transformers, despite the fact that they are called "aperiodic," work best at some particular frequency. However, they are supposed to work over a wide range of frequencies. The wide range is due to the introduction of resistance, or, if iron cores are used, by a combination of the advantage of the iron core with the effective resistance introduced into the transformer by the losses that occur in iron at high frequencies. In general, it may be said that, when there is much resistance or anything else that causes losses, the amplification will be less than that theoretically obtainable by the use of tuned transformers. A few stages of tuned transformer-coupled amplification have the advantage of giving great selectivity, that is, amplifying only one frequency (strictly speaking, only a very narrow band of frequencies) but have the disadvantage that as each stage must be carefully tuned, it is complicated to change from one frequency to another and difficult to pick up weak signals unless the proper setting for each tuning condenser is known in advance. In the super-

heterodyne system, this disadvantage disappears because the intermediate-frequency amplification is done at a fixed frequency, irrespective of the wavelength of the station being received.

The diagram shows a typical three-stage untuned transformer-coupled r. f. amplifier with potentiometer stabilization. The transformers are marked

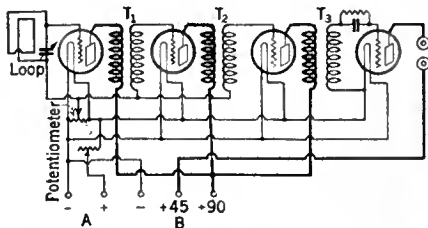

T₁, T₂, and T₃. Receiving sets of this type are not very selective as there is only one tuned circuit to do the "selecting," but they are easy to operate as the tuning condenser and the potentiometer are the only controls. Unless an arrangement for plugging in different transformers is provided, the range over which best amplification is obtained is usually only about two hundred meters.

No. 36

RADIO BROADCAST Laboratory Information Sheet

October, 1926

The Super-Heterodyne

ACTIONS AND PRINCIPLES

ESSENTIALLY, the super-heterodyne consists of a receiver constructed to receive on one single frequency (whatever frequency it is most efficient to work with), ahead of which is a frequency changing device in combination with a detector tube (known as the first detector) designed to change the frequency of the incoming signals to that of the fixed frequency receiver. The receiver designed to receive on one single frequency consists

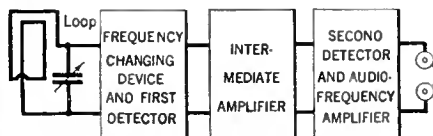

of several r. f. stages (known as the intermediate-frequency amplifier), a detector (the second detector), and the usual audio amplifier.

The tuning controls consist of two variable condensers, one to tune the loop to receive the incoming signals (which are passed to the grid of the first detector), and the second to tune the frequency changing device (known as the local oscillator).

It is a well-known fact that two frequencies,

if superimposed, will produce a third frequency, its value equalling the difference between the two superimposed frequencies. The object of the local oscillator is to produce locally a frequency which may be superimposed upon the incoming frequency. The frequency of the locally generated wave must be such that when it heterodynes (is superimposed) with the incoming signal, the third frequency will equal that which is capable of being received by the fixed frequency unit of the super-heterodyne. This third frequency may be 30 kc. Thus we hear mention of a 30-kc. super-heterodyne, which means that its intermediate amplifier is designed to pass signals of only that frequency.

A very realistic example of the super-heterodyne principle may be obtained any night these days by listening-in to the shorter wave broadcasting stations. Often the program is marred by a constant howl which may vary slightly in pitch. This is caused by two broadcasting stations straying from their allotted frequencies and heterodyning with each other, thereby causing an audible howl. This is known as "beating." The third frequency produced by the heterodyne action in such a receiver is known as a "beat" note.

The accompanying diagram makes clear the sequence of units in the super-heterodyne. In some receivers of this pattern, r. f. amplification is resorted to ahead of the first detector and frequency changing unit. Further details of the super-heterodyne appear on Sheet No. 41.

No. 37

RADIO BROADCAST Laboratory Information Sheet

October, 1926

Single Side Band Transmission

A SIMPLE EXPLANATION

THE carrier wave plays no important rôle in the actual conveyance of intelligence. It is required only for the purpose of modulation at the transmitting station and of demodulation at the receiving end. For actual transmission it may be left out entirely, only the modulated component being transmitted, provided that a local oscillator tube is used at the receiving end to supply current of the same frequency to take its place. The "balanced modulator," used to get rid of the carrier, is shown in the diagram. Analysis of this circuit (which consists merely of two tubes, each acting as an oscillator) shows that the two side bands generated by each tube act additively in producing current in the antenna, but the carrier frequency current in the plate circuit of one tube just cancels the effect of the carrier current in the other tube, as far as producing current in the antenna is concerned. Much power is wasted transmitting the carrier, but for most purposes it is best to do so because it is difficult to make the local oscillator at the receiving station supply just exactly the same frequency. Another advantage in suppressing the carrier is that the locally generated carrier frequency at the receiving end is not subject to variations in strength, and hence there is a reduction in the amount of fading of the received signals.

Furthermore, only one of the side bands is required to convey the speech or music, and, therefore, the channel required will only be one half as

wide, which is an important feature if the ether is crowded with transmitting stations. Also, the receiving set can be made to receive only one half as wide a band of frequencies and hence offers only one half as much chance for interference to get in. If both the carrier and one side band are suppressed, the local oscillator at the receiving end can be as much as fifty cycles different in frequency from the original carrier without serious interference with

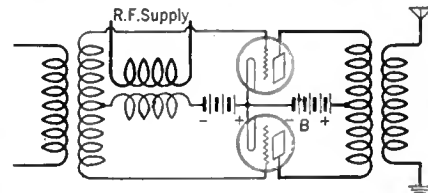

intelligibility of speech. However, the harmonic ratios in music would suffer. For the reasons mentioned above, the American Telephone and Telegraph Company is using single side band transmission in its transatlantic telephony tests. This system is not now practicable for short-wave work as it is too hard to "filter out" the side band that is not wanted when the width of these bands is only a small fraction of the carrier frequency.

A Hookup for Dealers that Eliminates Interference

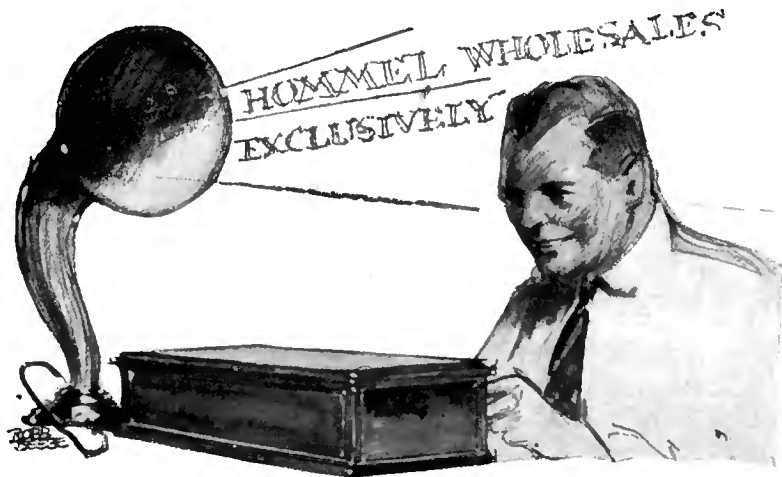

When a Radio Dealer "hooks up" with the House of Hommel—he is assured of the closest co-operation and of a dealer service unexcelled, if even equaled, by any other radio jobber—all of which means greater profits for Hommel Dealers.

The numerous user inquiries referred to their dealers—their policy of wholesaling only—the large stocks of reputable radio equipment carried at all times for immediate shipment to dealers—their inspection and repair department—their modern display room,—are but a few of the many features of Hommel Service that are responsible for the reputation and success of the Hommel organization to-day.

Hook up with Hommel—the helpful jobber—you will find Hommel's Catalog 566-B invaluable in ordering and dealing with your customers—write today.

WHOLESALE

EXCLUSIVELY

LUDWIG HOMMEL & CO

929 PENN AVENUE



PITTSBURGH, PA.

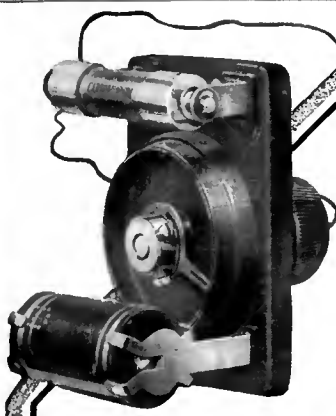

Tone Quality is the Thing

WITH the passing of the volume and distance fans there enters the demand for natural undistorted reproduction—the demand for a real quality of tone. The trend of radio is toward the crystal clear reception that you can get on any set with the Carborundum Stabilizing Detector Unit.

It's a Carborundum Detector permanent, rugged and fixed under a five pound pressure—no cat's whisker—no adjustment—no possibility of burning out.

By means of a potentiometer and tiny booster battery it is electrically controlled to match the receiving conditions of all sets of any type. Gives you greater selectivity and distance—but above all quality of tone.

Dealer or Direct
\$3.50
IN U. S. A.

THE CARBORUNDUM STABILIZING DETECTOR UNIT

Reg. U. S. Pat. Off.

Improves Any Set

Send for the 1927 Hookup Booklet on 6-tube Shielded Set, Improved 200-mile Crystal Set, Circuits, Etc.

Made exclusively by
THE CARBORUNDUM COMPANY
NIAGARA FALLS, N. Y.
SALES OFFICES AND WAREHOUSES IN
New York, Chicago, Boston,
Cincinnati, Cleveland, Philadelphia, Detroit,
Pittsburgh, Milwaukee, Grand Rapids
The Carborundum Co., Ltd., Manchester, Eng.



The Carborundum Company
Niagara Falls, N. Y.

Please send free Hook-Up Book D-2

The Detector Alone

\$1.50

IN U. S. A.

Name _____

Street _____

City _____ State _____

{ Carborundum is the Registered Trade Name used by The Carborundum Company for Silicon Carbide. This Trade Mark is the exclusive property of The Carborundum Company. }

American Transformer Company

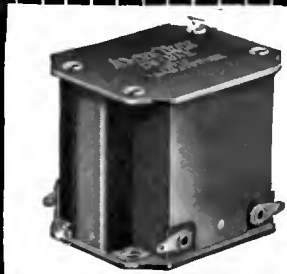

The AmerTran DeLux

STANDING out prominently among recent developments toward better reproduction, the AmerTran DeLux sets an entirely new standard of audio amplification.

Here is an audio transformer which reproduces the deep boom of the bass drum, the roll of the pipe organ and the lowest tones of the bass viol with startling realism, at no sacrifice of the highest sounds within the audible range. Used in connection with the new cone speakers and new tubes these transformers amplify uniformly over the entire audible range. The approach to absolute perfection is so close that the human ear is unable to note further improvement.

The AmerTran DeLux is made in two types—first and second stages and should be used by the pair!

The AmerTran Power Transformer and the AmerChoke are the result of over twenty-five years' experience in transformer building. They are among the finest units available for the construction of a power supply of the better type. The Power Transformer has filament supply windings for the rectifying tube and furnishes sufficient plate current, after rectification, for the operation of the set.

- AmerTran DeLux, 1st Stage . . . \$10.00
- AmerTran DeLux, 2nd Stage . . . 10.00
- AmerTran AF-7 (3:1) . . . 5.00
- AmerTran AF-6 (5:1) . . . 5.00
- AmerTran Power Trans. PF-52 . . . 18.00
- AmerChoke Type 854 . . . 6.00
- AmerTran Resistor Type 400 . . . 7.50
- AmerTran Heater Transformer Type H-28 (for A. C. Tubes) . . . 10.00

Write to-day for interesting free booklet "Improving the Audio Amplifier" and other data on the subject of better radio.

AMERICAN TRANSFORMER CO.
178 Emmet Street Newark, N. J.
AmerTran Products Are Sold Only at Authorized AmerTran Dealers

Transformer Builders for Over Twenty-Five Years

No. 38

RADIO BROADCAST Laboratory Information Sheet

October, 1926

Neutralization

WHAT IT ACCOMPLISHES

THE best way to prevent oscillation in an r. f. amplifier is by the "bridge," or "capacity neutralization" method. When this system is used, the variations of plate potential which are caused by the grid variations (which, in turn, may be caused by the incoming signal impulses) do not react upon the grid circuit and cause feedback. The method will be better understood if prefaced by a brief statement of what happens when the bridge is not used. The alternating current in the plate circuit flowing through the impedance, or "load," (such as a transformer primary) in the same circuit, produces an alternating potential-difference between plate and filament. This potential difference cannot exist without causing currents to flow from plate to filament by every possible path. One such path is from the plate to the grid through the grid-plate capacity of the tube, thence from the grid to the filament through the grid circuit. Now, this current flowing through the impedance of the grid circuit produces an alternating potential difference between grid and filament. As the impedances of both the plate circuit and the grid circuit probably contain

inductance, regeneration will result, and if enough inductive reactance is introduced into the plate circuit (for example, by tuning a secondary circuit coupled in any way to the plate circuit), oscillation will take place.

Considering what causes the regeneration or oscillation, it is easy to see that it can be eliminated by connecting a small condenser in such a fashion that the current flowing through it affects the grid to an extent just equal but exactly opposite in nature to the effect of the current flowing through the grid-plate capacity. This may be accomplished in a number of ways, a few of which are shown in the diagram.

In every case, the current flowing through the neutralizing condenser to the filament does away with the effect of current flowing through the grid-plate capacity provided the neutralizing condenser is adjusted to the proper capacity. For the sake of variety, the tuning condenser has been shown in several positions. It can be put across either part of any of the split coils, or across the whole coil, or across a separate coil coupled to the split coil.

The positions shown are the more commonly used ones.

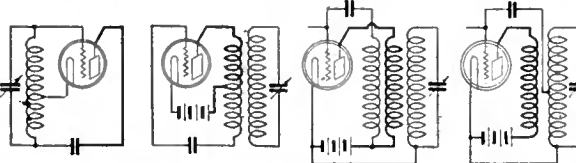

No. 39

RADIO BROADCAST Laboratory Information Sheet

October, 1926

Field Intensity Measurements

HOW THEY ARE MADE

IN A recent report by the Bureau of Standards, the following method of measuring the field intensities of broadcasting stations is suggested.

The method can be used for distances up to about fifty miles, and will give correct results at broadcast frequencies. For greater distances than fifty miles it gives approximately the maximum value of field intensity (not the average value) reached by waves subject to fading. The method makes use of what is termed the radiation constant. This constant is determined by making field intensity measurements at not less than five points distributed fairly evenly around the transmitting station at a distance of about ten miles. The radiation constant is then expressed as the average field intensity at ten miles in millivolts per meter.

The radiation constants of several stations are given below:

STATION	RATED POWER, kw.	RADIATION CONSTANT
KDKA	10	43
KFKX	2	28
WEAF	3	32
WHAS	0.5	5
WCAP	0.5	17
WLW	5	31

With the field intensity at ten miles known, the

resultant field intensity at any other distances is given by the formula:

$$F = \frac{10}{d} F_{10} \quad (1)$$

where F_{10} is the radiation constant and F the field intensity at any other distance. This value of F neglects any ground absorption and gives correct results up to about fifty miles, as mentioned above.

To make a measurement a receiver is set up and a milliammeter placed in the output of the detector circuit. The deflection of the needle is observed when signals from the base station—the radiation constants of which are known, are being received, and then the receiver is re-tuned to the station on which it is desired to make the test, and the deflection noted again. The field strength can be determined by substituting in the formula given below:

$$F = \frac{R}{R_B} \times \frac{I}{I_B} F_B \quad (2)$$

where R is the resistance of the receiving antenna, at a frequency corresponding to the transmitted signals of the station under test; R_B is the resistance of the receiving antenna at a frequency corresponding to the signal from the base station; I , the deflection on the signal from the test station; I_B , the deflection on the signal from the base station and F_B , the field intensity of the base station determined by formula No. 1. The derivation of formula No. 2 will be found on Laboratory Information Sheet No. 43.

No. 40

RADIO BROADCAST Laboratory Information Sheet

October, 1926

Analysis of Detection

THE REASON FOR THE GRID LEAK

A METHOD of detection commonly used makes use of a grid leak and condenser. The operation of the circuit may be roughly outlined as follows:

In the absence of incoming waves, the potential of the grid is the same as that of the filament. Incoming waves cause the grid to become alternately more positive and more negative than the filament. While the grid is more negative, nothing happens, but while it is more positive it attracts negative electrons. These electrons cannot get off the grid once they are on it (the grid is not hot like the filament) except via the high resistance which is called the grid leak. If, for the moment, we suppose there is no grid leak provided, we can see that after a very few waves have come in, the electrons drawn to the grid will charge it to a steady negative potential equal to the maximum instantaneous potential of the top of the coil in the antenna circuit. This steady negative potential causes a reduction in the plate current. Even if the waves cease coming in, or their amplitude is diminished, the grid retains its negative charge since there is no way for the electrons to get off it. So we put in a very high-resistance path by which they may slowly (compared to the wave frequency) escape so that, if the amplitude of the incoming waves slowly (i.e., at voice frequency) diminishes, electrons will leak off until the grid potential drops to the new maximum value of potential at the upper end of the coil. In this system, the greater the strength of incoming waves the less the plate current.

The connections shown in the diagram are often recommended.

The size of the grid leak is more or less important. If its resistance is too great it is possible that the grid of the tube will block on strong signals, whereas if the grid leak resistance is too low, the signal

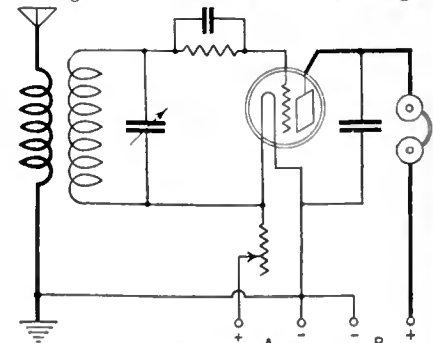

strength will be decreased. For the ordinary 201-A type tube, a grid leak of about four megohms resistance will give the best results. If a soft detector tube is used, a somewhat lower resistance leak is generally required; about one half to two megohms being about right.

YAXLEY
APPROVED RADIO PRODUCTS

**Gold Plated Parts
for the
King Equamatic System**

Your dealer will gladly secure Yaxley Approved Radio Products in the Gold Plated Finish for your hook-up.

The parts are actually gold plated, not merely washed, and will retain their rich, handsome appearance.

Prices are for Gold

- 10 and 20 Ohm Rheostats \$1.50
- No. 1 Open Circuit Jack .75
- No. 4 Interstage Jack . . . 1.05
- No. 10 Midget Battery Switch .75

All other parts also furnished in Gold

Cable Connector Plug

The No. 660 Cable Connector Plug for quickly and conveniently connecting and disconnecting battery wires will give you a new kind of satisfaction from cable plugs. Bakelite construction. Try it \$3.50

At your dealer's. If he cannot supply you, send his name with your order to

Yaxley Manufacturing Co.

★ Dept. B, 9 So. Clinton St.
Chicago Illinois

Bradley-Amplifier
Resistance-Coupled
PERFECT AUDIO AMPLIFIER

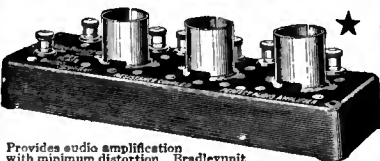

Provides audio amplification with minimum distortion. Resistor-coupled unit molded resistors used in the Bradley-Amplifier do not vary with age and are not affected by atmospheric conditions. Can be used to replace transformer amplifiers in standard radio sets with decided increase in tone quality.

Allen-Bradley Co.

Electric Controlling Apparatus
278 Greenfield Avenue Milwaukee, Wis.

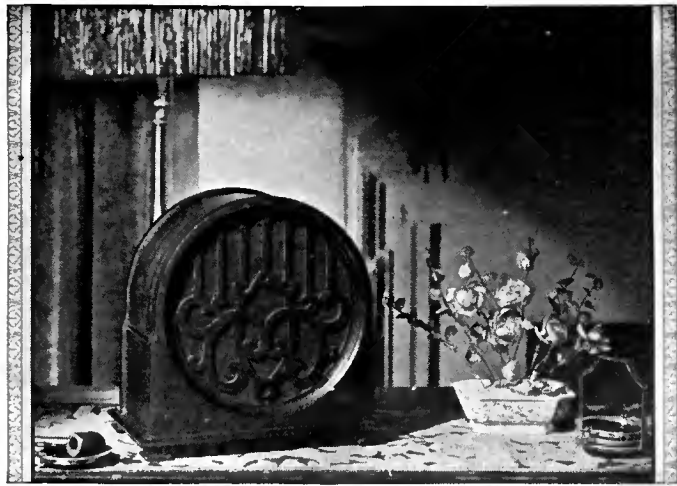

Artistically, this new Amplion Cabinet Cone graces the most exquisitely appointed drawing room—acoustically, it sets a new standard in radio reception.

AC12 . . . \$30

*HERALDING ~
a New Radio Voice*



AMPLION PATRICIAN

A new model of the air column type—as pleasing to the eye as to the musical ear. Non-directional general diffusion of sound. 48-inch air column in an 18"x12"x9" cabinet.

AA18 . . . \$45.00



AMPLION DRAGON

The world's "best seller"—adopted as the standard among leading radio engineers for experimental and comparative tests. Famous for its sensitivity to speech and musical signals, and for volume without distortion.

AR19 . . . \$42.50

When genius sings or speaks or plays—a breathless silence follows.

When the new Amplion Cone reproduces vocal or instrumental tones—an awed hush ensues.

For this new type of cone, designed by the engineering genius of the world's largest makers of sound reproducing devices, sets an entirely new standard in radio reception.

A precision of sound-values—a mellow clarity—an utter absence of distortion or "chattering"—characterize the new Amplion.

Built on an entirely new principle of balanced construction and exceptionally responsive to the weakest signals, the new Amplion reproduces the entire vocal and musical range with an astonishing purity, combined with the utmost volume.

Sensitive as a deer to the faintest sounds, this Amplion sets a new standard of reception for every set. It is the last link in the chain of quality broadcasting.

As you listen in—to classical music or jazz—to symphony concert or brass band—to speakers or singers—it becomes increasingly difficult to tell the difference between the actual performance and the new radio voice!

Write for the interesting Amplion Booklet

AMPLION ★

THE AMPLION CORPORATION OF AMERICA

Suite L, 280 Madison Avenue, New York City

THE AMPLION CORPORATION OF CANADA, Ltd., Toronto

"The House of Graham" is known throughout the world, through its associated companies

From 1887 A Path of Brilliant Achievement to 1927

Imitation Is
The Sincerest
Form of Flattery

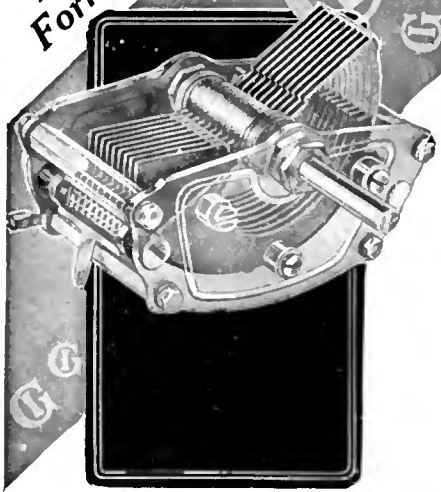

METRALIGN SLT STRAIGHT LINE TUNING

CONDENSERS opened a new principle of station separation on all wave lengths by engineering design, and as usual created a trend that is being rapidly followed, but *only in appearance.*

The METRALIGN SLT condenser was first publically announced in May.

The definite principles on which METRALIGN SLT is based still remain the *exclusive* design that assures

STATION SEPARATION ON ALL WAVE LENGTHS

Those condensers claimed as being "just as good" are *not* good enough. Ask your dealer for the original and genuine.

FREE

We have prepared a most comprehensive booklet on tuning. It is written in simple language and tells all you want to know about condensers. Write for a copy to-day.

GENERAL INSTRUMENT
CORP.

477 Broadway, New York

Makes Any Set a New
Set — in 15 Minutes.

Who Is To Control Broadcasting?

The Present Status of Radio Legislation—Why Secretary Herbert Hoover Renounced Absolute Control of Broadcasting

By THOMAS STEVENSON

HAVING guided broadcasting through its early stages of development until the adjournment of the First Session of the Sixty-Ninth Congress, almost overnight Secretary of Commerce Herbert Hoover renounced the so-called rôle of "traffic cop of the ether."

On the surface, two events alone were apparently responsible for the announcement by Mr. Hoover that the Department of Commerce would make no further attempt to assign wavelengths and regulate times of operation and power of stations.

These were the decisions of the Federal Court for the Northern District of Illinois, and of the Department of Justice, that any station is at liberty to use any wavelength at will, so long as trespass is not made upon the band from 500 to 187 kc. (600 to 1600 meters).

There was another factor—one that cannot be found in the record, and which is received with a fine display of scorn by Mr. Hoover and his staff assistants. It is the keen disappointment of Herbert Hoover over the failure of Congress to extend to him a vote of confidence in appreciation of his efforts in bringing broadcasting through the swaddling clothes and teething periods.

Equally disappointing to Mr. Hoover was the failure of the broadcasters to rally to the defense of the principles to which they unanimously committed themselves at the Fourth National Radio Conference.

For more than four years Mr. Hoover has been the "guiding genius" who has enabled the United States to make greater progress in the development and commercial and social use of broadcasting than any other country of the world. Through a system of self-regulation, worked out by annual national radio conferences, broadcasting in the United States has been unhampered by the laws and regulations which so often in the past have prevented the natural growth of many industries.

An extract from his address in opening the Fourth National Radio Conference clearly shows his pride in the success of the self-regulating experiment. Mr. Hoover said:

We have great reason to be proud of the results of these conferences. From them have been established principles upon which our country has led the world in the development of this service. We have accomplished this by a large measure of self-government in an art and industry of unheard-of complexity, not only in its technical phases but in its relation both to the government and the public.

Four years ago we were dealing with a scienti-

fic toy; today we are dealing with a vital force in American life. We are, I believe, bringing this lusty child out of its swaddling clothes without any infant diseases, and that is more than can be said of any other invention or industry that has developed in this country.

We have not only developed in these conferences traffic systems by which a vastly increasing number of messages are kept upon the air without destroying each other, but we have done much to establish the ethics of public service and the response of public confidence.

Increasing problems, due to rapid development, however, made imperative new legislation to take the place of the 1912 Radio Act, which was enacted before broadcasting was dreamed of. Mr. Hoover had purposely requested Congress to defer radio legislation until development progressed sufficiently to indicate the kind of law that might prove most beneficial to the industry and the public.

At the beginning of the last session, Mr. Hoover went to Congress with the views of himself, the industry, and the public, as to the sort of legislation that was needed. Mr. Hoover recommended the enactment of a law that would

provide authority for the limitation of stations, and regulation of power and time division along lines compatible with the "public interest, necessity, and convenience."

Mr. Hoover suggested that the details of enforcing the radio law be entrusted to the Department of Commerce, but that there be appointed a Commission of five members with authority to pass finally upon any matter referred

to it by the Department of Commerce, or any one else affected. The Commission would not be in continuous session but would meet only upon call of the chairman or when matters were referred to it for decision.

Outlining the necessity for such a commission, Mr. Hoover said:

We have, in the regulation of broadcasting a question of discretionary authority that may affect the right, the good will, the property, and freedom of individuals, that should never be vested in one single official of the Government; that is a point in government where a number of deliberative minds should be called into action.

In the whole of our government plan—the plan of the original Federal Government under the Constitution—we were most jealous to divide the authority of the government in such fashion that the judicial and legislative questions should rest in the hands of many men and not in the hands of administrative and executive officers.



SECRETARY OF COMMERCE, HERBERT HOOVER

There is One Best Way

Jones MULTI-PLUG, the Standard Set Connector, is illustrated below in its various models. To-day the discriminating buyer chooses a set MULTI-PLUG equipped or immediately equips his own set with the MULTI-PLUG because it affords greater simplicity, safety and more convenience than any other method used to connect the radio receiver with the current supply.



Type P. M. is mounted right in the panel. Plug leads go to batteries, ground and aerial.

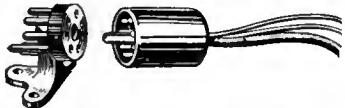

Type B. M. is mounted on the base and wires are soldered to back of socket posts; no binding posts are necessary.

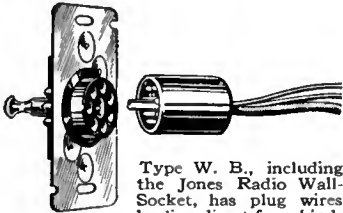

Type W. B., including the Jones Radio Wall-Socket, has plug wires leading direct from binding posts; plug goes into wall socket. Wall socket is connected with hidden batteries, ground and aerial. Adapted to any set.



Type B. P. is adapted to any set. The wires from the socket lead to the binding post, while the wires from the plug lead to the batteries, ground and aerial.



Double Plug Cable is used when both set and current supply are equipped with Jones Sockets.

★ Use the MULTI-PLUG in your Karas Equamatic hookup

HOWARD B. JONES
618 S. Canal St. Chicago, Ill.

Read Radio Broadcast

every month. You can't afford to miss an issue. Order your copy from your Newsdealer or Radio Store. If you wish to subscribe direct send \$4.00 for one year or \$6.00 for two years.

DOUBLEDAY, PAGE & COMPANY
Garden City, N. Y.

RADIO DEALERS

WRITE today for your free copy of Albin's LATEST Radio Money-Saver Catalog. More complete than ever. Every page crammed with latest in sets, speakers, kits, parts and accessories. Fast-moving items—unbeatable values—complete stocks—unqualified guarantee—SAME-DAY SERVICE. Buy from Albin and make this the BIGGEST YEAR you ever had.

THE ALBIN RADIO CO. INC.
223 FOURTH AVE., NEW YORK

Radio's Latest Necessity—

BRACH

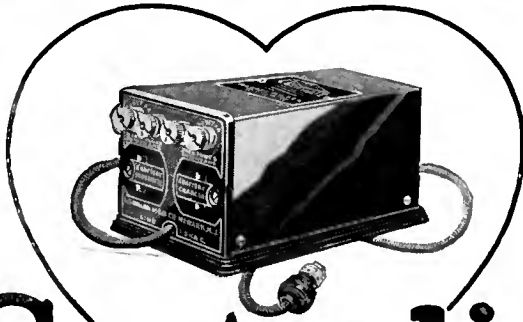

Controlit

THE HEART OF THE POWER PLANT

Your set switch or rheostat ALONE can now control "B" Battery Substitute and "A" Trickle Charger automatically.

Merely adding a BRACH CONTROLIT makes any set a light power-operated set, eliminating all switches from "B" Battery Substitute and Trickle Charger. No added wiring. No alterations to set required.

Anyone can install CONTROLIT, and the power plant can be placed anywhere—in cellar, or closet, or shelf. No radio user will be without it. Ask Your Dealer.

Price Only \$6 in U.S.A.

Storm Guard LIGHTNING Arrester

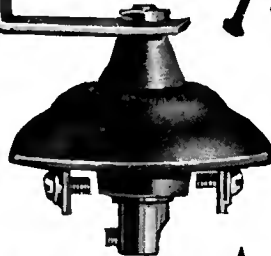

THIS Arrester for outdoor Aerials is constructed of Bakelite and will withstand years of exposure. It operates on the non-air-gap principle. It automatically diverts lightning currents into the earth, thus protecting radio equipment.

Price \$1.50

Brach Radio Products

L. S. BRACH MFG. CO., Newark, N. J.
Makers of Famous Brach Lightning Arresters

**GREATER DISTANCE
FINER SELECTIVITY
GREATER POWER**

with

AERO COIL
SUPER-SENSITIVE

INDUCTANCE UNITS



Tuned Radio Frequency Kit

\$12.00

Replace your present inductances with this Aero Coil Tuned Radio Frequency Kit. It will positively improve the performance of your receiver. Special patented Aero Coil construction eliminates radio frequency losses. You will notice instantly, a tremendous improvement in volume, tone and selectivity.

This Kit consists of three matched units. The antenna coupler has a variable primary. Uses .00035 condenser. Coils are uniformly air spaced. No dope is used. Consequently they tune into resonance on a "knife's edge."

FREE with Each Kit

Eight page color circuit, layout and instruction sheet for building the super-sensitive 5 tube Aerodyne Receiver packed with each kit. Get yours TO-DAY from your nearest dealer

AERO PRODUCTS, Inc. ★

Dept. 109

1772 Wilson Ave.

Chicago, Ill.

Bradlexstat
PERFECT FILAMENT CONTROL



Provides complete noiseless filament control for all radio tubes without change of connections. Metal parts are nickel plated. One hole mounting. Self contained switch opens battery circuit when desired.

Allen-Bradley Co.

Electric Controlling Apparatus

★ 278 Greenfield Avenue Milwaukee, Wis.

THE WHITE AND DILL BILLS

IN BOTH the Senate and House, bills were introduced incorporating the recommendations of Mr. Hoover—by Senator C. C. Dill, Democrat, of Washington, and Representative Wallace White Jr., Republican, of Maine.

During public hearings by the House Merchant Marine and Fisheries Committee, to which the White bill was referred, opposition developed among a number of Democratic members to some of Mr. Hoover's suggestions. Headed by Judge Ewin L. Davis, Democrat, of Tennessee, the Democrats urged establishment of a new commission to have entire jurisdiction over the regulation of radio, and the imposition of drastic anti-monopoly safeguards.

During discussions of the subject, no criticism was voiced toward the administration of Mr. Hoover, but the view was expressed that the White bill was a "half baked" proposition, and, if enacted, would have to be revamped within a few years.

With no thought of attempting to belittle the efforts of his colleagues, a prominent leader of the Democratic party gave this explanation of the minority point of view:

"Oh, they just want to be different from the Republicans!"

Despite Democratic protests, the White bill passed the House in the form recommended by Secretary Hoover without a record vote.

At about the time the Senate Interstate Commerce Committee took up the Dill bill, the Department of Commerce began proceedings against the Zenith Radio Corporation for alleged "piracy" of a wavelength. Decision of this case in favor of the Chicago broadcaster emphasized the necessity for legislation, and the subject received more time and attention in the Senate than might otherwise have been accorded it.

The chairman of the Senate Interstate Commerce Committee is James E. Watson, Republican, of Indiana. Mr. Watson is considered a politician of the highest rank and he has been told that he would make a "distinguished looking president."

Although Senator Watson admits he does not know anything about the technical side of radio, he shrewdly suspects it holds tremendous political possibilities. Even the suggestion of chaining such a force to the bidding of a political competitor would cause a look of horror to overspread his usually placid face.

Despite objections by the President, Senator Watson felt it incumbent upon himself to support the complete divorce of radio from the Department of Commerce and Secretary Hoover. His argument was that: "Secretary Hoover already has enough to do to keep him busy without tackling radio." It might be noted that the Department of Commerce has "tackled radio" ever since the first days of an American radio law, and that in his Department, has grown and developed, the complete machinery and trained personnel to enforce a complicated statute.

Keen to take advantage of the opening offered by the refusal of Senator Watson to follow the wishes of the President, the Democrats and insurgent Republicans gladly rallied around the banner of the Indiana Senator. If the regular Republicans in the Senate had gone to the support of the President, the story might have been different. But not one of them spoke a word in defense of the Chief Executive and his Secretary of Commerce.

To complicate matters, the broadcasters adopted a "hands off" policy. They left it entirely to Congress to pass a law and to Secretary Hoover to see that the proper kind of law was passed. Furthermore, a number of the broadcasters were quoted as expressing the view that Secretary Hoover had overstepped his authority, and that he had shown discrimination

toward certain companies in the allocation of wavelengths.

Following the Watson lead, Senator Dill entirely rewrote his bill and the new product provided for the establishment of an independent commission for the regulation of radio. After a few executive sessions, this bill was unanimously reported to the Senate for passage.

Although the Dill bill was reported to the Senate early in May, it was not taken up until the last week before adjournment. The thought was that the measure could be passed in short order and the differences between it and the White bill adjusted in conference in time for enactment. This scheme might have worked out but for the objections of Senator Cole Blease, Democrat, of South Carolina.

Asserting that he would "Want to know the religion of the Commissioners" and whether "they would favor the teaching of evolution by radio" before he would consent, Senator Blease forced a delay of one day, thereby preventing the bill from reaching conference until late the day before adjournment.

The Dill bill passed the Senate without a record vote, although a number of the members of that body expressed disapproval of some of its provisions and the hope that they would be eliminated or changed in conference.

With only a few hours to work, the Conference agreed to disagree, and an effort was made to pass an emergency resolution which would limit broadcast licenses to ninety days until the enactment of a new law. During the last minute jam even this failed of enactment because the Vice President did not have time to sign it.

SECRETARY HOOVER DISPLEASED

DURING consideration of radio legislation in Congress, Secretary Hoover was not particularly pleased at the implied reflection on himself by the move to take radio away from the Department of Commerce. He felt that he had done his job well and that his department was entitled to more consideration.

Although no one in the Department of Commerce will admit it, there is good reason to believe that even Mr. Hoover and his legal staff have been in some doubt as to their authority to enforce some of the recommendations of the national radio conferences which were put into effect for the benefit of the industry and the public.

There is no doubt in the minds of a number of people in a position to know, that the Department of Commerce might have been able to "carry on" during the summer despite the decision of the Chicago Court.

But, smarting from the criticisms of Congress and a number of the broadcasters, Mr. Hoover did not feel justified in attempting to shoulder the burden any longer. Therefore, he asked the Department of Justice for a ruling on the matter, realizing as he must have, what the decision would be. Upon receiving the Department of Justice ruling which upheld the Chicago Court decision, Mr. Hoover announced that the Department of Commerce would make no further attempt to regulate the wavelengths, time of operation, and power of stations. Referring to the Department of Justice ruling, Mr. Hoover said: "The general effect of this opinion is that regulation has broken down and stations are under no effective restriction as to wavelength or power used. The 1912 Act, under the various constructions, has failed to confer authority for the prevention of interference, which was its obvious intent."

The country now has to await such action as Congress may see fit to take when they reconvene this fall. Meanwhile the broadcasting situation is being "investigated" by many organizations, including the American Engineering Council and the National Better Business Bureau.

Constant and Standard Frequency Radio Stations

THE radio broadcasting situation is being stabilized in part by the frequency measurements of the Bureau of Standards, Department of Commerce. The friendly rivalry of broadcasting stations, which maintain their frequencies with high accuracy, for places on the Bureau's honor roll, is augmented by an announcement just made of a new list of stations. This new list includes stations which use special means of maintaining constant frequencies and which have given evidence of holding their frequencies accurately on the assigned values by the use of special devices for that purpose. The transmitted waves from these constant frequency stations are therefore of value to the public as frequency standards. The special devices for frequency regulation employed by the constant frequency stations include piezo oscillators, piezo resonators, and frequency indicators. The list below of constant frequency stations now supplements another list which the Bureau of Standards has been publishing monthly since November, 1923.

The list of standard frequency stations includes transmitting stations which have actually been found by measurements made in the Bureau's laboratory to maintain their frequencies very constant and close to the assigned values. The number of these stations is necessarily limited because of the practical difficulties involved in measurements of this kind which can be made at one place.

The use of the piezo oscillator and the frequency indicator, specifications for construction of these devices, and information on methods of utilizing the waves from any of these stations as frequency standards, are all covered in pamphlets obtainable on application from the Bureau of Standards

CONSTANT FREQUENCY STATIONS

STATION	LOCATION	ASSIGNED FREQUENCY (KILO-CYCLES)
WOC	Davenport, Iowa	620
WTIC	Hartford, Connecticut	630
WMAQ	Chicago, Illinois	670
WCCO	Minneapolis-St. Paul, Minnesota	720
WWJ	Detroit, Michigan	850
WLS	Crete, Illinois	870
KTAB	Lincoln, Nebraska	880
WJJD	Mooseheart, Illinois	990
WEAO	Columbus, Ohio	1020
KFKA	Greeley, Colorado	1100
KFH	Wichita, Kansas	1120
WENR	Chicago, Illinois	1130
WCAO	Canton, New York	1140
WAAM	Newark, New Jersey	1140
WSKC	Bay City, Michigan	1150
WOWO	Ft. Wayne, Indiana	1320
WBBM	Chicago, Illinois	1330
WEBQ	Harrisburg, Illinois	1330
KFVS	Cape Girardeau, Missouri	1340
WOK	Homewood, Illinois	1380
WPDQ	Buffalo, New York	1460

STANDARD FREQUENCY STATIONS

NSS	Annapolis, Maryland	17.50
WCI	Barneget, New Jersey	17.95
WGG	Tuckerton, No. 1, New Jersey	18.86
WII	New Brunswick, New Jersey	21.80
WRT	New Brunswick, New Jersey	22.60
WVA	Annapolis, Maryland	100.00
NAA	Arlington, Virginia	112.00
WEAF	New York, New York	610.00
WCAP	Washington, District of Columbia	640.00
WRC	Washington, District of Columbia	640.00
WJZ	Bound Brook, New Jersey	660.00
NAA	Arlington, Virginia	690.00
WGY	Schenectady, New York	790.00
WBZ	Springfield, Massachusetts	900.00
KDKA	E. Pittsburgh, Pennsylvania	970.00
KDKA	E. Pittsburgh, Pennsylvania	471.00

Further details concerning the stations are given in the July issue of the Radio Service Bulletin, a monthly publication of the Department of Commerce, obtainable from the Superintendent of Documents, Government Printing Office, Washington, District of Columbia, for 25 cents per year



A New and Advanced Model—

Norden-Hauck Super-10

Highest Class Receiver in the World



Panel Size: 36"x9"x1-4"

Weight: 55 lbs.

THE NORDEN-HAUCK SUPER-10 is an entirely new and advanced design of Receiver, representing what we believe to be the finest expression of Modern Radio Research Engineering. It is the product of years of experience devoted exclusively to the attainment of an ideal Broadcast Receiver—regardless of cost.

Results obtained in every respect will upset all your previous ideas of good radio reception.

Here are only a few of the host of features that place the NORDEN-HAUCK SUPER-10 far in advance of competition:

- 10 tubes employed to give perfect reproduction with unlimited range and volume power.
- Super selectivity on all wave lengths.
- Built to Navy Standards.
- Wide wave length range without change of coils, etc. (Adaptable 35 meters to 3600 meters if desired.)
- Use Loop or Antenna.
- Simple to operate, having only two major tuning controls.
- No Harmonics. Signals are received only at one point.
- Special Power Audio Amplifier, operating any loudspeaker and eliminates necessity of external amplifier.
- Can be operated directly from house current if used with NORDEN-HAUCK POWER UNIT AB-2.

The NORDEN-HAUCK SUPER-10 is available completely constructed and laboratory tested, or we shall be glad to supply the complete engineering data, construction blue prints, etc., for those desiring to build their own receiver.

TEAR OFF AND MAIL TODAY

Upon Request A complete catalog, attractively illustrated, will be gladly mailed without charge, or full size constructional blue prints, showing all electrical and mechanical data, will be promptly mailed postpaid upon receipt of \$2.00

Write, Telegraph or Cable Direct to

NORDEN-HAUCK
Incorporated
ENGINEERS
MARINE BUILDING
Philadelphia, U. S. A.

NORDEN-HAUCK, Inc.
Philadelphia, U. S. A.

Gentlemen:—

Please send me without cost or obligation on my part, attractive illustrated literature describing the new Norden-Hauck Super-10.

I enclose \$2.00 for which please send me, postpaid, complete full size constructional drawings and all data for building the Super-10.

Name _____
Address _____

How to Improve Your Neutrodyne

Some Easily Made Changes Which Will Put Last Year's Neutrodyne on a Par With Later Models

By THORP HISCOCK



Cushioned
to stop vibration—
that's why the Cushion
Base Tube makes such
a wonderful improve-
ment in reception—

Equip your set with Cushion Base Tubes and note the surprising softness and fullness of tone of reception that follows the elimination of vibration. Order your set from your dealer to-day.

No Change in Wiring
—with the Adapted
Mogul 5 VCX Power
Tube

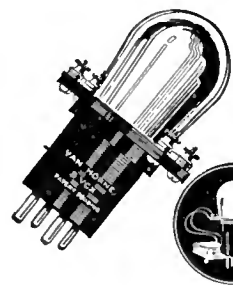

**For the
Last
Audio
Stage**

If you are not satisfied with the reception that you are getting—if you would appreciate a general increase in volume and an improvement in tone quality—put one of these tubes in your last audio socket. No other addition to your set will make such a noticeable improvement.

Van Horne Tubes are made in a number of types for all receiving purposes, every tube being unconditionally guaranteed.

Ask your dealer about Van Horne Tubes or write for descriptive matter.

NOTICE

A new Van Horne product, the 5 VD Squirrel Cage Detector Tube, will shortly be announced.

THE VAN HORNE CO., Inc.
1004 Center St. Franklin, Ohio

UNDoubtedly the first step to be taken in revamping the neutrodyne of last year lies in the audio amplifier stage of the receiver. Modern requirements call for improved output quality, and this is now made possible with the new transformers and tubes available. The often neglected question of grid bias is also nowadays receiving its full quota of attention—better late than never.

To increase the sensitivity of the set, and also, to a certain degree, the selectivity, the addition of properly controlled regeneration is sufficient. Regeneration is equal in amplification to about two stages of tuned non-regenerative radio frequency amplification.

The particular method used here to affect regeneration and properly control it, is open to much discussion. However, most of the ways generally known necessitate a fourth main con-

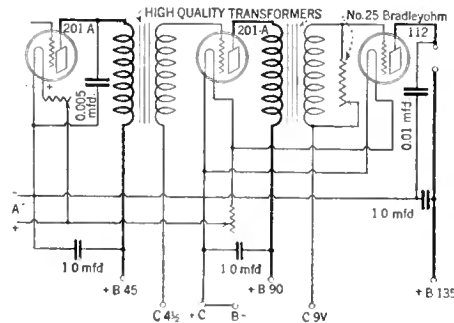

FIG. 1

Here are shown all the changes that are necessary to modernize the audio-frequency amplifier unit of the neutrodyne receiver as described in the text

trol which is quite critical in adjustment and, to be of any real advantage, demands a resetting each time the set is re-tuned. The method to be followed in this article, however, is not at all critical, and is very smooth and positive in action, and needs only slight adjustment to keep the set working at maximum sensitivity.

Should the addition of regeneration not increase the selectivity sufficiently, it is only necessary to loosen the antenna coupling, and subsequently the interstage couplings, until a degree of selectivity sufficient to work through the local stations is obtained.

In this discussion of the neutrodyne, it must be taken for granted that the set is already properly stabilized, and that it has no tendency to oscillate at the low end of the scale when the tubes are burned at their rated voltage. The set owner who knows anything about radio at all, and is handy with a soldering iron and pliers, can make his own changes with little or no trouble. The changes are outlined in steps, and it is advisable to operate the set after each step is completed to mark the increase, and to be sure that no wrong connections are made.

PUTTING IN NEW TRANSFORMERS

IN THE matter of audio frequency transformers, it is suggested that those of General Radio, Amerfran, Rauland Lyric, Thordarson, or Jefferson be used. There are other new makes of audio transformers on the market,

all just as satisfactory for use in the neutrodyne receiver.

Resistance-coupled audio frequency amplification could be used but it would entail the inclusion of another tube.

The first step is to replace the first-stage audio frequency transformer with a General Radio type No. 285, or similar instrument. The terminals are plainly marked and the substitution is easily made. If the small mica fixed condenser probably already across the primary of the transformer is not one of 0.005 mfd. or 0.006 mfd. replace it with one of approximately 0.005-mfd. capacity. This condenser may be connected from the plate terminal of the detector tube to the negative filament terminal of the same tube. It will later be changed but, for temporary operation while checking, it should be installed as though it were to be permanent. A bypass condenser of 1.0-mfd., or more, should be installed between the plus B terminal of the transformer and the nearest negative A battery lead to bypass the alternating current around the detector B battery, and to keep it out of the long battery leads.

If a C battery is not already in the circuit, one should be inserted. The Burgess 7½-volt type is advisable since a high plate voltage can then be used to advantage in the last stage if desired. This battery may be located anywhere there is room for it in the set since the length of the leads in this case is of little consequence. The positive terminal of this battery is connected to the negative A battery lead. The lead which originally connected to the minus F terminal of the transformer is broken, and in its stead a flexible lead is run from this minus F terminal to the proper negative tap on the grid battery, this grid-battery tap value depending upon the plate voltage used, as specified in the instruction sheet compiled by the tube manufacturer. For a 201-A type this will be 4½ volts where 90 volts is used on the plate of the first audio frequency amplifying tube. Should the same type of tube and the same voltage be used in the second stage,

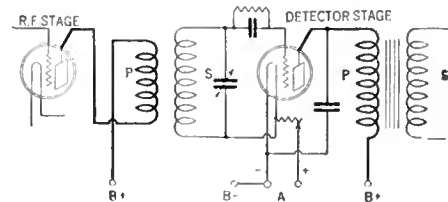

FIG. 2

The detector circuit in its original form looks like the circuit diagram shown here. To include the regeneration feature, it is necessary to revise the circuit as shown in Fig. 3

a flexible lead should also be run from the minus F post of the second audio transformer to the 4½-volt tap on this C battery, after disconnecting the old lead from this transformer.

The C battery may be fastened in position by a strap of bus bar wire cut to proper length, bending an eye in each end to receive a screw. The wire must be so shaped as to pass over the battery and screw down to the base-board on either side.

In some cases, the quality of the output is

greatly improved by connecting a resistance across the secondary terminals of the second audio-frequency transformer. This resistance may be a Bradleyohm No. 25, and should be mounted where convenient on the panel, preferably at the right hand end so that the leads will be as short as possible. The connections should be made as close to the transformer as

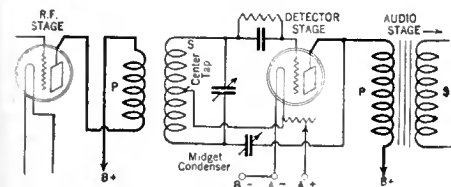

FIG. 3

For the addition of regeneration to the detector circuit, several changes are necessary, as shown. A center tap on the secondary coil must be made and a 13- or 15 plate midget condenser controls regeneration

practicable. The life of a C battery is considerable, but it should be inspected with a meter every six months or so, and if it shows any appreciable drop in voltage, should be replaced immediately. With a dead or low C battery, distortion will be very pronounced, and the B battery consumption will increase.

THE SECOND AUDIO STAGE

THE next step is to substitute a General Radio Company No. 285A or similar second-stage audio frequency transformer for the one now in the circuit. The proper biasing has already been outlined if 201-A tubes are used.

For use in the output stage, it is usually advisable to make provision for their use although the owner may not desire to use one immediately. It is only necessary to remove the lead running from the output jack to where it connects to the B battery plus post (probably 90 volts) and connect the jack to a separate binding post by an individual lead of its own, as outlined above. Thus, any voltage desired can be applied to the output tube without disturbing the voltage on any other portion of the set, extra B batteries, if necessary, being connected in series with those already in use. Provision for increasing the bias on this tube must also be made. To do this, disconnect the lead which was wired, according to previous instructions, from the minus F post on the second audio transformer to where it joins the 4½-volt negative C battery lead. Do not disturb the wiring to the No. 25 Bradleyohm or that to the first audio

transformer. Now install another binding post and run an individual lead from the minus F post of the second audio transformer to this post. Thus, a negative bias of any voltage can be applied to the last tube by connecting this post to the proper negative terminal on a second C battery of which the positive terminal is connected to the negative A post on the set. When only 90 volts is being used on a 201-A type tube in the final stage, this C post can be connected to the same minus 4½-volt terminal that supplies the first audio tube, and the new B post for the output stage can be supplied from the 90-volt post already on the set, by a jumper.

PROVIDING FOR THE NEW TUBES

In employing the type 112 tube, it is well to control its filament by a separate rheostat capable of carrying at least one half ampere. Or, if there is no panel space for a rheostat, a filament ballast unit may be mounted behind the panel to accomplish the desired result.

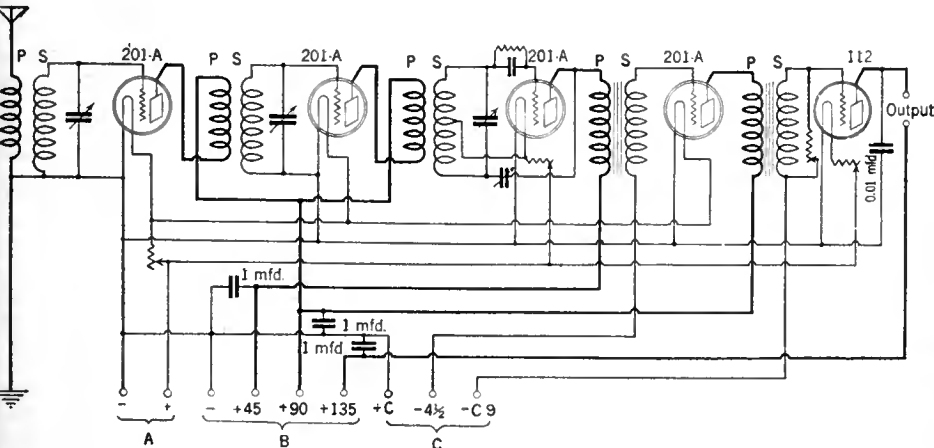

FIG. 4

This is the complete revised neutrodyne circuit with all the advocated changes clearly shown

With some horn type loud speakers a 0.01-mfd. condenser should be connected between the plate terminal of the last tube and the negative filament of the same tube. This results in it being shunted across the output whether that be a jack or a pair of binding posts or both. With some tubes it is found advantageous to include a 0.001-mfd. fixed condenser connected from grid of the second audio tube to the negative terminal of the same socket, but this can only be ascertained by test. The lead from the jack or output post to the positive B battery lead should be disconnected and transferred to a separate battery terminal. A 1.0-mfd. bypass condenser should be connected from this lead to the negative A battery lead to bypass the audio currents around the high resistance of the B battery and the long battery leads. If there is not already a 1.0-mfd. bypass condenser between this positive B-battery lead and the nega-

transformer. Now install another binding post and run an individual lead from the minus F post of the second audio transformer to this post. Thus, a negative bias of any voltage can be applied to the last tube by connecting this post to the proper negative terminal on a second C battery of which the positive terminal is connected to the negative A post on the set. When only 90 volts is being used on a 201-A type tube in the final stage, this C post can be connected to the same minus 4½-volt terminal that supplies the first audio tube, and the new B post for the output stage can be supplied from the 90-volt post already on the set, by a jumper.

In employing the type 112 tube, it is well to control its filament by a separate rheostat capable of carrying at least one half ampere. Or, if there is no panel space for a rheostat, a filament ballast unit may be mounted behind the panel to accomplish the desired result.

Now— One Dial Control Is Perfected

Perlesz
Trade Mark

1 · 2 · 3 · 4 · 5 Gang Condensers

The Perlesz gang-mounted condenser unit is a masterpiece of precision. Scientifically matched straight line frequency condensers operate together without variation. Accuracy guaranteed within one micromicrofarad over entire scale.

Each rotor, and stator is a solid one piece die-casting—the assembly lined up accurately on one shaft and mounted on a heavy, rigid, channel-shaped aluminum base.

Operation, by a self-adjusting worm and dial gear, gives a 340 degree movement to speedometer type dial.

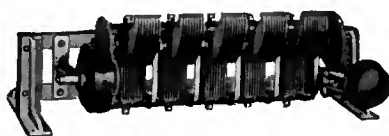

You never have seen the equal of the Perlesz in positive close tuning—nor have you seen any radio part so built for everlasting efficiency.

Adaptable without change for building into any radio frequency type of receiver.

Furnished complete with coils and shields if desired.

Delivery immediately. Order a sample unit and convince yourself that Perlesz solves one dial control.

★
**PERLESZ RADIO
MFG. CORP.**

560 W. Congress Street, Chicago

Manufacturers of
Perlesz 7-, 8- and 9-tube receivers—one
dial control—all metal construction

ADDING REGENERATION

Metallized!

A glass wire is spun and passed through a chemical, high-temperature process, forming a thin conducting layer of high resistance. Impervious to atmospheric conditions.

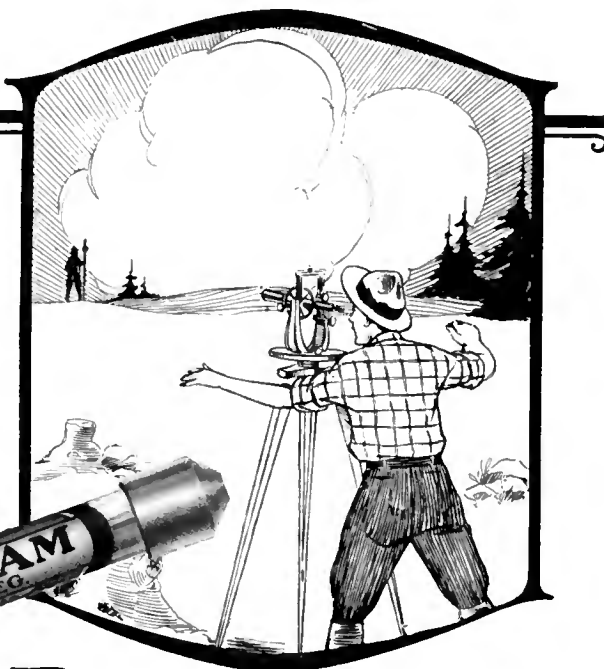

Precision!

DURHAM Metallized RESISTORS



Durham Resistor Mounting

Made of moulded insulation of exceptionally high resistance. Has best quality, tension-spring, bronze contacts. The only upright mounting made. Occupies but little space in set.

Single mounting.... 50c.
For condenser..... 65c.

THE bridge, the skyscraper, the great aqueduct, have been made possible only through the exactness of engineering plans and the precision of men and machinery in executing those plans.

Scientific precision of a high order enters into the manufacture of the Durham Metallized Resistor, developed by two leading university engineering professors. Noiseless, permanent, and guaranteed to maintain, under all conditions, the rated resistance for which the unit is designed.

500 ohms to 10,000 ohms.....	\$1.00
Above 10,000 ohms to .24 meg.....	.75
.25 meg. to 10 meg.....	.50

DURHAM METALLIZED RESISTORS

International Resistance Co.
Dept. D, Perry Building Philadelphia, Pa.



This is a good time to subscribe for

RADIO BROADCAST

Through your dealer or direct by the year, only \$4.00

DOUBLEDAY, PAGE & CO.

GARDEN CITY, NEW YORK

A name to
trust
★ in radio



Send for Booklet
THE BOSWORTH ELECTRIC MFG. CO.
3746 Main Ave. Cincinnati, Ohio
BOSWORTH

THE first step in adding regeneration is to disconnect the lead from the rotary plates of the third condenser to the A battery lead of the detector tube. The connection from the rotor plates of this condenser to the tuning coil adjacent to it must be left intact. Drill the panel for mounting a midget condenser. Be sure and get the thirteen or fifteen plate condenser, not the smaller ones. Connect the stator plates of this condenser to the rotor plates of the tuning condenser from which you have just removed the connection to the A-battery lead. Connect the rotor plates of the midget condenser to the plate of the detector tube with as short a lead as possible. Take out the 0.005 mfd. condenser that was connected to the primary of the first audio frequency transformer. Next ascertain the middle turn of the secondary of the tuning coil across which the third tuning condenser is shunted. Lift this turn up with a knife blade carefully so as not to injure the insulation on the adjacent turns. The wire will stretch so that it will raise out nicely. Take a sharp knife and scrape the insulation off just far enough to allow a connection to be made and soldered. To protect the winding from injury while soldering, slide a piece of paper under the lifted wire. The other end of this lead goes to the positive A-battery lead where you disconnected the lead from the rotor plates of the tuning condenser. The set is now ready to test again. If by any chance you have a short, the first place to look for it is in the midget condenser since a short here will place the B voltage directly on the filaments.

After the set is hooked up, adjust the midget so that the plates are out of mesh—its minimum capacity position. When mounting this condenser, it is convenient to arrange the knob so that the pointer is horizontal to the right when the plates are all in. This will give the minimum setting horizontal to the left, or "at nine o'clock." Tune-in a station and advance the midget. The detector should go into oscillation with a slight rushing noise and a "plop." After this, only a series of whistles can be received when trying to tune. By reducing the midget setting, the detector comes out of oscillation and reception is resumed. As the midget setting is increased, the volume will increase to a great degree. If the station tuned-in has a frequency of about 600 kc. (500 meters), the set should go into oscillation with the midget set at about "one or two o'clock." Varying the plate battery and filament voltage of the detector tube will correct this to the proper position. As the lower wavelength (higher frequency) stations are tuned-in, the midget will have to be backed off a little to stop the set from oscillating. The setting of the midget will have no appreciable effect on the setting of the third dial after it is once logged, though the readings will vary from those obtained before the circuit was changed. If the detector tube does not oscillate at any setting of the midget, increase the plate voltage and filament voltage to normal. The tube, if not faulty, must oscillate under these conditions.

Coming Articles

In an early issue of RADIO BROADCAST will appear the first of a series of articles on how to revamp some of the most popular and widely sold of the manufactured radio receivers. Photographs and diagrams show explicitly how the changes can be made. The first article describes the alterations which can be made on one of the most popular Atwater-Kent receivers.

BOOK REVIEW

A Useful Laboratory Handbook

RADIO FREQUENCY MEASUREMENTS.
By E. B. Moullin, M. A., A. M. I. E. E.,
Published by J. B. Lippincott Company,
Philadelphia. 278 pages and 134 illustrations. Price \$10.00

THERE are a few books on radio subjects which are essential to the equipment of any serious worker in the interesting phase of communication engineering. One of these books is Professor Morecroft's *Principles of Radio Communication*; another is Van der Bijl's well known book, *Vacuum Tubes*.

Lately a third book has appeared that cannot be too well recommended to those who can digest Morecroft and Van der Bijl. This is a book on radio frequency measurements and is by no less a person than F. B. Moullin, who probably deserves more credit than any other for the development of the vacuum tube voltmeter, an instrument that is gradually coming into the wide use it deserves.

This book, the full title of which is *The Theory and Practice of Radio Frequency Measurements* is published in England by Charles Griffin and Company, and in Philadelphia by the J. B. Lippincott Company. It bears the date of 1926, which means that it is right up to the minute. It has been written for the advanced worker as a laboratory guide or manual and for those students who are anxious to know more of what goes on in radio circuits.

Mr. Moullin assumes that his readers know something of electrical theory—particularly their alternating current theory; the first chapter heading indicates this, being entitled "The Valve Generator." Early in the chapter the vacuum tube voltmeter is brought into evidence, and throughout the volume of 278 pages the generator and the voltmeter go hand in hand in all sorts of valuable and interesting measurements. Along with the laboratory practice involved, goes considerable mathematics, but not too much to obscure the issue. Mr. Moullin and other sound British engineers and physicists have carried out the mathematical groundwork underlying the work to be done in the laboratory, and there is no need for them to repeat all of their involved mathematical circumlocutions. The writer of this book has not done that; he has used enough to show the points at issue.

The remainder of the book is devoted to the measurement at high frequencies of the various electrical elements around which all radio phenomena are built. High frequency resistance measurements are outlined in detail; the problems of measuring capacity and inductance each get a chapter, and two chapters are devoted to measurements on antenna characteristics and on the intensity of radiated waves. In the latter there is considerable interest at the present time, and little has heretofore been published of methods by which measurements of the important quantities, such as field strength, antenna resistance and effective height, can be made. Mr. Moullin again brings out his ubiquitous vacuum tube voltmeter and his generator, and the answer is soon at hand.

With regard to the vacuum tube voltmeter, it seems worth while to point out that it is not the infallible instrument that many in this country would believe. This is particularly true of the "slide back" meter in which an a. c. voltage is balanced by a d. c. grid bias.

KEITH HENNEY.

None other than high quality radio products can give good steady results—



All Benjamin Radio Products are of the same high standard as the far-famed Cle-Ra-Tone Sockets—

The most beautiful or the largest radio set it is possible to produce is helpless with just a little technical flaw in its interior. Thus if you would have clear and consistent radio reception you can not afford to use "bargain" radio parts.

There are just three characteristics which have gained popularity for Benjamin Radio Parts; the best possible quality in material; the highest perfection in technical construction; and absolute permanence in cooperating with other radio parts to give perfect radio reception.

Improved Tuned Radio

Frequency Transformers

Proved through exhaustive and comparative tests to be the most efficient coil for modern radio sets. Better in all important features and characteristics. Space wound. Basket weave. Cylindrical.

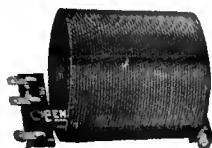

2 1/4" Diameter Transformer

Compact. Especially desirable for crowded assembly. Eliminates interfering "pickup." Set of three, \$5.75; Single transformers, \$2.10.

3" Diameter Transformer

Capacity coupling reduced to lowest degree. For use with .00035 Mfd. Condensers. Set of three, \$6.00; Single Transformers, \$2.25.

Push Type Cle-Ra-Tone Sockets

Spring Supported, Shock Absorbing. Stop Tube Noises. Greatest aid to non-noisy operation. Contacts always clean. 75 cents each.



Battery Switch

Quick, positive, clean-cut make and break. When it's "in" it's "off," eliminating danger of wasteful use of battery. 30 cents each.



Straight Line

Frequency Condensers

No crowding of stations. The broadcast range is spread evenly over the complete dial. Stations come in without interference, and tuning is much easier. Adjustable turning tension. Low loss characteristics give a definite and distinct radio reception. Beautiful in appearance—a credit to the looks and efficiency of any set. Finished in dull silver. Made in three sizes:

.00025 Mfd., \$5.00
.00035 Mfd., \$5.25
.0005 Mfd., \$5.50

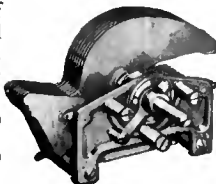

"Lekeless"

Transformers

Uniform high inductance, low distributed capacity and low resistance. The external field is so slight that it permits placing coils close together without appreciable interaction. Single transformers, \$2.50.



Brackets

An aid to simplification in set construction. Supports sub-panel, with room underneath for accessories and wiring. Plain and adjustable. Plain 70 cents per pair; adjustable, \$1.25 per pair.

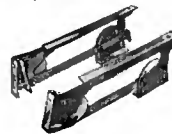

PRIZES FOR RADIO HOOKUPS

A contest for new and original circuits. Write our nearest office for full details.



Benjamin Electric Mfg. Co.

New York 120-128 South Sangamon Street San Francisco
247 W. 17th Street Chicago 448 Bryant Street
Manufactured in Canada by the Benjamin Electric Mfg. Co. of Canada, Ltd., Toronto, Ontario

If your dealer cannot furnish you with Benjamin Radio Products send amount direct to our nearest sales office with his name and we will see that you are promptly supplied.

Use the Handsome Bodine De Luxe Loop

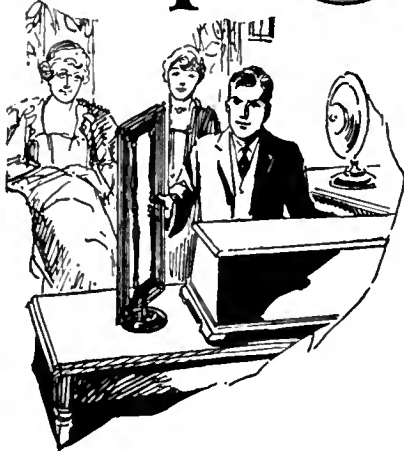

To Tune Out Interference

The artistically balanced, hand rubbed, solid walnut frame and lustrous silk winding of this beautiful loop harmonize with the finest furniture. It is very compact, yet highly efficient for its size. Equipped with jack which may be mounted in top of cabinet, to eliminate all exposed connecting wires. Improves tone quality by tuning out interfering stations. Designed for regular loop sets, but can be used with many serial sets with slight changes. Write for directions for converting aerial sets into loop sets. Ask your dealer to show you the beautiful Bodine De Luxe Loop.

Bodine Basket-Weave Folding Loop

Very popular because of its remarkable ability to pick up long distance signals. Specially designed wires do not sag. Loop holds its shape in service. Folds very compactly—ideal for camping. Calibrated dial permits logging. Ask your dealer about the Bodine Basket-Weave Folding Loop, the loop that is different.

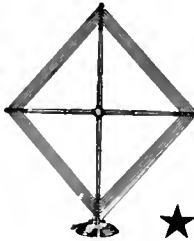

Bodine Twin-Eight R.F. Transformer

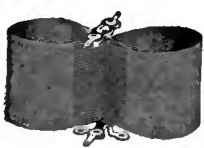

The dream of set builders. Readily improves tuned radio frequency circuits. Makes them sensitive and selective. Improves tone quality. Write for data on Bodine Twin-Eight Hook-up which utilizes Twin-Eight coils.

Mail the Coupon

Bodine Electric Company,
2246 W. Ohio Street, Chicago, Ill.
Kindly mail FREE circular describing:
Bodine Radio Loops.
How to use a loop with serial receiver.
How to build the Bodine Twin-Eight Receiver

Name.....
Address.....

The Microphone

The Theory and Application of the Various Forms of Microphones—Contact and Non-Contact Devices

By H. J. ROUND

THE term "microphone," originally used by Hughes to describe a loose contact device extremely sensitive to vibration, has been generalized to mean any piece of apparatus for converting rapid vibrational energy into electrical energy with similar vibrational characteristics. A number of such devices are now known; some are of scientific interest only, while others are used very extensively in industry.

Microphones Proper.—A loose contact between any two conductors is microphonic. That is to say, when subjected to vibration there is no sharp definition between completely open circuit and completely closed circuit. In between these two states there is a condition where varying pressure alters the resistance, and if one or both of the substances making contact are subject to vibratory pressure, the vibration is reproduced as a varying current. The characteristic between pressure and current is only linear over small limits.

The action at the point of contact is not exactly known. When the current passing through the contact while in the microphonic condition

music have been produced in many forms. The inventive drift has been towards multiple contacts and practically all contact microphones are now formed of prepared anthracite granules, the sound pressure being applied in various ways, usually by means of a diaphragm. In recent years a more accurate study of the response of microphones to sound pressure has been made, and two modern forms in which the response is practically independent of frequency have been made.

In the first form, the Western Electric carbon microphone (Fig. 1), a diaphragm of durable aluminum is stretched to a natural period well above the frequency it is required to reproduce.

A type of air damping is applied to the diaphragm and it is allowed to rest on carbon granules. The resulting currents are practically independent of frequency.

In a second form, known as the Reisz microphone (Fig. 2), a diaphragm is practically dispensed with, and a layer of carbon granules is laid on a heavy non-conducting block, such as marble, being held in position by some material such as silk or thin rubber. The current response is obtained at right angles to the direction of application of pressure.

The carbon granule-air system of a thickness of about 2mm. forms a system of a very high natural period in depth, also damped by the natural friction of the carbon.

The resulting response is similar to that of the stretched diaphragm type described in the last paragraph. Lowering the period of the diaphragm or thickening up the layer of carbon granules in these two types have similar results.

These high quality microphones are not sensitive and have to be used with a vacuum-tube amplifier.

In commercial telephony this amplification is

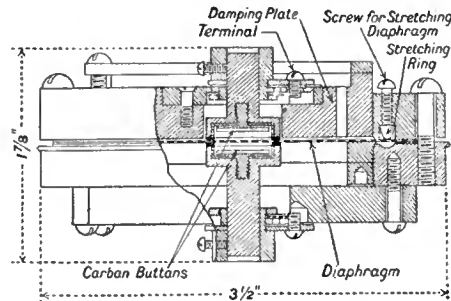

FIG. 1

is examined, it is found not to be absolutely constant, and this lack of constancy makes itself evident as a hiss in a telephone receiver. The discharge through a vacuum tube has a very similar sound when amplified.

The change of resistance with pressure varies greatly with materials used. Carbon in one form or another is universally recognized as the best material, in that the transitory stage between open and closed circuit is more marked than with other materials. This does not mean, however, that it gives the greatest change of resistance for a given change of pressure. A contact between gold electrodes, by delicate adjustment, can be put in a sensitive condition, and in the adjustment gives greater changes than carbon for the same change of pressure. A considerable amplification can be obtained with microphonic contacts, the output vibratory electrical energy being many times that of the input mechanical energy.

To Edison, Berliner, Hughes, and many others, we owe the introduction of the contact microphone and its development as a practical device, and microphones to translate noises and

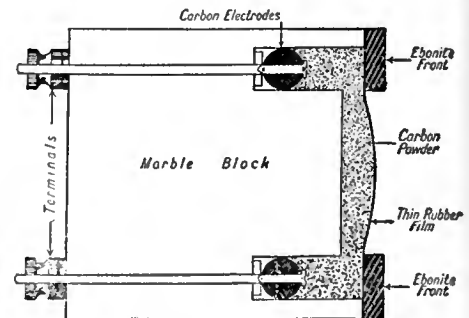

FIG. 2

not usually permissible, at least to any great extent, so that it is usual to greatly increase the sensitiveness by foregoing some of the accuracy of response.

Fortunately the human voice can be considerably distorted without lack of intelligibility and, by giving the diaphragm of the microphone a natural period in the middle of the important frequency ranges (about 800 cycles), amplifiers

can be dispensed with owing to the increased response; music, however, cannot be reproduced with anything like fidelity. These microphones are also used well outside their range of linear response.

Granule microphones all suffer to some extent with packing, that is, a tendency for the carbon to set itself in a hard contact condition where change of resistance with pressure is least, and much time has been spent in an attempt to overcome this difficulty. The commercial solid back microphone is one of the best forms, but occasional shaking is still necessary.

Other Response Devices.—The best known of non-contact devices is the E. S. microphone, developed into an instrument of precision by the

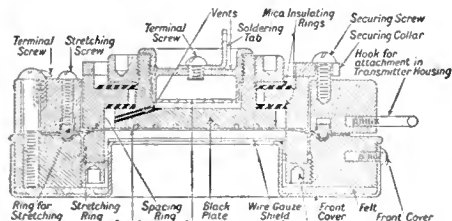

FIG. 3

Western Electric Company (Fig. 3). Here the same principle is used as in the carbon microphone. A high natural period diaphragm, air damped, forms one plate of a condenser, the other being a solid insulated metal piece spaced a few mils from the diaphragm. The chief use of this instrument is for measurement and for broadcasting. The amplification required is large.

Various magnetic microphones have been constructed; in fact, the first Bell microphone was practically the present receiver. The response with frequency is, however, a complex curve, although it is more linear with amplitude than a contact device. Moving coil devices have been produced by Sykes, Siemens-Halske, etc., the later forms of instrument being constructed so that the moving coil is the diaphragm.

In the Sykes microphone (Fig. 4), an annular ring of aluminum foil or wire is suspended in a

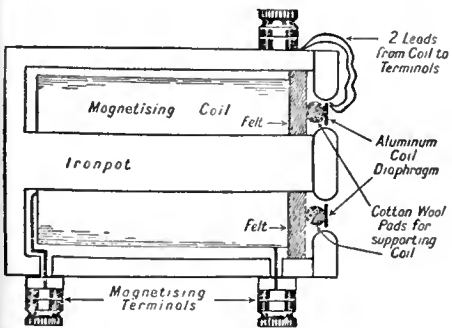

FIG. 4

magnetic field, and the response is sufficiently large to enable the method to be used for broadcasting. The law of response with frequency, although not nearly so correct as the electrostatic instrument, can largely be corrected for in the amplifier.

Thermal Devices.—Hot metal wires have been used for microphone purposes. The response is, however, small, except for very low frequencies, which property has been used by Tucker for gun ranging usually in connection with a resonance chamber.

Gas Discharge Devices.—Doctor Thomas of the Westinghouse Electric Company, and others, have investigated the use of point discharges but these devices have not come into general use.

A flame carrying a current is sensitive to sound but the effect is too small for practical purposes. The piezo-electric effect has also been used but not with much success, except for very high frequency work.

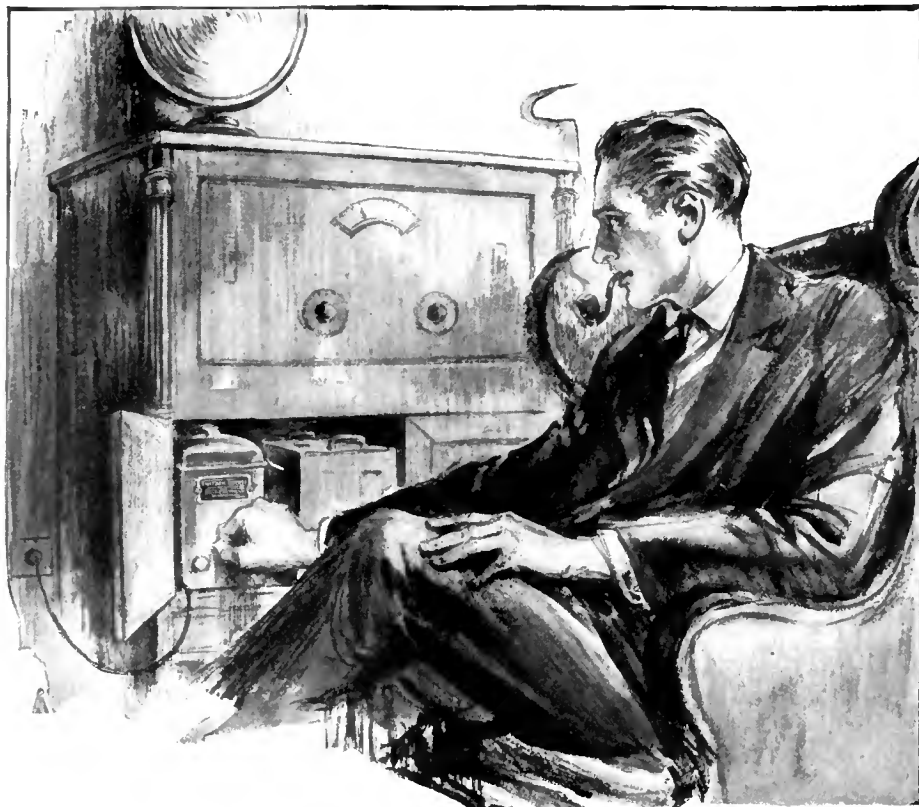

A New Type Trickle Charger With Three Charging Speeds!

No longer necessary to do without your radio a night or two while the trickle charger helps your "A" Battery to catch up! In the Unitron Trickle—three charging speeds are provided. If you've used your set to an unusual extent, simply move the little switch into high gear—and keep on using the set.

In such fashion each of the ten Unitron Radio Devices possesses some exclusive feature, some additional helpfulness that doubles its usefulness to radio.

Every Unitron is a saver of radio upkeep cost—each is absolutely noiseless and all are guaranteed foolproof.

Unitron Trickle

An unusual electrolytic "A" trickle charger—with three distinct charging speeds, controlled by three-way switch. Thus the small or large battery can have exactly its current needs. Permanently connected to battery, can be turned off or on by use of the toggle switch, or can be kept charging continuously. Rectifying elements guaranteed two years and will last a lifetime. Silent. Can't overcharge. Current cost 1-10 of a cent per hour when battery is charging. Mahogany Duco finished case, 9 x 3 1/2 x 6 1/2 inches high. **Complete \$12.00.**

Unitron Charger No. 00

A three-purpose battery charger for 6-volt "A" batteries, 4-volt "A" batteries, or up to 100 volts of wet "B" batteries. Three-way switch permits this flexibility. Can be used even while set is working. Overcharging is impossible and current cost is no more than 90-watt electric lamp. Absolutely noiseless. 6 1/2 x 6 1/2 x 8 1/2 inches high. Equipped with the new 2 1/2 ampere Unitron Electrolytic tube and through its use the charger will deliver either a trickle charge of 6-10 of an ampere or a 2 1/2-ampere rate at the option of the operator. This tube is filamentless, guaranteed for two years and lasts for many more. **Complete with tube, \$18.00**

UNITRON

REG. U.S. PAT. OFF.

RADIO POWER DEVICES

Send this Coupon for details about UNITRONS

FOREST ELECTRIC COMPANY, New and Wilsey Sts., NEWARK, N. J.
 Please mail me literature that tells about the ten Unitron Light Socket Devices, and how little it will cost to equip my set, which is

a.....tube..... using.....batteries.
 Name.....
 Address.....
 City..... State.....

Check here if a dealer, and write your firm name below

Radio Ops See Foreign Lands



Radio operators on ships have marvelous opportunity for travel and adventure. They earn good pay—in addition to board and sleeping quarters.



Study at home now for a voyage next summer.



Radio Institute of America—world's oldest radio school—offers Home Study Courses that qualify you to pass the U. S. Government Commercial or Amateur License examinations.



Radio Institute of America instruction is the finest obtainable at any price.



RADIO INSTITUTE OF AMERICA

formerly Marconi Institute

Established in 1909

328 Broadway, New York City



Mail coupon for complete description of course.

CUT HERE

Radio Institute of America
328 Broadway, New York City

Please send me full information about your Home Study Course of radio instruction.

I am interested in the complete course including code instruction.

I am interested in the technical course without code instruction.

Name _____

Address _____

“NOW, I HAVE FOUND”

A Department for the Exchange of Ideas and Suggestions of Value to the Radio Constructor and Operator

CONTRIBUTIONS to this department are welcome and those used will be paid for at the usual rates, that is, from two to ten dollars each. A prize of twenty-five dollars is given for the best idea used during each three-month period. The prize winner for the last period was announced in the August RADIO BROADCAST. Manuscripts intended for this department should not exceed about three hundred words in length, and should be typewritten. Little consideration can be given to manuscripts not typewritten. Envelopes should be addressed to this department, RADIO BROADCAST, Garden City, New York.

C POTENTIAL FROM THE LINE SUPPLY UNIT

THE writer has found that the ordinary home constructed line supply unit may be very easily modified so that all C potentials as well as B potentials may be obtained. The circuit used is shown in the accompanying sketch, Fig. 11, and consists of the standard Raytheon circuit modified to include the resistances R_1 , R_4 , and R_5 . R_1 is a 10,000 to 100,000-ohm variable resistance, and is used in supplying 90 to 100 volts plate voltage for radio frequency and first stage audio tubes. R_4 and R_5 are used in supplying the C or grid potential, and consist of two approximately 400-ohm potentiometers connected in series. The actual values of the resistances used for R_4 and R_5 will depend upon the grid potentials desired and the plate current supplied by the line supply, and may be determined from Ohms Law. Final adjustment should be made with the aid of a milliammeter in each plate circuit, in turn.

It is important that the 8-mfd. condenser be connected to the B negative as shown, and not to the C negative lead, as the 2-mfd.

soon as a carrier wave is tuned in, all hum from the set disappears amid the much louder generator noises from the broadcast station.

WILLIAM WOOLEY,
St. Louis, Missouri.

INTERCHANGEABLE COILS

THE advent of the new UX tubes, together with the corresponding sockets, makes a very good solution to the problem of a satisfactory plug-in coil for home constructors.

As shown in the diagram, Fig. 2, fasten a strip of wood across the bottom of the coil form with wood screws. This strip should be about $\frac{1}{2}$ inch thick, and $1\frac{1}{2}$ inches wide, rounded at the ends to fit.

In the center of this strip of wood, drill holes to correspond with the holes in an UX socket. The writer uses a No. 27 drill for the two small holes, and a $\frac{5}{32}$ -inch one for the two large ones.

Then cut four pieces of brass rod about $1\frac{1}{2}$ inches long. Two of these should be of $\frac{1}{8}$ -inch stock and the other two of $\frac{5}{32}$ -inch

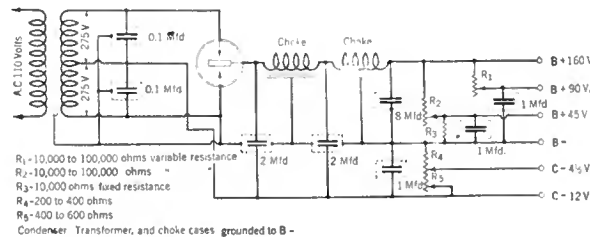

FIG 1

This diagram shows how it is possible to obtain C battery potential from a B battery line supply device. It is a standard Raytheon circuit modified so as to include the resistances R_1 , R_4 , and R_5 .

condensers are, because the latter connection will suppress the bass notes.

All grid and plate leads going to the line supply are bypassed in the receiving set with 1-mfd. capacities so as to eliminate the effect of the lead impedance as far as possible.

The writer is using this line supply circuit with a high grade amplifier and a W.E. cone speaker, and finds the results somewhat superior to those obtained with the use of C batteries, as the ripple hum is less. This is due to the fact that any voltage ripple tends to modulate the grid and plates of the tubes in opposite directions so as to cancel.

So far the writer has not been able to eliminate all hum from the cone speaker but at present the hum is not audible more than a foot or two from the speaker with no signal, and the set out of resonance. As

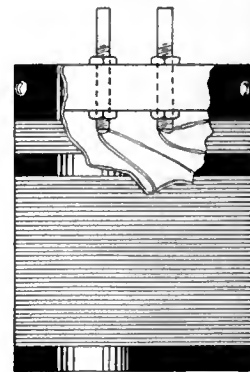
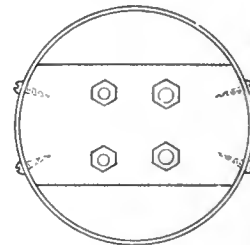

FIG. 2

Details are given in the accompanying text for the construction of a neat plug in coil arrangement. An UX socket forms an integral part of the construction

stock. Thread the two $\frac{1}{8}$ -inch pieces for about $\frac{3}{4}$ inch with a No. $\frac{5}{32}$ die, and the two $\frac{5}{32}$ -inch pieces for the same distance with a No. $\frac{8}{32}$ die. These threaded rods are then inserted in the holes drilled in the wooden strip, and held firmly in place with a hexagonal nut above and below the strip.

The four terminals of the coil are brought to these rods and soldered in place. The coil can then be inserted in the standard UX socket and a firm contact maintained.

The socket, of course, is wired into the circuit with proper regard for the identity of the coil prongs.

This makes a very neat and efficient installation, and coils can be interchanged in a second or two.

W. T. MITHOFF,
Detroit, Michigan.

A VERNIER TICKLER FOR THE ROBERTS

WHEN tuning-in for distant stations, some form of micrometer adjustment for the tickler coil in the Roberts circuit will often be found helpful. The following method of accomplishing this has been tried out by the author and found extremely satisfactory in operation.

A small rubber band is employed to exert a pull on the tickler coil form. By rotating a shaft, mounted in a bushing in the panel of the receiver, a string, one end of which is fastened to the coil form, the other to the shaft, is made to wind up on the shaft, thereby obtaining a slow smooth variation in position of the tickler coil. This string will not unwind. Only one bearing is used and, since the string

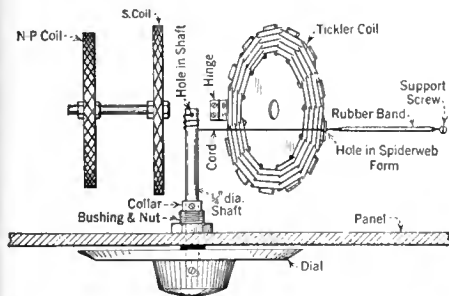

FIG. 3

Micrometer adjustment of the tickler coil in the Roberts receiver simplifies tuning considerably

is wound out near the end of the shaft, a brake action is obtained. If a quarter-inch shaft is used, you will have two complete revolutions of the dial from zero regeneration to maximum. See Fig. 3

EDWARD J. KYPKE,
Boaz, Wisconsin.

SAVE YOUR TUBES!

MOST of us who "roll our own" have tried hurried repairs with the screw-driver without first removing the tubes from our sets, with disastrous results, due to shorting the B-battery current; this often results in burned-out tubes. A good preventative is to obtain some small soft rubber tubing from the druggist, and to slip a length of it over all screw-drivers used in radio work, leaving just the end of the blade uncovered. This will permit safe use around the set, while tubes are lighted.

E. W. COUGHLIN,
District of Columbia.

In Coming Issues

The staff of RADIO BROADCAST Laboratory has prepared a splendid article on how to lay out and build an experimental radio and electrical laboratory in spare space in one's home. The article is most complete, with many helpful photographs and working drawings, together with a list of necessary tools so that the home constructor will not only have all the tools for his construction work but will have, if he follows the suggestions of the article, the base of a good radio experimental laboratory.

The Balloon Tire of your Radio Set



Takes out the bumps

The new Sofrubba Socket is a radical improvement over other sockets heretofore used and can be well compared to the improvement of the balloon tire over the old high pressure automobile tire as a shock absorbing factor.

All V. T. socket problems as well as microphonic noises can be eliminated.

Some of the improvements embodied in this new socket are:

Here are some of the remarkable features of the Sofrubba Socket. Ask your dealer about them or write us direct.

- It is a perfect shock-absorber.
- It is made of special process soft—live—rubber.
- It is guaranteed without qualification against rubber change or any other defect for five years.
- It is unbreakable.

- It is adaptable to top and sub-panel mounting with out change.
- It aligns itself to warped panels and imperfect panel drilling.
- It gives a perfect hugging contact.
- Each contact is one continuous piece and self-cleaning.
- It is Universal. Takes UV and UX types of tubes.
- It is good-looking—practical—efficient.
- Its low price, alone, makes it distinctive.

MOULDED PRODUCTS CORPORATION
549-551 West 52nd Street, New York City

Attention Department C



S O F R U B B A

Enjoy a Big Powerful Radio: 30 Days Free!



SEND COUPON FOR AMAZING SPECIAL OFFER!
NOTE: This offer is made to prospective buyers by famous big Radio Corporation, one of America's oldest reliable manufacturers of fine sets—seventh successful year. Many satisfied users in every state. Postal or coupon brings testimony of nearby users and proof Miraco's outperform sets costing up to 4 times as much. Very easy to install and operate this

BEAUTIFUL-BIG-POWERFUL
Ultra Selective MIRACO Ultra

Users everywhere report it sets programs Coast to Coast, also Canada, Cuba and Mexico, loud and clear on speaker; outperforms \$100 to \$200 sets. Some have heard Europe, So. America. Don't confuse it with small cheap sets. Unless trial proves it MOST SELECTIVE, CLEAREST TONED and MOST POWERFUL DISTANCE-GETTER among beautiful big 6-tube sets, don't buy it. Every Miraco comes completely assembled, rigidly tested and fully guaranteed.

Our Factory Prices Save You Up to 1/2! SEND NO MONEY! Save or make NOW Only \$49.75

Midwest Radio Corporation, Pioneer Builders of Sets
408-A, Mireco Bldg., Cincinnati, Ohio
WITHOUT OBLIGATION, send free literature, AMAZING SPECIAL OFFER, testimony of users, etc.

Built like a \$200 set
MIRACO RADIO GETS 'EM COAST to COAST
Send for Proof!

ONE DIAL CONTROL Model (not illustrated) also offered on 30 Days Free Trial. Enormous demand for Miraco's makes possible boats of costly new refinements and improvements at lower prices than ever. Genuine Bakelite sloping panels, dials beautifully finished in walnut to match cabinets; Connect P-Z Battery Cabinet; features (too numerous to mention) of high-priced sets. Send Now For Latest Literature

27 in. long
SPECIAL WHOLESALE PRICES
Yes! to our agents who show the set to friends.
DEALERS WRITE!

NAME: ADDRESS:

PARTS For the New SILVER SIX SHIELDED

The popularity and success of the Silver Marshall 1926 circuit promises to be eclipsed by the wonderful reception and distance qualities of the NEW SILVER "SHIELDED" SIX just announced; its new shielded feature makes it a vastly improved receiver over their previous one. We strongly recommend it and urge early buying of parts for the kit.

- 4 Silver Marshall 631 Stage Shields
- 2 Silver Marshall 316a Condensers (Variable)
- 2 Silver Marshall 316b Condensers (Variable)
- 4 Silver Marshall 515 Coil Sockets
- 3 Silver Marshall 115a Coils
- 1 Silver Marshall 116a Coil
- 3 Carter 200 ohm resistances
- 2 Kurz Kasch zero left 4 inch dials
- 1 Silver Marshall 275 Choke Coil
- 6 Silver Marshall 511 Tube Sockets
- 2 Silver Marshall 220 Audio Transformers
- 1 Silver Marshall 221 Output Transformer
- 1 Polymet .002 Condenser (Fixed)
- 5 Polymet 1 mfd Condensers
- 1 Silver Marshall 632 Link Motion
- 2 Carter Tip Jacks
- 1 Terminal Strip with Terminals
- 1 Crowe Metal Panel (ready drilled)
- 1 Steel Base (ready drilled)
- 1 Yaxley No. 10 Switch
- 1 Yaxley Special Antenna Switch
- 1 Carter 25000 ohm "Hipot"
- 1 Carter 1/2 ohm Resistor
- 1 Polymet .2 megohm Resistance.
- 1 Polymet Resistance Mounting
- 1 Coil of Hook-up Wire
- Assorted screws and nuts

Complete Kit Price . . . **\$89.50**

Complete parts for the Browning Drake Receiver

In Stock
Write for price

**We are distributors for
the NEW
Henry Lyford
Receiver**

Complete Parts **\$69.50**

Write for reprint as described in the October issue of Radio Mechanics

DEALERS

Write for new 1927 wholesale catalogue
Mail Orders Shipped the Same Day They are Received

HEINS & BOLET
Radio and Electric Supply
Corporation

WHOLESALE AND RETAIL

44 Park Place, New York

BLUE PRINTS

1 For the R. B. Impedance-Coupled Browning-Drake Receiver. Construction information and blueprints full-size of panel and sub-base, detail drawing circuit diagram, picture diagram. The set is a Browning-Drake brought up to the minute. Impedance amplification is used. Use the coupon below and send your remittance of one dollar.

2 For the RADIO BROADCAST "Aristocrat," a five-tube receiver, featuring single control and resistance amplification. This set described eleven months ago in RADIO BROADCAST has been constructed with great success by many enthusiastic readers. Instruction booklet and three full size blue prints, \$1.00. Order by coupon below.

3 For the Roberts Four-Tube Knockout Receiver, an ever popular receiver which has been constructed by some 50,000 radio enthusiasts. Instruction booklet and two full size blue prints, \$1.00 the set. Use coupon below.

4 *How Radio Receivers Work*, by Walter Van B. Roberts. A book on important principles of radio written by one of the foremost of the younger radio experimental engineers and the designer of the Roberts' Circuit. Boards, 65 illustrations, 52 large pages with a bibliography, \$1.00.

5 *How to Build Radio Broadcast's Series of Knockout Receivers*. A collection of all the information published in RADIO BROADCAST on the Knockout Series of radio receiving circuits. Price \$1.00.

-----USE THIS COUPON-----

RADIO BROADCAST BOOKLET DEPARTMENT
Doubleday, Page & Company
Garden City, New York

Gentlemen:

I enclose \$_____ for which please send me:

- R. B. impedance-Coupled Browning-Drake Blue Prints.
- RADIO BROADCAST "Aristocrat" Blue Prints.
- Four-Tube Knock-Out Receiver Blue Prints.
- How Radio Receivers Work.
- Knockout Receiver Series Booklet.

Please send to _____

(NAME)

(STREET ADDRESS)

(CITY)

(STATE)

RBO-26

THE "RADIO BROADCAST" INFORMATION SERVICE

How to Write for Technical Information—The Scope of This Service

AS WAS announced in the June RADIO BROADCAST, all questions which were formerly sent to "The Grid" will now be handled by the Technical Information Service, RADIO BROADCAST Laboratory. That service is maintained under the following rules:

1. All questions from subscribers to RADIO BROADCAST will be answered free of charge.
2. Non-subscribers to RADIO BROADCAST will be charged a fee of One Dollar for the Laboratory Technical Service.
3. All questions will be answered by mail and none will be published in RADIO BROADCAST. The Technical Information Service of the Laboratory feels that it is important to define the scope of its service to readers. Although the Service is of very general help to our readers, there are certain demands which can not be met.

The Technical Information Service:

1. Cannot make comparisons between various kinds of receivers or manufactured apparatus.
2. Wiring diagrams of manufactured receivers cannot be supplied. This information can be secured from the various manufacturers.
3. Complete information cannot be given about sets described in other publications, but in all cases (wherever possible), inquirers will be referred to a source of information where the data can be obtained. In this connection, the monthly department in RADIO BROADCAST "The Best in Current Radio Publications" should be of great help, and should be consulted. That department records the most important constructional, technical, and general radio articles which appear.
4. Special receivers or circuits cannot be designed by the Technical Service.
5. Those who ask questions which cannot be answered in the scope of a letter will be referred, if possible, to sources where the information can be obtained.

In response to many requests, lists of the various groups of apparatus tested and approved by RADIO BROADCAST Laboratory will be mailed to all inquirers without charge.

TECHNICAL INFORMATION INQUIRY BLANK

Technical Service,
RADIO BROADCAST Laboratory,
Garden City, New York

GENTLEMEN:

Please give me fullest information on the attached questions. I enclose a stamped addressed envelope.

I am a subscriber to RADIO BROADCAST, and therefore will receive this information free of charge.

I am not a subscriber and enclose \$1 to cover cost of the answer.

Name.....

Address.....

Another Radio Show

A radio show will be held in Kansas City under the auspices of the Kansas City Electric Club in Convention Hall, Kansas City, Missouri, September 27 to October 2, inclusive. G. W. Weston is Secretary-Manager at 819 Gloyd Building.

Goodrich Silvertown

The Radio Panel Supreme!

- 1 Easier to drill and machine.
- 2 Better color, lasting lustre.
- 3 Lower free sulphur—no discoloration.
- 4 Higher softening point—no warping.

Goodrich V. T. Sockets Spaghetti Tubing
Radiophone Ear Cushions
Battery Mats
★ Hard Rubber Tubes for Coils

The B. F. Goodrich Rubber Company
Established 1870 Akron, Ohio

This is a good time to subscribe for

RADIO BROADCAST

Through your dealer or direct, by the year only \$4.00

DOUBLEDAY, PAGE & CO. GARDEN CITY, NEW YORK

KARAS EQUAMATIC

Complete Parts \$90.24

WHOLESALE PRICES TO ALL DEALERS and PROFESSIONAL SET BUILDERS—All Parts in Stock—Write Today!

FREE New catalog showing our 79 other lines sent upon request FREE

SHURE RADIO CO., 11-19 S. Wells St., Chicago

RADIO PANELS OF GENUINE BAKELITE

Cut, drilled and engraved to order. Send rough sketch for estimate. Our New Catalog on Panels, Tubes and Rods—all of genuine Bakelite—mailed on request.

STARRETT MFG. CO. ★

521 S. Green Street Chicago, Ill.

"CAGE ANTENNA SPREADER"



DIAMETER 7 IN. Patented Sept. 8, 1925
Provision has been made for erecting either a 4, 6 or 8 wire Cage antenna or counterpoise.

Transmitting Amateurs need them—Broadcast Listeners should use them. Circular upon request. Price: \$5.00 per dozen; \$2.75 for a half dozen. Immediate delivery. I pay the postage.

Charles F. Jacobs (Radio 2EM)
278 Park Place Brooklyn, N. Y.

\$75 A WEEK BUILDING RADIO SETS In Your Spare Time

Join the Radio Association of America. Learn how to build and repair sets. The Association will train you—start you out in business, if you wish. Be the radio "doctor" of your community. \$3 an hour upwards easily made.

EARN \$500 IN SPARE HOURS

"I have at last found myself," writes Lyle Follick, Lansing, Mich. "I have already made over \$500." Werner Eichler, Rochester, N. Y., writes, "... have made over \$50 a week in my spare time." Our members are starting radio stores, increasing their salaries, securing better positions, passing radio operator examinations, earning big money in spare time.

JOIN ASSOCIATION NOW!

Are you interested in radio for pleasure or profit? Join now because we have a Special Plan whereby your membership need not cost you a cent. Only limited number of these memberships acceptable. Write now for details—before it is too late.

MAIL THIS COUPON

Radio Association of America,
Dept. B-10, 4513 Ravenswood Ave., Chicago.
Send me details of your Special Radio Association Membership Plan.
Name.....
Address.....
City..... State.....

Now a New Convenience for Radio

Here's the Reliable Automatic Power Control Switch, a self-acting device which controls your Trickle Charger and your B Eliminator by the simple action of turning your receiving set on or off.

For \$2.00 you can make the operation of your receiver as simple and as dependable as your electric light.

This new device, another product of The Reliable Parts Manufacturing Company, controls either or both your Trickle Charger and B Eliminator as required and all automatically, without thought on your part.

Sells for \$2.00 everywhere. If your dealer does not have it, order from us direct and send us his name.

If your receiving set uses Type 199 Tubes, order Model 14—List Price \$2.50

THE RELIABLE PARTS MFG. COMPANY

2819 Prospect Ave.
Cleveland, Ohio

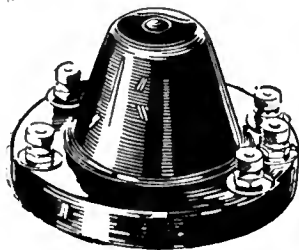

The Reliable Parts Mfg. Co. Cleveland, Ohio

Enclosed find check for \$2.00. Please send me a Reliable Automatic Power Control Switch. I buy my radio supplies from

.....
Name of Dealer

Name.....

Address.....

Fully guaranteed. Money returned if unsatisfactory for any reason. Sent C. O. D. if desired.

LETTERS FROM READERS

Contributions from Readers on Various Subjects of Radio Interest—An Open Forum for All

For Cheaper Radio Apparatus

ONE way to prevent any diminution in the sale of radio parts, occasionally anticipated, would be to reduce the prices of radio equipment substantially, contends our correspondent, Mr. Frank P. Illsley, of Chicago. We can't all be Henry Fords but it is suggested that some of the larger radio manufacturers might profit by applying—on a small scale—the methods adopted so long ago by the motor car king.

Editor, RADIO BROADCAST,
Doubleday, Page & Company,
Garden City, New York.

SIR:

This problem (referring to the question of excessive charges on radio units) does not affect me personally; I can afford what I want, and also can get trade discounts if I so wish. My views are as a friend of the industry, and even more so of the farmers and others to whom radio might be such a boon if it were not being so shortsightedly exploited and maintained at a price level they cannot afford.

I know all the reasons asserted by the sellers as to why this *must* be, but there is nothing new in these; the same problems have always come up in every other industry, and the same finale has always arrived—that either a way had to be found to do what everyone said was impossible, and give the public enough for its money to induce buying, or a quiet buyer's strike resulted, and the sellers and the trade papers, depending on them, went broke in the end.

I ride much across country on test runs, etc., and so am able to note what percentage of farms have antennas; also to hear what farmer neighbors at our summer place have to say. I see what a small percentage of farms have sets, and hear how many of those who did decide to buy, have lost interest due to the limited quality of what they were able to afford. Should they, however, decide to invest in a cheap receiver not beyond their means, they can, it is true, get the service of market reports, etc., but after the first thrill has passed, and their ears tell them that the quality of music they receive is as metallic as that from the old phonograph they long ago tired of, and when they find that the price of better transformers or other audio amplifying units is as fanciful as it is, that it will cost them \$25 or more for parts, and labor extra, to remodel their sets, or \$100 or so to buy a factory-built one, they decide that either course is not for them.

They understand all the seller's problems, that what is "it" to-day may be obsolete in a year, that costs of distribution are high, etc., etc., but they know also that they as farmers must do business with no guarantee that their years will show them a profit, or with any protection against the high distribution costs on farm products.

Though it is becoming the fashion to cite Henry Ford overly often, there is nevertheless value in noting some facts in his course; the chief reason for his success has been his courage to set a price first and take the risk that it would thaw out a large enough volume of sales to be profitable thereafter. His too-immense success thereby in the past led to overplaying matters finally, but the policy even so proved that it could be overdone widely and still continue a gold mine.

The slump in the radio field is no secret to me, and the lay public senses it more widely than is perhaps realized. It is due partly to the monotonous sameness in most of the broadcasters' programs, but more to the inability of the

average listener to get the quality of reception his ears demand, at the price he can afford. Given a capable set, he can perhaps "range" the air and pick out here and there, satisfying bits from this or that program.

But when I consider that Ford's entire engine costs less (\$15) to build than some manufacturers ask for a unit which is merely a can containing a condenser, coil, and socket, all marked at the tidy price of a mere \$20 per unit, or \$60 to \$100 for enough to make a set; when I see some dealer's window showing other electrical items such as fan motors, which contain several times the material and labor required for an audio transformer or impedance unit, but are priced lower, I wonder how many besides myself are struck by the disparity, and the seeds of a little revolt against buying anything more than is compulsory from the radio industry are thereby sown.

It is probably true that things are never as good or bad as they seem; the industry may face less of a slump than appears now likely. The impressions I have taken time to outline in the above may not be fully fitting the facts, but let me offer them as being broadly sketched, probably in the main warranted, and from a well-wisher—less of the industry than for radio and what it might do for farmers and great sections of the people, once it is brought to the needed level in price and quality.

Very truly yours,

FRANK P. ILLSLEY,
Chicago, Illinois.

From an "Universal" Enthusiast

FROM Oconomowoc—it's in Wisconsin!—comes the following epistle to our desk:

Editor, RADIO BROADCAST,
Doubleday, Page & Company,
Garden City, New York.

SIR:

Your Laboratory Information Sheets are a most satisfactory addition to the magazine. I have an index showing where articles of interest can be found in various papers and magazines, including clippings, and your Laboratory Sheets were promptly filed therein.

I have assembled a "Universal" receiver and am thoroughly pleased with its performance. It brings in remote stations clearly and with plenty of volume. My daylight range is Omaha, St. Louis, Cincinnati, and Indianapolis. My evening range, Denver, Miami, San Antonio, New York. From April 21st until May 18th, I logged fifty-six stations before 11 P.M. Central Standard Time.

Very truly yours,

J. C. FINNEY,
Oconomowoc, Wisconsin.

Hears Australia on the Roberts

WE HAVE much pleasure in advising you that it was our station you heard on the 25th of April. We would value any further reports you care to give us." Such is the inscription on the back of the photograph (which in reality is a post card), shown on the next page, and it is signed by the Broadcasting Company of Australia. The recipient is Mr. Karl Templin, of East Sound, Washington, who is to be complimented upon his reception of 3 LO, Melbourne. He used a five-tube Roberts for his accomplishment. The

letter below is from Mr. Harding Gow, a friend of Mr. Templin's who constructed the receiver in question.

Editor, RADIO BROADCAST,
Doubleday, Page & Company,
Garden City, New York.

SIR:

I enclose the confirmation card received on Karl Templin's reception of 3LO, Melbourne. Please return it as it is one of his cherished possessions. I arrived here from Seattle on May 1st, and then Templin told me that he had picked up a strange station at 4 A.M. on April 25th. He



got the call as 3LO, which I think was owing to the fact that he had no headphones. He gave me a description of the numbers he heard and showed me the dial settings. These latter checked with 3LO's wavelength. He said the program ended with a talk on the resources of Australia.

I wrote the letter to 3LO, hence my reason for writing you now. When signing off, the announcer used the word "evening," which put me on the track that it was real DX that my friend had heard. He had no broadcasting list of Australian stations.

I am a strong supporter of the Roberts receiver, and of RADIO BROADCAST, and am proud to have had a part, that of set builder, in the reception of the Australian broadcaster.

Very truly yours,
HARDING GOW,
East Sound, Washington.

France is Behind in Radio

DAVID SARNOFF, recently in France, gave it out that he was disappointed in radio development in that country. A letter to RADIO BROADCAST from a well-known British radio amateur visiting France, is in accord with this statement. He says:

Editor, RADIO BROADCAST,
Doubleday, Page & Company,
Garden City, New York

SIR:

Over here the wireless apparatus appears to me to be a long way behind our times. I visited the Paris Fair and I noticed the exhibitors still had exterior valves (tubes), unsprung bases, tapped inductances and generally one valve for all purposes. We have a French three-valve set and each of the three valves give different results though of the same type. Apparently they cannot afford to import American or British valves and apparatus, and have not the market or ability to make good ones of their own. The L. F. "Mico-Amph." costs, however, only 50 frs. (not \$1.50 of your money), and other types are 37 and 40 frs. There are a quantity of small wireless papers. A Frenchman remarked to me that every boy when he leaves college starts to edit one! Wireless shops in the small towns have scarcely anything in stock, and we can't find wire, terminals, plugs, and sockets, or most small gear there.

Very truly yours,
H. E. ADSHEAD,
Great Bardfield, England.

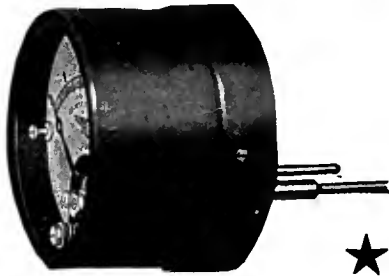

Your Set

will work better

-IF-

No. 135—A high resistance tip Jack Voltmeter for plugging into tip jacks on Radiola, Victor, Brunswick and other sets.

Our radio instrument line is most complete. We have an instrument for every portable or panel mounting use.

—provided with means for checking filament voltages and battery conditions.

Filament control is as important as tuning in radio reception.

Jewell quality instruments for radio mark the pinnacle. They are durable, accurate and reliable.

Send for new Radio Catalog No. 15-C

Jewell Electrical Instrument Co.
1650 Walnut St. Chicago

26 Years Making Good Instruments

In a Jiffy-anywhere
PUT UP-CHANGE-OR TAKE DOWN
Reel Aerial

NO MORE hours wasted putting up or taking down antennas. No lead-ins to solder. No holes to drill. No tangling of wire.

Carry a 21-ounce REEL AERIAL in pocket and put up a 100% efficient aerial in a few moments—any time, any place—outdoors, indoors. Its hard drawn FLAT copper wire (1/4 in. wide) can be led in under or over window or door which can be closed tight without harm to wire. Aerial can be reeled out or in to any desired length up to 100 ft. Unused portion in case does not cause dead-end losses. Place case on or near set and connect with cord which plugs into center of Reel Aerial. Order today. Satisfaction Guaranteed.

DEALERS, JOBBERS! Write for attractive literature and proposition. Use Reel Aerial in making free trial demonstrations. Sell Reel Aerials for indoor aeriels, portable set, to travelers and tourists, to experimenters and to people desiring highly efficient permanent aeriels.

SEND THE COUPON NOW!

In Apartments, Hotels, Offices, Hospitals, etc. Attach weight to insulator on Reel Aerial, and lower from window, any desired length. Bring the flat wire in between upper and lower sash and window frame—and attach to set. Or erect Reel Aerial on roof and bring in same way.

Experimenters, Engineers! Attach Reel Aerial insulator to a pole and push pole into ground. Bring antenna into house. By changing distance and locations of pole, and reeling antenna in or out, you can vary antenna as desired. May also be used as permanent aerial.

The best permanent aerial known. Reel Aerial has same inductance value as stranded copper wire. Being flat and smooth it is easily cleaned.

For indoor aeriels—can be put up a round walls or reeled out on floor.

For use in halls, theatres, laboratories, schools, clubs, on trains, at fairs, etc.

SEND NO MONEY, JUST MAIL COUPON

HAWKEYE RADIO CO. Dept. 1710. Cedar Rapids, Iowa. Division of Hawkeye Lighting Rod Co.

Ship me—on your MONEY BACK GUARANTEE—one Reel Aerial C. O. D. I will pay postman \$5 plus five cents postage (postage prepaid when money accompanies order).

NAME _____
ADDRESS _____

HERE'S 100 feet of 1/4 in. wide flat, bare, copper wire, with insulator on outer end, reeled up in a handomely nicked metal case, 4 1/2 in. diameter! Weighs only 21 ounces. Fits pocket. Unreel as long an aerial as desired, place case on or near set, insert plug on cable in center hole—attach other end of cable to set—and tune 'em in. When through, if desired, reel in like a tape measure. No tangling. Provides a 100% efficient aerial in a few moments—any time, any place—indoors, outdoors. Fine for demonstrating sets on trial.

★ Tested and approved by RADIO BROADCAST ★

ARBORPHONE

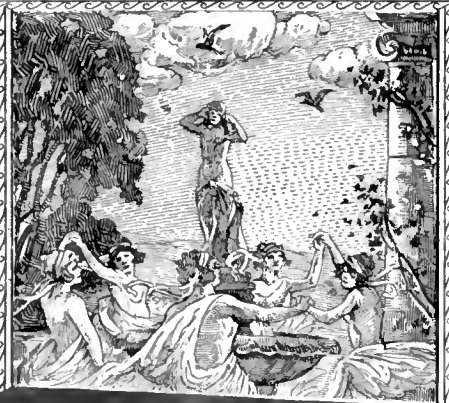

Announces

A NEW AND IMPROVED
MODEL

featuring

Two Dial Control
AND
Rare Cabinet Beauty

Price
\$60⁰⁰

Add \$5.00 in Rocky Mt.
and Pacific Coast States

Amazing value features the new ARBORPHONE 5-Tube Receiver. In appearance and in performance the ARBORPHONE matches, yes excels, point by point, sets listing for more than twice its price.

Your first impression—usually the best—is rare beauty of cabinet design and finish. The expensive rounded front is exclusive with ARBORPHONE.

The new model boasts many refinements of the same proved ARBORPHONE circuit now being used by thousands of satisfied owners.

Simplified tuning made possible by special dual condensers and a separate radio frequency control brings improved reception on low wave lengths and greater volume on long wave length stations.

DEALERS—A tremendous market awaits ARBORPHONE Franchised Dealers. Our discounts are as liberal as our exclusive merchandising plan is helpful. Wire or write for this plan of ARBORPHONE distribution. It assures volume business to ARBORPHONE dealers.

Manufactured by
PRECISION PRODUCTS CO.
Dept. B321 S. Main Street
Ann Arbor, Mich.

National Factory Representative
SANFORD BROS.
30 West Walton Place
Chicago, Ill.

"All You Can Ask of a RADIO"

BLUE PRINTS FOR THE "ARISTOCRAT"
RECEIVER DESCRIBED BY ARTHUR H.
LYNCH IN THE NOVEMBER MAGAZINE
CAN NOW BE OBTAINED AT YOUR
RADIO DEALER'S IF HE CANNOT SUPPLY
YOU SEND US HIS NAME AND ADDRESS.

Price one dollar for complete set.

THE GENEVA PLAN

*How Europe's Wavelengths
Have Been Re-Allocated
From a Central Bureau*

By

Lawrence W. Corbett

SOME eighteen months ago the Office International de Radiophonie came into being. This is a union of members gathered from European broadcasting organizations for the discussion and formulation of plans for the benefit of all European listeners. The Secretary General of the Council is Arthur Burrows, one time "Uncle Arthur" of the British Broadcasting Company, while Admiral Carpendale, "second in command" of the present B. B. C., is President of the Council.

The work of the organization is divided under three headings; Legal, Technical, and Artistic. It is with the Technical Committee that we are concerned, and this section is presided over by M. Braillard, of Belgium.

When the Bureau first came into existence, of paramount importance was the chaotic state of affairs then prevalent in the European ether. The allocation of transmitting frequencies was then a matter of national concern, and the individual governments were not in a position to consider geographical positions on an international scale when assigning wavelengths to their own stations. The result was a hopeless tangle of overlapping frequencies, so serious in fact, that the B. B. C. had to state that it would not be possible to announce in advance any changes in the wavelengths of their stations necessitated by other stations pirating, knowingly or unwittingly, the wavelengths near enough to those they (the B. B. C.) were using to cause heterodyning.

It was only a few weeks ago that the Office de Radiophonie announced their plan for the reorganization of the whole frequency allocation system of Europe, and there are those who will have it that the eighteen months taken to form this plan is out of proportion to the good that will result. The more serious minded will, however, realize that the mere working out of the plan on paper would not have been feasible, and that practical applications of the system had to be tried out very thoroughly before any definite plan could be arrived at. Many times during the eighteen months have temporary wavelengths been assigned to various of the European stations for a try-out, and only by such experiments has it been possible to present conclusive evidence that the plan will work.

THE GENEVA PLAN

THE "Geneva Plan," as it has been called, which will come into effect at about the time that this article appears in print, has caused the wavelengths from 201.3 to 588.2 meters to be divided into 99 distinct channels, each separated from its neighbor by 10 kilocycles. Of these 99 channels, 83 are what are known as "exclusive" wavelengths, the remaining 16 being termed "common" wavelengths. The exclusive wavelengths are for the sole use of the particular broadcasting station to which they are allotted, while the common wavelengths are to be shared by those stations which have no exclusive wavelength. These latter will generally be low power stations, and when a common wave is allotted, care will be taken in its choice to choose a frequency that is not shared by another station geographically near at hand.

The 83 exclusive wavelengths have been shared out to the various countries according to the following list: Albania, 1; Austria, 2; Belgium, 2; Bulgaria, 1; Czecho Slovakia, 3; Denmark, 1; Esthonia, 1; Finland, 2; France, 9; Germany, 12; Great Britain, 9; Greece, 1; Holland, 2; Hungary, 1; Ireland, 1; Italy, 5; Jugo Slavia, 1; Latvia, 1; Lithuania, 1; Luxembourg, 1; Norway, 3; Poland, 4; Portugal, 1; Roumania, 2; Russia (West), 5; Spain, 5; Sweden, 5; Switzerland, 1.

The area coming under the jurisdiction of the Office is bounded as follows: On the North, by the Pole; the South, by the Mediterranean and Black Seas; the East, by a meridian drawn through Eastern Russia; on the West, by the Atlantic Ocean.

There are some two hundred broadcasting stations in Europe either active or shortly to become so, thus it is apparent that the common wavelength channels will be shared by about seven stations each. However, some of the common waves are shared by only two stations, according to the list drawn up by the Geneva Bureau, while other common waves are shared by as many as ten or so stations.

BRITAIN'S INTERPRETATION OF THE PLAN

LET us see how the new plan affects—Great Britain, for example. There are twenty-one broadcasters in that country, this figure including Daventry, the high power long-wave broadcaster, 5 xx. This latter will not, of course, be affected by the "Geneva Plan." Of the remaining twenty B. B. C. stations, 9 are main stations employing a power output of from 1500 to 3000 watts. The other 11 are relay stations using about 200 watts, and are for purely local service. Every B. B. C. station, until the "Geneva Plan" came into being, used a different frequency. Under the new regime, Great Britain has been given nine exclusive wavelengths for the main stations, the supposition of the Office de Radiophonie being that the B. B. C. would choose to operate all of its relay stations on common wavelengths shared by other nations.

Captain Eckersley, the chief engineer of the B. B. C., has decided not to do this, however. He has made up his mind that it would be better for the B. B. C. to reserve one of its exclusive wavelengths for the use of nine of the eleven relays. The other two relays will operate on common wavelengths, allotted by the Office de Radiophonie. This plan leaves eight exclusive wavelengths for the use of the nine main B. B. C. stations. Aberdeen and Birmingham will therefore share a wavelength, the other B. B. C. main stations being operated on the remaining seven exclusive wavelengths.

Captain Eckersley's plan was formed to obviate the necessity of some of the relays working as high as 1200 kc. (250 meters), a frequency which he considered would be too high for many of the receivers to tune-in. By his revision of the "Geneva Plan," he displays no lack of confidence in the Office de Radiophonie's original allocation. The Office, when allotting waves, unnecessarily specified which individual stations should operate on the exclusive waves given to the various countries, to simplify matters. Captain Eckersley is simply re-allocating the waves given to Great Britain among the stations in the B. B. C. chain. He is not taking any frequencies not allotted to Great Britain. In fact, if his plan of stacking most of the relays on one wavelength works, it will leave the common waves allotted for those relays free for other uses. On the other hand, severe interference may be encountered by stocking nine relays on one wave, in which case the only remedy will probably be in utilizing all of the common waves allotted by the Office de Radiophonie for the relays.

Build Your Set With



Dependable Products

Endorsed and used by leading set builders

Quality at Popular Prices

May we send you our complete catalog?
Write Dept. R. B.

LESLIE F. MUTER COMPANY
76th & Greenwood Avenue
CHICAGO, ILL.





Variable High Resistance



Single Pole Double Throw



Double Pole Double Throw



Triple Pole Double Throw



Antenna Plug



Resistance Amplifier Unit



Fixed Grid Leaks



Resistance Amplifiers



Interference and Static Eliminator



Audio Frequency Transformer



Push-Pull Panel Switch



Automatic Shock-Proof Phone Plug



Fixed Condensers



Fixed Rheostat



Lightning Arrester



Antenne Lead-In Insulator



Adjustable Ground Clamp



Standard Complete Aerial Kit



Variable Condensers



stop that howl!



See that rubber jacket about to descend on the "howler"? Once this "howl absorber" slips over a tube the howl stops for once and all!

No more ruined reception. The thick shield of live rubber effectually soaks up the trouble-making vibration.

You can get it for every size tube!
Just ask your dealer, or write.

National Distributors for the U. S. A.
SPARTAN ELECTRIC CORPORATION
350 West 34th Street New York City

Manufactured in the U. S. A. by
SCIENTIFIC PRODUCTS CANADA, LTD.



Price 75c

A REVOLUTION in Radio Construction A REVELATION to the Radio Fan

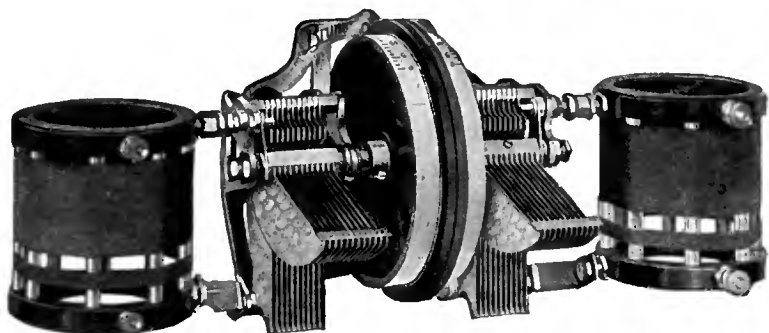

The Model "R. F." Unitone

The model "RF" UNITONE consists of two .0005 mfd. straight line frequency condensers with two matched radio frequency transformers adaptable to a wide variety of circuits, slipping type of drum control; no subcondensers necessary. Mounts to panel with only two screws. Price, including handsome bronze panel plate, \$17.00.

The new Bruno UNITONES are probably the most convenient instruments ever devised for the convenience of the amateur set builder and experimenter. The basic unit is a double condenser consisting of two .0005 mfd. bakelite-shaft, straight line frequency condensers mounted on an aluminum plate but entirely insulated from each other electrically. Manual adjustment is provided through the medium of a pair of moulded bakelite drums, whose knurled edges and graduated scales protrude through the front surface of the panel. The two drums can be operated individually or can be locked loosely together by means of slip bolts so that the two condensers are never more than 10 degrees different in setting. No supplementary "vernier" or "micrometer" condensers are necessary.

The other UNITONES are combinations of Bruno quartzite inductances with the basic condenser unit, UNITONE model "2C", the coils being mounted directly to the condenser binding posts. They are adaptable to practically every known radio receiving circuit.

All models mount to the back of the panel by means of only two screws, which also hold handsome bronze indicating plates. Special bronze mounting screws are supplied.

The appearance of the UNITONES is striking, the orange and green silk-covered wire on the coils forming an unusual contrast with the shiny black of the moulded coil rings and drums and with the brass and aluminum finish of the condensers.

<p>The "2C" UNITONE consists of two condensers on one frame, with drum control, bronze panel plate, and special bronze mounting screws. Price, \$11.00.</p>	<p>The "CF" UNITONE consists of "2C" unit with one fixed R. F. coupler and special three winding coil, with fixed primary and tapper, for use in capacity feed-back regenerative circuits. Price, \$19.00.</p>	<p>The "CC" UNITONE consists of one .0005 mfd. bakelite-shaft, straight line frequency condenser and a three circuit tuner on one frame, with regular Bruno drum control. Price, \$12.00.</p>
<p>The "TK" UNITONE consists of "2C" unit with one fixed R. F. Coupler and a three circuit (tapper) tuner mounted on condenser posts. Price, \$20.00.</p>	<p style="text-align: center;">NOTICE</p> <p>All regenerative UNITONE kits are licensed under the Armstrong patent No. 1,113,149 and are assembled by the Clapp-Eastman Company exclusively for us.</p>	

If your dealer cannot supply you—write us direct

★ **BRUNO RADIO CORPORATION**
L. I. CITY NEW YORK

KELFORD

Resistance-Coupled
AMPLIFIER

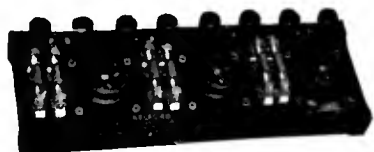

Distortionless
Amplification ★
Pure Tone, Perfect Clarity and Greater Volume **\$8.00**

Bakelite form with all connections and wiring concealed. Completely equipped with resistances and condensers; all metal parts highly nickel plated. Equipped with the famous Kelford "Cushion" Sockets. Can be used with all circuits to increase volume and clarity.

At your dealer's, otherwise send purchase price and you will be supplied postpaid. Free literature an request.

THE AMERICAN SPECIALTY CO.
Bridgeport Connecticut

A KEY TO RECENT RADIO ARTICLES

By E. G. SHALKHAUSER

THIS is the twelfth installment of references to articles which have appeared recently in various radio periodicals. Each separate reference should be cut out and pasted on cards for filing, or pasted in a scrap book either alphabetically or numerically. An outline of the Dewey Decimal System (employed here) appeared last in the August RADIO BROADCAST, and will be reprinted in an early number.



R800. (538) MAGNETISM. MAGNETISM.
Popular Radio, July, 1926, pp. 211ff.

"The Great Magnet that Rules Radio," E. E. Free.
The author discusses the nature of the magnetic and electric forces of the earth and their possible effects on radio waves. It is unknown to what the magnetism of the earth is due, but from observations it is known that the field is so distributed that it is impossible to locate any definite so-called poles of the earth's magnetic field. The region of the North and South magnetic poles is determined, although a gradual change is taking place from year to year, as is evidenced by the shifting of the magnetic dip of our compass needle. Daily and seasonal changes occur in the strength of the magnetic field at any one place, as is shown by the diagram.

The opinion is expressed that apparently the electricity and magnetism, and perhaps the gravitation of the earth, are problems which may be solved by the study of terrestrial radio waves.

R112.6. ABSORPTION: RECEPTION. RECEPTION.
Popular Radio, July, 1926, pp. 214ff.

"How to Get the Best Reception in Summer," R. H. Marriott.

Radio's four seasons, those characterized by strong signals, falling off signals, weak signals, and growing signals are compared to the four weather seasons, winter, spring, summer, and autumn. The seasonal conditions affecting radio reception, and thus varying the signal intensity, are summarized as follows:

1. The direct rays of the sun vary signal strength.
2. With no sun shining between transmitter and receiver, little variations occur.
3. Amount of humidity in the air at various localities may cause reflection or refraction.
4. Charges in the air with accompanying static and electric fields combine with radio waves and cause disturbances.
5. Light and heat waves, and the ionized condition of the air, cause changes.

For the above reasons the author recommends that receivers tune-in on local stations for good reception in summer.

R343.7. ALTERNATING CURRENT SUPPLY. RAYTHEON
Popular Radio, July, 1926, pp. 230-233. POWER PACK.

"Four New Combinations of Units," L. M. Cockaday.
Four more models of Raytheon power pack units are described. The first is a high-voltage power pack that is equipped with a relay in the A-battery circuit operated from the battery switch on the receiver. The second is a unit for lighting the last audio stage and supplying the necessary high voltage for the plate. The third is a unit to supply all B-battery current for the average receiver. The fourth is an arrangement whereby either high or low voltage may be obtained, depending on the value of the input voltage, which may be varied.

R113. TRANSMISSION PHENOMENA. TRANSMISSION
Popular Radio, July, 1926, pp. 234 ff. BY INDUCTION.

"How Energy Leaps the Chasm of Space by Induction," Sir Oliver Lodge.

Induction, says Sir Oliver Lodge, may be classed as electrostatic and electromagnetic. In the transfer of energy through space, the principle of induction plays an important part. Without it there would be no radio communication. After discussing the fundamental principles of induction, the writer states that, since magnetic and electric fields so to say interlock, and that one of these fields cannot be produced without the other, this relation is responsible for the generation and transmission of electromagnetic waves.

R384.1. WAVEMETERS. WAVEMETERS.
RADIO BROADCAST, July 1926, pp. 216-221.

"Wavemeters for the Home Laboratory," K. Henney.
The simple wavemeter consists of just a coil and a condenser. It may be calibrated by adjusting its setting to stations of known frequencies using an ordinary receiving set as a pick-up instrument, which is set into oscillation. Using a wavemeter in connection with a transmitting set, a coupling coil, a rectifier crystal, and some kind of indicating device are needed, in order to designate points of resonance. The heterodyne wavemeter consists of a simple Hartley circuit arrangement with grid meter or with phone jack in the plate circuit. Its uses are many, as enumerated, and together with the modulated oscillator described previously (Sept., 1925, issue pp. 604) many measurements of radio circuits and their characteristics can be made. The quartz crystal meter is used for fixed frequency measurements and is considered the most accurate standard in use to-day. Several circuit diagrams of crystal wavemeters are shown. Methods of calibrating wavemeters are described in detail, as by direct comparison with frequencies coming from outside stations through the regular broadcast receiver; by picking up harmonics from oscillating tubes; or by using both a short-wave receiver and a broadcast receiver at the same time.

R343. ELECTRON-TUBE RECEIVING SETS. RECEIVER. *Popular Radio*, July, 1926, pp. 242ff. *Short-Wave*. "The Schnell Short-Wave Receiver," L. M. Cockaday. Construction details and constants of the short-wave receiver used by F. H. Schnell are given in detail. Circuit diagrams and drawings are shown, the size of the coils for the different wave bands to be covered also being given.

R307. LABORATORIES. LABORATORY. *Radio News*, July, 1926, pp. 12ff. *Air Service*. "The Air Service Radio Laboratories," Lieut. H. F. Breckel.

The writer gives an account of a visit made to the Air Service Laboratories at McCook Field, Dayton, Ohio. He tells of the radio research work going on in guiding airplanes through the air without pilots, and of the work being done in perfecting transmitters and receivers for airplane use. The radio beacon, which directs planes without the aid of ground visibility on the part of the pilot, is considered the most important development during the past year—from the standpoint of air service.

R220 & 240. CAPACITY AND RESISTANCE CAPACITY AND MEASUREMENTS. RESISTANCE CHARTS.

RADIO BROADCAST. July, 1926, pp. 222-223. "Removing Mathematics from Resistance and Capacity Calculations," H. S. Davis.

Four charts are presented, by means of which resistances in parallel and capacities in series may easily be read, without resorting to mathematical calculation. Two charts, one covering resistances ranging from 5 to 100 ohms, the other ranges from 100 to 10,000 ohms, and two charts covering capacities from 0.0002 to 0.006 mfd. and 0.002 to 0.8 mfd., are shown. With suitable multipliers, these ranges can be extended.

R342.5. POWER AMPLIFIERS. AMPLIFIERS. RADIO BROADCAST. July, 1926, pp. 224-227. *A. C. Power*. "A Quality Amplifier Power Supply," A. H. Lynch.

A description of the construction of a combined power stage and plate supply device, to be used in connection with any good receiver, is presented. The arrangement consists of a voltage step-up transformer, a rectifier, filter circuit, and a power audio amplifier using a power tube such as the UX-210. A circuit diagram, and photographs of the constructed units, are presented.

R113.5. METEOROLOGICAL. STATIC. RADIO BROADCAST. July, 1926, pp. 232-235. *Summer*.

"Where Summer Static Comes From," B. F. Dashiell. The author relates the conditions of the atmosphere under which storms occur, telling us where the storm regions may be found, and points out in what way we may establish connection between weather conditions and radio reception. Thunderstorms have their origin in masses of warm and moist air. This air is in rapid motion and sets ions free from the atmospheric gases, thus producing a high atmospheric charge. From this we experience our lightning discharges. These may be of various forms, as described.

R148. MODULATION. MODULATION. RADIO BROADCAST. July, 1926, pp. 245-247.

"Technical Operation of Broadcasting Stations—Modulation," C. Dreher.

The Heising system of modulation, used in practically all of the broadcasting stations to-day, is discussed at some length. A large iron core choke coil, usually about 100 henrys inductance, is considered the governing part of the circuit. This coil prevents plate current variations of audio frequency being drawn from the high voltage plate supply, and is therefore known as the constant current system of modulation (Fig. 1). When the plate current of the modulator tubes (there should be at least two modulators to one oscillator when all of the tubes have the same capacity rating in a circuit) is varied, the plate current of the oscillator is changed correspondingly, thus varying the output energy. More than 35 per cent. to 40 per cent. modulation cannot be obtained without distortion if an equal number of modulators and oscillators are employed, says the writer. The degree of modulation may be determined either with a grid milliammeter, modulation meter, or oscillograph. The advantages of these systems is taken up in detail, diagrams being shown.

ROOT. LAWS; REGULATIONS. WAVELENGTH. RADIO BROADCAST. July, 1926, pp. 267. ASSIGNMENT.

"Frequency Channels Used by U. S. Radio Stations." A list showing the assignments given to stations of various natures of transmission, such as broadcasting, commercial, experimental, amateur, etc., gives the following data: kilocycles, meters, form of transmission, kind of service, and remarks.

R330. ELECTRON TUBES. ELECTRON TUBES. *Radio News*, July, 1926, pp. 30-31.

"Tubes Within Tubes," G. C. B. Rowe. Photographic reproductions, accompanied by illustrative discussion of new types of vacuum tubes, are presented. The inventor of these "many tubes in one" is Doctor Loewe of Berlin. It is stated that, by placing the various elements of a receiving set, such as condensers and resistances, within the tube, shorter leads can be used and many difficulties overcome thereby.

R582. TRANSMISSION OF PHOTOGRAPHS. TELEVISION. *Radio News*, July, 1926, pp. 267.

"The Latest Advance Toward Television," L. Fournier. With the aid of revolving mirrors Professor Bélin has succeeded in receiving and reproducing a moving scene, being able to show complete images at the rate of ten per second. The method utilized for this purpose may readily be applied to radio transmission of pictures. The system is clearly pictured and described.

R330. ELECTRON TUBES. ELECTRON TUBES. *Radio News*, July, 1926, pp. 50-51.

"A Departure in Radio Tube Design," H. K. Huppert. The advantages derived from double-grid vacuum tubes is discussed. The tubes may be used either as radio-frequency amplifiers, detectors or audio-frequency amplifiers. It is claimed that, with the aid of a second controlling device, it is possible to overcome capacity effects in tubes very effectively. Also, alternating current can be used on the filaments without having the objectionable 60-cycle hum present.

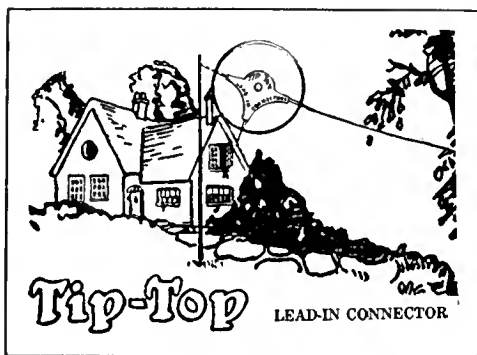

Don't Neglect this Vital Point of Contact!

A FEW spare moments, a screw driver and you have a sure, perfect connection between your aerial and lead-in wire. No noise, no soldering, no loss of "distance" due to swinging aerial or corrosion. Tip-Top cannot work loose.

★ *Jobbers and Dealers Write Us!*

JAMES F. DOOLAN MFG. CORP.
36-42 West 47th St. New York, N. Y.

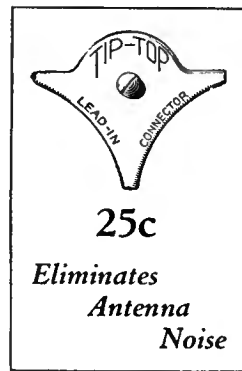

LEARN THE CODE AT HOME with the OMNIGRAPH

"Just Listen—The Omnigraph will do the teaching"



THE OMNIGRAPH Automatic Transmitter will teach you both the Wireless and Morse Codes—right in your own home—quickly, easily and inexpensively. Connected with Buzzer, Buzzer and Phone or Soudeter, it will send you unlimited messages, at any speed, from 5 to 50 words a minute.

THE OMNIGRAPH is not an experiment. For more than 15 years, it has been sold all over the world with a money back guarantee. The OMNIGRAPH is used by several Depts. of the U. S. Govt.—in fact, the Dept. of Commerce uses the OMNIGRAPH to test all applicants applying for a Radio license. The OMNIGRAPH has been successfully adopted by the leading Universities, Colleges and Radio Schools.

Send for FREE Catalogue describing three models. DO IT TO-DAY.

THE OMNIGRAPH MFG. CO., 13K Hudson St., New York City

If you own a Radio Phone set and don't know the code—you are missing most of the fun



TUNE IN for Big PROFITS!

Dealers jump at this live line of radios and accessories, including Bremer Tully, Bakite, All American, G. E., Tungar, Thorola, Majestic, Utah, R. C. A. Tubes, nationally advertised parts, batteries, chargers, etc. Send for catalog and attractive dealer's proposition. Exclusive territories to responsible dealers. Wholesale only. Quick sales and splendid profits assured. Don't pass this up. Write today.

NEW ENGLAND MILLS COMPANY

Distributors of Nationally Advertised Radio Lines
Dept. 91 A 825 Washington Blvd. Chicago, Ill.

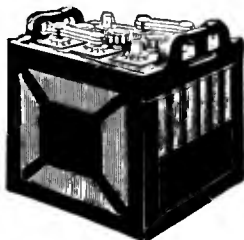

CHICAGO RADIO BATTERIES

Solid One Piece Rubber Containers

★ GUARANTEED FOR 2 YEARS

FAMOUS for unexcelled quality, guaranteed long-lived service and unvarying dependability Chicago Batteries offer the Radio fan an "A" Power that is backed by years of experience and master workmanship with the finest materials available. Endorsed and approved by leading Radio and Automotive authorities. Chicago Batteries in their new non-leak, solid rubber cases represent an amazing value at lowest cost.

PRICES RADIO BATTERIES
Solid Rubber Cases

6 volts, 100 amps. \$ 8.29
6 volts, 120 amps. 10.29
6 volts, 140 amps. 12.45

SAVE MONEY—ORDER DIRECT

Buy Chicago Batteries direct from the manufacturer. Batteries shipped same day order is received. Express C O D or 3% discount cash with order.

CHICAGO BATTERY WORKS
1206 So. Peoria St. Chicago, Ill.

S-M PARTS AT WHOLE-SALE PRICES

DEALERS AND PROFESSIONAL SET BUILDERS! We are wholesale headquarters for SILVER MARSHALL Products; also Bremer-Tully, Victrola, Samsco, Benjamint, K.K., Rayovac, Musselman, Yaxley, etc. Generous discounts. New FREE catalog including all above lines and 60 others. Write today. Address Dept. L.

SHURE RADIO CO., 19 S. Wells, Chicago



AEROVOX

"Built Better"
RAYTHEON CONDENSER BLOCKS

AEROVOX products are used by over 200 of America's Radio Manufacturers. AEROVOX Fixed Condensers are approved by M. I. T. and Yale Universities. AEROVOX WIRELESS CORP. 489-491-493 Broome St., New York

Branch Offices:
St. Louis, Mo., Syndicate Trust Building
Cincinnati, O., 304 Palace Theatre Bldg.
Chicago, Ill., 73 W. Jackson Boulevard
Boston, Mass., 94 Portland Street
Los Angeles, Cal., 324 N. San Pedro St.

Automatic Relay Switch

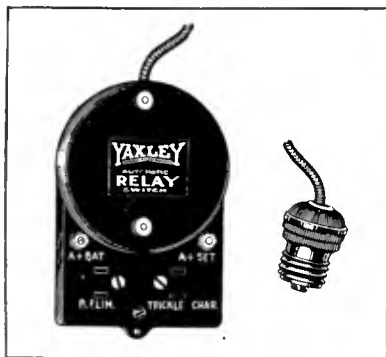

THE Yaxley Relay is for sets using trickle charger and B eliminator or either. The relay automatically cuts off the trickle charger, cutting in the A battery and B eliminator when the switch is turned on. When the set is turned off, the relay automatically cuts out the B eliminator and A battery, cutting in the trickle charger again. Voltage drop negligible. Self-cleaning, silver wiping contacts. Hand-some enameled metal case, with Bakelite base. Brackets for convenient mounting.

No. 444 Relay Switch, with cord and Separable plug \$5.00

YAXLEY MFG. COMPANY
Dept. B. 9 So. Clinton St.
CHICAGO



Silent "B" Power with World Radio Storage "B" Battery

12 Cells 24 Volts
Lasts Indefinitely—Pays for Itself
Dependable. Quiet "B" power, clear without "hom." Economy you have never before thought possible. Convenience. Outstanding performance. Recharged for almost nothing. Solid rubber case insures against leakage or acid. Extra heavy glass jars. Heavy rugged plates. Approved and listed as standard by Pop. Radio Laboratories, Pop. Sci. Inst. Standards, Radio News Lab., Lefax, Inc., and other Radio authorities.

SEND NO MONEY! just state number of batteries wanted and we will ship same day order is received. Pay expression after examining batteries, 5 per cent discount for cash with order. Send your order today—NOW!

WORLD BATTERY COMPANY
1219 So. Wabash Ave. Dept. 78, Chicago, Ill.
Makers of the Famous World Radio "A" Storage Battery
Prices: 6-volt, 100 Amp. \$10.50; 120 Amp. \$12.50; 140 Amp. \$13.25.
All equipped with Solid Rubber Case.

World STORAGE BATTERIES
Set your Radio Dial for the new 100-watt World Storage Battery Station. W.S.B.C. Chicago. Always something interesting.

R356. TRANSFORMERS. TRANSFORMER CURVES.
Radio News, July, 1926. pp. 52f.
"How Should Transformer Curves Be Plotted?" S. Harris.
When plotting characteristics of audio frequency transformers, the scale to use in showing the frequency-voltage ratio should depend upon the physiological sensation produced, which necessitates, in the writer's opinion, a scale showing each octave the same value as any other octave. By plotting a curve logarithmically to the base 2, this is accomplished. Curves are shown depicting the advantages of such procedure.

R343.7. ALTERNATING CURRENT SUPPLY. UNIT.
Radio, July, 1926. pp. 13ff.
"How to Build a Plate-Current Supply Unit," G. M. Best.
Information is given concerning the best circuits and methods of assembly to be used in constructing a plate-supply unit from the 110-volt a. c. circuit. All of the models considered employ the Raytheon tube. In the first assembly, Jefferson transformers and chokes are used. In the second, General Radio parts are shown, while in the third, Dongan transformers and Thordarson chokes are employed. The fourth uses Acme parts. All-American parts are utilized in the fifth, and in the sixth, Silver-Marshall parts are shown. A circuit arrangement showing filament type rectifier tubes, and another showing a power amplifier with built-in rectifier, are explained.

R343.5. ELECTRON-TUBE RECEIVING SET. RECEIVER.
Radio, July, 1926. pp. 17ff.
"An All-Around Short-Wave Receiver," L. Jacquet.
A short-wave receiver, range 30,000 to 2727 kc. (10-110 meters), is described. A detector and a one-stage amplifier is needed for either code or broadcast reception. The layout of the set, the list of necessary parts and the constructional details, are complete.

R343.7. ALTERNATING CURRENT SUPPLY. RECTIFIER, B Eliminator.
Radio, July, 1926. pp. 19-20.
"An Inexpensive B Eliminator," E. E. Griffin.
The constructional details of a 100- and 200-volt electrolytic B battery eliminator are outlined. Using parts on the market, readily obtainable at low cost, four rectifier cells are assembled and wired up according to the circuit diagram. According to the curve, which shows milliamps. output versus voltage, a steady drop in the voltage is noted as the output increases.

R132. AMPLIFYING ACTION. AMPLIFICATION.
Radio, July, 1926. pp. 23ff.
"Voltage Versus Power Amplification," J. E. Anderson.
The effects of resistance, impedance, and transformer coupling on the amplification, whether voltage or power amplification, is discussed, from a mathematical and quantitative standpoint. In resistance coupling the amplification constant, the ratio of the plate a. c. resistance to coupling resistance, and the amount of plate voltage applied, determine the increase in voltage amplification. How these values depend upon each other is shown in the graph, Fig. 1. In Fig. 2, a comparison is made between choke coil coupling and resistance coupling, with and without the effect of bypass condensers. It is evident, from the data presented, that high value bypass condensers cause considerable distortion.

In transformer coupling, contrary to general practice, the author presents arguments in favor of increasing the primary impedance considerably above that of the tube impedance for high amplification (Fig. 3). The effect of distributed capacity is to cause sharp variations in the amplification curve, especially if bypass condensers are added.

R270. SIGNAL INTENSITY. SIGNAL INTENSITY MEASUREMENT.
Radio Broadcast, August, 1926. pp. 300-304.

"How Was Reception Last Night?" A. F. Murray.
Graphic recording of radio signals, programs as well as static disturbances, over a considerable period of time, will enable the radio engineer to devise ways and means of combating undesirable signals from entering the receiver, says the writer.

In order to record these signals, the equipment necessary is given as follows:
1. ANTENNA; well erected and located.
2. RECEIVER; preferably of the super-heterodyne type.
3. RECTIFIER; to change the received a. c. energy to pulsating d. c. in order to affect the galvanometer.
4. RECORDER; a sensitive micro-ammeter or Shaw recorder.
5. CALIBRATOR; a local oscillator, which is used to check on intensity of received signal.
The calibrator must be built accurately and should be well shielded, the one described being placed in a copper wash boiler. Resistances in the circuit are so arranged that accurate calibration can be obtained readily. The process of recording is outlined.

R343.5. ELECTRON-TUBE RECEIVING SET. RECEIVER.
RADIO BROADCAST, August, 1926. pp. 305-309. "Local."
"A High Quality Local Receiver," K. Clough.
This four-tube receiver, designed for high quality local reception, has one stage of r. f., detector, and two stages of a. f. amplification. The individual stages are shielded to minimize undesirable pick-ups. Circuit diagrams and a list of parts are shown for the beginner, everything being given in detail.

R376.3. LOUD-SPEAKING REPRODUCERS. LOUD SPEAKERS.
RADIO BROADCAST, August, 1926. pp. 328-338
"Musical Reproduction Has Improved," A. F. Van Dyck.
A short survey of radio developments, relating in particular to broadcasting and improvements in receiver and loud speaker design, is given. Of the four fundamental parts of a receiver—antenna, tuning system, amplifying system, and loud speaker—the last mentioned has been the last to receive its due amount of attention. However, during the past year, the reproducer has undergone the needed changes, and now meets the specifications required. These changes have also been responsible for the modern phonograph's high quality of reproduction.

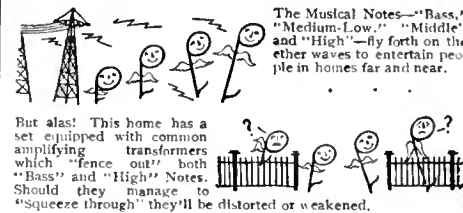

But alas! This home has a set equipped with common amplifying transformers which "fence out" both "Bass" and "High" Notes. Should they manage to "squeeze through" they'll be distorted or weakened.

Consequently, only "Medium Low" and "Middle" Notes pass through with ease, and the program doesn't sound as natural as it would were "Bass" and "High" Notes also present in full volume.

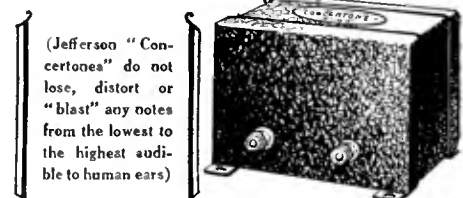

Coming, however, to the home using a pair of Jefferson "Concertone" in the set, the entrance is found wide open to all of the Musical Notes. They pass through without difficulty and are evenly amplified.

(Jefferson "Concertone" do not lose, distort or "blast" any notes from the lowest to the highest audible to human ears)

As a result, all the musical Notes—evenly amplified—come forth in proper unison as they left the broadcast in studio. You too will be very much delighted with the more natural tone and life-like reproduction of your programs. SENSITIVITY is also increased and long distance reception is improved by these new large-size Jeffersons. Only \$6 each at the stores. Install a pair and make your set a 1927 model in quality of tone!

JEFFERSON Concertone
(AL-2 SEALED) AUDIO FREQUENCY TRANSFORMERS
SEND FOR LATEST LITERATURE ★
Other Jefferson Guaranteed Radio Products include: "Star" A. F. Transformers, \$2.75; \$3; Tube Rejuvenators, \$7.50; Tube Testers (for dealers, experiments) \$8, \$9. No. 275 Tube Charger \$3.50—rejuvenates all tubes all at once, in the set. No. 280 Jefferson Tube Charger with large socket only, \$3.50. No. 285 Jefferson Tube Charger with small socket, \$3.50. No. 290 Jefferson Tube Checker, \$6.00.

Jefferson Electric Mfg. Co.
Largest manufacturers of small transformers
507 SO. GREEN ST. CHICAGO, ILL. U.S.A.

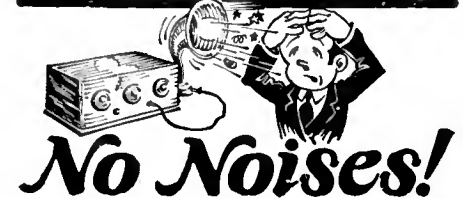

Tones clearer, voices more distinct, and volume greater with—AMPERITE. No moving parts. It brings the utmost out of each individual tube. Specified in all popular construction sets. Price \$1.10.

2 AMPERITES No. 1A
used in the
KING EQUAMATIC RECEIVER
described in this issue.

Radiall Company ★
Dept. R. B.-10 50 Franklin Street, New York City.
Write for FREE Hook-ups
AMPERITE
The "SELF-ADJUSTING" Rheostat

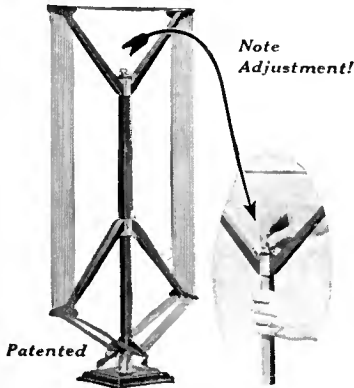

8000 MILE RECORD

The Quali-Tone Loop pictured above holds two World's Records for distant reception, having brought in stations 8000 miles away. Write for verification of these records. Exclusive Thumbscrew Adjustment keeps wires taut always. Guaranteed to improve the performance of any receiver. Price.....\$10



Quali-Tone Units

Quali-Tone DeLuxe Unit is an extremely powerful concert type built to handle extra heavy volume. Finished in black crystal enamel with nickel trimming. Adaptable to any standard make of phonograph or console set. Price \$7.50. Quali-Tone Phonograph Radio Unit. \$6.

QUALI-TONE SPEAKERS

4 Models

Junior

Ideal for portable Receivers. Black crystal finish. 13" high—8 1/2" Bell—Price.....\$7.50

No. 2

Semi-dull black leather finish. Artistic design. Height 15" Bell 10" Price.....\$10

No. 3

Bakelite Bell. Has Quali-Tone DeLuxe Unit. Height 19 1/2" Bell 11 1/2" Price.....\$15

No. 4

The Speaker Supreme—Bakelite Bell—Base finished in dull black morocco leather fashion. Height 22 1/2" Bell 14" Price.....\$25



Quali-Tone No. 4

DEALERS—Write for discounts—JOBBERs
Send for circulars

DURO METAL PRODUCTS CO. Chicago
2657 N. Kildare Ave

Order your copy of *Radio Broadcast* from your news dealer or radio store. Make sure that he reserves a copy for you each month. If your favorite radio store does not stock the magazine write us giving name of radio dealer and address.

Big FREE RADIO
Catalog & Guide
PARTS, HOOK-UPS, SETS and KITS
Send now for this valuable FREE book. Full of advanced hook-ups, parts and kits. A real guide. Shows factory built sets and the new ideas in radio. Send at once. No charge. No obligation. Please include name of radio fan.
BARAWIK CO.
102-109 S. Canal St., Chicago

A Kit Built With a Longing for
PERFECTION

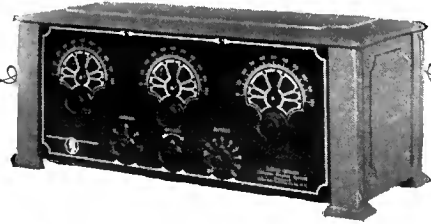

Assembled, Forms Its Own Crackle-Finish
Cast Aluminum Cabinet

HOW often have you wanted to build the most perfect set possible? What a real thrill it would be to put it together and then enjoy with others the very best quality in reception.

You know as well as anyone the way to go about it. You start with the best parts obtainable. You select, if possible, some radio engineer who is also striving for perfection, as your guide as to circuit and assembly. Then you go to it and get "laboratory results."

The Grimes Own Kit satisfies your longing for Perfection. There are no "nearly as good" parts. Every part is of the highest quality.

It is more! More than the most modern embodiment of Inverse Duplex, incorporating the latest improvements in the art. More than 100% shielded and equipped with the new "Greco" control. It is the first kit to form its own artistic crackle-finish cast aluminum cabinet!

Built to last a lifetime—complete including even the tools—no soldering—each wire already

attached at one end! A few connections, a few screws to insert, and it's built. Built with its every phase as near perfect as the Grimes Laboratory knows how. Here is your privilege to "carry on"—to put it together—to strive shoulder-to-shoulder for PERFECTION.

Study These Parts
With Care

- Startling Innovations**
- Entirely new radio-frequency circuit**—assuring equal amplification and super-selectivity over the wave length band.
 - Entirely new radio circuit**—designed for high quality reproduction, including those base notes.
 - Cast aluminum cabinet**—when assembled the Grimes Own forms its own artistic crackle-finish cabinet.
 - New "Greco" Control**—tuned by using either a single control or by special adjusting of all three controls—convenience, plus precision!
 - The First Inverse Duplex Kit ever made.**—two stages of radio, tube detector, and three stages of audio for power tube operation and new 200 A detector.

- Samson Auto Transformers.
- DeJur resistance coupling.
- Benjamin non-microphonic UX sockets.
- Semi-straight line Lind vernier tuning condensers and coils.
- Grimes RF Choke Coil to equalize all wave lengths.
- DeJur Rheostat
- Electrad Potentiometer.
- Drilled artistically etched black and gold metal panel.
- Grimes complete aluminum shielding cabinet.
- Grimes antenna switch.
- Sangamo fixed condensers.
- Acme flexible spaghetti wire in five colors.
- Battery Cable
- Blueprints and instructions.

Send for Grimes Own Working Plans

The coupon is handy. Tear it out. Pin a single dollar bill to it and mail it now. ACT—act for Perfection!

The Grimes Own Kit

100% Shielded
Inverse Duplex

Grimes Radio Engineering Co., Inc.
434 Washington Avenue, Long Island City, N. Y.

Not connected with any other company of a similar name

COUPON

DAVID GRIMES, Pres.
Grimes Radio Engineering Co., Inc.
434 Washington Ave., Long Island City, N. Y.

I want the facts on your latest I. D. S. Kit.
I enclose a dollar bill.
Send me those plans.

Name.....
Address.....

RADIO FANS, a one-year's subscription to *Radio Broadcast* will cost you four dollars, two years six dollars. Consider this expenditure as being a necessary investment on your part for the future development of your own knowledge of Radio.

Make any Good Receiver BETTER
★ **CC TUBES** ★
C.E.MFG.CO. Providence R.I.
Image of a CC tube.

DEALERS
Lowest Wholesale RADIO PRICES
Immediate deliveries from our tremendous stock of new, up-to-date radio sets, kits, parts and supplies. Write on your business letter head for free copy of our 1927 catalog.
COLUMBIA RADIO CORP.
711 W. Lake St., Dept. 804 CHICAGO, ILL.
Image of a catalog titled '1927 WHOLESALE CATALOG Sets Kits and Everything in RADIO'.

BOOKS
in a minute
by **TELEGRAPH**
DOUBLEDAY, PAGE BOOK SHOPS
New York Kansas City Newark Cleveland Toledo St. Louis

Bradleyometer
THE PERFECT POTENTIOMETER
Uses graphite disc resistors which are noiseless and not affected by atmospheric conditions. Metal parts are nickel plated. One hole mounting. Finish and knob match Bradleystat. Made in 200 and 400 ohm ratings.
Image of the Bradleyometer.
Allen-Bradley Co. ★
Electric Controlling Apparatus
278 Greenfield Avenue Milwaukee, Wis.

PRICES CUT

World STORAGE BATTERIES at Cost!



LIMITED TIME OFFER!

For a limited time only, genuine World Storage Batteries can be gotten at actual cost. Every cent of profit has been cut out in order to keep our full factory organization busy during the slack season. Prices below are lowest in history.

World Batteries are nationally known for dependable, long wearing performance. Solid Rubber Case prevents acid and leakage.

Send No Money!

Just state battery wanted and we will ship same day order is received, by Express C.O.D. subject to examination on arrival. 5% discount for cash in full with order. Send your order now and get your World Batteries at actual manufacturing cost.

WORLD BATTERY COMPANY
1219 So. Wabash Avenue Chicago, Ill.

Solid Rubber Case Radio Batteries
8-Volt, 100-Amperes \$10.50
6-Volt, 120-Amperes \$12.50
6-Volt, 140-Amperes \$18.25

Set your Radio Dial for the new 1000 w. World Storage Battery Station W 5 & C, Chicago. Interesting programs every night.

2-Year Guarantee Bond in Writing
Approved and Listed as Standard by Leading Authorities

including Radio News Laboratories, Popular Science Institute of Standards, Popular Radio Laboratories, Radio Broadcast Laboratories, Radio In The Home, and Lefax, Inc.

Solid Rubber Case Auto Batteries
6-Volt, 11-Plate \$10.60
6-Volt, 13-Plate \$12.50
12-Volt, 7-Plate \$15.25

KDKA WSBC WEAF KYW

Big FREE RADIO Catalog & Guide

PARTS, HOOK-UPS, SETS and KITS

Send now for this valuable FREE book. Full of advanced hook-ups, parts and kits. A real guide. Shows factory built sets and the new ideas in radio. Send at once. No charge. No obligation. Please include name of radio fan.

The LATEST HOOK-UPS & RADIO Catalog

BARAWIK CO.

102-109 S. Canal St., Chicago

FAMOUS BH TRANSFORMERS

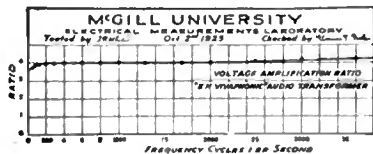
A PERFECT AUDIO AMPLIFYING TRANSFORMER

The BH Vivaphonic is the only transformer having a low loss shield structure (patented.) It is ideal for the Browning-Drake, Universal, Roberts, etc.

BENJAMIN HUGHES ELECTRIC CO.
298 Lagachetiere West Montreal, Can.
Transformer Builders Since 1910

(Continued from page 502)

R382. INDUCTORS. INDUCTANCES, QST. July, 1926, pp. 29-30. "Transmitting Coils," F. E. Handy. Coils of low distributed capacity are needed for frequencies above 3000 kc. (wavelengths below 100 meters), says the writer, especially when using them in transmitter circuits. For that reason, edgewound coils should be avoided, and flat wound coils substituted, since these have a much lower distributed capacity. Five coils, with curves for each, are shown, giving the wavelength range they will cover with a specified variable condenser. The effect of the tubes on the frequency of the circuit when the former are connected, is to change the frequency a little, although this is hardly noticeable at the longer waves.

R138. ELECTRON EMISSION; IONIZATION. ELECTRON EMISSION. Proc. I. R. E. June, 1926, pp. 325-331. "Maintaining a Constant Reading on an Ammeter in the Filament Battery Circuit of a Thermionic Triode," E. H. W. Banner. The distribution of current along the filament of a thermionic valve is not constant, on account of the emission which takes place from the filament to the anode. When the filament is not emitting, ammeters in each filament lead read the same value, but, when it is emitting, they are necessarily different; and, for the usual methods of connection between the anode battery and the filament, these readings are also both different from the non-emitting reading. It is necessary to have a constant reading for comparative tests, and, as the filament current cannot be maintained constant, a circuit has been devised in which there is no change in either ammeter reading when the anode battery is switched on.

R800 (621,353) BATTERIES. A, B, AND C SOURCES OF Proc. I. R. E. June, 1926, pp. 345-372. POWER. "Sources of A, B, and C Power for Radio Receivers," W. H. Holland. This paper describes and gives characteristics of the various present-day sources of A, B, and C power for radio receivers; namely, storage batteries, dry primary batteries, trickle charger power units, and battery substitute devices. The development of radio storage batteries from the earliest types up to the highly specialized radio A and B batteries of to-day, having built-in charge indicators, visible water level, and spray-proof construction, is traced, and information is given on A socket power units containing such batteries in combination with newly developed trickle chargers. Announcement is made of a perfected aluminum electrolytic rectifier. B battery substitutes, embodying this rectifier, are described, and their electrical characteristics are given. Rectifiers and smoothing filters generally, and their application to radio uses, are discussed.

R 600. RADIO STATION. RADIO STATIONS, Proc. I. R. E. June, 1926, pp. 381-389. Power of. "Choice of Power for a Radio Station," N. N. Tsiklinsky and V. I. Volynkin. The cost of a radio station may be looked upon as the combined value of the buildings, the generating machinery, and the antenna with its masts and ground connection. It is shown in this paper that, for a given radio transmission, the necessary power (P) in the antenna, and the effective height (h) of the antenna, are connected by an equation $P = a + bh^2$. By means of this formula, the cost of the antenna and the masts, as a function of their dimensions, may be expressed as a function of the power; hence, all the curves of cost may be combined graphically. The resulting curve of total cost clearly shows that there is some power for which the cost of a radio transmitter is at a minimum. A method is also given for choice of power by which the annual expenses are at a minimum. The methods described above are illustrated by a determination of the power in the antenna and the heights of the masts for a radio station with a range of 3000 km., and operating on an optimum wavelength of 5070 m. (59.13 kc.). In this instance, the power for the least outlay is 30 kw., and, for the lowest annual expenses, 20 kw.

R383. RESISTORS. RESISTORS. Wireless World. (London). June 30, 1926, pp. 892-893. "Some Notes on High Ohmic Resistances," Dr. H. Kroencke. High ohmic resistances of low current carrying capacity are used in radio circuits as grid leaks and coupling units. They should have no inductance or distributed capacity when used in high frequency circuits, which is the case with most units heretofore offered. Doctor Loewke has perfected a resistance unit consisting of a thin metallic film deposited on a short tube of insulating material, by the phenomena of "sputtering," which gives a straight current-potential curve as shown.

R582. TRANSMISSION OF PHOTOGRAPHS. PHOTOGRAPHS BY RADIO. Wireless World. (London). May 26, 1926, pp. 686-688. "Picture Transmission by the Ranger System." The Ranger system of picture transmission, as developed by the Radio Corporation of America, is described. This picture transmission is now in operation between the Marconi wireless stations on both sides of the Atlantic. The system is reliable, and the pictures, either in the form of line drawings or photographs, have reached a high standard of perfection, as is evidenced by the cuts shown. The image for transmission is in the form of a transparency, and is traversed by a pencil of light falling upon a photo-electric cell. Varying currents from the cell control the wireless transmitter, as is seen in the drawing. At the receiving end, an inked stylus traverses the paper in synchronism with the analysis of the picture at the transmitter. There are 128 lines produced to the inch at the receiving end.

R384.1. WAVEMETERS. WAVEMETERS. QST. July, 1926, pp. 31-32. "Short-Wave Wavemeters." Three makes of short-wave wavemeters are pictured and described. These include the General Radio type 358 (range 14-240 meters, with 4 coils), the J. Gross and Co. instrument, (range 20-200 meters, with 2 coils), and the Radio Engineering Laboratories Type A (range 20 to 550 meters, with 3 coils).

(Continued on page 506)



For Types for all mountings
"B" ELIMINATOR
and
C W TRANSMITTER
use
KROBLAK
Wire Wound 10 Watt
RESISTANCES

Sizes 750, 1500, 3000, 3500, 5000, 10,000, 25,000, 50,000 ohms. List Price \$1.00

FOR GREATER DISTANCE
MOUNTFORD
VARIABLE LEAK List Price 50¢

Over a Million in Use
Ask Your Dealer for

Mountford Grid Leaks	Price \$ 25
Mountford Grid Leak and Condenser Mountings	.30
Mountford RC Amplifier Mountings	.60
Mountford RC Amplifiers	7.50
Mountford RC Kits	5.50

Write for Hook-up Booklet
Manufacturers—Write for quotations
Jobbers and Dealers—Write for discounts.

C.E. MOUNTFORD

467 Greenwich St. New York City

This is a good time to subscribe for
RADIO BROADCAST
Through your dealer or direct, by the year only \$4.00
DOUBLEDAY, PAGE & CO. GARDEN CITY, NEW YORK

See that Screw

A screw-driver adjusts an X-L in crowded places



X-L VARIO DENSER

★

RESULTS in easier tuning, more distance, volume and clarity—greater stability. Indorsed by leading authorities.

Model "N" A slight turn obtains correct tube oscillation on all tuned radio frequency circuits. Neutrodyne, Roberts two tube Browning-Drake, McMurdo Silver's Knockout, etc. capacity range 1.8 to 20 micro-micro farads. Price \$1.00

Model "G" With grid clips obtains the proper grid capacity on Cockaday circuits, filter and intermediate frequency tuning in heterodyne and positive grid bias in all sets. Capacity range.
Model G-1—.0002 to .0001 MFD
Model G-5—.0001 to .0005 MFD
Model G-10—.0003 to .001 MFD
Price \$1.50

X-L Push Post. Push it down with your thumb, insert wire, remove pressure and wire is firmly held. Releases instantly. Price 15c.

Push Post Panel permanently marked in white on black rubber. In box including soldering lugs, raising bushings and screws for mounting, etc. Price \$1.50



X-L Radio Laboratories

2424 Lincoln Ave. CHICAGO, ILL.



For the New Type Eliminators

RAYTHEON A B C POWER UNIT
for the 199 tube use

DONGAN Transformer No. 2561

Choke No. 1591

R C A RECTIFYING TUBE AND
POWER AMPLIFIER

for No. 213 use Dongan No. 1587

“ “ 216 “ “ “ 531

Also Dongan B-Power Parts for all
accepted types of Eliminators.

Order from your dealer or send check
to factory.

Type H—Audio Transformer

A super transformer completely in-
closed in black enamel cas.

Ratios 1-1, 2-1, 3½-1 and 5-1

List \$4.50

Dealers—tremendous demand for B-
Eliminators make natural market for
Dongan B-Power Parts, essential in
proper construction of all approved
types. Write for Dongan Dealer
Offer.

Mfrs.—As exclusive parts manufac-
turers Dongan is in position to offer
you latest types in Audio and Elim-
inator parts of the highest quality.
Prices and samples on request. ★

DONGAN ELECTRIC MFG. CO.
2991-3001 Franklin St. Detroit

TRANSFORMERS of MERIT for FIFTEEN YEARS

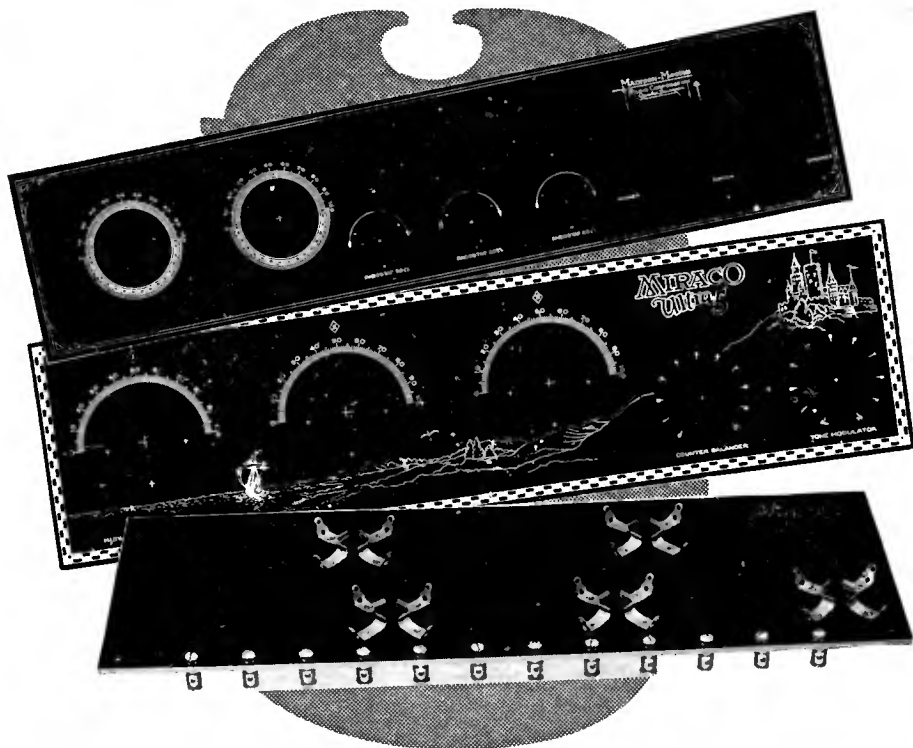

Formica For The Amateur

Formica panels for well known kits Veri Chromed in gold on high gloss Formica are sold by leading dealers and jobbers: Bremer Tully Counterphase; Browning Drake National; General Radio Four Tube Universal; LC 26 Cockaday; Victoreen Superheterodyne; Best's Superheterodyne; Madison Moore Superheterodyne; Camfield Duoformer; Aerodyne 5 Tube; St. James 8 Tube; Icarus Equamatic; Infradyne 7 x 30 and 7 x 28.

THE FORMICA INSULATION COMPANY

4628 Spring Grove Avenue

Cincinnati, Ohio

Hear the
Formica Orches-
tra, Tuesday, 9 to
10, Over WLW.

FORMICA

Made from Anhydrous Bakelite Resins
SHEETS TUBES RODS

Formica has a
Complete Service on
Insulating Material and
Parts for Radio
Manufacturers

Thorola Receivers and Speakers ★ Must Outperform

Reichmann Company, 1725-39 W. 74th St., Chicago



Hoyt CELLCHEK

The HOYT CELLCHEK is a more accurate
and more easily used instrument for obtaining
instantly the condition of separate cells of
Radio or automotive storage batteries. It tests
under load, without removal of filling caps or
the chance of spilling a drop of acid. Three
simple divisions on the Meter Dial show
whether the cells are up, fair, or need re-
charging. Price \$2.50.

Send for booklet R. B.

BURTON-ROGERS COMPANY
Boston Mass.
Notional Distributors

The New Raytheon A,B&C Current Supply

employing new high volt-
age. Raytheon BH Tube
requires Federal No. 25—
1850 ohm Wire Wound
Resistor.

List Price \$1.75

For all types of Power Pack
Amplifiers the Federal No.
25 Wire Wound Resistor is
ideal in standard. It is
used and specified as stand-
ard equipment by Raytheon,
AmerTran and others.

Dealers: We will make shipment
same day your order is received.
(Write for quotation). We have
tried to make it possible for cus-
tomers to obtain delivery through
the distributor, but if he cannot
supply you, we will mail upon
receipt of price.

RADIO JOBBERS, Inc.

142 Liberty St. New York City
(Sole Distributors Federal Products)



IT DELIVERS
FULL "B" VOLTAGE

Burns

B-Battery Eliminator

Operates from lighting current
like other household appliances.
No hum or vibrations. Smooth
constant plate supply. Once
connected it requires no further
attention or adjustment. Re-
markable results on local and
long distance reception.

Popular Price—Write for Data.

American Electric Company
State and 64th Streets Chicago, U. S. A.
Makers of Burns Speakers

Send for ~ Our New 1927 Catalog

Containing complete S-M line and other nationally advertised high-quality sets, cabinets, kits and parts.

Catalog just off the press

Dealers—Use your letter head

Western Radio Mfg. Co.

"The Big Friendly Radio House"

134 W. Lake St.

Chicago, Ill.



SM

Kits and Complete Sets of all SM Circuits

From our large stock, the most complete in the Middle West, we make 12-hour shipment of any SM kit—the Silver Shielded Six; Silver Seven; Silver Knockout; and S-C Four. Also SM Transformers and B-Eliminators.

Our Laboratory builds any standard circuit, or your own design, at from \$20 up, under guarantee based on complete test by our engineer, Geo. W. Van Sickle. Repairs and alterations at low charges.

Get our 1926-27 Catalogue

Full of the newest sets, parts, and kits. All the hard-to-get items that set-builders demand. B-Eliminator parts, power-audio equipment, Sargent Infradyne intermediate, short-wave supplies. Extra-good discounts.

Write for catalogue today.



Dan-Ashe Radio Co.

202 North 10th St. ST. LOUIS, MO.

(Continued from page 594)

R343. ELECTRON-TUBE RECEIVING SETS A PORTABLE RECEIVER FOR FIELD STRENGTH TESTS
Proc. I. R. E. June, 1926. pp. 333-344
"Portable Receiving Sets For Measuring Field Strengths at Broadcasting Frequencies," A. G. Jensen.
A measuring set for use in the field has been developed by the Bell Telephone Laboratories, and is here described. It is built on the principle of the super-heterodyne, with a sensitive meter in the plate circuit of the low frequency detector. A circuit diagram, and the method used in adjusting the set, are given.

R402. SHORT WAVES. SHORT-WAVE OPERATION.
QST. July, 1926. pp. 34-36.
"Progress and Plans at 5 Meters and Below," R. S. Kruse.
Tests conducted between stations at Staten Island, New York (2 EB), and Glastonbury, Connecticut, 1 XAQ, a distance of 120 miles, in order to determine what results could be obtained with 5-meter (60,000 kc.) operation, are related. Circuit diagrams of 5-meter transmitters, receivers, and antenna, are shown. It is suggested that more amateurs and experimenters try out this new wave-band in order to find out what its possibilities are.

R113. TRANSMISSION PHENOMENA. FEEDING THE ANTENNA.
QST. July, 1926. pp. 8-14.
"Feeding the Antenna," R. S. Kruse.
Transmission problems relative to antennas, and methods which may be used in connecting them to sources of energy, are discussed. A groundless antenna operates as a Hertzian oscillator, which is not the case with one that is grounded, the latter operating as an ordinary Marconi antenna. In coupling the antenna to the power source, it will be observed that the three forms, the vertical, the horizontal, and the bent forms, do not give the same results. They radiate differently. All of them have voltage antinodes at the ends, however, and oscillate at either a half wave or multiple thereof.

Two types of feed systems may be employed—current feed (large current at low voltage), or voltage feed (large voltage at low current). In the current feed system, coupling is made to the antenna at the center when operating at the fundamental, two connections being used. In the voltage feed system, connection may be made at one end through a series condenser. Diagram, Fig. 4, shows how either of these systems is used to work an antenna at some harmonic. In the voltage feed system, it is best to couple to the antenna through an inductive reactance rather than a capacity reactance, in order to reduce transmission on harmonics. The r. f. feed line should be kept low and free of standing waves. Mr. L. G. Windom, 8 GZ, 8 ZG, makes some very good suggestions regarding tuning a voltage feed system.

Using a two-wire r. f. feed line for the voltage feed, practically no energy is radiated from the line itself, and little trouble is experienced in making the system work. This two-wire line, used in the current feed system, makes adjustments easier and more flexible. Doctor Alexanderson suggests using a two-wire line which will not radiate together with a tunable antenna (as shown in Fig. 7). In order to have all of the tuning equipment in the operating room, the "Zeppelin" system is suggested as a very good type of voltage feed system.

R281.71. QUARTZ. QUARTZ MOUNTINGS.
QST. July, 1926. pp. 15-16.
"Quartz Crystal Mountings," R. M. Clayton.
Several forms of mountings for quartz crystals are shown and described. These include the method adopted by the General Radio Company, the Bureau of Standards, and the Stamps and Lidbury Company.

R343. ELECTRON-TUBE RECEIVING SETS. RECEIVERS, Short-Wave.
QST. July, 1926. pp. 20-26.
"Short-Wave Receiving Sets," L. W. Hatry.
Reference is made to designs of short-wave receiving sets covering the amateur bands to 1500 kc. (200 meters). The problems relative to methods of filtering the audio transformer output, single- or two-stage; the size and number of coils needed; the tuning of the antenna; the importance of the grid leak and condenser; the regeneration control; the r. f. chokes and the necessary constructional details of the set in general, are all fully discussed.

Italy's Share of International Radio

SOUTH AMERICA'S radio is being developed by a combination of interests of the United States, England, France and Germany. For some time, the large station at Buenos Aires has been in operation in transatlantic traffic and recently the Rio de Janeiro station has been put into commission. Now Mussolini, with his empire dreams, has suddenly awakened to the fact that in South America, his country has not been taken into the radio partnership.

Italy, according to a New York Times correspondent, has been invited to participate in the Rio affair with, however, an entrance fee of \$1,000,000. But Mussolini can't see the price of admission so probably won't get any of the gate receipts.

SM

630

SHIELDED SIX

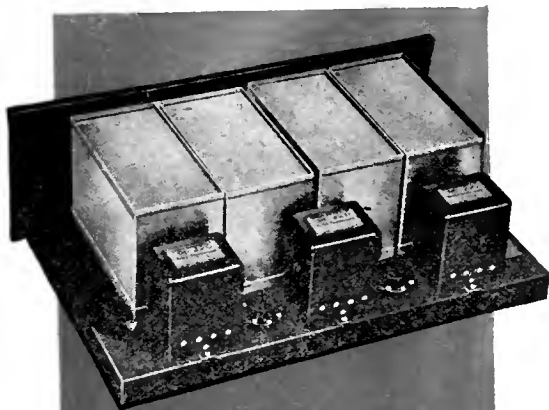

The Outstanding Features

- Individual shielding of all R. F. circuits
- Dual control
- Finest tone obtainable
- Extremely sensitive and selective
- Easy to assemble
- Ease of operation
- Beautiful in appearance
- Low cost
- Permanence

S-M 630 and 633 kits are manufactured by *Tresco* and licensed under Armstrong U. S. Patent No. 1,113,149. Silver-Marshall, Inc., Exclusive Distributing Agents.



220 Audio and
221 Output Transformer

THE Shielded Six is one of the highest types of broadcast receivers. It embodies complete shielding of all radio frequency and detector circuits. The quality of reproduction is *real*—true to the ear.

Behind the Shielded Six is competent engineering. It is sensitive. Day in and day out it will give distance—on the speaker. It is selective. Local stations in the most crowded area separate completely—yet there are but two dials to tune.

These features—its all-metal chassis and panel, its ease of assembly and many others, put it in that small class of ultra-fine factory-built sets priced at several times the Six's cost.

The S-M 630 Shielded Six Kit—including matched and measured parts to build this remarkable receiver—price \$95.00.

The 633 Shielded Six Essential Kit contains four condensers, four radio frequency transformers, four coil sockets, four stage shields and the link motion—all factory matched—price \$45.00.

Clear and complete instructions, prepared by S-M engineers, go with each kit—or will be mailed separately for 50c.

220 AND 221 AUDIO TRANSFORMERS

S-M 220—the big, husky audio transformer you hear in the finest sets—the only transformer with the *rising* low note characteristic that means real quality—not only on paper—but when you hear it. It is a power job—yet this finest of audio amplifying devices is sold, with a guarantee, for but \$6.00.

The S-M 221 is an output transformer that will bring out the low notes on your present set. It should be used between the last audio tube and the loud speaker—it eliminates blasting and will increase speaker capacity for handling strong signals without distortion. \$6.00.

"B" POWER UNITS

These units are particularly designed for all "B" supplies and power amplifier assemblies.

S-M 330 Power Transformer has two 300-volt secondaries, a 110-volt, 60-cycle primary and a 7.5-volt filament lighting winding—\$6.00.

S-M 331 Unichoke—a two winding high inductance filter choke—licensed under Clough patent application—\$6.00.

S-M 332 Condenser Bank—contains 10 1/5 mf. of tapped filter condensers—all tested at 700 volts D. C.—\$10.00.

S-M 329 Power Transformer is similar to 330, except that it is a low voltage type for Raytheon tubes. Primary, 110 volts A. C., two 220-volt secondaries, and a split 5-volt filament winding—\$6.00.



SILVER-MARSHALL, INC.

838 W. JACKSON BLVD. CHICAGO, U. S. A.

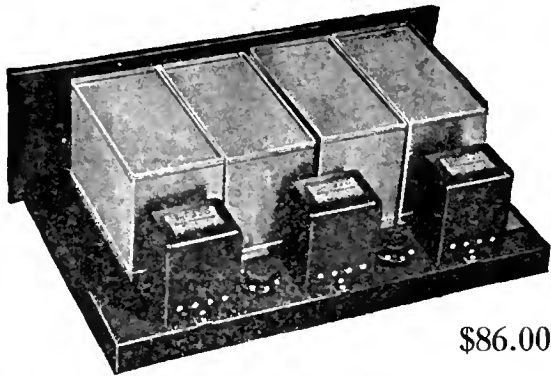

SM
NEW!
SILVER-MARSHALL PRODUCTS

630 Shielded Six

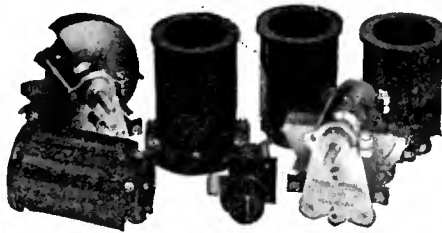

\$86.00

635 Short Wave Kit



\$23.00

**650
 Plug-In
 B
 Wired
 \$39.50**

We have a complete line of the new Silver-Marshall products including the 220 and 221 transformers at \$6.00, the 330 transformer and 331 Unichoke at \$6.00; the 332 condenser bank at \$10.00, all the new coils and condensers and the necessary parts for McMurdo Silver's latest success, the Shielded Six. Send for circular. MAIL ORDERS FILLED. DEALERS SEND 10c FOR CATALOG.

WIRELESS ELECTRIC CO.

206 Stanwix St., Pittsburgh, Pa.
DISTRIBUTORS
SERVICE
ENGINEERS
MAIL ORDER HEADQUARTERS

Radio Dealers

Headquarters for S-M Products

As distributors of Silver-Marshall products, we handle everything in the S-M line—Silver Shielded Six, Short Wave Kits, S-C Receivers and all parts, kits and circuits. Orders shipped same day as received and carefully packed to reach destination perfectly. We specialize in mail orders.

Year 'Round Business Plan

Hook up with our live dealer plan of doing business twelve months of the year. Our merchandise has been selected to keep the radio dealer going at top speed during the busy radio months, with a new line to take radio's place when the season is over. Electrical goods, auto supplies, sporting goods, and a variety of merchandise to keep profits up during every month of the year.

Forget about the dull months—there are none any longer for Braun Company dealers. Get our free 164-page catalog and see for yourself.

Free Catalog--164 Pages of Radio's Best

In this new 1927 edition of our radio catalog and guide you will find the complete S-M line, besides thousands of the necessary radio items required by live dealers—everything worth while in sets, kits, parts for all the new and popular circuits, the newest in power supply units, amplifiers and accessories—all under one roof, ready for immediate shipment anywhere. In addition to the complete general radio line we give exclusive franchises to selected dealers on the famous Monroe line of factory-built radio sets, at prices ranging from less than \$20 for 5-tube sets, up to \$200 complete with cabinets.

Besides radio you will find in this catalog and guide the popular lines of electrical and household goods, auto accessories, etc., that insure profitable business twelve months of the year.

Make Us Your Headquarters

Make us your headquarters and you will save time, money, and effort, for here you can secure all the goods you need from one reliable source and secure liberal discounts and a service unexcelled in the radio field.

Write to-day for the free 164-page Catalog and make comparisons. You'll be surprised at the variety of goods you can secure from one source.

W. C. BRAUN CO.
32-39A S. Clinton St., Chicago, U. S. A.

SM

635

IN THE TROPICS

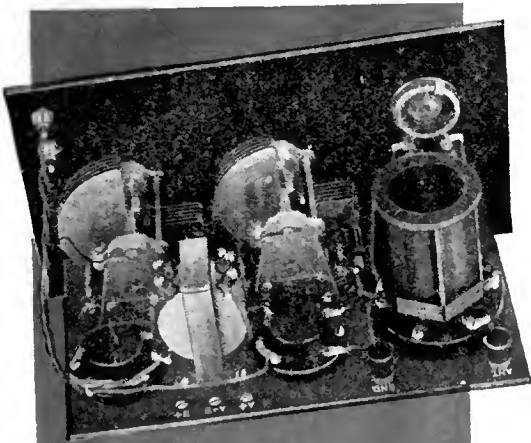

Commander Dyott's Short Wave Receiver

The Outstanding Features

Wavelength range, 18 to 150 meters.

Amateur transmitting bands fall in center of tuning dials.

Distance range practically unlimited.

May be assembled or used with any audio amplifier.

S-M 620 and 635 kits are manufactured by TRESKO and licensed under Armstrong U.S. Patent No. 1,113,149. Silver-Marshall, Inc., Exclusive Distributing Agents.

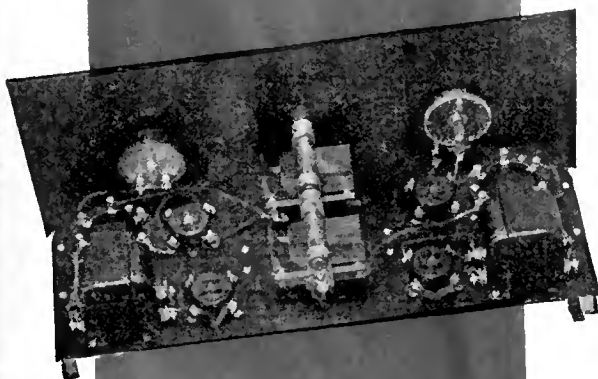

620 S-C Receiver

Commander Dyott on his expedition into the Brazilian Wilderness relied on the services of "Radio Broadcast" for the selection of the radio equipment that would enable him to keep in touch with civilization.

For the Short Wave Receiver—the most dependable and "distance getting" unit—"Radio Broadcast" selected the product of S-M engineers.

The receiver pictured on the left—a Silver-Marshall laboratory development—accompanies this expedition into the tropical wilderness. It is the unit that is most depended upon—when every other means of communication fails, the S-M Short Wave Receiver will still be on the job—depended upon and dependable.

635 SHORT WAVE KIT

This kit contains the essential units—duplicates of those found in Commander Dyott's receiver. It has a wavelength range of 18 to 150 meters with the four interchangeable plug-in coils supplied. The other essentials in the kit—all carefully matched and measured parts—are a coil socket, an antenna coupling condenser and two 140 mmf. tuning condensers. The 635 kit built up using a pair of 220 transformers for audio amplification, making a three tube set will give astounding results on short wave broadcast programs—in summer and also in the daytime. Many stations in America—and in other countries too, can be heard regularly on the shorter waves.

Price of 635 Kit complete with instructions, \$23.00.

620 SILVER-COCKADAY RECEIVER

The S-C single control all wave four tube receiver requires no introduction, for it has been a marked success since early in 1926. It has been endorsed and approved in the editorial columns of practically every prominent magazine and newspaper.

This receiver was designed by Laurence M. Cockaday and McMurdo Silver, assisted by engineers of seven prominent radio manufacturers.

Intended for experienced fans as well as for the absolute novice, it may be built without cutting or soldering a single wire. In its design is incorporated a stage of tuned radio frequency amplification, a regenerative detector and two stages of audio amplification—four tubes in all—either dry cell, storage battery or power types. The wavelength range is 50 to 1500 meters—all with a single tuning control.

The S-C is so simple that any member of the family can operate it, yet its range is up to 2500 miles, its volume ample for home entertainment and its selectivity more than adequate for congested areas.

The 620 kit contains necessary parts exactly as specified by the designers, and the "Key to the S-C Receiver," which explains simply the assembling of the set. Price \$59.25.



SILVER-MARSHALL, INC.

838 W. JACKSON BLVD. CHICAGO, U. S. A.

Digitized by Microsoft®

**EASY TO
BUILD!**

The SILVER SHIELDED SIX

WITH OUR **"READY-TO-WIRE PLAN"**

OUR PLAN WILL SAVE YOU MUCH TIME, WORK AND WORRY

All you need do is to connect bus-bar according to diagram, solder and your set is finished. These parts are sent to you completely mounted and assembled according to specifications and enclosed in a genuine solid Mahogany or Walnut Cabinet. Genuine parts listed below exactly as used Laboratory Models.

- 4 Silver Marshall 631 Stage Shields
- 2 Silver Marshall 316a Condensers (Variable)
- 2 Silver Marshall 316b Condensers (Variable)
- 4 Silver Marshall 515 Coil Sockets
- 3 Silver Marshall 115a Coils
- 1 Silver Marshall 116a Coil
- 3 Carter 200 ohm resistance
- 2 Kurz Kasch zero loft 4 inch dials
- 1 Silver Marshall 275 Choke Coils
- 6 Silver Marshall 511 Tube Sockets
- 2 Silver Marshall 220 Audio Transformers
- 1 Silver Marshall 221 Output Transformer
- 1 Polymet .002 Condenser (Fixed)
- 5 Polymet 1 mfd Condensers
- 1 Silver Marshall 632 Link Motion

- 2 Carter Tip Jacks
- 1 Terminal Strip with Terminals
- 1 Crowe Notal Panel (ready drilled)
- 1 Steel Base (ready drilled)
- 1 Yaxley No. 10 Switch
- 1 Yaxley Special Antenna Switch
- 1 Carter 25000 ohm "II'pot"
- 1 Carter 1/2 ohm resistor
- 1 Polymet .2 megohm resistance
- 1 Polymet resistance Mountings
- 1 Coil of Hook-up Wire
- Assorted screws and nuts.

READY-TO-WIRE KIT PRICE, **\$95⁰⁰**

Completely Wired Sets in Stock. Specially Priced.

SILVER ESSENTIAL KIT

For the SILVER SHIELDED SIX **\$45⁰⁰**

New!

COCKADAY L-C 27 BROADCAST RECEIVER

Exact Parts as used in the Laboratory Model

- 1 Hammarlund mid-line dual condenser, .000275 mfd.
- 1 Hammarlund mid-line single condenser, .000275 mfd.
- 1 Precision Duo-Octoform coil set comprising one antenna coupler and two interstage couplers.
- 1 Amertran De Luxe first stage transformer
- 1 Amertran De Luxe second stage transformer.
- 1 Amerchoke No. 854.
- 1 Dubilier or Tobe 4 mfd. Filter condenser.
- 1 Dubilier filter condenser, .1 mfd.
- 1 Mar-Co illuminated control, scale 0 to 100.
- 2 Mar-Co small controls, scale 0 to 50 and 50 to 0.
- 1 Carter battery switch.
- 1 Sansom radio-frequency choke coil No. 85.
- 4 Aluminum shields.
- 3 Aerovox, mica, fixed condensers, .00025 mfd.
- 1 Durham or Daven Resistor, 4 meg.
- 1 Lynch Grid Leak Mounting.
- 1 Carter Gem Jack.
- 1 Carter variable resistance, 0-10,000 ohms.
- 10 Eby binding posts.
- 1 Binding post strip 1 1/2 x 2 5/8 x 1/4".
- 1 Bakelite decorated panel, 8x 26".
- 5 Benjamin UX sockets.
- 1 Amperite No. 1.
- 2 Tait Brackets.

READY-TO-WIRE KIT PRICE, **\$85⁴⁰**

Completely Wired Sets in Stock Specially Priced.

New!

RAYTHEON A, B, and C ELIMINATOR

Does Away with all Batteries. Set Entirely Operates from Your Light Socket. Exact Parts as specified in Laboratory Model

- 1 Raytheon Tube Type BH
- 1 Ward Leonard 5,000 Ohm Resistance
- 1 Federal No. 25 Potentiometer
- 1 Ward Leonard 3,000 Resistance
- 1 Clarostat
- 1 Bradleyohm No. 10
- 1 Tobe 1,000 ohm Fixed Resistor
- 2 General Radio No. 141 Potentiometers
- 2 Tobe .1 mfd. Filter Condensers
- 2 4mfd. Filter Condensers
- 1 Tobe 6mfd. Filter Condenser
- 3 Tobe 1mfd. Filter Condensers
- 1 0-75 Milliampere Meter
- 2 General Radio Choke Coils 25 Henries while passing 85 Milliampere of D. C.
- 1 General Radio Transformer giving 350 Volts
- 1 Brach Transformer giving 5 Volts at 1/2 ampere
- 1 Socket, Binding Posts, Wire, etc.

COMPLETE KIT PRICE, **\$65⁹⁰**

WE WILL GIVE SERVICE AND GUARANTEE THE OPERATION OF ANY L-C 27 OR SILVER SHIELDED SIX KIT OR SET PURCHASED FROM US,

WRITE FOR OUR INTERESTING SPECIAL CIRCULAR WHICH WE HAVE PREPARED ON THE L-C 27 AND SILVER SHIELDED SIX RECEIVERS

DEALERS SUBJECT TO REGULAR DISCOUNT

AUTHORIZED SERVICE STATION FOR THE L-C 27 and SILVER SHIELDED SIX RECEIVERS

First in the Field
Specializing In
Cockaday Kits

S. HAMMER RADIO CO.
303-A Atkins Ave. Brooklyn, N. Y.

The Newest Circuits
in Set or Kit Form
Always in stock