

RADIO BROADCAST

WILLIS K. WING, Editor

SEPTEMBER, 1926

KEITH HENNEY
Director of the Laboratory

JOHN B. BRENNAN
Technical Editor

Vol. IX, No. 5

CONTENTS

Cover Design	From a Painting by Fred J. Edgars	
Frontispiece	The Firth of Clyde Radio Fog Signal	366
How Much it Costs to Broadcast	Austin C. Lescarbourea	367
The March of Radio	An Editorial Interpretation	372
Higher Efficiencies for Radio Frequency Circuits	Zeh Bouck	377
Getting the Most Out of Your Super-Heterodyne	Kendall Clough	380
Results of the Short-Wave Receiver Contest	A Description of the Best Receiver Submitted	384
Additional Notes on the R. B. Lab. Circuit	Keith Henney	388
The Listeners' Point of View	John Wallace	390
The Importance of Acoustics in Broadcasting	Benjamin F. Miessner	394
The R. B. Impedance-Coupled Browning-Drake Receiver	John B. Brennan	398
"As the Broadcaster Sees It"	Carl Dreher	405
Transformer-Coupled Audio Amplifiers	Alfred W. Saunders	409
"Radio Broadcast's" Laboratory Information Sheets		414
No. 25 Modulation		
No. 26 The Three-Electrode Tube		
No. 27 A Voltmeter Made from a Milliammeter		
No. 28 Calibrating a Home-Made Voltmeter		
No. 29 Tubes: Miscellaneous		
No. 30 Measuring Output Voltage of a Line Supply Device		
No. 31 Distortion in Receivers		
No. 32 Matching Tube and Loud Speaker Impedance		
"Now, I Have Found"		420
A Browning-Drake R. F. Transformer Suggestion		
A Rheostat Sub-Panel for the Roberts		
A Simplified Battery Throw-Over Switch		
Preventing Tube Burn-Outs		
Letters from Readers		424
Who Invented the Microphone?	Clara Louise Leslie	426
A Key to Recent Radio Articles	E. G. Shalkhauser	430
The "Radio Broadcast" Technical Information Service		440
Book Review	Glenn H. Browning	442
How Radio Receivers Work, by Walter Van B. Roberts		

BEHIND EDITORIAL SCENES

THE list of the contents of this magazine, directly to your left, contains, we believe, an extraordinary variety of radio information, and a group of articles as good as has ever assembled in a radio magazine. Austin Lescarbourea's article on "How Much It Costs to Broadcast" gives some news on the cost of broadcasting which the listener has never had available before. Mr. Bouck, a favorite writer with the readers of RADIO BROADCAST, old and new, announces a new system of radio frequency control, made available for the first time to the home constructor. We believe the possibilities of the King Equamatic system are quite large. More will be printed on this interesting subject. . . . Interest in super-heterodynes is by no means dead, and we feel that since so many of our readers are owners of these sets, of one model or another, the article by Kendall Clough containing, as it does, so much genuinely authoritative information on the operation of those circuits, will be of utmost help to the many owners of "super-hets."

FRANK C. JONES'S short-wave prize contest set, should provide a means of entry into the ranks of short-wave experimenting, and, to amateurs who are already familiar with receiving on such frequencies, a set which will give them a circuit suggestion which is extremely inspiring. . . . John B. Brennan, our technical editor, has prepared one of the most complete constructional articles it has been our privilege to present, on the Browning-Drake circuit, using impedance-coupled amplification. This model, while it features unusual standards of high quality amplification, sensitivity, and selectivity, has the predominant merit of being a beautiful constructional job. . . . The paper by Alfred W. Saunders, delivered before a recent meeting of the Radio Club of America, contains some most interesting information on transformer amplification.

RADIO BROADCAST for October will be one of the most interesting numbers ever presented to our readers. It will be the special Metropolitan Shows Number and will contain sixteen pages of extra text devoted to the news of the radio shows of the fall season. The new products of the manufacturers will be completely described and illustrated, and there will be some additional special features of unusual interest to everyone who gives a thought to radio. . . . There have been dismal howls for some time now about monopoly in radio and other indefinite awful things to happen in radio. RADIO BROADCAST has commissioned French Strother, one of the ablest special writers in the country, and the best we could find, to study the entire question of what is to become of radio in the United States. The first of his fundamental and highly important articles will be a feature of this magazine for October. Also there will be descriptions of several excellent receivers and a real wealth of radio information which will make the reading of RADIO BROADCAST essential to all well informed radio folk.

—WILLIS K. WING.

Doubleday, Page & Co.
MAGAZINES

COUNTRY LIFE
WORLD'S WORK
GARDEN & HOME BUILDER
RADIO BROADCAST
SHORT STORIES
EDUCATIONAL REVIEW
LE PETIT JOURNAL
EL ECO
THE FRONTIER
WEST

Doubleday, Page & Co.
BOOK SHOPS

(Books of all Publishers)
NEW YORK: { LORD & TAYLOR BOOK SHOP
PENNSYLVANIA TERMINAL (2 Shops)
38 WALL ST. AND 166 WEST 32ND ST.
GRAND CENTRAL TERMINAL
ST. LOUIS: { 223 NORTH 8TH STREET
4914 MARYLAND AVENUE
KANSAS CITY: { 920 GRAND AVENUE
1 206 WEST 47TH STREET
CLEVELAND: HIGBEE CO.
SPRINGFIELD, MASS.: MEEKINS, PACKARD & WHEAT

Doubleday, Page & Co.
OFFICES

GARDEN CITY, N. Y.
NEW YORK: 285 MADISON AVENUE
BOSTON: PARK SQUARE BUILDING
CHICAGO: PEOPLES GAS BUILDING
SANTA BARBARA, CAL.
LONDON: Wm. HEINEMANN, LTD.
TORONTO: OXFORD UNIVERSITY PRESS

Doubleday, Page & Co.
OFFICERS

F. N. DOUBLEDAY, President
A. W. PAGE, Vice-President
NELSON DOUBLEDAY, Vice-President
RUSSELL DOUBLEDAY, Secretary
S. A. EVERITT, Treasurer
JOHN J. HESSIAN, Asst. Treasurer

DOUBLEDAY, PAGE & COMPANY, Garden City, New York

Copyright, 1926, in the United States, Newfoundland, Great Britain, Canada, and other countries by Doubleday, Page & Company. All rights reserved.

TERMS: \$4.00 a year, single copies 35 cents



the
power
Radiotrons
give
volume
clearly

With any number of tubes, it is generally the last one that stands the strain when the volume is turned up too high. It blasts and chokes and distorts the tone. But the power Radiotrons are made to stand all the strain at that last-tube position. They make possible greater volume—finer, clearer tone.

Dry battery power Radiotron UX-120	Storage battery power Radiotron UX-112
..... \$2.50 \$6.50

Storage battery or A.C. power Radiotron UX-171	Storage battery or A.C. super-power Radio- tron UX-210
..... \$6.00 \$9.00



Research is an important part of RCA business. In transoceanic wireless—and in the tiniest detail of vacuum tube making—RCA continually offers the world new developments in radio. Be sure *all* your tubes are genuine RCA Radiotrons! And keep a spare handy.

RADIO CORPORATION OF AMERICA
NEW YORK CHICAGO SAN FRANCISCO

RCA Radiotron

MADE BY THE MAKERS OF THE RADIOLA

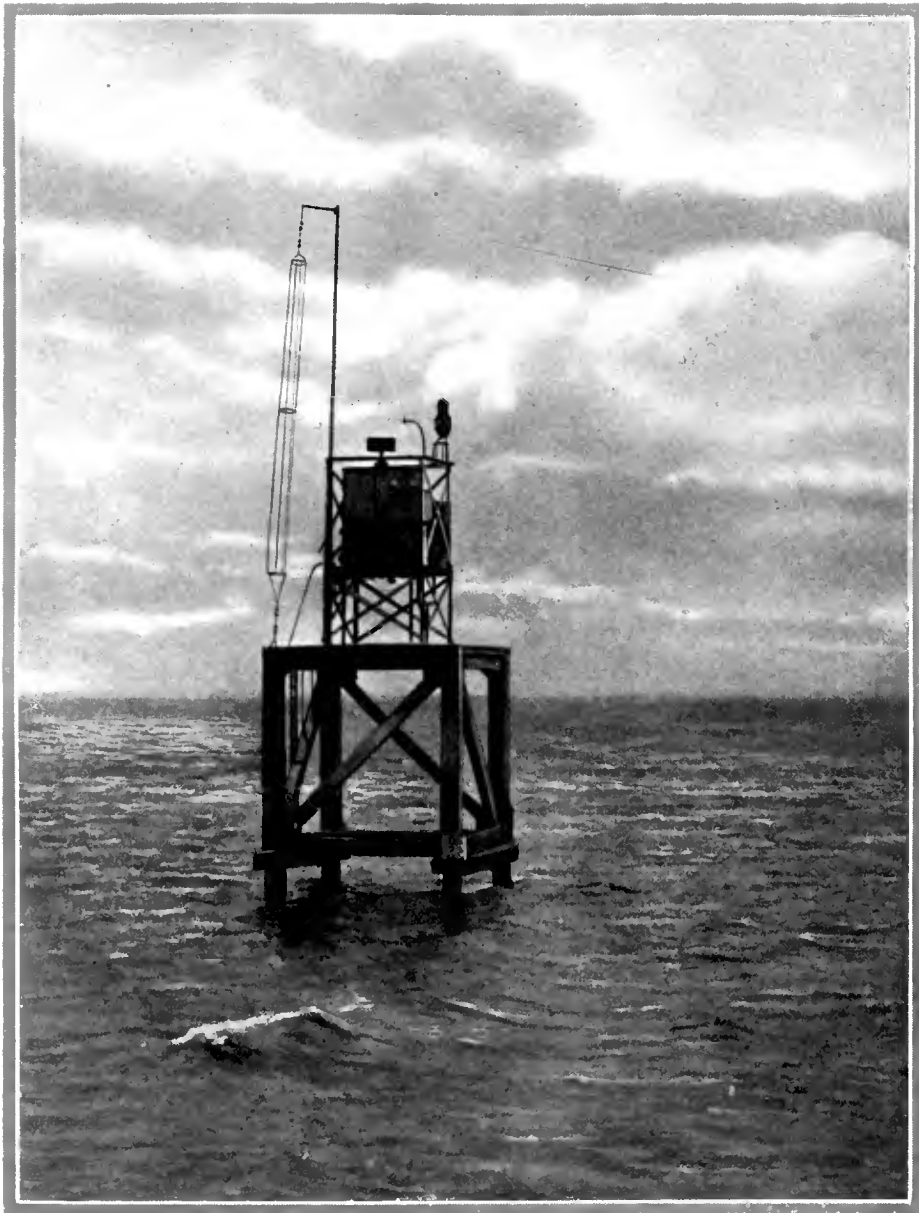

THE RADIO-CONTROLLED FOG SIGNAL AT THE ENTRANCE, FIRTH OF CLYDE

This Scottish fog signal is said to be the only radio-operated signal in existence. A transmitter on shore, a mile and a quarter away is used to send out a special signal which starts or stops the fog "gun". The starting and stopping radio signals are of different frequencies. The receiver comprises a two-tube unit for detecting and amplifying the incoming signals, and a two-tube unit for operating a moving coil relay. The receiver is entirely self-contained and needs attention only once in three months for battery recharging and tube replacement

RADIO BROADCAST

VOLUME IX



NUMBER 5

SEPTEMBER, 1926

How Much It Costs to Broadcast

*The Good-Will Program Is Solving the Problem of Who Is to Pay for Broadcasting—
In 1921 and 1926—Looking at Programs from the Other Side of the Microphone*

By AUSTIN C. LESCARBOURA

IT WAS a most pleasant evening after all. True, the trip to Newark, on the other side of the renowned Jersey Meadows, was somewhat tiresome for one residing up and across the Hudson River. Yet, to compensate for all that, I was met at the Tube Terminal by a private limousine, swiftly borne to the best hotel, entertained and dined by the cordial staff of mine host, motored to the broadcasting station located in a corner of a vast factory building, and introduced to an invisible audience with much flourish of vocal trumpets. The thing addressed seemed like nothing so much as a tomato can dangling from an adjustable support. I was given all the time in the world to say what I had to say—there was nothing else to fill out the allotted time of the station that evening except the hard working automatic piano—and then complimented, given an opportunity of calling my home and various friends to learn how my voice had gone over, offered refreshments, and then conveyed in regal state back to the Tube Terminal amid a shower of thanks. The next day, and for several days thereafter, I was veritably deluged with letters, telephone calls, telegrams, and personal calls, congratulating me on my radio talk and urging me to go before the microphone again at an early date!

And now, as the novelists say, six years have elapsed since the foregoing-mentioned experience, which took place late in 1921, when broadcasting was in its very infancy.

Once more I feel a radio talk coming on, and so I hasten to one of the largest local broadcasting stations to seek a place on the air. I am met by a bright young lady—the assistant program director, so I am told. I state my purpose. She smiles pleasantly despite her serious tortoise shell glasses. "It's a very good subject," she says, "and well worth putting on the air. Now let's see, we could book you for September 15th, just about nine weeks away at 11:25 in the morning, between the Mixum Soup Kiddies feature and Professor Bedingus's talk on the food values in noodles. Or if you

prefer the afternoon, we have an opening still left in our October schedule—yes, here it is, October 23rd, at 3:15. If you prefer the evening, we have an opening still left in our January schedule, yes, January 17th, at 7:15. No doubt you already know our rates, but here is a rate card and our short form contract. You will note, the morning talk is \$100.00 for ten minutes. The afternoon talk is \$150 for ten minutes. The evening talk is \$200 for ten minutes. Of course we must have a copy of your speech a week in advance. What's that? Do we pay you for the talk? Oh, you jollier! No indeed, you pay us for the privilege of speaking to our invisible audience. But getting back to all seriousness, I may put you down for—?"

The conversation terminated then and there.

We simply fled from the palatial studio office and sought solace in the big crowds milling about the busiest thoroughfare of Old Gotham, gradually regaining our normal senses once more.

That experience, however, aroused our curiosity. Was this station typical of the policy now pursued by the five hundred or so other stations scattered from one end of the country to the other? That we determined to find out at first hand; and accordingly, we launched into an extensive investigation of the broadcasting situation, addressing questionnaires to large and small stations alike, calling in person on many broadcasting directors, and listening-in on the programs of stations both near and far. All of which has resulted in a vast fund of information which, boiled down, predigested, and seasoned with personal opinions and deductions, constitutes the following essay.

BROADCASTING IS PAYING ITS OWN WAY

THE sum total of the survey is simply this; broadcasters have found a ready means out of their economic difficulties. Broadcasting is no longer a free service. While it may seem quite bizarre for twenty-five to thirty million persons to be served royally in their homes, day in and day out, with a procession of entertainment such as would make even old King Solomon turn green with envy, there is nevertheless nothing free about it. Someone is footing the bill in order to place certain ideas before the public in their very homes, while the public, in turn, is expected to repay for the programs by patronizing certain products in preference to all others. Broadcasters, in the main, have ceased to be philanthropists and, if anything, are fast becoming prosperous purveyors of sugar coated publicity served in a most palatable style at the home fireside. Perhaps no better proof of all this is to be found than in the fact that six hundred or more applications are pending for broadcast licenses. They are likely to be pending for a long while, since the air is already crowded with the voices of well over 500 broadcasters. And when have we



"GOOD WILL FEATURES"

The "Happiness Boys," Billy Jones and Ernest Hare, who are heard from WEAJ "every Friday night at eight." These two excellent popular singers have been a feature of an indirect advertising program with this station for a long time and are an excellent example of well presented, frank advertising

heard of a waiting list for a philanthropical service!

Rising costs and strenuous competition have been responsible for the advent of commercialism in broadcasting. It costs plenty of money to keep the air filled with programs, especially on a daily basis. Figures? Well, there is a leading broadcasting station, covering a large section of the country, which operates at a monthly cost of close to \$30,000, including the bills of the musicians, staff, electric service, and plant. Multiply that by twelve and you have \$360,000 for the year! A department store, operating a powerful broadcasting station, estimates its yearly operating costs at close on to \$60,000! Even the modest broadcasting station, of limited power and mediocre programs, must cost upward of \$25,000 a year. And then there is the heavy investment for the equipment which may run anywhere from \$10,000 to a \$1,000,000 or more for the latest high-power stations, at a rate of obsolescence which is positively appalling.

Little wonder, therefore, that broadcasters, realizing the futility of collecting funds from the radio audience, despite several pleas at spasmodic intervals in the past, have sought to solve their economic problem by collecting at the microphone end. At first it was the general belief that the operating expenses of broadcasting stations could be derived from the sale of radio equipment, but unfortunately, no manufacturer and not even a group of manufacturers could afford to broadcast throughout the entire country day in and day out in return for the sale of radio receivers and radio accessories. Existing receivers, some of them several years old, have long since received their quota of broadcasting many times over. The situation is quite like that which would result if automobile manufacturers sold their cars at the usual prices, and then offered to build more and more roads and maintain them in the best condition as a perpetual obligation to the purchasers. But automobile manufacturers make no promises regarding roads and do not support the cost of the roads. Others pay for the roads. And so with broadcasting; others pay for the programs, so that the public may ride the air waves.

YOU CAN'T ORDER 'EM TO BUY—ON THE AIR NOW, the regulations of the Department of Commerce, as applied to radio broadcasting, prohibit direct advertising of any kind. However, genteel publicity is by no means prohibited, hence we have many shades of publicity, ranging all the way from the mere sponsoring of an excellent musical program, to that very naked publicity talk which bor-

IN MARCH, 1925, RADIO BROADCAST awarded a prize of \$500 for the best answer to the question, "Who is to Pay for Broadcasting?" The winning plan provided for an indirect tax on the listener administered by the Government. But it was not genuinely practical because listeners feel, rightly or wrongly, that when they buy their equipment, their obligation to pay for anything is ended. The broadcasters were wondering about it all, too, but while speculation was rife, they quietly realized that they had something immensely valuable to sell, and that was their audience. They are selling it, and so wisely is "time on the air" being vended that not a complaint does one hear from listeners. RADIO BROADCAST commissioned Mr. Les-carboursa, formerly managing editor of the Scientific American, to find out what broadcasters were charging for their time and how commercialism was working with station and listener. This interesting article is the result. Facts gathered from every station in the United States are the basis for this story, which is, as far as we know, the first authoritative presentation of how broadcasting is paying for itself.—THE EDITOR.

ders so close on direct advertising that a jury must be sworn in to pass upon the evidence, while a judge must interpret the findings and render a final verdict. In fact, it may be said that advertising is not advertising when it is broadcast, for it now becomes "good will publicity!" A very flexible term, that! It seems to cover a multitude of sins.

Good will publicity, as interpreted by the leading broadcasting stations of the country, is by no means objectionable to the public, even to those who abhor that very necessary phase of modern commerce called advertising. Thus, good will publicity takes the form of excellent musical programs, rendered by highly paid musicians, preceded and followed by announcements to the effect that they are sponsored by such-and-such firm, who are the manufacturers of such-and-such product. Sometimes the announcement is worded in some other manner, such as "through the courtesy of"; but in any event, the public is told in no uncertain terms who is footing the bill and to whom it is obligated.

An analysis of the broadcasting stations of the country indicates seven broad classifications, according to their avowed purpose:

- (1) Commercial or toll broadcasting stations, which are in business to make such money out of broadcasting as there is to be made.
- (2) Individual publicity stations, operated by department stores, newspapers, radio companies, and other commercial institutions for the purpose of building good will for the owner, but not accepting outside pay for broadcasting.
- (3) Educational broadcasting stations, operated by colleges and schools as a means of extension study and lectures to the radio audience.
- (4) Agricultural broadcasting stations, operated by agricultural colleges and other institutions for the purpose of disseminating agricultural talks, crop reports, weather forecasts and so on, to rural audiences.
- (5) Religious broadcasting stations, operated by churches and religious societies and organizations for the purpose of spreading religious ideas.
- (6) Private broadcasting stations operated by individuals for the sheer pleasure of broadcasting.
- (7) Experimental broadcasting stations, the purpose of which is self-explanatory.
- (8) Governmental broadcasting stations, operated by Federal, State, or municipal government for the purpose of providing citizens with civic information, police reports, local entertainment and so on.

Despite the divergent purposes of these eight classifications, they have one point in common: they are all bent on selling something, whether it be a product or a religion, agricultural idea or interest in economics, better voice transmission or the name of the owner. All broadcasting stations are operated for pay, but it is just a question as to who foots the bill. In some instances, the owner of the station assumes the burden of the cost; in others, the owner leases part of his broadcast facilities in return for pay with which to support the operating and maintenance cost, as well as the cost of suitable program features.

Broadcasters are not entirely agreed upon the matter of who is to pay for their services. Some broadcasters deride the idea of paid programs or sponsored features. Others are keenly in favor of paid programs. Yet, if we read between the lines, we note that it is simply a matter of whether the owner of the station derives sufficient publicity value or educational value from the broadcasting to foot the bill himself, or whether he must go out and get help from others not only to foot the bill but also to fill his programs with worthy material. One thing is certain; the sponsored program is the solution of the old, old question, "Who is to pay for broadcasting?"

HOW PROFESSIONAL PROGRAMS CAME TO RADIO

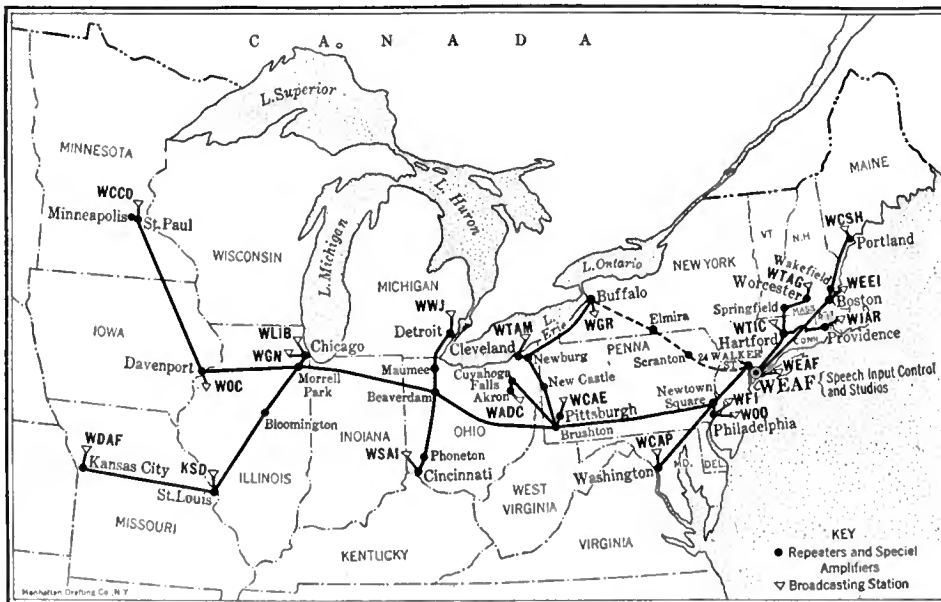

HOW COMMERCIAL PROGRAMS REACH A PART OF THE NATION

Many well established commercial "courtesy programs" are broadcast, originating from WEAF, in New York, and furnished to the broadcasting stations indicated on this outline map. Officials of WEAF assert that these programs reach 52.2 per cent. of the population of the United States. The chart shows the main telephone "repeater stations" through which the telephone lines pass. The programs are stepped up in volume before delivery to the tubes at each distant broadcasting station

SPONSORED programs provide the best professional talent, since there is money available to attract such talent. No



RADIO BROADCAST PHOTOGRAPH

THE CORRESPONDENCE DEPARTMENT OF WEAF

At this station, from 2000 to 3000 letters are received daily and sorted into the following groups: departmental, addressed to client, addressed to artist, addressed to WEAF. The first three groups are forwarded unopened, the fourth being opened, analyzed, and charted and excerpts made for the commercial client. Every letter is carefully read and the suggestions and praise noticed

longer is the broadcaster obliged to beg, coax, and promise the world to singers and musicians. Also, no longer need the broadcasting studio be an amateur theatrical proposition, with a never-ending procession of well-meaning amateurs whose musical efforts are a severe strain upon the nerves of the radio listeners.

The transition from amateur programs to professional programs has been so gradual that radio audiences have failed to realize the vast change that has taken place in the services of the leading broadcasting stations. Yet to-day, the typical leading stations have mostly professional talent appearing before their microphones, with just a sprinkling of carefully selected amateur talent. In fact, to be permitted to appear before the microphone of a good station is as much as an endorsement of one's musical ability, these days. And the advent of professional talent on the programs of the leading stations has caused those stations to command more and more attention from the radio audience, with the result that the amateur efforts of the smaller stations are becoming increasingly neglected. If, indeed, broadcasting is a question of the survival of the fittest, the professional programs of the leading stations, as contrasted with the amateur and crude programs of most of the smaller stations, will be the determining factor, although the writer is of the opinion that there will always be room for both extremes, just as in everything else.

It is reported that the typical leading stations have 80 per cent. of their programs devoted to good will publicity features—paid features, in other words. Yet no direct advertising is permitted. The broadcasters are not permitted to quote prices or anything of a definite advertising nature. Short talks are permitted, but these must be of an exceptionally interesting nature, with only a very general bearing on the business of he who foots the bill. Often the only tie-up is in the title of the speaker and the general trend of his talk. Such talks are limited to 15 minutes at the most. Experience has proved that longer talks will not hold the average radio listener. Of prime importance is the fact that the radio listener has a wide choice of radio programs at his disposal, and the mere flip of a dial will shut off any undesirable matter. Not only is this fact of importance to the sponsor of a given program feature, but also to the station itself, since that station must cultivate a steady audience if it is going to maintain its position in broadcasting. The situation is quite analogous

to the publishing business, where circulation is one of the supreme tests of goodness.

So it is that the sponsored musical program is to be preferred to talks. In the case of the leading broadcasting stations, the musical features must be of the very best. The announcements give just a brief mention of the sponsor and the sponsor's product. Sometimes, and quite effectively, the musical programs are identified with the sponsor and the product by an ingenious play of names. Again, the nature of the musical programs may have a special bearing on the product. All of which is quite obvious to all who listen-in to the present-day offerings.

BROADCASTING COSTS MONEY

NOW, there are two factors involved in good will publicity programs; first, the musical feature itself; secondly, the time or space on the broadcast program. In the case of commercial or toll broadcasting stations, the client is expected to pay for the musical feature in the first place, and pay again for the allotted time on the broadcast program. On the other hand, there are leading broadcasting stations to-day which do not charge for the allotted time but insist on the very finest musical features being supplied by those seeking good-will publicity.

"What, a female quartette!" exclaimed the program director over the telephone, while we were sitting in his office. "Nothing doing! You will have to put on at least a seven-piece orchestra that night, if you want to get in on our program. It wouldn't be fair to our other clients. No sir! Nothing doing on that female quartette! If you wish, I can fix you up with a good male quartette—that always pulls well with our audience. But that will have to be on a regular schedule."



ANNOUNCERS WHO ARE KNOWN TO HALF THE COUNTRY

Graham McNamee, right, and Phillips Carlin. Mr. McNamee usually announces the Eveready Hour, broadcast by WEAF and many other stations every Tuesday at nine P.M., eastern time. Mr. Carlin officiates during the Silvertown hour. These two excellent announcers have probably given the necessary details for more of the conventional commercial programs than any other two announcers in the country



RADIO BROADCAST PHOTOGRAPH

THE SALES STAFF OF WEAF

Holding one of their weekly conferences. A large sales staff has been built up by this station, whose activities are similar to those of advertising salesmen. They really sell "time on the air." Payment for this time is helping to solve the often-asked question, "Who is to pay for broadcasting?"

And we learned, during that visit which had been interrupted by the phone call, that program directors are particular folk. It seems that in the case of stations that do not charge for their time, but enjoy the highest reputation, that they are even more fussy as to what they'll accept. In this particular case, the program director has a card index of musical talent available at any time. The same artists are used by different organizations, for that matter, although to the radio audience they are the Dixie Boys for this hour, the Arctic Babies for the next, the Coal Miners' Quartette for another hour, and the Spanish Serenaders for still another hour. These appellations are purely fanciful, of course, but serve to convey the idea. To cite an actual example, a well-known group of versatile musicians was serving a musical concern in an hour's broadcasting feature once a week. Then the musical concern decided the bill was too high, and forthwith departed for another station where the musical standards were of a far lower order, substituting a much cheaper musical talent. Meanwhile, the well-known group of musicians became the such-and-such railroad boys so far as the radio audience was concerned, bringing just as much fame on the new sponsor as for the old. Just a little inside stuff, that!

Smaller broadcasting stations do not seem to be so particular as regards their broadcasting features—but then, they have less at stake. There are some small broadcasters now handling publicity talks which border closely on direct advertising, so much so, in fact, that one knows not whether to call it advertising or publicity. One Western station, for instance, broadcasts a shopping service in the morning and evening, mentioning definite stores, articles, qualities—well, everything but the price. And that is typical of the extent to which some broadcasters have gone in the way of collecting pay for their efforts. Unfortunately, it is a fact that only the largest concerns can see the value of genteel publicity, while the smaller firms will insist on inserting everything, even down to the names of the firm members, where they were born, the size of the plant, the amount of business done and other details of interest to no one else but themselves.

If there is any danger threatening the good will publicity activities of broadcasters, it is in the efforts of some of the lesser broadcasters, who, soliciting the smaller advertisers, are only too willing to promise everything in the way of microphone freedom. However, the radio public, no doubt, can well differentiate between good stations and poor stations, so that in the long run those who abuse good will publicity may only be signing their own

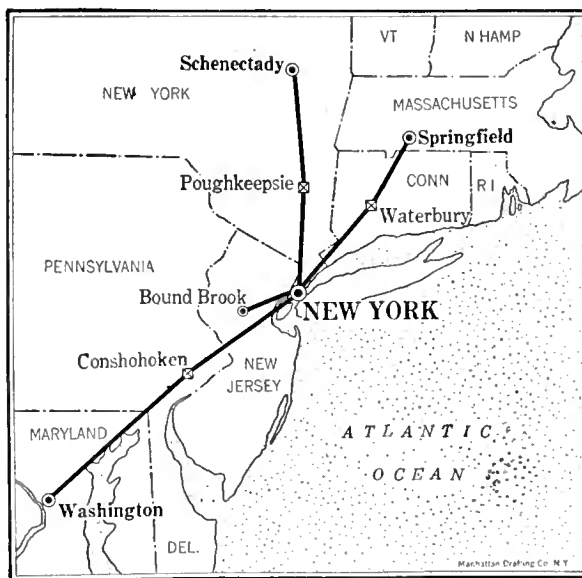

THE RADIO CORPORATION "CHAIN"

Programs which originate from the wjz studio are frequently distributed to other stations indicated on the map. Repeater, or stepping up, stations are indicated where the program, forwarded by wire, is increased in volume by amplifiers. In addition to WGY and WRC, WCAD, WBZ, KDKA, and KYW are sometimes included in this group

death warrant, thereby conferring a benefit on the radio broadcasting field as a whole.

Successful good will publicity via radio is an art, and should accordingly be left to artists. Broadcasters tell us that their experience has taught them that programs prepared by advertising counsellors or even stage directors, and then submitted to the studio staff for censoring and suggestions, are generally successful and fruitful of results for their sponsors. On the other hand, hit-or-miss, hurried-up, crudely prepared stunts are usually wasted effort before the microphone.

Hoggishness is fatal in good will publicity over the radio. Typical of this point is the case of a contracting firm which had arranged to sponsor the initial appearance of a well-known

operatic star before the microphone. Instead of the usual sponsoring introduction, the president of the contracting firm spoke for almost half an hour, telling the invisible audience of the size of his firm, how many jobs they handled, the number of men on their pay roll, how much lumber they employed in the course of a year, how many nails, and so on, almost without end, finally stepping aside most graciously so that the prima donna might do her bit. Needless to say, most of the audience, long since disgusted, had gone on to other programs. The sum total was, in the vernacular, "a flop!"

In radio good will publicity, as in other forms of advertising, the well-known saying "Keeping everlastingly at it brings success," holds true. Thus the most successful radio publicists are those who come back week after week, at the same time and day, with a distinctive program. The radio audience is thus trained to look forward to a given program time after time, and a close bond of friendship is established between the public and the sponsors of that program.

As for the tangible results of broadcast publicity, they are not altogether so vague as to be questionable. In fact, the regular radio publicists have had excellent results, not only in the widespread response to their efforts but also in the increased sale of their products or services. Some radio publicists report that their salesmen have received a far more cordial reception when calling on the trade or the public, as the result of the personification of their products over the radio. Well, be that as it may, it must pay; otherwise, we should not be hearing the same sponsors with their excellent programs week after week.

When something is given away, even if it is only a booklet, let alone samples, the broadcasters are virtually flooded with requests, attesting to the widespread influence of radio.

The two greatest factors in the furtherance of radio good will publicity are the chain system of broadcasting and the high-power broadcasting stations. On the one hand, the radio publicist is offered a number of different groups of radio listeners, reached through an equal number of broadcasting stations tied into one studio by means of telephone lines, while on the other, the radio publicist is offered one vast audience by means of high-power broadcasting. The Broadcasting Company of America chain, for instance, represents the leading exponent of the chain system of broadcasting. Upward of fifteen stations are included in this chain if desired, reaching all the way from New York to Boston to Minneapolis and to St. Louis, with many points between.

BROADCASTING COMPANY OF AMERICA

CHARGES FOR NETWORK STATIONS FOR HOURS AFTER 6 P. M.

The individual charges apply only when all the stations available in the network are taken

	CHARGE PER HOUR	CHARGE HALF HOUR	CHARGE QUARTER HOUR	CHARGE FOR 10 MIN.
WEAF, New York	\$480.00	\$300.00	\$187.50	\$240.00
WEEL, Boston	350.00	218.75	136.72	175.00
WCSH, Portland	170.00	106.25	66.41	85.00
WTAG, Worcester	170.00	106.25	66.41	85.00
WJAR, Providence	170.00	106.25	66.41	85.00
WGR, Buffalo	230.00	143.75	89.84	115.00
WFT or WOO, Philadelphia	210.00	131.25	82.03	105.00
WCAP, Washington	200.00	125.00	78.13	100.00
WCAE, Pittsburgh	210.00	131.25	82.03	105.00
WTAM, Cleveland	180.00	112.50	70.31	90.00
WWJ, Detroit	230.00	143.75	89.84	115.00
WSAI, Cincinnati	240.00	150.00	93.75	120.00
WLIB or WGN, Chicago	350.00	218.75	136.72	175.00
WOC, Davenport	170.00	106.25	66.41	85.00
WCCO, Minneapolis	250.00	156.25	97.66	125.00
KSD, St. Louis	250.00	156.25	97.66	125.00
WDAF, Kansas City	220.00	137.50	85.94	110.00
	\$4,080.00	\$2,550.00	\$1,593.77	\$2,040.00

NOTE: The daytime charge—before 6 P. M.—for groups of stations is one-half of the evening charge for a like period of time. The ten-minute periods are for talks only.

DISCOUNTS FOR DURATION OF CONTRACT BASED ON WEEKLY USAGE

6 months	5%
9 months	10%
12 months	15%



THE BONNIE LADDIES

Who broadcast over the wjz group of stations. wjz, unlike the WEAf group does not now accept pay for the indirect advertising programs they broadcast. In essence, the programs from the Radio Corporation group are quite similar to those presented over the A. T. & T. chain, except that no charge is made by these stations for their time

The Radio Corporation of America, on the other hand, operates the powerful wjz station at Bound Brook, New Jersey, some forty miles west of New York City, by direct wire from the studio in the metropolis. High-power wjz delivers reliable signals as far as the Mississippi River, thus covering a goodly part of the same area covered by a number of moderate-power stations of the chain system. Furthermore, wjz is connected by wire with the high-power station at Schenectady, and several other stations throughout the country, thus ensuring nation-wide distribution of programs when so desired.

The reason why chain systems and high power stations have a marked influence on radio publicity is simply due to the millions upon millions of listeners reached through such a medium. Imagine an audience of ten millions! Fantastic, to be sure, yet a nightly occurrence in chain work and high-power work. Little wonder, then, that the radio publicist can afford the highest kind of talent, since pro rata, on the basis of broadcasting stations participating or per listener, the cost is even less than is the case with the individual, low-power broadcaster. And here is the explanation of the appearance of the world's leading artists before the microphone: never before have they performed for such audiences—and incidentally, never before has the sponsor got his name before such a large and appreciative audience.

HOW MUCH DOES IT COST?

SO FAR, so good. But how about the dollars and cents involved? It is a matter of interest to note what the sponsors pay for broadcasting our musical programs.

The rates charged vary largely, depending on the power of the station, the importance of the area, the time of day, the day of the week, whether it is a single feature or a regular series, whether it is good music or simply talk, and so on. Let us not forget to mention, once more, that many leading stations do not charge for the allotted time, but insist on the best musical programs sponsored by others. At present we are dealing with the toll charges for the allotted time, with whatever charges there may be for the musicians.

New York rates lead the rest. It costs \$600.00 per hour to broadcast a sponsored program from one of the leading stations in that city, or \$375.00 for half an hour, during the late

afternoon and evening, which constitute the best part of the day so far as the largest and most attentive audience is concerned. The morning charges are \$300.00 for an hour, \$117.19 for half an hour. A ten-minute talk costs \$150.00.

Chicago follows close on the heels of New York, with \$350.00 for an hour and \$218.75 for half an hour, with a wire connection from the New York studio. Most of the other large cities command \$200.00 or \$250.00 for an hour, and \$125.00 or so for half an hour. The smaller cities drop down to \$150.00 for an hour, and \$93.75 for half an hour. All these rates are based on chain broadcasting, operating from the New York studio. The rates of the individual stations, broadcasting from their own studios, are considerably less. Take, for instance, a Buffalo station, whose chain rate is \$200.00 for an hour and \$125.00 for half an hour. The individual rate becomes \$120 per hour and \$60 per half hour, thus indicating the additional expenses involved in the chain operation.

On the other hand, some stations charge the same rate whether engaged in chain work or individually. All these rates are, of course, exclusive of talent.

Getting down to some of the smaller stations of modest power, it is interesting to note that the prices are as low as \$12.50 per hour. In fact, the rate cards—yes, they have rate cards, just like publications!—disclose an interesting analysis of the relative importance of the radio audience from early morning till late night, with corresponding charges. Thus, in the case of a Western broadcaster, his rates are; from 9-12 in the morning, \$12.50 per hour; 12-3 P.M., \$16.00; 3-6, \$18.00; 6-8, \$30.00; 8-11 (the cream of the program) \$36.00; 11-12 M. \$28.00.

Most broadcasters undertake to furnish the musical talent at

what is purported to be cost. One broadcaster, for instance, on his very explicit rate card, charges \$250.00 per hour from 6-8 P.M.; \$400.00 per hour from 8-11; and \$200.00 from 11 to 1 A.M., including the music. The choice of the following is offered:

- 1.—Classical or semi-classical musical programs by string quintette.
- 2.—Popular or semi-classical program by 4-piece concert orchestra and 2 singers.
- 3.—Musical program by male quartette and pianist.
- 4.—Musical program by quartette and solo numbers by mixed quartette and pianist.
- 5.—Dance program by 6-piece jazz orchestra. Remote programs cost \$35.00 more for the first hour.

As a general thing, the day rate runs about 40 per cent. less than that of the evening.

All in all, the business end of radio publicity seems very well organized, following closely that of the periodicals in soliciting advertising. We have seen elaborate charts prepared by broadcasters, indicating just what territories are covered by strong, reliable signals, secondary territories covered by fair signals most of the time, and tertiary territories covered under the best possible conditions.

Paid broadcasting is here to stay, if we read all signs correctly. It is the logical way to pay for broadcasting under our present system. For the most part the public seems well satisfied to accept sponsored programs and to reciprocate by extending its good will to those who make possible the wonderful programs of to-day.

BROADCASTING COMPANY OF AMERICA

CHARGES FOR STATION WEAf FOR HOURS AFTER 6 P. M.			
CHARGE PER HOUR	CHARGE HALF HOUR	CHARGE QUARTER HOUR	CHARGE FOR 10 MIN.
\$600.00	\$375.00	\$234.38	\$300.00

NOTE: The daytime charge—before 6 P. M.—for Station WEAf is one half of the evening charge for a like period of time. The ten-minute periods are for talks only.

DISCOUNTS FOR WEEKLY USAGE

Less than 13 consecutive weeks	Net
13 to 25	7½
26 to 38	10
39 to 51	12½
52	15

Charges subject to change without notice.

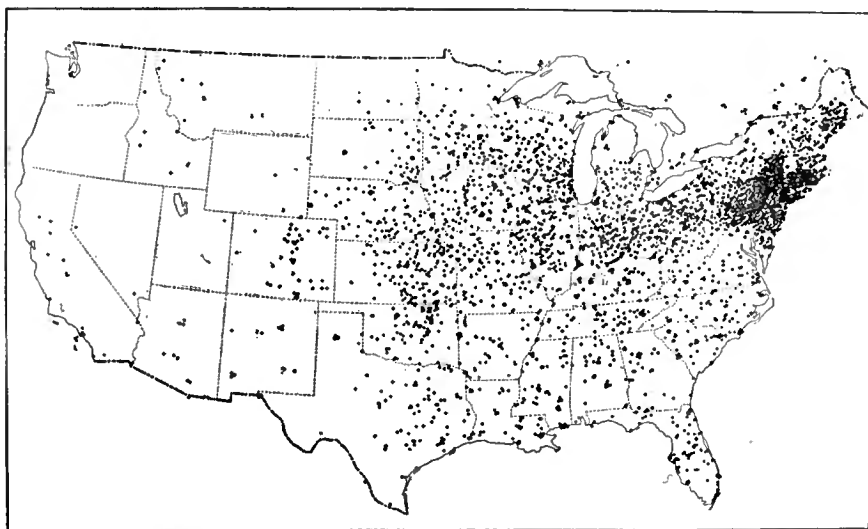

HOW WJZ REACHES OUT

Special tests were conducted last February to determine how the signals of this station were received. The dots on the map indicate the points from which letters were received from those hearing wjz. Engineers designed this station so that under favorable conditions, signals from it could be heard as far west as the Mississippi River

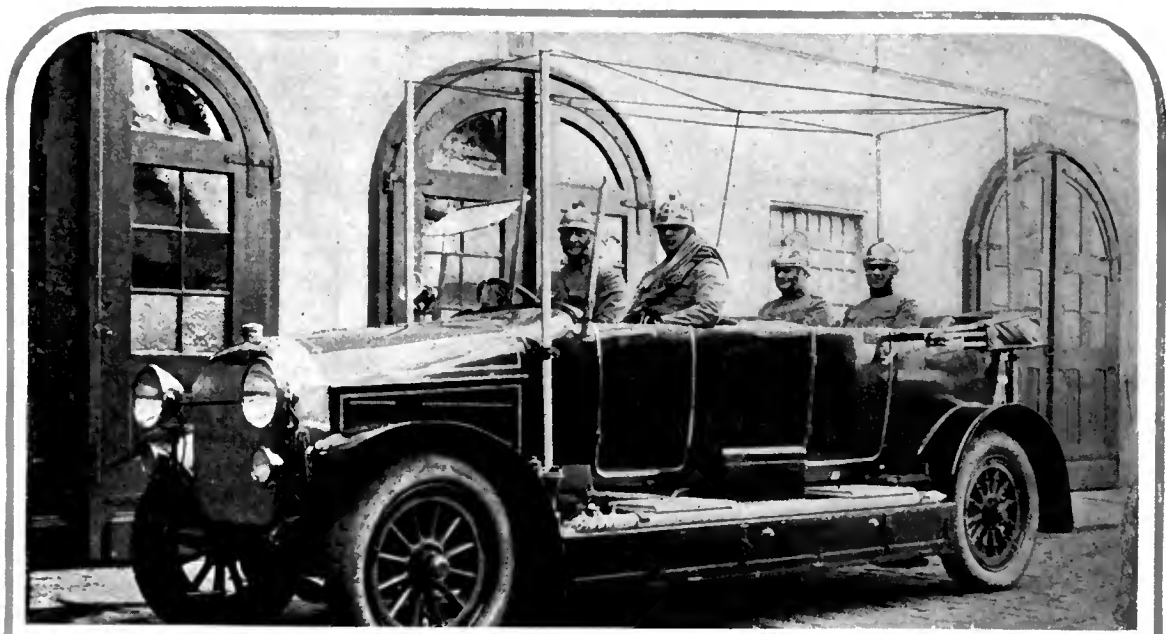

THE MARCH OF RADIO

News and Interpretation of Current Radio Events

Fourteen Years Without a Change in Radio Legislation

WHEN the eyes of legislators first turned to radio, some fourteen years ago, they placed its control in the hands of the Department of Commerce. More recently under the conscientious care of Secretary Hoover, it has been safely guided through a period of flaming youth. But radio is now about ready for a nervous breakdown, having been jilted by Congress just as the age of spinsterhood approaches.

Alarmists predict chaotic days for radio. In Chicago courts, a decision has been rendered, confirming the obvious fact that there is no authority vested in the Department of Commerce or any other branch of the Government to prescribe a particular wavelength in the broadcasting channel to each station. Another decision, in the District of Columbia, makes it compulsory upon the Department of Commerce to issue broadcasting licenses to all who apply. An unconfirmed report from Chicago states that, acting in accord with these decisions, the Chicago Federation of Labor plans to appropriate WEAJ's wavelength with a high power transmitter in that city. With radio neglected by Congress and the Department of Commerce defeated in the courts, Secre-

tary Hoover would be justified in surrendering the control of radio to the tender mercies of anarchy.

While it is possible that some of the 650 applicants for broadcast station licenses, emboldened by these court decisions, may begin operating on wavelengths already in use, we feel certain that common sense will rule the situation. Even without legal control, the present set-up of wavelength allocation and regulation is sufficiently sound to survive a short period of self-government.

But the failure of the legislative branch of our government to pass radio legislation, however imperfect, is not to be condoned. If a period of confusion arises, it will rightly be laid at the doors of our legislators who willfully mingled this non-partisan problem with political wrangles.

Briefly, any satisfactory radio legislation must clarify the following basic points:

1. Who shall administer the radio law?
2. Under what conditions shall licenses be extended to applicants for broadcasting stations so that the limited number of channels available shall be most equitably distributed?
3. What regulations, if any, shall control the political use of the broadcasting medium?
4. What shall the liability of the broadcasting station be with respect to slanderous and libelous statements?

5. What power limitations if any, shall be imposed?
6. If owners of copyrights permit one station to use their material shall they be compelled to extend the same right to other stations upon the same terms?
7. Under what conditions should preventable electrical interference be considered an invasion of public rights?

Our radio law will not be complete until satisfactory legislation covers all these points. Each one is a highly debatable question.

Our views on the very fundamental questions listed above, follow:

1. The Department of Commerce, under its present head, has demonstrated its ability to cope with the problem of the regulation of broadcasting. The dictatorial powers lately assumed by the Department are the outcome of the failure of Congress to enact a radio law and do not, in themselves, constitute an argument against future regulation by the Department. We do not favor a commission similar to the Interstate Commerce Commission for the regulation of radio because radio is *not* a public utility, being non-exclusive and non-essential; and second, because a commission consisting of political appointees is both expensive and inefficient. Adequate safeguards against usurpation of power can

The illustration forming the heading above shows a car used by the Vienna fire department. A receiving set is carried aboard and enables the officers to keep in constant touch with the central bureau

be incorporated in the law so that radio legislation may be administered in the same manner that marine regulation, irrigation, currency, and numerous other activities of our government are conducted.

2. We believe in the recognition of the principle that a station established with a wavelength which gives satisfactory service to the public has a priority over that wavelength regardless of any number of followers who may later covet it. We do not believe that any regional allocation of wavelengths so far proposed, either upon the basis of the nine radio districts or upon the basis of one wavelength to each state of the union, is at all satisfactory or reasonable. The Department of Commerce, supported by an advisory commission (not an executive one) or through deliberations, such as the annual radio conferences, can determine a regional distribution of exclusive wavelengths which will best serve the public.

3. The American press has prospered without undue political control, and any move to make radio the football of politics is inimical to the public interest. The object of broadcast stations is to secure listeners, just as newspapers seek to secure readers, and this controlling factor in itself

lished. This would permit the erection of adequately powered stations in sparsely populated districts and would, at the same time, prevent blanketing in congested areas. Any regulation adopted, however, should be subject to modification without special legislation because of the rapid changes in the radio art.

6. The control of a copyright should be fully protected. But, when an author or composer permits broadcasting of any particular composition, we feel that he has elected to place it at the disposal of the public through the broadcasting medium. Therefore, a maximum basis of charges should be determined upon which assures an adequate return to the author or composer, but which shall not be prohibitive to broadcasting stations. In phonograph recording, a composer who permits one phonograph company to record a number thereby automatically permits all others to do so at the same rate. The maximum charge per number is limited by law. Some such arrangement is possible for broadcasting.

7. Preventable interference with radio reception is as much a public nuisance as the erection of a refuse incinerator plant

in a residential district. Distinction, however, should be made between existing electric systems and new installations, just as one finds in building regulations in the large cities. Much preventable interference is caused by the equipment of public utilities whose rates and income are limited by public service commissions. Expensive changes in equipment, such as substituting underground third rails for overhead traction wires, cannot be accomplished without providing necessary funds. A newly installed smoke precipitator, interfering with large numbers of listeners, is a wanton outrage upon radio listeners which should not be permitted by law.

The legislative situation, at the close of the present session of Congress now is that the House has passed the White Bill, placing the control of radio in the Department of Commerce. The Senate, after oratorical absurdities of almost every possible kind, passed the Dill Bill, providing for an independent regulatory commission. The measures then went to conference on the day of adjournment. No agreement was reached. So legislation must await the pleasure of the next and 70th session of the Congress.

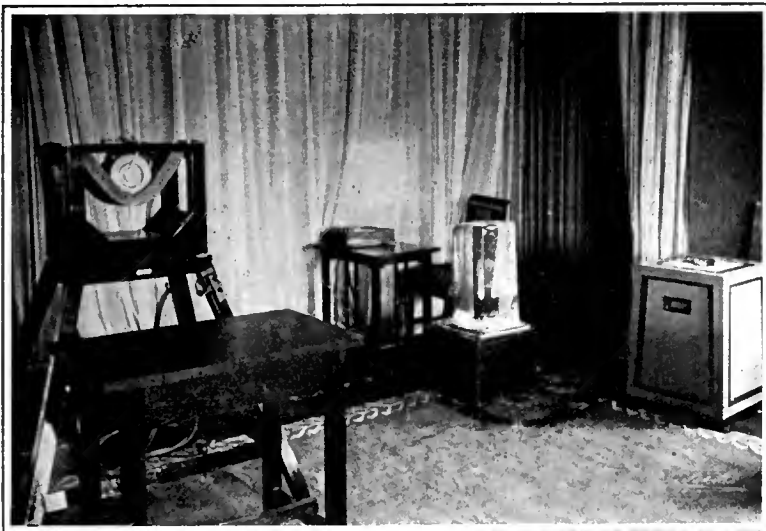

STATION JOCK AT NAGOYA, JAPAN

The top view shows a corner of the European type studio showing a block of ice which was used for cooling purposes when the station was opened and before the permanent cooling arrangements were completed. The sound of water, dripping from the melting ice to the pan below was distinctly heard during the early transmissions. The equipment is British Marconi and has a power at the plates of the tubes of 6 kw. The wavelength is 360 meters (832.8 kc.) The lower cut shows a Japanese Orchestra there in full swing

The Good Side of a Poor Year for Receiving

THERE has been much speculation among long distance enthusiasts as to the causes for less satisfactory receiving conditions during the past season. Many unproved explanations have been offered, but it must be admitted that we know little or nothing about what occurs between the transmitting and receiving antennas.

is ample to obtain a hearing for all parties concerned. Let us have no regulation which compels a broadcasting station to permit all sides of any question to be presented, lest the broadcasters elect to eliminate all political and educational features.

4. Although the broadcasting station does not have the same control that the newspaper has over what goes out through its medium, it should be held liable for what speakers say. One of the points in determining that liability is whether the speaker followed the copy submitted and approved by the station or whether he willfully changed the nature of his remarks from the submitted material.

5. A maximum field strength, based upon some such unit as microvolts per meter, which any station, regardless of location or power, may set up in cities above a certain size, could well be estab-





OTIS STANTZ, CHIEF RADIOMAN, U.S.N. Who, with two aviation pilots, was commended by Admiral W. R. Shoemaker, chief of the Bureau of Navigation for performance of duty and conduct during the hazardous flight over the Pacific in *PN-9 No. 1*. Others cited were Radiomen Wisendanger and Aubin

In one way radio is fortunate at this stage of its development to have had a season which was unusually poor in DX possibilities. It coincides with a period of greatest development in improved faithfulness of reproduction. Therefore, the experimentally inclined turned their attention to the more perfect and faithful reception of local stations rather than concentrating upon the useless but intriguing hunt for greater distance. Appreciation of tonal quality has, in direct consequence of this shifting of emphasis, taken many steps forward.

One of the theories advanced for lessened DX reception, is that so many high power stations, working through the so-called ether, cause a blanketing effect. This may be the explanation in congested districts, but a very large percentage of the country's area remains relatively unaffected by this condition, having no high power broadcasting station within several hundred miles. In these ideal receiving areas, we find the same general complaint of mediocre long distance reception.

On the other hand, so far, the summer has been excellent for radio reception. In fact, results comparable to those secured in winter are widely reported. We have just unpacked a small, portable receiver less than fifty miles west of New York and have heard three stations over four degrees of the dial, New York, Baltimore, and Richmond, each with loud speaker volume and enjoyable clarity. More than thirty stations are heard, without objectionable atmospheric noises, six days out of seven. Programs are maintained at most of these stations up to full mid-winter standards and it may be truly said that broadcasting has become a year round entertainment.

The mid-summer unpopularity of radio

reception is the heritage of the days of headphone reception. Receivers, uncomfortably clamped to the ears in hot weather, accentuating every thud of static, certainly did not encourage summer radio entertainment. But, with greatly increased power of stations, loud speaker reception, and the desirable habit of listening to nearer stations firmly established, there is, under usual conditions, but little diminution of the pleasure which may be derived from a good radio receiver.

Operating Two Stations on One Wavelength

FROM Boston comes news of an interesting experiment which yields promise of important developments. WBZ, the Westinghouse station at Springfield, although but eighty miles west of

Boston, through inexplicable obstinacy of the ether, is not heard well in the latter city. Accordingly, WBZA was established in Boston and connected by wire line with Springfield. Recently both stations began operating experimentally on exactly the same wavelength and it is reported that a successful means has been found to avoid heterodyning, presumably through the use of crystal control. Both stations can now operate upon the same wavelength, supplementing each other successfully.

It has been suggested from time to time that stations broadcasting the same programs simultaneously should operate on the same frequency, thus conserving ether lanes. Synchronizing fifteen or twenty stations under any circumstances would be no small matter and, until the successful experiment in Boston, it was considered impossible of accomplishment.

A listener located midway between two stations, operating simultaneously on the same frequency, would probably receive energy from both of them. Those who have a fancy for DX reception would no longer be annoyed by hearing the same program come through from ten or twelve stations.

Both of these contributions are of minor importance, but the release of many wavelengths, if it could be accomplished by this means, would be a great advantage. It is quite conceivable that eventually most of the stations on existing wire networks will take practically their entire programs from the network, thus making an individual wavelength for each station unnecessary.

Rain Is Independent of Radio

SINCE radio waves are invisible, they are freely blamed for any inexplicable phenomena. Recently Henri Painlevé secured international publicity by a statement offering the intensified activity of radio stations as a cause for the cool and rainy weather in Europe. With so eminent a personage the source of the statement, it is natural to suppose that it has considerable scientific foundation. However, M. Painlevé's contention is quite unsupported by conclusive evidence. Certainly, if radio affects the weather in Europe, it would have ten times the effect in the United States where there are many more stations and much higher power is used.

We have delved into the weather records since 1826 and find that, in the New York area, for example in the last hundred years, there have been seven Aprils with six or more inches of precipitation. Each of these occurred before 1922 when broadcasting stations became active. Of the five Mays with more than six inches pre-



ELECTRICAL ENGINEERING BUILDING, UNIVERSITY OF MINNESOTA

The communication laboratories, largely devoted to radio instruction, occupy the entire top floor. The radio work is in charge of Professor Jansky who says, "I believe our facilities for training men here in the communication field are the equal of any in the United States"

precipitation, none were since 1922; of the twelve Junes, only one was since 1922. The average rainfall by months from 1826 to 1922, for April, May, and June respectively, is 3.32, 3.46, and 3.48, while for the same months, 1922 to 1926, inclusive, it is 2.49, 3.06 and 3.61. The latter figure does not include June, 1926, which, at this writing, is running below normal.

The average annual precipitation, 1871 to 1925, is 42.86 inches. Since 1920 there was only one year above this average and that was 1922, while the average of 1921 to 1925, inclusive, is 37.54 inches.

As to temperature, while June, 1925, broke all of meteorologist James H. Scarr's records, to whom we are indebted for these figures, still the average of the last five years is but .8° above that of the last 54 years.

Let any and all accusers of radio stand forth!

Explaining Vagaries of Radio Transmission

WHEN Anaxagoras, more than four centuries before Christ, propounded the theory of infinitely divisible and continuous matter, upon which the conception of the atom is based, there were few loop holes to be found in it. As scientific knowledge increased through research, things were discovered which could not be reconciled with this theory. So the indivisible electron was added to this defective conception of the construction of matter. These electrons are supposed to vibrate in a medium which has been termed the ether, in all-pervading nothingness through which all unexplained wave motions travel.

The old illustration to explain the action of a radio transmitter by likening it to a stone thrown in the pond is familiar to every reader of radio textbooks. But, as Dr. J. H. Dellinger of the Bureau of Bureau of Standards points out, modern scientific discoveries have divulged many imperfections in this theoretically uniform medium, the ether.

"The way our ignorance is camouflaged," says Doctor Dellinger, "may be handsomely illustrated by the following remarkable description of the accepted theory:

The magnetoionic hypothesis, whereby the electronic phase velocity is so modified that there is a rotation of the plane of polarization for propagation along the earth's magnetic field and double refraction for transmission at right angles thereto.

As we delve further into the field of high frequency transmission, old theories tremble and new ones are propounded upon insignificant evidence at a very rapid rate. But it must be borne in mind that theories do not prove facts but that facts establish theories. Too often are accepted theories modified to fit some isolated fact.

To the public, these all too frequent announcements of revolutionary discoveries are accepted as proved facts. How much

wiser it would be, now that statements from laboratories and universities receive such wide attention, to await scientific proof before broadcasting new theories to the world.

The Ocean Newspaper—By Radio

WHEN the first newspaper was published on shipboard with the aid of items secured by radio, it caused a considerable stir. For a long time, the broadcasting of news items by radio telegraph was incidental to the business of various radio operating companies.

But the collection and editing of news items for ships at sea has gradually been handed over to specialists. How extensive this tendency is may be gleaned from the fact that the Chicago *Tribune's Ocean Times*, according to its editor, Perley Boone, is now serving no less than seventeen steamship companies and several private yachts. Mr. Boone selects four or five leading news stories, makes up an imaginary page one and radios the stories in the order of their importance, accompanied by display headlines.

The radio operators on ships receive the news according to a standard formula and turn it over to the printers aboard ship. The type is then set—some of the ships have linotype machines and others set by hand—and the wireless news is then printed on blank pages left in predated newspapers of eight to twenty pages. Through this system, the printer aboard ship is given his news dispatch already edited and "made up," and, when the passenger gets his paper at breakfast or lunch, he has a complete, although miniature, metropolitan newspaper, edited on land, radioed to sea, and with a radio news section printed at sea.

Among the lines being furnished by the Chicago *Tribune's* service are the United States Lines, the White Star, Red Star, Royal Mail, and Atlantic Transport. The newspaper is distributed by the Radio Corporation of America through WRQ at Marion, Massachusetts.

Broadcasting Is Not a Public Utility

A DEBATE on the subject of freedom of the ether was recently broadcast through WRNY with Dr. Norman Thomas of the League for Industrial Democracy urging that stations be compelled to permit speakers of both sides of any question and Hugo Gernsback, Editor of *Radio News*, defending freedom of operation on the part of a broadcasting station. Apparently, Mr. Gernsback had somewhat the better of the argument.

Of the 550 broadcasting stations now operating, less than 5 per cent. are owned by any one interest. Although patents make the construction of a practical transmitter impossible without infringement, owners of patents are not taking advantage of their rightful monopolies, but sell broad-



C. M. JANSKY, JR.
—Minneapolis—

Assistant Professor of Radio Engineering, University of Minnesota; in a paper before the Institute of Radio Engineers:

"The radio industry has enjoyed a remarkable growth during the last decade. It is not to be expected that such growth would take place without its problems. During the period when any radio manufacturer could sell equipment faster than he could make it regardless of quality it is small wonder that many have seen no necessity for services of well-trained engineers. However, conditions are changing rapidly. The public is already beginning to discriminate in favor of those manufacturers whose apparatus has been designed and constructed under the supervision of competent engineers. This discrimination on the part of the public will do much to stimulate development and improvement. It will also bring about greater rewards to those who have sacrificed time and effort necessary to secure an adequate training in what is the youngest as well as one of the most technical of the electrical sciences."

cast transmitters to all who can afford to purchase and use them.

To regard a broadcasting station as a public utility is to stretch the meaning of that term far beyond its original meaning. A public utility performs a service which is essential and which can be performed successfully only by a monopoly. It is accordingly granted a monopoly by governments and regulated so that it does not take advantage of that monopoly.

Broadcasting is, in the first place, non-essential. Even from our biased viewpoint, we must admit that some civilization existed before 1920. Broadcasting is not a monopoly, because hundreds of stations are in operation, giving ample opportunity for all sides of any reasonable question to be presented.

Some assert that if a speaker of one political complexion is permitted to broadcast at a station, one from the opposing side should also be given access to the ether through the same station. On this principle, no station could broadcast a talk on good government without inviting an

anarchist. One could not have a talk on uniform matrimonial laws without hearing an advocate of free love.

As Mr. Gernsback ably pointed out, a radio station may be compared to a newspaper. Its popularity depends upon appealing to the public tastes and interests and, consequently, any one who has something of sufficient importance to secure the attention of any considerable part of the radio listening public can easily obtain a hearing. We must heartily disapprove of any tampering with the development of broadcasting by the adoption of censorship or regulatory legislation.

The Month In Radio

THE Northwest Radio Association has set a good example to all similar organizations by its active promotion of radio retail business in its territory. It will spend, according to an announcement, \$150,000 in 1926 to promote the sales of radio sets.

Another example of a similar nature is the action of the retailers of Buffalo, New York, who by an assessment, are supporting with paid talent the programs of several near-by stations. They believe that improvement of programs means the betterment of their business and they have backed up this belief with real hard-earned dollars.

ONLY one of the 642 applicants for a broadcast license has withdrawn. A Department of Commerce estimate reports 817 active broadcasting stations in the world; 534 in the United States and 283 in 57 other countries. There are 98 projected stations abroad and 642 in the United States. If all went into operation, the total would amount to 1557. Canada is second to the United States with 37 stations, 2 projected, 4 suspended and 11 others using other stations. Australia, the United Kingdom, and Spain each has 20 broadcasting stations; Mexico and China 19 each, France and Cuba 18, Sweden 17, Brazil, 13, Argentina and Finland, 10; Russia only 3 with 18 projected.

THE government of Bermuda has established a comprehensive set of regulations for radio transmission and reception, providing for two broadcasting bands, one from 1 to 125 meters, the other from 200 to 295 meters. Amateurs will be permitted on the lower band and also may use 20 watts between 135 and 199 meters. In the upper 50 meters of this band, a silent period from 7 P. M. to midnight is provided for. Annual fees of 2, 5, and 20 shillings are required for crystal receivers, tube receivers, and broadcast transmitters respectively.

OF THE \$22,281,000 valued exports of radio materials from the United States in the four years 1922 to 1925, Canada took \$7,709,000, or about 35 per cent.; South America 25 per cent.; Australia 8 per cent.; and South Africa about 1 per cent. each.

The Statistical Division of the Department of Commerce makes as its unofficial estimate the figure of \$100,000,000 as the value of radio material made in 1925. Ninety per cent. of this went to American purchasers and 10 per cent. overseas. Exports for April, 1926, were only \$405,525, as compared with \$820,038 in March and \$835,148 April a year ago. Evidently, the radio industry is not taking increas-

ing advantage of the foreign market to stabilize its production in dull periods.

THE official gazette of the United States Patent Office publishes notice that the Westinghouse Electric & Mfg. Co. has filed suit against the Bruno Radio Company for violation of the Armstrong radio patent, No. 1,113,146; that the General Electric Company has filed suit against the Meyers Radio Tube Corporation, citing one of Langmuir's electron discharge apparatus applications; that the DeForest Radio Company has been sued by the General Electric Company under various Langmuir patents.

THE International Radio Advisory Committee announces a recommendation to adopt a frequency of 290 kilocycles (1034 meters) for the exclusive use of aviation beacons and the reservation of the band between 285 and 305 kilocycles (1052 and 983 meters) for all forms of beacon service. The only landing field in the United States at present equipped to send radio beacon signals is at Dayton, Ohio.

THE Bell Telephone Laboratories have purchased a large tract of land in Whippany, New Jersey for the erection of a high power radio station, to be used for "experimental purposes." Detailed plans for the station have not been announced, although there are those who suspect that WEAJ's radiations will eventually be impressed upon the ether from that point. This statement is particularly interesting in view of the recently announced sale of WEAJ.

THE *Lightning Jerker* is the name of a new publication which made its bow in June, published for the benefit of the professional American radio operator. We are pleased to see this newsy little contemporary, filling the need in a field which has been badly neglected. Commercial operators will find it worth while entering their subscription to the *Lightning Jerker* by writing 3850 North Avers Avenue, Chicago, Illinois. To the broadcast listener, discussion to the effect that Powers is "about the cream of bug senders" and that Francis Brown, on the other hand, is "the bees' knees with the cootie key" is hardly of interest, but it is as lively as a topic of discussion among commercial operators as the sensitiveness of Hammarlund-Roberts versus super-heterodyne among the entertainment-seeking fraternity.

AN INTER-STATE radio conference, held at Sidney, Australia, brought to public attention the fact that, of the \$4,500,000 spent for radio sets and material in the commonwealth, fully \$2,500,000, or more than 50 per cent., went to the government in the form of customs duties. Nevertheless, a report from another source indicates that the number of receivers in Victoria increased from 33,000 to 45,000 in three months; that is, one set for every seven families.

Interesting Things Said Interestingly

GRAHAM MCNAMEE (New York; announcer at WEAJ, writing in the *Saturday Evening Post*): "... as we undoubtedly would make but indifferent reporters in print, so the newspaper man does not always make the best broadcaster. Once I sat in with an editor—an expert, too, with a powerful style and a keen wit. Somehow, perhaps through self-conscious-



NORMAN THOMAS
—New York—

Executive Director of the League for Industrial Democracy; over WRNY

"There must be no censorship of radio speeches on the basis of the prejudice or fears of station managers. It can be illustrated by the experience of a friend of mine who is a professor at a famous college. He has lived and worked in the Near East and was invited to broadcast an appeal for relief, from a certain New England station. In accordance with custom, he sent in his speech in advance. The manager objected to it because he said that some people would not like some or the opinions expressed, and, to make a long story short, he finally forced my friend at the last moment to use what was virtually another man's speech. This is, of course, intolerable. It assumes that anything said from a station must be so colorless as to meet with no objection from anybody. No wonder the average radio fan prefers any sort of jazz or jest to speeches so dull. I can see some reason why program directors should be given the privilege of looking over speeches in advance. They might make very helpful suggestions, but no magazine editor—and remember, magazines are not public utilities—would exercise his editorial power in such autocratic fashion as do some station directors."

ness, but I don't think it was altogether that, he found it difficult to pick out the right things to tell; those that might score on the printed page were not so interesting on the air. An effect gained in one medium, you see, will not always get over in another. A musician may give the suggestion of color in the tone of a violin, but not with paint on canvas; and a fine actor cannot always write so well as he talks. So it is with our respective callings."

LEWIS M. CLEMENT (New York; Director of Reception, F. A. D. Andrea): "Obviously, simplification of controls is coming. I believe the ultimate is a two-dial control, but only on the high-grade and, in consequence, expensive sets. Two dials make a set which is easier to design and less likely to give trouble than the single-dial set, and one which, of course, loses less on efficiency. The two-dial set has advantages over the single-dial receiver in that the operator may pick up stations whose signal intensity is weaker than that which it is possible to pick up with the single-dial set."

Higher Efficiencies for Radio Frequency Circuits

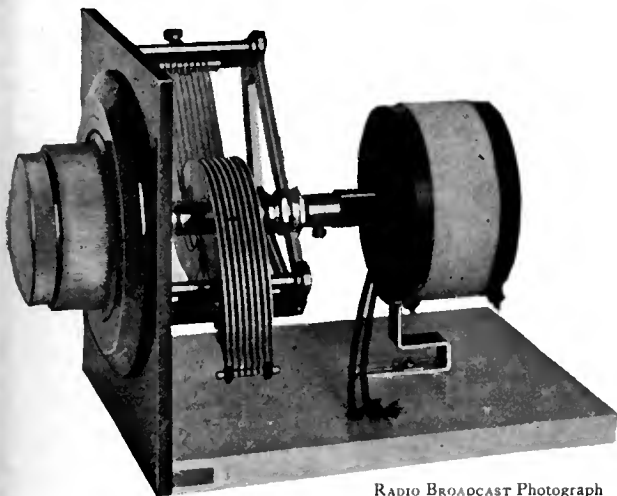

RADIO BROADCAST Photograph

FIG. 1

Shows the degree of coupling at maximum. The stationary coil has been pushed over the movable coil. The axis of the larger or secondary coil coincides with the condenser axis so the coupling is the same at all frequencies

Details of the Tuning Problem in Radio Frequency Circuits—The Importance of Optimum Energy Transfer at All Frequencies—The “Equatic” System for Automatically Varying the Coupling with Frequency—Applications of the System

By ZEH BOUCK

THE tuning of a radio circuit is nothing more than a simple proposition in efficiency. When we say that a receiver is tuned to a certain frequency or station, we mean that its capacitative and inductive values (condensers and coils) are so adjusted that a radio signal of the designated frequency will vibrate through the circuits with the lowest possible loss—in other words, with the highest possible efficiency.

If the set in question is a good one, no signals ten or more kilocycles away from the tuned station will be heard, due to the fact that the efficiency on other frequencies is so low that the energy (pounding-in on the antenna whether it is heard or not) is hopelessly dissipated. When you tune to another station, you merely shift the point of highest efficiency of your receiver.

There are several individual circuits in the average receiver—a grid and plate circuit for each radio frequency tube, and the antenna circuit. Each control—each dial on the set—governs the efficiency of one of these circuits. If each circuit is tuned individually to its point of least loss for the reception of a given signal, the entire system will operate at its highest efficiency on this same frequency. The idea is that of a chain with no weak links. If the efficiency of one circuit is lowered, the loss over the entire system is increased just so much, and the signal strength impaired. That this is so may be easily demonstrated by detuning one of the dials on your own receiver.

THE MORE CONTROLS, THE HIGHER
THE EFFICIENCY

A CONSIDERATION of these facts might lead one to think that the more sensible controls one could add to a receiver, the more efficient the set would be if operated correctly. This logical idea is quite true, and accounts for the

very high relative efficiency of old and modern commercial equipment. In prewar days, the shipboard receiver was a maze of from seven to twelve controls built up around a crystal detector. The operator spent months in getting acquainted with his apparatus, and his deft fingers coaxed consistent signals from relatively inefficient consistent transmitters two and three thousand miles away.

One of the most vital controls on commercial equipment is that varying the coupling (the coil relations between circuits)—an adjustment that contributes greatly to selectivity and general efficiency. The experienced operator appreciates that his coupling adjustments are second in importance only to those controls more directly affecting wavelength—the so-called tuning dials.

THE DESIRABILITY OF VARYING COUPLING

COUPLING is a primary necessity in radio circuits, and is the means of transferring high frequency energy from one circuit to another to achieve certain desirable or necessary effects. Were it not for coupling of some sort, the signal in the antenna would never reach the detector circuit.

There is an optimum or most effective

value in all electrical and mechanical devices. An automobile engine, for instance, operates best at a given spark adjustment for a given r.p.m. At higher or lower speeds, the spark is respectively advanced or retarded.

So it is with radio circuits. At a given frequency there is an optimum amount of power or energy to be transferred from one circuit to another, variations from which detract from the practical efficiency of the circuit. (“Practical efficiency” is an expression of the listener’s enjoyment, and does not necessarily coincide with electrical efficiency.)

The optimum value of energy transfer from one circuit to another changes more or less with the frequency—sometimes directly with the frequency and sometimes in a reverse order, depending upon the division of a receiving system in which the coupling is employed. (The coupling we are considering in this article is mainly “inductive”—the coupling caused by the interaction of the magnetic fields of two coils placed near to each other.) In other words, as the wavelength is shifted, more or less energy should be transferred from one circuit to another, in order to maintain the highest possible receiving efficiency at all frequencies.

It happens that the amount of power transferred from one circuit to another varies automatically as the frequency changes, but seldom in the correct direction, and almost never in the correct degree. The energy transferred between circuits increases roughly with the square of the frequency, and also with the square of the mutual inductance (or magnetic interaction) of the two circuits. The mutual inductance is a function of the coupling, or the nearness of the two circuits one to the other. As the coils are brought closer together the mutual inductance is in-



ANY practicable method for maintaining the efficiency and stability of tuned radio frequency circuits by means of varying the magnetic coupling at the same time the frequency of the circuit is varied has never been made available for the home constructor. This article by Mr. Bouck will interest every radio constructor, we are certain, because it introduces the details of a practicable system which can be simply applied to many types of excellent circuits. The author, has been working for months to reduce the details of the system to such simplicity that the army of home constructors could use it effectively. This article is the first of a series. The next will describe the construction of a five-tube, tuned radio-frequency receiver using this interesting method of coupling.

—THE EDITOR.



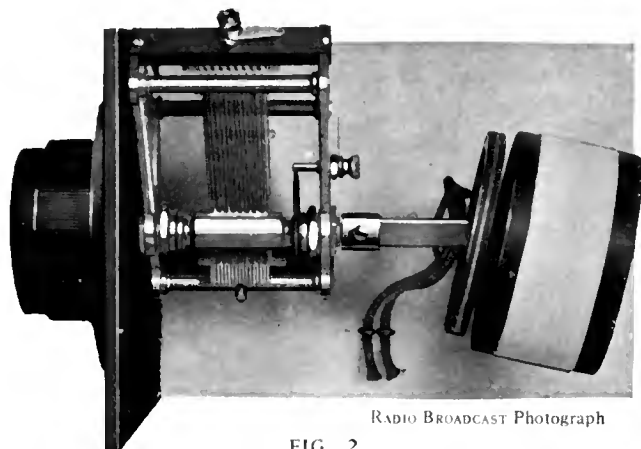

RADIO BROADCAST Photograph

FIG. 2

The large coil has been pushed back so that the coupling between the two coils is now quite loose. Also, there is now a small angle and the coupling will decrease as the condenser setting is decreased

creased. It is therefore possible to compensate the variations in energy transfer due to frequency change (as the set is tuned)—to maintain this transfer always at its optimum value—by the simple expedient of coupling adjustment (which is a determining factor of the mutual inductance).

Having laid down these principles, we can now reconcile them to practice.

WHERE COUPLING IS USED

INDUCTIVE coupling is employed in four instances familiar to the fan. They are as follows:

1. Between the antenna circuit and the input to the first tube. As a general rule, the amount of power transferred should remain fairly constant over the entire tuning range. In other words, the coupling should be loosened as the frequency becomes higher. With unusual antenna conditions this movement may be reversed.

2. Between tickler coil and grid circuit in a regenerative receiver. The correct transfer may increase or decrease slightly on the lower frequencies (longer waves) depending upon the characteristics of the coils. At any rate, to maintain the circuit at the desired point of regeneration over the tuning range, the coupling should be increased as the frequency is lowered. The correct amount and rate of increase, as suggested, will vary with different receivers.

3. In reversed feedback circuits such as the Superdyne. Here again the variation in coupling between tickler and secondary will increase the efficiency of the receiver.

4. In standard tuned r. f. systems. Such receivers employing a fixed relation between primary and secondary circuits are adjusted for the optimum transfer of energy on only the higher frequencies (shorter wavelengths). Since the coupling is fixed, these sets are comparatively inefficient on frequencies less than 1000 kilocycles (waves longer than 300 meters), due to the drop in energy transfer which, it will be remembered, varies with the square of frequency. This undesirable effect is further increased by the fact that the optimum value of energy transfer for such circuits is greater at the lower frequencies than at the higher. The result of the maladjustment is lack of sensitivity on the longer wavelengths. To correct this condition, the coupling should be increased as the frequency is lowered.

Before proceeding further, let us recapitulate two propositions to be maintained clearly in mind. Firstly, all other things remaining constant, the amount of

energy transferred from one circuit to another changes with the frequency. Secondly, to compensate this change, the optimum amount of energy transfer may be attained at any frequency by changing the coupling between the circuits.

It is by now apparent that the variation of coupling is essential to the operation of familiar radio circuits at their highest possible efficiency. However, coupling controls have been eliminated from all but regenerative broadcast receivers in order to

simplify the apparatus, regardless of the considerable sacrifice in possible efficiency. I write "possible efficiency," because the average fan would never study his receiver, as the ship operator does, and would not, therefore, take more than a slight advantage of his receiver's inherent possibilities. Indeed, with the multiplicity of controls, and their interaction, one upon another, it is doubtful if the ordinary enthusiast would secure as excellent results from an elaborately controlled receiver with coupling controls as he does on the more simple if less efficient tuned r. f. arrangements.

However, it has long been appreciated that if it were possible to develop a method of automatic coupling variation that increases or decreases coupling to the correct degree over the entire tuning range—a method that would contribute all the efficiency of coupling variation without an additional tuning complication—we should greatly enhance the possibilities of the broadcast receiver. And this brings us to—

THE KING EQUAMATIC SYSTEM

THIS arrangement is named after Louis G. King, who developed the idea we shall describe, and which solves the problem suggested in the preceding paragraph with charming simplicity. Fundamentally, the device consists in mounting one, or two coupled coils, on the shaft of the tuning condenser in such a manner that the coupling is varied as the condenser dial is turned, i. e., as the set is tuned. Thus the operation becomes automatic, and no controls are added to the receiver. (The interaction between coupling variations and resonance control, or tuning, is, of course, automatically compensated through a slight curving of the condenser frequency line.)

A glance at the accompanying illustrations will explain the manner in which coupling changes are adjusted and effected. When

certain conditions are known, such as one would learn after building several receivers of one certain circuit, it is possible to set the axes of the coils and condenser shaft at a predetermined angle. However, as set forth in our discussion on coupling, there are several variable factors in the case of the average receiver which make it necessary for the device to be capable of adjustment in reference to the following:

1. The degree of coupling at maximum—the tightest coupling to be obtained at any tuning point, generally the longest tunable wavelength. For instance, in Fig. 1, the stationary coil has been pushed over the movable coil for close coupling. In Fig. 2, the stationary inductor has been moved back for loose coupling. In any of the other illustrations showing maximum coupling (Fig. 3.) this adjustment can be similarly made by moving the larger coil *back and forth*. Once the optimum coupling is determined at maximum (a very simple process), it only remains to adjust—

2. The acceleration of coupling change, which governs the minimum coupling. This is accomplished by varying the angle between the axis of the coils and the axis of the condenser *at maximum coupling*.

Let us assume that we wish to loosen coupling as the frequency is increased (as the wavelength decreases with the adjustment of the condenser) which is the usual condition. In Fig. 1, the axis of the condenser coincides with the axis of the large or secondary coil. Therefore the coupling between the primary and secondary will remain constant, regardless of the dial position.

Fig. 3 shows the high frequency position (condenser out), with the coils turned to a small angle. Fig. 4 is a photograph of the position at long waves for the same angle. Coupling has been gradually increased as the condenser has been turned "in"—for the coupling is, of course, greatest when the coils are parallel one to the other.

Fig. 5 is a short wave position (loose coupling) with the angle considerably increased. As the condenser is turned down (as the wavelength is decreased, or the frequency increased) the coupling between the two coils is loosened much more rapidly than with the smaller angle, and with the con-

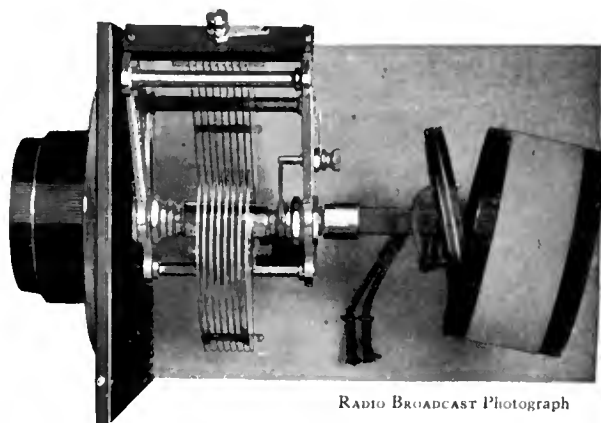

RADIO BROADCAST Photograph

FIG. 3

With the coils placed as in Fig. 2, the condenser was turned to zero. Note how the coupling has been automatically decreased. Herein lies the advantage of the Equamatic system. The method of mounting the movable coil on the condenser shaft is clearly shown in this figure

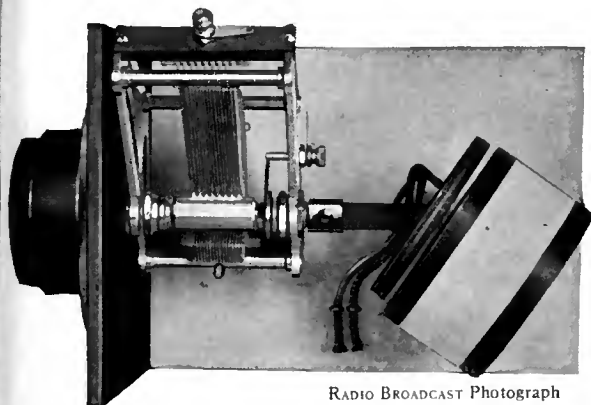

RADIO BROADCAST Photograph

FIG. 4

Here, with the condenser plates completely meshed, the degree of coupling is the same as Figure 2, although the angle has been increased. But as the dial is rotated watch what happens at the high frequencies!

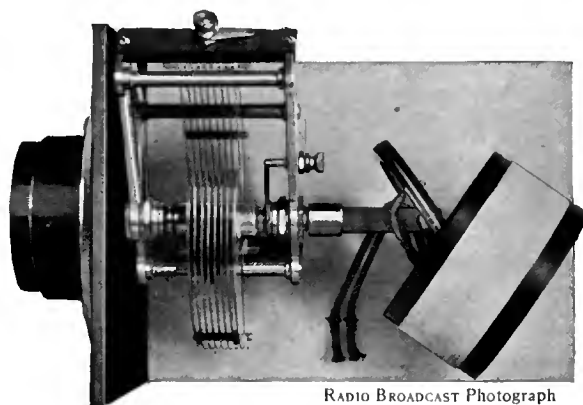

RADIO BROADCAST Photograph

FIG. 5

Coupling at the high frequencies. Note how loose it is in comparison with the coupling at the low frequencies. By adjustment of the angle, any desired degree of acceleration of coupling can be obtained as the condenser is revolved

denser all the way out, it is very loose indeed.

So it is thus possible to secure any maximum coupling desired, as well as any acceleration in coupling. With the correct size and type of condenser, one is able to adjust the transfer of energy to meet any of the possible conditions.

MECHANICAL DETAILS OF THE EQUAMATIC SYSTEM

THE mechanical arrangement is best made clear by the photographs. Fig. 6 shows a simple form of mounting for the moving coil. The condenser should be of the straight frequency-line type, with the shaft extending through the lower end plate. A number of commercially available condensers, designed for ganging, meet these requirements.

Further constructional data are also suggested in Fig. 6. From left to right

we have a stationary coil with mounting bracket; a condenser extension shaft; a movable coil arranged for simple mounting; and a more elaborate moving coil device mounted on an extension shaft.

IN ACTUAL CIRCUITS

THE applicability of the King system of coupling variation in the circuits previously referred to is immediately apparent. Considering again the first of four familiar propositions, the movable coil would be the antenna primary with the condenser shunted across the secondary or stationary coil.

In the regenerative circuit, the moving coil is, of course, the tickler, and the large

inductor, the grid coil tuned by the condenser. As already suggested, the interaction between the tickler and tuning control is automatically compensated. A simple three-circuit regenerative receiver of this type would be admitted to the best of radio society. It is a single-control set, with automatic regeneration necessarily prevented from spilling over and radiating at any frequency. This receiver will be considered in detail in a later article.

In the Superdyne arrangement the moving coil is the reversed tickler, eliminating one control from this excellent receiver. In tuned r.f. systems, the moving coil is the primary or output coil of a preceding tube. The controlling condenser is shunted across

the secondary inputting to the succeeding tube. The construction of a five-tube receiver of this type will be described in an early number of RADIO BROADCAST.



RADIO BROADCAST Photograph

FIG. 6

Constructional view of the essential parts of the system. From left to right we have a stationary coil with mounting bracket, a condenser extension shaft, a movable coil arranged for simple mounting, and a more elaborate moving coil device mounted on an extension shaft. Either type of movable coil may be used as secondary. The type at the extreme right is more elaborate, merely

How to Get the Most Out of Your Super-Heterodyne

Results of an Extended Laboratory Analysis of the Best Practise in Super-Heterodyne Construction and Operation—Instructions for Most Efficient Treatment of Each Section of the Receiver

By KENDALL CLOUGH

Director, Research Laboratories of Chicago, Inc.

WHILE many circuits have come and gone in the art, the super-heterodyne has consistently attracted the home builder and experimenter. This is rightly so because of the field of endeavor yielded by this circuit, embodying as it does, most of the fundamentals of radio engineering. The only regrettable angle in the development of this receiver along with the art is that it has appeared colorful to the barn-loft type of engineer, who in many cases has taken a standard circuit, cluttered it over with trick dials and freak knick-knacks until many of their products can scarcely be conceded to be radio sets, let alone super-heterodynes.

So many beautiful principles are involved in this circuit that in its simplest form it has presented a fruitful field of endeavor for four months of intensive research in a commercial laboratory, in an effort to determine for the experimenter which of this or that is best and to find plausible remedies for some of the glaring defects in receivers already constructed. While it was our original intention to embody these ideas in a complete constructional article, this plan miscarried and the results are being presented in such a way that those who have already built super-heterodynes may be afforded some means of improving them and locating defects in their design, it is hoped. So much has been said on super-heterodynes relative only to particular receivers or by those whose authority is to be questioned rather than respected, that it seems no more than just to tell the reader how the statements to be made in regard to the various components of the super-heterodyne were arrived at. In every case, the theory of the portion of the circuit in question has been carefully considered and checked by qualitative measurements on the laboratory bench and the results applied to a variety of receivers. In the net, we have attempted to make the results of such investigations applicable to as large a variety of receivers as possible, as well as to specific receivers to be presented to the readers of RADIO BROADCAST on a future occasion.

The most feasible method of treating the receiver will be to break it up into component parts as shown in Fig. 1, and consider them separately with respect to receiver as a whole.

ATTAINING GREATER SELECTIVITY

AS A collector, the short antenna with antenna-coupler has proved itself far superior to the loop. The latter's only claim to superiority is its directional effect which is considerably mitigated in the city by reflections from steel buildings, etc. It has a further disadvantage in that its physical proportions do not allow of an adjustment of coupling or absorption from the progressing wave front of the signal. The desirability of this feature will be pointed out in connection with the intermediate amplifier, as it follows some of the theory of that equipment. The unpopularity of the antenna coupler may be attributed to the fact that it has been recommended and used with such large antennas. This procedure will ruin the apparent selectivity of any super-heterodyne; from ten to thirty feet of wire in the same room with the receiver will provide all the pickup needed for a well designed set.

It is pretty generally known among heterodyne fans that the selectivity of a super-heterodyne may be improved in the intermediate amplifier only to a certain point; beyond that, the quality of reproduction is seriously impaired due to the cutting of the side bands of the carrier frequency. The remainder of the selectivity problem remains in the collector system. Obviously then, the antenna coupler and its condenser must have as low effective losses as possible. The construction of coils to yield low resistance has been so thoroughly treated in these and other pages that it is not necessary to review them here. The constructor need only be certain to use a coil and condenser which are low loss and not which are merely said to be low loss.

A further advantage of the antenna coupler is that it allows of a circuit arrangement which does away with body capacity on the tuning and regenerative condensers as is pointed out in Fig. 2. Note that both rotors are connected to the A battery.

The first detector has a function which is

purely as its name implies, one of detection; hence it should be as sensitive as possible. Of the two methods of detection, condenser and leak, and by C battery, the former is to be preferred as it yields somewhat greater sensitivity than the C battery type. In many cases an improved result will be obtained by careful selection of tubes, value of grid leak and condenser, using always a weak signal for comparative purposes.

It is often asked which of the two arrangements shown in Fig. 3 is more desirable. Briefly, we have not been able to establish any superiority of one over the other, save that (b) allows mounting the tuning condenser directly on the shield.

If the reader desires to make the corresponding portions of his circuit conform to this article, it is suggested that he select his equipment as outlined and insert a pair of phones shunted by a 0.005-mfd. condenser at x, Fig. 2. In this way he may tune-in local or near-by stations as on an ordinary regenerative receiver and make his selection of tubes, condensers, and leaks.

The feedback coil E-2 should be wound at the filament end of the secondary coil L-1 and of a sufficient number of turns so that the tube will go into oscillation near the maximum capacity of C-2, when C-1 is set at maximum. If any difficulty is found in bringing this about it will aid to insert a small r. f. choke in the circuit as shown in Fig. 2. This will prevent the first transformer from short circuiting the plate circuit, from a radio frequency standpoint. Such a choke may consist of one hundred turns of No. 34-38 wire on a 1-inch tube.

In view of the fact that we want perfect control over the amount of energy coupled into the receiver from the antenna, we must have the first detector unit shielded to prevent the coil from picking up signal energy other than that supplied it by the variable coupling coil L-3. The shield should be a well-constructed copper or aluminum can of sufficient size to accommodate the equipment with generous clearance around the coupler. All joints in the can should be lapped or soldered, and leads brought through the smallest holes possible. A pair of leads made of thickly insulated wires twisted together lead out of the shield to the oscillator pick-up coil.

The ideal super-heterodyne oscillator will embody certain qualifica-

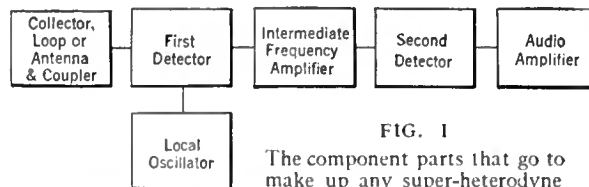

FIG. 1

The component parts that go to make up any super-heterodyne

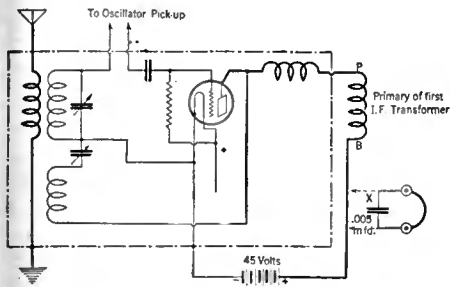

FIG. 2

The first detector of a super-heterodyne using regeneration. With this circuit arrangement there is no bothersome hand capacity because both of the condensers are at ground potential

tions met by very few to date. First, it will radiate no power save that fed out to the first detector from the pickup coil. This entails shielding in a carefully made copper or aluminum can. It also requires the use of a 1.0-mfd. condenser as shown in Fig. 4 and a choke in the battery lead to prevent the generated radio-frequency current from coupling with other parts of the receiver in the B battery and battery leads.

The shield also minimizes radiation to neighboring receivers. From the conditions in metropolitan districts, we should judge that few are altruistic enough to consider this an important point. Taking a selfish view of the thing, however, it does mitigate the possibilities of a neighboring "bloop" from mistaking your oscillator carrier for that of a distant station, thereby introducing an interfering heterodyne in your own reception.

It should be noted in Fig. 4 that only the grid circuit of the oscillator is tuned. This permits the shaft of the condenser to be grounded, eliminating "hand effects" so troublesome when the rotor is connected to the plate. Under proper conditions, the tuned grid type is subject to less trouble from harmonics.

In the metropolitan districts particularly, the presence of harmonics in the local oscillator output becomes troublesome. Their presence is indicated when in attempting to tune-in a distant station on a long wave (425 to 550 meters) a local station on a short wave is heard. In such cases, the second harmonic of the local oscillator is actually heterodyning the short-wave signal which is sufficiently strong to get through the input tuning device. A further effect is an apparent broadness of tuning on all near-by stations.

Presence of strong harmonics in the local oscillator causes stations to be tuned-in at several points on the dial.

This action may be explained as follows. Assume that an intermediate frequency of 45 kilocycles is used and that reception from a 600-kilocycle station is considered. In this case it would be necessary to supply a local heterodyne frequency of 645 kilocycles. Let us further assume that with the oscillator in question this frequency is at a dial setting of 80 and that the frequency varies with dial setting at a rate of 10 kilocycles per dial division.

Along with the fundamental the 600-kc.,

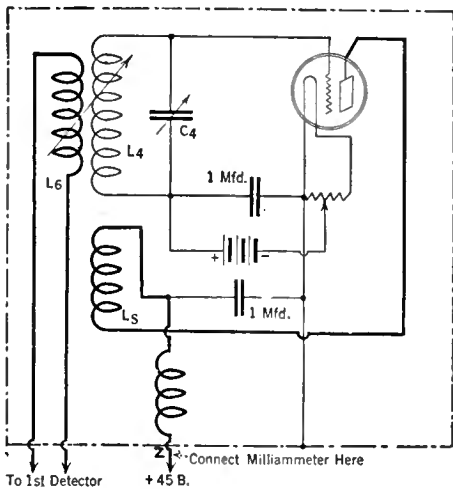

FIG. 4

The oscillator. Only the grid circuit is tuned so that hand capacity on the oscillator dial is eliminated. A positive bias is used on the grid to minimize the even harmonics generated by the oscillator

the station emits a second harmonic of 1200 kilocycles. Obviously a frequency of 1245 kilocycles which may be supplied by a harmonic of the local oscillator will heterodyne the 1200-kc. harmonic. The fundamental of the oscillator while supplying

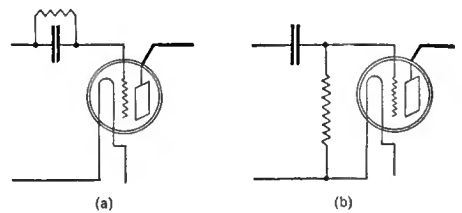

FIG. 3

Two methods of connecting the grid leak and condenser into the circuit. Results are the same with either arrangement

this frequency will be $\frac{1245}{2} = 622.5$ at a dial setting of 82.25.

In the same way it may be shown that another heterodyne action due to the third harmonics of the station and oscillator will be present at a dial setting of 83. Thus a strong local will have as many heterodyne points as there are harmonics.

The table A is illustrative of the foregoing.

If the intermediate amplifier is sufficiently selective there will be definite peaks on the dial at the points mentioned. If not so selective the dial settings mentioned will merge and cause the whole receiver to appear hopelessly unselective.

The generation of these harmonics is due to the curvature of the characteristic of the oscillator tube. Examination of the theory of the oscillating tube indicates that if such an adjustment of the oscillator circuit can be arrived at that the plate current will be the same in or out of oscillation, then the even harmonics will be minimized or even deleted. Since the interfering harmonic usually found troublesome is even (the second) it will be handled by this procedure.

Peculiar as it may seem, the 201-A type of tube requires a positive grid bias of 9 to 15 volts to bring this condition about. It might seem on first thought that the oscillator drain would be excessively increased by such procedure. Such is not the case,

however. In a representative case in which this principle was applied (201-A tube with 45 volts B battery) the plate current measured 10 milliamperes with the tube oscillating and zero grid potential. When the necessary positive grid bias was employed (11 volts), the plate current increased to only 13 milliamperes. In this same case the amplitude of the second harmonic was found to be reduced to 8.2 per cent. of its original value.

The application of this principle to the circuit of Fig. 4 is

High-Lights on the Super-Heterodyne

Detector

"As a collector, the short antenna, with antenna coupler, has proved itself far superior to the loop."

"For the first detector, grid leak and condenser detection is to be preferred as it yields somewhat greater sensitivity than the C battery method of detection."

"The first detector unit should be shielded to prevent the coil from picking up signal energy other than that supplied by the antenna coupler."

Oscillator

"The ideal super-heterodyne oscillator will radiate no power save that fed out to the first detector from the pick up coil."

I. F. Amplifier

"It seems almost entirely out of the question to use frequencies in the vicinity of 30 kilocycles."

"If the intermediate frequency is any integral

multiple of 10 kilocycles (30-40-50-etc.) there is grave danger of one station heterodyning another to your intermediate frequency, without the use of the local oscillator."

"The whole heart of the I. F. amplifier problem, after the selection of the proper frequency, seems to be in the proper matching of the transformers and filter."

"The super-heterodyne fan cannot take iron-core transformers, advertised to be equally efficient over a broad band of frequencies, and associate them with a filter tuned to any frequency in the band and expect to obtain best results."

"Unless shielding is made prohibitively large for the I. F. amplifier, the matching of the transformers is affected by its presence, which more than offsets any improvement by virtue of the shielding."

Second Detector

"C battery detection, in the second detector is better."

"Provided all the tubes are in good condition there is little or no need for separate rheostats on any of the tubes."

very simple for the broadcast experimenter. With an oscillator connected as shown in Fig. 4, a millimeter is connected into the circuit at the point Z. If a millimeter is not at hand, a low reading voltmeter of good quality, such as is used to test the storage battery, will usually serve the purpose. Now with the oscillator set near the upper end of the scale (500 to 600 meters) a trial value of C battery is inserted and the meter reading noted. The tuning condenser is now short circuited and the reading again noted. If the latter reading is lower than the first the C voltage should be increased and vice-versa. A potentiometer is shown in Fig. 4 across the filament terminals to facilitate this adjustment. After the correct value of C battery is found, the reading of the meter at Z will be unchanged by short circuiting the tuning condenser. If this adjustment cannot be arrived at with a convenient value of C battery and the tube kept oscillating, it may be necessary to alter the number of turns in L-5. Here persistence will be well rewarded, if you are bothered with the type of interference mentioned.

WHAT TO DO ABOUT THE INTERMEDIATE AMPLIFIER

IT IS customary to start discussion of the intermediate amplifier by stating what intermediate frequencies are best. It appears more logical in this case to state what frequencies are poorest. It seems almost entirely out of the question to use frequencies in the vicinity of 30 kilocycles. The writer has so far examined no transformers of this type that were not fairly effective down into the audio range with the results that the amplifier is inevitable noisy and unselective. Several transformers are available operating from 40 to 60 kilocycles which are generally more satisfactory if properly selected. In this group, however, there are several frequencies that are eminently undesirable.

Under the present system of allocating wavelengths, our broadcasters are 10 kilocycles apart. Each station is radiating not only its fundamental frequency assigned, but in most cases several harmonics or multiples of this frequency. This being the case, it is a simple mathematical demonstration, and we have proved it time after time in practice, that if the intermediate frequency is any integral multiple of 10 kilocycles (that is 30-40-50-60, etc.) there is grave danger of one station heterodyning another to your intermediate frequency without the use of the local oscillator. If you are already the possessor of a super-heterodyne you may check this condition by simply removing the oscillator

TABLE A

Strong harmonics in either the wave transmitted by the broadcasting station or in the wave generated by the oscillator will make it possible to tune-in a single station on as many points on the dial as there are harmonics. This table shows how. The distant station on 600 kc. can be tuned-in at three points due to these harmonics.

DISTANT STATION	LOCAL OSCILLATOR	LOCAL STATION	OSCILLATOR DIAL SETTING	BEAT NOTE
600 Kc. (Fundamental)	645 Kc. (Fundamental)	—	80	45 Kc.
—	1290 Kc. (2nd Harmonic)	1245 Kc. (Fundamental)	—	45 Kc.
600 Kc. (Fundamental)	—	—	—	—
1200 Kc. (2nd Harmonic)	1245 Kc. (2nd Harmonic of 622.5 Kc.)	—	82.25	45 Kc.
1800 Kc. (3rd Harmonic)	1845 Kc. (3rd Harmonic of 615 Kc.)	—	83	45 Kc.

tube and tuning slowly with the loop condenser at a time when the majority of your locals and semi-locals are on. If you can tune-in stations in this manner (they usually come in pairs), your intermediate amplifier is operating at or near one of the frequencies mentioned and should receive attention before attempting to improve the receiver by any other measures. Thus we may conclude that the best operating frequencies in the range mentioned are those values lying close to 45, 55, and 65 kilocycles.

The whole heart of the r. f. amplifier problem, after selection of the proper frequency, seems to be in the proper matching of the transformers and filter. Mismatching of these units is a deterrent to both selectivity and amplification. In view of the importance of the subject, a long study was devoted to it.

It has long been an established fact in electrical engineering that the inductance of a coil having an iron core, or with iron in its field, varies with the voltage impressed across the coil. This phenomenon is due to the fact that the permeability of iron and steel varies with the number of lines of magnetic force set up in the iron. While the phenomenon is an old one in low frequency practice, it was immediately wondered if the same laws regarding this variation held at high frequencies, say, 30 to 75 kilocycles, especially because the better transformers now on the market and designed to operate at these frequencies, contain more or less iron.

To make a long story short, these laws did hold. In fact, it was found that on setting up a representative stage of amplification, that is, a tube and transformer of a

certain type, that on impressing voltage of the order of one-half to one volt on the tube, the best operating frequency of the transformer was a great deal different from that obtained when voltages of the order of one to five-hundredths of a volt were impressed on the tube. As a specific example, with one type of transformer tested, we found that an input of half a volt showed an apparent best operating frequency of 60 kilocycles, whereas with an input voltage of two-hundredths, the best operating frequency of

the transformer was found to be 43 kilocycles.

I. F. TRANSFORMERS HAVE BEEN IMPROPERLY TESTED

IN THE usual operation of intermediate-wave transformers in practice, the voltage impressed on the amplifier tube has been found to be at the order of a few hundredths of a volt, rather than the larger values used by most manufacturers in their testing and matching operations. In view of this fact, it seems only reasonable that input or output transformers for intermediate-wave use should be designed and adjusted to the frequency of the transformers when tested at extremely low voltage. These laboratory experiments were substantiated in practice by using two of the transformers mentioned with a 60-kilocycle filter, with the result that local stations were brought in with extraordinary volume, and out-of-town stations with a rather mediocre output. In changing to the 43-kilocycle filter, out-of-town stations were doubled and even trebled in volume, while the intensity of local signals actually fell off, due to the tendency of the high input voltages from the local signals tending to throw the transformers out of tune with the filter. This effect was also substantiated by an extended series of experiments with completed amplifiers, measuring the input and output voltages at various frequencies with the tube filters.

A further point came to light regarding the character of the intermediate iron-core transformer, which was that each such transformer while apparently very broadly tuned when using high input voltages, showed very decided resonance or peaking characteristics when tested on small inputs, due, no doubt, to the lower losses induced by the iron at these lower densities. As a practical result, this means that the super-heterodyne fan cannot take iron-core transformers, advertised to be equally efficient over a broad band of frequencies, and associate them with a filter tuned to any frequency in that band, and expect

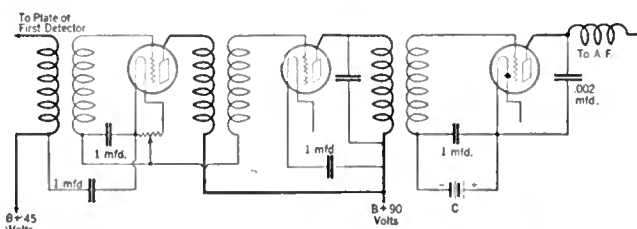

FIG. 5

The intermediate amplifier and second detector. By-pass condensers are used to prevent undesired interstage coupling. For most satisfactory control of the I. F. amplifier, it is sometimes necessary to place a small C battery bias on the first amplifier tube

to obtain the best results. Such results can be obtained only by finding the actual peak of the transformers, at low input voltages, and then using a filter of the same frequency.

The construction and calibration of a test set to perform these measurements at low input voltages is more of an expense and undertaking than the average experimenter would care to go to. In view of this fact, the equipment has been made available to several manufacturers who, we understand, are making the use of it available to experimenters at a nominal fee. In applying for matching service the experimenter should ascertain that the testing is done at low input voltages and state what type of tubes the transformers are to be used with, as the matching changes considerably with change of tubes.

After careful matching of the transformers and filters they must be installed in the receiver so as to conform to the methods used in matching. Grid and plate leads should be as short as it is possible to make them. The 1.0-mfd. condensers shown in Fig. 5 should be located as close as possible to the transformers to prevent long battery leads from ruining the calibration of the transformers.

With carefully matched transformers of high quality there is little point in using more than two stages of intermediate amplification. Two stages will get down to the noise level in most localities after which added amplification adds nothing to the effectiveness of the receiver.

CONTROLLING AMPLIFICATION

FOR the control of the amplification, the writer has found nothing more effective than the old fashioned potentiometer. It has the advantage of being the only system tried which does not change the calibration of the transformers to any extent. This by the way, brings up a point in connection with shielding of the i. f. amplifier. This has only the advantages of shielding against pickup of long-wave signals and a possible improvement of the cascade amplification of the system. The former reason has never been much of a factor in most localities and the second has been found futile by numerous measurements on long-wave transformers of various makes. In the latter case, unless the shielding is made

prohibitively large, the matching of the transformers is affected by the presence of the shielding material, which more than offsets any improvement by virtue of the shielding.

The principal difficulty experienced with the intermediate amplifier is that of inselectivity. This may be due to several causes. Mismatching of transformers and filters is the most flagrant and has been treated previously. The second is the use of transformers with too flat a characteristic. Under present conditions it is not feasible to depend entirely on the filter for selectivity. The transformers themselves must offer a certain degree of selectivity before the signal reaches the filter transformer.

A further source of difficulty has been termed by the writer a "splashing" effect. It is the effect of shifting peak referred to above in connection with transformer testing. Powerful local signals have a tendency to shift the operating wavelength of the transformers. This can be coped with only by loosening the antenna coupling or shortening the antenna to the point where the effect ceases, without sacrificing too much in the way of volume on distant stations.

For the sake of unity the second detector has been embodied with the amplifier in Fig. 5. C battery detection here is better than the grid leak and condenser method for several reasons. In the first place it is quieter in operation than the condenser and leak and results in better audio output with most amplifiers. The principal reason is because of the effect of the condenser and leak type detector on the output filter. Most filters now on the market are impaired by the use of a shunt resistance across their secondaries. In view of the

fact that the grid leak in the grid detector must be connected to the positive end of the filament, the grid of the tube will attract electrons, causing the input of the tube to be of the nature of a resistance across the filter. For this reason the C battery detector inevitably results in better selectivity in the filter. So little has been said with regard to the proper value of C battery that the curves of Fig. 6 were made. They indicate that the proper value of C battery for the various tubes and voltages, are as follows:

TUBE	B BATTERY	C BATTERY
201-A	45 volts	3 - 4½
201-A	90 "	8½ - 10½
195	45 "	6 - 8
199	90 "	16 - 18

These curves also show that slightly better response is obtained with either tube operating at 45 volts than with 90 volts.

So much has been published in RADIO BROADCAST with regard to audio amplifiers that we will not repeat here save to call attention to the choke coil L and the 0.002-mfd. condenser in Fig. 5. The choke should consist of 1500 turns of fine wire wound on a 1-inch spool. Both choke and condenser should be located as close as possible to the output of the intermediate amplifier with which they are associated. They are not a part of the audio amplifier and serve rather to isolate it from the receiver.

We mentioned previously the necessity of variable coupling in the antenna coupler. In a receiver constructed in accordance with the above ideas it should be possible in metropolitan districts to decrease the coupling to the point where the local stations will appear very sharp and well defined with plenty of room on the dials for out-of-town reception. This coupling is

very critical and is usually just short of the point where the volume falls off on distant signals. If it cannot be attained, then reduce the size of the indoor antenna to some extent until proper selectivity is obtained.

It is hoped that the above ideas have been presented in such a way as to be helpful to those building new receivers or in reconstructing old material. Every effort has been made to present ideas which are in keeping with sound engineering practice, and we hope will be of some assistance to the experimenter who is already fed up on unfounded hokum.

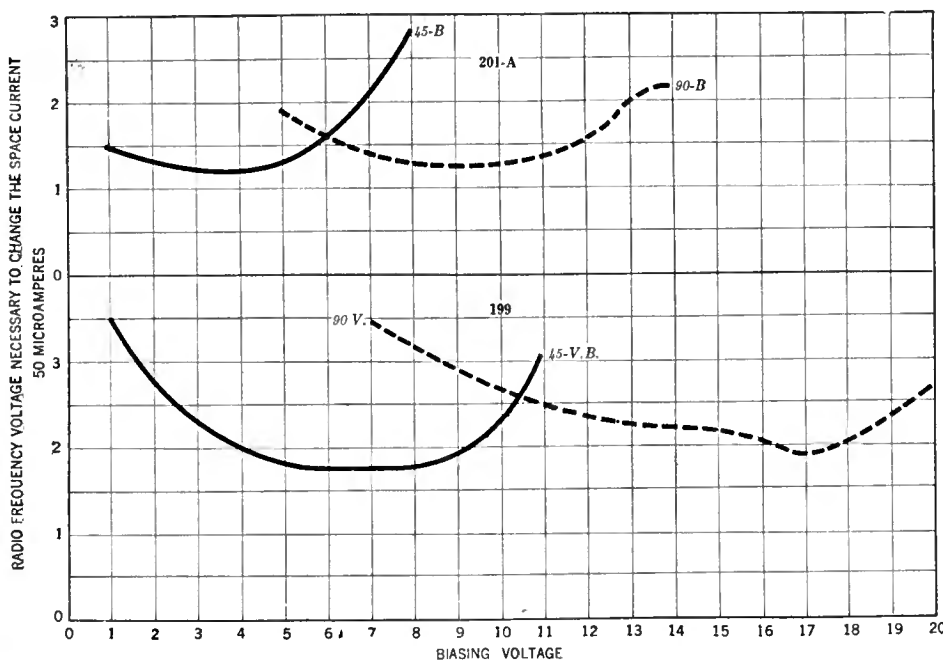

FIG. 6

Response curves of a C-battery detector for different values of plate voltage and C battery. The grid and plate voltages that give a change of 50 micro-amperes in plate current, with the smallest radio frequency voltage, are the best to use. From the curves it can be seen that best response is obtained with 45 volts on the plate of the tube and a C battery of approximately 3½ or 4 volts

RESULTS OF THE SHORT-WAVE RECEIVER CONTEST

Description of a Contest Receiver Submitted by Frank C. Jones—A Simply Built and Operated Set Which Radiates Far Less Than Standard Amateur Receivers

AS A feature of the RADIO BROADCAST-Eveready short-wave experiments conducted in the short-wave experimental laboratory of RADIO BROADCAST at its station 2GY a contest was announced, in February, 1926, open to all, in the hope of inspiring some able amateur to bring forward the design of a non-radiating short-wave receiver. During the early days of broadcasting, when the radiating regenerative receiver was at the height of its popularity, RADIO BROADCAST took the then revolutionary step of barring from its pages, the advertising and constructional description of receivers which radiated. That policy has been maintained, as far as broadcast receivers are concerned, to the present day.

In the short-wave amateur field, however, the radiating receiver—the only type in use by the thousands of amateurs who fill the bands assigned to them—has not brought about the same widespread condemnation as has its use in the broadcast range. Feeling that the work of the amateurs could be greatly improved by a wider use of a sensitive receiver which would not radiate, a prize contest for such a design was arranged by RADIO BROADCAST.

About fifteen manuscripts were selected for consideration out of all those submitted in the contest. Exhaustive tests conducted at 2GY showed that all of the receivers submitted by contestants did radiate—especially those that actually received signals. To determine those which radiated the least, the following tests were made. In station 2GY, a standard Reinartz receiver is in use. By keying the plate circuit of this receiver, code was transmitted to another receiver in the office of RADIO BROADCAST, some 400 yards away. Later, when a microphone was placed in the ground lead of the Reinartz, speech was readily understandable at the office. The contest receivers were compared to this set. Those which radiated as badly were at once eliminated.

It soon became apparent that not one of the surviving group of the contest receivers satisfied the conditions of the contest. With the permission of the judges, Boyd Phelps, Prof. L. A. Hazeltine, Zeh Bouck, G. C. Furness, Arthur H. Lynch, Edgar H. Felix, Dr. Lawrence Dunn, Prof. J. H. Morecroft, and Dr. A. Hoyt Taylor, and the designers of the receivers which came nearest to satisfying the conditions, it was decided to award \$100 to the designer of the receiver which radiated the least and which was, at the same time, sensitive.

The set described in the accompanying article has been given the \$100 award, and its designer is Frank C. Jones, operator of station 6AJF of Berkeley, California. This set is not as sensitive as a Reinartz, and a second audio amplifier should be added which will bring it up to equality with a Reinartz. Mr. Jones's receiver radiates far less than the Reinartz, and under actual test for a number of months in our Laboratory, more stations were heard on the set than can be "worked" by the average transmitter. We feel that Mr. Jones has described an interesting circuit, simple to construct and certainly as simple to operate as the conventional amateur radiating set.

We are frank to admit that the set described does radiate slightly, that it is given an award, not the \$500 prize as originally planned, in spite of the fact that the main condition of the contest was not completely met. RADIO BROADCAST believes it is performing a greater service in making public this design, which has much in it to inspire other experimenters to work along similar lines, than by refusing to give currency to any of the interesting designs. Several other ingenious circuits were submitted. Two using push-pull detectors intrigued the Editors greatly, but the transportation company wrecked both of these sets twice. It is still hoped that these sets may be received at 2GY in good condition. Much of the delay in deciding this contest was due to the complications caused by damaged sets.

It is hoped that this article and others to follow will help experimenters to develop a really non-radiating short-wave receiver. Dr. A. Hoyt Taylor, the famous short-wave experimenter, has written us: "It is entirely possible to make a receiver which will not radiate, no matter how sensitive it is, provided that proper principles are applied. It must be admitted, however, that the method employed to suppress radiation will naturally run up the cost of the receiver. It does seem rather strange that no one has been able to produce a receiver which will completely suppress the radiation. The problem is by no means impossible of solution, nor is it too difficult for a high grade amateur to attempt." At eighty meters it is entirely possible to build a neutralized radio frequency amplifier and transmitting stations using master oscillation systems use neutralized amplifiers as low as fifteen meters.

The editorial pages of RADIO BROADCAST will always be open to the "high grade amateur" who can produce such a receiver.

—THE EDITOR.

How to Build and Operate the Jones Receiver

By FRANK C. JONES

Amateur Station 6AJF

ALL of the ordinary short-wave tuners in use at present radiate energy to some extent, which is rather undesirable, especially in cities where a number of short-wave receivers are likely to be in operation. Any one can check up on that by listening to all the little chirps as someone swings his oscillating receiver across your wave a few times, even though the owner of the set may be some distance away. There are several ways of lessening the radiation from a short-wave tuner such as using a stage of neutralized radio frequency or a blocking tube ahead of the oscillating detector, or by using very loose coupling to the antenna. These all have

their disadvantages. Perhaps it is an extra tuning control, or an extra tube or insufficient coupling to the antenna. After all, these expedients do not fully accomplish the desired result, the elimination of radiation from the oscillating tube. In the receiver described here, radiation is practically eliminated if proper care is taken in making the final balance adjustments.

The circuit of this receiver is shown in Fig. 1, and as can be seen, there is nothing startlingly new about it except that the principle of the Wheatstone bridge is employed in the circuit. An analysis of the circuit brings it down to the familiar bridge circuit as shown in Fig. 2. The tuning

inductance L₂ is tapped in the exact center and forms the inductance arms of the bridge while C₃ forms one of the other legs which must be made equal to C₄ in order that no potential will exist between points A and B or across L₂. C₄ is the grid-to-filament capacity of the oscillating detector tube plus other small capacities due to location of the wiring and the grid condenser, etc. The fixed tickler is placed at the center of L₂ so that equal voltages are induced across the two halves of L₂. If the bridge is balanced, no current will flow through L₃, which corresponds to a galvanometer or a telephone receiver in the ordinary form of the Wheatstone bridge. Since the antenna

system is connected across L₃, no radiation occurs from the oscillating tube into it—which is the long sought for result.

When a voltage such as an incoming signal is applied across points A and B of Fig. 2, there is zero voltage across points E and D, and if the detector tube had its grid and filament leads to E and D, no signal would come through the tube circuit. However, the grid is connected to point E and the filament to point B so that there is an actual voltage across it. The voltage due to the incoming signal voltage drop across L₃, splits at A and B through the two halves of the circuit so that the maximum amount impressed across the grid and filament is half of the total signal, while the other half is lost or dissipated through C₃, and the other half of L₂. This is of no practical concern, since a little larger receiving antenna, or closer coupling to the same antenna as used with one of the common types short-wave tuner, will bring the signal strength back to normal. Actually, with this system it is possible to get greater coupling to an antenna without causing the tube to stop oscillating, than with most other receivers due to the balanced system used in it.

The effect of the tuning condenser C₂ on the circuit is merely to increase the effective inductance of L₂ in one sense of the word, and has no effect on the balance of the bridge, since it is across points E and D of Fig. 2. Since interchangeable coils are used in order to cover the amateur bands of from 15,000 kc. to 1500 kc., (below 20 meters up to 200 meters), the center taps on the coils should be at the exact center and the tickler coil should be fastened quite rigidly in the center of each of these coils. This eliminates resetting the small condenser C, each time the coils are changed, since the "effective" value of C₄ is about constant.

DETAILS OF THE RECEIVER

THE actual tuner itself is subject to a number of modifications. No one ever makes a short-wave tuner exactly according to specifications, so no rigid rules are given. The pictures of the set give the general panel and baseboard layout. The set was built for the new ux tubes. Rubber sponge cushions are glued to the ux sockets and to the baseboard. The cushions are quite effective in eliminating

Facts About the Receiver

Type of Circuit = Modified Wheatstone Bridge Principle.
 Number of tubes = 2 tubes = 1 regenerative detector plus 1 audio-frequency amplifier.
 Type of tubes = 201A's throughout.
 Frequency bands = 17,640 kc. to 1764 kc. (17 to 170 meters).
 Type of Antenna recommended = Pickard Horizontal Antenna; any other type satisfactory.

ringing sounds due to vibration. Microphonic noises are especially troublesome when one is tuning on the higher frequencies. Automatic filament control is obtained by the use of Amperites which work quite satisfactorily and eliminate one or two controls. Twenty-two volts are used on the plate of the detector tube and 90 on the audio stage.

The front panel can be a 7" x 12" or 6" x 12" bakelite or hard rubber panel, while the rear panel supporting the condensers should be of hard rubber and about 4" x 9".

It is necessary to have the panels quite rigid since extension shafts are used on the condensers. In this receiver, three brass "angles" or box corners were used on each panel to fasten it to the baseboard. In the front panel is a filament snap switch and an open circuit jack for the telephone receiver plug. Each of the two condenser

extension shafts terminate in a 4-inch dial, the one on the tuning condenser C₂, having a Tiny Turn vernier, which gives a 40 to 1 ratio with a very smooth and noiseless control for fine tuning. A good vernier is very important. The other dial which operates the "throttle" of feed-back condenser is unimportant and could as well be a knob as the regeneration control C, has practically no effect on the tuning condenser C₂.

The rear panel should be far enough from the front panel so that the effect of hand-

capacity while tuning will be nil. If the space between the panels is about 7 or 8 inches, that will generally be sufficient. The two large variable condensers C₂ and C₁, of approximately 0.00015- and 0.0002-mfd. respectively should be mounted on the rear of this panel and the rotor shafts connected by means of insulating fibre bushings to the extension shafts and dials. These bushings were made of 2" lengths of fibre

tubing with a 1/4" bore and were drilled and tapped for 3/8" machine set-screws near the ends. The writer believes that it is much better to use extension shafts than to use metal shielding in any kind of short-wave receiver construction. That point is especially important in this circuit where every small capacitance is important when balancing the circuit, as a bridge. The tuning condenser C₂ should preferably be of the straight-line frequency type, or be a model where the plates are trimmed, and should also preferably be of a skeleton construction in order to have a low minimum capacity.

The grid condenser of 0.0001-mfd. or smaller should be of the best and can be conveniently mounted on the back panel. The grid leak should be from 6 to 10 megohms and a "quiet" one if it is possible to obtain such a thing. The balancing condenser C₃, was also mounted on the back panel using a small bracket. This was a midget condenser of about 0.00003-mfd. maximum and a low minimum capacity and after it is once set it can be left alone.

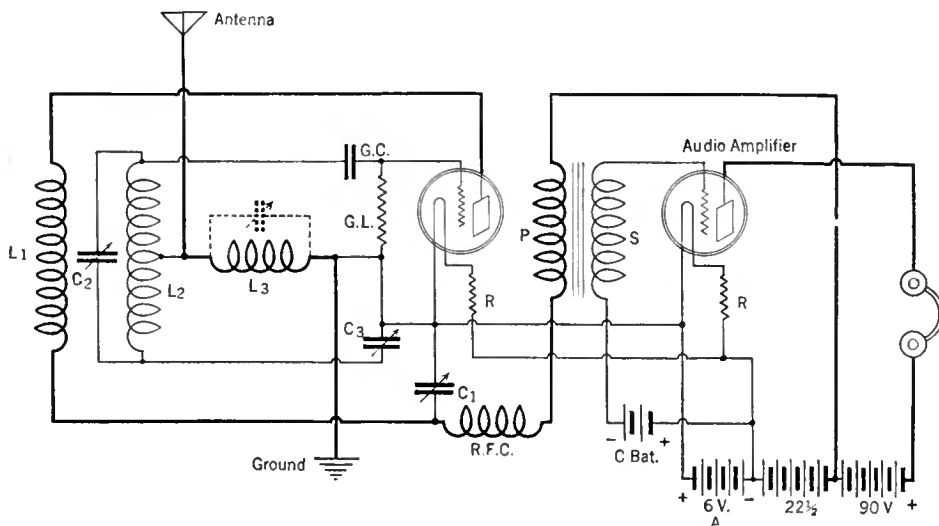
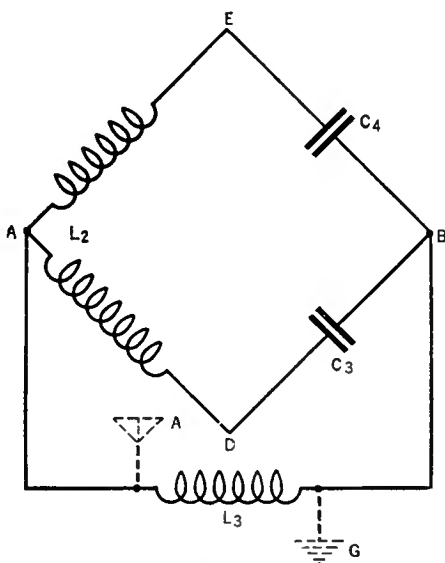

FIG. 1

The circuit diagram of the short wave receiver described in this article. It looks complicated but really is quite simple



C₄ = C₂ + Capacities between wires, etc.

FIG. 2

The equivalent bridge circuit of the input part of the circuit shown in Fig. 1

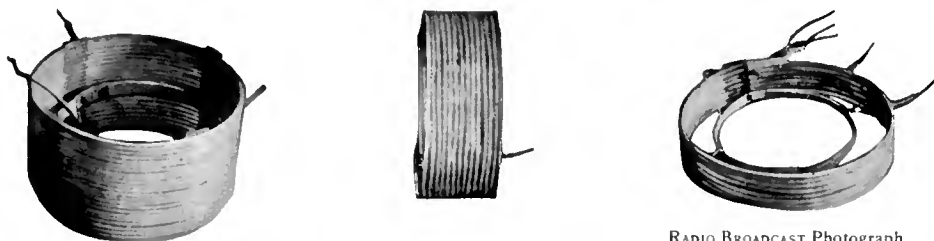

FIG. 3

Coils for the receiver, which include the inductance used in the tuning circuit, and the fixed regeneration coil situated in the center of the tuning inductance

RADIO BROADCAST Photograph

THE IMPORTANT ANTENNA CIRCUIT

LEADS for the inductance L_3 were brought out to binding posts on a small hard rubber strip. This was done so that the coil L_3 could be placed a foot or two away from the rest of the tuner. It is the voltage drop across this inductance that is impressed on the arms of the bridge and so on the grid of the detector, which means that for maximum drop the antenna circuit including L_3 should be tuned to resonance with the incoming signal. This generally means too much coupling, similar to bringing the primary coil of an ordinary tuner tight up against the secondary coil, so it is best to tune the entire antenna circuit to some frequency (wavelength) just below the range of the tuner such as 1492 kc.

(201 meters). An easy way to tune this circuit to some such frequency is to set the shunt condenser, shown in dotted lines in Fig. 1, just below the setting for a near-by broadcasting station whose frequency is around 1500 kc. (200 meters). For instance, if the local station was on 1440 kc. (208 meters), and it was possible to hear it with the detector not oscillating and the L shunt condenser set at 25° , setting the condenser at about 20° should fix it about right. This arrangement gives a pretty good voltage drop across the coil L_3 for all frequencies above 1500 kc. (below 200 meters), and is better than using, say 3 or 4 turns which would give very little "coupling" on the higher amateur bands. The coil L_3 depends on the antenna used and may be anything from 5 up

to 30 or more turns. By using the new horizontal type of receiving antenna described in *QST* for February, 1926, by Dr. Greenleaf Pickard, very excellent results are obtained. This type of antenna is very inefficient for longer wavelengths, such as those used by broadcasting stations, and extremely efficient for short waves. A horizontal wire 75 to 100 feet long with the coil L_3 and its shunt condenser inserted in the center certainly works fine when tuned to 1492 kc., (201 meters) and left at that adjustment.

At least one stage of audio frequency is necessary and a high ratio transformer may be used to advantage. The radio-frequency choke coil which taps on to the feed-back condenser should be small so as to have a small field and should be wound for minimum self-capacitance. A small honey-comb coil such as is used in certain superheterodyne transformers is very good or one can be wound on a $\frac{3}{4}$ " wooden form with finishing nail pegs. The best way of obtaining such a coil is to show the wife how fascinating it is to weave the pretty green silk covered wire in and out around the pegs on the coil form. That system worked excellently in the writer's case and produced a nice 500-turn miniature honey-comb coil at his station, 6 AJF.

HOW TO MAKE THE COILS

THE tuning coils, L_2 , are made of spaced windings with a 3-inch diameter. A 3-inch cardboard tube was used and four narrow celluloid strips tied down with string around the circumference of the tube. No. 16 d.c.c. wire was used on the smaller coils and No. 18 d.c.c. wire for the larger ones. The turns were spaced about the diameter of the wire or slightly less while winding it on the tube. Winding the coil is really quite simple, providing that the wire is free from kinks. The coil can be wound in a very short time. After fastening down the ends of the coil, collodion, or a solution of acetone with celluloid dissolved in it, is applied along the wire above the strips of celluloid which then dissolve slightly, letting the wire sink into it a small amount. When the coil is thoroughly dry, these celluloid strips hold the wire very firmly in place and the cardboard tubing may be broken out leaving the coil in a skeleton form. The losses in such a coil are quite low and it is about as efficient as it can be made. The tickler or feed-back coils were wound on two-inch cardboard tubing on celluloid strips using No. 26 d.c.c. wire but with no spacing between turns. A rather thick solution of acetone and celluloid was used to coat the entire coil and after drying, the cardboard tubing was removed. It was found desirable not to use any tubing as a form for these coils since they were to be fastened by thread in the center of the tuning coils. The tickler coils were tied to the tuning coil celluloid strips at four points, making a skeleton form of tuning unit which should have quite low losses. To diminish the losses further, the coil unit is mounted

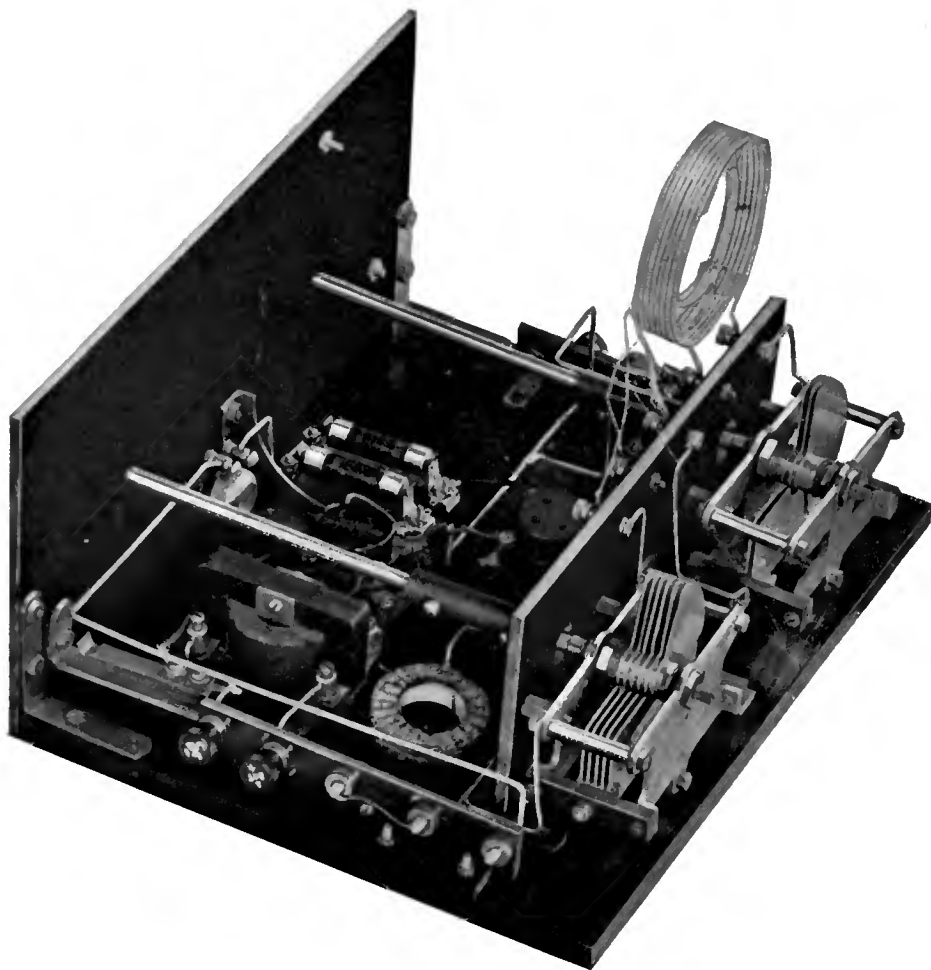
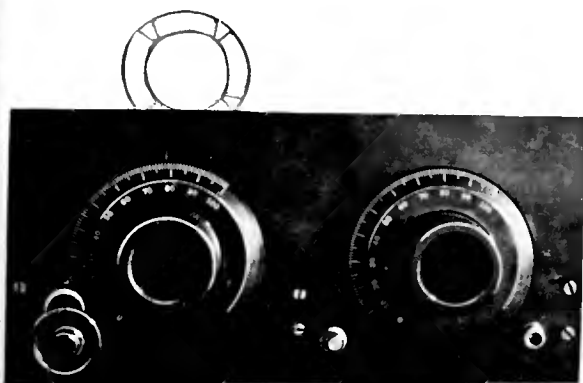

FIG. 4

A view from behind the panel of the Jones receiver. The position of the inductance, the location of the condensers and the choke coil are noteworthy

RADIO BROADCAST Photograph



RADIO BROADCAST Photograph

FIG. 5

How Mr. Jones's receiver looks from the front. Simple, as all short-wave receivers are, it has but two dials, only one of which needs to be a vernier, and a switch and jack. The inductance coil is also visible

Tuning Coil L2 No. of turns	Tickler Coil L. No. of turns	Wavelength range, meters	Kilocycle range
4	5	17-30 (approx.)	17,640-9994
8	7	29-55	10,340-5451
13	9	41-92	7303-3259
24	11	75-130	2998-2306
43	13	80-170 (approx.)	3748-1764

range of the receiver. Unless the balancing condenser is properly set, the receiver will not oscillate over the whole tuning range so that C₃ can be easily adjusted down to a hairsbreadth until the receiver will oscillate properly.

To test the other tuning coils to see if they were exactly center tapped, other sizes of coils should be used for the coil L₃ and the whole set worked on until the balancing condenser can be left in one position for all of the interchangeable coils. Then adjust the antenna circuit including L₃ to a frequency just above the lowest which will be used such as 1482 kc. (201 meters) and the set is completed and ready for operation.

up in the air above the rest of the apparatus and supported by the three heavy leads from the coil L₂ which slip into binding posts up at the top of the rear hard-rubber panel.

The set of coils made up by the writer tuned over the wavelengths given in the table when using the secondary condenser in this set.

The adjustment of the balancing condenser C₃ will change the secondary coil L₂ calibration, so after it is once adjusted, it should be left alone. The method of adjustment used was to disconnect the antenna and counterpoise from coil L₃ and tune it by means of the shunt condenser to some wavelength within the

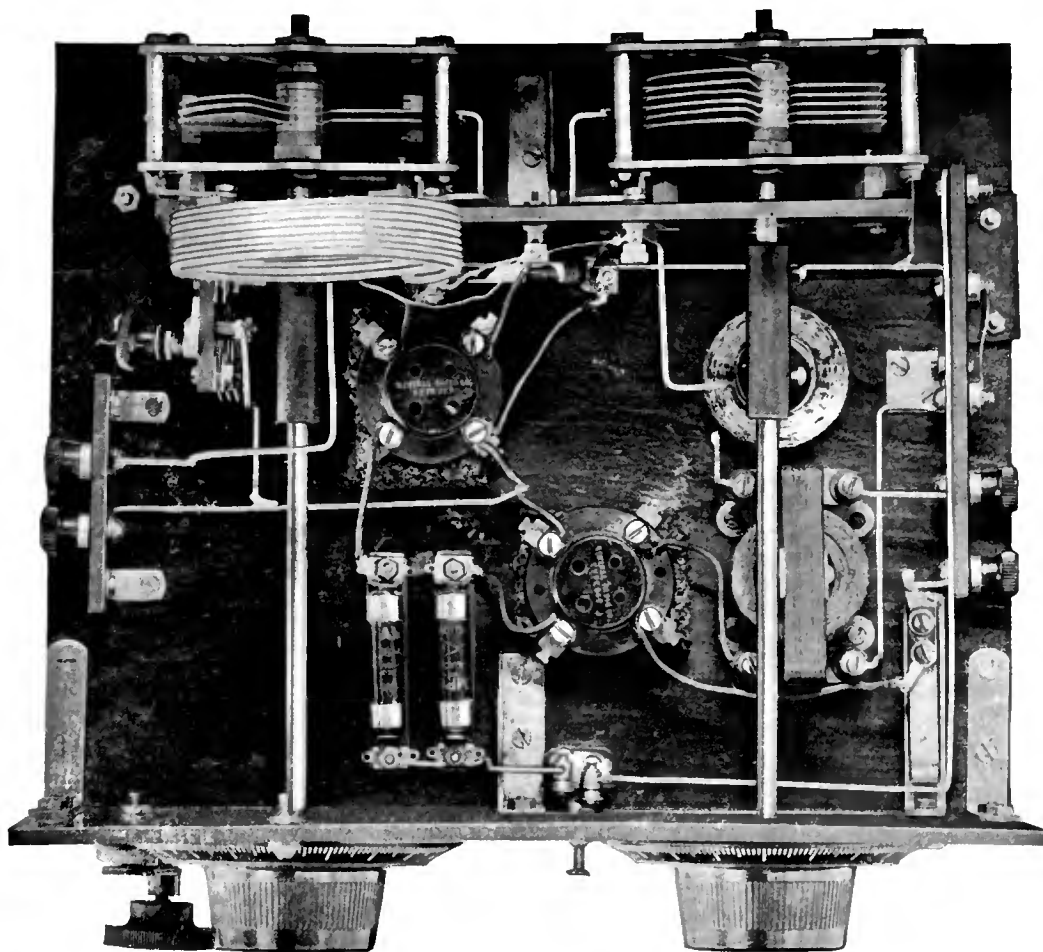

RADIO BROADCAST Photograph

FIG. 6

Looking down on the Jones receiver. This view gives a good idea of how the condensers are insulated from the dials in front of the panel. This method eliminates all danger of hand capacity. One stage of audio is included, although one additional stage can well be used, since the noise level on short waves is quite low

Additional Notes on the "R.B. Lab" Circuit

Experiences of Readers With an Extremely Interesting Circuit Described in *Radio Broadcast* for June—How to Run Leads Properly—Voltage Gain in the Amplifier—Use of Solenoid Coils

By KEITH HENNEY

Director, Radio Broadcast Laboratory

A CIRCUIT was presented in June RADIO BROADCAST that had been in use in the Laboratory for some months. It was called the R. B. Lab. circuit. A request was made of those readers who experimented with it to write of their difficulties or successes. This circuit was published for the first time in this country by Dr. L. M. Hull and was one of several which have come from the Radio Frequency Laboratories.

This circuit is shown again in Fig. 1. It will be seen that it differs from other amplifiers only in the transformer connecting the amplifier to the regenerative detector. In the original circuit built up in the Laboratory, toroid coils were used because of the exceptionally high gain of the amplifier. This characteristic made it necessary to either shield the amplifier or to use other means of eliminating unwanted couplings.

There is no reason, however, why ordinary coils, whether solenoid, diamond-weave, or whatnot, cannot be used in this circuit, provided the proper precautions are taken. The great difficulty constructors have with this circuit—as with all other high-gain amplifiers—is in neutralization and a few kinks will be described here that may be of aid. They will also apply to other radio-frequency amplifiers so that some of this information ought to be useful for all those home constructors who build good amplifiers for use ahead of their detectors.

In Fig. 1, the important leads are numbered. Now, in any amplifier, the tendency to oscillate varies directly as the capacity between the grid and plate and the wires attached to them, to the coupling between the grid and plate coils, and to the inductance in the plate circuit. In other words, no tube will oscillate unless there is coupling of some sort between the output and input circuit, and if there is no inductance in the plate circuit. If there are few turns in the plate, the thing will not oscillate—nor will there be much gain at the lower frequencies. With the ratios of coils given in the June article, the tube will oscillate if not properly neutralized, and it will oscillate then unless great care is taken to prevent

magnetic feedback between coils. For this reason, toroid coils were chosen. Solenoids of small diameter can be used, but they must be separated by several inches, must be at right angles to each other, and there must be no metallic material between the coils. This latter point is important.

There is another important point. No matter how much capacity exists between grid and plate, it can be neutralized. It is only a matter of using a larger neutralizing condenser. In other words there is no particular harm in letting wires 1 and 3 be fairly close together. Since wires 1 and 2 are attached to opposite plates of a condenser there is no harm in letting them be fairly long or close together since the only result will be to increase the condenser capacity. The same may be said of wires 2 and 3, 3 and 4, and 3 and 5.

ABOUT RUNNING THE LEADS

BUT between any other pair of wires there are phase differences which cannot be compensated by condensers—that is, these differences make it impossible to neutralize the amplifier. Especially important and obnoxious is the lead connecting the detector grid to the leak-condenser. The best way to avoid trouble here, is to make the tube socket terminal connect directly to the grid condenser-leak. Wire 6 is the cause of much trouble. It needs watching.

If the above precautions are taken, the tube can be neutralized at all broadcast frequencies, it will give considerable gain, and will not radiate into the antenna.

The radio-frequency choke in the amplifier mid-tap is important. The Samson choke is the only commercial choke that has been used. It is entirely satisfactory.

One may be made at home by winding about 400 turns of small wire—No. 30—in slots carved into a bakelite rod about one-half inch in diameter.

If this choke is not included, the amplifier will oscillate at the natural frequency of the upper half of the input coil and the capacities attached to it. Another method of stopping this parasitic oscillation is to attach a small condenser from filament to the bottom of the coil as shown in Figs. 2, and 3.

Some readers have confused this circuit with the RADIO BROADCAST Universal described in RADIO BROADCAST for January and February and the L-C circuit described in *Radio*. In the June article the difference was pointed out. The circuit differs from the Universal in only one main respect—the plate coil has been reversed. The L-C adheres to the original circuit published in *QST*. The *Radio* circuit has the peculiar feature that it is neutralized only at the point of resonance between the amplifier and the detector. Signals come with a shriek and a whiz—but once in they stay there.

Mr. R. P. Courtis of Detroit has played with the two circuits and has the following to say:

I was very much interested in the article in June RADIO BROADCAST regarding the "Series Resonant" transformer of Doctor Hull.

I have been doing considerable work on this type of transformer during the past year and I am very enthusiastic as to the possibility of developing an exceptionally efficient set from it.

There are some points mentioned by Doctor Hull in connection with this circuit which do not appear in your article. One of them is the fact that the plate and grid coils do not need to have mutual inductance. It is perfectly possible completely to shield both of them and still have

the circuit operate. Another point is the fact that the compensation by the neutralizing condenser is independent of the frequency when the transformer is tuned to resonance. The "locking-in" effect described in the article is due, as Doctor Hull points out, to the fact that compensation is not perfect for frequencies off the resonant point. The effect is very marked with low resistance coils, the set going out of oscillation with a shriek and click which is quite characteristic. It is a very interesting experience to tune one of these sets and have the broadcasting come in clear at the end of a violent howl.

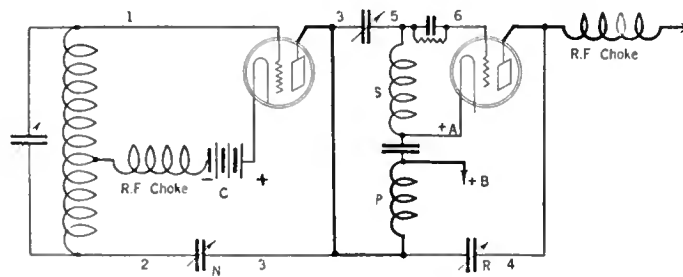

FIG. 1

The important wires in this circuit are numbered and in the text is outlined the wires which must be kept away from each other. The experimental circuit was described in RADIO BROADCAST for June, 1926, pages 121-5

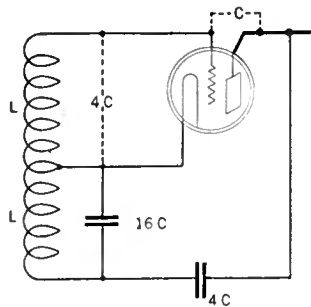

FIG. 2

A method of avoiding parasitic oscillations in the "Lab" circuit radio-frequency amplifier. It includes the addition of a small condenser from the mid-tap to the lower part of the coil. This makes a bridge whose arms are properly balanced

In connection with the separation of the primary and secondary, it would seem from this that it should be possible to use separate toroidal coils for these two inductors, thus allowing their use to best effect.

I would suggest, if you have not already tried them, that you insert a radio-frequency choke coil in the B-battery lead of the primary, and that you also try a transformer with the turn ratio of 3.16, with the primary and secondary in inductive relation but separated by about three inches. These coils may be wound on opposite ends of the same tubing for convenience in mounting.

The question of coupling between the two parts of the coupling transformer brought up by Mr. Courtis is interesting but does not seem to be of great importance. As a matter of fact, one of the reasons for our interest, originally, in the circuit was because the primary and secondary could be isolated from each other and thereby do away with any capacity coupling that ordinarily exists between the two windings of a transformer. In the Browning-Drake circuit, an effort has been made to reduce the capacity coupling which should introduce an out-of-phase voltage and reduce the energy transfer.

VOLTAGE GAIN IN THE AMPLIFIER

THE curves in Fig. 4 will be interesting. They show the voltage gain from three methods of connecting a primary and secondary coil. Curve 1 is the ordinary transformer coupling, curve 2 the auto-transformer as used in the Universal, and curve 3 as used in the "Lab" circuit. There was no coupling between primary and secondary in this case. The coil constants were as follows: Primary inductance 60 microhenries. Secondary inductance 160 microhenries. Mutual inductance 25 microhenries. Secondary Resistance at 500 meters—16 ohms.

Using two poor coils—resistance about 30 ohms at 500 meters—The gain was about unity so that with a tube whose amplification constant was 8, there would be a volt-

age gain of eight, due to the coil and tube. As a matter of fact, it is simpler to use coils with mutual inductance between them since any coil tapped in the right place can be used.

Difficulty from hand capacity in the antenna circuit can be remedied by the scheme indicated in Fig. 5. Here

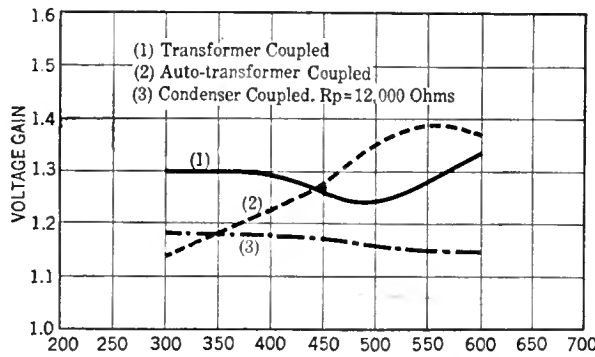

FIG. 4

The voltage gain of the interstage transformer of the "Lab" circuit, compared with two other types of coupling. The flat curve is important since it tends toward stability and evenness of regeneration and gain. Curve 3 is made on the coupling arrangement in the "Lab" circuit

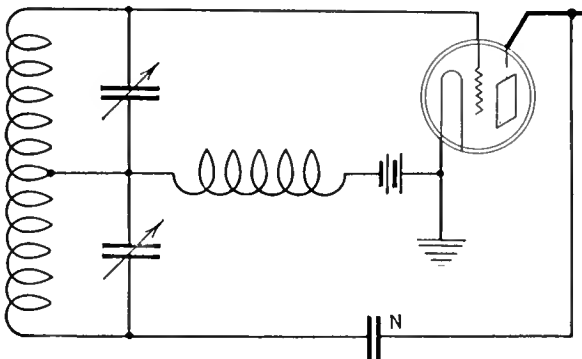

FIG. 5

A method of avoiding hand capacity in the radio-frequency amplifier. Two similar condensers with one side grounded are used. This necessitates that the condensers be alike and that the coil be tapped in the center

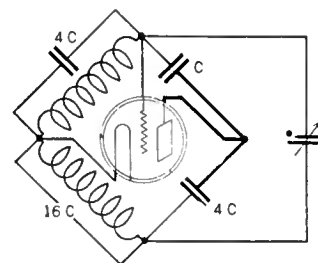

FIG. 3

The equivalent bridge circuit of that shown in Fig. 2

is a balanced rotor condenser, or two condensers may be ganged and the proper side grounded. This puts that part of the condenser at ground potential.

EXPERIENCE OF ANOTHER READER

AN interesting letter about the "Lab" circuit has come from Mr. E. H. Brewer of Belmond, Iowa, who writes as follows:

We are about 300 miles from Chicago and it takes a very good set to bring in any of these stations in the day time but I get KYW any time on the speaker, when the static is not too strong.

I have not used the best of parts, and the coils are all home made, using .0005 condensers. Am using a toroid of 145 turns, cutting off 48 turns for primary, but found I got better results using a solenoid space wound on air, sec. 50 turns, primary 12 turns, these on a 3-inch form in the r. f. end.

Have not had any trouble in getting perfect neutralizing so have not had to use the tuned trap you speak of. The tone is all that one could wish with volume to equal any 5 or 6 tube: am using a 2-1 a. f. transformer in first stage with a 3 1/2 to 1 in the last.

My opinion is you have the best four-tube circuit ever published for the public.

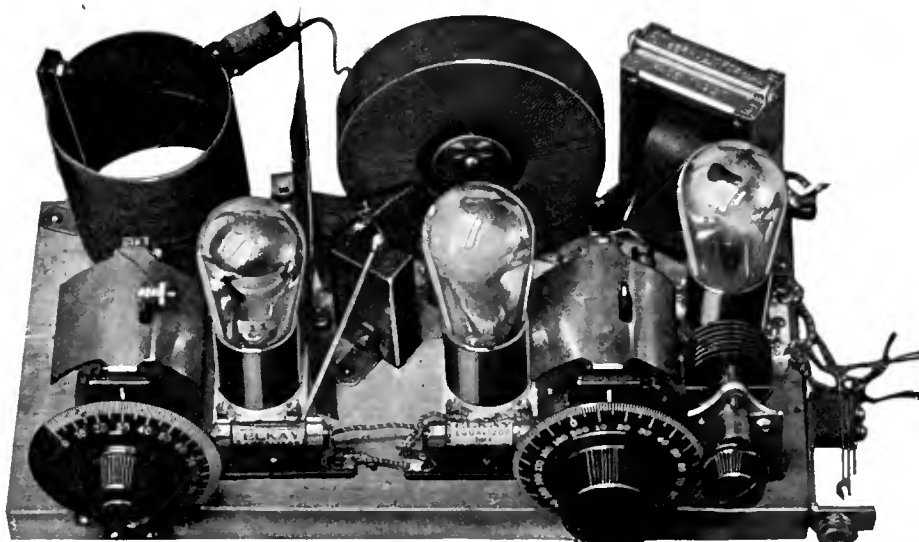

RADIO BROADCAST Photograph

FIG. 6

An especially compact experimental model of the "Lab" circuit which was built up to determine proper wiring and placing of parts. Complete constructional data on several receivers of this type will appear in an early number of RADIO BROADCAST



The Listeners' Point of View

Conducted by John Wallace

The Curious Jargon of the Broadcasting Industry

WITH every new industry, superstition, or pastime, there is introduced into the language a host of new words necessitated by the late discovery. The airplane introduced enough of new words to fill a tidy little volume. Psychoanalysis forced its pet word "complex" into common use. Radio, on its technical side, has introduced a bewildering number of hybrid Afro-Graeco-Franco-Whato words. These we are not concerned with here, but only with the new expressions that have arisen in connection with broadcasting itself. There are only a handful of such new words, but they vary from the very choice to the utterly reprehensible.

When, in the earliest days of broadcasting, the necessity arose for some word to describe a new operation, it was naturally enough borrowed from the older profession of nautical "wireless." These terms, which found origin on shipboard, had a fine savour of the salt. Unfortunately for radio's vocabulary, they have fallen by the wayside and only two of them survive: Sign off, and Stand by. We admire these terms for the respectable air of age they lend to an industry that is so tragically new. May they endure and prosper!

The search for the proper word to describe the act of disseminating into the ether music, speeches, gun shots, and bad jokes, would seem to be still in progress; though the term broadcasting has a firm foothold. That horrible variation "broadcasted" which was introduced by some illiterate a while ago and enjoyed a lusty vogue, has now, happily, disappeared. The erroneous form once appeared in all the dignity of type in the first draft of the White Bill, H. R. 5589, and was thus given an official stamp of approval it nowise deserved. However in the revised radio Bill, H. R. 9108, the committee changed the word to "broadcast" which ought to settle that point for good.

[*Editor's Note:* for the past three years, RADIO BROADCAST has used only the form, "broadcast"]

Some time ago an effort was made to substitute the ugly coined word "radiocast" for "broadcast." The poor excuse was that "broadcast" conveyed the wrong shade of meaning. Dr. Frank H. Vizetelly, lexicographer and managing editor of the *New Standard Dictionary* put this subterfuge on the kibosh in the following words:

Perhaps I am to be permitted a word of comment upon the so-called "discovery" that the word "broad-

cast" as a verb means "to sow with seed or material substances." No careful student of language could possibly have introduced such a definition, for the word "broadcast" has been applied to pneumatology for more than 100 years. In other words, the term has been employed to cover both the concrete and the abstract. More than 100 years ago the Church was talking of "the doctrine of missionary zeal" having been "broadcast over Christendom," and "broadcast accusations" have been common to civilization almost since the dawn of politics.

To my mind "radiocasting" is an ambiguous term, for it does not connote "diffusion," and as I understand it, that is what the radio stations do. It seems to me that such a term as "radiospread" or some word that conveys the sense of diffusion more clearly than "casting" might be used. We shall probably live to see the time when, just as we "phone" and "wire," we shall "radio," and the people, will understand what is meant without the necessity of our adding any suffix to convey the sense of dissemination which we know means "the act of disseminating, scattering or spreading abroad, originally seed, but now doctrines," etc.

But still the cacophonous "radiocast" lingers on in some benighted quarters. wjz, which prides itself on its polite language, once said

"radiated" which seems to us equally offensive.

The best term in present use is that employed by woc. The expression "woc transmitting" is simple, dignified, euphonious and quite adequately descriptive.

Word coining is at best a nefarious practice and should be prohibited by constitutional amendment. It has resulted always in hideous monstrosities. Witness the unpronounceable collection of letters—Realtor. Word coining has become a national obsession. Great hosts of persons devote the greater part of their lives to devising new adjectives to describe Sparry's Lightning Auto Spoke Kleanser or new appellations to dignify the job of the Rubber of Lame Muscles. The glorified janitors of Chicago's tall buildings have been seeking new titles, and among those proposed were a couple of wows, viz. Blidgadors, and Skyscrapadors.

This mania has entered into the field of radio with dire results. wlw described a serial mystery play as a "radario"! The question of libel by radio, which came up for the first time only recently, stirred discussion in New York over what name to call the new air menace. Suggested names were etheric turpitude, radio-spense, aero-slam and eth-bel!

But the worst crime was committed by KOA. After spouting a lot of tommyrot about how they were going to broadcast an all night program to all the principal continents on the globe, they said "when the General Electric company unleashes the vibrations of KOA and the silent ripples of ether sweep across oceans and international borders, the world will have experienced for the first time, the 'orb-ricing' of a radio program." The word "orb-ray," it seems, was the glorious result of a much touted contest entered into by some ten thousand listeners for the purpose of devising a word with the same meaning in broadcasting circles that "circumnavigate" conveys to mariners. Ada C. Sessions, of Colorado Springs, coiner of the prize-winning word, received an especially designed ring, set with precious stones, as her reward.

When Ada Sessions comes to realize the heinousness of her deed we hope she eats that ring and chokes. Runners-up for the prize (which KOA believes "may be accepted a synonyms") include: "unicast," "georad," "adiate," "radiogrid," and "telearth."

The radio announcer has as part of his stock in trade a myriad of rubber-stamp phrases. One of the most com-

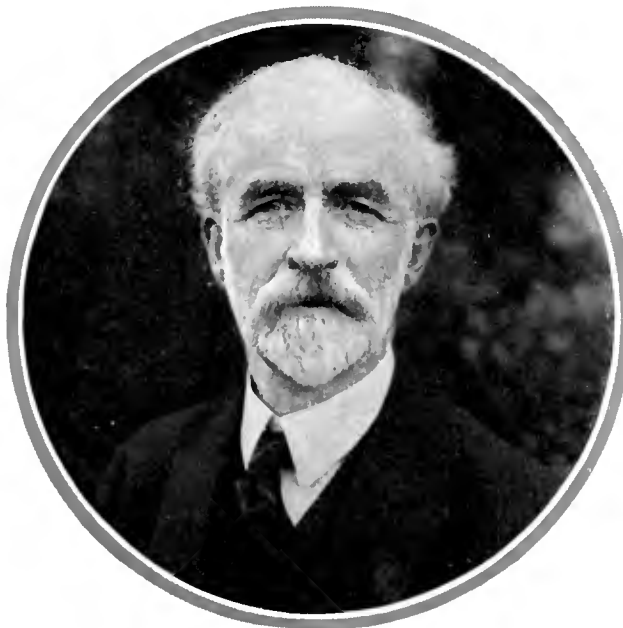

PROFESSOR EDMUND S. MEANY

Of the University of Washington, an authority on the early history of the Puget Sound Country, who has broadcast interesting talks on pioneer days through KFOA

mon of them: "You have been listening to station xxx." This phrase ought to be scrapped, and for two reasons: first, it is verbose; and secondly, if the listener happens to have just tuned-in, it is untrue.

Clipping the foregoing down to "This is radio station xxx" leaves it still in a wordy condition. For obviously, if the listener has received this signal via a radio receiving set he is enabled to assume that it is a "radio station" he is hearing. "This is xxx" is quite enough.

"Olga Bedstein-Storry will now sing for you Suchandsuch" is another one of our pet abominations. Why the "for you"? Of course she is going to sing it "for us." If her intention was to sing it solely for herself she wouldn't have come to a radio studio.

"This program is presented through the courtesy of the Izaak Blotz Toothpick Company" involves a poor choice of words. Mr. Blotz is supplying the program not as a grandiloquent gesture of "courtesy" but as a cold and hard business proposition.

But if we seem to take offense at some of radio's pet phrases—and there are many more equally odious ones—do not think we see good in none of them. For among the expressions that radio has brought into being there is one we revel in and gloat over. And that is: By remote control.

Broadcasting by remote control! Ah, there is a toothsome morsel! How slitheringly it slides over the tongue! And if its pronunciation is delightful, its connotation is more so. The words suggest majesty, power, omnipotence. We haven't any clear idea as to just what the mystic phrase means—which only makes it all the more intriguing.

The Ipana Troubadours

AS WE have before stated in this department, it is our belief that the best that radio has to offer is to be found in the regular weekly programs of the various indirect advertisers. Among such programs we think those of the Ipana Troubadours demand a high rating. The impression gained while listening to them is "here is a program that is prepared and is not merely happening." Studio programs too frequently convey to us the impression that we are listening-in on a rehearsal. The Troubadours play with a spirit and a precision which, if we are any judge, indicates careful and frequent rehearsal.

When the manufacturers sponsoring this program decided to go on the air they sought one Sam Lanin to direct their radio entertainment. Lanin had had six years as leader of a popular Broadway dance orchestra and a great deal of experience as a recording artist. He agreed to undertake the organization and leadership of the Ipana Troubadours providing he was permitted to get his own artists, and to pick them from the country's best dance and symphony orchestras.

That he did get the artists he wanted is now known to many thousands of radio listeners throughout the country. Lucien Schmit, for example, virtuoso 'cellist, was Walter Damrosch's first 'cellist for five seasons and he is also an accomplished pianist and saxophone player. Schmit is representative of the group.

The Ipana Troubadours broadcast their first program on April 8, 1925, from stations WEA and woo. They continued on these two stations until September 16 when they extended their broadcasting to six other stations. Since then, from time to time, other stations have been added until now these artists may be heard each Wednesday from the following chain stations: WEA, WEEL, WGR, woo, WCAP, WWJ, WLIB, WSAI, WOC, KSD, and WCCO.

That the Ipana Troubadours are popular there is no doubt. It is reported that from April 8, 1925, to December 31, 1925, most of the time using only two stations, they received more than 30,000 letters and cards of praise, suggestions, requests for special numbers and so on. After March of this year the correspondence department of WEA, which has jurisdiction over the analysis of the thousands of letters received from WEA's fans, concluded its study of the mail received during that month and gave highest honors to the Ipana Troubadours. The Vikings, and Blanch Elizabeth Wade, the G. R. Kinney Co. story teller, practically ran neck and neck for second place, but were more than a thousand letters below the total reached by the Ipana Troubadours. Other regular WEA features which stood high in the list for the month were, respectively, The Gold Dust Twins, The Atwater Kent Radio Hour, Shinola Merry-makers, Silvertown Cord Orchestra, the Clicquot Eskimos and the Eveready Hour in the order named.

The Publicity-Seeking Listener

IF WE recollect our kindergarten days correctly, there was in effect, in that now distant class room, an efficacious custom designed to curb our infant urgings to play leap-frog in the aisles, gedunk small girls' pig tails in the ink wells or conceal white mice in the teacher's desk; and likewise intended to reward our juvenile zeal in the manufacture of paper chains, pen wipers, and sundry other useful articles.

The system was a simple one. All the little boys and girls who had been good little boys and girls during the week were privileged to see their names emblazoned in glittering white chalk on the blackboard of a Friday.

And the value set upon this distinction was inconceivably enormous. An equivalent delight could have been secured by no less than six lollypops, with perhaps a top and a fish hook thrown in. To see our own name, our very own, blooming there on the blackboard in great big Palmer Method characters! And even more delightful was the ensuing bit of ritual. Teacher grandly and impressively approached the blackboard, and designating each successive name with her long pointing stick, read each and every one of them aloud. Aloud! The joy of hearing one's own name read out—and out loud at that!

But now in these our later years, it unpleasantly occurs to us that we were being duped all along! We begin to gravely suspect that the six lollypops might have possessed slightly more in-



THE IPANA TROBADOURS

Heard through WEA and about a dozen stations regularly each Wednesday night. The lower illustration shows the mail received by this organization during their first season of broadcasting. Correspondents need have no fear that their letters are not carefully examined, for at WEA, for instance, a special department devotes itself to nothing else. The upper illustration shows the Ipana musical organization, led by Sam Lanin

trinsic value, or perhaps even the lowly fish hook. Perhaps old age has embittered us, perhaps we have been too ruthless in sloughing off our first illusions, but be that as it may, we have come to the final, irrevocable, and perhaps cynical conclusion that there is no immense value attached to having one's name read aloud.

But our sad business of listening to the radio has forced upon us the further conclusion that advancing age has not effected in all our fellow beings the same disillusionment. We find an alarming number of persons—adults if you were to go by the size of their shoes—who continued to revel orgiastically in the sensuous delight of hearing their names made known to the world at large.

This number is dedicated to Mrs. Sarah B. Guelph of Safron, Ohio" and "This one is by special request of John and Minnie Henshaw of 4337½ Sunnyside avenue" and "We have here a nice little telegram: "Your program coming in fine, Joe Blotz, Pillsburg, Texas."

Arff! It hardens our arteries and makes us foam at the mouth. But listen! We'll let you in on a secret. We have discovered a way to still our wrath. We just utter into the loud speaker in a hissing voice: "Morons! Morons!" For we have decided that since our maximum delight at hearing our name read aloud was experienced at the age of six, all other persons who continue to enjoy this proceeding way into their adult life are still mentally about six years old.

Well, we don't intend to attempt to change human nature, even such decadent manifestations of it; but at least we can enjoy the radio station managers, who presumably aren't all morons themselves, to stop encouraging this infantile practice. If each and every station would simply refuse to read out names, even at the cost of a few listeners' vanity, there would soon be no names to read—and everybody would be happy, particularly ourself.

The stupidity of reading telegrams for the edification of any one other than the sender is painfully evident. No telegram we ever heard contained an intelligent remark and all could be boiled down to the "program coming in fine" formula.

Likewise glaringly apparent is the absurdity of formally dedicating a ditty that takes about one minute to sing and is probably poorly sung at that. Such practice evinces a sadly distorted sense of proportion. It is like making out a last will and testament, gorgeously embossed on thick crisp parchment, and decorated with multitudinous signatures, seals, attests and red ribbons, for the purpose of bequeathing three cents to cousin Charlie.

If the singer who squawks a piece has a right to dedicate his or her operation why not extend the privilege? On the sheet music, alongside the composer's quite legitimate dedication line, let's have a dedication by the printer who set up the type, and another by the binder, and perhaps one by the paper maker, with a publisher's dedication thrown in. And how about the office boy who keeps the publisher's office neatly swept extending his felicitations "To My Father" or "To M. K. H." on the copy?



CARRIE PRESTON RITTEMEISTER
Who broadcasts a daily shopping service—an advertising feature—through KNX at Hollywood

Nor can we see much sense in dragging in some listener's name by the "by request" device. It is a fact worthy of note that the pieces played "by request" are generally the most worn out and hackneyed numbers in the whole of radio's repertoire. We wish that some of our more homicidically inclined fellow listeners would make careful note when "The Prisoner's Song" or "Mother Machree" is ordered by Mr. Blank of 27 East First Street, Daytona, Alaska, and immediately despatch to the given address an infernal machine of sizeable proportions. Of course we do not rail against the listeners' communicating with the stations and requesting particular selections, and we further think that the stations should comply by playing them if they are not too hackneyed. But it is so tremendously asinine for the announcer to predicate the piece with a long story about who it is for. There is no excuse for the practice; if the assumption is that the listener who wrote in must be advised that this is his request number the assumption is silly. For if he asked for a particular piece it is only reasonable to presume that he will recognize it when it comes on. Or if, on the other hand, the assumption is that the announcement will summon the listener to his receiving set, it is slightly more silly, for, if he is not at his set, his set is probably turned off, in which case the announcement would not come through very loudly anyway.

In short, there's not a reason in the world for ever announcing a listener's name from a radio station except to please that listener himself. And if he is so much of an idiot as to be pleased by hearing his name broadcast we would rather see him not pleased—in fact we would rather see him shot.

Several of the best stations have, for quite a while, enforced more or less definite rules against such publicizing. A few make a half hearted effort to cut it down to a minimum. But the vast majority do it to death.

Just recently three Mid-Western stations have turned their attention to this matter with varying results. WOAW managed to put on its third anniversary program (O gala day!) with a drastic reduction in the number of names disseminated. But this worthy move was not to last. On the question of the continuance of the policy the management of WOAW had these silly remarks to make:

The institution of an absolute non-dedication program depends largely on the attitude of the artists, and we are going to allow them to settle the matter. Dedications have become numerous in the last year or two. Complaints have increased proportionately. There are many times when acknowledgment of communications becomes necessary, such as during elections, storms, world's series and other occasions. This also applies to the award of prizes on radio programs. We believe a gradual solution is preferable to any hasty conclusion. The leading stations, both in the East and West, as well as in the Middle West, are still acknowledging communications and offering prize programs, and in view of the fact that these are often beneficial to the listeners, we have not adopted any definite restriction, although acknowledgment of communications and prize programs do not take place as often as in the past.

The manager of WSAI without mincing matters at all, made announcement that he "did not want listeners to send telegrams in order that they might hear their names mentioned over the air."

KMOX at St. Louis made the following caviling compromise:

It is the policy of station KMOX not to interrupt programs by the reading or acknowledgment of telegrams, but realizing that radio listeners who send telegrams desire them acknowledged by radio, KMOX has adopted the policy of acknowledging all telegrams received before 5:00 P. M. at 5:00 P. M. each day. All telegrams received after 5:00 P. M. are acknowledged at 11:00 P. M. each evening. Under this plan, those who desire to hear acknowledgment of their telegrams may tune-in at a specified time and be sure to hear the acknowledgment.

Against Sentimental Ballads

AS WE sit here writing, Mr. Jeremiah Sullivan, of wqj Chi-KA-go fame, is drooling into our left ear, via the loud speaker, a silky stream of sentimental ballads.

We do not object over-strenuously to Mr. Sullivan as an announcer. But as a singer we like him not. He is one of that terrible Two-Voiced Tenor type. One voice for the low notes; a sign and a pause, for the then—another voice for the



MUSICIANS HEARD BY HALF THE COUNTRY

Willem Von Hoogstraten, left, and Edwin Franko Goldman. Mr. Von Hoogstraten, is conductor of the New York Philharmonic Orchestra, which broadcasts on Wednesday and Saturday nights through wjz and associated stations. The Goldman Band, led by Edwin Franko Goldman is heard through WFAF and associated stations several times per week. Both organizations are foremost of their type

high notes; the latter bearing not the slightest sort of resemblance to the first.

The effect is very disconcerting; as though two different individuals were cooperating, with only a fair degree of synchronization, on the singing of the same solo. An effect which, as far as getting across properly, is about as successful as crossing a river in two jumps.

Moreover as we sit here pounding these long-suffering typewriter keys the temperature is hovering around ninety in the shade. It is high noon and the sun is beating down abundantly. Nothing daunted, Mr. S. continues to sing saccharinely about couples wandering in the moonlight and watching the rest of the world go by. In about two seconds we shall gracefully exterminate him by that simple method known as tuning-out. For the present we shall revel in the torture. For next to occasionally being pleased by our radio there is nothing we enjoy more than getting thoroughly mad at it. If we can't have the one extreme, give us, we beg, the other. And singing sentimental ballads at noon of a hot Saturday is certainly the last extremity of something or other.

As the perspiration trickles down our nose we find ourself somehow unable to sympathize with the swain who "would climb a thousand mountains just to hold your hand agayn-uh." In fact we are inclined to consider him an idiot and to wonder why he doesn't forget "the sweetest little girl-uh who's waiting for me-uh" and sit him down somewhere in the shade with a fan and a cool pop bottle.

It has been said there is a time for everything. If this is true there is probably some appropriate time for the singing of sentimental ballads. We suggest that it is at three o'clock in the morning. For if any hardy listener has succeeded in keeping himself up until that late hour he is probably in a ripe mood for such like crooning. If he has kept himself up with the aid of the juice of the juniper he may even chime in himself!

For, in truth, sentimental ballads were never meant to be listened to. Their pleasure lies in the performing. They are meant to be sung by isolated—and preferably slightly deaf—groups of males, in automobiles, in shower rooms, at Kiwanis club luncheons, at Class of '03 reunions, in the wee small hours, and in spiritus frumenti. Click! Exit Mr. Sullivan.

Broadcast Miscellany

THE American Society of Authors, Composers and Publishers, according to wjz, is limiting the broadcasting of certain tunes to keep them from being "killed" by too frequent radio repetition. Many selections from some eight musical shows now playing in New York are protected by a radio restriction of one performance a week.

WITH the increase in the number and quality of paid and courtesy broadcast programs, the so-called "chain hook-ups" are becoming more popular and extensive. There are to-day seven radio circuits, or chains of stations, which broadcast certain features simultaneously. No longer is the famous Bell System chain the sole circuit to offer entertainment of this calibre to several communities at one time.

The competition began when the Radio Corporation, General Electric and Westinghouse companies began to tie up their stations through the use of telegraph wires. To-day it is possible to connect, not only wjz, New York; wrc, Washington, and wcy, Schenectady, but also wbz, Springfield; kdka, Pittsburgh; kfkx,

Hastings, KOA, Denver; KGO, Oakland; KYW, Chicago, and WCAD at Canton, New York, which make a chain almost as extensive as the WEAf, WCAf et al. circuit, and literally a longer cross-country hook up.

In the Pacific Northwest, stations KGW, at Portland; KFOA, Seattle and KHQ, Spokane, have combined for the mutual exchange of good programs. KFI, at Los Angeles, and KFO at San Francisco are also understood to swap their best features by interconnection.

Some of the New England stations have also connected their transmitters on occasions; WEAN, Providence; WNAC, Boston, and WLWL, New York, all now controlled by the Sheppard Company, are hooked up for special features. WIP, Philadelphia; WGBS, New York, and WGP, Atlantic City, tie up so that they can carry a single program when found desirable.

Another scheme for the handling of indirect advertising features is sponsored by Norman Baker, owner of KTNT, who suggests that the smaller stations combine to transmit simultaneously on the same wavelengths, but without interconnection. That is, each station would carry similar programs independently, but on the same wave, to avoid utilizing so many channels for the same program.

CHARLES E. ERBSTEIN, who was the guiding spirit of WTAS, is back on the air again together with his Personality and his familiar "heh-heh," which should give delight to "Willie, Tommy, Annie, Sammy," and others of his one time vast audience.

He is offering a series of programs over WLIB on Tuesday nights from 9 until 1 o'clock. As formerly, he presents Fred Hamm's orchestra—The Boss's Own—in special jazz numbers, and occasionally the band accompanies Mr. Erbstein's readings of "The Bowlegged Boy," "The Cremation of Dan McGrew," "That Old Sweetheart of Mine," and "The Curse of Drink."

NEXT to this peerless potage of program piffle there is no department of radio reviewing we more enjoy reading than Quin Ryan's "Inside the Loud Speaker" column in the Chicago *Sunday Tribune*. It fairly teems with ideas. This from a recent issue:

All the radio stations should lay off the air for two weeks—the same two weeks—while the performers take their vacations. Listeners need vacations, too. On the other hand, the radio stations might start broadcasting vacations, so that the listener could stay right at home and enjoy himself without leaving the city. You could hear the jolly sound of people splashing in the water, the swish of the canoe, paddle, the whir of the fishing reel.

Deer hunting might be broadcast from the north woods—bang! bang!—or the puffing of the fat man climbing mountains, or the hectic mutterings of another gent as he slices a fast one into the tall grass.

A summer vacation on the radio, with all the feel and sound of a jolly

recreation, minus the troubles and tribulations of the usual summer trip—served right in your home free of charge.

WE LISTENED to the broadcast of a track meet for the first time last Saturday—that of the National Collegiate Athletic Association. And our verdict is: not so good. Like basketball and hockey, track is ill adapted to broadcasting. True, a track meet is a magnificent spectacle, but one which it is quite impossible to depict in words. Unlike football, track is quite devoid of the element of the "unexpected." Of course we do not mean that the man whom you expected to win may not come in last. But there are no sudden and dramatic reversals such as occur in a football game. The most "newsy" thing that could happen would be for a man to break his leg on a hurdle or for a new world record to be set. Neither of these events occur with any degree of frequency.

The announcer—we forget what station it was—did his darndest to put some excitement into the thing but succeeded only in being stage-talky and uninspiring. Thusly:

And now as a bee-u-ti-ful fleecy cloud half obscures the sun and casts a fleeting shadow on the colorful throng that crowds the grand stand, the runners take their marks. They're off! My, my, how those boys can run! Just watch those boys run! My, my! Listen to that crowd shout! Can you hear that crowd shout? Just listen to that crowd shout!

Unfortunately the race, which was a hundred yard dash, occupied only about ten seconds. As you may judge by timing yourself on the above quotation, the announcer came in a bad sixth.

FOR the first time in the history of broadcasting, a series of exclusive radio talks has been published in book form and offered to the radio public. This book is titled "The Universe of Stars" and is made up of 22 chapters, each chapter comprising the manuscript of a radio talk in the Harvard Observatory series broadcast through the Boston station, WEEI.



AT THE STUDIO OF KFH, WICHITA, KANSAS
A rehearsal of Flowtow's opera, "Martha," one of the recent feature broadcasts from this station. Left to Right: Roy Campbell, tenor; Sybil Johnson, soprano; J. L. Fox, announcer; Sue Fulton, contralto, and Lester Weatherwax, baritone

The Importance of Acoustics in Broadcasting

Distortion in Receiving and Transmitting Apparatus—A Little Discussed Form of Distortion—The Importance of Correct Microphone Placement in Studios

By BENJAMIN F. MIESSNER

IF A piano dealer sold you a perfectly toned piano, to all intents and purposes exactly similar to the one used in the studio of your favorite broadcasting station, moved it into your home, and if when playing it gave the tinkly imperfect notes which you are accustomed to hear from a loud speaker when listening to a pianoforte recital being broadcast, you would certainly not be satisfied with your deal! Yet, look at the exaggerated statements which constantly appear in radio advertisements—statements backed up by superlative adjectives descriptive of the perfect reproduction obtainable with such and such a set or loud speaker.

Broadcasting and receiving apparatus, taken as a whole, is an *acoustical* instrument, and this fundamental fact must be fully realized if it is ever to attain a high state of development. The value of such a system depends chiefly on the accuracy attained in the reproduced sounds as compared directly with the originals. Absolute perfection is not necessary, of course, for pleasure to be derived from its use. It is obvious, nevertheless, that the higher the quality and more natural the reproduction, the more valuable the system becomes. Poor quality should not be tolerated but highest quality must always be the goal of the engineer. By the acoustician's expression "quality" is meant the degree of perfection or degree of naturalness attained in reproduction. There is a definite difference between the quality of a musical number, the quality of the sounds comprising it, and the quality of their reproduction. The first is obviously an aesthetic attribute defining the musical worth of the composition; the second refers to the timbre or tone color of the sounds comprising the music; and the third describes the degree of perfection attained in duplication or reproduction of those tones at the receiving end.

There are many sources of distortion in every modern radio system. The input sound must undergo numerous conversions from one type of vibration to another; there is a chain of these steps in the transmitter and a similar one, reversed in sequence, at the receiver. Each converting device, such as the microphone, audio-transformer, vacuum tube, loud speaker, etc., adds its share of characteristic distortion. Some distortions are opposite to others so that neutralization occurs to some extent. Others are the same in type and exagger-

ation results. These distortions may be likened to a series of translations from one language to another of an original piece of literature. If one of Shakespeare's works, say *Romeo and Juliet*, was translated from the original English into Chinese, then from Chinese into Russian, then from Russian into German, and then backward through the same series, each translation being made by a different translator and none familiar with the subject matter, the final re-translation into English would, no doubt, only remotely resemble the original.

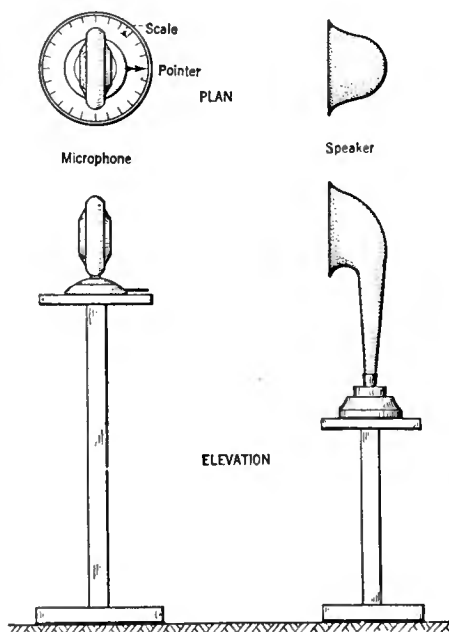

FIG. 1

The arrangement of emitter (loud speaker) and receiver (microphone) for measuring directional characteristics of a sound receiver, is here shown. If the characteristics of the emitter were desired, the scale and pointer would be transferred to it from the microphone

Or, if you see an object itself and its reflected image, side by side, these so arranged that the image is the final one of a number of reflections from a number of imperfect mirrors, a striking visual analogy is presented. Imagine some of the mirrors to be concave and others convex planes, others doubly curved, some of colored glass, and others very dirty in places, and you can imagine for yourself how nearly like the original object will be its last reflection; and yet this is similar to the process of the radio system.

Most of us fail to realize the great degree of distortion in radio because we have unconsciously grown so accustomed to the even worse performance of the telephone and phonograph, and because our sound memory is inaccurate in many ways. If we listen to the reproduction of sounds that we are familiar with, our subconscious self tries to fit what we hear to what we have heard before, and the imagination, if we repress our critical impulses, supplies the deficiencies, providing they are not too great.

In this way we accept substitutes in audition as we do with moving pictures in vision. By long experience and habit, we can forget the lack of stereoscopic effect, of color, and sound, and other omissions which are present in real life yet are absent from the screen. But our ability to do this does not lessen the desirability of completing the picture by supplying the missing parts.

Acoustically, the most familiar sources of distortion in broadcasting and receiving apparatus may be grouped in two general classes:

1. Those due to an overall frequency characteristic of the system which is not flat. That is, the ratio of reproduced intensity to original intensity of sounds is not the same for all frequencies.

2. Those due to an overall amplitude characteristic of the system which is not rectilinear. That is, the ratio of reproduced intensity to original intensity of all sounds is not the same for all intensities. Assuming both flat frequency and rectilinear amplitude characteristics, there may be distortion due to the loss of certain sounds because of insufficient sensitivity. This will result in the omission of weak tones; or there may be distortions due to the introduction of extraneous sounds, caused for example, by carbon hiss in microphones, commutator ripple in transmitter plate-current generator, tube noises, static, interference, etc. All of these have received and are now receiving considerable attention from radio engineers, and will therefore not be discussed further at this time.

A NEW KIND OF DISTORTION

THERE is, however, another and very serious type of distortion in radio systems, which, so far as the writer has observed, has not been discussed and is not being investigated. This new type of distortion is caused by the directional charac-

teristics of microphones and loud speakers. We are all familiar with the megaphone, which is used to increase the voice intensity in some particular direction. Surely most of us have also noted that loud speakers give strongest sounds at a given distance when one listens directly in front of them. We have perhaps also listened through megaphones to a distant source of sound and noticed that the sounds were loudest when the megaphone was pointed towards that source. We see, therefore, that sound receivers and emitters do have directional characteristics, and most of us are aware of that fact in a general way. The exact nature of these directional effects, however, is not generally known or understood, and it was because of this fact that an investigation was undertaken, and its results herein reported.

The writer first observed and made use of these directional effects at the Naval Aviation Station, Pensacola, Florida, in 1916, during the development of anti-noise microphones for aircraft for the United States Navy. From 1918 to 1922, he investigated them further, and applied the knowledge so gained in electro-phonographic research for one of the large phonograph companies. Further studies on the subject were made in 1924-5.

It has been found that practically all sound receivers and emitters, including horns, diaphragms, etc., have directional characteristics. Sound emitters project sound best in some directions, and sound receivers receive sound best from some directions. Moreover, the directional characteristics vary with the frequency of the sound, so that sounds of equal intensity and at the same angle to the receiver or emitter, but differing in pitch, are received or emitted in differing intensities. Complex sounds from any musical instrument, due to the wide variation in frequency of their component fundamental and harmonic elementary tones, are changed in quality because the intensity ratios of these component tones are altered. The distinctive quality of any sound source is determined by the number and relative intensities of its overtones and fundamental. If any of these component partial tones are omitted or changed in intensity, the tone timbre or quality is altered. The complex tones of violins and clarinets sometimes degenerate into the simpler tones of the flute because the high partials that determine the difference between them are suppressed in the radio system (transmitter and receiver). The flute, in certain registers, is almost a simple tone; the violin and clarinet tones on the other hand, contain many high harmonic components. If these are suppressed by the inability of the microphone to respond to them, the characteristic timbre is lost, and the remaining simple tone is in-

distinguishable from that of the flute or from that of an organ pipe which, in effect, it is. The important matter in regard to microphones and loud speakers is to determine whether the directional characteristic is constant or variable with frequency. If it is constant, only the loudness of the sound will be changed with varying direction; if variable, the loudness, and in addition, the timbre, or quality of the sounds will be changed, which is a much more serious matter.

STUDIO DIRECTORS SHOULD UNDERSTAND MICROPHONE DIRECTIVITY

THE directional effects of microphones, therefore, become of great interest to the studio director. For example, the mere positions of the various instruments in an orchestra may completely spoil the quality of the reproduction. The tone balance of the various instruments must be determined not merely by their relative

tuning with a piano as a known frequency reference standard. The microphone was mounted so that it could be turned horizontally about a vertical axis through the instrument. A pointer and angularly divided scale indicated the angle between a line joining the speaker and microphone, and the horizontal axis through the face of the horn or microphone. The microphone in either case was connected to a resistance-coupled audio amplifier operating through a step-down transformer into a thermomilliammeter. For each frequency, the amplification was adjusted for full scale meter deflection with the microphone facing the loud speaker. The microphone was then turned through successive angles and the meter read for each angle. For each curve, the frequency, sound emission intensity, and the distance, were invariable, only the angle of incidence on the microphone being varied. The audio-amplifier was tested for non-linear amplitude distortion by subjecting it to a voltage input of the same frequency range and intensity impressed on it in the microphone tests. It was found to be linear within the range of amplitudes used in these tests. Inasmuch as the frequency was constant in any given test, the frequency characteristic of the emitter and receiver could not influence the results.

One factor of importance, however, was beyond our control, so that the measured data are somewhat disturbed by it. I refer to the impurity of the impressed sounds. At all frequencies, the emission contained, beside the fundamental frequency noted, numerous overtones, the presence of which cloud to some extent, although not greatly, the accuracy of the measured results. Nevertheless, the nature, if not the precise degree of the effects under study, is determined, and it is certain that pure sound sources will accentuate the characteristics herein shown.

Fig. 1 is a sketch showing the physical arrangement of the apparatus in these tests, and Fig. 2 is a diagram of the connections.

TEST CONDITIONS AND PROCEDURE

THE distance between the loud speaker and the microphone was six feet during the tests. Great care was exercised in supporting both, so that no reflecting surfaces of appreciable size were near either microphone or loud speaker. The operator who set the microphone angle for each measurement was required to be at least ten feet away during the actual measurement. At two or three feet, the presence of his body so altered the sound field about the microphone as to cause large errors in the measurement.

The test procedure was as follows:

1. Set up emitter and receiver facing each other as shown in Fig. 1.

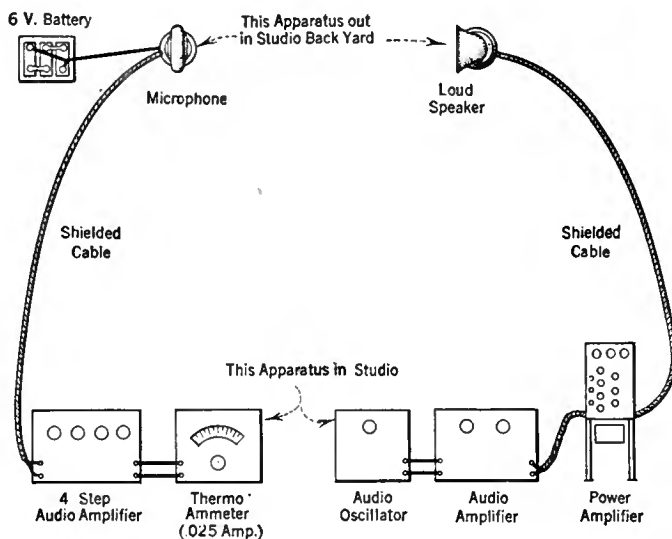

FIG. 2
In this diagram is shown the general arrangement of the entire apparatus for directional characteristic measurements. Very careful precautions are necessary to shield the receiving and transmitting apparatus to prevent direct transfer of electrical energy between these two units

intensities and distances from the microphone, but by their angles to it. Furthermore, some types of instruments, regardless of volume or distance, reproduce with changed timbre unless faced by the microphone. Others may be at a great angle to the face without much change. For some types of microphones, sounds approaching the sides or back are only moderately reduced in volume. In others, the back is as sensitive as the front, while the sides have practically no sensitivity.

The accompanying curves show the directional characteristics of several types of microphones and loud speakers for various sound frequencies. The measurements were made out of doors far enough from reflecting bodies, such as buildings and ground, to prevent errors due to interfering reflected waves. A vacuum-tube audio oscillator of variable frequency, feeding into a loud speaker, provided the sound source. The frequency was determined by

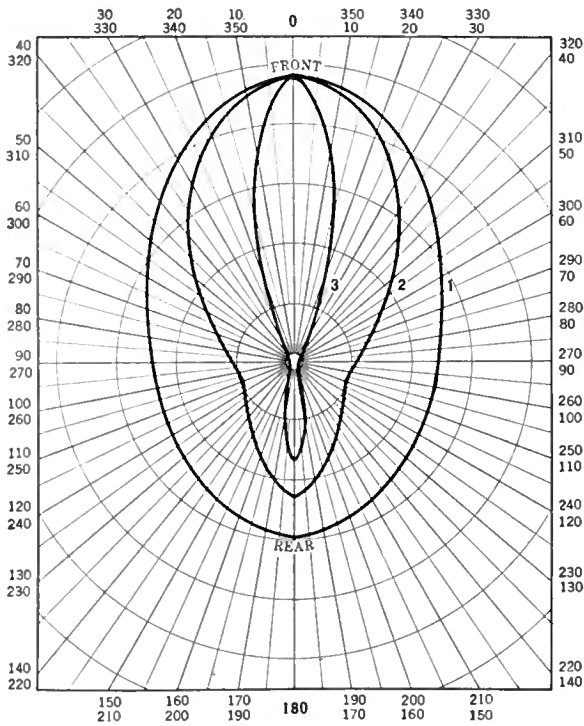

FIG. 3

This group of polar curves shows the directional characteristics of horns and also of flat diaphragms enclosed on one side, as shown in Class 1, Fig. 4, for frequencies of (1) 100 cycles; (2) 1000 cycles, and (3) 5000 cycles

2. Adjust test tone frequency to desired value.
3. Adjust intensity of test tone so that the thermo-ammeter measuring the received tone gives full scale deflection.
4. Turn emitter or receiver (depending upon which characteristics it is desired to determine) through successive 10-degree angles and read meter for each angle.
5. Repeat 2, 3, and 4 for each tone frequency desired, as for example, 100, 1000, and 5000 cycles.

While many different microphones and loud speakers have been investigated in this manner, they may all be reduced to three general classes so far as directional characteristics are concerned, as suggested by the results of these investigations. These three classes are as follows:

1. Horns; diaphragms with one side closed.
2. Conical diaphragms open on both sides.
3. Flat diaphragms open on both sides.

These three types are shown schematically in Fig. 4. It may here be remarked that the directional characteristics of any given type are reversible, *i.e.*, they are the same for emission and reception.

In the first class are included all types of single horns as used on loud speakers or in phonographs; also flat diaphragms, as used in the usual studio microphones where sound waves have access only to one of its sides, are included in this class.

In the second class are the open cone speakers such, especially, as the Crosley,

Pathé, and others, having both sides of the cone fully exposed, and some cones having the back partially open, such as the Western Electric, Farrand-Godley, and similar types.

In the third class are flat diaphragms or double cones vibrating together and fully exposed on both sides, such as the reproducers of C. Messick and the Acme Apparatus Company.

Fig. 3 shows three curves for a loud speaker horn of ordinary type, typical of Class 1. In Fig. 5 are shown three curves for an open cone speaker typical of Class 2. Fig. 6 shows three curves for a flat diaphragm typical of Class 3. In each of these figures the three curves correspond to frequencies of 100, 1000, and 5000 cycles.

ANALYSIS OF CURVES

THE general features of the curves in Fig. 3 are:

1. A gradual falling off in intensity from front to back at

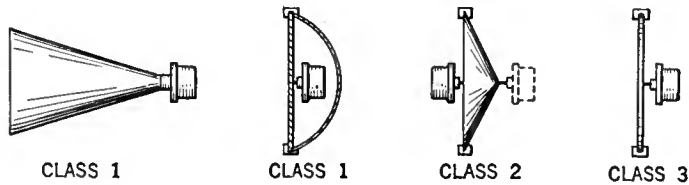

FIG. 4

The three general types of electro-acoustic devices used to convert sound into electric currents, or vice versa, the directional characteristics of which have been carefully studied

low frequencies, and a tendency toward definite minimums at about 90 to 120 degrees from the face with increasing frequency.

2. A definite tendency towards beam effect at higher frequencies.

The general features in Fig. 5 are:

1. A definite minimum at about 90 to 115 degrees.
2. Approximately equal front and rear intensities, and decreasing rear intensity with increasing frequency.
3. Definite tendency towards beam effect with increasing frequency.

The general features of Fig. 6 are:

1. Equal front and rear intensities.
2. Very sharp and low minimum at 90 degrees.
3. Definite tendency towards beam effect with increasing frequency.

So far as broadcasting microphones are concerned, those

in wide use in this country have approximately the characteristics of Class 1, as shown in Fig. 3.

Strange as it may seem, these instruments are about half as sensitive on the back side as they are on the front, and the direction of minimum sensitivity lies a little towards the rear of the sides. This directional sensitivity shows the studio director that direction as well as distance plays an important part in the placing of his instruments.

A far more important point, however, is the changing of directional characteristic with frequency. It is plainly evident that if a musical instrument, say a cello with low pitched fundamental and high pitched overtones, be placed on an angle of 45 degrees to the face, as it well might in a studio, the fundamental would be received about 75 per cent. as loud as if it were in front of the microphone, while overtones of the order of 5000 cycles would be reduced to less than 10 per cent.

It will be noted that the variation in directional characteristics of the three types indicates a progressive change from Class 1 to Class 3, that is, Class 1 is most nearly unilateral; Class 2 shows strong signs of bilateral characteristics, and Class 3 is purely bilateral. It may be added that the horns and diaphragms whose character-

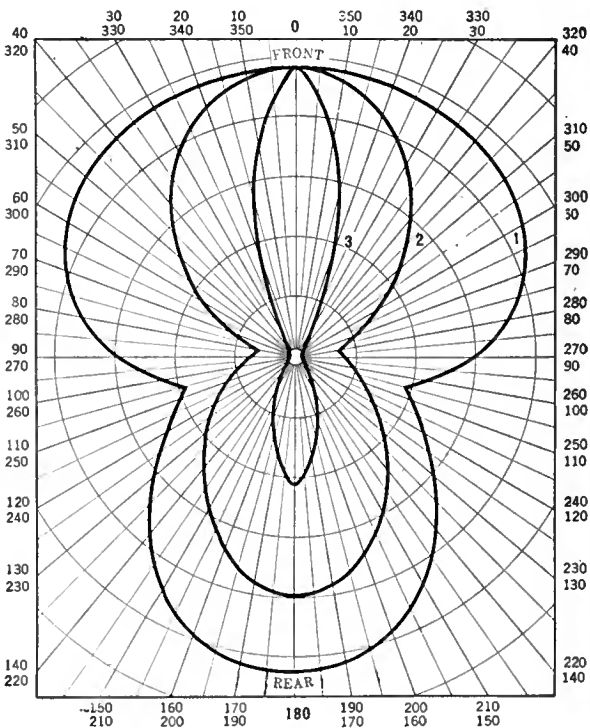

FIG. 5

In the group of polar curves shown above, we find the directional characteristics at (1) 100 cycles; (2) 1000, and (3) 5000 cycles, for open cone acoustic devices as shown in Class 2, Fig. 4

istics are here shown, all had a diameter of one foot.

AN OPTICAL ANALOGY

CEILING lights are often provided with reflecting or diffusing devices the function of which is to distribute the unequal illumination of the lamp uniformly about the room. If these devices acted like loud speakers in acoustics, the light of different frequencies or colors comprising the white illuminant emission would be unequally distributed. The longer wavelengths of red light would be spread over the room with about uniform intensity. The yellows and greens would show signs of concentrating over a narrow region, while the blues and violets would be confined almost entirely to a small area directly beneath the lamp. At every point in the room we would find some color region predominant, from violet, below the lamp, to red at the extreme sides. At no point in the room could the true white (assuming that the lamp emits white light) illumination be present. This optical analogy compares very closely with the action of sound projectors in acoustics. At no point about a loud speaker with a directional emission varying with frequency can the sound color or timbre of a complex sound have the true color found in the source of its sound, for example, the throat of the horn. This, no doubt, is one of the factors

which make loud speaker reproduction inferior to head phone reproduction as all of the emission in the latter is confined directly to the ears of the listener, and this directional distortion cannot occur.

It is shown by these acoustical measurements that a serious form of distortion results from the directional characteristics of broadcasting microphones and receiving loud speakers, which has been absolutely unexpected by the radio engineer. The seriousness is even much greater than the curves indicate as the directional distortion of the microphone is again repeated by the loud speaker. This means that the overall directional distortions of the system as a whole, from microphone to loud speaker, may be represented by the square of the curve values shown.

The directional characteristics described herein apply, of course, to modern broadcasting microphones, such as the WE-373-W. Briefly, the reasons are as follows:

This microphone acoustically is of the type with exposed front and closed back. It is most sensitive to sounds approaching its front side and less for other directions, as shown in the curves for that type in Fig. 3. The reason it responds to sounds approaching its back is that these sounds diffract around the housing or back shield and reach the diaphragm in that way. The amount of this diffraction depends on

the wavelength as compared to the size of the housing. If the housing be small compared to the wavelength, the tones will diffract around it very easily and with but little loss in intensity. If it be large in comparison, the diffraction will be suppressed and the diaphragm itself will be in a region of pronounced "shadow," or low intensity sound. This effect is well known for all types of wave motion, and applies to objects and apertures alike.

The fact that a microphone cannot be used as a loud speaker has no bearing on the subject. The diaphragm itself and the nature of its housing and near-by objects only determine these characteristics. The size of the diaphragm has some influence, inasmuch as, with a given frequency of sound, it determines the ratio of object to wavelength, which governs the degree of diffraction. However, its only effect is to shift the frequency region wherein directional distortion is greatest, that is, the curve shapes shown, instead of applying for frequencies of 100, 1000, and 5000, might apply to 500, 5000, and 25,000—or for the same frequencies, the curves will appear as shown in the accompanying Fig. 7.

The effects are clearly demonstrable with light and other forms of radiant wave energy—radio, for example. They are very clearly shown in the accompanying curves for sound.

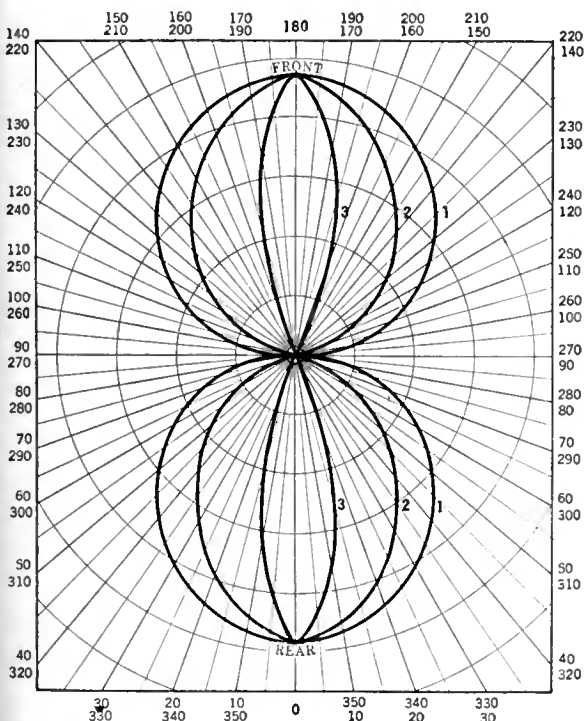

FIG. 6

The directional characteristics for flat, open diaphragms, of Class 3, Fig. 4, are here shown. The frequencies are the same as mentioned for the two previous diagrams

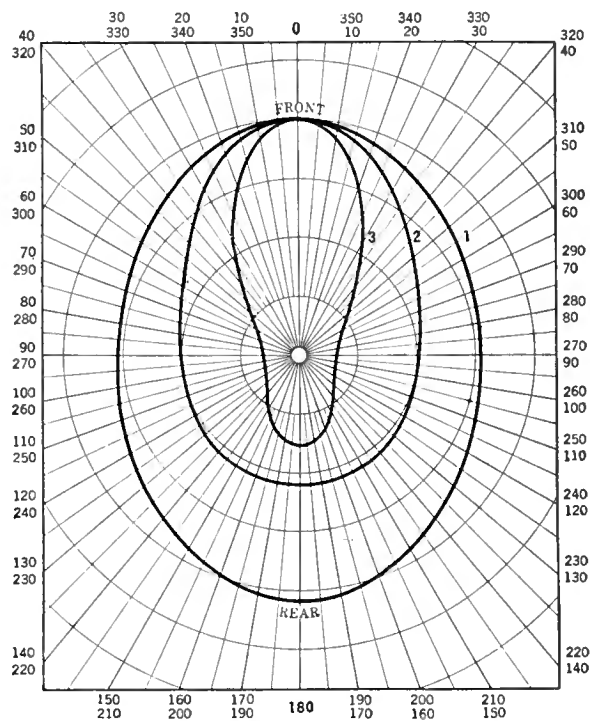
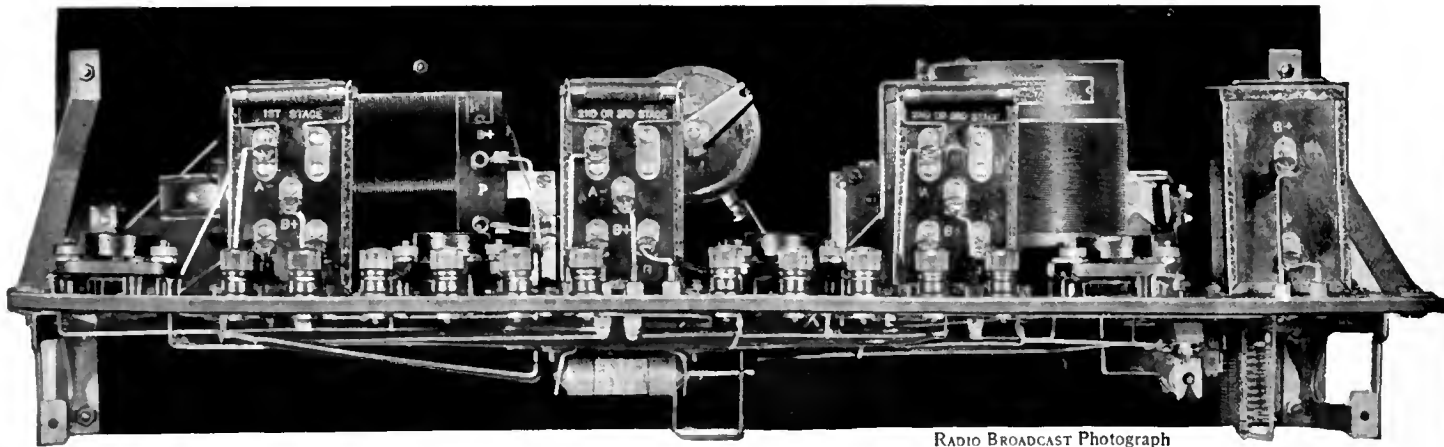

FIG. 7

The approximate directional characteristics for broadcasting microphones at the standard test frequencies. Variations from those of Fig. 3 are due to decreased size of these microphones



RADIO BROADCAST Photograph

ONE ASPECT OF THE R. B. IMPEDANCE-COUPLED BROWNING-DRAKE

A rear view of the receiver indicates the disposition of the various parts both above and below the sub-panel. Note how the central support bracket aids in preventing the sub-panel from sagging at its middle. This picture should be studied in conjunction with that on page 403

The R. B. Impedance-Coupled Browning-Drake

A New Model of An Ever-Increasingly Popular Standard Circuit Incorporating Latest Constructional Ideas · A Five-Tube Set With Impedance-Coupled Audio Amplification

By JOHN B. BRENNAN

Technical Editor, Radio Broadcast

IF A careful analysis of the outstanding receiver circuits of the past twelve months be made, it is not unlikely that of them all, there will be only a few that rate high in popular esteem by virtue of their excellence in performance. Of these few, not many were patterned after other than the old and familiar tuned radio frequency plus regenerative detector circuit.

In most cases, receivers are what they are because of the individual type of apparatus employed, providing that to start with a good circuit is selected.

The Browning Drake, not an exception to the rule, is one receiver that amply illustrates this principle. First described in RADIO BROADCAST for December, 1924, that circuit has stood the test of time remarkably well. The circuit itself is not revolutionary; just a simple tuned, neutralized, radio-frequency amplifier, with regenerative detector. To this may be added any type of audio amplifier that strikes the fancy of the constructor. It is the tuned part of the receiver that requires the main attention because, with a good audio amplifier, the signal in the plate circuit of

the detector tube may be amplified to the desired power and then outputted to a satisfactory loud speaker. In speaking so of the audio amplifier, it is not the intent to belittle this very important section of a receiver; it is intended that emphasis be placed on that end of the receiver upon which we depend for the accomplishment of our tuning, for if that part of the receiver is not satisfactory, the best audio amplifier in creation will not help matters.

And so in the following description of a Browning-Drake receiver improved and re-

fined down to the minute, especial attention is placed upon the tuning units with which the proper selection of stations is made.

Note that the coils employed are so fashioned as to incorporate all the main features of low loss design with which we usually associate fineness of tuning and excellent sensitivity. The condensers which tune the coils are of the conventional straight frequency-line type, so useful in tuning to the shorter wavelength stations. The particular coils employed in the model described here, are manufactured by the National Company of Cambridge. However,

for those who wish to approximate this coil construction at home, suitable specifications enabling one to do so are presented elsewhere in this article.

In tuning the National coil-condenser combination, the operator will note an apparent broadness of tuning. This effect is produced by the peculiar shaped condensers which allow of a 270-degree rotation for a given capacity range. A change in capacity takes place at a correspondingly slower rate here than if other straight capacity-line condensers with semicircular rotor plates were employed.



The Browning-Drake Receiver Circuit

THE Browning-Drake circuit, now immensely popular, was first introduced by a national radio magazine when Glenn H. Browning's article on that circuit, designed by him and Fred Drake, appeared in the December, 1924, RADIO BROADCAST. That circuit employed transformer-coupled amplification. One year later, in December, 1925, Mr. Browning described, in this magazine, another model of his circuit with impedance-coupled audio amplification. Great advances in constructional ideas have occurred since that time. This article, by John B. Brennan, completely describes a Browning-Drake receiver employing impedance-coupled amplification which has as neat a constructional appearance as is possible to find outside of the product of a factory. Every home-builder may easily duplicate this design himself. And when he is through, he will have a set that is noted for its sensitivity, high quality of reproduction, and, not unimportant, extremely neat appearance. Install the set in a handsome cabinet, and the two in a well appointed living room—what more in a radio set could one ask? This set was designed in the Laboratory of RADIO BROADCAST by Mr. Brennan with the able collaboration of Mr. Glenn H. Browning. For those constructors who prefer to build with large blue prints, a set of these can be secured from the Booklet Department of this magazine at \$1.00 the set.—THE EDITOR.



PROPERLY CONTROLLING VOLUME

ONE problem in the design of a radio receiver has been to control volume effectively without affecting the quality of the output in the loud speaker. In cases where the volume control is incorporated in the audio amplifier channel of a receiver, some shifting of the audio frequency characteristics usually results when the control is varied. This change is one direct cause of imperfectness of quality.

Obviously, if the volume control is "moved" far enough forward of the audio channel, it then becomes possible to regulate volume without thereby causing mild forms of distortion in the all-important audio channel. Some constructors place this volume control in the detector circuit; others in the radio-frequency amplifier circuit. In the Browning-Drake model described here, the volume control, consisting of a variable 30-ohm resistance, is inserted in series with the filament ballast which regulates the flow of current to the radio-frequency tube filament. The advantages thus gained are two-fold. First, a very smooth control of volume is obtained without affecting the tone characteristics of the audio channel. Secondly, by placing the variable resistance in this position, overloading of the radio-frequency amplifier, especially on local station reception, is prevented. This control, at this point, enables the constructor to maintain a high degree of neutralization which in turn allows of fine tuning without the probability of self oscillation.

In the radio-frequency amplifier stage, it was observed that a type 199 tube neutralized more perfectly and consistently than a 201-A tube. Also, the actual gain for the 199 tube, taking into consideration the possibility of incomplete neutralization for the 201-A tube, was perhaps as much as

For ease of assembly, the National Impedafomers were selected, although if it is so desired, any standard type of choke coil, condenser, and grid leak may be substituted. The National Impedafomers combine, in one unit, the choke coil, isolating condenser, and grid leak; by means of convenient terminal posts it is a simple job to wire these units into the circuit. Also, in the input unit, following the detector stage, a most serviceable radio-frequency choke coil is conveniently included within the housing. It is employed to insure against passing radio frequency currents into the audio-frequency channel.

The plate impedances L5, L6, L7 are one hundred henries each, and the grid leaks R5, R6, R7, are all 0.1 megohms. The isolating condensers C5, C6, and C7 are of 0.1 mfd. These values are given for

those who prefer to buy their choke coils etc., separately.

The Facts About This Receiver

Name of circuit Type of circuit	Browning-Drake. One stage tuned, neutralized, radio-frequency amplification, a regenerative detector, plus three stages of impedance-coupled audio-frequency amplification, including output device.
Number of tubes	Five. R. F. (199); Detector (201-A); Three A. F. (high-Mu in first and second stage, and semi power, such as the 112 or 171, in last stage).
Frequency Range Volume Control	1500 kc. to 545 kc. (200-550 meters). Series resistance in filament circuit of radio-frequency amplifier tube.

with the latter, and is to be preferred in the final construction.

In the detector circuit, regeneration is obtained by the usual tickler method whereby a movable coil is coupled to the secondary circuit. A 201-A tube is employed in this circuit.

IMPEDANCE COUPLING FOR AUDIO CHANNEL

THREE stages of this impedance-coupled audio-frequency amplification are employed. In the first and second stages, high-Mu tubes permit of a higher amplification than if ordinary 201-A tubes were used. In the last stage, a special output coil is included for the following reason: Where quality output is desired of an audio amplifier, it is out of the question to use other than the type 112, 171, or other tubes especially designed for power work. With such a tube in the last stage, better quality is obtained than if the 201-A type of tube were



RADIO BROADCAST PHOTOGRAPH
THE COMPLETED RECEIVER
A front panel view of the R. B. Impedance-Coupled Browning-Drake receiver, showing some of the "insides," impresses one with the similarity between it and a neat manufactured set

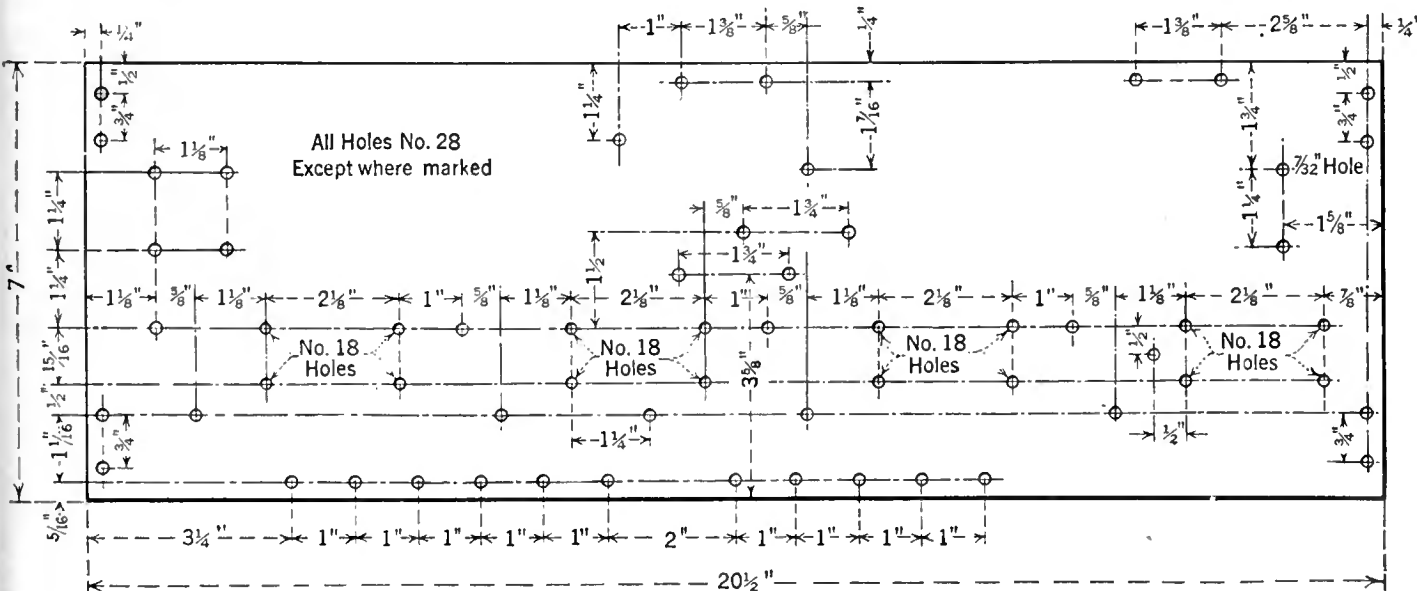

FIG. 1

The holes to be drilled in the sub-panel for mounting the various pieces of apparatus thereon are laid out in accordance with the specifications given above. It will be noted that, excepting for the antenna adjusting condenser hole and the holes for securing the Impedafomers, all the holes are drilled with a No. 28 drill. In addition to the holes indicated here, numerous small holes are conveniently located in the sub-panel to allow connecting wires to be fastened to their terminals. Lastite connectors may be utilized for this latter purpose

to be used. Since with the power-output type of tube it is necessary to employ a high value of B battery voltage on the plate, it would be ruinous to do so without making some provision for the protection of the loud speaker windings. This is exactly what the output coil does. Instead of the drag that is exerted on the diaphragm of the loud speaker by the direct current when the output coil is not contained in the circuit, thereby tending partly to paralyze the diaphragm, the special output circuit places on the loud speaker an a. c. signal voltage, allowing the diaphragm to swing freely in synchronism with the signal impulses or discharges of the isolating condenser in this circuit.

THE CIRCUIT AND PARTS

IN REVIEW of the circuit, we find it consists of the following: A stage of tuned, neutralized, radio-frequency amplification, and a regenerative detector followed by three stages of impedance-coupled audio-frequency amplification, in the output of which is arranged a special isolating device as a protection for the loud speaker.

To construct a receiver similar to the model described here, the following parts should be obtained:

- 1 Micarta Panel $\frac{3}{8}$ " x $7\frac{1}{2}$ " x 21"
- 1 Radion Sub Panel $\frac{3}{8}$ " x $7\frac{1}{2}$ " x $20\frac{1}{2}$ "
- 1 National BD-1B Tuning Unit (or home-made coils)
- 1 National B-D 2B " " (as described)

- 2 National Illuminated Dials
- 5 Benjamin Universal Sockets
- 3 National Impedaformers
- 1 National Choke—100 henries
- 1 Precise 50-mmf. Tuning Condenser.
- 1 XL Neutralizing Condenser Model N.
- 1 Sangamo 0.00025-mfd. fixed condenser with grid leak clips



RADIO BROADCAST Photograph

FIT FOR A KING

The R. B. Impedance-Coupled Browning-Drake receiver all dressed up in a console cabinet, the product of the Detroit Woodcraft Company. The lower section contains the batteries, while the compartment above holds the receiver. A slot is sawed in the back of the cabinet, allowing the connections from the batteries to be made to the various binding posts arranged along the rear of the sub-panel

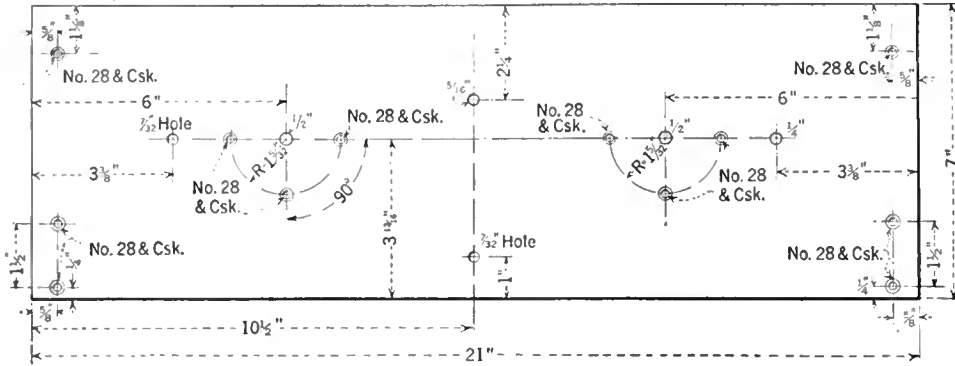

FIG. 2

All the dimensions necessary to lay out the main panel are given here. Care should be taken in accurately spotting and centerpunching the hole marks. In drilling, be sure not to tilt the drill—this would be sure to result in erroneous spacing of holes

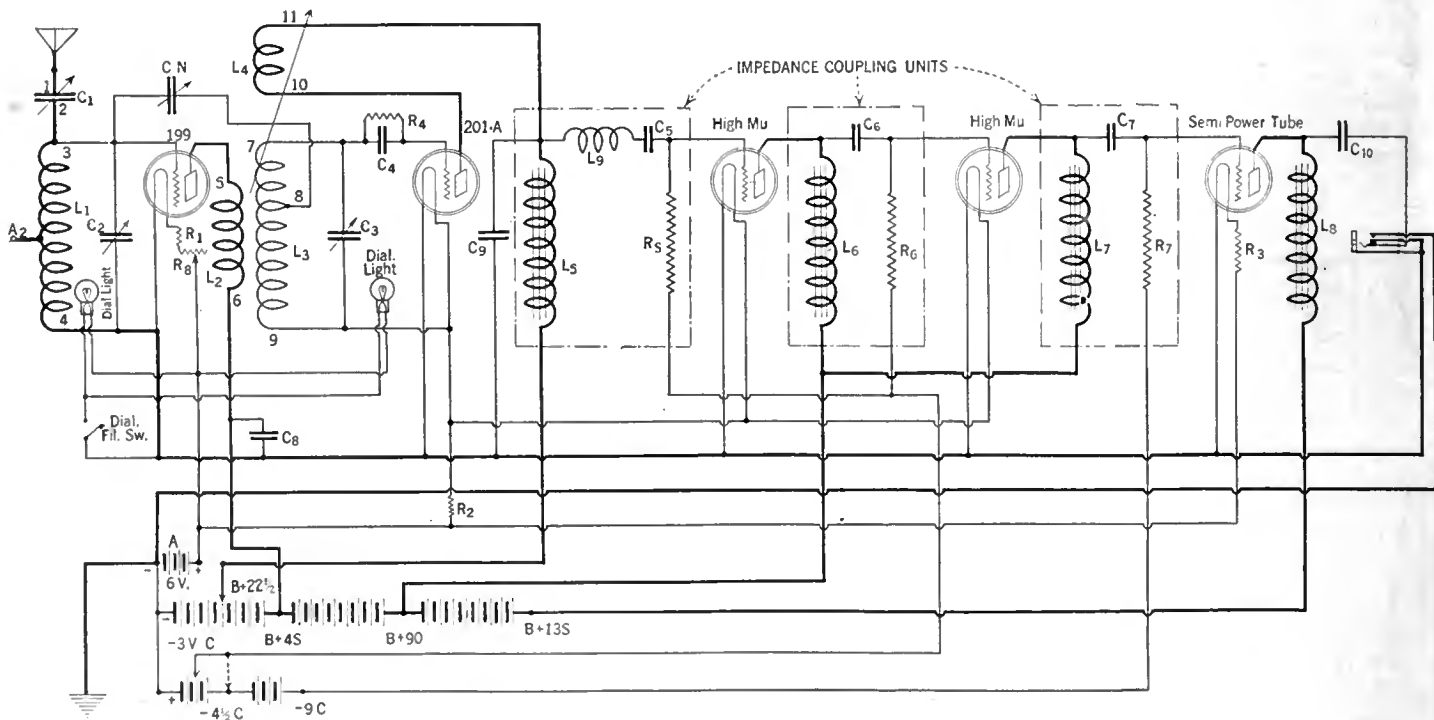

FIG. 3

This is the complete circuit diagram of the R. B. Impedance-Coupled Browning-Drake receiver. Note that in the radio-frequency amplifier, a 199 tube is employed while in the other sockets a 201-A is used for the detector, two high-Mu's for the first and second audio stage and a semi-power tube in the output stage. A choke coil, L8, and condenser, C10, are employed to good advantage in isolating the direct current component of the B potential from the loud speaker windings. Only alternating current finds its way to the loud speaker. The values for the various parts indicated by letters are as follows: C1, 0.00005 mfd.; C2, 0.0005 mfd.; C3, 0.00025 mfd.; C4, 0.00025 mfd.; C5, C6, and C7, 0.1 mfd.; C8, 1.0 mfd.; C9, 0.005 mfd.; C10, 1.0 mfd.; CN, 0.00002 mfd. neutralizing condenser; L1, antenna coil; L2, plate coil; L3, detector secondary coil; L4, tickler coil; L5, L6, and L7, plate impedance coils, 100 henries each; L8, output impedance coil, 100 henries; L9, radio-frequency choke coil; R1, 50 ohms; R2, 1.33 ohms; R3, 0.5 ohms; R4, 5 megohms; R5, R6, and R7, 0.1 megohms; R8, 30 ohms

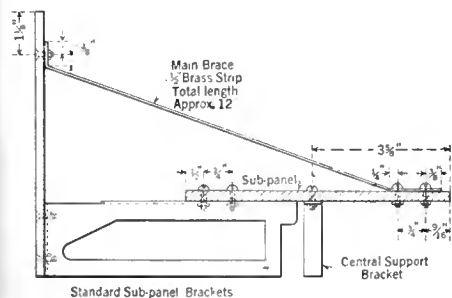

FIG. 4

Besides utilizing a standard sub-panel bracket such as that manufactured by Benjamin, two additional supports are employed to provide a substantial assembly. Due to the fact that the sub-panel is located so near the end of the Benjamin brackets, additional supports are necessary. The diagonal braces prevent the sub-panel from warping along its width, while the central support bracket insures against warping along its length

- 1 Electrad Grid Leak—5 megs
 - 1 Sangamo 0.005-mfd. fixed condenser
 - 2 Sangamo 1-mfd. fixed condensers
 - 3 Brachstats with mountings, types 1D, 2B, and 3B
 - 1 Carter Filament Switch
 - 1 Carter Filament Control Output Jack
 - 1 Centralab Rheostat—30 ohms
 - 2 Benjamin Standard Brackets
 - 12 Eby binding Posts
 - 1 Brass Strip 31" x 1/2" x 1/8"
 - 10 1" x 3/8" RHBM Screws with Hex. nuts
 - 16 1/2" x 3/8" " " " "
 - 13 1/2" x 3/8" " " " "
 - 6 1/2" x 3/8" FHBM " " " "
 - 5 1" x 3/8" RHBM " " " "
- Lugs, Bus Bar, and other wiring material.

sions are accounted for. After this has been done, the vertical dimensions are laid off, working from left to right. It will be noted that most of the holes are drilled with a No. 28 drill except where otherwise specified. At any rate, all the holes may first be drilled with a No. 28 drill and then enlarged to correct size where necessary.

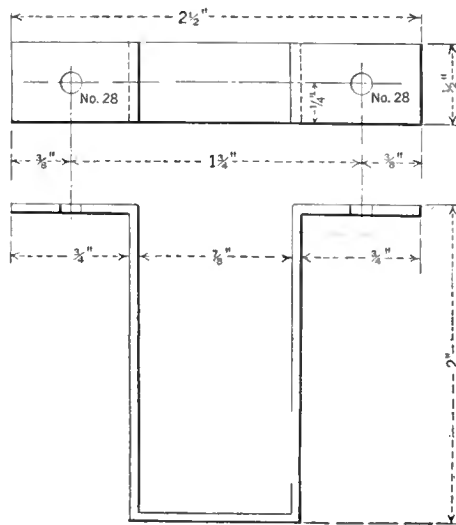

FIG. 5

The central support bracket is fashioned from half-inch brass strip 1/8" thick, as indicated above. Roughly, six and one half inches of strip are required for the bracket

panel and prevent sagging at the middle. Next, the tuning units, 30-ohm rheostat, filament switch, and output jack are mounted on the main panel. Before each piece is finally fastened, make sure that all bolts, nuts, etc. are tight.

Then, the three audio units and output coil are fastened to the sub-base with the 1/2" x 3/8" round head brass machine screws. In between these units are mounted four of the Benjamin sockets by means of the 1" x 3/8" round head brass machine screws. The fifth socket is mounted directly forward of the second and at the extreme front edge of the panel. At the rear are arranged eleven of the twelve binding posts.

The Benjamin brackets may now be fastened to the main panel with the 1/2" x 3/8" flat head brass screws, after which the sub-panel is mounted in place. The brass strip braces are then screwed into place. At the main panel 1/2" x 3/8" flat head screws are used for the purpose, while at the sub-base, round head screws are used.

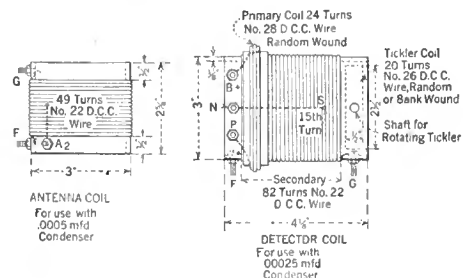
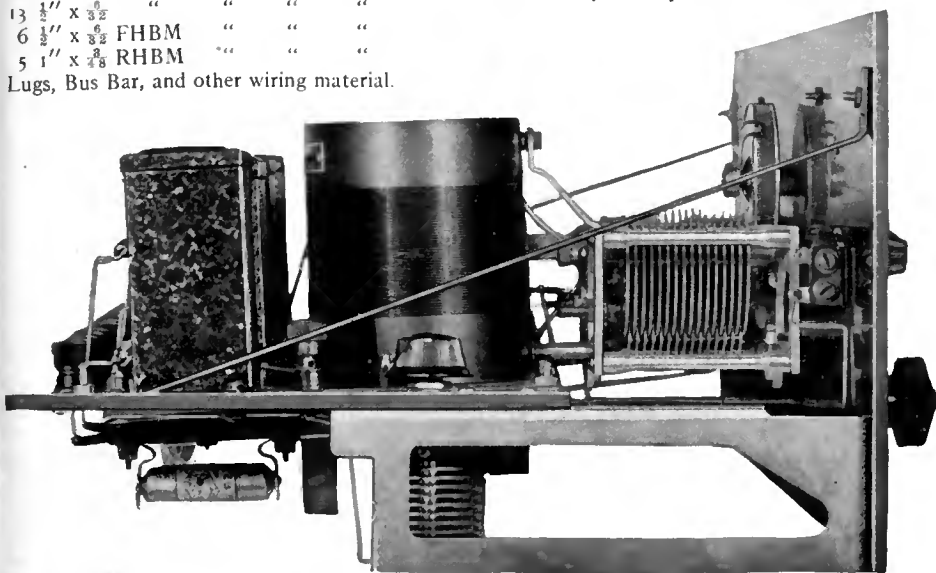

FIG. 6

When it is desired to construct coils for use with other condensers than those specified, the sketches here will prove of aid. Should coils of low loss characteristics be desired, the constructor may well follow the coil winding specifications outlined by Mr. Thatcher in the March, 1926, RADIO BROADCAST



RADIO BROADCAST Photograph

READY TO BE PLACED IN A CABINET

This end view clearly illustrates the compact construction of the receiver. Fixed condensers, filament ballasts and antenna adjusting condenser are situated below the sub-panel, while above it are the tuning and audio amplifier units

For the sub-panel, undoubtedly it will be necessary to obtain a 21" length and then with a hack saw remove a half inch strip from one end. After this has been done, the hole marks may be spotted on the sub-panel in accordance with the layout in Fig. 1. The use of a T-square will aid materially in marking off these holes correctly. From the lengthwise edge nearest, scribe a line with a sharp-pointed nail or pencil 1/8" in. Then another 1 1/16" away from the last one and so on, until all the lengthwise dimen-

When all the holes have been drilled in the sub-panel, the main panel (Fig. 2), may be laid out in exactly the same manner as the sub-panel and then drilled.

ASSEMBLING THE PARTS

BEFORE passing on to the assembly of the apparatus upon the sub-panel and main panel, it will be well to prepare the bracket and braces which must be fashioned from 1/2" brass strip as shown in Figs. 4 and 5. These strips serve to support the sub-

Directly behind the second audio unit and third socket, on the under side of the sub-panel, is mounted the central support bracket, necessary to prevent sagging which would otherwise occur due to the weight of the material mounted above.

Looking over the top of the main panel from the front, two holes will be seen at the left of the antenna coil unit. In the larger of these two holes is mounted the 50-mmf.

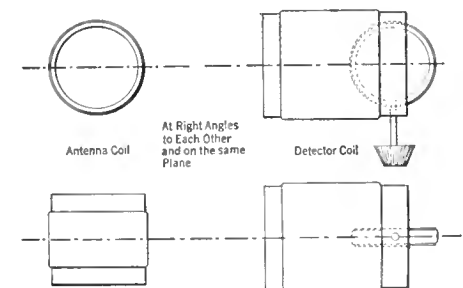
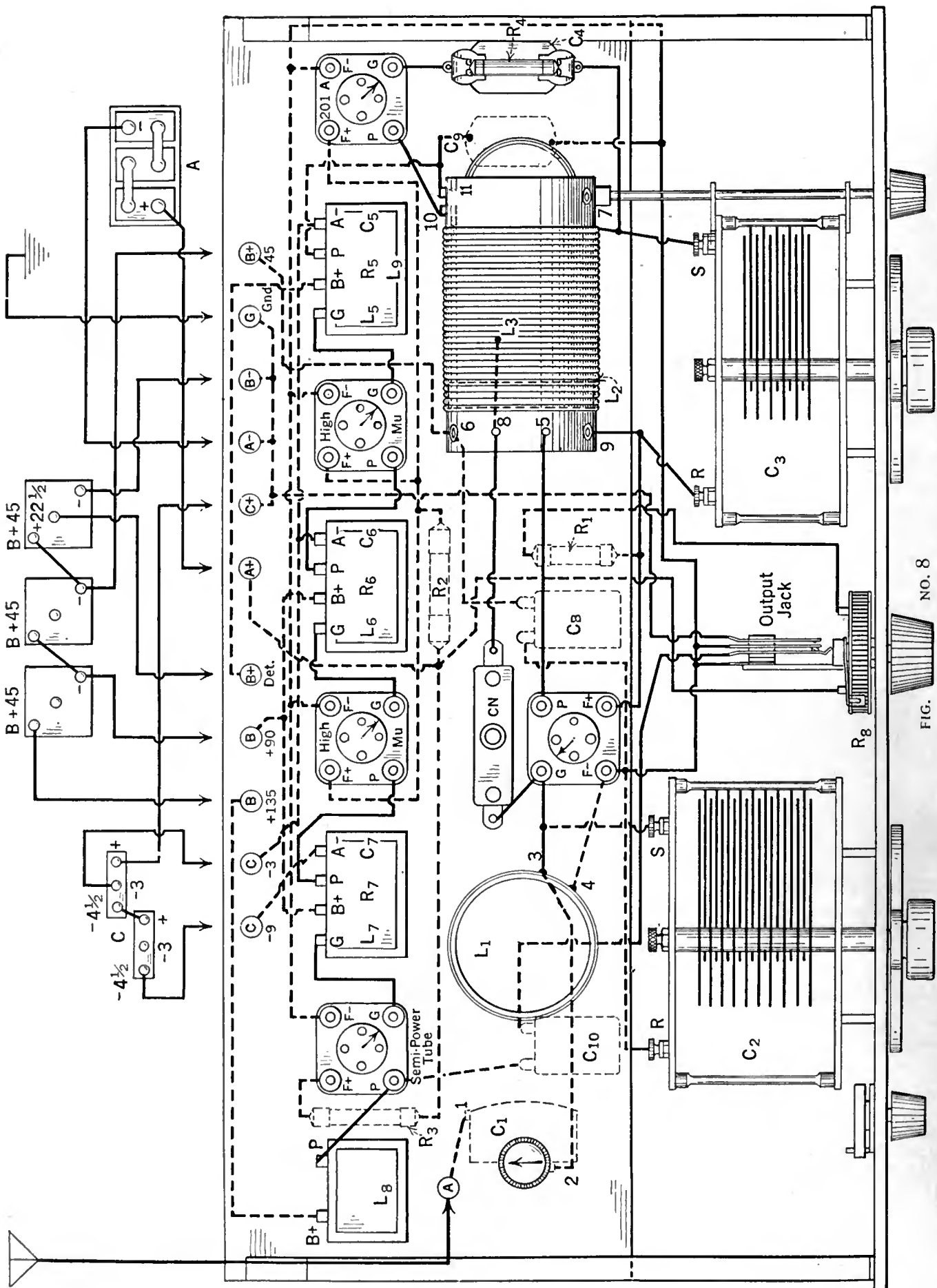

FIG. 7

When employing home-made coils, it is absolutely essential to the successful operation of the receiver that the coil units be at right angles to each other and mounted on the same plane. If this point is not observed, neutralization is practically impossible. The sketch here shows how the home-made coils should be mounted



A picture diagram of the completed Browning-Drake receiver. The dotted lines indicate connections and wires located underneath the sub-panel. In the construction described, La-site connectors were employed as a means for connecting apparatus above the sub-panel with that below. The parts are all indicated by letters and numerals, and by comparing with the circuit diagram, Fig. 3, and the photograph on page 403, identification may be made complete. The letters R and S on the condensers C2 and C3 indicate the rotors and stators

Precise antenna tuning condenser, while in the smaller is fastened the antenna binding post. At the right of the detector tuning coil unit will be observed four small holes arranged in a square. In the two near the coil is mounted the 0.005 mfd. fixed bypass condenser C₉—on the under side of the sub-panel. To its right—still looking over the front—is mounted on top of the sub-panel the grid leak and condenser C₄, R₄.

The only parts left are the two 1-mfd. Sangamo fixed condensers and the three filament ballast mountings. The former are mounted one to the left of the antenna tuning unit at the edge and the other to the right of the socket located between the two coil units. One of the screws holding down this socket is employed to support this fixed condenser. Of course these condensers, together with the filament ballasts, are mounted on the under side of the sub-base.

WIRING

IN THE model receiver described here, bus bar was used throughout, but others may wish to use the cable system of wiring wherein insulated wires, preferably each of a different color, are employed. Such a system has much to recommend it, as there is not the possibility of closed loops and other causes for feedback as with the bus bar style of wiring.

Small holes drilled in the sub-panel near the terminals of the various parts permit the constructor to make connections from underneath the sub-panel to objects as-

sembled above it. The wires may pass through the holes or, if it is so desired, Lastite connectors, as illustrated, may be employed for the purpose.

The wiring and circuit diagrams are given in Figs. 3, and 8.

OPERATION

WITH the coil and condenser combination employed the receiver will readily tune from 1500 kc. (200 meters) to 545 kc. (550 meters). The approximate position of the dials, since they read alike, conforms to the frequency-wavelength chart shown in Fig. 9.

Assuming that all the batteries, antenna, and ground are connected, and a pair of phones or a loud speaker plugged in the jack, proceed first to neutralize the radio-frequency amplifier as follows.

Tune-in a station—preferably a short-wavelength one, to be found at the lower readings on the dials. Then advance the tickler coil slightly until a squeal is heard. Now, by rotating the antenna coil condenser, the squeal will vary both in pitch and intensity, if the set is not neutralized. By adjusting the position of the neutralizing condenser with a piece of wood sharpened to resemble a screwdriver blade at the end, the squeal can be brought to the point where it will vary only in intensity—not in

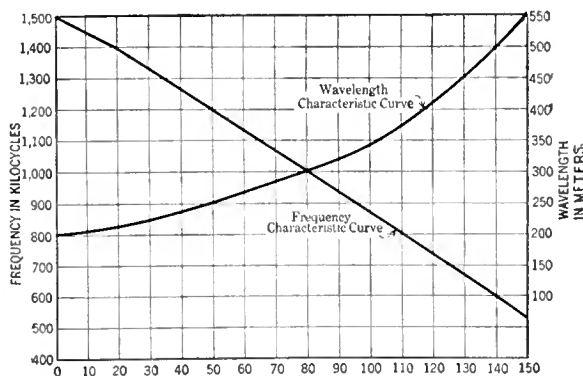
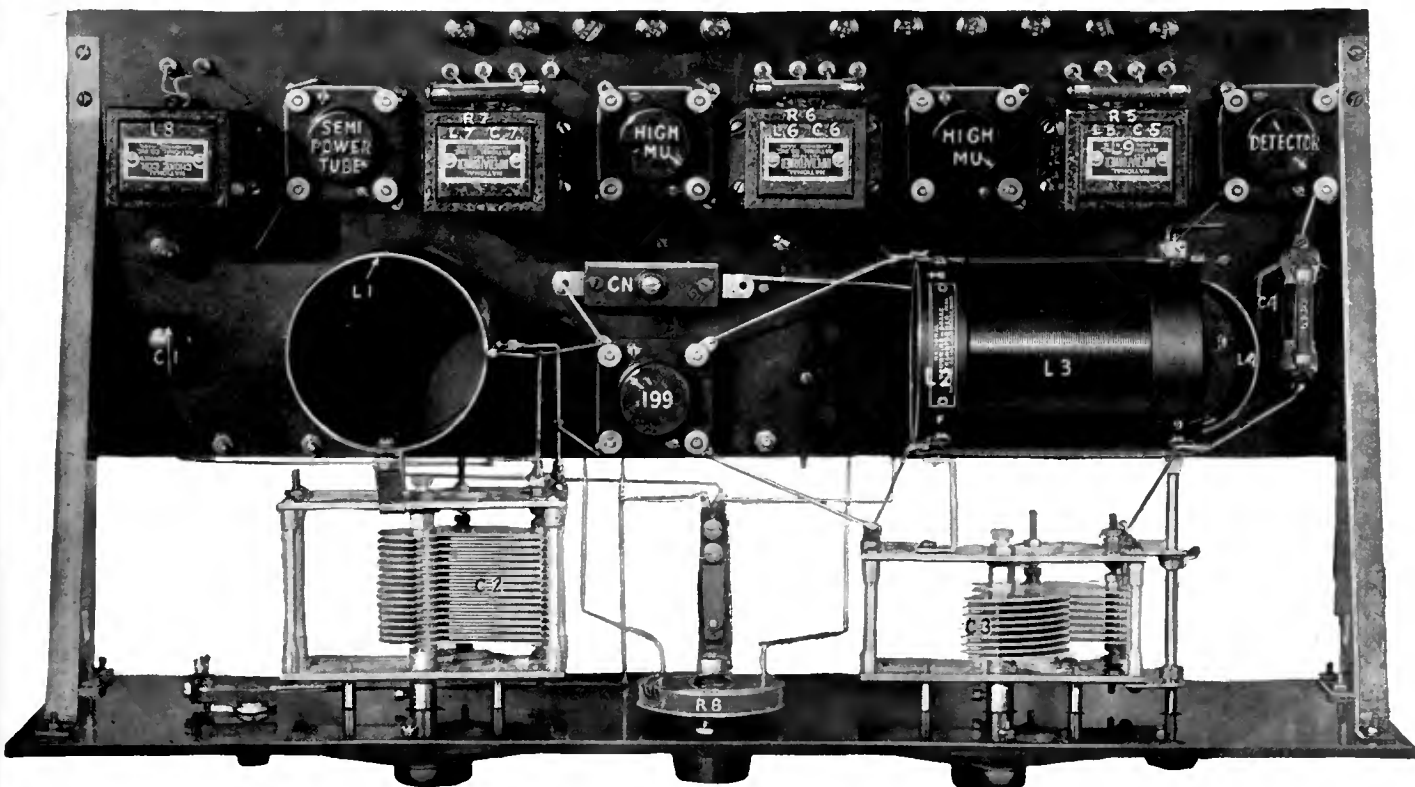

FIG. 9

Constructors will find that the tuning characteristics of their completed R. B. Impedance-Coupled Browning-Drake receiver will closely approximate the tuning curves for the National Company's coil and condenser combination shown here

pitch. This is the point where neutralization is obtained. Another method of neutralization is to turn off the filament rheostat of the radio-frequency tube after a station has first been tuned-in—then vary the adjustment of the neutralizing condenser until the signal is either diminished to a minimum or else entirely eliminated. The antenna series condenser will be found useful in making the two main tuning dials read approximately the same over the entire scale.

When it is intended to reduce volume, the 30-ohm rheostat inserted in the radio-frequency stage filament circuit will accomplish the desired result without any unwanted distorting effects. With some 199



RADIO BROADCAST Photograph

LOOKING DOWN ONTO THE SUB-PANEL

This photograph closely coincides with the picture wiring diagram as shown in Fig. 8 and cross reference between the two will be helpful in completing the assembly and wiring. At the time this view was taken, the older type of National dial was used; consequently, the new illuminated type is not shown. In appearance there is no great difference. Merely two contacts are provided to which connections may be made for illuminating the dial, as an aid to accurate tuning should the set be placed away from other light

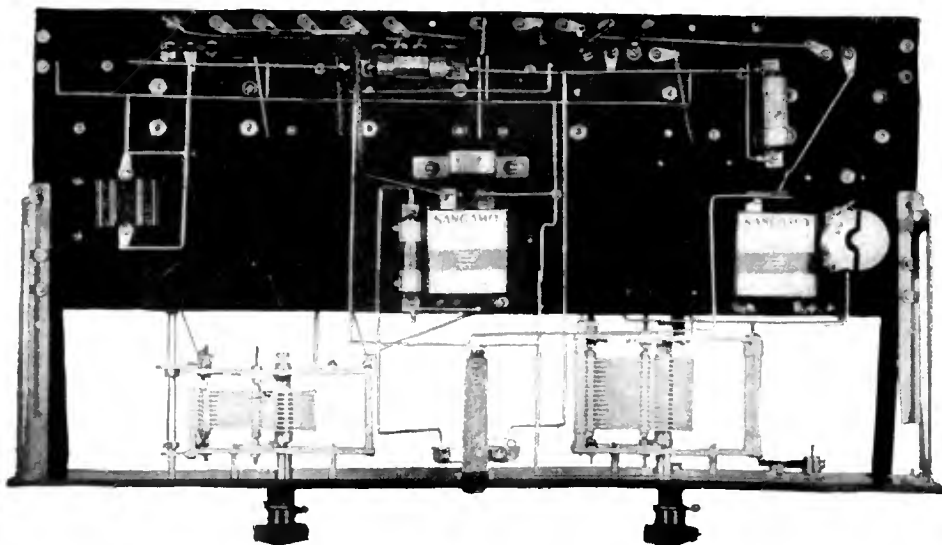

THIS IS WHAT YOU'D SEE

Looking at the set from the bottom. From this view, the connections underneath the sub-panel are clear

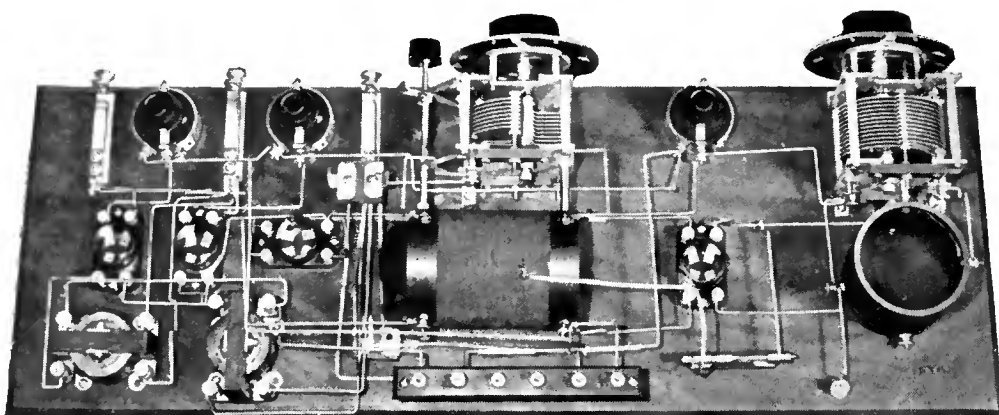

A VETERAN OF RECEIVERS

By way of comparison, this illustration of the first Browning-Drake receiver, described in the December, 1924, issue of RADIO BROADCAST, is shown. Type 199 tubes were used in every socket of this four-tube receiver. The bread-board layout gives a fair idea of the constructional and wiring details involved

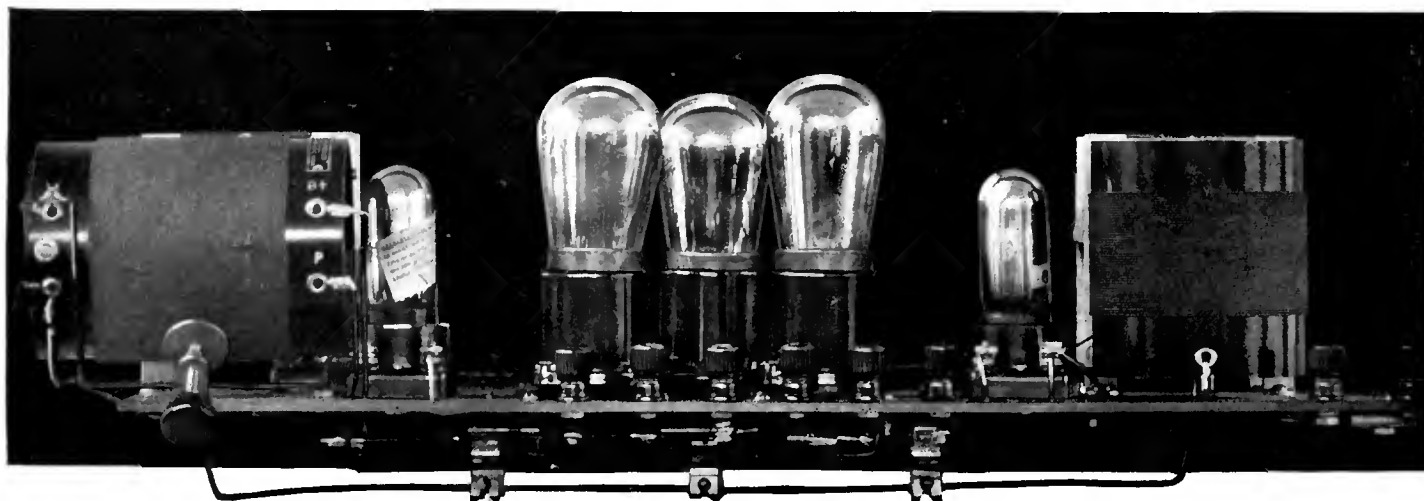

A RECENT MODEL OF THE BROWNING-DRAKE RECEIVER

One year later, in the December, 1925, RADIO BROADCAST, another Browning-Drake receiver of more pleasing appearance was described. Here, five tubes were employed, three being included to act in the capacity of impedance-coupled audio-frequency amplifiers. The two type 199 tubes had their filaments arranged in series so as to work directly from the six-volt filament supply. While not clearly shown, the impedance coupling units are mounted below the sub-panel. A novel form of neutralization was featured in this model whereby a small circular metal plate, about the size of a nickel, is employed as one plate of the neutralizing condenser while the metal wire comprising the secondary coil of the detector circuit forms the other plate. Adjustment is controlled by means of a threaded rod upon which the metal disc is mounted

tubes, the control of volume will not be so pronounced as with others, due, most likely, to varying conditions of filament emission. If a tube is purchased which has an exceedingly high emission factor, more accurate volume control will be possible by the insertion of an additional 20-ohm resistor in its filament circuit.

Regeneration control should be smooth and not too pronounced. If this is not so, then try regulating the B battery voltages to the detector tube. The correct voltages for all the circuits are shown in the circuit diagram Fig. 3 and the wiring diagram, Fig. 8.

The radio-frequency amplifier will function satisfactorily with 45 volts of B potential. If higher values of voltage are employed, no appreciable gain will accrue and besides, neutralization will become more difficult, if not impossible.

The value of grid bias applied to the audio amplifier stages is somewhat critical and it will be found in some cases that when $4\frac{1}{2}$ volts are applied to the first and second stages, the entire volume output will be reduced. With 3 volts of C battery, very pleasing tone quality with satisfactory volume is obtainable. In the last audio stage, the grid bias voltage depends entirely upon the type of tube used and its corresponding plate voltage. For a type 112 tube, 135 volts are recommended with 9 volts of C battery.

Taking advantage of the special tubes which are now procurable, results in tone quality and sensitivity may be much improved over what is ordinarily expected. This is especially true when such tubes as the Ceco special detector tube or the similar R. C. A. UV-200-A are used.

AS THE BROADCASTER SEES IT

by CARL DREHER



Drawings by Stuart Hay

What About Stacking Several Broadcasters on One Wave?

ACCORDING to reports, some of the deep thinkers of the International Union which supervises European broadcasting from Geneva, goaded to desperation by the heterodyning and interference between stations which exist there as in the United States, have evolved a plan whereby a number of stations will broadcast on a common wavelength.

This scheme rests on several observed characteristics of radio telephone transmission and reception. One is that two stations will heterodyne each other with a whistling note at points where the signal of one or the other, or both, is inaudible at a given sensitivity setting of a receiver. For example, a listener may have his receiver adjusted for reception from a local station with a moderately strong signal. With the amount of amplification required under these conditions, another station 500 miles away may be quite inaudible—when the local station's carrier is off. But with the two carriers on the air, the distant transmitter may beat with the local one, producing the familiar and anathematized continuous squeal.

The pitch of this squeal, by elementary heterodyne theory, is the difference of the two combining frequencies. If one carrier is on 1000 kilocycles and the other on 999 kilocycles, the resulting note will be 1 kilocycle, or 1000 cycles. If the two carriers are on exactly the same frequency, there will be no beat note at all.

Hence, the savants argue, if we place a number of stations, well separated geographically, on the same wavelength, accurately, and keep them there, all will be well, and the excess of stations will be absorbed through the multiplication of stations on one wavelength. The carriers being exactly on the same frequency, there will be no beat notes, and as the stations are limited in power, direct interference of the different signals, demodulated, is precluded.

The obvious difficulty is keeping a number of carriers on one wave. And, as soon as one varies, in come the beat notes. As we know from experience, it is hard to keep stations separated by 10 kilocycles or more on their respective wavelengths. It will be even harder to keep them precisely on the same wavelength. And precisely it will have to be, or the whole scheme goes into the ash can.

Another technical objection lies in the probable interaction of the side bands. As everyone who has graduated from the radio kindergarten knows, a normal broadcasting station radiates its carrier and two side bands, the frequencies of the latter being the carrier plus and minus the modulating frequency, respectively. Even if we assume that

the carriers of the stations sharing one wavelength are exactly superimposed, the side frequencies will necessarily be different, if the programs are different. We may, therefore, expect spurts of interference as these rapidly varying frequencies interact. Just how serious these interfering sounds will be remains to be seen. Judging from observations on stations whose carriers were beating with a low audible note, this difficulty would not be a minor one.

Big Tubes and Little Ones

COMPARISONS, while allegedly odious in society, are illuminating and valuable in technology. It would not do to compare a little millionaire with a big one; the little millionaire would be angry. But we may compare

Technical Information Previously Printed
in this Department

IN RESPONSE to requests we print a list of the previous titles and the issues in which they appeared:

Microphone Placing in Studios,	September, 1925
Outdoor Symphonic Pick-up,	October, 1925
Personnel and Organization in Broadcasting,	November, 1925
Technical Routine in Broadcasting Stations, 1. <i>Wire Lines</i> ,	December, 1925
Studio Microphone Placing—Further Consideration,	January, 1926
Technical Routine in Broadcasting Stations:	
2. <i>Control Work</i> ,	February, 1926
3. <i>Monitoring</i> ,	March, 1926
4. <i>Multiple Pick Up</i> ,	April, 1926
5. <i>Equalization</i> ,	May, 1926
6. <i>Types of Equalizers</i> ,	June, 1926
7. <i>Modulation</i> ,	July, 1926
8. <i>Public Address Systems</i> ,	August, 1926

large and small radio tubes without offense to any one.

Water-cooled transmitter vacuum tubes, used in transoceanic telegraphy and telephony, and in large broadcasting stations, are generally rated at ten or twenty kilowatts oscillating output. It is not customary, for reasons of prudence, to undertake to get more than 10 kw. out of one unit, day in day out. The filament consumption of such a tube is about 45 amperes at 15 volts,

corresponding to 675 watts. Some consume 750 watts apiece. An UX-199, which is a dry-cell detector and amplifier tube used in receivers, takes 60 milliamperes at 3 volts in the filament circuit. This amounts to 0.18 watt. Dividing 750 by 0.18, we discover that we could light 4166 UX-199's with the filament energy required for one water-cooled triode of the usual types. Allowing five tubes to the average set, it appears that we could run 833 receivers, using UX-199 tubes, with this amount of power.

At this point in my divagations, I recollect some figures from an article by Dr. Alfred N. Goldsmith, in which it is calculated that the receiving sets of the United States use 30,000 kilowatts in filament and plate power, and this Dr. Goldsmith estimates is 100 times the antenna power of all the broadcasting stations in the country. This is all I remember of the Doctor's discussion, but, as he was also comparing receivers and transmitters, I presume that I unconsciously cribbed the idea of the article I am now writing from the previous paper. Well, if so, it is not the first time I have borrowed an idea from Doctor Goldsmith. Having made this blanket acknowledgment, I may proceed.

Now, a station on the 50-kw. level uses around 32 of the water-cooled tubes aforementioned. The filament generator in the case of WJZ is rated at 23 volts and 1000 amperes, or 23 kw. Allowing 1.0-watt filament consumption for a five-tube UX-199 receiver, we now learn that this filament generator will do right by 23,000 receivers. However, no one has tried to connect even one receiver to the machine in question, which looks rather formidable. Hence I am not insisting that these figures should be taught to every school child in the United States. As an afterthought, there are two filament generators at this station, so make it 46,000, if you don't mind. Incidentally, if you went to one of the Edison Waterside power plants in New York, you could look at a few generators which would also run a lot of receiver filaments—just how many millions I hesitate to estimate. But that's not radio, so it is barred.

And now one last display of figures, before the customers fall asleep with weariness. This time I point to the UX-171, an output tube with unusually low impedance (about 2000 ohms) and a normal grid bias of minus 45 volts or thereabouts. This last figure intrigues me, because 45 volts was what I used on the plate of my first audion. I assembled it laboriously, using thirty 1½-volt flashlight cells, which gave up the ghost in a lamentably short time. As for a grid bias, not even Lowenstein thought of such a thing then.

You connected the flashlight cells for your plate, lighted your filament, and let her ride! We used to short-circuit the plate battery purposely, sometimes, to admire the fat blue arc. And now it's a grid voltage!

A Lesson for the Radio Class

IF RADIO engineers, now and then, would sit at the feet of older, if not better, engineers, in the other branches of technology, and, while imbibing knowledge, construct a few analogies based thereon, it might not be a bad thing for the radio art.

The other day a large Hudson River steamer got tangled up with an oil tanker in a fog. The oil tanker went on her way. The river boat went to the bottom of the Hudson in about fifteen minutes. And, of all places, she had to founder directly over the Holland vehicular tunnel in course of construction between New Jersey and New York. Filled with water, the *Washington Irving* now rests a considerable part of her not inconsiderable weight on the structure of the tunnel bored through the silt and rock of the river bed.

When this disconcerting accident occurred, did the hair of the tunnel engineers turn white overnight? Did the wall of the tunnel crash in, overturning the whole tube or sections of it with water, drowning the workers, while the design engineers went home, said good-bye to the children, and shot themselves? Not at all. Be it known, the original design of the tunnel, in addition to the usual ample safety margins provided by structural engineers, took into account the possibility of an ocean liner sinking over the tube. This being the case, a river steamer, with its trifling 5000 tons displacement, is nothing to worry about. The possibility of an ocean liner going to the bottom at this particular point is of course slim. But so was the chance of a large river steamer taking the plunge just there, in the 150-mile stretch between New York and Albany—and the thing happened. And the engineers had guarded against it!

What has this to do with radio? A good deal, I venture to answer. Think of the four or five years during which we radio men turned out receiving sets in which we tried to get a big output

with little tubes. Think of what that output sounded like. If we had borne in mind the first principle of the structural engineer's art—to build his bridge or his skyscraper or his tunnel ten times as strong as he has reason to believe it will ever have to be in order to stand up—would we not have had power output tubes that much sooner? Overloading and distortion in the output tube of a radio set correspond to a structural collapse in civil engineering. It is true that one crash is not as serious as the other, but they represent equally bad engineering.

Well, we have reformed. We have some pretty good output tubes these days, adequate for the work they must do, and capable of delivering several times as much volume as any sane listener will require, without distortion. But, in view of the past, I submit that we should make a low bow in the direction of our colleagues in the A. S. C. E., A. S. M. E., etc., etc.

Note on Radio Inventions

THE era of luxury is certainly upon us, in the radio field. Luxury, that is, not only in the relatively big things—period cabinets and that sort of thing, but in details of installation and control. I believe a man could build a set of five-and-ten-cent store parts today with more ease, and operate it more comfortably after it was finished, than the wealthiest amateur of ten years ago buying the best components obtainable at that time.

Such little items as battery cables and pin jack filament voltmeters are what I am thinking of. It used to be a nuisance to connect the various batteries to a set by separate wires straggling up a table leg, more or less skillfully cabled. Cutting the strands to length and skinning the ends was a little job in itself. Now you can buy a neat mercerized cotton cable with five or six individually insulated conductors, clearly color-coded, with suitable terminal lugs, for thirty-five cents, and connect your batteries to the set in five minutes, if you are slow. And it looks better and is safer when it is finished. The filament voltmeter is another blessing. It substitutes dependability and control for uncertainty. You turn the rheostat until the pointer touches the red line, and if anything changes the

meter will show it. You know when your dry A-battery requires renewal. You no longer work in the dark.

I am not so enthusiastic about all radio inventions. For example, I am rather lukewarm about antenna innovations. I do not see the special virtue of metal strip in place of wire, or insulated wire as against bare. These ideas are supposed to reduce antenna resistance materially. But all they can reduce is the ohmic component of the resistance, and that is one of the smaller items. The big factor in the total resistance is the proximity of the antenna to conducting and semi-conducting masses. If the people who run their insulated lead-ins seventy feet or so along the brick walls of apartment houses would swing the conductor three or four feet out, the antenna resistance, through the reduction in the dielectric losses, would be improved ten times as much as by the use of devices for obviating corrosion or increasing superficial area of conductors. Not that these devices are harmful—they just don't matter one way or the other, in my opinion. Again, I am dubious about loud speaker volume controls incorporated in telephone plugs. Such dinguses are easily misused—the volume being throttled down at the loud speaker while the output tube overloads. The place for a volume control, logically, is ahead of, not after, the audio tubes of the receiver. Then, when the volume is reduced, the margin against output tube overloading is increased, as it should be.

Yet the inventive spirit as such is salutary. Therefore I don't like to end on a pessimistic note, and I will concede merit to the people who put up antenna wire in 150-foot coils for the longer antennas, thus obviating a splice. That is a simple and yet valuable idea.

Technical Operation of Broadcasting Stations

9. Protection Against R. F. Pick-up

IN SOME cities there are fifteen or twenty broadcasting stations, which is too many, viewed from several angles. They interfere with each other, not only in the listeners' sets, but even before this point. They pick up and radiate one another, not obligingly, but involuntarily. The manner of it is as follows:

One station is engaged on a pick-up job in the field. It sends out a field squad with an amplifier feeding a wire line going to the control room of this station, which we shall designate Station No. 1. The wire line runs close to Station No. 2, or perhaps the pick-up location is in a building adjacent to No. 2. Then Station No. 1 is in imminent peril of broadcasting Station No. 2, in addition to its proper pick-up. The wire line, you see, although intended for the transfer of audio currents only, is unaware of its purpose, and picks up radio frequency oscillations, often very strongly, from Station No. 2. These oscillations travel to the field amplifier of Station No. 1, where they are rectified by one or more of the tubes. If you impress a strong r. f. voltage on even a properly designed audio amplifier it will rectify more or less. The resulting a. f. reproduction of Station No. 2's program flies blithely to the modulation circuits of Station No. 1 and is radiated. Or the r. f. of Station No. 2 may go directly to the control room of Station No. 1 and succeed in getting rectified there. A third method of admittance is by way of the microphone leads of station No. 1 at the field pick-up point, rectification in the field amplifier, and so to the air once more.

The remedies are not complicated. For one thing, field amplifier boxes should be shielded



"I BELIEVE A MAN COULD BUILD A SET OF FIVE-AND-TEN-CENT STORE PARTS"

with $\frac{1}{4}$ " copper sheeting. The shield, the filament battery of the amplifier, the mid-point of the output transformer line side winding, and the common posts of the carbon microphones, may then all be bonded together, and connected to a suitable ground at the remote pick-up point. This is a great aid in eliminating radio induction in an intense field at the location where the program is to be picked up. Sometimes even the microphone leads must be shielded. The Belden Manufacturing Company makes up shielded microphone cord to order. The shield forms the third conductor. The Western Electric Company also supplies shielded transmitter cord to owners of its broadcast stations.

Radio frequency traps are another device useful in guarding against pick-up from other broadcasting stations. If only one station is involved the double trap arrangement of Fig. 1, in the line, will prove effective. The shunt circuit is tuned to the station to be eliminated. This is a regular rejector trap. A number of them may be used for getting rid of the corresponding number of stations.

A neater procedure is to make up a general r. f. filter to take out all high frequency oscillations, without tuning. One such circuit, due, I believe, to Mr. Jesse Marsten, appears in Fig. 2. This may be placed in a line or microphone circuit without loss of quality due to by-passing the higher audio frequencies, but it is sure death to any radio frequencies which may be hanging about. A simpler filter is sometimes equally effective; try simply the two 150-turn coils and two 0.02-mfd. condensers with midpoint ground, if the boss is yelling about economy. But if the pick-up is very heavy you may require the whole works, as shown in Fig. 2, to get it all out.

Besides the remote control points at which filters on this order may be installed, it is well to have one at the station end in each incoming line, to block r. f. oscillations coming directly to the station. They should be placed in the line, ahead of the repeating coil.

10. Calculation of "Gain"

IN RADIO, the general practice has been to measure amplification in terms of voltage, current, or power. For example, we would say that under certain conditions a stage of audio amplification gave a voltage (or current) amplification of 15 times, corresponding to a power amplification of $(15)^2$ or 225 times. (The power expended or generated in a circuit always varies as the square of the voltage and current, the simplest illustration being the well known formula for the electric power, P , expended in a simple circuit of resistance R , the current flowing being I :

$$P = I^2 R$$

This energy appears as heat.)

In the telephone field, however, it has been customary to express amplification in terms of "miles gain." This method arose from the fact that telephone engineers got into the habit of expressing the loss of signal strength along a line in miles of standard cable, No. 19 gauge. "That signal is down five miles," they would say, meaning that it sounded as if it had passed through five miles of standard cable. Their datum or fixed reference mark was "zero level," corresponding to the output of a standard transmitter. When amplification was introduced, it was natural for the telephone men to express the "gain" in the same terms as the loss they were trying to overcome, that is, in miles of No. 19 cable.

Since the wedding of radio and wire telephony in broadcasting, with some of the technicians talking amplification in one language and the rest

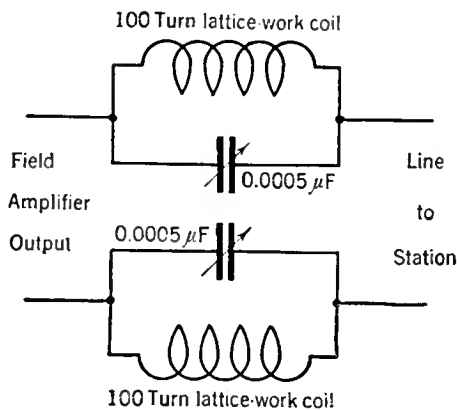

FIG. 1

in the other, a certain amount of confusion has resulted. The relationship, however, is a very simple one, and there is no reason why broadcasters should not be able to convert power or voltage amplification into miles gain, if a book of logarithms or a slide rule is handy. The expression is

$$\text{Miles Gain} = 10.56 \log_{10} \frac{P_2}{P_1} \quad (1)$$

where P_1 is the input power of the amplifier, and P_2 the output power. These powers vary as the square of the input and output voltages, as pointed out above. The mean speech frequency is assumed to be 796 cycles per second.

A single numerical example is probably sufficient to show the working of the formula:

Given a field amplifier with a voltage amplification of 200 times, what is the equivalent gain in miles of standard cable?

Solution: The power amplification of the amplifier is the square of the voltage amplification. Then we may write

$$\frac{P_2}{P_1} = (200)^2 = 40,000$$

Substituting in (1) above, we have

$$\text{Miles Gain} = 10.56 \log_{10} (40,000)$$

The log to the base ten of 40,000 may be looked up in a table of logarithms. The value is found to be 4.60206. Hence we write

$$\text{Miles Gain} = 10.5 (4.60206) = 48.6$$

The amplifier in question therefore has a telephone gain of about 48 miles when the voltage amplification is 200 times.

This amount of amplification, incidentally, is about half the voltage amplification of a two-stage, transformer-coupled audio amplifier, allowing an amplification constant of 5, for the tubes, and a turns ratio of 5, in the first transformer and 3, in the second. The overall amplification, in terms of voltage ratio, is then 375. If we use the formula again, we find that this corresponds to a gain of 54 miles. Inasmuch as the gain in miles is a logarithmic function of the power ratio of the amplifier, the former does not increase as rapidly as the voltage ratio, and almost doubling the voltage ratio, as in this case, only adds a telephone gain of about six miles.

For purposes of mental computation, the last observation is a handy one to keep in mind. We note from the formula (1) above, and the power-voltage relation, that whenever the voltage or current amplification is doubled, the

ratio P_2/P_1 is multiplied by 4. The logarithm to the base 10 of 4.0, to two places, happens to be 0.60. Inasmuch as we have a coefficient of 10.5 in the formula, this means that the increment in miles gain, for a doubling of the voltage ratio of the amplifier, is regularly 6 miles, approximately. Hence if you make a mental note of the voltage amplification and miles gain in one case, say, roughly, fifty miles gain corresponding to 200 times voltage amplification, from the above example, you can approximate the miles gain corresponding to any voltage amplification, without putting pencil to paper. For example, what is the miles gain corresponding to a voltage amplification of 3200? It is necessary to double 200 four times. Four times six is twenty-four. Add twenty-four miles to fifty and you have the answer: 74 miles. Or, going in the opposite direction, what is the telephonic gain corresponding to 25 times voltage amplification? This time you halve 200 three times, which lands you at 25, and, multiplying six by three, you get eighteen miles to subtract from the fifty with which you started. The answer is 32 miles. But if the problem involves low gains, say 10 miles or under, it is well to use the formula directly, as the inaccuracies involved in the mental figuring become serious in this region.

Memoirs of a Radio Engineer.

XIV

WHEN I began this series, I prefaced it with a little explanation, which I shall now repeat for the information of the patrons who came in after the show started. My apology for writing my radio autobiography at the age of thirty was that I wanted to set down these incidents before I forgot them. Another reason which has been brought to my notice during the writing of the articles, is that many other amateur and professional workers in radio have gone through practically identical experiences, so that the reminiscences which I am turning out are not individual, but hold more or less for the whole group. Of course my old-time stuff is largely juvenile, and there were important professional developments in progress while I was still potting the neighborhood cats with bean shooters. Mr. Marriott has written entertainingly and instructively about some of his experiences in the early history of radio telegraphy. And George Burghard, in a Radio Club of America paper, published in the August, 1923, *Radio Broadcast* under the title of "Eighteen Years of Amateur Radio," covered the rise to eminence of the West Side group of New York City amateurs. There have been other contributions in this magazine by Armstrong, Butler, Worts, Gowen, Irwin, among the rest. In short, radio men, being a group who combine romance with commerce in their profession, are strong on reminiscences, and I am following a well-established precedent. In radio we always glorify the past and look forward eagerly to the triumphs of the future; only in the present we are

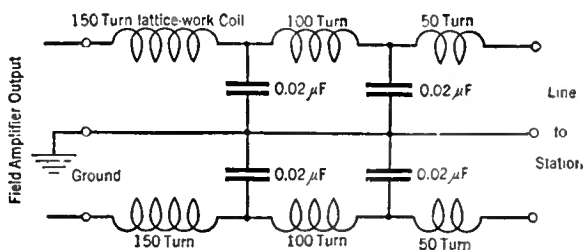

FIG. 2

full of groans and denunciations. In this we are like other people. And I am like other radiomen.

We left off, in the July number, with the founding of the radio club at the College of the City of New York. Among the pieces of equipment there I recollect a long-wave regenerative receiver, with coils of annunciator wire wound on cardboard tubes about three feet long. Mr. F. T. Dickey, at about the same time (1915) had a private set of the same type, on which he let me listen to Glace Bay and other sustained wave stations. These, however, were not my first experiences with vacuum tubes. I had had one, in fact two, of my own. But they were gone. They had died, so to speak.

Nowadays janitors and poor working girls own five-tube sets, but ten or twelve years ago the possession of a single tube was a mark of distinction, among radio amateurs, equivalent to ownership of a Nubian lion by a poor Roman, say. The comparison is slightly crippled, but it has this in its favor—

a Nubian lion will consume the entire income of his master, if the latter is in middle circumstances or below; and the audion bulbs did just that for the poor radio addicts of the pioneer days. First, there was the job of getting one. The early tubes were not sold outright; you were entitled to buy one only if you were the owner of an amplifier, which cost several hundred dollars for some of the models, and less, but not enough less to come within reach of the average amateur, for a single-stage outfit. However, if you brought a burned-out tube to the manufacturer, that was accepted as *prima facie* evidence of ownership of an amplifier. The company then graciously sold you a bulb for \$5.00 or \$7.50, depending on the type of filament. Naturally there was a thriving trade in burned-out tubes; it was almost as great a triumph to get a defunct audion as a new one, inasmuch as there was no possibility of attaining the consummation of desire without going through this preliminary step. Anyway, there was not so much difference between good and burned-out audions, the former turned readily into the latter. My first lasted about fifty hours; my second, about forty minutes. But it had an extra filament, Allah be praised. The second filament, unfortunately, while it would light, showed little merit as an emitter of electrons. The best I could do on it was NAH, the Brooklyn Navy Yard, about six miles away, and he was not as loud as on a crystal detector. I therefore rescinded my praise to Allah, and lamented bitterly and lengthily the loss of my five dollars—a Christmas present. I wrote to the manufacturer of the tube,

but without obtaining satisfaction. No doubt he had his own troubles, and it is probable that he needed the five dollars as much as I did. I then tried to weld the ends of the broken filament together, by applying the battery voltage and slapping the bulb in such a manner that the ends might make contact and stick together. I have never concentrated more ardently on any problem, in the years that have passed since this audion betrayed its trust, than on that sixty-fourth inch air space which showed through the glass between the broken ends of that filament. As I gazed fixedly at the small but overpowering gap, it sometimes seemed as if it must close up in obedience to my will, but the laws of matter were not suspended in my behalf. Surrounded by the protecting vacuum, the little gap continued to flaunt its presence in my face. If I ever took any stock in faith healing, it disappeared then.

More desperate measures failed likewise.



"NOWADAYS JANITORS OWN FIVE-TUBE SETS"

One of these methods of resuscitation was to apply the voltage of a spark coil secondary to the filament terminals. Sometimes the ends would leap together and stick. In my case they did not leap together, and hence they did not stick. I used a larger spark coil, borrowed from another surgeon. I reversed the polarity. I reversed it back again. Finally I wrapped the audion in tissue paper and went back to my crystal detector. The faithful crystal took me back to its bosom, but I could not love it as before. As usual, faithfulness was unrewarded. My heart and imagination remained with the scintillating and coquettish audion. It could be unfaithful and costly, and get away with it, because of the incomparable moments it brought its admirers. For, when they were working right, the old audions were not to be despised as detectors. They were imperfectly evacuated, and their characteristic curves

sometimes had kinks and loops where the rectification was first rate. It is true that the tube factory had little more control over the operating characteristics of their product than over the annual frequency of sun spots, but this element of gambling in the purchase of an audion only added to the thrills. Flung into deepest despair by the demise of a beloved tube, or the failure of a new one which never worked at all, the audion speculator would save up his pennies and plunge again.

The early vacuum tubes were rounded into graceful shapes, like a Greek vase. They were not severely rectilinear, like the standardized, uniform, efficient products of the present day. They were not made by machine, but by hand, and sometimes, apparently, the hand was not a steady one. No two tubes looked alike, and few acted alike. The innards of the creature were wide open to view, for they were not within a cylindrical plate element, as nowadays, but in flat shape. The plate was a metal tab about half an inch square, then came the zig-zag grid, somewhat askew, and then a feeble looking flat loop of wire, the filament. Insulated flexible leads issued from the bulb, the grid lead green, the plate red, and the two filament leads usually in plain rubber. It was a romantic looking object, and no mistake.

The amateurs took strange measures to increase the sensitivity of their audions. They would heat the glass tube over a Bunsen flame, until the wall softened and an indentation resulted, in order to regulate the vacuum. Another stunt was to suspend a good sized horseshoe magnet with the bulb between the poles, thus subjecting the electron stream to a magnetic field. This sometimes increased the sensitivity remarkably. Some latter-day genius is going to rediscover this trick one of these days, and have his afternoon in the radio supplements.

Some, apparently, of the more sensitive specimens regenerated in the circuits in which they were used. I recollect one I had in 1913, which brought in Boston stations in New York in daylight. This tube, like many of the audions, had chromatic qualities. When at work it glowed internally with a delicate pink-violet light, like a rather refined and emasculated Geissler tube. Irritated by strong signals, it would turn a deep blue in synchronism with the dots and dashes, so that, with the room darkened, one could read the signals visually. It was a sweet and charming companion, and I hereby dedicate this article to its memory. I regret that I never gave it a name.

Transformer-Coupled Audio Amplifiers

A Paper Delivered Before the Radio Club of America, Which Considers the Proper Design of Audio Transformers, How Their Characteristics May Be Measured and Evaluated—A Comparison Between Resistance-, Impedance-, and Transformer-Coupling

By ALFRED W. SAUNDERS

Engineer, F. A. D. Andrea Company

RADIO broadcasting of musical programs, speeches, and other matter of general interest has made tremendous advances during the last few years. Probably the only reason for public interest in the art, during its early stages, was the novelty of using the ether as a medium of transmitting programs. In the early stages of the art, the quality of a program was secondary in importance to "reaching out." Developments during recent years, however, have served to make radio as much a necessity as a novelty or luxury, with the result that quality is of prime importance to-day. Radio reception is no longer a novelty in the eyes of the public, but it is, instead, a firmly grounded institution, and like other public utilities it must meet the demands of its customers both in regard to the quality and form of entertainment to be broadcast. As one writer has aptly put it, "Radio is in every sense a public institution and should therefore be controlled by the public for the public good."

It is well known that in general the quality of the transmitted programs is far more satisfactory than the quality of those received. The economics of the situation would lead us to expect the existence of this state of affairs, since any radio receiver must be relatively cheap compared to a transmitter which serves a large number of listeners. While it is true that the quality of reception depends on a number of circuit elements, probably none is more important than the audio amplifier. However, the fact must not be overlooked that quality is also affected by the tuning characteristic of the radio-frequency amplifiers, the time constant of the grid leak and condenser combination of the detector, the loud speaker, and by overload in any portion of this circuit. It is the purpose of this paper to outline some of the fundamental considerations involved in the design of a specific type of audio amplifier and to show how some of the desirable amplifier characteristics may be obtained in practice.

Since the performance of a transformer-coupled amplifier depends primarily upon the transformer characteristics it seems logical to start with the transformer itself. The perfect transformer has been defined by K. S. Johnson—*Transmission Circuits for Telephone Communication*, D. Van Nostrand Company as one which neither stores nor dissipates energy. That is to say, an ideal transformer has no dead resistance,

no losses, and a perfect flux linkage between windings. This amounts to saying that the primary and secondary self impedances must be infinitely high with respect to the sending and terminating impedances and that each must be purely imaginary in character. Moreover, for this definition to hold, the mutual impedance must be an imaginary quantity equal to the geometric mean of the primary and secondary self impedances. The reasons for these limitations are evident from Fig. 1.

If the transformer is to cause no loss in the circuit it must evidently draw zero current from the source when Z_2 is infinite. Moreover, it is evident that L_1 must be imaginary as well as infinite if it is to have zero loss when it draws current. The same criteria of course hold for the secondary self impedance. If all these conditions hold for a given transformer, the impedance looking into the primary will be Z_2 divided

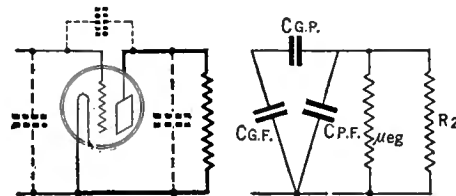

FIG. 2

by the square root of the turns ratio, where the turns ratio is given as the secondary turns divided by the number of primary turns.

THE IDEAL TRANSFORMER

EVIDENTLY then, an ideal transformer will absorb only sufficient power from the source to supply the load being drawn. Construction difficulties, however, permit us only to approach rather than realize ideal transformers in practice. That is to say, the coupling in any physical transformer is never perfect, nor are either of the self impedances infinite. The physical transformer, however, can, for all practical purposes, be considered as made up of an ideal transformer with series resistance and inductance added to take care of the dead resistance of the windings and the so-called leakage reactance. The dead resistance of the windings can usually be neglected for all except the lowest frequencies. While losses are always present in any physical transformer, proper design generally makes them negligible at all except the extremes of the transmitted frequency band. It is well known that the input impedance of a vacuum tube introduces a highly capacitative load. Fig. 2 shows the capacity and resistance network of a vacuum tube. It has been shown by J. M. Miller, *Bulletin United States Bureau of Standards*, No. 351, November, 1919, and others, that the input capacity of a vacuum tube is:

$$C = C.G.F. + \left\{ \frac{\mu R_2}{R_0 + R_2} + 1 \right\} C.P.F.$$

Since input transformers operate into the highly reactive input impedance of a vacuum tube, it is evident that the impedance reflected into the primary can match the tube impedance in magnitude at only one frequency. This is of little importance since it is only necessary to deliver a constant voltage rather than constant power to the tube input to produce a flat amplifier characteristic. It is therefore unnecessary to match impedances at all transmitted frequencies to limit distortion. See W. L. Casper, *Journal A. I. E. E.*, March, 1924.

The capacities of the transformer windings under conditions met in practice become of considerable importance at the upper extreme of the transmitted frequency band, just as the resistance of the windings in many cases plays an important rôle at the lower extreme. Fig. 3 shows diagrammatically some of these capacities. For simplicity these capacities have been shown lumped at certain points, although in reality they are distributed capacities in every case. In this diagram C_1 is the interwinding capacity, C_2 and C_3 the distributed capacities of the primary and secondary respectively, C_4 the capacity of the inner winding to core, and L_x the leakage reactance. It is obvious that the leakage reactance can be kept small by winding the secondary next to the core with the primary over the secondary. In general, each of the above capacities are of the order of 20 to 60 micro-microfarads, depending, of course, on the construction of the transformer. The tube input impedance is represented by C_5 and R_5 . These values are, of course, dependent on the load in the plate circuit of the tube.

ACTION OF THE TRANSFORMER IN CIRCUIT

LET us consider the action of the transformer when it is used to couple two amplifier tubes. This is illustrated schematically in Fig. 4. It is customary to represent the gain or voltage amplification of input transformers as such, rather than to rate them in terms of a perfect transformer. In this diagram, μ_{eg} represents the voltage generated in the plate circuit of the first tube, R_0 its plate impedance, and E the voltage applied to the grid of the second amplifier tube. Now it is well known that maximum power is absorbed by a given load when the impedance of the load is equal to that of the generator, and further, for a complex impedance load, the magnitude of both com-

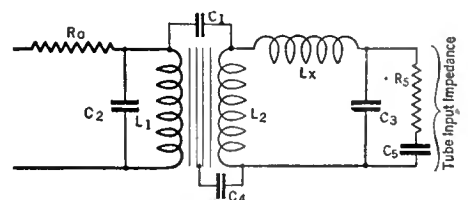

FIG. 3

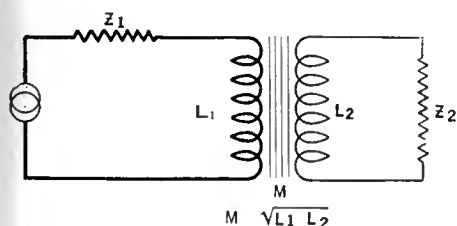

FIG. 1

ponents of the load impedance should be equal to the generator impedance, and the imaginary components of the two should be in phase opposition for maximum power transfer. As previously stated, the impedance reflected into the primary circuit can match the output impedance of the tube at only one frequency. It is obvious that if the transformer were ideal and of the proper ratio to match impedances, a flat transmission characteristic would not be obtained due to the losses on either side of the frequencies at which the impedances were matched. It has been found that it is practical to use a much lower ratio transformer than one having the ratio for optimum power transfer. It is quite common practice, too, to design transformers in which the secondary resonates with its own distributed capacity plus that of the load at frequencies less than 500 cycles. This has a tendency, of course, to increase the efficiency at these lower frequencies and in most cases it serves to further flatten the characteristic. The expression, secondary resonance, is not rigorously correct but amounts to resonance of the secondary self impedance plus the impedance reflected into the secondary by virtue of the mutual impedance of this transformer. See Pierce, *Electric Oscillations and Electric Waves*, also Casper, *Journal A. I. E. E.*, March, 1924. The ratio of the transformer is, however, de-

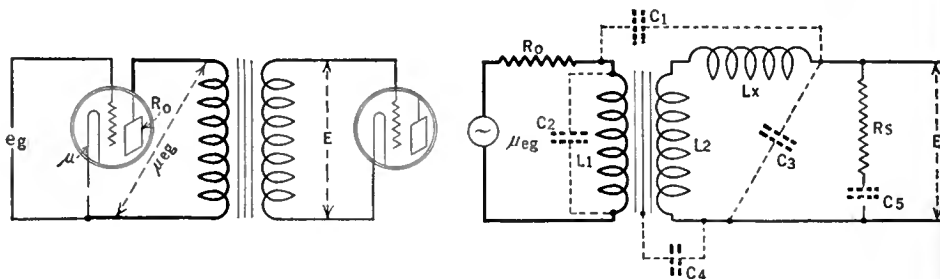

FIG. 4

relatively more of the voltage drop will be across the tube output impedance and winding resistance (which for practical purposes can be lumped since both represent a dead loss) and less across the primary winding. It is for this reason that it is necessary that the primary self impedance be high in value. The sudden drop at the higher frequencies is due to the effect of the leakage reactance and shunt capacities which together act to suppress high frequency notes. The frequency at which the peak occurs can be readily changed by properly poling the secondary winding so as to utilize the secondary distributed capacity. This is illustrated in Fig. 6. Curve A is for the transformer connected so that only the secondary distributed capacity and the tube

course, not illustrative of the action of the transformer when it is terminated in an amplifier.

This is entirely due to the change in transformer terminations. The essential difference in the two cases is a matter of the load impedance supplied to the tube. In the case of the detector, the load impedance in the plate circuit of the tube is practically zero. Reference to the equation for input capacity will show that for the case of the detector the input capacity is relatively small while for the case of the amplifier the input capacity is relatively large, which means in the latter case we have a lower impedance. As a matter of fact, in the case of the amplifier, the input impedance consists of a resistance as well as a capacity. From this it is obvious that the transformer characteristic as taken by the detector will be changed in two respects when the transformer is terminated in the amplifier. First, the resonant peak will be at a lower frequency due to the larger capacity, and second, it will not be as sharp due to the resistance effectively added by the amplifier. This is illustrated in Fig. 7. Curve 1 is that of a characteristic measured with a detector. Curve 2 shows the characteristic of the same transformer terminated in an amplifier.

Two stages of transformer-coupled amplification might or might not give a desirable characteristic. If the tubes and the transformers are identical, it is at once apparent that the peak will be relatively very much higher for two stages than for one. This will in general result in an undesirable characteristic and may even cause singing at a frequency corresponding to the tip of the resonance peak. The most obvious way to avoid this is to stagger the transformer characteristics. This is easily accomplished by reversing one of the transformer primaries or secondaries. It is at once apparent that there are a number of combinations, each giving a different characteristic, not all of which are desirable however.

Fortunately, it so happens that the leakage

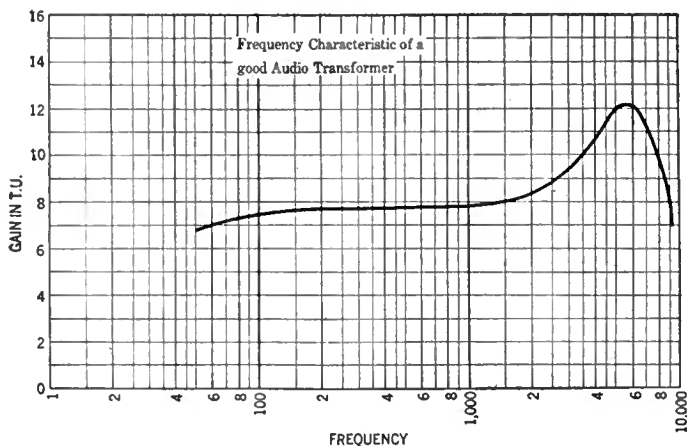

FIG. 5

terminated to a certain extent by the ratio of the input and output impedances of the amplifier tubes. For this reason it is customary to use lower ratio transformers between detector and amplifier than between two amplifiers, since the output impedance of a tube functioning as a detector is in general greater than when it functions as an amplifier.

The characteristic of a good audio transformer is shown in Fig. 5. The peak at the upper end of the frequency spectrum is due to resonance between the transformer leakage reactance and the tube input capacity combined with the secondary distributed capacity. The falling characteristic at the lower end of the frequency spectrum is largely influenced by the resistance and inductance of the primary winding. This would be expected because the primary self impedance increases with frequency while the winding resistance is practically a constant value. It is obvious then, that at low frequencies, the effect of the primary resistance will become more and more apparent in that it absorbs relatively much more power than at the higher frequencies.

Moreover, the primary self impedance being of the same order of magnitude as the output impedance of the tube at the lower frequencies,

amplification of about 2.5 to 1. It might be mentioned in this connection that it is difficult with ordinary core materials to obtain a good transmission characteristic with a transformer having a voltage step-up of more than 3 to 1.

DETERMINING THESE CHARACTERISTICS

THE method used in obtaining these characteristics is that in general use for this purpose. It consists essentially in the application of a constant amplitude voltage to the primary through a series impedance equal to the output impedance of the tube. The secondary is terminated in a calibrated C-battery detector. A biased d.c. micro-ammeter in the plate circuit of the tube serves to indicate changes in rectified current. Curves obtained by this method are, of

the secondary distributed capacity and the tube capacity are effective. Curve B represents the condition in which the secondary is poled so that the interwinding capacity or the capacity of winding to core or both are effectively added to the tube and secondary distributed capacities. It is at once obvious that the transformer characteristic can be materially altered by the simple expedient of grounding the core or reversing the secondary. The curves of Fig. 6 are almost identical with some characteristics of good commercial transformers recently measured, having a voltage

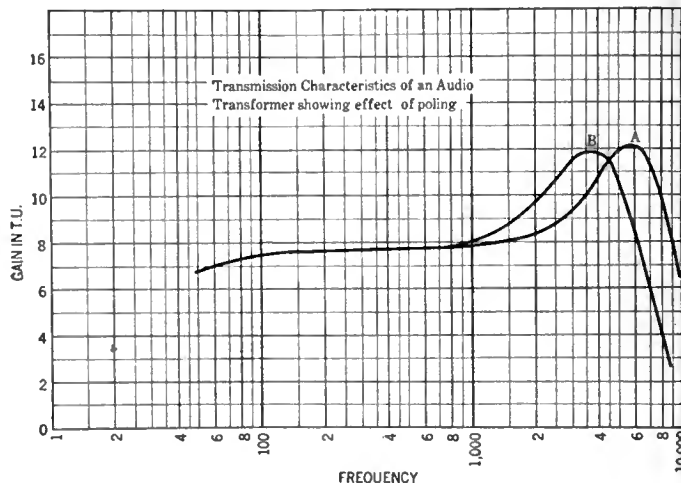

FIG. 6

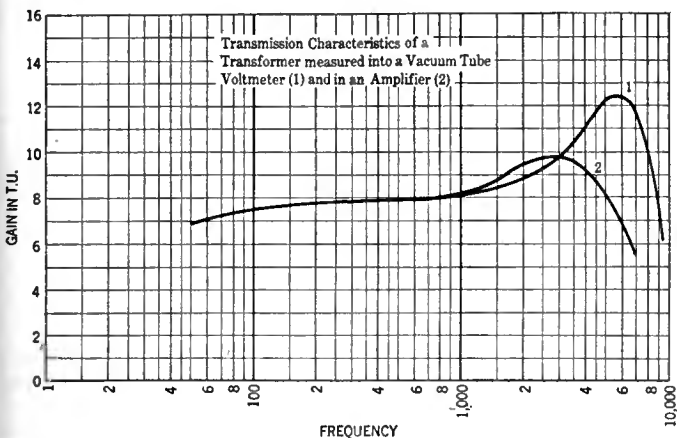

FIG. 7

reactance of the transformer can be turned to a practical use. For example, tube noises and other undesirable noises and crackles, with which all radio fans are familiar, can be very effectively eliminated without undue distortion to the transmitted signal frequency band by arranging for the leakage reactance to resonate at a frequency of about 5 kilocycles. That is to say that the amplifier characteristic will fall much more rapidly and drop much more sharply with the two stages than with either one alone. This is clearly illustrated in Fig. 8, in which Curve A is a characteristic of a two-stage amplifier arranged to obtain a flat gain characteristic. Curve B depicts the squared characteristic of one stage, while Curve C represents the squared characteristic of the other stage.

TWO TYPES OF AMPLIFIER CHARACTERISTICS

THERE are in general two types of amplifier characteristics of interest. The first is a gain-frequency characteristic, some examples

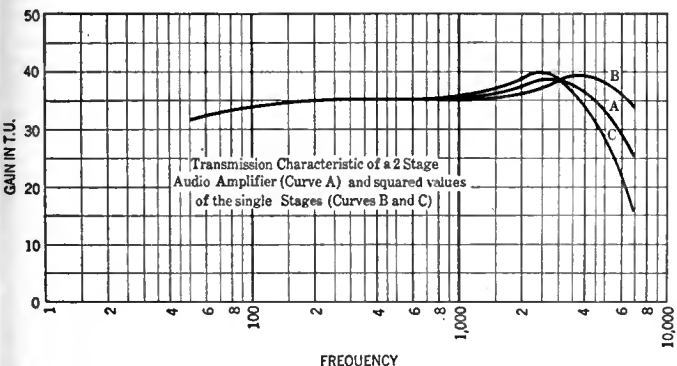

FIG. 8

of which are shown in Fig. 9 and the second is the load characteristic of Fig. 10.

Fig. 9 also illustrates what results may be expected from the simple expedient of altering transformer connections. Here the second transformer connections were left unchanged while the connections of the first transformer were varied. Curve 1 we will call normal. Curve 2 indicates the change caused by reversing the primary of the first transformer. Curve 3 shows the results of reversing both the primary and secondary of the first transformer. Curve 4 indicates the change caused by grounding the transformer cores.

The load characteristic of an amplifier, while not in such common use, is equally as important as the frequency characteristic. Overloading

as a grid rectifier if insufficient C battery is used, or as a plate rectifier if too much C battery is employed. (Plate circuit rectification may also occur when insufficient C battery is used, the criterion usually being the impedance of the transformer secondary.) As is often the case, the volume desired is beyond the capabilities of the last audio tube. Overloading is of course accompanied by amplitude distortion. Overloading can easily be detected by observing the plate current of the amplifier

creasing the plate voltage. Overloading tends to cut down the gain of an amplifier because of the presence of the generated harmonics. The energy which is used to supply the overtones might just as well be used to supply the fundamental. It is true that more volume may be obtained in some cases when the amplifier is overloaded, but the desired fundamental is usually materially decreased.

Considerable information is obtained from the

of tubes is the cause of serious distortion in the audio-amplifier and must be avoided if good quality is to be insured. Everyone is familiar with the grid voltage-plate current characteristics of a vacuum tube. These tube characteristics show that distortion is introduced when insufficient or too much C potential is used for a given plate potential. It is also evident that too much or too little plate potential for a given C battery introduces distortion. In general the tube func-

load characteristic of an amplifier. It expresses the relation between transmission gain and output power. It clearly indicates the overload point of an amplifier and also the maximum output level possible without serious overloading. A common definition of transmission gain follows:

The transmission gain caused by the insertion of an amplifier in any circuit is measured directly by the ratio of the power delivered to the load when the amplifier is in the circuit and when it is removed. Having decided upon a definition of transmission gain, measurements may be made to conform with this definition, which is similar to that commonly employed in telephone practice. An input voltage is applied to the amplifier input through a resistance corresponding to the output impedance of a detector tube, and the output of the amplifier is terminated in a resistance which matches the a.c. output impedance of the last tube. This is the condition

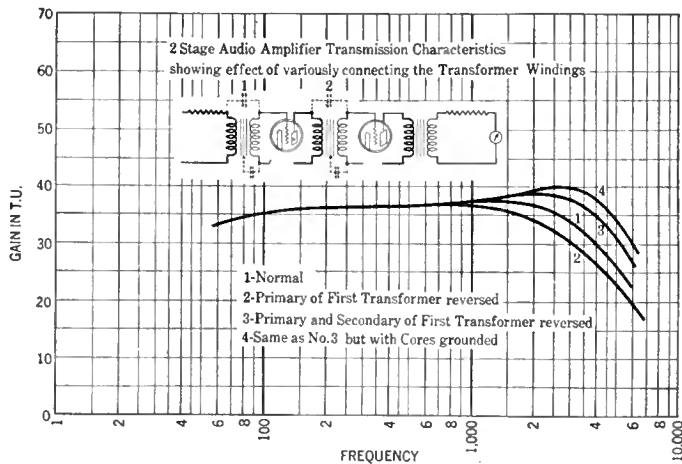

FIG. 9

tubes. Any change in the plate current of an amplifier tube indicates that overloading and distortion are taking place. Grid rectification predominates when the plate current decreases. This can easily be remedied by increasing the C potential employed or by decreasing the plate potential. If the plate current increases, plate rectification is taking place. This may be remedied by decreasing the C potential or in-

under which maximum power is delivered to the load. Gain is measured in terms of the ratio of the power delivered by the amplifier to the power which would be delivered without the amplifier. When gain characteristics of the amplifier are measured, the input frequency is varied and the input voltage maintained constant. The load characteristic was measured by maintaining a constant frequency and varying the amplitude of the input voltage.

COMPARING RESISTANCE-, IMPEDANCE-, AND TRANSFORMER-COUPLING

PRIOR to the development of high quality audio-frequency transformers, resistance- and impedance-coupled audio-frequency amplifiers led the field in quality. The advent of high quality input transformers and better

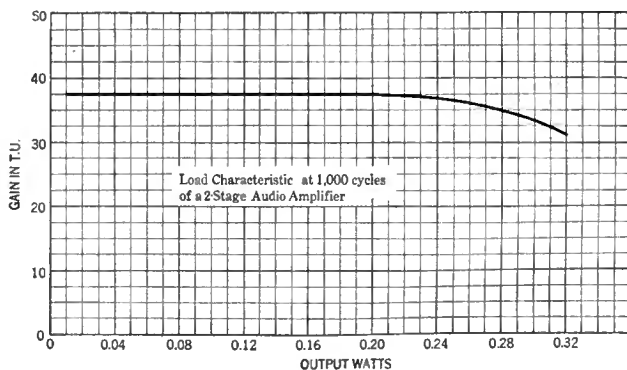

FIG. 10

acoustic translating devices, however, have all but made such devices obsolete. They represent one of the first steps toward better quality, and during the early stages of the art served their purpose. The limitations of both these types have been admirably pointed out by Mr. J. L. Schermerhorn, as follows: "An impedance- or resistance-coupled amplifier cannot be perfect. If the fixed condensers are not sufficiently large, the bass notes are missing. If they are large enough to pass the bass notes, they tend to introduce a time lag in the circuit. These conditions fix a definite limit for preventing the absolutely uniform amplification of all the audio frequencies." The time lag mentioned by Mr. Schermerhorn refers, of course, to the time constant of the condenser-resistance combination on the tube input. The minimum value of the series coupling-condenser is obviously fixed by its reactance to low notes. Now the time constant of the resistance-condenser combination must necessarily be low in order to prevent disagreeable hangovers which may either seriously alter the phase relations of independent notes or even cause some of the higher notes to disappear entirely, or be seriously masked by some of the higher amplitude low frequency notes. Inspection of the discharge curve of a condenser through a resistance would lead us to suspect this state of affairs. The product of the shunt resistance into the series capacity yields the length of time necessary for the condenser to lose about 63 per cent. of its charge. To prevent hangovers, it is necessary that the condenser discharge in less than a quarter cycle of that frequency which is the reciprocal of the time constant of the coupling combination. This of course imposes such a severe requirement on the amplifier that it would result in an overall transmission loss thereby defeating the purpose of the device. Hence it is necessary to affect a compromise between gain and distortion, and design the amplifier accordingly. The table in the next column shows a few values of time constant and their corresponding frequencies:

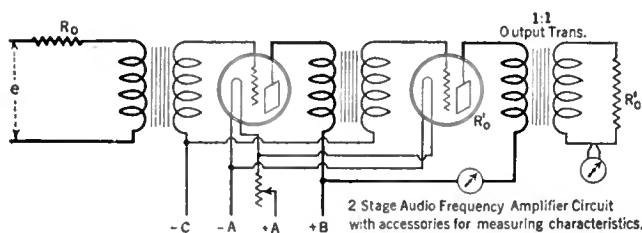

FIG. 11

C	At 50 cycles	R	RC	F	f.
mfd.	Xc ohms	ohms	sec.	c.p.s.	c.p.s.
1.0	3,180	10 ⁸	.1	10	2.5
		10 ⁴	.01	100	25.0
0.1	31,800	10 ⁸	.1	10	2.5
		10 ⁴	.01	100	25.0
0.01	318,000	10 ⁸	.001	1,000	250.0
		10 ⁴	.001	100	25.0
0.001	3,180,000	10 ⁸	.0001	10,000	2,500.0
		10 ⁴	.0001	1,000	250.0
		10 ⁴	.00001	100,000	25,000.0

In the above table, RC is the time constant of the resistance-condenser combination, in seconds, F the frequency having a period equal to the time constant, and $\frac{1}{4}f$, the highest frequency that will be unaffected by hangovers. It will be observed that an exceedingly low resistance must be used across the tube input if a reasonable time constant is to be maintained with a coupling condenser large enough to pass

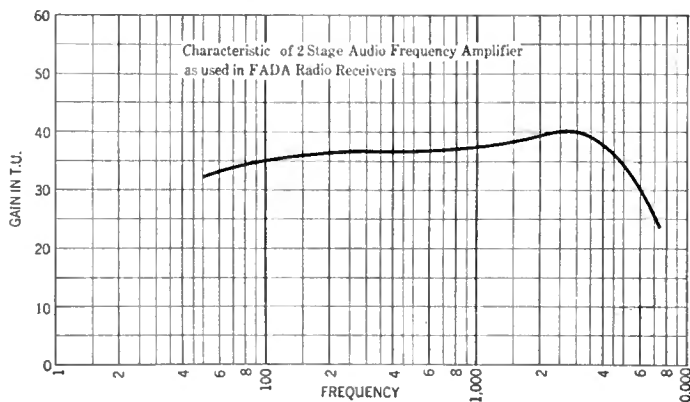

FIG. 12

the low notes without undue attenuation. There are, of course, a number of other factors that enter, such as change in the gain frequency characteristic with the applied input voltage, etc. These facts are such general knowledge, however, that they merit no further discussion here. Two-stage transformer-coupled amplifiers, on the other hand, can easily be designed to give an overall amplification varying less than 40 per cent. from the average value for all frequencies

between 50 and 5000 cycles.

To summarize: A perfect transformer has been defined as one which has perfect coupling and which neither stores nor dissipates energy. It has also been shown that it is desirable that a good input transformer depart from this definition since it is required that the input transformer deliver constant voltage rather than constant power. Furthermore, it is obvious that the leakage reactance can in some cases be used to advantage in eliminating high frequency noises by connecting the transformers in such sense that the inherent capacities resonate the leakage reactance at the proper frequency. A transformer characteristic as commonly measured by a C-battery detector does not give the true picture of its action in an amplifier, due mainly to the different input impedance of the amplifier tube. The general tendency of the amplifier tube is, of course, to decrease and broaden the resonance peak and to cause it

to occur at a lower frequency. Transmission gain has been defined as the ratio of the power delivered to the load with the amplifier in the circuit to the power delivered with the amplifier removed. A method of measuring amplification conforming with this definition gives a truer picture of amplifier operation than the voltage amplification as ordinarily measured. There are, in general, two types of characteristics necessary to completely define amplifier operation. The first is the gain-frequency characteristic and the second the load characteristic. The former indicates the frequency distortion while the latter shows the load carrying capacity.

This paper by Mr. Saunders is the third of a new series, printed through the courtesy of the Radio Club of America. RADIO BROADCAST is the official publication of that organization and all papers delivered before the Club appear in this magazine. We, of course, do not assume responsibility for controversial statements made by authors of these papers. Readers of RADIO BROADCAST, we are sure, welcome the opportunity to read the papers presented by the Radio Club and we are very glad to have the opportunity to publish them regularly. Other Radio Club papers will appear in subsequent numbers of the magazine.



5 tube SINGLE DRUM

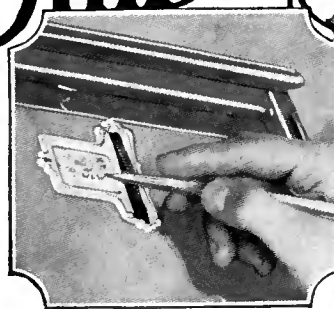

STATION
SELECTOR

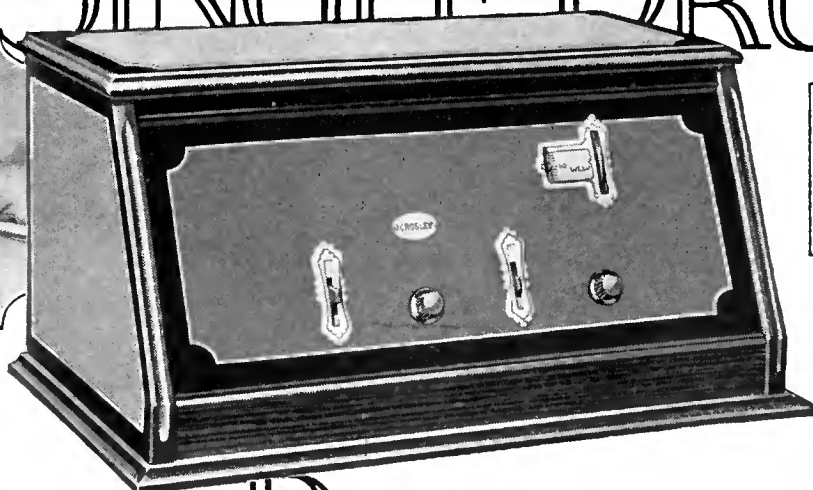

RADIO RECEIVER

6 Other Crosley Radio Achievements

The Crosley 1-tube "Pup"—\$9.75—a double-circuit set, with which laymen have heard radio signals probably the greatest distances.

The 4-tube 4-29—\$29—a 4-tube receiver of amazing efficiency. Already proven its right to a permanent position in the Crosley line. CRESCENDON equipped!

The 5-tube 5-38—\$38. The 5-tube tuned radio frequency set incorporating the CRESCENDON—a spectacularly popular model.

The 5-tube RFL 75—\$65—true cascade amplification; non-oscillating—non-radiating, regardless of how it may be mishandled.

The 5-tube 5-75—\$75—embodying the 5-tube single control, with drum station selector, as offered in a table model at \$50. SOLID MAHOGANY cabinet. Musicone built-in—41 inches high.

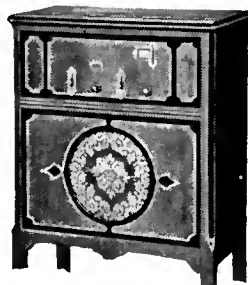

The 5-tube RFL 90—\$90—introducing the double drum station selector! Solid mahogany cabinet. Musicone built-in—ample room for batteries and all accessories, 41 inches high, 30 1-2 inches wide.

Prices slightly higher West of the Rockies.

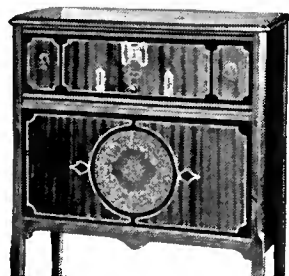

\$50.

Contrast the surpassing performance of this new type of Crosley Radio with what has hitherto been considered radio perfection.

The cabinet is solid mahogany, beautifully finished in two-tone and striped in gold. Metal fittings are rose gold finish.

The metal shielded chassis is divided into three compartments. The units shielded from each other, prevent interstage as well as external coupling. This improves stability of circuit and increases selectivity. This has never before been offered in sets of moderate price.

Crescendon Control affords unusual volume from distant stations.

Heretofore single dial control sacrificed selectivity. By means of the Acuminators, very sharp tuning is accomplished where the reception from local stations spreads broadly over the dial. Under average conditions, when once adjusted, these acuminators do not have to be touched again.

The CROSLLEY MUSICONES

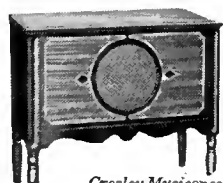

The announcement of the new Super-Musicone is predicated on the success of the Regular (12 inch cone) Crosley Musicone in replacing hundreds of thousands of old type loud speakers. **Musicone Regular 12 inch cone \$12.50. Super-Musicone 16 inch cone \$14.75. Musicone sole with built in Musicone \$32.00.**

Crosley Musicones are manufactured under basic patents issued and pending, controlled by Crosley.



With the Graphic Station Selector, Stations from one end of the wave band to the other, are easily brought in at all times—**IN THE SAME PLACE**



BETTER
...
COSTS
LESS

CROSLLEY · RADIO

Write Dept. 20

CROSLLEY RADIO CORPORATION, CINCINNATI, O.

Digitized by Microsoft®

★ Tested and approved by RADIO BROADCAST ★

BURGESS RADIO BATTERIES Win Again



The illustration pictures the take-off of the winning flight and in the insert is the radio equipment carried. (Burgess 'A', 'B' and 'C' Batteries furnished the electrical energy to operate the set.)

When the Goodyear III won the right to represent the United States at Belgium, Burgess Radio Batteries supplied the electrical energy for the operation of the balloon's radio equipment.

Almost every day from somewhere in the world news comes to us of new Burgess adventures.

And that Burgess Batteries have contributed their bit in so many interesting events of sport, commerce and science reflects the esteem in which they are held.

"Ask Any Radio Engineer"

Your own radio dealer down the street sells Burgess Batteries. He probably sells the famous Burgess Flashlights, too.

BURGESS BATTERY COMPANY
GENERAL SALES OFFICE: CHICAGO

Canadian Factories and Offices:
Niagara Falls and Winnipeg

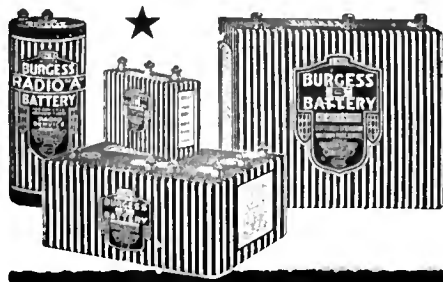

The Radio Broadcast LABORATORY INFORMATION SHEETS

INQUIRIES sent to the Questions and Answers department of RADIO BROADCAST have until recently been answered either by letter or in "The Grid." The latter department has now been discontinued, and all questions addressed to our technical service department are now answered by mail. In place of "The Grid," we present herewith a series of Laboratory Information Sheets. These sheets contain much the same type of information as has appeared in "The Grid," but we believe that the change in the method of presentation and the wider scope of the information in the sheets, will make this section of RADIO BROADCAST of much greater interest to our readers.

The Laboratory Information Sheets cover a wide range of information of value to the experimenter, and they are so arranged that they may be cut from the magazine and preserved for constant reference. We suggest that the series of Sheets appearing in each issue be cut out with a razor blade and pasted on filing cards, or in a note book. The cards should be arranged in numerical order. Several times during the year, an index to all sheets previously printed will appear in this department.

Those who wish to avail themselves of the service formerly supplied by "The Grid," are requested to send their questions to the Technical Information Service of the Laboratory, using the coupon which appears on page 440 of this issue. The June, July, and August issues of RADIO BROADCAST, in which appeared the first few sets of Laboratory Sheets, may still be obtained from the Subscription Department of Doubleday, Page & Company.

No. 25

RADIO BROADCAST Laboratory Information Sheet September, 1926

Modulation

THE HEISING METHOD

THE process of impressing audio frequency current on the radio frequency output of a transmitter is called "modulation."

The simplest case of modulation occurs when a pure note of single frequency, such as is produced by a tuning fork, is transmitted. If the tuning fork is struck and is placed near the microphone, the sound produced by the fork will be transmitted by the microphone to the radio transmitter. These audio-frequency currents will cause the radio-frequency wave to vary in amplitude and also in frequency. If the radio wave without any modulation had a frequency of 500,000 cycles, and a 1000-cycle note was produced by the tuning fork, the radio-frequency wave would change in frequency and would be composed of three frequencies; one equal to the original frequency of 500,000 cycles, another equal to 499,000 cycles, and another equal to 501,000 cycles.

These latter two frequencies are equal, respectively, (1.) to the difference between the original, or carrier frequency, and the audio frequency, and (2.) the sum of the carrier and audio frequency. In actual transmission, we are not dealing with a single 1000-cycle note but are dealing with the entire band of frequencies between approximately 50 and 5000 cycles, so that all of these various frequencies are impressed on the carrier wave during modulation.

The most common method of modulation used by broadcasting stations is the Heising method,

and it is shown in its elementary form in the diagram on laboratory Sheet No. 26. Here tube No. 1 is the oscillator, and No. 2 the modulator. Choke coil L is sometimes called the Heising choke. The oscillatory circuit is the familiar Hartley type using an inductively coupled antenna coil.

The voice signals are impressed on the grid of the modulator tube as is shown in the diagram. Actually, between the microphone and the modulator tube, it would be necessary to use several stages of additional amplification. These audio signals impressed on the modulator cause its plate current to vary and produce a corresponding plate-current variation in the oscillator tube.

The total current supplied to the circuit by the battery supply, marked B on the diagram, does not vary appreciably as the modulation is impressed on the grid of the modulator tube No. 2, due to the fact that the choke coil has a very high inductance and, therefore, offers considerable impedance to any variation in the current flowing through it. This Heising choke coil is an essential part of a radio transmitter using this type of modulation.

If a radio wave is completely modulated, the power transmitted will be about one and a half times as much as an unmodulated wave having the same average current. However, in ordinary broadcasting, it is not advisable to completely modulate the carrier and, therefore, it can be said that the power transmitted when the wave is being modulated is about the same as the power transmitted when the wave is not being modulated.

No. 26

RADIO BROADCAST Laboratory Information Sheet September, 1926

The Three-Electrode Tube

ITS VARIOUS FUNCTIONS

THE three-electrode tube can be used in a great many ways, but its use in connection with radio transmission and reception is confined almost exclusively to the following:

1. **MODULATION:** Vacuum tubes are used in this connection in all the large radio broadcasting stations throughout the world. Modulation can be defined as the process of varying the amplitude of the transmitted radio waves in accordance with the variations of air pressure that constitute the voice or music. The actual process of modulating the power of a high-power station, in general, requires considerable essential auxiliary apparatus. However, modulation can be accomplished using a single circuit such as that shown in the accompanying diagram, where tube No. 2 is the modulator. A careful analysis of modulation appears on Sheet No. 25.
2. **DETECTION (also called RECTIFICATION and DEMODULATION):** This is the process of converting modulated radio-frequency alternating currents into direct currents varying in strength in accordance with the original voice or music.
3. **REGENERATION:** The process of neutralizing some of the unavoidable resistance in the receiving circuits, resulting in greater currents being produced by the incoming waves.
4. **AMPLIFICATION:** Increasing the energy of either radio- or audio- (voice and music) frequency currents, without changing their form. The tube

itself is an amplifier, the ordinary type giving an output voltage about seven times greater than the input voltage. The tube may function in conjunction with a transformer, in which case an even greater overall amplification is obtained.

5. **OSCILLATION:** The production of high-frequency alternating currents. At the transmitting

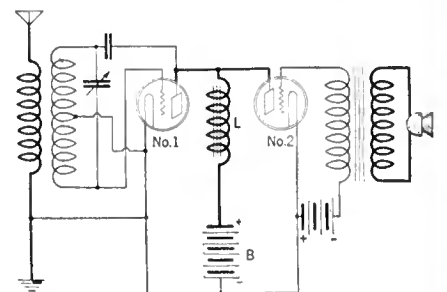

stations it is high frequency current flowing in the antenna that radiates energy in the form of electromagnetic waves (in this case, radio waves). Tube No. 1 is an oscillator in the diagram shown.

*Not "How Far?"
Not "How Many Stations?"
But "HOW REALISTIC?"
is now the pertinent question of radio*

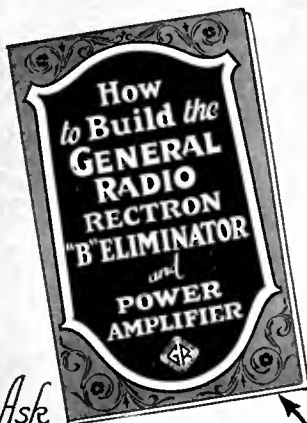

Ask your dealer or write for this folder

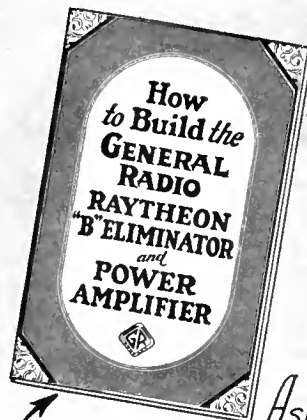
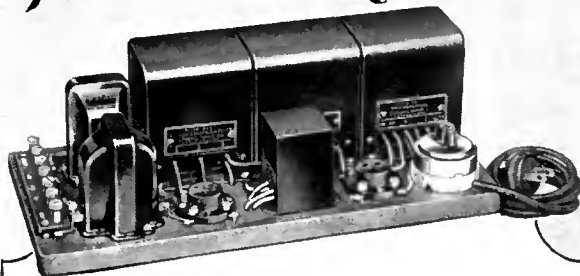

Ask your dealer or write for this folder

THE spell of magic in radio is over. No longer are we mystified by programs from far off cities. No longer do we spend whole evenings in dial fishing for all the stations we can get—just for the sake of boasting a long list of call letters.

Today we are in a new era of radio—one of quality reproduction. Broadcast listeners everywhere are demanding above all else reception that is natural.

If your radio customers have not yet modernized their receiving sets, by the improved type of loudspeaker, better transformers, "B" voltage supply units and power amplifiers, they cannot appreciate what clear, sweet-toned music athrob with human expression is in store for them.

This is going to be a big year for **TONE QUALITY**. Be prepared to sell your customers devices that improve **TONE QUALITY**. Show them the new General Radio "B" eliminator and Power Amplifier kits, that can easily be assembled in a single evening. Tell them about the new type 285D transformer, and type 387 Speaker Filter.

Ask your distributor or write us for full information on these new General Radio products.

GENERAL RADIO CO. Cambridge, Mass.



The Type 285-D Audio Transformer has a high impedance to match the output of the new 200-A detector tube. When used in the first stage of audio amplification following the 200-A the 285-D produces a very marked improvement in tone quality.
Price \$6.00



The Type 387 Speaker Filter adapts the impedance of the amplifier to the Western Electric and other cone speakers of similar design and quality so that unusual purity of tone is produced. It has a very wide frequency range.
Price \$6.00

GENERAL RADIO

Behind the Panels of Better Built Sets

American Transformer Company

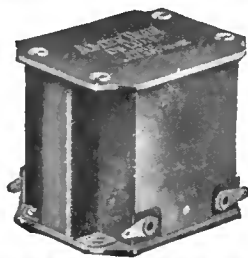

The AmerTran De Luxe

Approaching the Ideal

THE AmerTran De Luxe now makes possible a transformer coupled amplifier which excels all other form of amplifiers.

When used in connection with the better loudspeakers of the cone type and the new tubes permitting the use of higher plate voltages in the last stage to prevent overloading, this new transformer provides faithful reproduction over the entire audible range. It so closely approaches perfection that further developments cannot be noticeable to the human ear.

The AmerTran De Luxe is the result of twenty-five years' experience in transformer building, and beyond all question sets an entirely new standard of audio amplification.

For economical, simple power operation of the set the American Transformer Company is now offering two units of the finest type—especially adapted to the use of the new 7½ volt power tubes in the last audio stage. These are the AmerTran Power Transformer and the Amer Choke, both ideally constructed for the type of audio amplifier required. The Power Transformer also has filament supply windings for the power tube, and supplies sufficient plate current, after rectification, for the operation of the set.

- AmerTran De Luxe, 1st Stage . \$10.00
- AmerTran De Luxe, 2nd Stage . 10.00
- AmerTran AF-7 (1-1) 5.00
- AmerTran AF-6 (5-1) 5.00
- AmerTran Power Trans. PF-52 . 18.00
- AmerChoke Type 854 6.00
- AmerTran Resistor Type 400 . . 7.50
- AmerTran Heater Transformer Type H-28 (for A. C. Tubes) . 10.00

Write to-day for interesting free booklet "Improving the Audio Amplifier" and other data on the subject of better radio.

AMERICAN TRANSFORMER CO.
178 Emmet Street Newark, N. J.
AmerTran Products Are Sold Only at Authorized AmerTran Dealers

Transformer Builders for Over Twenty-Five Years

No. 27

RADIO BROADCAST Laboratory Information Sheet September, 1926

A Voltmeter Made From a Milliammeter

CALCULATING THE NECESSARY RESISTANCE

IN THE course of their experiments, most home constructors acquire one or more d. c. milliammeters for use in measuring the plate current of tubes. These instruments are comparatively cheap and are essential in making general tests on radio parts.

Another very useful instrument is the d. c. voltmeter for use in measuring the voltage of all kinds of batteries and line supply devices. It is possible to make up a very useful and fairly accurate voltmeter using a milliammeter and a good fixed resistance, and thereby make unnecessary the purchase of a voltmeter. Actually, a voltmeter consists of a sensitive milliammeter in series with a high resistance. In calibrating, such a meter, in series with the resistance, is placed across known voltages, and its scale marked off in volts instead of milliamperes.

Suppose we have a meter with a full-scale reading of 2 milliamperes (.002 amperes), and we want to use it as a voltmeter for use on line supply devices which supply voltages up to 200. To determine the required resistance necessary in series with the meter, we divide 200 by .002, and the quotient, 100,000, is the required resistance in ohms. If we place the milliammeter in series with the 100,000-ohm resistance across an unknown voltage, as shown in the diagram, the needle will deflect an amount proportional to the voltage. We have

made our voltmeter so that if the meter reads 2 milliamperes the voltage is 200. Now, if the meter reads 1½ milliamperes, the voltage is 150; if it reads 1 milliamperer, the voltage is 100, etc.

It is not always possible to obtain accurate resistance units so that it is, in general, wise to calibrate the voltmeter so as to allow for errors in the fixed resistance. On Sheet No. 28 is given information regarding the calibration of a home-made

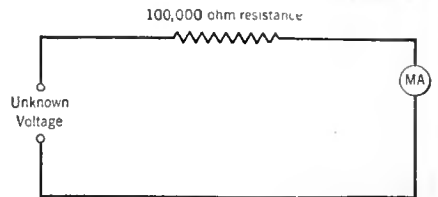

voltmeter, and if the calibration is done carefully, it should be possible to obtain readings which will be accurate within a few per cent. For rough measurements, no calibration is necessary since, if good fixed resistances capable of passing several milliamperes are purchased, their marked resistance value can be depended upon within about ten per cent., and usually the per centage error will be even less than this.

No. 28

RADIO BROADCAST Laboratory Information Sheet September, 1926

Calibrating a Home-Made Voltmeter

PLOTTING THE CURVE

ON LABORATORY Sheet No. 27 were given data regarding the construction of a simple voltmeter from a milliammeter. Information is given here for the calibration of such a meter.

First determine the required resistance in series with the milliammeter by the following formula:

$$R = \frac{E \times 1000}{I}$$

where E is the maximum voltage it is desired to read, I is the full scale reading of the meter in milliamperes, and R the unknown resistance.

Examples:

1. It is desired to read 500 volts using a 10-milliamperer meter.

$$\text{Then } R = \frac{500 \times 1000}{10} = 50,000 \text{ ohms.}$$

The calibration is performed by placing the fixed resistance and meter across different known voltages and plotting a curve showing the deflection of the meter for different values of voltage.

By making such a calibration, it will be possible to compensate for any inaccuracy in the fixed resistance. If no voltmeter is available whereby the applied voltages for calibrating purposes can be measured, it will be possible to use new B Batteries, since the marked voltages will then be quite dependable. First 22½ volts could be placed across the combination and the meter reading taken, then 45 volts, etc., until several points are obtained.

It will not be necessary to calibrate the full scale of the meter since the calibration will be a straight line. The abscissa, or horizontal axis, of the curve should be plotted in milliamperer deflections, and the ordinate, or vertical axis, should be plotted in the corresponding voltages. Such a curve is illustrated on this Sheet.

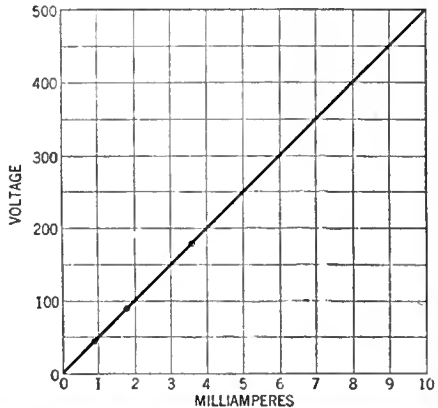

No. 29

RADIO BROADCAST Laboratory Information Sheet September, 1926

Tubes: Miscellaneous

UX-213

This is a full-wave rectifier for use with line supply devices. Its filament voltage is 5, and it takes a filament current of 2 amperes at this voltage. The maximum value of the a.c. input voltage is 220 volts (effective value), and the maximum rectified current the tube can deliver is 65 milliamperes.

UX-216-B

This tube is a half-wave rectifier for use in line supply circuits. Its filament voltage is 7.5, and current is 1.25 amperes. The maximum value of the a.c. input voltage is 550 volts (effective value). The maximum rectified current is 65 milliamperes.

UX-874

This tube is used as a voltage regulator and, when correctly connected in a circuit, it functions to maintain a constant voltage. The voltage drop is 90 volts d.c., and the starting voltage is 125 volts d.c. The maximum current is 50 milliamperes d.c. The positive lead is connected to the rod and the negative lead connects to the cylinder. This tube is used in the line supply device manufactured by the Radio Corporation of America and also in their Model 104 loud speaker.

UV-876

This is a ballast tube and when correctly connected in a circuit it functions to maintain constant current. It has a current rating of 1.7 amperes, and the voltage drop is 30 to 60 volts. This tube is designed for use on units using 105 to 125 volts supply at from 50 to 75 cycles.

UV-886

This tube is practically the same as the model UV-876 except that it is for use on from 40- to 45-cycle current. It has a current rating of 2.05 amperes, and the voltage drop is from 40 to 60 volts.

UV-877

This is a protective tube, and is used in the B battery circuits of receivers to prevent damage to tubes or wiring, if the B batteries are accidentally short-circuited. The voltage drop across half the filament is 2.5 volts at 20 milliamperes d.c., and rises to 45 volts at 90 milliamperes d.c. Across the entire filament, the voltage drop at 20 milliamperes is 5 volts. With 90 milliamperes flowing through it, the voltage drop is 90 volts. From these figures it is evident that, if the B batteries are accidentally short-circuited, practically all the voltage will be consumed by this tube, and the current definitely limited to a safe value.

Perhaps you, too, can cut your "B" battery costs in half. Just follow the chart. It gives you the secret of "B" battery economy.

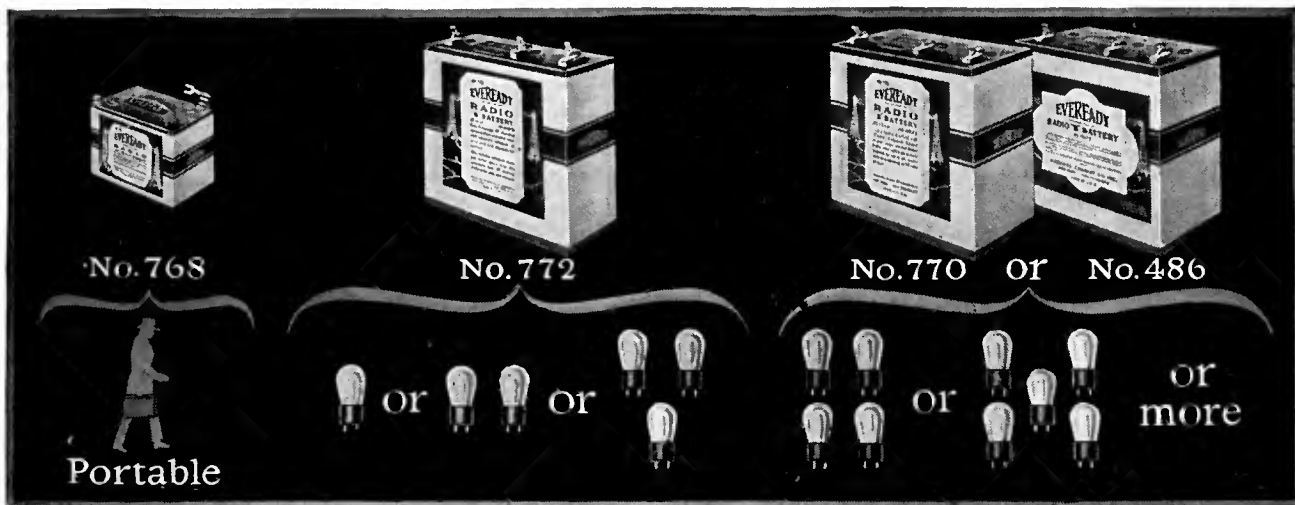

THOUSANDS of people have made the discovery that Eveready "B" Batteries, when used in the proper size, and on sets equipped with a "C" battery*, are a most economical, reliable and satisfactory source of radio current.

Here is the secret of "B" battery economy, reliability and satisfaction:

On all but single tube sets—Connect a "C" battery. The length of service given below is based on its use.*

On 1 to 3 tubes—Use Eveready No. 772. Listening in on the average of 2 hours daily, it will last a year or more.

On 4 or more tubes—

Use the Heavy-Duty "B" Batteries, either No. 770 or the even longer-lived Eveready Layerbilt No. 486. Used on the average of 2 hours daily, these will last 8 months or longer.

These figures are based on the average use of receivers, which a country-wide survey has shown to be two hours daily throughout the year. If you listen longer, of course, your batteries will have a somewhat shorter life, and if you listen less, they will last longer.

Evereadys give you their remarkable service to the full only when they are correctly matched in capacity to the demands made upon them by your receiver. It is wasteful

to buy batteries that are too small. Follow the chart.

In addition to the batteries illustrated, which fit practically all the receivers in use, we also make a number of other types for special purposes. There is an Eveready Radio Battery for every radio use. To learn more about the entire Eveready line, write for the booklet, "Choosing and Using the Right Radio Batteries," which we will be glad to send you on request. There is an Eveready dealer nearby.

Manufactured and guaranteed by
NATIONAL CARBON CO., Inc.
 New York San Francisco
 Canadian National Carbon Co., Limited
 Toronto, Ontario

Tuesday night means Eveready Hour
 —8 P. M., Eastern Standard Time,
 through the following stations:

EVEREADY ★
Radio Batteries
they last longer

- WEAP—New York
- WJAR—Providence
- WEEI—Boston
- WTAG—Worcester
- WFL—Philadelphia
- WGR—Buffalo
- WCAE—Pittsburgh
- WSAI—Cincinnati
- WTAM—Cleveland
- WWJ—Detroit
- WGN—Chicago
- WOC—Davenport
- WCCO—Minneapolis
- WCCO—St. Paul
- KSD—St. Louis

X-L

VARIO-DENSER

Used by
RADIO BROADCAST
 in the
Impedance Coupled
Browning-Drake
Hookup

"I was really surprised at the fine adjustment I was able to get."

GLENN H. BROWNING

also specified by
 GERALD M. BEST

Endorsed by
 LAURENCE COCKADAY

Tested and approved by
 G. M. WILCOX

Prof. of Physics, Armour Institute of
 Technology

SEE THAT
 SCREW

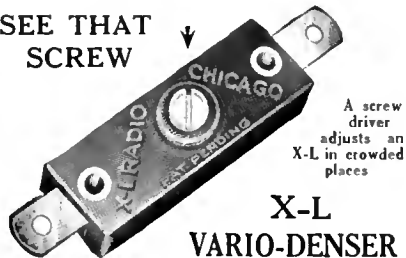

A screw
 driver
 adjusts an
 X-L in crowded
 places

X-L
 VARIO-DENSER

Results in easier tuning, more distance,
 volume and clarity—greater stability.

Model "N" A slight turn obtains correct tube oscillation on all tuned radio frequency circuits. Neutrodyne, Roberts two tube Browning-Drake, McMurdo Silver's Knockout, etc. capacity range 1 to 20 micro-micro farads. Price \$1.00

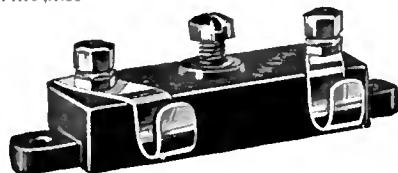

Model "C" with grid clips obtains the proper grid capacity on Cockaday circuits, filter and intermediate frequency tuning in heterodyne and positive grid bias in all sets. Capacity range:

Model G-1—.00002 to .0001 MFD

Model G-5—.0001 to .0005 MFD

Model G-10—.0001 to .001 MFD

Price \$1.50

X-L PUSH POST

Push it down with your thumb, insert wire, remove pressure and wire is firmly held. Releases instantly. Price 15c

Push Post Panel permanently marked in white on black insulating strip. In box including soldering lugs, raising bushings and screws for mounting, etc.

Price \$1.50



X-L Radio Laboratories 2424 Lincoln Ave.
 CHICAGO, ILL.

No. 30

RADIO BROADCAST Laboratory Information Sheet September, 1926

Measuring the Output Voltage of a Line Supply Device

REQUIREMENTS OF A SUITABLE METER

CONSIDERABLE care must be taken in measuring the output voltage of a line supply device if an accurate reading is to be obtained. The output voltage of such devices depends to a great extent upon the current being drawn from them, and if any considerable amount of current is also drawn by the voltmeter which is used in determining the output voltage, the reading will not be accurate and cannot be used.

Also, if true results are to be obtained, the output voltages must be measured when the instrument is connected to the receiver and a normal load is being drawn from it, since, if these conditions do not exist at the time of the test, the voltage read with the voltmeter will be considerably higher than would actually be applied to a receiver during operation. A reading taken without any load on the line supply device will sometimes be 100 volts higher than the reading taken with load.

The voltmeter used to measure the output voltage must have a very high resistance in order to prevent large currents from flowing through it. On Sheet No. 27 is given information regarding the construction of a home-made voltmeter which can be used.

It is also possible to purchase suitable units for use in measuring the output of B eliminators. In

any event, the voltage cannot be at all accurately read if one of the cheaper low-resistance type of meter is used.

A numerical example might make more evident the errors which will be introduced in the reading, if the incorrect type of voltmeter is used. As an example, suppose that we desire to measure the output voltage of a Raytheon B line supply device such as was described in the December, 1925, RADIO BROADCAST. If the receiver was drawing from the eliminator 20 milliamperes, the output voltage would be about 120 volts. However, if this output was measured with a low resistance meter, itself drawing about 20 milliamperes, the voltage read would be 75, an actual error of 38 per cent. However, if a high-resistance meter is used, such as is described on Laboratory Sheet No. 27, only about 2 milliamperes will be required by the voltmeter, and then the voltage read would be practically the same as the actual voltage, and a truer indication of the voltage being supplied to the set would be obtained.

The care which is necessary in measuring the output voltages of B line supply devices is not necessary in measuring B batteries, since a drain of 20 or 30 milliamperes will make very little change in the voltage of a B battery. Therefore, it becomes possible to read the voltages of these units with an ordinary voltmeter whether it have a low resistance or not.

No. 31

RADIO BROADCAST Laboratory Information Sheet September, 1926

Distortion in Receivers

SOURCES AND REMEDIES

THERE are several points in a receiver where distortion can occur. In the first place, if the radio-frequency amplifier or detector circuits are tuned too sharply, distortion will occur due to the fact that the side bands of the radio frequency waves which carry the voice or music will not be equally transmitted by the tuned circuit, and in this way unequal amplification is obtained.

If a grid leak and condenser system of detection is used, it is not at all impossible to overload the detector tube on strong local stations. If this occurs, the various frequencies will not be properly amplified by the detector tube and serious distortion will occur. For real quality on local stations, a C battery detector is advisable since it can handle comparatively larger amounts of signal strength without overloading.

Distortion can occur in the audio frequency amplifier. To prevent this, good transformers should be employed, if this form of coupling is used, and a C-battery bias should always be placed on the grids of all the audio amplifiers in order to prevent the tubes from overloading. If overloading does occur, the peaks of the voice waves will be cut off, and serious distortion results. Also, if the wiring of the audio amplifier is rather poorly done, it is not at all impossible that the audio amplifier

will begin to oscillate, sometimes at inaudible frequencies and sometimes at audible frequencies. If the oscillation is audible it can be fairly easily checked up and corrected, but if it is inaudible, it is sometimes quite a while before we realize just what the trouble is. The only practical method that can be used to detect these inaudible oscillations, is to place a milliammeter in the plate circuit of the tube of the suspected circuit. After putting this meter in the plate circuit, the input to the tube is short-circuited (if a transformer-coupled amplifier is used, a lead would be connected between the G post and the F post on the transformer) and no change should take place in the reading of the plate milliammeter. If a change in the reading does occur, it is a fairly good indication that the circuit is oscillating. Of course, during this test, no signals whatsoever should be received.

The final point at which distortion might occur is in the reproducing device. In order to obtain best reproduction from a cone speaker, it is necessary to use a semi-power tube in the output stage, with sufficient voltage to prevent overloading. It is also essential that the impedance of the loud speaker be fairly closely matched with the plate impedance of the output tube. If any discrepancy between the two impedances does exist, the tube should be preferably of a lower impedance than the speaker.

No. 32

RADIO BROADCAST Laboratory Information Sheet September, 1926

Matching Tube and Loud Speaker Impedances

THE USE OF AN OUTPUT TRANSFORMER

MANY recent articles dealing with quality amplification have stressed the point that an endeavor should be made to approximately match the impedance of the output tube with the impedance of the loud speaker. This fact is important from two standpoints; first, from the standpoint of quality and, secondly, from the standpoint of efficiency.

Regarding the first point, if a low-impedance cone speaker is used with a high-impedance tube, such as the 201-A, the low frequencies will be lost and undue prominence will be given to the high frequencies. In order to eliminate this drawback, and at the same time make it possible to obtain a considerably greater amount of undistorted power, the new type 112 and 171 tubes have been developed; both of these have quite a low plate impedance. The characteristics of these two tubes were printed on Laboratory Sheets Nos. 7 and 12 respectively. By the use of such tubes, the frequency distortion (produced when a high-impedance output tube is used) is practically eliminated.

When we use a low-impedance tube and thereby better the quality output of our receiver, we at the same time increase the efficiency with which the power developed by the tube is delivered to the loud speaker. Maximum power will be delivered

to the output when its impedance is equal to the tube impedance, so that, for best results, the loud speaker impedance at a medium frequency, say 1000 cycles, should match fairly well the output impedance of the tube.

A simple method whereby tubes and loud speakers of different impedances may be used together, is by the inclusion in the circuit of a suitable output transformer, several of which are now on the market. When this plan is resorted to, it is necessary for the impedance of the transformer primary to approximately match that of the tube. The secondary should have an impedance similar to that of the loud speaker. In this way, it becomes possible to use a low-impedance speaker with a high-impedance tube, although it is not particularly advisable since the high-impedance tubes are not capable of handling any great amount of power and will very likely overload, if they are used to supply a loud speaker.

If a semi-power tube is used in the output, it is not generally advisable to connect the loud speaker directly into the plate circuit of the tube since, if this is done, the d. c. plate current will pass through the loud speaker windings and will harm the magnets used in the loud-speaker unit. In order to eliminate the d. c. from the loud speaker windings, either an output transformer or a combination of a choke and condenser should be used.

DOUBLE the pleasure to be gotten from your receiving set with the

Cornell Voltage Supply

(B Battery Eliminator)

Vastly better and richer tone, greatly increased volume and distance, a constant and even flow of power, are some of its many advantages.

And it is an actual money saver also as compared with the use of batteries.



Where Reliability is Born

THE desirability of eliminating the B Battery with its constant "run-down" and other objectionable features, has long been appreciated but it has remained for Cornell engineers to solve the problems in the best, most simple and most truly scientific manner, in the new Cornell Voltage supply.

Price Type "B" complete in handsomely finished case (with Raytheon Tube and necessary cord and plug), ready for use with practically any receiving set, containing from 1 to 10 tubes, variable radio frequency voltage from 50 to 150 volts (audio amplifier voltage from 100 to 180 volts) and any speaker \$39.50.

Type CB is similar to type B but with the addition of variable C Voltage Supply, giving from one to fifty volts, C voltage \$49.00.
West of the Rockies add \$1.90

If your dealer cannot supply you, write us and on receipt of price we will send the instrument you select, carefully packed express prepaid.

Full descriptive circular will also be mailed on request with name of nearest dealer.

CORNELL ELECTRIC MANUFACTURING CORP.

General Offices:
135 East 58th Street, New York
Cor. Lexington Avenue

\$39.50

F. O. B. New York

To Dealers — The Cornell Voltage Supply is sold only through authorized Cornell dealers. If you feel you can qualify, send money order for a sample and write today for full information.

★ Cornell Voltage Supply

"B" Battery Eliminator

Tested and approved by Raytheon Laboratory



CORNELL ELECTRIC MFG. CO., 135 E. 58th St., Cor. Lexington Ave., New York

Gentlemen: Send me full information regarding your Cornell Voltage Supply (B Battery Eliminator) with name of nearest dealer.

Name _____ Address _____

If a dealer make cross here and receive very special proposition, dealer helps, etc.

"NOW, I HAVE FOUND . . ."

A Department for the Exchange of Ideas and Suggestions of Value to the Radio Constructor and Operator

CONTRIBUTIONS to this department are welcome and those used will be paid for at the usual rates, that is, from two to ten dollars each. A prize of twenty-five dollars is given for the best idea used during each three-month period. The prize winner for the last period is announced in the August RADIO BROADCAST. Manuscripts intended for this department should not exceed about three hundred words in length, and should be typewritten. Little consideration can be given to manuscripts not typewritten. Envelopes should be addressed to this department, RADIO BROADCAST, Garden City, New York.

A NEW PRIMARY FOR THE BROWNING- DRAKE R. F. TRANSFORMER

ON ACCOUNT of its extraordinarily high efficiency, the Browning-Drake circuit has won much favor with radio fans; especially since the construction of this type of set is simple and straightforward.

The only difficulty I came across when building the coils for my first receiver of this kind was in the construction of the former for the primary of the r. f. transformer. This primary is wound in a nar-

row groove, and a turned form made of wood or hard rubber is generally specified. Having no lathe, I made some experimental forms consisting of three cardboard discs. Two of these were cut just large enough to go into the coil former with slight pressure, the third was about $\frac{5}{16}$ " less in diameter. The three discs were cemented together with their centers coinciding. Quite a useful form was the result, but for the finished set, something better was desired.

Draw the outer circle X in Fig. 2, with a diameter equivalent to the inside diameter of the cylindrical tube and mark the width of the arms on this circle. This width may be about $\frac{3}{8}$ ". From the points A and B, draw tangents to the small holes drilled previously.

Using a sharp new hacksaw blade, cut out the form along the lines marked. Some care must be exercised during this operation or the hard rubber sheet may split. The cutting is made much easier if the sheet is clamped in a vise.

The sheet of paper which had been pasted to the hard rubber sheet is now washed off with warm water and the coil form is thoroughly dried. Finish it by rubbing it all over with a little machine oil and polishing it with the finest sandpaper you can lay your hands on.

It only remains to slot the arms of the form for the primary winding. Again it is clamped in the vise, with the top of the arm just projecting. To prevent it being marked by the jaws of the vise, place a thin smooth board on each side of the hard rubber form before clamping it.

The slot should be about $\frac{1}{16}$ " wide. A

Control Volume with this Modulator Plug

WITH your radio set operating under full power, you can now regulate tone and volume to suit your mood, by simply turning the knob on this *Centralab Modulator Plug*! Replaces ordinary loud-speaker plug. Provides perfect control of volume from a whisper to maximum, without touching the tuning dials or rheostat. *Cuts down powerful local stations, and brings through programs sweet and clear—improves reception wonderfully!*

\$2.50 at your radio dealer's—or sent direct if he can not supply you. Write for literature describing this and other Centralab controls.



Central Radio
Laboratories

22 Keefe Ave., Milwaukee, Wis.

Centralab

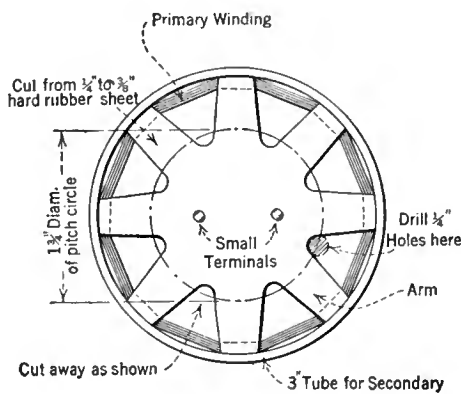

FIG. 1

row groove, and a turned form made of wood or hard rubber is generally specified.

Having no lathe, I made some experimental forms consisting of three cardboard discs. Two of these were cut just large enough to go into the coil former with slight pressure, the third was about $\frac{5}{16}$ " less in diameter. The three discs were cemented together with their centers coinciding. Quite a useful form was the result, but for the finished set, something better was desired.

Having some small pieces of $\frac{5}{16}$ " hard rubber in my junk box I set to work and finally evolved the new low loss form shown in the accompanying sketches Figs. 1, 2, and 3. It is merely a star-shaped pattern with eight arms. The top ends of the arms are slotted to take the primary winding (as shown in Fig. 1.)

The tube used as a form for the secondary winding had an outer diameter of three inches; the form for the primary was filed and sandpapered down until the arms made a good fit within the outer, larger, tube.

To mark out this form, paste a piece of drawing paper over the piece of hard rubber selected. Draw the center lines, and divide each ninety-degree section formed by these center lines into four equal parts, as indicated in Fig. 2. Next draw the pitch circle for the $\frac{1}{4}$ " diameter holes, and

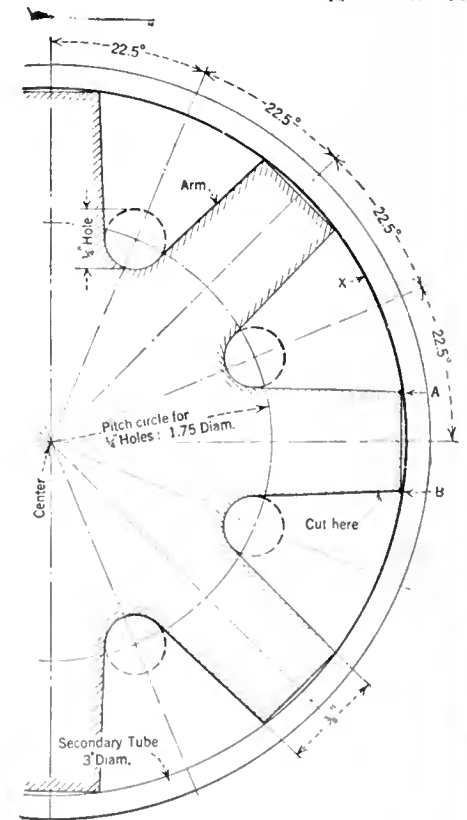

FIG. 2



The New Balkite Charger

MODEL J has two charging rates. A low trickle charge rate and a high rate for rapid charging. Can thus be used either as a trickle or as a high rate charger. Noiseless. Large water capacity. Rates: with 6-volt battery, .25 and .5 amperes; with 4-volt battery, .8 and .2 amperes. Special model for 25-40 cycles. Price \$19.50. West of Rockies \$20.



Balkite Trickle Charger

MODEL K. With 6-volt "A" batteries can be left on continuous or trickle charge thus automatically keeping the battery at full power. With 4-volt batteries can be used as an intermittent charger. Or as a trickle charger if a resistance is added. Charging rate about .5 amperes. Over 200,000 in use. Price \$10. West of Rockies \$10.50.



A New Balkite "B" at \$27.50

Balkite "B" eliminates "B" batteries and supplies "B" current from the light socket. Noiseless. Permanent. Employs no tubes and requires no replacements. Three new models. Balkite "B"-W at \$27.50 for sets of 5 tubes or less requiring 67 to 90 volts. Balkite "B"-X for sets of 8 tubes or less; capacity 30 milliamperes at 135 volts—\$42. Balkite "B"-Y, for any radio set; capacity 40 milliamperes at 150 volts—\$69.



Balkite Combination

When connected to your "A" battery supplies automatic power to both "A" and "B" circuits. Controlled by the filament switch on your set. Entirely automatic in operation. Can be put either near the set or in a remote location. Will serve any set now using either 4 or 6-volt "A" batteries and requiring not more than 30 milliamperes at 135 volts of "B" current—practically all sets of up to 8 tubes. Price \$59.50.

All Balkite Radio Power units operate from 110-120 volt AC current with models for both 60 and 50 cycles. Prices are higher in Canada.

Announcing the new Balkite Light Socket Radio Power Units

A new Balkite Charger with both trickle and high charging rates. Three new Balkite "B's" including the new popular priced Balkite "B"-W at \$27.50. The new Balkite Combination—with the "A" battery it furnishes automatic power to both circuits.

Now you can operate your radio set from the light socket. Merely by adding the new Balkite Radio Power Units—either by adding a Balkite Charger and Balkite "B," or by adding the new Balkite Combination Radio Power Unit.

In either case the result is the same—light socket operation, maximum convenience, and smooth silent power.

Balkite Light Socket Power is noiseless. There is no hum. It is never low and never runs down, but is always exactly what is required by the set. It is permanent. Balkite Radio Power Units are permanent pieces of equipment. They employ no bulbs, and have nothing to replace or renew. They cannot deteriorate from either use or disuse. Other than a negligible amount of household current their first cost is the last. With sets of high current requirements their use is highly desirable for the saving alone. They require no changes in your set.

Over 600,000 radio receivers—one of every ten—are already Balkite equipped. Equip yours with Balkite and convert it into a light socket receiver. Know the pleasure of owning a set always ready to operate at full power.

FANSTEEL Balkite ★ Radio Power Units

Manufactured by FANSTEEL PRODUCTS COMPANY, INC., NORTH CHICAGO, ILLINOIS

Sole Licensees in the United Kingdom: Messrs. Radio Accessories Ltd., 9-13 Hythe Rd., Willesden, London, N. W. 10

A NEW and BIGGER Bradleyohm for B-Eliminators

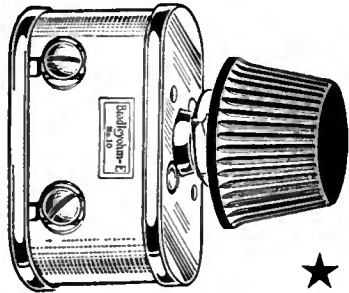

Announcing the Bradleyohm-E

Perfect Adjustable Resistor for B-Eliminators

THE rapid development of B-Eliminators for radio receivers has created a growing demand for an adjustable resistor of high resistance to regulate the plate voltages to the radio set. Bradleyohm-E is a new, large size Bradleyohm of increased capacity and ample range for B-Eliminator service. It is made in several ranges for various types of circuits. If you are building a B-Eliminator, be sure to ask your dealer for Bradleyohm-E of correct range and you will be assured of complete satisfaction regardless of the length of time your B-Eliminator is in service.

Mail the Coupon for interesting literature on Allen-Bradley Perfect Radio Devices

Allen-Bradley Company
278 Greenfield Avenue
Milwaukee, Wisconsin

Please send me your latest literature on Allen-Bradley Perfect Radio Devices including the Bradleyohm-E.

Name.....

Address.....

.....

fine hacksaw blade will cut a slot of just this width. The depth of the slot will have to be $\frac{3}{8}$ " or more, according to the gauge of wire used for the primary winding. To take the ends of this winding, fit two small terminals near the center of the form. I say small intentionally, for even slight amounts of metal within the field of a coil tend to reduce its efficiency. These terminals are very convenient, since connections to the bus bar leads can now be made with short lengths of flexible wire, and the primary can be removed without having to undo a soldered joint.

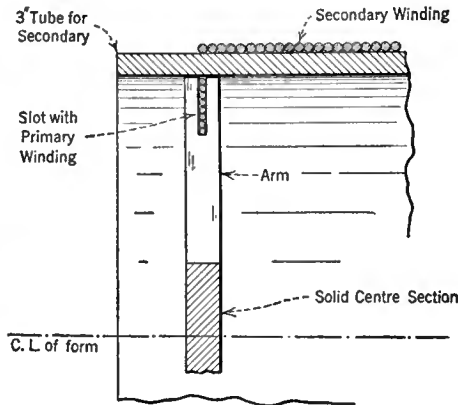

FIG. 3

The form is wound as usual, the greater part of the wire lying exposed between the arms, and therefore we are justified in calling the coil a low loss one.

So far as efficiency is concerned, it will be found that a coil made in this manner compares very favorably with coils made to the standard design. A form of this type is really far more difficult to describe than to make, the one shown in the illustrations being made and wound completely in less than two hours.

C. A. OLDROYD,
Barrow-in-Furness, England.

A RHEOSTAT SUB-PANEL FOR THE ROBERTS RECEIVER

A SIMPLE method of eliminating the rheostat knobs from the panel front on the Roberts receiver, is shown in the accompanying Fig. 4. It consists of a sub-panel, SP, about 2 x 4 $\frac{3}{4}$ inches, on which are mounted the

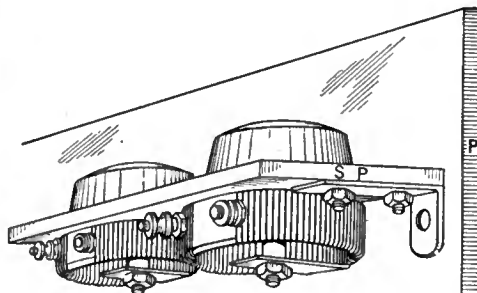

FIG. 4

rheostats. On this sub-panel are bolted two small brass angles, one at each end. In order to avoid bolt heads showing on front of the panel P, a small hole should be drilled almost through the panel from behind and tapped for a short bolt. Then the sub-panel is screwed to the panel. If a brace is used for the panel, one of the bolts can be so arranged that it will answer for

both the brace and angle. It is well to keep the unit high on the panel, allowing just enough room for the rheostat knobs to clear the cabinet easily.

This unit will fit perfectly over the antenna and secondary coils in the Roberts receiver. For a slanting panel it is advisable to bend the angles so that the sub-panel is parallel to the base board. The unit allows easy adjustment of rheostats, and makes possible the simplification of the panel on any set where the rheostat adjustment, once determined, has little or no effect on the operation of the set.

L. D. SAUER,
Dayton, Ohio.

A SIMPLIFIED BATTERY THROW-OVER SWITCH

THE layout in Fig. 5 permits, by a simple twist of the wrist, as it were, the connection of the storage battery to the set or to the charger, as may be desired. The old "clip and plug" process has been discarded, and in its stead a double-pole double-throw switch, with permanent wiring, has been substituted. This hook-up can be used for panel or wall mounting, or may be used inside a radio table or cabinet.

This, I believe, to be an improvement over the hook-up contained in the April, RADIO BROADCAST inasmuch as a two-blade knife switch is substituted for the three-blade switch; furthermore, the necessity for the extra long contact connecting the charger to the line supply (which type of

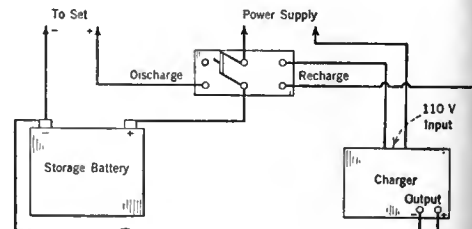

FIG. 5

throw-over switch must be specially constructed), is eliminated.

H. R. NICHOL,
Washington, District of Columbia.

A PRECAUTION TO PREVENT TUBE BURN-OUTS

FIVE perfectly good vacuum tubes had burned out and the owner was afraid to put any more in for fear that they would go too. Here is what the service man found when he came to look at the installation. Acid had at one time been spilled on the 90-volt cable and had eaten away all of the insulation. This bare wire had apparently bumped up against the negative pole of the storage battery. The negative B lead being connected with the positive of the A battery, the full 90 volts were placed directly across the tube filaments, thus burning them out. The lesson to be learned from this is that one cannot be too careful in keeping the storage battery free from excess acid and also to keep the wires well separated at all times. If separate compartments cannot be had for the two batteries, it is always best to fasten the various wires with staples so that they cannot possibly be mixed up and cause damage.

K. B. HUMPHREY,
Brooklyn, New York.

Fully Amplifies
every
note!

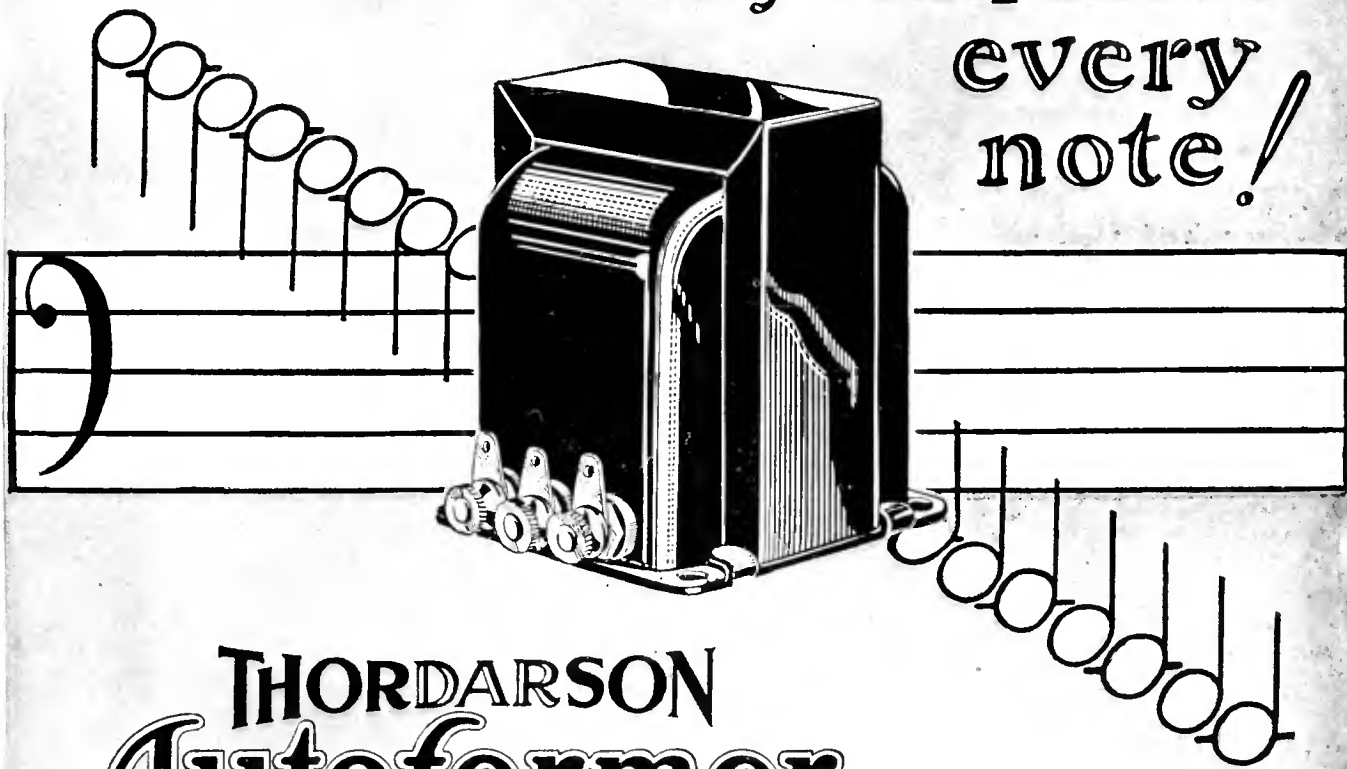

THORDARSON Autoformer

Step-up Impedance Coupled Amplifier

Full Amplification
of Bass Notes

Greater Clarity
on all Programs

Improved Reception
of Weaker Stations

Better Volume Control

Impedance coupling is universally accepted as the most perfect form of amplification from a reproductive standpoint—But the amplification increase of the straight impedance is low.

The Thordarson Autoformer is an impedance with a step-up ratio—It combines the faithful reproduction of the impedance with the amplification increase of the transformer, paving the way for the release of the deeper tones with increased volume and unrestrained quality.

Price each \$5.00

Note: Only Thordarson makes the Autoformer

POWER From the A. C. Line

Power Amplifier Supply Transformer R-198 furnishes current for both plate and filament of the power stage using the U. X. 210 power tube with 400 volts on the plate and 7½ volts on the filament. In addition furnishes complete B-supply for the set.

Price \$12.00



B-Eliminator Transformer R-195 is designed for use with the Raytheon tube, furnishing B voltages for the entire receiver. Capable of supplying 140 volts at 40 milliamperes. Conservatively rated. Will not heat up in continuous service.

Price \$7.00



30 Henry Choke Coil R-196 is used in the filter circuits of power amplifiers and B-eliminators operating from the house lighting current. D. C. resistance 280 ohms. Capacity 70 milliamperes.

Price \$5.00



THORDARSON ELECTRIC MANUFACTURING CO.
Transformer specialists since 1895
WORLD'S OLDEST AND LARGEST EXCLUSIVE TRANSFORMER MAKERS
Chicago, U.S.A.

LETTERS FROM READERS

Contributions from Readers on Various Subjects
of Radio Interest—An Open Forum for All

Broadcasting Stations in Argentina

HERE is a list of broadcasting stations now operating in Argentina, which we print—as far as our America-resident readers are concerned—rather as a record than an exhortation to be “up and doing,” so to speak.

Editor, RADIO BROADCAST,
Doubleday, Page & Company,
Garden City, New York.

SIR:

Herewith a list of broadcasting stations now in operation in Argentina. This list makes obsolete yours which appeared in the February RADIO BROADCAST.

LOCATION	CALL	WAVE-LENGTH	POWER IN WATTS
Buenos Aires	LOO	250	—
Buenos Aires	LOQ	260.8	500
Buenos Aires	LOR	400	1000
Buenos Aires	LOS	285.7	5000
Buenos Aires	LOT	272.2	1000
Buenos Aires	LOV	352.9	1000
Buenos Aires	LOW	300	1000
Buenos Aires	LOX	375	500
Buenos Aires	LOY	315.8	1000
Buenos Aires	LOZ	333.3	1000
Buenos Aires	R2	275 & 214.8	100
San Fernando	D3	235.3	100
La Plata	L0P	425	1000
Santa Fé	F1	275	20
Rosario	F2	270	100
Rosario	F3	265	100
Rosario	F4	260	100
Río Cuarto	H5	275	100
Cordoba	H6	250	20
Cordoba	H7	320	100
Villa Maria	H8	296.4	250
Cordoba	H9	381.1	100
Mendoza	L0U	380	500

There are also two small stations in Mendoza, but I have no details to hand of these.

Trusting this material may be of use to you in correcting your lists,

Very truly yours,

C. E. SMITH,
La Calera, Argentina.

That Spark Interference

AN INQUIRY from RADIO BROADCAST to the Independent Wireless Telegraph Company concerning spark interference, brings the following self-explanatory letter. There are three sides to the question, those of listener, interference producer, and apparatus manufacturer. We have not investigated the latter but, judging from the letter herewith, it is apparent that the Independent should not be condemned without due consideration of the hardships under which they apparently labor.

SIR:

I am in receipt of your letter of the first instant advising that the general tendency in the operation of ship-shore service has been to convert the transmitter to continuous-wave operation as rapidly as it was financially and technically feasible, and in which you called our attention to the fact that our station at East Hampton, Long Island, continues to use a spark transmitter. We are thoroughly in accord with the change over from spark transmitters to continuous-wave transmitters, and we have spent a large sum of money in changing over same at our East Moriches (wsh) Station. We have also directed about 90 per cent. of our traffic via the continuous-wave station at East Moriches.

Unfortunately at East Hampton we have been unable to obtain a suitable continuous-wave transmitter for short waves at what we figure to be a reasonable price. In taking the matter up with the manufacturers, the price quoted us was considered excessive, in that, in addition to the usual purchase price, which we learned was greater than that charged to others, we were required to pay a 10 per cent. royalty on gross receipts for five years. In other words, after having made a payment in excess of the usual price for the apparatus, we still had to pay 10 per cent. of the gross receipts for five years. This would mean a loss in operation during some of the periods when traffic is light.

The question of the price of the equipment has again been taken up with the manufacturers, and we hope to be able to reach some agreement. If a satisfactory arrangement can be made with the manufacturers, we plan to use the East Hampton Station as a purely receiving station and place all of the transmitting gear at East Moriches, operating same by remote control.

We fully appreciate and sympathize with the broadcast listeners who are more or less affected when the East Hampton transmitter is being operated, but unfortunately we are unable to clear this interference until a satisfactory arrangement can be made with the manufacturers of the short-wave continuous-wave apparatus.

Very truly yours,

C. J. PANNILL,
Vice-President,

Independent Wireless Telegraph Company.

In Which We Permit a Gentle Pat on the Back

GRACIOUS reader, you are now deigning to read the last column of text in the September RADIO BROADCAST. If you have enjoyed our program, won't you please drop us a line and . . . we'll, maybe we shall reconsider that paragraph under the “Help Wanted” in this morning's *Times*, for, after the above, we must assuredly qualify for that position open for man with ability to say the right thing at the right time, etc. Nevertheless, we must admit that we rather like receiving letters such as that printed below from Doctor Baetz, Californian.

Editor, RADIO BROADCAST,
Doubleday, Page & Company,
Garden City, New York.

SIR:

Your June number of RADIO BROADCAST has just arrived on the Coast and is making a great hit with its Silver-Marshall-Six improvements. The usual radio publication has done a great deal of harm by boosting a new circuit every month and dropping it “for better or worse” in favor of the next advertiser.

I thank you very much for your recent letter of information concerning radio troubles. It is the first useful information I have been able to obtain. I had previously applied for information at the manufacturers and a number of radio magazines to which I subscribe. All previous answers were written by clerks who knew less about radio than I do.

I thank you for your courtesy and help.

Yours very truly,
WALTER G. BAETZ, M. D.,
Huntington Park, California.

the final condenser!

The Country's
Foremost
Radio Engineers
Have Acclaimed

METRALIGN

SLT STRAIGHT LINE
TUNING

Here at last is the final condenser—acclaimed by both amateurs and experts as the ONLY condenser embodying new and vitally important improvements—over old type condensers—solving forever, the tuning evils of the past.

Makes any set
a new set—in
15 minutes

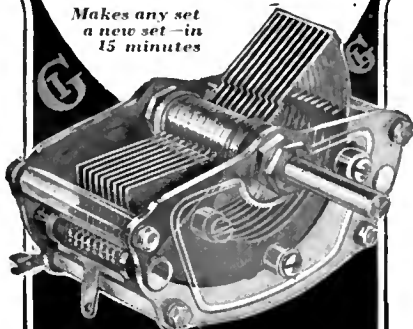

SEPARATES ALL
STATIONS ON
ALL WAVE
LENGTHS

METRALIGN SLT is the only condenser combining Straight Line Capacity, Straight Line Wave Length and Straight Line Frequency, eliminating the faults and retaining the advantages of each type—the result is a perfect tuning unit

METRALIGN SLT spreads stations so evenly over the dial that all stations on all wave lengths can be quickly and easily tuned in or out and accurately logged.

FREE

We have prepared a most comprehensive booklet on tuning. It is written in simple language and tells all you want to know about condensers. Write for a copy to-day.

General
Instrument
Corp.

477 H'way New York City

You hear *all* the tones

with an



ALL-AMERICAN Reproducer

An All-American Quality Product

A good speaker is the only kind worth having. A poor one will ruin otherwise good reception.

We're making a good one for you—the *Lorel* Reproducer; a cone type correctly balanced with sounding-board and sounding-chamber, to give you that purity of *all* tones, which you desire.

This remarkable unit combines the good features of both cone and sounding-chamber types of speaker; and eliminates their inherent weaknesses. You can hear *all* the high and low tones with the *Lorel*; clear and full.

Ask your dealer for a demonstration of the Lorel. You'll find it a real improvement in radio reception.

Price \$25 Slightly higher west of the Rockies



Lorel Model

ALL-AMERICAN RADIO CORPORATION

4211 Belmont Avenue, Chicago



A Remarkable Improvement in Audio Amplification

A development by All-American laboratories—the Rauland-Lyric-Trio. You know the Rauland Lyric Transformer, famous among music critics for its exceptional tone perfection. It is now combined with two Rauland Trio impedance units; retaining the advantages and eliminating the weaknesses of the two leading systems of audio amplification. The result is the last word in audio amplification. *Free book, "Modern Audio Amplification," tells more about this interesting development. Write for handbook "B-90."*



Pure full tone is possible only with unvarying "B" power. With All-American "Constant B" you get a permanent, constant plate power. There's nothing to take care of; no annoying hum, and no acid. Permanently sealed. "Constant B" has a 10 to 60 volt tap, varied in output by a "detector" control; a 67½ volt and a 90 volt tap; a variable voltage "power-tube" tap uniformly controlled by a "High-Low" switch.

Price \$37.50 Complete with Raytheon tube Slightly higher west of the Rockies

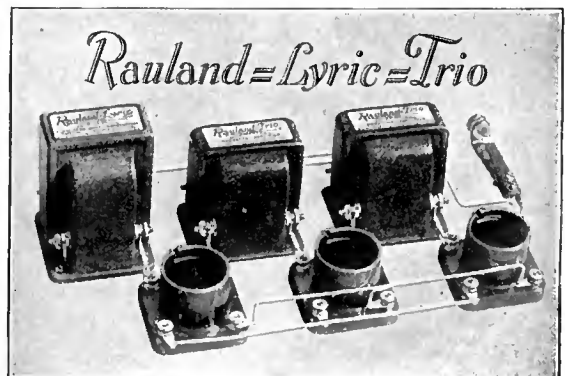

72500

A New Convenience for RADIO USERS

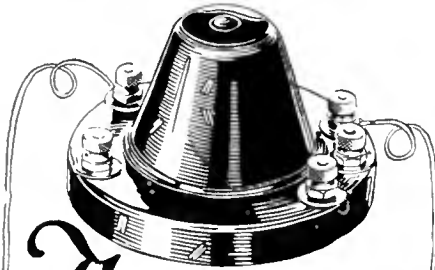

This shuts off
or turns on

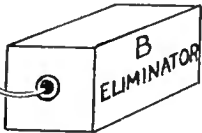
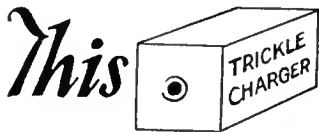

or
This

Automatically

THIS new device makes the A Battery switch on the receiving set automatically turn on and off, either or both the Trickle Charger and B Eliminator as they are required.

Protect your A battery; save current consumption; eliminate line noises and insure efficient operation of Trickle Charger and B Eliminator with a Reliable Automatic Power Control Switch.

Buy from your radio dealer. If he does not have it, order direct from us. Retail for \$2.00 everywhere.

THE RELIABLE PARTS MANUFACTURING COMPANY
2819 Prospect Ave. Cleveland, Ohio

THE RELIABLE PARTS MFG. CO.
Cleveland, Ohio.

Enclosed find check for \$2.00. Please send me a Reliable Power Control Switch. I buy my radio supplies from

Name of Dealer.....

Name.....

Address.....

Fully guaranteed. Money returned if unsatisfactory for any reason. Sent C. O. D. if desired.

Who Invented the Microphone?

How the Prototype of the Modern Broadcasting Microphone Was Evolved After Six Weeks Experiment—From Crude Equipment

By CLARA LOUISE LESLIE

THE heart of radio broadcasting is the microphone—that little instrument which has become the world's mouthpiece; yet little is heard of its origin. It is the purpose of this short story to place before the reader the interesting facts relative to the discovery of the microphone principle, which dates back almost half a century. In keeping with the important rôle it was destined to play, the microphone was no casual discovery; nor was its launching among the world of inventions an uneventful experience.



EMILE BERLINER

He is here shown examining an up-to-date example of his own inventive genius, the microphone at wrc, Washington

At the time of its issue, the microphone patent was the most commercially valuable patent ever issued, and, as may be supposed, the story surrounding the birth of this "adjunct to civilization" is not without its romance.

The microphone was invented in 1877, and the man who lays claim to the unique title of "Father of the Microphone" is Emile Berliner.

Berliner was born in Hanover, Germany, and immigrated alone to the United States when only 19 years of age. He had been living in this country only about long enough to master the English language when he became engrossed in the subject of science, particularly electrical science, which began to sweep over public thought at that time. It is just half a century ago that the public mind became electrified seemingly all at once, to the thought of strange new possibilities.

It was to Washington, District of Columbia, that young Berliner had gone to make of himself "a good American." He clerked in a dry goods store in the day time, and during the nights he pondered these great new subjects alone in his little "third floor back." He was poor, and had been equipped with nothing but a public-school education.

A great man was once asked how he accomplished a certain great achievement. His reply

was, "By always thinking about it." This, without question, was the system Berliner used. He dug up scientific secrets out of that mine of inner logic. He had heard rumors of Bell's telephone but it was not yet in public use, and he had never seen one; and it is remarkable that within six weeks from the time Berliner had bought his first equipment and begun to experiment with his tin can telephones and soap box transmitters, that he brought to light the microphonic principle that has never been changed nor superseded.

The first microphone consisted of a portion of a toy drum. The head of the drum constituted the diaphragm, and the delicate loose contact—a startling innovation in electrical science up to that time—was made by a steel dress button hanging by a fine bit of metal embroidery thread so that it just touched the point of a steel sewing needle which had been projected through the drum head from the back. Berliner used this arrangement on March 4, 1877. This contact, when attached to a battery, was found to act both as a transmitter and receiver. Berliner thus had a telephone system of his own, and it resembled Bell's magneto system only in that it employed the basic undulatory current.

The original Bell instrument was a magneto telephone. Berliner was the first to introduce a battery current transmitter and also an induction coil or transformer into a telephone circuit. He obtained a patent for the latter on January 15th, 1878. The induction coil, or transformer, is, in radio, the connecting link between the telephone circuit and the ether current, and is, of course, one of the real essentials in broadcasting.

But the idea of the loose contact, which principle is the basis of all microphonic action, came to Berliner in a flash of inspiration. He had been experimenting for a short time with the meager equipment in his improvised bedroom-laboratory when, one day, he was talking to a friend of his in charge at a telegraph station near by.

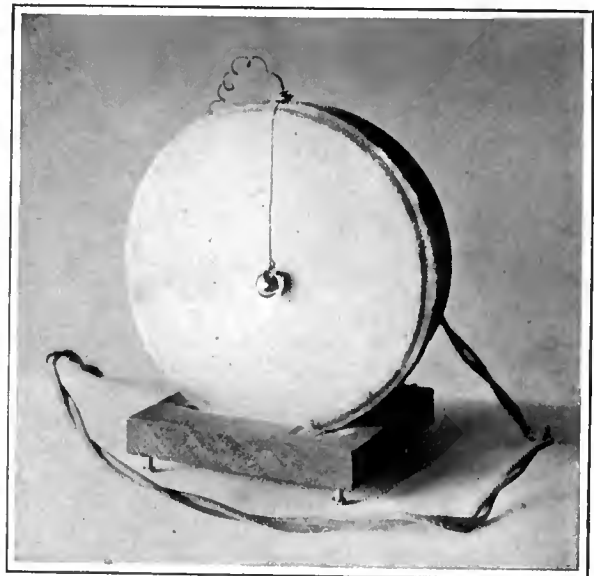

BERLINER'S FIRST MICROPHONE
Of March 4, 1877. That illustrated is a replica made by him in 1879

★ Cardwell Condensers

PERFECTION

IN the modern dreadnaught, every part is tested, retested, and tested again. It must be perfect.

No other condenser available has nearly the inspection which is part of the manufacture of every Cardwell Condenser. Like the Battleship, it must be right. There can never be a failure.

The Taper Plate Type "E"



Modified Straight Wave Length Type "C" for more long wave separation



PRICES:

173-C	192-E	0005	\$4.00
173-C	192-E	0005	\$4.75
170-C	168-E	00025	\$4.25
168-C	167-E	00015	\$4.00

The Allen D. Cardwell Manufacturing Corp.
81 Prospect Street - Brooklyn, N.Y.

"THE STANDARD OF COMPARISON"

ELECTRAD

Just Plug In— That's All, No Trouble With This Antenna

NO trouble putting up an aerial. Just plug in on any electric light socket. No inconvenience or interference from neighbors' sets and aerials. Also smothers static and helps get distance. Uses no current. Perfectly safe to use. Tested and certified electrically. The simplest, neatest and most efficient on the market.

At all good radio stores, or they can easily get it for you. Price U. S. 75c., Canada \$1.10.

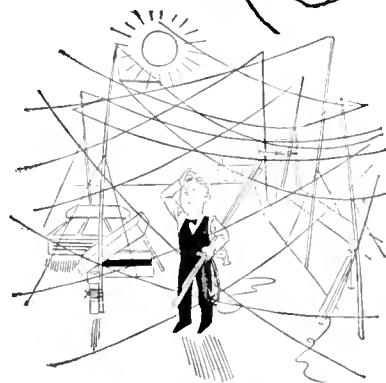
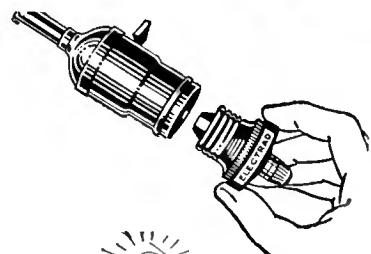

Order your copy of *Radio Broadcast* from your news dealer or radio store. Make sure that he reserves a copy for you each month. If your favorite radio store does not stock the magazine write us giving name of radio dealer and address.

Our Radio Dealers Make Big Money



Dealers looking for big turnover and quick profits will send for this 96-page catalog of radios and accessories, including Bremer Tolly, Biskite, All American, G. E. Tungal, Thoronia, Majestic, Utah, R. C. A. Tubes, nationally advertised parts, batteries, chargers, etc. Write for catalog No. 91A, full facts, territories open, etc. Tell us about your business, as we sell wholesale only. Real money waiting. Don't delay.

NEW ENGLAND MILLS CO.
Distributors Nationally Advertised Radio Lines
Dept. 91A Chicago, Ill.

For Perfect Tone and Volume Control, Use ELECTRAD ROYALTY 500,000 OHM COMPENSATOR

The remarkable results secured by the use of this perfected device are due to the fact that it controls the output without any distortion or noise, so that pure music is received through the loud speaker. Note these six important features of design and construction:

- 1—Resistance element is not exposed to any mechanical operation.
- 2—Electrical contact is made positive by a metallic arm on the wire-wound strip.
- 3—The same resistance is always obtained at the same point.
- 4—The resistance value is under control in the process of manufacture and does not change in use.
- 5—The entire range of resistance is covered with less than a single turn of the knob.
- 6—There is no mechanical binding and the shaft is turned over the entire range with a perfectly smooth operation.

Made in various types for various purposes. Prices, \$1.50 to \$2.00; in Canada, \$2.10 to \$3.00. Write for circular.

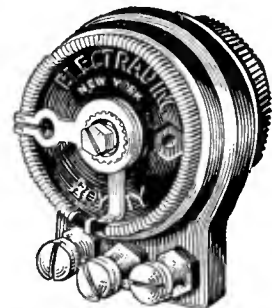

A Universal Range Variable Resistor

CLAROSTAT

Endorsed and Used by:



\$2.25

Maximum Capacity
20 Watts

- Acme Apparatus
- All American
- American Elec.
- Cooper
- Dongan Elec.
- Erla
- Ford
- General Radio
- Grigsby-Granow-Hinds
- Jefferson Elect.
- King
- Kokomo Elect.
- Mayolian
- Raytheon
- Modern Elect.
- Silver Marshall
- Sterling Mfg.
- Storad Radio
- Thordarson
- Webster Co.
- Zenith

Modulation, Oscillation, Regeneration, Grid and Voltage control—all covered in interesting booklet sent upon receipt of 4c in stamps. Address Dept. R. B.

American Mechanical Laboratories, Inc.
285 N. 6th St., Brooklyn, N. Y.

If You Have an Outdoor Aerial Demand the Genuine ELECTRAD LEAD-IN

Copied and imitated, but the quality never approached. Triple-ply insulation—full 10 inches long. Fahnestock clips, all connections riveted and soldered. Fits under locked windows and doors. Bends to any shape. Saves walls, windows and door trim. Price U. S. 40c., Canada 60c., at all good radio stores.

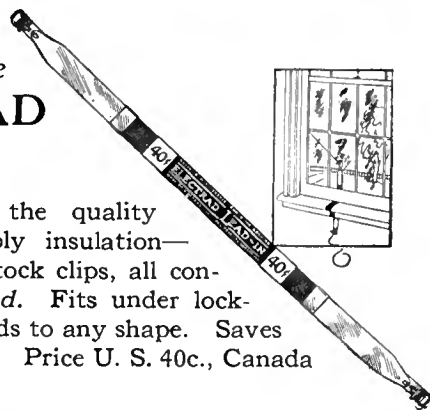

For perfect control of tone and volume use the Electrad 500,000 ohm compensator. For free hookup write 428 Broadway, New York City.



ELECTRAD Inc.

Metallized!

A glass wire is spun and passed through a chemical high-temperature process, forming a thin conducting layer of high resistance. Impervious to atmospheric conditions.

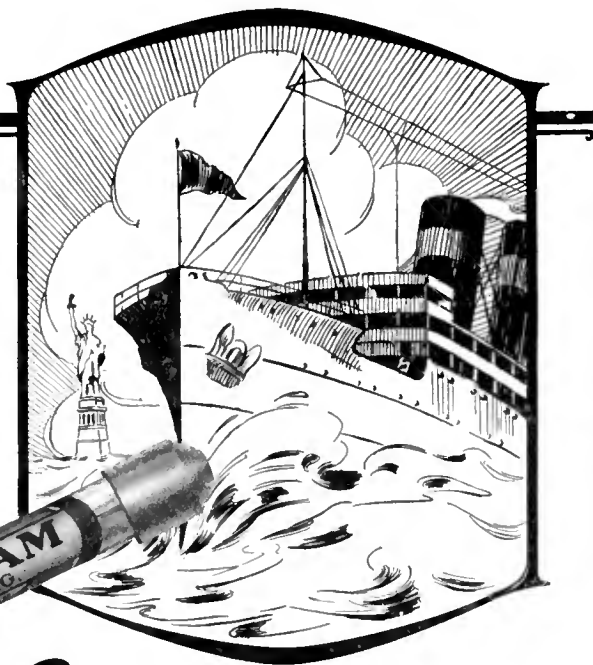

Supremacy!

DURHAM Metallized RESISTORS

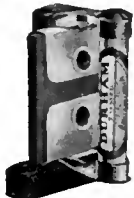

Durham Resistor Mounting

Made of moulded insulation of exceptionally high resistance. Has best quality, tension-spring, bronze contacts. The only upright mounting made. Occupies but little space in set.

Single mounting 50c.
For condenser 65c.

LIBERTY, epitomizing the Land of the Free! The Leviathan, symbol of America's power on the sea! Both supreme expressions of a Nation's greatness.

The Durham *Metallized* Resistor is the supreme grid resistor of radio. Supreme because it embodies improvements that lift it above most competition. Noiseless in operation, unaffected by dampness or atmospheric changes, and permanent in its resistance value as stamped on the label.

500 ohms to 10,000 ohms	\$1.00
Above 10,000 ohms to .24 meg.75
.25 meg. to 10 meg.50

DURHAM METALLIZED RESISTORS

★ **International Resistance Co.**
Dept. D, Perry Building Philadelphia, Pa.

This is a good time to subscribe for
RADIO BROADCAST
Through your dealer or direct by the year, only \$4.00
DOUBLEDAY, PAGE & CO. GARDEN CITY, NEW YORK

For Better Radio
Hammarlund
PRECISION
PRODUCTS ★

Watch for the Hammarlund "MIDLINE" (Copyright 1926)
HAMMARLUND MANUFACTURING CO.
424-438 West 33rd Street New York City

★ Tested and approved by RADIO BROADCAST ★

"Do you mean that more current goes over the wire when I make a firm contact?" Berliner asked, as they stood conversing over a Morse key. Being answered in the affirmative, Berliner sped back to his lodging house as one under a spell. He knew he had mentally solved the problem. That cold spring night he rigged up the toy drum and it responded! That constituted the birth of the microphone.

LEGAL STRIFE PRECEDES PATENT RECOGNITION

IN BERLINER'S office to-day is a replica of that first microphone, and over it one can plainly hear even the ticking of a watch. About a year after the invention was made it was found that it was the combination of Berliner's microphone transmitter with Bell's magneto receiver that made the perfect telephone circuit as we have known it ever since. Radio is, of course, an extension of telephony.

Then, the microphone patent, applied for by Berliner on June 4, 1877, was destined to play the star rôle in one of the greatest patent dramas ever staged. It became tangled up in patent interference which lasted more than fourteen years and during which time all kinds of accusations were aimed at it in an endeavor to declare someone else the prior inventor. However, Berliner's application was finally recognized by the Patent Office on November 17th, 1891. Being controlled, as it was, by the Bell Telephone Company, the issuance extended the life of the Bell monopoly for another seventeen years. Immediately following the day the patent came out, the newspapers from Maine to California were flooded with comment on the subject. The following is taken from the *Boston Globe* of November 18th, 1891:

The Berliner patent, issued this morning from the patent office at Washington, is, next to the original Bell patent, the most important patent in the telephone field ever issued. It covers every known form of battery transmitter, and underlies the Blake transmitter, the mechanical device in use in the ordinary box transmitter, and the Hunning transmitter, the mechanical device behind the mouthpiece of the ordinary "long-distance" transmitter. The Blake transmitter uses two single points of variable contact in the transmission of speech. The "long distance" transmitter uses a multiplicity of carbon points of variable contact, but the Berliner patent just issued covers the principle of any variable contact used in the transmission of the sounds of the human voice. All forms of the microphone, of carbon, or any other contact in use for magnifying sound, the "hear-a-fly walk" device, an amusing illustration of the wonderful powers of the microphone which entertained many people about 10 years ago—all these and all succeeding mechanical devices, built upon the variable contact principle, now come under the Berliner patent, which bears date to-day, and can be protected from infringement for the next 17 years. . . . No known device can be practically used in the telephone exchange system, or in the transmission of speech over long distances except by the Berliner principle of a variable point of contact.

The *Electrical World*, of November 18th, 1891, made the following statement:

Rarely has a patent on any subject whatever caused so profound a sensation as has the granting to Emile Berliner, on November 17, of what on its face appeared to be a broad claim on the microphone transmitter now used well nigh universally wherever the telephone exists. Electrical circles were less surprised than the general public, but a feeling akin to consternation has pervaded the atmosphere during the past week. It is indeed an extraordinary patent, no less on account of the sweeping character of some of its claims than by reason of its remarkable history in the Patent Office. For an application to remain for one cause or another locked up in the

(Continued on sixth page following)



The Pacent Powerformer is only 8 x 8 x 10 inches and its weight is approximately 32 pounds, making it truly portable. The Pacent Cone is made in two sizes, 17 inches in diameter and 3 feet in diameter.

A new day has dawned in radio with the arrival of the Pacent Powerformer and Cone

It is no exaggeration to say that, with the development of the Powerformer by a group of engineers, under the direction of Louis Gerard Pacent, a new day has dawned in radio.

The Pacent Powerformer reproduces music and speech with a tonal quality and range that defy description, the volume ranging from a whisper to a roar. It also eliminates B Batteries.

List Price, exclusive of tubes but including all necessary connections \$82.50.

The Pacent Cone Speaker (illustrated above) is manufactured under the Lektophone patents. The supremacy of the cone type of speaker over all others is now generally recognized. The supremacy of the Pacent Cone is due not only to its practically unlimited tone range, but to the volume and faithfulness which gives full rich tones with delicacy and without distortion.

PACENT CONE, Type A, 17 inch, Bronze base . . . \$28.50
West of the Rockies \$31.50

PACENT SUPER-CONE, Type, SA, 3 feet in diameter, mounted on walnut stand . . . \$79.50
Slightly higher West of the Rockies

PACENT SUPER-CONE, Type WA, Similar to Type SA, but arranged for hanging on wall . . . \$65.00
Slightly higher West of the Rockies

All types are equipped with a suitable length cord and Pacent Detachable Plug

Each of these new Pacent developments must be heard to be appreciated and the absolute revolutionary quality of reproduction realized.

If your dealer cannot supply you, write us. Interesting and informing literature on request.



PACENT RADIO CORPORATION
156 West 16th Street New York



IN PLANNING what you are to handle this coming season, you hope, of course, for none of the grief which has accompanied many receivers in the past, and the Browning-Drake sound merchandising principles, in marketing a product of undisputed excellence, we believe, will be interesting to you.

The research at the Cruft Laboratory of Harvard University, begun in the summer of 1923 by Glenn H. Browning and Frederick H. Drake, has set the mathematical standard of design for radio frequency transformers, and is universally recognized as the scientific authority on this most important subject, justly called the "heart of any circuit."

One stage of scientifically designed radio frequency, incorporating the Browning-Drake transformer, together with the

flexibility of a two control receiver, has yet to be improved upon for all around satisfactory reception. Our research facilities are such that minor refinements are constantly being made without the necessity of yearly models to upset the industry.

Producing one model fairly priced, with reasonable dealer discount, and distributed only by the highest grade jobbers, the Browning-Drake Receiver has never been cut, and no dealer has ever lost money on Browning-Drake. Your percentage of returned sets will be an absolute minimum, for your customers have confidence in the Browning-Drake name and its standards, and know it represents a laboratory standard of development which will not be superseded or radically changed for many years.



The
BROWNING-DRAKE FIVE

★
For further information
address the Browning-
Drake Corporation,
Brighton Mass.

BROWNING-DRAKE



The Satisfaction of Successful Accomplishment

In one way or another, this is the basis of every man's interest in life.

No one tires of the satisfaction of a good job well done. You might hesitate to tackle alone the construction of a grand piano, with any expectation of getting a thrill out of it.

But with National Radio set essentials

and the necessary additional parts and accessories, you can produce a modern, sensitive, selective, attractive and beautifully toned Radio set.

It will have every desirable quality that can be bought. It will have one quality which cannot be bought,—the thrill of successful self-accomplishment.

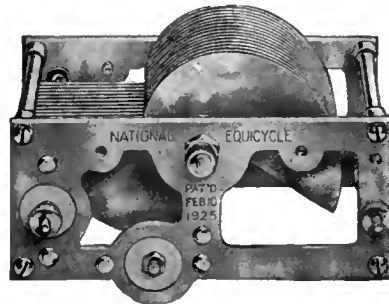

For Tuning
The NATIONAL
"Equicycle" Condenser

True straight-line-frequency—but in three-quarters instead of a half-turn—spreading out crowded stations still more, rigid frame, plates—bearings smooth, yet without suspicion of end-play. Made to stand up, to log the same next year as this, and with the same high efficiency.



For Tuning Control
The NATIONAL
Velvet-Vernier Dial, Type B

Gives velvety, even movement of condenser shaft with variable reduction ratio of from 6-1 to 20-1. Large, easily operated knob without any back-lash—clear yet mathematically accurate dial with simple logging guide—heavy, lasting Bakelite case; easy to mount and gives precise and fine tuning on any set.



For Audio-Frequency
Amplification
The NATIONAL
Impedaformers, Type B

Three to a set—making possible, in the compactest form, true and faithful audio-amplification, from notes too low to be reproduced in phones or cone, to shrillnesses out of reach of our mortal ears. Each Impedaformer cases a high-inductance choke—a .1 Mfd. TOBE Coupling Condenser—a Lynch grid-leak—and the first one an R. F. choke, without which impedance-amplification is like meat without salt.

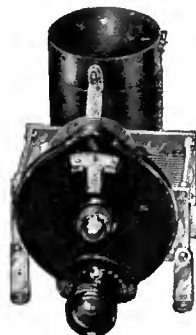

For Radio-Frequency Amplification
The Genuine NATIONAL Browning-Drake
Radio-Frequency Transformers

With their scientifically computed coil-constants—product of research of G. H. Browning and F. H. Drake at Harvard University. Their theoretically correct space-wound enamel wire coils withstand rough handling; without alteration of characteristics—yet tests show lowest R. F. resistance recorded for coils of this type. Their simple supports make them units with their "Equicycle" Condensers, yet hold them far enough away to prevent absorption losses or increase their resistance.

These NATIONAL Radio-Set Essentials with the required sockets, panels, wire and accessories,—may be put together EASILY by you into a modern receiving-set:—Sensitive to distant signals, selective in its separation of closely-spaced stations, capable of lifelike, faithful reproduction,—simple to operate.

See our Exhibit at New Madison Square Garden, New York, September 13-18; and the Coliseum, Chicago, October 11-17

NATIONAL CO., Inc.

W. A. Ready, President
Engineers and Manufacturers



110 BROOKLINE STREET

CAMBRIDGE, MASS.

GREATER DISTANCE

FINER SELECTIVITY

GREATER POWER

with

AERO COIL
SUPER-SENSITIVE

INDUCTANCE UNITS



Tuned Radio Frequency Kit

\$12.00

Replace your present inductances with this Aero Coil Tuned Radio Frequency Kit. It will positively improve the performance of your receiver. Special patented Aero Coil construction eliminates radio frequency losses. You will notice instantly, a tremendous improvement in volume, tone and selectivity. This kit consists of three matched units. The antenna coupler has a variable primary. Uses .00035 condenser. Coils are uniformly air spaced. No dope is used. Consequently they tune into resonance on a "knife's edge."

FREE with Each kit

Eight-page color circuit, layout, and instruction sheet for building the super-sensitive 5-tube Aerodyne Receiver packed with each kit. Get yours TO-DAY from your nearest dealer.

AERO PRODUCTS, Inc. ★

Dept. 109, 1772 Wilson Ave. Chicago, Ill.

The Latest Circuits Specify
JEFFERSON
Concertone

(AL-2 SEALED) AUDIO FREQUENCY TRANSFORMERS

Because they do not lose, distort or "blast" any notes (from the lowest to the highest audible to human ears) the new large Jefferson "Concertone" Transformers are being used in latest circuits.

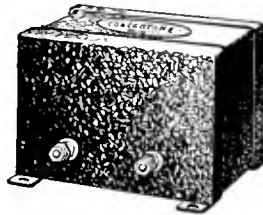

Not only do they make programs sound wonderfully natural and life-like by amplifying all tones equally; they also increase sensitivity and improve distance reception. Ideal for use with power tubes because of heavily insulated extra large cores and windings. Each "Concertone" is sealed against moisture in a 3 1/2" long x 2 3/4" high metal case—convenient for double-decking. Make your set a 1927 model in quality of tone by installing a pair of "Concertones." \$6 each—at your dealer's.

★
SEND FOR LATEST LITERATURE!

Other Jefferson Guaranteed Radio Products include: "Star" A. F. Transformers, \$2.75, \$3; Tube Rejuvenators, \$7.50; Tube Testers (for dealers, experimenters) \$8, \$9; Tube Chargers (described below). No. 280 Tube Charger with large socket only \$3.50. No. 285 Tube Charger with small socket only, \$3.50.



Without removing your tubes from the set

KEEP TUBES LIKE NEW—CHARGE THEM MONTHLY and ALL AT ONCE

Tubes gradually weaken with use, as do batteries. Once a month attach Jefferson Tube Charger to light socket and connect with set for 10 minutes. Keeps 201-A or UV-199 type tubes like new—at full efficiency. Rejuvenates run down tubes. Improved reception with longer life of tubes and batteries will be worth many times the price to you. Guaranteed.

JEFFERSON TUBE CHARGER, \$3.50

Makes it easy to regularly charge tubes, all at once, in your set, at home. Enjoy top-notch reception every night. Get one from dealer to-day.

Jefferson Electric Mfg. Co.

Largest manufacturers of small transformers
507 SO. GREEN ST. CHICAGO, ILL. U.S.A.

This is a good time to subscribe for

RADIO BROADCAST

Through your dealer or direct, by the year only \$4.00

DOUBLEDAY, PAGE & CO. GARDEN CITY, NEW YORK



BI-PASS and FILTER CONDENSERS

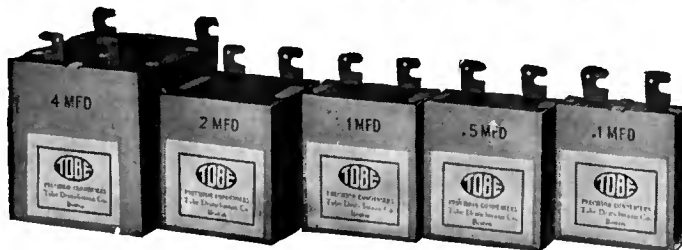

Are specified wherever quality sets are described for home construction. It is possible to get something resembling speech and music from a Radio set not equipped with good condensers—but truthful reproduction is impossible without them.

And in B-Eliminator filters, the TOBE Filter Condensers and the TOBE B BLOCKS have come to represent a definite standard of high quality. TOBE means good condensers. If you build a B-Eliminator use the TOBE B BLOCK. It saves you much time and wiring and saves you money, too.

We have tried to make it possible for you to obtain TOBE technical apparatus at your dealer's. If he is not yet stocked, we shall be glad to fill your order, postage paid, on receipt of your check or money order.

TOBE DEUTSCHMANN CO.

Engineers and Manufacturers of Technical Apparatus

Cambridge

Massachusetts

Third Judicial District Court
in and for
Salt Lake County,
State of Utah

Nathaniel Baldwin
INCORPORATED

Patent Infringement Notice

Pursuant to an Order of The Third Judicial District Court, in and for Salt Lake County, State of Utah, duly made and entered on the 25th day of June, 1926, in the matter of the Receivership of Nathaniel Baldwin Incorporated, the undersigned Receiver of said Company hereby serves notice on manufacturers, jobbers, dealers and purchasers of Radio Products that said Nathaniel Baldwin, Incorporated is the owner of United States Patents, Number 957403 dated May 10th, 1910, Number 1,153,593, dated September 14th, 1915, and Number 1,581,155 dated April 20th, 1926, all of which are duly recorded in the United States Patent Office at Washington, D. C. and that all persons manufacturing, jobbing, dealing in or purchasing Radio Products that are infringements on the aforesaid patents will be held liable for damages to the said Nathaniel Baldwin Incorporated.

Notice is also given that no rights of any kind or description are held by any Corporation, Company, person or persons to manufacture Radio Products under the aforesaid Patents.

Bankers Trust Company, Receiver for
NATHANIEL BALDWIN, Incorporated

John K. Hardy
Vice President

Salt Lake City, Utah.

1926-7 Models
Now Ready



J. W. & W. L. WOOLF

Eastern Representatives and
Exporters for

Nathaniel Baldwin, Inc.

227 Fulton St.

New York

Telephone 6519 Cortlandt

SEE ~
HEAR ~
the NEW
AMPLION
★ LOUD
SPEAKERS

Should your dealer not have them—write—

THE AMPLION CORPORATION
OF AMERICA

Suite 1, 280 Madison Avenue, New York
Amplion Corp. of Canada, Ltd., Toronto

This is a good time to subscribe for

RADIO BROADCAST

Through your dealer or direct, by the year only \$4.00

DOUBLEDAY, PAGE & CO. GARDEN CITY, NEW YORK

PRICES CUT

World STORAGE BATTERIES at Cost!



LIMITED TIME OFFER!

For a limited time only, genuine World Storage Batteries can be gotten at actual cost. Every cent of profit has been cut out in order to keep our full factory organization busy during the slack season. Prices below are lowest in history.

World Batteries are nationally known for dependable, long wearing performance. Solid Rubber Case prevents acid and leakage.

Send No Money!

Just state battery wanted and we will ship same day order is received, by Express C.O.D. subject to examination on arrival. 5% discount for cash in full with order. Send your order now and get your World Batteries at actual manufacturing cost.

WORLD BATTERY COMPANY
1219 So. Wabash Avenue
Chicago, Ill.
Sept. 24

Solid Rubber Case Radio Batteries
6-Volt, 100-Amperes \$10.50
6-Volt, 120-Amperes \$12.50
6-Volt, 140-Amperes \$13.25

Set your Radio Dial for the new 1000 w. World Battery Station **W5AC**, Chicago. Interesting programs every night.

★ **2-Year Guarantee Bond in Writing**
Approved and Listed as Standard by Leading Authorities

including Radio News Laboratories, Popular Science Institute of Standards, Popular Radio Laboratories, Radio Broadcast Laboratories, Radio In The Home, and Lefax, Inc.

Solid Rubber Case Auto Batteries
8 - Volt, 11 - Plate \$10.50
6 - Volt, 13 - Plate \$12.50
12 - Volt, 7 - Plate \$15.25

KDKA W5BC WFAF KYW

Radio's Latest Necessity—
BRACH

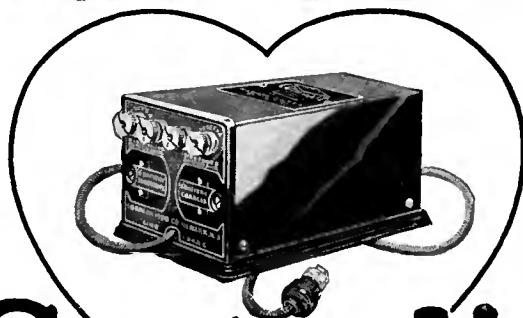

Controlit
THE HEART OF THE POWER PLANT

Your set switch or rheostat ALONE can now control "B" Battery Substitute and "A" Trickle Charger automatically.

Merely adding a BRACH CONTROLIT makes any set a light power-operated set, eliminating all switches from "B" Battery Substitute and Trickle Charger. No added wiring. No alterations to set required.

Anyone can install CONTROLIT, and the power plant can be placed anywhere—in cellar, or closet, or shelf. No radio user will be without it. Ask Your Dealer. **Price Only \$6** ⁱⁿ **U.S.A.**

See How CONTROLIT Operates—

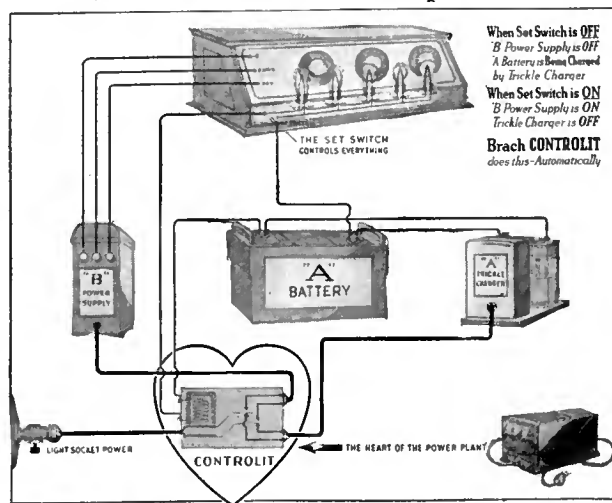

★ **Brach**
Radio Products

L. S. BRACH MFG. CO., Newark, N. J.
Makers of Famous Brach Lightning Arresters

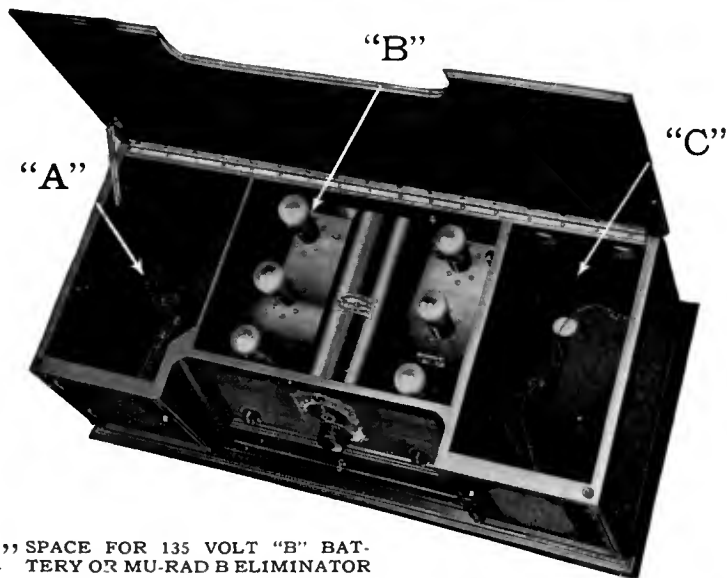

“A” SPACE FOR 135 VOLT “B” BATTERY OR MU-RAD BELIMINATOR

“B” POWER TUBE

“C” SPACE FOR “A” BATTERY AND TRICKLE CHARGER

PERFECTION

is never attained. Each year sees improvements in what was thought “the ideal” the year before. Thousands of persons have bought MU-RAD receivers in the past five years—thousands of others will buy MU-RAD Super-Sixes this year. And the MU-RAD Company now provides an exchange plan on old for new model receivers, so that owners of last year’s sets can secure a liberal allowance toward the purchase of a new

★ MU-RAD SUPER-SIX RECEIVER

- | | |
|--------------------------------|---|
| 1. Perfection of tone quality. | 4. Thunderous volume controllable to a whisper. |
| 2. Selectivity. | 5. Fine appearance. |
| 3. Long range. | 6. Single tuning control. |

There is a pride in possessing fine things.

MU-RAD RADIO CORP.

DEPT. B ASBURY PARK, N. J.

Why not subscribe to *Radio Broadcast*? By the year only \$4.00; or two years, \$6.00, saving \$2.40. Send direct to Doubleday, Page & Company, Garden City, New York.

Build Your Set Around ★ I. C. A. PANELS

For artistic beauty and insulating efficiency nothing can compare with I. C. A. Panels of Insuline or Bakelite. Furnished in Black and Wood finishes; Insuline also in “Frieze” finish as illustrated.

At your dealers or direct from us. Write for Free Booklet.

INSULATING COMPANY OF AMERICA, Inc., Dept. B9, 59 Warren St., New York City



Standard size blanks or drilled and decorated for all popular circuits.

Patent Office for 14½ years before its issue, is almost unique.

Not until about three years later, when this famous Berliner patent had, through strategy, been summoned before the Supreme Court of the United States, was Emile Berliner finally granted unreservedly by every legal means of investigation that could be summoned, his just claim to the distinction of being the inventor of the microphone.

Berliner to-day, is still living in Washington, and still inventing. His inventions have always been related to the science of acoustics. His lateral cut disc talking machine record and principle of making innumerable duplicates of it, are as fundamental to the talking machine industry to-day as are his gifts of the microphone and transformer to telephony and radio.

It remains to be seen what Berliner’s latest invention will do; early this year he was granted a patent for “acoustic tiles” and “acoustic cells.” They are for the purpose of rendering perfect acoustics in all large buildings used for auditorium purposes. “The problem of hall acoustics has always been a guess by architects,” Berliner explains. He claims that his latest invention solves the problem.

A KEY TO RECENT RADIO ARTICLES

By E. G. SHALKHAUSER

THIS is the eleventh installment of references to articles which have appeared recently in various radio periodicals. Each separate reference should be cut out and pasted on cards for filing, or pasted in a scrap book either alphabetically or numerically. An outline of the Dewey Decimal System (employed here) appeared last in the August RADIO BROADCAST, and will be reprinted in an early number.

R113.5 METEOROLOGICAL. STORMS. *Radio*. June, 1926, pp. 8-11. Effects of, “Bending of Radio Waves by Storms,” J. J. O’Neill.

Storms are said to act as reflectors and refractors of radio waves in the same way that a lens or a prism bends or refracts light rays. A storm is composed of atmospheric gases in various degrees of ionization. The effect of electrostatic and magnetic fields of force of radio waves is not unlike the effect of magnetic fields on light waves. High and low pressure areas and their effects upon the electrical condition of the atmosphere, the magnetic field of the earth and the effect of ionization by the sun on the outer atmospheric layers, make it possible to account to some degree for the bending of radio waves when passing through such complex electrical structures.

Observations have shown that the course the waves follow from the transmitting station varies considerably from the normal path, and that the refracted wave of each station tends to describe an arc of a circle concentric with the center of the high pressure area, or parallel to the isobars in the anticyclone area. Diagrams show how this distortion of the waves may occur. Since storms have a vertical as well as a horizontal structure, it is likely that the radio waves, which have a circular vertical as well as a circular horizontal section, would be subject to distortion.

R138. ELECTRON EMISSION; IONIZATION. ELECTRON EMISSION. *Radio*. June, 1926, pp. 12 ff. “Why Do Radio Tubes Peter Out,” V. G. Mathison.

The writer presents a simple explanation covering the structure of filament wires in vacuum tubes. Some of the late scientific discoveries about action of electrons emitted from various substances are told, and the problem of tube rejuvenation and the increasing of the active life of vacuum tubes is discussed.

R342. AMPLIFIERS. AMPLIFIERS. *QST*. June, 1926, pp. 25-28. “Amplifier Ins and Outs,” C. T. Burke.

The question of good and poor amplifiers is considered for the audio stages. An audio transformer may be represented by an equivalent filter circuit (shown in Fig. 1), which will bypass a definite band of frequencies as desired—for broadcast 100 to 5000 cycles, for telegraphy 800 to 1200 cycles, approximately.

Transformers are compared by reproducing their amplification curves, using frequency as abscissae and amplification as ordinates. This the author has done for four widely different transformers. The effect of using low or high primary impedance, and low and high ratio of turns, is outlined in detail, illustrations supplying the necessary information. Shunting transformers with leaks or condensers usually is detrimental for most transformers, as shown by curves.

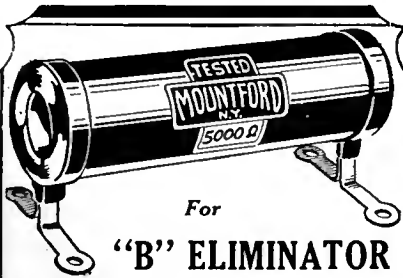

For
"B" ELIMINATOR
 and
C W TRANSMITTER

use
MOUNTFORD KROBLAK

Wire Wound 10 Watt
RESISTANCES

Sizes 750, 1500, 3000, 3500, 5000, List Price
 10,000, 25,000 and 50,000 ohms \$ **1.00**

FOR
 GREATER DISTANCE
MOUNTFORD
 VARIABLE LEAK List Price
50c

Over a Million in Use ★
 Ask Your Dealer for
 Mountford Grid Leaks Price \$.25
 Mountford RC Amplifiers 7.50
 Mountford RC Kits 5.50

FREE—Write for eight-page booklet of hook-ups
 Manufacturers—Write for quotations.
 Jobbers and Dealers—Write for discounts.

C.E. MOUNTFORD

467 Greenwich St. New York City

Thorola Receivers and Speakers ★
Must Outperform

Reichmann Company, 1725-39 W. 74th St., Chicago

ELECTRAD

Don't Fool With Lightning!

It doesn't pay to economize on a lightning arrester, or to use one you aren't sure of. You can't collect insurance unless

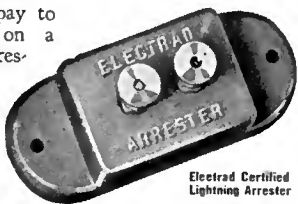

you have an arrester capable of passing the National Board of Fire Underwriters. Put in an Electrad Certified Lightning Arrester—then you're sure.

Air-gap type, exterior moulded porcelain, attractive finish. Completely sealed and moisture proof. Cost little, simple and easy to attach. At all good radio stores, 50c; in Canada 75c. Outdoor type \$1.50; in Canada \$2.10

III ★

For perfect control of tone and volume use the Electrad 500,000 ohm compensator. For free hookup write 428 Broadway, New York City.

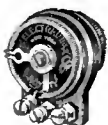

ELECTRAD Inc.

THE TUBE WITH THE SENSIBLE GUARANTEE



The Dam Support!

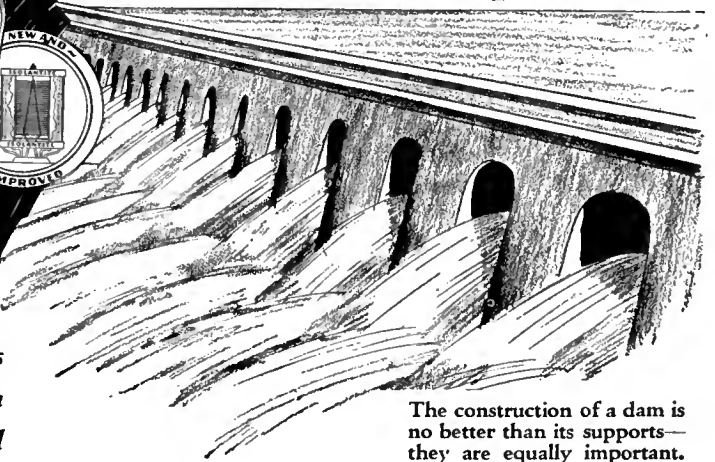

Vibrationless
 Uniform
 and Good

The construction of a dam is no better than its supports—they are equally important.

THERE are three elements in a radio tube. The slightest movement in relation to each other causes a characteristic change, invariably disqualifying the tube.

THE NEW SUPERTRONS HAVE SUPPORTS THAT TIE THE THREE ELEMENTS INTO ONE UNIT

The BASE and SUPPORTS are ISOLANTITE

All Types—At Public Demand Prices

SX 201 A	\$2.00
SX 199	2.25
SV 199 small	2.25
SV 199 large	2.25
SX 112	5.00
SX 120	2.50
SX HiMu	3.00
SUPERTHEON Half	4.00
SUPERTHEON Full	5.00

In Canada slightly higher

SUPERTRON MFG. CO., INC.
 HOBOKEN, N. J.

Export Dept.—220 Broadway, N. Y. C.
 Chicago Office—30 North Dearborn St.



SUPERTRON

A SERIAL NUMBER GUARANTEE

The Foremost Independent Tube in America

SM

Quality



—such as you've never heard. The Silver-Marshall 220 audio transformer compensates not only for shortcomings in modern broadcasting but it is the first transformer manufactured with a rising low note characteristic which compensates for conditions of a reverse nature in our speakers. Price \$6.00.

Read more about it in "The Secret of Quality" which covers every practical phase of audio amplification. Get a copy of this 96-page book from your dealer. Price 10c.

Long Wave Transformers



The 210 and 211 long wave transformers are measured and guaranteed. They are tested with equipment approximating actual receiving conditions, and actual amplification to the fraction of one percent is predicted in the tests that these transformers have to pass. The 210 is an untuned iron core transformer and the 211 is a sharply tuned air core filter. Supplied, measured in any quantity for 199 or 201A tubes. Each \$6.00.



Silver-Marshall, Inc.
838 West Jackson Blvd.
Chicago, U. S. A.

Now is the time to subscribe for **RADIO BROADCAST**
Through your dealer or direct, by the year only \$4.00

DOURLEDAY, PAGE & CO.

GARDEN CITY, NEW YORK

F. D. PITTS COMPANY

INCORPORATED

219-C Columbus Avenue, Boston, Mass., U. S. A.

"Pioneers in the Distribution of Radio"

DEALERS—Send for large and profusely illustrated catalog on the products of nationally advertised radio manufacturers.

MERCHANDISING RADIO SINCE 1919

R386. FILTERS. SUPER-HETERODYNE
Radio. June, 1926, pp. 22-24. BANO FILTER.
"Design of Band Pass Filters for Super-Heterodynes,"
R. B. Thorpe. (Coot'd from May issue, pp. 25)
A study of design factors for band pass filters used with super-heterodynes is discussed, and a table presented showing values of filter constants for definite cut-off frequencies. Formulas are given for determining the constants of the filter circuit, inductances, and capacities, for the cut-off frequencies desired.

R342.2. RESISTANCE COUPLING. COUPLING.
Radio. June, 1926, pp. 25-26. Resistance and Impedance.
"Improving the Resistance- or Impedance-Coupled Amplifier," C. Osborne.
The resistance- and impedance-coupled audio amplifier sometimes has r. f. currents bypassed, which results in howls and squeals being heard in the reproducing device. This is especially the case with super-heterodynes, where two a. c. components are found after the second detector tube. The r. f. component should be eliminated, which can be done by introducing an r. f. choke coil and a condenser next to the plate of the detector tube (shown in Figs. 1 and 2). The size of the choke will depend upon the type of r. f. amplification employed.

R343.5. HETERODYNE SETS. SUPER-HETERODYNE.
Radio. June, 1926, pp. 29-30. Best's.
"Improvements in the Best Super-Heterodyne,"
G. M. Best.
The writer presents four schematic wiring diagrams of the Best Super-Heterodyne with improvements in the design, previous articles having appeared in May, 1924, January, August, and September, 1925, showing this circuit layout.

R430. INTERFERENCE ELIMINATION. INTERFERENCE.
Radio. June, 1926, pp. 31-32.
"Radio Interference From Power Lines," P. S. Donnell.
The causes of radio interference and suggested remedies are listed as follows: Line troubles, insulator leaks, lightning arresters, transformers, generators, motors and synchronous converters, arc light circuits, smoke and dust precipitators, sign flashers, heating pads, violet ray machines, X-ray machines, mechanical rectifiers, electric elevators, electric furnaces.

R613. SHIP STATIONS. MARINE TUBE
Radio. June, 1926, pp. 33-34. TRANSMITTER.
"Modern Marine Radio Equipment," H. S. Pyle.
The text discusses in detail the four component parts of one of the modern shipboard radio telegraph stations—Transmitter type ET 3627-A using three 6V-211 power tubes rated at 100 watts each; type 501 receiver; power plant, and auxiliary supply source.

R110. RADIO WAVES. POLARIZED
QST. June, 1926, pp. 9-16. TRANSMISSION.
"Polarized Transmission," R. S. Kruse.
In an interview with Doctor Alexanderson, Mr. Kruse points out some discrepancies between common knowledge gained from old text books regarding radiation, and information obtained through short-wave experiments. Our former conception of radiation was based on loaded antennas, fairly long waves, and ground connection or fairly high capacity counterpoise, he states. With the use of short waves, transmission and reception was reported very good using horizontal instead of vertical antennas. Alexanderson constructed a special horizontal loop tuned to 6000 kc. (50 meters) in order to study horizontally polarized waves. The various effects were observed with an exploring antenna (described) and a four-tube receiver reading comparative values in microvolts per meter. The composite picture which was obtained from the test was a continuously twisting plane of polarization with alternated points of plane and circular polarization. Therefore, a horizontal and a vertical wave component exist with different velocity of propagation, he says. When the horizontal and the vertical are in phase, they give plane polarization; when 90 degrees out of phase, they give circular polarization.
The mechanical model used to illustrate this phenomena is described, and its operation discussed. There seems to be no doubt that the currents induced in the ground play some part in the transmission of radio waves, as noted.

R344.3. TRANSMITTING SETS. TRANSMITTER,
QST. June, 1926, pp. 29-32. Crystal-Controlled.
"A Multi-Stage Crystal-Controlled Transmitter,"
J. M. Wells and E. D. Tillyer.
A three stage power-amplifier crystal-controlled transmitter is presented with detailed information on how to build and operate it. Either a 937 kc. (320-meter) or a 1874 kc. (160-meter) crystal may be used, depending upon the number of stages of amplification and the final working wave desired. Each successive stage is worked on the harmonic of the preceding one, thus unusually stable operation is obtained.

In building the set, each tube circuit should first be set up and adjusted separately before starting the next one. Beginning with an UX-112 oscillator and reduced plate voltage, this circuit contains the crystal. The output is then fed into another UX-112, and from there into an UX-210 tube. To this arrangement may be added either a 50-watt or a 250-watt. The method of tuning and making adjustments is given in detail.

R344.3. TRANSMITTING SETS. TRANSMITTER,
QST. June, 1926, pp. 45-48. 1 XM.
"A. R. R. L. Standard Frequency Station 1 XM,"
K. V. R. Lansing.
The experimental station located at the Massachusetts Institute of Technology, call 1 XM, is described. An 100-watt transmitter, consisting of two 50-watt tubes in a push-pull circuit of unusual design (shown in Fig. 4), is mounted on a vertical panel with tube rectifiers for plate voltage. A second transmitter, used for sending standard frequencies, uses a 250-watt tube in a tuned-plate, tuned-grid circuit (diagrams shown). The method of quickly adjusting this transmitter to the desired frequency is outlined. A power panel, similar in appearance to the transmitter panel, supplies power to both transmitters.

Only the Best Radio Parts are good enough for a Good Set

All Benjamin Radio Products are of the same high standard as the far-famed Cle-Ra-Tone Sockets—

Quality in every part of a radio set is depended upon for true-to-life reproduction of radio. There dare not be a flaw anywhere. And all the parts must synchronize. Each Benjamin Radio Product fits in perfectly with the power and conditions of the set and contributes greatly to its sensitivity, selectivity, volume and quietness. The use of Benjamin Radio Products in every part of the world—by authorities and amateurs—endorses the quality and effort that the Benjamin Electric Mfg. Co., has put into each product.



Volume
With
Clarity

DOUBLE ENJOYMENT
From Any Set With

★ Burns LOUD SPEAKER

Why sacrifice the excellent reproducing qualities of a set by the use of an inferior speaker. With a BURNS it is possible to reproduce with amazing exactness every note of music and inflection of voice that the set can pick up. A trial will convince.

AT YOUR DEALER'S OR WRITE DIRECT

**American Electric
COMPANY**

State and 64th Sts. Chicago, U. S. A.

Ask About BURNS B-Eliminator

RADIO PANELS

OF GENUINE BAKELITE

Cut, drilled and engraved to order. Send rough sketch for estimate. Our New Catalog on Panels, Tubes and Rods—all of genuine Bakelite—mailed on request.

STARRETT MFG. CO. ★

521 S. Green Street

Chicago, Ill.

If you want real radio enjoyment—buy a Majestic! "B" current supply unit!

A MAJESTIC will give you added volume—better tone. It will supply constant dependable power. Operates direct from your light socket at an average cost of only one-tenth cent an hour!

Majestic "B" Current Supply delivers pure, direct current from your light socket.



**Economical, Powerful
Lasts as Long as Any
Receiver**

Go to the dealer from whom you bought your set or any other reliable dealer and get a Majestic "B" Current Supply.

Attach it to your set. At the end of seven days if you are not fully satisfied, your money will be refunded by your dealer. Fully guaranteed. Its low purchase cost and the saving it will mean to you in just a few months make it an investment that soon pays for itself.

Majestic Standard "B" for sets up to seven 201-A Type tubes or six 201 plus on power tube. Price \$32.50

Majestic Super "B" capacity 1 to 12 tubes, including the use of new power tubes. Price \$39.50

GRIGSBY-GRUNOW-HINDS CO.
4570 Armitage Ave. Chicago, Ill.

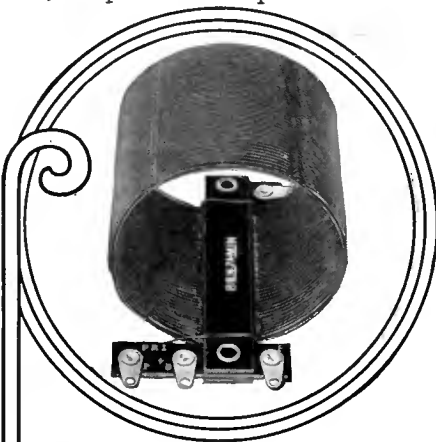

Improved Tuned Radio Frequency Transformers

Proved through exhaustive and comparative tests to be the most efficient coil for modern radio sets. Better in all important features and characteristics. Space wound. Basket weave. Cylindrical. Highest practical air dielectric. Gives wonderful sharpness in tuning, better volume and purer tone quality.

2 1/4" Diameter Transformer

Compact. Especially desirable for crowded assembly. Eliminates interfering "pick-up." Set of three, \$5.75—Single Transformer, \$2.10.

3" Diameter Transformer

Capacity coupling reduced to lowest degree. For use with .00035 Mfd. Condensers. Set of three, \$6.00—Single Transformer, \$2.25.

"Lekeless" Transformers

Uniform high inductance, low distributed capacity and low resistance. The external field is so slight that it permits placing coils close together without appreciable interaction. Single Transformer, \$2.50.



Brackets

An aid to simplification in set construction. Support sub-panel, with room underneath for accessories and wiring. Plain and adjustable. Plain 70 cents per pair; a adjustable \$1.25 per pair.



Push Type Cle-Ra-Tone Sockets

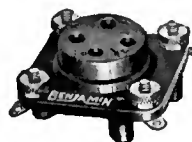

Spring Supported, Shock Absorbing. Stop Tube noises. Greatest aid to non-noisy operation. Contacts always clean. 75 cts. each.



Battery Switch

Quick, positive, clean-cut make and break. When it's "in" it's "off," eliminating danger of wasteful use of battery. 30 cents each.

Straight Line Frequency Condensers

No crowding of Stations. The broadcast range is spread evenly over the complete dial. Stations come in without interference, and tuning is much easier. An instrument made with the precision and compactness of a watch. Adjustable turning tension.

.00025 Mfd., \$5.00 .00035 Mfd., \$5.25
.0005 Mfd., \$5.50

If your dealer cannot supply you send amount direct to our nearest sales office with his name

See Benjamin Products at the
Radio Shows

San Francisco, Calif., Aug. 21-28. Booth 87.
New York, N.Y., Sept. 13-18. Booth 9, Sec. CC.
Chicago, Ill., October 11-17. Booth 9, Sec. P.

Benjamin Electric Mfg. Co.

New York 247 W. 17th Street
120-128 S. Sangamon St. Chicago
San Francisco 448 Byrant Street
Manufactured in Canada by the Benjamin Electric Mfg. Co. of Canada, Ltd., Toronto, Ontario



No Change in Wiring ~ with the adapted Mogul 5VCX Power Tube

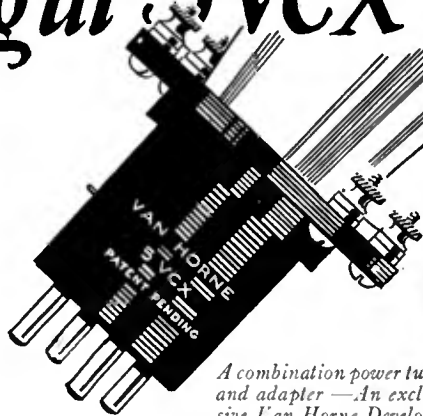

A combination power tube and adapter—An exclusive Van Horne Development

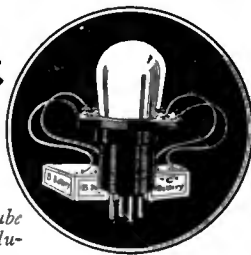

This unusual tube—which you can put in your set like an ordinary tube—makes a decided improvement in reception.

The Adapted Mogul 5VCX power tube not only increases volume but gives that roundness of tone and clear cut reproduction of voice and music that is lost when an ordinary tube of insufficient capacity is used.

Ask your dealer to demonstrate this tube to you, to-day. The Van Horne Company manufactures a variety of tube types for all receiving purposes. You are urged to become acquainted with the complete line—write for descriptive matter or see your dealer.

THE VAN HORNE CO., Inc.

904 Center St.

Franklin, Ohio

Now is a good time to subscribe for

RADIO BROADCAST

Through your dealer or direct, by the year only \$4.00

Doubleday, Page & Company

Garden City, New York

BAKELITE for Radio Parts



The use of Bakelite parts in the set you buy or build, will insure you against inferior reception through defective insulation. Write for booklet 29.



BAKELITE CORPORATION

247 Park Ave., New York, N. Y. Chicago Office: 636 W. 22nd St.
BAKELITE CORP. OF CANADA, LTD., 163 Dufferin Street, Toronto, Ontario, Canada

R344.3. TRANSMITTING SETS. TRANSMITTER, Crystal-Controlled.
QST. May 1926, pp. 43-45.
"Adjusting the Crystal-Controlled Transmitter," S. P. McMin.

The adjustments of a crystal-controlled circuit are easily made if proper precautions are considered. The operator of station 2 WC presents his experimental layout, consisting of one UX-210 oscillator, and two 203-A amplifiers, and explains the details concerning adjustment and operation. Proper precautions are necessary to avoid ruining the crystal in the oscillator plate circuit.

R343. ELECTRON-TUNE RECEIVING SETS. RECEIVER, Roberts.
Radio News. May, 1926, pp. 1562ff.
"Building the Roberts Circuit," A. MacGillicuddy.

The layout of a five-tube Roberts circuit is shown, information being given on the proper operation and neutralization of the set.

R134.4. REGENERATIVE ACTION. REGENERATION.
Radio News. May, 1926, pp. 1564ff.
"What is Regeneration—Part II," K. W. Jarvis. (Continued from April issue).

A tube begins to oscillate at the point of "critical regeneration," says the writer. Regenerative amplification is said to depend on the choice of the tube and not the type of circuit. The effect of grid leak and condenser on regeneration, the explanation of "negative resistance" when speaking of regeneration, the effect of series resistance in the grid circuit, heat reception phenomena, the question of sharpness of tuning, and the effect of re-radiation from antennas are discussed in detail.

R344.3. TRANSMITTING SETS. TRANSMITTERS, Schenectady.
QST. June, 1926, pp. 33-39.
"South Schenectady and the April Tests."

The paper presents a short description of the various short-wave stations used in recent tests at Schenectady. These include 2 XAG, 2 XAH, 2 XK, 2 XAC, 2 XAF, 2 XAD, 2 XAW, and 2 XAF. The method of controlling the 20-kw. energy output from 2 XAF, using fifth harmonic and an UX-210 tube as master oscillator, is described.

R113. TRANSMISSION PHENOMENA. EARTH ELECTRICITY.
Popular Radio. June, 1926, pp. 111ff.
"Earth Electricity—Does It Affect Radio Reception?" E. E. Free.

The problem of earth currents, the amount, the changes, the source, and the effect on radio waves, is discussed. Radio waves are supposed to travel between two great electric charges, the positively charged upper air and the negatively charged surface of the earth. Near the surface a potential gradient averaging 150 volts per meter is found, this value decreasing with height. The negative charge of the earth is not a constant, but undergoes daily and seasonal variations which may or may not be regular. The negative charge on the earth is continuously being dissipated to the air, but at the same time constantly renewed from some source unknown, and little understood. The variation in earth potentials, results in earth currents flowing from places of higher potential to those of lower potential, and this flow is said to affect the travel of radio waves.

R550. BROADCASTING. MICROPHONE, FRIGHT.
Popular Radio. June, 1926, pp. 114ff.
"Micro-Fright," Homer Croy.

The experiences of the writer, as he steps before a microphone for the first time, are related. He sets down four rules a broadcaster should follow. First, rehearse your talk or your song before you face the microphone. Second, bring your sheet music or your manuscript with you. Third, use a porous paper that does not crinkle when you turn the pages. Fourth, clear your throat before you begin to talk or sing. Several points a radio director should consider before placing a number on a radio program are mentioned and discussed.

R110. RADIO WAVES. RADIO WAVES.
Popular Radio. June, 1926, pp. 124-126.
"Radio Uses no Ether Waves," W. W. Massie.

Instead of accepting the Hertzian wave theory of radio wave propagation, the writer adheres to the magnetic wave theory. He explains his conception of wave transmission by stating that "Wireless signals are a wave motion, in, or disturbance of, the magnetic forces of the earth, and are propagated through this magnetic field, following the curvature of the earth, just as a tidal wave would follow the surface of the ocean." Practice indicates that the nodal points of the waves are at, or near, the earth's surface. Accordingly, the magnetic field runs parallel to the surface of the earth and any disturbances set up are propagated along these magnetic lines of force. Also, there is a direct connection between earth currents and radio reception, the strongest signals being heard along the lines of earth current travel.

R343. ELECTRON-TUBE RECEIVING SETS. FERGUSON, MODEL 8.
Popular Radio. June 1926, pp. 131-136.
"How To Get the Most Out Of Your Ready-Made Receiver," S. Gordon Taylor.

The Model 8 Ferguson receiver is described and explained in detail. The construction, the operation, the circuit and its theory, the correct tubes and batteries to use, and the design of the set, are all clearly outlined for the owner of such a set.

R. 342.7. AUDIO FREQUENCY AMPLIFIERS. AUDIO FREQUENCY AMPLIFICATION.
Popular Radio. June, 1926, pp. 138ff.
"Audio-Frequency Amplification," John V. L. Hogan.

The question "What constitutes good amplifiers and loudspeakers?" is considered. The loud speaker and the amplifying system are inter-dependent and must be so considered in the practical and theoretical analysis. A practical transformer should magnify uniformly between 64 and 6000 cycles per second, says the writer. Good amplification consists—first in efficient tube coupling apparatus; second, in the elimination of tuning or resonant effects or feedback conditions in the audio system; third, in using vacuum tubes large enough to handle the maximum output of the set without overloading; and, fourth, in the proper choice of a loud speaker.

ACME CELATSITE BATTERY CABLE

—a silk-covered cable of vari-colored Flexible Celatsite wires, for connecting batteries to set. Prevents "blowing" of tubes: gives your set an orderly appearance.



Stranded Enameled Antenna

Best outdoor antenna you can buy. 7 strands of enameled copper wire; maximum surface for reception. Prevents corrosion and consequent weak signals.



The Original Celatsite

—a tinned, copper bus bar wire with non-inflammable "spaghetti" covering, for hook-ups. 5 colors; 30-inch lengths. We also offer the highest grade of "spaghetti" tubing for Nos. 10 to 18 wires. 5 colors; 30-inch lengths.



Flexible Celatsite

Flexible, stranded wire for point-to-point and sub-panel wiring. Non-inflammable "spaghetti" covering. In black, yellow, green, red and brown; a color for each circuit. Put up in 25-foot coils.



Send for folder

THE ACME WIRE CO., DEPT. B
NEW HAVEN, CONN.

ACME WIRE MAKES BETTER RADIO

SENT ANYWHERE ON 10 DAYS' FREE TRIAL

5 TUBE RADIO
GUARANTEED
BIG POWERFUL
MIRACO ultra 5

Users everywhere report it gets programs coast to coast. Canada to Gulf, loud and clear on speaker; outperforms \$100 to \$250 sets. Many \$59.50. Hear Europe. Marvellous value. Let user's testimony convince you. Retail

FACTORY PRICES—SAVE **MIRACO RADIO GETS 'EM COAST TO COAST**

1/3 TO 1/2. Smaller Sets \$13.75 up, retail. FREE Literature on latest 10 tube models (Agents new low prices and SPECIAL OFFER!) Write! **MIDWEST RADIO CORPORATION** Pioneer Builders of Sets 406-B-E 8th St., Cincinnati, Ohio

Simplifies!

No guessing, less wiring and—no grief—with **AMPERITE**. Eliminates hand rheostats. **AMPERITE** is the only perfect filament control. Specified in all popular construction sets. Price \$1.10.

Radiall Company
Dept. RB-9 50 Franklin Street, New York City

Write for FREE Hook-ups

AMPERITE

The "SELF-ADJUSTING" Rheostat



A New and Advanced Model—

Norden-Hauck Super-10

Highest Class Receiver in the World

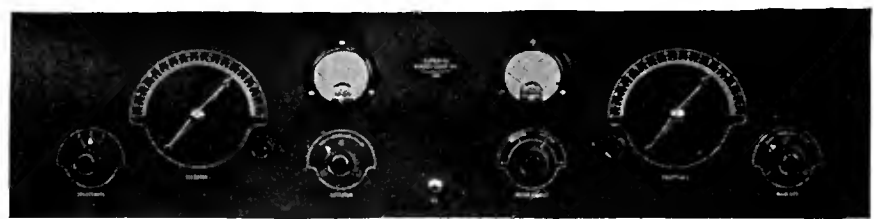

Panel Size: 36"x9"x1-4"

Weight: 55 lbs.

THE NORDEN-HAUCK SUPER-10 is an entirely new and advanced design of Receiver, representing what we believe to be the finest expression of Modern Radio Research Engineering. It is the product of years of experience devoted exclusively to the attainment of an ideal Broadcast Receiver—regardless of cost.

Results obtained in every respect will upset all your previous ideas of good radio reception. Here are only a few of the host of features that place the NORDEN-HAUCK SUPER-10 far in advance of competition:

- 10 tubes employed to give perfect reproduction with unlimited range and volume power.
- Super selectivity on all wave lengths.
- Built to Navy Standards.
- Wide wave length range without change of coils, etc. (Adaptable 35 meters to 3600 meters if desired.)
- Use Loop or Antenna.
- Simple to operate, having only two major tuning controls.
- No Harmonics. Signals are received only at one point.
- Special Power Audio Amplifier, operating any loudspeaker and eliminates necessity of external amplifier.
- Can be operated directly from house current if used with NORDEN-HAUCK POWER UNIT AB-2.

The NORDEN-HAUCK SUPER-10 is available completely constructed and laboratory tested, or we shall be glad to supply the complete engineering data, construction blue prints, etc., for those desiring to build their own receiver.

TEAR OFF AND MAIL TODAY

Upon Request A complete catalog, attractively illustrated, will be gladly mailed without charge, or full size constructional blue prints, showing all electrical and mechanical data, will be promptly mailed postpaid upon receipt of \$2.00

Write, Telegraph or Cable Direct to
NORDEN-HAUCK
Incorporated
ENGINEERS
MARINE BUILDING
★
Philadelphia, U. S. A.

NORDEN-HAUCK, Inc.
Philadelphia, U. S. A.

Gentlemen:—

Please send me without cost or obligation on my part, attractive illustrated literature describing the new Norden-Hauck Super-10.

I enclose \$2.00 for which please send me, postpaid, complete full size constructional drawings and all data for building the Super-10.

Name _____

Address _____

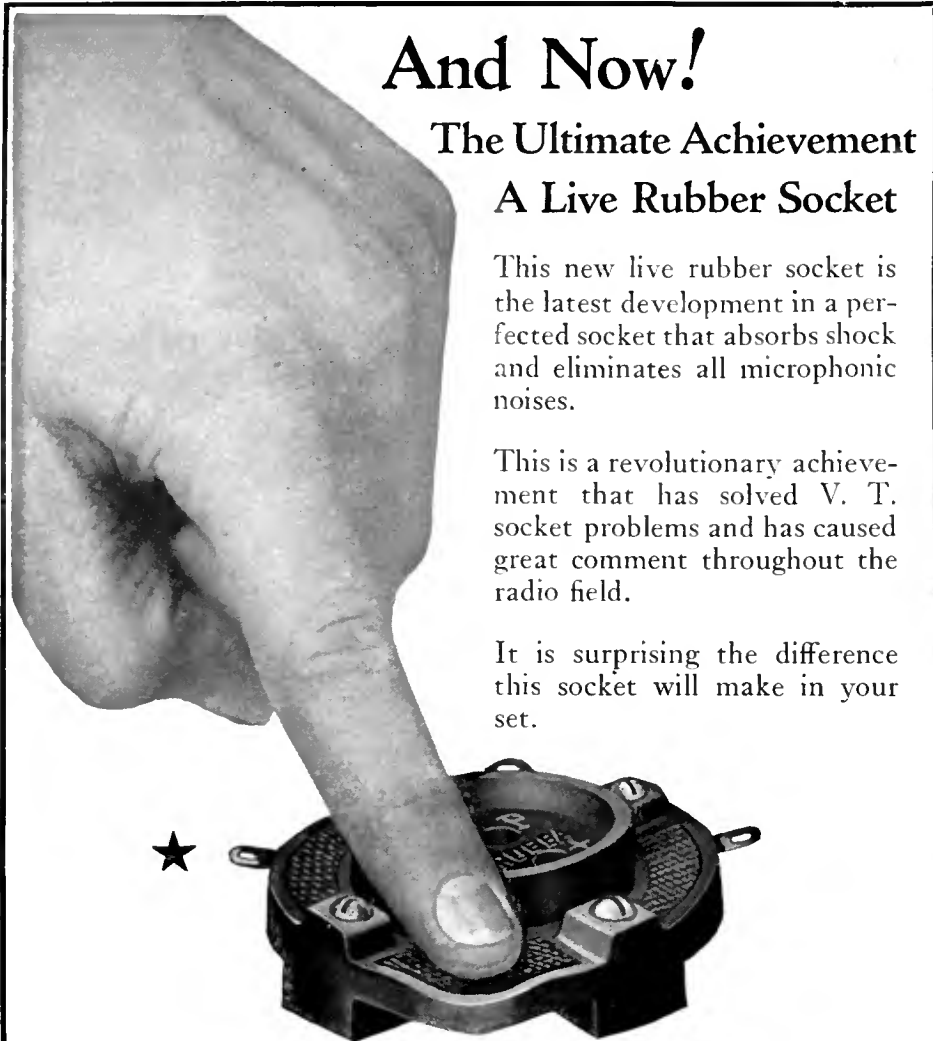

And Now!

The Ultimate Achievement

A Live Rubber Socket

This new live rubber socket is the latest development in a perfected socket that absorbs shock and eliminates all microphonic noises.

This is a revolutionary achievement that has solved V. T. socket problems and has caused great comment throughout the radio field.

It is surprising the difference this socket will make in your set.



SOFRUBBA

Here are some of the remarkable features of the Sofrubba Socket. Ask your dealer about them or write us direct.

- It is a perfect shock-absorber.
- It is made of special process soft—live—rubber.
- It is guaranteed without qualification against rubber change or any other defect for five years.
- It is unbreakable.

- It is adaptable to top and sub-panel mounting without change.
- It aligns itself to warped panels and imperfect panel drilling.
- It gives a perfect hugging contact.
- Each contact is one continuous piece and self-cleaning.
- It is *Universal*. Takes UV and UX types of tubes.
- It is good-looking—practical—efficient.
- Its low price, alone, makes it distinctive.

Attention, Department C.



MOULDED PRODUCTS CORP.

Moulders of Bakelite and other compounds

549-551 West 52nd Street, New York City

Why not subscribe to *Radio Broadcast*? By the year only \$4.00; or two years \$6.00, saving \$2.40. Send direct to Doubleday, Page & Company, Garden City, New York.

ALHAMBRA

LOW FREQUENCY PAPER

FOR

CONE TYPE SPEAKERS

THE SEYMOUR CO. ★

323-329 West 16th Street, New York

R380. PARIS OF CIRCUITS; INSTRUMENTS. METERS. *Popular Radio*. June, 1926, pp. 141ff. *Use in Receivers.* "Use Meters to Avoid Breakdowns," D. B. Hill.

The use of meters in receiving sets is important. It is recommended that, if possible, four meters be used in recording the condition of the energy supply to the receiver. These meters, in their order of importance, are: Filament voltmeter, plate voltmeter, plate milliammeter, and filament ammeter. The practical use and the operation of each in its place is discussed.

R350. BROADCASTING. *Popular Radio*. June 1926, pp. 144ff. *BROADCASTING. Effects of "Rebuilding Bodies by Radio,"* Sir B. Bruce-Porter.

The psychological effect that radio programs have upon the subconscious mind of people, especially upon the mind of a patient in a hospital, is told by the writer, who is head of the Third London General Hospital. Disordered minds are soothed by the broadcast programs and likewise morbid thoughts prevented.

R343.7. ALTERNATING CURRENT SUPPLY. *RAYTHEON Popular Radio*. June, 1926, pp. 147-151. *POWER PACK. "The Raytheon Power-Pack, Part II,"* L. M. Cockaday.

Four models of Raytheon Power-Pack units are shown, together with blue-prints of circuit diagrams and lists of materials needed to construct each. The transformers selected for these models are All-American, Thordarson, Acme, and Precise.

R110. RADIO WAVES. *Popular Radio*. June, 1926, pp. 155ff. *RADIO WAVES. "Can We Make Use of Millimeter Waves?,"* E. E. Free.

Doctor Langmuir suggests the use of millimeter waves for communication purposes, using new methods in producing these waves. He suggests some totally new device for generating and refers to similar devices which have been used, such as the iron-dust generator of Madam Glamolew-Arkedewa, or the vacuum tube having all parts enclosed in it, or a reflector method, or production of waves directly from heat energy. The radio amateurs in his opinion are best equipped to undertake such experimental work.

R113. TRANSMISSION PHENOMENA. *EARTH Radio News*. June, 1926, pp. 1624ff. *ELECTRICITY. "Radio Reception by Ground Alone,"* S. R. Winters.

The experiments conducted by Doctor Rogers with his eight-tube super-heterodyne and underground radio system seem to indicate the advisability of further investigation. Static is said to be practically unknown and reception seems to be much improved. Earth propagation of radio energy is considered in relation to aerial propagation, reference being made to some other theories of wave travel, such as the Kennelly-Heaviside layer, and the Hertzian wave theory.

R381. CONDENSERS. *Radio News*. June, 1926, pp. 1640ff. *CONDENSERS. Fixed. "The Manufacture of Mica Condensers,"* S. Siegel.

Fixed condensers must meet two requirements, namely, accuracy and electrical efficiency. In the manufacture of fixed mica condensers the mica must undergo rigid tests. Thorough impregnation, to guard against moisture, is necessary. Capacities may vary greatly, even after being assembled cautiously and as nearly identical as possible. Present patented processes insure more accurate capacity ratings now, even before making final assembly.

R355. FORESTRY. *Radio News*. June, 1926, pp. 1644ff. *FORESTRY AND RADIO. "Static Forecasts Forest Fires,"* S. R. Winters.

The use of radio in detecting the relation of static conditions to forest fires has been fairly well established during the past few years. What are known as static stations have been in operation in various localities in the Northwestern forests where weather conditions, humidity, barometer readings, etc., are studied in comparison to static or atmospheric. It has been found that humidity increases with static, although daily and seasonal variations must be taken into consideration.

R342.15. AMPLIFIER TRANSFORMERS. *Radio News*. June, 1926, pp. 1662ff. *TRANSFORMERS. Audio-frequency. "Audio-Frequency-Amplifier Transformers,"* S. Harris.

Good transformers must have output voltages which in every way correspond to the input voltages, so that the voltage ratio at any instant be a constant, says the writer. This idea is made clear by an extensive comparison of harmonics and frequencies of the musical scale to the natural characteristics of the transformer with its possible irregular amplification of harmonics and overtones over the audible scale.

R342.15. AMPLIFIER TRANSFORMERS. *Radio News*. June, 1926, pp. 1665ff. *TRANSFORMERS. Constants of. "How Transformer Constants Are Measured,"* S. Harris.

The measurement of transformer characteristics, voltage ratio, primary inductance, resistance, power losses, core losses, impedance, etc., are easily made by using the set-up described and illustrated. The circuit consists of an audio-frequency generator, an amplifier, the transformer under test, and the measuring instruments. The operation of the set-up is considered very simple, equations and mathematical deductions being presented to facilitate its use.

R160. RECEIVING APPARATUS DESIGN. *RADIO BROADCAST*. July, 1926, pp. 248-252. *RECEIVERS. Design of. "Tendencies in Modern Receiver Design,"* J. G. Aceves.

In a paper delivered before the Radio Club of America, the author surveys the field of radio receiver design, classifying it as follows: (1) The regenerative detector; (2) The neutralized radio-frequency amplifier with or without regeneration; (3) The double detection or super-heterodyne types. These receivers are studied from various standpoints, namely: technical, acoustical, and operative, and in turn the radio-frequency amplifier, the detector, the audio-frequency amplifier, the translating device or loud speaker, and the source of power, are considered. Supplemented by various diagrams and curves, the article gives considerable information relative to the history and the developments of receiving sets in use to-day.

VOLUME ~ CLARITY
LONG LIFE



signify

VOLTRON TUBES

POWER TUBES are coming more and more into use so we are adding the following to our line;

VOLTRON 5 L-S & 5 P
Filament Voltage 5.
Filament Current .5
Plate Voltage 135

NOTE — 5 L-S should be used only in the last audio stage.

VOLTRON 7½ P-R
Filament Voltage 7.5
Filament Current 1.25
Plate Voltage 425.



MAC LAREN
MANUFACTURING Co. Inc.
26 Park Place
NEW YORK CITY



New "A" Power Unit for better radio service. A regular charger or trickle charger combined.



Radio standard battery, built specially for radio use, with extra heavy plates.

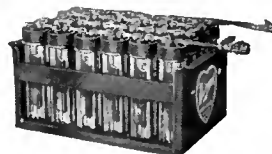

A 48 volt Universal "B" Battery. Assures constant voltage and clearest possible reception.

Abolish crackling and fading with this new "A" Power Unit

PLUG-IN style combining a specially built battery of new type with a bulb type charger — all in one unit, enclosed in attractive aluminum cabinet. Compact, efficient, silent.

Trickle-charges your battery while the set is in use or charges it at a higher rate if desired—easily controlled by one switch.

Beautifully made and finished, the battery having specially molded glass case, this Power Unit is a handsome addition to any set.

It keeps your "A" battery in top notch condition at all times thus assuring the perfect reception that is best obtained with a good storage battery.

Like all Universal products, this Unit is made from the finest and most suitable materials, tested in our own laboratories, pronounced perfect by experts before it leaves our factory.

Universal Radio Batteries are made solely for use with Radio sets—they're not ordinary storage batteries re-named.

Send for Free Battery Guide—the book which made such a hit when broadcasted. Thoroughly covers care of batteries for both Auto and Radio.

UNIVERSAL BATTERY COMPANY
3449 South La Salle St., Chicago
Batteries for every Purse and Purpose
AUTOMOBILE • RADIO • FARM LIGHT
Parts for all makes of batteries
SHOP EQUIPMENT



UNIVERSAL BATTERIES

for
radio
aerials
—COPPER
wire



COPPER combines
the essential
qualities of—
resistance to cor-
rosion,
tensile strength,
high conductivity.



COPPER & BRASS
RESEARCH ASSOCIATION

25 Broadway, New York

RADIO FANS, a one-year's subscription to Radio Broadcast will cost you four dollars, two years six dollars. Consider this expenditure as being a necessary investment on your part for the future development of your own knowledge of Radio.

Big FREE RADIO
Catalog & Guide

PARTS, HOOK-UPS, SETS and KITS

Send now for this valuable FREE book. Full of advanced hook-ups, parts and kits. A real guide. Shows factory built sets and the new ideas in radio. Send at once. No charge. No obligation. Please include name of radio fan.

The LATEST HOOK-UPS & RADIO Catalog

BARAWIK CO.
102-109 S. Canal St., Chicago

THE
"RADIO BROADCAST"
INFORMATION SERVICE

How to Write for Technical Information—The Scope of This Service

AS WAS announced in the June RADIO BROADCAST, all questions which were formerly sent to "The Grid" will now be handled by the Technical Information Service, RADIO BROADCAST Laboratory. That service is maintained under the following rules:

1. All questions from subscribers to RADIO BROADCAST will be answered free of charge.
2. Non-subscribers to RADIO BROADCAST will be charged a fee of One Dollar for the Laboratory Technical Service.
3. All questions will be answered by mail and none will be published in RADIO BROADCAST.

The Technical Information Service of the Laboratory feels that it is important to define the scope of its service to readers. Although the Service is of very general help to our readers, there are certain demands which can not be met.

The Technical Information Service:

1. Cannot make comparisons between various kinds of receivers or manufactured apparatus.
2. Wiring diagrams of manufactured receivers cannot be supplied. This information can be secured from the various manufacturers.
3. Complete information cannot be given about sets described in other publications, but in all cases (wherever possible), inquirers will be referred to a source of information where the data can be obtained. In this connection, the monthly department in RADIO BROADCAST "The Best in Current Radio Publications" should be of great help, and should be consulted. That department records the most important constructional, technical, and general radio articles which appear.
4. Special receivers or circuits cannot be designed by the Technical Service.
5. Those who ask questions which cannot be answered in the scope of a letter will be referred, if possible, to sources where the information can be obtained.

In response to many requests, lists of the various groups of apparatus tested and approved by RADIO BROADCAST Laboratory will be mailed to all inquirers without charge.

TECHNICAL INFORMATION INQUIRY
BLANK

Technical Service,
RADIO BROADCAST Laboratory,
Garden City, New York

GENTLEMEN:

Please give me fullest information on the attached questions. I enclose a stamped addressed envelope.

I am a subscriber to RADIO BROADCAST, and therefore will receive this information free of charge.

I am not a subscriber and enclose \$1 to cover cost of the answer.

Name

Address

Errata

TWO unfortunate errors crept into our August number on Lab. Sheet No. 20. Under the numerals, there should be five dashes for "Zero" while the code expression for "Transmission Finished" is dot-dot-dot-dash-dot-dash.



Important

little gateways of
reception

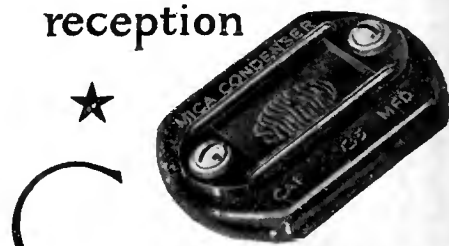

CONDENSERS are the entrances that make or mar a good performance. A good condenser stores up tone impulses, to be released at the instant they reach full-rounded perfection. An inaccurate condenser lets only a distorted part of the tone trickle through, and cuts down the receiving range of your set by putting it out of electrical balance. You'll realize the importance of accurate condensers the day you equip your set with Sangamo Mica Condensers.

SANGAMO
Mica Condensers

Being solidly molded in bakelite, Sangamo Condensers are accurate forever. All edges are sealed tight against moisture, the worst enemy of condenser accuracy. Ribs of bakelite give mechanical strength and prevent a change in pressure on the delicate mica inside, which would also change the condenser capacity. All edges are rounded to prevent chipping.

A range of 35 capacities makes it possible to get exactly the right capacity for your circuit.

Sangamo By-pass Condensers are now available in 1/10, 1/4, 1/2 and 1 mfd. capacities.



Sangamo Electric Company
6332-7 Springfield, Illinois

RADIO DIVISION, 50 Church Street, New York

SALES OFFICES—PRINCIPAL CITIES

RAYTHEON
For Reliable Reception



RADIO DEALERS

WRITE today for your free copy of Albin's LATEST Radio Money-Saver Catalog. More complete than ever. Every page crammed with latest in sets, speakers, kits, parts and accessories. Fast-moving items—unbeatable values—complete stocks—unqualified guarantee—SAME-DAY SERVICE. Buy from Albin and make this the BIGGEST YEAR you ever had.

THE ALBIN RADIO CO. INC.
223 FOURTH AVE., NEW YORK

CRYSTAL CLEAR TONES ON ANY SET

Carborundum Detector

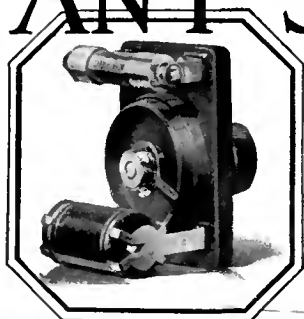

Stabilizing Unit

THERE is no denying the pure true quality of crystal reception.

And you can get such reception on any set without the fuss and worry of a nervous Cat's whisker jumping off the sensitive spot.

The Carborundum Stabilizing Detector Unit has revolutionized crystal detection. It is built around the Fixed Permanent Carborundum Detector—no Cat's whisker—no adjustments—retains its sensitivity and simply can not burn out.

The Stabilizer gives you a resistance controlling feature through which the Detector can be made to match the

impedance of any circuit. Simply turn the potentiometer knob.

The addition of an ordinary flash light dry cell gives the necessary booster voltage.

For greater sensitivity—greater distance—but above all for the reception of tones of natural quality equip your set with **The Carborundum Stabilizing Detector Unit**—it improves any set.

IN U. S. A.
\$3.50

Dealers
or
Direct

The
Carborundum
Company
Niagara Falls, N. Y.
Please send free
Hook-Up Book D-2.

★
THE CARBORUNDUM COMPANY, NIAGARA FALLS, N. Y.

SALES OFFICES AND WAREHOUSES IN
New York, Chicago, Boston, Philadelphia, Cleveland, Detroit Cincinnati, Pittsburgh, Milwaukee, Grand Rapids

Carborundum is the Registered Trade Name used by The Carborundum Company for Silicon Carbide. This Trade Mark is the exclusive property of The Carborundum Company.

Name _____
Street _____
City _____
State _____

ROBERTS FANS—ATTENTION!

For One Dollar you can possess a book giving complete constructional specifications and wiring data, together with much additional helpful information on all the Knock-out Reflex and several Roberts Reflex Receivers.

Another Dollar brings to you Radio Broadcast's Knock-out Four-Tube Roberts Receiver full-sized blue-prints.

Send your Dollar to

RADIO BROADCAST,

Booklet Department

Garden City, N. Y.

ALL TYPES A "SPEED" TUBE FOR EVERY RADIO NEED

You will never want anything better than

Speed
RADIO
TUBES

Uniform Quality

Less Replacements

The most perfectly balanced tubes produced

JOBBER—DEALER—MANUFACTURER

A "Speed" Franchise is valuable. It enables you to obtain the better business at a greater profit. Write for details.



X200
The New Special
Power Detector

★ Greater Sensitivity
Longer Distance
Finer Tonal Quality

CABLE SUPPLY COMPANY, Inc.

Manufacturer — Distributor
Executive Offices
Suite 1312-13-14-15, 31 Union Square
New York City

YAXLEY
APPROVED RADIO PRODUCTS

**Midget
Battery
Switch**



YAXLEY No. 10

Efficient
Filament
Control

MANY of the finest factory-made sets are equipped with the Yaxley Midget Battery Switch because of its correct design and superior construction.

You, too, will like the positive, easy action of this switch. Never gets out of order.

Small in size. Phosphor bronze springs. Pure silver, self-cleaning contacts. One nut mounting in a single 7/16" panel hole. Complete with nameplate, as illustrated.

No. 10—Midget Battery Switch 50c

Order from your dealer or send his name with your order to

YAXLEY MFG. CO.
Dept. B, 9 So. Clinton St.
CHICAGO



Oh boy

KESTER
Rosin Core
Radio SOLDER

Sure! is Safe and Simple

Approved by
Radio Engineers
A Genuine Solder

CHICAGO SOLDER COMPANY

4222 Wrightwood Ave., Chicago, U. S. A.

Originators and
World's Largest Manufacturers of
Self Fluxing Solder

YOUR DEALER
CAN SUPPLY YOU

BOOK REVIEW

The Radio Fan's Vade Mecum

HOW RADIO RECEIVERS WORK. By Walter Van B. Roberts, B.S., E.E., Ph.D. Published by Doubleday, Page & Company. 53 pages. \$1.

THERE has been a demand the last few years for a really comprehensive book dealing with the principles underlying radio reception. The average set builder desires to know the functions of the pieces of apparatus he uses in a receiver, and gradually is inspired to go deeper and deeper into the subject. Most available books either are so elementary as to give one a misconception of the phenomena occurring or else they go into elaborate calculations so that the physical picture of the mechanisms operating are entirely lost.

"How Radio Receivers Work," by Walter Van B. Roberts, is a book which fills a long-felt need on the part of many radio experimenters. It gives the elementary electron theory in terms that anyone can grasp, with the help of the mechanical analogies used, and at the same time the ideas conveyed are physically accurate. A few pages are given to alternating current theory in which the function of a coil and a condenser is explained, as well as the circuit which results when inductance and capacity are combined in parallel, to form an oscillatory circuit. This latter circuit is really the foundation upon which any receiver is built, for without it, stations operating on different wavelengths would not be separated, and the word "selectivity" would drop out of our electrical vocabulary.

Antenna systems of various types are discussed, and one theory of fading is given which, though interesting, does not seem to explain some of the phenomena which are so readily taken care of by the assumption of the existence of a "Heaviside Layer".

Those who have wondered why a vacuum tube can be made to operate as either an amplifier, a detector, or a generator of alternating current, should read the third chapter of Mr. Roberts' book, where the principles of the tube, "The Aladdin's Lamp of Radio"—are discussed in everyday terms.

The latter part of the book deals with modern types of receivers, discussing different methods of radio frequency amplification, including the super-heterodyne and super-regenerative principles, as well as regeneration. Audio amplification, under the headings of "Impedance and Resistance Coupling," "Transformer Coupling," and "Push-Pull Amplification," are discussed. Thus, the important parts of the receiver, the r. f. amplifier, the detector, and the a. f. amplifier, are discussed as separate units, giving the reader the proper perspective on the complete receiver.

It should be apparent from this brief resumé that here is a book that the experimentally inclined radio fan can well afford to own, one that is a welcome addition to that only too small existing library of authoritative simplified radio texts.

GLENN H. BROWNING.

Another Radio Show

TO OUR list of radio shows scheduled for the coming season (this list was printed in the August RADIO BROADCAST), should be added the Omaha Radio Show. This latter will take place during the week of September 6th to 11th, and is being held under the auspices of the Omaha Radio Trade Association, in the Omaha Auditorium. Manager, Chas. A. Franke.

Make any Good Receiver

BETTER
CC
TUBES
C. E. MFG. CO.
Providence
R. I.



This is a good time to subscribe for

RADIO BROADCAST

Through your dealer or direct, by the year only \$4.00

DOUBLEDAY, PAGE & CO. GARDEN CITY, NEW YORK



**FAHNESTOCK'S
NEW SWITCH**

A new reliable double pole, double throw switch. Binding posts and contacts are made of phosphor bronze. Copper handle with insulated knob.

This switch is made by the makers of the famous Fahnestock Connectors that are essential for perfect contact

FAHNESTOCK ELECTRIC COMPANY

LONG ISLAND CITY

NEW YORK



The New Balkite Charger

MODEL J. Has two charging rates. A low trickle charge rate and a high rate for rapid charging. Can thus be used either as a trickle or as a high rate charger. Noiseless. Large water capacity. Rates: with 6-volt battery, 2.5 and .5 amperes; with 4-volt battery, .8 and .2 amperes. Special model for 25-40 cycles. Price \$19.50. West of Rockies \$20.



Balkite Trickle Charger

MODEL K. With 6-volt "A" batteries can be left on continuous or trickle charge thus automatically keeping the battery at full power. With 4-volt batteries can be used as an intermittent charger. Or as a trickle charger if a resistance is added. Charging rate about .5 amperes. Over 200,000 in use. Price \$10. West of Rockies \$10.50.



A New Balkite "B" at \$27.50

Balkite "B" eliminates "B" batteries and supplies "B" current from the light socket. Noiseless. Permanent. Employs no tubes and requires no replacements. Three new models. Balkite "B"-W at \$27.50 for sets of 5 tubes or less requiring 67 to 90 volts. Balkite "B"-X for sets of 8 tubes or less; capacity 30 milliamperes at 135 volts—\$42. Balkite "B"-Y, for any radio set; capacity 40 milliamperes at 150 volts—\$69.



Balkite Combination

When connected to your "A" battery supplies automatic power to both "A" and "B" circuits. Controlled by the filament switch on your set. Entirely automatic in operation. Can be put either near the set or in a remote location. Will serve any set now using either 4 or 6-volt "A" batteries and requiring not more than 30 milliamperes at 135 volts of "B" current—practically all sets of up to 8 tubes. Price \$59.50.

All Balkite Radio Power units operate from 110-120 volt AC current with models for both 60 and 50 cycles. Prices are higher in Canada.

Operate your radio set from the light socket

Either with a Balkite Charger and Balkite "B" or with the new Balkite Combination Radio Power Unit.

The most convenient way of operating your radio set is from the light socket. Now you can do it merely by adding the new Balkite Combination or Balkite "B" and a Balkite Charger. Either way will give you full silent power for both circuits from the light socket.

All Balkite Radio Power Units are permanent pieces of equipment. They use no tubes. They have nothing to wear out or require replacement. They are noiseless. They do not hum. They always give just the power needed by the set because they do not run down or run low. Other than a slight consumption of household current their first cost is their last. With sets of high current requirements they effect a decided saving.

Operate your set with Balkite Light Socket Power. Over 600,000 receivers—one of every ten—are already Balkite equipped. Equip yours with Balkite and convert it into a light socket set. Know the pleasure and satisfaction of owning a set always ready to operate at its best.

FAN STEEL

Balkite

Radio Power Units

Manufactured by FANSTEEL PRODUCTS COMPANY, INC., NORTH CHICAGO, ILLINOIS

Digitized by Microsoft®

