

# RADIO BROADCAST

WILLIS K. WING, Editor

AUGUST, 1926

KEITH HENNEY  
Director of the Laboratory

JOHN B. BRENNAN  
Technical Editor

Vol. IX, No. 4

## CONTENTS

Cover Design	- From a Painting By Fred J. Edgars	
Frontispiece	- - - - - The New Rugby Station	286
One Billionth of a Meter	- - - - - James Stokley	287
How Is Your A Battery?	- - - - - B. L. Shinn	292
The March of Radio	- An Editorial Interpretation	295
How Was Reception Last Night?	- Albert F. Murray	300
A High Quality "Local" Receiver	Kendall Clough	305
Looking Ahead to 1927	- - - - - Zeh Bouck	310
The Listeners' Point of View	- - - John Wallace	315
How To Rate the Power of Radio Stations		
"As the Broadcaster Sees It"	Carl Dreher	319
	Drawings by Stuart Hay	
Ohm's Law Charts	- - - - - Homer S. Davis	325
New Apparatus	- - - - -	326
Musical Reproduction Has Improved	- A. F. Van Dyck	328
News of the Short-Wave Receiver Contest	- - - - -	332
"Radio Broadcast's" Laboratory Information Sheets		334
No. 17.	Inductance of Single-Layer Solenoid Coils	
No. 18.	Volume Control	
No. 19.	Learning to Read Code	
No. 20.	The Continental Morse Code	
No. 21.	Rejuvenating Tubes	
No. 22.	A Simple Loop Receiver	
No. 23.	Rheostats	
No. 24.	Bypass Condensers	
"Now, I Have Found"	- - - - -	338
	A Control for the Raytheon Eliminator	
	A Combined Voltmeter and Rheostat Switch	
	Improving the Roberts NP Coil	
	A Phone Diaphragm Kink	
	Oscillation Control of the "Universal"	
	Power Equipment Switching	
	Neutralizing Condenser Adjustment	
A Key to Recent Radio Articles	E. G. Shalkhauser	341
Book Review	- - - - - John Wallace	344
	<i>Everybody's Guide to Radio Music</i> , by Percy A. Scholes	
Radio Shows Scheduled for 1926	- - - - -	348
Letters from Readers	- - - - -	350

## BEHIND EDITORIAL SCENES

**A**MATEURS all over the country have been writing to know what has become of the RADIO BROADCAST-Every-ready Short-Wave receiver contest to find a good nonradiating short-wave set. Due to causes beyond our control, the selection of the prize-winners has been delayed, but an announcement about the contest appears on page 332, and the selected receiver will be described in our September number. Austin Lescarboua tells in that number how much it costs to broadcast. "Courtesy" programs—a most interesting development—are really paying for broadcasting and this story tells how.

**B**L. SHINN, of the Vigilance Committee of the Associated Advertising Clubs of the World tells on page 292 some surprising facts about misleading sales and advertising practise in marketing storage batteries. It will help every radio purchaser to get most value for his money to read this article. We are proud to present, on page 300, the story of Dr. G. W. Pickard's interesting work on measuring the variation in radio signal strength. Doctor Pickard's careful experiments are some of the most interesting and most important now going on in the radio field, and this first of two articles about his work is an exclusive announcement. Kendall Clough, of the Research Laboratories of Chicago, describes a local receiver which will give great satisfaction to the city-dweller, intent on beautiful reproduction of his local program. This receiver is another version of the set described in our May number. The other articles in this number are of more than usual interest.

**M**UCH favorable comment has come into the office on the RADIO BROADCAST Laboratory Data Sheets, which started with the June issue. They will be a regular and, we believe, a very valuable feature of the magazine. Since we appeared in our enlarged size with the November, 1925, issue, many readers have complimented us on our policy of not "running over" the articles which appear in the main text section of the magazine. That practice, a distinct help to the reader, is exclusive with this magazine and will be continued.

**T**HE September RADIO BROADCAST will contain in addition to the details of the prize-winning short-wave receiver, a description of the Browning-Drake circuit employing impedance amplification plus some interesting refinements. This Browning-Drake model will please the many correspondents who continually write us for instructions on how to build the circuit with this system of amplification. RADIO BROADCAST described that popular circuit first, in December, 1924. Many other interesting and important technical articles will be a part of the September magazine, as well.

Doubleday, Page & Co.  
MAGAZINES  
COUNTRY LIFE  
WORLD'S WORK  
GARDEN & HOME BUILDER  
RADIO BROADCAST  
SHORT STORIES  
EDUCATIONAL REVIEW  
LE PETIT JOURNAL  
EL ECO  
THE FRONTIER  
WEST

Doubleday, Page & Co.  
BOOK SHOPS  
(Books of all Publishers)  
NEW YORK: LORD & TAYLOR BOOK SHOP  
PENNSYLVANIA TERMINAL (2 Shops)  
38 WALL ST. AND 166 WEST 32ND ST.  
GRAND CENTRAL TERMINAL  
ST. LOUIS: 223 NORTH 8TH STREET  
4914 MARYLAND AVENUE  
KANSAS CITY: 920 GRAND AVENUE  
1306 WEST 47TH STREET  
CLEVELAND: HIGBEE CO.  
SPRINGFIELD, MASS.: MEEKINS, PACKARD & WHEAT

Doubleday, Page & Co.  
OFFICES  
GARDEN CITY, N. Y.  
NEW YORK: 285 MADISON AVENUE  
BOSTON: TREMONT BUILDING  
CHICAGO: PEOPLES GAS BUILDING  
SANTA BARBARA, CAL.  
LONDON: WM. HEINEMANN, LTD.  
TORONTO: OXFORD UNIVERSITY PRESS

Doubleday, Page & Co.  
OFFICERS  
F. N. DOUBLEDAY, *President*  
A. W. PAGE, *Vice-President*  
NELSON DOUBLEDAY, *Vice-President*  
RUSSELL DOUBLEDAY, *Secretary*  
S. A. EVERITT, *Treasurer*  
JOHN J. HESSIAN, *Asst. Treasurer*

DOUBLEDAY, PAGE & COMPANY, Garden City, New York

Copyright, 1926, in the United States, Newfoundland, Great Britain, Canada, and other countries by Doubleday, Page & Company. All rights reserved.  
TERMS: \$4.00 a year; single copies 35 cents.

# bring your radio set up to date

for greater distance  
for bigger volume—  
for finer tone & &

**N**EW RADIOTRONS—new performance—better radio! By keeping up with the progress of the Radiotron laboratories, you can get new results with your old set—keep it up to date. If you have a storage battery set, here is the way to equip it now, to make it *many times better:*

1. Distance! Take out the detector tube and put the new RCA Radiotron UX-200-A in the socket. This newest development of RCA research means greater sensitivity—longer distance reach.
2. Quality! Put all genuine RCA Radiotrons UX-201-A in the radio frequency sockets, and the first audio stage.
3. Volume, and finer tone! Use either power tube, Radiotron UX-112 or Radiotron UX-171 in the last audio stage, for volume—full, clear-toned volume.

With the laboratories of RCA, General Electric and Westinghouse steadily at work to develop Radiotrons, radio reception is being improved year by year. Many of these improvements can be made right in your old set. Keep pace with Radiotrons. And, for your own protection, always look for the RCA mark on the base and inside the glass of every tube you buy.

RADIO CORPORATION OF AMERICA  
New York Chicago San Francisco

RADIOTRON  
UX-200-A—  
special detector  
tube for storage  
battery sets.



# RCA Radiotron

MADE BY THE MAKERS OF THE RADIOLA

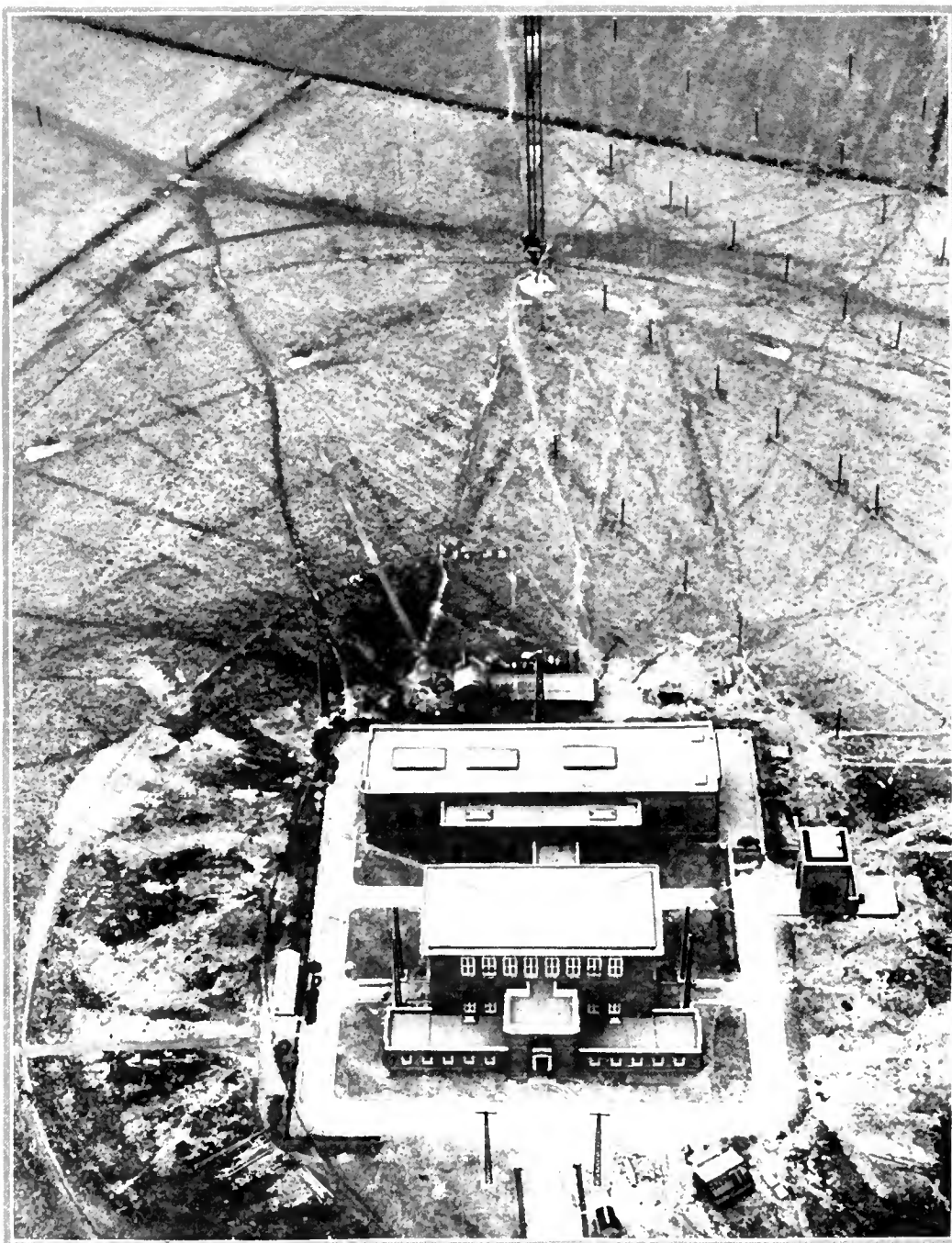

*LOOKING DOWN ON THE NEW RUGBY STATION*

*Nine-hundred acres of land are devoted to the masts and station houses of this new world-wide British station. Five-hundred kw. in the antenna is generated by means of water-cooled tubes. The main masts are 820 feet high, and are provided with elevators to carry three men. Here is located the British transatlantic telephony transmitter, the signals of which have been heard in Australia*

# RADIO BROADCAST

VOLUME IX



NUMBER 4

AUGUST, 1926

## One Billionth of a Meter

*The Sun Transmits Light Waves with Three-Hundred Billion Kilowatts' Power—Röntgen's Discovery of the X-ray in 1895, and Laue's Experiments Twenty Years Later—How the Theory of the Structure of Crystals Was Proved—The Work of the Braggs, Coolidge, and Moseley—"Atomic Number"*

By JAMES STOKLEY

IT IS a long step from the long ether waves used in intercontinental commercial radio communication to the shortest waves now used for radio purposes, but just as much shorter than these latter are those ether waves, similar in nature to our radio waves, which we detect by means of the eye, and which we call light. Radio is such a recent invention that people still look on it with wonder, yet if they look at a star in the heavens, such as the brilliant Sirius, the "Dog Star," which shines in the winter sky, or even at the sun itself, it causes them no wonderment, but instead, they take it as a matter of course because they are used to it.

Yet the waves which make us aware of the presence of the sun, or Sirius, are like those used in radio, except that they are shorter in length, and hence vibrate more rapidly. And the distances they travel make the range of the most powerful broadcasting station seem insignificant in comparison, for the light waves from the sun travel about 93,000,000 miles before they reach us; those from the star Sirius come something like fifty trillion miles before we see them—so far that though ether waves travel fast enough to encircle the earth seven times in one second, the light from Sirius keeps on its journey for eight and a half years in order to cross the gap separating the star from us. And Sirius is one of the nearest of all the known stars!

And then there's the question of power. Broadcasting stations of fifty kilowatts refer to them-

selves as "super-power," but what must we call Old Sol, the station that we see in the heavens every day? It has been calculated by Dr. George C. Southworth, a New York engineer, that when a radio station is operating with enough power to give a fairly loud signal with the ordinary receiving set, the energy of the ether waves flowing through every square meter of a place perpendicular to

a line to the station is about a quarter of a microwatt—such a small amount of power that one hundred and sixty million times as much would be required to light an ordinary 40-watt electric lamp.

With the sun, however, the power is vastly greater, for each square meter of the earth's surface receives, according to Dr. Southworth, not a fraction of a microwatt, but about one and a half kilowatts, enough power to light all the lamps in a good sized building, and about six billion times as much power as from the broadcasting station! And this in spite of the fact that the sun is more than ninety million miles away!

A little better for man's handiwork is the comparison of receiving sets. Nature provided each of us with two of these capable of detecting ether waves when she gave us our eyes, but, though man has not been able to compete with the sun in the matter of transmitters, he has developed a better receiver than the eye as regards sensitivity. While a receiving set may readily be constructed that will respond to an electric field of five-hundred millionths of a volt per meter, as electrical field strength is measured, the eye will not be aware of any sensation of light unless the energy is the equivalent of an electric field of forty-three millionths of a volt per meter. The best radio set is therefore nearly a thousand times as sensitive as man's eye.

THE DISCOVERY OF THE X-RAY

BUT just as much shorter than the light waves as they themselves are shorter than the radio



WILHELM KONRAD RÖNTGEN

A German physicist of Wurzburg, who, in 1895, discovered what he termed "X-rays" on account of their then enigmatical nature. It was some twenty years later before a fellow countryman of his, named Laue, solved the problem of "X," the unknown quantity

waves, are the vibrations which enable man to look into his own body, or into the interior of molecules of which matter is made to study the structure of the atoms themselves. These are the X-rays.

Despite the value that X-rays have proven to possess, it was only about thirty years ago that Wilhelm Konrad Röntgen made their discovery in his little laboratory at Wurzburg, Germany.

In his interesting book, "Light, Visible and Invisible," the late Prof. S. P. Thompson quotes Röntgen's own account of the birth of the X-rays.

"There is no history," said Professor Röntgen, when asked to tell of the history of the discovery. "I had been for a long time interested in the problem of the cathode rays from a vacuum tube as studied by Hertz and Lenard. I had followed their and others' researches with great interest, and determined, as soon as I had the time, to make some researches of my own. This time I found at the close of last October (1895). I had been at work for some days when I discovered something new."

"What was the date?"

"The 8th of November."

"And what was the discovery?"

"I was working with a Crookes' tube covered by a shield of black cardboard. A piece of barium platinocyanide paper lay on the bench there. I had been passing a current through the tube, and I noticed a peculiar black line across the paper."

"What of that?"

"The effect was one which could only be produced, in ordinary parlance, by the passage of light. No light could come from the tube because the shield which covered it was impervious to any light known, even that of the electric arc."

"And what did you think?"

"I did not think; I investigated. I assumed that the effect must come from the tube, since its character indicated that it could come from nowhere else. I tested it. In a few minutes there was no doubt about it. Rays were coming from the tube, which had a luminescent effect upon the paper. I tried it successfully at greater and greater distances, even at two

meters. It seemed at first a new kind of light. It was clearly something new—something unrecorded."

"Is it light?"

"No." (In this answer he was mistaken.)

"Is it electricity?"

"Not in any known form."

"What is it?"

"I do not know. Having discovered the existence of a new kind of rays, I of course began to investigate what they would do. It soon appeared that they had penetrative

But Röntgen was mistaken when he said that the rays, which he named X-rays because he did not know what they were, were not light. True, they were not light as he knew it, for when he tried to reflect the rays from a mirror or refract them through a lens, their paths were not disturbed. Surely if they were light they could be reflected and refracted!

How easily someone else might have anticipated the German scientist is shown by the fact that as soon as his discovery

was announced, physicists in dozens of laboratories the world over immediately began to repeat his experiments and to take X-ray photographs. Crookes tubes, such as Röntgen used, were rather common pieces of laboratory equipment; so were fluorescent screens, but no one had happened to observe the effect when a tube in operation was separated from a screen by a piece of apparently opaque material, or, more important, if they had noticed it, unlike Röntgen, they did not investigate.

#### THE EXPERIMENTS OF LAUE

NOT for nearly two decades later was the "X", the unknown quantity in the X-rays, to be solved. A fellow countryman of Röntgen's, Prof. M. Von Laue, of Munich, suggested that the X-rays were the same as the rays of light, but very much shorter in wavelength, so short that mirrors, prisms, or lenses, which turned ordinary light rays from their path, had no effect on the X-rays. Neither did the finest available diffraction grating have any effect.

This latter consisted of a piece of glass on which were ruled parallel lines as close as 15,000 to the inch, and which spread a beam of white light out into a spectrum in much the same way as a prism.

It occurred to Laue that if he had a grating as much finer as the ordinary grating as he supposed the X-rays waves to be shorter than light waves, he might succeed in bending them, but such a grating seemed impossible, as the finest that had ever been ruled had only about 30,000 to the inch.

The accepted theory of the structure of crystals stated that the molecules of which



AN X-RAY PICTURE OF A BOUQUET

The three center flowers are tulips, while the others are jonquils. Note the developing masses of seeds in the ovules of the latter flowers, and also the faint outline of the leaves in the lower corners of the picture

power to a degree hitherto unknown. They penetrated paper, wood, and cloth with ease, and the thickness of the substance made no perceptible difference, within reasonable limits. The rays passed through all the metals tested, with a facility varying, roughly speaking, with the density of the metal."

And so Röntgen made his discovery, describing it first in a scientific paper entitled "Ueber eine neue Art von Strahlen" ("On a New Kind of Rays"), published in the proceedings of the Wurzburg Physico-Medical Society.





#### ATOMIC ARRANGEMENT IN SOLID BODIES

Is indicated by these atomic models which, of course, are magnified millions of times. From left to right, the models represent the diamond, magnesium, and calcite

a crystal were made were arranged in successive tiers, layer cake fashion, each layer being one molecule deep. Laue thought then, that he might obtain his grating by using the molecular planes of a crystal.

At his suggestion, two of his colleagues, Friedrich and Knipping, tried this, and were successful, thereby killing two birds with a single experiment, for not only did they show that the X-rays were actual forms of wave motion, but also that the structure of the crystals was the same as theory had predicted. Three years later, two English physicists, Sir William Bragg and his son W. L. Bragg, collaborated in a very careful and exhaustive series of experiments which culminated, in 1915, in the publication of their book "X-rays and Crystal Structure," and which won for them the joint award of the Nobel prize in physics the same year.

From this beginning there developed a new method of studying X-rays. Just as the invention of the spectroscope by Fraunhofer, in 1814, enabled scientists to study light in a way they had been unable to do before, so did the work of Laue, and the Braggs, which led to the X-ray spectrometer, lead to new methods of studying materials of all kinds as well as the X-rays themselves. Resembling the optical spectroscope, except that a crystal of rock salt replaces the glass prism, many laboratories are now equipped with the X-ray spectrometers as an aid to analysis. In fact, this instrument is now manufactured and carried in stock by one large manufacturer, even though it was only a very few years ago that the first crude form was invented.

All solid metals consist of crystals, and so, though the work of Laue and Bragg might not have seemed at that time to have any practical value, it has now opened tremendous possibilities in metallurgical research. The way the atoms and molecules are put together is just as much a characteristic of a metal, and just as important, as its density or melting point; indeed, it is the arrangement of the atoms that determine its physical properties.

For example, metals, like human beings,



#### A PORTABLE X-RAY OUTFIT

It is used to produce diffraction patterns from crystals. A narrow pencil-like beam of the rays is permitted to pass through the crystal, after which it emerges in a spread-out condition. It is thrown onto the small screen, and is visible as a series of rings of spots

show fatigue. A piece of brass may be bent a certain number of times before it breaks, but after it has been bent a hundred times, though it may have its surface polished, and look the same as a fresh piece on the outside, it will not be nearly as strong. By the use of the X-ray spectrometer, however, the difference in the lines in the photograph shows a great difference between the fresh piece and the one that has been fatigued, for the one shows the lines sharp and distinct, while in the other they are hazy and ill defined.

Such studies have shown why steel, and various alloys, are stronger than iron, or, perhaps, than any of the metals of which they are made. In such metals as aluminum, silver, copper, and gold, X-ray studies indicate that they consist of closely packed atoms, the plan of the crystal being simply the direction in which the packing is most dense. If it breaks, it does so most easily along one of these planes, but if the metal consists of a mass of crystals, rather than a single one, the planes of weakness lie in different directions, and so it is not so easy to break. Now, if a number of atoms of another substance are mixed with them, as carbon atoms in steel, which apparently tend to fill up the interstices between the iron atoms, they lessen the possibility of the atoms slipping over each other, and the mixture is harder than either iron or carbon.

#### HOW THE X-RAY TUBE WORKS

THE ether vibrations called X-rays result when cathode rays—rapidly moving electrons produced when a high-tension electric current is passed through a highly evacuated tube—are suddenly stopped. In the Crookes tube, which produced these rays, and which Röntgen was using when he made his discovery, the cathode rays are stopped by the glass wall of the tube, but early in the history of X-rays it was found that if the cathode rays were focussed on a target of a dense metal, such as platinum, far more copious amounts of the rays were produced.

There was another advantage in focusing the rays on such a target, for the X-rays all radiate from a small point,

#### PROF. AND SIR WILLIAM BRAGG

Father and son. Professor W. L. Bragg is of the University of Manchester, England, while Sir William is of the Royal Institution, London. They were jointly awarded the much coveted Nobel prize for physics in

1915

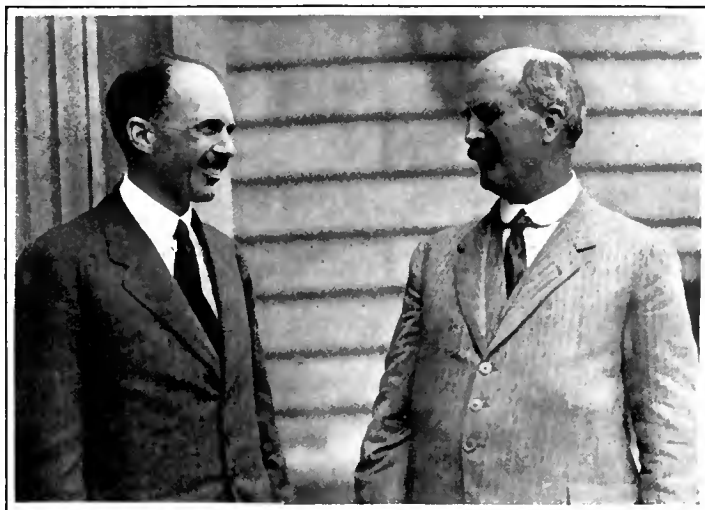



DOCTOR W. D. COOLIDGE

He is the inventor of the Coolidge X-ray tube, and is shown at his desk in the Research Laboratory of the General Electric Company, examining one of the latest types. In the background may be discerned a collection of tubes likely to make any X-ray expert envious

while in the tube that Röntgen used, their source was a large area. The X-ray photographs of bones in the body are only shadow pictures. They are similar to those that we might obtain of a person's head by standing him beside a large photographic film and then allowing light to fall on the person so that a silhouette of his head was on the film. If the source of light was a large north window, the shadow would not be as distinct as if the illumination came from a small concentrated source, such as an electric arc. In the same way, X-rays from a small source give more distinct photographs than if they came from a larger surface.

But all the early X-ray tubes were more or less erratic in behavior. The penetrating power of the rays—the hardness, as it is called, depends on the degree of vacuum in the tube, and too little gas left in was almost as bad as too much, if the most satisfactory results were to be obtained. In some of the various tubes that were constructed, elaborate devices were used to allow the degree of vacuum in the bulb to be changed.

However, in 1913, Dr. W. D. Coolidge, now assistant director of the Research Laboratory of the General Electric Company, designed the form of tube which now bears his name. In this tube, advantage is taken of a fact familiar to every radio fan, namely, that a hot filament in an evacuated bulb gives off electrons. This makes possible the operation of radio tubes, and it also has made possible the most satisfactory source of X-rays ever devised.

In the Coolidge tube there is an extremely high vacuum, about a hundred times as high as in the older forms, and so high that an electric discharge will not pass through it in the ordinary manner. The

cathode, however, consists of a small coil of tungsten wire—a filament, and when it is heated by the ordinary lighting current, it emits electrons. The higher the voltage, and the hotter the filament, the more copious are the electrons. Thus, adjusting a rheostat has the same effect that changing the vacuum had in other tubes. Resembling the radio vacuum tube, the Coolidge X-ray tube has two sources of current, for besides the relatively low voltage used for heating the filament, a high tension current is used to drive the electrons to the

heavy tungsten target and produce the X-rays. Because of its convenience and reliability, the Coolidge tube has largely replaced other forms in medical and physical laboratories.

However, while platinum was used in the earlier forms of X-ray tubes as the target from which the rays emanate, and tungsten is used in the Coolidge tube, numerous other substances may be employed, and by analyzing the radiations from various kinds of targets with the aid of the crystal of the X-ray spectrometer, exact characteristics of the elements used as targets may be determined. Elements are now classified by chemists (and physicists too, for the boundary between physics and chemistry, formerly so distinct, is fast disappearing) according to their atomic number, from one to ninety-two.

#### EXPLAINING "ATOMIC NUMBER"

THE atomic number of an element is simply its order in the procession of elements when arranged according to the weight of their atoms. They have been compared to a flight of 92 steps, hydrogen being number 1 and uranium number 92, but one step may be occupied by more than one element, while one element may occupy more than one step. This is due to isotopes, which are forms of the same element of slightly different atomic weight. In our high school chemistry we learned that the gas chlorine, for example, had an atomic weight of 35.5, but this is really the average atomic weight of all its atoms, some of which may be 35, and others 37. In the case of some elements, whose previously accepted atomic weight was a whole number, as oxygen, of atomic weight 16, there are no isotopes, but all the atoms weigh the same. However,



AN EXCELLENT EXAMPLE OF X-RAY PHOTOGRAPHY

It shows a pipe elbow in a plaster wall. By means of a newly developed portable X-ray outfit, it becomes a simple matter to examine objects such as the above. In the case of a pipe in a wall, it becomes unnecessary to tear down a large section of the wall to find the damaged section

the atomic number refers to the average, so chlorine is number 17 and oxygen number 8.

Among the early workers in the subject of X-ray spectra was a young Englishman named Henry G. J. Moseley, who worked with Sir Ernest Rutherford, then at Manchester, and at Oxford University, his Alma Mater. One of his experiments was to test with the X-ray spectrometer the X-rays with different substances as targets. This led him to the important discovery, at the age of 25, that the spectra of the X-rays from different elements were remarkably similar in regard to the position of their dark lines, but with the difference that the wavelength of the radiation which corresponded to the lines becomes shorter as the atomic number of the element increases. For example, nickel being number 28 and copper number 29, the position of the lines in the copper spectrum shows

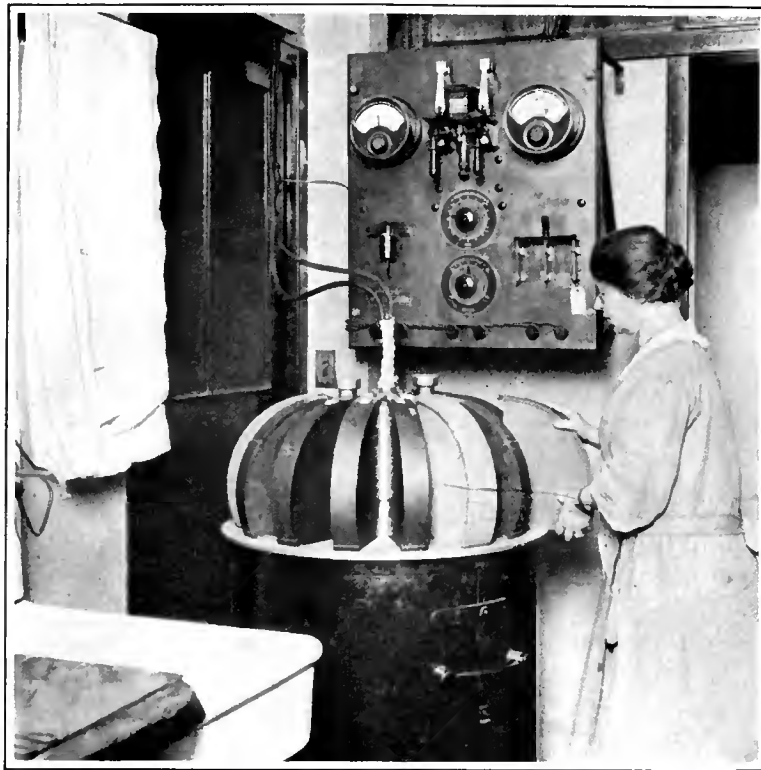

X-RAY DIFFRACTION APPARATUS

It is used for obtaining X-ray spectra from which the arrangement of the atoms in metals and other solids may be determined

infallible means of identifying the element. Not only is the method applicable to already known elements, but as blank numbers are left for ones which have still been undiscovered, the presence of a hitherto unknown element may be demonstrated as easily as one that is already common.

Until about a year ago, there were five empty ranks in the parade of elements. Since then, three have been filled. Numbers 43 and 75 were filled by Dr. Walter Noddack and his associates, working at the University of Berlin. They concentrated solution of ores containing platinum, and when their X-ray spectra showed the lines in the positions corresponding to their numbers, according to Moseley's law, they knew they had found the new elements, and named them Masurium and Rhenium. Still later, Dr. S. B. Hopkins, at the University of Illinois, found number 61, which he named Ilnium after his college,

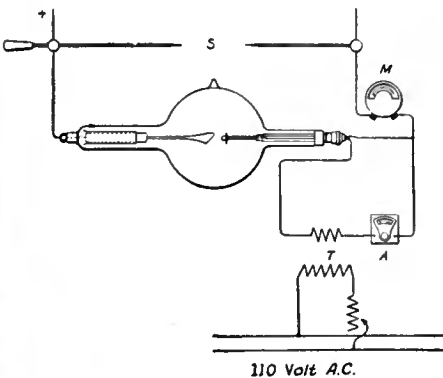

COOLIDGE X-RAY TUBE WIRING

As is the case with the ordinary radio vacuum-tube circuit, an electron flow is emitted from the filament. To the cathode of the Coolidge tube, which corresponds to the filament in the radio tube, is applied an 110-volt current. A high-voltage current from a transformer also flows through the tube and, as the electrons bombard the tungsten target, X-rays are produced

them to be of slightly shorter wavelength than in the spectrum of nickel.

In the summer of 1914, after he had made this discovery, Moseley went to Australia to attend the meeting of the British Association for the Advancement of Science, and to tell them of his work. August came, and with it the outbreak of the World War, and Moseley hurried back to England and joined the Royal Engineers. He was soon in the thick of fighting and on August 10, 1915, was in the Gallipoli campaign, when a Turkish bullet ended the life that had already made such great contributions to science and which had given every prospect of many more. The work he began has already led to brilliant discoveries in the hands of his successors. Since each element has its characteristic X-ray spectrum, and since the wavelength of the lines varies according to the atomic number, a single X-ray spectrum photograph gives an

and with it, too, the X-ray spectrum corresponded precisely to Moseley's law.

Elements number 85 and 87 are still absent and unaccounted for, though we know what their X-ray spectrum will be when they are discovered.

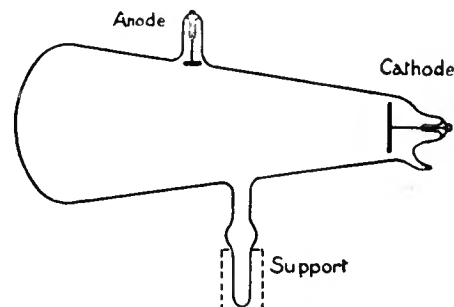

AN EARLY X-RAY TUBE

This was the type employed by Röntgen when he discovered X-rays. The cathode rays impinged on the broad end of the tube

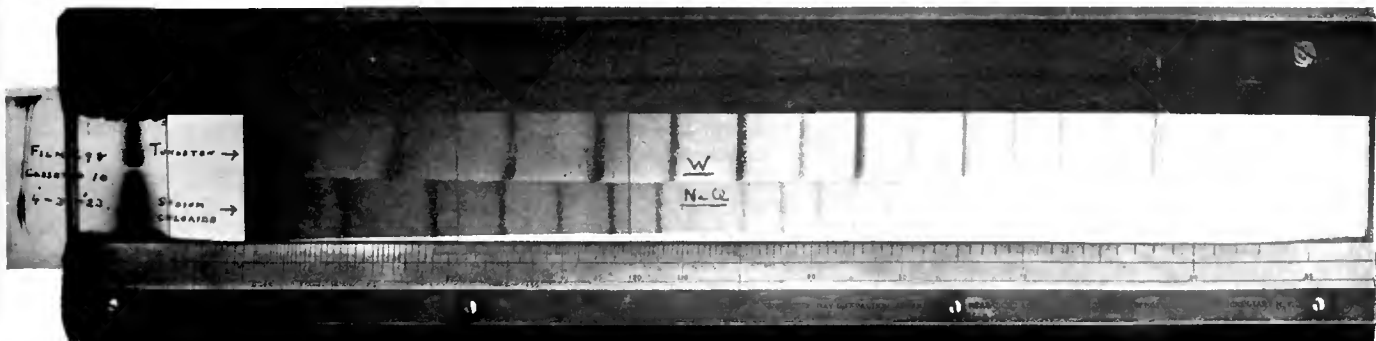

THIS SCALE HAS BEEN SPECIALLY DEVELOPED FOR MEASURING X-RAY SPECTRA

As seen here, it is being used with two spectrum photographs. The upper photograph is of the tungsten spectrum while the lower one is of ordinary table salt. The numbers on the scale indicate the wavelengths of the rays in 250/1,000,000ths of an inch.



# How Is Your A Battery?

Which Explains Why All A Batteries are not Always What They Seem—  
When Buying an A Battery, Look for the Rated Ampere-Hour Capacity  
—Products of Nationally Known Manufacturers Can Be Relied Upon

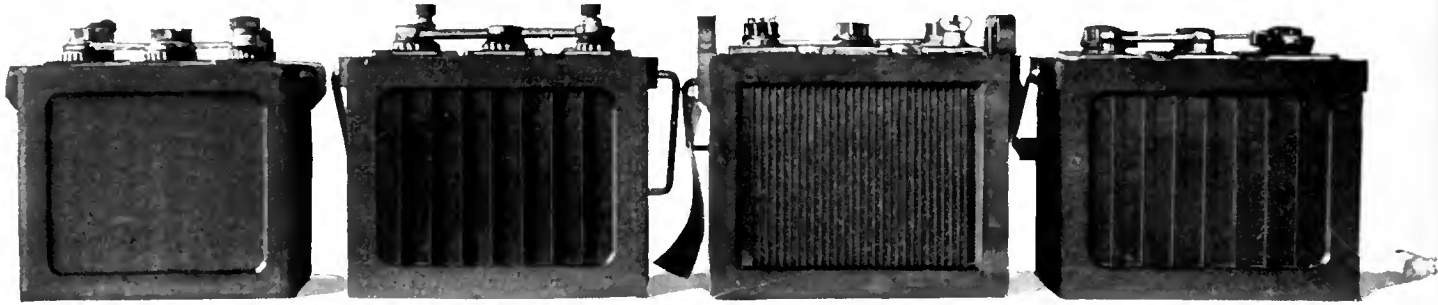

## WHICH A BATTERY WOULD YOU BUY?

The first and fourth batteries above are rated at 100 amperes and will deliver it. The second was sold as a "140-ampere" battery and when tested, gave but 80 ampere-hours. The third was labeled "amp.-hours 120", and a test showed it would deliver but 75 ampere-hours

By B. L. SHINN

National Better Business Bureau

WHEN you flip your radio switch this evening, will each tube be warmed with its normal filament voltage and kept that way until you shut off the set? Or will you wonder all evening whether the last charge you gave your battery is going to last until next Sunday? When you bought your battery, did you get the *ampere-hour capacity* you were led to expect? Do you know how to get it in the next battery you buy?

The *ampere-hour capacity* of an A battery is a factor of vital importance in the satisfactory reception of radio broadcasting—and for any other services as well. True, the discharge of the battery is but a fraction of what is used in the starting or lighting of an automobile. But, as radio sets are not yet equipped, like automobile motors, with generators for recharging, and as the average fan's enthusiasm leads to many hours' usage each week, enough *ampere-hour capacity* to service the set without too frequent recharging is essential.

When the radio public became an important market for storage batteries, the leading battery manufacturers produced batteries especially designed for radio use to give a relatively low discharge over a long time period. The first of these batteries which appeared were often rather cumbersome affairs. This created the impression among many fans of little technical knowledge that the brute size of a battery is at least one indication of the number of hours of service which it will give. While the manufacturers already in

the field strove to fit the design of radio storage batteries into cabinets of reasonable size, while retaining maximum *ampere-hour capacity*, a host of newcomers invaded the field of storage battery manufacturing. In this field, as in others, fair competition has usually the effect of spurring on the improvement of the product and of its advertising, marketing, and servicing. As in other fields, however, unfair competition, once it appeared, threatened at one time to

concerns were able to undersell by several dollars any legitimately rated battery in the market.

Some of the older battery makers, although but for a brief interval, succumbed to the economic stress of this manifestly unfair type of competition. Picture to yourself the "gyp" getting the business with veritable junk, the honest product lagging on counter and shelf while radio fans scramble for spurious "bargains."

Some companies, for a short time, were thus led to overrate the batteries which they had designed for radio use. Others, while maintaining a fair degree of accuracy as to the batteries sold under their own trade mark, manufactured for jobbers batteries made up in oversize boxes, some of which were misbranded as to *ampere-hour capacity*, and some of which were unbranded.

The effect of such practice is visualized for you in the illustration which heads this article. Just as most radio fans

---

IT SHOULD be said that, without major exception, the radio manufacturers that you and I are apt to have dealings with are entirely reputable and have no thought but to give the consumer his money's worth in radio products. They believe that good merchandise should be exchanged for good money. But like all large and growing business, radio has had its camp followers—its unprincipled fellows who prefer to "get away" with something than to do the job properly. Through the cooperation of the National Better Business Bureau, RADIO BROADCAST, in its August, 1924, and February, 1925, issues, published the first information on how tubes and sets were being misbranded and sold dishonestly. Now, we have the privilege of presenting information of importance to every battery buyer. Readers who know of dishonest selling practices, such as outlined in this story, will confer a favor by writing to either RADIO BROADCAST or to the National Better Business Bureau.—THE EDITOR.

---

play havoc generally with the selling of radio storage batteries.

Numerous battery assemblers, with not even a reputation to lose, exploited the radio fan's innocence of storage battery construction by placing very few plates and correspondingly small quantities of active material in very large boxes, and either misbranding these "hope chests" with much higher capacity ratings than they possessed, or selling them unbranded to the type of dealers who take advantage of such a product to misrepresent it on their own account. Using a very small number of plates, frequently of poor quality, these

could not tell without the caption under this picture which of these batteries truly have a capacity of 100 ampere hours, so most of you might be similarly confused by the batteries themselves. The two whose actual capacity is far below 100 ampere hours were rated 120 and 140 ampere hours. One was so marked by the maker. The other was made up oversize and unbranded, and the high amperage was claimed by the retailer.

The spread of the oversize box, misbranded and unbranded, would soon have meant chaos in the marking and selling of storage batteries for radio use. It had

arrived in a comparatively short interval of time, and was allowed to develop no further than enough to demonstrate its unfairness and its destructive character, whereupon it was quickly and effectively dealt with.

#### THE CONSUMER FINDS A CHAMPION

THE National Better Business Bureau is an organization maintained by national advertisers to protect the consumer, to promote fair play between seller and buyer, and to protect industry from the usually unfortunate sequel of such developments as we have just described. Affiliated with forty Better Business Bureaus operating locally in the retail field, it has an unusual bird's-eye view of what is happening to an industry and to its consumers. For several years the National Bureau has had intimate contact with the storage battery industry in connection with the advertising, marketing, and servicing of automotive storage batteries. The development of the radio storage battery market was carefully watched by the national staff and its local contacts. When the seriousness of the situation became apparent, the National Bureau urged the industry to cooperate in a house-cleaning. A number of leading manufacturers agreed to the suggestion enthusiastically and instantly.

"But before we can make headway," said the National Bureau, "in eliminating the 'gyp' battery and the box of junk sold for radio use, the leaders in storage battery manufacture must set the example for the entire trade by cleaning house themselves."

The radio battery merchandising code reproduced above on this page was offered to the industry as the first step in the protection of the radio battery user and the establishment of the whole trade upon a four-square basis. Within a few weeks, the makers of 85 per cent. of the storage battery pro-

#### Code for Merchandising Storage Batteries for Radio Use

1. Make sure that every battery is appropriately and correctly rated.

2. Brand each battery with the correct rating figure, or with maker's name and type or symbol number from which the rating may be determined. Preferably this branding should be on the box itself, at least on the name plate or other exposed part.

3. In each catalog or piece of advertising matter, advise dealers of the rating method employed and what any type or symbol numbers used may mean.

4. Decline to misbrand batteries made for others, or to deliver batteries in oversize boxes unless marked with correct capacity rating in plain figures.

#### NATIONAL BETTER BUSINESS BUREAU, INC.

383 Madison Avenue  
New York City

duction of the United States had pledged themselves to follow such a code.

The National Better Business Bureau then turned its attention to the battery makers who had not voluntarily placed their marketing upon a fair basis. Numbers of these were approached regarding their practices. It was assumed in each instance that such a concern was perhaps unaware of the unfairness of the misleading custom of assembling and branding of batteries, and of the general clean-up which had taken place. Each was courteously invited to make over its method of marking and marketing so as to be fair to the consumer. A large number of those approached in this fashion saw the trend of events and revised their methods of representing batteries to the public in accordance with the suggested code.

A few chose to continue misbranding their products or putting up batteries in oversize boxes for certain types of retailers to misrepresent to their customers. Batteries were purchased from these concerns and tested by actual cycles of charge and discharge in the engineering laboratories of a nationally known institution. It was found that some of these batteries were marked and sold as and for products having a capacity nearly twice that recorded by the testing engineer. Batteries were photographed, inside and out, disclosing the useless additional clearance in each cell jar and the deceptive appearance of the box when placed beside batteries of the same rated capacity which would actually deliver the service for which they were rated. Other photographs, reproduced in this article, show the interior construction of some of these batteries.

In two bulletins, published in February and May, 1926, the National Better Business Bureau took to the trade and to the public these outstanding facts:

1. That *ampere-hour capacity* is the commodity which the radio user seeks in a storage battery.
2. That the size of the box alone is an untrustworthy indication of storage battery capacity.
3. That weight alone is likewise an unsafe guide to capacity.
4. That number of plates does not by itself determine the *ampere-hour capacity* of a radio battery.
5. That *ampere-hour capacity* depends directly upon the correct proportion of active available materials in the battery.
6. That the radio user *Can Play Safe* by buying the products of trustworthy manufacturers from trustworthy retailers, instead of looking for big boxes or heavy boxes of dubious parentage and indiscriminate distribution.
7. That the trustworthy manufacturer marks or identifies radio batteries so that the correct *ampere-hour capacity* may be readily learned by the consumer.

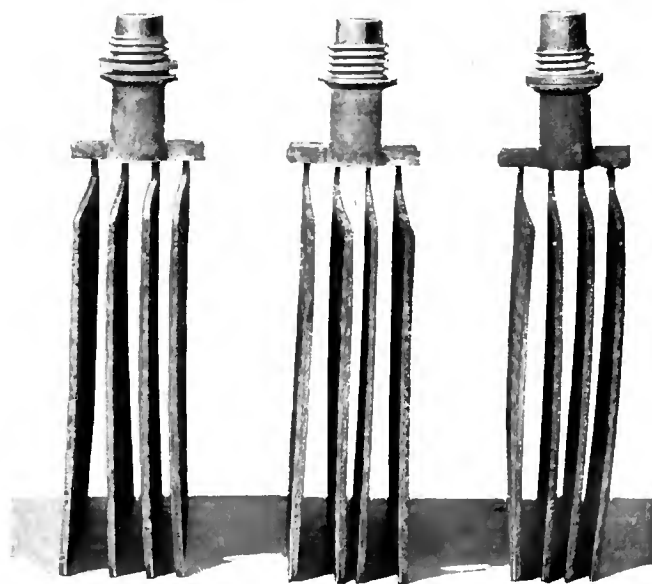
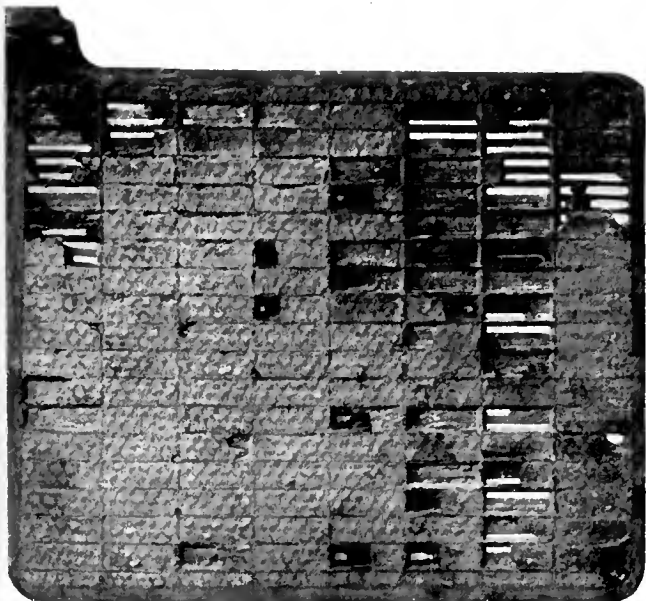

TWO ILLUMINATING EXAMPLES

Plates from a bargain battery after testing at radio rates. These plates were put in an oversize box, and the whole battery represented to be of a larger capacity than it could possibly be with the number and size of the plates. The positive plates were only one-tenth inch thick and after testing, the plates shed active material and warped. A battery like this is a poor one to make any filament glow—for long

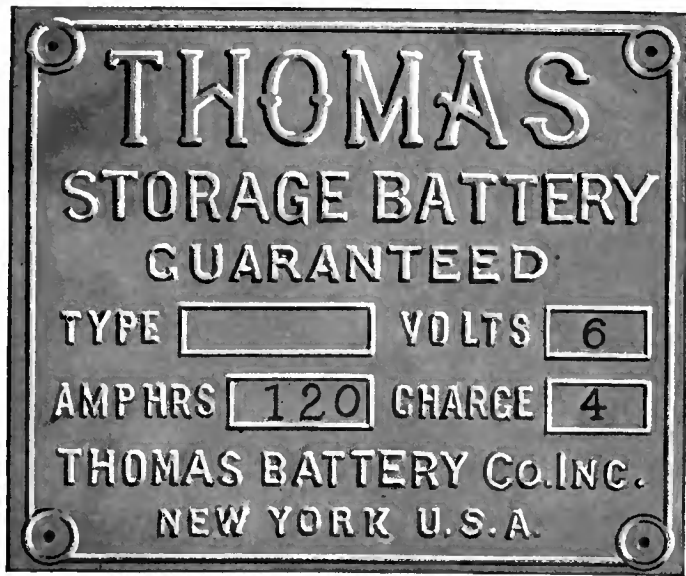

MISBRANDING

Laboratory tests on the battery bearing this label disclosed the fact that its capacity did not actually exceed 75 ampere-hours

8 That the trustworthy retailer is eager to show the rating or identification on the battery and in the maker's catalog.

HELPING THE CONSUMER HELP HIMSELF

THE reception accorded these bulletins by the battery trade and the radio trade will be interesting to radio users. As an indication that many of those who serve the radio public take this subject seriously, we can record that the original edition of the first bulletin was snapped up inside of a week by battery makers, local Better Business Bureaus, and radio retailers in New York City. Sample copies of this bulletin were sent to battery service stations.

Do you think the service station man is not interested in straightforward radio battery business? The number of these men who ordered quantities of the bulletin "Buy Battery Capacity!" for distribution to their customers was so large that the second edition did not last much longer than the first.

Local battery dealers in Boston, Massachusetts, became sufficiently interested in the proposal to give the radio user an A

concerns in this field requested a similar meeting, which was held not long ago with like results. As this issue of RADIO BROADCAST goes to press, battery and radio companies in Chicago are urging a similar procedure there.

HOW TO GET MORE INFORMATION

ANY reader of RADIO BROADCAST who is interested in the subject may obtain a copy of "Buy Battery Capacity" without cost, by writing to the National Better Business Bureau at 383 Madison Avenue, New York City, and mentioning this magazine. The Bureau will also supply such inquiries with a copy of its May bulletin concerning

battery which will deliver the ampere-hour capacity claimed for it for them to apply to the Boston Better Business Bureau and the Associated Industries of Massachusetts for a meeting on this subject, which was held with the representatives of seventeen concerns in attendance. Resolutions were passed pledging the adherence of those represented to the code, and urging the Boston Better Business Bureau to mop up any local misrepresentations which might remain. Philadelphia concerns

a Philadelphia battery manufacturer whose career of misrepresentation had as its sequel an offer to his creditors to settle for twenty-five cents on the dollar. The significant subtitle of this bulletin is "Fair Play Has A Cash-Drawer Value." Both bulletins are written in simple and understandable language. They are intended as a guide to the battery user in obtaining products of the desired ampere-hour capacity, and as a warning to the trade that the apparent gains of "gyp" selling do not build permanent profits for any business.

The National Better Business Bureau has not concluded its service to the trade and to the public with the issuance of these bulletins. It expects to stay on the job until the radio public runs substantially no risk of encountering further deception of this type. It has the cooperation of the better publishers (both magazine and news-



ROOM TO SPARE IN THIS "HOPE CHEST"

From the outside, this battery looked quite all right, but the space for the proper number of plates was not completely filled. Note that an inch of space remains unused. Some manufacturers have followed this practice, which is hard for the layman to detect

OPEN EVENINGS TILL 8 P. M.  
A Guarantee Bond With Every Purchase

**PERFECTION**  
130 LINDEN ST. (COR. BROADWAY)  
39 CORTLAND ST. (COR. BROADWAY)

Perfection Leads as Always

Exide 100 Amp. Rubber Case	\$11.45
CORNELL 100 Amp. Rubber	\$8.35
CORNELL 140 Amp. Rubber	\$10.90
ASSORTED, 100 Amp.	\$5.00
WILLARD, 100 Amp. Rubber Case	\$10.95

6 Sockets

**GREENHUTS**  
"The Radio Hub of New York"  
85 Barclay Street  
73 West Broadway

6 WARREN STREET

**Greenhut Fans**  
St. Will Be Open Saturday.

The Famous **ATLAS** Reg. \$30  
10.95

**BATTERIES**

3 Dry Cells - M	\$ .85
2 1/2 v. Small - M	.65
2 1/2 v. Large - M	.95
4 1/2 v. Large - M	1.95

**OSCAR'S**  
RADIO SHOPS

172 Washington St.  
176 Greenwich St.

100 Amp. NEIDICH STORAGE BATTERY \$8.25

NEWSPAPER ADVERTISEMENTS

How unbranded, oversize box batteries were represented in advertising. In the advertisement at the left the first and the last batteries in the list were not subject to investigation

paper) in the form of effective self-censorship of their advertising columns and in the publication of such articles as this. (Editor's Note. Batteries, dishonestly marked, as explained by Mr. Shinn, have not been recommended by RADIO BROADCAST and would not, of course, pass the tests of our Laboratory). It invites the cooperation of the radio public. If you have found your A battery of suspiciously low ampere-hour capacity, notify the National Better Business Bureau, giving the maker's name and the time and place of purchase. In so doing, you are rendering a service to the thousands of new radio fans who purchase battery equipment every day.



# THE MARCH OF RADIO

*News and Interpretation of Current Radio Events*

## How Short Waves Are Linking Far Corners of the Globe

**I**N DAYS of old, the fading light of the last northerly port was the courageous Arctic explorer's last contact with civilization. Then followed months, usually years of cold silence. Just half a century ago, Sir Allen Young faced this dreariness in a mission of mercy. With him he carried a packet of letters for his compatriot, Sir George Nares; letters of home, of friends, of news, to break the cruel silence of the Arctic. These, by pre-arrangement, were left at Cape Isabella. MacMillan, several years ago, found this packet, unopened. And twenty feet away from it, he found another, records Young had buried before resuming his northward march.

What a change in fifty years. A dirigible whisks sixteen men skyward. A matter of hours, and they pass over the Pole. A newspaper correspondent clicks off a radio message to his sheet, where waiting men only hours later set up the type which crystallizes the achievement. The busy world soon forgets, but Sergeant Albert Payne will never forget. His Signal Corps radio station at Nome handled 22,000 words of press about the flight of the *Norge*.

The flight of the *Norge* has been the sub-

ject of thousands of words of comment, but not all the commentators have taken into consideration the fact that it was radio which mainly made it possible. The direction finding equipment was in constant use and gave important bearings to the navigators. Groping through the Bering Sea fogs, a chance signal from an Alaskan station told the navigators where they were and led to the successful landing of the ship at Teller, Alaska. The transmitting equipment of this ship, following the lines of present English practise, did not provide for short waves. They depended on 900 meters and 1400 meters (333 and 214 kc.) which worked successfully enough up to and over the Pole. But from the Pole to Alaska, the longer waves did not come through. One ventures to say that if the *Norge* had profited by the previous short-wave experience of others, the operators could have maintained constant communication.

The year 1926 is the year of explorations. Six expeditions will have penetrated the Arctic before July. At least two important expeditions will pierce the heart of South America. Francis Gow Smith, of the Museum of the American Indian, aided by native guides, is now going slowly up the River of Death, perhaps the most dangerous region in all South America. With

him is a simple two-tube short-wave receiver. Signals from wgy's 32.79-meter (9140-kc.) transmitter were received by him with excellent volume at Corumbá, Brazil, almost 5000 miles from Schenectady. In the interior, the time signals and news broadcasts will prevent the silent forests from shutting off all contact with civilization. The receiver was designed and built by RADIO BROADCAST Laboratory.

By the time this magazine appears, the Dyott Expedition led by Commander G. M. Dyott under the auspices of the Roosevelt Memorial Association will have sailed for Brazil, to explore and photograph in still and moving pictures the territory first traveled by Roosevelt—the River of Doubt. Two complete radio stations will be set up, one at a base station above Corumbá, Brazil, and another portable set with the party. Short waves will form the link with the United States, and Commander Dyott hopes to send frequent dispatches back to the *New York Times*. His equipment is being built and operated under the direction of RADIO BROADCAST Laboratory.

Toward the last of June, two ships sailed to Greenland in the MacMillan expedition. The good old *Bowdoin*, commanded by MacMillan will lead, and the new schooner *Sachem*, newly built for this

The top-of-page illustration shows the apparatus employed by the government to check up on broadcasters to see that they do not stray from their assigned frequencies





A RECORD-MAKING SHORT-WAVE RECEIVER

Francis Gow Smith (right), who is exploring the River of Death in central South America, photographed at the Explorer's Club, New York, with John B. Brennan, Technical Editor of RADIO BROADCAST. The short-wave receiver was designed and built by the RADIO BROADCAST Laboratory and loaned to Mr. Gow Smith. Special programs have been sent out by 2 XAF, one of the experimental stations of the WGY group, on 9140 kc. (32.79 meters) and have been received successfully by Mr. Gow Smith, who informed RADIO BROADCAST, "The radio created a positive sensation in Corumbá. Several of the most important people of Corumbá heard WGY programs on this receiver and were amazed at its clarity." Mr. Gow Smith is gathering material for the Museum of the American Indian and the American Geographical Society. Note the case which is built to stand rough handling and to contain the entire radio equipment.

expedition by Rowe B. Metcalf and commanded by him will accompany the *Bowdoin*. The *Sachem* carries a particularly interesting short-wave equipment, about which more will be said later. It has been built and will be operated under the direction of RADIO BROADCAST Laboratory.

Professor Hobbs of the University of Michigan will shortly start for Labrador where he will set up a semi-permanent short-wave station as a part of his meteorological expedition to learn more about Northern weather. Operator Oscanyan, a New York amateur, will be in charge. Still another group with George Palmer Putnam started for Northern Greenland about July first, also depending on short waves for their contact.

One of the most reliable ways to step into the limelight in this day and age is to pack up a short-wave transmitter and make your way beyond the real estate developments. Then the *Times* will probably tell the world how you slept the night before, what you had for breakfast, and what birds twittered about you as you typed your dispatches.

### The Radio Legislative Arena

IN NO department of radio has there been more active controversy than in the codification of its law. Interwoven with problems of wavelength assignments and administrative detail are such fundamental issues as freedom of speech, censor-

ship, political influence, and the eternal struggle between the executive and legislative branches of our government. While Congress is actively considering radio legislation, we cannot predict what changes each day will bring. At this writing, we fear more no legislation at all, than the harmful effects of any particular bill or method of control proposed by the many influences seeking to shape the government's future policy.

State and local governments have been generally inactive in complicating the situation, but there have been two instances which merit attention. Bay City, Michigan, has adopted a municipal ordinance regulating radio reception and the legislature of the state of Washington is considering an Act which has the support of radio enthusiasts of that state.

Radio is regarded, in a legal sense, as an interstate matter and its regulation therefore falls within the jurisdiction of the national government. This is as it should be. While we may view with some impatience the slow formation of radio's legal structure, we must realize that the cautious approach of our legislators to the problem is engendered as much by the difficulty of writing radio legislation as by political considerations. Local legislation, however, imposing regulations upon broadcast listeners, is undesirable and burdensome. Radio's problems are national in scope and triple regulation by municipalities, states,

and nation are bound to work hardship upon millions of owners of receiving sets.

Bay City has attempted to make radiating receivers illegal. The ordinance which it has adopted establishes a license fee of \$2.00 for every radio receiver installed in the city. Sets must not be operated so as to radiate or cause disturbance with neighboring receivers. Violations are subject to fine up to \$100 or three months imprisonment or both.

In a small community, where such a regulation might possibly be enforceable, protection against radiating receivers might be worth \$2.00. But in cities, where radiation problems are most acute, no staff of radiation prohibition enforcement agents can hope to smoke out every invisible squeal, with a radiating speak-easy in every other home. Improvements in receiving sets and education of the listener offer a much more productive prospect than easily evaded and irksome local legislation.

Two factors must be considered with regard to radiation: first, the receiver itself and second, the skill and temperament of its users. No matter how good the intentions of manufacturers, a malicious or careless user can make almost any kind of receiver radiate. Merely legislating them out of business will not eliminate them. Engineers and manufacturers will ultimately solve the problem by developing non-radiating receivers so superior to radiating sets in point of sensitiveness, selectivity, volume, and economy that the incentive to cause howls and squeals will disappear.

### Correcting an Unfortunate Misstatement

ON PAGE 118 of RADIO BROADCAST for June, 1926, in an editorial captioned "Important Radio Patents at Present in Litigation" there appeared the following statement:

There are at present being tried in the courts, several of the important radio patents, the decisions on which may very materially affect the radio business. The Armstrong idea of regeneration, insofar as it relates to oscillating tubes, is being contested by the government in a suit in the state of Delaware. Armstrong's priority over other inventors apparently depends altogether upon a sketch of a supposedly regenerative circuit, which was accompanied by practically no explanatory disclosure. Should this sketch be proved by the government's experts to be no true disclosure of the regenerative principle, there is a possibility that the Westinghouse Company may lose one of its most valuable radio patents.

The advance sheets of this article which reached 900 newspapers also contained the sentence, in reference to this sketch: "It was, to be sure, certified by a notary, but there has apparently been some question raised as to the genuineness of the notary's signature."

The editorial, from which the above is taken, formed the first paragraph of a report on patent suits now being litigated. Succeeding paragraphs had reference to other patents than those issued to Mr.



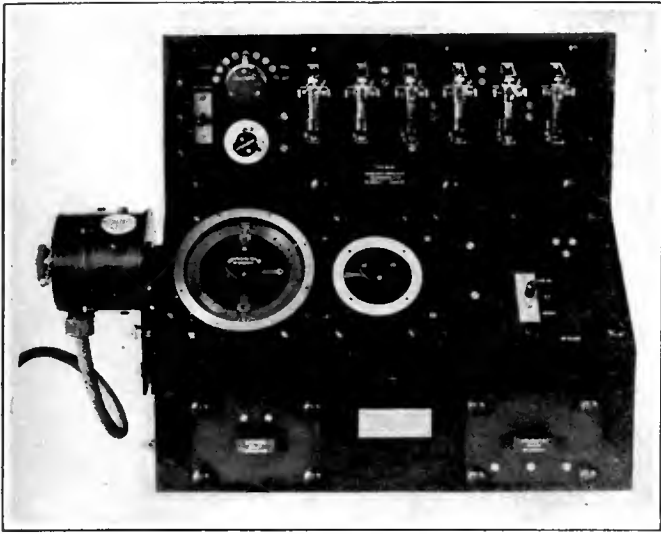

ENGLISH DIRECTION-FINDING EQUIPMENT

This photograph shows the combination direction-finder and the Sperry gyro-compass, manufactured by Marconi's Wireless Telegraph Company, London. The metal box fitted to the left side of the direction-finder is coupled to the ship's main gyro-compass. The variations of the gyro-compass are communicated to the metal ring of the dial of the goniometer, so that the true bearing of the ship can be directly obtained by reading from the outer ring without any correcting calculations. The bearing relative to the ship's head is read in the usual way from the inner ring of the dial. The radio receiver shown here, is of course connected to the special loop antenna on the bridge

Armstrong. Since the publication of the editorial referred to, it has been brought to our attention that the statement "Armstrong's priority over other inventors apparently depends altogether upon a sketch of a supposedly regenerative circuit, which was accompanied by practically no explanatory disclosure," and "it was, to be sure, certified by a notary, but there has apparently been some question raised as to the genuineness of the notary's signature," are entirely unjustified by the facts.

The sketch in question, which was certified by a notary, has been upheld as genuine by at least six different tribunals. Judge Julius Mayer said, from his bench in Federal Court, on one occasion:

The signature which appears in the County Clerk's record, of course, is a different signature than that which appears on Plaintiff's Exhibit No. 37; and in such circumstances, I do not see that the defendants would be blamed, from any moral or sentimental standpoint, from taking any advantage that there may have been in that circumstance.

As a matter of common experience, I have, of course, in my life, seen signatures of the same man that varied, for some reason or other, best known to himself. Men have peculiarities in such respects.

I am perfectly satisfied on the testimony in this case that the signature to Exhibit 37 is the signature of the same man who was the notary, whose certificate was filed in the office of the County Clerk. (Exhibit No. 37 is the sketch with the notary's signature.)

In point of fact, there can be no doubt whatever that the signature, to which reference was made in the editorial in our June issue, is genuine. Obviously, the way in which the editorial, and the advance sheets quoted above, mentioned the sketch disclosing the regenerative circuit, cast

suspicion on the character of Major Edwin H. Armstrong. RADIO BROADCAST has always had the highest respect for that famous radio worker and we are glad to state that there is no justification whatever for the suggestion in that editorial, real or implied, that he had been a party to dishonest or at the least, unfortunate practices, in the earliest recording of his regenerative circuit. The paper in question bears the date of January 31, 1913.

RADIO BROADCAST regrets very deeply that, in its effort to report the important radio news of the moment, any damage should have been done to the reputation of a radio investigator of the high standing and unquestioned character of Major Armstrong. We are glad to give this item equal prominence with the original editorial in our June number.

### Washington Proposes to Make Interference Illegal

RADIO enthusiasts of the state of Washington are reported to be actively supporting a bill before the State Legislature, which is intended to

eliminate interference by "electro-radiant" systems. Such systems are defined as any source of radiant electrical energy which interferes with radio reception.

The state's Bureau of Weights and Measures is to be charged with the enforcement of the measure. It is to be authorized to license radiant systems upon payment of a fee of \$2.00 if the system does not interfere with radio reception. Owners of vacuum tube receiving sets are to pay an annual fee of \$1.00. In addition, an appropriation of \$25,000 is proposed to meet the cost of enforcing the Act.

Complaints of interference filed by broadcast listeners, when accompanied with a \$10.00 fee, are to be investigated by the Bureau. If no interference is found, the fee may be returned to the complainant upon the discretion of the Bureau. If the source is found to be one which the Bureau has licensed, the fee is also returned and corrective measures are to be recommended to the owner of the interference source. If it is not a legalized noise, the owner of the system is called to pay the \$10.00 and to eliminate the noise forthwith.

From the standpoint of the broadcast listener, the Act leaves nothing to be desired, unless he should happen to be a stockholder in a light and power company or is attempting to cure his rheumatism with an ultra-violet ray machine. Undoubtedly there are minor cases of noise interference which may be eliminated by corrective devices and improved insulation. But what will the harassed public service corporations, providing electric light, power, and traction at rates fixed by law, do if the Act is adopted by the legislature?

At the behest of any one owning a nine-dollar receiver, who pays an annual fee of \$1.00, they may be compelled to spend

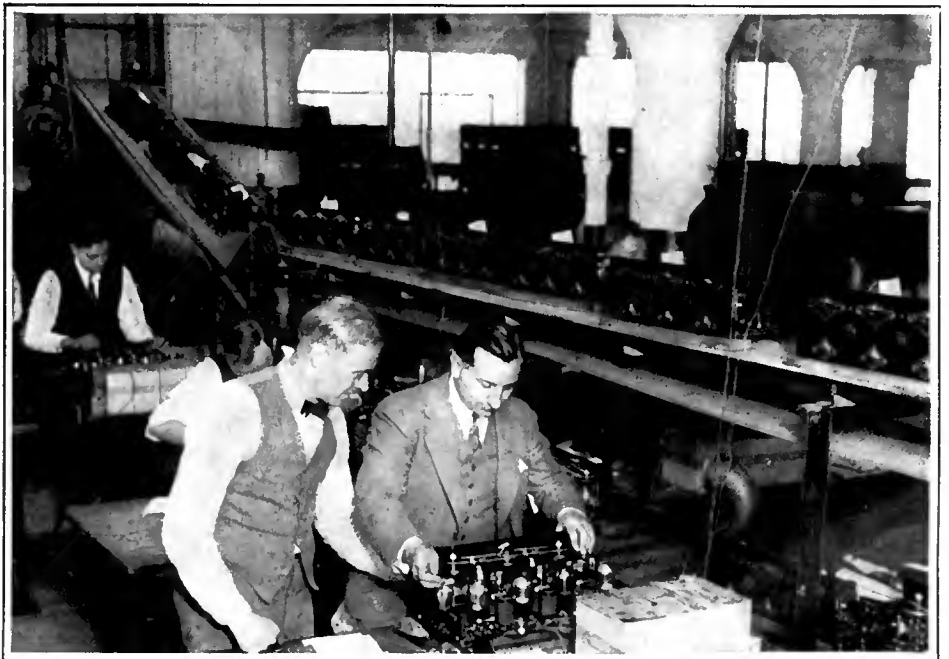

RADIO RECEIVERS IN QUANTITY

Completed receivers coming down the factory conveyor left in a New York radio factory. Large radio factories turn out their sets on the same efficient methods as does a certain large motor car maker of Detroit

sums running into thousands of dollars to eliminate a single source of interfering noise. Until the radio listener is prepared to pay for his demands for a silent ether, he may rest assured that interference from power sources will not be universally eliminated. The telephone companies have wrestled with the problem of induction from power systems for many years and only by diplomatic cooperation have they been able to make progress. Had they attempted coercive legislation instead, the chances are that telephone lines would still hum with sixty-cycle "music."

### Are 500 Kilowatt Broadcasters Coming?

ACCORDING to Harry Sadenwater, the engineer in charge of wgy, the next step in broadcasting may be the erection of a 500-kilowatt broadcasting station. He points out that each step in power increase—from half a kilowatt to five, from five to fifty—has invariably caused a wave of turmoil from

listeners, which has been quickly silenced when the improved service resulting has been appreciated. Ten-folding the power, he states, only three-folds the service area and triples signal strength at any point.

The easiest way to overcome disturbing noises, whether from power lines or radiating receivers, is to provide increased signal strength. The effect of noise is diminished by a comparatively stronger signal. Radiation is lessened because the user of a regenerative receiver has nothing to gain when receiving strong signals by forcing his set to oscillate violently.

There are two important limitations, however, to continued increases in power. Within a radius of fifty to seventy-five miles, a 500-kilowatt station would more or less blanket reception. It would be difficult to locate such a station without excluding the reception of other stations to large numbers of listeners. wjz's fifty kilowatts at Bound Brook has not been an altogether happy choice for a large and populous section of New Jersey, yet that station could not be located further from New York

and still serve the metropolitan area satisfactorily. The other limitation lies in the high cost of maintaining a 500-kw. station.

In England the problem of providing a uniformly good signal in every part of the country has been attacked by a different method. In areas where the original British network of B. B. C. stations were not furnishing good signal strength, they have erected 100- and 500-watt relay stations and supplied them with programs by wire line connections. The British problem is greatly simplified by the fact that they do not seek to serve as large an area as American stations. The area of Great Britain is but twice that of Pennsylvania.

American listeners would be better served by a combination of the two systems than by the use of extraordinary power at widely scattered points. For instance, a chain of three 50-kilowatt stations, supplemented in congested areas by a series of 5-kilowatt stations would meet with greater public approval, without undue financial hardship upon the broadcasters, than would a single 500-kw. transmitter.



THE MARCONI SOUTH AFRICAN BEAM STATION

This is the transmitter house, located at Kliphevaal, near Capetown. The 800-foot tower on the left was originally built for a high-power station on which work has now been suspended. This station is one of the first of the group being perfected for the British Imperial chain, designed to link all the Dominions and Possessions with London. Other stations now nearing completion are at Bodmin in Cornwall, Bridgewater in Somerset, and in Canada. Much smaller power is required by the beam system than by the present method of longer wave, high-power work, the British Marconi Company reports



HARRY SADENWATER

—New York—

engineer in charge of stations WGY, KGO, and KOA

*"The expression 'super-power,' when applied to a radio broadcasting transmitter operating on 50 kilowatts, is a misnomer. The term is misleading and inaccurate, for actually 50 kilowatts of power is often used in lighting a sign, and when one considers the large amount of service that a broadcasting station is called upon to deliver to a large number of listeners, it seems ridiculous to call it 'super-power.' Discussion of 'super-power' leads many radio listeners to expect impossible results from 50-kilowatt transmission. Some feared to turn up their tubes lest the expected influx of power would destroy them. In reality, it was found that a tenfold increase in power (from 5 to 50 kilowatts), developed approximately three times the signal strength. The next practical step forward is to increase again the power of the radio broadcasting transmitters by a factor of ten. Such a step, to give any gain in volume to the broadcast listener, would mean an increase to 500 kilowatts in the case of WGY."*

Who Will Market Radio?

THE music store, the electric store, the radio shop, the automotive supply store, the hardware emporium and the department store (perhaps we have omitted a few) have engaged, with more or less enthusiasm, in the retailing of radio equipment. As a consequence, the radio industry scatters its selling efforts through so many retail outlets that over-production and over-stocking is bound to result. One manufacturer who recently brought out a new line, stated that 30,000 of his sets were sold within six weeks, in spite of the summer season. Yet that number of sets is not sufficient to supply one sample of each type to each of his dealers. Under the circumstances, how can a manufacturer adjust his production schedules to the pulse of public demand?

The sooner the radio industry narrows down its channels of retail distribution to a reasonable number, the sooner it will be able to control production to demand.

Everybody will be more prosperous—the dealer, with fewer competitors and larger volume; the manufacturer, with accurate knowledge upon which to base production; the public, with fewer, larger, and better equipped radio stores.

In the aggregate, it makes but little difference which of these channels is selected. Each can justly assert special qualifications. The music store claims to be the natural channel for the distribution of radio products because it knows how to sell sets as musical instruments, how to serve women, and how to handle time payments; the electric store because of technical knowledge in selling, servicing and repair; the automotive supply store, because of accessibility and experience with storage batteries; the hardware, because of influence in the rural community, and so on. We are loath to weigh the claims of the various groups, but from the standpoint of the radio public, one good prosperous radio department, with a comprehensive up-to-date stock is worth half a dozen neglected radio counters starving from needless competition.

The Month In Radio

A NEW 500-watt short-wave transmitter for transoceanic service has recently been installed at Chapultepec Park, Mexico City, according to an announcement from the Department of Commerce. The extensive wireless towers are being pulled down to make way for the small 45-foot antenna used by the modern transmitter. A similar outfit is being developed at the Chapultepec Radio Laboratories for installation at Campeche.

LITIGATION between the De Forest and Armstrong interests has been placed before the Supreme Court, as a result of the appeal of the De Forest Radio Telephone Company from the decision of the Federal Court in New York City, which restrained the De Forest Company from manufacturing a "regenerative receiver," known as the "D-17."

IF THE Naval Radio Service finds the demand for radio compass bearings continuing at the present rate of increase, one of the busy compasses is bound to develop a hot box sooner or later. The United States Navy reports that its compass stations furnished 126,607 bearings during the last fiscal year, without charge to mariners. Other countries charge between \$1.25 to \$1.50 for each bearing, so that, if a charge were made for each bearing at the lower figure, the Navy would have earned \$158,257 for its service. During a recent month, a total of 19,952 bearings were given, showing a substantial rate of increase. Of this number, Cape Hatteras handled 1337, a record for any compass station for that period.

BY ALTERING its articles of association so that not more than 25 per cent. of its stock shall be held by foreigners together with other protective features, Marconi's Wireless Telegraph Company of England has recently secured a license from the British Postmaster-General to establish services with certain Continental and other foreign countries outside of Europe.



PROF. HUBERT TURNER

—New Haven—

Radio specialist, Dunham Electrical Laboratory at Yale. To the New York Times:

*"The outlook for the elimination of static is not promising. Super-power, which is now being used at several of the larger broadcasting stations, will overcome static effects, however. The problem in the elimination is that static and signal waves both set up oscillations in the receiving circuits, and by attempting to eliminate the static, the desired signal is also decreased in amplitude. By the use of super-power in broadcasting, the person with a radio set can decrease the pick-up efficiency of his receiver without seriously interfering with the reception of the desired signals. The important thing is to make a signal strong as compared with the static, which is still there, of course, although its effect will be decreased. . . . A set which is not extra sensitive, and which gets local and near-by stations satisfactorily, is the best set to have. The less sensitive a set is, the less static is picked up."*

Interesting Things Said Interestingly

H. B. KROGER, 2 ALL (New York; in a letter to the New York Times): Those in charge of radio installations on the *Norge* did not show good judgment when they chose the long waves for the transmissions from that ship. Several wavelengths were chosen in the vicinity of 333kc. (900 meters). When anything was received from the *Norge*, it was in such small fragments as to be almost meaningless. As the region north of the Arctic Circle is in continued daylight, and it is a well-known fact that transmission on the long waves is greatly affected by daylight, it was a great surprise to me to hear that the twenty- and forty-meter hands were not chosen. Luckily nothing happened to the *Norge* that would have made it imperative to establish good contact with another station. If, however, anything had happened, I believe that one more dirigible would have gone to its fate. Let us hope, for the safety of future expeditions, that that was the last omission of a short-wave transmitter in the equipment of such an undertaking."

# How Was Reception Last Night?

*A Description of the Pioneer Work and Methods of Dr. G. W. Pickard in Measuring Radio Signal Intensity—Circuits and Details Completely Shown Opening Up New Fields for the Serious Experimenter*

By ALBERT F. MURRAY

*Engineering Department, Wireless Specialty Apparatus Company*

ON A chilly corner of Boylston Street, in Boston, two old friends meet; one a radio dealer, the other a radio engineer. After greeting each other the dealer asks: "Well, Al, how was reception last night?"

"Very poor, I think, Harry, but look in tonight's *Transcript*; they usually give an accurate report. Why the frown?"

"Was I frowning? It must have been because this long run of poor radio weather is not only spoiling business but has been getting on my nerves. This morning another customer who bought an expensive set from me at Christmas time said that WJZ was the only station, except the locals, that he could pick up, and that he wanted to return the set."

"Yes, I know how it is," replied the engineer, "friends ask me what is wrong with their sets or what is wrong with the ether. There is nothing wrong with the former and what is wrong with the latter cannot be fixed."

"Why don't you engineers do some research on this erratic ether of ours? Do you know I would give five-hundred dollars right now, for five consecutive good radio nights!"

The engineer smiles, but realizing the seriousness of the situation suggests to his companion:

"Another thing that money can not buy. Money can erect high-power transmitters, but even these stations cannot force their signals through 'dead spots' in the ether. Yet at other times, when ethereal conditions are right, a mediocre half-kilowatt broadcaster will be heard half-way across the country."

"But don't think that this most interesting and truly universal question of radio transmission is not being looked into by scientists. There are, for instance, twenty-eight college, corporation, and private laboratories cooperating with the Bureau of Standards, in gathering data on fading, etc. Do you remember the fading records taken during the eclipse of 1925? Well, this whole project was under the guidance of Mr. G. W. Pickard."

"Oh, yes, I know Mr. Pickard. He is consulting engineer, Wireless Specialty Apparatus Company, and among other things the inventor of the crystal detector and the loop direction finder. I once heard him give a paper before the I. R. E."

"As I was saying," continued the engineer, "Mr. Pickard is an authority in the radio world on variations in radio transmission, having published charts showing such variations as early, I find, as 1905. Each year during the last twenty-one, he has explored further and

further the mysteries of what happens to radio waves as they travel from transmitter to receiver. Although it is not generally known, he is now engaged in measuring, during a two-hour period each night, the field strength of a certain broadcast station in Chicago. In fact, he has shown me continuous signal strength and static records which he makes on long rolls of paper."

"Can one see from these records how strong signals from Chicago are?" asked the dealer.

"Yes, and the strength of static, too."

"Did you ask him how reception was the last week?"

"He said, except for one night, reception had been poor," reported the engineer.

"Ha, an idea!" the dealer wore a wide grin. "Could I get these records to show my customers?"

"I don't know. Your customers, except those scientifically inclined, would not care to bother with the inspection of a very jagged line running the length of a six-foot strip of paper to find out whether reception last night was good or poor. However, Mr. Pickard has worked out a 'Reception Factor,' a number, which, when obtained from each night's record, gives at once an idea, not only of whether the night was good or poor for radio, but how good or how poor."

"Say," the dealer becomes enthusiastic, "such scientific measurements of reception are just what we need. If they were only published!"

"I asked Mr. Pickard why he did not write, in that inimitable style of his, about these measurements and the interesting data which he has been collecting for weeks."

"And what was his reply?"

"That he, having to be at the radio recorder six nights a week, did not have time just now. I believe, however, he would be glad to give the facts for publication. Have you heard the term 'De-bunking Radio?' Well, Mr. Pickard, in common with other scientific radio men, believes in aiding in the 'de-bunking' process, so naturally he prefers to see the radio public furnished with accurate scientific data on reception conditions, since, at present, there is so much 'bunk' about the relation between radio and the weather being circulated by partially informed experimenters, so-called radio weather forecasters, and the like."

"Yes, even I am able to tell by nightly checks that newspaper radio forecasts are wrong as much as fifty per cent. of the time," said the dealer.

"Mr. Pickard is also anxious to interest as many radio experimenters as possible in this interesting game of recording, so that by a broad systematic research, such as you asked about a few minutes ago, it will be possible to find out more about the elusive ether—if indeed there is such a thing," said the engineer. "To tell the truth, my own interest has grown to such an extent that, if I can arrange it, I am going to attach a signal recorder to my

## A New Field For The Ambitious Experimenter

**H**OW does the broadcast carrier wave travel? No one knows. That is why we are recording and collecting data little by little, in a methodical effort to piece together the answer to the gigantic—yet probably simple—puzzle, of what happens in the intervening link between receiver and transmitter. The more radio listeners who turn observers, the faster the data will accumulate and the quicker we will all know the answer to the puzzle. Once knowing the answer, it is logical to believe that many of the limitations and vagrancies of transmission will be overcome to the great gain of all of us who are users of radio. To those broadcast listeners, who, having become fascinated by the mysteries of radio, have developed into serious radio experimenters, and are looking for new fields of endeavor, this interesting subject of research is heartily recommended. No technical preparation is necessary. If properly carried on, the results are more satisfying and worth while than, say, learning the code or operating an amateur transmitter."



DOCTOR PICKARD

Whose experiments to determine what happens in the ether between transmitter and receiver, are related in this article by Mr. Murray, one of his associates

receiver and follow some definite line of research. Doctor Pickard has kindly asked me to come to see his recording apparatus and I am going Tuesday evening."

"Well, Al, don't forget to ask him to make available to all of us, the reception data which he is taking."

And Tuesday night finds a visitor at Mr. Pickard's door. A few moments later, the visitor is being shown to the library-laboratory by the genial host himself.

What the visitor saw and what he learned from Mr. Pickard, concerning the recording of radio signals, the apparatus, and methods used is told below.

THE GRAPHIC RECORDING OF RADIO SIGNALS

THE most commonly used recorder of radio reception to-day is the human ear. Unfortunately, as ordinarily used, the accuracy of this recorder is so low that signals can vary

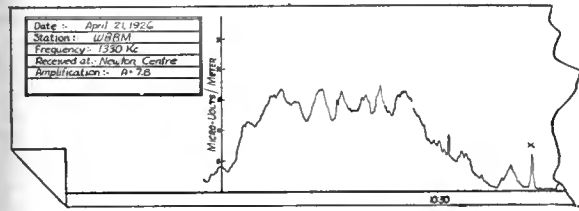

FIG. 1

A typical reception record as made with a Shaw Recorder. Note the peculiar carrier-wave variations, many of which would not be perceptible to the human ear

100 per cent. in intensity before a change is noticed. This means that for accurate results, upon which scientific conclusions can be based, the response as noted by the unaided ear can not be used, especially if the greatly varying intensity of speech and music is used to judge reception conditions. Therefore, since listening with phones or loud speaker to broadcast stations does not give results that are dependable, for investigations of radio reception, it is necessary that the r. f. output of the radio receiver be rectified and passed through a galvanometer, the reading of which is recorded either intermittently, by noting the scale reading, or continuously on a moving strip as is done in the Shaw Recorder.

As is well-known, the carrier wave received from the average near-by broadcast station in daytime, remains fairly steady. Fading and night-time effects, of course, make it vary greatly, and these are the variations in which we are interested in recording and studying. When looking at the peculiar variations in a typical reception record, reproduced in Fig. 1, it should be understood that it is not the audible variations, due to speech frequency modulation, which are recorded, but the moment to moment change in the intensity of the carrier wave. This "carrier," as far as the broadcast transmitter is concerned, is radiated with constant amplitude, only to be twisted, deformed, suppressed, refracted, absorbed, by the medium in which it travels. How does it travel? No one knows. That is why we are recording and collecting data little by little, in a methodical effort to piece together the answer to the gigantic—yet probably simple—puzzle of what happens in the intervening link between radio transmitter and receiver. The more radio listeners who turn observers, the faster the data will accumulate and the quicker we will all know the answer to the puzzle. Once knowing the answer, it is logical to believe that many of the limitations and vagrancies of transmission will be overcome to the great gain of all of us who are users of

radio. To those broadcast listeners who, having become fascinated by the mysteries of radio, have developed into serious radio experimenters, and are looking for new fields of endeavor, this interesting subject of research is heartily recommended. No technical preparation is necessary. If properly carried on, the results are more satisfying and worth while than, say, learning the code or operating an amateur transmitter.

For those who wish to collect data on radio reception, the necessary equipment is described below in sufficient detail to give the average experimenter an idea of the apparatus he should have if he wishes to make observations so as to be able to answer the question, "How was reception last night?"

This list of apparatus includes the antenna, the receiver, the rectifier, the recorder, the calibrator and—the observer, for he must become a part of the equipment, possessing to some degree the patience, reliability, and tirelessness of a machine. It is surprising, however, how quickly the observer falls into the way of automatic recording, that is, the necessary motions become reflex actions.

WHAT EQUIPMENT IS NEEDED

THE Antenna (1.) should be of the open type in order to avoid directional effects. It should be substantial and permanent with the lead-in wires rigidly fixed in place so that there is no change from day to day in antenna characteristics. It is desirable to know the effective height of the antenna at the working frequencies. A simple way of measuring this will be described later.

2. The Receiver should cover the desired frequency range with tuning controls that can be accurately set and logged. Radio amplification is necessary (unless powerful radiations from near-by transmitters are to be studied), and the amplifier must be of a type such that considerable amplification can be obtained with stable operation. It is very important that the amplifier be equipped with an amplification control which can be calibrated. For the sake of constancy, both A and B power should be supplied from storage batteries. Since the degree of amplification is usually dependent upon the filament and plate voltages, both of these, especially the former, should be indicated by voltmeters easily visible to the observer. Receivers of the so-called regenerative type are barred. The neutrodyne receiver has been used, with a separate heterodyning oscillator, but the super-heterodyne is recommended, since it possesses the required sensitivity and, if the intermediate amplifier is stable, the required reliability.

While the audio amplifier portion of the receiver is not necessary when a recorder is used, it is retained for the purpose of operating a loud speaker, or phones, used in monitoring.

Special attention is directed to the amplification control on the receiver. The signal intensity from the station being recorded may vary widely, so that in order to keep the needle of the recording galvanometer on the scale it is necessary to change the output from the receiver from time to time, by changing the sensitivity a definite and known amount. After trying

several methods of control, it appears best to calibrate a variable resistance, shunted across the input to the radio, or intermediate-frequency amplifier; or to vary the rheostat controlling the filament brilliancy of one of the amplifier tubes. The variable coupling between the antenna and the tuned secondary circuit of the receiver may be used, after calibration, to vary the output to the recorder. The method of calibrating will be explained later.

3. The Rectifier. Since the recorder galvanometer operates on pulsating d. c. it is necessary to rectify the received a. c. energy

"RECEPTION FACTOR" TABLE

Mr. Pickard has worked out a "Reception Factor," a number which, when obtained from each night's record, tells at a glance just how good or how bad reception was on any particular night. The table below was compiled by listening to WBBM, Chicago, between 9-11 P. M. E. S. T. nightly, except on silent nights.

DATE	RECEPTION FACTOR	STATIC
May 4, 1926	79	0
5	—	—
6	14	0
7	65	0
8	218	1
9	173	2
10	—	—
11	225	3
12	258	3
13	165	3
14	8	1
15	22	3
16	148	3
17	—	—
18	210	3
19	245	3
20	266	1
21	219	2
22	60	2
23	46	2
24	—	—
25	188	2
26	258	1
27	186	1
28	200	0
29	241	0
30	334	0
31	—	—
June 1	61	1
2	—	—
3	—	0
4	107	2
5	77	1
6	94	1

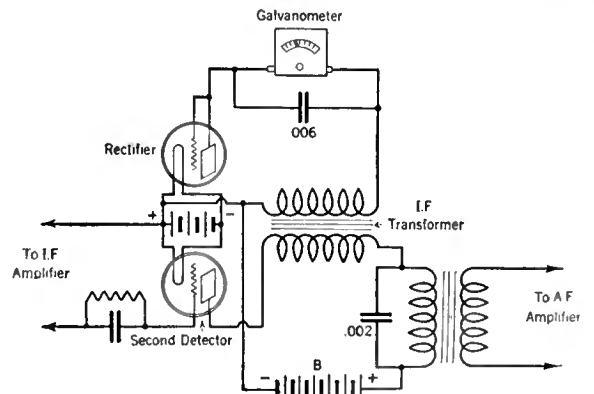

FIG. 2

A suitable rectifier for use in combination with the sensitive galvanometer is formed by joining together the plate and grid terminals of a 199 tube, and connecting it in the circuit as shown in this diagram



(of intermediate frequency, say 40 kc.), before it will work the sensitive galvanometer. A sensitive measuring instrument must be used, otherwise the rectifier is likely to be overloaded, under which condition its output is no longer proportional to the square of the input voltage. The importance of maintaining the square law relationship is mentioned below. A crystal detector may be used for this purpose, but a more satisfactory and dependable rectifier is formed by joining together the plate and grid terminals of

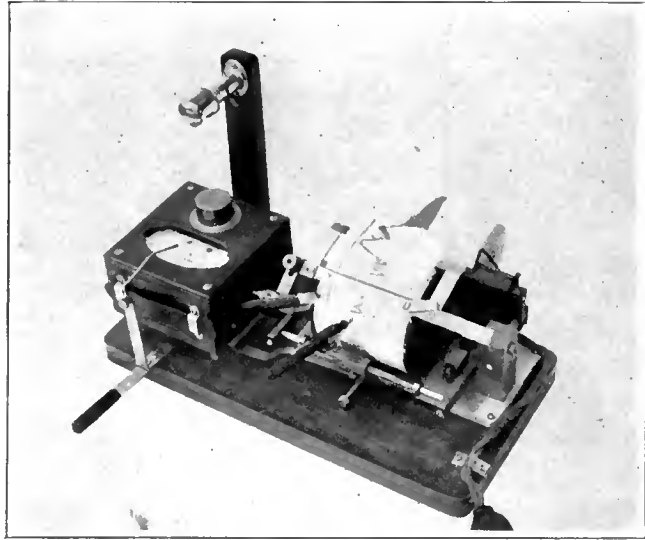

FIG. 3

The Shaw Recorder, a manually operated graphic signal recorder. The instrument illustrated is a product of the General Radio Company

a 199 type tube and connecting it in the circuit in series with the galvanometer and intermediate transformer secondary, as shown in Fig. 2. The connections in this diagram show the insertion of the primary of an extra intermediate-frequency transformer in the plate circuit of the second detector of a super-heterodyne, in a way that does not disturb the audio amplifier. The auxiliary rectifier tube handles only the inaudible 40-kc. intermediate frequency voltage which is fed to it through the radio-frequency transformer, hence its rectified output does not vary at the voice or modulating frequency, but is proportional to the square of the amplitude of the carrier wave. Since the filament voltage of this tube must be kept constant, it is well to have the filament controlled from the same rheostat that controls the other tubes in the receiver.

4. The Recorder. The output of the rectifier operates a sensitive micro-ammeter, the readings of which can be noted and plotted, but since the intervals between reading should be small if a complete record is desired, this method while not requiring extra equipment, is very laborious.

#### USING THE "FADING RECORDER"

MR. H. S. SHAW, of Boston, who has been engaged with Mr. Pickard in radio reception measurements for the last several years, has designed a manually operated graphic signal recorder, known as the Shaw Recorder. This instrument, shown in Fig. 3, consists of a galvanometer (14 micro-amperes full scale), mounted so that a movable index, attached to the handle protruding at the left of the picture, can be made accurately to follow the movements of the galvanometer needle. Attached to the handle is a sliding carrier holding a fountain pen which, moving over the paper strip, leaves an ink line trace, varying in position with the galvanometer

reading, if the observer, watching the meter, keeps the index pointer aligned with the galvanometer pointer. This alignment is made easy by the automobile dash lamp, which is located above the instrument in a way that the shadow of the index pointer falls across the scale and therefore upon the meter needle. The paper tape, being attached to a slowly rotating brass drum, by means of tiny spikes, is unwound at a constant speed, since the small electric driving motor is a synchronous a. c. one similar to those used in electric clocks made by the Warren Clock Company. A second fountain pen is set to trace the zero line on the reception chart, as shown on the sample record in Fig. 1. The speed of the paper past the recording pen is approximately five-eighths of an inch per minute. With a rectifier tube connected as described above, a small steady current flows through the galvanometer when there is no incoming signal. This steady deflection is reduced to zero by some operators by turning the zero-adjusting screw on the meter; Mr. Pickard, however, pointed out to the writer that he allowed the pointer to come to rest at about one-half of a division above zero, when no signal was being received, so that this slight zero reading would indicate to him that

the receiver filament voltage was normal.

The Shaw Recorder can be purchased from the General Radio Company, Cambridge, Massachusetts, under the name of "Type 289 Fading Recorder." For field work, where a. c. is not available, recorders equipped with spring motors can be supplied.

5. The Calibrator. In order to maintain the sensitivity of the receiver constant from night to night, or from hour to hour, some type of miniature transmitter, the output of which can be adjusted to and held at a known value, must be provided to operate over the desired frequency range. An easy way to fulfill this requirement is to construct an oscillator, using a UX-120 tube, connected in a standard oscillating circuit which utilizes the tuned grid circuit. The variable tuning condenser is in series with a Weston thermo-galvanometer (115 ma. full scale), so that the oscillating current can be adjusted to the required value by means of the filament rheostat. This oscillator, if unshielded, will have to be placed 50 to 100 feet from the receiver and adjusted to have a known output at the desired frequency. The strength of the received signal is then noted by reading the deflection of the recorder galvanometer when the receiver is properly tuned and the amplification control at a definite setting. This test for receiver sensitivity is made when the distant radio transmitter is not in operation. Or, the testing is done at a frequency slightly different from that which would give a noticeable deflection due to the remote station.

justed to the normal value, the local oscillator is stopped and we may begin to record reception from the selected station. Careful tuning is imperative. After a few minutes of recording we will probably find that the signal, gradually increasing in strength, will reach such an amplitude that in order to keep the galvanometer on the scale it will be necessary to drop the receiver amplification to the next lower position. Now, such positions should have been marked on the amplification control dial when the oscillator, known as the "calibrator," was running. One adjusts the oscillator output until, using maximum amplification, the galvanometer reads 100 divisions. Next, decrease the amplification until one quarter this reading is obtained, 25 divisions, and at this point mark the amplification control in a manner that indicates that the sensitivity of the receiver has been reduced one half of its former value. Lower ratios than two to one are often needed. They may be obtained by allowing the amplification control to remain in the last mentioned position and increasing the calibrator output so that a 100 division deflection is again noted. This reading may then be dropped to one quarter of its value, as before, and thus the amplification control dial is calibrated at another point, corresponding, this time, to one quarter maximum sensitivity. Remember that the deflection of the galvanometer is proportional to the square of the received voltage.

The use of the calibrator, as outlined above, is necessary if one night's results are to be compared with those of the preceding night, since it is necessary to check receiver sensitivity at least once each day. While, by its use it is possible to compare various records taken at different times by the same observation station, it is not possible to compare easily records obtained from other radio observatories in different parts of the country unless a uniform scale of signal strength measurement is used. As radio experimenters know, the signal, or field strength of a radio wave is expressed in microvolts per meter.

#### RADIO RECORDS IN MICRO-VOLTS PER METER

IN ORDER that our records will indicate the signal strength at our receiving antenna in the universal unit of microvolts per meter, it will be necessary to add three resistances to our calibrator set-up so that we can obtain from it very small voltages of known value. These are arranged as indicated in Fig. 4. The total oscillating current, read by the thermo-galvanometer-flows through the 1.0-ohm resistance marked "A." The voltage drop across this forces current through resistance "B," 29 ohms, and a slide-wire which has a resistance of 1.0 ohm.

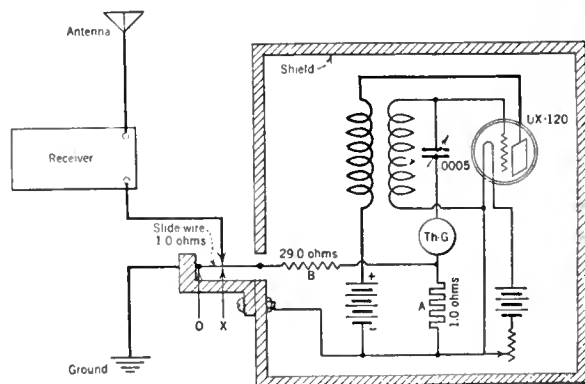

FIG. 4

Three resistances are arranged in the calibrator set-up so that very small voltages of known value may be obtained

A slider moving over the calibrated slide-wire, is so connected in the receiver ground lead that the voltage (in micro-volts), injected into the antenna by the calibrator, can be computed. For convenience the calibrator must now be near the receiver and this means it must be well shielded. Mr. Pickard found a copper wash-boiler made a satisfactory shield. His calibrator is shown in Figs. 5 and 6.

The writer knows from the difficulties experienced in measuring the effective height of the transmitting antenna of a naval station near Newport, Rhode Island, by the method of measuring the field strength, how important it is to have complete shielding when making field strength measurements with a sensitive receiver, and wishes to caution experimenters that the shielding must be good enough, so

antenna enters into consideration, if we would know the field strength of a distant station in micro-volts per meter. This can be obtained by locating the unshielded calibrating oscillator at a point two or three wavelengths away from the receiving station. Enlarge the coil in the oscillating circuit to the proportions of a loop antenna if necessary, so that a fair signal is produced at the receiver with a known oscillating current (of the desired frequency) at the tiny transmitter. If the receiver has previously been calibrated, the intensity of the received signal in micro-volts can be ascertained. A value for the received current can be obtained if the antenna resistance is known. By using this value of current in the Bureau of Standard's formula for loop to open antenna transmission and by substituting the physical di-

described above. Imagine that the battery voltages are right and the receiver amplification has been checked, the fountain pens on the recorder filled (and our favorite pipe filled as well). The lights in the room are lowered so that in the semi-darkness the galvanometer pointer can be more easily followed by the light of the little lamp above it. It is two minutes to nine. The receiver is switched on and the recorder is started to get an indication of the background noise. An occasional click of light static is heard from the monitoring loud speaker. As the clock on the wall indicates 9 p. m. the carrier-wave comes on, then the announcer's voice, from the distant station under observation, reaches us faintly. The ink line on the paper strip pushes upward. The frequency of the carrier wave of the distant station is so constant

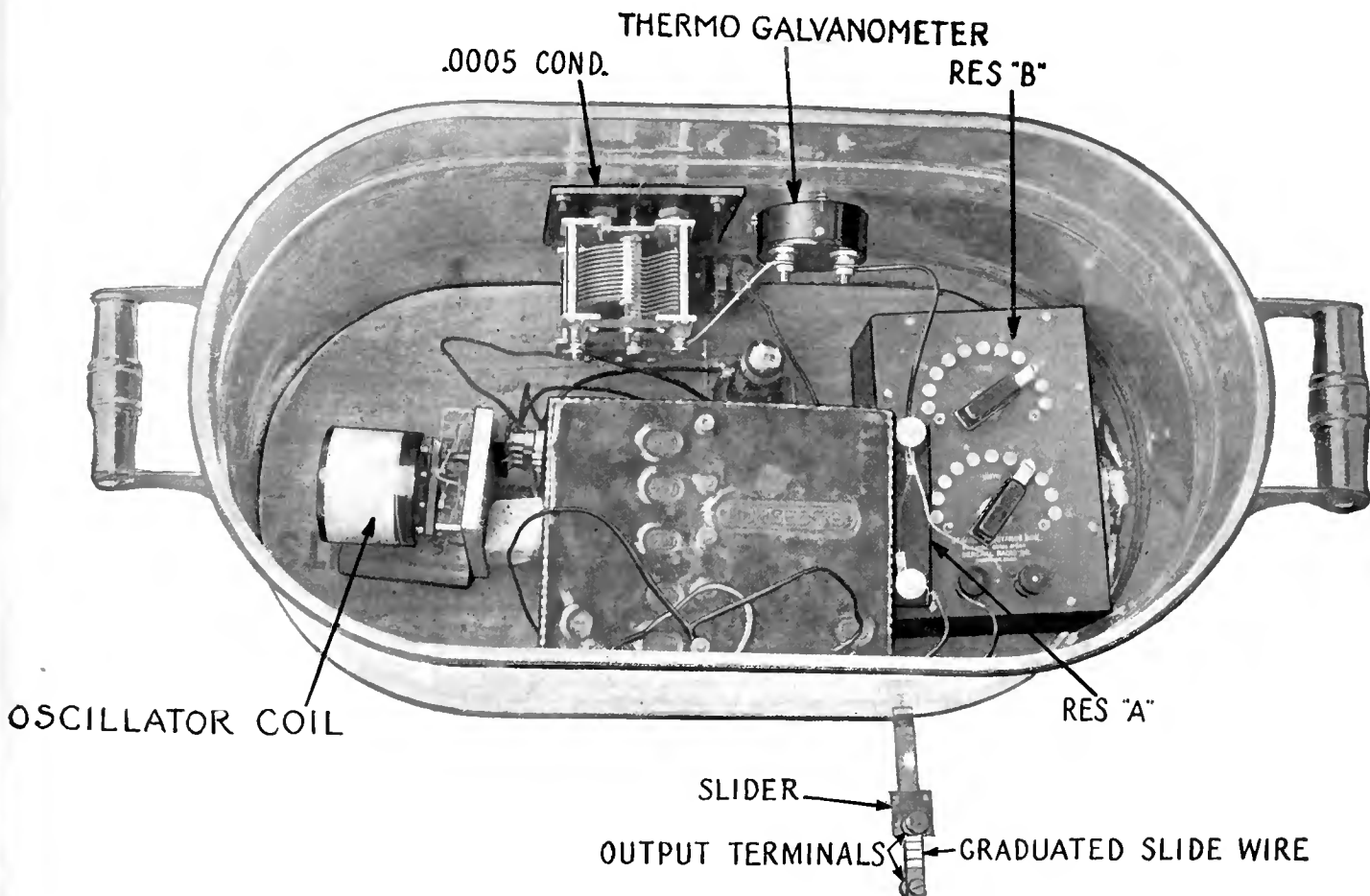

FIG. 5

For convenience the calibrator must be placed near the receiver, which means that it has to be well shielded. Doctor Pickard placed his calibrator in a copper wash-boiler, as shown in the illustration above

that there is no recorded galvanometer deflection, even with maximum amplification, when the calibrator is running but its output control (the slide wire) is set at zero. The easiest way to attain this, is to follow closely the lay-out of apparatus shown in the picture of the interior of the wash-boiler shield, Fig. 5. Mr. Pickard says that it is best to ground to the shield at one point *only* to prevent circulatory currents in the copper.

Because of the mathematical example, illustrating how to compute the recorded field strength in micro-volts per meter, and because it is of general interest to the reader, the page of Mr. Pickard's log dated February 22, 1926, is reproduced in column three of page 304. The diagram of the calibrator, which appears on the original page, is reproduced here as Fig. 4.

It will be noted that the effective height of the

mensions of the loop, the effective height of the receiving antenna is computed.

In completing this description of the equipment of a "Radio Observatory," attention is called to the excellent report of Mr. T. Parkinson, Bureau of Standards, on *Coöperative Investigation of Radio Wave Phenomena*, R1130, containing information on apparatus and procedure of interest to those who are investigating radio reception.

#### THE PROCESS OF RECORDING

AS IS usually the case, a certain amount of rather tedious work must necessarily be done before we arrive at the place where we get everything going smoothly and can sit back and enjoy the results. That radio recording is fascinating, there can be no question.

Let us try recording with the apparatus

that it is not necessary to retune the receiver from night to night. We are fortunate in having this kind of a station to observe. The line on the chart works higher and the music from the loud speaker is of fair volume. The occasional beat note from a neighbor's oscillating receiver is heard, but it does not affect the recorder appreciably, and since the signal is weak, the neighbor quickly gives up and moves away on a quest for easier game. It is interesting to see how much the received carrier-wave intensity has to change on the record before the ear tells you that the sound has begun to increase. Occasional clicks of man-made static are recorded, recognized and marked with an "X" by the observer, to distinguish them from real static, which is now making our record quite jagged. The signal slowly fades out. A red pencil in the hand of the observer notes on the record when

the signal becomes inaudible and later when it rises again to audibility. The correct time is also marked on the moving paper at each half hour period. In the next few minutes the signal rises to a peak; the soprano's voice is ringing through the room, only to die away in a prolonged fade out. The observer, puffing at his pipe remarks, "It may turn out to be a fairly good radio night." Static increases, until the peaks cause full scale deflections of the galvanometer. Each of these are followed by the observer who almost automatically moves the signal recorder handle with an easy sweep of the wrist. As is customarily the case, the signal increases with the static and the night is beginning to have the earmarks of a "good" radio night. But to actually determine how reception has been it is necessary, when the record for the period has been completed, to calculate the "Reception Factor." This convenient factor, originated by Mr. Pickard, makes it possible to give broadcast listeners an accurate answer to "How Was Reception Last Night" since it is a combined measure of the length of time the distant station was audible and the loudness of the signal peaks.

EVALUATING THE RECEPTION FACTOR

TO OBTAIN the "Reception Factor" from a record, Mr. Pickard notes in every half-hour period (a) the percentage of the time the station was audible, to which he adds (b) ten times the average of the highest signal peaks in micro-volts per meter. The evening's Reception Factor is the average of the half hour periods. A plot of this Reception Factor for the past months is shown in Fig. 7. The intensity of static, as shown on this graph, is obtained by averaging observations on the height of the static peaks above the varying amplitude of the carrier-wave as shown by the



FIG. 6

This is an exterior view of Doctor Pickard's calibrator mounted in a wash-boiler shield. The arrangement of the apparatus may be approximated by glancing at the interior view of this unit, as shown in Fig. 5 on page 303

records, combined with the aural impressions of the observer, who listens as he records. The curve showing the average radio reception has an interesting form. A few of the conclusions which may be drawn from it, relating to much discussed questions, such as the effect of weather on radio, will be discussed in a later issue of this magazine.

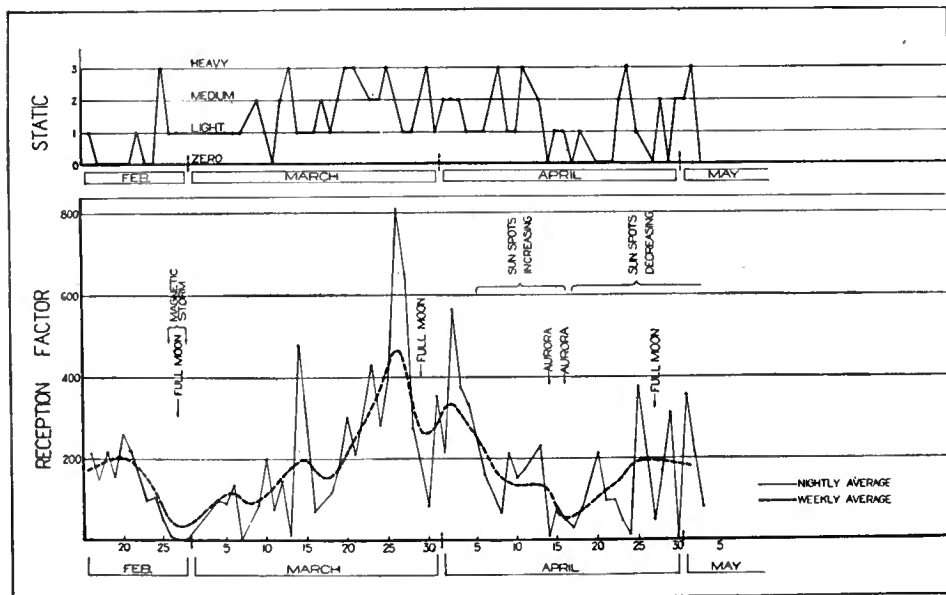

FIG. 7

A typical Reception Factor chart. The intensity of static may be told by merely glancing at this chart

FIELD INTENSITY MEASUREMENT

February 22, 1926

Calibration of record in micro-volts per meter.

With the oscillating circuit enclosed in a No. 8 copper washboiler, and the ground lead from the receiver at 0 on the slide wire, the shielded oscillator was turned until it gave zero signal in the receiver. The shielding was complete electrostatically, but there was a slight magnetic field outside the shield, which could be so directed that it did not couple with the receiver.

The antenna was a flat top, with an effective height of 8 meters. The Weston thermo-galvanometer had a 30-division scale, with full deflection on 89 milli-amperes (special meter). With the receiver tuned to WBBM's frequency, 1330 kilocycles, and an amplification of 64X, the following readings were taken:

Thermo-galvanometer, 3.5 scale divisions, current 31 milliamperes (obtained from calibration curve taken at 60 cycles) 0-X=0.375 inch, slide wire resistance 0.455 ohm per inch. Galvanometer on Shaw Recorder, 100 scale divisions,

Voltage across A, 0.03 volt. Current in circuit A, B, 0, 1 milliampere. Voltage drop per inch of slide wire, 455 microvolts. Voltage across 0-X, 171 microvolts. Corresponding field strength for 8 meters effective height, 21 microvolts per meter.



RADIO BROADCAST Photograph

THE "LOCAL" RECEIVER

This front view gives an idea of the simplicity of the tuning; the two large dials on the condensers are the only controls

# A High Quality "Local" Receiver

Another Version of the "Radio Broadcast Local Receiver"—Wise Shielding and Good Design Offer a Selective Set for Purely Local Programs With High Quality as the Primary Object

By KENDALL CLOUGH

THE receiver described and pictured in this article is the result of an attempt by the author to present a receiver designed primarily for local reception, and one which is so simple in assembly that the average man, possessing little or no knowledge of radio technicalities, will have no difficulty in putting it together and operating it. The "Local" Receiver is capable of real quality reproduction, is low in upkeep and initial cost, and dependable to the last degree. It is a version of the RADIO BROADCAST "Local" Receiver first described in the May issue. Its advantageous points can best be brought out by an examination of the circuit and material used.

From the rear view of the receiver, Fig. 1, we note that at the right-hand end is a shielded can containing a stage of tuned radio-frequency amplification preceding the detector tube which, together with its circuits, is contained in the next shield. At the left of these two stage shields is an audio amplifier consisting of two amplifying transformers, two tubes, and an output transformer. These parts are represented symbolically in the schematic diagram, Fig. 3, which will serve as a basis for an explanation of the points of the receiver.

While at first it may seem unimportant in a local receiver to employ such careful and effective shielding, yet this is one of the factors which contributes materially to the overall efficiency of the outfit. The shielding tends to stabilize the operation of the r. f. amplifier by eliminating practically all of the feedback between the detector and r. f. amplifier circuits. In any radio receiver an antenna is used to collect the desired signal energy which, if

the receiver is to function properly, must pass progressively through the various circuits, designed to provide adequate selectivity. If shielding is not employed, strong local signals will be picked up on the receiver coil systems and wiring with resultant poor control of selectivity. The two stage shields employed in this model of the Local Receiver eliminate this condition as effectively as can be done simply since their seams are all quite tightly closed. They further tend to prevent the pick-up of local noise such as that produced by X-ray machines, motors, and other forms of electrical equipment. While this pick-up is not completely done away with, the undesired energy is forced to come through from the antenna circuit, and a large portion is eliminated due to the selective effects of the tuning circuits—a condition that would not hold were it picked up on the coil systems themselves.

At the left of the diagram, Fig. 3, will be seen a coil serving to couple the antenna circuit to the

input of the radio-frequency amplifying tube. This tube, its tuning condenser, and coil system, is contained in an aluminum stage shield  $7\frac{1}{2}$  inches deep, 5 inches high, and  $3\frac{1}{4}$  inches wide. The coil employed is of an interchangeable type, plugging into a six-contact socket. The grid inductance is composed of enameled copper wire wound upon a threaded, ribbed, moulded bakelite form. Thus, the winding, supported at but six points about its circumference, has spaced turns. The actual shape of the coil, together with the wire size, insulation, support, and general design, provides an inductance of extremely low high frequency resistance and, further, of extremely low distributed capacity.

The antenna coupling coil consists of a coil of silk-insulated copper wire with turns wound closely together and inserted inside of the grid winding. This primary is located in a very intense magnetic field and serves to give maximum inductive coupling with a minimum of capacitive coupling, since it is approximately one-quarter of

an inch away from the grid winding at all points. A small feed-back winding is wound in a slot in the moulded form at the bottom end of the grid inductance. This coil is connected in the plate circuit of the radio-frequency amplifying tube and may be arranged to oppose oscillation in the r. f. amplifier. At times this is an extremely important factor, as will be seen later, and serves to stabilize the r. f. amplifier over the entire broadcast wavelength range.

The socket taking the coil-form carrying these three windings, is provided with the necessary contact springs making contact with buttons on the coil-form. It is mounted on studs so that it is located in the exact

## What the Radio Broadcast "Local" Receiver Is

### Special Characteristics of the Receiver

High-quality reception from local stations, with very simple tuning adjustments. The set will operate satisfactorily on a short indoor or outside antenna.

### Type of Circuit

One stage tuned radio frequency, a non-regenerative C-battery detector, and two stages of high-quality transformer coupled audio amplification.

### Shielding

Both radio frequency and detector circuits are completely enclosed in cans which act as total shields to minimize greatly undesired pick-up and unwanted inter-stage coupling.

### Coils

Standard coils having the usual primary and secondary may be used. Specifications for building one's own coils are given in the article.

### Tubes

Radio frequency amplifier—a 199 or 201-A (preferably a 199).  
 Detector—201-A  
 First audio amplifier—201-A  
 Second audio amplifier—112 or 171

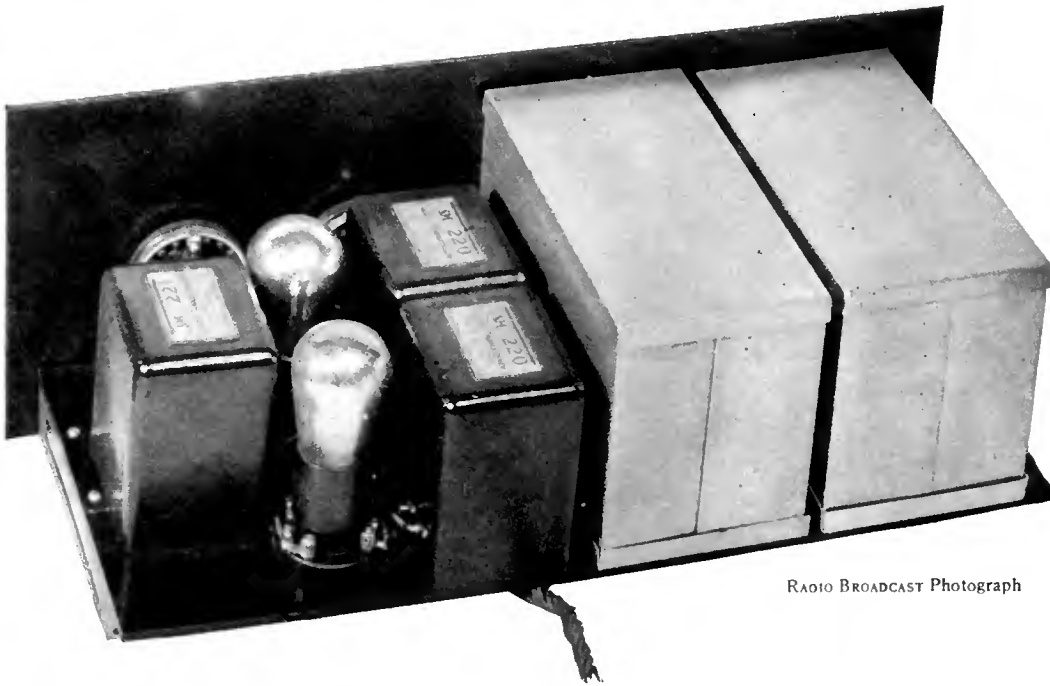

RADIO BROADCAST Photograph

FIG. 1

A rear view of the completed receiver. At the right are the two stage shields, with their covers on

center of the stage shield, from top to bottom. This serves to introduce a minimum of resistance by virtue of the shielding.

A stage of r. f. amplification has been used ahead of the detector in order that the receiver may be operated with a small antenna, either indoor or outdoor, and in order to provide the requisite degree of selectivity for satisfactory operation in congested broadcasting centers such as New York, Chicago, and Los Angeles.

The detector circuit is made up of a coil system exactly similar to that employed in the r. f. amplifier, with a 0.00035-mfd. tuning condenser.

#### DON'T OVERLOAD THE DETECTOR

SINCE this receiver will be operated on comparatively strong signals at all times, it is important that the detector tube be not overloaded for, if this should occur, quality will be ruined before the signal ever reaches the audio amplifier. Since the handling capacity of the detector tube operating with a grid condenser and leak is very definitely limited, and is not comparable with that of a detector operating with a negative grid bias, a negative grid biased detector is employed in this receiver. On any normal signal volume this will allow the substantially distortionless rectification which is vitally essential to good quality.

The detector tube can be very easily overloaded, however, if any endeavor is made to operate a loud speaker on any less than two stages of audio amplification. For this reason, the audio amplifier has no provision for using less than two stages. The signal volume control is located ahead of the detector. This means that if all local stations are adjusted to give substantially the same volume, the power input to the detector will be practically uniform and will be far below that necessary to overload it. At the same time, the power input to the audio amplifier will be uniform and the audio amplification characteristic will remain substantially constant—something that it would not do were the input power to be varied over a considerable range as would be the case were an endeavor ever made to operate a loud speaker upon a single audio stage or to control volume in the audio amplifier, after the detector tube.

The volume control used is a 25-ohm resistance in series with the filament of the radio-frequency amplifier tube. This type of volume control gives a minimum of detuning effect and impairs the quality of reproduction practically not at all. The proper location of any volume control in a radio receiver is before the detector tube.

This combination of a stage of tuned radio-frequency amplification and a non-regenerative grid-biased detector, will give ample selectivity and amplification for reception of local stations, and even for stations perhaps as far distant as 50 or 100 miles under good conditions. Yet, the amount of equipment used is very small, the simplicity of the circuit highly desirable, and

stage of a transformer-coupled amplifier, where we will practically never encounter voltage variations in excess of one volt in a properly operated system, a negative grid potential of one volt would be entirely adequate to prevent excursions of the grid voltage over to the positive side of the grid-voltage, plate-current curve. Hence we will use approximately one volt negative grid potential obtained by virtue of the voltage drop across the master filament rheostat.

While such a low C battery voltage will result in a somewhat higher plate current for this tube than would be obtained with a lower value of C voltage, this is an indication of the exact condition we desire—a low plate impedance for the

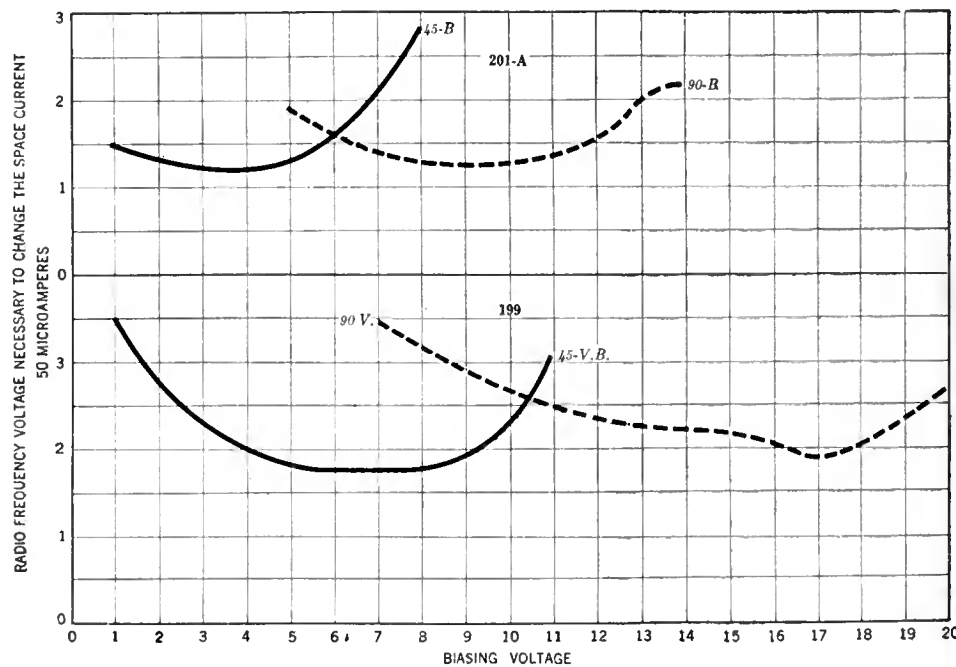

FIG. 2

Response curves of a C-battery detector for different values of plate voltage and C battery. The grid and plate voltages that give a change of 50 micro-amperes in plate current, with the smallest radio frequency voltage, are the best to use. From the curves it can be seen that best response is obtained with 45 volts on the plate of the tube and a C battery of approximately  $3\frac{1}{2}$  or 4 volts



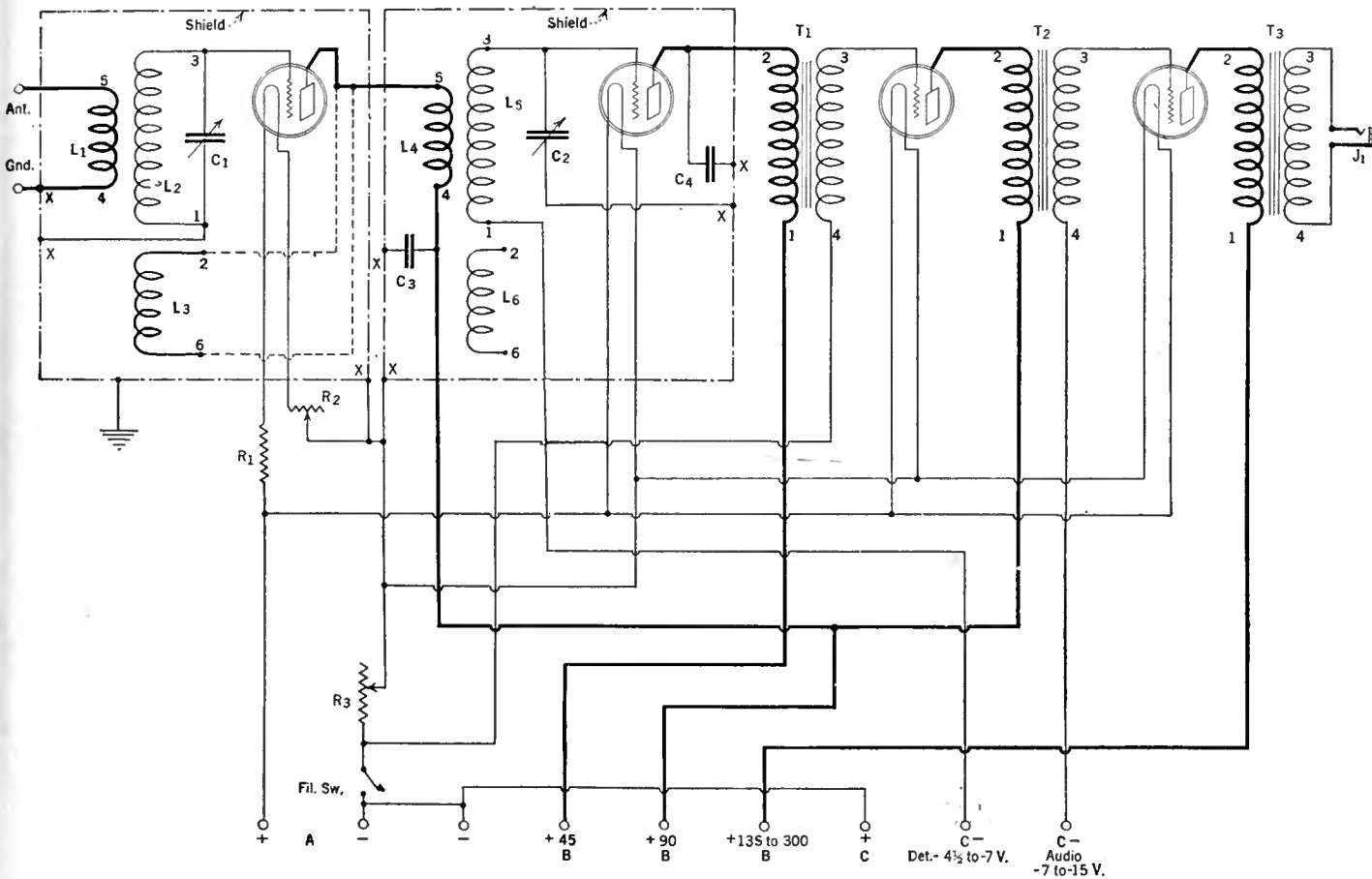

FIG. 3

The schematic circuit diagram of this RADIO BROADCAST "Local" Receiver. The receiver consists essentially of a stage of tuned radio frequency, a non-regenerative detector of the C battery type, and two stages of high quality transformer-coupled audio amplification. The various X's on the diagram indicate parts of the wiring that are grounded to the shields. The shields, indicated in heavy dash lines, prevent a certain amount of inter-stage coupling and also make the receiver somewhat more selective. The only tuning adjustments are the two variable condensers C<sub>1</sub> and C<sub>2</sub>

tube. The lower the plate impedance of the tube, the more uniform will be our amplification over the entire frequency range, in a measure, and it is this effect, among other things, that the makers of power tubes are striving for.

In the second audio stage, a higher value of C voltage will be required. With a UX-112 tube operating on 135 volts plate potential, a negative grid bias of 9 volts will be required. In actual operation, the proper value of grid bias for the second amplifier tube should be very carefully adjusted by connecting a milliammeter (reading 0-25) in the tube's plate circuit. Then, with a strong signal being received, the C voltage should be very carefully adjusted to a point where the movements of the needle are at an absolute minimum, since this is the point of minimum distortion.

Since the handling capacity of any loud speaker is determined by the current which will cause saturation, it is essential that the direct current used to supply the plate circuit of the tube feeding the loud speaker be kept out of the speaker windings, since this plate current will represent in most cases several times the actual signal variation used to actuate the speaker, and since it serves no useful purpose in the speaker, but, on the contrary, will in time tend to demagnetize the permanent magnets used in its construction. A common method of accomplishing this is through the use of a 100-henry choke in the B-battery supply line to the plate of the last tube, together with a condenser 4 to 6 mfd. in series with the loud speaker, both connected across this choke.

One or two additional details of the receiver

deserve attention. A single output jack connecting the loud speaker or headphones to the output transformer is employed. A three-ohm filament rheostat for adjusting the comparatively non-critical filament temperature of the four tubes is employed, together with an on-off switch for turning the entire set on and off.

THE PARTS WHICH CAN BE USED

A LIST of the parts used by the writer is given below, and it is suggested that, while "Local" receivers may be built in a number of different ways, the parts specified be strictly adhered to in building this particular outfit. If this list is adhered to, the author is practically willing to guarantee any builder practically perfect quality.

- 1—7 by 18 by  $\frac{3}{16}$ " bakelite front panel
- 1—7½ by 17 by  $\frac{3}{16}$ " bakelite sub-panel
- 1—pair S-M 540 mounting brackets
- 1—Yaxley 3, ohm rheostat—R<sub>3</sub>
- 1—Yaxley 25-ohm rheostat—R<sub>2</sub>
- 1—Yaxley No. 1 open circuit jack—J<sub>1</sub>
- 1—Yaxley No. 10 filament switch
- 2—S-M 316a 0.00035 condensers—C<sub>1</sub> & C<sub>2</sub>
- 2—Kursch Kasch 4-inch dials, zero left
- 2—S-M No. 631 stage shields
- 2—S-M 515 coil sockets
- 2—No. 115 A coils—100-550 meters
- 4—S-M No. 511 sockets
- 1—Sangamo 1.0 mfd. condenser—C<sub>3</sub>
- 1—Sangamo 0.002 condenser—C<sub>4</sub>
- 2—S-M 220 audio transformers—T<sub>1</sub> and T<sub>2</sub>
- 1—S-M 221 output transformer—T<sub>3</sub>
- 1—coil Belden flexible hook-up wire
- 6—½" x ¼" lengths brass tube for mounting coil sockets
- 1—Elkay Equalizer—Type 35—R<sub>1</sub>.

An assortment of  $\frac{6}{32}$ " round head screws and nuts, together with lugs.

If parts other than those specified above are used, care should be taken to make whatever changes necessary in order to permit the parts to fit into the circuit in the correct manner. The drilling template for the panel and sub-panel given in this article is laid out for the use of the parts given in the above list and will have to be changed if other units are used. The construction of the receiver will be very much simplified if a complete kit is purchased, since it will include all necessary parts, including the shields, which are drilled ready for assembling.

The home constructor may make up his own coils for use in the receiver. The construction of a home-made coil is shown in Fig. 4 and a very satisfactory receiver can be made up made in accordance with the specifications given in the figure. Fig. 6 shows complete data on the coils in the receiver described in this article. If forms are purchased, the coils may be wound in accordance with the specifications given in the diagram, or the coils may be purchased complete.

If the home constructor desires to make up his own shields, they can be put together by constructing a can 7½ inches deep, 5 inches high and 3½ inches wide. The top and bottom should be made separately so as to permit easy construction of the receiver. The cans should preferably be made out of aluminum, although sheet brass on copper may be used.

The panel may be laid out and drilled in accordance with the drawings accompanying this article. The bottoms of the two shields should,

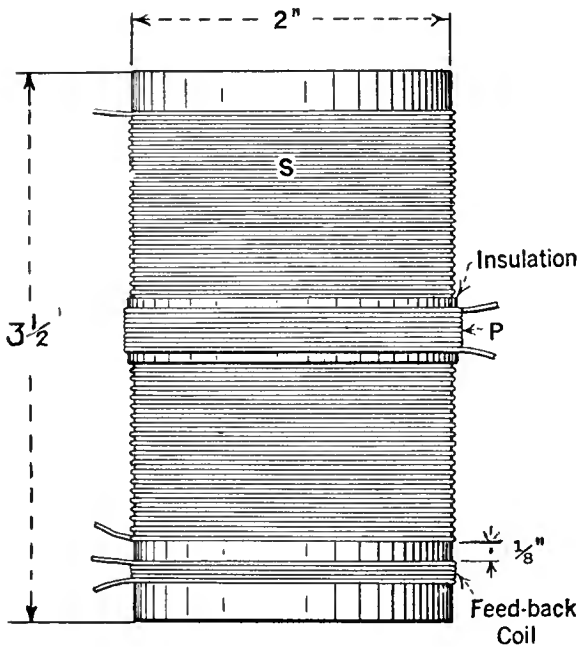

FIG. 4

Data for home-made coils The secondary is wound on a 2-inch cardboard tube and the primary is wound over the center of the secondary; the two windings being separated by about two thicknesses of cambric tape or other insulating material. The secondary should be space wound, but the primary should be closely wound so as to take up very little space. The feedback coil, wound at the filament end of the secondary, is only necessary if a 201-A type tube is used in the radio frequency stage. Complete data concerning the wire sizes and number of turns are given in Fig. 6

be mounted on the sub-panel with the rest of the apparatus, consisting of the coil sockets, tube sockets, transformers, bypass condensers and tuning condensers. The coil mountings connect directly to the sub-panel with the aid of the 1/4-inch brass tubing. The condensers are mounted on the shielding, and to make sure a satisfactory contact is made, the rotor plates are also electrically connected to the shield.

WIRING THE OUTFIT

THE wiring is not especially difficult and it is somewhat simplified by the fact that no binding posts are used; the various external connections to the receiver are made long enough to connect directly to the battery circuits. In connection with the wiring, Fig. 8 will be found quite valuable, and if this picture is used in conjunction with the schematic diagram, Fig. 3, no trouble should be experienced. The coil terminals are indicated by numerals on the schematic diagram and in wiring the receiver care should be taken to be sure that the various contacts on the coil sockets are correctly connected into the circuit. In connection with the wiring, always remember that any lead which is finally grounded can be directly connected to the shield at any point. This fact will quite frequently make possible very easy wiring. For instance, since the negative lead of the detector tube filament is grounded, it is only necessary to run a short lead from the filament terminal of each socket to the shielding in order to connect the negative filament into the circuit. One side of bypass condenser C<sub>3</sub> is grounded so that it can be connected directly to the shielding. In the same manner it will be unnecessary to run a lead connecting terminal 1 of the r. f. coil to the rotor plates of the condenser. Since the rotor

terminals of the condenser are fastened through the sub-base, and thereby brought into contact with the shield, it is only necessary to solder a lead between terminal 1 of the coil socket in order to complete the circuit between the condenser and coil.

When all the apparatus has been mounted on the sub-panel and the connections made, the stage shield sides are slipped over the shafts of the two tuning condensers and are fitted into the bottom can. The panel is then screwed to the mounting brackets and two screws put through into the condenser mounting studs, one of which will be found on each condenser. This serves to fasten the entire assembly rigidly together and the tubes are really easily accessible in the stage shields by merely removing the top covers. In all of the wiring, leads should be connected to the different points by as short a path as possible. Since insulated wire is being used there is no danger from short-circuits. Practically all of the high-potential leads of the receiver are contained

The advantage of using the 199 is that the tendency of the r. f. amplifier to oscillate is not as great as with the 201-A, and if a 199 is used, it is not necessary to connect coil L<sub>3</sub> into the circuit. However, if it is desired to use a type 201-A tube, it will very likely be necessary to use coil L<sub>3</sub> and it should then be connected between the plate of the r. f. tube and terminal No. 5 of the second coil as shown on the schematic diagram, Fig. 3. Then the small coil, together with the increased resistance effect due to the shielding, give a resultant amplification curve which is quite uniform over the entire wavelength range of the receiver. It is suggested that both arrangements be tried and in that way it will be possible to determine whether a 199 or 201-A tube gives most satisfactory results. When a 201-A is used, be sure to short-circuit resistance R<sub>1</sub>, since if this is not done, the tube will not receive sufficient filament voltage.

It is suggested that a total B battery voltage of 180 be used on the last audio amplifier, when using the UX-171 tube although 135 volts will be ample for ordinary home reception when the UX-112 is used. With 135 volts the plate current will be in the neighborhood of 15 to 20 milliamperes; with 180 volts in the neighborhood of 20 to 25 milliamperes. While this current is not as low as might be desired, it is absolutely essential if

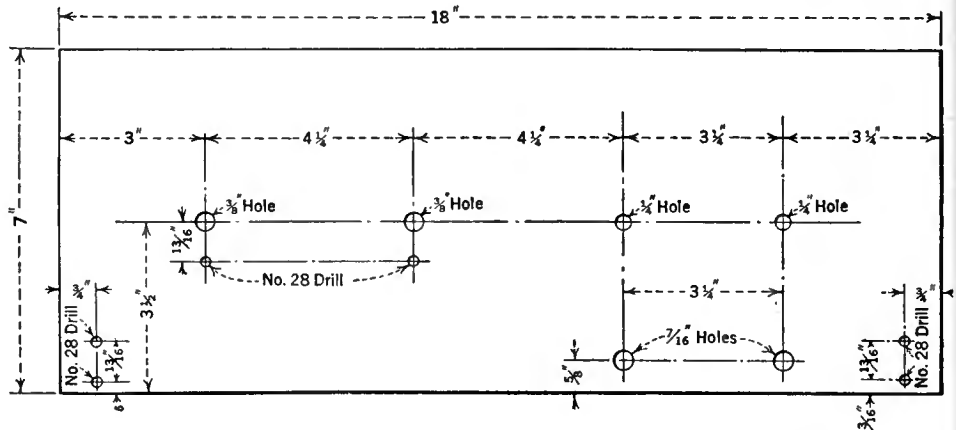

FIG. 5

The panel drilling template, to be followed if the same parts specified in the article are used

within the shields and, therefore, there exists very little possibility of coupling between the various parts of the r. f. amplifier and detector circuit.

PROPER USE OF PROPER TUBES

THE receiver as designed uses a type 199 in the r. f. stage, a type 201-A for the detector, and in first audio amplifier socket. This may be a UX-112 if the very best results are to be obtained. In fact it seems inadvisable to sacrifice any quality whatsoever when every endeavor has been made so far to obtain it. The second audio stage should be a UX-112 or preferably one of the new UX-171 tubes with the proper C voltage. With this arrangement, the filament current will be approximately 1.06 amperes. However, a type 201-A may be used in the r. f. stage, if it is so desired, and the only alteration necessary is to short-circuit resistance R<sub>1</sub>. This increases the filament voltage obtainable at the r. f. amplifier socket so as to permit the use of a 5-volt tube in place of a 3-volt tube. With a 201-A in the r. f. stage the filament current of the receiver will be 1 1/4 amperes which can easily be supplied by a storage battery.

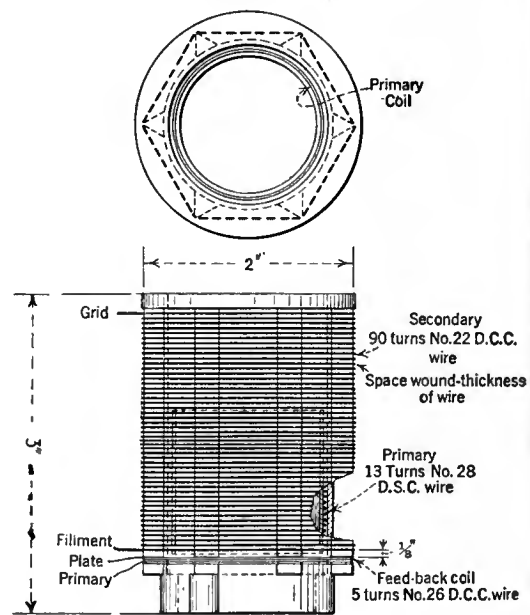

FIG. 6

Specifications of the coil. Any one desiring to make up coils exactly the same as those used in the receiver will find complete data in this diagram

quality reproduction is to be obtained; and it is assumed that the builder of this receiver is willing to go to some slight expense which will be amply repaid by the quality of reproduction obtained.

USING THE RECEIVER

**A**N ANTENNA of from 50 to 100 feet may be used with the receiver, either indoor or outdoor. The entire tuning of the set is done by the two large dials which read substantially alike for the different wavelength settings used for different stations.

The calibration chart shown in Fig. 7 will be found of aid in tuning, since if the frequency of the station you desire to hear is known, it can easily be located on the chart and the corresponding dial readings noted.

This chart is, of course, made up using the coils and condensers mentioned in the list of parts and will differ somewhat if home-made coils or some other type of manufactured coil is used.

The three-ohm rheostat at the right of the panel is first set with its arrow, which falls directly over the contact arm, pointing straight to the right, though it later may be set as far to the left as is practical without loss of quality in order to conserve A-battery current and tube life. The left rheostat should be turned all the way to the right for maximum volume and may be retarded to any desired position to decrease the volume for powerful nearby stations.

The proper value of detector C battery has been found to be between  $4\frac{1}{2}$  and 6 volts for 201-A tubes at 45 volts plate potential. A curve indicating the variation of rectification efficiency with variations in C voltage for both 199 and 201-A tubes is shown herewith.

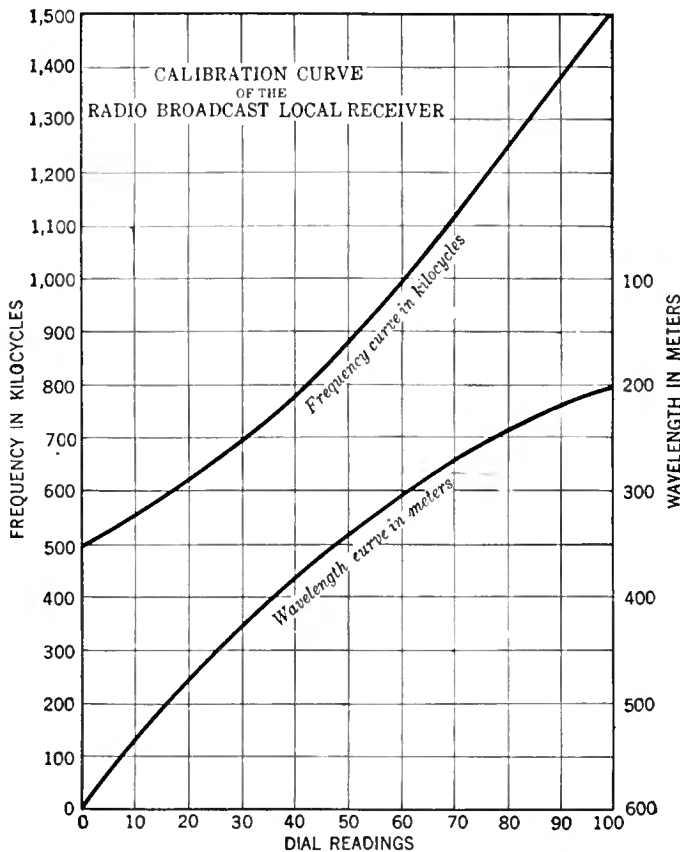
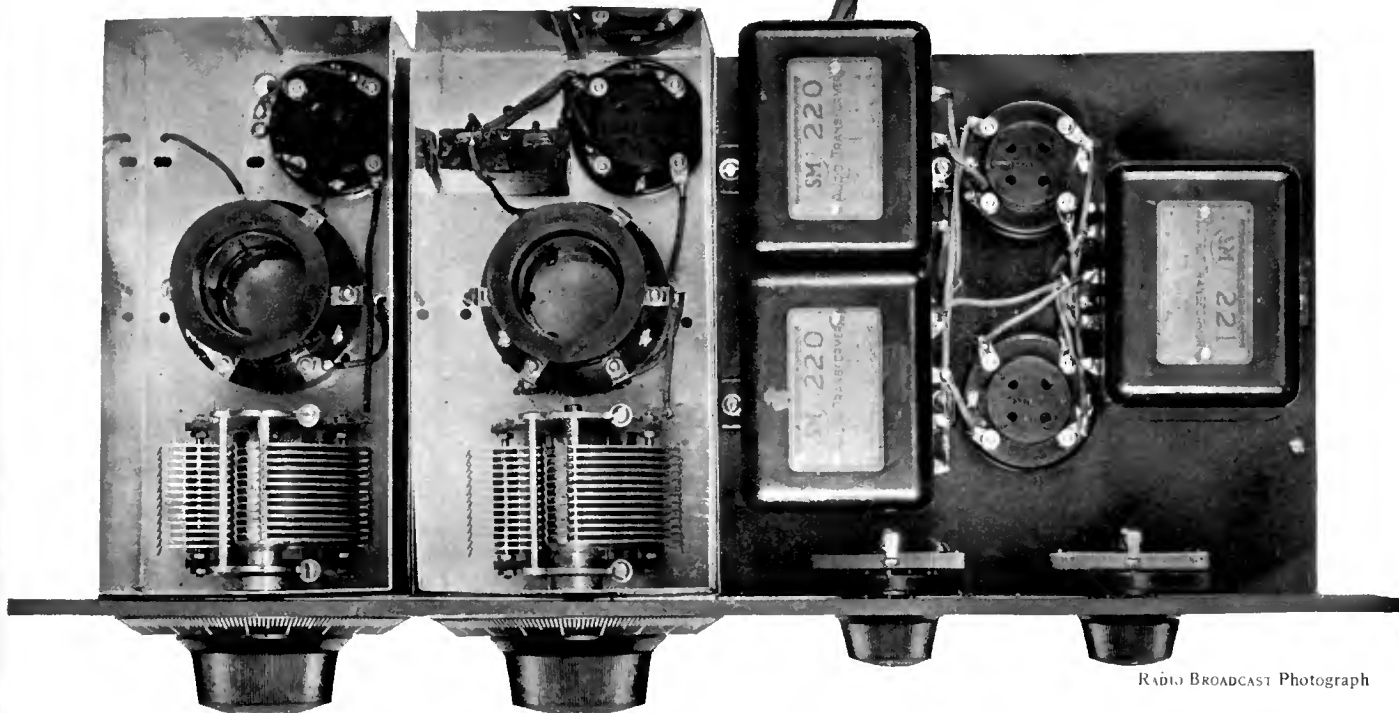

FIG. 7

A handy tuning chart, calibrated in both frequency and wavelength, to be used if the coils and condensers indicated in this article are incorporated in the receiver. If home-made coils are used, it is likely that the dial settings will be somewhat different

When more than average volume is desired, the writer cannot recommend too strongly the use of a UX-171 tube operating with 180 volts plate potential, or of a UX-210 tube with from 180 volts to 300 volts plate potential in the last audio stage. Such tubes will increase the power handling capacity of the amplifier to a point where the maximum volume simply cannot be tolerated in the average residence. If a UX-112 tube is used in the output stage at a 135-volt potential, there is absolutely no question but that it will be sadly overloaded if any endeavor is made to use the full volume output of the set. Therefore, if such a tube is to be used, the builder of the receiver must be content with a volume sufficient for the average large living room. If he anticipates operating the set at maximum power, then a larger tube with higher plate voltage must be used if quality is to be maintained. The required high voltages can be supplied by standard power supply units now on the market, as also can the filament lighting voltage for a UX-210 tube. This use of a large power tube in the last stage cannot be stressed too strongly and is, to the mind of the writer, vitally essential.

If interest is sufficient, a future article will describe methods of operating the Local Receiver completely from a standard type of power supply unit capable of an output sufficient to meet adequately the requirements imposed. Thus the Local Receiver could be entirely mounted in a cabinet with the power supply entirely self-contained so that it will be dependable in operation to the last degree—simple to a point where but a single switch need be thrown, the two dials set to any station desired, and the volume adjusted to suit the individual taste.



RADIO BROADCAST Photograph

FIG. 8

Looking down on the sub-base. Notice the arrangement of apparatus within the shields. The audio transformers are enclosed in metal cases, which prevents any inter-stage coupling that might otherwise produce howling

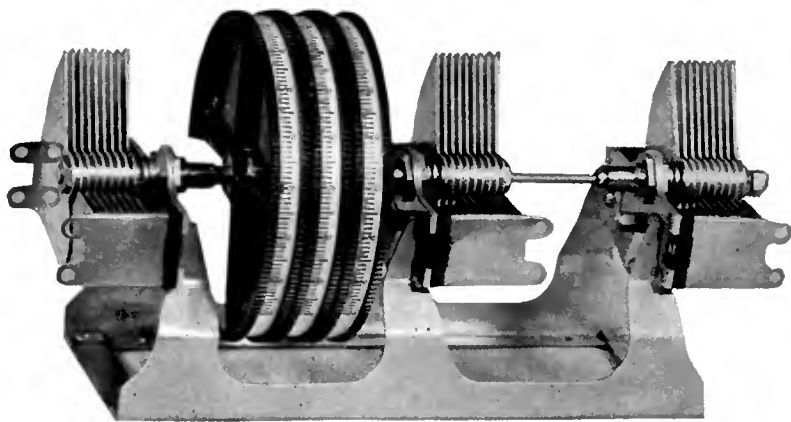

THE ALDEN "LOCALIZED CONTROL" UNIT

Each condenser may be tuned separately without holding the remaining dials. All three condensers may be turned simultaneously by placing two fingers on the center peripheries

# Looking Ahead to 1927

*The Second of Two Articles Discussing the Probable Trends in Radio Manufacturing for the 1927 Season—Reduction of Controls a Predominant Tendency—The Modified "Straight Frequency-Line" Condenser—Shielding Becoming More Popular—Automatic Variation of Coupling in R. F. Units*

By ZEH BOUCK

**T**HIS is the second and concluding article by Zeh Bouck on what the manufacturers will do the coming season. The first article, which appeared in RADIO BROADCAST for July, covered the audio frequency developments, particularly in reference to the changes in commercial radio apparatus reflecting the use of the new power tubes. In this article, Mr. Bouck covers the radio frequency side of the question. Once again the writer's efforts have been twofold. The writer has tried to make the article of practical interest to the prospective buyer by means of detailed descriptions and prices; and to explain to the enthusiast, as far as possible, the theoretical significance of the advances in radio practice.

—THE EDITOR.



**T**HE tendency to reduce controls by tandem tuning, which has been gaining more favor as it has solved its problems, is one of the predominant features of the 1926-27 tuning circuits. Tandem tuning refers to the mechanical linking of two or more tuning units. These units generally consist of united condensers, with rotors mounted on a common shaft revolving through individual stator plates built into a rugged, extended frame work. The isolated but simultaneously varied capacitances are connected to individual circuits—one, two, three or more r. f. stages, and detector. The problems associated with tandem tuning have been the matching of the various inductors and capacitances.

For really successful tandem tuning, it is essential that the inductance or coil effect of the different circuits, and the capacity or condenser effect, be the same at all frequencies (wavelengths). This means that, in complete sets employing tandem tuning, the stray capacity and inductance caused by wiring and the juxtaposition of parts,

must be exactly the same in all radio frequency circuits, a balance that requires finesse only recently attained in the art of radio production. The use of vernier condensers can compensate for the discrepancies in stray capacity. But if employed to correct condenser or coil discrepancies, these are, in effect, additional controls, for the compensation differs for every setting of the main dial.

An appreciation of the difficulties involved in the tandem tuning of three individual circuits finds its expression on the part of the manufacturer in two ways—in the development of "localized control," and the design of receivers having two controls instead of one control.

The localized idea is perhaps most familiarly illustrated in the R. C. A. superheterodynes. The oscillator and tuning dials, in the form of closely parallel drums, are so arranged that they may be turned together by a single motion of one hand. However, either dial can be turned separately, permitting those fine variations of a

Three condensers of a modified straight frequency-line type are mounted concentrically, with shafts parallel to the panel, rather than perpendicular to it. The three condensers are not mechanically linked, and each is controlled individually by its respective dial. However, all three may be turned simultaneously by two fingers, placed upon the center peripheries. Scales reading from zero to one hundred, depressed in the rim, are supplied as standard equipment, but these are easily altered and such special designations as wavelengths, frequency, or call letters, can be substituted to suit individual needs.

The Alden arrangement is supplied in two and three "gang" (two and three condenser) units, selling respectively for \$8.00 and \$10.00. In the two-gang device, the extra shaft may be used to control a tickler coil, thus making the combination very suitable for the Roberts, Browning-Drake, and similar two-condenser regenerative receivers.

Another "localized control" unit is made by the Perlesz Company of Chicago. Its price is \$55.00 without coils. It is shown on this page.

TWO HANDS—TWO CONTROLS

**A**S ALREADY intimated, a second system of circumventing the complications of tandem tuning, considers our natural manual endowments. We have two hands, so why go below two controls?—an argument not devoid of logic. Therefore, if we design a two stage r. f. receiver (such as the standard three-control neutrodyne), using a two-gang tandem condenser and a single condenser, or a three-stage tuned r. f. receiver employing two two-gang condensers, we shall have a receiver easily operated, and certainly one less complicated electric-

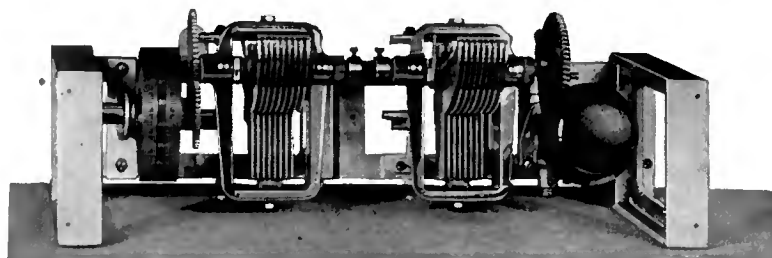

RADIO BROADCAST PHOTOGRAPH

A ROBUSTLY MADE TWO-"GANG" CONDENSER—THE PERLESZ

The two condensers are tuned simultaneously by means of a single knob. It takes seventeen rotations of the knob to reduce the condenser to minimum from maximum capacity, due to a special gearing arrangement employed. The condensers are of the s. f. l. type

degree or two which are essential to efficiency on uncompensated circuits.

A similar arrangement is available to the constructing fan in the form of the "Na-Ald Localized Control Unit," illustrated in an accompanying photograph.

the standard three-control neutrodyne), using a two-gang tandem condenser and a single condenser, or a three-stage tuned r. f. receiver employing two two-gang condensers, we shall have a receiver easily operated, and certainly one less complicated electric-

cally than the same set designed as a single control arrangement.

Several new condensers specifically for use in receivers of this type, but, at the same time, quite applicable to single control systems, are being made. These condensers will be of the modified straight frequency-line type. The rotors will be electrically common.

Disdaining to compromise with lessened precision in the design of associated coils and circuits, Amsco Products are on the other side of the fence and are going into production on a four-gang condenser, especially designed for use in a single tuning control circuit, recently developed by Lester Jones. A combination of tuned and untuned r. f., through nine tubes (including detector and a. f.), makes the receiver operative from a small enclosed loop.

However, the difficulties of tandem operation have been carefully considered in the design of this four-gang unit. Small compensating capacitances form an integral part of the unit, and make possible the correcting of capacity discrepancies in the circuit. In other words, the condensers are "started right." Consistent resonance throughout the tuning range is assured by painstaking design and construction of the condenser unit itself. An unusual point of design in the Amsco four-gang arrangement is that the stators rather than the rotors are electrically common. The rotors are insulated from each other, and from the stator frame, with isolantite, and they are evenly distributed on each side of the frame and shaft, providing a true mechanical balance. The four-gang condenser will sell for about \$25.00.

Many other manufacturers are responding to the market demand for ganged condensers. Allan T. Hanscom is manufacturing two and three condenser units retailing with dials at \$15.00 and \$20.00 respectively. Rathbun is putting out a single condenser that can be grouped in "gangs" of any number of units. This

condenser, after the fashion of Rathbun, is of the straight capacity-line type, and is designed for use with their dial converter thus providing straight frequency-line tuning. The condenser itself being of the s. c. l. type, it requires less panel space than the average s. f. l. condenser.

Thompson Levering, precision machin-

part of the consumer who, changing from straight capacity-line condensers, which spread the upper wave stations and cramp the lower, to straight frequency-line condensers which separate the stations equally over practically the entire tuning range, has found it difficult to become used to his new condensers. To his empirical mind, the straight frequency-line condensers seem to cramp the upper wave stations and spread the lower waves, and he demands a combination of the two condensers as an ideal arrangement. Actually, the modified condensers give an exaggerated spacing between the longer wavelength stations. As long as the government continues to allocate stations at tenkilocycle intervals, the proper way to tune for them is by a condenser giving as closely as possible equal frequency variations per degree of dial movement—in other words, by means of straight frequency-line condensers.

In passing, it might be well to mention that the substitution of s. f. l. condensers for other types of the same capacity and electrical efficiency in no way affects the operation of the receiver other than in the readjustment of the dial settings. The receiver will work no better and no worse; selectivity will not be affected, except in so far as it is affected by convenience in tuning.

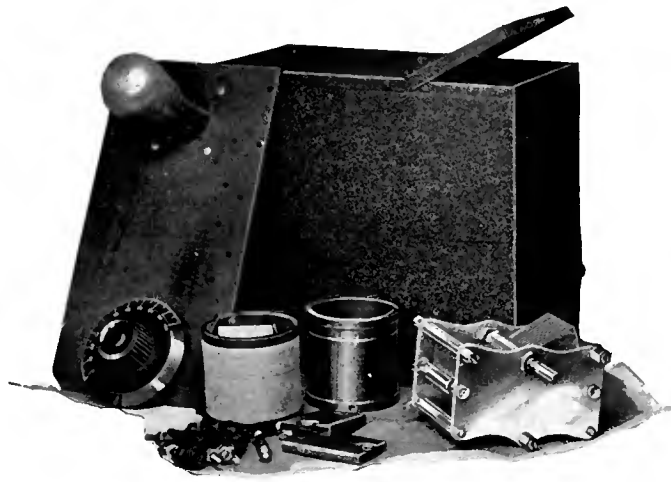

THE GENERAL INSTRUMENT R. F. UNIT

All these parts go to make up the r. f. unit which is totally shielded. The top of the "can" is removable so that the parts, when wired, are readily accessible. The unit sells for \$20.00

ists, are also making a balanced condenser designed for combination into "gangs."

FREQUENCY, WAVELENGTH, AND CAPACITY LINES

IT WILL be observed that some manufacturers are bringing out "Modified Straight Line Frequency" condensers. (Or, rather, it is more correct to say "modified straight frequency-line condensers." Frequencies are not characterized by lines. However, there is such a thing as a "frequency line," which refers to the line of resonant frequency plotted against capacity variations in a tuned circuit.) These modified condensers are designed to give a straight frequency-line effect on the shorter waves and something approaching a capacity-line effect on the longer waves. It is interesting to consider this movement. It seems to be in answer to a demand on the

SHIELDING

ANOTHER interesting development that is assuming commercial proportions this season, is the shielding of radio frequency circuits. Mechanically, shielding consists of placing all radio frequency elements in a can, generally of copper. In other words, all parts of each r. f. stage, input coil, secondary, tuning condenser, and tube, are completely inclosed in the shielding material. Partial or localized shielding is comparatively ineffective, being efficacious only against simple stray effects.

The idea of shielding is to make the

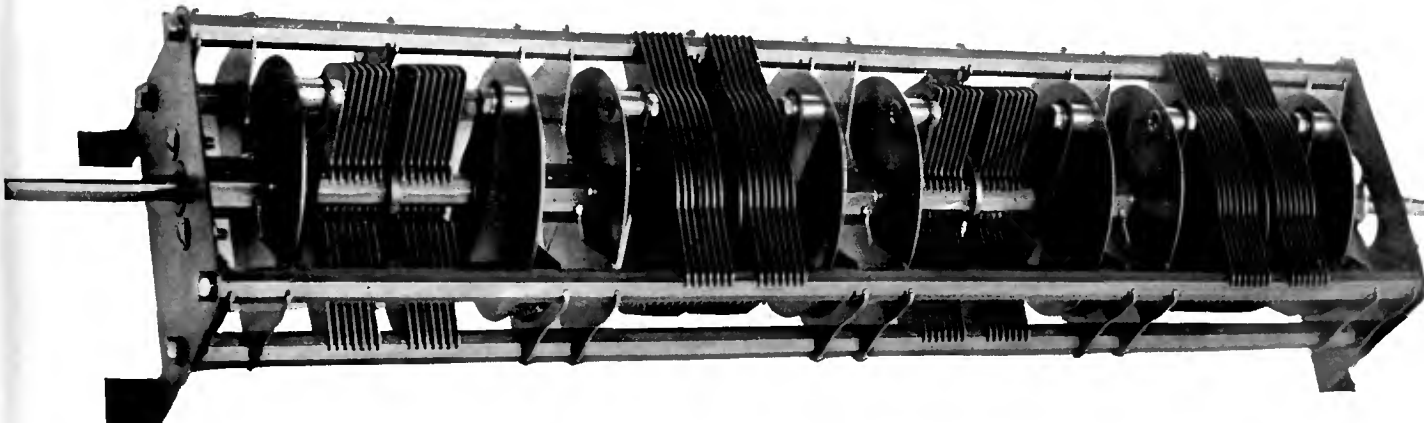

A CENTIPEDE OF CONDENSERS—THE AMSCO FOUR-"GANG"

This multiple "gang" condenser has been specially designed for incorporation in a nine-tube receiver which is to have single control and to work off a small enclosed loop. A combination of tuned and untuned r. f. is employed in the circuit



radio frequency currents and fields behave—go where they are supposed to go and nowhere else. The helter-skelter distribution of an electric field, which spreads out from every wire carrying current, is responsible for many radio ills. Due to these fields, radio frequency impulses have a tendency to jump from the antenna and intermediate circuits to the detector circuit without going through the r. f. amplifying tubes, thus escaping the amplifying action. Also, these renegade currents may have such a phase relation with the legitimate amplified impulses as to “buck” them with a general debilitating effect. And again, other impulses originating in the neighborhood of the detector circuit will often find their way back to other circuits by this same road of uncontrolled fields, rendering the entire system unstable even to the extent of self-oscillation.

Correct and complete shielding practically eliminates these stampeding fields. All pickup is confined practically to the antenna system, and forced through the amplifying circuits, achieving a genuine “cascade” effect—each stage amplifying the output of the step immediately preceding.

The General Instrument Company is manufacturing a shielded r. f. unit, comprising tube socket, stabilized coils, and tuning condenser. The “can” opens at the top to permit the changing of tubes. The entire unit, which can be mounted behind the panel, sells for \$20.00 with dial.

Hammarlund and Silver Marshall are also manufacturing shields for enclosing individual r. f. systems.

The Sickles Coil Company are making a shielded radio-frequency transformer selling for about \$2.50. While, as intimated before, shielding only the coil is not so efficacious as protecting the complete r. f. unit, it admits of much greater freedom in the placing of the coils and adjacent parts. No attention need be given to coil angles, and a much more compact arrangement is possible.

Shielding is hardly worth while in a single r. f. stage. Indeed, it is seldom beneficial when less than three radio frequency steps are employed. On one and two stages, the concomitant losses of shielding are rarely compensated by the advantages gained. However, on three or more steps, it is practically a necessity, contributing greatly to overall efficiency.

#### R. F. CHOKE COILS

**R**ADIO frequency choke coils perform a function somewhat akin to that of shielding, and are designed to keep r. f. currents within bounds. In parallel feed oscillating circuits—such as are

often employed in short-wave reception—and in many super-heterodynes and reflex arrangements, these coils vary from a desirable addition to a necessity. Their specifications in several comparatively new and complicated circuits, has stimulated their manufacture on a commercial basis by the Samson Electric Company (types 85 and 125) and Silver Marshall. The Silver Marshall r. f. choke retails for \$1.00 and the Samson, models 87 and 125 respectively, at \$1.50 and \$2.00.

#### VARYING ENERGY TRANSFER

**I**N ANY radio-frequency amplifier, it is impossible to obtain maximum efficiency unless the coupling between primary and secondary is varied at different frequencies. In the average radio-frequency amplifier, the system is arranged to provide efficient energy transfer only within a limited band of waves. As a result, sensitivity (and often selectivity) is impaired on the other waves. An ideal arrangement would enable the coupling between primary and secondary to be varied with dial changes so that transfer would be at its optimum value at every frequency.

The Zenith Company of Chicago, and other manufacturers of complete sets, have been employing the Lord system of energy transfer adjustment for some time. The Lord device comprises an r. f. transformer with a split primary functioning after the manner of a variometer. The shaft of the variometer is linked, by means of a projecting axis, with the tuning condenser across the secondary. As the one tunes lower in frequency, the variometer action reduces the effective coupling between primary and secondary with a desirable

and corresponding reduction in the energy transfer factor. The concomitant lessening of the inductance of the primary also contributes to this condition.

The Lord system is being made available to the constructing fan by the Hammarlund Company, who are making r. f. transformers of this type to retail at \$2.50.

The King system achieves a similar variation in energy transfer between primary and secondary in a different manner, to which a later article will be devoted. Kits and parts for use in various circuits to which the King arrangement is applicable will be featured in the Karas line this coming season. A side light on the King device which makes it particularly interesting to the less experienced fan, is the simplicity with which it lends itself to the construction of a single-control nonradiating three-circuit regenerative receiver.

It should be observed that both the Lord and King arrangements require condensers with extending shafts—a condition that has been met inadvertently by the manufacturers of condensers designed for “ganging.”

#### COILS

**T**HERE have been few changes in coil design other than a continual trend toward unusual shapes brought about by the desire for a coil of reduced external magnetic fields. It will be remembered that these are the troublesome fields, to control which shielding is resorted to. As coils approach the toroidal or “doughnut” form, the external field is reduced, and similarly, their susceptibility to stray fields. The toroid is practically a self-shielded coil as far as magnetic fields are concerned. Unfortunately, the efficiency of these coils—the ratio of inductance to resistance—is comparatively low, and compromises between shielding effects and efficiency result in such coils as the Grebe binocular coils, and similar arrangements.

“Doughnut” coils are being manufactured by Bremer-Tully, and similar inductors are used in the various “Thorola” receivers.

Silver-Marshall have brought their standard plug-in inductors to a higher stage of perfection. These are now wound with spaced turns of enameled wire. The r. f. transformers are provided with reversed feedback windings for stabilization. These coils are made in sizes covering frequencies of 167 to 10,000 k.c. (wavelengths from 30 to 1800 meters), the various coils being plugged-in to a standard coil socket. The broadcast range coils (type A) sell for \$2.50, and the sockets for \$1.00 apiece.

The American Mechanical



THE THOROLA MODEL 59 RECEIVER

It is equipped with toroidal coils which have become very popular due to the fact that they have little or no external magnetic field, and therefore may be placed close to other apparatus without ill effect

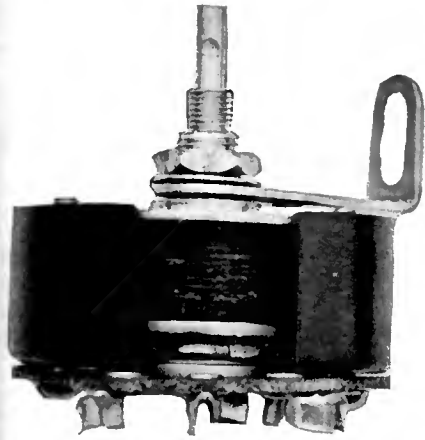

THE "CLAROSTAT"

The side has been cut away in this photograph so that the essential parts of the interior may be seen. Mica and carbon particles are compressed to give lower resistances. It is made by the American Mechanical Laboratories

Laboratories are introducing improved models of the "Clarotuner." These are radio frequency coils designed for use with Roberts, Browning-Drake and three-circuit receivers. The tickler coil is fixed, regeneration being controlled by a variable shunt resistor. As the resistance is lowered, a gradual short is imposed across the tickler, and regeneration is reduced. The advantage of resistive controlled regeneration lies in lessened effect of the regeneration control on tuning, as compared with the usual retuning necessitated by varying the coupling between the conventional tickler and the secondary it feeds back to. The Roberts type (2RK) "Clarotuner" sells for \$7.50, while the three-circuit arrangements retail at \$4.50.

The Sickles Diamond Weave Coil Company have developed a highly efficient inductor for the RADIO BROADCAST "Aristocrat" receiver. It is a modification of their standard Roberts coil with the N and P coil so arranged as to give a greater energy transfer at the higher wavelengths, at the same time reducing the capacity between primary and secondary—changes in design which are highly desirable and contribute to the overall efficiency of the coils. The "Aristocrat" coil sets sell for \$8.00.

RESISTIVE STABILIZATION

THE resistive stabilization of radio frequency circuits has caught the popular fancy, and several manufacturers have developed improved variable resistors especially for this purpose. Stabilization by means of a variable resistor is most efficiently obtained by placing the variable element in the plate circuit of the r. f. amplifier. So placed, the cutting-in of resistance lowers the plate voltage applied to the r. f. tubes, increasing the plate-impedance, with a lowered transfer of feedback energy (which is the cause of instability). At the same time, less energy is available across the r. f. primary to feed back. Thus, by means of the variable resistor, the r. f. system can be maintained

a little below the oscillation point—in other words, at a high degree of amplifying efficiency—throughout the tuning range. A 0-200,000-ohm resistor is generally employed for this purpose on a standard two-stage tuned r. f. system. The Electrad Royalty, types B and C, at \$1.50; the Centralab No. 200M at \$2.00; and the Clarostat at \$2.25, can be employed effectively in this arrangement.

critical and easier to operate, functioning with almost equal satisfaction on any plate potential between 20 and 40 volts. The R. C. A. and Bristol tubes sell respectively for \$3.00 and \$5.00.

The Cleartron r. f. tube, retailing for \$2.50, has been especially designed for radio frequency amplification, where its amplification constant of ten is said to be remarkably effective.

Apco is bringing out a new double filament 201-A type of tube, selling for \$2.00. A small switch on the bottom of the standard Navy type base transfers one of the filament prongs to either filament.

MISCELLANEOUS DEVICES

ASIDE from the mentioned items affecting directly the electrical efficiency of the radio frequency circuits, many new devices will appear on the fall and winter market contributing to the general utility and convenience of radio apparatus.

The "Dyal Quietron Cap," is a useful and simple "gadget" selling for fifty cents. It is a heavy, hollow, metal hemisphere, that fits over the top of a 201-A size tube. Its weight adds to the inertia of the tube, lowering its period of mechanical vibration and practically eliminating microphonic howls. The loud speaker can be operated close to any receiver when the detector tube, and such others as may be responsible for vibratory feedback, are capped with this logical if simple "Quietron." Bremer-Tully have manufactured, for some time, a device which clasps the tube to cut down vibration effects.

The Karas Electric Company have developed one of the most efficient vernier dials that the writer has seen. It is known as the Karas "Micrometric," and is a gear-driven dial with a ratio of 63 to 1. The gears are so designed that there is absolutely no backlash. Rough tuning is accomplished by a large knob, and vernier adjustments by a smaller knob. The dial

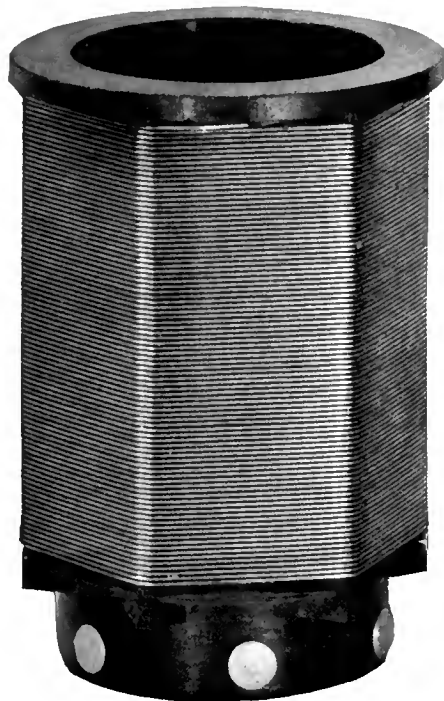

INDUCTOR AND SOCKET

As manufactured by the Silver-Marshall Company. These coils may be obtained in various sizes to cover from 167 to 10,000 kc (30 to 1800 meters)

MORE ABOUT TUBES

AS MENTIONED briefly in the July article, several tubes contributing to efficiency in radio frequency circuits have recently been put on the market. The R. C. A. 200-A, and the Bristol-Donle tubes are gaseous detectors, and both exhibit a sensitivity to weak signals greater than that of the 201-A type bulb. Of the two, the writer has found the Bristol-Donle to be the more sensitive. However, the Radio Corporation model seems to be less



AN ELECTRAD RESISTOR

Of the "Royalty" type. It may be utilized effectively for controlling regeneration in r. f. circuits

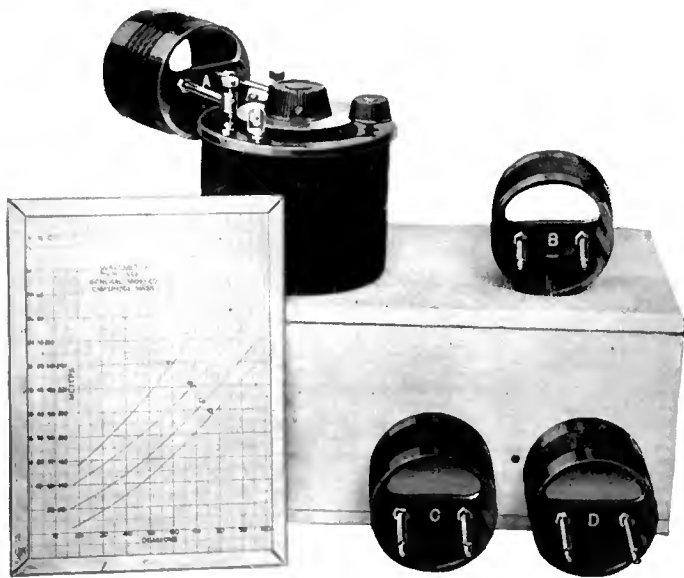

THE GENERAL RADIO TYPE 358 WAVEMETER

It will have a direct appeal to the fan who is going in for short-wave work. It has a range of from 1250 to 21,426 kc. (14 to 240 meters), and features a resonance indicating lamp

is  $4\frac{1}{2}$  inches in diameter, and the scale marking, in  $\frac{1}{2}$  degrees, can be obtained in gold or white inlay. The price is \$3.50.

Rathbun have improved their straight frequency-line convertor. This is an ingenious dial selling for \$3.50, arranged with a form of differential gearing which makes



THE KARAS "MICROMETRIC" DIAL

It is a gear-driven dial with a ratio of 63 to 1. Rough tuning is accomplished by the larger knob while the smaller knob is for vernier adjustment

any straight capacity-line condenser tune as a straight frequency-line instrument in respect to the dial motion.

For the benefit of the many satiated fans who are turning to short waves and code work as a relief to their ennui, the General Radio Company has designed a new wavemeter which retails at \$20.00. The general appearance of the 358 meter is reminiscent of the older type 247W. The coupling coil of the latter, however, has been dropped, and a resonance indicating lamp has been added to the newer instru-

ment. The range is 1250 to 21,426 kc. (14 to 240 meters), and is covered by means of four coils. An individual calibration chart is supplied with each wavemeter.

Hanscom Radio Devices are marketing a novel arrangement known as the Hanscom "Set Tester." This is nothing more than a transmitting wavemeter covering the broadcast band. No batteries are used, the instrument drawing both plate and filament potential from the 110-volt a. c. line. This device will transmit a signal over at least fifty feet to prac-

tically any receiver, and is most useful for calibrating sets, determining their wavelength range, and sensitivity. The tester sells for \$10.00.

Rathbun has developed a wave trap selling for \$5.00, that is particularly recommended to enthusiasts suffering from code, super-power, and other types of tunable interference.

The Acme Wire Company is continuing and supplementing its excellent line of wiring products. "Celastite," the wire with the non-inflammable spaghetti insulation, will be available in 25-foot coils of flexible wire, as well as the more usual bus bar lengths. Stranded enameled antenna,

wire, loop wire, and non-inflammable spaghetti tubing, are an additional contribution to convenience and efficiency.

Still exhibiting the influence of the new power tubes, the National Carbon Company is modifying the Eveready 768 battery (a  $22\frac{1}{2}$ -volt portable B supply.) Taps will be added, making it suitable as a C battery for use with the ux-171 output tube. Employing from 90 to 180 volts on the plate, this tube is the most efficient power tube available to the fan, but requires a C potential higher than those applied to the grid of the 201-A or 112 tube. The new battery will still be known as the 768, and will sell for the same price, namely \$1.50.



THE NA-ALD SOCKET STRIP

This strip is obtainable in various lengths to accommodate any number of tubes. It costs fifty cents per tube length

Several new cushion sockets are making their appearance. The Amco "Floating" socket is supported on four coiled springs combining a genuine cushion effect with unusual ruggedness. The "Floating" socket sells for \$1.00.

Na-ald is also featuring an excellent vibrationless socket. In addition, they are making strip sockets, taking any number of ux or cx tubes—at \$0.50 per tube. In brief conclusion, the coming radio season should be a most prosperous one. We venture to prophesy that the ratio of bankrupt fans to bankrupt radio concerns will be raised to an appalling degree.

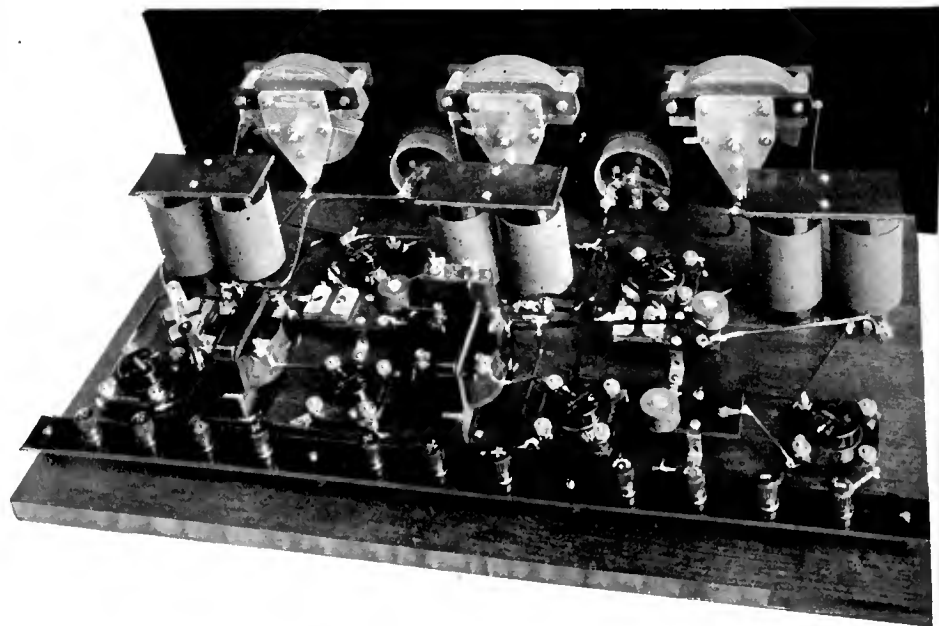

A SOMERSALO BALANCED CIRCUIT RECEIVER

In which "binocular" coils, a toroidal compromise, are used. These coils, due to their form, are partially self-shielded, thus obviating, to a certain extent, the necessity for metal shielding

# The Listeners' Point of View

Conducted by — John Wallace

## Where Are the Rewards for American Radio Musicians?

**T**HE British Broadcasting Company (the source of all broadcasting in Great Britain) has recently offered an important opportunity to all younger and lesser-known composers of British birth. It proposes to hold in London in the Autumn of this year a great Musical Festival. Prizes amounting to £1000 will be awarded for original musical compositions which will be performed at this festival and afterward will take their place in regular broadcast and concert hall repertory.

The young British composer has in the past suffered not only from lack of opportunity for gaining a first public hearing, but also from the difficulty in securing the publication of his work; without such publication it is, of course, impossible for conductors and concert managers to judge the merits of the composition. The offer made by the B.B.C. in cooperation with the Oxford University Press, is, it will be seen, a double one, and ensures not only a worthy first performance before the vast radio audience, but also publication under the most favorable auspices.

The variety of composition invited is shown in the list of prizes offered:

- (a) A work in Symphonic form—Symphony, Poem (in 3 or 4 movements), or a Symphonic Suite—lasting not less than 25 or more than 45 minutes Prize £300
- (b) A short work for Chorus and Orchestra (solo voices optional), lasting not less than 20 or more than 45 minutes Prize £250
- (c) A Symphonic Poem or a work in

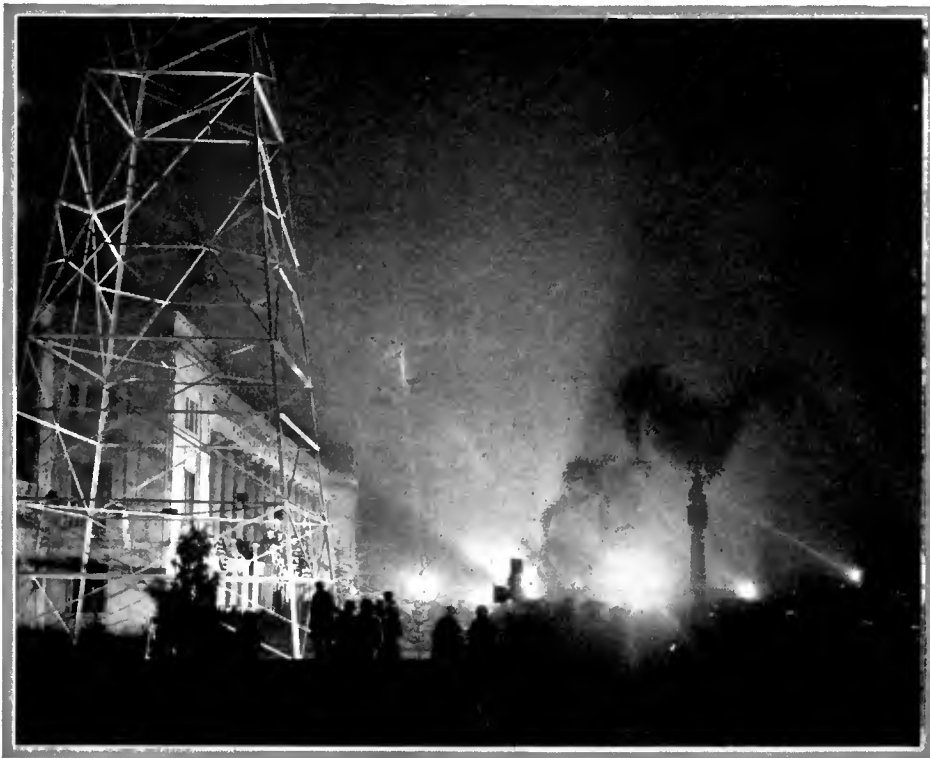

WARNER BROTHERS RADIO STATION

A striking night view of KFWB, at Hollywood. The administration building of the company and the twin 150-foot towers of this 500-watt station are effectively illuminated by the many Kleig lights

- Overture form (one movement), lasting from 10 to 20 minutes Prize £150
- (d) A poem for Voice and Orchestra (with or without words) lasting from 8 to 15 minutes Prize £150
- (e) A work for Military Band in one or more movements, suitable for performance by the ordinary Military Band Prize £100
- (f) A Song-Cycle for one or more voices with not less than 3 solo prizes Prize £50

This move on the part of the B.B.C. we consider a most praiseworthy one. It is altogether fitting and proper that radio be instrumental in bringing to composers the fat and handsome profit that is their due.

In the course of the lengthy controversy that

has been waging during the last couple of years on the question of copyright laws we have held to only one decided opinion. And that is that whatever way the thing be settled, and no matter how many other factors may enter in, in some manner or means it should be contrived that the musician reap the major part of the profits resulting from the twentieth century's latest invention.

To every dog his day! And this should be the musician's day. Of course it isn't; the money is being made by the manufacturers of radios, radio parts, and accessories, and in some instances by the operators of toll stations. Evidently these men are entitled to some of the gold for their work in making radio and broadcasting what it is. But the fact remains that, while radio would be impossible without ra-

dio receiving sets, it would be likewise impossible without music, which constitutes about eighty per cent. of program material.

The age old economic principle of Demand affecting the price of Supply should hold. The supply of musicians, considering the death rate and the output of the conservatories' as equal, is exactly what it was five years ago. In the course of those same five years the demand for music has increased in amazing proportions. We think it is little exaggeration to say that the demand for music has increased an hundred fold. Formerly the only music a man heard, week-in-week out, was the church organ on Sunday, or his daughter's practice hour when he got home too early, with maybe a couple of phonograph records thrown in on Saturday night. Now he hears several hours of assorted music a week. And his tribe has increased and continues to increase daily.



What the Farmer Listens To



GUSTAV KLEMM

Conductor of the WBAL Concert Orchestra that broadcasts a "twilight program" every Sunday evening

And so, if a hundred cubic feet of music is being heard now to the one cubic foot that was heard in 1920, it seems only reasonable, if the law of Supply and Demand hold, that each and every musician in the country should have an income approximately one hundred times as large as it was five years ago.

That may sound ridiculous, certainly it sounds impossible, but, we repeat, give the dog his day! The musician has been the under-dog long enough. In the cycle of time he may soon be the under-dog again. So let him gather his rosebuds while he may. (Perhaps we mixed that metaphor: the average dog doesn't pick flowers). His position, with the advent of radio, was not unlike that of the khaki cloth manufacturer at the time the war started. Both suddenly found a hundred men using their goods where one had used it before. The khaki cloth manufacturer now has an estate on Long Island and a swimming pool in Florida. And so we say to the musician, profiteer, profiteer, and profiteer! Turn down the screws as tightly as you can and gather in all the sheckels you can squeeze, directly or indirectly, from your new found public!

But the proper subject of this discourse, from which we seem to have strayed, is the encouragement, by radio, of native talent. Perhaps some American station has sponsored a similar prize contest that we have not heard of. At any rate one should be undertaken, and, considering the relative wealth of two countries, the prizes offered here should be considerably in excess of £1000.

We do not mean that radio in the United States has ignored home talent. Probably every station has at some time or other made remarks on the subject. We remember some "All American Programs" from WBAL. WLW, during American Music Week featured American compositions. KFI presented an Artist-Composer series in which composers were heard in interpretations of their own works. In this series appeared Cadman, Grunn, Gilberte, Tandler, Ross, Barbour, Bond, and others. WEF has, since last February, presented a regular Tuesday night feature called "A Half Hour with American Composers" which has introduced to the populace several important musicians and many lesser lights.

To sum up these random remarks, we think that radio owes a very definite and unescapable debt to the musician and should seek every opportunity to assist him. Our motto: A Rolls Royce for every Piccolo Player.

THE National Farm Radio Council has been making a nation-wide survey of farms where radio sets are owned, to find out just what the farmer wants to hear over the radio. The basis of this survey was a questionnaire of eighteen questions. Twenty-five thousand of these questionnaires were sent out directly to farmers by the National Farm Radio Council and many thousand more by other cooperating agencies such as agricultural publications, radio stations, and agricultural colleges. The resulting information, based on tabulation of 44,550 individual answers, has been compiled in an elaborate booklet, a copy of which we have recently received.

The average urban listener doubtless has the impression, as had we, that the farmer is most interested in having himself uplifted and educated—for the reason, no doubt, that every program we hear announced as a "special feature for farmers" is of such uplifting or educating nature. But lo and behold! it seems the tired farmer, just as the tired business man, is more eager to be entertained by his radio than taught.

According to the survey, orchestra or band, educational talks, weather reports, market reports, and singing are the features with the greatest appeal. But first place is won by the orchestra, with farm talks trailing in second. Weather reports and market reports have about the same general appeal. A wide decline of interest is registered regarding vocal efforts.

Some slight interest in church services and in the broadcasting of plays was shown. Other features did not excite sufficient interest to be charted. Under educational talks were classified talks by farm leaders, talks by agricultural production and marketing experts, convention speeches and the like.

While the orchestra and band were given first place, there was a general objection to jazz and a general demand for more Hawaiian and old time music. Vocal selections were not popular and those who wanted vocal were carefully discriminatory. Male voices were preferred, particularly male quartettes. A soprano voice found general disfavor among farm radio audiences.

In some sections where radio stations have developed their own dramatic talent and real radio dramas are broadcast from the studios, genuine interest and approval was registered. News bulletins were in general demand.

Radio as an important factor in the marketing of farm products was illustrated in the National Farm Radio Council survey by specific reports from 43 states. An amazing total of 46 per cent. of the replies gave specific examples of cash

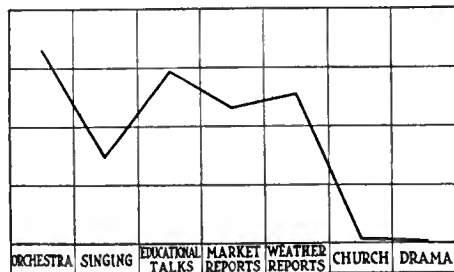

HOW PROGRAM FEATURES APPEAL TO THE FARM FAMILY

In a survey conducted by the National Farm Radio Council, 7618 expressions giving the relative importance of ten different types of program features were analyzed and tabulated.

The chart above shows the result



MILTON CROSS

One of the veterans of the staff of WJZ who announces most of the important musical events broadcast from that station

savings effected by the use of radio. Practically every report indicated the importance and value to the farmer of having market reports from 24 to 48 hours earlier than they are available through any other medium.

A graphic account of just how this market information serves the farmer we cull from another source—a survey made by Kenyon W. Mix, representative of a New York radio manufacturer:

A hog buyer from Kansas City visited a farmer at 9 o'clock one morning and offered him a certain price for a quantity of his hogs. The farmer and his wife demurred, complaining that the figure was too low. The buyer excused himself and rode off to another farm.

Two hours after the farmer tuned his radio set and caught the 11 o'clock market quotations. The broadcast price for hogs was below the one offered by the departed buyer, so the farmer did some quick thinking. He knew the man was at another house a few miles up the road, so he called up by telephone, got in touch with him, and after saying that he needed some money and had decided to sell at the quoted terms, he closed a profitable deal. The buyer did not know of the sudden price change, and was held to his original quotation by the ethics of the business.

In another case I met a farmer who had for a neighbor a man he intensely disliked. The first farmer had a radio set, and the neighbor didn't. One day, while the former was listening to his receiver, he learned that the price of cabbages had gone up \$20 a ton. Thereupon he went out, bought from his neighbor all the latter's available cabbage, at the old and lower price, of course, and then resold at a healthy profit. The other man now also has a radio receiver in his living room.

Can you hold with us for some further statistics? We have at hand the report of another survey which is interesting in that it so closely corroborates the above. This is a survey of more than 18,000 farm homes which is being made by the farm women themselves, under the guidance of Mrs. Mary C. Puncke, of the Sears-Roebuck Agricultural Foundation. The results were gathered by some twelve hundred observers, each of whom studied carefully the conditions in a small group of homes in her own neighborhood. These are some of the conclusions:

Although the silver tongued salesman may sell the farmer his radio set as a business investment, once it is installed in the home, its chief function is entertainment as far as the man of the house is concerned.

Twenty-five per cent. of them prefer music to



any other program; 24 per cent. are making the most of the practical side of radio, using them regularly to get the daily weather and market reports. This is especially true among corn belt farmers, in Iowa, Illinois, Missouri, Indiana, and Ohio, where 42 per cent. state that they rely almost entirely on weather and market information which their radio brings them. Down in the cotton country, both east and west of the Mississippi, farmers still prognosticate coming weather events by the look of the sky and the smell of the wind; 3 per cent. only give this as an important feature of their radio programs.

Church and sports by radio make little appeal to the farmer, according to his wife's report on him, and he still prefers to get his political opinions, first hand, at the general store. Farm women, as a rule, like the household home makers' programs best, for 41 per cent. tune-in on these most frequently. Thirty one per cent. prefer musical programs, 8 per cent. want lectures; 1 per cent. are especially interested in farm talks on gardens and poultry and 3 per cent. enjoy their radio most for the church services and sacred music it brings them.

The thrifty housewives of New England poll the largest vote for the home makers' hour, with its hints on economics and new recipes; corn belt farm wives run them a close second, probably due to the circumstances that these two sections are close to stations which specialize in programs of help and interest to rural homes.

Farm women in the tobacco lands, Kentucky and the Virginias, will tune-in on anything, just so it is music, and they likewise are the most enthusiastic about church and religious programs. Women in the cotton growing states west of the Mississippi, like their husbands, enjoy the serious, educational programs; 37 per cent. will always fish around in the ether after a lecture.

But farm folk, on the whole, are not prone to be fussy about the kind of entertainment they can get over the air; 18 per cent. of the men and 16 per cent. of their wives refuse to state a preference, because they like it all so well.

The most radios are found in the New England States, New York, and Pennsylvania where they have invaded 38 per cent. of the homes. The central corn belt, Iowa, Missouri, Illinois, Indiana, and Ohio, run a close second, 33 per cent. But the Eastern cotton states should be the radio salesman's paradise, for radio has found its way into only 3 per cent. of the homes.

### Checking Up the Announcer

AS WE have said before in this department, we do not think that radio will ever amount to much as a medium of education. But we made at the time an exception: we thought, and still think, that radio can do some little missionary work in the line of disseminating correct pronunciation of the English language. This can be done by the most fundamental mode of pedagogy—example. Many terms—particularly musical ones—which the average man hears on the radio, he hears nowhere else. Hence his pronunciation of these terms is guided absolutely by that of the announcer. So convinced are we that the announcer wields a considerable influence in the matter of pronunciation, that we believe that if by mutual connivance all the announcers in the country mispronounced even some very simple word for two weeks straight they could dupe the whole nation into so pronouncing it. So we are interested in the pronunciation game originated by *woaw* which is described in the following account:

Many times listeners have occasion to criticize announcers on their pronunciation of certain names of compositions, artists, towns and composers. Many of these suggestions are well taken by announcers who benefit from constructive criticism. On the other hand, there are occasions when pronunciation is regionally relative, and, as regards proper names, it is al-

most impossible to have a definite rule. Frequently the names of compositions are in a foreign language, and Americanisms are as popular as the foreign pronunciation. But there is a great variation on this particular point.

*woaw* is interested in maintaining the high standard of announcing, and, as a means of interesting the listeners as well as stimulating the announcer to the nearest perfect pronunciation on all occasions, a novelty contest has been arranged in which the listeners pointing out the mistakes of the announcer on certain programs will be rewarded with a gift. The contest, was given its first tryout on May 20, between 9 and 10 P.M.

In order to determine the first listener to make correction of an error, the listeners telegraphed their correction so that the time registered upon the telegrams determined the first correction. In order to assure the listener that the program was not memorized in advance, the announcer made at least five errors on each program of the contest.

Prizes will be awarded only for the first 10 errors made by the announcer. The pronunciation of all words, not including proper names, is determined by the Funk & Wagnalls' Unabridged Dictionary.

### Broadcast Miscellany

NO ONE has asked us to select the Best Radio Speech of the year. And had a delegation of listeners, accompanied by a brass band, appeared at our "Listening-In Studio" a week ago with such a request we should have been sorely perplexed and unable to answer. Certainly we should have found it easier to suggest a Worst Radio Speech, as a myriad such would immediately come to mind clamoring for the honor. But now we are not only willing but anxious to constitute ourself judge and jury empowered to select the year's best speech, for we have heard it.

Thomas A. Edison, perhaps the greatest man living in this current manifestation of Civilization, made said speech. The occasion was the convention of the National Electric Light Association at Atlantic City, the proceedings of which were broadcast by *WEAF* and company. Mr. Edison was introduced by the chairman amid the thunderous applause of the delegates who paid just tribute to him.

Mr. Edison's speech was as follows:

"This is the first time I ever spoke in a radio. Good night."

AN INSTANCE in which radio performed a service of genuine musical importance was the broadcasting by *wgbs* of Gluck's opera "Orpheus" from the Provincetown Playhouse, New York. "Orpheus" is one of the group of venerable musical dramas whose revival is continuously and piteously urged by a very small wing of the opera going public, and which are never revived for the good

reason that they would not fill ten rows in the average opera house.

"Orpheus" was first produced at the Hofburg Theatre in Vienna on October 5th, 1762. The first record of a performance in America is at the Winter Garden (also called Tripler Hall) on May 25th, 1863. Since 1910 when it was sung at the Metropolitan Opera House, the music of "Orpheus" has been heard only in a single concert performance, presented by the Society of the Friends of Music, Arthur Bodanzky conducting.

The opera was revived by the Provincetown Players as its last subscription offering of the season and was well received by New York critics. And we trust it was heard by at least some of the Gluck and Mozart devotees.

PERHAPS it is because we are not used to dealing with large figures, perhaps it is because we consider three letters in one delivery a rather large sheaf of mail, at any rate we are generally skeptical of the statistics eternally emanating from radio station publicity departments relating to the fabulous numbers of applause letters received. Never do we receive a photograph labeled "Six Foot Stack of Telegrams Received on *kkk*'s Third Birthday" without scrutinizing it carefully to discover old soap boxes and other padding in the center of the pile. But if ever we wanted to believe implicitly in the exactness of the count it is in connection with the 1553 letters mentioned in the following item:

When the new broadcasting schedule of Westinghouse Station *kyw* was put into effect on Monday, April 19, the studio gang wondered how many youngsters would be listening-in on Uncle Bob the first night, because the time was changed from seven o'clock to six o'clock with no previous announcement.

On the first evening of this time, Uncle Bob promised to write a personal letter to each of the children who were then listening and who would write to him about it. Uncle Bob thought only a few would be received, but on three days following, he got 1553 letters. He is now writing answers, morning noon and night and still has many hundreds to go before the job is done.



SELMA LAGERLÖF

One of the greatest of Swedish writers, before a microphone in her own country. Her latest book, *Treasure*, has recently been published

Uncle Bob being one of the pernicious tribe of bed time story tellers who refer to their listener's as "kiddies," we hope he gets dislocation of the jaw licking the 1553 stamps.

**D**INNER music at the Hotel Traymore in Atlantic City is now shared by radio audiences via WPG. This is one of the best of hotel orchestras. Its personnel is Alex Hill, director and violinist; Allen Feldman, second violin; V. Vladimir Coonley, viola; Jean Kayaloff 'cellist and Nicolas Stember, pianist.

**I**T IS high time we made some mention in these columns of "Sam 'n' Henry." "Sam 'n' Henry" is a WGN institution and has been running every night since about as far back as we can remember. It is a sort of radio adaptation of the comic strip—and just about as comic. Sam and Henry are two colored boys who came up to Chicago, from where we have forgotten, and proceeded to get themselves in a series of jams of more or less humorous nature. They evidently have an enormous audience; every soul we know has at some time or other asked us, "When are you going to write up Sam and Henry?" This very faithful audience is treated every night at 10 P.M. to ten minutes of eavesdropping on the colored boys' affairs.

Sam—or is it Henry?—has a very deep bass voice, and the other a thin piping one. They engage in drawling conversation with frequent repetition of stock gag lines. To give them due credit, their characterization is excellent. Their patter—on the few occasions that we have listened to them—has seemed to us exceedingly dull. But don't let that scare you off, as we have been assured, by persons to whose good taste we

humbly acquiesce, that if they are listened to with some regularity their daily adventures attain an enthralling interest and listening to their 10 to 10:10 program becomes an unbreakable habit.

**F**ROM certain publicity material furnished by WHAZ:

The tendency toward the combination of education and public service as the highest ideal in radio broadcasting is seen in the plan recently inaugurated by the WHAZ station at Rensselaer Polytechnic Institute to devote a certain number of evenings each year to broadcasts under the auspices of the Troy Chamber of Commerce, in which civic features and entertainment representative of the talent of the city are presented. The second of these programs will be presented next Monday evening about 10 o'clock, Eastern Standard time, an hour calculated as best for hearing through the larger part of the country.

And so—the dissemination of information concerning the attractions of Troy, New York, is the highest ideal in radio broadcasting! Hurray!

**T**HOUGH at the time we write the series has not yet commenced, we are given cause to rejoice in the announcement by Charles B. Popenoe, manager of WJZ, that the radio audience will have the opportunity of listening to the Stadium Concerts of the New York Philharmonic Orchestra twice weekly during the summer months.

The opening concert was to be given on Wednesday night, July 7. The series will continue throughout the summer until September 1 with WJZ broadcasting the Wednesday night programs

and both WJZ and WRC broadcasting Saturday nights. As in the last few years, the New York Philharmonic Orchestra will play at all the Stadium Concerts.

Established in 1842, the New York Philharmonic Orchestra is now in its eighty-fifth season and has, by virtue of its most excellent ability, won the place of prominence in American musical circles. Both the Winter Series and the Stadium Concerts during the summer months attract the most exacting of audiences and it is indeed a great privilege that the radio audience is to be allowed the entree to these musical treats.

The Chief Conductor for the season will be Willem Van Hoogstraten, who has led the Stadium Concerts for the last four years. The guest conductors will be Nikolai Sokoloff, of the Cleveland Orchestra; Henry Hadley, associate conductor of the Philharmonic Orchestra; and Frederick Stock, conductor of the Chicago Symphony Orchestra. Messrs. Sokoloff and Hadley are already well known to the radio and Stadium audiences; but Mr. Stock's appearances will be his first in the New York summer season.

Mr. Van Hoogstraten was to open the season on July 7th and will conduct until July 28th, when Mr. Sokoloff will appear until August 3rd. Henry Hadley will lead the concerts from August 4th until August 10th, with Mr. Van Hoogstraten reappearing for the week of August 11th. Mr. Stock is to conduct during the week of August 18th, and Mr. Van Hoogstraten will conduct the concerts of the final week, beginning August 25th.

As an added feature of the broadcast Stadium concerts this year, the radio audience is to be allowed to select the compositions to be rendered by the Philharmonic in the last radio concert of the season. As the season nears its close, the radio listeners are requested to send in the names of the selections which they consider would make an ideal farewell concert or a selection which they have particularly enjoyed, and from these selections of the radio audience, the program of the final concert will be compiled.

**P**ERHAPS we have already given enough publicity in this department to the Atwater Kent Hour. But we're going to hazard a little more. For, after all, the Atwater Kent Hour is in the business for the publicity, and hence, conversely; publicity is what keeps it in the business and we want it kept in the business of supplying what is indisputably the best of radio's regular weekly features. And so, for the benefit of the few who may not have heard the program, we here record the impressive line-up of stars in the final concert of the 1925-1926 winter series.

Josef Hofmann and John Powell, pianists, Francis Alda and Maria Kurenko, sopranos, Albert Spalding, violinist, Louise Homer and Katherine Meisle, contraltos, and Allen McQuhae, tenor, each of whom had been heard earlier in the series, were assembled in a joint concert of an hour and a half duration.

The summer Atwater Kent series is now in progress, differing in that the concerts last but a half hour and are lighter in type. They are under the direction of Allen McQuhae. The regular 1926-1927 series will start some time in October.

**A**ND further good news concerning summer programs is the announcement by WEA that arrangements have been completed for the broadcasting of the popular Goldman band concerts. The first concert was held on June 14. They are broadcast direct from New York University and from The Mall, Central Park.

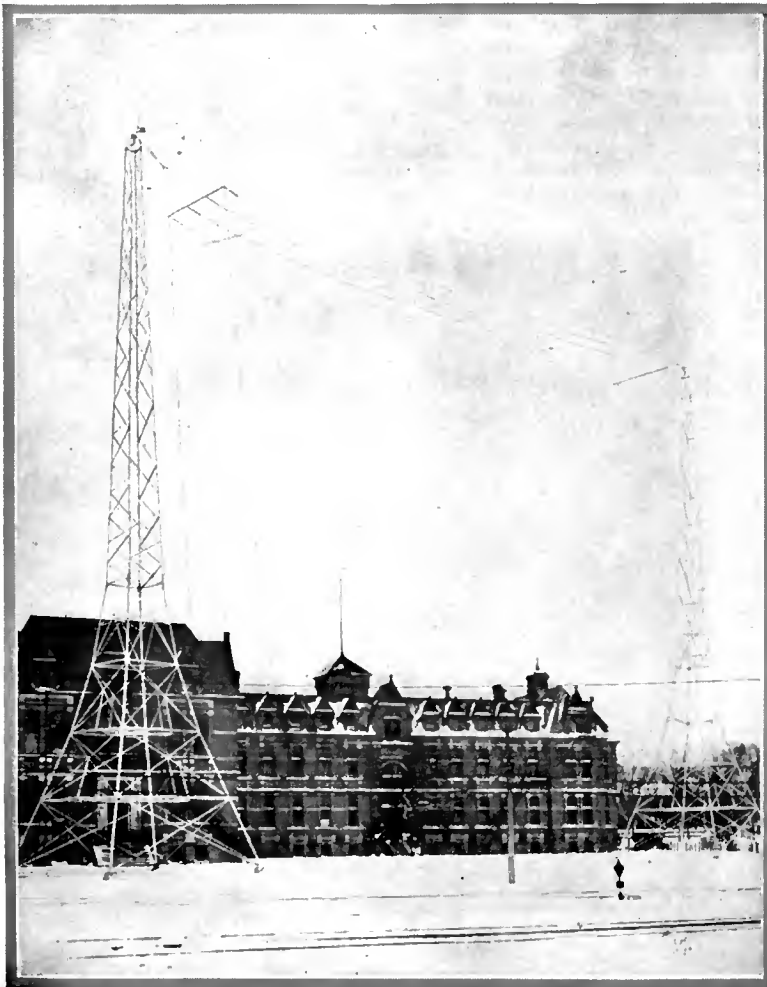

THE STATION HOUSE AND MASTS OF CNRA

The Moncton, New Brunswick, station of the Canadian National Railways' chain of ten broadcasting stations. Most of these broadcasters are heard as well and as generally in this country as in Canada. The masts at CNRA are 150 feet high and the towers are spaced 200 feet apart

# How to Rate the Power of Radio Stations

Details of International Practise—Power Relations in Wire Telephone Lines—  
The Avalon-Deer Park Circuit—Operating Public Address Systems—A Law  
Against Fading—Comment of Interest to the Public and Broadcaster Alike

## “AS THE BROADCASTER SEES IT”

By CARL DREHER

Drawings by Stuart Hay

BEFORE broadcasting appeared to amuse and vex the world, radio engineers were concerned with the power of wireless telegraph transmitters. These, in 1916 and thereabouts, were mainly of the spark type, consisting essentially of a motor generator feeding 500-cycle alternating current to a high tension transformer, which charged a condenser in connection with a suitable spark gap and oscillating circuit, and so ultimately produced damped high frequency oscillations in a radiating antenna. Such sets, in America, were rated in terms of energy input to the primary of the step-up transformer. The most popular size of set for ship-to-shore work was rated at 2 kilowatts on this basis. Possibly 15 per cent. of this energy got to the antenna, which therefore received something in the neighborhood of 300 watts of radio frequency power. The set designers of that day preferred to talk about input to the transformer, for one reason which was obvious—the greater ease of measuring power at a commercial frequency and low voltage, and for another reason which their self-esteem probably did not allow into the upper stories of their consciousness very often—the fact that 2000 watts sounded more impressive than 300, and did not illuminate the miserable over-all efficiency of the transmitter too unsparingly.

The Germans, however, with that tactless thoroughness which has given rise to various emotions in other peoples, were already rating their radio transmitters in terms of radio-frequency power in the antenna—“Turm-Kraft,” as they called it, which, literally translated, means “Tower-Power.” When a German said he had a 250-watt radio set, he meant that it could put that much energy into a suitable antenna. In the United States, when radio telephony came into its own, we adopted this basis of grading transmitters. Practice in this regard is not uniform all over the world, however.

This is pointed out by Capt. P. P. Eckersley, Chief Engineer of the British Broadcasting Company, in an article on “Power: a Vexed Question,” in the *Radio Supplement* (London) for March 5th. Eckersley gives the following table for a “Standard 1½ Kilowatt Set”:

Point of Measurement	Power	Used by
Total high tension input to set from transformers	6 kw.	Some Continental organizations.
Power to anodes of oscillating valves	1.5	British and all members of the Geneva Bureau for comparison purposes.
Power to aerial	1.0	American and some Continental.
Meter-amperes	300	Governments and scientific bodies

When Eckersley speaks of a “standard” 1½-kw. set, he means the British standard, of course. The British rate their sets on the basis of power delivered to the plates of the oscillators. As tubes now go, their efficiency in converting high tension direct current into radio frequency oscillating energy is about 60 per cent. Thus the power delivered by the oscillators to the antenna is about ¾ of that received by the plates, or working in the other direction, if we multiply the output of the oscillators by 1½ we get the high tension input. It follows that to convert the power of an American station to the British standard, we must multiply by a factor of 1.5, while if we wish to rate British

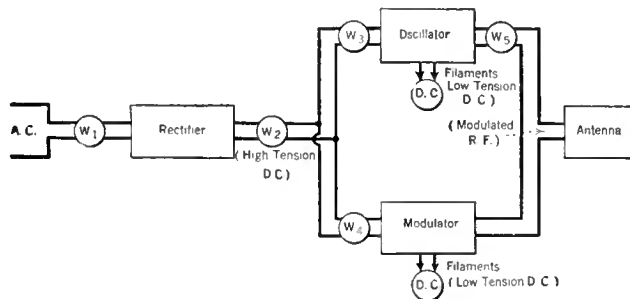

FIG. 1

stations according to American practice we must multiply the nominal power by 0.66.

To me the American-German method of expressing power seems more logical. The output is what counts. The ultimate output (radiated energy) is very difficult to ascertain, thus we are unable to follow the really scientific procedure of expressing the power of the station in terms of that quantity. The next best thing is to work in terms of radio-frequency power in the antenna. The antenna current may be measured with reasonable accuracy, and the resistance of the antenna at a given frequency is likewise determinable. The power equals the square of the current multiplied by the resistance—a law not confined to antennas. If telephone stations are to be rated by power at all, the antenna power seems the most rational figure to be chosen. If we are to stop at any point ahead of the antenna, the total input to the rectifiers is just as pertinent as the high tension input to the oscillators, and will please the press agent of the station much more. In the above table, the 6 kw. rating is just as defensible as the 1.5 kw. rating, and perhaps more so, for there is some warrant for expressing the power of a machine in terms of the total input, when the output is in a form not readily measured. For example, we talk about a 0.5-kw. electric heater or flat-iron, this being the power

absorbed by the heating element. In such cases, the power consumption, which determines the operating expense, as well as the effect on the supply circuits, is the chief quantity of interest to the user.

To show how the power varies, we may analyse the actual conditions in one modern station at an arbitrary power level chosen for illustration only, and considerably below the full power and rating of the station. Fig. 1 will aid the reader in following the energy transformations involved. We start with the rectifier, which consists of 12 tubes fed from an a. c. source, suitable alternating voltages being applied to plates and filaments. The first wattmeter, W1, reads 135 kw. The output of the rectifier is about 11 amperes d. c. at 9300 volts, corresponding to 102 kw. on the d.c. side. This high tension power is split equally between the oscillator and modulator frames of the set. Thus, W2 being 102 kw., W3 and W4 will each equal 51 kw. As W3 is the plate input of the set at this level would be 51 kw. Assuming 66 per cent. efficiency, the oscillators deliver 33.6 kw. of radio-frequency energy (W5). This would be the American power rating of the transmitter for the illustrative output power we have chosen.

Another factor, however, must be taken into account. The oscillators and modulators require filament current, which in this case is in the form of d.c. Each tube takes 45 amperes at 15 volts, or 0.675 kw. If eight oscillators and 12 modulators are used, the former absorb 5.4 kw. and the latter 8.1 kw. for filament heating alone.

The total power consumption of the set is 135 kw., a.c. and 13.5 kw., d.c., adding up to a total of 148.5 kw. The mean r. f. power delivered to the antenna is 33 kw., an approximate power efficiency, overall and for this particular adjustment, of 20 per cent. Of course we must take into account, in comparing this figure with efficiencies of other machines, that we require at least as much energy to modulate the carrier as to produce it in the first place (Technical Operation of Broadcasting Stations. 7. Modulation. July, 1926. RADIO BROADCAST). Another element which prevents the over-all efficiency of even the best modern radio transmitters from attaining a more respectable level is the fact that several units must function in tandem, owing to the peculiar nature of the machine as a whole. The rectifier has an efficiency of about 75 per cent., and the oscillator of 65 per cent., which are middling good performances in the field of energy transformation. Taken together, however, they drop somewhat below 50 per cent. Then when we add the burden of filament heating, and the large energy consumption of the modulator, we ruin the efficiency of the transmitter considered as simply an energy transformer. But to consider it in this way alone is meaningless. It is as much as to say that a beautiful and healthy

woman is useless because she is a poor piano mover. We rate such a woman by her physical beauty; we rate a modern radio telephone transmitter by its acoustic beauty, i. e. fidelity of reproduction. Efficiency in the narrow sense is allowed to go hang, very properly.

However, as energy is sacrificed apparently so recklessly in the best broadcasting stations, that is the more reason for not rating them at any intermediate stage, when the question of range and power is being considered. If power ratings in radio are to be made uniform internationally, therefore, the radio-frequency power delivered to the antenna would seem to be the most valid basis of comparison.

Those readers who are interested in the meter-amperes product as an expression of the effective range of stations, are referred to the article in this department on "Computing How Far a Radio Station Can Be Heard," in the June, 1925, RADIO BROADCAST. This factor takes the radiating qualities of the antenna into account, and is hence a step in advance of power ratings in terms of mere watts. Even then, however, we must consider percentage modulation, as Captain Eckersley points out, and as yet no one has worked out a rigid formula including this variable. Practically, as probably most stations run their modulation around 80 per cent. peaks, this factor cancels out in many instances, leaving meter-amperes or watts in the antenna as a valid basis of comparison between transmitters the frequency of which does not differ too widely.

this outline that the original paper is of value to a reader, the best thing he can do, whenever possible, is to get a copy of the complete paper and keep it in his technical library. A very useful collection of technical data can be built up from such small beginnings, and at a trifling cost compared to its value. We have no desire to interfere, however slightly, with the circulation of such invaluable media as the journals of the American Institute of Electrical Engineers and the Institute of Radio Engineers; on the contrary, we continually urge all technical broadcasters to join these organizations and to obtain their publications and reports with the other benefits of membership. In accordance with this policy, our general practice here will be to abstract papers a few years old, whose contents might otherwise be lost as far as the average broadcaster is concerned, where the material remains pertinent and valuable. Recent papers will be abstracted only under exceptional circumstances.

ABSTRACT OF "APPLICATIONS OF LONG DISTANCE TELEPHONY ON THE PACIFIC COAST," by H. W. Hitchcock. *Journal of the American Institute of Electrical Engineers*, Vol. XLII, No. 12, December, 1923.

Wire telephony is almost as important to the broadcaster as the radio portion of his activities, and a partial outline of the above paper is presented because it contains a valuable description of one very variegated long distance toll telephone circuit, and the power relations existing therein.

The circuit in question runs approximately north and south through California, Oregon, and Washington as one of the "backbone routes" in this region. The diagram (Fig. 2) shows the various repeater stations between the terminals (Avalon, California, and Deer Park, Washington), the distances, type of line and method of transmission (cable—submarine, underground, or aerial; open wire; with voice and carrier frequency transmission) and the power levels along the entire circuit. The latter data are of

most interest to the broadcaster, since he can compare the power levels along the wire circuit with the power levels in his own equipment. The fundamental difference, of course, is that the wire telephone people do their amplifying in moderate increments at convenient distances along the line, while in radio (excluding possible radio relay systems) we have no choice but to amplify on a grand scale at the beginning and end of the circuit only, with nothing but attenuation in between.

The speech is assumed to originate at Avalon, on Catalina Island. The transmitter there delivers about 1000 microwatts of speech energy to the line, which starts with a submarine cable to San Pedro on the mainland, followed by a stretch of aerial and underground cable, loaded. At Los Angeles this straight audio system changes to a 25-kilocycle carrier current transmission over No. 12 gauge open wire, which takes it up to San Francisco, where there are again some submarine and underground sections crossing the bay and in the city. On the return to Oakland the carrier frequency becomes 10 kilocycles over No. 8 wire, which is sustained all the way to Portland, where the carrier is discarded and the speech travels the rest of the route at audio frequency over a phantom and open wire circuit.

There are voice-frequency line repeaters at San Pedro and Walla Walla. Seven carrier-frequency amplifier stations are shown. There are also voice-frequency cord circuit repeaters at Los Angeles where the change is made from the toll cable to the 25-kc. carrier system, at San Francisco, to join the 25-kc. to the 10-kc. carrier circuits, and at Portland, where the transition to audio frequency is again made. In all there are some 15 repeaters on the stretch of 1622 physical miles. These repeaters keep the power between a maximum of 1000 microwatts and a minimum somewhat below 1 microwatt. Through this agency the over-all equivalent of this telephone circuit, running north and south practically the length of the United States, is reduced to 25 telephone miles, 4 microwatts being delivered to the instrument at Deer Park.

Abstracts of Technical Articles

**B**EGINNING with this issue, there will be included in this department abstracts on acoustics, telephony, public address systems, broadcasting, and related subjects, where these papers have appeared in periodicals not readily accessible to some broadcasters. A few words are in order as to the purpose and limitations of these abstracts. An abstract is not a substitute for the original article. The abstract is an outline of the contents of a paper, no more. If it appears from

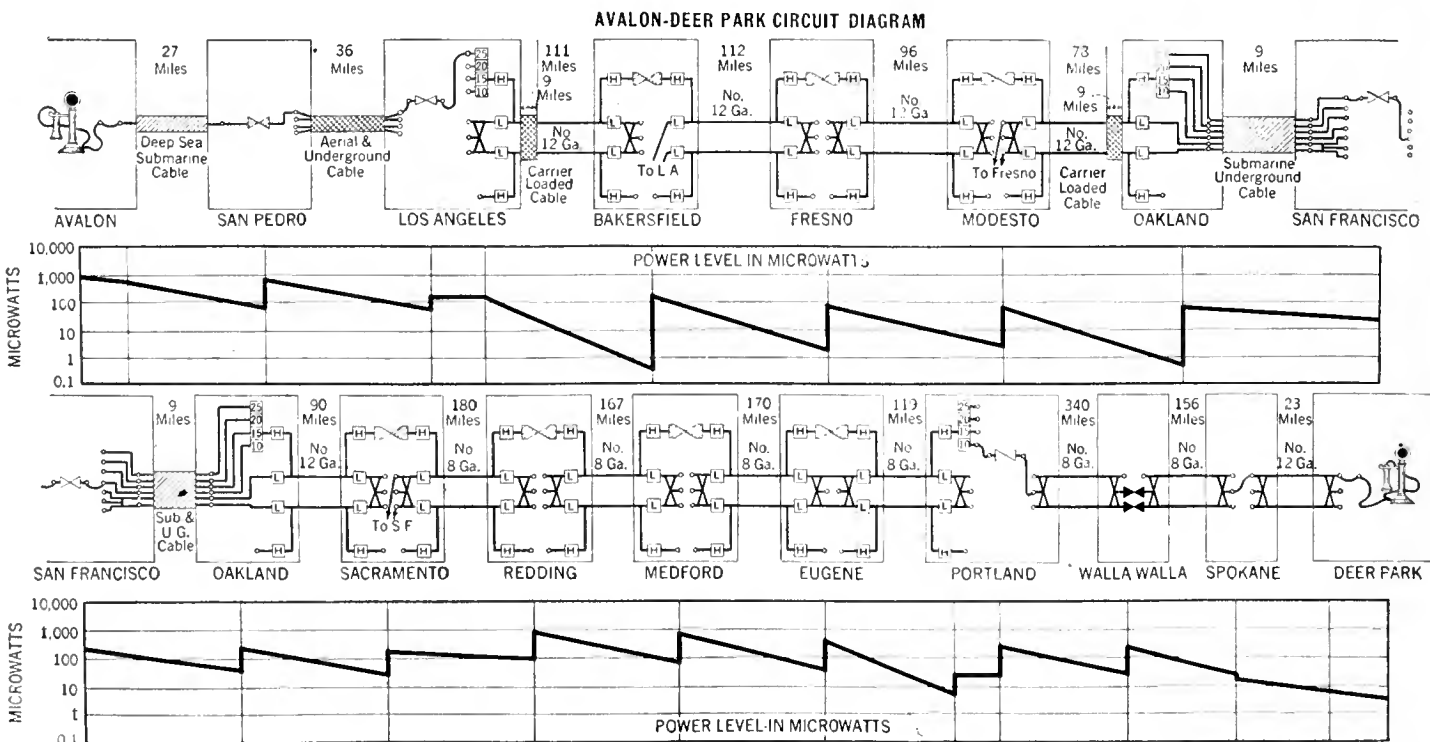

FIG. 2



That is, by means of the vacuum tube amplifier, a telephone circuit covering 1600 miles of territory is reduced, electrically to a standard transmitter and receiver connected by a 25-mile stretch of standard cable, and one can talk with the same ease over the one as the other.

Hitchcock's comments on the power relations are illuminating and are quoted in full:

Consider the conditions at a time when the power delivered to the line in question by the Avalon telephone is 1000 microwatts. The overall circuit efficiency is about 0.4 per cent. (25 mile equivalent) so that four microwatts are delivered to the Deer Park instrument. Were the cord circuit repeaters omitted, the power transmitted would be reduced to 0.02 microwatts. Should all the repeaters, including those in the carrier systems, be omitted, the received power would be  $1.3 \times 10^{-16}$  microwatts.

Not only is it necessary to maintain a certain over-all efficiency, but it is also required that the power be kept within certain upper and lower limits at all points along the way. Should the voice currents become too great, overloading of the repeater tubes accompanied by distortion of the speech waves will occur. If the current becomes too weak, the circuit will be noisy or experience excessive crosstalk from other lines. These upper and lower limits make it necessary to amplify the current at regular and fairly frequent intervals as is done in the circuit shown. Were all the amplification to be effected at the receiving end, the noise and crosstalk would completely drown out the speech current. In case the amplification were all applied at the sending end, the speech input power would have to be about thirty billion kilowatts. Such a mode of operation is of course impossible.

## Technical Operation of Broadcasting Stations

### 8. Public Address Systems

A CERTAIN municipality which undertook the job of running a broadcasting station placed on its civil service list, in addition to a broadcast engineer and operators, two public address operators. This was not illogical. The two jobs have much in common. In fact, right up to the radio frequency circuits, a public address system, with the horns omitted, is scarcely distinguishable from a broadcasting station. They diverge at the point where the one set of audio amplifiers modulates a carrier and the other set is turned onto a battery of loud speakers to convert their energy back into acoustic form. Both systems start with a high quality microphone. Their acoustic and pick-up problems are similar. And, when the two are used simultaneously in the same place or neighborhood, interactions may occur which must be taken into account. Broadcasters, therefore, should know something about public address systems, how to connect them with their own equipment, and how to avoid deleterious effects from them in other instances.

The usual public address system consists of microphones, generally of the carbon type and identical with those used in broadcasting, a "speech input" amplifier of about three stages, and a power amplifier which comes in several sizes, and feeds the projectors or loud speaker units. The "High Power Amplifier" size will deliver as much as 40 watts of electrical speech energy, which, assuming one per cent. efficiency in the loud speakers, may be converted into 4 watts of acoustic energy, or about four times the maximum sound emission of a hundred-man symphony orchestra. Or, to use the comparison of Green and Maxfield, whose complete paper on the public address art will be abstracted in a later issue, this 40-watt-output machine will

feed all the twelve million telephone receivers in the Bell system at a level slightly above that usually considered commercial. This prodigious volume of energy—prodigious by acoustic standards, where, owing to the sensitiveness of the human ear, a little energy goes a long way—is required only for the largest audiences, particularly outdoors. For ordinary purposes, a "Medium Power Amplifier" with about one-tenth the output, or four watts electrical voice frequency energy, is provided. These power amplifiers generally use a push-pull arrangement of power tubes, two being provided for the medium power size and four (two in parallel on each side of the push-pull circuit) for the high power or 40-watt size. The tubes used in such amplifiers, if oscillating at radio frequency, would be rated at outputs of the order of 50 and 250 watts, and the plate voltages for public address work range up to about 1000 volts.

The speech input amplifier which precedes the power stage runs on 350 volts or lower, and its maximum output, under half a watt, is suitable either for feeding the power stage or for transfer to a line. Thus, if it is desired to feed a broadcasting station or chain from a public address system, the proper point at which to tap off is the output of this first amplifier. If connected to a line, the amplifier must be terminated in a suitable step-down transformer, according to the usual method of matching impedances, in a ratio of about 5000 ohms on the amplifier side to about 250 on the line side.

For a medium size hall of the order of sixty by forty by twenty feet, adequate public address service may be provided with one stage of power amplification following an ordinary field amplifier used in broadcasting. Such an amplifier is similar to the "Speech Input Amplifier" partially described above, with a maximum voltage amplification of the order of 3000, a "gain," in telephone terminology, of 75 miles. This is fed from the usual 373-W carbon transmitter. The power stage may consist of a single tube, 7.5 watts oscillator rating, with 400 volts on the plate, the tube being biased to draw a plate current of 25 milliamperes at this voltage, and feeding a cone loud speaker through a suitable transformer (probably 1:1) to keep the d. c. out of the loud speaker windings.

The main difficulty to be guarded against in operation of loud speaking systems is acoustic coupling between the projectors and the microphone. This acoustic feed-back results in audio-frequency howling, if the coupling is close enough, or in distortion and loss of high frequency components at points below this. The usual solution of the problem is to mount the loud speakers so that the sound they emit will not reach the microphone in any great degree. This is usually accomplished by placing the horns or cones well above the microphone position, and slightly in front, so that the microphone lies somewhat in the lee of the loud speaker emission.

Frequently, in the business of broadcasting banquets and other functions, a broadcast and public address pick-up work side by side and independently. In such cases the broadcaster wants to pick up as little of the public address acoustic output as possible, because it stands to reason that the quality of the latter will not be

as good as the speech input to the microphones. Furthermore, if the public address system is in a singing condition, or on the verge thereof, its output will interfere with or distort the input to the broadcast microphones. In self-protection the operators of the public address system must shield their own input from the projectors, and, as the two sets of microphones are normally side by side, the broadcaster is protected at the same time. In practice, however, a preliminary test of both systems in simultaneous operation is by no means to be neglected.

A broadcasting station may also interfere with a nearby public address installation by sending radio frequency into the latter. If rectified in the amplifiers, this pick-up may end up as audio frequency in sufficient quantity to be audible in the projectors. The remedy is to provide radio frequency traps at a few strategic points. This measure will be discussed in a later issue in an article on the general topic of protection against extraneous radio frequency pick-up, which is sometimes quite serious in large cities where many broadcasting stations are crowded together.

## Ducks and Broadcasters

IF YOU observe the expression of a live duck, you will note that he looks exceedingly alert and stupid at the same time. This complication arises from the fact that the duck's characteristics fall into two divisions. Under the first he seeks food. When in the water his search is necessarily aqueous. When on land, the duck stretches his serpentine neck in all directions with short, jerky movements, and his beak quivers expectantly. He hopes he may catch a fly. In this endeavor all his energies are engaged, and hence the fowl looks alert. The other qualities of the duck's character, are found to be of a low order. Hence, aside from the limited vivacity which he exhibits in his search for nourishment, the duck looks stupid. In short, he is only a duck.

I do not wish to insult the profession which I grace in company with other precious jewels, but some broadcasters and hangers-on of broadcasting remind me of ducks. They exhibit the same jerky activity and a considerable degree of adaptability in one direction; the rest is silence, if one wishes to be charitable. They vibrate from one thing to another, giving the impression of remarkable briskness, but in a short time you discover that they really have no idea of what they are doing. There is no coherence to their movements; they simply jump around. They know a little about a number of things, but they know nothing thoroughly, and at bottom they are simply stupid. They are noisy and restless.

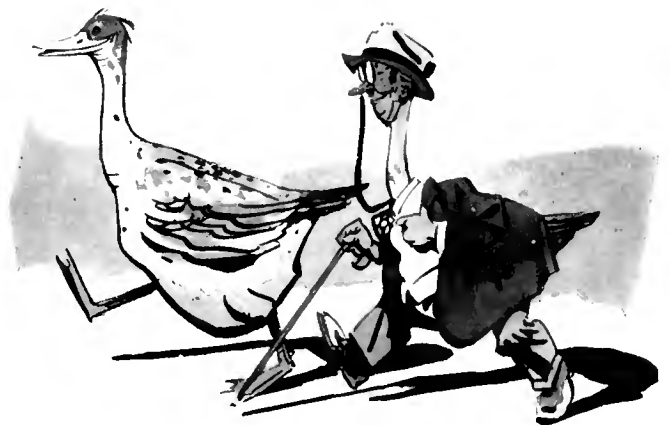

"SOME BROADCASTERS REMIND ME OF DUCKS"



This gives them the same restricted expression of alertness which we see on the duck, and for the rest they look like half-wits, which they are. Heaven send the day when some hard working and sensible broadcaster, tried beyond endurance, will throw one of them downstairs and scare the rest out of the studios.

## Radio Takes Us Back to Nature

**A** WHILE ago Professor Morecroft ironically suggested that the Government undertake an investigation to determine the causes of poor radio reception last winter, with a view to preventing a recurrence of the atmospheric phenomena which prostrated so many DX fiends. A law would in due course be promulgated, forbidding the sun to break out in spots every eleven years and thus giving the earth's magnetic field the D. T.'s and raising hob with the propagation of the precious broadcasting waves. About everything else has been regulated, so why not the atmosphere and the celestial bodies?

Why not, indeed? The regulation would not work, to be sure, but it might give some body of regulators comfort, not to speak of a possible income. There are plenty of precedents. Everybody knows that nature cannot be regulated, that we can only follow her laws, which are immutable, although our understanding of those laws is by no means immutable. Yet we constantly act as if Nature could be chucked under the chin and cajoled into giving us what we want.

Radio may have some effect in curing us of this illusion. By "us" I mean the general public, excluding engineers and scientists, who

must come to terms with Nature early in their careers, if they are to hold their jobs. But, some one will say, how can radio bring us back to Nature? Is not radio a highly artificial thing, the last of a series of mechanistic developments? It is, but it is nevertheless profoundly natural. In the last analysis everything is natural. It does not matter whether it is a nasturtium seed just pushing its green stem out of the earth, or a revolving piece of iron with wire wound around it. Furthermore, radio is unique among machines, in that it consists of two mechanisms separated by a natural medium. It therefore includes a cross section of both kinds of natural behavior, that of the machine and that of the atmosphere and the forces of space. At present we have more control (i. e., we know better how to conform to the natural laws) of the machine. We have considerable control over what we broadcast and what we receive—after we receive it—but between the two the carrier and its side bands frequently get a terrific mauling, and as yet our brand of law and order has not been introduced into the reaches of space through which the waves must travel.

What will be the effect of all this on the average citizen with his radio set? On some the effect will be nil. They want to get music or baseball scores out of their sets; if anything interferes with that reasonable purpose they swear, turn off the filaments, and go to the movies. But other BCL's are of a more inquiring disposition. They want to know why stations fade, why the quality of reproduction is not as good from a station two thousand miles away as from the local two miles away, why the six UV-201A's went up the flue when the B-battery lead touched the filament rheostat.

Such questions are rather a novelty. For once the man participates in the machine life around him, instead of leaving the running of it to specialists. Take the city dweller, for example. He is out of touch with the life of the country, which he sees about two weeks each year. He utilizes the conveniences of city life around him, without wondering about it, letting it stir his imagination, or trying to find out how it works. Does the traveler in the subway think about the oil circuit breakers and the rotary converters in the sub-stations? Does he consider how his food reaches him, and in how many days he would starve if the distribution system cracked? Does he read a book about his machine switching telephone? Probably he does none of these things. There is something curiously numbing about modern life. Everything is done for one, for money, down to one's very amusements. Radio in its early stages is a step in the opposite, and, I think, healthy direction. The passive recipient becomes a participant. Of course, when radio is

perfected, perhaps he will become passive again, and radio sets will be exactly like vacuum cleaners or fountain pens. That day is not yet on us. That radio can be divested of all romance and uncertainty also seems doubtful. Rather it seems to me that it partakes of the nature of travel, which always contains something potentially exhilarating and uncertain.

These elements in radio are valuable in two ways: as a mental discipline and as something which tends to heighten interest in life. The second has been outlined above. The first is equally important. It has been pointed out by many observers ahead of their age, such as Bertrand Russell, that it is of the utmost importance that people should not harbor views for which there is no definite evidence. Actually, very few people think at all in the proper sense of the word. They merely employ a sort of association that passes for logic, in the endeavor to satisfy shifting emotional states. Only scientists, engineers, some lawyers, judges, writers, business men, and administrators really think professionally, and then only in their special fields, as a rule. This distrust of reason costs us dear. Since we have made the world so complicated, by introducing machinery and thereby greatly increasing its population, it is of the utmost importance that we learn to act more reasonably. The direct intellectual content of radio, as yet, is not high. But it has introduced a considerable body of people to the inside of the world which sustains them, in a form which they do not take for granted, like the weather or the 8.18 into town. Perhaps the effect will be beneficial. We must wait and see. If it does nothing more than to teach people what legislation can *not* do—to return to Professor Morecroft's satirical observation—it will be worth its upkeep on that score alone.

## A Question of Phraseology

**A** MONG the British announcers the use of the form, "London calling," and similar phrases remains very common. To such an extent is broadcasting still dominated by its parent, radio telegraphy. Could anything be more inept? "Calling" whom, or what? Does one "call" the audience between arias at the opera, or between numbers at a song recital? If it is necessary to announce call letters or to give the origin of a radio concert, the simple mention of the letters, or the sentence "This is . . .," or "You are listening to . . ." is surely more appropriate. In radio telegraphy, where one calls a specific station by the repetition of its designated signal, followed by one's signature, the use of the term "calling" has some sense. In broadcasting it is, at best, an unintelligent adaptation.

There are plenty of such fossils in the broadcasting art. In the United States, at least, at this writing, the law under which all radio activities, including broadcasting, are carried on, is some fourteen years old. It has little more valid applicability to broadcasting than a city ordinance prohibiting sweeping sidewalks after eight o'clock in the morning. The Secretary of Commerce has been able to carry on his administrative functions only by extending his authority, by common consent, beyond the patent limitations of the law. Under the circumstances, it can hardly be expected that the phraseology of radio broadcasting should not also show traces of a past epoch.

One broadcasting station boasts of a stronger "signal" than another in some locality. To "signal" is to communicate by signs or symbols. Direct transmission of speech and music is not signalling. Again the regression to the tele-



"A LAW WOULD BE PROMULGATED, FORBIDDING THE SUN TO BREAK OUT IN SPOTS"

graph level. The announcer "signs off," and asks the radio audience to "stand by." Then there is the phrase, "broadcasting direct from—" used by field announcers. The "direct" is totally unnecessary. Originally the custom was to say, "by direct wire," when the use of telephone lines in connection with broadcasting stations was still a novelty, and the broadcasters could not refrain from boasting about their new achievement. They tried to emphasize that their wires did not run promiscuously all over town like the pairs rented by telephone subscribers for \$3.50 a month, but proceeded virtuously and exclusively to the point of broadcasting. From such origins our radio phrases spring.

### SOS Publicity

READERS of the article on the above topic in the May, 1926, issue will be interested in the following communication from the Commissioner of Navigation, Department of Commerce:

"The Bureau has your letter asking an expression of the opinion of this office on the subject of sos publicity.

"You are no doubt familiar with our radio laws and regulations and also the International Convention. The 19th regulation under Section 4 of the Act of August 13, 1912, provides a penalty for divulging or publishing the contents of a message which is addressed to someone. Radio distress messages are not usually addressed to anyone in particular though there are times when a vessel in distress does address some particular ship, but this is rather an exception than a rule. "Article 2 of the St. Petersburg Convention of 1875 which is made a part of the London Convention referred to in Article 17, provides that the high contracting parties bind themselves to take all the necessary measures for the purpose of insuring the secrecy of the correspondence and its safe transmission. No reference is made in either case to sos calls.

"Good reasons can probably be offered why the sos call should not be considered secret and equally good reasons can no doubt be offered why they should be considered secret.

"It is believed that you desired to have the argument against the secrecy of distress calls. Therefore one of the arguments advanced is furnished you which is as follows:

"It sometimes happens that a vessel sends out a distress call when the people on board are not in immediate or actual danger of loss of life. Publishing information that the vessel is in distress causes undue alarm and worry on the part of relatives ashore who have not an opportunity or do not know how they can get the correct information as to the seriousness of the accident or the extent of the danger.

"Taking the other side of it, if secrecy is carried too far, it might cause some inexperienced operator to withhold information which might be helpful in connection with saving the vessel."

D. B. CARSON  
Commissioner of Navigation,  
Department of Commerce.

### Power and Code Interference

PROGRESSIVE ship-to-shore radio companies are rapidly discarding spark transmitters in favor of c.w. sets, principally of the tube type. But this takes time, and the immediate elimination of spark transmitters in the marine band is out of the question, hopeful radio critics notwithstanding. Hence it would be a good thing if the letter printed below could be put into the hands of every spark transmitter operator in the country. It is taken from *World Wide Wireless*, now the *Wireless Age*, the house organ of the Radio Corporation of America, and is addressed to Mr. J. B. Duffy, the superintendent of the Eastern Division of the Marine Department of that company.

Below is a list of stations worked on extremely low power during this past voyage. I have been interested in determining the amount of power necessary to insure satisfactory communication, and am more than convinced that coastwise vessels fitted with spark are using too much power. The 600-wave on full 2 kw. is bound to overlap the broadcast waves, particularly when the vessel is ten or fifteen miles from shore. I have heard several complaints of spark still interfering with programs. Coastwise vessels, as you know, often go as close as ten miles to large cities, viz. Charleston, Jacksonville, etc., and their use of unnecessary power is bound to cause disturbance.

From the following achievement it becomes evident that the use of a fraction of the maximum power rating is all that is necessary.

May I ask you to have this list printed in *World Wide Wireless* in order that it may reach RCA operators, and cause them to cut down power when possible?

STATION WORKED	POWER	RADIATION	SIGNALS
WPA, Port Arthur, Tex.	0.25kw.	5 amps.	QSA
WSC, Tuckerton, N. J.	0.10	2	"
WIM, Chatham, Mass.	0.10	2	"
WSA, Easthampton, N. Y.	0.10	2	"

Time, about midnight. Our position about 30 miles south Hatteras.

At ten o'clock in daylight, Savannah was worked about 200 miles on one-quarter kilowatt,



"RADIO IS LIKE TRAVEL, ALWAYS CONTAINING SOMETHING EXHILARATING AND UNCERTAIN"

two amperes in the aerial, and reported us loud. Transmitter, Marconi P-4.

H. L. CRANDALL.  
Radio Operator, SS *City of Montgomery*.

The *City of Montgomery* was about 1100 miles distant from Port Arthur, Texas, which Mr. Crandall worked on one-quarter kilowatt, or about one-eighth of his available power; while the distances covered on one-tenth kilowatt, or one-twentieth of the available power, varied between 300 and 600 miles, roughly. This is admirable work with a spark set.

These figures should not be taken as proving that marine sets are excessive in power. It is one of the characteristics of radio transmission that the power required to communicate over a given distance varies enormously. The work done by this operator shows the small amount of energy required under favorable conditions. Under other conditions, the full 2 kw. might be none too high for ranges much less than those covered. Heavy static, an sos, and any number of other situations the radio man knows, may demand the full power available. (Incidentally, the use of minimum power required for reception also facilitates marine communication, and has been urged for years past on this basis alone.) The point is, however, that the output of sets is made variable in order to meet varying conditions effectively, and too many operators, through sheer indifference, run their transmitters full blast everywhere and always. To these muddlers the men on the *City of Montgomery* present a welcome contrast.

THE entire contents of Radio Broadcast are fully protected by copyright. Editors of periodicals and others are reminded that no part or any article, including circuit diagrams or other illustrations can be reprinted without the express permission of the Editor. Those wishing to use all or any part of an article appearing in this magazine are requested to communicate with the Editor.

SIZE OF FILAMENT RHEOSTAT

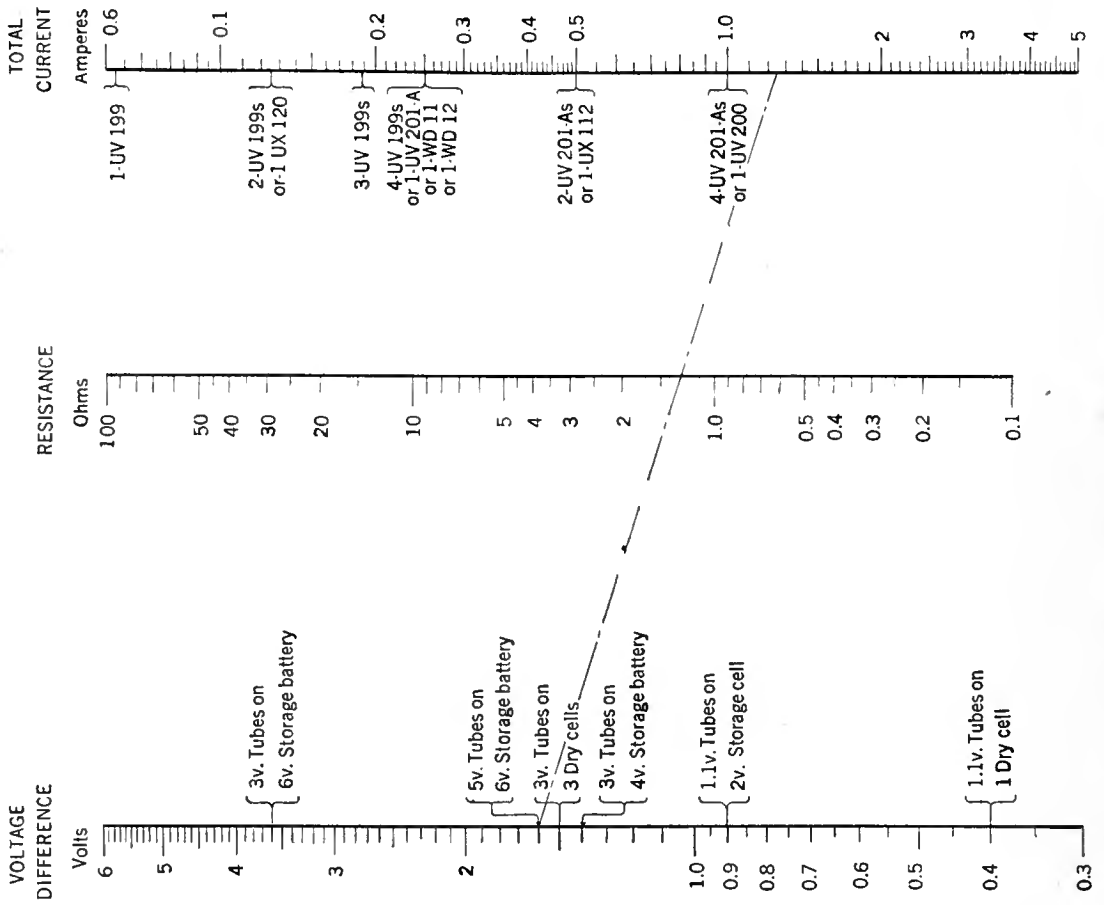

B

OHM'S LAW

$$\frac{E}{I} = R$$

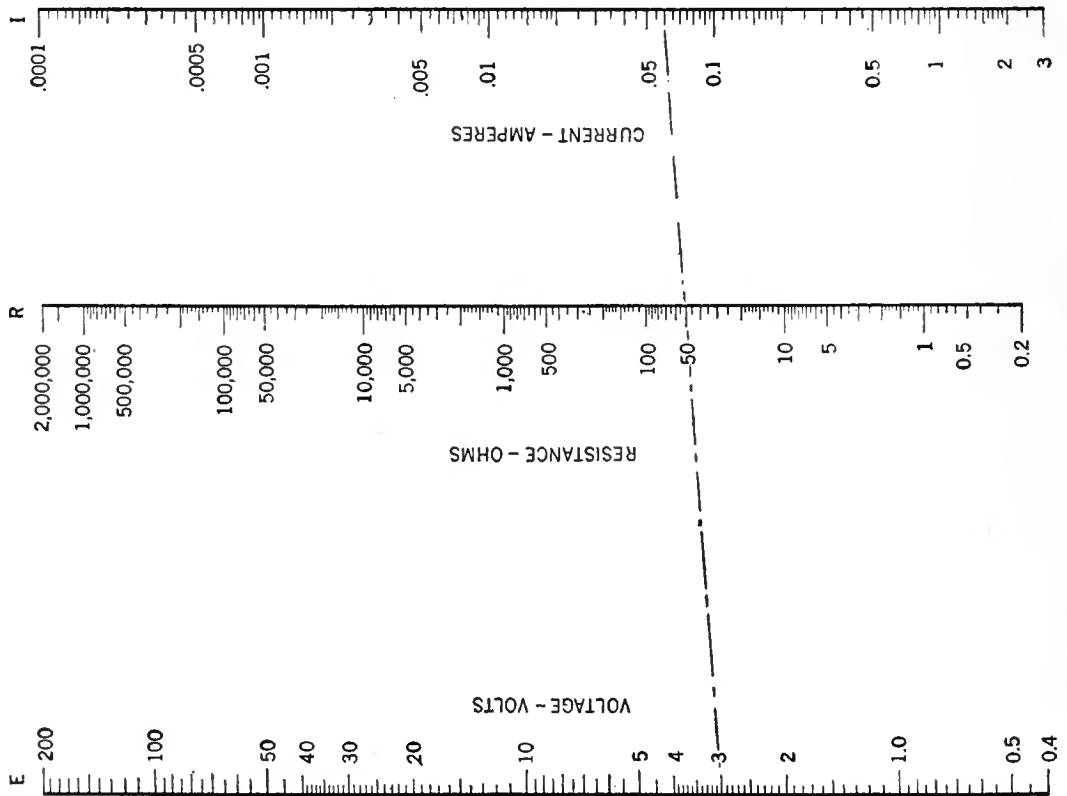

A

# How Ohm's Law Can Help Every Radio Fan

*A Simple Explanation of this Well-Known Electrical Formula—How it May Be Applied for Determining the Size of Rheostats or Voltage Drop Across a Resistance, Etc.—The Use of the Accompanying Tables*

By HOMER S. DAVIS

ONE hundred years ago, George Ohm, a German physicist, found that an increase in the voltage applied to a conductor caused a directly proportional increase in the flow of current. Now known as Ohm's Law, this is one of the most important principles of electricity, and is expressed mathematically as  $\frac{E}{I} = R$  where  $E$  stands for pressure, exerted by the battery or other energy source, in volts,  $I$  the current in amperes, and  $R$  the resistance in ohms. This rule applies to each separate portion of an electric circuit as well as to the circuit as a whole.

The home experimenter will find many uses for Ohm's Law; estimating rheostat sizes, battery drain through potentiometers or voltmeters, voltage drop across instruments in the plate circuit, etc., are some of the uses to which this law may be employed. To avoid the mathematical calculations involved in using it, the two alignment charts accompanying this article have been prepared; one applies to Ohm's Law itself, while the other is a special chart for determining the size of rheostat required for any combination of filament control. Of the three quantities, voltage, current, and resistance, two must be known in order to use the charts; the latter consist of three parallel scales of these quantities. Simply draw a straight line between the two known values; the point at which this line, extended if necessary, intersects the third scale, marks the value of the unknown. Working out two or three examples will better illustrate this procedure. To find the filament resistance of the UV-199 tube when lighted, draw a line, on chart A from the filament voltage, 3 volts, to the value of the current consumption, 0.06 amperes; this line crosses the middle scale at 50, the resistance in ohms. Again, suppose a 200-ohm potentiometer is connected across the filament leads of a receiver using 5-volt tubes. A line between 5 on the voltage scale and 200 on the resistance scale, when extended, will meet the current scale at 0.025, the drain in amperes on the A battery. To take still another case; a milliammeter in the plate circuit of one of the tubes of a resistance-coupled amplifier reads 0.3 ma., using a 100,000-ohm coupling resistor; the loss in plate voltage across the resistor may be found

from the chart by drawing a line from 0.0003 amperes through 100,000 ohms until it intersects the voltage scale, indicating a

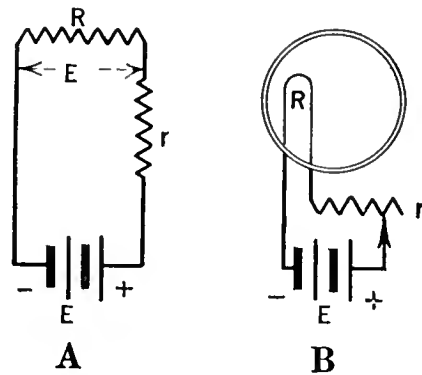

$$r = \left( \frac{E}{I} \right) - \left( \frac{E_1}{I} \right)$$

Where  $r$  = Rheostat resistance  
 $E$  = Battery voltage  
 $E_1$  = Filament terminal voltage  
 $I$  = Filament amperes

Example:

$$r = \left( \frac{6}{.25} \right) - \left( \frac{5}{.25} \right) = 4 \text{ Ohms}$$

### AN OHM'S LAW EXAMPLE

Without the aid of the charts, to find the resistance value of a unit as in  $r$  above, would involve the actual use of the formula with its attendant mathematical calculations. The battery voltage, the tube filament resistance and the filament current are usually known; from these values it is possible to calculate the unknown

drop of 30 volts. Other applications of this chart should suggest themselves to the experimenter.

TYPE	FILAMENT VOLTAGE	FILAMENT CURRENT IN AMPERES
112 . . . . .	5	0.5
199 . . . . .	3	0.06
120 . . . . .	3	0.125
200 . . . . .	5	1.0
201-A . . . . .	5	0.25
11 . . . . .	1.1	0.25
12 . . . . .	1.1	0.25

While the last-mentioned chart can be used also for determining rheostat sizes, the second, chart B accompanying this article is better adapted to this purpose. The function of a rheostat being to take up the voltage difference between that sup-

plied by the A battery and that required by the tube filament, the voltage scale of this chart is calibrated in terms of difference in voltage. The filament constants of the different types of receiving tubes in common use are shown in the accompanying table for reference.

The voltage of a single dry cell may be taken as 1.5, and that of a single wet or storage cell as about 2.2 volts when fully charged. A 6-volt storage battery contains three cells. The use of the chart is again best illustrated by working out a few typical examples. Suppose five 201-A tubes are to be controlled by one rheostat and operated from a 6-volt storage battery; the voltage difference is therefore 1.6 volts (6.6 minus 5) and the total current drawn by five tubes is 1.25 amperes (5 x 0.25). A straight line drawn between these two values on the chart intersects the resistance scale at 1.3 ohms. The nearest available commercial size above this should be chosen, such as a 2-ohm power rheostat, care being taken not to exceed the manufacturer's maximum current rating, in order to avoid overheating. Again, suppose that two UV-199 tubes operate from a six-volt storage battery on one rheostat; a line from 3.6 volts to 0.12 amperes crosses the resistance scale at about 29 ohms, indicating that a 30-ohm rheostat is the correct size. To take a third case; suppose it is desired to operate a 199 tube from the same rheostat with one or more 201-A tubes; this will necessitate a fixed resistance unit in series with the 199 to take up the difference of two volts. A line on the chart between 2 volts and 0.06 amperes indicates a resistance value of 32 ohms. Other cases may be worked out in the same manner.

EDITOR'S NOTE: Mr. Davis assumes that in the use of the storage battery the voltage is 6.6. Where 5-volt tubes are used, the voltage difference would then be 1.6 volts as he states. In the article on filament control by J. B. Brennan in the April RADIO BROADCAST, the voltage of a fully charged storage battery on "no load" test was considered as 6.6 volts, but when a load was applied, the voltage rapidly fell to the usually accepted 6 volts. Where the reader assumes that his battery is 6 volts rather than 6.6, then the voltage difference is 1 volt instead of 1.6. However, this change will not alter the use of the filament rheostat chart, but it is mentioned to allay any doubt in the minds of users as to the correct rating of a storage battery and subsequent use of this value in the chart shown on page 324.

# NEW APPARATUS



No.	NAME OF APPARATUS	MANUFACTURER	USE OF PRODUCT	PRICE	REMARKS
1.	Fixed Condenser, 2-mfd.	Mayolian Radio Corp., 1991 Broadway, New York City.	Filter circuit condenser in plate supply devices.	\$ 1.50	A compact condenser unit made with high grade materials. Simple to include in home-constructed plate-supply units.
2.	D. C. Voltmeter, 0-6 Volts.	Sterling Mfg. Company, Cleveland, Ohio.	Measure filament terminal voltage.	\$ 7.50	The voltmeter, which is fitted with pins, may be plugged into pin jacks to read tube filament voltages.
3.	Filament Switch and Pilot Light.	Bruno Radio Corporation, 222 Fulton St., New York City.	Indicates continuous circuit and also breaks circuit.	\$ 0.75	By turning the knurled head which is fitted around the ruby window, the circuit may be "made" and "broken." A light situated behind the ruby window indicates when contact is made.
4.	Pedestal Loud Speaker.	H. C. Saal Company, 1800 Montrose Avenue, Chicago, Illinois.	Sound producer for use with receiving sets.	\$38.00	A piece of furniture of pleasing appearance, the Saal Pedestal speaker makes use of an extra long sound chamber to produce good quality sounds.
5.	Filament Rheostat, Type 706.	H. B. Frost & Co., 314 W. Superior Street, Chicago, Illinois.	Control of filament voltage.	\$ 0.50	Rigidly constructed and assembled in a metal frame. Positive contact over entire surface. Resistance 6 ohms. Current-carrying capacity 0.60 amperes. Other sizes procurable.
6.	Concertone Audio-Transformer.	Jefferson Elec. Mfg. Company, 501 S. Green St., Chicago, Illinois.	Transformer for amplification at audio frequencies.	\$ 6.00	One of the newer types of audio transformers having large cores and large windings to insure good tone quality.
7.	Tungar Trickle Charger.	General Electric Company, Schenectady, New York.	For charging storage A batteries at various trickle charging rates.	\$12.00	For use with 60-cycle a. c. line. Three charging rates, each for 2 sizes of A battery—small and compact. Employs tube for rectification.
8.	Browning-Drake Receiver.	Browning Drake Corp., 353 Washington St., Brighton, Massachusetts.	Broadcast reception.	\$95.00	Employs five tubes, one r. f., one regenerative detector, and three stages of resistance-coupled audio frequency amplification. Excellent tone quality and covers entire broadcast band.
9.	"Orchestrion" Loud Speaker.	Radio Cabinet Company, 2123 Olney St., Indianapolis, Indiana.	Sound producer for use with receiving sets.	\$37.50	The throat and neck piece of this horn is made of a composition material resembling papier-mâché. The flared mouth is made up of segments of wood. The unit produces tones of good quality.
10.	Radio Lamp.	Faries Manufacturing Company, Decatur, Illinois.	To be placed on top of receiver cabinet for purpose of illuminating dials when tuning.	\$ 6.00	A simple lamp enclosed in a metal case and supported on a movable arm, to be connected directly to lamp socket or base outlet. Finished in statuary bronze.



Recent Additions to the Radio Market Which Have Come to the Radio Broadcast Laboratory for Our Examination and Approval



13



17



11

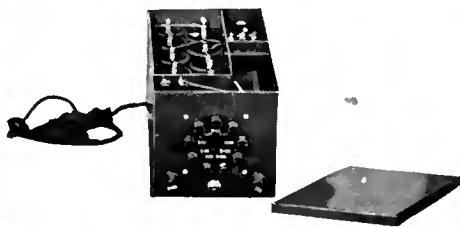

14

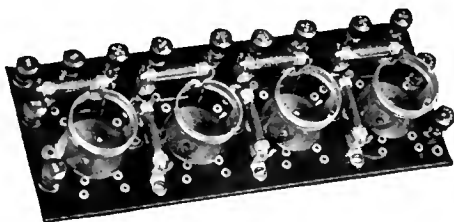

15

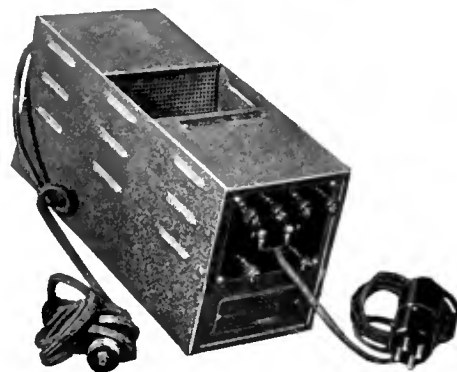

18

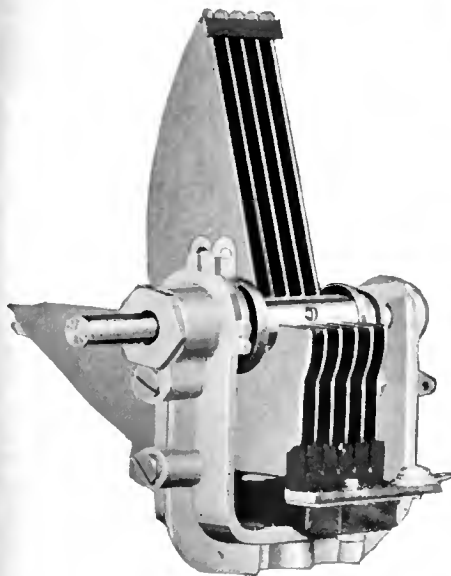

12



16

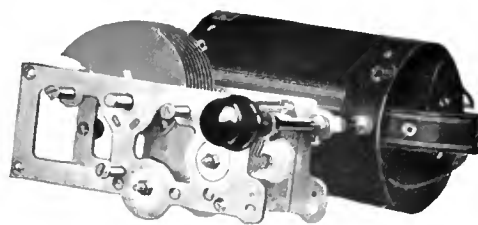
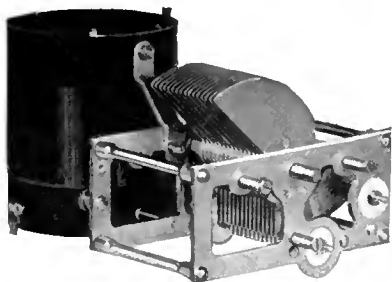

19

RADIO BROADCAST Photographs

NO.	NAME OF APPARATUS	MANUFACTURER	USE OF PRODUCT	PRICE	REMARKS
11.	Line Supply Device	Ferbend Electric Company, Chicago, Illinois.	Supply high voltage for plate of receiving sets.	\$12.50 A. C. \$ 9.75 D. C.	This type of line-supply unit employs a chemical rectifier to change the stepped up voltage to a pulsating d. c. A filter enclosed in the metal can smoothes this d. c. so that it may be used with receiving sets. For use on a 60-cycle line.
12.	Short-Wave Variable Condenser	Hammarlund Mfg. Company, 414 W. 33rd St., New York City.	For use in short-wave receivers.	\$ 4.25	Double spaced plates to prevent accumulation of dust. The ball bearing arrangement provides smooth movement. Maximum capacity, 100 mmfd. Minimum capacity, 3 mmfd.
13.	Resistance-Coupled Audio Amplifier.	DeJur Products Company, 199 Lafayette Street, New York City.	Standard three-stage resistance amplifier for connection to output terminals of detector tube of a broadcast receiver.	\$10.00	All connections to the various units employed in the amplifier are made underneath the panel. Bypass condensers are mounted underneath and are enclosed in the wooden box which forms the base.
14.	Superadio Line Supply Device.	Dewitt LaFrance Co., Inc., 54 Washburn Street, Cambridge, Massachusetts.	Supplies B and C voltages to receiver and audio amplifier.	\$42.00	A chemical rectifier is employed in this device. Regulation of C voltage is by means of a control on the panel end of the unit. The detector voltage is also variable. For use on a 60-cycle line.
15.	Resistance Audio Amplifier and detector combined.	Heath Radio & Elec. Mfg. Company, 210 First St., Newark, New Jersey.	Detector and audio amplifier unit for use directly with tuning coils.	\$10.00	A four-tube unit consisting of a detector stage and three stages of resistance-coupled audio amplification
16.	Hydrometer.	In-A-Cap Hydrometer Co., 1343 W. 14th Place, Chicago, Illinois.	Test storage batteries to determine specific gravity of electrolyte.	\$ 2.00 for three	The hydrometer glass is mounted in a battery vent so that when the latter is screwed in place, the hydrometer is ready for constant use.
17.	Line Supply Device.	Modern Elec. Mfg. Company, Toledo, Ohio.	Supplies B voltages for receiver.	\$50.00	A Raytheon tube is employed as a rectifier. The detector voltage is adjustable as is the voltage for the radio stages of a receiver. For use on 60-cycle line.
18.	Power Amplifier and Line Supply Unit.	Timmons Radio Products Corp. Philadelphia, Pennsylvania.	Separate power audio-frequency amplifier operated by a. c. with plate supply for entire set.	\$70.00 with tubes	This device employs the 210 tube as a power audio amplifier and the 216-B as a rectifier of the high voltage a. c. Three taps provide connection to the receiver proper for supplying plate voltages from 45 to 90 volts. For use on a 60-cycle line.
19.	Tuner Units.	National Company, Cambridge, Massachusetts.	Complete coil and condenser assemblies for use in receiver construction.	\$24.00 a pair	The coils are space-wound with enamel wire on cylindrical tubing. The condensers, termed "Eucycle," give a straight frequency line characteristic.

# Musical Reproduction Has Improved



*How the Improvement in Loud Speaker Design Has Brought Well-Nigh Perfect Acoustical Reproduction—The Electrical Phonograph Allows the Perfect Combination With Radio*



By A. F. VAN DYCK

*Development Engineer, Radio Corporation of America*

SINCE our subject is Modern Radio, there is no need to discuss radio as it has been in the past, and I shall refrain from the usual tracing of growth of the art from the beginning, in the belief that all of you are familiar with the milestones of radio progress. It would be possible to start with a description of Marconi's work, or even that of Hertz, or Maxwell, and continue right up to that of, say, Graham McNamee, but so much is happening in radio current events that we must, and can afford to, confine attention to the present day. My remarks at first will be very general and will probably seem very simple to Radio Club members, but there are a few fundamentals which it is well to recall once in a while so that we will not lose sight of the radio picture as a whole.

Radio broadcasting here requires most attention, of all the branches of radio, but I should like to mention the other branches briefly, for the sake of completeness, and to give a full and true picture of radio today.

First, in transoceanic radio telegraphy, additional channels to South America, Central America, and Europe, have been added during the past year (1925). Channels to the Orient are being studied. Very soon, this country will have radio telegraph

channels to nearly every important country. The importance of this service is quite obvious. International trade and international goodwill follow the courses of communication, wax and increase in effect with the enlargement of the contacts afforded by communication. The service afforded by radio in this field is steadily improving, not only in the number of channels existing, but in speed of operation, and various other technical respects.

Transoceanic radio telephony is not yet ready for public service use. Experimenting and development of technique are proceeding with great promise, but it is too early to see definitely the degree of success which this service may have, or the degree of usefulness which such service would have if technically satisfactory.

Marine radio telegraphy, that is, ship-to-shore communication, which is the oldest branch of radio, has improved steadily, and the ship service has reached a degree of speed, distance, and reliability which is quite remarkable, but which is accepted without remark or surprise, for this branch has long been considered an established public service. The halo of mystery and mysticism which once surrounded the radio operator at sea is no more, and he is accepted as part of a system of service un-

derstandable and fully established. There has been improvement in the apparatus used in marine radio, and some change in the frequencies (wavelengths) used, both of which have lessened the conflict of this branch with that of broadcasting in respect to interference.

Navigational radio, that is, the use of radio for the determination of position of ships at sea, and in general, their safeguarding when near coasts, is being extended in scope and usefulness. There can be no doubt that this service will eventually be the primary and unailing means by which navigators may guide their vessels safely and surely, regardless of weather. I believe it is correct that eighty to ninety per cent. of sea disasters occur near the coasts, arising from ignorance of the true position of the ships, and it is therefore obvious that a method of location which is accurate and faithful at all times is of enormous help to navigation.

It should not be forgotten, in thinking of these marine uses of radio, that their interests are paramount. Broadcasting means entertainment and instruction to millions of people, but radio at sea often means safety of life to hundreds and thousands. Fortunately there has been no serious conflict of interests between these

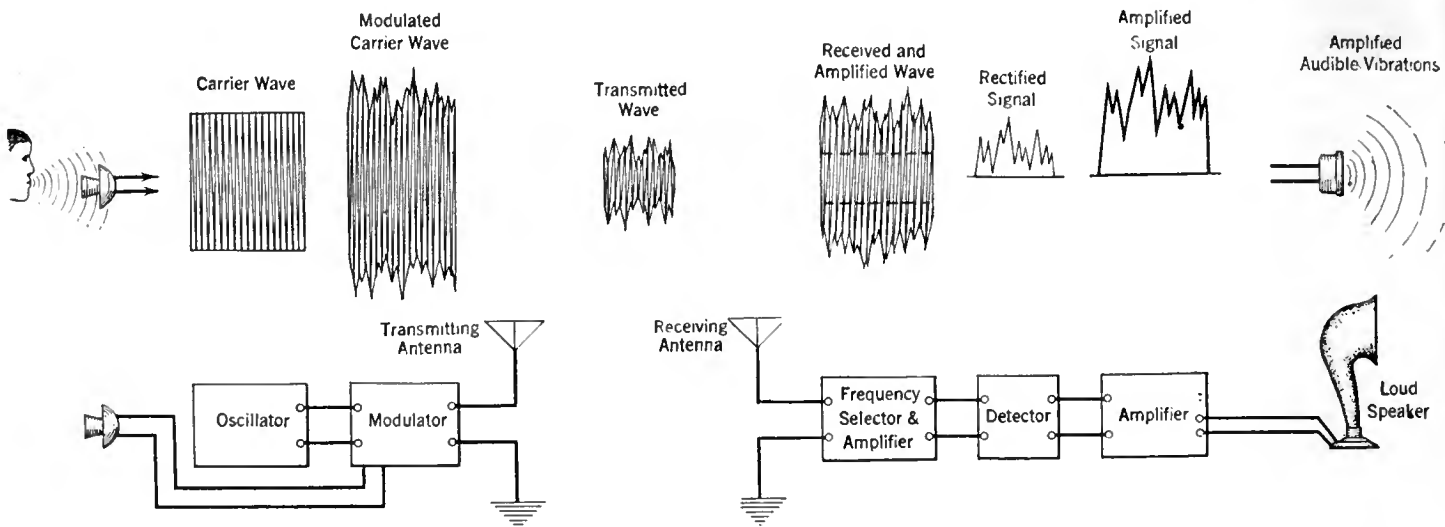

HOW SOUND WAVES ARE BROADCAST AND RECEIVED

The broadcast transmitter is composed of two main parts, the oscillator and modulator systems. The former produces a steady signal called the carrier wave while the latter superimposes voice variations upon the carrier wave, so that the transmitted signal assumes a varying shape depending upon the variations in amplitude, which go to make up a complete radio signal. At the receiver, this wave must first be selected or tuned-in, then amplified at radio frequencies so as better to actuate the detector which rectifies and makes audible the radio signal, and then amplified at audio frequency to operate the loud speaker. At the transmitter, sound is changed into electrical energy by means of a microphone and at the receiving end, electrical energy is changed into sound by means of a loud speaker, causing a column of air to vibrate in synchronism with the vibrations of the diaphragm or other actuating mechanism of the loud speaker



RADIO BROADCAST Photograph

A GIANT HORN

Within predetermined limits, the longer the air column that is actuated within the walls of a horn, the more pleasing to the ear will be the signal delivered. The horn shown here has an exceptionally long air column which gradually increases in width, terminating at the bell of the horn, which is some 25 inches wide and 18 inches high. Despite its size, this horn is not unduly heavy on account of the composition employed

two branches, and they are developing side by side in amity and effectiveness.

BROADCASTING—THE PRECOCIOUS RADIO PRODIGY

AND so we come to broadcasting—the precocious prodigy of the radio family. This child is perhaps afflicted more or less with growing pains at present,

but it is apparent that it has a strong and healthy constitution, and will have a long and useful life. Broadcasting has grown with an amazing rate, as you all know. Even during the past year its rate of growth has not lessened.

To-day, radio is an industry—a public service, filling a place in the daily lives of a large proportion of the people of this country, and of a sizable percentage of the people of the earth. Any device which extends the range or the power of the major human senses, and does so with sufficient



RADIO BROADCAST Photograph

A TYPICAL HORN

This horn type of loud speaker depends entirely upon the movement of a column of air confined within the walls of the throat and bell of the horn to cause air vibrations which may be heard. The driving mechanism is a loud speaker unit of the conventional magnet and diaphragm type

similarity to the unaided sense, has instant appeal and widespread usefulness. Radio broadcasting is in this category, and hence, has had the stimulus of ready and increasing public demand.

The nature of radio broadcasting is such that an extraordinary interest in its purely technical aspects has taken hold of the public. Its nature is also so complicated technically, since it utilizes the most involved electrical relations known to electrical science, that it has been very difficult for the layman to grasp the subject adequately, or to separate its fundamentals from the interesting but non-essential matters.

To-day, nearly every automobile purchaser and owner understands the theory of automotive vehicles sufficiently well to be able to see clearly the differences between the various existent types, and he has little difficulty in choosing the type which most nearly meets his individual

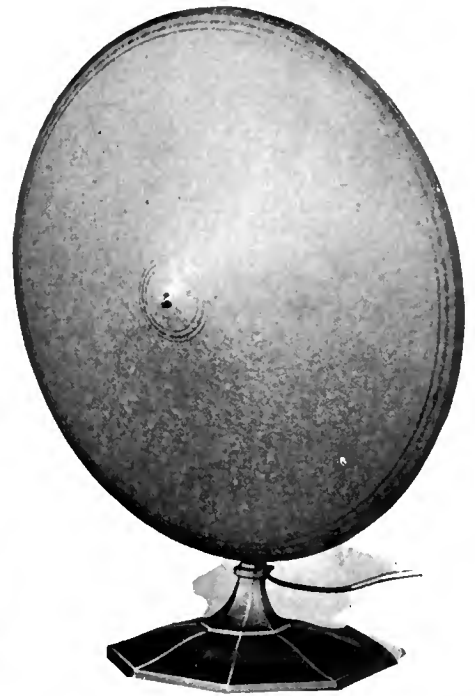

RADIO BROADCAST Photograph

AN EIGHTEEN-INCH CONE

Of the several types of loud speaker illustrations accompanying this article, the eighteen-inch one shown above is a distinctive type. The cone proper consists of a front and back of convex shape. In an opening in the back is situated the operating mechanism connected by means of a driving pin, to the apex of the front side of the cone

needs, desires, and preferences. For example, he knows that such vehicles require fuel, and that the fuel may be gasoline, steam, or electricity. Further, in the gasoline type, he knows that there is necessary a system of fuel feed to the motor, a fuel carburetion system, a fuel ignition system, a cooling system, a gear system, a braking system, and so on. He knows that there are certain types of body from which to choose.



RADIO BROADCAST Photograph

A NEW THIRTY-SIX INCH CONE

In this instrument are found several of the features which are predominant in the baffle board type of loud speaker construction. The cone itself is situated within a wide band or ring of wood which serves as the baffle board. In the rear, three arms attached to the baffle board support the driving mechanism which actuates the cone by means of a driving pin



RADIO BROADCAST Photograph

A "FREE-EDGE" CONE

Here is shown a recently developed loud speaker that employs two concave cones which are of the "free edge" type. The cones are so arranged that their apexes are brought to a common point at the driving mechanism, producing what might be termed a "push-pull" action

Similarly, in the radio receiver, there are fundamental considerations which govern design, and determine performance. We must consider also the radio transmitter, for the transmitted signal is the "fuel" of our radio system. Progress in transmission has kept pace with that in reception, and to-day it is true that good transmitters and good receivers are well matched in characteristics. A radio telephone transmitting station is an installation which sets up waves in the ether and does so by generating electrical currents in its antenna. These currents are alternating back and forth, thousands or millions of times per second, and this is the first fundamental which must be understood. The chief characteristic of a transmitting station is the frequency of these currents, or its wavelength. This frequency of the currents is also the frequency of the waves sent out in all directions, and waves of this frequency are therefore associated indissolubly with this station. If other waves originate from any other source, having this same frequency, they become interlopers, traveling under the disguise of our first station and entering into any receiver ready to receive that station. It can be seen readily, therefore, that every station should have a frequency all its own. This involves a radio problem which is perhaps the biggest one in the art to-day. I have said that each transmitting station requires a frequency at which it can radiate alone and undisturbed. Actually each station requires more than a single frequency—it needs a *band* of frequencies, rather than a single frequency. The frequencies of waves which can be utilized to-day by all branches of radio, range from about 15,000 cycles to about 15,000,000 cycles per second. This range is divided up among the various branches of radio service, and the part assigned to broadcasting, and in fact the only part which can be used satisfactorily for that purpose at present, lies between about 550,000 and 1,500,000 cycles. In other words, there is available for broadcasting, in the radio wave spectrum, a range of frequencies *about one million cycles wide*. The band of frequencies required by every radio telephone station is at least 10,000 cycles wide for reasons which need not be discussed here, and this figure can not be made less. Therefore it is obvious, by dividing one million approximately, by ten thousand, that there is room in the ether for about 100 broadcasting stations. Of course, if two stations were located so far apart geographically that their waves did not reach to the same points, they could use the same fre-

quencies without any interference, but even our great country is not large enough to permit this duplication on a very large scale. At present this country has 578 broadcasting stations, instead of 100, and this has been arranged partly by dividing time of operation between two or more stations in the same territory, and partly by using the same frequencies for different stations. The ether is therefore overcrowded. The National Radio Conference called by Secretary of Commerce Hoover last fall, adopted a recommendation that no additional stations should be licensed, since more would simply add to the congestion. Various problems arising from this situation remain to be solved.

#### STRENGTH OF SIGNALS AT THE RECEIVER

THE strength of the signals at a receiver depends upon the strength of the waves reaching it, and the strength of

of service per station is not economical, there has come about a general increase in the power of stations, until now thirty-two stations have one kilowatt, twenty-five have five kilowatts, and two are experimenting with as much as fifty kilowatts. It was feared at first by some, that higher power stations would interfere with other lower power stations. This was not expected by experts however, and actual experience has demonstrated high-power stations not only to be harmless, but to have realized the advantages sought. Stronger signals, with consequent greater freedom from interference, from static and other noises, is a most important improvement in modern radio.

The remaining part of our radio "fuel," which is of interest, is the program. This needs little description because you are familiar with its improvement. The entertainment and instruction provided by modern radio, the nationwide broadcasting of nationally interesting events, has increased, with consequent improvement in quality of entertainment over the country at large.

A summary of modern radio transmission shows that high quality programs are available; transmitting apparatus, from the microphones to the antenna, has been refined, and stronger signals are being delivered to the receivers.

#### WHAT THE RECEIVER DOES

SO WE come to the receivers. Receivers are devices which transform traveling electrical waves of certain kinds into sounds. The more nearly the reproduced sounds are like the original sounds which operated the transmitter, assuming a perfect transmitter, the more nearly ideal is the receiver.

The fundamental parts of receivers are four in number. First, a wave pick-up system, or antenna; second, a tuning system; third an amplifying system, and fourth, a mechanism for converting electric currents into sounds, commonly called the loud speaker.

The pick-up system is necessary to intercept the traveling waves. When it does so, electric voltage is created in it. The tuning system is necessary to *select* that particular voltage which has the frequency which is desired, and reject all others. The antenna has electric currents in it resulting from all the various waves which pass it, but it is the function of the tuning system to increase the currents which are desired, and decrease the currents which are not desired. The degree to which it is capable of doing this determines the ability of the receiver to avoid interference from

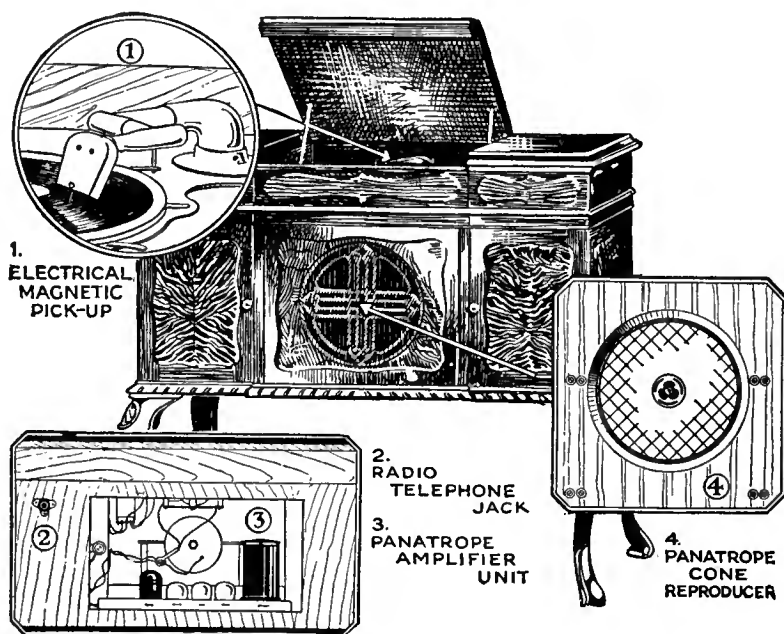

#### THE PANATROPE

This is the Brunswick phonograph employing electrical reproduction and amplification of sound. In this device, a baffle-board speaker, together with a power amplifier, produce plenty of volume of pleasing quality

the waves depends upon the power of the transmitter. Transmitters first used for broadcasting, had a power of  $\frac{1}{2}$  kilowatt, mainly because that size transmitter was standard, being already in use in other services. As the quality of broadcast service improved, it became apparent that transmitters of this size did not deliver, at reasonable distance, waves sufficiently strong to dominate other electrical waves which also caused responses in receivers, and which originate in various electrical services. It is not sufficient, for good broadcast service, merely to be able to hear a transmitting station—its program must be clear from all other sounds to make its service really proper and enjoyable. Under this standard, the average year-round range of the  $\frac{1}{2}$ -kilowatt station is less than twenty-five miles, and under some conditions is as low as ten miles. Since such a small area

other stations. This ability is called "selectivity."

The amplifying system is necessary because the currents which are generated in the antenna and tuning system are exceedingly small, and must be made larger before they will be powerful enough to operate the loud speaker. These magnified, or amplified, currents, are fed into the loud speaker, and cause sound waves to be produced.

To repeat, the antenna system picks up energy from all waves, the tuning system selects the desired one, the amplifier amplifies it, and the loud speaker reproduces it. Now, each one of these parts, except the antenna, has been undergoing improvement continuously. All these parts were used in radio telegraph sets before radio telephony and broadcasting were developed—except the loud speaker. Consequently, they had been developed to a greater extent than had the loud speaker. Until very recently, the loud speaker was the "weak link" in the chain of parts of the broadcasting system. Tuning systems of various sorts, and amplifying systems of various types, both satisfactorily effective, were available, but the loud speaker was then subject to great improvement.

The outstanding feature of the past year, has been the development of loud speakers. Loud speakers are now available which accomplish their part of the receiver system work, as efficiently as the tuning and amplifier parts do theirs. This means that there is no longer a weak link in the chain of transformations of energy which take place between the microphone and the loud speaker. In fact, the improvement in loud speakers has been so great as to be startling to any one hearing it for the first time.

Radio receivers may be looked at in a different way, namely, from the performance point of view, instead of from the design point of view, as we have done so far.

To use the automobile analogy again—in buying a car, the buyer is interested in performance features, such as power, speed, acceleration, maintenance cost, comfort, ease of handling, and so on. The radio receiver owner is interested in performance features such as sensitiveness, selectivity, ease of operation, maintenance cost, and quality of reproduction. A proper degree of sensitiveness is required to permit the reception of long distance signals when desired. A sufficient degree of selectivity is necessary to permit the desired program to be picked out from all the others in the air without interference. The operative characteristics should be such that special skill is not required to operate the receiver,

and that desired stations can be tuned-in quickly and, without fuss or difficulty. The maintenance care and cost must be small. The quality of reproduction must be sufficiently close to the original to be enjoyable and, to be ideal, must be such as will permit the illusion of the performer being in the room.

Of the four radio receiver fundamentals—sensitiveness, ease of operation, selectivity, quality of reproduction—the first two, sensitiveness and ease of operation, were incorporated in the very first broadcast receivers. The third, selectivity, was in-

cast programs, and the entrance of leading artists into broadcasting, have focused public attention upon the tonal quality and fidelity of the reproduction. Mere long distance reception, which usually involves weak and distorted signals, has simultaneously decreased in interest. Sustained interest, and real service, require high quality of reproduction, and I wish to emphasize, as the most important fact of modern radio, that high quality reproduction is now possible, as it never was before, and that it greatly enhances the value of broadcasting, and extends its service possibilities.

The fundamental requirements of a loud speaker to have perfect reproduction, are that it shall be omnitonal and equitonal. To be omnitonal, it must respond to all frequencies or pitches within audibility range, and to be equitonal it must respond to all frequencies equally, and proportionately to their intensities as performed. The faithful musical frequency range of loud speakers one year ago was less than four octaves. To-day the best types have a faithful musical range of seven octaves.

It should be understood clearly that high quality faithful sound reproduction by the loud speaker requires something more than the proper loud speaker. No matter how good the loud speaker may be itself, it cannot respond faithfully unless faithful, undistorted, currents are fed to it by the receiver. This means that the receiver must not distort the signals, but must select them and amplify them without loss or change of any tones. The amplifying part of the receiver is the most critical factor in reproduction, next to the loud speaker.

There is another characteristic of loud speakers which requires mention, in addition to faithfulness of reproduction. It is the volume, or loudness of sound, which it will deliver without distortion. This is dependent upon the nature of the receiver's amplifying system as well as upon the speaker itself. A loud speaker and its associated amplifying system should be capable of reproducing sounds to values as loud as the original, but modified to suit the room conditions at the point of reproduction. Good, modern reproduction is so like the original in this respect, that many of the precautions which have to be taken in the original rendition—for example, the location of pianos in the room—have to be followed with the loud speakers. It is quite likely, in fact practically certain, that many homes of the future will be designed with consideration of the acoustic characteristics of the rooms, in order that the fullest enjoyment may be had from high quality broadcasting.

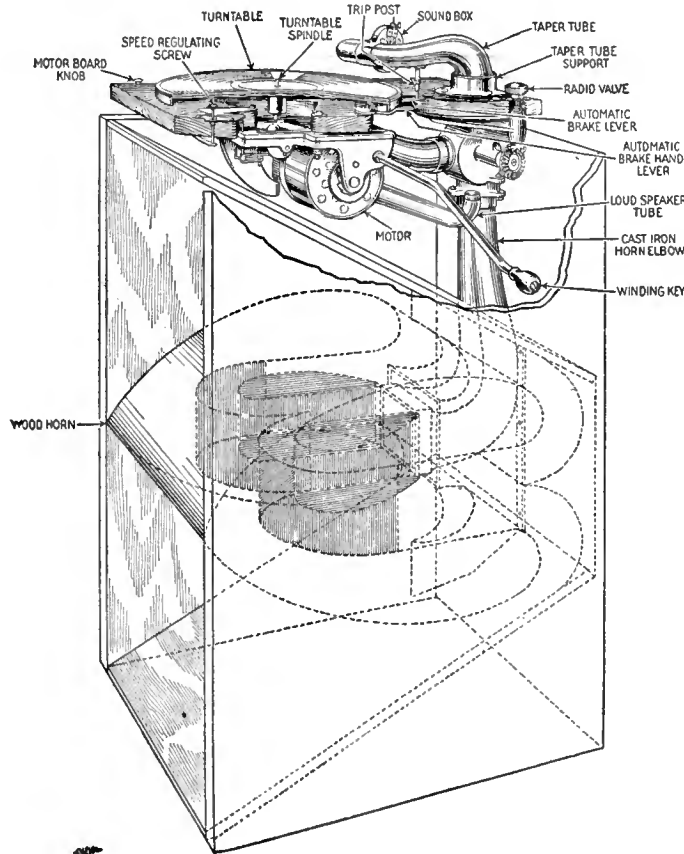

THE ORTHOPHONIC'S SOUND CHAMBER

This new Victrola differs greatly from the old type of phonograph because a carefully designed wood horn having a winding passage, as shown here, is used. Provision is made for the attachment of a loud speaker unit so that the horn may be used as a loud speaker. Unlike the Panatrope, the Orthophonic does not feature electrical reproduction

produced as soon as the number of broadcasting stations had increased to the point where it was necessary. The fourth, quality of reproduction, was not so easy, and was not accomplished until recently. Of course, good reproduction by the receiver depends also upon good transmission quality at the transmitting station end of the system. There are many stations on the air to-day which will not reproduce properly on any receiver, no matter how good the latter may be. In fact, as many such stations sound worse, the better the receiver.

#### GOOD LOUD SPEAKERS ARE HERE

THE recent improvement in loud speakers has removed the last barrier to substantially perfect reproduction of sound. The steady improvement in broad-



## THE ELECTRIC PHONOGRAPH

THE chief characteristic of radio is, of course, that its reproduction is simultaneous with the original performance, and is available at many different receiving points simultaneously. There is another form of reproduction which is also useful, that of reproducing, from a previously made record of the performance, at any desired later time. This is accomplished by the phonograph, and the magnitude of the phonograph industry is evidence of the usefulness of, and the demand for, this type of reproduction.

Even with a perfect radio broadcast service in existence there will still be the desire for hearing a particular artist, or a particular musical selection, at a particular time, and this need can be met only by the phonograph.

The phonograph reproduction capabilities available until recently were limited and were, in fact, about equal to those of the radio receivers available at that time. Now, however, the *electrical* phonograph has been developed, and this utilizes several parts found in radio receivers, so that the two instruments are closely parallel in technique, and in possibilities of reproduction quality.

The phonograph instrument with which we are all familiar through past years was mechanical throughout—from the making of the record to the final reproduction. In the recording process, the sound waves of performance acted upon a diaphragm to which was attached a cutting tool, this latter being moved by the vibrations of the diaphragm and which cut impressions upon a wax master record. The final records, when played upon the phonograph, gave vibrations to a diaphragm through movements of a needle attached to the diaphragm and bearing upon the record. The diaphragm movements set up air sound waves which were amplified by a horn attachment. All of these processes

were, therefore, dependent upon small mechanical forces and employed mechanical resonance, which prevented equal response to all frequencies. There have been great improvements in this type of phonograph recently, with which most of you are doubtless familiar.

## ADVANTAGES OF THE ELECTRICAL PHONOGRAPH

IN THE electrical phonograph, we have further possibilities. Electrical forces are more easily and more flexibly controlled and used than are purely mechanical forces. In electrical recording, the tool which cuts the master record can be actuated by electrical means, and the electric power for this be obtained from powerful amplifiers, which, in turn, are fed by sensitive and faithful pick-up devices. For example, the artist may perform before a microphone of the broadcasting type, or its equivalent, and the electrical output of this microphone can be amplified faithfully to any power necessary to operate the record cutting tool. In other words, the power necessary to cut the record does not come from the voice of a singer, for example, but from the power supply of the amplifier. This means that modern records are more nearly omnitonal and equitonal than old type records, and considerable improvement in phonograph reproduction results.

On the reproducing end, the needle which runs in the record groove and is moved thereby, can be attached to a tiny electric generator which will generate currents exactly in accord with the movements of the needle. These small currents can be amplified, by an amplifier identical with those used in radio receivers, and the amplifier output transformed to sound by a loud speaker, also identical with those used in radio receivers. This process is therefore electrical from beginning to end, and is practically omnitonal and equitonal, that is, it reproduces all the musical frequencies, and reproduces them equally and

proportionately to original intensities. All the technique of vacuum tube and loud speaker practice is therefore directly applicable to the phonograph art, which benefits accordingly.

Since the electrical phonograph is operated entirely by electricity, and electrical forces can be amplified to any desired extent by vacuum tubes, and can be controlled easily, we find that it is capable of producing enormous sound volume when desired, and that the sound can be reduced to a whisper when desired. The instrument is therefore suited to reproduction under all conditions of the home, as well as being capable of supplying sufficient volume for a large auditorium.

To demonstrate the capabilities of the electrical phonograph, a series of records can be selected, to be chosen not with the idea of providing a balanced program of entertainment, but to illustrate the technical performance features. Records of various kinds, orchestral, band, choral, and vocal, can be used to see how faithful the reproduction is compared with the original. In particular, in vocal-choric work you will be able to distinguish the individual voices clearly, and in orchestral selections—the individual instruments. This is possible only when practically all frequencies are being reproduced faithfully. Also in speech and song, note the intelligibility.

I believe that any one who has heard the modern radio and electrical phonograph instruments will agree that there has dawned a new era in sound reproduction. It is my own belief that such reproduction has now reached the stage of development, where it is ready to provide a public service of complete merit, and of inestimable value.

And that is the thought I would leave with you—that science, in its continual struggle to master and use the infinite resources of Nature, has given another service to mankind, to make life broader, more enjoyable, and more valuable.

## Results in the Short-Wave Receiver Contest

TO ANSWER the questions of many readers who have been interested in the RADIO BROADCAST-Eveready short-wave receiver contest, the following facts will be of interest.

At the present time there is no amateur short-wave receiver that is in general use that does not radiate. This means that each of the 16,000 and more amateurs who are listening on the short-wave bands with their Reinartz and other simple receivers is endangering the reception of his fellow amateurs due to the fact that his receiver is not only a receiver—it is a small transmitter as well. It is true that this disturbance is small, and is confined to a limited area, but every one remembers the early days of broadcasting when practically all of the receivers in use were "bloopers." And so much interest has been displayed in short-wave reception, and so many queries have come to RADIO BROADCAST's experimental station 2GY for receiver circuits, that the Editors have not felt free to advise the further construction of blooming receivers.

For these reasons, three prizes totalling \$500

were offered for non-radiating amateur short-wave receivers. Some twenty-five manuscripts were selected for submission, but only about fifteen were considered since the others were hopelessly out of the contest. Of the final fifteen, three were eliminated in favor of twelve, and these twelve receivers were actually tested in the Laboratory.

Now one would think that three out of the twelve could satisfy the conditions of the contest as set forth in the February RADIO BROADCAST. Unfortunately, however, every one of the receivers radiated, some more, some less, and there seemed to be a definite relation between the sensitivity of the receiver and its radiation. In other words, the more sensitive the more it radiated—usually due to closer coupling to the antenna.

Owing to these facts, it has been manifestly impossible to award three prizes as originally planned. With the permission of the judges in the contest, the following plan has been worked out.

From the twelve receivers the three best have

been selected, that is the three which most nearly meet the conditions of the contest. These three are sensitive and radiate less than the standard Reinartz which is in use at 2 GY. The best of the three will be awarded \$100, in addition to the usual rate paid for articles. While it is not claimed that this receiver will receive more stations or weaker signals than the Reinartz, nor can it be said to be absolutely non-radiative, it is felt that it will be a considerable improvement over the blooper now in use. The winner will be announced in September RADIO BROADCAST.

It is not impossible to build a non-radiating short-wave receiver. No less an amateur than Dr. A. Hoyt Taylor assures us of that—why doesn't some amateur do it? The editorial pages of RADIO BROADCAST are always open to receivers whether for broadcast or amateur bands that are distinct improvements. We can think of no single thing that is more needed than a non-radiating short-wave receiver that is simple to build and to operate.—THE EDITOR.

# CROSLLEY



On June 8 and 9, the fourth Annual Convention of the Crosley Distributors was held in Cincinnati.

Powel Crosley, Jr., announced the most startling line of radio receiving sets in the history of the industry.

Every lover of radio is urged to get the story from his nearest Crosley dealer immediately.

# RADIO

*Better - Costs Less*

*Digitized by Microsoft®*



# SPEED

SUPER-EMISSION

## RADIO TUBES

*Excel in All Characteristics*

Standard Types  
Power Amplifiers  
Type 200 Power Detector

**JOBBERS** **DEALERS**

A few territories open for  
exclusive distribution

*Write Now for Details*

**CABLE SUPPLY CO.**  
INC.

Sales Offices

907 Broadway New York

## The Radio Broadcast

# LABORATORY INFORMATION SHEETS

**I**NQUIRIES sent to the Questions and Answers department of RADIO BROADCAST have until recently been answered either by letter or in "The Grid." The latter department has now been discontinued and all questions addressed to our technical service department are now answered by mail. In place of "The Grid," we present herewith a series of Laboratory Information Sheets. These sheets contain much the same type of information as has appeared in "The Grid," but we believe that the change in the method of presentation and the wider scope of the information in the sheets, will make this section of RADIO BROADCAST of much greater interest to our readers.

The Laboratory Information Sheets cover a wide range of information of value to the experimenter, and they are so arranged that they may be cut from the magazine and preserved for constant reference. We suggest that the series of Sheets appearing in each issue be cut out with a razor blade and pasted on filing cards, or in a note book. The cards should be arranged in numerical order. Several times during the year, an index to all sheets previously printed will appear in this department.

Those who wish to avail themselves of the service formerly supplied by "The Grid," are requested to send their questions to the Technical Information Service of the Laboratory, using the coupon which appears elsewhere in this issue. The June and July issues of RADIO BROADCAST, in which appeared the first two sets of Laboratory Sheets, may still be obtained from the Subscription Department of Doubleday, Page & Company.

No. 17

RADIO BROADCAST Laboratory Information Sheet

August, 1926

### Inductance of Single-Layer Solenoid Coils

#### CALCULATION FORMULA

IT IS possible to obtain quite a close approximation of the inductance of a solenoid coil by the use of the Bureau of Standards formula, which is as follows:

$$L = \frac{a^2 n^2}{10h} K$$

in which—

- L = Inductance of coil in microhenries.
- a = Radius of coil in inches, measured from the center of the coil to the center of any wire.
- h = Length of coil, in inches.
- n = Number of turns.
- K = A constant, depending upon the ratio of  $\frac{2a}{b}$ .

The constant K in the formula can be obtained from the accompanying curve.

This formula can be used very well in determining the approximate inductance of any particular coil, or can be used to determine the number of turns necessary in order to give certain inductances.

It does not take into account the shape or size of the wire, nor does it consider the effect of the capacity of the coil. However, since the coil capacity is usually negligible in comparison with the capacity of the tuning condenser, it is not especially important insofar as the tuning range of the coil is concerned.

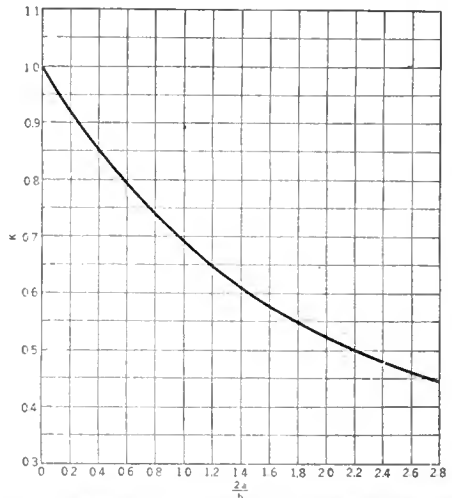

No. 18

RADIO BROADCAST Laboratory Information Sheet

August, 1926

### Volume Control

#### CORRECT METHOD TO USE

**A** GREAT many of the present receivers now in use are not equipped with any really satisfactory means of volume control. The most common method used on these receivers is to control volume by means of one or more filament rheostats. Usually these rheostats control the audio frequency tubes and, when such is the case, the quality is sure to suffer when the volume is reduced by lowering the filament current. Under such conditions, the quality will be impaired due to the two following causes.

In the first place, lowering the filament temperature will increase the plate impedance. Now the frequency characteristic curve of any audio transformer depends to a great extent upon the impedance of the plate circuit. If this impedance is high, the quality will be poorer than if the impedance was low and, for best results, the impedance of the transformer primary should be at least three times the impedance of the plate circuit. Lowering the filament temperature will destroy this ratio, and the quality thereby becomes poorer.

In the second place, lowering the filament temperature has the same effect as increasing the negative grid bias. If the temperature is lowered to any great extent, the tube will operate on the lower bend of its characteristic curve and distortion of the signals will then take place because a certain amount of detection will occur. Detection should only take

place in the detector circuit and, if it occurs at any other point, it will invariably cause distortion.

If volume control is at present being accomplished by filament rheostats in the audio amplifier, it will be wise to revise the set so as to permit the use of some other system.

Volume can be controlled quite satisfactorily by means of a potentiometer across the secondary of the first audio transformer. This resistance will, actually, somewhat better the quality, since, if a rather poor transformer is being used, it will smooth out the amplification curve and make it quite flat. This unit should have a maximum resistance of about 500,000 ohms, and should always be placed across the first audio transformer. It is then possible, on strong signals, to cut down the volume and incidentally prevent overloading of the audio tubes. However, if the resistance were connected across the second transformer, it would not be possible to prevent overloading of the first tube. Connection across the first transformer is, therefore, advisable.

It is also possible to control volume very nicely by means of the filament rheostat controlling the radio frequency tube, without getting into any of the difficulties that occur if filament variation of the audio tubes is used to control volume. This is due to the fact that variations in the plate impedance of the radio frequency tube merely tend to cut down the overall amplification, but there is no possibility of frequency distortion since we are working with what is practically a single frequency.

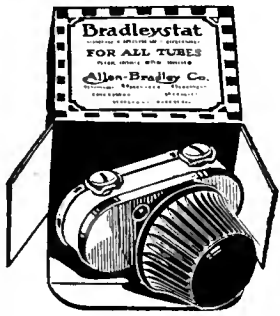

## Bradleystat

PERFECT FILAMENT CONTROL

FOR noiseless filament control and maximum range, ask your dealer for the Bradleystat. This graphite disc rheostat can be used for all tubes without change of connections. The bakelite knob is removable if desired. The one-hole mounting and small size make the Bradleystat easily adaptable to any radio set.

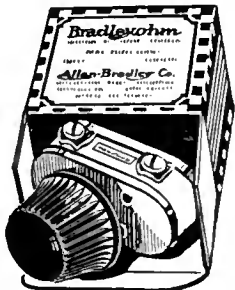

## Bradleyohm

PERFECT VARIABLE RESISTOR

This ideal variable resistance unit is offered in several ranges as, for instance, from 10,000 to 100,000 ohms. These units are recommended by radio engineers for B-battery eliminators and solve the problem of obtaining variable voltage control from the B-eliminator. For fixed resistance units, always specify the Bradleyunit.



ALLEN-BRADLEY COMPANY  
278 Greenfield Ave., Milwaukee, Wis.

Please send me your literature on the Allen-Bradley line of perfect radio devices.

Name.....

Address.....

.....



## Are You Building a Set?

If so—you should use either a Jewell 135 or 135-B voltmeter on the panel of your set. Check your batteries and control your filament voltage if you wish to have the maximum of pleasure. Don't guess.

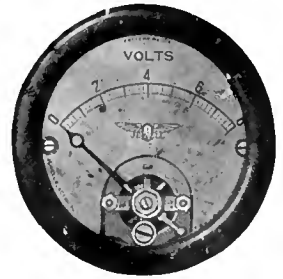

Jewell Pattern 135. Panel mounting voltmeter

## Pin Jack Voltmeters—

Many manufacturers are supplying pin jacks in the panels of their sets into which a Jewell No. 135A pin jack voltmeter can be plugged. The Jewell No. 135C portable voltmeter can also be used with the pin jack sets.

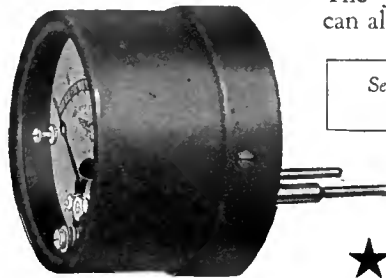

Jewell No. 135A Pin Jack Voltmeter

Send for Jewell's New Radio Catalogue 15-C  
Now on the Press

**JEWELL ELECTRICAL INSTRUMENT CO.**

★ 1650 Walnut St. Chicago  
26 Years Making Good Instruments

THE TUBE WITH THE SENSIBLE GUARANTEE



# Definite Quality!

## When You Buy Ordinary Tubes You Are Buying Doubtful Quality

Tubes may leave a factory in good condition but whether they reach you that way is "Doubtful." Because it is commonly known that ordinary constructed tubes may be disqualified in handling—therefore if they are good after you receive them, it's "just luck," and even Luck is doubtful.

## When You Buy New Supertrons You Are Buying Definite Quality

Supertrons are internally re-enforced—so that the three elements are tied into one unit. They are vibrationless—Uniform and Oh Boy! what quality—DEFINITE QUALITY.

Guaranteed by serial number—to assure a refund if they are not better.

SUPERTRON MFG. CO., Inc., Hoboken, N. J.

Chicago Office: 39 N. Dearborn St.  
Export Dept.: 220 Broadway, N. Y. C.



Vibrationless,  
Uniform,  
and Good



**SUPERTRON**

A SERIAL NUMBER GUARANTEE

The Foremost Independent Tube In America

**American Transformer Company**



The AmerChoke

**M**OST satisfactory in the long run is the set of dependable parts throughout. One of the most reliable and useful of AmerTran products is the AmerChoke Type 854—a choke coil or impedance designed primarily for use in filter circuits. As an output impedance with a fixed condenser it forms an ideal filter for the loudspeaker, insuring tone quality equal to and more economical than the average output transformer. For filter circuits in B eliminators, the AmerChoke will give excellent results due to its scientific design and generous proportions.

AmerTran Power Transformers are also of high efficiency—and are especially adapted to the use of the 7½ volt power tubes in the last audio stage. After rectification, they supply sufficient plate current for the operation of the set.

In two stages, AmerTran De Luxe Audio Transformers are famous for the natural tones developed over the entire audible range. Whatever else a set may have—if it is good, the use of these transformers will make it better. You may pay a little more but you will get a great deal more.

- AmerTran De Luxe, 1st Stage . \$10.00
- AmerTran De Luxe, 2nd Stage . 10.00
- AmerTran AF-7 (3-1) . . . . . 5.00
- AmerTran AF-6 (5-1) . . . . . 5.00
- AmerTran Power Trans. PF-45 . 15.00
- AmerTran Power Trans. PF-52 . 18.00
- AmerChoke Type 854 . . . . . 6.00

Write to-day for free booklet "Improving the Audio Amplifier" and other data designed to make radio reception simpler and more realistic

**AMERICAN TRANSFORMER CO.**  
178 Emmet Street Newark, N. J.

AmerTran Products Are Sold Only at Authorized AmerTran Dealers

**Transformer Builders for Over Twenty-Five Years**

**No. 19**

RADIO BROADCAST Laboratory Information Sheet

August, 1926

**Learning to Read Code**

A GOOD CIRCUIT TO USE

ONE of the best methods for use by a novice in learning the code is to construct a simple receiver capable of receiving the long wavelengths ranging from 600 to 15,000 meters (500 to 20 kc.). Practically all of the transatlantic stations operate on these low frequencies, and usually the transmitting is done at a fairly low speed, so that it is possible for anyone with just a rudimentary knowledge of the code to decipher quite a few letters. In a comparatively short time it will be found possible to receive whole words—and then sentences.

The circuit diagram of a long-wave receiver that can be used to receive code signal is shown in the accompanying diagram. L is a honeycomb coil, the size of which depends upon the wavelength it is desired to receive. Condenser C is an ordinary 0.001-mfd. variable condenser. Forty-five volts of B battery is sufficient. This receiver is regenerative, and feedback is controlled by variation of the 20-ohm filament rheostat.

The receiver should be connected to an antenna about 100 feet in length, and a good ground should be used. Most of the long-wave stations operate on pure c. w. which means that the antenna at the transmitter is fed from a high frequency oscillator, the output of which is controlled by the key. When the key is depressed the set breaks into oscillation, and when the key is raised the set stops oscillating.

Therefore, the energy radiated into the air consists of a series of high frequency impulses. These signals are not audible until they are heterodyned by the oscillations that take place in the receiver. Therefore, in using this receiver, the filament rheostat should be advanced until the set oscillates. A copy of the International Morse Code is shown on Sheet No. 20.

The following table gives the coil sizes for L to cover the various wavelength bands commonly used—

600-meter traffic, L = 100 to 150-turn coil
1200- 2600 " " , L = 300 to 400 " "
2600- 5000 " " , L = 750 " "
5000-15,000 " " , L = 1500 " "

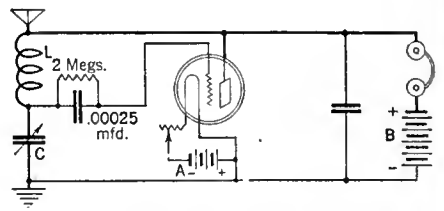

**No. 20**

RADIO BROADCAST Laboratory Information Sheet

August, 1926

**The Continental Morse Code**

A	· —	Å (German)	· · · ·	Period	· · · ·
B	· · · ·	Á or Ä	· · · ·	Semicolon	· · · ·
C	· · · ·	Spanish-Scandinavian	· · · ·	Comma	· · · ·
D	· · · ·	CH (German-Spanish)	· · · ·	Colon	· · · ·
E	· · · ·	(É French)	· · · ·	Interrogation	· · · ·
F	· · · ·	(Ñ Spanish)	· · · ·	Exclamation Point	· · · ·
G	· · · ·	Ö (German)	· · · ·	Apostrophe	· · · ·
H	· · · ·	Ü (German)	· · · ·	Hyphen	· · · ·
I	· · · ·	1	· · · ·	Bar indicating fraction	· · · ·
J	· · · ·	2	· · · ·	Parenthesis	· · · ·
K	· · · ·	3	· · · ·	Inverted Comma	· · · ·
L	· · · ·	4	· · · ·	Underline	· · · ·
M	· · · ·	5	· · · ·	Double dash	· · · ·
N	· · · ·	6	· · · ·	Distress Call	· · · ·
O	· · · ·	7	· · · ·	Attention call to precede every transmission	· · · ·
P	· · · ·	8	· · · ·	General inquiry call	· · · ·
Q	· · · ·	9	· · · ·	From (de)	· · · ·
R	· · · ·	0	· · · ·	Invitation to transmit (go ahead)	· · · ·
S	· · · ·			Warning-high power	· · · ·
T	· · · ·			Question (please repeat after _____) interrupting long messages	· · · ·
U	· · · ·			Wait	· · · ·
V	· · · ·			Break (double dash)	· · · ·
W	· · · ·			Understand	· · · ·
X	· · · ·			Error	· · · ·
Y	· · · ·			Received (O.K.)	· · · ·
Z	· · · ·			Position report (to precede all position messages)	· · · ·
				End of message (cross)	· · · ·
				Transmission finished (end of work)	· · · ·

**No. 21**

RADIO BROADCAST Laboratory Information Sheet

August, 1926

**Rejuvenating Tubes**

CONSTRUCTION OF A SUITABLE UNIT

IT NOT infrequently happens that, with tubes having thoriated filaments, the emission gradually decreases after considerable use so that the tube is rendered useless, even though the filament still lights. Under such conditions, it is usually possible to subject the tubes to a treatment that will put them once more in usable condition. This treatment is called reactivation, or rejuvenation, and is quite easily accomplished by the home experimenter with a few fairly cheap parts that can easily be assembled into a suitable instrument for reclaiming apparently useless tubes. Many tubes will, after reactivation, give off as much emission as they did when new.

The parts needed to assemble a rejuvenator are a toy transformer of the type usually employed to operate small electric trains, two tube sockets, one for 199's, and the other for 201-A's, a 30-ohm rheostat, and some odd screws, nuts, etc. The connections are clearly shown in the accompanying diagram.

Practically all toy transformers have on the top of the case a small switch by means of which the secondary voltage can be raised or lowered. Volt-

ages from six to twelve can usually be obtained.

Suppose we desire to reactivate a 201-A. The tube is placed in the 201-A socket (which is the left hand socket in the diagram) and the plug connected to the 110-volt alternating current supply. The tap switch is set for twelve volts and the tube is allowed to burn at high voltage for about one minute. The voltage is then reduced to six or seven volts, and the tube is permitted to "cook" for about one-half hour. It can then be removed and, generally, when placed in a receiver, it will be found to give entirely satisfactory operation.

The procedure to be followed in treating a 199 tube is practically the same. At first the tube is "flashed" at eight volts for half a minute. The switch is then placed at the lowest voltage, which is usually about six volts, and then the rheostat is used in order to reduce the voltage to 4½ volts. With this applied voltage the tube is cooked for half an hour, when the treatment is complete.

The voltages given above are only approximate and need not be followed exactly. The rheostat for 199's is not essential, and if it is dispensed with, the tube should not be cooked as long at the higher voltage.

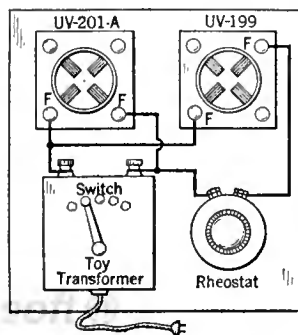



No. 22

RADIO BROADCAST Laboratory Information Sheet

August, 1926

### A Simple Loop Receiver

GENERAL DATA

IT IS possible to make up a very simple yet quite efficient loop receiver using condenser feedback for the control of regeneration. Such a receiver will be useful for local reception when sufficient audio frequency amplification is added. If the receiver is made up in the form of a portable set, it will also be found extremely valuable in locating sources of interference.

The circuit diagram of such a receiver, using two stages of audio amplification, is given herewith.

- L<sub>1</sub> = Any standard loop designed for operation with a 0.0005-mfd. variable condenser.
- C<sub>1</sub> = 0.0005-mfd. variable condenser.
- R = 5-megohm grid leak.
- C<sub>2</sub> = 0.00025-mfd. grid condenser.
- C<sub>3</sub> = 0.00025-mfd. variable condenser used to control regeneration.
- K = Radio frequency choke coil. This coil may consist of about 300 turns of No. 30 d.s.c. or other fine wire, bank wound on a 1-inch tube.
- T<sub>1</sub> and T<sub>2</sub> = Audio frequency transformers.
- J = A single-circuit filament control jack.
- R<sub>1</sub>, R<sub>2</sub>, and R<sub>3</sub> = filament ballast resistances of type satisfactory for the kind of tubes employed.

If the set is to be designed for portable use, uv-199 tubes are recommended and, in this case, it will be best to supply the filaments with three 1½-volt dry batteries in series. The tuning of such a receiver

is quite simple and depends entirely upon the setting of the condenser C<sub>1</sub>. As in any regenerative receiver, maximum volume will be obtained when the detector tube is adjusted so as to operate slightly below the oscillating point, this adjustment being controlled by variation of condenser C<sub>1</sub>. Particularly in interference investigations the directional effects of the loop will be found very valuable, the loudest interference being received when the plane of the loop is pointed toward its source.

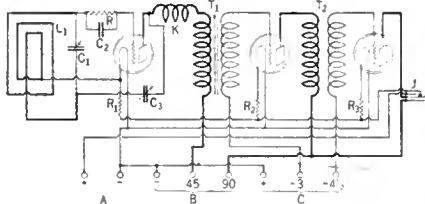

At all times during the operation of the receiver, care should be taken so as to keep the detector tube below the oscillating point since, if this tube does oscillate, a certain amount of radiation will take place which will produce interference with other receivers. Since a loop is being used, this radiation will not be very great, however.

No. 23

RADIO BROADCAST Laboratory Information Sheet

August, 1926

### Rheostats

DETERMINING CORRECT VALUES

ON THIS sheet are given data regarding the amount of resistance necessary in a single rheostat in order to control various numbers of tubes. The values of resistance that are given are just sufficient to reduce the battery voltage by the necessary amount, and if it is desired to operate the tubes at somewhat below the rated voltage (not al-

together a good practice), rheostats with about 50 per cent. more resistance than specified, should be used.

In any case, it will generally be found impossible to obtain rheostats with the exact resistance given in the table, and it will be necessary to use the next larger size. It should be noted that two lines are given to both the 199's and 12's to cover the use of either dry cells or a storage battery.

NUMBER OF TUBES IN PARALLEL → TYPE OF TUBES ↓	1	2	3	4	5	6	7	8
	RESISTANCE IN OHMS							
201-A—With 6-Volt Supply . . . . .	4	2	1.5	1	.8	.7	.6	.5
199—With 4½-Volt Supply . . . . .	25	13	9	7	5	4.5	4	3
199—With 6-Volt Supply . . . . .	50	25	17	13	10	9	8	7
12—With 1½-Volt Supply . . . . .	1.6	.8	.6	.4	.4	.3	.25	.2
12—With 2-Volt Supply . . . . .	4	2	1.2	.9	.75	.6	.55	.45
112—With 6-Volt Supply . . . . .	2	1	.7	.5	.4	.35	.3	.25
120—With 4½-Volt Supply . . . . .	12	6	4	3	2.5	2	1.7	1.5
120—With 6-Volt Supply . . . . .	24	12	8	6	5	4	3.5	3

No. 24

RADIO BROADCAST Laboratory Information Sheet

August, 1926

### Bypass Condensers

RULES FOR LOCATION

AT SEVERAL locations in a receiver it is essential that bypass condensers be used and, at several other points, their use is advisable.

In practically all receivers, a bypass condenser is necessary across the primary of the first audio transformer, which is, of course, connected in the plate circuit of the detector tube. In those cases where transformer coupled amplification is not used, the condenser should be placed across the impedance or resistance in the detector plate cir-

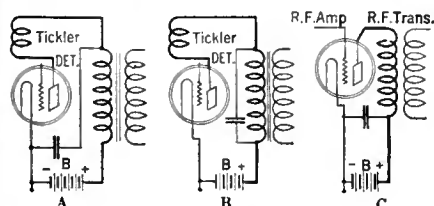

cuit, depending upon whether an impedance- or resistance-coupled amplifier is used. In any event, the method of connection shown in A, is to be preferred to the method shown in B.

With the former method of connection, the radio frequency currents are returned, by the condenser, directly to the filament and do not need to pass through the B battery. The condenser used at this point should not be larger than is necessary to give good results. Usually a 0.00025-mfd. condenser is large enough, and a 0.001 one should not be used unless it is found necessary.

It is frequently wise to place a large bypass condenser across the B battery. This condenser, which should have a capacity of about 1 mfd., bypasses the audio currents around the B battery. A condenser connected as shown in C, will usually be found of value in obtaining more stable operation from a radio-frequency amplifier. If this condenser is not used, the r. f. currents, in returning to the filament, must pass through various leads and then through the B battery and, quite possibly, there will be sufficient coupling to other parts of the circuits to prevent accurate neutralization. This condenser should have a value of not less than 0.1 mfd.

The function of any bypass condenser is to return certain currents, by as short a path as possible, to the tube where they originated. A bypass condenser is practically worthless if connected to any part of the circuit without giving regard to this rule. Therefore, whenever possible, one side of the bypass condenser should connect to the filament terminal of the socket containing the tube to which the currents are to be returned.

# Here's Work That is Almost ROMANCE!



## Many EARN \$50. to \$250. a Week in RADIO

Get into the great new BIG-Pay Industry—Radio. If you're earning a penny less than \$50 a week, clip coupon now. Send for AMAZING FREE BOOK. Be A Radio Expert, and draw down big money for the easiest and most fascinating work in the world. Positions everywhere. Need for Radio Experts in every community. Short hours. BIG PAY. Free book gives all the facts.

**Learn Quickly And Easily At Home**  
Master Radio Engineers will show you how to qualify, quickly and easily at home, for Radio's fine jobs. We guarantee to train you successfully. Every day N.R.I.-trained men are taking good places in the Radio field. Thousands of openings now awaiting the trained man. FREE EMPLOYMENT SERVICE. Many other big features. Get the facts—CLIP COUPON.



"My charges for consultation \$2.50 per hour. All success due to you." R. W. Blackhill, Brooklyn.



"Radio a gold mine—our course worth thousands." A. R. Herke, Winnipeg.

**Get This FREE Book!**

Send coupon below for FREE BOOK—"Rich Rewards in Radio." Read for yourself. No previous experience needed. Common schooling enough. WRITE NOW.



You get all these sets

Receiving sets, from simplest kind to thousand mile receiver, included to help you learn. AN UNEQUALLED OFFER. Other special features for limited time only, so ACT QUICK!

National Radio Institute  
Dept. HU-5, Washington, D. C.

## MAIL COUPON

NATIONAL RADIO INSTITUTE  
Dept. HU-5, Washington, D. C.

Without obligating me in any way, please send me your free book "Rich Rewards in Radio," also complete information on your practical, home-study Radio course.

Name ..... Age .....

Address .....

Town.....State.....

# LYNCH METALLIZED FIXED RESISTOR

WARRANTED—

Absolutely Noiseless  
Permanently Accurate  
Dependable!

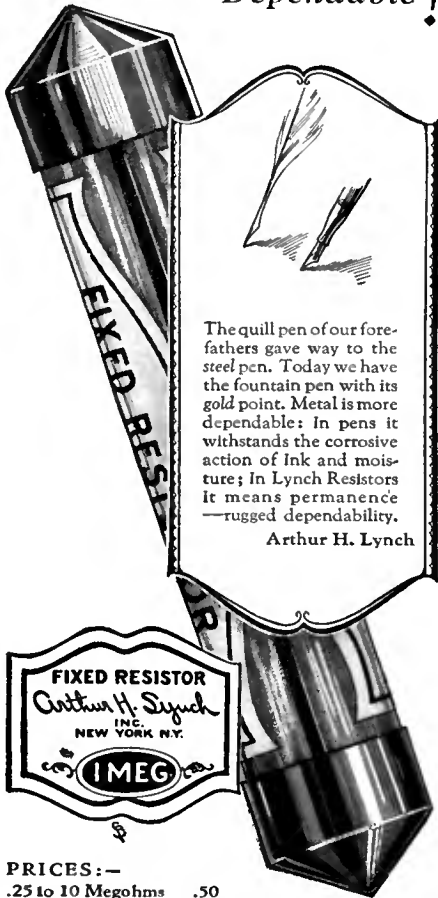

The quill pen of our forefathers gave way to the steel pen. Today we have the fountain pen with its gold point. Metal is more dependable: In pens it withstands the corrosive action of ink and moisture; In Lynch Resistors it means permanence—rugged dependability.

Arthur H. Lynch

PRICES:—  
.25 to 10 Megohms .50  
above .01 to .24 " .75  
.001 to .01 " \$1.00 Single Mounting .35

METAL long has been recognized as the best of electrical conductors. The LYNCH METALLIZED RESISTOR, comprising a concentrated metallized deposit one-thousandth of an inch thick upon a glass core, gives conductive, non-arcing resistance that wins in the exacting tests of time and service.

Endorsed by leading engineers, experimenters and test laboratories, this LYNCH better-built product marks as great an advance as did the tungsten lamp over its predecessor—the carbon incandescent bulb.

If your dealer cannot supply you, it will pay you to wait for the mail—we ship postpaid, and Lynch products are sold on a money-back guarantee.

Dealers—Write us!

ARTHUR H. LYNCH, Inc.  
Manufacturers of Radio Devices  
Fisk Bldg., Broadway & 57th Street  
New York, N.Y.

## “NOW, I HAVE FOUND . . .”

A Department for the Exchange of Ideas and Suggestions of Value to the Radio Constructor and Operator

CONTRIBUTIONS to this department are welcome and those used will be paid for at the usual rates, that is, from two to ten dollars each. A prize of twenty-five dollars is given for the best idea used during each three-month period. The prize winner for the last period is announced at the foot of page 340. Manuscripts intended for this department should not exceed about three hundred words in length, and should be typewritten. Little consideration can be given to manuscripts not typewritten. Envelopes should be addressed to this department, RADIO BROADCAST, Garden City, New York.

### CONTROL FOR RAYTHEON ELIMINATOR

ACCORDING to the directions furnished with the Raytheon tube for use in a line supply device, the maximum output voltage should not exceed 150, otherwise the tube heats up badly, and injury may result.

The writer has a four-tube set and found that even on the low voltage tap the amplifier output voltage was around 180 volts. This problem was solved by the use of a “Dim-a-lite” socket. This is a socket that burns a lamp at four different light intensities due to a resistance inside, which may be set at four different values.

The socket was hooked up to the 110-volt supply and the line supply unit was in turn plugged into the “Dim-a-lite” socket. Adjusting it to the first voltage brought the output voltage of the line supply to just 145 volts.

This arrangement will also prove very useful when too low a voltage is secured on the low tap and too high a voltage on the high tap, which will occur with the larger sets.

It can also be used for the same purpose, namely a primary resistance, in any other similar transformer arrangements where the voltage is normally too high.

EDWARD J. FANLEY,  
Columbus, Ohio.

a switch; and it is not difficult to make. The contribution of a couple of supplementary parts to the standard Pacent rheostat is all that is necessary.

On these Pacent rheostats, two bindings posts are provided, one of which connect with the sliding arm which, in turn, makes contact with the resistance wire. In a receiver, this binding post must be connected to the minus A terminal of the tube socket. The other binding post is connected to the minus A lead from the storage battery. To complete the battery circuit, the plus terminal of the A battery is led to the remaining post of the tube socket.

Between the two binding posts of the rheostat will be found a hole, and into this hole—is inserted a 1/2-inch No. 6/32 brass screw. This screw holds a specially-made brass angle-piece which, when a reading is taken, makes contact with the shaft (and therefore, via the sliding arm, to the minus A terminal of the tube socket). In Fig. 2, this screw is indicated by the lettering “Connect to Voltmeter,” while the details for the brass (or phosphor bronze) angle-piece are shown in A, Fig. 1.

The next procedure is to file a small notch 1/4 inch in width in the shaft. This is made clear by reference to B, Fig. 1. If the panel is 3/16 inch thick, the 1/4-inch notch will make a gap of 1/16 inch between the brass angle-piece and the tip of the shaft. If a thicker panel is employed, decrease the 1/4-inch dimension at the end of the shaft accordingly. The reassembly of the rheostat is now begun, but not before a washer and spring of the specifications given in C, Fig. 1, are procured. These are placed between the panel and the rheostat knob, as shown in Fig. 2. The assembly details can be followed by reference to Fig. 2.

When the voltmeter is being wired into a set employing these combination rheostat-voltmeter switches, it should be connected, the minus terminal to the screw supporting the brass angle-piece, and the positive terminal to the A plus binding post on the set. In Fig. 3 are shown the connections when several tubes are employed.

If the above connections are carefully adhered to, by simply pressing-in the knob of either of the rheostats, the voltmeter will be thrown into circuit, and its reading will indicate the filament voltage of the particular tube controlled by that rheostat.

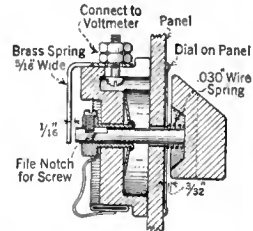

FIG. 2

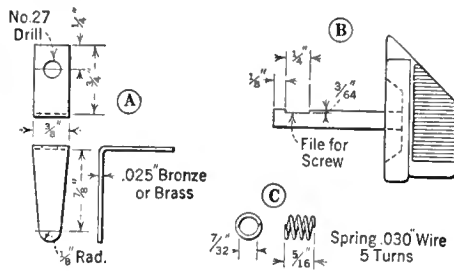

FIG. 1

### A COMBINED RHEOSTAT AND VOLTMETER SWITCH

SO THAT the correct filament voltage may accurately be applied to the vacuum tubes in a receiving set, many manufacturers advocate the use of a voltmeter. When, as is generally the case, one meter is to be used to take the reading of each tube individually, some switching arrangement becomes vital so that the meter may rapidly be switched across the filament posts of the tubes without the necessity of changing connections, etc. It is a simple matter to obviate this switching arrangement and, in the writer's case, a combined rheostat and voltmeter switch was designed to accomplish this. Such a gadget, in addition to saving panel space, is considerably handier to operate than is

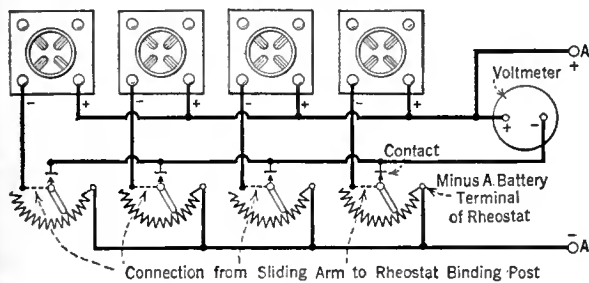

FIG. 3

The spring will keep the voltmeter out of circuit except when the rheostat knob is subjected to pressure.

H. E. CARLSON,  
East Saugus, Massachusetts.

IMPROVING THE NP COIL FOR THE ROBERTS RECEIVER

MANY constructors of the Roberts receiver, who have set out to construct their own coils, have met with certain difficulties. Either the receiver tunes broadly on the wavelengths in the vicinity of the local station's wavelengths, or it cannot be neutralized for all wavelengths, or perhaps it has certain dead spots. These faults can usually be attributed to the design of the NP coil.

In the regular NP coil, two wires are wound simultaneously on the spiderweb

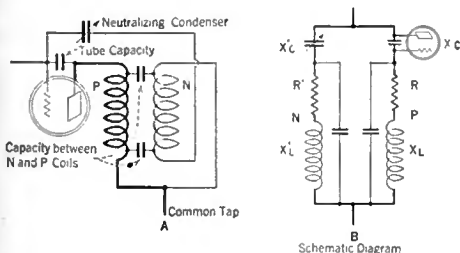

FIG. 4

form. Frequently these wires are twisted together before winding. In either construction the inside of one winding is connected to the outside of the other winding.

These coils constitute two circuits, one counterbalancing the other. Fig. 1, A, B, shows the usual representation and a schematic representation of these circuits. Each of these consists of resistance, inductance, and capacity, as shown in heavy ink. The light ink indicates capacity that is present as tube and distributed capacities. To obtain a coil that will neutralize for all wavelengths, it is necessary to have the same quantity of inductance and resistance in each of the two coils. In the event that the two coils are tightly wound together throughout their length, it will be found that the receiver has dead spots

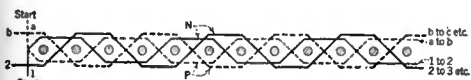

FIG. 5

and will tune broadly on local stations. This last fault is caused by the large losses between the two coils coupled by a large amount of distributed capacity.

The following coil design has been found to eliminate all of these difficulties and makes the spiderweb coil a desirable coil for this receiver. To wind this coil, two lengths of wire are wound simultaneously on

the spiderweb form, one wire is wound on one side of the form, under two and over two, and the other wire, under two and over two, on the other side of the form. Fig. 5 clearly indicates how this method of winding separates the two coils so that the distributed capacity is reduced to a minimum and at the same time permits the construction of coils of equal constants, to assure proper neutralization over the whole wavelength range.

H. C. RUSSELL,  
Arnold, Pennsylvania.

IMPROVING PHONE DIAPHRAGMS BY REVERSING

DIAPHRAGMS in ear phones or in loud speaker units, used in radio reception, will become concave or "set" after the parts have remained assembled for a long time. The magnetic pull of the permanent magnets in the coils drags the discs, and these assume a cup shape, with the center surface of the metal closer to the magnets than when originally constructed.

Reversing these diaphragms increases the distance from the disc to the magnet, but after a short time the disc again assumes a normal flat surface.

As will be evident from a consideration of the phone, the concave plate is not as responsive to the magnetic pulsations as will be the flat disc, or a disc reversed so that the magnetic pull will be in a direction that will tend to deflect the diaphragm.

A test to determine the concavity of the disc is made by simply placing a straight edge, as a ruler, across the face of the disc, as in Fig. 6. This will show, in an old set of phones, that the center of the disc is set back, sometimes as much as one thirty-second part of an inch or more.

It is not advisable to hammer or attempt

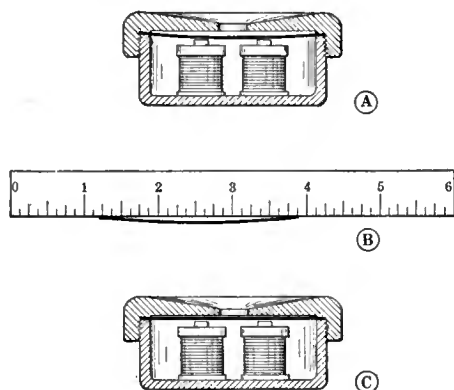

FIG. 6

to twist the disc to shape, as the accuracy required is too much for the average person to gauge, and better results are generally obtainable simply by reversing it.

In Fig. 6, A shows how the diaphragm is warped after constant use; B shows how the disc is tested by placing it against a straight edge, such as a rule; and C indicates the position of the diaphragm after it has been reversed.

G. A. LUERS,  
Washington, District of Columbia.

Hoyt CELLCHEK



A NEW accurate method for testing your storage battery in your radio set or car is available in the Hoyt CELLCHEK.

It uses a carefully built meter, correctly designed, with the proper load to place on the cells, and with a special scale on which you read direct whether the battery needs recharging, is low, or is in good condition.

Does away with hydrometer difficulties, dangers from damaged furniture, rugs, and clothes and the inaccuracies due to the greatly increased care necessary to make hydrometer readings.

Tests one cell at a time,—one instrument fits all radio batteries whether 2, 4 or 6 volts. In this way a weak cell will immediately show up and it can be then separately charged to bring it up to the level of the others.

Ask your dealer to show you the new Hoyt Radio instruments for 1926-7:—the Universal "Tip-in" Voltmeter for attachment in any position to sets equipped with tipjacks; the new Type 17, Flush-Mounting instruments with zero-adjustor; the easily mounted Front of Panel Case moving coil voltmeters and milliammeters—Type 17; the Phone-Plug Milliammeter instantly attached to the loudspeaker plug for checking B-battery consumption and adjusting C-battery voltage for distortionless signals; the new precision and standard pocket meters; and, finally, the Model 200 Direct Reading Tube Tester which gives mutual conductance, MU and plate-impedance of all vacuum tubes without the use of a pen or pencil.

BURTON-ROGERS COMPANY  
26 Brighton Ave., Boston, Mass.

# THESE EDGES



## won't admit moisture

THE leaky spot in ordinary mica condensers is the exposed edge. That is where moisture slyly creeps in — atmospheric moisture, salt air, steam from radiators, and acid fumes that corrode, create resistance and cause a condenser to change its capacity.

# SANGAMO Mica Condensers

have no exposed edges. The delicate parts inside are protected by an armor as hard and impermeable as marble.

Use them anywhere—and anyhow—expose them to acid fumes, boil them, freeze them, drop them on the floor, solder wires to the terminals—and you will still have accurate condensers.

They cost little—and make a world of difference in tone, accuracy and range. Recommended by every nationally known radio laboratory and by professional set builders.

Try SANGAMO BY-PASS CONDENSERS they won't break down



Sangamo Electric Company Springfield, Illinois

6332-4 RADIO DIVISION, 50 Church Street, New York

### SALES OFFICES—PRINCIPAL CITIES

- For Canada: Sangamo Electric Co. of Canada, Ltd., Toronto
- For Europe: British Sangamo Co., Ponders End, Middlesex, Eng.
- For Far East: Ashida Engineering Co., Osaka, Japan



SENT ANYWHERE ON 10 DAYS' FREE TRIAL

**5 TUBE GUARANTEED** **BIG POWERFUL MIRACO ultra 5**

Users everywhere report it gets programs coast to coast. (Canada to Gulf, loud and clear on speaker; outperforms \$100 to \$250 sets. Many \$59.50 value. Let users' testimony convince you. Retail

**FACTORY PRICES—SAVE** **MIRACO RADIO GETS 'EM COAST to COAST**

1/3 to 1/2. Smaller Sets \$13.75 up, retail. FREE Literature on latest 10 tube models. Agents new low prices and Dealers SPECIAL OFFER! Write! MIDWEST RADIO CORPORATION Promoters of Sets 498-B-E 8th St., Cincinnati, Ohio

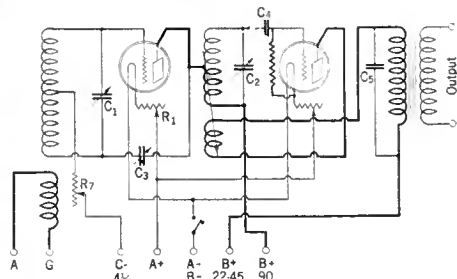

FIG. 7

### OSCILLATION CONTROL OF THE "UNIVERSAL"

IN EXPERIMENTING with the RADIO BROADCAST "Universal" Receiver, I stumbled upon an idea which I found increased the volume of the receiver many fold, stabilized it, and considerably simplified the control of oscillation and regeneration. This was accomplished by putting a resistance in series with the negative of the C battery and center tap of the secondary coil, L2, as shown in the accompanying diagram, Fig. 7.

The resistance I used was a Bradleyohm, 10,000 to 100,000 ohms. It worked best when set at its minimum resistance. I would suggest that other sizes and kinds of resistances be tried. In my set I employed the variable tickler method of regeneration control.

CONRAD PHILBRICK, Olympia, Washington.

### SWITCH CONTROL FOR BATTERY, LINE SUPPLY, AND CHARGER

AFTER purchasing a line supply unit, I realized that it would be a nuisance to have to turn off two switches in order to cut off both the A battery and the line supply from the set. Investigation and consultation both demonstrated that anything I did toward the unifying of these controls would have to be original, for there seemed to be nothing on the market specifically designed for the purpose. A little thought evolved the scheme showed in Fig. 8, A, in which the switch is a Carter or Yaxley panel mounting jack switch, single pole, double throw.

Then the addition of a trickle charger complicated matters somewhat. In my

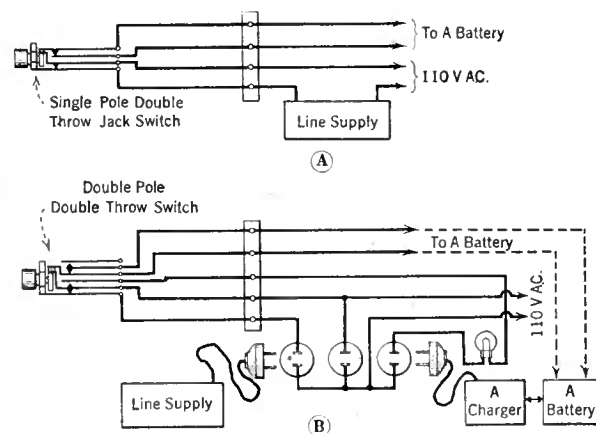

FIG. 8

case, the current consumption was so high that I found it advisable to have the charger going whenever the set was not in operation. Further investigation showed but one suitable device to apply. This was the Brach power control, which turns off the line supply and turns on the charger. There were two objections to such a system, however.. First, the necessity for a separate switch to control the A battery input and, second, that the unit did not lend itself well to being built in. A jack switch again provided the means for doing what I desired—turning off the A battery from the set, turning off the 110-volt line to the line supply unit, and connecting the trickle charger to the 110-volt line. Fig. 8, B, shows how this was done. A double pole, double throw switch on the panel controls the three circuits. As added conveniences, I included in the battery cabinet three plug receptacles and a socket for a series lamp in the charger circuit—one plug for the line supply, one for the charger, and one connected to the 110-volt line without switch for occasional connection of the tube rejuvenator. The series lamp in the charger line has two features; it regulates the rate of charging, and it provides light in the battery compartment for inspection of the battery and charger. The trickle charger may be disconnected at any time by unscrewing the lamp. The use of socket and plug on the units gave the built-in feature, and at the same time provided ease of removal of any unit. Of course, this arrangement is applicable to any type of charger, the charger being plugged-in only as needed.

GORDON T. WILLIAMS, Cleveland, Ohio.

### A NOVEL METHOD FOR NEUTRALIZING CONDENSER ADJUSTMENT

HERE is a simple method for neutralizing condenser adjustment. The method can be applied to any set employing one step of neutralized radio frequency amplification plus a regenerative detector, such as the Roberts and the latest model of the Browning-Drake. The result is accurate, despite its extreme simplicity.

Place your neutralizing condenser at zero, i. e., so that its capacity is at minimum value, and turn your feedback coil or feedback condenser until the detector breaks into oscillation. Under these conditions, when you touch the antenna post with the wetted finger tip, you will hear a loud click in the phones or the loud speaker.

Increase the neutralizing condenser capacity and the loudness of the pop will gradually diminish and reach a state where it leaves only the faintest click.

This is the state of the most perfect neutralization.

You can perform this process with your antenna connected.

KIYOSI KAWAHARA, Hukuwoka, Japan.

THE quarterly \$25 dollar prize award for the best idea submitted to this department during that period, is this time awarded to W. B. Harrison, whose idea was printed in the July RADIO BROADCAST. Particulars of this award appear at the top of page 338



# THE BEST IN CURRENT RADIO PERIODICALS

The Tenth Installment of a Useful Classified Survey of Material Appearing in the Radio Press

By E. G. SHALKHAUSER

How This Survey Can Help You

**H**OW often have you looked for information contained in some article which you recall having read months ago—the description of the Browning-Drake receiver, or the measurement of losses in inductance coils, for example? After looking through probably several issues of a dozen different publications, you either give up or become interested in something altogether different.

When data is wanted on some particular subject, a systematic file of subjects and titles becomes a real radio encyclopedia. Instead of having merely the title of an article given, which often is misleading, a summary of the contents gives all the information. These surveys cover the radio field as gleaned from material in to-day's periodicals. They will always serve as a future reference-guide to all who are interested in the science of radio, whether engineer, manufacturer, dealer, experimenter, or listener.

To be of practical value and easily accessible, these surveys should either be pasted in a scrap book, or, better still, be pasted on individual cards and filed according to numbers, or alphabetically. In the matter of classification of articles, the Bureau of Standards circular No. 138 has been followed. This may be obtained from the Government Printing Office, Washington, District of Columbia, for ten cents. In addition, each abstract has certain key-words placed at the upper right, which may be used for the purpose of filing articles alphabetically.

With this series of surveys we hope to aid our readers and help them through many difficulties which they no doubt have often experienced. The writer is prepared to give information and references to articles previously surveyed upon receipt of a stamped and self-addressed envelope.

Following is the series of headings, made up according to the Dewey Decimal System used in the Bureau of Standards circular No. 138:



**R000 RADIO COMMUNICATION IN GENERAL.**

Under this heading will appear all subject matter pertaining to laws, regulations, history, publications, etc., which deal with radio in a general way.

**R100 PRINCIPLES UNDERLYING RADIO COMMUNICATION.**

Here will be given the phenomena of radio waves, their underlying theory of propagation, the principle of antenna and counterpoise, design and characteristics of vacuum tubes and their behavior in circuits, types of circuits, transmitting and receiving apparatus and their principles of operation.

**R200 RADIO MEASUREMENTS AND STANDARDIZATION METHODS.**

The various known methods which have been used in measuring frequency, wavelength, resonance, capacity, inductance, resistance current, voltage, dielectric constants, and properties of materials, will be mentioned here.

**R300 RADIO APPARATUS AND EQUIPMENT.**

A description of various types of antennas and their properties, the use of the electron tube in various types of receiving and transmitting sets, other methods of transmission of signals, various detecting devices used in reception, instruments, and parts of circuits, come under this heading.

## A Key to Recent Radio Articles

**R113. TRANSMISSION PHENOMENA** "SINGLE SIDE BAND" TRANSMISSION. RADIO BROADCAST. June, 1926, pp. 111-115.

"How New York Talks to London," E. H. Felix. A new telephone transmitting station of 150-kw. power has been installed at Rocky Point, Long Island, utilizing the "single side band" system of transmission. It is claimed that this new method of energy transmission is superior to other schemes in several ways. Only one-quarter to one-sixth the power is required to transmit a given distance, only one-half the wavelength band is used, and it is less subject to fading than the double side band system used at present. The underlying principle of "single side band" transmission is explained. The new water-cooled vacuum tube forms the nucleus for this new station. Photographs and diagrams are shown.

**R140. RADIO CIRCUITS.** "RADIO BROADCAST LAB." CIRCUIT.

RADIO BROADCAST. June, 1926, pp. 121-125. "The Radio Broadcast Lab." Circuit," K. Henney. In experimenting with radio receiving circuits it is well to begin with the simple hookup shown, according to the writer. The bridge circuit (known as the Hull circuit),

**R400 RADIO COMMUNICATION SYSTEMS.**

The spark, modulated wave and continuous wave systems in transmission, beat and other methods of reception, wired wireless, automatic printing, the buzzerphone and Fullerphone, will be given here.

**R500 APPLICATIONS OF RADIO.**

To aviation, navigation, commerce, military, private, and broadcasting, and the specific information under their headings, are referred to here.

**R600 RADIO STATIONS.**

The operation, equipment, and management of radio installations, both transmitting and receiving, the testing, the rules and regulations concerning stations, the reports and bulletins issued will follow under this heading.

**R700 RADIO MANUFACTURING.**

Data relative to costs and contracts of radio equipment from raw material to finished product, including factories, tools, equipment, management, sales and advertising, is under this head.

**R800 NON-RADIO SUBJECTS.**

The matter of patents in general; the mathematics and physics, including chemistry, geology, and geography; meters of various kinds; all information not strictly pertaining to radio, but correlated to this subject, will be found under this heading.

**R900 MISCELLANEOUS MATERIAL.**

used in conjunction with the toroidal coil, is analyzed for the benefit of the experimenter. Attention is called to parasitic oscillations likely to occur at about 3748 kc. (80 meters), which can be balanced out by using a trap circuit. The correct turn ratio to use in the r.f. transformer depends upon the plate impedance of the tube used, a table of values being given. Data governing the characteristics and the operation of the circuit are presented.

**R375.3. ELECTROLYTIC RECTIFIERS.** RECTIFIERS, Radio. May, 1926, pp. 19ff.

"Electrolytic and Mercury Arc Rectifiers," J. B. Dow. Electrolytic rectifiers usually consist of lead and aluminum plates in either a borax solution or a neutralized solution of phosphoric acid. To form new cells, either a direct or an alternating current may be used, the latter not being as good for the purpose. The method of cooecting cells to the circuit, amount of current to use in forming, and the phenomena to observe when cells are in operation, are discussed. For the various types and sizes of tubes on the market recommendations are made concerning cell dimensions and the correct number to use. The thermionic and the mercury arc rectifiers are also mentioned in this connection.



## B-Power Unit

No. 1582

For Standard Raytheon Tube

\$11.00 List

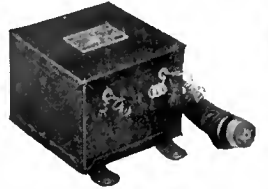

Undoubtedly this new Dongan B-Power Unit (1 transformer and 2 chokes) represents the highest point yet reached in the successful elimination of B Batteries. Built in strict accordance with Dongan's exacting specifications, this compact, smooth-operating B-Power Unit assures efficient B-Power when built according to instructions.

In addition to this model Dongan builds various designs of both cased and uncased transformers and chokes for use with all types of Full and Half-Wave Rectifying Tubes.

Orders filled direct from factory if dealer cannot supply you.

Set Mfrs. — Complete information and prices upon request.

Special Transformers for Trickle Chargers.

## New Models Audio Transformers for Set Manufacturers

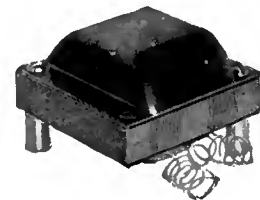

No. 117 Semi-cased

Those Set Mfrs. who have solved the problem of production and marketing are turning, in even greater numbers, to the time-proved principles of Dongan Audio Transformers. They recognize the superior qualities of design and manufacture in Dongan products. It is to be expected that Dongan's 15 years' experience in the quantity production of quality transformers should place Dongan in the lead in audio transformer requirements.

Get engineering data and samples immediately

★ Dongan Electric Manufacturing Company

2991-3001 Franklin St., Detroit, Mich.







# APPROVED..... by the most critical eye

Look at the Bosworth, and you will sense an inborn dependability.

Those who actually use it, either as expert radio technicians or ardent broadcast listeners, place their further stamp of approval upon it.

The fan, because he finds that Bosworth Radio gives him good, clear, consistent, dependable reception, night after night, from a multitude of stations.

The technical man, because he recognizes a correctness of construction and engineering which makes these results possible.

Thus it is inevitable that those who know radio, from either angle, are recommending Bosworth to those who are still uncertain.

Two Bosworth models, a six tube set at \$155, and a five tube set at \$115. Write for booklet "B", "The Spirits of Entertainment". Address The Bosworth Electric Mfg. Co., Norwood, Ohio.

## BOSWORTH RADIO

Why not subscribe to *Radio Broadcast*? By the year only \$4.00; or two years \$6.00, saving \$2.40. Send direct to Doubleday, Page & Company, Garden City, New York.

### LEARN THE CODE AT HOME with the OMNIGRAPH

*"Just Listen—The Omnigraph will do the teaching!"*



THE OMNIGRAPH Automatic Transmitter will teach you both the Wireless and Morse Codes—right in your own home—quickly, easily and inexpensively. Connected with Buzzer, Buzzer and Phone or to Sounder, it will send you unlimited messages, at any speed, from 5 to 50 words a minute.

THE OMNIGRAPH is not an experiment. For more than 15 years, it has been sold all over the world with a money back guarantee. The OMNIGRAPH is used by several Depts. of the U. S. Govt.—in fact, the Dept. of Commerce uses the OMNIGRAPH to test all applicants applying for a Radio license. The OMNIGRAPH has been successfully adopted by the leading Universities, Colleges and Radio Schools.

Send for FREE Catalogue describing three models. DO IT TO-DAY.

THE OMNIGRAPH MFG. CO., 13K Hudson St., New York City

*If you own a Radio Phone set and don't know the code—you are missing most of the fun*

## BAKELITE for Radio Parts

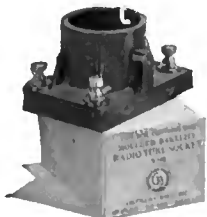

The use of Bakelite parts in the set you buy or build, will insure you against inferior reception through defective insulation. Write for booklet 29.



BAKELITE CORPORATION

247 Park Ave., New York, N. Y. Chicago Office: 636 W. 22nd St.

BAKELITE CORP. OF CANADA, LTD., 163 Dufferin Street, Toronto, Ontario, Canada

## ELECTRAD

### Don't Fool With Lightning!

It doesn't pay to economize on a lightning arrester, or to use one you aren't sure of. You can't collect insurance unless

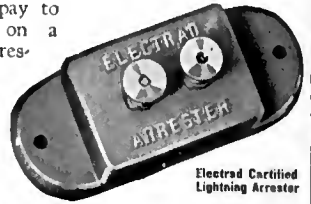

Electrad Certified Lightning Arrester

you have an arrester capable of passing the National Board of Fire Underwriters. Put in an Electrad Certified Lightning Arrester—then you're sure.

Air-gap type, exterior moulded porcelain, attractive finish. Completely sealed and moisture proof. Cost little, simple and easy to attach. At all good radio stores, 50c; in Canada 75c. Outdoor type \$1.50; in Canada \$2.10



For perfect control of tone and volume use the Electrad 500,000 ohm compensator. For free hookup write 428 Broadway, New York City.



## ELECTRAD Inc.

## Send for Latest RADIO CATALOG and GUIDE



### Sets—Parts—Kits Radio's Newest

You need this big FREE book. A practical guide to success in set building. Gives advanced hook-ups. Shows all newest parts and kits, built up sets ready for use, battery eliminators, radio's newest creations. Write for Copy Free, also send name of radio fan. Send to-day.

**BARAWIK CO.**  
102-109 S. Canal St., Chicago



## Fool Proof

AMPERITE—the perfect filament control. Takes the guess out of tube control. No knobs to turn. Makes tubes last longer. Makes any novice a master operator. Specified in all popular construction sets. \$1.10.

Radiall Company ★

Dept. RB-8 50 Franklin Street, New York City



Write for FREE Hook-ups

## AMPERITE

The "SELF-ADJUSTING" Rheostat

**R900. PACKING RADIO SETS.** PACKING RADIO SETS.  
**RADIO BROADCAST.** June, 1926, pp. 126-127.  
 "How to Pack Radio Sets for Shipment," S. W. Todd.  
 Suggestions and information are given to those who wish to ship radio sets by express or freight. The best container to use is an air-cushioned corrugated cardboard carton. The accompanying photographs show clearly how receivers should be packed.

**R386. FILTERS.** WAVE-TRAPS.  
**RADIO BROADCAST.** June, 1926, pp. 138-142.  
 "Cutting Out the Locals," H. E. Rhodes.  
 A series of tests to develop a simple wave-trap for receivers located within a few miles of high-powered broadcasting stations, are described. By the use of a simple condenser and coil arrangement, receivers can easily be made more selective. Also the sensitivity can be increased by adding an additional stage of r.f. amplification, such as the "Penetrol."

**R700. MANUFACTURING.** A JOB IN THE RADIO FIELD.  
**Radio.** May, 1926, pp. 8ff.  
 "Breaking Into the Radio Game," H. S. Pyle.  
 The radio field may be divided into three main branches: manufacturing, selling, and operating, says the writer. In order to enter the manufacturing field, the prospective job-seeker is advised to enter some factory making either marine radio equipment or broadcast receivers, in order to gain his fundamental knowledge.  
 In the selling side of radio it is essential that you know the product you desire to sell. You may become an outside commission salesman or a counter salesman. Both branches however, require sales ability which is necessary in all selling lines. A good radio salesman must know the latest developments in radio circuits, hookups, apparatus, etc., to be a real success.  
 As a station operator, the applicant must have passed the government license examination for the particular type of transmitting stations he wishes to operate. These may be classified as radio broadcast stations, private stations, high-powered transoceanic stations, and ship stations. In all, a thorough knowledge of the principles of radio communication are essential.

**R344.5. ALTERNATING CURRENT SUPPLY.** ABC ELIMINATOR.  
**Radio.** May, 1926, pp. 13ff.  
 "The Half-Wave ABC Eliminator," G. M. Best.  
 A description of a half-wave ABC eliminator, using General Radio rectifying transformer, is given, accompanied by circuit diagrams and constructional data. A method of connecting up a Bremer-Tully "Counterphase," with filaments arranged in series, is also shown.

**R381. CONDENSERS.** CONDENSER PRINCIPLES.  
**Radio.** May, 1926, pp. 18ff.  
 "What Constitutes a Good Variable Condenser and Why," H. M. Bishop.  
 The prime requisites of a good variable condenser are said to be:  
 (1). Low high-frequency resistance; (2). Adequate insulation; (3). Ruggedness; (4). Adjustability; (5). Compactness; (6). Smoothness of operation. These requisites are taken up in order, and discussed.

Either brass or aluminum can be used for the plates, and silver plating adds little to the efficiency. Low resistance joints are necessary. Insulating material should be so placed that it be out of the electric field as much as possible. Surface leakage should be avoided. Low eddy current losses are obtained by making plates thin and small without sacrificing strength and durability. Although this loss is of little consequence compared to the other losses, its value is greatest in solid heavy end plates.  
 The following are said to be good insulating materials: Hard Rubber, Bakelite, Micarta, Formica, Porcelain, Isolantite, and Pyrex. Electrical efficiency should remain paramount and not be sacrificed when design and construction are considered. This pertains to plate thickness, end plate construction, condenser bearings, rotor contact, and the method of mounting. A good condenser is usually also compact. Its maximum to minimum capacity ratio should be about 50. A higher ratio is not necessary and may result in excessive resistance.

**R343. ELECTRON-TUBE RECEIVING SETS.** RECEIVER, Short-Wave.  
**Radio.** May 1926, pp. 21ff.  
 "Improving 40-Meter Foreign Reception," Don C. Wallace.  
 The problem of extraneous noises, and the effective shielding of short-wave receivers against these noises, is discussed. The author proceeds to describe an efficient short-wave receiver to operate from 9094 to 6250 kc. (30-48 meters). Long antenna wires up to 750 feet in length have been found very effective in picking up the extremely high frequencies from foreign amateur stations.

**R386. FILTERS.** SUPER-HETERODYNE BAND FILTER.  
**Radio.** May, 1926, pp. 25ff.  
 "A Super-Heterodyne Band Filter," R. B. Thorpe.  
 An electric wave filter, designed and developed by G. A. Campbell to be used in conjunction with super-heterodynes in the intermediate stage amplifying circuit, promises to make the receiver considerably more sensitive and selective without cutting away any of the desired sidebands. The constructional details of a typical filter circuit to operate at 30,000 cycles, is given.

**R113.5. METEOROLOGICAL TRANSMISSION PHENOMENA.** AURORA BOREALIS.  
**Popular Radio.** May, 1926, pp. 11-18.  
 "Does the Aurora Borealis Affect Radio Reception?" W. D. Terrell.  
 Unusual electrical disturbances are probably due to a display of Northern Lights, says the writer, his statements being based on personal observations, and reports from other observers. Possibly the discharges of atmospheric electricity related in the Aurora may create electromagnetic waves of irregular type, suggests Doctor Terrell. It is known that an Aurora display affects telegraph transmission lines, setting up stray currents. All radio districts in the United States report bad blanketing effects on radio reception with the exception of the New Orleans and Florida areas. The direct cause of all of these unusual disturbances may be attributable to sun spots, and to heavy ionic and electronic discharges from the sun.

**R800 (510) MATHEMATICS.** FORMULA FOR RECEIVERS.  
**Radio.** May, 1926, pp. 31ff.  
 "The Arithmetic of Radio," E. M. Sargent.  
 The various radio formulas applicable to simple radio circuits are outlined, and examples given. A two-tube regenerative circuit is shown as a typical example. Equations governing antenna current, ohmic resistance, inductance, capacity, and natural wavelength of the antenna; coefficient of coupling between primary and secondary; and wavelength and voltage induced in a secondary circuit, are discussed. The effect of connecting condensers across the primary of the transformer is shown, and the calculation of tube impedance is described.

**R144.3. TRANSMITTING SETS.** TRANSMITTER, 15-Watt.  
**Radio.** May, 1926, pp. 35ff.  
 "A 15-Watt Tube Transmitter," D. B. McGown.  
 Using a UX-210 or CX-310 vacuum tube, which has characteristics similar to the old 1V-202, the writer presents a transmitting set, the construction and operation of which is described in detail. The Hartley circuit is used, the set operating on 15,000 and 7500 kc. (20 and 40 meters). A new keying system is used whereby a high positive potential, obtained from the plate-voltage source, is placed on the filament to stop the tube from oscillating. When the key is open, the tube does not oscillate, but when it is closed the potential of the filament is reduced to that of the grid, and the tube oscillates. Special arrangements are made to keep the high frequency energy out of the keying system. Compactness, and simplicity of adjustment, are advantages of the set.

**R133. GENERATING ACTION.** PARALLEL OPERATION OF TUBES.  
**Radio.** May, 1926, pp. 42ff.  
 "Parallel Operation of Tubes," G. F. Lampton.  
 The data presented intend to show that with a coupled Hartley oscillator circuit the output of tubes connected in parallel is proportional to the number of tubes used. The information is given in a series of curves. Curve No. 2 shows the adjustment of grid excitation for maximum output; curve No. 3 shows the grid leak adjustment for maximum output; curve No. 4 shows the relation of output to the number of tubes in parallel; curve No. 5 shows the relation of plate voltage to output; and as a comparison, curve No. 6 shows the relation of power output to number of tubes in parallel for conductive coupling. All tests were made with 5-watt Koice tubes on a frequency of 3750 kc. (80 meters).

**R375. DETECTORS AND RECTIFIERS.** SYNCHRONOUS RECTIFIERS.  
**QST.** May, 1926, pp. 9-16.  
 "Taming the Synchronous Rectifier," R. S. Kruse.  
 The synchronous rectifier used in rectifying 60-cycle a.c. has its disadvantages because of the bad sparking at the contacts. Two types of rectifiers are generally used, the vibrating type and the rotary disc. To either prevent this sparking or reduce it to an absolute minimum, the author discusses several filter circuits, which may be used. One of the circuits makes use of either an 5 tube or a kenotron rectifier. Other circuits, the so-called Hoover, the Morris, and the Indianapolis, have their advantages, and are used with great success.

**R343. ELECTRON-TUBE RECEIVING SETS.** RECEIVER, Reflex.  
**QST.** May, 1926, pp. 23-26.  
 "A Reflex Receiver with Resistance Audio Coupling," L. W. Hatry.  
 The problem of proper reflex circuit design is considered, and its advantages and disadvantages summarized. A four-tube resistance-coupled reflex set is illustrated and described in detail. Tubes to use, constructional hints, and results to expect, are given.

**R320. ANTENNAS.** ANTENNAS.  
**QST.** May, 1926, pp. 27-29.  
 "Picking a Good Antenna for the Short-Wave Station," C. H. Starr.

In the writer's opinion, good results in short-wave transmission depend upon a steady note and a good antenna. A good antenna can only be discovered by making comparative measurements. The resistance of an antenna may be measured in the usual way, or the results may be compared by taking field strength measurements at many distances. The question of operating an antenna at its fundamental or at one of the harmonics is still open to discussion. A radio frequency feeder line may be used, as suggested, if the antenna is in a remote location.

**R375.3. ELECTROLYTIC RECTIFIER.** RECTIFIER, Electrolytic.  
**QST.** May, 1926, pp. 30-32.  
 "A Dry Electrolytic Rectifier," R. S. Kruse.  
 A dry electrolytic rectifier has been placed on the market, using magnesium as one plate and a composition disc as the other. The theory of operation is not disclosed, but diagrams and a general description are given.

**R113. TRANSMISSION PHENOMENA.** "SINGLE SIDE BAND" TRANSMISSION.  
**Wireless World (London).** March 31, 1926, pp. 487-489.  
 "Single Side Band Transmission," E. K. Sandeman.  
 The fundamental principles of ordinary radio telephone transmission, taking up modulation, analysis of the modulated wave, complex wave forms, side bands and their detection, and a preliminary discussion of "single side band" transmission is discussed. (Continued April 7, 1926, issue pp. 529-542).

The characteristics of single 'side band transmission' and carrier suppression are summarized as follows:  
 (1). The frequency range occupied by the side bands is halved, the energy radiated in the side band frequencies being unaltered if the carrier is radiated as in the normal case.  
 (2). By suppressing the carrier, the side band amplitude may again be doubled. The net result of these changes is an improvement in noise ratio of 4 on a voltage basis.  
 (3). Since two side bands occupy half the frequency range occupied by one, it is possible to transmit each side band frequency with more nearly the same attenuation.  
 (4). The frequency band width occupied in the ether is one-half that occupied by the normal system of transmission, so that twice as many channels of communication are made available.  
 A practical method of producing a single side band, which is actually in use at the present time, is described in this article.

**R343.7. ALTERNATING CURRENT SUPPLY.** RAYTHEON POWER PACK.  
**Popular Radio.** May, 1926, pp. 19-25.  
 "How to Build the Improved Raytheon Power-Pack," L. M. Cockaday.  
 Several models of power-pack units, incorporating three values of plate voltages, are illustrated and described. Blue print diagrams, circuits, and a list of parts are included in the discussion to facilitate construction.

**R230. INDUCTANCE.** INDUCTANCE.  
**Popular Radio.** May, 1926, pp. 42-43.  
 "An Easy Method for Calculating Coil Inductance," M. M. Silver.  
 The equations and accompanying charts show how, with a given size of condenser, the inductance of a coil can be determined, the number of turns and the coil diameter to length ratio determining the wavelength range to which the combination will tune. Also, having coils of known dimensions, it is possible, with the aid of the charts, to determine with what size condenser they should be combined to tune over a given frequency band.

**R110. RADIO WAVES.** POLARIZATION OF RADIO WAVES.  
**Radio News.** May, 1926, pp. 15-16ff.  
 "Changes in the Polarization of Radio Waves," G. W. Pickard.  
 Electric waves are polarized at the source since they are produced by currents set up along fixed conductors; light waves, on the other hand, are non-polarized at the source since they are set up by electronic vibrations in all planes. It has been determined that the lower frequencies, 10-700 kilocycles, are vertically polarized, but frequencies above these values, exceeding one or two megacycles, whether radiated horizontally or vertically, are horizontally polarized.  
 Tests were made to determine: (1). The polarization at different distances from high-frequency transmitters radiating vertically plane polarized waves; and (2). What a comparison at both low and high frequencies from a distant transmitter, which should radiate alternately vertical and horizontal waves, would show.

Precautions must be taken when making measurements, since ground reflection may cause erroneous conclusions to be made, the author citing an example of a wave coming to the test apparatus at an angle of 45°, plane polarized. Measurements made in an isolated locality in New Hampshire, 7 meters above the earth, with a resonator wire 8 meters long, and a super-heterodyne of special construction, gave results which indicate that the above mentioned statements are correct. The chart indicates the relation existing between horizontally and vertically polarized waves at various distances and at different frequencies. The cause for the rotation of the plane of polarization of radio waves may be partially due to the earth's magnetism, says Doctor Pickard. Data are presented covering specific tests.

**R330. ELECTRON TUBES.** VACUUM TUBE, 110-Volt.  
**Radio News.** May, 1926, pp. 15-16ff.  
 "A 110-Volt Filamentless Tube," A. N. Lucian.  
 A new type of vacuum tube, operating directly either from the regular 110-volt a.c. or d.c. source, or from some other heat source, is described. The writer first mentions some of the many disadvantages of the present type of filament tube and then states the advantages of his filamentless bulb. A coil heater is used to cause electrons to leave a Wehnelt oxide coated thimble, these electrons being controlled by a regular plate and grid arrangement. Diagrams and photographs illustrate the tube and its details.

**R330. ELECTRON TUBES.** DONLE B-6 DETECTOR.  
**Radio News.** May, 1926, pp. 15-18ff.  
 "The New Donle B-6 Detector," H. P. Donle.  
 A new gas-filled detector tube, known as the Donle B-6 detector, has been developed. The tube needs no critical filament current adjustment, but is rather sensitive as to plate voltage. Its output is greater for weak signals than other tubes used for the same purpose, and therefore can be used in sets to pick up distant stations. A new gas is contained in the tube. A grid leak and condenser is not necessary. Curves showing its characteristics and points of merit are shown.

**R800 (543.85). VACUUM APPARATUS.** VACUUM PUMPS.  
**Radio News.** May, 1926, pp. 15-16ff.  
 "How Radio Tubes Are Evacuated," Dr. C. B. Bazzoni.  
 (Continued from March issue)  
 Mercury air pumps are used in the majority of cases for obtaining high vacua. Of these, the Sprengel pattern is the simplest (described in the March issue). Three types of high speed pumps are here discussed, namely: (1). The Gaede rotary mercury pump; (2). The Langmuir mercury pump; (3). The Holweck mercury pump.

The Gaede pump is really a high speed continuously acting Sprengel pump. It will produce a vacuum of .00001 mm. pressure when backed up by another pump which can maintain the pressure below 1 cm. About 40 pounds of mercury are required to fill the pump to the proper level. Diagrams of the pump, and its operation, are discussed.  
 In the Langmuir mercury-jet condensation pump, a stream of high speed mercury molecules is used to drive out the air molecules from a chamber connected to the bulb. Unlike the Gaede pump, in which evacuation depends on successive expansion of the air in the container, the condensation pump depends for its efficiency on the rapidity and completeness of the condensation of the mercury vapor on the walls of the inner vessel. To prevent mercury and water vapor from getting into the bulb being evacuated, liquid air is used in freezing these vapors out. A pressure as low as .000001 mm. of mercury has been obtained. The molecular pump, although very effective, is expensive due to the fact that it must be made exceedingly accurate. The principle of operation depends on the high speed of the drum within the pump, which gives the air molecules motion in a definite direction. A forepump of .001 mm. pressure is required. Designs of the Holweck pattern pumps are shown.  
 In commercial work, not much time can be spent in obtaining high vacua, and for that reason substances like phosphorus, arsenic, sulphur, iodine, are introduced into the vessel, these acting as "getters." The vapor of these substances collects on the surface of the glass and in some way covers up the left-over gases within a short time after the filament of the tube has been burnt. In the laboratory, charcoal is used for the purpose of absorbing gases, when cooled with liquid air.

# Sheet Copper for Shielding

## Shielding

*Prevents* aerial radiation and feedback.

*Insulates* against interference from adjoining circuits.

*Improves* efficiency, selectivity and tone quality.

USE SHEET COPPER because it combines low resistance with easy working qualities.

COPPER & BRASS  
RESEARCH ASSOCIATION  
25 Broadway — New York



This is a good time to subscribe for  
**RADIO BROADCAST**  
Through your dealer or direct, by the year only \$4.00  
DOUBLEDAY, PAGE & CO. GARDEN CITY, NEW YORK

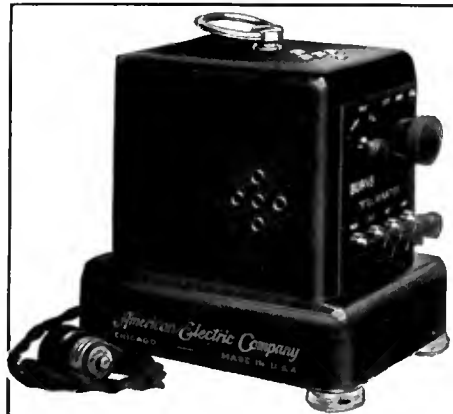

IT DELIVERS  
FULL "B" VOLTAGE

**Burns** ★

B-Battery Eliminator

Operates from lighting current like other household appliances. No hum or vibrations. Smooth constant plate supply. Once connected it requires no further attention or adjustment. Remarkable results on local and long distance reception.

Popular Price—Write for Data.

*American Electric Company*  
State and 64th Streets Chicago, U. S. A.  
Makers of Burns Speakers

Make any Good Receiver  
★ **BETTER**

**CC**  
TUBES

C.E.MFG.CO.  
Providence  
R.I.

**Big FREE RADIO**  
Catalog & Guide

Send now for this valuable FREE book. Full of advanced hook-ups, parts and kits. A real guide. Shows factory built sets and the new ideas in radio. Send at once. No charge. No obligation. Please include name of radio fan.

**BARAWIK CO.**  
102-109 S. Canal St., Chicago

## BOOK REVIEW

### A Primer for the Tyro Who Wishes to "Hear" Music

EVERYBODY'S GUIDE TO RADIO MUSIC.  
By Percy A. Scholes. Published by the Oxford  
University Press, American Branch, New  
York. 204 pages. \$2.

THIS book, "Everybody's Guide to Radio Music," is our familiar friend the music appreciation primer dressed up in the plus-fours and perforated oxfords of the radio age. But the fact that the material is handled from the radio listener's point of view should make it considerably easier to take. The occasional references to radio serve as a friendly buoy to which the neophyte can cling trustingly from time to time before venturing into the terrifying sea of musical fact.

It is a book that no radio fan who wishes to get the maximum enjoyment out of his receiving set can afford to be without. The author, Percy A. Scholes, is an outstanding authority on music, and has written numerous volumes on the subject. Moreover, he occupies the position of music critic to the British Broadcasting Company. "This," he says in preface, "brought me hundreds of letters—friendly, inimical, dogmatic, inquiring. I can claim, then, to understand something about the mind of the listener to broadcast music, and if I fail to provide what that mind demands or requires, it will be my own fault."

Some idea of the contents of the volume can be gained from a random selection of chapter headings, among them: "What Is Music?"; "The 'Form' of Music"; "How to Listen to an Orchestra"; "A Chapter on Songs"; "What is Good Singing?"; "The Two Qualities of Music—Good and Bad"; "Is Modern Music Any Good?"; "What Will Broadcasting Do for Music?"

We have often wondered why that most powerful incentive "curiosity" has not been more of a factor in promulgating a knowledge of music. The individual who hears music with his ears only—and his number is legion—is constantly being told that there is something in music to which he is totally oblivious; that there is a pleasure to be derived from music which he has never experienced and the nature of which he has never for an instant conceived.

Unless he chooses to believe that all such talk is simply part of a gigantic hoax, we fail to see why his curiosity is not vastly excited. For instance, Messrs A and B listen to the same symphony. Mr. A kens music. Mr. B does not. Mr. A has a good time. Mr. B is bored. Mr. A, being impolitely frank, tells B "Of course you were bored, you didn't hear the symphony!" Now Mr. B knows that his ears were as wide open as those of his more erudite companion; unless he secretly concludes that A is a *poseur*, we should think he would be enormously curious to know what in the world there was in that collection of sounds that A heard and he did not.

The language of music is so completely different from the language of any other of the arts that it is almost imperative that outside help be engaged for the elementary lessons. Once started, it may be possible to continue alone. Such tutelage may be gained in either of two ways—by the personal assistance of some music loving acquaintance, or by perusal of a book on the subject.

It is for just this purpose that "Everybody's Guide to Radio Music" was designed. It is written in a breezy style, with a thorough omission of technical jargon. Its aim is to conduct the willing reader gently by the hand and initiate him painlessly into the mystery of music. And



★  
**Micamold**  
REG.

Raytheon  
Standard

"B" ELIMINATOR RESISTORS

Moulded in Bakelite under pressure of 50 tons

Build your Eliminator with Micamold "B" Power Resistors for constant dependable service under all conditions. The unusually large radiating surface of these resistors gives the highest power rating of any fixed resistor now employed for "B" Battery Eliminators. They are adopted as Standard by the Raytheon Manufacturing Company and are used exclusively by those desiring uninterrupted service.

Price at Dealers or by Mail \$1.00 each

MICAMOLD RADIO CORPORATION

Flushing and Porter Avenues, BROOKLYN, N. Y.

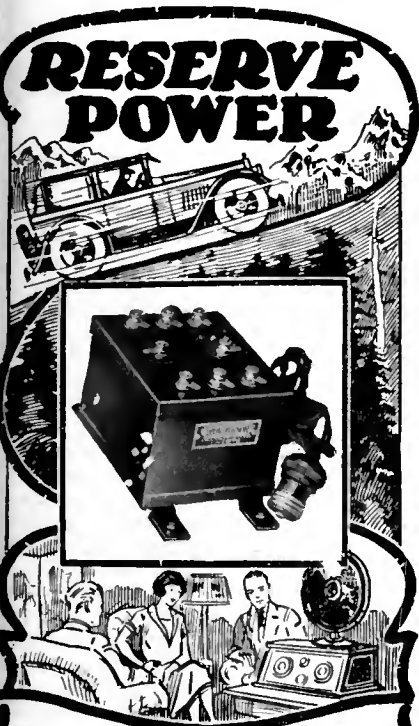

# THORDARSON

**POWER AMPLIFICATION**  
and  
**B-SUPPLY**  
From the A. C. Line

Force a car up a steep hill and the engine knocks. Force a radio set and the quality becomes ragged and the reproduction distorted.

Faithful reproduction of the deeper bass tones requires a considerable expenditure of electrical energy—more, in fact, than the vacuum tube of the average receiver can handle.

A power amplifier built with Thordarson transformers and chokes uses larger capacity tubes and reproduces the heavier, more vibrant tones with undistorted quality and volume.

*Operates from the light circuit. B-supply for entire receiver. No controls. Requires no adjustment. Uses larger capacity tubes.*

TRANSFORMER R-108 supplies 425 v. plate and 7½ v. filament for UX 210 Tube. **Price \$12.00**

★ 30 HENRY CHOKE R-106, 70 M. A. capacity for filter circuits. **Price \$5.00**

**THORDARSON**  
**ELECTRIC MFG. CO.**  
500 W. Huron St., Chicago, Ill.

**Transformer Specialists Since 1895**  
**WORLD'S OLDEST AND LARGEST**  
**EXCLUSIVE TRANSFORMER MAKERS**

# Safety



demands

## the BRACH ARRESTER

Each flash of lightning subjects your radio set to damage unless a highly sensitive arrester is used.

For over 20 years noted engineers have insisted on Brach Arresters for protecting railway signal systems and radio instruments because they have found them to be the *most sensitive, the most reliable* arresters obtainable.

Today every Brach Arrester is backed by a \$100 guarantee. Play safe! Accept no substitutes. Insist on a Brach.

*Listed by National Board of Fire Underwriters under Reexamination Service*

### OTHER BRACH RADIO PRODUCTS

- Complete Aerial Outfits*
- Shockproof Radio Plugs*
- Extension Cord Connectors*
- Brach-Stats*      *Solderall*
- Electric Soldering Irons*



**L. S. BRACH MFG. CO.**  
Newark, N. J.

Now is the time to subscribe for RADIO BROADCAST  
Through your dealer or direct, by the year only \$4.00

DOUBLEDAY, PAGE & CO.

GARDEN CITY, NEW YORK

## F. D. PITTS COMPANY

INCORPORATED

219-C Columbus Avenue, Boston, Mass., U. S. A.

*"Pioneers in the Distribution of Radio"*

DEALERS—Send for large and profusely illustrated catalog on the products of nationally advertised radio manufacturers.

MERCHANDISING RADIO SINCE 1919





**Oh boy**

**KESTER**  
Rosin Core  
**Radio SOLDER**  
Sure! is Safe and Simple

Approved by  
**Radio Engineers**  
A Genuine Solder

**CHICAGO SOLDER COMPANY**  
4222 Wrightwood Ave., Chicago, U. S. A.

Originators and  
World's Largest Manufacturers of  
Self Fluxing Solder

YOUR DEALER  
CAN SUPPLY YOU

# ELECTRAD

*New!*



**ELECTRAD**  
Heavy Duty Metallic Resistor

Specially developed for B eliminators and power supply units.

*Special features are:*

- 1—High current-carrying capacity.
- 2—Non-inductive. Accurate calibration.
- 3—Low temperature coefficient.
- 4—Resistance element fused to inside of Lavrock tube.
- 5—All standard high resistance sizes.

List price \$1.00; in Canada \$1.40

Ask your dealer for detailed Circular

**ELECTRAD, Inc.**

428 Broadway New York City

# ELECTRAD

*If you want real radio enjoyment—buy a Majestic! "B" current supply unit!*

A MAJESTIC will give you added volume—better tone. It will supply constant dependable power. Operates direct from your light socket at an average cost of only one-tenth cent an hour!

Majestic "B" Current Supply delivers pure, direct current from your light socket.

**Economical, Powerful**  
**Lasts as Long as Any**  
**Receiver**

Go to the dealer from whom you bought your set or any other reliable dealer and get a Majestic "B" Current Supply.

Attach it to your set. At the end of seven days if you are not fully satisfied, your money will be refunded by your dealer. Fully guaranteed. Its low purchase cost and the saving it will mean to you in just a few months make it an investment that soon pays for itself.

**GRIGSBY-GRUNOW-HINDS CO.**  
4570 Armitage Ave. Chicago, Ill.



**Majestic Standard "B"**  
for sets up to seven 201-A Type tubes or six 201 one power tube. Price \$32.50

**Majestic Super "B"**  
capacity 1 to 12 tubes, including the use of new power tubes. Price \$39.50

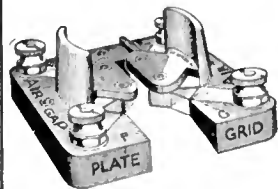

Type U. X. Universal  
Price 60c

They prevent closed circuit, absorption of current, intercoupling of circuits, feedback and undesirable capacity; making your set more stable, sharpening tuning, resulting in purer and clearer tones with more volume on local and distant stations.

Sent direct Post-paid if your Dealer cannot supply you

★ **AIRGAP PRODUCTS CO.**

9 Campbell Street

Newark, N. J.

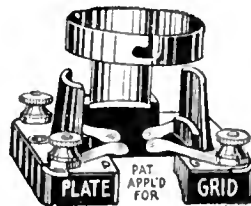

Type 201A  
Price 75c

AIRGAP Sockets will rid your set of those squawks, howls and frying noises due to socket capacity; they keep your grids negative, stabilizing your circuit causing tube to go into oscillations more smoothly and not "spilling over" until maximum results are attained

**The AIRGAP**  
**SOCKET**

music is a mystery, a baffling one, until it is once comprehended, when it becomes all very simple.

In his effort to make the book informal, Mr. Scholes has succeeded too well, and has sacrificed continuity and proper balance of material. It is a collection of miscellaneous chapters rather than a progressively developed unit. But this makes for easy reading as the volume may be picked up and begun anywhere.

An instance of the lack of balance is the far too great space devoted to opera. He gives it thirty pages and includes a lengthy catalogue of libretti. One of the most startling of contemporary phenomena is the absurdly inflated esteem that is accorded opera. The word is printed in large capitals and mentioned in reverent whispers as though it were the highest, greatest, and most noble manifestation of music. As a matter of fact, it is probably the lowest, and should occupy a niche only slightly above the cabaret song. There are good operas, but they are the ones that are never performed, or, if ever, only once or twice a season, and then to meager houses. We are of the opinion that a good opera would make very poor radio material; for, if it is truly good, the action and scenery is so wedded to the music and words as to be essential to a proper enjoyment. However, the operas that are regularly broadcast are probably improved by being shorn of their silly mummery. Mr. Scholes defends opera broadcasting on the ground that before long we shall have the action as well as the sound transmitted.

We should have liked to have seen Mr. Scholes devote more space to pounding in the fact that music is a self contained art. For it is ignorance of this fact that constitutes the most serious stumbling block to the would-be connoisseur. It is true of all the arts that this conception of "uniqueness" is the first barrier to be surmounted if further progress is to be made. While superficially the arts may seem to overlap, they are in their purest elements absolutely distinct. The masterpiece, in any one of the arts, is that work that most fully develops the possibilities of its own particular medium, and borrows the least from other mediums. Thus, to say that a painting has sculptural or musical or poetical values, is to damn it far more than to praise it.

The book takes up the various instruments of the orchestra and describes and illustrates each. There is an easily intelligible discussion of the "form" of music, and several chapters that aim to provide the reader with some standards of intelligent criticism. The devotee of jazz—good jazz—need have no fear that Mr. Scholes is going to deride him. Says the author, "If the cabaret song and the symphony are both good, then I am in favor of both. But if they are both bad, then I am against them both."

As successive subjects come up for discussion, the reader is referred to various books, all accessible in the public libraries, which discuss the subject at hand more fully. This greatly enhances the value of "Everybody's Guide to Radio Music," which, in its brevity and simplicity, makes no pretension to be more than an introduction to further study. And a stimulating and entertaining introduction it is.

JOHN WALLACE.

THE following books published by RADIO BROADCAST, Garden City, New York, are obtainable at \$1.00 each:

"RADIO BROADCAST's Knock-out Four-Tube Roberts Receiver."

"RADIO BROADCAST's Knock-out Reflex Receiver."

"How Radio Receivers Work," by Walter Van B. Roberts.

"How to Build the RADIO BROADCAST 'Aristocrat'" (Eight page booklet and set of three large blue prints).



# TOBE Now— A Better Resistor!



VACUUM TIPON  
LOEWE-LEAK

“The Changeless Resistor in a Vacuum”

Look for the TIPON. It is proof that the Resistor tube has been evacuated and sealed.

Noiseless, free from capacity effects and independent of moisture, the VACUUM TIPON LOEWE-LEAK is a better resistor, for use with detector tubes and in impedance and resistance-coupled audio.

The quality leak in the individual silvered, sealed package.

PRICES

10,000 ohms. .... \$1.00	1 megohm. .... \$ .50
50,000 ohms. .... .75	2 megohms. .... .50
1/10 megohm. .... .75	4 megohms. .... .50
1/4 megohm. .... .50	8 megohms. .... .75
1/2 megohm. .... .50	10 megohms. .... 1.00

Tobe Deutschmann Co.  
CORNHILL, BOSTON, MASS.

## FROST-RADIO

Type 700 Metal Frame Rheostats

To meet the requirements of new tubes an entirely different type of metal frame rheostat has been designed by FROST-RADIO engineers to give perfect output (volume) as well as filament control. Supplied in resistances from 2.5 to 75 ohms. Bakelite pointer knob; smooth acting lever; carries 25 to 50% overload without overheating. Ask your dealer to show you these new models. List: 50c.



HERBERT H. FROST, Inc.  
160 North LaSalle Street Chicago, Illinois  
New York City Los Angeles

## RADIO PANELS

OF GENUINE BAKELITE

Cut, drilled and engraved to order. Send rough sketch for estimate. Our New Catalog on Panels, Tubes and Rods—all of genuine Bakelite—mailed on request.

STARRETT MFG. CO.

521 S. Green Street Chicago, Ill.

## FOR CLEAR, QUIET “B” POWER



RADIO Storage “B” Battery

12 Cells 24 Volts Lasts Indefinitely—Pays for Itself Economy and performance unheard of before. Recharged at a negligible cost. Delivers untiring power that is clear, pure and quiet. Approved and listed as Standard by leading Radio Authorities, including Pop. Radio Laboratories, Pop. Sci. Inst. Standards, Radio News Lab., Lefax, Inc., and other important institutions. Equipped with Solid Rubber Case, an insurance against acid and leakage. Extra heavy glass jars. Heavy rugged plates. Order yours today!

SEND NO MONEY Just state number of batteries wanted and we will ship this day order to be received. Extra offer: 4 batteries in series (96 volts), \$11.50. Pay expressman after examining batteries. 5 per cent discount for cash with order. Mail your order now!

WORLD BATTERY COMPANY  
1219 So. Wabash Ave., Dept. 78 Chicago, Ill.  
Makers of the Famous World Radio “A” Storage Battery  
Prices: 6-cell, 100 Amp. \$11.25; 120 Amp. \$12.50; 140 Amp. \$14.00.  
All equipped with Solid Rubber Cases.

World STORAGE BATTERIES

Set your Radio Dials at 210 meters for the new 1000 watt World Storage Battery Station, WSBC, Chicago. Watch for announcements.

WKA-WFAF-WGN-WIS-KRZ-KGO-KFAF-WJY-KOP

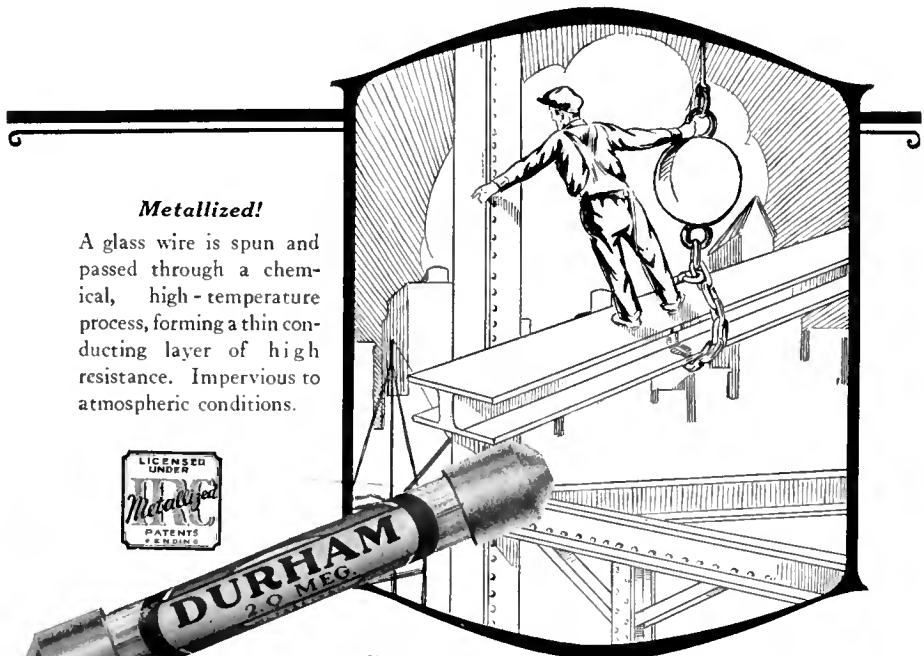

Metallized!

A glass wire is spun and passed through a chemical, high-temperature process, forming a thin conducting layer of high resistance. Impervious to atmospheric conditions.



# Permanence!

DURHAM Metallized RESISTORS

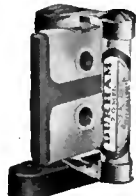

Durham Resistor Mounting

Made of moulded insulation of exceptionally high resistance. Has best quality, tension-spring, bronze contacts. The only upright mounting made. Occupies but little space in set.

Single mounting .... 50c.  
For condenser ..... 65c.

HUGE girders, held together by small rivets, make towering skyscrapers. Durham Metallized Resistors are the enduring link in radio receivers and associated apparatus. Made impervious to atmospheric changes. Permanent in resistance value—and necessary to good reception.

500 ohms to 10,000 ohms .....	\$1.00
Above 10,000 ohms to .24 meg.....	.75
.25 meg. to 10 meg. ....	.50

# DURHAM METALLIZED RESISTORS

International Resistance Co.  
Dept. D, Perry Building Philadelphia, Pa.

This is a good time to subscribe for

## RADIO BROADCAST

Through your dealer or direct by the year, only \$4.00

DOUBLEDAY, PAGE & CO.

GARDEN CITY, NEW YORK

## The Finishing Touch to the Home-Built Set

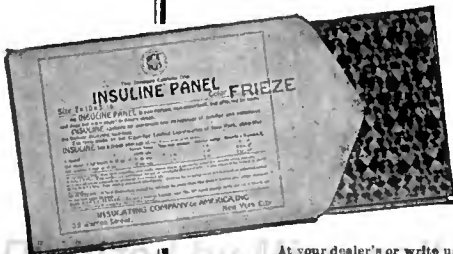

INSULINE

BAKELITE

## PANELS

These beautiful panels give your set a professional, “factory-built” appearance. Insuline may be had in Black, Mahogany and “Frieze” Finish; and Bakelite in Black, Mahogany and Walnut. Standard size blanks, easily worked with ordinary tools; or drilled and decorated for all popular circuits.

At your dealer's or write us direct. Don't take a substitute. Send for Free Booklet, Dept. B8. Insulating Co. of America, Inc. 59 Warren St., New York City

### Radio Shows for 1926

THE list printed below, of radio shows and conventions scheduled to take place this year, has been compiled with the aid of information supplied through the courtesy of *The Radio Dealer*. Full information concerning the various shows may be obtained by addressing the secretaries, whose names and addresses are included in the list.

**AKRON, OHIO**

SEPT. 15-18. Akron Radio Show. Auspices Radio Dealers Association and *Times-Press*. George Missig, Secretary, *Times-Press*, Akron, Ohio.

**BOSTON, MASSACHUSETTS**

SEPT. 27-OCT. 2. Boston Radio Exposition, Mechanics Building. Sheldon Fairbanks, Manager, 209 Massachusetts Avenue, Boston, Massachusetts.

**BROOKLYN, NEW YORK**

OCT. 30-Nov. 6. Third annual Brooklyn Radio Exposition, 23rd Regiment Armory. Stephen T. Rogers, Managing Director. Suite 513, Albee Building, Brooklyn, New York.

**CHICAGO, ILLINOIS**

SEPT. 27-OCT. 2. Second Allied Radio Congress and National Radio Exposition, Exhibition Hall, Hotel Sherman, Chicago. Milo E. Westbrooke, Manager, 440 South Dearborn Street, Chicago, Illinois.

OCT. 11-17. Fifth Annual Chicago Radio Show, Coliseum. Radio Manufacturers Show Association 127 North Dearborn Street, Chicago, Illinois.

**CLEVELAND, OHIO**

SEPT. 20-26. Cleveland Radio Industries Exposition. Public Auditorium. George B. Bodenhoff, Manager, 511 Guarantee Title Building, Cleveland, Ohio.

**DETROIT, MICHIGAN**

OCT. 25-31. Detroit Radio Show, Convention Hall. Auspices Radio Trade Association of Michigan. A. M. Edwards, Secretary, 4464 Cass Avenue, Detroit, Michigan.

**INDIANAPOLIS, INDIANA**

OCT. 25-30. Second Annual Indianapolis Radio Exposition, State Fair Grounds. Auspices Broadcast Listeners' Association. A. J. Allen, Secretary, 1406 Merchants' Bank Building, Indianapolis, Indiana.

**LOS ANGELES, CALIFORNIA**

SEPT. 5-11. Los Angeles Radio Exposition, Ambassador Auditorium, Auspices Radio Trades Association of Southern California. A. G. Farquharson, Secretary, 515 Commercial Exchange Building, Los Angeles, California.

**MILWAUKEE, WISCONSIN**

SEPT. 25-29. Fourth Wisconsin Radio Exposition and Convention, Auditorium, Milwaukee. N. C. Beerend, Manager, P. O. Box 1005, Milwaukee, Wisconsin.

**MINNEAPOLIS, MINNESOTA**

SEPT. 27-OCT. 2. Northwest Radio Exposition, Kenwood Armory and Coliseum, Minneapolis. Harry H. Cory, Executive Secretary, 301 Tribune Annex, Minneapolis, Minnesota.

**NEW YORK CITY, NEW YORK**

SEPT. 13-18. Third Annual Radio World's Fair, New Madison Square Garden, New York City. Radio Manufacturers' Show Association, 611 Times Building, New York City.

A Universal Range Variable Resistor

# CLAROSTAT

Endorsed and Used by:



\$2.25

Maximum Capacity  
20 Watts

- Acme Apparatus
- All American
- Dongan Elect.
- General Radio
- Grigsby-Grunow-Hinds
- Jefferson Elect.
- Kokomo Elect.
- Mayolian
- Raytheon
- Modern Elect.
- Silver Marshall
- Sterling Mfg.
- Storad Radio
- Thordarson
- Webster Co.
- Zenith

★ *Modulation, Oscillation, Regeneration, Grid and Voltage control — all covered in interesting booklet sent upon receipt of 4c in stamps. Address Dept. R. B.*

American Mechanical Laboratories, Inc.  
285 N. 6th St., Brooklyn, N. Y.

## Thorola Receivers and Speakers

★ **Must Outperform** ★

Reichmann Company, 1725-39 W. 74th St., Chicago

# RAYTHEON

For Reliable Reception



## Cardwell Condensers

**OVER THE POLE!**

WHERE the failure of a single instrument might mean disaster, unusual care is exercised. So Cardwell Condensers were used in all the Radio apparatus built especially for Commander R.E. Byrd.

Straight frequency!  
Concentric! Compact!  
Rugged!

The Taper Plate Type "E"

Modified Straight Wave Length type "C" for more long wave separation

PRICES:			
425-C	102E	0005	\$5.00
171-C	150E	00015	\$4.75
170-C	168E	00025	\$4.25
166-C	167E	00015	\$4.00

The Allen D. Cardwell Manufacturing Corp.  
81 Prospect Street - Rosklyn, N. Y.

"THE STANDARD OF COMPARISON"

DD-18—Includes the NATIONAL Equicycle (straight line frequency) Condenser and the genuine BROWNING-DRAKE Inductance Coil with the new Type B Dial. Price \$10.25.

**The New NATIONAL Tuning Units**

Comprising the genuine BROWNING-DRAKE SPACE WOUND TRANSFORMER and the NATIONAL Velvet Vernier Dials and Condensers

Are now in the hands of your dealer. Their beauty and efficiency will greatly surprise you. See them at your dealer's. Send for Bulletin 105 R. B.

NATIONAL COMPANY, Inc.  
W. A. Ready, Pres., 110 Brookline St., Cambridge, Mass.

DD-20—Includes the NATIONAL Equicycle (straight line frequency) Condenser and the genuine BROWNING-DRAKE Transformer with the new Type B Dial. Price \$13.75.

Solves all Radio Troubles

# RADIO WORLD

is the only National Illustrated Radio weekly, 15c a copy. All newsdealers \$6 yearly (52 issues); \$3 six months; \$1.50 three months.

Every Issue Contains Special Articles by Experts—Many Illustrations, Including Diagrams—Up-to-date List of Stations—Cures for Radio Troubles—Radio University; Great Question and Answer Dept.—RADIO WORLD'S "Diamond of the Air" has swept the country. Special Booklet and Blueprint sent for 50c.—All the News of the Art, Science and Business of Radio, Weeks Ahead of the Monthly Radio Magazines.

**SPECIAL TO RADIO BROADCAST READERS**

Send \$1 and receive a trial subscription of ten issues.

**Special Offer Subscription Blank**

Radio World, 145 W. 45th St., N. Y.

Send me RADIO WORLD for 10 weeks for enclosed \$1.00.

Name.....  
Street.....  
City and State.....

PITTSBURGH, PENNSYLVANIA

OCT. 4-9. Pittsburgh Radio Show. James A. Simpson, Managing Director, 420 Bessemer Building. Pittsburgh, Pennsylvania.

PORTLAND, OREGON

SEPT. 20-25. Pacific Northwest Radio Exposition, Public Auditorium. George J. Thompson, Jr., Secretary, 411 Journal Building, Portland, Oregon.

ROCHESTER, NEW YORK

OCT. 11-16. Rochester Radio Show, Convention Hall. Auspices Rochester Radio Dealers Association, Rochester, New York.

ST. LOUIS, MISSOURI

OCT. 18-23. Second Southwest National Radio Show, New Coliseum, St. Louis. Auspices St. Louis Radio Trades Association. William P. Mackle, Executive Secretary, 1207 Syndicate Trust Building, St. Louis, Missouri.

SAN FRANCISCO, CALIFORNIA

AUG. 21-28. Pacific Radio Exposition, Civic Auditorium, San Francisco. Pacific Radio Trade Association, 905 Mission Street, San Francisco, California.

SIoux FALLS, SOUTH DAKOTA

OCT. 26-29. Sioux Falls Radio Show, Coliseum. Auspices Civic Club. Roger S. Brown, Secretary, Sioux Falls, South Dakota.

Canadian Trade Shows

MONTREAL, QUEBEC

OCT. 4-9. Montreal Radio Show, Windsor Hotel. Auspices Canadian Exhibition Co., 204 East King Street, Toronto, Canada.

TORONTO, ONTARIO

OCT. 25-30. Toronto Radio Show, Coliseum, Canadian National Exhibition Grounds. Auspices Canadian Exhibition Co., 204 East King Street, Toronto, Canada.

WINNIPEG, MANITOBA

SEPT. 13-18. Winnipeg Radio Show, Royal Alexandria Hotel. Auspices Canadian Exhibition Co., 204 King Street, East, Toronto, Canada.

Conventions

DETROIT, MICHIGAN

OCT. 25-31. State Radio Dealer Convention. Auspices Radio Trade Association of Michigan, Convention Hall, Detroit. A. M. Edwards, Secretary, 4464 Cass Avenue, Detroit, Michigan.

MILWAUKEE, WISCONSIN

SEPT. 27-28. Wisconsin Radio Trade convention, Auditorium, Milwaukee. N. C. Beerend, Manager, P. O. Box 1005, Milwaukee, Wisconsin.

ST. LOUIS, MISSOURI

OCT. 18-23. Jobbers and Dealers Convention. Southwestern states. Auspices St. Louis Radio Trades Association. William P. Mackle, Executive Secretary, 1207 Syndicate Trust Building, St. Louis, Missouri.

For Better Radio  
**Hammarlund**  
PRECISION  
**PRODUCTS** ★

Send 10 cents for illustrated booklet, "How to Build the Hammarlund-Roberts Receiver"

**HAMMARLUND MANUFACTURING CO.**  
424-438 West 33rd Street New York City

Why not subscribe to *Radio Broadcast*? By the year only \$4.00; or two years, \$6.00, saving \$2.40. Send direct to Doubleday, Page & Company, Garden City, New York.

IMPOSSIBLE!

SUCH, probably, would be your reply to neighbor Smith, were he, on the morrow, to challenge you with a hearty "Old man—I bagged sixteen stations in three minutes last night."

"The 'ARISTOCRAT,'" he replies to your natural inquiry.

"But—"

"A single control affair," he adds, hardly giving you a chance to get a word in edgeways. "Pulls 'em in like hot cakes, and quality, oh boy! We hardly care to chronicle Smith's remarks, so colloquial does he wax in his enthusiasm, as he relates how his 'ARISTOCRAT' brings in 'Animal Crackers,' 'Gimme a Little Kiss, Willya, Huh?,' 'Valencia,' etc., at least six times as loud as Jones is able to bring in Rimsky Korsakov's 'Scheherazade' on his eight-tube super.

When the "ARISTOCRAT" was first described in *RADIO BROADCAST*, some 150 newspapers all over the country published the circuit diagram with constructional details, in their editorial columns. Smith was no doubt one of the many who became interested in the description of this receiver as presented in his local *Gazette*, but, lacking the necessary technical knowledge to build the receiver from the schematic diagram, he was delighted to learn that blue prints of this receiver were obtainable from *RADIO BROADCAST* for \$1.00 the set of three exceptionally large ones. So explicit are these blue prints that even the veriest of potential radio set constructors need not fear meeting with trouble in constructing the "ARISTOCRAT" from them. Technical knowledge is not at all necessary if you wish to build this receiver.

The "ARISTOCRAT" is a five-tube receiver which is tuned by one main control and consists of one stage of tuned, neutralized radio frequency amplification, a regenerative detector, and three stages of resistance-coupled audio frequency amplification. It is the very latest edition of the famous "Knockout" receiver which is still enjoying universal popularity. Due to the neutralized feature the "ARISTOCRAT" will not radiate and interfere with your neighbor's reception, and is remarkably selective. During an actual test, sixteen different broadcasting stations were received within three minutes by turning a single dial.

Send \$1 for blueprints and interesting booklet to Booklet Dept. *RADIO BROADCAST*, Garden City, N. Y.

SERVICES

The Laboratory Service of *RADIO BROADCAST* can help you. When writing for technical information or in relation to our set repair service, please use the proper coupon below.

REPAIR SERVICE BLANK

Repair and Service Department  
*RADIO BROADCAST* Laboratory,  
Garden City, New York

GENTLEMEN:  
I am enclosing with this blank, a letter to the Repair and Service Department, *RADIO BROADCAST* Laboratory. I am not forwarding my receiver at this time but I desire to submit a receiver, which is a..... described in *RADIO BROADCAST*, for.....

Repair  
 Overhauling  
 Rewiring  
 Inspecting and Test  
.....  
.....

Name.....  
Address.....

TECHNICAL INFORMATION INQUIRY BLANK

Technical Service,  
*RADIO BROADCAST* Laboratory,  
Garden City, New York

GENTLEMEN:  
Please give me fullest information on the attached questions. I enclose a stamped addressed envelope.

I am a subscriber to *RADIO BROADCAST*, and therefore will receive this information free of charge.  
 I am not a subscriber and enclose \$1 to cover cost of the answer.

Name.....  
Address.....



**COMPLETE  
CONDENSER SERVICE  
FOR  
MANUFACTURERS**



**The Faradon No. 3700 Quality  
Line is Complete**

These accurately rated high factor of safety condensers are available for manufacturers to suit individual requirements:—

- As separate units with tabs for special grouping.
- As grouped units ready for insertion in containers.
- As completely cased blocks, tapped as desired.

**Inquiries Requested**

Send sketch showing connections and capacities of units. Advise Flash Test and Operating Voltage requirements and space available.

**Quotations Furnished Promptly** ★

Also By-Pass units in 1/2, 1, and 2 Mfd.

**Wireless Specialty Apparatus Co.**  
Jamaica Plain Boston, Mass.  
*Established 1907*



—a tinned, copper bus bar wire with non-inflammable "spaghetti" covering, for hook-ups. 5 colors; 30-inch lengths.  
We also offer the highest grade of "spaghetti" tubing for Nos. 10 to 18 wires. 5 colors; 30-inch length.

**Flexible Celatsite**

Flexible, stranded wire for point-to-point and sub-panel wiring. Non-inflammable "spaghetti" covering. In black, yellow, green, red and brown; a color for each circuit. Put up in 25-foot coils.

**Celatsite Battery Cable**

—a silk-covered cable of varicolored Flexible Celatsite wires, for connecting batteries to set. Prevents "blowing" of tubes; gives your set an orderly appearance.

**Stranded Enameled Antenna**

Best outdoor antenna you can buy. 7 strands of enameled copper wire; maximum surface for reception. Prevents corrosion and consequent weak signals.

Send for folder

**THE ACME WIRE CO., DEPT. B  
NEW HAVEN, CONN.**



**WHAT OUR  
READERS WRITE**



*The Naval Research Laboratory Replies to Professor Morecroft*

IN THE JUNE RADIO BROADCAST, Professor Morecroft remarked upon certain newspaper articles which purported to have resulted from an interview with Dr. H. C. Hayes, of the Naval Research Laboratory, and which claimed for the Naval Laboratory the invention of the transmission of ultra-audible sound waves through water. Professor Morecroft wrote as follows: "... During the war, a group of scientists, principally from Columbia University, was assigned the problem of ultra-audible sound, and in the Navy files are complete accounts of all the properties now hailed as inventions of the Naval Research Laboratory. Those scientists were sworn to secrecy by the Naval authorities on all the work they had done, or the scientific journals would have received authentic reports of this fascinating branch of acoustics." Here is a letter from Doctor Hayes in reply:

Editor, RADIO BROADCAST,  
Doubleday, Page & Company,  
Garden City, New York.

SIR:

The article "Something about Supersonics," published in the June number of RADIO BROADCAST, calls for reply out of fairness to the Naval Research Laboratory and its staff. Had it been written by a newspaper reporter as a result of an interview with Professor Morecroft, we should know that its statements contain more of fancy than of fact, and would reserve our comment.

We have not seen the newspaper articles in question but are willing to believe they are typical, in that the reporter has used the facts given to him as a basis for a "story" which makes the scientist interviewed the hero and which is discolored and distorted by the writer's imagination so as to give a false impression, if indeed, it gives any clear and definite impression at all. We will say in defense that the interview which led to these news articles was granted contrary to our recommendations, and the reporters were only given certain general facts that were already somewhat widely known. We stated clearly that other scientists in England, France, and the United States had helped to develop the subject during the past ten years, but we scrupulously avoided crediting individuals, ourselves included, for fear that someone might be slighted or wholly overlooked.

We, too, are sworn to secrecy, and we made an honest effort to tell the reporters nothing of value and to do this in a way that would not be unfair to others. We did not write the articles or have an opportunity to correct them before they were published. If they convey the impression that we claim the whole or any major part of the credit for developing the "supersonics," they do so without our consent. We do not make such claims and never have.

We know that most of the credit for developing the supersonics should, and eventually will, go to foreign scientists, and we are convinced that Professor Morecroft knows this as well as we do. It is, therefore, inconsistent, to say the least, that he should criticize us for assuming such credit and in the next paragraph claim this credit for the Columbia University scientists "principally."

Very truly yours,  
H. C. HAYES,  
Physicist, U. S. N.,  
Naval Research Laboratory.



★  
**Noiseless-  
full radio power  
from the  
light socket with  
Balkite "B" & Balkite  
Battery Charger**

**FANSTEEL PRODUCTS CO., Inc.**  
North Chicago, Illinois

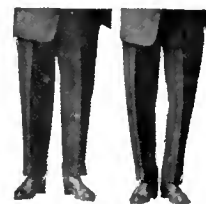

**Bow Legs and Knock  
Knees Unsightly**

Those afflicted with BOW LEGS should wear the "PERFECT LEG FORMS" and overcome this deformity. Trousers hang perfectly straight. Made of the highest grade Aluminum. Sanitary, light, and durable. Easy to put on or off. Send for booklet showing photos of men with and without the "PERFECT LEG FORMS".  
**PERFECT SALES CO.** Dept. 68  
140 N. Mayfield Ave., Chicago, Ill.

**To Roberts Knockout Fans**

Do you know that we have published two books on the Roberts Knockout Receivers? One is a treatise containing all the articles printed, and the other is just one article with complete blue prints on how to build this wonderful receiver. Price one dollar each. Write to Booklet Dept., Radio Broadcast, Garden City, N. Y.

**See That Screw** ↓

A screw-driver adjusts an X-L in crowded places



**X-L  
VARIO  
DENSER**

★  
**RESULTS** in easier tuning, more distance, R volume and clarity—greater stability. Indorsed by leading authorities.

**Model "N"** A slight turn obtains correct tube oscillation on all tuned radio frequency circuits. Neurodyne, Roberts two tube, Browning-Drake, McMurdo Silver's Knockout, etc., capacity range 1.8 to 20 micro-microfarads. **Price \$1.00**

**Model "G"** With grid clips obtains the proper grid capacity on Cockaday circuits, filter and intermediate frequency tuning in heterodyne and positive grid bias in all sets. Capacity range .00016 to .00055 and .0003 to .001 microfarads. **Price \$1.50**

**X-L Push Post.** Push it down with your thumb, insert wire, remove pressure and wire is firmly held. Releases instantly. **Price 15c.**

**Push Post Panel** permanently marked in white on black rubber. In box including soldering lugs, raising hushings and screws for mounting, etc. **Price, \$1.50**

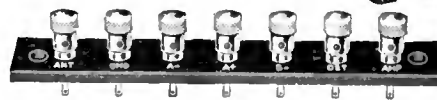

**X-L RADIO LABORATORIES**  
2424 Lincoln Avenue Chicago, Ill.

# AMSCO

FOR EXCELLENCE

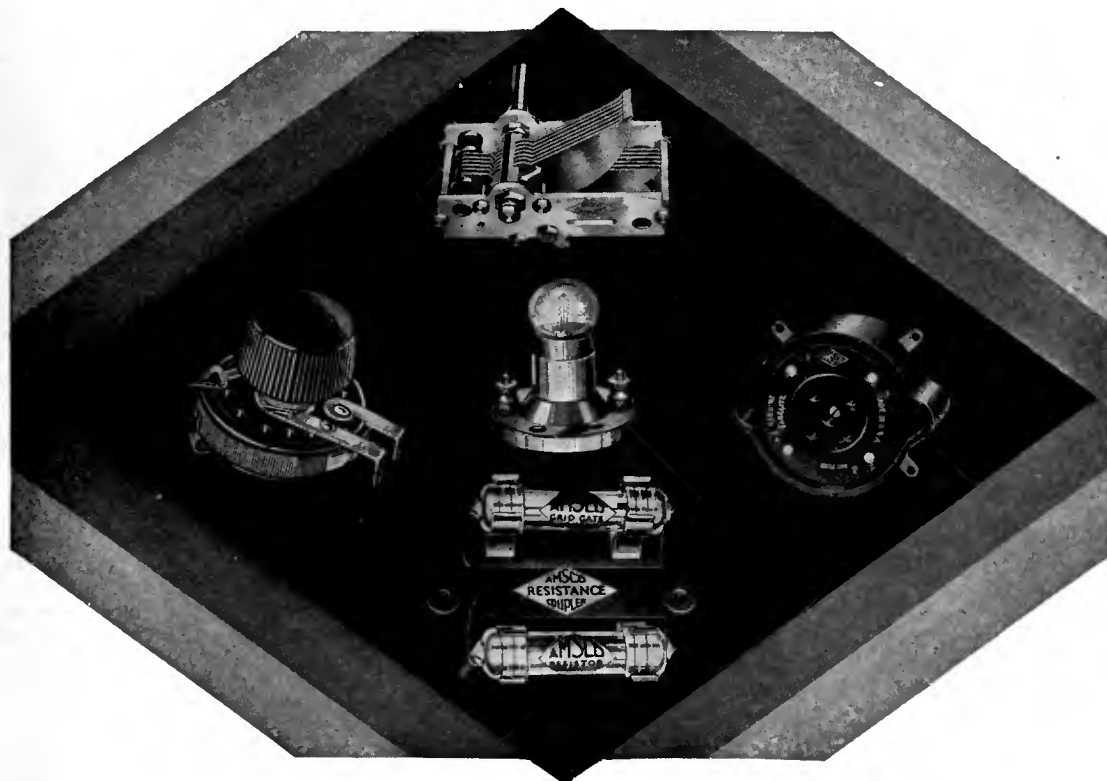

# NEW!

AMSCO Announces new apparatus of new electrical and mechanical perfection for the new Radio year of 1926-27.

- ALLOCATING CONDENSERS . . . . .  
*Spread the stations with engineering precision*
- METALOID GRID GATES . . . . .  
*Superseding grid leaks*
- METALOID RESISTORS . . . . .  
*Stable, Silent and Sure*
- RESISTIVE COUPLING AMPLIFIER UNITS . . . . .  
*Most Compact and Efficient*
- AMSCO FILATROLS . . . . .  
*Perfected Automatic Rheostats*
- AMSCO FLOATING SOCKETS . . . . .  
*Non-microphonic at last*
- AMSCO TOM THUMB RHEOSTATS . . . . .  
*The midgets for giant performance*

Ask your dealer or write for particulars

AMSCO PRODUCTS, Inc.  
Broome & Lafayette Streets, N. Y. C.  
*Exhibitors: New York and Chicago Radio Shows*



Digitized by Microsoft®

★ Tested and approved by RADIO BROADCAST ★