

# RADIO BROADCAST

WILLIS K. WING, Editor

JULY, 1926

KEITH HENNEY  
Director of the Laboratory

JOHN B. BRENNAN  
Technical Editor

Vol. IX, No. 3

## CONTENTS

|   |     |
|---|-----|
| Cover Design . . . From a Painting by Fred J. Edgars                                  |     |
| Frontispiece Receiving "Photoradiograms" in London                                    | 206 |
| Looking Ahead to 1927 . . . . . Zeh Bouck   | 207 |
| The March of Radio . . . . . J. H. Morecroft  | 211 |
| Wavemeters for the Home Laboratory Keith Henney                                       | 216 |
| Series and Parallel Connection of Condensers and Resistances . . . . . Homer S. Davis | 222 |
| A High Quality Amplifier . . . Arthur H. Lynch  | 224 |
| Improving the Popular Hammarlund-Roberts Receiver<br>John B. Brennan                  | 228 |
| Where Summer Static Comes From<br>B. Francis Dashiell                                 | 232 |
| The Listeners' Point of View . . . John Wallace                                       | 236 |
| The Lightning Arrester . . . H. Melchior Bishop                                       | 241 |
| "As the Broadcaster Sees It" . . . Carl Dreher  | 243 |
| Drawings by Stuart Hay  |     |
| Tendencies in Modern Receiver Design<br>Julius G. Aceves                              | 248 |
| The "Radio Broadcast" Laboratory Information<br>Sheets . . . . .                      | 258 |
| No. 9. Data on the Roberts Four-Tube Receiver   |     |
| No. 10. The Four-Tube Roberts Circuit Diagram   |     |
| No. 11. The ux-200-A Tube   |     |
| No. 12. The ux-171 Tube   |     |
| No. 13. Charging Storage Batteries on Direct Current                                  |     |
| No. 14. Dry A Batteries   |     |
| No. 15. Loop Antennas   |     |
| No. 16. Carrier Wave Analysis   |     |
| "Now, I Have Found" . . . . .   | 263 |
| Verniers and Their Application to Radio   |     |
| A Lateral Basketweave Form  |     |
| Controlling Regeneration in the "Universal"   |     |
| Loud Speaker Comparison   |     |
| A Constant Non-Inductive Resistance Unit  |     |
| An Easy Method of Doping Solenoids  |     |
| Two Ways of Mounting Crystals   |     |
| Improvising Your Own Bus Bar  |     |
| How the Patentee Is Covered by Law Leo T. Parker                                      | 266 |
| Frequency Channels Used by U. S. Radio Stations                                       | 267 |
| Adapting the Roberts for Long Waves C. A. Oldroyd                                     | 268 |
| The "Radio Broadcast" Laboratory Service . . . . .                                    | 270 |
| A Key to Recent Radio Articles E. G. Shalkhauser                                      | 272 |
| Letters from Readers . . . . .  | 277 |

## BEHIND EDITORIAL SCENES

FOR those who have been wondering, "Whither is radio design going?" several of the articles in this issue should prove especially interesting. Mr. Zeh Bouck's leading article, for example, shows how the newest products of the manufacturers—which were announced in time to be included in his story—are meeting the new trends in radio design. Professor Morecroft in his always interesting "March of Radio" sketches some of the important engineering problems which are to be met. And in the paper by Mr. Aceves, one finds an extremely good outline of the technical trend of radio receiver design in recent months. So the July issue is really a forecast number—what to expect in receiver design.

ZEH BOUCK, author of the leading article, is well known to old readers of RADIO BROADCAST. For a long time he conducted the department, "In the R. B. Lab." He is now preparing a series of constructional articles which are more than interesting. We shall have something to say about that in a later number. Keith Henney's article on "Wavemeters for the Home Laboratory," besides showing the many valuable uses of simple wavemeters, tells something about the use of quartz crystal oscillators. So many experimenters are interested in the uses of quartz and the information is timely.

ARTHUR LYNCH'S article describing the construction of a high quality amplifier and power supply will interest those who seek good quality and a way to make their 110-volt a. c. work for them. . . . How many thousands of our readers have built the Hammarlund-Roberts, we do not know, but it is certain that the article on page 228, sketching important, and for the most part, extremely simple improvements in that set, will interest them extremely.

Also, there is the interesting story by Mr. Dashiell on where summer static comes from, and a companion story by Mr. Bishop, describing the installation and use of the lightning arrester. Lightning and static are not to be feared, once we know both ogres for what they are.

ANOTHER Radio Club paper will appear in the August RADIO BROADCAST, one by A. F. Van Dyck, an engineer of the Radio Corporation. The story deals with modern radio and the electrical phonograph. We shall soon publish a story about A batteries. They are not always what they seem, and we learn from this article what to buy and how to avoid being deceived. A host of interesting material for the set constructor, the general technician, and the casually interested radio person will be found in the August RADIO BROADCAST.

### Doubleday, Page & Co. MAGAZINES

COUNTRY LIFE  
WORLD'S WORK  
GARDEN & HOME BUILDER  
RADIO BROADCAST  
SHORT STORIES  
EDUCATIONAL REVIEW  
L'E PETIT JOURNAL  
EL ECO  
THE FRONTIER  
WEST

### Doubleday, Page & Co. BOOK SHOPS

(Books of all Publishers)  
NEW YORK: LORD & TAYLOR BOOK SHOP  
PENNSYLVANIA TERMINAL (2 SHOPS)  
38 WALL ST. AND 166 WEST 32ND ST.  
GRAND CENTRAL TERMINAL  
ST. LOUIS: 223 NORTH 8TH STREET  
4914 MARYLAND AVENUE  
KANSAS CITY: 1920 GRAND AVENUE  
CLEVELAND: 1306 WEST 47TH STREET  
HIGGEE CO.  
SPRINGFIELD, MASS.: MEEKINS, PACKARD & WHEAT

### Doubleday, Page & Co. OFFICES

GARDEN CITY, N. Y.  
NEW YORK: 285 MADISON AVENUE  
BOSTON: TREMONT BUILDING  
CHICAGO: PEOPLES GAS BUILDING  
SANTA BARBARA, CAL.  
LONDON: WM. HEINEMANN, LTD.  
TORONTO: OXFORD UNIVERSITY PRESS

### Doubleday, Page & Co. OFFICERS

F. N. DOUBLEDAY, President  
A. W. PAGE, Vice-President  
NELSON DOUBLEDAY, Vice-President  
RUSSELL DOUBLEDAY, Secretary  
S. A. EVERITT, Treasurer  
JOHN J. HESSIAN, Asst. Treasurer

DOUBLEDAY, PAGE & COMPANY, Garden City, New York

Copyright, 1926, in the United States, Newfoundland, Great Britain, Canada, and other countries by Doubleday, Page & Company. All rights reserved.

TERMS: \$4.00 a year; single copies 35 cents.

# Patent Information

*furnished by* Radio Corporation of America

Many inquiries are made in respect to the patent situation on vacuum tubes, such as are used for radio purposes. The Radio Corporation of America takes this method of answering these inquiries and states that there are numerous patents under which its tubes are manufactured and sold. Among these patents, not excluding others, are the following:

- |                                      |  |
|--------------------------------------|--|
| 921,526, May 11, 1909, Eisenstein    | 1,316,967, Sept. 23, 1919, Moore           |
| 954,619, Apr. 12, 1910, Fleming      | 1,329,283, Jan. 27, 1920, Arnold           |
| 982,873, Jan. 31, 1911, Regenstreif  | 1,341,006, May 25, 1920, Babcock           |
| 1,022,182, Apr. 2, 1912, Dempster    | 1,353,976, Sept. 28, 1920, Stoekle         |
| 1,032,476, July 16, 1912, Fagan      | 1,354,939, Oct. 5, 1920, Arnold            |
| 1,066,468, July 8, 1913, Chubb       | 1,374,679, Apr. 12, 1921, Pratt            |
| 1,082,933, Dec. 30, 1913, Coolidge   | 1,398,665, Nov. 29, 1921, Arnold           |
| 1,105,050, July 28, 1914, Whitney    | Re-15,278, Jan. 31, 1922, Langmuir         |
| 1,113,745, Oct. 13, 1914, Blow       | 1,409,658, Mar. 14, 1922, Brann            |
| 1,116,595, Nov. 10, 1914, Knight     | 1,423,956, July 25, 1922, Mitchell & White |
| 1,124,555, Jan. 12, 1915, Thatcher   | 1,423,957, July 25, 1922, Mitchell & White |
| 1,140,134, May 18, 1915, Eldred      | 1,444,438, Feb. 6, 1923, White             |
| 1,140,136, May 18, 1915, Eldred      | 1,456,505, May 29, 1923, Knoop             |
| 1,154,081, Sept. 21, 1915, Weintraub | 1,456,528, May 29, 1923, Arnold            |
| 1,180,264, Apr. 18, 1916, Lederer    | 1,461,360, July 10, 1923, Lederer          |
| 1,191,630, July 18, 1916, Weintraub  | 1,464,104, Aug. 7, 1923, Nicolson          |
| 1,196,744, Aug. 29, 1916, Chubb      | 1,472,477, Oct. 30, 1923, King             |
| 1,203,495, Oct. 31, 1916, Coolidge   | 1,477,868, Dec. 18, 1923, Donle            |
| 1,204,456, Nov. 14, 1916, Knight     | 1,477,869, Dec. 18, 1923, Donle            |
| 1,209,324, Dec. 19, 1916, Nicolson   | 1,478,072, Dec. 18, 1923, Van der Bijl     |
| 1,231,764, July 3, 1917, Lowenstein  | 1,479,778, Jan. 1, 1924, Van der Bijl      |
| 1,244,216, Oct. 23, 1917, Langmuir   | 1,480,219, Jan. 8, 1924, Nicolson          |
| 1,244,217, Oct. 23, 1917, Langmuir   | 1,498,908, June 24, 1924, Fink             |
| 1,268,647, June 4, 1918, Van Keuren  | 1,506,468, Aug. 26, 1924, White            |
| 1,266,394, Dec. 3, 1918, Northrup    | 1,529,597, Mar. 10, 1925, Langmuir         |
| 1,287,265, Dec. 10, 1918, Dushman    | 1,531,966, Mar. 31, 1925, Mackay           |
| Re-14,572, Dec. 17, 1918, Nicolson   | 1,536,855, May 5, 1925, Houskeeper         |
| 1,293,781, Feb. 11, 1919, Hoyt       | 1,558,436, Oct. 20, 1925, Langmuir         |
| 1,294,694, Feb. 18, 1919, Nolte      | 1,558,437, Oct. 20, 1925, Langmuir         |
| 1,303,579, May 13, 1919, Nicolson    | 1,565,857, Dec. 15, 1925, Kelly            |
| 1,307,510, June 24, 1919, Nicolson   |  |

To enforce the rights secured by these patents, suits have been brought and are now pending on the following patents included in the above list:

- |                       |                             |
|-----------------------|-----------------------------|
| 1,558,436, Langmuir   | 1,529,597, Langmuir         |
| 1,082,933, Coolidge   | 1,341,006, Babcock          |
| 1,231,764, Lowenstein | 1,423,956, Mitchell & White |
| 1,244,216, Langmuir   | 1,423,957, Mitchell & White |
| 1,244,217, Langmuir   | Re-15,278, Langmuir         |



*Suits on other patents in the above list are in preparation and such further steps as may in the future be deemed necessary will be taken to fully enforce the rights which these patents grant.*

# Radio Corporation of America



*RECEIVING TRANSATLANTIC PHOTOGRAPHS IN LONDON*

*Captain R. H. Ranger, of New York, who developed the "photoradiogram" transmitter for the Radio Corporation of America. The apparatus shown is the receiver. During the recent British general strike, its progress was shown by snapshots made in London, radioed to New York, and printed in newspapers, in some cases not more than twelve hours after they were taken*

# RADIO BROADCAST

VOLUME IX



NUMBER 3

JULY, 1926

## Looking Ahead to 1927

*How the New Tubes Will Affect Design and Be the Cause of Improved Quality—The Advent of the High-Voltage Line-Supply Unit—Better Loud Speakers and Audio Stage Resistance Units*

By ZEH BOUCK

**E**VER since those far-off days when fanfares of trumpets celebrated the sending of the letter "S" across the Atlantic Ocean, the attention of the radio engineer and designer has been devoted to increasing the sensitivity of his apparatus, and his problem has been to receive more distant signals. It has only been during the most recent years of the broadcasting era, however, that more than just passing attention has been devoted to improving the quality of reproduction of the average receiver.

Several factors have combined to bring about this alienation from an old ideal. First of all, there is the realization that increasing the sensitivity of a receiver beyond definite limits has the effect of raising the noise level (bringing in those parasitic strays of static, doorbell radiations, and the like), with a volume that is uncomfortably out of proportion to the true ratio of stray energy to average signal strength.

Super-power transmission has also served to subdue that perpetual inquiry into the nature of greater sensitivity by demonstrating a logical method of providing adequate signal strength on distant stations with an effective reduction of the noise level. The idea is a very simple one, and consists merely of putting more power into a signal than chance puts into strays. Another important factor in this mild revolution in radio development is the very much improved quality of local

programs, with the consequent lessened excuse for distance angling.

RADIO BROADCAST took the initial step toward quality reproduction in presenting the first resistance-coupled audio amplifier to the public, in May, 1924.

Since that time, the emphasis has been placed more and more on quality while less attention has been paid to other considerations. The most recent appreciation of this new point of view is reflected in the power tubes brought out by the Radio Corporation, Cunningham, and other organizations.

Like super-power, the power tube was a logical development in radio progress. It is impossible, regardless of the excellence

of one's amplifier, loud speaker, and associated apparatus, to obtain quality if the tubes distort. All tubes, under certain battery and load conditions, can output just so much audio frequency power without the strains, twists, and stresses we know as distortion. In the case of the average listener, the signal intensity demanded from his amplifier is in excess of the distortionless capacity of the 201-A type of tube.

Fundamentally, there is one way of increasing the audio frequency power variations a tube can handle without distortion, and that is by the simple expedient of raising the plate voltage with corresponding C battery changes.

In addition to "straightening out the characteristic curve of the tube,"—which is another way of saying that the power-handling ability of the tube has been increased, raising the plate voltage tends to improve the impedance relationship between the tube and its "load," the loud speaker. Thus, bringing up the plate voltage of an audio amplifying tube is in the nature of a cure-all for distorting ills.

However, it becomes necessary to design tubes capable of withstanding the strains imposed by these high plate voltages, and at the same time it is desirable to incorporate other modifications which, often reducing the voltage amplification, increase the ability of the tube to handle power.

Quite logically, the power handled in an amplifier in-

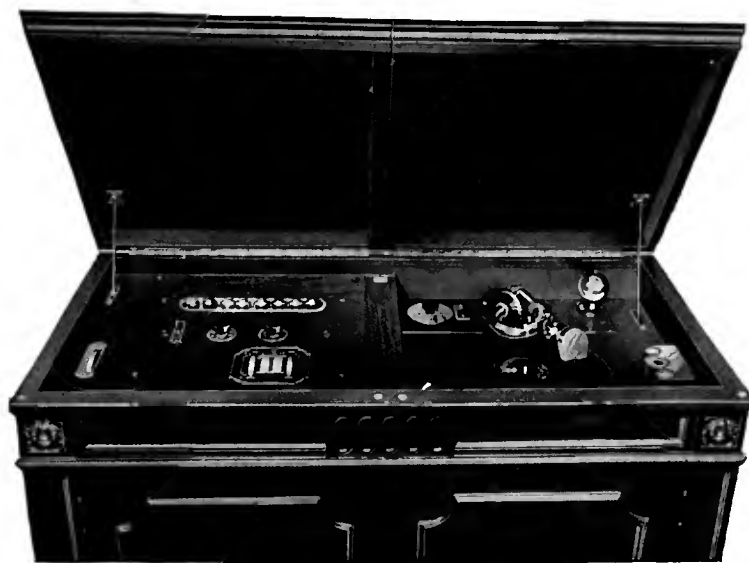

THIS IS THE HYPERION MODEL ELECTROLA-VICTROLA

Which is operated directly from the a.c. supply mains. The reproduction from the records is through electrical pick-up, electrical amplification, and the cone, which is also utilized for the radio side of the instrument. An UX-120 power stage gives undistorted output with volume. The instrument retails at \$500

creases progressively from the minute variations in the detector plate circuit to the relatively violent fluctuations in the windings of the loud speaker. It is only in the last stage of the average amplifier that these fluctuations exceed the distortionless capacity of small tubes. Therefore, power tubes are rarely necessary in any amplifying step other than the output or final stage.

#### THE UX-210 AND THE CX-310

THE reader is probably familiar with the smaller power tubes such as the UX-112, 120 (CX-212 and 220), which are overgrown 201-A and 199 types respectively, as well as the somewhat similar tubes manufactured by Daven, Schickering, and other companies. These tubes, which are to be continued through the coming season, have advantages over the 201-A and 199 types, and are designed for operation from plate voltages under 150, and A potentials no higher than six volts. They are, however, inadequate in the majority of cases.

The first of the relatively high-power tubes, the influence of which is reflected in the design of associated apparatus, is the UX-210, and the corresponding Cunningham CX-310 tube. This new tube is designed for operation from a 300-volt plate supply. At 7 volts, its XL filament draws 1.1 ampere. The UX-210 lists at \$9.00.

Operated according to directions, this new tube, in a power stage of amplification (following two steps of transformer, impedance, or resistance coupling), will feed enough undistorted power into a really good loud speaker to fill a medium size

quise high voltage and rectified by means of 216-B rectifying tubes. A three-step amplifier is incorporated in the unit, consisting of two 201-A stages outputting to a UX-210. This line power unit, with tubes, retails for \$125.00.

The Pacent line power device is similar to the AmerTran excepting that it includes only the power stage of amplification, and sells for \$82.00 without tubes.

Voltage taps provide plate potentials for other sections of the receiver.

Another popular power amplifier with self-contained line power apparatus, is the R. C. A. Uni-Rectron, selling for \$105.00. The R. C. A. and the Pacent units are designed for operation from the first or second stage of the conventional amplifier.

Special secondary windings supply the required 7-volt filament potential in the Uni-Rectron line power units. The tubes in the receiver, however, must be lighted from an A battery. Grid bias potentials are secured by an IR drop within the rectifying unit, thus eliminating the C battery. It might be well to note here (particularly for the benefit of the home constructor) that power tubes, as a general rule, require comparatively high C voltages, running from 22½ to as high as 75 volts, depending on the type tube and the voltage applied to the anode.

A corresponding design by the Western

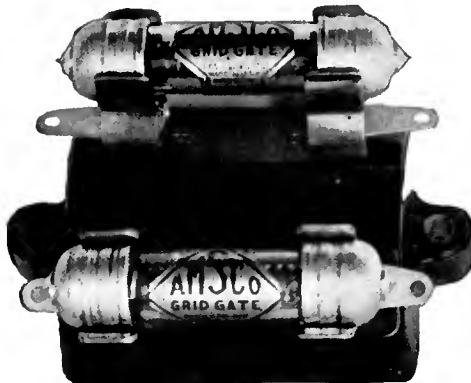

RADIO BROADCAST Photograph

AMSCO'S NEW RESISTOR-COUPLER UNIT Which is of special rugged construction. The necessary coupling condenser is sealed in the base of the coupler. Price \$2.45 with resistors

hall with orchestra volume. Plate potentials as high as 450 volts can be applied to the UX-210 with increased undistorted volume.

As already suggested, tube innovations must affect receiver design fundamentally, and will be reflected in changes in the associated apparatus. And thus it is that the 1926-1927 season will provide a market for new and interesting equipment.

First of all, it is obviously impractical to supply 300 volts (or more) to the plate of a CX-310 type tube from a B battery. If lower voltages, within the economical limits of B battery operation, are applied, little will be gained by the use of the large tube.

Similarly in respect to the 7-volt filament potential; while the tube will light and operate with only 6 volts across the terminals, its distortionless amplifying possibilities are impaired.



THE UNI-RECTRON

Is an amplifier capable of delivering considerable volume when connected to the output terminals of a receiver which already employs one stage of amplification. The Radio Corporation retails this instrument at \$105, and it obtains both filament and plate power from the a.c. line

The line power-supply unit, several of which are now on the market, is the obvious answer to the problem.

The AmerTran line power unit is typical of the desired arrangement. The 110-volt lighting current is stepped up to the re-



THE 36-INCH W. E. CONE

The use of tubes capable of delivering more power without distortion necessitates the use of speakers capable of delivering such volume faithfully. It is said that the power handling capabilities of the cone may be increased by adding to the diameter. The new Western Electric cone is three feet across



A STROMBERG-CARLSON CONE  
The use of a soundboard on this speaker is said to add timbre and volume



Electric Company is observed in their 205 amplifier line power unit (list \$115.00 with tubes). This amplifier employs two 25-D tubes, one rectifying and one amplifying.

The ux-210 or cx-310 power tube is particularly well adapted to the requirements of electric phonograph reproduction, and is found in many of the recent Victor and Brunswick designs.

The Cromwell Victrola (\$450.00) employs such an amplifier, which can be used as an external power amplifier for radio receivers. Adequate power is again supplied by the transformer and rectifier combinations.

The more elaborate phonographs, such as the Radiola Victrolas from \$900.00 up, combine receiving sets with power amplifiers and line power arrangements.

The Radiola No. 30, with the Rice-Kellogg speaker, is a complete receiver, plus power amplifier, operated altogether from an efficient line supply system. No batteries whatever are used.

THE NEW UX-171

WHILE there is a definite need for a tube of the ux-210 type, the average fan will never have occasion, justified by more than neighborly spite and malice, to push these tubes anywhere near their capacity output. In appreciation of this fact, a lower power tube has been designed more consistent in price and power rating with the requirements of the fan. This tube is known as the ux-171. Cunningham manufactures it as the cx-271, while other companies, such as the Cleartron and the Ureco, making similar tubes, refer to it merely as their trademarked 171 tube. The Radio Corporation and Cunningham tubes of this type list at \$6.00, while those of other manufacturers mostly sell at one dollar less.

This medium power tube, which, properly operated, should prove the ideal output tube for the fan, is designed for operation from the conventional six-volt filament source, drawing one half ampere, and from a plate supply of 180 volts. As will be noted in laboratory sheet No. 12 in this issue of RADIO BROADCAST, at 90 and 135 volts the proper biases are 16.5 and 27 volts respectively, and under these conditions sufficient undistorted power output will be delivered for all ordinary purposes. The plate currents will be approximately 13.4 and 16.5 milliamperes; this means



RADIO BROADCAST Photograph

GREATER VOLTAGE OUTPUT FOR THE NEW TUBES

Is possible with the new Mayolian line supply unit. A Raytheon filamentless tube is the nucleus of this device, which is capable of delivering a higher potential at the desired amperage for the plates of the receiver tubes than has heretofore generally been the case with the average commercial line power supply

that at 90 and 135 volts the 171 is an economic B battery tube. Operated on plate potentials under 180 volts, the medium power tube is still superior to lower power tubes.

The design of line power units will no

doubt be modified to meet the requirements of the new tube. Several manufacturers, in anticipation of the 171's popularity, have discontinued their relatively low-voltage line power arrangements in favor of systems supplying 180 volts. Apco is bringing out an 180-volt line supply in several models, including baseboard and inclosed arrangements, employing the ux-213, and Raytheon rectifying tubes. The price on this apparatus will vary from \$38.00 to \$45.00 with rectifying tubes. A similar device is the Mayolian, a cabinet job, selling for \$55.00.

As may be noted, the rectifiers used in representative line supply units are the Raytheon, an efficient no-filament tube; the ux-213 (cx-313), a full wave electronic tube; and the ux-216-B (cx-316-B), a half wave electronic tube.

A new electrolytic rectifying bulb is being brought out by the Forest Electric Company for use in their line supply products.

The 171 tubes can be operated from low-voltage line power units at high efficiency, by the simple expedient of connecting a heavy duty B battery in series with the loud speaker (plus post to plate of the power tube). This increases the plate voltage applied to the last tube.

The Apco Electric set anticipates the demand for receivers designed for use with the 171 type tubes. All batteries are eliminated in this set, and a plate potential of 180 volts is applied to the output tube. This receiver will be priced under \$200.00.

To justify fully the use of the power tube, the loud speaker must be constructed to handle its output, again reflecting the influence of tube design on associated apparatus. The power handling capabilities of loud speakers can be increased by extending the air column, in the case of the horn type, and by increasing the diameter of the cone in the cone type.

These principles are typified respectively in the researches of the Miller Rubber Company, who are manufacturing horns with four to six foot air columns, and the Western Electric Company, who are producing a 36-inch cone selling for \$76.00.

Another cone power speaker of rather different design is incorporated in the R. C. A. Rice-Kellogg unit. The A and B powers, and C potentials, are supplied to the ux-210 power tube, and the receiver tubes, through a system of 216-B rectifying tubes, a ballast tube, and a voltage regulator.



THE EIGHT-TUBE "RADIOLA 30" SUPER-HETERODYNE

This instrument retails for a little under \$600 complete and ready to operate. It is capable of exceptionally great volume when required, and obtains all power direct from the a.c. house supply



THE PACENT POWERFORMER

This unit is somewhat similar in nature to the Radio Corporation's Uni-Rectron. Voltage taps on the instrument provide for the plate potential requirements of the tubes other than those in the Powerformer. \$82 without tubes

Refinements—a general movement toward increased quality—evidenced in improved actuating mechanisms and horn material, are to be noted in the Teletone and Amplion speakers.

Still further exhibiting the influence of the power tube, the fact that it is undesirable to place the loud speaker directly in a high-voltage high-current plate circuit has suggested to manufacturers the convenience of an output coupling unit. This consists of a high-impedance choke coil shunting the a. c. power variations through a bypass condenser to the loud speaker. Among several desirable effects, such an arrangement eliminates the relatively powerful magnetic influence of the direct plate current tending to draw the diaphragm toward one of the pole pieces, which results in rattling when loud signals are being received. Such a unit is on the Amsco list of fall production.

In passing, it may be well to mention several new tubes less directly associated with quality amplification. Two super sensitive detector tubes, the R. C. A. 200-A and the Donle-Bristol, have made their appearance. While it is not intended that these tubes should replace 201-A types in the detector socket of receivers, they will probably be quite popular on account of their extreme sensitivity. Reception with the R. C. A. 200-A is accompanied by a slight hiss caused by the action of the gaseous content within the tube. The Cleartron r. f. tube, featuring a relatively high amplification constant, has been developed especially for radio frequency amplification circuits, where the manufacturer claims for it a distinct superiority over other tubes, in this position. The three above mentioned tubes sell for \$5.00, \$3.00, and \$3.00 respectively. The 200-A is fully dealt with in laboratory sheet No. 11 in this issue of RADIO BROADCAST. Apco is making a 201-A

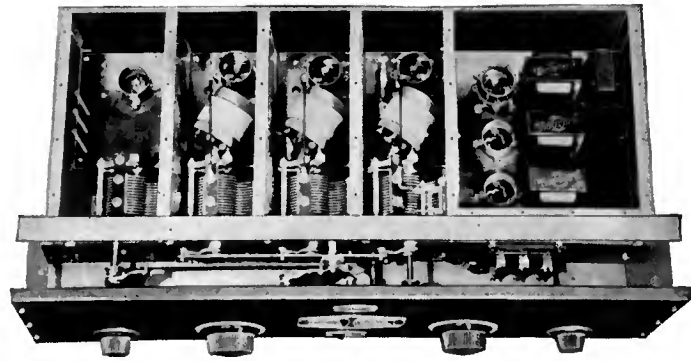

THE HOWARD SEVEN-TUBE NEUTRODYNE

Embodies all the patented Hazeltine features and is a totally shielded receiver. In this illustration, the top shield has been removed to show the disposition of the parts. Three r. f. stages are employed, as are also three stages of specially designed audio amplification. A loop is used, and the Howard is adapted for use with light socket power devices

type double life tube (two distinct filaments) that is reminiscent of the two filament audiotrons of 1918. The characteristics of these tubes, and their application to receiving circuits, will be discussed at greater length in a later article.

The amplifying apparatus of the 1926-27 season shows a marked improvement over that of preceding years. The better transformer manufacturers are still holding their own (in the favor of the general user). AmerTran, Rauland Lyric, General Radio, Pacent, and Karas to mention a few, are perfecting their products with untiring effort, while resistance coupling has assured itself of permanent favor. For all that, the writer is of the opinion that the

trend of engineering thought, justified by results, and the manufacture of applicable choke coils by such well-known concerns as AmerTran, Thordarson, General Radio, National, and Haynes-Griffin, forebodes a powerful swing toward impedance-coupled audio amplification.

Among the transformer developments are the interesting tunable transformers of the General Instrument Company (price \$10.50), and of the Wagner Radio Company, in which a variation of the mutual inductance of the windings enables the experimenter to match his transformers, within limits, to individual tube conditions.

The Donle-Bristol Company has designed a new coupling unit which, mechanically, would seem to be a cross between a coupling impedance and a low ratio transformer.

There are many recruits in the resistance-coupled field. Daven, Amsco, and Electrad are forging ahead in the manufacture of kits and parts, while Allen-Bradley, DeJur, Heath, and Daven, etc., are marketing complete three-stage units.

The most marked progress in the field of resistance coupling is the concerted effort on the part of a half-dozen manufacturers to produce an efficient low priced resistor. By efficient, one has in mind a resistive element capable of dissipating at least one watt of power without appreciable change in electrical characteristics, absolute permanence, and noiselessness. This research has practically eliminated the paper impregnated type of leak and resistor, which falls down on all three points; and has brought forth the Electrad metal resistor (a sprayed deposit on glass), the metal resistor manufactured by Arthur H. Lynch, Inc.; the Amsco "Metaloid" (a new element deposited spirally on an interior glass rod), and a new Daven resistor.

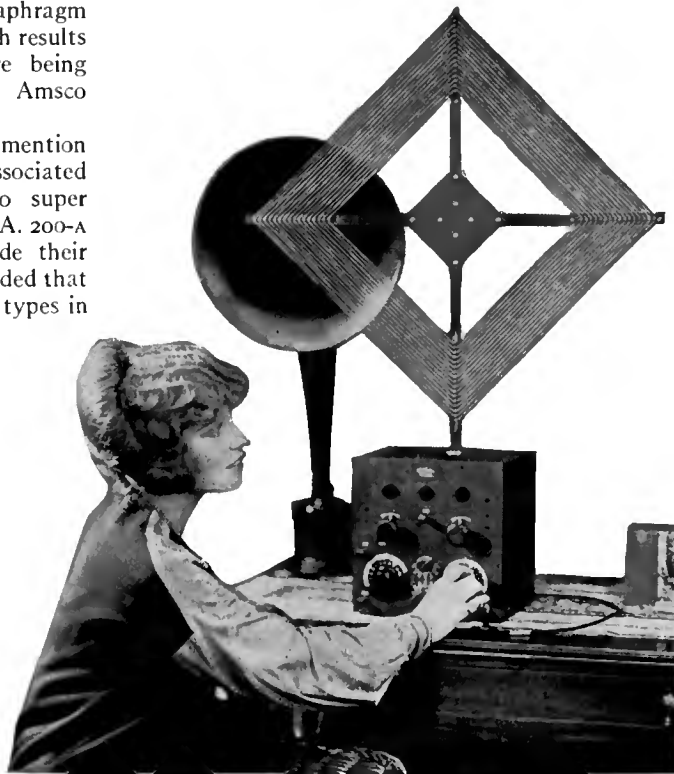

JUST ABOUT THREE YEARS AGO

We would have hailed the receiver depicted herewith as an example of modern beauty and efficiency. Nowadays our appetites have been whetted by more elaborate affairs, and more costly, such as those multi-tube receivers illustrated elsewhere in these pages

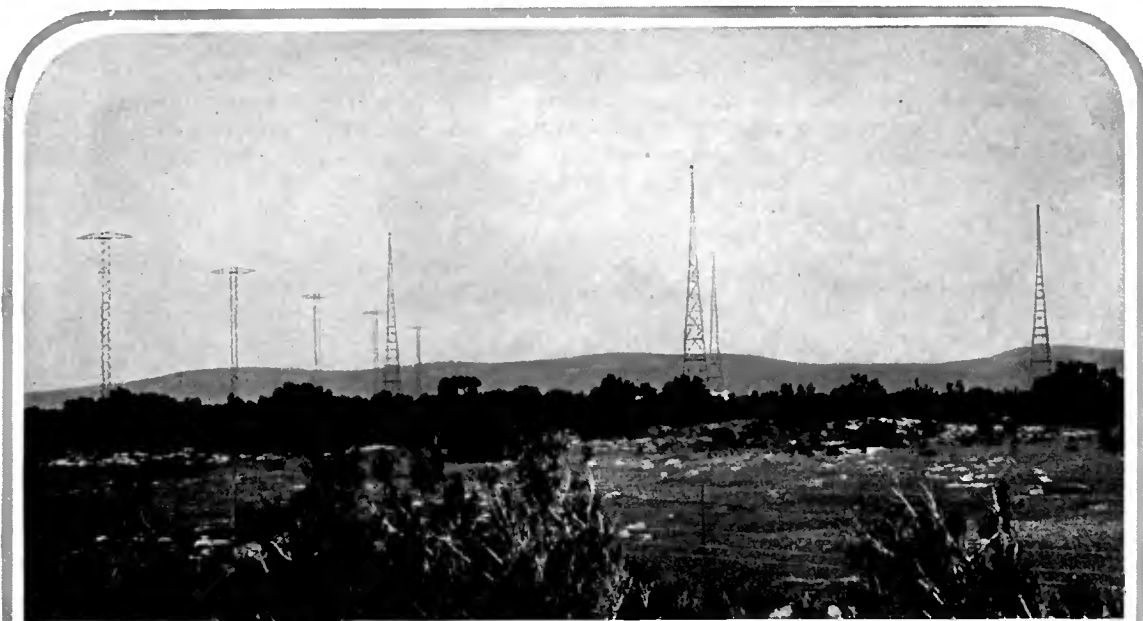

# THE MARCH OF RADIO

By *J. J. Morecroft*

Past President, Institute of Radio Engineers

## The Outlook in Radio Apparatus for the Coming Months

**D**URING the past year, many things have happened in the radio business. The changes, while less rapid than in preceding years, have in some ways, been more fundamental. The past year has seen several complete sets disappear from the market. Bankruptcy has overcome some of the formerly well advertised firms. It may loom for several more, before the present period of readjustment is completed.

The average buyer of radio sets knows little of their process of manufacture. It is true that some of the large manufacturers themselves make practically all of the parts which go into their completed product. But this is the exception and not the general rule. The radio set has suffered a great deal because of its diversified parentage. It is not unnatural that some manufacturer desires to purchase transformers, for example, where they are cheapest. Transformers are what he wants and the eighty-seven-cent kind is just eight cents better in his eyes than the one he can buy for ninety five cents. This rule, one more of human nature than of radio, has applied to the other components of a radio set.

However, there is the brighter side, and there are a few reputable manufacturers who endeavor consistently and steadily to improve their product. They expect to be in business next year as well as this, and so establish the kind of apparatus they can stand behind and guarantee. Their laboratories are manned by intelligent and experienced engineers who are capable of making constant improvement in their products. From these manufacturers, one gets sets of continually improving performance. But we are interested in concrete facts and not in theorizing about the morality of the radio business.

Simplicity of receiver control has been featured in the past year and will continue. The one-dial set, or the two-dial, is economically possible and is what the public is interested in. This means the user who buys a radio set complete. The home constructor does not favor single control.

We know of several laboratories whose engineers have made real advances in the design and construction of audio-frequency transformers. Several years ago, this was one of the poorest parts of a radio receiver. Probably even now, there is room for more improvement. With these improved transformers, the drums of an orchestra become audible. Perhaps in 95 per cent. of the radio receivers in use to-day, it is impossible

to hear a note as low as that given by a drum. Better iron for the cores of our transformers is an important contribution which future laboratory work must develop.

We hear very little now about the "low loss" condenser; any really good condenser has losses so low compared to those of the other parts of the circuit that they are negligible. When this became generally known, the "low-loss" bunk of a year ago generally went into the discard. But a real advance has been made in condenser construction; we refer to the straight-line frequency form. The nearly equal spacing of stations which these new condensers give is an advantage not to be despised. Undoubtedly the s. l. f. condenser is with us to stay.

It seems very questionable if the horn speaker is ever again to find general favor in spite of the excellent development of it which the engineers of some of our companies have made. The disc or cone speaker, possibly much bigger than those we now use, will continue to be the favorite.

Better tubes are possible and will probably be on the market soon. Undoubtedly, the Radio Corporation will continue to lead in tube development, even if the patent situation should permit the wide exploitation of tubes by other manufacturers.

The heading illustration shows the Marconi short-wave beam receiving station and some of the transmitting towers at Wilverton, near Cape Town, South Africa



It is an expensive job to carry on real research work along these lines, and it requires more complete facilities, in men and materials, than any but the largest companies can afford. A better output tube is really needed. Several forward steps along this line have been made by R. C. A., but the goal is not yet reached. The present output tubes can easily be improved to five times their present worth. The increased plate current required by such tubes will make questionable the use of dry cells for the operation of their plate circuit and so the possibility of light socket power for the receiving set acquires new importance.

Probably this is the one important advance in radio reception which is disappointingly slow. To be sure, it is no easy task, but many good engineers are now working on it, and have been for some time, so that the hoped-for achievement may be realized in the not-distant future. From what we know about tubes, we believe that a possible output of five watts is required for satisfactory loud speaker operation and this certainly requires something other than dry cells. The five-watt tube would normally be giving to the loud speaker not more than one-twentieth of a watt, having in reserve a power one hundred times as much as this. This seemingly exorbitant reserve is what is required for quality reproduction and certainly better quality will ever be the engineer's aim. Devices incorporating a power tube for the loud speaker, for operation from the light socket have recently appeared. They are to be used in addition to a radio receiver having one step of good audio frequency amplification and when so used, they perform very well indeed.

It is not impossible that some remarkable

new types of tubes may appear on the market. Besides the "thimble tube" with the alternating current filament supply, and the shield grid tube with its remarkable amplification possibilities, even at very short wavelengths, it may be that someone will develop a tube which doesn't even require a heated filament. Theoretically it is possible, so someone may yet do it.

### Seeing Things—By Radio

FOR many years, radio has proved of great help to the newspaper man.

A quarter of a century ago, the then infant Marconi service kept landmen informed as to the progress of the international sailing races off Sandy Hook. "Via Marconigram" had a most fascinating sound in those days; that the papers could be kept informed of the race by an observer miles at sea seemed indeed a miracle. But already the miracle, expanded a hundred times, has become commonplace.

But now another achievement signals that progress is being continually made, that the hopes and ambitions of at least a few radio workers actually are realized. The Radio Corporation has several times recently hinted that pictures would soon be coming across the Atlantic along one of its radio channels. It has now been done. Pictures are now being "regularly" sent from England to America. The first one took nearly two hours to send, but irregularities in the performance of the apparatus were rapidly eliminated and soon it was taking only minutes to flash across a recognizable copy of the picture three thousand miles away. One estimate places the time for transmission of a picture of ordinary size at twenty minutes. But of

course this will depend upon conditions, primarily the amount of atmospheric disturbance existing at the time the picture is sent.

Naturally the cost of the service must at first be so high that only exceptional circumstances warrant its use. A great deal of valuable apparatus is being tied up to send the four-by-five, black and white prints, and someone must pay for the large overhead and development charges.

Crude as those first pictures are, the engineering staff of R. C. A. receives our hearty congratulations on the accomplishment and our best hopes for its improvement and increasing usefulness.

### Coolidge and Hoover Oppose a Radio Commission

PRACTICALLY no criticism of any weight has been aimed at Secretary Hoover's control of radio up to the present. There are many who feel that to place the control of radio under one man is too autocratic a scheme to fit into our form of government.

President Coolidge is said to believe that whatever commission may be created for radio regulation, their findings must be subject to his review and criticism. The Democratic floor leader, however, made the silly observation that such an arrangement "would mean full publicity for Coolidge's speeches, while political opposition would be deprived of the right to speak through the ether to the voters." It certainly is a fact that while Hylan was mayor of New York City, the Municipal Broadcasting station was used in that manner. What control there is over radio must assuredly be non-partisan. Whether Republican or Democrat be in power, the other party must have equal opportunity to use the ether channels. In closing his remarks Senator Robinson says "Whatever be the evils, the remedy is not to concentrate in the White House the authority of complete control."

But Secretary Hoover says:

Boards and commissions, by their divided authority have always been a failure in administration; they are desirable for discretionary or judicial determination. The tendency to create in the government independent agencies whose administrative functions are outside the control of the President is, I believe, thoroughly bad.

The Secretary of Commerce commended the members of his staff who have worked very hard on the radio control problem, trying to solve by tact and diplomacy situations in which the law gave them no real power to act. And, said he "so far as the Department of Commerce is concerned, the extraordinary difficulties and conflicts in the situation are such that we will be well satisfied to see radio administered by any other department which can properly undertake its regulation."

One fears that the Senate proposal to establish a five-man radio commission, with exclusive control will merely provide five more political jobs and greatly decrease

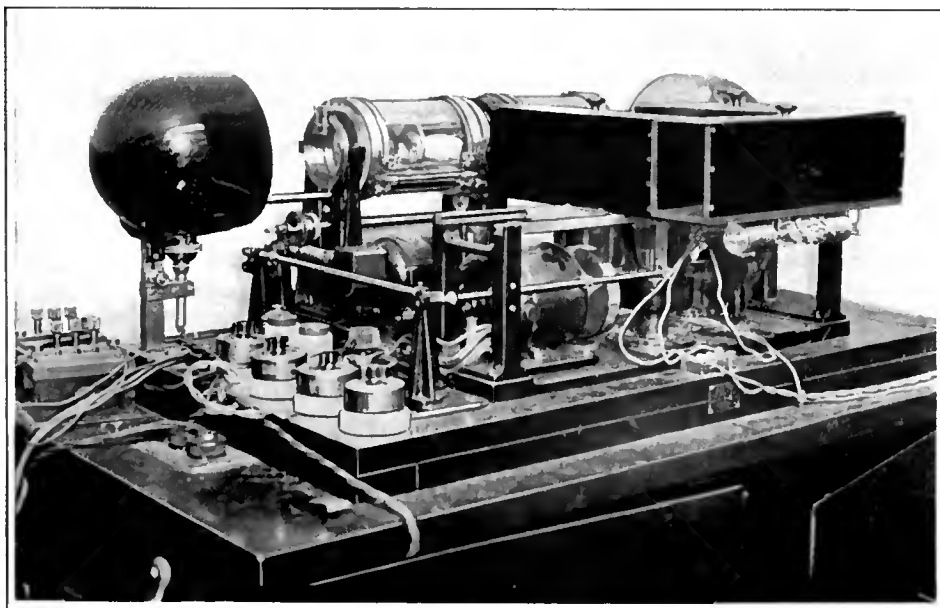

THE PHOTORADIOGRAM TRANSMITTER IN LONDON

The photographer shows the transmitter, developed by Capt. R. H. Ranger of the Radio Corporation of America as it is installed in Radio House, London. The high power, long wave transatlantic circuit of the Radio Corporation of America is used. The process is at present expensive for the reason that each picture takes an average of 20 minutes to transmit and during that time, a very expensive radio "circuit" is tied up



THE AMUNDSEN-ELLSWORTH AIRSHIP "NORGE"

cent. of the sets use five tubes, but last year only 22 per cent. used this number of tubes. Most of the new five-tube sets are apparently the outgrowth of three-tube sets because the number of such sets show a decrease from last year's figure of 36 per cent. to only 15 per cent. this year. Ap-

prefer them to batteries. Milwaukee is as yet a fruitful field for the dry cell and storage battery man, but from the statistics it looks as though a reasonably priced, reliable plate supply unit would make a mint of money for the progressive dealer.

British Broadcasting

IT IS interesting to note that at the same time there is talk of rearranging the governmental control of our radio, the same question has arisen in Great Britain. There, a private company, the

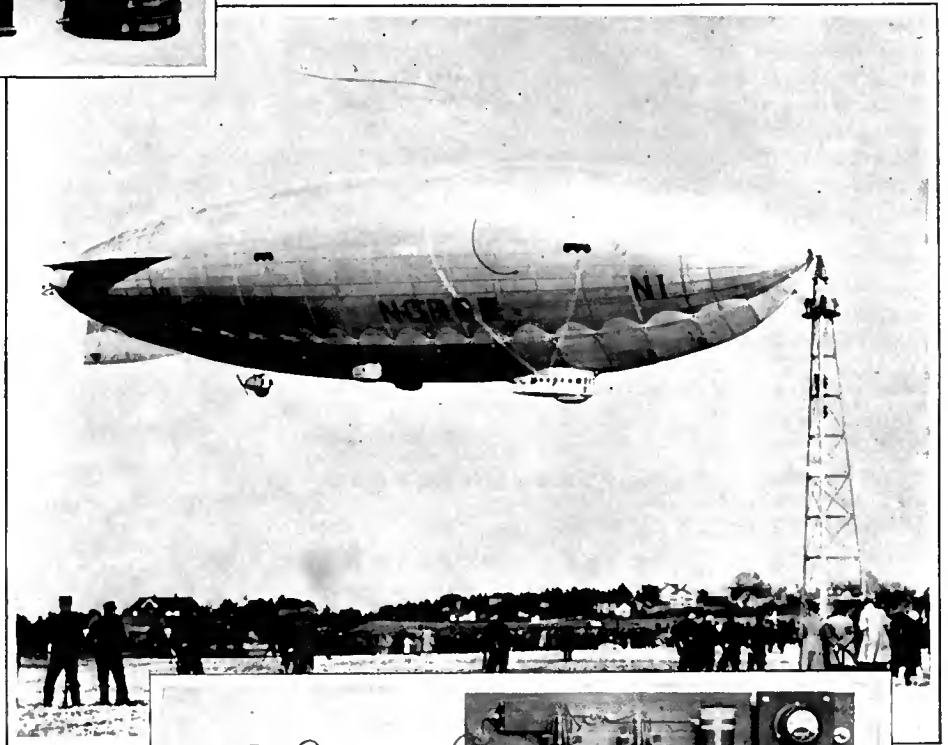

The center illustration shows the ship at her mooring mast at Oslo, enroute for the North Pole which was successfully crossed. The ship successfully completed the epoch-making voyage, landing at Teller, Alaska. Direction-finding loops, fitted diagonally around the outside of the envelope and "doped" to the fabric with linen tape, can be seen coming together underneath the gondola. The top illustration shows the Marconi tuner, range 300-25,000 meters (1000-12 kc.) Eleven coils are used to cover the band. The ship also has a short-wave receiver to receive from Point Barrow, Alaska. The lower illustration shows the Marconi type "U" 1/2-kw. transmitter, specially mounted on a board for lightness and ease of mounting

the efficiency of all radio supervision and control. Can Congress point to any "independent" commission established by them which has really been a success?

Radio Sets Are Still Being Built At Home

THE Milwaukee Journal has sent us an extremely interesting and reliable analysis of the radio situation in that town and one of the most interesting sections of the report has to do with the home builders. Set manufacturers frequently state that practically all radio sets installed nowadays are factory-made but certainly this is not so in Milwaukee. In the year just past Milwaukee families bought 20,000 factory made sets and the astonishingly large number of 8000 were made at home.

The questionnaire from which the above information is gleaned had to be returned to the bureau at the Journal office personally, so that there was no chance of getting a stuffed ballot. The housewives to whom the questionnaire was sent were urged to return them properly filled out by promises of grocery samples (free), and other such inducements. From twenty thousand names circulated, four thousand questionnaires were returned.

Crystal sets are rapidly disappearing. Only 1.7 per cent. of Milwaukee's listeners use receivers of this kind. Radio sets in combination with phonographs have found practically no market. More than 53 per

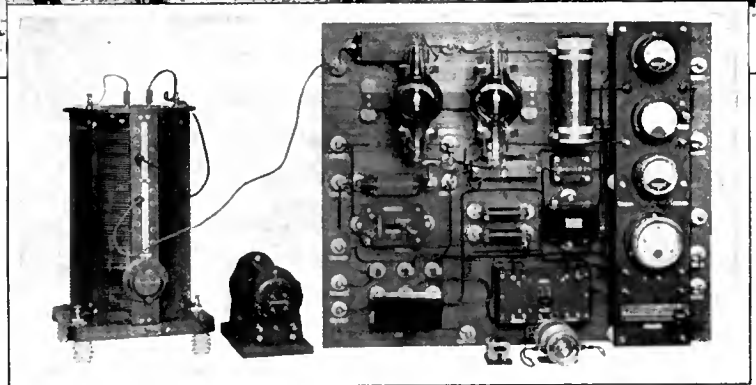

parently an extra radio frequency stage for distance getting and an extra audio stage for loud speaker operation has proved desirable to thousands of Milwaukee's radio fans.

More than 67 per cent. of the receiving sets operate loud speakers; most of them are of the horn variety, only 2 per cent. of the receivers being as yet equipped with cone type speakers.

Battery eliminators have not found great favor in this locality as yet. Less than one half per cent. of the listeners use A and B battery substitutes. Even B voltage supply units have not yet proved popular, as 3.5 per cent. of the listeners

British Broadcasting Company, has been granted a monopoly of broadcasting. From the press comments, we judge that their work has been well done. It speaks well for a monopoly of this sort when the public is so ready to praise its work.

The contract with the B. B. C. runs until 1927. In anticipation of the expiration of this contract, the Postmaster General appointed a committee to study and report on the radio situation with recommendations as to carrying on the broadcasting when the B. B. C.'s contract terminates. This report advocates the formation of a commission to be constituted of five to seven members appointed by the Crown

to serve for five years. The commission will be responsible for carrying on the entire broadcasting activities in Great Britain. The money annually collected by the Postmaster General (\$2.50 for each receiving set) will be turned over to the commission up to a certain amount—the surplus will accrue to the Postmaster General's bureau. This one feature receives condemnation and well it may. When a listener pays his ten-shilling license fee, he is paying for radio, not to help out a possible deficit accumulated by the mail service. All of the license money (except that required for administration work in the Collector's office) should be turned over to the commissioners for program and development work.

It is anticipated in any case, that the new body will take over the staff and apparatus of the B. B. C. "as is"—there is to be no interruption in the broadcasting while change of title is taking place. There are at present ten principal stations and eleven more of lesser power being operated by the B. B. C. and it is expected that several of higher power will be erected by the new commissioners, to take the place of the many low power ones.

One Share of Stock = One Radio Set

A CAREFUL report by Dow, Jones and Company of New York shows how much of the public's money has been lost in radio. The stocks of all the radio companies have gone down with a bang during the past year, and some of them hit bottom altogether.

To the credit of some of the houses which floated this stock it must be reported that note was always made regarding the gambling feature involved in investments of this sort. And gamble it certainly was, for during the past year the shrinkage in value of radio stocks reached nearly one hundred million dollars.

Dow, Jones, and Company report that during 1924 for every receiving set sold, at least one share of stock in some radio company was sold. Where the money which the public sunk in this way went to is a mystery to one not having access to the books. The Music Master Corporation, for example, was valued at \$10,000,000.00 during 1925, and now this stock has a market value of \$67,500.00. A tabulation of the radio stock market for the year's period gives some interesting data. For

the benefit of those whose capital has shrunk so rapidly in some of these companies, we give a list of the more important companies which have been listed on the exchange so that they can see to what extent their neighbors have also suffered.

| NAME                  | TOTAL SHARES | VALUE DEC. 1924 | VALUE TO-DAY |
|-----------------------|--------------|-----------------|--------------|
| Music Master Corp.    | 450,000      | \$ 9,675,000    | \$ 67,500    |
| D. Grimes             | 235,000      | 6,345,000       | 254,583      |
| De Forest Radio       | 208,208      | 5,413,408       | 208,208      |
| Dubilier C & R        | 134,450      | 9,108,988       | 537,800      |
| Duplex C & R          | 62,500       | 765,625         | 46,878       |
| Freed-Eiseman         | 300,000      | 9,800,000       | 1,200,000    |
| Hazeltine             | 175,000      | 8,400,000       | 1,375,000    |
| Inter-Ocean           | 100,000      | 1,262,000       | 100,000      |
| Jones Radio           | 225,000      | 1,771,875       | 112,500      |
| Liberty Radio         | 120,000      | 960,000         | 12,000       |
| Rad. Corp. of Am. co. | 1,155,400    | 71,204,450      | 41,594,400   |
| Rad. Corp. of Am. pf. | 395,597      | 19,771,850      | 17,801,865   |
| Rova Radio            | 75,000       | 900,000         | 37,500       |
| SI'per Radio          | 110,000      | 1,870,000       | 27,500       |
| Garod Radio           | 150,000      | 1,775,000       | 545,000      |
| Thermodyne            | 250,000      | 4,812,500       | 120,000      |
| Thompson              | 127,100      | 2,621,438       | 195,000      |
| Tower Mfg.            | 87,500       | 1,966,500       | 812,500      |
| Ware Radio            | 75,000       | 2,943,750       | 37,500       |
| TOTAL                 | 4,433,755    | \$161,367,384   | \$65,085,734 |

RCA Takes Out a License

THERE are very few patents of value in the radio field to-day which the R. C. A. does not control through its license agreements with the large electric companies. The idea of the R. C. A. condescending to take a license to make

|                   |                   |                   |                   |                      |
|-------------------|-------------------|-------------------|-------------------|----------------------|
| イ ● ● ● ●         | ウ ● ● ● ●         | エ ● ● ● ● ● ● ● ● | A ● ● ● ● ● ● ● ● | W ● ● ● ● ● ● ● ●    |
| ロ ● ● ● ● ● ● ● ● | キ ● ● ● ● ● ● ● ● | ン ● ● ● ● ● ● ● ● | B ● ● ● ● ● ● ● ● | X ● ● ● ● ● ● ● ●    |
| ハ ● ● ● ● ● ● ● ● | ノ ● ● ● ● ● ● ● ● |                   | C ● ● ● ● ● ● ● ● | Y ● ● ● ● ● ● ● ●    |
| ニ ● ● ● ● ● ● ● ● | オ ● ● ● ● ● ● ● ● | 一 ● ● ● ● ● ● ● ● | D ● ● ● ● ● ● ● ● | Z ● ● ● ● ● ● ● ●    |
| ホ ● ● ● ● ● ● ● ● | ク ● ● ● ● ● ● ● ● | 二 ● ● ● ● ● ● ● ● | E ● ● ● ● ● ● ● ● | 1 ● ● ● ● ● ● ● ●    |
| へ ● ● ● ● ● ● ● ● | ヤ ● ● ● ● ● ● ● ● | 三 ● ● ● ● ● ● ● ● | F ● ● ● ● ● ● ● ● | 2 ● ● ● ● ● ● ● ●    |
| ト ● ● ● ● ● ● ● ● | マ ● ● ● ● ● ● ● ● | 四 ● ● ● ● ● ● ● ● | G ● ● ● ● ● ● ● ● | 3 ● ● ● ● ● ● ● ●    |
| チ ● ● ● ● ● ● ● ● | ケ ● ● ● ● ● ● ● ● | 五 ● ● ● ● ● ● ● ● | H ● ● ● ● ● ● ● ● | 4 ● ● ● ● ● ● ● ●    |
| リ ● ● ● ● ● ● ● ● | フ ● ● ● ● ● ● ● ● | 六 ● ● ● ● ● ● ● ● | I ● ● ● ● ● ● ● ● | 5 ● ● ● ● ● ● ● ●    |
| ヲ ● ● ● ● ● ● ● ● | コ ● ● ● ● ● ● ● ● | 七 ● ● ● ● ● ● ● ● | J ● ● ● ● ● ● ● ● | 6 ● ● ● ● ● ● ● ●    |
| ル ● ● ● ● ● ● ● ● | エ ● ● ● ● ● ● ● ● | 八 ● ● ● ● ● ● ● ● | K ● ● ● ● ● ● ● ● | 7 ● ● ● ● ● ● ● ●    |
| ヲ ● ● ● ● ● ● ● ● | テ ● ● ● ● ● ● ● ● | 九 ● ● ● ● ● ● ● ● | L ● ● ● ● ● ● ● ● | 8 ● ● ● ● ● ● ● ●    |
| ワ ● ● ● ● ● ● ● ● | ア ● ● ● ● ● ● ● ● | 〇 ● ● ● ● ● ● ● ● | M ● ● ● ● ● ● ● ● | 9 ● ● ● ● ● ● ● ●    |
| カ ● ● ● ● ● ● ● ● | サ ● ● ● ● ● ● ● ● |                   | N ● ● ● ● ● ● ● ● | 〇 ● ● ● ● ● ● ● ●    |
| ヨ ● ● ● ● ● ● ● ● | キ ● ● ● ● ● ● ● ● |                   | O ● ● ● ● ● ● ● ● | ● ● ● ● ● ● ● ●      |
| タ ● ● ● ● ● ● ● ● | ユ ● ● ● ● ● ● ● ● | ゝ (濁点) ● ● ● ●    | P ● ● ● ● ● ● ● ● | ● ● ● ● ● ● ● ●      |
| レ ● ● ● ● ● ● ● ● | メ ● ● ● ● ● ● ● ● | 〇 (半濁点) ● ● ● ●   | Q ● ● ● ● ● ● ● ● | ● ● ● ● ● ● ● ●      |
| ソ ● ● ● ● ● ● ● ● | ミ ● ● ● ● ● ● ● ● | ー (長音) ● ● ● ●    | R ● ● ● ● ● ● ● ● | ● ● ● ● ● ● ● ●      |
| ツ ● ● ● ● ● ● ● ● | シ ● ● ● ● ● ● ● ● | ・ (句読点) ● ● ● ●   | S ● ● ● ● ● ● ● ● | ● ● ● ● ● ● ● ●      |
| ネ ● ● ● ● ● ● ● ● | エ ● ● ● ● ● ● ● ● | ∟ (新章) ● ● ● ●    | T ● ● ● ● ● ● ● ● | ● ● ● ● ● ● ● ●      |
| ナ ● ● ● ● ● ● ● ● | ヒ ● ● ● ● ● ● ● ● | ∟ (括弧) ● ● ● ●    | U ● ● ● ● ● ● ● ● | ? ● ● ● ● ● ● ● ●    |
| ラ ● ● ● ● ● ● ● ● | モ ● ● ● ● ● ● ● ● |                   | V ● ● ● ● ● ● ● ● | ! ● ● ● ● ● ● ● ●    |
| ム ● ● ● ● ● ● ● ● | セ ● ● ● ● ● ● ● ● |                   |                   | ● ● ● ● ● ● ● ●      |
|                   |                   |                   |                   | ( ) ● ● ● ● ● ● ● ●  |
|                   |                   |                   |                   | 危急信號 ● ● ● ● ● ● ● ● |

RADIO CODES THEY USE IN JAPAN

Japanese radio operators have to be conversant with the International Morse Code—that is, the "Continental" and a special code of their own, shown in the first three columns. Note how sos is written in the Japanese ideograph. The three dots, three dashes, three dots below the extreme right hand columns are sos in any language, but it takes four Japanese characters to indicate the signal. The ten numerals, with their Japanese equivalents are shown in the third column. The cut is reproduced from *The Radio Experimenter*, Tokio

any radio apparatus is somewhat unusual, but to think of them paying \$200,000 for the privilege is still more so.

Yet that is what has happened, according to a well authenticated report. Some of the fundamental patents on the cone type speaker are owned by the Lektophone Company, in which Hazeltine's patent attorneys appear to have a strong interest. The new cone speaker, which R. C. A. has been putting out, comes near enough to infringing some of the Lektophone patents that the Radio Corporation has apparently thought its most profitable course was to settle any possible disputes with the tidy sum mentioned above.

We understand also that the Western Electric cone speaker is due for a patent suit from the Lektophone Company.

### Street Lighting and Radio Reception

IT WASN'T very long ago that most of the smaller towns in the United States had their streets lighted by arc lamps; we liked to hear them hiss when the carbons fed together and we used to gather the discarded carbon rods to make wet batteries. This arc lamp scheme of street lighting was very bad in so far as interference with other circuits was concerned. Telephone companies especially looked on it with disfavor.

In most cities, the old fashioned arc lamp has been displaced by the small tungsten filament lamp, which burns on ordinary alternating current with but very little commotion. But in Butte, Montana, the rugged miners still stand for the pioneer lighting scheme. As miners it was good enough for them, but as radio fans they demand something better. The disturbances from the arc lighting system interfere seriously with radio reception so the lighting company has been asked by the Butte radio club, a laudably active organization, to renovate its system. The company estimates it will cost them \$12,000 to change to a modern lighting scheme.

### One Way to Kill the Bloopers

ANY way to rid the air of the blooper's whines is welcome. The Sterling Electric Company of Minneapolis has run an advertisement offering a five-tube t. r. f. set for sixty dollars, on which they will allow \$17.50 for a one-tube regenerative outfit and correspondingly more for regenerative sets using more than one tube. Says the ad, with respect to turning in the old squealer, "Keep the accessories. All we want is your old trouble-making set. All sets turned in will be destroyed."

More power to the Sterling Company—providing its own five-tube sets don't oscillate into the antenna. This idea might well be taken up by other radio dealers. The appeal to the regenerative set user is practical—which is the only way in which practical results—what we are all after, can be obtained.

### More Tractors Than Radio Sets On American Farms

THE farmer who uses a tractor to haul his plows and harrows shows appreciation of the value of modern devices and also sufficient prosperity to follow the suggestions arising therefrom. When we consider the value of a radio set to the farmer, both from the standpoint of market reports and weather predictions, as well as from that of the evening's entertainment and amusement, it seems as though there should be at least as many radio sets on our farms as there are tractors. But that is far from being the fact.

The Department of Commerce has just given out as part of its 1925 Farm Census a comparison of tractors and radio sets on the farms throughout the country for 1920 and 1925. The total number of farms in the United States in 1925 was 6,371,617. Of these 474,694 had one or more tractors, and only 284,053 had radio sets.

### Interesting Things Said Interestingly

C. B. SMITH (Chicago; president, Stewart Warner Radio Corporation): "For the most part radio's early exponents were well meaning gentlemen recruited largely from the shoe trades and the marts of the cloak and suit. These opportunists might have had trouble distinguishing between a variometer and a B battery, and they thought that induction was something punishable by law in all states except Nevada, but they knew that this radio thing in its little pine box, through some operation of legerdemain quite beyond their ken, was making music without a record or a motor. Obviously, a thing capable of such wonders was a thing capable of virtually limitless opportunity. Most of the pioneers looked upon the crystal set as a device that must ultimately give one the wrong numbers, now so essentially the stock in trade of the wired telephone. They did not attempt to analyze the means by which this would be brought about. It was enough for them that a crystal set could be constructed of bell wire and cardboard tubing, and sold to the gullible public for \$25—a haphazard prognosis that might well have then expected to produce the haphazard industry that it actually did produce."

D. R. J. H. DELLINGER (Washington; Chief of the Radio Section, Bureau of Standards) "There is no longer any more reason for waiting to buy a good radio set than there is in waiting to buy a good piano. While there doubtless will be occasional refinements in receiving equipment, these are not likely to affect appreciably the comparative value of the standard sets of to-day. Tubes, of course, will lose their efficiency after from 1000 to 2000 hours of use, but most of these can be reactivated at small cost. The set as a whole, however, will retain its efficiency and value indefinitely."

T. P. O'CONNOR, M. P. (London; discussing the desirability of broadcasting the Budget Speech, in the *Radio Times* London): ". . . You will see on a Budget night the post office assailed with scores of members sending telegrams to their friends or their partners announcing the provisions of the Budget. This

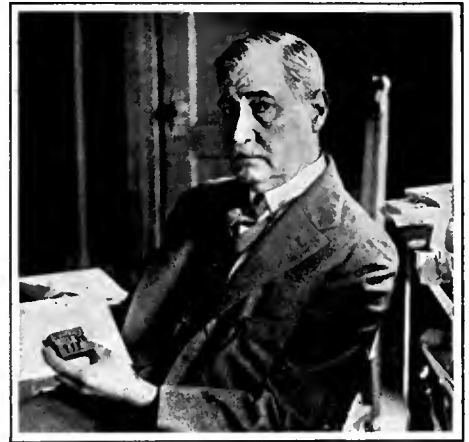

FRANK B. NOYES

—Washington—  
President of the Associated Press:

"News is flashed across the water by both cable and wireless, all available transmitting means being employed, although the fastest and most reliable naturally get the bulk of the service. Sometimes conditions are highly favorable to the use of wireless, and then this method of transmission is employed extensively. At other times, trouble on the air route requires a shift to the more stable under-water channel. In the case of highly important bulletins, nothing is left to chance. Big developments are flashed both by radio and cable. Wireless communication with South America is not as yet so dependable as is the service between Europe and the United States."

is inevitable, as these great businesses have at once to accommodate themselves to the new conditions.

"Now what I want to ask is, why this most valuable and necessary information in the business of the country should be kept back for one second longer than it is necessary? The evening newspapers are able to cover a certain amount of the ground, of course, and the morning newspapers, next day, all the ground; but why should millions of people living in districts remote from evening newspapers be handicapped in their preparation for the future of their business by being denied the information which broadcasting could give them immediately? There are millions of people outside London whom even the latest editions of evening papers cannot reach with this most necessary information.

"I protest against the policy that would leave in the darkness of perilous ignorance those millions of people to which the broadcasting could bring light and knowledge."

A. ATWATER KENT (Philadelphia; radio manufacturer; especially written for *RADIO BROADCAST*): "The precision in the manufacture of radio receiving sets now attained, together with constantly improving radio programs, make for increased popularity of radio. The estimated five million receiving sets now in use will be greatly augmented in the near future. I believe a great increase in the number of sets will be noted on farms, where the isolation of farm life gives to radio a more practical value than in the city. There will certainly come a greater use of radio in education, not only in school rooms but in educational uses in the home.

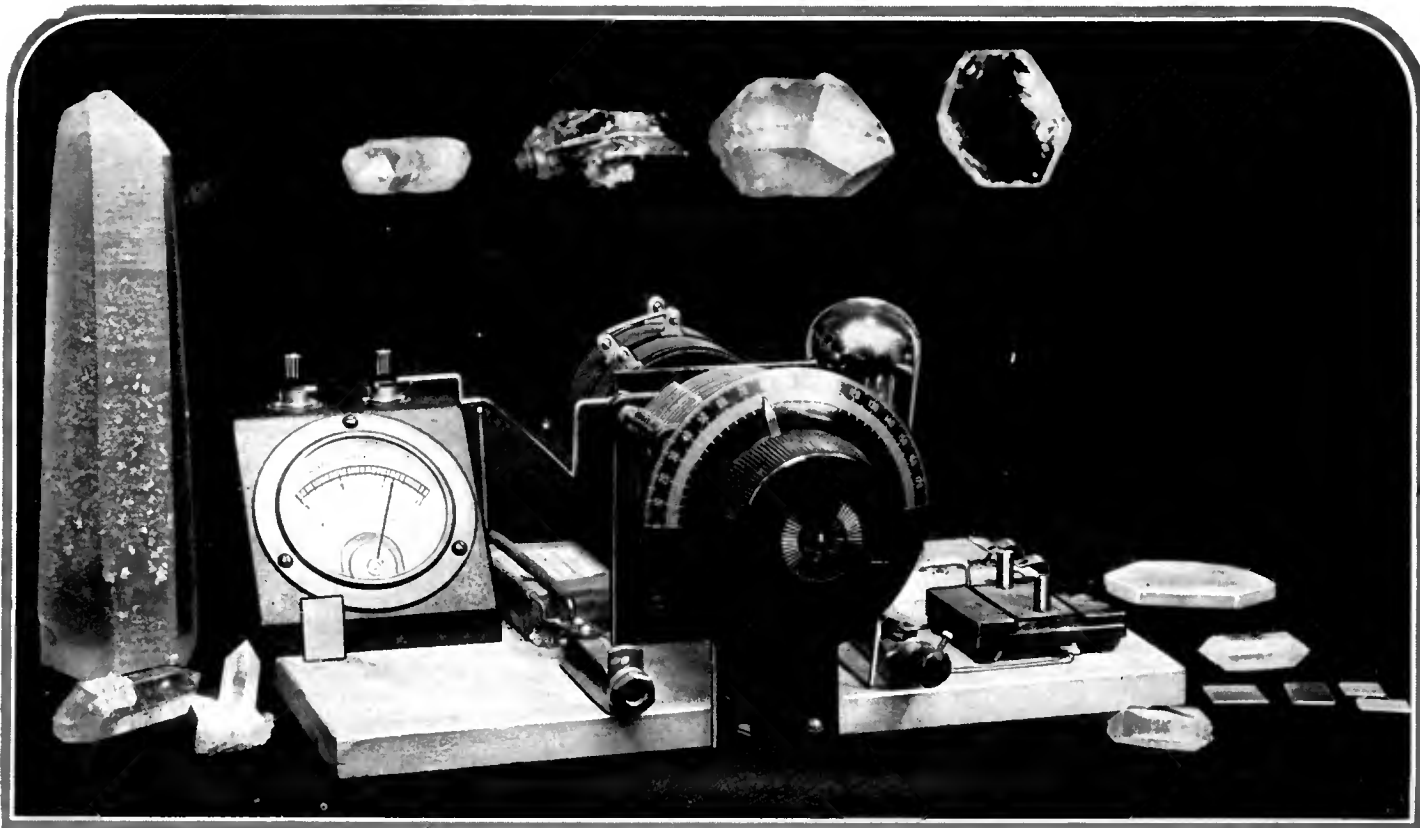

RADIO BROADCAST Photograph

### WHAT QUARTZ CRYSTALS LOOK LIKE

Quartz plates are coming into their own as standards of frequency. Papers are delivered before the learned societies, articles are written in magazines, and the world is scoured for clear quartz crystals. These crystals were furnished the Laboratory through the courtesy of Mr. Robert F. Collins, of Columbia University. The instrument is a heterodyne wavemeter

# Wavemeters for the Home Laboratory

Another Helpful Article for the Home Experimenter—Simple and Inexpensive Meters and Their Use—The Extremely Useful Heterodyne Wavemeter—How to Calibrate All Types of Wavemeters

By KEITH HENNEY

Director, Radio Broadcast Laboratory

ONE of the earliest and most laudable desires of the home experimenter is to measure something. He knows that the meat of any research lies in the data obtained from a succession of experiments, and that these experiments are marked almost entirely by the business of making measurements. This article, which is one of a series of several for home experimenters, describes the simplest and perhaps most fundamentally useful part of a radio enthusiast's laboratory—a means of measuring frequency or wavelength.

In the good old days, such instruments were termed wavemeters and even now, when we speak of frequency instead of wavelengths, it is common practice to hear engineers speak of wavemeters and kilocycles in the same breath. Regardless of the appellation of the apparatus, however, there is little doubt that the simplicity and usefulness of a wavemeter recommend it as one of the first measuring instruments to be made for the home laboratory.

Other articles in this series have described a simple oscillator and its uses as well as standards of capacity and inductance and a bridge by

which unknown coils and condensers may be compared. Future articles to appear promise experiments upon coils and condensers, tubes, and meters, many of which are based upon actual work carried out in the RADIO BROADCAST Laboratory as well as experiments indicated by reading

the Bureau of Standards Bulletin 74 or the Signal Corps book, *Principles Underlying Radio Communication*.

It has already been mentioned that a wavemeter is a simple piece of apparatus. In fact, the first wavemeter the home laboratory worker should make is composed of but two units, a coil and a condenser. Who is the experimenter who has not an idle condenser, lying about the laboratory, and where is he who can not wind a few turns of wire on a form of some sort?

With such a meter one can do the following things:

1. Measure the frequency of received signals.
2. Measure the frequency of transmitted signals.
3. Set a receiver, or transmitter, to a given frequency.
4. Trap out unwanted signals.
5. Measure frequency in laboratory experiments.



FIG. 1

A coil and a condenser make a wavemeter as this photograph shows

Fig. 1 shows the complete simplicity of such a wavemeter. The inductance in this case is part of a Hammarlund-Roberts antenna coil, composed of wire wound on a thin cellulose form,



each wire separated from its neighbor by about the diameter of the wire. It makes a coil of very low loss, and the wavemeter will, for this reason, tune sharply.

A low loss coil is not at all necessary for a wavemeter—in fact, what is really wanted is rigidity, so that once the meter is calibrated the owner has the certainty that he will not have to recalibrate it because the coil drops on the floor. For this reason, rather large wire—say No. 20 bell wire—wound on a good form is to be preferred to a more flimsy but low loss type.

The condenser may be any variable capacity. If the meter is to be calibrated in kilocycles, which is advisable, the condenser should be of the straight line frequency type, but that is not necessary, for if such a characteristic is wanted one of the straight line capacity condensers may be fitted with a special frequency converter dial—like the Rathbun dial illustrated in Fig. 2. Even this is not necessary, for once the meter is calibrated, wavelengths in meters may be converted to frequency in kilocycles by the simple process of dividing 300,000 by the wavelength in meters. For example, 600 meters equals 500 kilocycles.

The condenser, however, should be of sturdy construction and well protected from dust and from mechanical injury. The General Radio "can" condensers lend themselves well to this purpose, and Fig. 3 is a General Radio wavemeter and wave filter (trap) which is very useful. The dial is calibrated in wavelengths, 200 to 600 meters.

The leads to the coil-condenser combination should be short and heavy, and when the wavemeter is equipped with several coils to cover different frequency bands, a plug-in arrangement is useful. At any rate, the device must be



RADIO BROADCAST Photograph

FIG. 3

The General Radio company makes a wavemeter that can be used as a filter too, and this photograph gives an idea of its appearance. The condenser is calibrated in wavelengths from 200 to 600 meters

calibrated with the leads connected to it as it is to be used later, and each time the leads are changed, a new calibration must be made.

To calibrate such a meter is simplicity itself. One moves the coil near a receiving set that is in operation. The wavemeter is tuned until signals from a known broadcasting station—which is probably pretty near its assigned frequency and which is being heard in the receiver—disappears. This indicates that the meter is tuned to that frequency and is absorbing energy from the receiving set. By noting the condenser scale for several stations the frequencies of which are known, a complete calibration may be obtained.

FIG. 2  
If one has a straight line capacity condenser—and who hasn't?—he may get an approximately straight line frequency graph by using this Rathbun converter which is a dial having an eccentric cam arrangement attached to the shaft receptacle

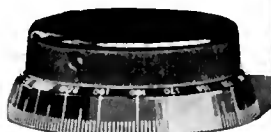

RADIO BROADCAST Photograph

A curve can be made by plotting on a sheet of graph paper the condenser degrees against the frequency in kilocycles, or wavelength in meters. For example, in the Laboratory, the Hammarlund-Roberts-General Radio combination tuned as Table 1 shows; and in Fig. 4 is the chart showing how such data is plotted.

| TABLE 1 |            |                   |
|---------|------------|-------------------|
| STATION | WAVELENGTH | CONDENSER DEGREES |
| WNYC    | 526        | 90                |
| WEAF    | 492        | 78                |
| WJZ     | 455        | 65                |
| WOR     | 405        | 51                |
| WHN     | 360        | 40                |
| WPG     | 300        | 28                |
| WFBH    | 273        | 24                |
| WBNY    | 210        | 14                |

It will be found that some stations will not fall on the curve. This indicates that the station in question has strayed from its assigned frequency. There are few localities, however, where one may not hear at least one of the stations in Table 2. These are very close to their assigned frequencies as indicated by recent reports of the Bureau of Standards. At any rate, a curve should be drawn through as many points as possible and naturally, the more points, the more accurate the curve.

| TABLE 2 |           |                            |
|---------|-----------|----------------------------|
| STATION | FREQUENCY | AVERAGE DEVIATION Per cent |
| WJR     | 580       | 0                          |
| WEAF    | 610       | 0                          |
| WCAP    | 610       | .1                         |
| WRC     | 640       | .1                         |
| WSB     | 700       | .2                         |
| WGY     | 790       | .1                         |
| WRZ     | 900       | .1                         |
| KD'CA   | 970       | .1                         |

So much for the construction and calibration of the simplest wavemeter, a tuned coil-condenser combination. We shall return to more accurate methods of calibration later.

There is another simple wavemeter that is used at 2 GY, the scene of the RADIO BROADCAST short-wave experiments. This meter has been described by the Bureau of Standards and is composed of the components described above together with a method of indicating resonance. It is essentially a meter to be used at a transmitting station, and a photograph is shown in Fig. 5. Coupled to the coil of this wavemeter is a pick-up circuit in which is a crystal detector and a milliammeter or small flash light bulb.

The purpose of placing the indicating device external to the circuit is to keep the resistance of the tuned circuit as low as possible. What actually happens is as follows: Currents of radio frequency are picked up from the transmitter and flow around the tuned circuit. The pick-up



circuit gets its energy from the coil-condenser circuit and after this current is rectified, the d. c. component is measured by the milliammeter or the flash lamp. The circuit is shown in Fig. 6.

HETERODYNE WAVEMETERS

THERE is another type of wave or frequency meter that is vastly more useful than the simple ones just described. This is known as a heterodyne wavemeter, and is really a small receiving—or transmitting set—in which resonance is indicated by a pair of telephones or a milliammeter.

The radio-frequency oscillator which was part of the modulated oscillator described in the first article in this series (September, 1925) may be used with the addition of a jack in the grid or plate circuit of the tube. A separate tube, however, may be rigged up with its accessory apparatus and with the modulated oscillator many interesting experiments may be performed, for here are two miniature transmitters, one of them modulated, and with proper jacks one can listen in either circuit, noting what changes take place as the two transmitters are tuned alike. Or one can listen in his receiver and, setting the two oscillators 10,000 cycles apart, ascertain if his receiver is selective enough to separate two stations tuned to within 10 kilocycles of

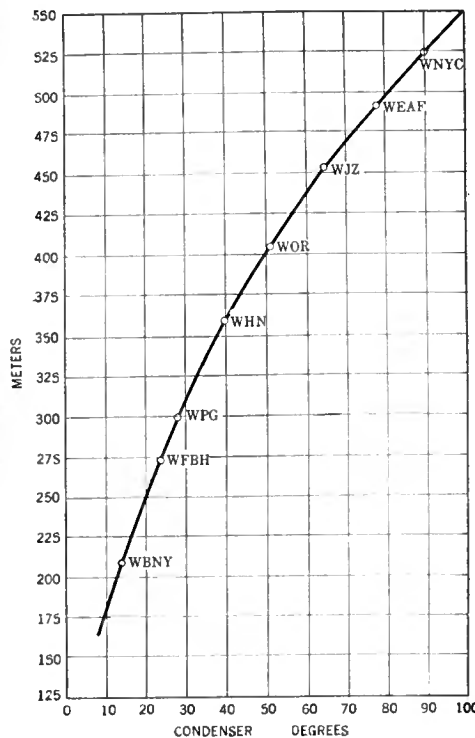

FIG. 4

The coil-condenser combination of Fig. 1 tunes as this graph shows. Knowing the wavelength of a station one can easily read from this chart the condenser degrees to tune the wavemeter to it

each other. The note heard in the receiver will serve to show the experimenter the origin of "heterodyne" squeals now in the ether on short-waves. If the receiver can separate two signals 10 kilocycles apart, it may be considered sufficiently selective.

A jack placed in the grid or plate circuit of the modulated oscillator has several important uses. In the first place a milliammeter may be plugged in these circuits and the effects of tuning noted,

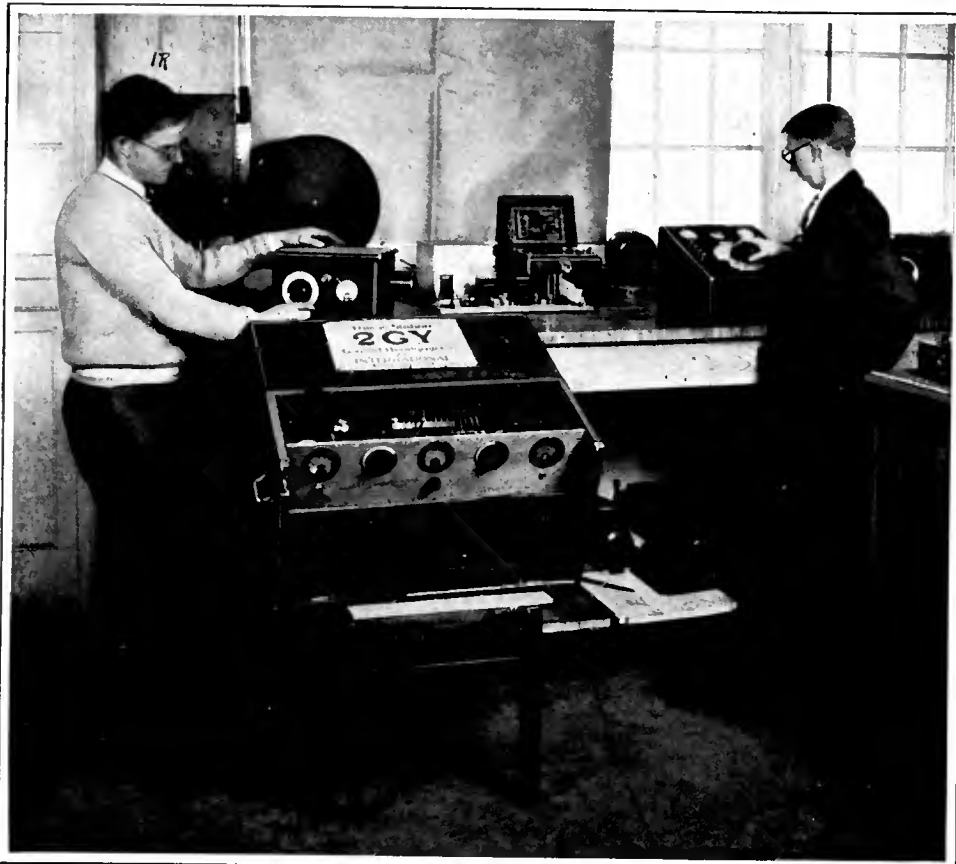

FIG. 5

RADIO BROADCAST Photograph

An oscillator, a short-wave transmitter, and a wavemeter all in one picture. The transmitter is being tuned by means of the wavemeter which is first calibrated against the Laboratory oscillator. When the transmitter is properly tuned, the wavemeter picks up energy which is indicated on the milliammeter

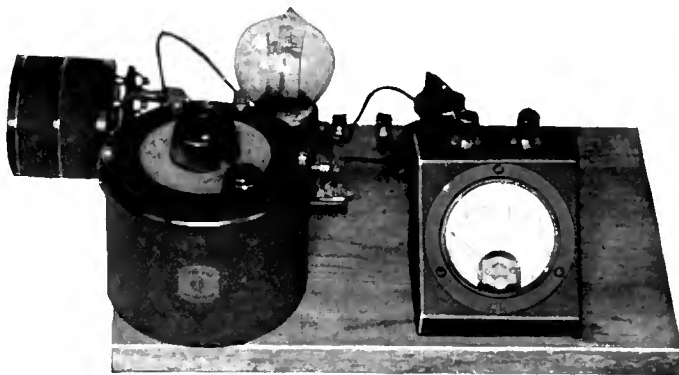

FIG. 7

RADIO BROADCAST Photograph

An experimental heterodyne wavemeter that is also a laboratory oscillator. When this circuit is tuned to another near by, a deflection of the plate meter shows the exact point of resonance. The device is also an excellent source of high frequency current for laboratory experiments

and in the second place, a pair of receivers plugged-in the plate circuit will indicate resonance with some tuned circuit by a decided "thump."

A very sensitive instrument may be made if a milliammeter with a full scale reading of 1.5 milliamperes is used in the grid circuit. If a plate meter is used it must be able to read 5.0 milliamperes. The grid meter arrangement is more sensitive, but has the disadvantage that the meter is more expensive. Whether the milliammeter is placed in the grid or plate circuit it should be by-passed with a 0.006-mfd. condenser. It may be permanently connected or plugged-in as indicated.

plate voltages. The meters must be shunted to avoid damage and a new calibration will be necessary if the B potential is increased.

USES FOR THE METER

THERE are many uses to which this form meter is adaptable. For example, let us suppose that we wish to measure the frequency to which a coil-condenser combination is tuned. The inductances of the circuits are coupled together, not too closely, and the wavemeter condenser varied. When the two circuits are tuned alike, a sharp deflection of the grid or plate milliammeter

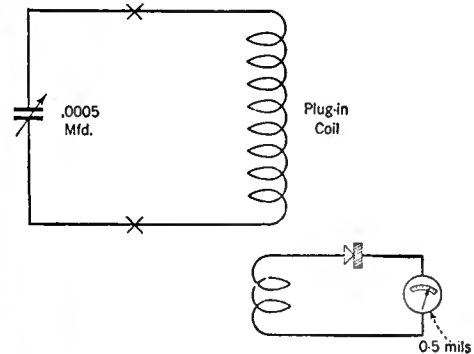

FIG. 6

A circuit diagram of the wavemeter used at 2 GY and illustrated in Fig. 5. The crystal detector rectifies the energy picked up from the transmitter and the resulting d.c. current is read on the milliammeter

will indicate resonance. Coupling between the two circuits should be only tight enough so that a slight dip occurs in the milliammeter. As a matter of fact, a tuned circuit a foot distant from a heterodyne meter will produce a decided deflection.

A pair of phones inserted in the jack of the meter will give a sharp click when the circuits are tuned to each other, and, if desired, the grid or plate milliammeter may be dispensed with and resonance indicated only by the telephones. In this case, however, somewhat closer coupling must be used. The graph, Fig. 9, shows how the plate, or grid current meter varies as resonance is approached.

The circuit of this interesting and sensitive indicator of resonance is the Hartley, as shown in Fig. 10. The polarity of the battery does not matter although it should be reversed before permanent connections are made to determine which is better. Plug-in coils may be used, as shown in Fig. 8 and, with a set of General Radio inductances, frequencies between 500-

An experimental laboratory set-up is shown in Fig. 7, and a photograph of the Laboratory heterodyne wavemeter in Fig. 8. A wd-12 tube is used in this instrument and batteries are provided within the cabinet so that the whole outfit is easily portable. Any tube may be used, although for reason of portability, the dry cell operated ones are to be preferred. If more power is desired, it is only necessary to use a larger tube with higher

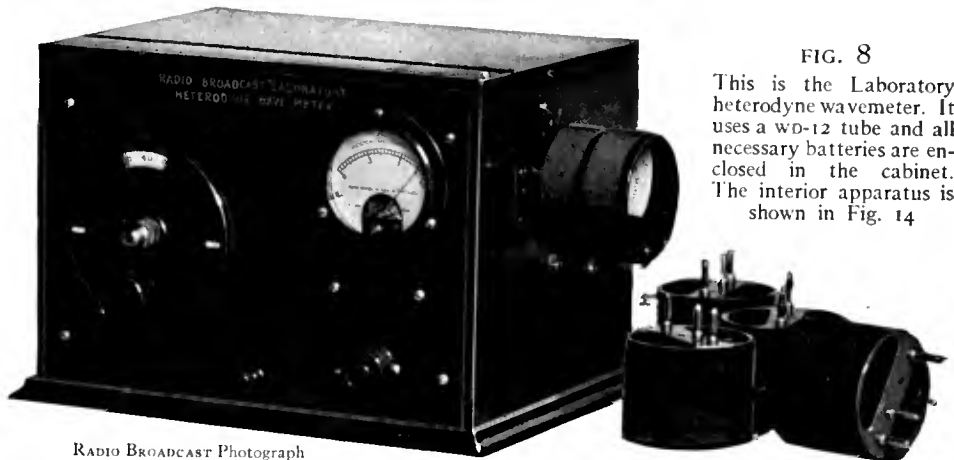

FIG. 8

This is the Laboratory heterodyne wavemeter. It uses a wd-12 tube and all necessary batteries are enclosed in the cabinet. The interior apparatus is shown in Fig. 14

RADIO BROADCAST Photograph

and 6000 kilocycles may be accurately measured. Other plug-in coils are made by Aero Products, Inc., Chicago; Radio Engineering Laboratories, New York, and others.

The tube of this circuit oscillates at the frequency determined by the inductance and capacity of the tuned circuit, and when another tuned circuit is brought near it, energy is extracted from both grid and plate circuits so that the current changes.

By means of the click as heard in the phones, or by the dip in milliammeter, the frequencies of receivers, of tuned circuits, natural wavelengths of antennas, or coils, may be measured with an accuracy that depends entirely upon the accuracy with which the meter is calibrated and the mechanical accuracy with which the dial can be set and read.

A QUARTZ CRYSTAL METER

THERE is still another type of wavemeter that has come in for much attention during the last few years. This is the wavemeter employing a quartz plate which acts as a standard of frequency. It is perhaps the most satisfactory standard of frequency that modern science has produced, for once the plate is cut and ground to the desired thickness, its frequency will not vary.

Such quartz crystals are connected to a wavemeter in one of the ways shown in Fig. 11, and

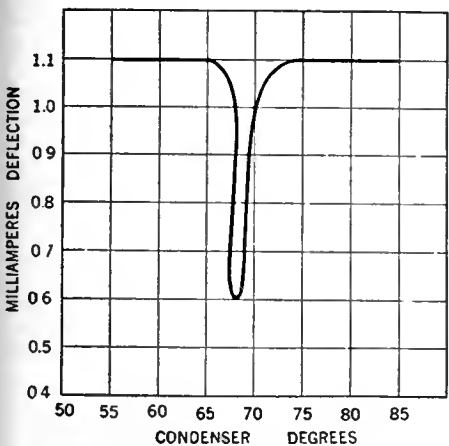

FIG. 9

When the heterodyne wavemeter is tuned to an absorbing circuit near by, the plate-meter "plops" in a curve similar to the one in this illustration. If one listens in the plate circuit at the same time, he will hear a distinct click as the point of resonance is passed through

clamped between two metal plates. The photograph at the top of the first page of this article shows such an arrangement. The crystal is held in the small gadget resembling a fixed condenser on the extreme right of the baseboard. An explanation of this phenomenon, one of the most interesting in modern science, may be read on Page 116 of the June RADIO BROADCAST, and is by Professor Morecroft.

The tuning condenser in a quartz-crystal-controlled oscillator or wavemeter may be varied over several degrees without the actual frequency of the system varying. In other words, the quartz plate acts as a frequency stabilizer. In practice the quartz which is held between two metallic plates forming the electrical contacts of the frequency stabilizer merely defines one point on the frequency curve very accurately, and one can tell from time to time if the calibration of the wavemeter has changed by noting this one point. It often happens that some

slight change in tube constants or leads, may shift the entire curve of a wavemeter, and by noting where the quartz crystal frequency appears on a new curve, the corrections may be made. Several most valuable articles on this subject have appeared in the radio press recently. The Bibliography with this article lists the more important. Quartz crystals may be purchased from the General Radio Company, Scientific Radio Service, Mount Rainier, Maryland, and others.

HOW TO CALIBRATE THE WAVEMETER

THE simplest method of calibrating a meter has already been described. It consists in absorbing energy from a non-oscillating receiver by

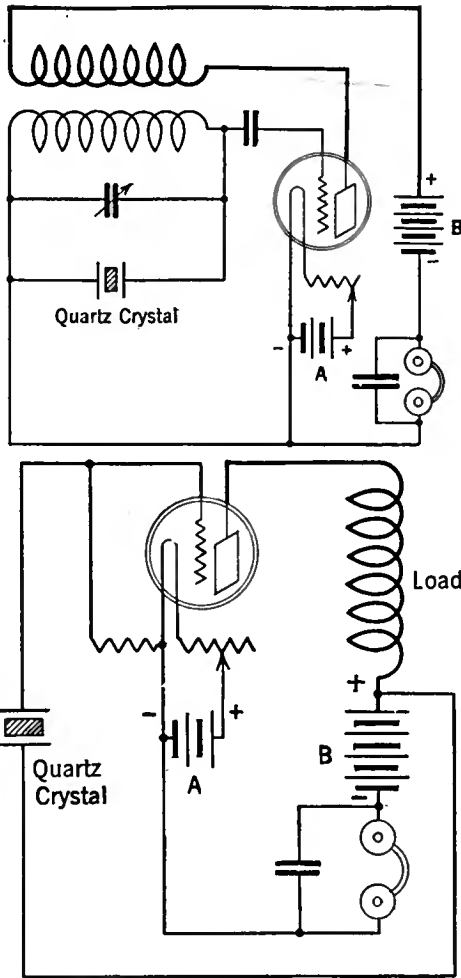

FIG. 11

As standards of frequency, there are nothing like quartz plates, as Professor Morecroft explained in the June RADIO BROADCAST. Here are a few circuits which utilize quartz, and others may be found in a recent paper before the Institute of Radio Engineers by August Hund of the Bureau of Standards

the wavemeter and noting the decrease in signal strength in a pair of telephones. Another, and more accurate method, is by means of the "click" of an oscillating detector such as that in the Roberts, the Browning-Drake, etc. If there are two clicks, or if the exact resonance point is not sharp, the coupling is too close.

Let us suppose that we wish to calibrate a simple coil-condenser combination. We rig up a single-circuit "blooper" detector and by listening as usual with a pair of telephones, tune to some broadcasting station whose frequency we know. Suppose it is WEA F operating at 610 kilocycles or 492 (approximately) meters. The detector is tuned to exact resonance with WEA F by means of a vernier condenser. One method of doing this is shown in Fig. 12, in which a Haig and Haig condenser with an additional plate is utilized. The main condenser is tuned as closely as possible to 610 kilocycles and a strong beat note will result. Then the single plate is tuned until this beat note disappears. We are then certain that the detector is operating at exactly 610 kilocycles. It should not be changed. Coupling to the antenna should be loose enough so that an accurate adjustment is made.

The wavemeter is then brought into resonance with the receiver, and the click noted in the receivers. This is one point for our wavemeter. Other stations can be received in the same manner and several points located on our curve

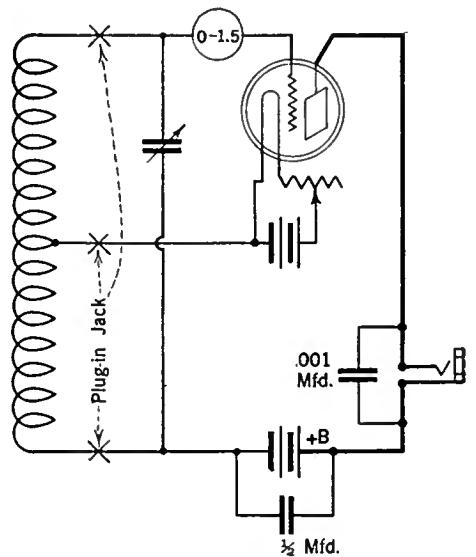

FIG. 10

The simple Hartley circuit of the oscillator-wavemeter

of frequency against condenser setting. If we are calibrating the heterodyne meter, it is only necessary to tune its condenser until the note emitted from it exactly coincides with that of WEA F or any other stations. Loose coupling must be used.

There is an alternative method that is very interesting and instructive, and when one comes to calibrate the higher frequencies (shorter wavelengths) this method is most useful.

CALIBRATION BY HARMONICS

THE method is one which utilizes the harmonics generated by an oscillating tube. A definite experiment will make clear the method.

We have already set our oscillating detector to 610 kilocycles. Now this tube not only generates a frequency corresponding to WEA F's wavelength but also generates other frequencies

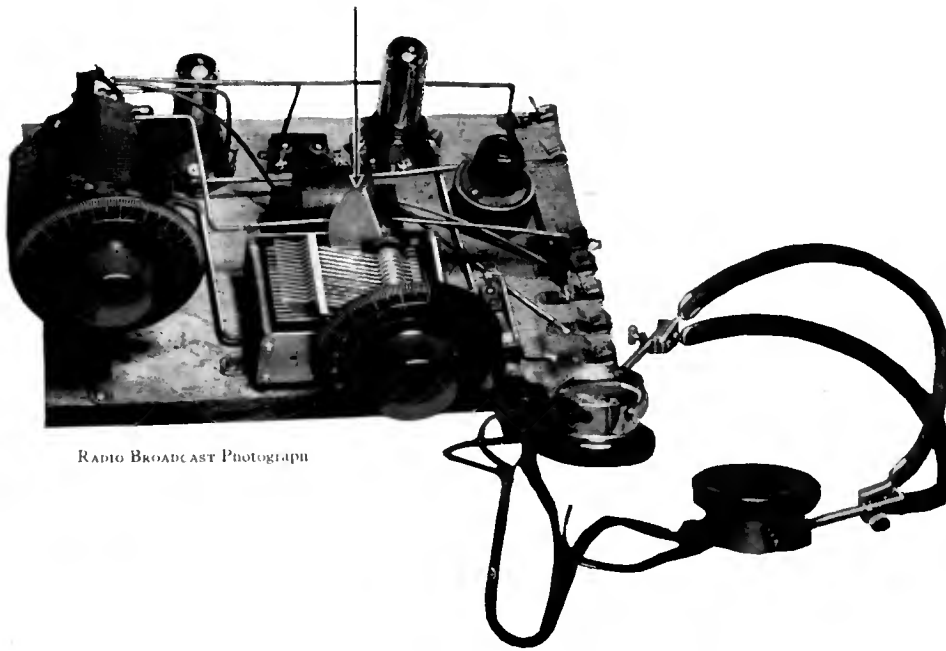

RADIO BROADCAST PHOTOGRAPH

FIG. 12

A simple "bloopers" that is useful in standardizing wavemeters. The arrow indicates the single plate of the Haig and Haig condenser that is useful in tuning to exact resonance with incoming signals

of twice, three, etc., times this frequency. In other words, if one could look at the output of this tube he would see frequencies as indicated below.

|                 | FREQUENCY<br>K. C. | WAVELENGTH<br>METERS |
|-----------------|--------------------|----------------------|
| Fundamental     | 610                | 492                  |
| Second Harmonic | 1220               | 246                  |
| Third Harmonic  | 1830               | 164                  |
| Fourth Harmonic | 2440               | 123                  |
| Fifth Harmonic  | 3050               | 98.5                 |

Now, using a plug-in coil of about 60 turns on a 3-inch form for our first coil in the wavemeter, we may rest assured that with a 0.0005-mfd. condenser our frequency range will be 500 to 1500 kilocycles. Listening in our bloopers receiver which is still tuned to 610 kilocycles, we may tune the heterodyne wavemeter, which is also generating harmonics, until it tunes to 1220 kilocycles when a loud beat note will be heard in the telephones. Here then are two points from a single station which will be as accurate as we are able, mechanically, to adjust our apparatus.

If we use 30 turns in the same length of winding on the second plug-in coil, it should tune to exactly one-half the wavelength, or twice the frequency, of the 60-turn coil, or 100 to 300 meters, 1000 to 3000 kilocycles. This will include the second, third, fourth, and possibly the fifth harmonics of 610 kilocycles. Listening in the receiver and tuning the heterodyne wavemeter, we shall hear beat notes whenever the meter is tuned to one of these harmonics. If the two instruments are too closely coupled, clear beat notes will not be heard, or it is possible that fractional harmonics may be found—which will be described later. A 15-turn coil will double the frequency of the 30-turn one, and will tune from 50 to 150 meters or 2000 to 6000 kilocycles. This will include harmonics between the fourth and the tenth.

Thus by getting one single station tuned very carefully by means of a vernier adjustment, we may calibrate a whole series of wavemeter coils and our accuracy of calibration will depend upon three things, the accuracy with which the transmitting station is tuned to its assigned frequency, the accuracy with which we can set our receiver to its exact frequency, and the

accuracy with which we can set the heterodyne meter and read the dials. There is an optional method which makes use of a short-wave receiver.

#### CALIBRATING WITH A SHORT-WAVE RECEIVER

SUPPOSE we tune our broadcast receiver again to 610 kilocycles. Since the tube is oscillating, it is grinding out many other frequencies as well, some of them very high. For example, the tenth harmonic will be 49.2 (approximate) meters or 6100 kilocycles. Suppose we have a short-wave receiver operating

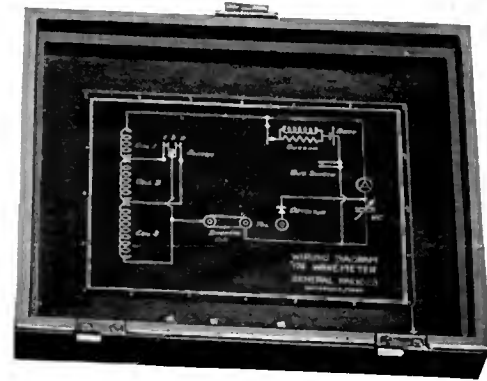
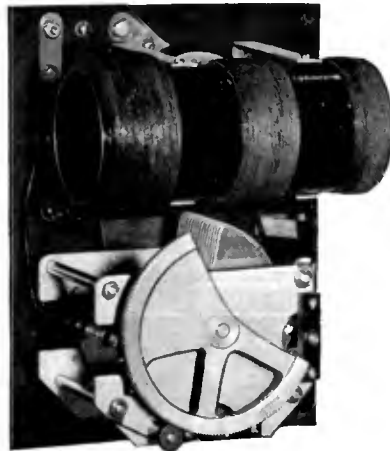

FIG. 13

This is an interior view of a buzzer type wavemeter which is a product of the General Radio Company. It has a range of 2000 to 100 kilocycles (150 to 3000 meters). Note the rugged construction of the coils

on the 40-meter band. It will probably receive the 49.2-meter harmonic from our broadcast receiver. Here then is a point for our short-wave receiver calibration. Other points may be obtained in the same manner. The receivers (short-wave and broadcast) may be coupled loosely by winding a turn around each inductance and connecting them together.

Let us, however, try another scheme. Suppose we tune our short-wave receiver so that

a beat note is heard when the broadcast tube is oscillating at 610 kilocycles. This means that some harmonic of 610 kilocycles is beating with either the fundamental, or a harmonic, of our short-wave tube. It is probably the fundamental, and at any rate the following routine will determine exactly what wavelength it is.

Let us listen in the "bloopers" receiver, accurately set it at 610 kilocycles, and tune the heterodyne wavemeter until a beat note is heard—without changing the short-wave set, of course. The heterodyne oscillator is now tuned to 610 kilocycles. Now we can listen in the short-wave set and it will be found that other beat notes will be heard if the heterodyne meter is varied from 610 kilocycles to some other value, and a particularly strong note will be heard when the meter is tuned to 246 meters or 1220 kilocycles, the second harmonic of 610 kilocycles.

Now between 492 meters and 246 meters there is a difference of 246 meters. And supposing for example, that as we tuned the heterodyne wavemeter we heard four beat notes between these two wavelengths, we may say that four times between 492 and 246 meters, a total difference in wave length of 246 meters, we have tuned to some frequency which has a harmonic that beats with the fundamental of our short-wave set. This fundamental will, naturally, be 246 divided by 4, or 61.5 meters, which is the setting of the short-wave receiver, and the points on the heterodyne meter which cause beat notes will be 61.5 meters apart. This means that the first beat note below 492 meters is 492 minus 61.5, or 430.5, the second is 430.5 minus 61.5, or 369, and so on.

Suppose, for example, that three beat notes are heard between 492 and 246 meters and that a fourth is a few degrees below 246 meters. In other words, a beat does not appear at 246 meters. Let us say, then, that there are three and one-half wavelengths in this range. This is only approximately true but will give us an approximate point for our calibration. Dividing 246 meters by  $3\frac{1}{2}$  gives 70.3 meters which is the approximate setting of the short-wave receiver.

It is simpler, however, to adjust the short-wave receiver until a beat note is heard at both

the fundamental and second harmonic of 610 kilocycles—or whatever the original frequency happens to be. This method will give us several points on the 60-turn coil of our heterodyne meter.

Setting the short-wave receiver at some definitely known wavelength, obtained by the above method, we may use a smaller coil in the heterodyne wavemeter and tune it until a beat note is again heard in the receiver. This will indicate

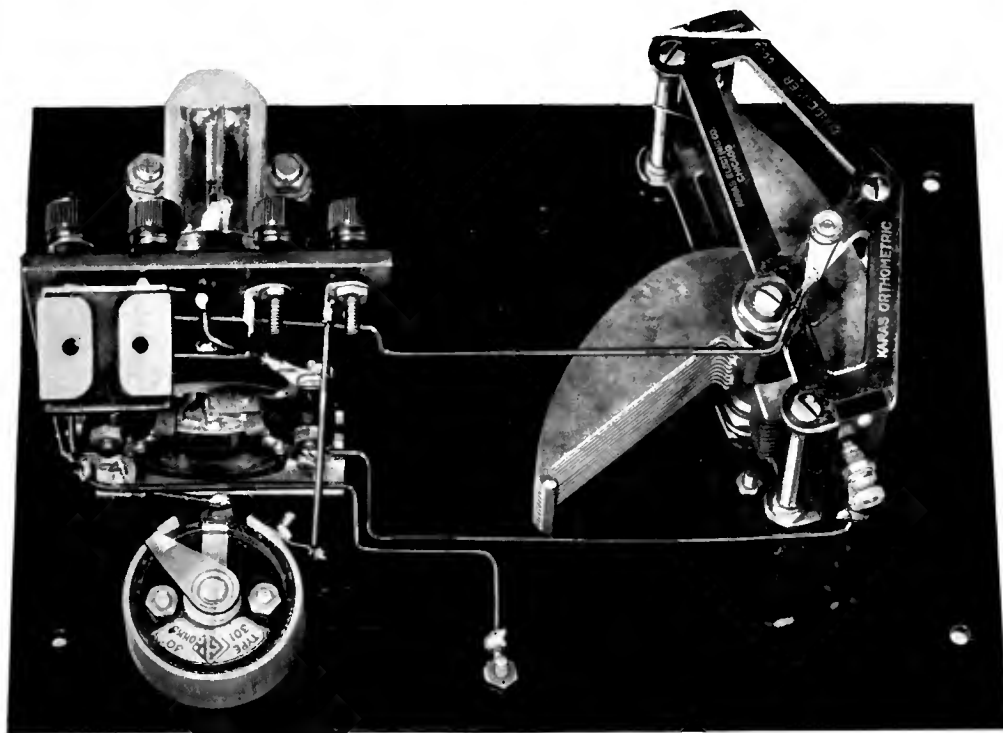

FIG. 14

The interior of the RADIO BROADCAST Laboratory heterodyne wavemeter. Note the rigid construction, the short leads, and the accessibility of all parts

RADIO BROADCAST Photograph

that the heterodyne meter and the short-wave receiver are tuned to the same frequency.

In this manner, with a single accurately known frequency, a set of coils for the heterodyne meter, and a short-wave receiver, we may completely calibrate the wavemeter as well as the short-wave receiver.

There are several precautions that must be taken when one calibrates a wavemeter or a receiving set by means of harmonics. In the first place, one must know definitely what harmonic he is beating with, for if a single harmonic is missed the calibration will be out. If too close coupling is used between the source of oscillations and the receiver, fractional harmonics will be heard which are difficult to estimate in wavelengths. For example, it is possible that the second harmonic of one frequency will beat with the third of another instead of with the fundamental.

The following method of taking data will aid in avoiding difficulty of this nature. Suppose again that our heterodyne oscillator is set at 610 kilocycles, and that we tune the short-wave receiver until a beat note is heard. Some harmonic of 610 kilocycles is then beating with the fundamental of the short-wave set. Now vary the condenser of the heterodyne meter and note each point that a new beat note is heard. If we are picking up the beat between the correct harmonics there will be approximately

the same number of condenser degrees between each beat note.

For example, on our Laboratory oscillator, 610 kilocycles is found at 60 degrees on the tuning condenser. Beats are obtained when the condenser is tuned as follows:

91 74½ 60 47 36 26½ 18 10½

Subtracting each one of these figures from the preceding one we obtain

16½ 14½ 13 11 9½ 8½ 7½

And subtracting again we obtain

2 1½ 2 1½ 1 1½

These differences are perfectly regular, showing that we have not missed any harmonics on our path from 610 kilocycles to the second harmonic of 610 or 1220, and beyond. The line of



FIG. 15

With the aid of the oscillator shown in this photograph, the characteristics of various coils may be determined before they are included in a wavemeter

RADIO BROADCAST Photograph

reasoning then is as follows: Between 60 and 18 degrees were four beat notes which are caused by different broadcast frequencies, each of which has a harmonic whose wavelength is equal to that to which the short-wave receiver is set. The difference between 610 and 1220 kilocycles is 246 meters, which, divided by four makes 61.5, the setting of the receiver.

BUREAU OF STANDARDS SIGNALS

IN CONNECTION with calibration problems, the short-wave transmissions of several Radio Corporation stations are important, and their frequencies may be found by consulting one of the tables of short-wave stations mentioned in the bibliography. Standard frequencies are transmitted from wwv, Bureau of Standards, Washington, District of Columbia, from 6x8M at Leland Stanford, Jr. University, and 1xM, Massachusetts Institute of Technology (short waves only). Methods of receiving and interpreting these signals from wwv may be obtained from the Bureau of Standards *Letter Circular 171*.

For the home laboratory, the first meter should be a simple coil-condenser affair calibrated by means of broadcasting stations. The next meter should probably be a heterodyne meter which may be equipped with a wd-12 tube and a grid milliammeter, which will cost about \$15, but which in general usefulness surpasses many other expensive instruments. A plate 0-5 millimeter lists at about \$8.

It is sometimes useful to shunt the tuning condenser across a small part of the coil so that greater accuracy may be obtained. In this case the full scale of a 180-degree condenser may be made to cover but a few kilocycles instead of several hundred.

Future articles in this series for home experimenters will show more of the uses to which the modulated oscillator and the heterodyne wavemeter may be put.

BIBLIOGRAPHY

1. Piezo-electric Oscillators, G. W. Pierce *American Academy of Arts & Sciences*, Vol.60, No. 5
2. *Piezo-electric Resonators* Adam Hilger, Ltd., London
3. *Wavemeter Calibration*, John M. Clayton *Q S T*, February, 1926
4. *List of Short-Wave Stations*. *Q S T*, March, 1926
5. *How Crystal Frequency Control Works*, Professor Morecroft, *RADIO BROADCAST*, page 116, June, 1926
6. *List of Short-Wave Stations*, *RADIO BROADCAST*, page 708, April, 1926



RESISTANCES IN PARALLEL  
(in Ohms)

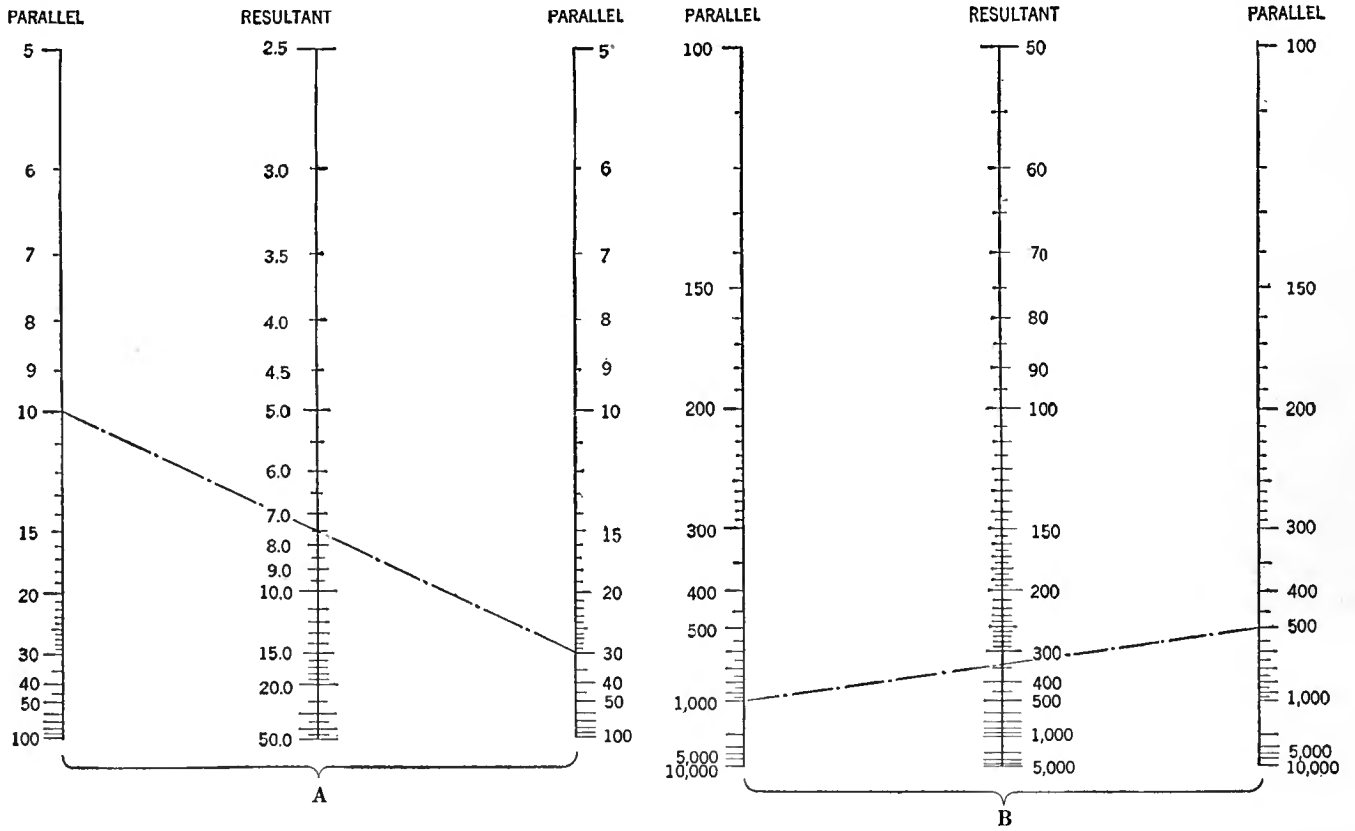

CAPACITIES IN SERIES

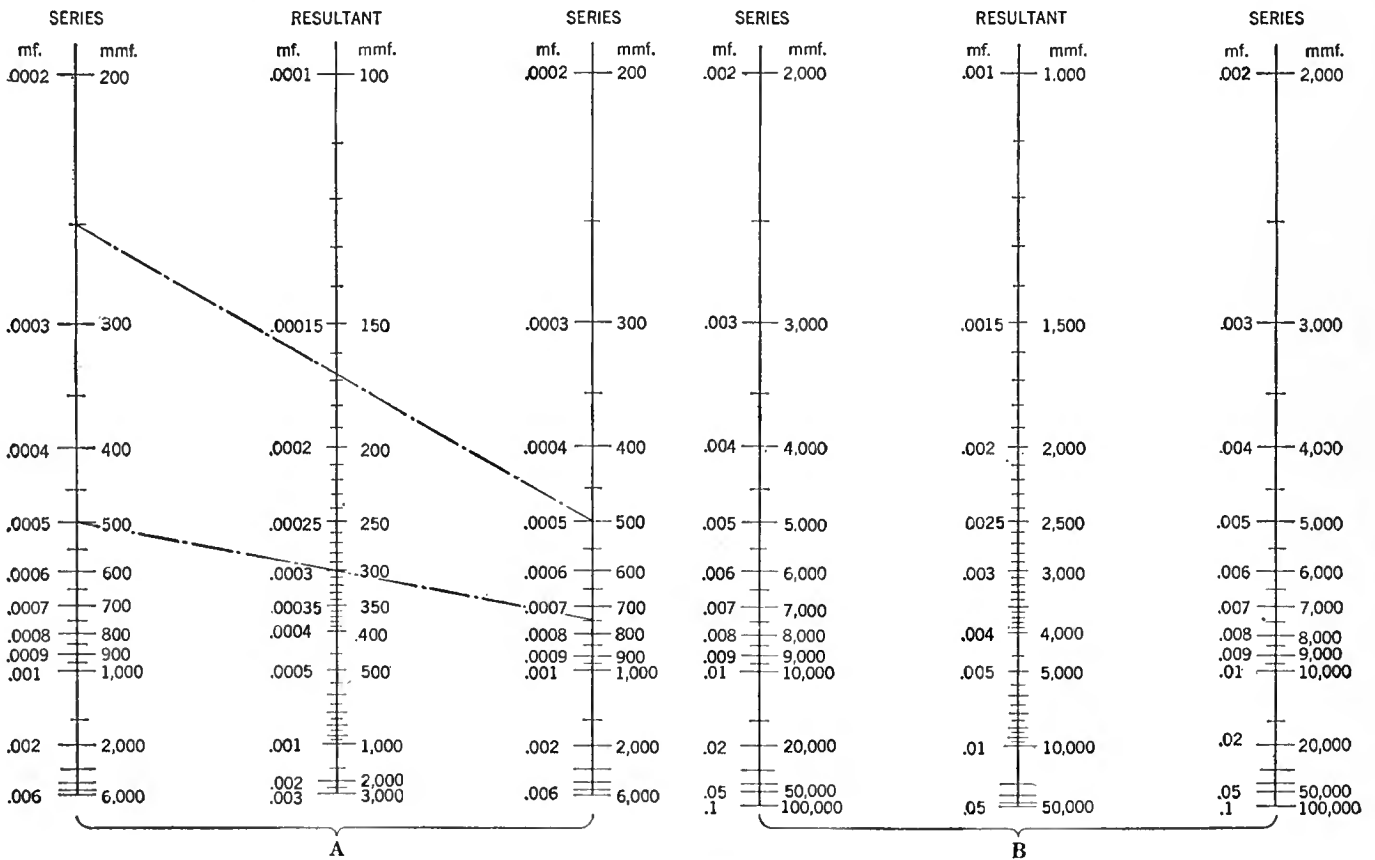

# Removing Mathematics from Resistance and Capacity Calculations

*How Your Filament Rheostat's Value May Be Altered to Accommodate New Tubes—Combining Fixed and Variable Condensers to Give a Required Capacity—The Range of the Accompanying Charts May Be Extended*

By HOMER S. DAVIS

## RESISTANCES

**A**LIGNMENT or calculation charts have long been in use among engineers for the easy solution of mathematical formulas. By their means, difficult calculations are avoided. The drawing of one or two straight lines with a pencil and a ruler is the only effort necessary to arrive at an answer when such charts are utilized, and that answer is more likely to be correct since the possibility of numerical errors is eliminated. A knowledge of advanced mathematics is not at all necessary. In the March, 1926, number of *RADIO BROADCAST*, such a chart was presented by means of which the reader was enabled to design a single-layer inductance coil to cover a given frequency range with a given size of tuning condenser. A wavelength-frequency conversion chart appeared in the February, 1926, *RADIO BROADCAST*. In the present article, charts have been further applied to the solution of resistances in parallel and of capacities in series. Additional charts dealing with other problems in the design of radio apparatus and receivers are now in preparation. It is suggested that the reader preserve these charts for future reference.

When resistance units, such as rheostats, grid leaks, coupling resistors, are connected together in series, the resultant resistance of the combination is the sum of the individual values. Thus, if a rheostat or grid leak is found to be too small, and the correct size not available, the required additional resistance may be connected in series with it. But when they are connected in parallel, or shunt, an entirely different relation holds. The resultant resistance is then less than that of any one component, and in the case of only two resistances, is given by the formula:

$$R = \frac{r_1 r_2}{r_1 + r_2}$$

when  $R$  = the resultant resistance and  $r_1$ ,  $r_2$ , the resistances in parallel. By virtue of this property, a resistor may be reduced in value by shunting it with another.

Two charts are presented for resistances in parallel, based on the above formula, the first, A, covering the range of 5 to 100 ohms, the second, B, 100 to 10,000 ohms. Their correct use is best illustrated by working out one or two examples. Suppose that two rheostats, one of 30 ohms, the other 10 ohms, are at hand, and it is desired to know their resultant resistance when connected in parallel. Draw a straight line between 10 on one outside scale of Chart A, and 30 on the other outside scale; the point where this line cuts the center scale marks the value of the resultant resistance, 7.5 ohms in this case.

To find the resistance necessary to shunt across an existing resistance to bring it down to any desired size, draw a line from the known value on an outside scale to the desired resultant value on the center scale, and continue the line to intersect the other outside scale, reading the answer at this point. The range of either of these two charts may be extended by considering the values on each of the three scales as multiplied by some constant. For instance, if the values on Chart B are multiplied by 1000, the range then will be from 100,000 to 10,000,000 ohms, or 0.1 to 10 megohms. To take an example, the resultant resistance of a 500,000-ohm (0.5 megohms) and a 1,000,000-ohm (1.0 megohm) resistor in parallel may be found by drawing a line between 500 and 1000 on the outside scales, the intersection with the center scale at 330 giving the answer as 330,000 ohms (0.33 megohm). In extending the range of a chart in this way, the reader should be careful to use the same multiplier on all three scales.

Resistance units are coming into more extensive use every day, some of the more recent applications being as coupling resistors, stabilizers for radio-frequency amplifiers, regeneration controls, volume regulators in audio-frequency amplifiers, and voltage regulators for battery eliminators. A knowledge of how to combine them to obtain different values of resistance should be of value to the constructor in avoiding delays and affecting savings in his outlay of parts.

## CONDENSERS

**C**ONDENSERS may also be connected in series or in parallel to obtain any desired value of capacity, but here the case is reversed from that of resistance units. That is, if two or more condensers are in parallel, their capacities are added to obtain the resultant; but if they are connected in series, the resultant capacity is then less than that of any one of them, and in the case of only two condensers, is given by the formula:

$$C = \frac{c_1 c_2}{c_1 + c_2}$$

where  $C$  is the resultant capacity, and  $c_1$ ,  $c_2$ , etc., the various capacities in series.

Charts for this formula are presented, again in two ranges. Values in microfarads and in micromicrofarads have been plotted on opposite sides of the scales. To work out an example illustrating their use, suppose that a radio-frequency transformer is to be used which requires a 0.0003-mfd. tuning condenser to cover the broadcast band of frequencies, and that a 0.0005-mfd. condenser is the only one at hand. To use this condenser would be undesirable, since it would crowd the tuning toward the lower end of the scale, and a considerable portion of the upper end would be unusable. This may be remedied by connecting a high grade mica fixed condenser in series with the tuning condenser to bring its maximum capacity down to 0.0003 mfd. The size of the fixed condenser may be found with the calculation chart by drawing a straight line from 0.0005 on an outside scale through 0.0003 on the center, or "resultant," scale, and extending it to meet the other outside scale; this point indicates 0.00075 as the required size of the fixed condenser. If this size is not available commercially, it may be made up by connecting together a 0.00025- and a 0.0005-mfd. condenser in parallel. To take another example, it is desired to know the resultant capacity of a 0.00025- and a 0.0005-mfd. condenser in series. Connect these values on the outside scales and read the answer, 0.000168 mfd., at the intersection with the middle scale. The ranges of these charts may be extended by the use of a suitable multiplier as was done with the resistance charts.

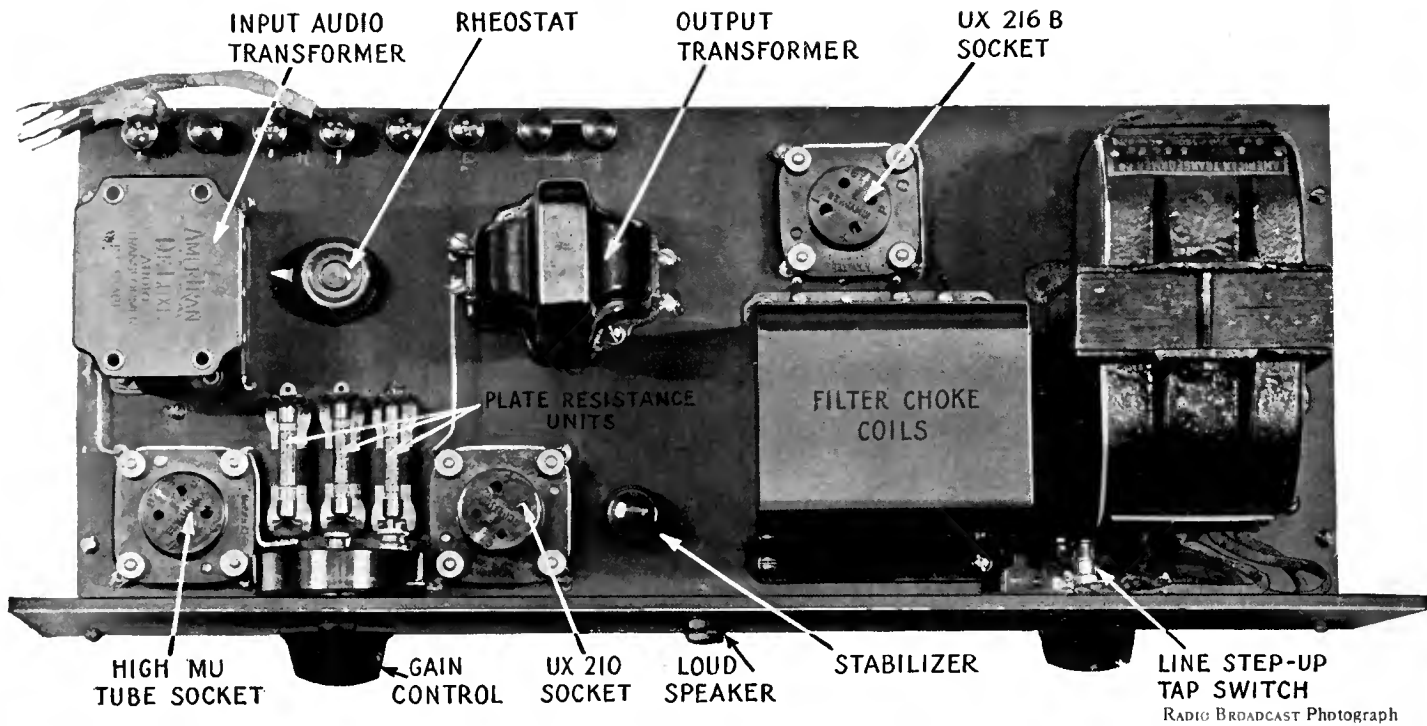

RADIO BROADCAST Photograph

# A Quality Amplifier—Power Supply

*Description and Constructional Details of an Amplifier Operating from the 110-Volt Mains Which Delivers Sufficient Plate Potential for Use with the New Tubes*

By ARTHUR H. LYNCH

WHAT constitutes a good audio amplifier system? This question has been argued pro and con, among radio dealers, in the pages of radio publications, at engineering societies—everywhere. Even among the engineers who are engaged in research and experiments to investigate the field of audio frequencies, this subject is a very prominent bone of contention.

To classify the audio amplifier systems is not difficult and each particular one has very definite qualifications which make it a favorite. Those who desire great volume and fairly good quality find the transformer style of audio amplifier entirely satisfactory. Others are more interested in the resistance and impedance systems of audio amplification. It is not the purpose of this paper to continue the argument but rather to describe a type of amplifier which, while not new or revolutionary, combines some very distinctive and worth while features that go toward making up a complete unit satisfactory to the *n*th degree.

As early as September, 1925, the trend toward better and better audio amplification started when George C. Crom, in a paper, "Some Remarks on Better Audio Amplification" in the October, 1925, RADIO BROADCAST, outlined the general requirements for an audio amplifier system that would not outrageously distort the signals introduced to an amplifier.

The slight trend has gradually become a landslide as evidenced in the many new contributions

from radio manufacturers in the form of high quality audio frequency transformers, power tubes, semi-power tubes, choke coils, and resistance units for amplifiers. All these insure, on the part of the constructor, something better in results than before. The trend is unmistakably manifest, too, in the new designs of complete power amplifiers which have been placed on the market such as the Pacent Power-former and Radio Corporation Uni-Rectron.

As one answer to the question that forms the first sentence of this paper, the description of the construction of a combined power stage and plate supply device, employing high grade parts easily obtainable, is offered. Much is due to James Millen and Frank M. Squire for their collaboration and contributions to the design of the device described here.

The diagram, Fig. 1, shows simply the system described in this article.

The test of a good amplifier is summed up in its ability to reproduce faithfully and magnify the signal as it is passed out of

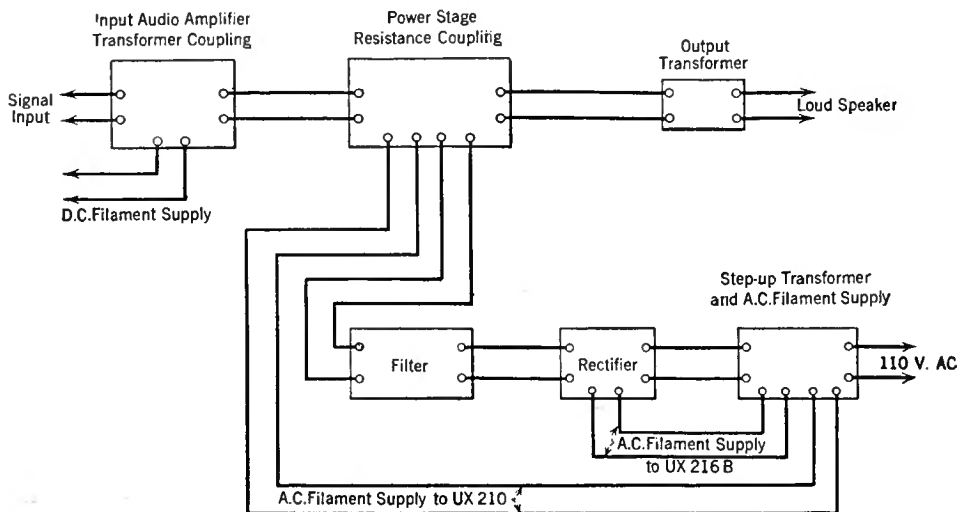

FIG. 1

The power amplifier consists of several major units which in turn consist in some instances of lesser units. Then, too, there are several lesser connecting links. This is made clear above where the three major units are 1—input amplifier, 2—power stage, 3—power supply. The power supply itself is made up of three units, namely the step-up transformer, rectifier, and filter

the detector of a receiver. This necessitates the use of high quality transformers that are designed to work in the particular stage in which they are used; that are designed with cores large enough to prevent saturation effects and other requirements that, in the new designs, have been met. The constructor can select his parts with a bit of reason and the assurance that the completed job will produce good results.

Where the coupling medium between tubes is to be resistance units, there are other requirements that must be met. These resistances must not deteriorate—at least not too quickly; they must be so used and constructed as to enable one to pass a high current through them and have the generated heat dissipated without injury to the resistance unit or causing a change in its resistance.

The power supply must be noiseless in operation and should be capable of supplying an output voltage sufficient to apply to the plate of the tube in the power amplifier, such as the UX-210 or other power tube.

PLENTY OF VOLTAGE FOR THE AUDIO STAGES

THE power amplifier illustrated and described here was built to provide a model fulfilling these requirements and to provide additional refinements evident from the description and illustrations. This high quality power amplifier device is designed to operate from the detector of a regular receiver.

The input unit of the power amplifier is one of the new AmerTran transformers to whose primary terminals is connected the output of the



RADIO BROADCAST Photograph

FIG. 2

Two controls and an output jack mounted on the panel are the only visible parts of power supply

detector. The transformer secondary terminals lead to a high-mu tube whose output is coupled by resistance coupling to the power tube, the UX-210. Three 100,000-ohm units are connected in series for the plate circuit and a 500,000- and 50,000-ohm resistor are inserted in the grid return circuit. The 50,000-ohm unit is a standard Centralab variable resistor which to a large degree controls the volume of the power amplifier.

The loud speaker connections do not come directly from the plate of the power tube because the applied voltage is on the order of some 400 or 500 volts. The effects produced when one comes in contact with the live side of the power supply are not over-pleasant and might result in some injury. To avoid that danger, an output transformer arrangement effectively isolates the loud speaker terminals from the high voltage supply, yet preserves the quality of the output because the impedance of the loud speaker may be more accurately matched with the impedance of the secondary coil of the output transformer.

The voltage supply, perhaps, is most difficult of all the units to construct, but with a bit of

care and patience a very good looking job of correct electrical design may be approximated by the individual constructor.

The constructional features outlined above are clearly depicted in the circuit diagram for the amplifier shown in Fig. 3. Here also may be seen the arrangement of the voltage supply unit. An AmerTran step-up transformer, having a 3-step variable primary and a secondary 500-volt

output is rectified by the R C A 216-B rectifier tube. After rectification, the transformer output is filtered to minimize the pulsations caused by rectification so that as little hum as possible is passed along to the loud speaker. In the construction described here no hum could be heard on the sensitive Western Electric 540-AW cone. The filter unit is a General Radio type 366 consisting of two 30-henry choke coils to which are externally connected three 2-mfd high voltage 'Jobe Deutschmann' condensers arranged as shown in the circuit. The ordinary run of bypass condensers will not consistently stand up when included in the filter part of a power supply circuit, and for this reason it is well to obtain condensers designed for the purpose and which have been tested for 750 or 1000 volts breakdown. If a larger size of filter condenser, such as 6- or 8-mfd, is procurable it is exceedingly advisable to place it in the filter circuit to take the place of the 2-mfd. condenser shown at the extreme left end of the filter circuit in the diagram, Fig. 3.

Besides furnishing the high voltage for the plate circuit of the two amplifier tubes, the line transformer is provided with two additional

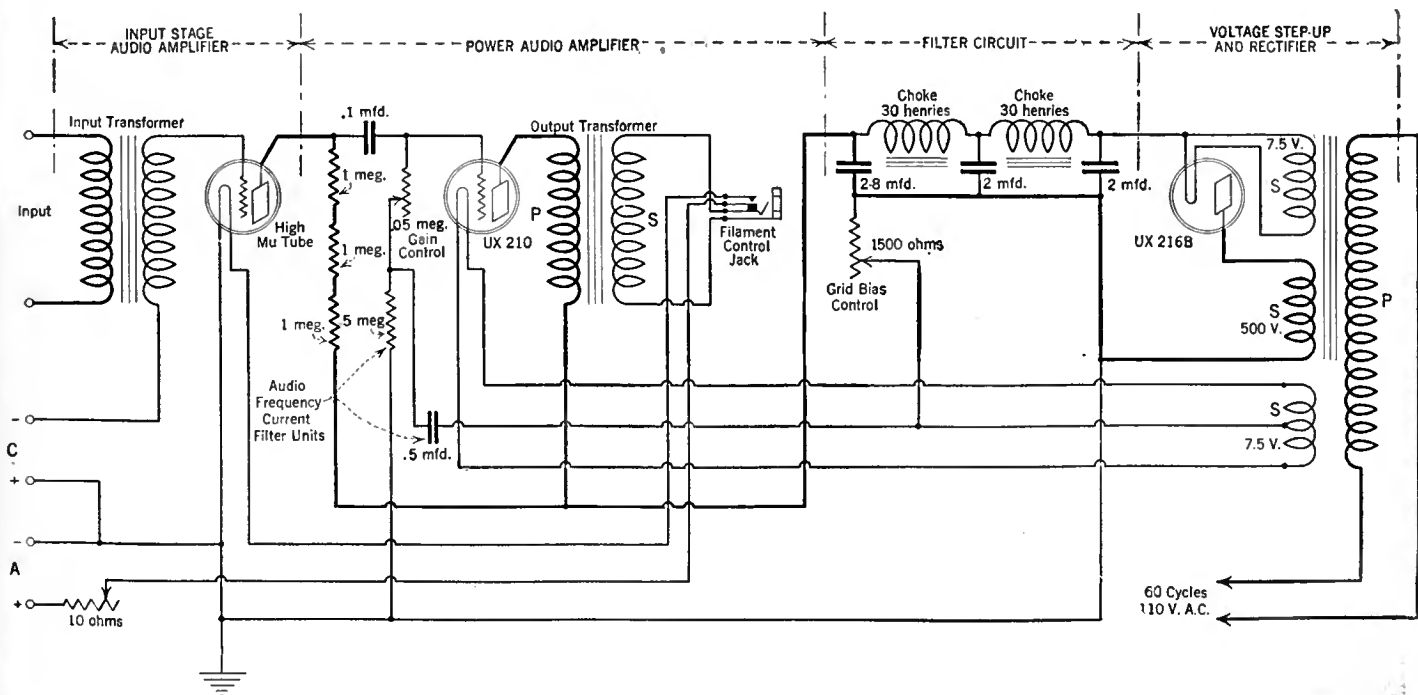

FIG. 3

This is the complete circuit diagram of the power amplifier. The path of the signal, as it is amplified, is from left to right until it passes out into the loud speaker. The path of the voltage supply begins at the right, is stepped-up, rectified, filtered and then delivered to the amplifier tubes. Of importance is the fact that the filter condensers should be capable of withstanding 1000 volts d.c. flash test. If a line transformer such as the AmerTran is used a line top switch may be included to vary the step-up ratio of the transformer. This switch is shown at the right of illustration Fig. 2.

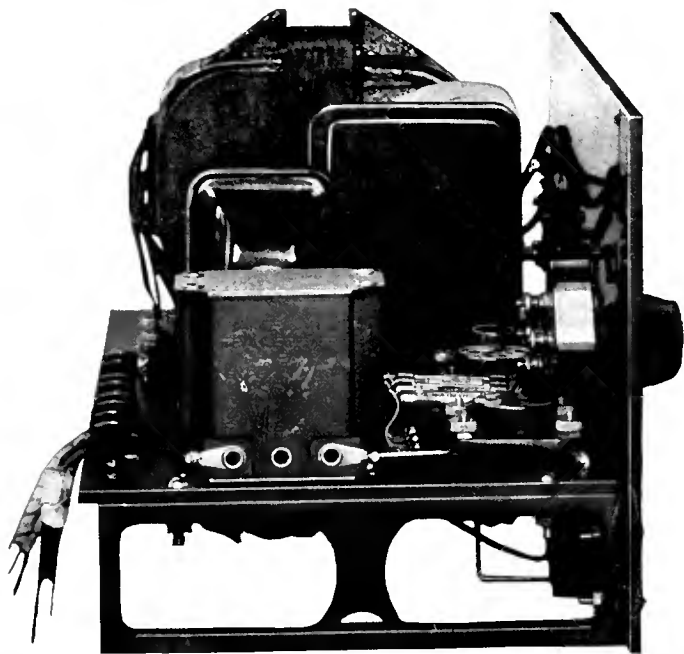
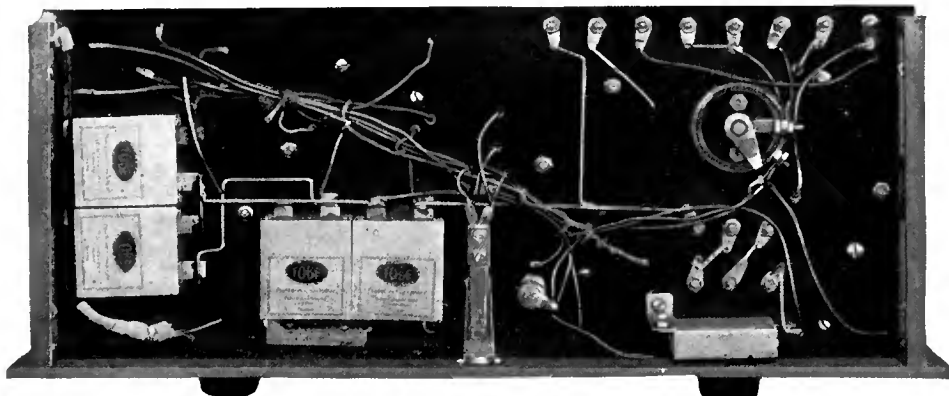

FIG. 5

From this right side view of the power supply unit may be observed the alignment of the various transformers and sockets, etc., on the sub-panel. The layout closely follows the order of signal and voltage paths as described in the caption for Fig. 2



RADIO BROADCAST Photographs

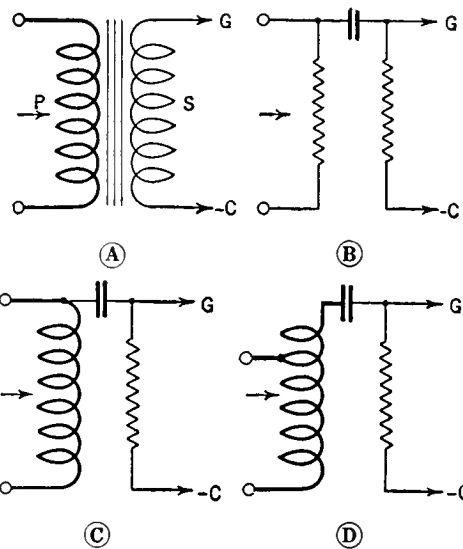
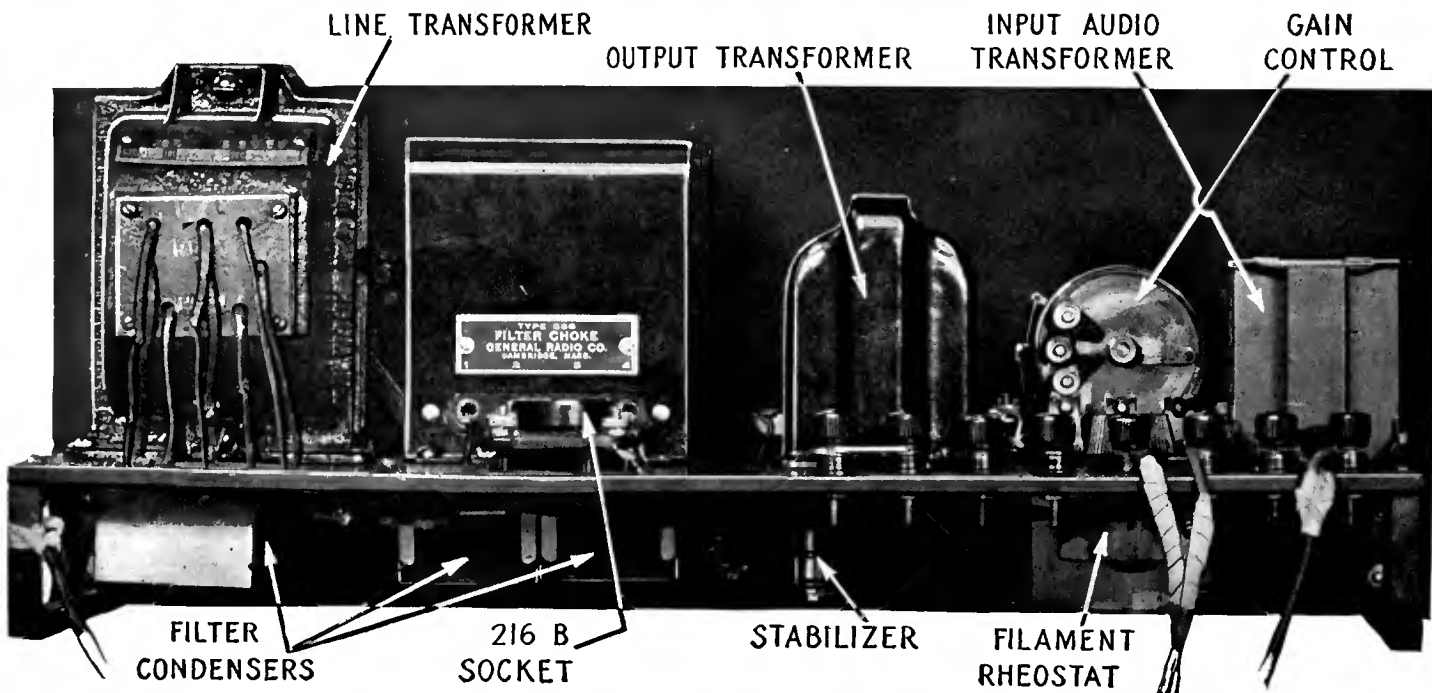

FIG. 4

Here are various methods of coupling that may be employed as the system input in this amplifier, between it and the receiver. A is a transformer, B is resistance coupling, C impedance, and D auto-transformer impedance coupling

windings capable of supplying 7.5 volts each, for lighting the filaments of the UX-210 and the 216-B. Of course, it is possible to light the filament of the high-mu tube from a.c. That involves a complication in construction with the probability that a noticeable hum will be evident in the loud speaker. This has not been made a part of the present layout and here the filament is energized from the A battery. By means of a filament circuit jack in the output of the amplifier, the high-mu tube filament is turned on when the plug is inserted and turned off when removed. By removing the plug of the cord attached to the primary of the line transformer from the base outlet or lamp socket, the high voltage and filament voltage is simultaneously removed from the rectifier and power amplifier tubes. The

FIG. 6

As may be observed from the photograph to the left and the others accompanying, a major portion of the wiring is located underneath the sub-panel, presenting a clean non-complicated appearance of "the works" situated on the top of the panel. Below is a self-explanatory rear view of the unit



new Brach switch can well be used for this purpose.

PARTS WHICH CAN BE USED

ALL the parts used in the experimental model described here are readily obtainable. For those who desire to duplicate the construction shown here, the following list of parts is given first, and several alternative makes of parts are also listed.

- Line transformer*  
AmerTran, Dongan, General Radio, Thor-darson
- Sockets*  
Benjamin, Cutler Hammer, Eby, Pacent
- Audio transformer*  
AmerTran, Pacent, Jefferson, Rauland Lyric
- Resistance coupling unit*  
Lynch, Dubilier, Durham,
- Grid Control*  
Centralab, Royalty Clarostat
- By-pass and filter condensers*  
Tobe Deutschmann, Dubilier, Sangamo, Mayo, American Electric
- Filament Jack*  
Carter, Yaxley, Pacent
- Filter Chokes*  
AmerTran, General Radio, Dongan Thor-darson
- Binding Posts*  
Eby, Fahnestock
- Sub Panel Brackets*  
Radion, Cardwell, Benjamin
- Filament Rheostat*  
General Radio, Carter, Yaxley, Centralab
- Output Transformer*  
General Radio

There are many ways in which the individual constructor may mount all this material, and the photographs accompanying will suggest several possibilities. It is well to employ a construction where a sub-panel is included so that most of the smaller type of apparatus, such as by-pass and filter condensers, resistance units, rheostats, etc., may be mounted underneath it. Up on top of the sub-panel may be located the tube sockets, line transformer, audio transformer, resistance-couplers, output transformer and filter choke coils. On the main panel which should be higher than 7 inches, to prevent the tube from projecting above the top, the volume control, line top switch and output jack are situated.

It is absolutely essential in wiring the amplifier that rubber covered or other good insulated wire be used. If possible, all exposed terminals should be well taped so as to reduce the possibility of body contact with the high voltage output. By referring to the illustration, it is possible to approximate the layout of the model which, since its first moment of use, has given admirable results.

In a future issue will be given the actual specifications and directions for building a power amplifier unit that meets with the most drastic regulations set up for this type of device by the National Board of Fire Underwriters.

The model described here serves well indeed for experimental purposes where it is desired to use the same power supply as a complete plate voltage supply unit.

OPERATING NOTES

IN OPERATING the power amplifier it will be noticed, if a 50 mil milliammeter is placed in the plate circuit of the UX-210, that a slight fluctuation of the meter needle occurs when receiving strong signals, denoting some distortion. This distortion can be cleared up by adjusting the variable grid bias control until the needle remains constant in its deflection.

To prevent audio frequency currents from going through this grid bias control, a special filter circuit is provided consisting of the 0.5-meg. resistance unit and 0.5-mfd. condenser. The resistance offers enough impedance to the flow of audio frequency currents so that the only path available is through the 0.5-mfd. condenser. An average plate current for the UX-210 is 25 milliamperes, and if this reading is less even when the grid bias control is at a minimum resistance value, this shows that one or more of the filter condensers is defective. Another indication of a broken down or leaky condenser is in the overheating of the rectifier tube.

ALTERNATIVE INPUT COUPLING METHODS

THE input to the power, or current-amplifier tube, is through a rather unique resistance coupling device, which serves the dual purpose of feeding the output of the first or voltage amplifier stage into the grid circuit of the power tube and also reduces the high voltage from the filter system to approximately 150 volts, which

is suitable for impressing on the plate of the first amplifier tube, which may be of the ordinary 201-A type, or one of the high-mu tubes.

The reason for using the three 0.1-megohm resistors in series, instead of a single unit with a resistance of 0.3 megohms, is that the latter would not carry the current without heating. This would vary the resistance as the temperature varied. As a matter of fact, where ordinary fixed resistors are used for this purpose, their resistance should be checked from time to time. A simple method of checking this resistance is to measure the voltage impressed on the plate of the first amplifier tube. Obviously, if the resistance of the units varies, the voltage on the plate will vary also. Except for these points, there is nothing novel about the resistance coupled stage, save that it has been found very satisfactory to use a high-mu tube for the first stage or voltage amplifier.

There may be some discussion concerning the most advisable system of coupling the first stage to the detector tube. Four kinds of coupling indicated in Fig. 4, A, B, C, and D were tried. The best results for general use were obtained from the system shown in A, Fig. 4, where the transformer is one of the new AmerTran De Luxe Type and the tube, one having an amplification constant of approximately 20. Other transformers were tried and satisfactory results were obtained from a number of them, but the AmerTran showed up best.

The systems shown in Fig. 4, C and D, being National Impedaformer and Thordarson Auto-former coupling, respectively, were very satisfactory, from the standpoint of tone, but not capable of very great volume. Where impedance or autotransformer coupling was used, it was noted that a slight gain in volume was brought about by the use of a high-mu tube.

The best tone quality, but the poorest volume, was obtained from the resistance coupling arrangement, shown in B, Fig. 4. This system is not recommended for use where more than enough volume to fill an average size living room with dance volume is to be required. In fact, since the volume may well be controlled by the Centralab Modulator, in the grid circuit of the power tube, from a whisper to a roar, the use of a good transformer and high-mu tube combination is highly recommended and was found most satisfactory.



FIG. 7

RADIO BROADCAST Photograph

A bread board layout of an earlier experimental amplifier-supply unit constructed in RADIO BROADCAST Laboratory. One other unit was assembled employing other parts, such as Dongan line transformer and chokes. Potter condensers, Eby sockets, Jefferson Concertone audio transformer, etc., but space limitations prevent its being shown here



#### THE MODIFIED HAMMARLUND-ROBERTS

Has as its chief features a new method of regeneration control. In this article are given the fullest particulars for the necessary changes. A panel view of the revamped receiver, shown at the left denotes the location of the various parts employed in the change

# Improving the Popular Hammarlund-Roberts Circuit

*Easily-Made Changes Which Bring This Circuit Up to the Minute—How to Attain Smoother Regeneration Control—Using Power Tubes—How to Add Filament Control Jacks—The Final Circuit*

By JOHN B. BRENNAN

*Technical Editor, Radio Broadcast*

**I**N REVIEWING the long line of circuits which have forged to the front in recent months, each one with its own special attributes claiming their due amount of attention, one cannot neglect considering the very popular Hammarlund-Roberts. Built up around the older famous Roberts reflex, it won immediate approval, and in its present form is satisfying its countless users. Yet, when one looks over this circuit, just as with others, there is the constant urge for improvement, revision, modification, and slight alterations to make it better.

RADIO BROADCAST Laboratory, in experimenting with the Hammarlund-Roberts version of the original Roberts circuit, has tried out numerous changes with the idea of improving the circuit. Some of the changes merely consisted in replacing the dials with ones of a vernier type while other changes were made in the actual circuit arrangement.

To begin at the beginning, it

was found that the substitution of a different form of regeneration in the detector circuit, in place of the variable tickler

method, would be worth while, in that control of regeneration itself would be smoother and also the changing field set up by variation of the tickler coil position would be eliminated. The method found to be most successful, and involving the least number of changes, was the condenser-feedback regeneration system, involving only the addition of a small variable condenser of the midget type and a radio frequency choke coil

#### ADDING A NEW FORM OF REGENERATION

**I**N MAKING this change, the entire detector coil unit is unsoldered from its connecting leads and removed from the panel. Then the tickler coil and its shaft are removed by simply cutting off that part of the bakelite strip which supports the shaft and its bearing. The bushing, located on the top of the bakelite mounting strip, is removed from the cut-off section and by means of a  $\frac{3}{4}$ " x 6 machine screw is fastened at the bottom of the mounting strip. This

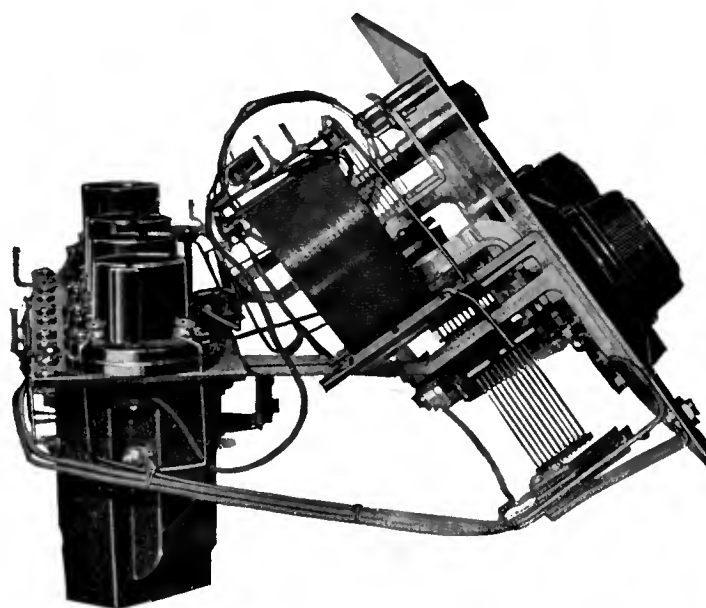

RADIO BROADCAST Photograph

FIG. 1

By means of a Fahnestock clip attached to a flexible lead, the antenna turns may be connected in the circuit. Below is shown the filament circuit jack for head phones or reduced volume

screw replaces the one used to hold the coil between its insulated support strips. Now at that end of the secondary coil at which the NP coil is located, a tap is made thirteen turns from the bottom turn. These changes are evident from an inspection of the illustration, Fig. 2.

The detector coil may now be laid aside. A fifteen-plate Hammarlund midget condenser is mounted in the hole formerly taken up by the shaft of the tickler coil.

When this is accomplished, the detector coil

What the Changes Will Do

| BEFORE   | AFTER  |
|--|--|
| <b>CIRCUIT:</b> One stage tuned neutralized radio frequency amplification, detector (with tickler regeneration), and two stages audio frequency amplification. The past stage employs a parallel tube arrangement. | <b>CIRCUIT:</b> One stage tuned neutralized radio frequency amplification, detector (with capacity feedback and r.f. choke coil), and two stages audio frequency amplification. The last audio stage employs a power tube. |
| <b>TUBES:</b> Five 201-A type.   | <b>TUBES:</b> Three 201-A type. Last audio stage uses either UX-112 or UX-171.   |
| <b>VOLUME CONTROL:</b> Rheostat control on r.f. tube filament.   | <b>VOLUME CONTROL:</b> Variable high resistance shunted across the secondary of the first stage audio transformer.   |
| <b>FILAMENT CONTROL:</b> Panel switch.   | <b>FILAMENT CONTROL:</b> Filament jacks, one in plate circuit of first audio tube, and one in plate circuit of power stage.  |
| <b>PARTS DISCARDED</b>   | <b>NEW PARTS REQUIRED</b>  |
| Filament switch, socket, open-circuit jack, rheostat, tickler coil, fixed 4-ohm resistance, bypass condenser.  | Choke coil, 65-mmf. regeneration condenser, filament circuit jack (1st stage), filament circuit jack (2nd stage), volume control (variable resistance of 500,000 ohms).  |

to accomplish the desired result was to increase the value of resistance in the filament circuit of the radio-frequency amplifier tube or loosen up on the regeneration or sensitivity control. Quality sometimes suffered when the former method was employed. Selectivity and sensitivity suffered in the latter.

As a final refinement for volume adjustment, and also as a tone control, the rheostat and fixed resistance for the radio-frequency amplifier stage are removed. In the audio amplifier cir-

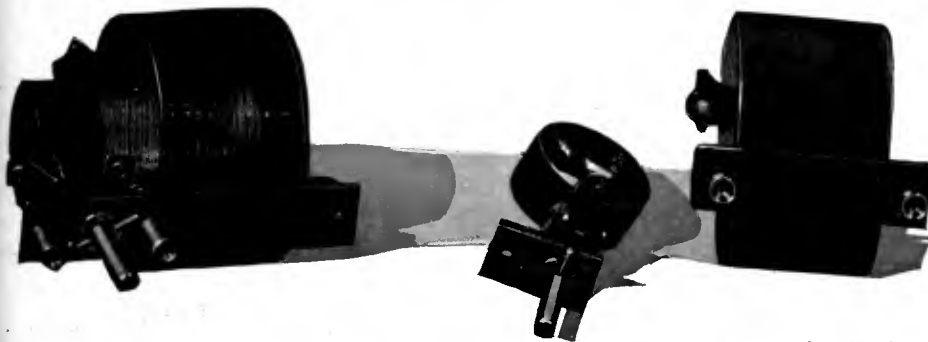

FIG. 2 RADIO BROADCAST Photograph

This is a "before and after" view of the Hammarlund detector coil unit. At the left is shown the coil before the alteration and at the right after the tickler has been removed. The bushing in the removed section is re-located at the lower end of the larger coil unit

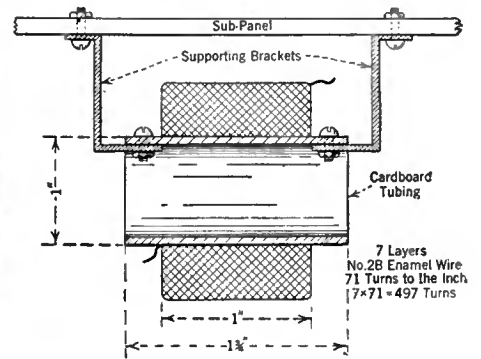

FIG. 3B

For those who wish to make their own r.f. choke coil, the specifications given in the above sketch will prove helpful

mounting holes are "spotted" on the main panel as illustrated in the sketch, Fig. 3A. These holes are drilled and countersunk for the 3/8" machine screws which screw into the mounting bushings on the coil unit.

To obtain regeneration satisfactorily with these alterations it is necessary to in-

discarding one of the parallel audio stage sockets as is explained later. For those who desire to wind their own choke coil, the detailed specifications are shown in Fig. 3B. The connections for their revised detector circuit are shown in Fig. 4. It will be noted that the bypass condenser employed to shunt the primary audio transformer has been eliminated from the circuit.

clude a choke coil in the audio transformer primary circuit. The one manufactured by Samson is entirely satisfactory. This choke is employed to keep the radio frequency currents out of the transformer primary circuit so that the only path for these currents to take is through the capacity element employed for regeneration. While not shown in the accompanying illustrations, this choke coil may be mounted on the sub-panel in the place left vacant by

Upper Right Corner of Panel

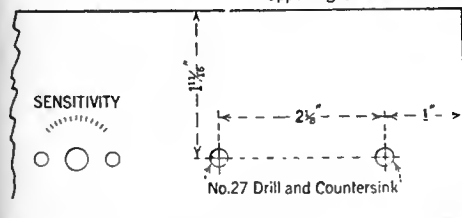

FIG. 3A

Two holes must be drilled in the panel to mount the detector coil. The layout is shown here

clude a choke coil in the audio transformer primary circuit. The one manufactured by Samson is entirely satisfactory. This choke is employed to keep the radio frequency currents out of the transformer primary circuit so that the only path for these currents to take is through the capacity element employed for regeneration. While not shown in the accompanying illustrations, this choke coil may be mounted on the sub-panel in the place left vacant by

THE AUDIO CIRCUIT

MANY times it is found advisable to operate the receiver at reduced volume. In its original state, the only way

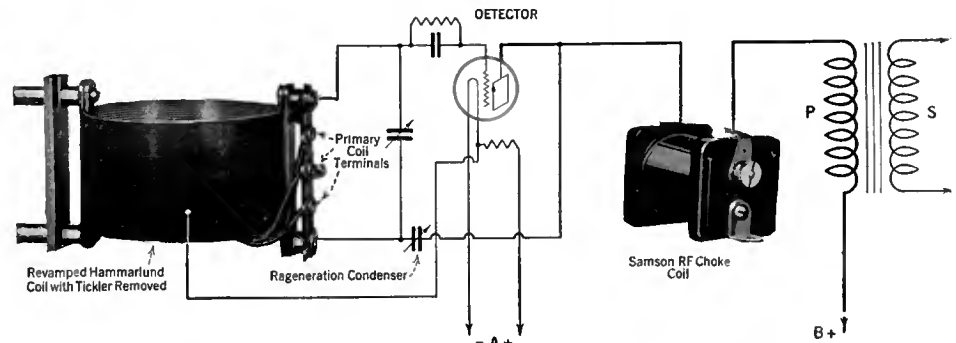

FIG. 4

A number of changes in the detector circuit make for very smooth regeneration control. A choke coil is necessary with the capacity feedback system employed to keep the r.f. currents from passing on through the primary of the audio transformer

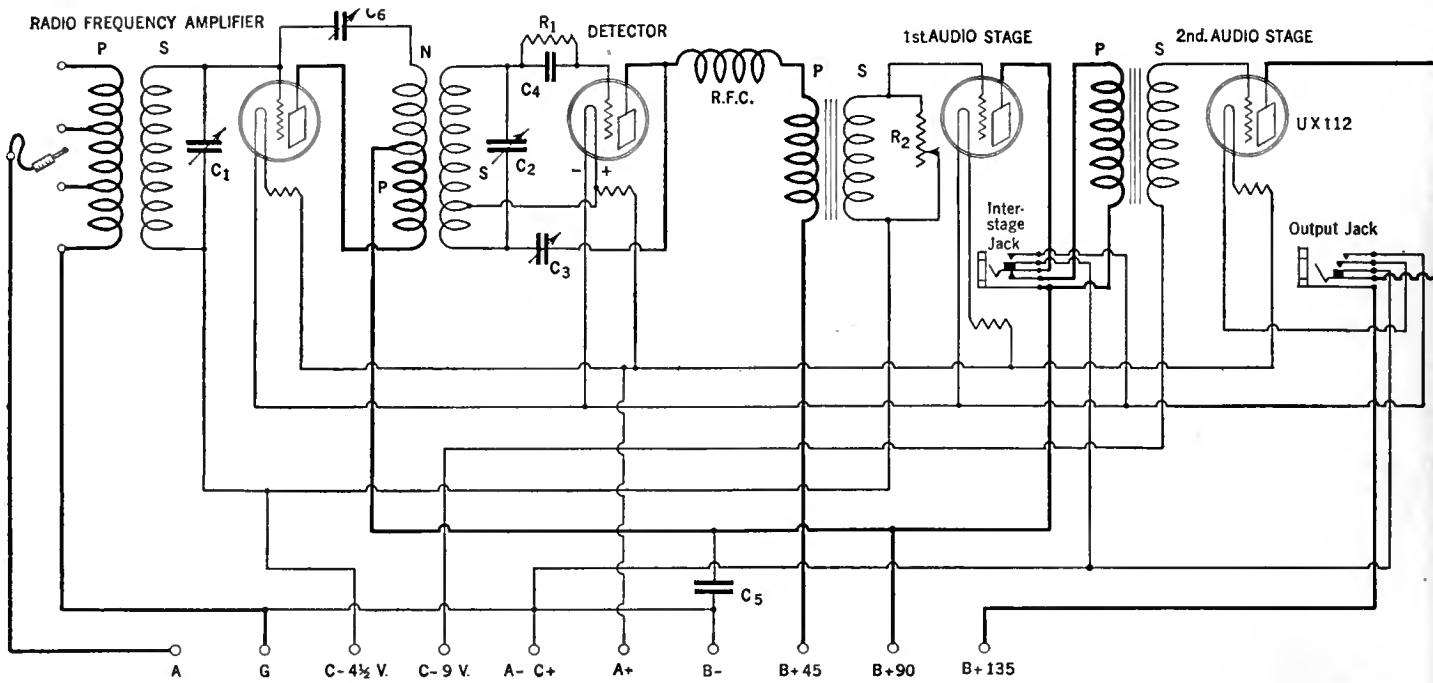

FIG. 5

All the changes in the circuit described in the text are shown in the diagram above. The values for the various parts are: C1 and C2, 0.0005 mfd; C3, 0.000065 mfd, a 15-plate midget condenser, C4, 0.00025 mfd; C5 0.006 mfd; C6, 0.000016 mfd; R1, 3-6 megs.; R2 is of 0-500,000 ohms

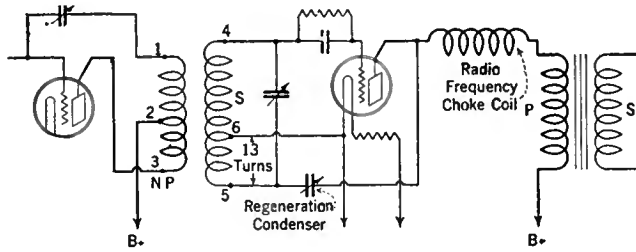

FIG. 6

How the coil and r.f. choke fit into the detector circuit is clearly indicated here. This circuit may be used for cross reference with the detector circuit diagram in Fig. 4

tendency to give the amplifier a "flatter" characteristic, that is, the amplifier will amplify all frequencies very nearly alike.

Listening-in with headphones before the first audio stage, one finds there is sufficient volume

FIG. 7

Notice that the detector coil unit in its new position is on the same plane and at right angles with the antenna coil unit. The regeneration condenser located in the hole formerly taken up by the tickler is a 15-plate Hammarlund Midget condenser of 0.000065 mfd. capacity

INTERSTAGE COIL WITH 13 TURN TAP

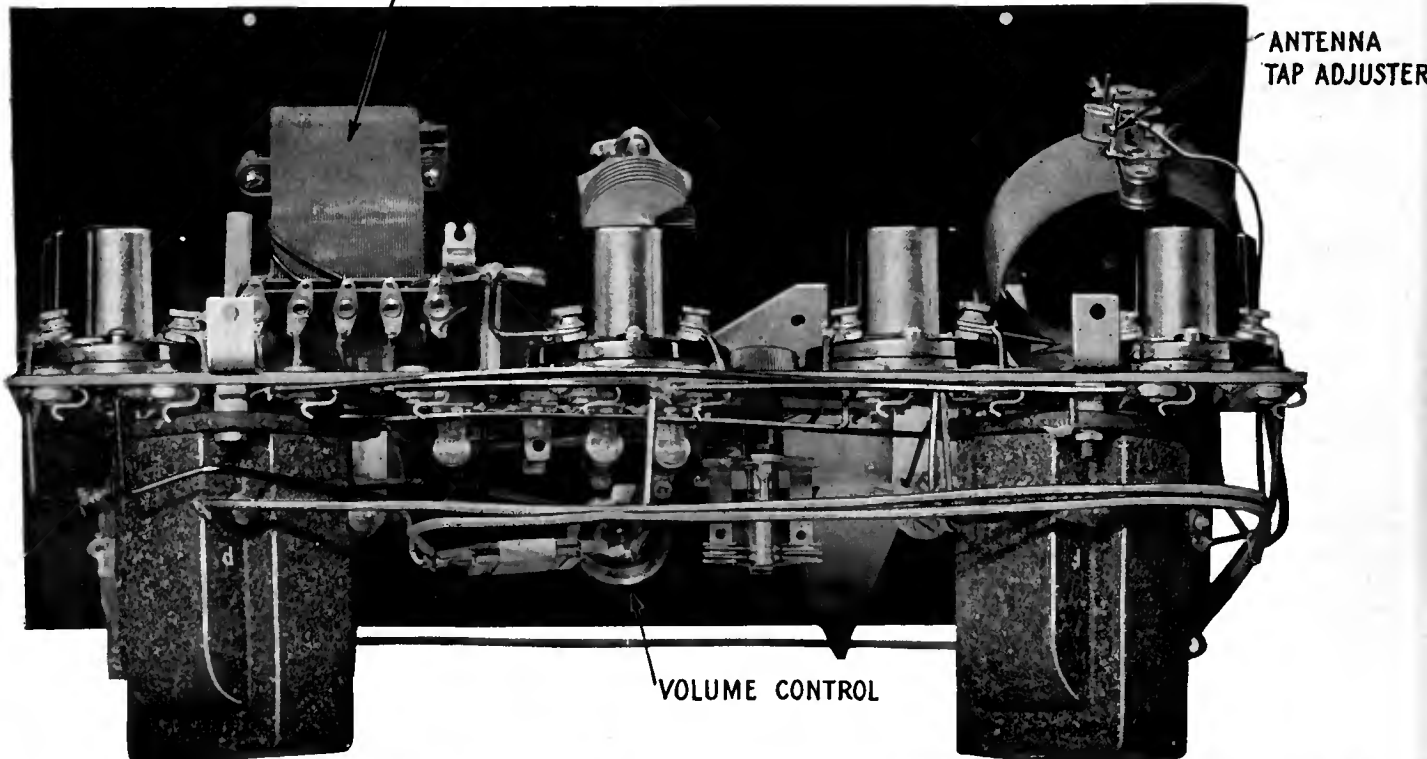

RADIO BROADCAST Photograph

to work head phones in a very satisfactory manner. To make it possible to change readily from the last audio stage to the first audio stage required nothing more than the inclusion of a jack in the primary circuit of the first stage audio transformer. At the same time, it was found desirable to have some automatic means of turning off the last audio amplifier filament when the phones were used on the first stage. Filament circuit jacks did the trick and their connection into the circuit is shown in Fig. 9. To employ this type of jack in the circuit shown, sometimes necessitates alterations being made to the jacks obtained, however. In the circuit described in this article, two No. 105 Carter jacks were taken apart and the blades rearranged so as to correspond with the blade positions as shown in the accompanying circuit diagrams.

With the addition of filament circuit

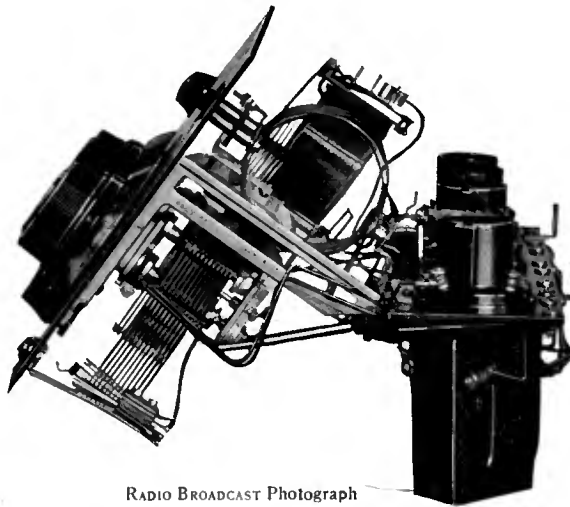

RADIO BROADCAST Photograph

FIG. 8

The output jack for the loud speaker has different control blades for cutting in and out the filament circuit. Comparison between the two types of jacks employed can be made by referring to the revised circuit diagram Fig. 5

CAST Laboratory Information Sheet No. 12, in this issue. Needless to say, the output jack too is of the filament control type so that when the plug is inserted in the last stage, all the tube filaments are lighted. When inserted in the first stage jack only the first three tubes, r.f. amplifier, detector and first audio stage, are lighted.

For a tuning control refinement, Na-Ald vernier dials replace the ordinary dials with the result that sharper and more accurate tuning is accomplished.

The circuit then, in its completed form, consists of one stage of tuned, neutralized radio frequency amplification, a detector employing capacity feedback with choke coil in the audio circuit, filament control jacks for first and second audio stages, an approved volume control, and power tube output. These changes are shown complete in Fig. 5.

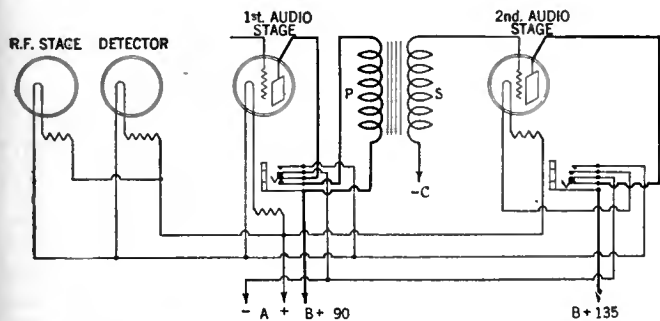

FIG. 9

Filament control jacks permit the loud speaker or phones to be plugged from the last stage to the first stage of audio amplification and automatically control the filaments of the tubes so that only those tubes actually employed to receive the signals are lighted

jacks it becomes unnecessary to continue using the filament switch and by discarding it, the first audio jack may be mounted in the switch hole.

The 500,000-ohm variable resistor, which may be either the new Carter Hi-Ohm unit or Carter Hi-Pot unit, is mounted in the hole previously occupied by the rheostat.

POWER TUBES FOR THE LAST STAGE

AS A final circuit change, one of the parallel tube sockets in the last audio stage is removed and its Amperite is wired in the circuit to control the filament of radio frequency stage. Then in the remaining last stage socket a UX-112 or UX-171 tube is employed as a power stage. It will be found that the grid-plate shunt condenser for the last stage may be removed when the power tube is employed.

For the 112 type of tube, at least 135 volts of B battery with 9 volts of C battery will be found necessary for good tonal results. With the UX-171, 180 volts of B battery with 40.5 volts of C battery will furnish well-nigh perfect tone output. For detailed information on this tube, the reader is referred to RADIO BROAD-

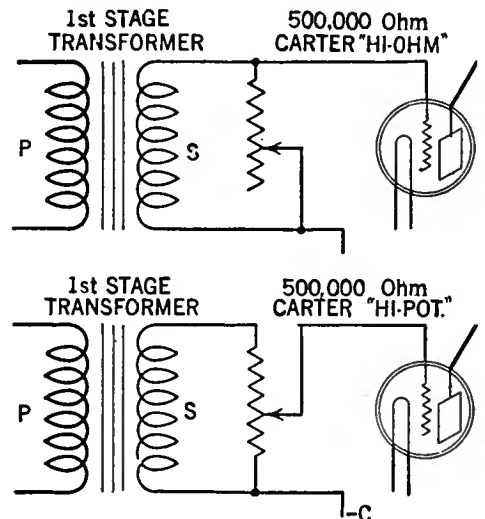

FIG. 10

Two volume control methods are shown here. The volume may be brought from its full value down to a mere whisper. With this control, clarity of signal is also improved because with its intelligent regulation overloading is prevented

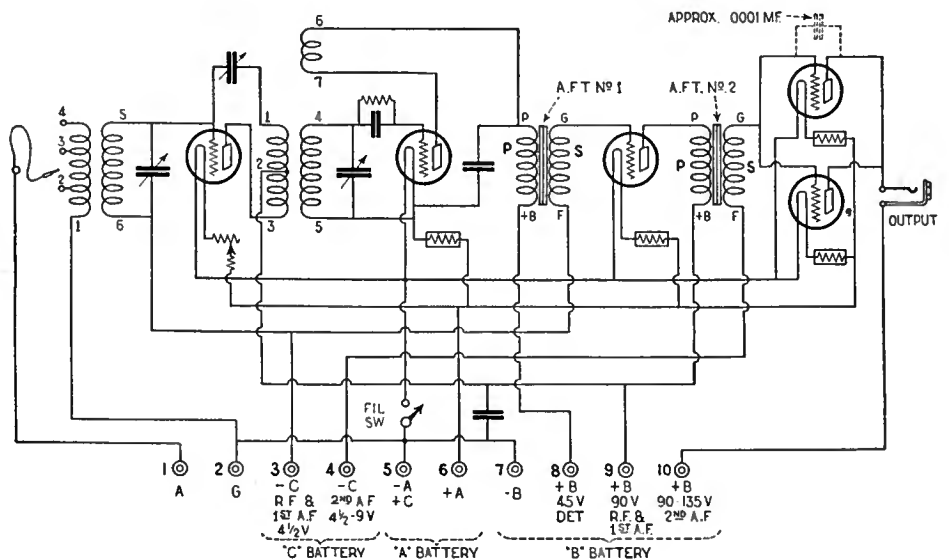

FIG. 11

This is a diagram of the original Hammarlund-Roberts—as it was before the changes described in this article were made. Compare this diagram with that shown on the previous page, and note the alterations





LIGHTNING PLAY BETWEEN CLOUDS

Discharges of this sort produce severe static which is not heard over very great distances

# Where Summer Static Comes From

*How the Thunderstorm Affects the Radio Set—What a Thunderstorm Is and the Localities Generally Affected—How to Produce Local Static Experimentally—Various Types of Lightning and Its Source*

By B. FRANCIS DASHIELL

**T**HE thunderstorm is well known to everyone, for there are very few inhabited portions of the globe that are free from this phenomenon. It may be defined as a storm that occurs locally at all places along its path, lasting from but a few minutes, to an hour or more, and evidently moving slowly across the country, sometimes for a considerable distance and again but a few miles. The approach of the thunderstorm is heralded by several phenomena which usually follow a fairly well defined order of succession. There is a very close and definite association between these storms and radio reception conditions in summer. During the approach of a thunderstorm, and while it is in progress, static interference becomes so great that satisfactory radio reception is practically impossible on an outside antenna. The static noises die away with the passing of the storm, but many such outbursts, due to distant lightning, may be noted for a number of hours although with diminishing frequency and intensity.

#### DIAGNOSIS OF A THUNDERSTORM

**A**FTER nearly a full day of fairly clear weather, with perhaps a suggestion of light southerly breezes, a general calm sets

---

*IT IS almost an open secret that during the summer months, the reception of radio programs is quite apt to be interrupted by rolling of static in the loud speaker. Sensible folk do not criticise radio for this shortcoming of static, but rather praise the art for its great advance. They look on static as an annoyance, certainly, but believe that the presence of an obstacle like static contributes much to the advancement of the art because it gives the engineering folk a goal to strive for. This article by Mr. Dashiell tells a good deal of interesting information about the parenthood of static, particularly the varieties common in summer. The article is authoritative, besides being "good reading." Mr. Dashiell is a member of the Institute of Radio Engineers and also of the American Meteorological Society.—THE EDITOR.*

---

in and the air becomes very oppressive. The humidity is noticeably high. A few clouds of the cumulus type have been drifting lazily across the sky during the day and, as the afternoon progresses, they have gradually increased in size and number until the entire horizon becomes well banked. The muttering of the thunder from distant lightning becomes audible, growing louder and louder, and before long, the entire lower stratum of clouds may be seen to be advancing rapidly. Static interference in the radio set has been increasing greatly during the past hour or two, and, now, with the sound of thunder, the static crashes become so loud that the radio should be shut off and the antenna grounded. Little gusts of warm wind begin to blow toward the advancing storm from an opposite direc-

tion, becoming stronger. The air feels oppressive. As the clouds become lower and darker, the first few drops of rain fall while the wind now suddenly shifts into the same general direction taken by the advancing storm. The wind increases, blowing dust ahead of the cloud, and heavy rain begins to fall in torrents. Lightning that has been occurring sporadically before the rain, now becomes more frequent and more severe. This portion, or the center of the storm, may continue but a few minutes or perhaps an hour or more, depending upon the intensity of the disturbance. After the greatest period of wind and rain severity has passed, the lightning diminishes and finally ceases locally, although a light rain may set in and continue throughout the night. If the storm passes during the late afternoon, the clouds will break away and the rear of the great cumulus-nimbus clouds of the storm, with the great dark rain area beneath, can be seen with the sun lighting them up from the western sky, but through which nothing can be seen except the flashes of occasional lightning. With the passing of the storm, the lower atmosphere becomes cooler and drier, the sky nearly clear of clouds and a pleasant breeze sets in from a westerly direction.

Static interference practically diminishes as the atmosphere clears of all electric producing phenomena, although the distant lightning will still continue to set electromagnetic waves in oscillation which will be heard in the radio set for some time afterward. It is not the sound of thunder that is heard in the radio set, but the actual wave that is propagated by the electric spark, or lightning flash. Thunder is merely the sound of the air as it rushes in to fill the space or vacuum made by the passing of the spark. Such a wave will be heard simultaneously with the visibility of the flash, but ahead of the sound of the thunder. Electromagnetic waves travel at the same speed as light waves, 299,725,000 meters, or 186,000 miles per second, while sound travels but approximately 1000 feet per second.

THUNDERSTORM REGIONS

**T**HERE are certain regions which produce more thunderstorms than others, and there are certain weather conditions, as shown by the daily weather map, favorable to the inception of thunderstorms. Purely local storms of a sporadic character may be caused by local regions of warm air within a high air pressure area and predominating clear sky. These give rise to local static only, last but a short time, and seldom cross over much territory. There are thunderstorms which occur chiefly in the regions of southerly winds, either to the southeast or northeast of a low air pressure area, probably caused by local topographical conditions and consequent upward deflection of the warm surface winds, all of which stimulate the formation of large cumulus clouds. These storms have con-

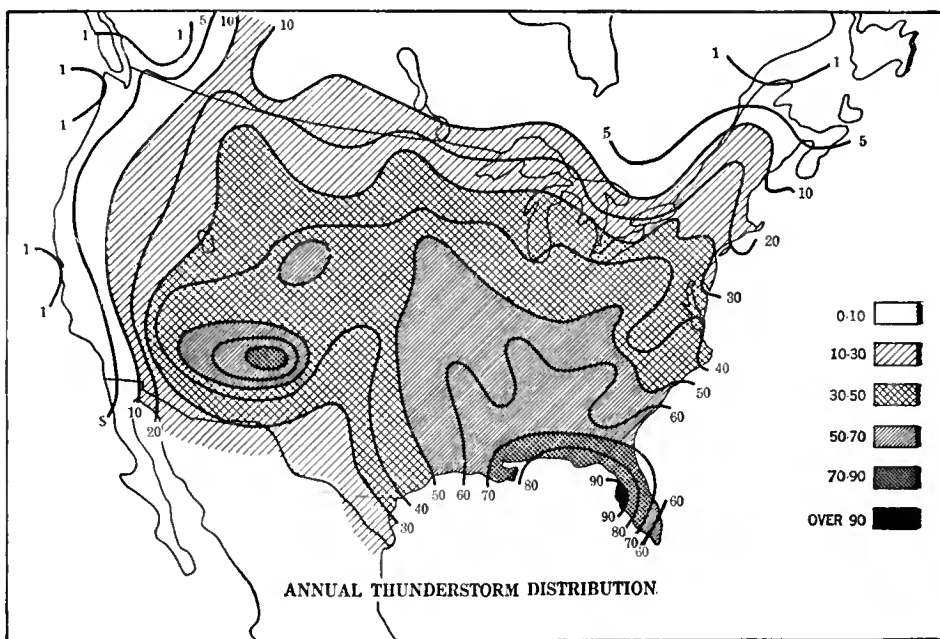

ANNUAL THUNDERSTORM DISTRIBUTION

THUNDERSTORM HEADQUARTERS

The chart shows the annual distribution of thunderstorms over the United States. The greatest number of storms occur in the vicinity of Tampa, Florida, and the least number along the Pacific Coast. The large number of storms occurring over the Southwest, especially in Arizona and New Mexico are usually unaccompanied by rain, and are due to hot winds and dust. Storms elsewhere are accompanied by rain and considerable static, while electrical dust storms give rise to local static of short duration

siderable static associated with them, not entirely due to the storm itself, but also to the meteorological elements of the central low air pressure area to which they are attached. Some of these disturbances will be of the nature of a mere thundershower while others will be intense thunderstorms. Even after the passing of the storm, static will exist as long as the electric influence

of the central "low" is felt. The most severe of all thunderstorms occur south or southeast of a central low air pressure area along a line or front of a great mass of cooler and drier air which is slowly descending from the upper atmosphere and under-running or lifting up the warmer and moister air ahead of it. Much static predominates, not only from the central low area itself, but from the mechanical action of the vigorous air currents. Lightning associated with such storms is very severe and spreads out over a large area, affecting radio receivers over many miles, often a whole state, or more.

Thunderstorms occur in nearly all parts of the world, but the number decreases rapidly as we pass from the equator toward the pole. In the tropics, there are many places that nearly average a thunderstorm for every day of the year, while in the far north but one or two storms may occur in the course of several years. Fewer storms occur over the ocean than over land, and mountainous regions have far more than the level plains. In the United States, the largest number occur over the Gulf States. In New England there occur but approximately one-fourth of the thunderstorms experienced along the Gulf, while at certain Pacific coast sections the proportion is very small as such storms are rare.

Let us now go behind the scenes and look into the mechanics of the thunderstorm and the production of summer static.

WHERE SUMMER STATIC COMES FROM

**T**HUNDERSTORMS have their origin in masses of warm and moist air. This air rises because of convection, cools be-



POWERFUL LIGHTNING DISCHARGES BETWEEN CLOUD AND EARTH

Discharges of this sort are the source of severe static which can be heard over great distances



#### AFTER THE STORM

Alto-cumulus clouds follow the breaking up of the storm and precede the clearing of the sky. A fresh breeze and cooler weather accompany these clouds, but little local static will be observed.

cause of expansion and therefore reaches a vapor point, resulting in the formation of a cloud. Practically, only clouds of the cumulus family are so built, but they may become overgrown and the condensation of moisture is sufficient to cause precipitation. The cloud has now become a cumulus-nimbus cloud with strong descending air currents forming beneath it, which push forward as they reach the earth and displace the warm air which is ascending and being condensed into vapor, or cloud, as above explained. In the region between the descending cool air and the rising warm air, a vigorous eddy forms and can be seen as a turbulent squall cloud rolling along in advance of the cumulus-nimbus thunderhead. The air pressure rises and the temperature falls when this squall cloud passes due to the descending cool air, of greater density, in the rear of the turbulence. Rain now falls in torrents and the lightning flashes follow in close succession. Hail may fall depending upon the degree of expansion that the rising air passes through, resulting in a lowering of temperature, and the presence of snow and freezing weather toward the tops of the clouds. Storms of this character should occur with greatest vigor when large masses of warm and moist air are present, during the hottest time of the year and the hottest part of the day. The natural requirements are therefore in good accord.

In order that condensation may form and rain begin to fall, it is necessary that some sort of particles be in the air to form nuclei upon which the moisture can condense or collect. These nuclei are very minute, but as they slowly pass through the clouds, they collect and attract moisture and be-

come larger until, overcoming the upward air currents because of the attraction of gravity, they fall as rain. Dust particles serve as nuclei as well as ions, or electrically charged portions of atmospheric gas. The number of ions in the atmosphere is by no means constant as they are produced through many causes. Warm, moist air which, due to convection, is in rapid motion and is highly conductive. The action of the air currents produce ions through dissociation or the removal of an electron from an atom of atmospheric gas. Still again, when moisture is condensed on the various types of nuclei and rain drops form, they are constantly broken up or combined before they fall upon the earth beneath, an action which divides or increases their individual charges until the atmosphere becomes highly charged. When these raindrops, as well as the air molecules, are broken up through impact and friction, both positive and negative ions are given off, but whenever a negative ion is given off, the raindrop retains a positive charge and is believed to bring down much more of that kind of electricity to earth. The removal of one kind of charge from a cloud must leave a charge of opposite kind on the cloud. As there are many detached clouds within the thunderstorm and different charges arrange themselves along the upper and lower surfaces of the clouds, through attraction and induction, many differences in potential must exist between points in the atmosphere. They may become zero through negative differences in potential, and they may attain values so large that a breakdown of the dielectric, or air gap, will eventually take place and the lightning flash will result.

#### WHAT A LIGHTNING DISCHARGE IS

IF A cloud is a thick one, or the rainfall is quite heavy, the charge may become very large, and such clouds are likely to be attended by lightning discharges. Eventually, the potential difference between the cloud and the earth becomes sufficient to cause an electric spark to pass between the two. Again, different parts of the same cloud, or different clouds, may become so charged with different kinds of electricity that internal lightning flashes will result. Lightning occurring between clouds probably occurs more often than between cloud and earth. The air gaps are less with constant changes in distance between clouds while between clouds and earth, the distance may be as much as a mile. While appearing to be a single spark, a lightning flash does not pass from the cloud to the earth, but travels rapidly back and forth a number of times, in a time interval of perhaps less than a thousandth of a second. A lightning flash is, therefore, an oscillatory discharge lasting but an extremely short time and capable of generating a powerful electromagnetic wave. It has been estimated that at least 20,000 amperes of electric current are liberated in an ordinary discharge. The voltage greatly varies, depending upon the length of the discharge. When we consider that many millions of similar flashes take place throughout the world every day, propagating electromagnetic waves with an electric power that exceeds by many thousand per cent., that used by the greatest radio stations, it is small wonder that static is practically forever present in some amounts in sensitive radio receiving sets.

Lightning that occurs between clouds and clouds and the earth is usually zig zag in appearance. It is an electric spark on a tremendous scale. There are several causes that contribute to give it this shape. The most general of these are various layers of different temperature, density and ionization in the atmosphere. Refraction is therefore different and a broken line appears; the eye is somewhat blinded by the glare, and much of the finer detail is lost. The electric discharge also follows the lines of least resistance or from one mass to another which contains the heaviest ionization and continuity of conductivity.

#### STATIC IN POCKET EDITIONS

EVERY meteorological action within the development and existence of a thunderstorm is incident to the production of atmospheric electricity. The breaking of a raindrop into two separately charged portions gives rise to, a minute electromagnetic wave. This may be simply demonstrated by placing two small sheets of thin paper together and rubbing them with a piece of cloth so that they become electrified and adhere together. Hold them over the radio set and pull the sheets quickly apart. The discharge will make a loud static crash in the loud speaker. Other charges of greater value are neutral-

ized and set up waves that reach the radio set at least an hour or more before the storm develops locally, while the waves from distant lightning may be heard some hours before the storm approaches. As a rule, however, when the weather is such that thunderstorms will develop in the late afternoon, the mechanical production of ionized atmosphere takes place throughout a period of several hours before the storm and considerable static will be heard. Directional radio compass apparatus will locate the general direction of the region of static or the approaching thunderstorm. Local static in the atmosphere surrounding the set will have no directional effect on the apparatus. In some cases, the increase of static will foretell the development of a storm within a few hours. With the passing of the storm, local atmospheric electricity is cleared from the atmosphere and static interferences rapidly diminish.

Small patches or areas of ionized and positively charged atmosphere come into contact with the antenna and are dis-

charged, or falling rain drops add their slight charges to the antenna, so that static discharges pass into the radio set and produce these spasmodic noises we know so well. Such a method of producing static may be termed "shock excitation." Other discharges, between clouds, clouds and earth, or even between small charged masses of gas, will generate oscillatory electromagnetic waves which will be picked up by the set in much the same manner as any radio wave. Since these waves are so similar to radio waves, there is no way to tune them out as they are propagated on all frequencies within the limits of electromagnetic waves. The small amount of electricity necessary to produce static may be demonstrated by passing a rubber comb through the hair and then touching it to the antenna. A powerful static crash will be heard instantly in the loud speaker.

Other kinds of lightning, such as sheet and heat types, which also produce electromagnetic waves, deserve some consideration and explanation.

Sheet lightning is applied to the sudden lighting up of a whole cloud as if a curtain were suddenly drawn aside to disclose the bright cloud. The duration is quite long, a second or two, and usually occurs during a thunderstorm, or, at least, thunder may be heard. It may be a brush discharge around the edges of the cloud and it may also be due to the reflection of a flash of lightning some distance away.

Heat lightning has been applied to the sudden lighting up of the atmosphere, usually when it is hazy but when no distant or approaching thunder is audible. This form of lightning is so indefinite that it is hard to localize and thunder is never heard. Considerable static interference will be heard which is indicative of electric discharges taking place at some remote place. In this case, directional radio apparatus would locate a storm area beyond the scene of heat lightning. This form of lightning is simply the reflection on the hazy atmosphere of a thunderstorm below the horizon.



HOW A THUNDERSTORM LOOKS FROM A MOUNTAIN-TOP

A view taken from Mount Wilson, in California, which shows very clearly the composition of a thunderstorm. The shadow of the advancing clouds may be seen on the valley floor beneath, and the dark cumulus-nimbus clouds with rain, following from the left. Accompanying static is severe





# The Listeners' Point of View

Conducted by ..... John Wallace

## A Genuinely New Type of Radio Program

**H**AVE we ever expounded our theories concerning radio novelties? Well, we're agin 'em. And for the reason that, more often than not, they are merely novel, with nothing further to recommend them. Tricks, in the long run, always become boring and uninteresting. To elucidate our point: one good jazz band that consistently plays honest American jazz, well orchestrated and devoid of trimmings, is worth a dozen fly-by-night bands that are purveyors principally of trick effects and quite devoid of any understanding of the fundamental good points that jazz does possess.

In general this is true of every type of program. It is the quality, not the novelty, that counts. You have seen second rate vaudeville comedians come out with a bag full of tricks and a stage full of props and yet achieve a complete "flop." The headliner strolls casually on the stage attired in business clothes and, without even a chair to sit on, brings down the house by the sheer quality of his performance.

We do not mean to disparage novelty completely, since we are by no means immune to the universal craving for it. But it is meritorious only when it is combined with quality. It can't stand on its own legs. And that combination, unfortunately, is a *rara avis*. So we think that the time and money expended by program directors in a frantic search for something new and different could much better be utilized in ferreting out better artists.

Well, let that be an indictment of novelty for novelty's sake. And now to prove the foregoing statements by citing the inevitable exception: The "Old Time Prize Fights" that have been heard lately from WGN constitute, perhaps, the most ingenious program innovation of the year.

As far as our listening experience indicates, the idea is an entirely original one—that of recreating an historical event and broadcasting it as though it were actually taking place.

There is no kinship between this and the broadcasting of an historical play or sketch. Radio versions of the Landing of Columbus and the Storming of the Bastille, and so forth, have already been heard. In such presentations the listener is asked to imagine himself present at

the scene in question. By dint of imagination he must transfer himself from Peewaukee, Idaho to Paris, France and mingle with the mob before the Bastille. Such a jump is quite a chore, and in consequence the illusion of reality is fleeting and hard to capture. In the WGN stunt, all that is asked of you is that you forget the date on the wall and overlook the fact that radio has not always existed—nothing more. You are still, for all purposes of the illusion, seated in your front parlor before the loud speaker, but the event, the progress of which you are following, is in reality long passed.

The first of the series of "Old Time Prize Fights" was the famous battle between Jake Kilrain and John L. Sullivan for the "championship of the world," the last boxing match in this country under the old London Prize Ring rules, which have been superseded by the present Marquis of Queensbury rules. The fight took place on July 8, 1880, in Marion County, Mississippi. Gray-beards among fight fans will recall how the two stalwarts battered each other under the glaring sunshine of that hot July afternoon, with Sullivan finally emerging as the victor.

Listeners were asked to turn back the calendar and imagine themselves in the last century. Then we were informed "this is WGN broadcasting the Kilrain-Sullivan fight by leased wires from Marion County, Quin Ryan announcing. And in a very few minutes we were entirely convinced that the statement was a fact. The familiar murmur of the crowd, always audible in a sporting event broadcast, could be heard. Occasionally the shouted remark of some spectator nearer the microphone could be distinguished. A roar from the crowd evidently heralded the appearance of the fighters, and a moment later the gong sounded.

Mr. Ryan's excellent portrayal of a frenzied announcer, all but carried away by the excitement of the match was largely responsible for the effectiveness of the illusion. Another factor was the accuracy of the noise effects; for instance the shouts of the darkies selling corn cakes and molasses between rounds. No one who chanced to cut in on the program without hearing the introduction could have helped but believe that he was listening in on a sure-enough prize fight.

Other fights in the series have been the Sullivan-Corbett bout, the Fitzsimmons-Jeffries fight, the well remembered fracas between the famous colored fighter and Jess Willard, who preceded Jack Dempsey as champion of the world. The running stories of the fights were, in each instance, derived from old newspaper reports and from eye witness descriptions of the scene. The staging, of course, took place in the station's studio.

The re-creation of prize fights, noble though it may be, does not, we think, by any means exhaust the possibilities of this ingenious program device. While it would take more thought than we have the ambition to put in at present to devise further variations, we are sure many would present themselves after proper research. Have you any suggestions?

The re-enacting of some important political event, say a coronation or a parliamentary session might work. Or a famous trial could be repeated, making use of the court stenographer's record. The possibilities are numerous but restricted by this important consideration:



MRS. K. G. POLYBLANK, NORTHERN QUEBEC

How's this for a change on a hot June day? Mrs. Polyblank, shown with her children near her Northern Quebec home was the principal in one of the most interesting "human interest" broadcasts of the year. She had performed a most unusual act of heroism in plunging from a boat into the icy waters of Long Lac to rescue a child who had slipped from the moving craft. She was awarded the life-saving medal of the Royal Canadian Humane Association. The presentation speech was made by Sir Henry Thornton, president of the Canadian National Railways, through CNRO. At the same time, an official of the Society pinned the medal on Mrs. Polyblank, after a journey to her almost inaccessible home





ALLAN W. FAIRCHILD  
Originator of the "Blue Monday" programs from KNRC

could the event (if radio had existed at the time) have been broadcast by ordinary means? For instance: an acquaintance whom we consulted suggested that the destruction of Pompeii would make a thrilling subject for such a broadcast. The catch is that a radio station, conceivably existing in Pompeii in 79 A.D., would have been all too soon put out of commission by the falling ashes and the inevitable static to have continued broadcasting through the holocaust. Besides, in the interest of absolute realism, the announcer would have to talk in Latin! But the idea is suggestive.

Painless Ways of Improving Radio Programs

COÖPERATION from radio listeners is urged by Officials of the Radio section of the Department of Commerce, as the next step in perfecting radio broadcasting.

The Department has gone as far as it can under present appropriations, the broadcasters are striving to give the fans what they want, and the industry itself is improving both transmitting and receiving apparatus, but the big thing remains undone, according to Chief Radio Supervisor W. D. Terrell. The fans don't tell the stations what they like; at least, not enough of them report on programs.

Some may think this is unnecessary; others that it is desired only for the publicity value to broadcasters, while many will admit that they are too lazy to send a telegram, letter, or postal. However, Mr. Terrell is very serious in his suggestion, urging that fans assume the responsibility which rests upon their shoulders and let the stations know whether they like a program or not and why.

In this country there are no fees charged for listening-in and no taxes for owning and operating a receiving set. Some fans appreciate this, but yet seem unwilling to fulfill the requirement of reporting frequently to their favorite station managers what in their opinion is good and also what seems bad or poor.

By an accumulation of reports from near-by and distant points—and only through such returns—station managers can judge whether or not programs are getting over; whether the fans are pleased, disappointed, or peeved at entertainment offered.

The paragraphs above are from a Washington bulletin, and we heartily endorse it. The second page of the bulletin, continuing the subject, had

much to say about the listener's duty to the broadcasting station; how he owes it to the station to send in critical comments as his just compensation for the entertainment offered "gratis." That page now gently rests in our waste basket.

We are sickened unto tantrums by all such talk about the listeners' duties to the broadcasters. The listener has no duty to the broadcaster. Broadcasters are not in the business for philanthropical purposes. The Association of Broadcasters is no glorified Salvation Army. If their programs are offered "gratis" as a "gift" it is as impolite for them to call attention to the fact as it would be for us to remind Aunt Susan that we gave her a pair of stockings last Christmas and she ought to be crashing through with a necktie for our birthday.

We join in urging the fans to send comunicados to the broadcasters, not because they owe it to the broadcasters, but because they owe it to themselves. For truly, cussing out a punk station to your neighbor is not going to improve matters a bit; whereas a letter to the station advancing the same complaint is bound to have an affect. Obviously, a station cannot afford to ignore letters from its customers when its business is entirely dependent upon pleasing its customers.

Of course, the writer need not imagine that his letter is going to have an immediate and revolutionary effect on the station's policy. The manager's private secretary will not immediately rush into the boss's sanctum sanctorum waving the letter about and shouting, "We just got a note from Timothy Doe out to Oshkosh and he says he doesn't like sopranos! Shall I go fire them all?"

The letter will probably be received by a professional letter opener who will glance through its contents as quickly as possible and enter them concisely on an imposing looking form drawn up by some inspired statistician. But such a procedure, if more impersonal, is likewise more provocative of results. For if the column in the letter-reader's book entitled "Dislikes Sopranos" reaches a dangerous length the program director will be promptly advised, and in the interest of efficient business methods soprano's voices will be heard no more from that station.



NORTON H. PAYNE

Organist of the Capitol Theatre, Montreal, heard through CKAC. When a popular entertainer faces the microphone and gives a special number which has been requested by 500 fans, arrangements are made with a local phonograph record manufacturer and one of these two numbers are registered via CKAC through the recording laboratories of the local firm. A program by Mr. Payne was the first to be so recorded



CYNTHIA GREY

A Denver newspaper columnist. She conducts KOA's newest afternoon broadcast attraction for women—microphone snapshots of human nature

The British Broadcasting Company—as do many American stations—uses such a system of cataloguing correspondence. In their own words:

Of course, it is not practicable to build programs in absolute accord with the views of individual listeners, but the cumulative effect of all our program correspondence gives a sound indication of the trend of public opinion.

The mail, as it comes in each day to the Program Correspondence Department at the central office at Savoy Hill, is carefully sorted after perusal, there being three main groups into which letters fall, viz.: (1) Criticism; (2) Appreciation; and (3) General—the latter term including letters of inquiry, request, suggestion, or, in fact, any letter which calls for some kind of reply.

It is impossible, and in most cases it is not desired, that a reply be sent to postcard messages of appreciation; similarly, letters expressing enjoyment of an item, artist, or program can only be briefly acknowledged by card. All other letters, however, do receive considered answers, and in cases of criticism a real effort is made to explain to the correspondents the reasons which caused them to complain; and in some cases, if a matter is brought to light which should be remedied, steps are taken to avoid a repetition of the trouble.

A daily *précis* of this correspondence is prepared and circulated, not only to members of the Program Board, who are responsible for the construction of the programs, but also to other officials who are directly concerned with program building. This *précis* shows in detail all appreciations and criticisms of program items, and, in the case of the latter, the actual letters of criticism are also circulated. Requests and suggestions of a general character are also noted on the *précis*, whereas those of a specific nature are sent to the individual departments concerned.

Listeners should realize that their letters are indeed "read, marked, learned, and inwardly digested."

What Radio is Like in the Far West

WITH dx conditions as unsatisfactory as they have been the past several months it has been difficult to get a comprehensive idea of what goes on in the great open spaces west of the Rocky Mountains. Accordingly we have solicited the opinion of Mr. James L. Marshall of the *Seattle Star* concerning Pacific Coast programs and he has the following to say:

"The Pacific Coast program still is in the song-

and-dance stage of development. It runs largely to impassioned announcements by sopranos, altos, bassos tenors and mixed quartets that they want to be like a tree, as per the Rasbach ode; to appeals by male duets to 'Remem-bah!' via Irving Berlin; to talks on the care of the hair and scalp, by lady beauty-parlorists; to details of what's what on the public market stalls; and to renditions on saxophones, oboes, clarinets, ocarinas, pipe organs, and musical saws of 'That Certain Party.'

"There has been lately, a tendency to cater to women listeners by putting various women's clubs and federations on the air for afternoon programs—and this is a step in the right direction. But a comprehensive plan for taking radio out of the primary class and making it intelligent still seems lacking.

"The advertiser in the West still is the bane of studio managers. Very few of them have been 'sold' to radio; hardly any of them realize what radio is all about. They insist on frequent and comprehensive announcements of their names, location, bargains, stock in trade, slogan, and business ethics, if any. And they cannot be convinced that this wins them, not good will, but a turn of the dials to another station.

"Some intelligent managers of studios are doing missionary work, trying to instill into advertisers' minds the idea that radio is merely an *n*th power extension of the Chautauqua. But, up to now, they have had little success.

"One coast station and one in the Rockies have adopted the Chautauqua idea—and the results have confirmed its success. But while KGO at Oakland, and KOA, at Denver, really offer popular education, a score of other stations do no good for themselves or anybody else by insisting

that chatty talks about hair restorers, patent budgets and the history of pants pressing and general laundry work are 'educational.' State colleges in Washington and Oregon, and the University of Montana, are running three-times-a-week courses, appealing generally to farmers, fruit growers, and stockmen. But they are small stations, generally run as an appendix to a department, and are not very effective. Neither do their courses appeal to the city radio fan, who is largely in the majority.

"But, even so, radio is producing some new ideas on the Coast. One studio, operated by KRCL, the north coast's largest station, has tried to visualize for its artists and speakers, their audience.

"Hanging in the studio is a large photograph of a working man's wife, with her babies. Printed matter, with the picture, says: 'This is Mrs. So-and-so, living at 1000 Blank Street.' It goes on to tell who Mrs. Smith is; what she likes; and what she does; what her husband is, does and likes—a family history in short. And the end of the story says: 'You are a guest in Mrs. Smith's home while you are on the air. She is your "average listener." Broadcast for her.' Never an off-color song or story goes out on the air over that station.

"Eastern studio managers will be surprised to know that time over some thousand-watt Western stations may be bought for as low as \$10 and \$15 an hour, contrasted with the hundreds of dollars for the same privilege in the East.

"But the Western audience is scattered, not concentrated. The broadcaster who gets 200 letters a day counts himself successful. The average audience, except for outstanding events, probably never exceeds 15,000. Perhaps 10,000

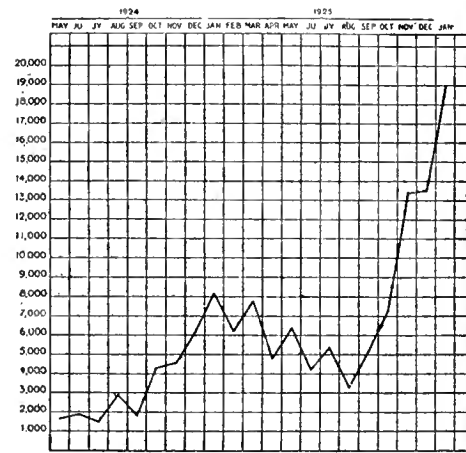

HOW THE BRITISH WRITE THEIR STATIONS

A chart showing the quantity of letters addressed to the various stations of the British Broadcasting Company during the last two years. The chart is reprinted from a recent number of the *Radio Times*

would be a better figure. KGO's Monday 'educational night' broadcast and the weekly dramatic broadcast of well-known plays from the same station, generally are conceded to have the biggest audience west of the mountains.

"While the problem of the Eastern fan is to separate stations, the problem of his Western brother—and sister—is to get distance. He is not bothered particularly by crowded dials, but he demands a receiver that will give him loud speaker volume at 1000 or 1500 miles.

"Congestion is rapidly becoming a problem in the West, though California, at the last count, had 62 stations, most of them on the air every night. The same state has more 'religious stations' than any other. Some of the 'revival broadcasters' even run to church orchestras, putting popular selections on the air.

"The coast fan, as a rule, is not luckily situated for Eastern or Midwestern reception. Much of the coast is in a 'radio shadow,' cast by the Sierra Nevada, the coast range, the Cascades or the Rockies. Thus, WJZ, with enormous power, is scarcely ever heard with any volume west of the ranges. Yet Mexico City stations, with one-hundredth of the power, come in with loud speaker volume on the average set on a good night. North and south the coast fan gets good reception; east and west it's 'not so good.'

"Reception of Japanese stations is becoming common; Alaskan fans are reporting reception of a few Australian stations; and Honolulu comes in with fair regularity on the crowded 1090-kc. (275-meter) band. Incidentally, those fans who want to log the Japanese stations have to stay up until 2 and 3 A.M. to do it. The Orientals sign off just when most coast folks are getting up.

"In entertainment, in technical excellence of broadcasting, in educational features, the West coast fans still have much to be desired. They are learning, however, that a well-modulated 500-watt station is to be preferred to a badly operated 5000-watter; they are coming to realize that programs may be vastly improved, and are demanding the improvement; and they are coming to know some of the difficulties of broadcasting. But there are still no fighting radio clubs on the coast, as in Chicago and Eastern cities. 'Silent nights' are conspicuous by absence. Definite cleaning up of power-line and other interference is a hit-or-miss proposition as yet.

"Radio in the West, for the greater part, still is primitive."



WEAF BROADCASTING THE "OPENING GAME OF THE SEASON"

Graham McNamee at the microphone, which is equipped with the private little invention of the WEAF technical department, designed to prevent the speaker from coming too close to the microphone in a moment of excitement and causing the system to overload. At McNamee's left is George McElrath, a field or "outside" operator. The scene is the Polo Grounds, New York, the game is between the New York Giants and the Brooklyn Dodgers

### Educational Broadcasters Association Formed

JUST to demonstrate how broad minded we are—for we think most educational broadcasting is the bunk—we here record the fact that an association of educational broadcasters has been formed viz: The University Association of Broadcasting Stations. A considerable expansion of educational broadcasting is contemplated under the direction of Dr. C. A. Culver, Carleton College, Northfield, Minnesota, and J. C. Jensen of Nebraska Wesleyan University. Members of the association at the time we write include the following:

WHA, University of Wisconsin, Madison, Wisconsin; WEBW, Beloit College, Beloit, Wisconsin; WEAO, Ohio State University, Columbus, Ohio; KFMX, Carleton College, Northfield, Minnesota; WOI, Iowa State College, Ames, Iowa; WKAR, Michigan State College, E. Lansing, Michigan; WMAZ, Mercer University, Macon, Georgia; and KFMR, Morningside College, Sioux City, Iowa.

Also WBAO, Millikin University, Decatur, Illinois; WPAK, North Dakota Agricultural College, Agricultural College, North Dakota; WHAD, Marquette University, Milwaukee, Wisconsin; WEW, St. Louis University, St. Louis, Missouri; KUSD, University of South Dakota, Vermillion, South Dakota; WTAW, Agricultural and Mechanical College of Texas, College Station, Texas.

And KFUT, University of Utah, Salt Lake City, Utah; KWUC, Western Union College, Le Mars, Iowa; WABQ, Haverford College Radio Club, Haverford, Pennsylvania; KFDY, South Dakota State College of A. & M. Arts, Brookings, South Dakota; KFMQ, University of Arkansas, Fayetteville, Arkansas; WSUI, University of Iowa, Iowa City, Iowa; and WCWU, Clark University, Worcester, Massachusetts.

Also, WCBH, University of Mississippi, University Postoffice, Mississippi; KFJM, University of North Dakota, Grand Forks, North Dakota; KOAC, Oregon Agricultural College, Corvallis, Oregon; KFKA, Colorado State Teacher's College, Greeley, Colorado; WGBX, University of Maine, Orono, Maine; KFHA, Western State College of Colorado, Gunnison, Colorado; and KWSC, State College of Washington, Pullman, Washington.

### Broadcast Miscellany

A RECENT survey of the field of radio entertainment features reveals the fact that the "Eveready Hour" is the "veteran" of them all in point of regular and continuous service.

This weekly broadcast program first went on the air on December 4, 1923. From that time on, without exception, each week has had its "Eveready Hour," through station WEAF and, since early in 1924, a gradually extending network of stations scattered throughout the East and Middle West. There are contemporary broadcast features which began just about the same time as the "Eveready Hour," but none of these others has had an unbroken run.

The "Eveready Hour," in its earliest days, however, was not the same type of broadcast program that it is to-day. It began, like most other features, as a program of more or less miscellaneous numbers. Slightly less than a

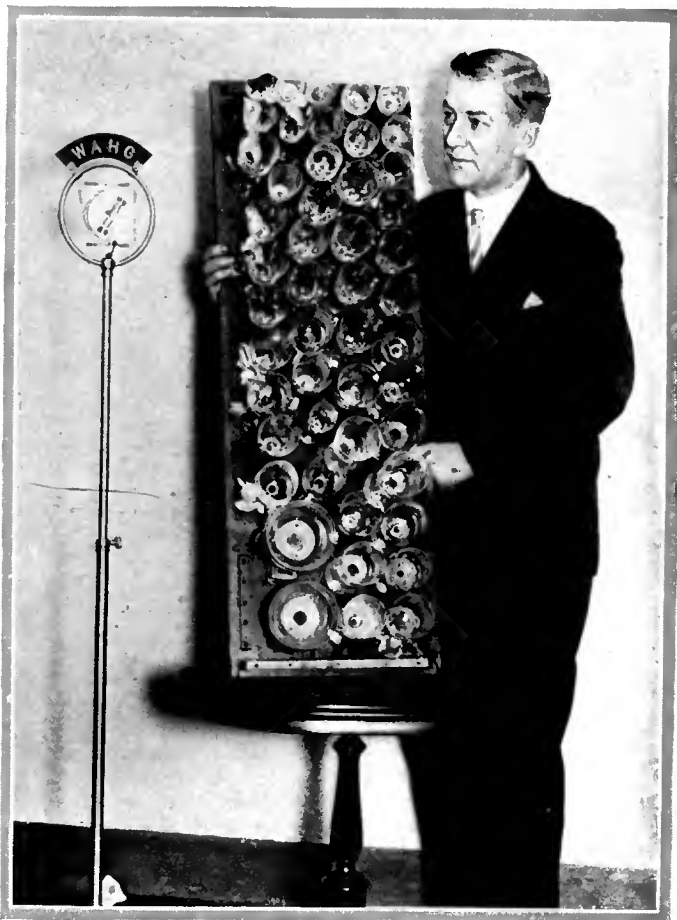

CHARLES WOLD AND HIS MUSICAL GLASSES

The glasses are arranged in the manner of a regular musical keyboard. There are 52 perfectly tuned glasses of all sizes and shapes, each of which correspond to the notes of the scale. By moistening his fingertips, the player is able, when striking the glasses, to effect a really sweet tone and has managed to play the most difficult of the more popular classical compositions. He has played from a number of New York broadcasting stations



AT KGW, PORTLAND, OREGON

Herman Kenin's Multnomah Hotel dance orchestra, an excellent organization which plays two programs a week from the Oregon station. Speaking purely as an amateur, the photograph seems to indicate that there are enough musical instruments on deck to supply a couple of other orchestras

year after its debut, it began its present type of program which has come to be known as the "continuity" radio program—a sort of radio scenario which tells a story with a combination of music and the spoken word. The first of these "continuity" programs was broadcast on the evening of November 10, 1924, on the eve of Armistice Day and the story was that of America's part in the World War.

TO WHAZ we are indebted for a "Jokeless Minstrel Show." We have heard jokeless minstrels before, but this differed in that jokes were not even attempted. The program was put on by the Delaware and Hudson Railroad Car Shop employees' chorus and orchestra who have been heard before from this station.

L AFF? Why we thought we'd die! At Ford and Glenn (WLS) arguing as to whether or not the windmills on farms are there to cool off the cows. And probably of the whole five minutes' discussion not a single sentence would seem funny in print. Perhaps that's the secret of radio humor?

THE New York Edison hour, which used to be on WJZ is now being heard from WRNY, New York.

ONE of our pet peeves is the practice of multitudinous stations of setting some ham to belaboring the studio organ whenever a lapse occurs in the program. The reason doubtless is



THE CLICQUOT CLUB ESQUIMAUX QUARTET

Heard during the weekly program sponsored by a national advertiser. The Eskimaux are heard through WEAJ and a chain of stations every Thursday evening from 9 to 10

that the station is entitled to be on the air at that time and intends to assert that right whether or not for any good cause. The result is inevitably popular music of the rag-time variety, for which, moving picture theaters notwithstanding, the organ was never constructed. A "Hot Mamma" tune played on the organ is not lacking in similarity to a scarf dance as executed by an elephant.

THE ever present jazz vs. "classical music" controversy presents as juicy opportunities for talking a lot and saying nothing as the weighty to-bob-or-not-to-bob problem. Nevertheless the director of wcco, in a memorandum sent to all those who share in making up the musical programs of the station calling upon them to cooperate in holding down the amount of jazz, managed to make some sage comments on the subject:

"One trouble is that no two people agree as to what constitutes jazz. To one it means all forms of syncopated dance music, although Beethoven knew and used the trick more than a hundred years ago. To another it means rhythm without melody, though Beethoven (again to quote a classic example) put what is practically a kettle drum solo into one of his symphonies. To a third it means clashing dissonances, and yet the person who objects to discords in a dance orchestra would not find any fault with the same sounds in Richard Strauss.

"What we really want to do is to eliminate, so far as possible, the kind of music which is nothing but a riot of noise, in which the melody is so trivial as to be practically not there at all, and in which the dissonances are the result of nothing more than the desire to make a racket. Such music is possible when one is actually dancing, and the noises of the hall help to overcome the sounds of the orchestra, but it is certainly not suitable for broadcasting.

"It must be remembered, however, that the radio audience represents every conceivable variety of tastes, and also that until all the programs are broadcast direct from the studios, and not by remote control, the station cannot exercise complete authority over the music. We are working in the right direction, but we cannot reach the goal as fast as many of our listeners would like."

WOAW celebrated its fourth birthday recently with an ambitious program. A musical-dramatic exposition of the history of the United States (announced as a pageant!) was heard in an eight hours continuous broadcast. Twenty-three episodes involving the outstanding incidents of American history were presented.

WE ARE informed by WTAM that "a new development in programs is being put on Tuesday and Thursday mornings beginning at 8:45 Eastern time for the benefit of public school pupils.

"These programs are planned and worked out by Alice M. Keith of the Music Appreciation Department of the Cleveland Board of Education and were originally planned for Cleveland schools. Schools all over Ohio, Michigan, Illinois, Indiana, Kentucky, and Pennsylvania are recognizing the value of these programs in their school curriculum and the station is receiving many favorable and complimentary reports on the value of the programs to pupils in public schools. The music offered is of the best procurable, given by members of the Cleveland Symphony Orchestra and other artists of the highest talents."

WTAM's transmitting apparatus is now located at Mentor, Ohio, about twenty miles east of Cleveland.

AMONG the best of radio's harmonizers are Correll and Gosden of WLIB and WGN. Their singing of a little ditty having to do with "Who'll be the papa?" is incomparable, and their side remarks are actually funny. After only a few months on the air, they have already been captured by the phonograph record people which, we suppose, constitutes the most tangible tribute a radio minstrel can receive.

PERHAPS the best weekly program on the air during the past spring, certainly the best if time-hallowed reputation is the criterion, was that of the Boston Symphony Orchestra as broadcast by WEEI from Symphony Hall during the regular Saturday night concerts. Unfortunately WEEI doesn't penetrate very far into the hinterlands, so the full value of this noteworthy feature was far from realized. WEEI is on the WEAJ circuit and this seems by all odds the best instance where the direction of the circuit might well be

inverted—as has been suggested from time to time. We hope that another season will see this program, if it is still made available, extended, westward by wire.

ONLY two or three times have we heard a radio concert by an orchestra composed exclusively of wood-winds. Considering the fact that wood-winds reproduce better, probably, than any other type of instrument they could be well made more use of. A concert by the Bruno Labate Wood-Wind Ensemble recently heard through wjz proved to be one of the least radio programs we have ever heard. The illusion of being in the same room with the orchestra was almost complete.

IF YOU like a story with your music, we suggest the series of musical dramas based on famous composers' lives as produced by Mr. Dailey Paskman, director of WGBS. The first of the series was a dramatization of the most interesting moments in the life of Ludwig von Beethoven. It was compiled by Mr. Paskman from a study of the biographies, letters, and music of Beethoven. Several characters were introduced and, of rather more importance, a symphony orchestra played selections from the nine symphonies. Similar dramatizations of the lives of Chopin, Schubert, Wagner, and others are scheduled.

TWO college organizations heard recently through wbz proved excellent offerings. The Holy Cross College Combined Musical Clubs under the direction of Edward Bouvier was heard in a two-hour program presenting a 60-man chorus, a 40 piece orchestra and a saxophone sextet. The principal song hits and orchestral numbers from the twenty-eighth annual Tech show were heard on another occasion. In previous years wbz has broadcast this show direct from the stage of the opera house at Boston, but this year secured a special studio performance which, by omitting non-musical stage business, was made more suitable for the air.



FREEMAN F. GOSDEN AND CHARLES J. CORRELL

These grinning subjects are two harmony singers often heard from WLIB and WGN. During the short time they have been on the air, they have established themselves thoroughly



# The Lightning Arrester

*The Different Types Available—How the Arrester Works, Its Care, and Installation—The Best Ground to Use—The Rules of the National Board of Fire Underwriters*

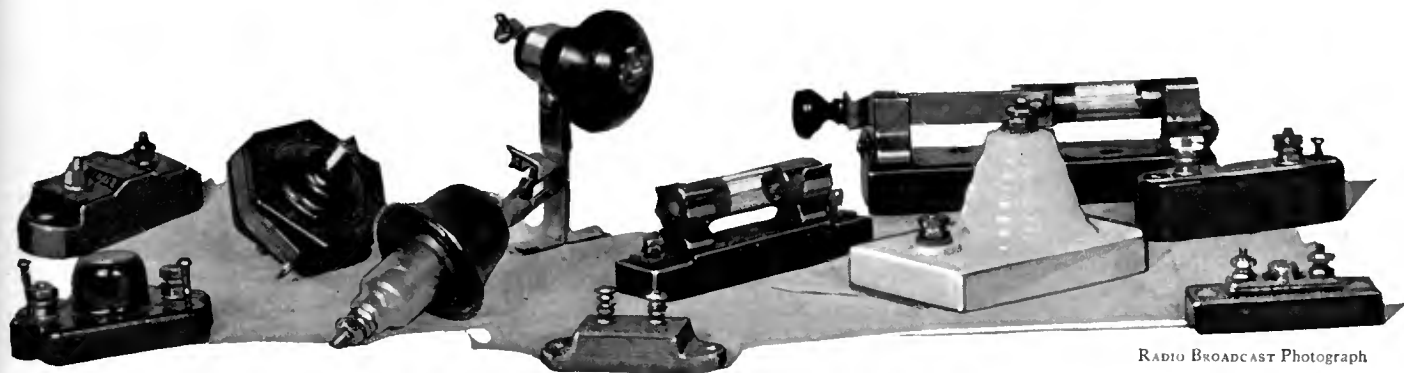

RADIO BROADCAST Photograph

By H. MELCHIOR BISHOP

**P**ARAPHRASING that famous writer who began his discourse on "Snakes in Ireland" with the flat statement that there are no snakes in Ireland, the author will begin his discussion of "Lightning Arresters" with the declaration that there is no such thing as a lightning arrester. So far, nothing has ever been found which could "arrest" lightning, or even slow it up, because once started, it has that pronounced "go-getter" quality which always succeeds. In the case of lightning, the success is often disastrous to the *n*th degree.

So the term "lightning arrester" is a misnomer. Yet the device called by that name has a very distinct utility in protecting the radio set from injury by lightning. In fact, it protects the entire building, for there is no better lightning rod installation than a properly erected antenna, grounded through a suitable "lightning arrester."

The word "grounded" in the previous sentence, gives us our first real key to the actual action of the lightning arrester. The device is really a condenser of very low capacity which is connected in some suitable manner across the antenna and ground posts of the set and which could be more accurately termed a "protective condenser." It is not, of course, located on the set, but is usually placed at the point where the lead-in enters the building, and preferably on the outside of the building.

Due to the extremely low capacity of the arrester, its tendency to by-pass radio frequency currents is so small as to be negligible, and due to the infinitesimally low voltage of these currents, they cannot possibly jump the air gap. A high voltage, high amperage charge, however, which would be capable of injuring the set, tends to jump the air gap between the terminals of the arrester (this gap is usually about 0.005-inch), and ground itself. Let us see why this is so, and how this operation protects the set and operator from injury by lightning.

To do this, let us first refer to Figs. 1 and 2, which show the principles of construction of the two types of arrester in common use. Fig. 1 shows the air gap type, while Fig. 2 shows the vacuum gap, or vacuum type, as it is often simply called. There are other types of lightning arresters in use, such as the horn gap and saw tooth type, but due to their bulkiness, and to the fact that no circuits of great current-carrying capacity are to be protected, they are rarely used in radio receiving work. Of the two types in general use, there are many variations, and practically all of these are good if properly constructed.

#### HOW THE ARRESTER WORKS

**W**E NOW turn to Fig. 3, which shows an air gap type of lightning arrester connected to the radio-frequency input end of a receiver. Suppose a signal to be

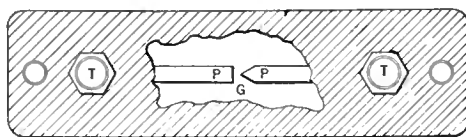

FIG. 1

The air gap arrester. The air gap, G, is about 0.005 inches wide

impressed upon the antenna; the radio-frequency current is too weak and low in voltage to jump across the points which form the gap in the lightning arrester, although these points, as stated above, are usually only about five thousandths (0.005) of an inch apart. The area of these points is so small that their condenser or capacity effect is practically nil, hence there is no path for the signal except that through the antenna coupling coil and thence to ground. The set is therefore actuated by this radio frequency current, and a signal is produced in the telephones or loud speaker, as the case may be. Suppose now that a high potential atmospheric electrical

discharge takes place, and is picked up by the antenna. Such discharges are almost always erratic and fluctuating in character, therefore the antenna coil of the set exerts a powerful choking action upon them, even though the inductance of this coil is comparatively very low in value. For this reason, and due also to the high voltage nature of the discharge, the major portion of it tends to jump the short gap in the arrester and ground itself, without causing any more effect on the set than a loud static crash which will possibly drown out the signal for a moment. Though the length of the gap in the vacuum type of lightning arrester is greater, its action is identical due to the fact that the partial vacuum which is maintained in this type reduces the discharge resistance between the points.

"It is all very well," you say, "to drain off ordinary high potential atmospheric electricity in this manner, but what has all this to do with actual lightning protection?" To answer this question, it is necessary to ascertain what lightning is, and what causes it.

Lightning is a discharge of extremely high potential atmospheric electricity, and is really the breaking down of the dielectric of a huge condenser, in which the storm cloud is one plate, the earth the other, and the intervening atmosphere is the dielectric. During, and just before a storm, this charge gradually builds up, never attaining its full potential suddenly. If, then, a grounded conductor projects into the storm cloud, or even, as is the case with most antennas, comes close to it, the effect is to prevent the building up of this charge to the tension necessary to cause a breakdown of the intervening air strata, and hence, that particular spot is rarely, if ever, visited by lightning. The effect, then, of a properly grounded antenna, is that of a lightning rod, but, due to its greater collecting surface, the result obtained is more completely efficient, offering unequalled protection from lightning.



CARE AND INSTALLATION

WHILE the lightning arrester is a very necessary and useful piece of equipment, it may in rare cases be the cause of poor reception, or even actual failure to receive any signals. The fact that a lightning arrester, after months or even years of use, is finally the cause of this type of trouble, does not necessarily prove that the device was faulty, for the following reasons.

In the first place, and especially in the case of the air gap type, repeated discharges across the gap to ground may gradually burn the surface of the points, causing a powder of metallic oxides to form on the burned surfaces. This oxide tends to fall off, and gradually fill the gap, causing a partial or complete short-circuit of the arrester, which in turn causes the radio frequency currents to be erratically bypassed to ground before they reach the set.

In the case of the vacuum gap type, if the vacuum is destroyed by any accident to the arrester, such as the breaking of the cement which seals the gap points into the glass or bakelite tube, the operating resistance of the arrester becomes higher, and the degree of protection is consequently reduced. This defect, however, can fortunately be detected in the average case due to the fact that the terminals will be loose, or the casing cracked.

When installing the lightning arrester, locate it preferably on the outside of the building and near to the window where the lead-in is to be brought in. Then run the lead-in directly down to the arrester in as short and straight a line as is consistent with good appearance, directly to the set. Do not cut the lead-in at the arrester, but wrap it around the terminal of the arrester and bring it in without breaks or joints. This is recognized by radio engineers as the very best practice.

The best type of lightning ground is an iron rod or pipe from four to six feet in length driven into the ground as far as possible, directly below the ground terminal of the lightning arrester. From this terminal, a wire, bare or insulated, but preferably the latter, and at least as heavy as the lead-in wire, is run in a direct line to the ground pipe and fastened securely to it by means of a stoutly constructed ground clamp. The clamp is exposed to the weather and a flimsy one will soon corrode and make poor contact.

If impossible to obtain this type of ground, the next best one is a cold water pipe, located as near as possible to the set and lead-in. A hot water pipe or radiator connection can also be used with very good results, but don't use a gas pipe.

Where it is more convenient to use an inside ground connection, it is necessary

for high receiving efficiency to keep the ground lead-in well separated from the antenna lead-in, or to mount the lightning arrester on the interior of the building.

FIRE UNDERWRITERS' RULES

IN THE 1925 issue of the code book of the National Board of Fire Underwriters, some rules are given with regard to the in-

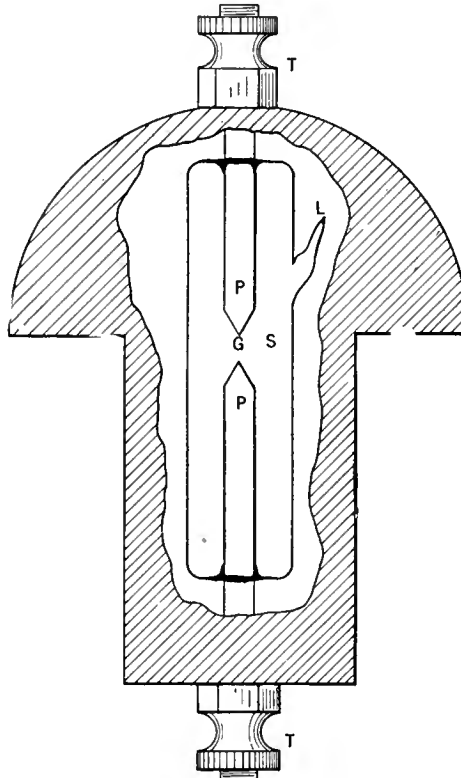

FIG. 2

The vacuum type of arrester. The width of the gap depends upon the degree of vacuum. The inner glass vacuum tube is indicated as S. L is the seal off

stallation of lightning arresters. These regulations are given below, for the aid of the reader, and have been taken from pages 144 and 145 of the code book.

1. Each lead-in conductor shall enter the building through a non-combustible, non-absorptive, insulating bushing, slanting upward toward the inside, or by means of an

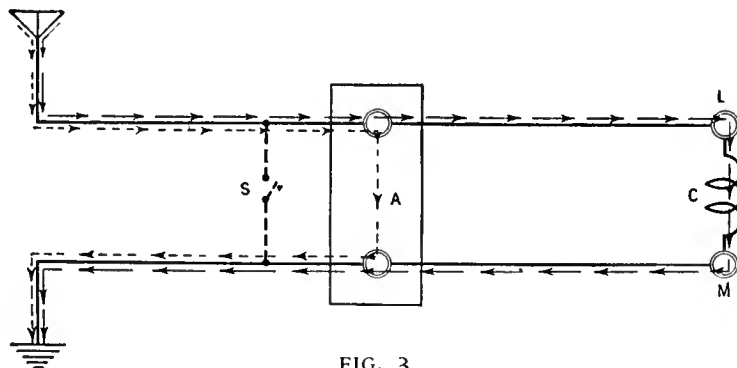

FIG. 3

The correct connections for an arrester. The antenna and ground posts are shown as L and M., while C represents the antenna coil of set. The dotted arrows show the path followed by high potential atmospheric, while the other arrows indicate the course of the incoming signals

approved device designed to give equivalent protection.

2. Each lead-in conductor shall be provided with an approved protective device (lightning arrester) which will operate at a voltage of 500 volts or less, properly connected and located either inside the building at some point between the entrance and the set which is convenient to a ground, or outside the building as near as practicable to the point of entrance. The protector shall not be placed in the immediate vicinity of easily ignitable stuff, or where exposed to inflammable gases or dust or flyings of combustible materials.
3. If an antenna grounding switch is employed, it shall, in its closed position, form a shunt around the protective device. Such a switch shall not be used as a substitute for the protective device. (Note "S," Fig. 3).

It is recommended that the antenna grounding switch be employed, and that in addition a switch rated at not less than 30 amperes, 250 volts, be located between the lead-in conductor and the receiving set.

4. The protective grounding conductor may be bare and shall be of copper, bronze, or approved copper-clad steel. The protective grounding conductor shall be not smaller nor have less conductance per unit of length, than the lead-in conductor, and in no case shall be smaller than No. 14 if copper nor smaller than No. 17 if of bronze or copper-clad steel. The protective grounding conductor shall be run in as straight a line as possible from the protective device to a good permanent ground. Preference shall be given to water piping. Other permissible grounds are grounded steel frames of buildings or other grounded metal work in the building, and artificial grounds such as driven pipes, rods, plates, cones, etc. Gas piping shall not be used for the ground.

5. The protective grounding conductor shall be guarded where exposed to mechanical injury. An approved ground clamp shall be used where the protective grounding conductor is connected to pipes or piping.
6. The protective grounding conductor may be run either inside or outside the building. The protective grounding conductor and ground, installed as prescribed in the preceding paragraphs, 4 and 5, may be used as the operating ground.

It is recommended that in this case, the operating grounding conductor be connected to the ground terminal of the protective device.

If desired, a separate operating grounding connection and ground may be used, this operating grounding conductor being either bare or provided with an insulated covering.

# AS THE BROADCASTER SEES IT

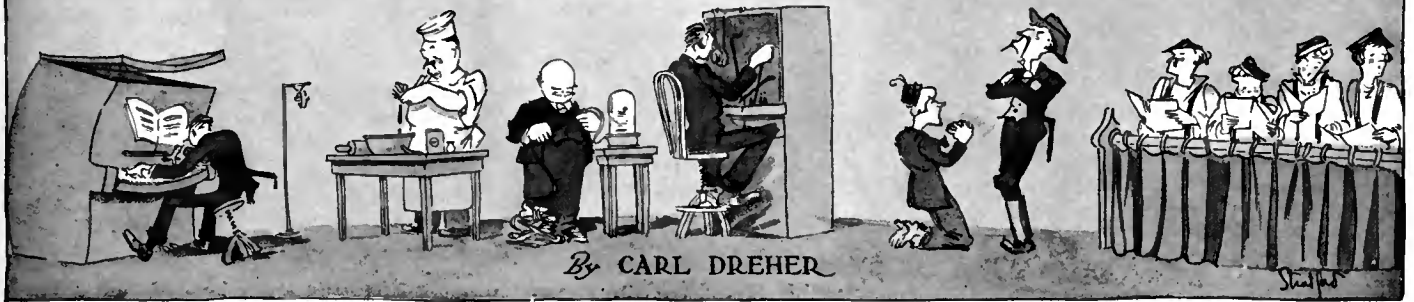

Drawings by Stuart Hay

## Glaring Faults in Newspaper Radio Journalism

**M**ORE than once, and in various media, I have wrinkled my nose and stuck out my tongue at the gentlemen who uplift radio in the press. The result has been striking. Statistics show that in 1925, when I first became rabid on this subject, three times as many radio editors died as in any previous year. In nether Mozambique so many of them perished that none was left to edit the radio sheets of the country, and a chiropractor had to be called in to perform this duty. In the United States, those who remain at their posts are unable to sleep, eat, or speak courteously to their wives; they look pale and drawn, and 65 per cent. are in the hands of nerve specialists. So low have the radio newspaper supplements fallen in the public estimation, as a result of my campaign, that it is necessary to pay the writers 20 cents a word, and I contemplate contributing to them myself. However, the other day a delegation of the relatives of the unfortunate radio editors called on me to ask wherefore I persecute their loved ones, and whether I would not set them at rest by saying plainly what I had against them. I have therefore decided to devote an article to the subject of radio newspaper supplements, and hereafter to hold my peace on this topic.

Before I go on, I wish to set down a few reservations. I realize that it must be a difficult job to be scholarly and to edit a radio sheet at the same time. Maybe if I went into radio journalism, as an editor, I'd be worse than any of the men now in the high seats of power. This, however, is no reason why I should not speak my mind, by the same theory that permits the radio critics of the metropolitan journals to razz a radio station when a modulator goes soft during a program, although they could not even build a single-circuit regenerative set themselves, much less run a broadcasting plant. Therefore, let me be candid. I think some of the radio sheets are pretty good, considering that they are compelled

to be spectacular in order to get readers, that they need advertisers in order to live, and that, through economic ills for which they are not to blame, they find themselves unable to hire \$20,000-a-year radio engineers to criticize their stuff before publication. On the other hand, I find in them lapses which any talented amateur could avoid. Let me illustrate.

The quotation below is from a 32-page radio supplement which I shall not name, because it is one of the best of the lot and my selecting it as an example might make it seem, unjustly, as one of the worst. The article is about some set-building celebrity of whom I never heard before, so I have nothing against him. We shall call him Smith. A sample paragraph from the epic of Mr. Smith:

Popular opinion said it couldn't be done, but he did it just the same! In 1920, Mr. Smith hooked up a De Forest audion to a crystal detector in an attempt to amplify signals received on the crystal alone. Hours of careful thought and planning went into the experiment. Leading amateurs scoffed at the idea. It couldn't be done! But Mr. Smith refused to be daunted. He tried various hook-ups, he experimented for hours. Finally it worked!

Do you recognize the style and method? The three exclamation marks in one short paragraph, the playing up of the scoffed-at-but-undaunted-inventor theme, the triumphant climax. "Finally it worked!" Where have we seen it before? In the green and scarlet Sunday magazine sections of the past two decades, with their illustrated confessions of seduced artist's models, rehashes of the divorce scandals of the rich, spectacular suicides (the arrow marks the point where the woman jumped off the bridge), and entertaining murders. In these sheets, science receives its full measure of attention, sea-serpents wiggle across the pages, hairy gorillas armed with clubs attack explorers, and the skyscrapers of New York are shown crumbling to the ground under the influence of violin notes bowed by a young man with long hair and a

determined expression. Some of the masters of English who have been turning out this stuff, moderating their style a little, have turned to radio. The underlying scheme is the same: to make something out of nothing, and to make that something exciting.

But the style is the least objection. The facts are the thing. From the paragraph quoted, you would think that in 1920 the proposal to use a vacuum tube as an audio amplifier was an astounding and unheard of novelty. Now, I am fairly ignorant myself, and offhand I can't say who did it first, or when. But I do know that, either in 1913 or 1914, Mr. E. E. Bucher wrote a series of technical articles for the *Wireless Age*, under the general heading of "How to Conduct a Radio Club." Among other things, Mr. Bucher threw the amateurs of the day into great excitement by printing the technique of using a vacuum tube as an amplifier after a crystal detector. The input transformer was a spark coil, there being as yet no such specialized device as the cute little audio transformers of our generation. The reason I remember the article is that I performed the experiments outlined, using a one-inch spark coil, and got fairly good results. To clinch the matter, refer to the *Proceedings of the Institute of Radio Engineers*, Vol. 3, No. 2, June, 1915, in which Haraden Pratt printed a paper on "Long Range Reception with Combined Crystal Detector and Audion Amplifier." In the discussion, in which Lee De Forest, Alfred N. Goldsmith, J. H. Morecroft, E. F. W. Alexanderson, Roy A. Weagant, and others took part, no one made the slightest mention of the crystal-tube combination as such; it was evidently nothing very startling. It probably dates back to around 1910.

This is no isolated instance. Without looking for them, one cannot help seeing a dozen such blunders in the average newspaper radio section. Another amusing case was a chronology of tube development, in which a commercial company was stated

to have sold certain rights, in 1913, for \$50,000,000; additional rights, in 1914, for \$90,000,000; and a final batch, in 1917, for \$250,000,000. The only trouble was that each figure had three zeros too many, the actual sums having been thousands of dollars, not millions. Calculating on this basis, we should all be millionaires. And there was no mistake about it; the figures were printed three times over, in separate paragraphs. Is there no one on that paper who knows the elementary facts in the history of radio? Of course, if you look at the text as simply a means of drawing equally uninformed readers to the advertisements flanking the reading matter, then it's quite all right. But let us hope that not all the men in newspaper radio look at the matter quite so sordidly. If they do, they cannot blame a radio man with respect for his craft for emitting a few roars, as I do now.

Another thing that grieves me in some of the radio sections, is the way in which they allow some mushroom investigator (clothing business till 1917, then Naval Radio School to Electrician 3rd Cl., clothing business again after the war, and reentered radio in 1922 because it looked like money) to alter a well-known circuit in a few negligible respects, call it by his name, make arrangements with the gyp retailers to recommend parts with which they are overstocked, and persuade innocent office boys and bank presidents to buy the junk and build a wonder set which will be supplanted in a week. I said it irritates me, although in general I eschew indignation, on the theory that it will take three thousand years to reform human nature—

far too long to wait. But it does set one's teeth on edge to see these camp-followers of radio attaching their names to inventions over which genuine investigators sweated blood years ago, while the actual inventors are forgotten, or dead, or both.

I write, as I always do in this place, from my personal point of view as an engineer. And is there no balm in Gilead? Very likely there is. I know the arguments—some of the sets described have merit; the supplements contain much material valuable in the education of novices; they facilitate ready adjustment of the retail market, especially in the sale of parts; and all these things must be done in haste, in the nature of newspaper work. All true and admitted, and if some newspaper radio editor wants to write up a good article in defense of the supplements, he is welcome to as much of this department as he needs to present his case. But it seems to me that these objects could be achieved with some regard for technical standards, engineering ethics, and reasonable accuracy in reporting. There must be many newspaper radio writers who would hesitate, even for their bread and butter, to violate the traditions of a decent profession. To those men, I address this article. There is room for improvement, and it is through them that improvement must come.

### Radicalism and Radio Broadcasting

SOME months ago the program directors of the great metropolis on the Eastern seaboard, as well as other literate citizens, read with shudders a newspaper report that the radicals were about

to establish a broadcasting station, or to buy their way into an existing one, using funds derived from the endowment founded by Mr. Charles Garland. Although I am no braver than other radio men, and stay further away from the 10,000-volt buses than some, I must confess that I scanned the item without a single quiver, except perhaps one of anticipation. The ether, economically and politically, is too much one-way, one-side for my taste. I have a Jeffersonian leaning toward free discussion, and, were I a program director (which God forbid should be added to my existing troubles) with a station where I had a free hand (no such station exists) I fear I should give ten minutes now and then to anarchists, Mormons, birth controllers, and people who say there is no Santa Claus. Alack, I was disappointed. No radical station gripped the ether by the larynx. Maybe they couldn't get a wavelength, maybe Moscow didn't supply the money, maybe they had the money but spent it on the picket line at Paterson, New Jersey, and environs, where the textile strike rages at this writing. Whatever the cause, to date no carrier wave has been modulated in crimson.

However, there was one little spasm during March. Our friend "Pioneer," an eminent New York radio critic, declared himself, one morning, as follows:

The perversity of the radio impresarios is infallible and astounding. Just when we detect symptoms of an universal conservatism among the metropolitan program arrangers, a dumfounding piece of exuberance such as the publicity release below bursts in on us:

"Having been pulled off many soap-boxes and run faster than many bluecoats, the radical leaders have at last found a place where they can expound their theories without even an umbrella being broken over their heads. In honor of Karl Marx' birthday, March 12, WRNY has turned novelty night period over to the radical leaders of New York and they have been promised they can go as far as they like and, whether or not you agree with them, it promises to be a red hot hour."

Possibly WRNY regards radicalism as a huge joke, capable of stirring uproarious mirth in all listening bosoms. Possibly WRNY cherishes the belief that all radio listeners tune-in promptly at the beginning of every program and stay to the end, thus hearing all the explanatory announcements made by the station. Possibly WRNY labors with the delusion that a listener always takes what comes out of the loud speaker in the same spirit that prevails in the studio.

Possibly WRNY has evolved a system whereby utterances barred under the sedition and treason definitions are neither seditious nor treasonable. Or possibly WRNY is going to pull a program "dud" after the advance publicity explosion. Any way you look at it, WRNY seems to have let its pursuit of novelty carry it into a not-nice position.

The advance-censure of the estimable "Pioneer" had its effect. Or possibly it was something else. At any rate, Mr. Gernsback's 258-meter radiation remained pure and undefiled. The radical hour was cancelled.

Unable to listen myself, I had my agents



"IN MOZAMBIQUE SO MANY PERISHED THAT NONE WAS LEFT TO EDIT THE RADIO SHEETS OF THE COUNTRY"

planted on the wavelength, their ears in the loud speaker, waiting with sharpened pencils for whatever might betide. What I wanted to know particularly was who the radical leaders of New York were. I have never been able to find out. The fact is that they do not agree among themselves on that point, which is one reason why the Republic stands.

For one, however, I rise in meeting and state candidly that I resent the solicitude of the Monsieur Pioneer in my behalf. I dislike pap, in books, newspapers, or on the air. I have heard on the air an enormous amount of extreme conservatism, and it has not hurt me. The radicals, I am confident, would not have hurt me either. If they are seditious, let them be thrown into the hoosegow. But first let them be seditious.

When the radical brethren cry that the country is run from the corner of Wall and Broad Streets, I stroke my chin. Maybe they're right. But what the radicals must next show me, before I clasp them to my bosom, is that they can run the show, if it be handed over to them, as well as the predatori aforementioned. This I doubt. I doubt, also, that if the Red gentlemen had been allowed by WRNY and "Pioneer" to have their say, their arguments would have convinced me on this salient point. And I doubt some more that, had they convinced me, I should immediately have heaved a bomb across the street at the chateau of Mr. Charles M. Schwab, murdered the traffic cop on the corner, and sent Dr. Nicholas Murray Butler a cigar box full of tarantulas. My belief is that if I had been allowed to listen, I should have yawned, gone to bed, and resumed my wage slavery docilely the following morning. As for the listeners not blessed with my astounding sapience, I believe they would not have attended to the radical menace at all. Rather, their ears would have been attuned to some radio vaudeville nearer their hearts.

### Technical Operation of Broadcasting Stations

#### 7. Modulation

IN PRESENTING the seventh article in the "Technical Operation" series, and the eleventh technical discussion since we began printing a department for and by broadcasters, a few words of explanation may be tolerated. This is a hand-to-mouth series. The titles have no especial order and are picked from month to month largely in response to requests from other broadcasters to this broadcaster who happens to be writing the articles. Our object is to be of immediate service to technicians in a relatively new field by clearing up points which are causing trouble. Later we may undertake a more complete and formal treatment of the subject of broadcast station design and operation, but the present task is more urgent. We shall continue it while our correspondence indi-

cates a need for it. Suggestions and inquiries are most welcome. And if you disagree with what is said, or have something to add, let us have that. The writer does not pretend to be always right or to know it all.

In response to requests we print a list of the previous titles and the issues in which they appeared:

|   |                 |
|---|-----------------|
| Microphone Placing in Studios                   | September, 1925 |
| Outdoor Symphonic Pick-Up                       | October, 1925   |
| Personnel and Organization in Broadcasting      | November, 1925  |
| Technical Routine in Broadcasting Stations      | December, 1925  |
| 1. <i>Wire Lines</i>                            | December, 1925  |
| Studio Microphone Placing—Further Consideration | January, 1926   |
| Technical Routine in Broadcasting Stations      | February, 1926  |
| 2. <i>Control Work</i>                          | February, 1926  |
| 3. <i>Monitoring</i>                            | March, 1926     |
| 4. <i>Multiple Pick-Up</i>                      | April, 1926     |
| 5. <i>Equalization</i>                          | May, 1926       |
| 6. <i>Types of Equalizers</i>                   | June, 1926      |

This month we shall devote the space to the topic of "Modulation,"—how it is done and the moot question of how much it should be done.

Modulation is the process of moulding the carrier oscillations of a telephone station in accordance with the acoustic vibrations which are to be reproduced, ultimately, at the receiving end. Probably the most effective method as yet developed is that disclosed by R. A. Heising of the Western Electric Company, before the Institute of Radio Engineers, on December 1, 1920, and described in Heising's paper on "Modulation in Radio Telephony," in the August, 1921, issue of the *I. R. E. Proceedings*. This is popularly known as the Heising or constant-current method of plate modulation. A lot of water has

flowed under the radio bridges since 1920, and some of the statements in Mr. Heising's classical paper would have to be revised in this day of broadcasting. For example, he said of the condition where  $K$ , the modulation constant, is less than unity (per centage modulation less than 100 per cent.): "Such a condition is very undesirable. It wastes power. . . . We should . . . always use radio systems which will give complete modulation." Well enough for the radio telephony of 1920, dealing with commercial speech requirements only, but the high quality musical radio telephony of 1926 requires gentler treatment. When a decent broadcasting station modulates 100 per cent., it is by accident, and the transmitter operators go out and commit harikari. But more of this later. The Heising method itself remains the same, and is used in almost all the large broadcasting stations of Great Britain and the United States.

Fig. 1 shows how it works. The large iron core inductance  $C$ , known variously as the Heising, voice, speech, constant current, control, or modulation choke, is the solar plexus of the diagram. It will be noticed that both the oscillator tube or tubes  $O$ , and the modulators  $M$ , receive their plate supply through this impedance coil. The effect of the choke, as the term designates, is to block current variations and to keep the total plate current of the oscillator and modulator banks constant. But obviously the microphone MIC, impressing audio potentials corresponding to speech or musical input on the grid of the modulator tube  $M$  (in practice this is done through a suitable number of stages of audio amplification, not directly as shown in the schematic diagram of Fig. 1) will result in large variations in the plate current of  $M$ . Since, therefore, the current



"THE RADICALS HAVE AT LAST FOUND A PLACE WHERE THEY CAN EXPOUND THEIR THEORIES"

through the main or common ammeter (1) remains sensibly constant, while that of the ammeter (2) in the modulator branch varies at audio frequency, the current through the ammeter (3) in the oscillator branch must vary correspondingly, as an inverted image of the modulating currents. (D. C. ammeters in these leads will show a constant reading, which is the *mean* plate current; only an oscillograph could follow the audio-frequency variations.) The last variation continuously affects the amplitude of the carrier. Thus the carrier, which when blank, or unmodulated, appears as in Fig. 2, is narrowed and widened according to a modulation "envelope," as in Fig. 3. This envelope is the audio variation which it is desired to impress on the carrier, and which will be reproduced after rectification or demodulation in the receiver.

It may be shown mathematically that the power content of a completely modulated wave is  $\frac{3}{2}$  the power content of an unmodulated wave of the same average current. Inasmuch as complete modulation is not now attempted in broadcasting, except in a few stations whose owners and operators should be delivered over to the public hangman, we may say that practically modulation by the Heising method leaves the antenna power about the same as when the carrier is left blank. Roughly, the energy added to the carrier by the modulators, when their plate current

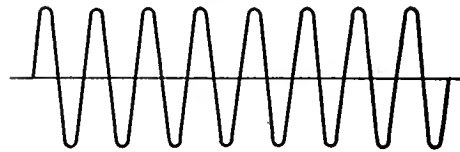

FIG. 2

Unless the set is constructed on this principle, the depth of modulation is very limited, if decent quality is to be preserved, or, if an attempt is made to modulate higher, there will be severe distortion on peaks. Many transmitters are built with an equal number of oscillators and modulators—often two of each. If the same type of tube is used for the two functions, such a combination



FIG. 3

cannot be modulated by the Heising method over about 35 per cent. without distortion. Above this value, the grids of the modulators swing positive, drawing current, all the load conditions leading up to the oscillators change on peaks, and distortion is inevitable.

If the same type of tube is used for oscillation and control, a good rule is to allow two modulators per one oscillator.

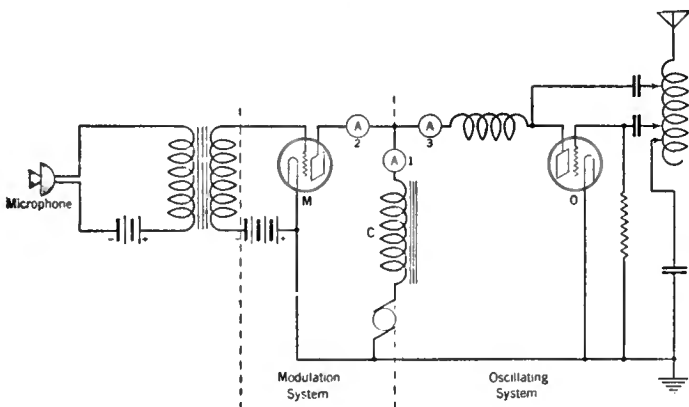

FIG. 1

drops, is equal to the energy of which the modulators rob the oscillators in the next half of the cycle, and the average radio-frequency power remains practically unchanged. This point has been much disputed, but its interest is largely theoretical.

Several precautions must be taken in this method of choke telephone control if distortion is to be avoided, but at least serious distortion is not inherent in the method, as in most of the other schemes which have been proposed. Thus the duplication (or worse) of valves is justified.

One requirement which is so frequently neglected that it must be mentioned here, although these articles deal with operation rather than design, is that the total power taken by the modulators should at least equal the power taken by the oscillators.

Even this does not satisfy the equal power requirement, for, used as an oscillation generator, a tube will normally draw three or four times the power it will take as a modulator. The reason for this is that an oscillator is merely a converter of energy and gets rid of over half its input, swinging all over its characteristic curve and drawing grid current

freely as it does so, while a modulator should not be allowed to draw grid current, and must not stray too far off the linear portion of its curve. Kellogg ("Design of Non-Distorting Power Amplifiers," by E. W. Kellogg, *Journal of the A. I. E. E.*, May, 1925), points out that the power rating of a given tube as an amplifier, for these reasons, is only of the order of one-tenth its rating as an oscillator. And a modulator is a special

sort of amplifier. Kellogg also says, in a very brief treatment of the subject of modulation, in the same paper, "If the same design of tube is used for modulator as for oscillator, it will generally be found that several modulator tubes should be employed for each oscillator tube, in order to take care of the peak voltages without exceeding the straight line range of the modulators. Failure to provide adequate modulator capacity is a frequent cause of distortion in radio transmitters."

The constant-current choke requires an inductance of the order of 100 henrys, in order to avoid loss of the low speech and music frequencies, and the capacity should be low to preserve the high frequencies. The situation here is the same as in the design of small audio transformers and chokes for receiving sets.

Assuming sufficient modulator capacity to obviate modulator grid current and rectification, and proper design of the control choke, and other parts, the question next arises as to how modulation shall be checked and how high it should be allowed to go.

The listening check is the most common as well as the most fundamental. The transmitter operator monitors on a receiving set and modulates as high as he can without injuring quality as far as he can judge. The rub is in the qualifying phrase. Not every "radiotrician" has a sharp ear for distortion, and even if he starts with this qualification at the beginning of a program, after four or five hours of listening it will probably take a dog fight to arouse him. Thus, while the audio check is indispensable, visual aids are desirable.

Fig. 4 shows one, the simple modulator grid milliammeter; Fig. 5, another, the modulation meter; Fig. 6, a third, the oscillograph. Which you use depends largely on how much money you have to spend. The grid meter, costing only a few dollars, should always be used. If cash is plentiful, all three will come in handy.

On a 1 kw. set, the modulator grid milliammeter will have about a 0-10 milliamperes scale. It should be provided with a short-circuiting switch in case it burns out. In operation the modulation may be run up so that, on the highest peaks, this meter "kicks" one or two mils. It

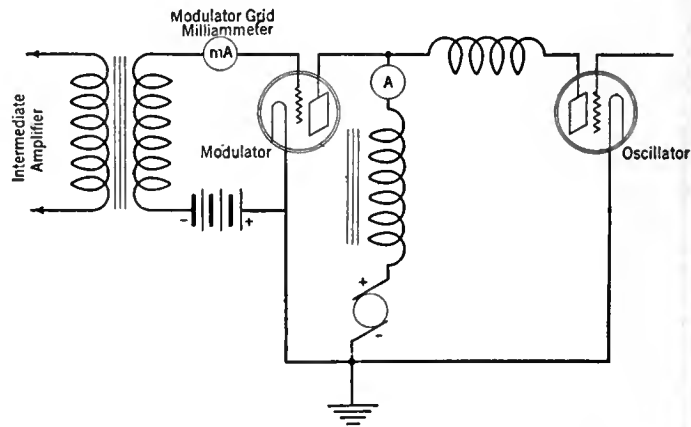

FIG. 4



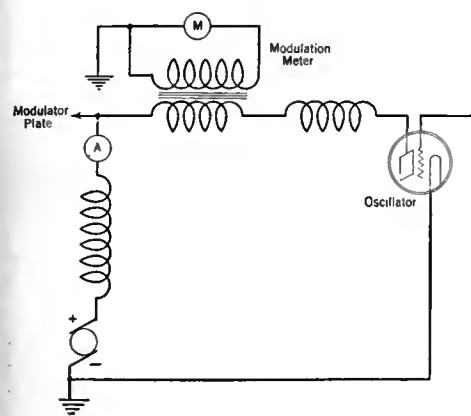

FIG. 5

should never be allowed to show a constant deflection, and most of the time the needle should rest against the zero stop.

A modulation meter is simply an a. c. ammeter connected through a current transformer in the oscillator plate feed so that it will register the audio variations therein, and calibrated in terms of percentage modulation. The full scale value is largely a matter of convenience, depending on the current transformer and other alterable factors; 0-1 ampere is the size in the case of some very large telephone transmitters. The scale is uneven, crowded at the lower end and expanding at the upper, as in all a. c. meters, and marked in percentages from 10 or 15, below which point it is unreadable, to 100. Such meters give only an approximate indication. The inertia and damping of the moving element necessarily play a great part in the response of the meter. Even if the instrument is accurately calibrated, reading it is a matter of skill and guesswork, for the needle bobs around, only rarely holding a definite position for a sustained note.

The most accurate and reliable means of observing percentage modulation is the oscillograph—but you can't get one for less than \$500 or so. If you have the capital, it is a good investment. As shown in Fig. 6, the instrument consists essentially of a stretched conducting fibre in a strong d. c. magnetic field. The stretched fibre has a very low natural period and responds indifferently to the various audio frequencies which it gets from the radiating antenna after rectification. A minute mirror cemented to the vibrator strip, as it is called, reflects a beam of light and reproduces a visual image of the modulation on a revolving, four-sided prismatic mirror. On this mirror, when the carrier is blank, one sees an undeviating line of light, which is broken up into a wavy stream when the carrier is modulated. The width of the carrier representation is readily marked on the instrument, and the extent to which the light vibrations approach this reference line indicates the percentage of modulation. An average observer can read the value to between 5 and 10 per cent. without difficulty.

And, once we have means of measuring the degree of modulation, how high shall we

let it go? Assuming that the design of the set is such that full modulation may be reached without distortion, my recommendation is 80 per cent. for the highest peaks. This gives a 20 per cent. margin against overmodulation, (an average modulation of 40 per cent. (roughly, average modulation is half of the peak values) while on pianissimo passages, the figure will rarely drop below 5 per cent. and there will still be some signal left for the dear listeners. High modulation is desirable, because the strength of the received signal depends not only on the carrier amplitude, as measured by the radio frequency amperage in the antenna, but the degree of change of this amplitude. Also, the carrier as such is an amplifying agency, and to let it go out undermodulated amounts to amplifying disturbances against one's own signal. On the other hand, overmodulation is ruinous, and a reasonable margin must be maintained against it. 80 per cent. top peaks is my compromise, for general conditions. If you don't know the soprano, even that may be cut down somewhat. Raise it at your own risk.

### Memoirs of a Radio Engineer, XIII

THE next momentous event in this development was the founding in 1915 of the City College Radio Club, an organization which, I understand, still flourishes. By this time, I was a sophomore at the College of the City of New York, studying various branches of physics under Doctor Goldsmith and other teachers, and still much interested in "wireless." Of course I was not the only amateur at the College, and most of us knew each other and discussed the problems of reception and transmission during our off-hours. We then conceived the idea of forming a radio club. Our resources, however, were almost nil. As usual, therefore, everything depended on Doctor Goldsmith. The Physics Department had a first-rate radio laboratory, which he directed, and he was known to have a generous disposition. We therefore approached the Doctor, outlined our project, and asked for his help, without which it was clear we could not proceed. This assurance he gave us, and we went ahead, putting up a notice on all the Physics bulletin boards that a radio society was in process of formation, and that Doctor Goldsmith would be the Faculty Advisor. Interpreted, this meant that he would be the "angel" of the concern,

with the privilege of donating the advice, rotary spark gaps, and quarter-kilowatt transformers for which we longed. Immediately the flies were buzzing around the honey, and we started with twenty members or so, besides some younger boys from Townsend Harris Hall, the preparatory school, who were admitted and patronized in an associate capacity. The founders of this brotherhood, as I recollect, were Edward T. Dickey, Joseph D. R. Freed, Herbert Kayser, Maurice Buchbinder, Jesse Marsten, and I.

Contrary to the experience of most college clubs, this one flourished, without financial difficulties or schisms. Freed was president, Buchbinder officiated as treasurer, I was chairman of the technical committee (which had charge of the apparatus) and chief operator, and the other fellows were officers also—I think Dickey was vice-president and Kayser secretary; at any rate, all the founders were officers and each got his share of the glory. Everybody worked together beautifully. I have said there were no financial difficulties. This was for the same reason that the Rockefeller Institute has no financial difficulties. Doctor Goldsmith presented us with a judiciously picked array of apparatus, including Leyden jars, transformers up to a half-kilowatt rating, quenched and rotary gaps, tuning helices for the transmitter, keys, and all other accessories, tuning coils, condensers, and loose couplers for receiving sets, an omnigraph and automatic tape transmitter for code practice, and numerous other equipment which need not be itemized. Part of it was loaned by the Physics Department, being no longer required in the laboratory work of the division, and much of it was the personal property of Professor Goldsmith. Compared to other radio clubs, we rolled in wealth. At the same time the Doctor took care not to spoil us. We wired up and constructed a great deal of equipment ourselves, such as tables for code practice and a long-wave receiver, held code practice sessions several times a week, and ran off technical meetings at which the members presented papers. When he could find time, Doctor Goldsmith would lecture to us on some aspect of radio engineering, and, as I have remarked before in these articles, it was here, at the Radio Club and, necessarily to a greater extent, in the Laboratory, that no negligible part of the radio engineering of to-day originated, about ten years ago.

(To be continued)

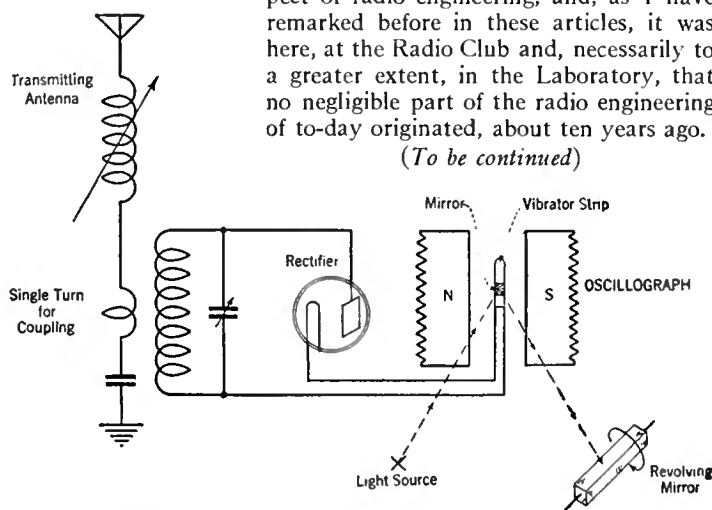

FIG. 6

# Tendencies in Modern Receiver Design



A Paper Delivered Before the Radio Club of America in Which Interesting Data Relative to R. F. Amplification, Audio Amplification, Etc., Are Given—Power From the Electric Light Lines



By JULIUS G. ACEVES

Research Assistant to Prof. M. I. Pupin

IF WE look back into the history of radio sets, we will remember that it was not very long ago when the only available matter to be received was radio telegraphy, or "code," which came to us as a rule in the form of short and long musical tones usually of a pitch close to high "C," or about 1000 cycles frequency. To be sure, there were some sixty-cycle operated spark transmitters emitting lower tones, but their harmonics were the sounds that were usually heard in the telephones.

In order to accomplish the reception of "code," a rather simple hook-up was used, but when vacuum tubes came into use, and the regenerative detector became more or less understood, the number of controls increased to such a point that playing on the Wanamaker five-manual organ with its two hundred and twenty-five stops, became easy in comparison with the manipulation of some of the old-time sets for DX work.

With the radiophone started the tremendous development in radio with which we are dealing. The same instruments formerly used for telegraphy were now employed for listening to speech and music, with the same audio-frequency transformers that passed only about two octaves in the scale; yet many radio fans thought that the quality was quite close to the original.

It is our present purpose to review briefly how matters have changed since those days, and what we may expect in the future.

In order to do this in a systematic order, let us follow the developments from various standpoints, namely: technical, acoustical, and operative. Let us study: (a) the radio-frequency amplifier; (b) the detector; (c) the audio-frequency amplifier; (d) the translating device, or loud speaker; and (e) the source of power.

From a technical point of view, after the vacuum tube appeared, the discovery of regeneration by Armstrong was the first landmark in the history of modern radio. As we are supposed to be well acquainted with the mathematics and physics of this phenomenon, we will only touch on the subject lightly here insofar as the quality of reproduction when we deal with this phase of reception. Many investigators found regeneration very readily in radio-frequency amplifiers, but nobody was able to eliminate it from them without also eliminating the amplification, and the next step of importance was the discovery of a means of neutralizing or balancing, the omnipresent regeneration wherever tubes were used, and particularly at high frequencies. Dr. L. A. Hazeltine developed the Neutrodyne, a receiver which has become very popular during the last two or three years on account of its non-radiating properties, and because it is easily tuned.

From these two forms of radio-frequency amplification the regenerative and neutralized forms, numerous

combinations soon appeared, the most popular and simple being the Roberts, Browning-Drake, and other similar circuits.

During the War, a great step was taken to do away with the difficulties presented by regeneration in high-frequency amplifiers. As is well known, the cause of regeneration and oscillations in a high-frequency amplifier is the internal coupling in the tubes themselves, even if all the external sources of back coupling are eliminated. This is principally due to the capacity between the grid and the plate, which tends to introduce an effective resistance and an effective reactance in the grid circuit, depending upon the nature of the plate impedance. As a rule, the resistance is negative and therefore if it overcomes the positive effective resistance of the grid circuit, oscillations will immediately be set up. Inasmuch as capacitive couplings are more effective as the frequency becomes higher, it was very difficult to construct amplifiers for frequencies much higher than a few hundred kilocycles. Here we find a very good way of crossing the bridge—by jumping across. If we can't use high-frequency amplifiers, let us not use high-frequencies; rather, let us convert those high frequencies into lower ones that we can handle. The invention of the super-heterodyne by Armstrong was the result.

There are three classes to which most radio sets may belong: (1) The regenerative detector; (2) The neutralized radio-frequency amplifier with or without regeneration; and (3) The double detection or super-heterodyne types, which we shall take up each in its turn.

## RADIO-FREQUENCY AMPLIFICATION

IN ORDER to avoid distortion before the detector, it is necessary that the radio-frequency amplification should be equal for all the frequencies within the transmitted band. This band is usually ten kilocycles wide for good articulation and for the highest notes in music, not including their overtones. These latter are,

as a matter of fact, inaudible to many people when they exceed five kilocycles, and are rather unimportant for people who can hear them since frequencies above five kilocycles are overtones to high pitches. In many organs, the reed stops, such as the trumpets and oboes, extend to about one octave below the top note, and the last octave is made of flue pipes that have very much weaker overtones than reeds. If, however, the frequency band is reduced to much less than five kilocycles on either side of the carrier, the articulation becomes defective and the voice sounds nasal and the music, dull and drummy. This is precisely what happens when regeneration is pushed beyond a certain limit in order either to reach greater distance or to increase the selectivity. Here the multi-stage tuned amplifier comes in for additional selectivity without sacrificing unduly the side bands. It has been shown that a number of tuned stages in concatenation approach the effect of a band filter which would pass with practically the same amplitude, all the components of the band. The filter which would represent a multi-stage amplifier is represented in Fig. 1. The ideal band filter should not contain resistance elements in any part of the circuit if it must show the characteristics of the filter shown in Fig. 2, namely, a square top; but if the sharpness is not carried too far, a good practical compromise may be reached, and characteristics such as shown in Fig. 3 may be obtained. When regeneration is introduced in an amplifier of this sort, it is possible to vary the shape of the characteristics from curve A, Fig. 3, to curve E, according to the amount of feed-back, so that for distant stations the selectivity and sensitivity may be increased although the reproduction may be somewhat impaired. In multi-stage neutralized amplifiers, the sharpness of the tuning increases with the number of stages up to three or four; beyond this number the selectivity does not increase at the same rate. The filter shown in Fig. 1 exhibits the same characteristics.

## SUPER-HETERODYNE RECEIVERS

NOW we come to the double detection or super-heterodyne receiver. It has been shown, both mathematically and experimentally, that as a result of the action of the local frequency with the incoming signal wave, the resultant lower frequency wave keeps exactly the same modulating envelope that the original carrier contained, and this is the same as stating that the first detection does not follow the square law, but a linear detection is obtained. Consequently, if the intermediate-frequency amplifier does not discriminate against frequency, the detector would receive a carrier modulated exactly the same as the original but of a lower frequency, and there would have been no inherent distortion introduced by the double detection or frequency conversion system. This holds, of

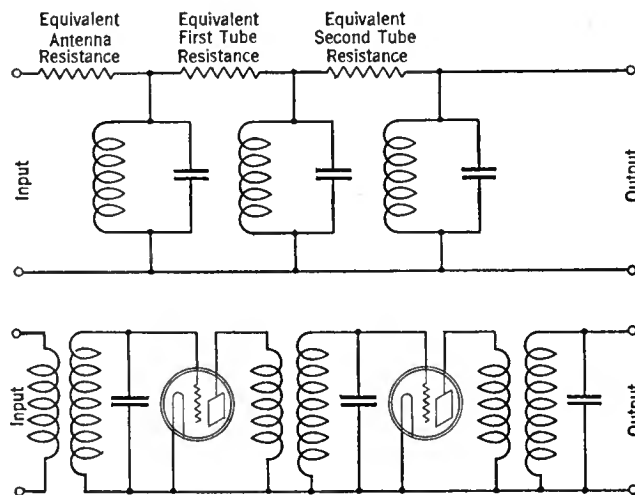

FIG. 1

course, within certain limits of intensity of signal, and local source. It follows that if there is any distortion in a super-heterodyne, it comes from the properties of the intermediate-frequency amplifier and the filters attached to it.

If a band filter, of the type shown in Fig. 2, is introduced between the first detector and the intermediate-frequency amplifier, and the frequency of the local source is so adjusted that the resultant beat frequency band comes exactly over the shaded area, the reproduction would be as good as if no filter were inserted, but the selectivity would be very

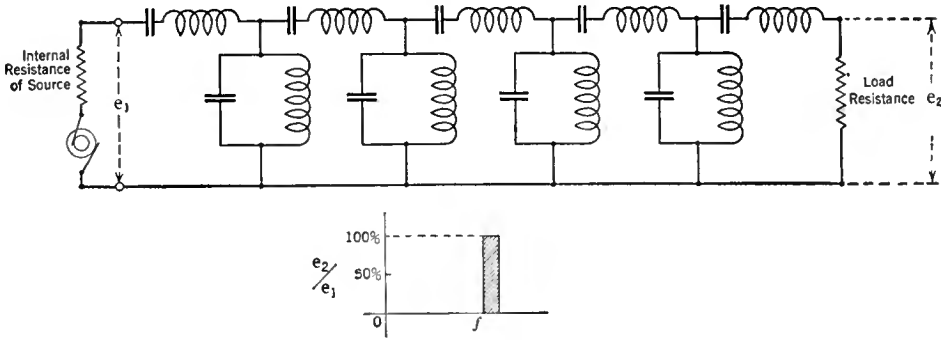

FIG. 2

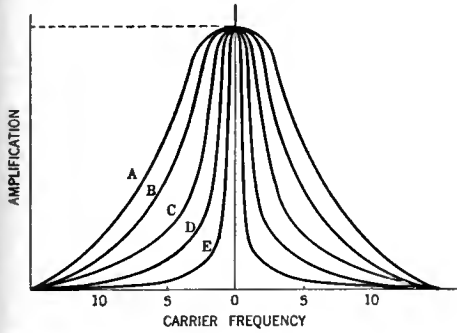

FIG. 3

great, in fact as great as it may be desired by properly constructing the filter. With this system there would be only one other band of frequencies that would pass through, and that is the corresponding band to a station having a frequency greater or less than that to which the receiver is adjusted by double the amount of the intermediate frequency. For that reason, all super-heterodynes have two points in the second dial for every station. As a rule, the undesired band is eliminated by tuning the loop, or input circuit, but this is not anywhere near as effective as the elimination due to the band filter, and for that reason I have suggested the use of a rejector in the input circuit that would short-circuit almost completely the undesired band. This contraption may be in the form of a series coil and condenser

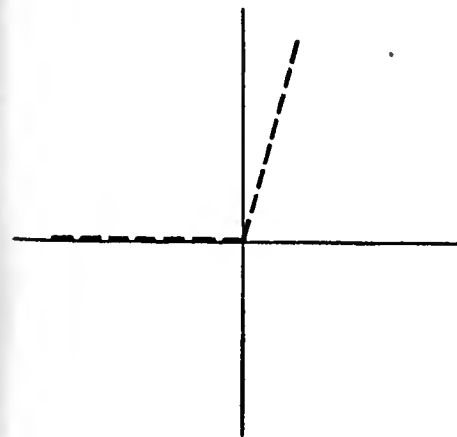

FIG. 7

from the grid to the filament of the first detector or inductively coupled to the loop, as shown in Figs. 4 and 5. The same dial that controls the tuning of the loop may be made to control the variable condenser of the rejector, and thereby simplify the operation of the set. It must be borne in mind that the local oscillator should give a pure sine wave. Otherwise some of its harmonics may heterodyne with some other station whose frequency may give beats of the frequency of the band filter, and therefore will not be excluded as they should be.

Having examined the three principal types of radio-frequency amplifiers from a standpoint of good reproduction, let us see how they stand for simplicity of operation.

Unquestionably, the regenerative detector is the simplest receiver to tune if it is properly constructed, and providing a sufficiently long antenna is used so that the coupling between it and the tuned grid circuit may be made as weak as

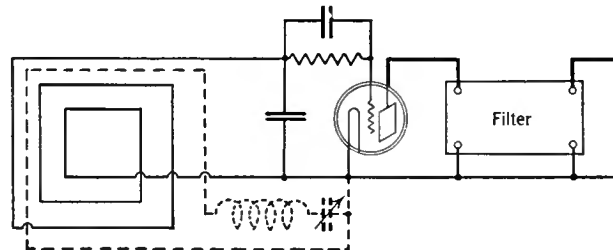

FIG. 5

possible to obtain a fair degree of selectivity with a single tuned circuit.

For local stations only, a very simple set may be made in accordance with Fig. 6, which will have the minimum of control dials, namely, one for selecting the station and another for volume control. If the circuit is in the hands of an intelligent operator, it will never "squeal."

Then comes the type of tuned multi-stage amplifiers in which no attempt is made to neutralize automatically the inherent regeneration. Here we may have a very great amount of distortion if the set is not properly tuned, and also if the regeneration is pushed to the limit. In the hands of inexperienced people, the tuning of several dials, and the control of the so-called "stabilizer", may produce very poor results. To obviate the difficulty, some sets have the "stabilizer" permanently adjusted, and the tuning operations become as simple as when handling a neutrodyne. However, the higher frequencies will be amplified more than the lower ones because the capacitive regeneration of the tubes increases with the frequency.

In order to simplify the tuning, both neutrodyne and tuned radio frequency sets are now being made so that the various tuning condensers may be operated by means of a single dial. If the various parts are made mechanically perfect within a reasonable cost of manufacture, there should be no need of auxiliary dials to correct the deviations, except in the antenna circuit where the reaction of the antenna on the first tuned circuit may be quite appreciable if the optimum coupling is used. A compromise may be reached by slightly sacrificing the sensitivity by reducing the coupling of the antenna to a point where the reaction is hardly appreciable. Also, the condenser that tunes

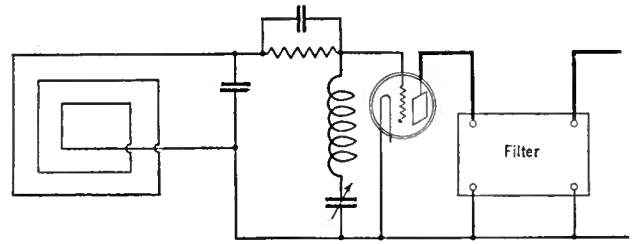

FIG. 4

the first tube and the antenna may be controlled by a separate dial, and the rest of them by a single dial. In order to control the amplification without resorting to dimming of the filaments, a variable inductive coupling from the antenna to the first input tuned circuit may be used, as in Fig. 6, where two coils at right angles are mounted on the shaft of the volume control dial or knob; one of these is connected to the antenna and the other one to a condenser having a capacity equivalent to that of the antenna. In this manner, the reaction of the antenna on the tuned circuit remains almost independent of the position of the volume control knob. The other tuned circuits of the multi-stage amplifier may be provided with coils similar to the first one, with condensers across them, so that an equivalent reaction may be introduced in the other tuned circuits, and all of them controlled from a single dial.

The super-heterodyne type of receiver comes next to the regenerative detector in simplicity of operation. There are only two dials to adjust, and then, if the parts are mechanically accurate and straight line frequency condensers are used, it is possible to control the tuning of

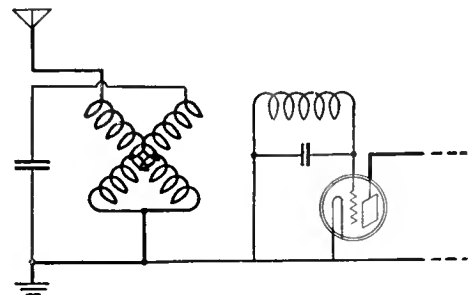

FIG. 6

the loop, or input coil, and the local oscillator by means of a single dial. As we said before, a rejector circuit may also be tuned by the same dial to eliminate the second frequency band, and this would bring us to the ideal receiver from a point of view of simplicity of manipulation and of the greatest distance range and highest degree of selectivity. With a band

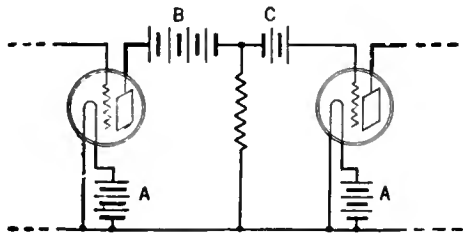

FIG. 8

filter of the type shown in Fig. 2, we would get a modulated carrier wave at the grid of the second detector as near as possible to the original.

DETECTORS

ONE of the elements that is quite often overlooked in a radio receiver is the detector. As a vacuum tube has a non-linear characteristic, it follows that every tube detects to some extent; even the audio-frequency tubes detect to a very small degree. In order, therefore, to make a tube detect, it is necessary to obtain a non-linear relation between the input voltage and the plate current either directly or indirectly. It is done directly when a very strong negative bias is applied to the grid so that the grid-voltage-plate-current characteristic at that point will bend considerably toward the voltage axis. The indirect method consists in utilizing the grid-voltage-grid-current curve which is considerably sharper than the former characteristic. To this end, a small condenser, with a high resistance leak in shunt with it, is interposed in the grid circuit so that when the grid takes current there will be a potential difference across the condenser, and this voltage will act upon the plate current following the grid-voltage-plate-current curve.

This latter method is used to a very much greater extent in radio receivers than the former, and it will not be entirely out of place to say something concerning the values of the bias voltage condenser and leak to be used.

The positive bias makes very little difference as a rule in the efficiency of the detector when strong signals are received, but for very faint

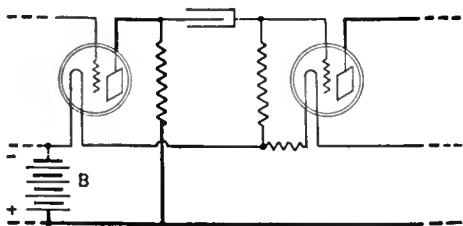

FIG. 9

ones it is best at a value close to the voltage of the A battery. In a recent paper before the I. R. E., a very good discussion on this subject was completely presented, and curves for various types of tubes were shown. Apparently the 6W-12 is the most efficient detector with a grid bias of one volt.

The size of the condenser is fixed by the

highest audio frequency to be detected, and by the value of the leak. The product RC gives the time constant of discharge of the condenser and leak, and should be smaller than the duration of a cycle for the highest audio frequency. On the other hand, the condenser should be larger than the grid to filament capacity of the tube so that the available signal voltage may not be reduced by the drop across the condenser.

The leak should have as high resistance as possible compatible with the condition above named about the product RC. This holds on the assumption that the tube has no internal leakage, that is, no gas. For strong signals, it may be better to use a lower resistance leak to avoid "blocking," and to flatten somewhat the detecting characteristic so that detected signals may not suffer distortion. An ideal detector should have a curve approaching the line of Fig. 7 so that there may be perfect rectification and linear detection. As much as the detection characteristic will approach this ideal, there will be more efficient detection and less distortion that is, the audio-frequency current will resemble the envelope of the carrier more closely. Crystal detectors are noted for their non-distorting properties, but unfortunately the great majority of them are not uniform and do not stay constant.

Now that we have glanced over the various

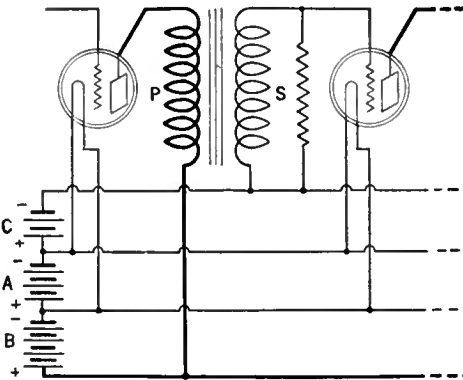

FIG. 10

types of radio-frequency amplifiers, let us examine the audio-frequency circuits.

AUDIO-FREQUENCY AMPLIFIERS

THE ideal audio-frequency amplifier would be made by using a resistance in the plate circuit of each tube and transferring the voltage variations directly to the grid of the following tube, the potential of the grid with respect to the filament being brought to a suitable value by means of a C battery, Fig. 8. This scheme is not practical, and in order to obtain the same results there are two general methods which theoretically should give exactly the same results as the directly coupled resistance amplifier, namely, by means of resistances and condensers, and by transformers.

It is obvious that in the case of resistance and condenser coupling, Fig. 9, if the reactance of the condenser for the lowest frequency is somewhat greater than the resistance of the leak, there would be a constant amplification at all frequencies, and therefore we would have ideal conditions. In the second method, if we had ideal transformers, that is, transformers in which the open cir-

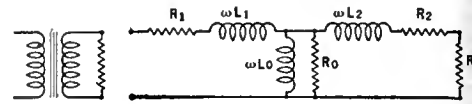

FIG. 11

cuit primary reactance is infinite, the leakage field between primary and secondary zero and the resistance of the windings also zero, and we connect a resistance across the secondary, as in Fig. 10, we would also have equal amplification of all frequencies, just as in the direct coupled resistance circuit of Fig. 8. In practice, the limitations are due to the magnitude of the primary reactance of the transformer, the leakage factor, and the distributed capacity of the windings. The eddy current losses in the iron may be represented by a shunt resistance across either winding, and, for that reason, in many cases it is not necessary to connect a high resistance across the secondary to get the effect of an equivalent resistance only across the primary. There are many excellent transformers on the market that have made their appearance within the last year or so that approach very closely the ideal conditions. They have a primary reactance of over 30,000 ohms at 50 cycles, which is about the lowest frequency transmitted by some of the very best stations, and the internal capacity so low that the upper frequency limit is beyond four kilocycles, which is the highest fundamental tone of the piano scale.

In order to illustrate, or rather to prove, that an ideal transformer used for coupling two tubes is equivalent to a resistance-coupling within a certain predetermined band of frequencies, let us assume that the transformer is of one-to-one ratio; for other ratios, it is only necessary to multiply the constants of the secondary by the square of the ratio of turns. A transformer is equivalent to a network as represented in Fig. 11 where  $R_1$  and  $\omega L_1$  represent the copper resistance and the leakage reactance of the primary,  $R_2$  and  $\omega L_2$  those of the secondary,  $R_0$  the iron losses, and  $\omega L_0$  the open circuit primary reactance.  $R$  is the load. If the transformer approaches the ideal,  $R_1$  and  $R_2$  will vanish in comparison with  $R$  and also  $\omega L_1$  and  $\omega L_2$ ; that is to say there will be no leakage field,  $\omega L_0$  being very large in comparison with both  $R_0$  and  $R$  in multiple, it may be taken off, and then the circuit will be reduced to a simple resistance.

Comparing the condenser-resistance and the transformer couplings, it will be noted that if the transformers approach the ideal, we may obtain a higher degree of amplification at all frequencies, since the ratio of turns may be made about three to one in practice without departing very much from perfect conditions. It will also be noted that when resistance-condenser coupling is used, a much higher plate voltage has to be used in order to bring the plate at rated potential. This has led to the so-called impedance coupling. Impedance coupling is identical with resistance-condenser coupling except for the substitution of the plate resistance by a very high reactance which has relatively low copper resistance, so as to get the full battery voltage

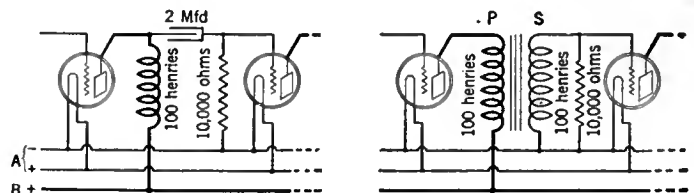

FIG. 12

on the plate. This system has just the same limitations as transformer coupling, and is theoretically equivalent to a one-to-one transformer, as shown in Fig. 12.

The faithfulness of reproduction of the demodulated wave at the detector grid, through the audio-frequency amplifier to the terminals of the loud speaker, may be preserved intact if the following conditions are fulfilled:

1. The amplifier must pass all the frequencies under consideration with an equal degree of amplification.
2. The plate impedances must contain no reactive component.
3. The tubes must be worked within the straight portion of their characteristics even for the loudest signal.
4. The grids must take a very small current if any; so small that the effective conductance at the peak values of that current may be negligible in comparison with the conductance of the plate circuit of the previous tube.

We have examined the requirements to fulfill (1).

It is quite essential to have plate impedances as nearly void of reactance as possible (2) because the dynamic characteristic of a tube with a reactance in the plate is not straight, but has the shape of a hysteresis loop, and therefore the plate current variations are not proportional to the grid voltage changes.

Tubes are worked beyond the straight portions of their characteristics in many radio sets in order to obtain sufficient volume, and this is particularly true of the last tube, when insufficient plate voltages are used, and also when tubes of low power output are used in the last stage. For a moderate amount of volume, tubes such as the UX-171 with some 180 volts, should be selected, and for a volume approaching the original in the broadcasting room, a tube of five or more watts should be used with over 300 volts on the plate. In case a plate voltage sufficiently high is not available, for instance, when a set is operated from the 110 volt d. c. lines, an increase in volume may be obtained by the use of an extra tube and working the last stage in the positive part of the characteristic, provided that condition (4) may be fulfilled. The extra tube is not meant for additional voltage amplification, but simply to supply sufficient power to the grid of the last tube so that the grid may take an appreciable current, yet without lowering the voltage impressed upon it. Fig. 12 shows how this may be accomplished with impedance-capacity coupling, and with transformer and resistance coupling.

Having preserved the wave shape of the modulated carrier from the broadcasting station and then detected and faithfully amplified to the terminals of the loud speaker, it is only necessary to avail ourselves of the best instrument on the market in order to complete the last link in the chain. As a number of very good papers on loud speakers have been read in the recent past, I shall not attempt to repeat their contents, and I will only make a few remarks on my personal experience with various types of speakers.

TRANSLATING DEVICE OR LOUD SPEAKER

APPARENTLY there is no speaker on the market which can reproduce equally well all frequencies from 25 to 8000 cycles. Some very good types approach a linear and horizontal curve from 150 to 3000 cycles and can deliver a tremendous amount of tone, as, for example, the Hewlett and the Rice-Kellogg types. With large cones, very much lower frequencies may be reached. In 1923, I used a very large horn with an exponential curvature of expansion, approximately 19 inches in diameter at the opening and 71 inches long, with a very large diaphragm unit at the base. It has been working ever since quite well at the end of a three-stage resistance-condenser amplifier, with Western Electric high- $\mu$  tubes and a five-watt tube in the last stage (besides the last tube), using 400 volts B battery voltage, the latter being obtained from the 60-cycle 110-volt line, by means of S tubes. This horn gives a fairly uniform frequency reproduction from 120 cycles to about 1200 cycles, and then becomes weak very gradually, and for this reason I supplemented the deficiency by a short horn, with a condenser in series so that it would not rob the large horn of the lower tones. In order to obtain tones lower than 125 cycles, a cone was added, and the three of them together give a quality of reproduction that has received very favorable comments from all those who have heard them. The Western Electric cone seems to be at the present time the best all around reproducer of moderate price, and with a well made audio-frequency amplifier, all the harshness and rattle that it usually gives with carelessly designed sets disappears, and considerable volume almost approaching that of the Rice-Kellogg speaker may be obtained. This cone covers very well the two extremes of the musical scale for the average listener.

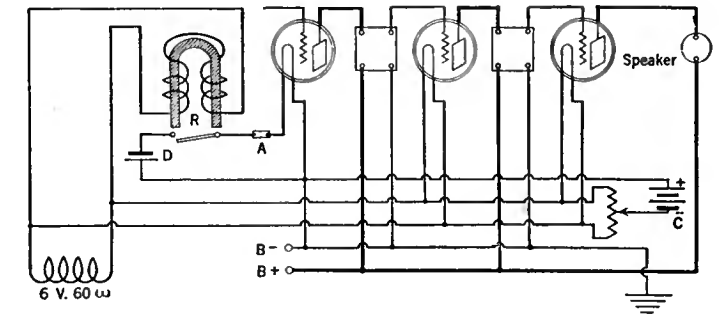

FIG. 14

alternating current. In some isolated cases 220 volts are furnished for lighting purposes, and also some lower or higher frequencies are found occasionally. On farms, a 32-volt equipment is often found. As the most common form of energy supply is the alternating current 60-cycle 110-volt lines, we will confine our discussion to this condition.

The first use of power for the operation of radio sets was to charge a storage battery by means of vibrating or tube rectifiers, there being no method of charging the B and C batteries. Later we find storage B batteries charged by means of tube rectifiers. Although the electrolytic rectifier was discovered by Doctor Pupin in 1895, it was not until recent years that it has been used for the purpose of charging radio batteries. Very good examples of chemical rectifiers are found in the market, and some of them are associated with storage cells of low capacity which they charge at a very low rate for considerable periods of time, or continuously. Alternating current has been used to energize the filament of transmitting tubes even in the days of radio telegraphy, but few have used it for radio telephone reception with any degree of success. As early as 1921, the author made a complete super-heterodyne receiver with all the tubes lighted by alternating current, and B and C potentials were derived also from the rectified current by the use of S tubes. To be sure, that particular receiver was not intended to cover thousands of miles, but on all local and moderate distance work it accomplished its purpose without objectionable hum. It must be said that the transformers used were of such type as would hardly pass frequencies below 200. Alternating current may be used to light the two last tubes of a receiver without an audible hum one or two feet away from a cone speaker provided that the following conditions are fulfilled: (1) The C voltage must be such that the grids never become positive with respect to any point in the filament unless the conductance of the circuit attached to the grid is large and takes a current many times greater than that which the grid may take at the peak values; (2) The middle point of the filaments must be at ground a. c. potential at all times; (3) The construction of the tube, with respect to the plate must be symmetrical with regard to the two ends of the filament; this is fairly well fulfilled in most of our commercial tubes; (4) The plate impedance must be non-reactive and large as compared with the internal plate resistance of the tube; in other words, the dynamic plate-current-grid-voltage characteristic must be straight within the portion used; (5) There shall be no inductive effects between the filament leads and the grids of the detector and audio-frequency amplifiers. From the first condition it follows that the detector cannot be lighted by alternating current except when moderately strong signals are available, and when the detection is accomplished by the curvature of the

SOURCE OF POWER

NOW we come to another department of the radio receiver that has received considerable attention during the last few years, and that is the utilization of power from the electric light lines.

Power is delivered to consumers at a potential of 110-125 volts direct current, or 60 cycle

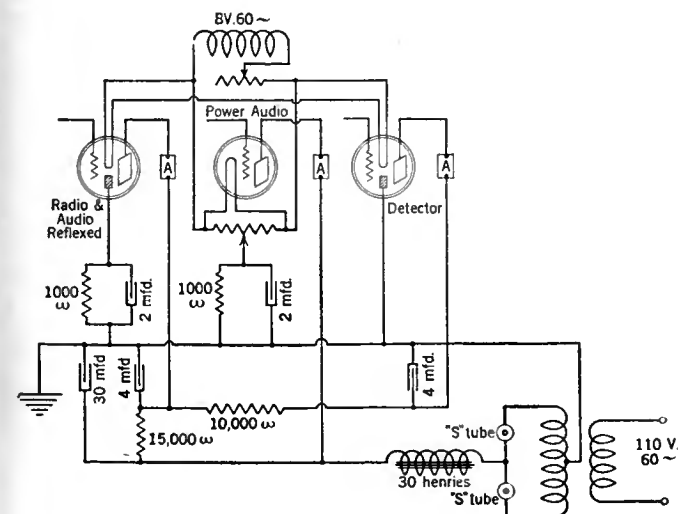

FIG. 13



plate current characteristic at the negative end, and no condenser and leak device is attached to the grid.

#### ALTERNATING CURRENT TUBES

IN ORDER to solve the difficulty, and at the same time obtain a tube with very high amplification properties, Doctor Hull, of Schenectady, discovered a uni-potential cathode keno-pliotron which contains a separate heating element lighted by any current you please, and the cathode is at the same potential all over its surface. The McCullough tubes are built on this principle, and I had exceptionally good results with a pair of such tubes in a three-tube Roberts reflex set operated from a 60-cycle supply, using a power tube for the last audio stage with high plate voltage, as shown in Fig. 13. Unfortunately those tubes are not made with any degree of uniformity, and although their life should be theoretically much longer than thoriated tubes, it may be only one month, after which the emission has been reduced to a useless value, or the heater may burn out in a few weeks. If the McCullough tubes were properly made, they would unquestionably be the tubes of the future, and radio sets would be designed for them on account not only of the complete elimination of the A battery, but for their inherent high amplification with low plate resistance properties.

Another solution to the A battery elimination problem consists in using the same source of rectified current that furnishes the plate potential for the purpose of lighting the filaments. At present, with the 60-milliampere tubes connected in series, the problem is considerably simplified, since the size of filtering inductances may be materially reduced. Care must be taken to shunt every filament, or possibly every pair of tubes, with a certain resistance so proportioned that the plate currents from the following tubes that have to find their way through the series filaments will not increase the filament current of the tubes nearer to the negative pole of the d. c. source. Sets using  $\frac{1}{4}$ -ampere filament current, and operated by rectified a. c., are in existence. I constructed one that is still in operation at a club house after three years of continuous use. This receiver is a neutrodyne with 201-A tubes in series and a rectifier and filter unit containing S tubes and electrolytic condensers.

There are also hybrid sets in which a single dry cell is retained to energize the filament of the detector tube and the two audio-frequency tubes lighted by 60-cycle a. c. A relay, R, operated from either the B voltage supply, or from a. c., closes the circuit of the dry cell, D, through an "Amperite" A, and the filament of a WE-12 detector tube, Fig. 14.

The solution of the B voltage problem is very well known in principle, and the accompanying filters have been described in many publications. It should be emphasized that a B battery source costs a little more when made to supply over 300 volts than for less than 100 volts, and the resultant advantages of the high plate voltage in the last tube have been pointed out before in our discussion of faithfulness of reproduction. The resistances required to lower the plate voltage for

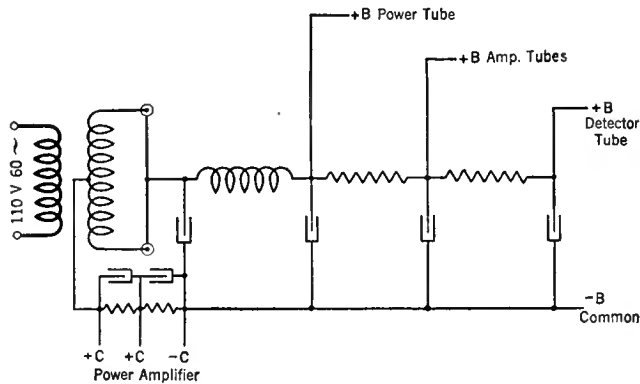

FIG. 15

the other tubes besides the last, and for the detector, fulfill a double rôle, that of voltage reducers and also filter impedances, as shown in Fig. 15. C battery voltage may be obtained from the same equipment as indicated.

[Editor's Note: With the new RCA UX-171 output tube, considerable undistorted power, without the use of high voltages, may be delivered to the loud speaker.]

In connection with some of these sources of rectified a. c., both for plate and for plate and filament power supply, an interesting phenomenon was observed during the early experiments that I conducted along these lines. A neutrodyne with tubes connected in series was supplied from a power unit similar to the one depicted in Fig. 15, using S tubes, two Mershon condensers, and a 25-henry RCA filter coil. By connecting a pair of head telephones with a condenser in series across the d. c. end, there was no sound to be heard, as was expected. Then the unit was made to supply the set, and a loud speaker attached to it, and still no sound or hum came forth from it; but as soon as the three dials of the neutrodyne were tuned to any particular frequency (the same for the three of them), a tremendous roar came from the speaker. This roar was aggravated if the carrier wave happened to be there and the set tuned to it. No amount of filtering would mitigate the racket and, if a separate ground was used for the set and the negative terminal of the power unit, the noise was somewhat diminished. Then, an apparently foolish thing was done; a tuned circuit, consisting of a coil and a condenser in series with it, were inserted in the ground lead that connected the neutrodyne to the radiator and when this contraption was tuned to the same wavelength as the neutrodyne, the roar disappeared just as if the power had been shut off. The case was undoubtedly one of shock excitation, and was proven to be such by operating the set from batteries and then running the power unit without any connection to the set. There was a faint sound like a saw mill the moment the a. c. switch was turned on, but the minute that any lead, even the negative terminal of the power unit, was touched to the negative terminal of the filament battery, the roar started almost as viciously as when the neutrodyne was operated by the power unit.

The rectifying tubes, when they allow the current to start with a rush, as in the case of the S tubes that I had, are equivalent to a rotating spark gap, or to a vibrating contact

interrupter, in their production of severe interference with a radio set.

Another source of power for the operation of the filaments and plate current which has been used very little in receiving sets, yet is commonplace in transmitters, is the motor generator.

#### MOTOR GENERATORS FOR OPERATING RECEIVERS

AS EARLY as 1917 I successfully operated multitube sets by means of motor generators using various types of filters, and with the filaments in series, mainly with the idea of securing an absolute constancy of voltage and current, such as given by a synchronous motor generator set. Here we have many interesting effects produced by grounding or not grounding certain leads, even with perfect filtration of the commutator ripple and with a generator without visible sparking, but it would be rather long and involved to delve into this matter here.

Just let it be said that a well insulated d. c. generator of a very small capacity, with field coils wound in series and with a large condenser across the brushes and another one across the output lead, as shown in Fig. 16, can operate very successfully a Freed-Eisemann receiver without noticeable noise.

When it is desired to energize a set that contains a semi-power tube from a source of direct current, it is not necessary to filter the current that lights the last tube, and a corresponding saving in the size of filter inductances may be effected by letting through them only the filament current of the other tubes connected in series. As a rule, one inductance of more than one henry is enough to filter out the commutation from an average radio set, except where motors with unbalanced armatures happen to be running in the vicinity of the set, which introduce tones of very low frequencies hard to eliminate with a single choke. The resistances that reduce the voltage for the operation of other tubes than the last, when large storage condensers are used, are sufficient to filter the B voltage supply.

A very useful device has appeared lately for the purpose of preventing the B voltage from rising to a dangerous value should any of the tubes go out. It consists of a tube of gaseous content that glows at about 90 volts, and which has the property of maintaining a constant current from a supply unit irrespective of the number of tubes or of the amount of emission in them. It is used in some power units made by the Radio Corporation of America.

As a result of our investigations we find that there is a very strong tendency toward the attainment of a reproduction as faithful as possible to the original, both in quality and volume. Then there is the tendency to simplify the tuning operations compatible with the required degree of selectivity, especially in the congested areas. And, thirdly, the elimination of adjustments and care and attention to the sources of energy to operate the set, using the available forms of power as supplied by the utility companies has received considerable attention. There is also a tendency to dispense with outdoor antennas in congested sections.

This paper by Mr. Aceves is the first of a new series, printed through the courtesy of the Radio Club of America. RADIO BROADCAST is the official publication of that organization and all papers delivered before the Club appear in this magazine. We, of course, do not assume responsibility for controversial statements made by authors of these papers. Readers of RADIO BROADCAST, we are sure, welcome the opportunity to read the papers presented by the Radio Club and we are very glad to have the opportunity to publish them regularly. Others will appear in early numbers of the magazine.

# B-POWER

By  
JONAS B. JUDD



Most people have an idea in the back of their heads that they would like to be one of those high-salaried advertising writers. It must be a pretty easy way to make a living, so they think, to sit back in a swivel chair and conjure up high-sounding phrases that will lure the unwary reader into a purchase.

Who could not, for example, write a few paragraphs in the following style:

*"Until you have sunk deep in the luxurious upholstery of the beautiful Overford car you will never know what riding comfort is. Over cobblestones, ruts, railway crossings or smooth boulevard, it's all the same to this marvelous Norge of the road. A touch at the throttle and you are away like a captive bird released; a touch at the brake and motion ceases as abruptly as the end of a song. Overford spells the best of beauty and the pinnacle of power in automobiles."*

Alas, gentle reader, much as we dislike to disillusion you, the particular chair which we happen to occupy is of the dining room, rather than the swivel variety, and instead of soaring through the clouds in search of superlatives we have strict orders to keep our feet planted firmly on the ground.

## *Mr. Judd Wins Disapproval*

Only last week we submitted a piece of copy on B-power units that had what the English would call "swank," not exaggerative frills you understand, and yet it did have that atmosphere of superiority which made competitors look like

ADVERTISEMENT

## RAYTHEON for Reliable Reception

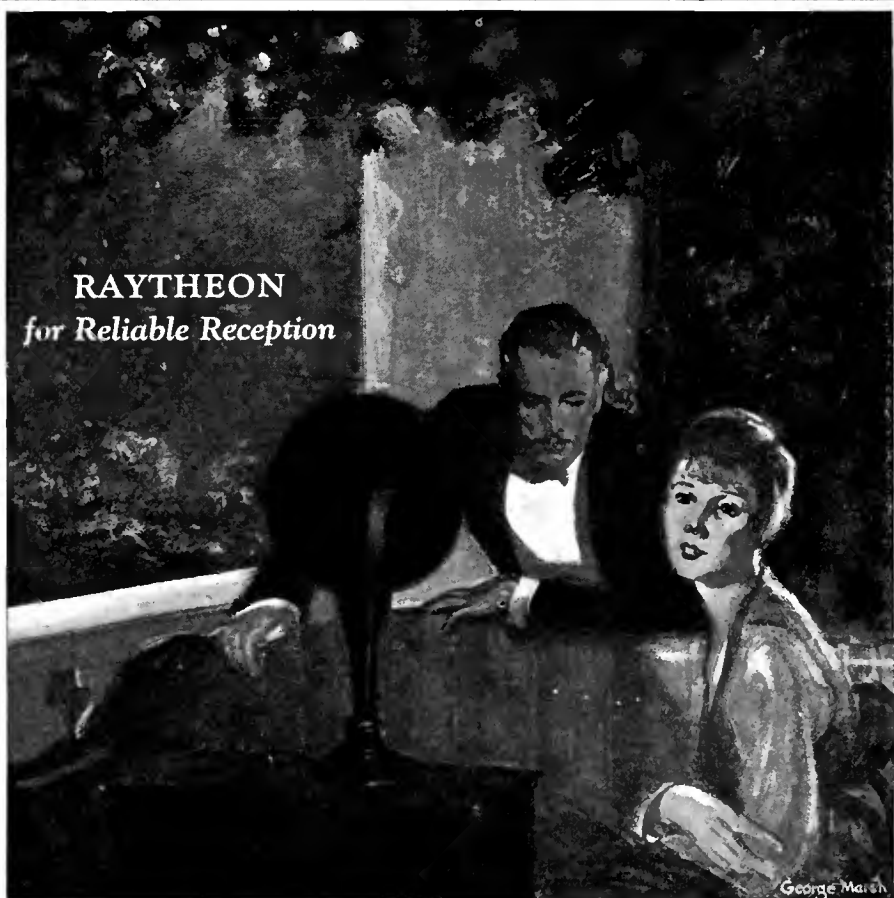

YOUR receiver, whether it is an old model or the very latest type, can be improved by the installation of a high quality B-Power unit.

Everyone realizes the advantage of reliable B-Power, but few have the facilities or the time to select the right B-Power unit from the scores that are now offered.

The Raytheon Laboratories have simplified the choice. By selecting and approving only those that pass certain minimum requirements, we have made it possible for the radio owner to select his unit from a few good ones, rather than from a hundred of doubtful value.

Raytheon B-Power units are now made in a variety of styles that satisfy the needs of every receiver, and meet the approval of every pocketbook. Your dealer will recommend a Raytheon B-Power unit best suited to your needs. Raytheon spells reliable reception.

The B-Power unit is a non-filament rectifier of ample capacity to eliminate B-batteries on even the largest tube set.

Raytheon B-Power units are manufactured by Companies selected for their excellent engineering and production facilities.

# RAYTHEON

RAYTHEON MANUFACTURING COMPANY

CAMBRIDGE, MASSACHUSETTS



# RAYTHEON



*"A Better Condenser"*

A constantly increasing number of the discriminating American Radio Public call a filter condenser a "TOBE." They have learned—as we have known—that the "TOBE" is "the better condenser."

When you build your improved Raytheon plate-supply unit, ask your dealer for the "TOBE" B Block, containing in one unit all the required capacities and at a saving of \$2.50 over the cost of separate condensers. And Raytheon recommends "TOBES" as unsurpassed by any for use in Raytheon circuits.



**Tobe Deutschmann Co.**  
CORNHILL BOSTON, MASS.

poor second-raters. But did it win that warm welcome of approval that we anticipated? Not a bit of it. Instead, we heard something along the following lines from the boss, whom we'll call Mr. Raytheon for fun:

"Now see here, Mr. Judd, the July issue of 'Broadcast' closes on the 18th, and here you have spent two thousand words trying to 'paint the lily.' Don't say so many nice things about us and we'll like you better."

Of course we were quick to remonstrate that we hadn't said a thing that wasn't absolutely true and that the Raytheon B-power unit on our radio at home would prove that the results were in accordance with the description as written.

"Quite so, quite so," was the response from Mr. Raytheon. "But you simply must use more restraint, otherwise the public will think it a little too good to be true. Take this piece of copy, for example"—(Here a proof of the advertisement which accompanies this article was produced.) "Now that *is* conservative. But we figure that if we can get a fellow to talk it over with his dealer, or take one of the units home to try, we don't need to say another word."

*He Tries Another Approach*

Now you can see what a handicap we writers are under. Not only are we prevented from giving play to our imaginations, but we are re-proved for writing the facts as we see them.

Undaunted by this gentle rebuff your humble correspondent, Mr. Jonas B. Judd, again took pen in hand. This time it was with a determined set of the jaw that signified the will to win, for now we would fortify our column with

ADVERTISEMENT

**GENERAL RADIO**

Type 365  
Rectifier  
Transformer  
Price \$10



Type 366  
Filter Choke  
Price \$10



Modernize your Radio Set—  
Build a Practical "B" Eliminator

The popular topic of discussion among radio experimenters today is "B battery Elimination." Constant worry whether the "B's" are run down—and their continual replacement will soon be a thing of the past in radio. A "B" Eliminator never runs down and never has to be replaced.

For a dependable plate supply unit which requires absolutely no attention other than its original installation, build a "B" Eliminator of General Radio parts.

Write today for full data on General Radio Rectifier Transformers and Filter Chokes, and get our circular with full instructions for building a Practical "B" Eliminator.

**GENERAL RADIO CO.** Cambridge 39, Mass.

**MODERN "B" Power Unit**

*It's Better Because It's Modern*

**THE** Modern "B" Power Unit is a perfected unit behind which is our unconditional guarantee of satisfaction.



Patent Pending

It is an electrically correct unit. Into it has been built every element that makes for practicability. It can supply 150 volts, thereby permitting the use of big power tubes. A variable amplifier control allows the use of any intermediate voltage as in the case of Super-Heterodyne and other types of receivers requiring more than one amplifier voltage.

The Unit is moisture proof and is tested for 2500 volts between input and output in order to eliminate all fire hazard.

**MODERN ELECTRIC MFG. CO.** ★ Toledo, Ohio

**RAYTHEON**

★ Tested and approved by RADIO BROADCAST ★

facts which every reader knew, at least if he did not know them he would check their accuracy by some simple calculations based on his own experience.

The more we thought about this new attack the better we liked it. What is so convincing as a re-statement in print of the things we already know and have told the wife? If Arthur Brisbane and Dr. Frank Crane could hold the front page by stating the obvious about life, certainly we could score a bull's eye by pointing out some facts pertaining to B-eliminators.

*Thinking It Over*

This is real sport. One of the best things about it is that in speaking of these rather important facts we can refer to authorities—and we always feel easier at mind when we can find someone else to rather hold us up. You see, we have been reading some radio books—big thick ones—containing a lot of big equations and peculiar looking signs. We hadn't the least idea what they meant but we were right at home when we came across a statement that read to the effect that one of the commonest points, at which amplifier noises originate, is the "B" supply. For we have been using, for quite a while, a B eliminator with a Raytheon tube, and we have never heard any of these noises.

These radio engineers must be an intelligent lot for here is another interesting statement from our "authority." He says that if the "B" voltage decreases to any considerable extent, the quality will be impaired. Now that we think of it, we can remember several occasions when this happened—before we began using a "B" eliminator. And it would have been terrible if it had occurred on some occasion

ADVERTISEMENT



# Micamold

REG.

## Raytheon Standard

### "B" ELIMINATOR RESISTORS

Moulded in Bakelite under pressure of 50 tons



Build your Eliminator with Micamold "B" Power Resistors for constant dependable service under all conditions. The unusually large radiating surface of these resistors gives the highest power rating of any fixed resistor now employed for "B" Battery Eliminators. They are adopted as Standard by the Raytheon Manufacturing Company and are used exclusively by those desiring uninterrupted service.

Price at Dealers or by Mail \$1.00 each

### MICAMOLD RADIO CORPORATION

Flushing and Porter Avenues BROOKLYN, N. Y.

# CLAROSTAT

## O.K.'d by RAYTHEON—

because CLAROSTAT passed with flying colors the most searching tests Raytheon had ever given a variable resistance. CLAROSTAT has no equal for voltage control in "B" Battery Eliminators. Only CLAROSTAT gives you a wide range of control and a current carrying capacity greater than that of any other variable resistor.

*P. S. A host of other nationally known eliminator makers have also approved and endorsed Clarostat*

*If your dealer cannot supply you, write direct*

### AMERICAN MECHANICAL LABS. INC.

285-287 North Sixth St., Brooklyn, N. Y.

Special Types for "A" and "B" Battery Eliminators for Manufacturers



★  
\$2.25

*Raytheon B-eliminator is the first "B" plate supply unit Thordarson has approved. Even on the modern all-frequency amplifiers it operates without hum, when built with the specially designed*

# THORDARSON

## "Raytheon-type" Transformers and Chokes

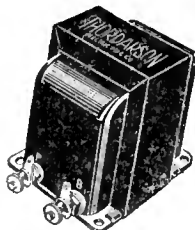
Transformer R-195 Larger in capacity—Will not heat up in continuous service. Separable plug, 6 foot cord attached. Unconditionally guaranteed. Price, at dealers, or by mail, \$7.00.

Choke R-196 Completely shielded and mounted in large steel case. Binding posts at base for neat assembly. Capacity 60 milliamperes. Unconditionally guaranteed. Price, at dealers, or by mail, \$5.00.

*Write for Hook-up Bulletin*

### THORDARSON ELECTRIC MANUFACTURING CO.

*Transformer specialists since 1895*  
**WORLD'S OLDEST AND LARGEST EXCLUSIVE TRANSFORMER MAKERS**  
 Chicago, U.S.A.

★

# RAYTHEON

**W-B-3** Two Voltages—  
Detector and Amplifier - \$47.50  
One variable resistance

**W-B-4** Three Voltages with  
power tube tap - 50.00  
Two variable resistances

**WB-Z** Special—Single adjust-  
ment extra high voltage - 50.00

**W-B-D** For 110-125 D. C.—  
Three Voltages - 25.00

Prices slightly higher in Canada and  
West of the Rockies



Compact—4 1/2" high, 4 1/2" wide  
10" long—overall

# ★ Webster SUPER-B

(With the Raytheon Tube)

The "B" that Improves any Receiver

**G**ETS 25% to 50% more volume and better tone quality on distant stations as well as locals. Brings in stations never before logged. All parts properly balanced in new Webster filter circuit—an improvement, particularly noticeable in super-power receivers.

It supplies steady, noiseless flow of plate current and thereby clarifies signals and builds up volume. It forever eliminates noises from run down "B" batteries and the expense of replacing them. It reduces cost of operating set to minimum. Just connect it to light socket and it keeps your "B" power always ready at full efficiency—costs less than 1/10 of a cent per hour.

Model W-B has two variable resistances—one for varying detector supply from 5 to 100 volts and the other for varying the intermediate amplifier supply from 20 to 135 volts—with a power tube tap delivering up to 180 volts. This model delivers up to 60 milliamperes at 135 volts. It is adjustable to any set and essential for those using power tube in last audio stage. Model WB-Z is special for receivers requiring more than 50 milliamperes at 135 volts or more. Write us today for full information and Free booklet, "Improving Your Radio."

THE WEBSTER COMPANY

3506 West Lake Street

Chicago, Ill.



## New B-Power Unit (Transformer and Chokes)

The latest advancement in the elimination of the B-Batteries. Used with standard Raytheon Type B Full Wave Rectifying Tube the new Dongan B-Power Unit furnishes the most efficient B-Power ever devised and at a new low cost.

Order from your dealer or send money order to factory. Set manufacturers: Dongan specializes on mounted and unmounted transformers and chokes for B-Eliminators.

Transformer and Chokes for NEW RAYTHEON BH TUBES now ready. Write for data ls.

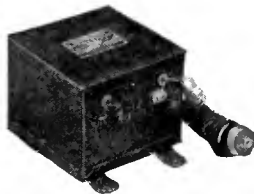

Specification 1582  
For Standard Raytheon  
Tube  
\$11.00 List ★

DONGAN ELECTRIC MANUFACTURING CO.

2991-3001 Franklin Street

Detroit, Mich.

TRANSFORMERS of MERIT for FIFTEEN YEARS



## Whatever Power Supply Unit You Build there are Potter Filter Condensers Made for It

It is absolutely necessary to have the best condensers to have good results with either your "A" or "B" Supply Unit. Potter Condensers meet every requirement—they are made with the best foil, best insulation, best impregnating compounds obtainable. They remove all traces of A. C. impulses, eliminating all hum. In many

tests they have proved their exceptionally long life under hard continuous usage.

Made in three types—A, B, and C, tested 300, 500 and 1000 volts D. C. respectively. Each type comes in all capacities. Special models for Raytheon "B" Eliminator, Raytheon Power Pack, etc.

At your dealers  
or write direct  
to us

**Potter** ★  
FILTER  
**Condensers**

An  
American-made  
Product

POTTER MANUFACTURING CO., NORTH CHICAGO, ILL.

when Alexander Wollcott or Deems Taylor had just stopped in for a chat. (Neither of these gentlemen ever visited me, but I always live in hope that some day they will). But now, they can come around any time, for with a good "B" eliminator, my troubles with plate supply are over, forever.

One of my philosophically inclined friends was very much interested in my "B" eliminator. "It's really wonderful," he said, and taking on a philosophical air, he continued. "It is so silent! Yet it ceaselessly supplies your receiver with the essential electricity which is itself a silent, yet powerful, manifestation of nature." This was almost too much for me and I could only stare at him. I had never thought of my "B" eliminator in just that way. However, I suppose what he said, was true enough. You see, I had always considered the practical side of the thing. Yet, it does seem rather remarkable, that one tube is developed to receive radio signals, and that then, another tube, the Raytheon, is developed to supply them with plate current.

Did we refer to the quick-stopping qualities of that remarkable Overford car? Something about the end of a song, wasn't it? Well, it must have been one of those slow and never-ending "Forty-nine Bottles Hanging on a Wall" songs compared with the speed to which Mr. Judd's little joy ride of self-approval was brought to a stop. "Blank, blank-blank," was the aforesaid Mr. Raytheon's first comment. "Haven't you woke up enough to know that B-power units have arrived, and that they are not competing with batteries? People don't want to hear any more about battery troubles, besides Raytheon B-power units are in an absolutely

ADVERTISEMENT

# RAYTHEON



different performance class, and B-batteries are necessary for homes that aren't wired anyway!"

So there you are. Now do you blame us for being angry? Just when we were about to make a name for ourselves in the last of the articles in this series we get tramped on like that. But we are going to get even, and the time is now, and the place is here.

*Revenge Is Sweet*

These B-power units aren't just all they are cracked up to be. We know because we're on the inside and we see some of the letters that come in. They hum! Yes sir, they do it almost every time, if your set isn't grounded. That means you have to connect a ground wire if you haven't already got one.

Another thing—some of them won't work at all with a Raytheon tube. We know a fellow who has had one for two years and at least a dozen filament tubes would work (they did for a while anyway) but when he put in a Raytheon tube instead he couldn't get a sound! Apparently the unit has to be designed for Raytheon.

As for the voltage output—the less said about it the better. The excuse as I get it is that the average voltmeter won't read the actual operating voltage because it draws so much current. But if a voltmeter draws more current than a radio set why doesn't it say so on the meter? We never did see a voltmeter label which read, "O. K. for use on power lines but not on B-power units."

Yes, they have their drawbacks, as you can see. But we will say this for them—if you want real quality reception you need lots of power, and that usually means a good Raytheon B-power unit.

ADVERTISEMENT

# Improve Your Radio Reception this Summer!



Use a Majestic "B" Current Supply in place of the ordinary "B" batteries. It attaches to your lighting circuit and is easily adjusted to the voltage desired for your particular set. It gives you a constant, dependable, and uniform power (Voltage does not drop with use) and brings in full tonal strength yet with ample filtering capacity to eliminate all A-C hum, thus allowing you to operate your set at its highest efficiency. Current costs average 1-10 cent per hour.

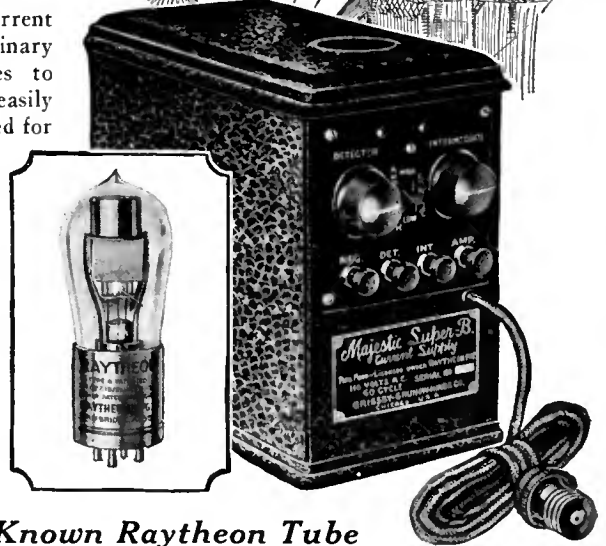

**Uses Nationally Known Raytheon Tube**

All Majestic B Current Supply Units are equipped with the Raytheon tube (endorsed by numerous radio engineers and editors) which is a non-filament tube with full wave rectification, no liquids or back surge.

**No Acids Used**

The use of acid is objectionable because of the possibility of damage to furnishings and the corrosive action makes periodical replacement of the elements necessary.

**Try a Majestic B Current Supply at Our Risk**

Go to the dealer from whom you bought your set or any other reliable dealer and get a Majestic B, and attach to your set. We want you to judge for yourself. If you are not convinced that it improves your set—that it is the most satisfactory as well as most economical unit you have ever owned after a week's use, return it and your money will be cheerfully refunded. *Every Majestic is positively guaranteed for one year.* It is the most remarkable improvement yet made in Radio reception.

**List Prices**

- Majestic Super B Current Supply complete with Raytheon Tube capacity 1 to 12 tubes including the use of new 135-150 volt power tubes. Price ..... \$39.50
- West of Rocky Mts. .... \$42.50
- Majestic Standard B complete with Raytheon Tube, a smaller unit designed for sets having not more than six 201-A-type tubes of five 201-A, plus one 135-150 volt power tube. Price ..... \$32.50
- West of Rocky Mts. .... \$35.00

Operates on 100-120 volt-60 cycle alternating current.

**GRIGSBY-GRUNOW-HINDS CO.** ★

4540 Armitage Ave.

Chicago, Illinois

# RAYTHEON

# The Radio Broadcast LABORATORY INFORMATION SHEETS

**I**NQUIRIES sent to the Questions and Answers department of RADIO BROADCAST have until recently been answered either by letter or in "The Grid." The latter department has now been discontinued and all questions addressed to our technical service department are now answered by mail. In place of "The Grid," we present herewith a series of Laboratory Information Sheets. These sheets contain much the same type of information as has appeared in "The Grid," but we believe that the change in the method of presentation and the wider scope of the information in the sheets, will make this section of RADIO BROADCAST of much greater interest to our readers.

The Laboratory Information Sheets cover a wide range of information of value to the experimenter, and they are so arranged that they may be cut from the magazine and preserved for constant reference. We suggest that the series of Sheets appearing in each issue be cut out with a razor blade and pasted on filing cards, or in a note book. The cards should be arranged in numerical order. Several times during the year, an index to all sheets previously printed will appear in this department.

Those who wish to avail themselves of the service formerly supplied by "The Grid," are referred to page 270 where it is explained in detail. The June RADIO BROADCAST, in which appeared the first series of Sheets, may still be obtained from the Subscription Department of Doubleday, Page & Company.



## Bradleyunit PERFECT FIXED RESISTOR

**R**ADIO circuits frequently call for a fixed resistance unit. This is particularly true for B-battery eliminators which provide several B-battery voltage taps for the radio set.

Be sure to use Bradleyunits for this service, because Bradleyunits are solid molded fixed resistors calibrated with great accuracy and fitted with silver-plated terminal caps which can be soldered without damage to units. These units are made in more than 20 different ratings, and will not deteriorate with age.

For experimenters who prefer to build their own resistance-coupled amplifiers, a special set of Bradleyunits has been prepared and sold in a convenient carton ready for use in a resistance-coupled amplifier.

Be sure to order Bradleyunit Amplifier Resistors from your dealer, today.



ALLEN-BRADLEY COMPANY  
278 Greenfield Ave., Milwaukee, Wis.

Please send me your latest literature on Bradleyunits and Bradleyunit Amplifier Resistors.

Name .....

Address .....

No. 9

RADIO BROADCAST Laboratory Information Sheet

July, 1926

### Data on the Roberts Four-Tube Receiver

#### COIL DETAILS, ETC.

**O**N SHEET NO. 10 is shown a diagram of the popular four-tube Roberts receiver. It is quite an easy matter to wind coils for this receiver, and there are given below complete data regarding their construction.

- L<sub>1</sub> = 40 turns No. 22 d.c.c. wire wound on a 3" cylindrical form. The coil is to be tapped at every 10 turns.
- L<sub>2</sub> = 45 turns No. 22 d.c.c. wire wound alongside L<sub>1</sub> on the same form. The spacing between L<sub>1</sub> and L<sub>2</sub> should be a quarter of an inch.
- L<sub>3</sub>, L<sub>4</sub> = 40 turn bunch-wound coil of No. 26 d.c.c. wire tapped at the center and wound over the filament end of the secondary winding, L<sub>5</sub>.
- L<sub>5</sub> = 45 turns No. 22 d.c.c. wire on a 3" form.
- L<sub>6</sub> = Tickler, 20 turns No. 26 d.c.c. wire wound on a 1 1/2" cylindrical form and mounted at the grid end of the secondary winding, L<sub>5</sub>.

Besides the coils, it is necessary to have the following additional apparatus in order to construct the receiver.

- T<sub>1</sub> Audio transformer; ratio about 4:1.
- T<sub>2</sub> Input push-pull transformer.
- T<sub>3</sub> Output push-pull transformer.
- C<sub>1</sub> Variable condenser 0.0005-mfd. capacity.
- C<sub>2</sub> Variable condenser 0.0005-mfd. capacity.
- C<sub>3</sub> 0.0025-mfd. fixed condenser.
- C<sub>4</sub> 0.005-mfd. fixed condenser.

- C<sub>5</sub> Midget variable condenser.
- V<sub>1</sub> 41-volt C battery.
- V<sub>2</sub> 9-volt C battery.
- J<sub>1</sub> Double-circuit jack.
- J<sub>2</sub> Single-circuit jack.
- R<sub>1</sub> 10-ohm rheostat
- R<sub>2</sub> 10-ohm rheostat
- R<sub>3</sub> 10-ohm rheostat
- G Grid leak and condenser, 0.00025-mfd. condenser and a 4-megohm grid leak.

After the receiver has been completely built, it should be neutralized. The following method of doing this will, in general, be found the simplest. First, tune in some local station that is broadcasting with a frequency of about 1000 kc. (300 meters). Advance the tickler until the detector begins to oscillate. Now, by varying the setting of the first condenser, it will be found that the pitch of the whistle will change. The variation of the pitch of the whistle is due to the fact that the radio frequency stage is oscillating and heterodynes the oscillations in the detector stage. When the receiver is properly neutralized, oscillations will not take place in the radio frequency amplifier, and the pitch of the whistle will not change. The problem is, therefore, to so adjust the neutralizing condenser as to bring about this condition. When the receiver is properly neutralized, the tuning of the first condenser will have no effect on the tuning of the second condenser.

No. 10

RADIO BROADCAST Laboratory Information Sheet

July, 1926

### The Four-Tube Roberts Circuit

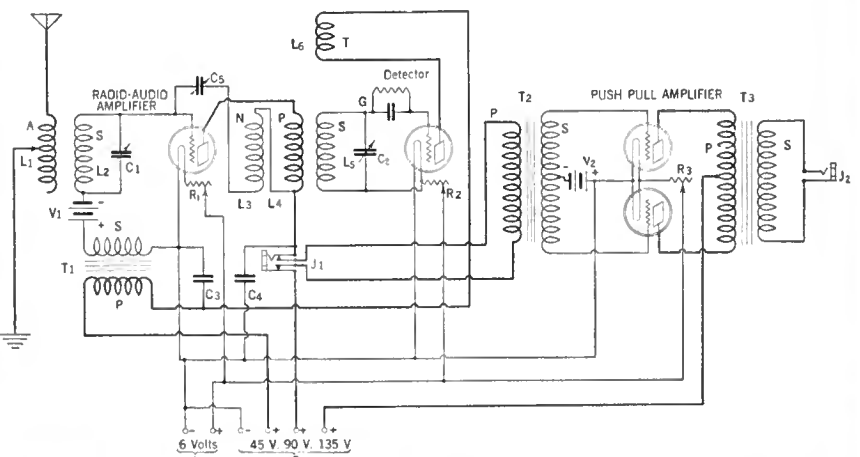

Complete data on the sizes of the various units used in this circuit appear on sheet No. 9



# Better now for \$9<sup>75</sup> than it was in 1920 for \$85

Recall that in 1920 a one-tube radio sold for \$85. Today Crosley makes a better one for \$9.75 (The Crosley Pup). There's the picture of Crosley manufacturing genius.

This year will see the millionth Crosley radio set produced. And somewhere, the first hundred still bring joy and satisfaction to their owners. Only this winter, one of Crosley's early one-tube radios won a nationwide radio reception contest, in which one-tube sets of all makes and dates were entered.

Powel Crosley, Jr., has so improved tuned radio frequency circuits in the present Crosley sets, that experts the country

over have grown wildly enthusiastic over their performance.

"The first set to beat my pet——", says one fan. "The only set I have ever seen that would tune out our local station in our building", writes another. "How can Crosley do it for the money!" is one exclamation, typical of hundreds of letters.

These new Crosley sets are truly wonderful for they not only represent a tremendous forward step in radio development, but are offered for even less than the closing-out prices of questionable and obsolete sets.

See and hear the new Crosley sets at your nearby Crosley dealer's.

Prices slightly higher west of the Rockies—For descriptive catalog write Dept. 20

THE CROSLEY RADIO CORPORATION, CINCINNATI, OHIO

Powel Crosley, Jr., President

Owning and Operating WLW, first remote control super-power broadcasting station in America

# CROSLEY RADIO

*Better - Costs Less*

Manufactured under Armstrong U. S. Patent No. 1,113,149, or under patent application of Radio Frequency Laboratories, Inc.



Mass manufacturing operations on the million scale has so saved pennies in production that the public sees them reflected in dollars saved on the retail prices of Crosley radios. One great example of this is the Crosley Musicone. Its success created so great a demand that a saving to the public of \$2.75 was soon effected through increased production. Today it is the fastest moving item in radio—its quality of reproduction and its low price is inducing the rapidity by which it is replacing thousands of other type speakers.

ASK . . ANY . . RADIO . . ENGINEER

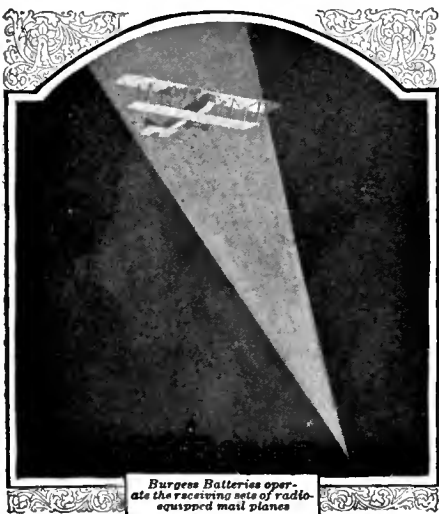

Burgess Batteries operate the receiving sets of radio-equipped mail planes

## An every-night adventure of Burgess Radio Batteries

ONE of the reasons why you should always buy Burgess Radio Batteries is that the batteries used by air-mail pilots—battleships—explorers—and the majority of recognized radio engineers—are evolved in the Burgess Laboratories and manufactured in the Burgess factory.

These batteries are identical with the batteries sold by your dealer and thousands of other good dealers everywhere.

### BURGESS BATTERY COMPANY

GENERAL SALES OFFICE: CHICAGO

Canadian Factories and Offices:  
Niagara Falls and Winnipeg

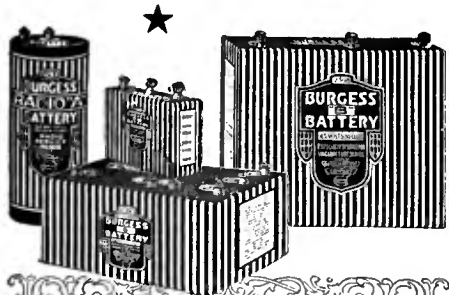

**BURGESS**  
RADIO  
BATTERIES

No. 11

RADIO BROADCAST Laboratory Information Sheet

July, 1926

### The UX-200-A Tube

A STABLE SOFT DETECTOR TUBE

A NEW detector tube, manufactured by the Radio Corporation of America, has recently been placed on the market. It is called the UX-200-A, and insofar as its operation is concerned, it is similar to the old UV-200, since its efficiency as a detector depends upon the presence of a gas in the tube. The major difference in appearance between this new tube and the UX-201-A, is the absence of the silver coating on the bulb. The UX-200-A has a bluish smoky color due to the special gas content. The characteristics of this new tube, as given by the manufacturers, are as follows:

|                  |                           |
|------------------|---------------------------|
| Design           | Same as standard UX-201-A |
| Base             | Same as standard UX-201-A |
| Filament Voltage | 5 Volts                   |
| Filament Current | 0.25 Amperes              |
| Plate Voltage    | 45 Volts Maximum          |
| Plate Current    | 2.0 Milliampere           |
| Plate Impedance  | 28,000 Ohms               |
| Grid Leak        | 2.0 Megohms               |
| Grid Condenser   | 0.00025 Microfarad        |

It might be of interest if the action of a gas-filled detector tube is reviewed, and an attempt made to show why such a tube can be made very sensitive for detecting signals.

The gas contained in the tube is composed of innumerable atoms, each of which consists of a nucleus surrounded by electrons, which are negatively charged. Normally, the positive charge on

the nucleus exactly equals the negative charges on the electrons, and the atom is in a stable condition. When the filament is heated, it emits a great many electrons which are projected from its surface at very high speed. As they pass through the space between the filament and the plate, they frequently collide with some of the gas atoms, disrupting them and causing one or more of the negative electrons to be torn away from the atom, leaving what is called an ion, which is an atom that has lost one or more of its negative electrons. As soon as the negative electron is separated from its atom, it moves toward the positively charged plate with the other electrons emitted from the filament, and the plate current is thereby increased. Now, this breaking down of the atoms is called ionization, and it usually occurs at some particular value of grid and plate voltage. At the point of ionization, large changes in plate current occur with only small changes in grid potential, and if the tube can be operated at this point on the plate current curve, it will be very sensitive. In the old style UV-200 tube, the various voltages required very accurate adjustment in order to make the tube operate at the critical point of the characteristic, and this fact more or less detracted from its increased sensitivity. With a UX-201-A tube, however, very stable operation can be obtained over a wide range of voltages. As with the UV-200, operation of the UX-200-A is accompanied by a slight hiss, not unlike escaping steam, but it is not sufficiently loud to become bothersome.

No. 12

RADIO BROADCAST Laboratory Information Sheet

July, 1926

### The UX-171 Tube

THESE data on the new UX-171 tube show the important constants for this tube under various operating conditions. It is designed to handle relatively large amounts of input voltage and to deliver, with a low plate voltage, relatively large amounts of undistorted power. The table below shows the amount of power that can be delivered by the UX-171 under various input voltage conditions. This new tube will provide undistorted power

handle the input with 135 volts on the plate. Its power output under the above input conditions will be below that of the UX-210. As a matter of fact, the UX-210 will deliver 1.08 watts while the UX-171 will deliver .3 watts under these conditions. This latter figure, however, is more than sufficient for all normal conditions.

It must be remembered that greater input voltages are required to secure greater output power.

|                        |                |                |                |                |
|------------------------|----------------|----------------|----------------|----------------|
| Filament current       | .5 amp         | .5 amp.        | .5 amp.        | .5 amp.        |
| Plate current          | 13.4 mils.     | 16.5 mils.     | 20 mils.       | 21.5 mils.     |
| Plate impedance        | 2200 ohms      | 2200 ohms      | 2250 ohms      | 2325 ohms      |
| Amplification constant | 2.65           | 2.65           | 2.65           | 2.7            |
| Mutual Conductance     | 1200 micromhos | 1200 micromhos | 1180 micromhos | 1163 micromhos |
| Plate voltage          | 90             | 135            | 157.5          | 180            |
| Grid voltage           | -16.5          | -27            | -33            | -40.5          |
| Power output in watts  | .1             | .3             | .486           | .64            |

to a loud speaker in considerable volume without the use of high plate voltages. It is to be compared with the UX-112 and the UX-210 tubes. The UX-112 requires 135 volts plate battery to handle input voltages of 9 volts, and under these conditions will deliver a maximum of .12 watts of undistorted power. The UX-171, however, with only 90 volts on the plate, will handle input voltages up to 16.5, and will deliver approximately the same amount of power to a loud speaker.

With input voltages of 27, the UX-210 requires a plate battery of 350 volts, while the UX-171 will

There are few radio receivers that will deliver 27 volts to the grid of the last amplifier tube without more amplification (an additional stage), and without taking care of overloading all along the line of low frequency amplification.

The low impedance, 2000 ohms, of this tube, recommends it for use in high quality amplifiers. This is considerably below the impedance of loud speakers now on the market, which will tend to bring up the low notes. For these reasons, it will be wise to use an output transformer, as the manufacturer's circular recommends.

No. 13

RADIO BROADCAST Laboratory Information Sheet

July, 1926

### Charging Storage Batteries on Direct Current

NECESSARY RESISTANCES, ETC.

IF ONE has a convenient source of direct current, it is a comparatively simple matter to charge storage batteries. Although such charging will necessarily be done rather wastefully, it will nevertheless be cheaper and much more convenient than having it done at a charging station.

The charging may be accomplished by either of the two methods illustrated in the diagram. In A, the charging rate is determined by the value of the resistance R. Most of the power companies supply 110 to 120 volts, and for this line voltage, the following values of resistance should be used. The values are approximate and based on an average voltage of about 115.

| CHARGING RATE | RESISTANCE | POWER DISSIPATED IN RESISTANCE |
|---------------|------------|--------------------------------|
| 1 Amp.        | 110 Ohms   | 110 Watts                      |
| 2 Amps.       | 55 "       | 220 "                          |
| 3 "           | 37 "       | 330 "                          |
| 4 "           | 28 "       | 440 "                          |
| 5 "           | 22 "       | 550 "                          |

The last column is given so that if a resistance unit is purchased care can be taken in choosing one that is capable of dissipating the power given in the table.

In place of the resistance units we can substitute a bank of electric lights as is illustrated at L, in B. The charging rate will be determined by the total wattage of the entire bank of lamps, and this total will equal the sum of the individual wattages of the lamps. If five 40-watt lamps are used, the total

will be 200 watts. If the bank consisted of one 40-watt lamp, one 150-watt lamp, and one 60-watt lamp, the total would be 40+150+60=250 watts. By reference to the table, the total power (wattage) required, for any value of charging rate, can be found in the last column.

There are several precautions to be taken. In the first place, be sure to connect the positive side of the line to the positive side of the battery.

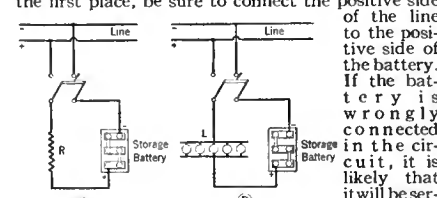

If the battery is wrongly connected in the circuit, it is likely that it will be seriously damaged. Secondly, be sure that none of the leads touch any metal surfaces, such as water pipes, for if this occurred a short-circuit might result. Thirdly, be certain that the charging rate is not too high. Information regarding this is generally given on the name plate of the battery. However, if this information is lacking, the charging rate should be determined by the heating of the electrolyte. As the battery charges, the temperature of the solution gradually increases, and no damage will result if the temperature is not allowed to exceed 110 degrees Fahrenheit.

# Popular Preference

*established through years of*

# Unfailing Service

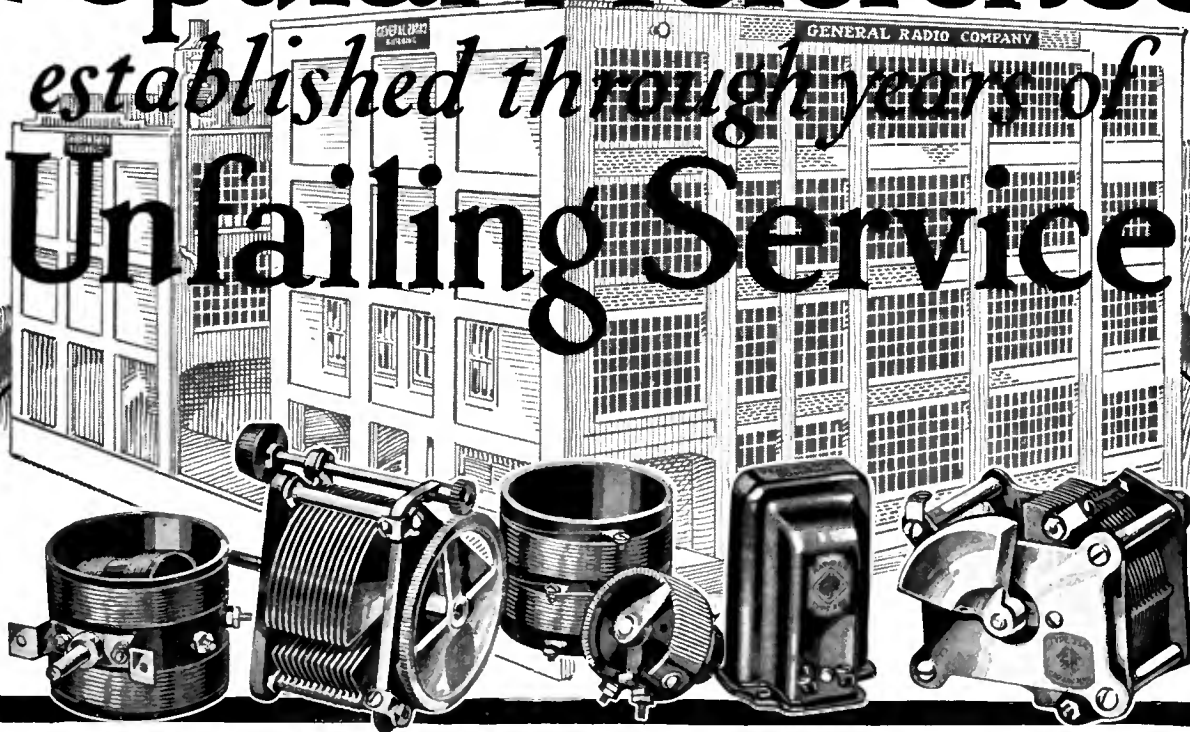

"By ye deeds shall ye be known," is an old yet significant proverb that applies to industry as well as to the individual. It is but natural that a pioneer organization which has pursued a steadfast policy of integrity should be the present day leader in its particular field of endeavor.

The General Radio Company has attained its position as the outstanding manufacturer of radio parts and laboratory instruments through the recognized merits of its products.

Since the early days of radio, amateur operators and set-builders have looked upon the General Radio Company as a time-tried producer of dependable apparatus.

The careful and conservative buyer of radio parts looks first to the reputation of the

manufacturer. He knows from his own experiences and those of others whether this reputation warrants his confidence. It is this self-same confidence upon which the popular preference for General Radio parts is based.

All products of the General Radio Company whether for the scientist or set-builder embody the same outstanding craftsmanship and materials in their construction.

As a consequence the General Radio Company has gained the esteem and confidence of amateur operators and experimenters—an enthusiastic group who are thoroughly familiar with the technique of radio design and to whom the science of radio owes much of its rapid advancement.

You will invariably find General Radio parts "behind the panels of better built sets."

To-day General Radio precision instruments are standard equipment in nearly all the commercial and technical school laboratories throughout this and many foreign countries.

Every instrument made by the General Radio Company is thoroughly guaranteed.

WRITE FOR PARTS CATALOG 924-B

★  
GENERAL RADIO Co. CAMBRIDGE 39, MASS.

# GENERAL RADIO

*Behind the Panels of Better Built Sets*

# PARTS



# WHY SNUBBERS?

Did you ever ride in an automobile without shock absorbers or snubbers? If so, you know what happened when you hit a bump.

The better the springs, the longer the up and down vibrations continued—hard on the rider and hard on the car.

That's why automobiles require snubbers to damp out spring vibrations—

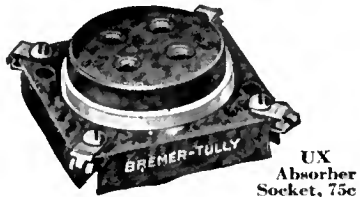

—and that's why B-T UX sockets are designed to absorb vibrations as well as shocks.

The new B-T socket is the result of years of intensive study of the problem of protecting the vital, delicate tube elements—it absorbs the shocks that cause damage to the tube and stops the vibrations that ruin reception.

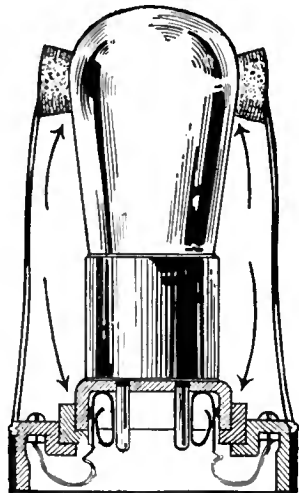

UX Detector Socket. \$1.00

The Detector Type carries double absorbers—top and bottom—its efficacy has been proved by our year's experience with the B-T Silent Socket (still in use with Universal Base, \$1.25).

The spring contacts of the new UX are noteworthy—and show typical B-T efficiency. Long contact surface—soft and yielding to prevent side strain—with continuous flexible leads.

**YOUR TUBES MUST HAVE PROTECTION  
USE B-T SOCKETS IF YOU BUILD —  
INSIST ON B-T SOCKETS IF YOU BUY**



**WATCH the B-T Line and Profit**  
Authorized dealers are now being franchised on the new Counter-phase Seven—when you hear the story you'll understand the rush. ★

**BREMER-TULLY MFG. CO.**  
532 South Canal Street Chicago, Ill.

## No. 14

RADIO BROADCAST Laboratory Information Sheet

July, 1926

### A Batteries

#### THE DRY TYPE

FOR the majority of receivers using type 199 tubes, a bank of dry cells can be used to supply the filament current. For portable sets such an arrangement is very convenient, and although, in general, the operation of these tubes will be found somewhat more expensive than storage battery tubes, their added convenience usually more than compensates for the greater cost of upkeep.

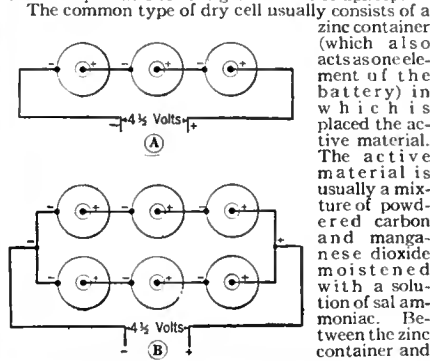

The common type of dry cell usually consists of a zinc container (which also acts as one element of the battery) in which is placed the active material. The active material is usually a mixture of powdered carbon and manganese dioxide moistened with a solution of sal ammoniac. Between the zinc container and

the active material, there is usually placed a layer of blotting paper. The layer of paper acts, not only as an absorbent of some of the electrolyte but also as a separator which prevents the manganese dioxide from coming into contact with the zinc. If such contact does occur, an internal short-circuit takes place and the cell becomes useless.

The zinc case of the cell forms the negative terminal, and the positive terminal is a carbon rod that is placed in the center. This carbon rod is insulated from the zinc shell and does not react chemically with any of the other substances used.

The current from any one cell should not exceed one-quarter ampere. In the case of portable sets, it is not always possible to use that number of cells which would give greatest efficiency. In an installation in the home, arrangements should be made to use sufficient cells for most effective operation.

For any receiver using up to four 199 tubes, only three dry cells are necessary, connected as is shown in A on the accompanying diagram. If the receiver uses more than four tubes, two banks of dry cells should be used connected as shown in B.

Dry cells can be tested most easily by means of an ammeter. The instrument should be capable of reading up to about 50 amperes, and in testing the cell, it should be connected as in C. The cell should be thrown away if it reads less than five amperes.

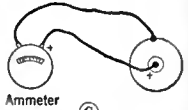

## No. 15

RADIO BROADCAST Laboratory Information Sheet

July, 1926

### Loop Antennas

#### THEORY OF OPERATION

A LOOP antenna is quite commonly used in connection with multi-tube receivers, especially super-heterodynes. The action of a loop is not quite as simple to understand as is the action of a simple antenna.

The theory of the operation of a loop is commonly explained in the following manner. Suppose we have two vertical wires separated by a distance of 200 meters, both of them insulated from each other and from the ground. Now, if a wave approaches from a direction perpendicular to the plane of the two wires, the wave will reach each wire at exactly the same time, and the voltages induced will be exactly in phase. If the wave approaches from some other direction, it will reach the two wires at different times and, therefore, the induced voltages will be out of phase with each other. If the wave approaches in the direction of the plane of the two wires and has a wavelength of 400 meters, the two induced voltages would be 180 degrees out of phase. Therefore, the voltage at the top of one wire will be a positive maximum when the voltage at the upper end of the other wire is at a negative maximum. Now, if the upper ends are connected together and the input to a receiver is connected across the lower ends, current will flow around the circuit, and if the circuit is tuned by a condenser, the currents will become comparatively large. The induced voltages will be greatest when the wave and the loop are

both in the same plane, since this will result in maximum phase displacement between the voltages induced in the front and rear wires of the loop.

With regard to the design of loops, it will generally be found that the current induced in the loop varies directly as the area, directly as the number of turns, inversely as the resistance, and inversely as the length of the wave being received.

The common type of loop antenna consists of several turns of wire wound on a rectangular form. The turns should be spaced about one-half or one inch from each other, so as to keep the capacity low. The distributed capacity of a loop also increases with the number of turns. This capacity increases rapidly with the first few turns, and then the rate of increase becomes slower. A very satisfactory loop for use with a 0.0005 mfd. condenser can be made by constructing a four-foot square form and winding on it six turns of No. 22 wire. Such a loop would have a range of from 1500 kc. (200 meters) to 600 kc (500 meters).

Generally, for satisfactory operation, no connection to ground is necessary. However, somewhat louder signals can usually be obtained if the low potential end of the loop is connected to ground. When such a connection is made, it is likely that the loop also acts as a small antenna by reason of its capacity to ground. In this connection, it should also be pointed out that the inner end of the loop should always be at the lowest potential.

## No. 16

RADIO BROADCAST Laboratory Information Sheet

July, 1926

### Carrier Wave Analysis

#### HETERODYNE INTERFERENCE

RADIO waves travel with the speed of light—300,000,000 meters per second. Now, in any wave motion, the frequency, or number of waves passing a given point per second, multiplied by the wavelength, gives the speed with which the waves are traveling. If a train of railroad cars passes a given point at the rate of two cars per second and each car is fifty feet long, the speed of the train is obviously one hundred feet per second

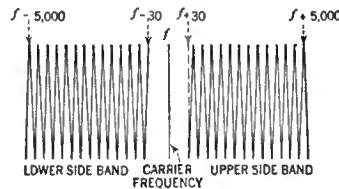

Quite similarly, if the frequency of passing radio waves is one million per second, then the length of each wave must be 300 meters to make the speed come out the value stated above. Broadcasting stations have a frequency separation of 10 kilocycles to prevent heterodyning, and no uniform wavelength separation can be given that will be applicable throughout the broadcasting band. If we work with wavelengths, we must calculate anew the width of channel expressed in meters for every

different wavelength. Thus a 10-kilocycle channel at three-hundred meters wavelength is only a three meter channel, while at three thousand meters wavelength, it is a three hundred meter channel. There are about nine times as many 10-kilocycle channels available between the wavelengths 30 and 300 meters as there are between 300 and 30,000 meters.

For very high quality music, all tones between about 30 and 5000 vibrations per second should be transmitted with equal efficiency. To transmit the former, we must transmit a frequency 30 cycles greater than the carrier and another 30 cycles less than the carrier, in addition to the carrier itself. To transmit the 5000-cycle note we must use the frequencies 5000 greater and 5000 less than the carrier, and to transmit all the intermediate tones, we must use the two bands of frequencies (called the upper and lower side bands) shown in the accompanying diagram.

The whole range of frequencies used is called a "channel." In the case just described, the width of the channel is 10,000 cycles. The important thing about all this is that broadcasting stations do not use only a single frequency or wavelength as might be supposed from the figure given at the top of the newspaper radio programs (that figure is the frequency of their carrier wave in kilocycles per second), but they each require a channel of definite width, and hence only a rather small number can work at once without their channels overlapping. Overlapping results in a continuous whistling sound (of high pitch if the channels overlap only slightly, and of lower pitch if the overlapping is greater).

# "NOW, I HAVE FOUND . . ."

A Department for the Exchange of Ideas and Suggestions of Value to the Radio Constructor and Operator

CONTRIBUTIONS to this department are welcome and those used will be paid for at the usual rates, that is, from two to ten dollars each. A prize of twenty-five dollars is given for the best idea used during each three-month period. The prizewinner for the current period will be announced in the August RADIO BROADCAST. Manuscripts intended for this department should not exceed about three hundred words in length, and should be typewritten. Little consideration can be given to manuscripts not typewritten. Envelopes should be addressed to this department, RADIO BROADCAST, Garden City, New York.

## VERNIERS AND THEIR APPLICATION TO RADIO

THE word "vernier" has come to mean in radio terminology "a slow motion," but in engineering, it has kept its original meaning—to divide into, or measure, small parts. This method was called after its inventor, Pierre Vernier, who died in 1637.

After a careful examination of advertisements and descriptions of so-called vernier dials, only one (the Erla) was found that had a true vernier incorporated in its design.

In the "Now, I Have Found" department of the February, 1926, RADIO BROADCAST, page 490, appeared an article on a long-wave receiver, in which a piece of slotted bakelite was used to vary the distance between the coils. This method would be an excellent one for short-wave receivers, and if the bakelite strip were graduated with a scale, and a vernier added on the panel (one such as is shown here), very accurate calibration of the receiver would be possible. Coil positions could be recorded to the fortieth of an inch, or closer even, if a smaller scale is used.

To make such a vernier scale, first decide the size of the main scale divisions, then, with a good pair of dividers, divide on this vernier scale, into ten equal parts, a length equal to nine divisions of the main scale. In the illustration, Fig. 1, one quarter of an inch is supposed to be the main scale division. Therefore, the vernier scale which is divided into ten equal parts,

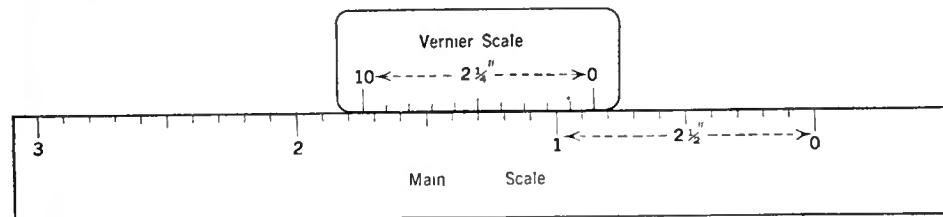

FIG. 1

is  $2\frac{1}{4}$  inches long. Readings to one fortieth of an inch will be possible with the arrangement shown. If the main scale is divided into one-tenth divisions, and the vernier correspondingly changed, readings to one hundredth of an inch will be possible.

Referring to the scale shown on this page, we see that the setting is 0.85, and this is the way it is read. First of all the reading on the main scale opposite the zero of the vernier scale is taken. In this instance it is less than 1—it is something over 0.8. To find out what the second decimal figure is, we glance along the vernier scale and see that one of the division lines on it will be in alignment with one of the division

lines of the main scale. In the example given, this is at 5 on the vernier. The second decimal point is  $\frac{5}{10}$ , then. The complete reading is therefore 0.85, as stated above.

The application of this vernier arrangement to the long-wave receiver mentioned previously, is a simple matter. The main scale is pasted on the sliding strip of bakelite while the vernier scale is pasted to the panel by the side of the sliding strip. When a station is heard, the coil setting may be jotted down by following the instructions above. It is simple to slide the strip of bakelite along until the required setting is found when tuning-in for a station which has previously been heard and its setting marked down.

DOUGLAS H. NELLES,  
Ottawa, Ontario.

## A LATERAL BASKETWEAVE COIL FORM

DO you ever try to bore a dozen or so perpendicular holes in a small piece of wood to hold the pegs in a form for winding lateral basketweave coils? If yours was the usual experience, you have probably found that a drill press, or jig, is necessary in order to have the pegs stand up at right angles, as must be the case to make a neat looking coil.

The following method of making the coil form has proved very satisfactory. Use a piece of wood  $\frac{3}{4}$  inch thick for the base. For the uprights get a pound of 20-penny

finish nails. These are slipped into holes drilled at the proper points on a circle laid out on the base.

The difficulty is to drill the holes perpendicularly. Take a second piece of wood about  $4 \times 4 \times \frac{3}{4}$  inches. Drill a hole in its center, using a twist drill just a shade larger in diameter than the nails. Slip a nail through this hole and test with a carpenter's or draughtsman's square to see if it is perpendicular—which it probably will not be at first attempt. Drill other holes until you get one that is perpendicular. Mark it, and use it as a guide or jig, placing it over the base when drilling holes for the uprights.

# The LYNCH METALLIZED RESISTOR

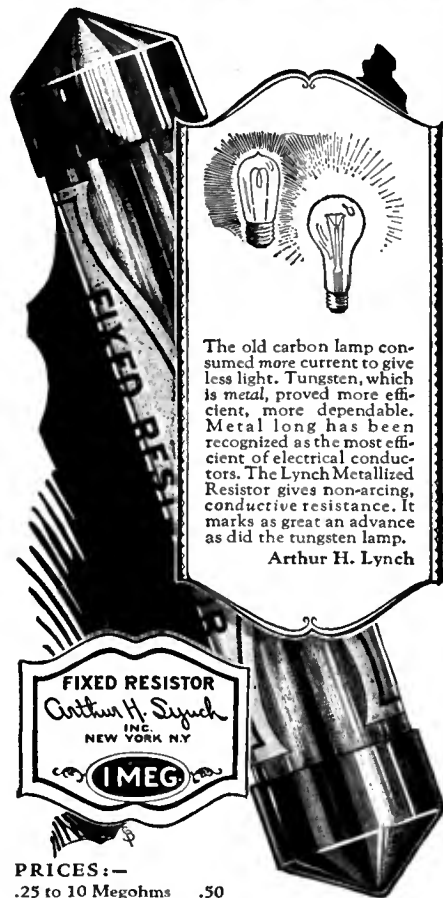

The old carbon lamp consumed more current to give less light. Tungsten, which is metal, proved more efficient, more dependable. Metal long has been recognized as the most efficient of electrical conductors. The Lynch Metallized Resistor gives non-arcing, conductive resistance. It marks as great an advance as did the tungsten lamp.

Arthur H. Lynch

PRICES:—  
 .25 to 10 Megohms .50  
 above .01 to .24 " .75  
 .001 to .01 " \$1.00  
 Single Mounting .35

Warranted—★  
 Absolutely Noiseless  
 Permanently Accurate  
 Dependable!

COMPRISING a concentrated metallized deposit one-thousandth of an inch thick upon a glass core and sealed within a glass tube, each LYNCH METALLIZED FIXED RESISTOR wins in the exacting tests of time and service. This better-built product has been endorsed by leading engineers and experimenters and the test laboratories of the leading magazines.

If your dealer cannot supply you, it will pay you to wait for the mail—we ship postpaid, and Lynch products are sold on a money-back guarantee.

Dealers—Write us!

ARTHUR H. LYNCH, Inc.  
 Manufacturers of Radio Devices  
 Fisk Bldg., Broadway & 57th Street  
 New York, N.Y.

# Here's Work That is Almost ROMANCE!



**Many EARN \$50. to \$250. a Week in RADIO**

Get into the great new BIG-Pay Industry—Radio. If you're earning a penny less than \$50 a week, clip coupon now. Send for AMAZING FREE BOOK. Be A Radio Expert, and draw down big money for the easiest and most fascinating work in the world. Positions everywhere. Need for Radio Experts in every community. Short hours. BIG PAY. Free book gives all the facts.

**Learn Quickly And Easily At Home**

Master Radio Engineers will show you how to qualify, quickly and easily at home, for Radio's fine jobs. We guarantee to train you successfully. Every day N. R. I.-trained men are taking good places in the Radio field. Thousands of openings now awaiting the trained man. FREE EMPLOYMENT SERVICE. Many other big features. Get the facts—CLIP COUPON.



"My charges for consultation \$2.50 per hour. All success due to you." R. W. Blackbill, Brooklyn.



"Radio a gold mine—my course worth thousands." A. R. Herke, Winnipeg.

**Get This FREE Book!**

Send coupon below for FREE BOOK—"Rich Rewards in Radio." Read for yourself. No previous experience needed. Common schooling enough. WRITE NOW.



**You get all these sets**

Receiving sets, from simplest kind to thousand mile receiver, included to help you learn. AN UNEQUALLED OFFER. Other special features for limited time only, so ACT QUICK!

**National Radio Institute**  
Dept. GU-5, Washington, D. C.

## MAIL COUPON

**NATIONAL RADIO INSTITUTE**  
Dept. GU-5, Washington, D. C.

Without obligating me in any way, please send me your free book "Rich Rewards in Radio," also complete information on your practical, home-study Radio course.

Name ..... Age.....  
Address .....  
Town..... State.....

Three tips: Slightly start each hole on the coil form base before using the jig; this makes it easy to slip the drill through the jig and locate the exact point to be drilled. Keep the jig and block in firm contact—use your foot or a clamp. File off any burrs on the nails just back of the points, and sandpaper any rust off the shanks.

Bases for various diameters can be made up for a few cents.

E. S. ANDERSON,  
Springfield, Massachusetts.

### CONTROLLING REGENERATION IN THE "UNIVERSAL"

THE usual methods of controlling regeneration in the RADIO BROADCAST "Universal" are to employ a variable resistance either in series, or in parallel with a fixed tickler coil. Each of these methods has slight disadvantages, in the opinion of the writer. If the parallel method is used, the tube must be kept fairly near to the oscillating point or practically no regeneration will occur. Also the adjustment is apt to be very critical, which will cause the detector to break into oscillation suddenly. This is not always the case but is true of some detector tubes.

With the variable resistance in series with the tickler, the control is smoother than with the method just outlined. This latter method, however, causes the entire plate current to pass through the resistance with some losses to the audio frequency part, which should have free passage to the audio transformer. Changing the value of the series resistance in tuning will change the value of the B-battery voltage that is applied to the plate of the detector. As the resistance is decreased to cause regeneration at the lower frequencies (higher wavelengths), the plate voltage is increased. This is apt to cause instability at the lower frequencies.

The ideal method is one that will allow free passage of the audio frequency currents through the primary of the audio transformer, the batteries, and back to the filament. The radio frequency currents which cause regeneration should be separated from the audio currents and sent through a separate channel to the tickler coil, and then back to the filament. This may be easily done as shown by the diagram, Fig. 2. The primary of the transformer is connected to the plate of the de-

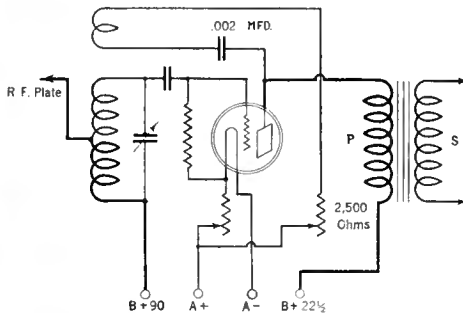

FIG. 2

tor tube and the other end of the primary to the B plus 22½-volt post. One side of a .002-mfd. fixed condenser is connected to the plate. The other side of this condenser goes to the end of the tickler which formerly went to the plate. The other end of the tickler goes to one side of a 2500-ohm variable resistance. The other side of this resistance goes to the plus filament post.

The audio currents are now allowed free passage to the transformer, and the plate voltage is the same at all times. The impedance of the primary of the transformer is sufficient to cause the radio frequency currents to pass through the condenser and fixed tickler coil where they cause regeneration. After going through the tickler they return to the filament by way of the variable resistance, which acts as a valve con-

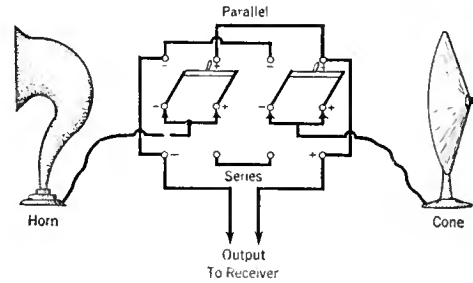

FIG. 3

trolling the amount of current flowing through the tickler. This control is very smooth; in fact it is so smooth that if the detector is adjusted to a sensitive condition at 1000 kilocycles, it will be quite sensitive at 550 kilocycles with the same adjustment.

LAWRENCE S. BABCOCK,  
Jamestown, New York.

### LOUD SPEAKER COMPARISON

FREQUENTLY it is desired to test out two loud speakers for comparison; or, perhaps, two speakers are to be used alternatively. It is an accepted fact that the usual horn reproduces the treble somewhat better than the base, while the cone does the opposite. If the two instruments are connected in series, the reproduction is very satisfactory over the entire scale, possibly with a slight adjustment.

The wiring diagram in Fig. 3 will allow a quick change from one speaker to the other or to both either in series or parallel, by the use of two double-pole double-throw switches.

This system is applicable to the needs of radio dealers for demonstration purposes. When one of the instruments is not required, its switch is left in the "open" position while the d.p.d.t. switch of the speaker to be used, is placed in the parallel position.

L. H. SEARING,  
Auburn, New York.

### A CONSTANT NON-INDUCTIVE RESISTANCE UNIT

FOR the home constructor and experimenter, especially now that resistance-coupled amplifiers are so popular, a cheap and easily constructed resistor that has a higher current carrying capacity than the paper strip type should meet with general approval.

The type described here is remarkably constant, and will carry much more current than the usual kind without changing its resistance. The writer constructed a number of them a year ago, and though the resistance increased slightly the first week, there has been no appreciable change since.

The materials needed are as follows: A bottle of India drawing ink; some scraps of muslin or other thin and absorbent cloth; a few pieces of glass tubing with an inside

diameter in the neighborhood of 3-16 inch; a little brass or copper tubing which will fit rather snugly over the glass tube; some thin sheet brass, copper, or even a tin can if the latter is bright and clean enough to take solder readily; and some sealing wax.

First, soak a piece of the muslin in the ink and dry *thoroughly* over a radiator or stove.

Next cut your tubing into lengths to suit (an inch and a half is about right) by nicking with a file and breaking with the fingers.

Now make two ferrules out of the copper

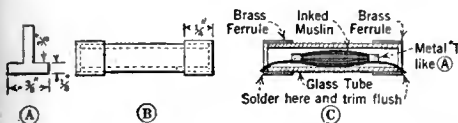

FIG. 4

or brass tubing about 1/4-inch long. If you can't get the right size tubing, roll a piece of 1/4-inch wide brass or copper foil around each end of each piece of tubing, and solder the joint.

One more thing and you are ready for the assembly. For each resistor you will want two "T" shaped pieces of the thin metal. See A, Fig. 4.

Cut the muslin into strips a half-inch less in width than the length of the glass tubing. Roll one of these strips up tightly until the roll is about an eighth of an inch in diameter and clamp both ends in the "T" shaped metal pieces by curling the top ends of the "T" pieces around the ends of the roll. Assemble as shown in C, soldering the ends of the "T" pieces to the edges of the end ferrules, and seal both ends by dipping in melted sealing wax, leaving long enough for the wax to flow all around between the glass tube and the ferrules. The excess wax on the outside can be easily removed with a knife. If difficulty is met with in completely closing the ends of the assembled units with the hot wax, the whole device may be filled with melted wax. If permanency of calibration is desired, it will be necessary to make airtight seals at the ends; otherwise the resistance will vary with atmospheric changes.

The writer made up a dozen of these units, using Higgins ink, and varying the length between the "T" clamps from 1/4 inch to one inch, measuring the resistance after assembly with a B battery and high-resistance voltmeter. The twelve ranged from 50,000 to about 250,000 ohms, and have been used with excellent results in resistance-coupled amplifiers, etc.

W. B. HARRISON,  
Miller School, Virginia.

AN EASY METHOD OF DOPING SOLENOIDS

THE following method provides all the advantages of a "doped" coil and, as will be obvious, practically none of its disadvantages.

Having procured from a Kodak dealer a sheet, or sheets, of celluloid (this is as thin as tissue), and from a druggist a pint bottle of amyl acetate, first cut a strip of celluloid to cover a coil form of the desired diameter and length. If the strip is not long enough to overlap half an inch, join two pieces by softening a narrow band on the ends of two strips with amyl acetate and pressing them together. Bind the strip around the coil form, first applying amyl acetate in two or three places to the under side of the strip and the overlapping edges, and wind fifteen or twenty turns of cotton

thread around the celluloid. Leave it for five or ten minutes until the celluloid is set.

Then remove the thread and wind the coil as usual, fastening the ends as you usually do. Now apply amyl acetate to the coil with a brush, fairly liberally, so that it will soak through to the celluloid. Allow it to dry slowly for half an hour, and then place over a register or radiator so as to volatilize all the chemical.

The acetate will have dissolved the surface of the celluloid to the consistency of cement and, as it dries, the coil will be firmly held. At the same time, the chemical will have evaporated practically entirely from the coil and it may be slipped from the form.

To wind a primary over a secondary, put a narrow strip of the celluloid over the secondary and repeat the process.

E. S. ANDERSON,  
Springfield, Massachusetts.

TWO PRACTICAL METHODS OF MOUNTING CRYSTALS

FOR facility to change crystals rapidly and to obtain dependable contact in the circuit, this method of mounting crystals in miniature lamp bases will be found hard to equal, considering the cost.

Either the candelabra type of miniature lamp, or the bayonet type of lamp base, and corresponding sockets, are used as the means of holding the crystals. See Fig. 5. To prepare the lamp bases, the glass and plaster of Paris is broken out, and the crystal is hot-led into the base. Contact is made with the lamp socket through the

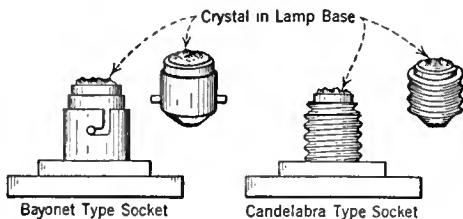

FIG. 5

terminals as is the case with the electric bulb, but only one side of the circuit is used.

By mounting several grades and types of crystals in these bases, change can be made immediately without loosening screws, and with a minimum of delay.

G. A. LUERS,  
Washington, District of Columbia.

IMPROVISING YOUR OWN BUS BAR

SOFT drawn copper wire can be made into very effective lengths of bus bar with which to wire receivers. Usually this soft drawn copper wire is sold in rolls of 100 feet and any gauge may be obtained, depending upon the choice of the radio constructor.

To change the soft copper wire into stiff lengths, merely cut the roll into 10 foot pieces. Fasten one end of a piece in a vise and the other end into the jaws of a hand drill; then by alternately turning one way and then the other and at the same time exerting a pull on the wire, it will be observed that the wire stiffens perceptibly, after which it may be removed from the vise and cut into the desired lengths. Do not make the wire too stiff by the alternate turning or else it will become brittle, and break when bent.

GENE RALELE,  
Montreal, Canada.

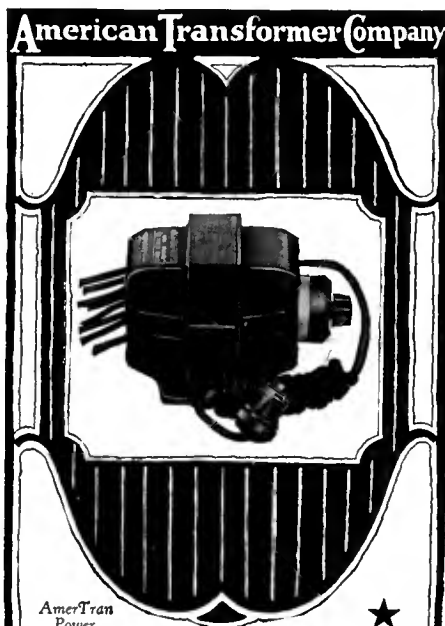

AmerTran Power Transformer

WHERE the power supply for receiver operation comes from a steady source, such as the house lighting circuit, radio reception is greatly improved, providing properly constructed B and A Eliminators are employed. This is due to the steadiness and constancy of the alternating current supply as contrasted with the internal changes which are always going on any type of battery, storage or dry cell type.

The American Transformer Company offers two units—the AmerTran Power Transformer and the AmerChoke—especially adapted to the use of the 7 1/2 volt power tubes in the last audio stage. Their efficiency may be absolutely depended on in the type of audio amplifier required. The Power Transformer also has filament supply windings for the power tube in the last stage and for the rectifying tube. It supplies sufficient plate current, after rectification, for the operation of the set. The AmerChoke is designed primarily for use in filter circuits. As an output impedance for by-passing direct current from the loudspeaker it is equally efficient and more economical than an output transformer.

The AmerTran De Luxe Audio Transformer gives faithful amplification with natural quality over the entire audible range. For the best in audio amplification use this transformer in both stages.

- AmerTran De Luxe, 1st Stage . . . \$10.00
- AmerTran De Luxe, 2nd Stage . . . 10.00
- AmerTran AF-7 (3-1) . . . . . 5.00
- AmerTran AF-6 (5-1) . . . . . 5.00
- AmerTran Power Trans. PF-45 . . . 15.00
- AmerTran Power Trans. PF-S2 . . . 18.00
- AmerChoke Type 854 . . . . . 6.00

Write to-day for free booklet "Improving the Audio Amplifier" and other data designed to make radio reception simpler and more realistic

AMERICAN TRANSFORMER CO.  
178 Emmet Street Newark, N. J.

AmerTran Products Are Sold Only at Authorized AmerTran Dealers

Transformer Builders for Over Twenty-Five Years



## screw machine products —brass



For plugs, jacks, clips, condenser and transformer parts; etc., BRASS assures economy in quantity production. It also gives the right electrical conductivity and the mechanical accuracy essential to proper operation of radio sets and parts.



**COPPER & BRASS**  
RESEARCH ASSOCIATION

25 Broadway, New York



**Jewell**  
**Lightning**  
**Arrester**  
Price \$1.10

*Thunder Storms* ★

are now with us. Your customer will be asking for dependable lightning arresters. Jewell arresters have been tested and listed by Underwriters Laboratories for indoor and outdoor installation. A stable item and good profit.

**Jewell Electrical Instrument Co.**  
1650 Walnut St. Chicago

## How the Patentee Is Covered by Law

*Legal Protection Granted to Patentees and Instances of Important Suits—  
How the Inventor Collects His Royalties When Private Individuals Infringe*

By LEO T. PARKER

*Patent Attorney*

THE matter of infringement of patents is an important subject about which the average individual is entirely unfamiliar. Considerable hearsay information is commonly being circulated among inventors regarding what is and what is not infringement, and just how it can be avoided. But through actual observation, the writer has determined that it is a subject concerning which the majority of individuals should become at least acquainted with the fundamental principles.

For example, it is generally thought to be perfectly within the law for a person to make a patented invention for his own individual use, but this is *not* permissible. A patent gives an inventor the exclusive right to make his invention, as well as to "use and sell" it. General home construction of patented radio circuits is generally allowed on the basis that the result is for "experimental purposes" and not for sale.

Then, too, there is another thing about which many inventors are misinformed, and that is the privilege, or, rather, the non-privilege, of selling an article which, when sold, is not an infringement of a patent, but which is so arranged that it is convenient for the purchaser to change the product into an infringing device. In this case, not only is the user liable as an infringer but also are the maker and seller. Not so long ago, a United States Court had occasion to decide a patent litigation between the Westinghouse Electric and Manufacturing Company, and the Independent Wireless Telegraph Company *et al.* The question, decided by the Court in favor of the Westinghouse Electric and Manufacturing Company, is one of particular importance inasmuch as a common point of discussion with varied opinions among radio fans is definitely answered by the decision.

The Independent Wireless Telegraph Company *et al.*, employs a large number of wireless operators to whom the company furnishes wireless apparatus. The Company issued absolute instructions to the operators forbidding them to tamper or change any of the connections on the regular wireless sending and receiving instruments. But the operators soon discovered that considerably better reception of the incoming signals could be effected by simply connecting a wire from the antenna post to the plate. This simple change converted the receiving apparatus into one employing regeneration, which is a direct infringement of Armstrong's patent No. 1,113,149. Although the Independent

Wireless Telegraph Company originally supplied non-infringing wireless apparatus to their employees, and the operators made the changes unbeknownst to the Independent Wireless Telegraph Company, the Court decided the practice was an infringement, and granted an injunction to stop the employees making the alteration. This decision was rendered although De Forest had, since the suit was filed, been awarded certain claims in the Armstrong patent.

### AVOIDANCE SCHEMES DIFFICULT

ANOTHER practice that has gained considerable popularity among certain manufacturers and other persons, is supplying the users with certain parts of a patented product and giving instructions to the purchasers how to make other parts of the apparatus, so that when the whole structure is completed, an infringing instrument is the result. Such tactics as these do not avoid infringement of a patent, and both the user and manufacturer are liable as co-infringers.

Moreover, it is not fair to those persons who devote time, effort, and money in perfecting an invention to permit others, to later devise some scheming means of indirectly avoiding infringement of the patent, without paying the inventor his just royalty. The Courts tend to favor the inventor, and will look through the shrewd methods employed to deprive him of his rights.

For these reasons, the Patent Offices at Washington are kept busy filing applications for patents of inventors who have faith in the Courts upholding their rights.

Another common method of avoiding payment of royalties to an inventor is to make and use the patented product without the knowledge of the inventor. The maker and user ordinarily believe that the amount of money involved is too small for the patentee to attempt to bring suit to recover. But if a sufficiently large number of actual users are properly located, the patentee is privileged to file but one suit to recover damages from each infringer, collectively. This method is permitted by the Courts to eliminate a multiplicity of suits. Thus an advantage is once again given to the patentee.

So for these various reasons, it is unwise to attempt to avoid paying just royalties to the originator of a radio article or device from which a user is deriving material benefits of far greater importance and value than the small royalty requested by the inventor.



# Frequency Channels Used by U. S. Radio Stations

*All New Stations, Including Broadcasters, are Assigned Wavelengths According to this List*

WHEN a new radio station commences operation, it is assigned a definite frequency (or frequencies), this latter figure being allocated depending upon the type of service etc., from bands already decided upon. The list printed below gives these bands, and was drawn up at the Fourth National Radio Conference, and only differs slightly from that drawn up at the previous conference. Wavelength allocations by the Department of Commerce are based upon the information contained in this list.

An important matter treated by the Conference Committee was the utilization of the frequency bands above 2000 kilocycles (below 150 meters). Certain additional services have been placed in some of these bands, as will be noted from the list. Special thought was given to the application of the ultra-high frequency bands to beam and amateur services, but, as it will be noticed, no bands have as yet been specially put aside for the transmission of photographs by radio. It was concluded that certain of these channels should be available for experimental work other than beam transmission, and the allocations were accordingly modified in that respect. The Committee stated that the allocations above 2,000 kilocycles (below 150 meters) must be considered to some extent temporary or experimental.

A question of primary interest to the broadcast listener was also dealt with. This was relative to a proposed extension of the present band of frequencies used for the broadcasting service. It was fully recognized by the Committee that such an extension would result in a certain amount of relief of the present congested state of affairs, but it was not found feasible to make any extension without encroaching upon the major wave band used by the amateurs. Many present-day receivers too, would be unable to tune down to the extended wave band, so no alterations to the present band are put in force, nor are any such alterations likely.

| KILOCYCLES      | METERS        | TYPE OF TRANSMISSION  | SERVICE  | REMARKS          |
|-----------------|---------------|-----------------------|--|------------------|
| 95-120          | 3,156-2,499   | CW and ICW            | Government only  |                  |
| 120-153         | 2,499-1,960   | CW and ICW            | Marine and aircraft only   |                  |
| 125             | 2,399         | CW                    | Government   | Non exclusive.   |
| 153-165         | 1,960-1,817   | CW and ICW            | Point to point, marine, and aircraft, only.  |                  |
| 155             | 1,934         | CW and ICW            | Government   | Do.              |
| 165-190         | 1,817-1,578   | CW and ICW            | Point to point and marine only   |                  |
| 175             | 1,713         | CW and ICW            | Government   | Do. <sup>1</sup> |
| 190-230         | 1,578-1,304   | CW and ICW            | Government only  |                  |
| 230-235         | 1,304-1,276   | CW and ICW            | University and college experimental only.  |                  |
| 235-285         | 1,276-1,052   | Phone                 | Marine only  |                  |
| 245             | 1,224         | CW and ICW            | Government   | Do.              |
| 275             | 1,090         | CW and ICW            | do   | Do.              |
| 285-500         | 1,052-600     | —                     | Marine and coastal only  |                  |
| 300             | 1,000         | CW and ICW            | Beacons only   |                  |
| 315             | 952           | CW and ICW            | Government only  |                  |
| 343             | 874           | CW and ICW            | Marine only  |                  |
| 375             | 800           | CW and ICW            | Radio compass only   |                  |
| 410             | 731           | CW, ICW, spark        | Marine only  |                  |
| 425             | 706           | CW, ICW, spark        | do   |                  |
| 445             | 674           | CW and ICW            | Government   |                  |
| 454             | 660           | CW, ICW, spark        | Marine only  | Do.              |
| 500             | 600           | CW, ICW, spark, phone | Calling and distress, and messages relating thereto, only.   |                  |
| 500-550         | 600-545       | CW, ICW, phone.       | Aircraft and fixed safety of life stations.  | Do.              |
| 550-1,500       | 545-200       | Phone                 | Broadcasting only  |                  |
| 1,500-2,000     | 200-150       | CW, ICW, phone        | Amateur only   |                  |
| 2,000-2,250     | 150-133       | —                     | Point to point   | Do.              |
| 2,250-2,300     | 133-130       | —                     | Aircraft only  |                  |
| 2,300-2,750     | 130-109       | —                     | Mobile and Government mobile only.   |                  |
| 2,750-2,850     | 109-105       | —                     | Relay broadcasting only  |                  |
| 2,850-3,500     | 105-85.7      | —                     | Public toll service, Government mobile, and point-to-point communication by electric power supply utilities, and point-to-point and multiple-address message service by press organizations, only. |                  |
| 3,500-4,000     | 85.7-75.0     | —                     | Amateur, Army mobile, naval aircraft, and naval vessels working aircraft, only.  |                  |
| 4,000-4,525     | 75.0-66.3     | —                     | Public toll service, mobile, Government point to point, and point to point public utilities.   | Do.              |
| 4,525-5,000     | 66.3-60.0     | —                     | Relay broadcasting only  |                  |
| 5,000-5,500     | 60.0-54.5     | —                     | Public toll service only   |                  |
| 5,500-5,700     | 54.5-52.6     | —                     | Relay broadcasting only  |                  |
| 5,700-7,000     | 52.6-42.8     | —                     | Point to point only  |                  |
| 7,000-8,000     | 42.8-37.5     | —                     | Amateur and Army mobile only   |                  |
| 8,000-9,050     | 37.5-33.1     | —                     | Public toll service, mobile, Government point to point, and point-to-point public utilities.   | Do.              |
| 9,050-10,000    | 33.1-30.0     | —                     | Relay broadcasting only  |                  |
| 10,000-11,000   | 30.0-27.3     | —                     | Public toll service only   |                  |
| 11,000-11,400   | 27.3-26.3     | —                     | Relay broadcasting only  |                  |
| 11,400-14,000   | 26.3-21.4     | —                     | Public service, mobile, and Government point to point.   | Do.              |
| 14,000-16,000   | 21.4-18.7     | —                     | Amateur only   |                  |
| 16,000-18,100   | 18.7-16.6     | —                     | Public toll service, mobile, and Government point to point.  | Do.              |
| 18,100-56,000   | 16.6-5.35     | —                     | Experimental   |                  |
| 56,000-64,000   | 5.35-4.69     | —                     | Amateur  |                  |
| 64,000-400,000  | 4.69-0.7496   | —                     | Experimental   |                  |
| 400,000-401,000 | 0.7496-0.7477 | —                     | Amateur  |                  |

<sup>1</sup>Ice patrol, broadcasting, etc.



## SPEED SUPER-EMISSION RADIO TUBES

*Excel in All Characteristics*

Standard Types  
Power Amplifiers  
Type 200 Power Detector

JOBBERS                      DEALERS  
A few territories open for  
exclusive distribution  
*Write Now for Details*

**CABLE SUPPLY CO.**  
INC.

*Sales Offices*

907 Broadway                      New York



**Oh boy!**

**KESTER**  
Rosin Core  
**Radio SOLDER**  
Sure! is Safe and Simple

Approved by  
**Radio Engineers**  
A Genuine Solder

CHICAGO SOLDER COMPANY  
4222 Wrightwood Ave., Chicago, U. S. A.

Originators and  
World's Largest Manufacturers of  
Self Fluxing Solder

YOUR DEALER  
CAN SUPPLY YOU

This is a good time to subscribe for

**RADIO BROADCAST**

Through your dealer or direct, by the year only \$4.00

DOUBLEDAY, PAGE & CO. GARDEN CITY, NEW YORK

**MORE PROFITS**  
for the **PROFESSIONAL**  
**SET BUILDER**

**W**E have an unusually interesting proposition to make to the man who is now building (or has the ability to build) radio receiving sets for resale.

This is a real opportunity. Write today for full information.

**Gearhart-Schluter Radio Corp.**  
716 Voorman Ave. Fresno, California

## Adapting the Roberts to the Long Waves

How a British Fan Made Coils Suitable for Reception of the B. B. C's Long-Wave Broadcaster

By C. A. OLDROYD

**T**HE popularity of the Roberts circuit in Great Britain is steadily increasing, and it is probable that far more sets of this type would be constructed if suitable long-wave coils were available. England's principal broadcasting station, that located at Daventry and known as 5 XX, transmits with a frequency of 187 kc. (1600 meters), which is far above the upper wavelength limit of the standard Roberts coils. In addition to Daventry, there are many other European broadcasting stations transmitting on even lower frequencies (longer wavelengths) than Daventry, and the average British fan is not content unless he is able to receive these long-wave broadcasters as well as those employing the shorter waves. This is essentially the reason why the Roberts has not gained even more supporters over here in Europe than it has done. There are extremely few factory made receivers on the market that are not capable of at least picking up Daventry, this being accomplished, in many cases, by means of simple loading coils.

For nearly a year now, the author has been experimenting with the Roberts, and much interesting data has been gathered. During these experiments, to permit rapid changes with a minimum of trouble, a simple breadboard layout was employed. On the usual broadcasting wavelengths, which are almost identical to those employed by the American broadcasting stations, very excellent results have been obtained. When conditions have been favorable, broadcasting from American stations has been heard with perfect clarity.

As most readers are aware, broadcasting in Europe is at present in a very bad state. Considerable interference is experienced through new stations opening up on frequencies which are already being used by other stations close at hand, and the constant heterodyning is the bane of the DX fans' existence. Up to the present time, the Bureau established at Geneva to look into radio matters, has been unable to improve matters to any great extent.

The Daventry station, fortunately, has been little affected by other stations, and many listeners in Europe confine them-

selves almost exclusively to listening to this station.

### DATA ON THE COILS

**T**HE ordinary three-circuit tuner fitted with honeycomb coils is easily changed to another waveband, but with circuits like the Roberts and the Browning-Drake, things are far more difficult. Nevertheless, the writer obtained very excellent results in adapting the Roberts for the longer waves.

Solenoid coils wound with wire of the usual gauges were out of the question, on account of their size. The only way out of the difficulty seemed to lie in the utilization of multi-layer coils wound with fine wire.

These were wound on a machine such as the one shown in the RADIO BROADCAST of February, 1925, and the number of turns equalled about five times the number employed in the standard Roberts coils.

Fig. 1 shows the antenna coil; on the left is the primary, and on the right, the secondary. These two coils are separated by a strip of hard rubber about one quarter of an inch thick. Both coils are clamped to an upright strip of

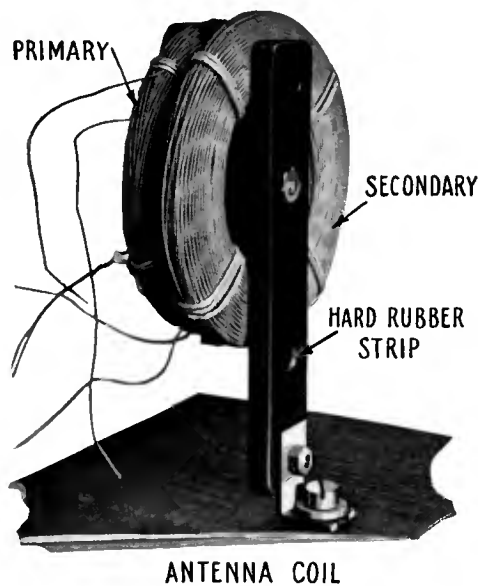

FIG. 1

hard rubber, the latter being fixed to the baseboard by a metal bracket.

The radiofrequency transformer is shown in Fig. 2 (page 276). Again the NP coil and the secondary are separated by a thin hard rubber strip, and both are attached to the upright. The tickler coil is shown lying in the foreground. It was arranged to swing parallel to the secondary.

The NP coil is tapped at the center, according to latest practice. As the wire used for these coils was very thin (about 30 gauge), no very startling results were expected, especially as the layers of the coils were close together. But when the set was switched on, the writer was agreeably surprised. When receiving Daventry, about 180 miles away, the volume was far greater than when receiving the nearest station, Manchester, 2ZY, about seventy miles away.

Interference was absent, and only a faint whisper of Morse was heard at very rare intervals. Other long-wave stations, for

(Continued on page 276)

# ELECTRAD

**Don't Fool With Lightning!**

It doesn't pay to economize on a lightning arrester, or to use one you aren't sure of. You can't collect insurance unless

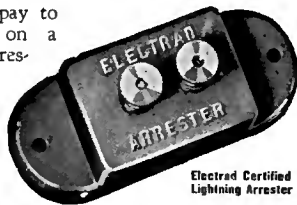

Electrad Certified Lightning Arrester

you have an arrester capable of passing the National Board of Fire Underwriters. Put in an Electrad Certified Lightning Arrester—then you're sure.

Air-gap type, exterior moulded porcelain, attractive finish. Completely sealed and moisture proof. Cost little, simple and easy to attach. At all good radio stores, 50c; in Canada 75c. Outdoor type \$1.50; in Canada \$2.10

For perfect control of tone and volume use the Electrad 500,000 ohm compensator. For free hookup write 428 Broadway, New York City.



# ELECTRAD Inc.

22½ Volt  
ever-acid  
everlasting  
rechargeable  
"B"

Storage Battery

**\$2.95**

includes  
chemical



45 volts \$5.95, 90 volts \$10.00, 112½ volts \$12.50, 135 volts \$14.75, 157½ volts \$18.80.

Truly the biggest buy today. Easily charged on any current including 32 volt systems. Any special detector plate voltage had. Tested and approved by leading authorities such as Popular Radio laboratories. Over 3 years sold on a non-red tape 30 day trial offer with complete refund if not thoroughly satisfied. Further guaranteed 2 years. Knock-down kits at greater savings. Complete "Hawley" "B" Battery Charger \$2.75. Sample cell 35c. Order direct—send no money—simply pay the expressman cost on delivery. Or write for my free literature, testimonials and guarantee. Same day shipments.

B. Hawley Smith, 312 Washington Ave., Danbury, Conn.

# AMPLION

Product of nearly 40 years' Experience  
Upholding Amplion  
Supremacy

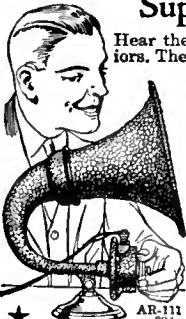

Hear the new Amplion Juniors. They have larger, more powerful units. The Amplion's world-wide supremacy in better radio reproduction is established even more firmly by this latest improvement at no increase in price. To hear your set at its best, hear it with an Amplion. New Junior models with cords and plugs: AR-111, metal flare, \$24. De Luxe, mahogany flare, \$27.50.

THE AMPLION CORPORATION OF AMERICA

Suite L, 280 Madison Avenue, New York  
Chicago Branch: 27-29 North Morgan St.  
Amplion Corporation of Canada, Ltd., Toronto



# A New and Advanced Model— Norden-Hauck Super-10

## Highest Class Receiver in the World

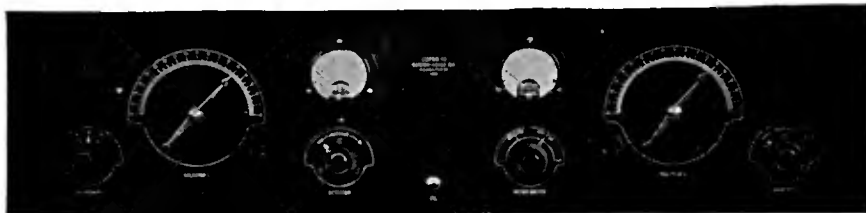

Panel Size: 36"x9"x1-4"

Weight: 55 lbs.

**T**HE NORDEN-HAUCK SUPER-10 is an entirely new and advanced design of Receiver, representing what we believe to be the finest expression of Modern Radio Research Engineering. It is the product of years of experience devoted exclusively to the attainment of an ideal Broadcast Receiver—regardless of cost.

Results obtained in every respect will upset all your previous ideas of good radio reception.

Here are only a few of the host of features that place the NORDEN-HAUCK SUPER-10 far in advance of competition:

- 10 tubes employed to give perfect reproduction with unlimited range and volume power.
- Super selectivity on all wave lengths.
- Built to Navy Standards.
- Wide wave length range without change of coils, etc. (Adaptable 35 meters to 3600 meters if desired.)
- Use Loop or Antenna.
- Simple to operate, having only two major tuning controls.
- No Harmonics. Signals are received only at one point.
- Special Power Audio Amplifier, operating any loudspeaker and eliminates necessity of external amplifier.
- Can be operated directly from house current if used with NORDEN-HAUCK POWER UNIT AB-2.

*The NORDEN-HAUCK SUPER-10 is available completely constructed and laboratory tested, or we shall be glad to supply the complete engineering data, construction blue prints, etc., for those desiring to build their own receiver.*

**Upon Request** A complete catalog, attractively illustrated, will be gladly mailed without charge, or full size constructional blue prints, showing all electrical and mechanical data, will be promptly mailed postpaid upon receipt of \$2.00

Write, Telegraph or Cable Direct to

**NORDEN-HAUCK**  
Incorporated  
**ENGINEERS**  
MARINE BUILDING  
**Philadelphia, U. S. A.**

TEAR OFF AND MAIL TODAY

NORDEN-HAUCK, Inc.  
Philadelphia, U. S. A.

Gentlemen:—

Please send me without cost or obligation on my part, attractive illustrated literature describing the new Norden-Hauck Super-10.

I enclose \$2.00 for which please send me, postpaid, complete full size constructional drawings and all data for building the Super-10.

Name \_\_\_\_\_  
Address \_\_\_\_\_

# Faradon

## ELECTROSTATIC CONDENSERS



### BY-PASS AND FILTER CONDENSERS

should have a high factor of safety in insulation resistance both between the terminals and between the terminals and the casing to prevent destruction from occasional high voltage surges and operate indefinitely under the continued application of the rated operating voltage.

They should be of suitable dimensions and have convenient terminals. Uniform production and a dependable source of supply are important.



### COMPACT GROUPING

Faradon By-Pass and Filter Condensers pass exacting tests and are produced in various types to suit desired conditions. ★

Complete data and quotations will be furnished promptly upon receipt of advices as to just what is wanted. Inquiries requested.

**WIRELESS SPECIALTY APPARATUS COMPANY**  
JAMAICA PLAIN                      Established 1907                      BOSTON, MASS.

Why not subscribe to *Radio Broadcast*? By the year only \$4.00; or two years \$6.00, saving \$2.40. Send direct to Doubleday, Page & Company, Garden City, New York.

## ALHAMBRA

# LOW FREQUENCY PAPER

FOR

## CONE TYPE SPEAKERS

# THE SEYMOUR CO. ★

323-329 West 16th Street, New York

## THE "RADIO BROADCAST" LABORATORY SERVICE

*How to Write for Technical Information, Repair Service, or Calibration and Measurement Work*

**A**S WAS announced in the June RADIO BROADCAST, all questions which were formerly sent to "The Grid" will now be handled by the Technical Information Service, RADIO BROADCAST Laboratory. That service is maintained under the following rules:

1. All questions from subscribers to RADIO BROADCAST will be answered free of charge.
2. Non-subscribers to RADIO BROADCAST will be charged a fee of One Dollar for the Laboratory Technical Service.
3. All questions will be answered by mail and none will be published in RADIO BROADCAST.

The Technical Information Service of the Laboratory feels that it is important to define the scope of its service to readers. Although the Service is of very general help to our readers, there are certain demands which can not be met.

The Technical Information Service:

1. Cannot make comparisons between various kinds of receivers or manufactured apparatus.
2. Wiring diagrams of manufactured receivers cannot be supplied. This information can be secured from the various manufacturers.
3. Complete information cannot be given about sets described in other publications, but in all cases (wherever possible), inquirers will be referred to a source of information where the data can be obtained. In this connection, the monthly department in RADIO BROADCAST "The Best in Current Radio Publications" should be of great help, and should be consulted. That department records the most important constructional, technical, and general radio articles which appear.
4. Special receivers or circuits cannot be designed by the Technical Service.
5. Those who ask questions which cannot be answered in the scope of a letter will be referred, if possible, to sources where the information can be obtained.

In response to many requests, lists of the various groups of apparatus tested and approved by RADIO BROADCAST Laboratory will be mailed to all inquirers without charge.

### REPAIR SERVICE FOR READERS

**T**HE service of the Laboratory will be further extended to aid readers, and we are glad to announce the inauguration of the "Repair and Service Department, RADIO BROADCAST Laboratory." The Laboratory will undertake to repair and put in condition, for a moderate charge, receivers built by readers. Only sets which have been described in this magazine will be eligible for this service. In a later number of RADIO BROADCAST, the full scope of the Repair and Service Department, will be outlined. Those readers who now have sets which they would like to submit, should communicate by letter with The Repair and Service Department of the Laboratory, RADIO BROADCAST, Garden City, New York. Facilities are available to repair readers' receivers at once. The Laboratory has no wish to compete with local radio repair services, but many readers desire to submit their sets directly to RADIO BROADCAST for attention and we are glad to accommodate those who feel that their local facilities are not sufficient to help them out of any difficulties they may have experienced.

CALIBRATION AND MEASUREMENT

A THIRD service of the Laboratory which is available to readers, is the Calibration and Measurement Service. For a moderate fee, wavemeters, coils, transformers, etc., will be measured or calibrated by the Laboratory. Characteristics of tubes will be measured and the Laboratory is in a position to perform other similar services. Communications on this subject should be addressed to the Director of the Laboratory.

Our correspondence indicates that an increasing number of readers of RADIO BROADCAST are becoming interested in home experimental radio work. Many of these newly interested experimenters have been led into this work through Keith Henney's articles which appear from time to time in the magazine, telling how the constructor can build and properly use his own simple and reliable wavemeters, audio- and radio-frequency oscillators and other important valuable laboratory apparatus. The Calibration and Measurement Service should be of practical help to these home experimenters.

Before apparatus is shipped to Radio Broadcast Laboratory for calibration, it should be preceded by a letter detailing exactly the purpose of shipment, and not until this letter has been acknowledged and permission given for it to be sent to the Laboratory, should it be dispatched. The greatest care should be exercised in packing all apparatus intended for the Laboratory, especially when tubes are included in the shipment

REPAIR SERVICE BLANK

Repair and Service Department  
RADIO BROADCAST Laboratory,  
Garden City, New York.

GENTLEMEN:

I am enclosing with this blank, a letter to the Repair and Service Department, RADIO BROADCAST Laboratory. I am not forwarding my receiver at this time but I desire to submit a receiver, which is a..... described in RADIO BROADCAST for

- Repair
- Overhauling
- Rewiring
- Inspecting and Test
- .....
- .....

NAME.....

ADDRESS.....

TECHNICAL INFORMATION INQUIRY BLANK

Technical Service,  
RADIO BROADCAST LABORATORY,  
Garden City, New York.

GENTLEMEN:

Please give me fullest information on the attached questions. I enclose a stamped addressed envelope.

- I am a subscriber to RADIO BROADCAST, and therefore will receive this information free of charge.
- I am not a subscriber and enclose \$1 to cover cost of the answer.

NAME.....

ADDRESS.....



# Your Antenna IS Subject To Lightning Induction!

Authoritative information received from all parts of the country proves beyond doubt that all radio antennas are subject to lightning induction. Furthermore, these same records show that where damage to radio sets has been caused by lightning the sets were either not protected with arresters or were equipped with arresters of a cheap and inferior make.

## PLAY SAFE!

### Insist on a Brach Arrester

Your set, your home, deserves the best protection you can secure. Why risk danger? Equip your set with a BRACH arrester and thus obtain the best radio protection available and do so at an insignificant cost.

BRACH Arresters, for over 20 years, have been used to protect America's leading Railway, Police and Fire Alarm Systems and to protect radio sets since 1913. They are absolutely dependable—so dependable that every BRACH Radio Lightning Arrester now carries a \$100.00 Guarantee against damage by lightning to electrical parts of any standard make set.

**L. S. BRACH MFG. CO.**  
NEWARK, N. J.

Why not subscribe to *Radio Broadcast*? By the year only \$4.00; or two years, \$6.00, saving \$2.40. Send direct to Doubleday, Page & Company, Garden City, New York.

## BAKELITE for Radio Parts



The use of Bakelite parts in the set you buy or build, will insure you against inferior reception through defective insulation. Write for booklet 29.



**BAKELITE CORPORATION**

247 Park Ave., New York, N. Y. Chicago Office: 636 W. 22nd St.  
**BAKELITE CORP. OF CANADA, LTD.** 163 Dufferin Street, Toronto, Ontario, Canada



# STRONG

~ as well as Accurate

Guaranteed accurate within 10  
per cent of marked capacity

Accidents will happen—but it takes a worse blow than a fall on a cement floor to break a

## SANGAMO Mica Condenser

It is solidly molded in tough bakelite, with a velvety, smooth, rich brown finish. All corners are rounded to prevent chipping. High ribs give great mechanical strength. You might break one deliberately—with a hammer—but you will not even scratch the hard surface by dropping it.

This impenetrable bakelite armor protects the delicate condenser inside, and keeps it accurate forever. There are no exposed edges where moisture can creep in to create resistance. Rattling around in a spare-parts box does no harm. Spilled battery acid dries off harmlessly. An accurate part when bought, the Sangamo Condenser defies hot soldering irons, wet weather, knock-about use and blows from slipping tools. It stays accurate.

If you have never realized how much difference really accurate condensers make in tone, range and volume, try these condensers and enjoy better radio reception.

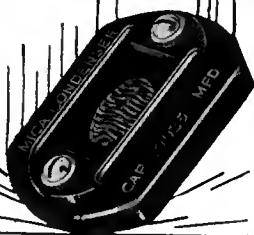

Sangamo By-pass Condensers stand  
high voltages without breakdown.

6332-5

**Sangamo Electric Company**  
Springfield, Illinois

RADIO DIVISION, 50 Church Street, New York

SALES OFFICES—PRINCIPAL CITIES

For Canada—Sangamo Electric Co. of Canada, Ltd., Toronto  
For Europe—British Sangamo Co., Ponders End, Middlesex, Eng.  
For Far East—Ashida Engineering Co., Osaka, Japan

RADIO FANS. A one-year's subscription to Radio Broadcast will cost you four dollars, two years six dollars. Consider this expenditure as being a necessary investment on your part for the future development of your own knowledge of Radio.

Send for Latest  
RADIO CATALOG  
and GUIDE



Sets—Parts—Kits  
Radio's Newest

You need this big FREE book. A practical guide to success in set building. Gives advanced hook-ups. Shows all newest parts and kits, built up sets ready for use, battery eliminators, radio's newest creations. Write for Copy free, also send name of radio fan. Send to-day.

**BARAWIK CO.**  
102-109 S. Canal St., Chicago

## A KEY TO RECENT RADIO ARTICLES

By E. G. SHAULKHAUSER

THIS is the ninth installment of references to articles which have appeared recently in various radio periodicals. Each separate reference should be cut out and pasted on cards for filing, or pasted in a scrap book either alphabetically or numerically. An outline of the Dewey Decimal System (employed here) appeared last in the May RADIO BROADCAST, and will be reprinted in an early number.



R381. CONDENSERS. S. L. F. CONDENSERS.  
Popular Radio. April, 1926, pp. 318-330.  
"What a Straight Line Frequency Condenser Really Is,"  
H. J. Harries.

The what and why of straight line frequency condensers leads the writer into a detailed discussion concerning the design and practical working principle of this type of condenser. The question of perfect straight line frequency condensers as applied to tuning circuits, is discussed from the mathematical and commercial viewpoint. Since coil capacity will to some extent vary the overall tuning of a circuit, the principal factor to be considered in determining the proper curvature of the plates is the frequency ratio, says the writer.

R570. DISTANT CONTROL BY RADIO. RADIODYNAMICS.  
Radio News. March, 1926, pp. 1280 ff.

"Controlling Power and Motion by Radio," A. K. Laing. Radiodynamics is defined as the science of controlling mechanisms at a distance without the aid of wires or other connecting materials. Five methods of signalling are considered: 1. Light waves, visible and ultra-violet; 2. Sound waves in air, earth, and water; 3. Earth conduction of electric charges; 4. Hertzian or radio waves; 5. Heat, or infrared waves. These are considered in detail with various forms of detectors employed in picking up the energy used at the signalling stations.

R113. TRANSMISSION PHENOMENA. POLARIZATION  
Proc. I. R. E. April, 1926, pp. 205-212. OF WAVES.

"The Polarization of Radio Waves," G. W. Pickard. Prior measurements of wave polarization made at the lower transmission frequencies have uniformly shown vertical electric force at all distances from the transmitter. The present work extends such measurements to the higher frequencies, where it was found that the electric force at any considerable distance from the transmitter was no longer vertical, but, instead, predominantly horizontal. Comparative measurements were also made of radiation alternately horizontally and vertically polarized at the source, which indicated that the ratio of horizontal to vertical electric fields depended only upon the frequency, distance, and time of day, being substantially independent of the plane of polarization at the transmitter.

R582. TRANSMISSION OF PHOTOGRAPHS. PHOTOGRAPH  
Proc. I. R. E. April, 1926, pp. 161-170. TRANSMISSION.

"Transmission and Reception of Photoradiograms," R. H. Ranger. This paper describes the art of electric picture transmission from its inception, over 80 years ago, to the results of present day development. It is pointed out that the seemingly rapid strides that have been made in the art during the last ten years of its 83-year existence, may be attributed to the larger supply of electrical and mechanical contrivances from which modern photo-transmission engineers can draw. Picture transmission is not, as many think, a modern art. It is as old as the communication art itself, and this paper carries us through the work, ancient and modern, of photo-transmission engineers, commencing with that of Alexander Bain, in 1842.

A Denison facsimile of telegraph tape, taken in 1901, is shown, together with examples of the work of Korn taken in 1922; that of Hart-Lane in 1922; Bélin, 1924; Ferree, 1924; Jenkins, 1924; and results of the A. T. & T. system in 1925.

The basic elements of all picture transmission systems are shown to consist of synchronously covering a surface, point by point, at both transmitter and receiver, and electrically identifying point values at the receiver so that any integral section of the received copy will have the same relative tonal value as the identical integral section on the transmitting surface.

Economics is as important a factor in the transmission of pictures as it was in the establishment of a telegraphic system of communication, and the reason that the Morse code still exists is because it is the most economical means of getting a given amount of words from one point to another, in the shortest time, with the least power, over the greatest distance, and through the greatest amount of interference. The necessity of a picture shorthand was visualized and developed. Whereas the usual newspaper half-tone has 65 dots to the inch, and 5 tonal values are desired per dot, making a total of 325 photo-pulses per inch, the picture shorthand developed in the photoradiogram system reduced this to 65 photopulses per inch, giving a reduction, or shorthand ratio, of 5 to 1.

The photographic angle of the problem is touched on lightly, and the 11,000,000 mile-a-minute flight of the picture pulses from the transmitter to the receiver are followed through their several transformations in "slow-motion."

The development of this system of picture transmission is shown graphically by examples of photoradiograms taken from epochal stages in the course of the development. The commercial possibilities of this system are discussed, and in closing, it is pointed out that one very immediate and effective use to which photoradiograms will be put is in the transmission of words, printed, typewritten, or handwritten.

# ELECTRAD

New!



ELECTRAD  
Heavy Duty Metallic Resistor

Specially developed for B eliminators and power supply units.

Special features are:

- 1—High current-carrying capacity.
- 2—Non-inductive. Accurate calibration.
- 3—Low temperature coefficient.
- 4—Resistance element fused to inside of Lavrock tube.
- 5—All standard high resistance sizes.

List price \$1.00; in Canada \$1.40

Ask your dealer for detailed Circular

ELECTRAD, Inc.

428 Broadway New York City

# ELECTRAD

## If Your Set Won't Percolate

write us about it. RADIO BROADCAST is establishing a special repair department to assist set builders in getting the best out of the receivers they build from plans published in the magazine. Write for complete information about this new department established for your benefit.

Holtzer-Cabot



## REPRODUCING UNIT

Many Receiving Set Manufacturers who supply built-in speakers are now using this high grade unit.

QUALITY AT A PRICE

with a factory back of it able to take care of any quantity required is what Holtzer-Cabot has to offer you.

SPECIFIED DELIVERIES ASSURED

Manufacturers write for full particulars

THE HOLTZER-CABOT CO. ★

Manufacturers of signal apparatus for fifty years  
125 Amory St. 6161-65 S. State St.  
Boston, Mass. Chicago, Illinois

R344.3. TRANSMITTING SETS. SHORT-WAVE  
*Popular Radio*, April, 1926, pp. 348-355. TRANSMITTER.  
 "How to Build and Operate a Low Power Transmitter,"  
 G. Fraser.

Complete details covering specifications for constructing a low power transmitter working on the higher frequencies (80 and 40 meters), are presented. A list of parts, including the size of meters, a circuit diagram, and photographs of completed sets are shown.

R381. CONDENSERS. CONDENSERS,  
*Radio*, March, 1926, pp. 8-10.  
 "Paper Condensers," A. Nyman.

The mechanical and electrical properties of manufactured paper condensers, are given. Paper condensers are usually impregnated under pressure, the variation of pressure effecting the capacity as shown by a graph. The breakdown voltage, the life of a condenser, and the resistance, is determined by test, these factors entering into the manufacture. The methods of building up paper condensers, and the right and wrong way of making lead contacts to the foil, determine the operating characteristics.

R900. MISCELLANEOUS.  
*Proc. I. R. E.*, April, 1926, pp. 181-195.  
 "Sleet Removal from Antennas," J. H. Shannon.

A method is described for automatically releasing the antenna wires in case of an excessive sleet load. Also a new type of suspension condenser is described, which was developed for the sole purpose of preventing the low frequency energy going to the ground and thus making it possible to melt sleet from the individual antenna wires of the multiple tuned antenna without the use and inconvenience of complicated switching at each ground point. The mechanical as well as the electrical design of this condenser is unique. Further, it is believed that dinotrips and pliotrips can be adopted to power transmission lines in such a way as to prevent a big percentage of interruptions. These pieces of apparatus can be so arranged as to automatically introduce into the lines at intervals, additional lengths of conductor, and thus increase the sag. It is expected that for long spans over canyons, these would be almost indispensable.

510. NAVIGATION, APPLICATION OF RADIO TO. MARINE  
*Proc. I. R. E.*, April, 1926, pp. 197-204. RADIO.  
 "Recent Advances in Marine Radio Communication,"  
 T. M. Stevens.

It is stated that the development and use of vacuum tube apparatus by commercial and government stations has not only doubled the range of marine communications, but at the same time has made it possible to carry on a more extensive service with a far smaller number of corresponding stations on shore. Due to the much sharper waves emitted by vacuum tube transmitters, a greater number of channels have been opened for marine communications, which has resulted in the development of multiplex stations where marine activities are concentrated. Discontinuance of the use of spark apparatus at coast stations, and to a large extent on shipboard, has almost totally eliminated the interference formerly caused by spark stations.

R213. HARMONIC METHOD GENERATOR FREQUENCY  
 OF MEASURING FREQUENCY. CALIBRATION.  
*Proc. I. R. E.*, April, 1926, pp. 213-216.

"A Method of Calibrating a Low Frequency Generator with a One-Frequency Source," S. Harris.  
 A simple method of calibrating an audio-frequency generator is described, a standard single frequency source of oscillation, in the form of a 1000-cycle carbon-contact tuning fork, being employed. The mathematical derivation of the final relations existing, are presented. The method makes use of the harmonics of the standard source and of the generator under calibration.

R343. ELECTRON TUBE RECEIVING NEUTRODYNE.  
 SETS.

*Proc. I. R. E.*, April, 1926, pp. 217-247.  
 "The Shielded Neurodyne Receiver," J. F. Dreyer, Jr.,  
 and R. H. Manson.

A brief historical outline of the development of the neurodyne receiver precedes the discussion of the construction and operation details of the improved neurodyne. The unshielded neurodyne presents many difficulties according to the paper, and these can only be overcome, with considerable overall efficiency for the receiver, if magnetic shielding is employed. Many of the magnetic and static fields which give trouble are taken up in the discussion. Using a shielded receiver of the Stromberg-Carlson type, three or four stages of r.f. coupling can be employed without stray interferences spoiling reception, neutralization may be made perfect, coil pick-ups on intermediate circuits from the outside are eliminated, and tuning adjustments may be reduced to two. The commercial design and construction of the new Model 610 Stromberg Carlson receiver is shown and described in detail.

R560. MILITARY ARMY AMATEUR  
*Radio*, April, 1926, pp. 8ff. RADIO

"Army Amateur Radio Nets," R. Lohry.  
 Plans, whereby the transmitting stations of amateurs are organized to furnish communication channels for the National Guard and reserve components of the Army of the United States, are presented. These plans include the appointment of several radio stations in each Army Corps Area to carry out the work outlined. A certificate of appointment is issued the chosen applicant, who gives his services voluntarily, but he may withdraw at any time he chooses.

R343.5 HETERODYNE RECEIVERS. SUPER-HETERODYNE.  
*Radio*, April, 1926, pp. 10ff. Best's Five Tube.  
 "Best's Five-Tube Super-Heterodyne," G. M. Best.

Best's five-tube, antenna connected, super-heterodyne receiver is shown and described. The intermediate frequency used is optional with the builder, the frequency to choose depending upon the frequency of any close-by broadcasting station, according to the author. Complete data on the constructions of this intermediate transformer are given. The salient features claimed for this new circuit are: Selectivity, even with the antenna connection; superb quality of output, due to the use of crystal detectors and high grade audio amplifiers; excellent volume with cone type loud speaker, by use of a power tube; economy in battery consumption, as only five tubes are required; and ease of assembly. Complete details are presented.

You can use any combination of tubes in the same set with the

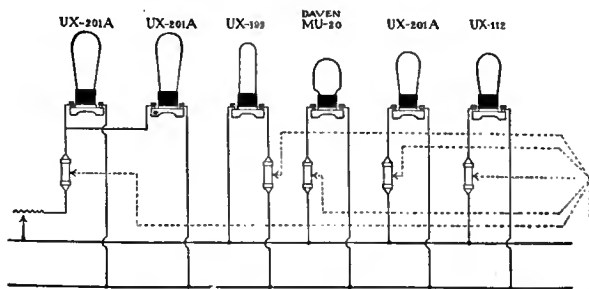

## TUBE EQUALIZER SYSTEM of Automatic Rheostats

THESE pre-adjusted cartridge rheostats (or Equalizers) deliver the correct amount of filament current to the tubes automatically.

This system prevents overloading . . . gives control of volume without distortion . . . eliminates several rheostat knobs . . . and makes the installation of a filament meter unnecessary.

The individual Equalizers retail for but 50c. or 75c. with mount. It is cheaper to use them than rheostats. They take up less room, and, being on the base-board, they shorten the leads and make a neater looking job. And any combination of tubes may be used in a set so equipped. Write for complete Equalizer System folder.

**JOBBER, DEALERS**  
 Look Well to Your Next Set

**MANUFACTURERS**  
 Save 10c. to 20c. on Each Set

The modern radio set has this automatic filament control. Before getting behind any set next season, look into this thoroughly. Already a number of well known sets are Elkay equipped. We shall be glad to give you the names of these.

The Elkay Tube Equalizer System enables you to omit several adjustments, needless wire, and an expensive filament meter. Our low quantity prices will be sent you gladly; also a sample set of Equalizers if you are a bona fide manufacturer.

**THE LANGBEIN-KAUFMAN RADIO CO.**  
 Dept. R, 511 Chapel St., New Haven, Conn.



Now is the time to subscribe for RADIO BROADCAST  
 Through your dealer or direct, by the year only \$4.00  
 DOUBLEDAY, PAGE & CO. GARDEN CITY, NEW YORK

For Better Radio

# Hammarlund

PRECISION PRODUCTS

Send 10 cents for illustrated booklet, "How to Build the Hammarlund-Roberts Receiver"

HAMMARLUND MANUFACTURING CO.  
 421-438 West 33rd Street  
 New York City

# ELECTRAD

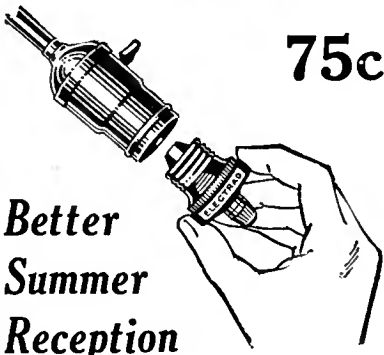

75c

**Better  
Summer  
Reception**

with  
**ELECTRAD Lamp  
Socket Antenna**

Thousands have found the way to better summer reception with this simplest of all antennas. Just screw it into any lamp socket in the house and get volume, distance, clarity, with a minimum of static and of interference from neighboring sets. End lightning worries.

Consumes no current. Absolutely safe. Tested and certified electrically. At most good radio stores, price, 75c. In Canada, \$1.10. ★

# ELECTRAD Inc.

New York City

**Thorola Receivers  
and Speakers ★  
Must Outperform**

Reichmann Company, 1725-39 W. 74th St., Chicago

# FROST-RADIO

This is the new **FROST-RADIO**  
Bakelite  
Rheostat **LIST 75c**

An air-cooled Bakelite base rheostat of superior construction and design; has ample heat-radiating capacity and is sturdily made, operates smoothly and noiselessly and positively will not heat up even after hours of use if proper resistance is selected. Equipped with **FROST-RADIO** Bakelite pointer knob and tinned soldering lugs. Made in 2, 4, 6, 10, 20, 25 and 30 ohm types, 75c, and 200 or 400 ohm potentiometer, \$1.00. Ask your dealer which type is best for your set. ★

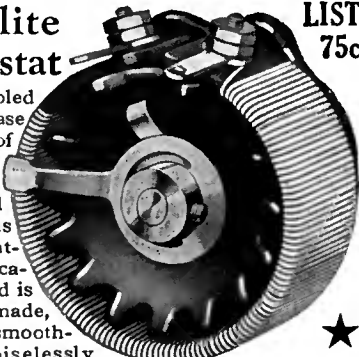

**HERBERT H. FROST, Inc.**  
314-324 WEST SUPERIOR ST., CHICAGO, ILL.  
New York City Cleveland Kansas City  
Los Angeles

R430. INTERFERENCE ELIMINATION. INTERFERENCE.  
*Proc. I. R. E.* April, 1926, *Method of Reducing.*  
pp. 249-262.

"A New Method Pertaining to the Reduction of Interference in the Reception of Wireless Telegraphy and Telephony," H. de Bellescize.

The usefulness of directional reception and of resonant circuit selectivity in reducing the effect of atmospheric disturbances of reception is first considered. Assuming that sinusoidal forces coexist in a system with much larger impulses, it is shown that they will not pass through systems having internal frictional losses under certain definite conditions. The analogy between mechanical frictional systems and magnetic hysteretic systems is utilized in devising differential circuit arrangements whereby strong impulses, passing through two opposing circuits of controllable hysteric damping, are ultimately balanced out, whereas smaller sinusoidal currents are delivered at the output of the system. The application to radio reception is described in detail.

R113.6. REFLECTION; REFRACTION; REFLECTION,  
DIFFRACTION. *Short-Wave.*

*Radio.* April, 1926, pp. 21-23.

"Short-Wave Reflection Phenomena," F. W. Thatcher. The author presents an analysis of experimental observations made on the higher frequencies (80, 40, 20-meter band) over a period of several months. Comparison is made with like phenomena occurring in the case of light waves, since radio waves and light waves are electromagnetic in nature, and therefore subject to the laws of reflection and refraction. The conclusion arrived at shows that each band has a maximum and minimum average range, and all three bands are necessary to effectively cover both short and long distances during twenty-four hours of the day.

R402. SHORT WAVES. SHORT-WAVE  
*Radio.* April, 1926, pp. 29ff. RECEIVING.

"The Efficient Reception of Short Waves," W. L. Nye. A summary discussion of the various types of well known circuits as applied to the reception of the higher frequencies, is presented. The Hartley, Reinartz, Colpitts, the standard three-circuit, and the capacity-controlled feedback, are several of the circuits mentioned. Each circuit has its own peculiarities which must be taken into consideration, although all of them give about the same results, states the writer.

R386. FILTERS. FILTER  
*Radio.* April, 1926, pp. 31ff. DESIGN.

"Design of Low-Pass Filters," J. B. Dow. Various arrangements of inductance and capacity filters are shown diagrammatically, and their particular application to a 60-cycle frequency circuit considered. The arrangements presented are divided into three groups, each group having its peculiarities regarding "attenuation" and "cut-off frequency." The details of design of these circuits are presented mathematically, and then the ideas applied to specific problems.

R402. SHORT WAVES. TRANSMITTER,  
*QST.* April, 1926, pp. 8-13. *Short-wave*

"Breaking Into Amateur Transmission," J. M. Clayton. A description of an inexpensive short-wave transmitter using ux-210 tubes, is given for the benefit of the beginner in amateur radio. Details of construction of the various parts are worked out, a list of materials given, and complete assembly is shown.

R281.9. INSULATING MATERIALS. ISOLANTITE.  
*QST.* April, 1926, pp. 14-16.

"Isolantite—A Unique Material," A. C. Lescarbourea and R. S. Kruse. A new insulating material, Isolantite, is being extensively used in radio apparatus because of its hardness, toughness, moisture-resisting qualities, and exact machining properties. The authors describe the new material, how it is machined and then hardened by a special heat-treating process. Its dielectric strength is over 30,000 volts per millimeter. The phase angle is less than .010 degree, showing low dielectric losses. The dielectric constant is 3.6 and at 50 per cent. relative humidity, the resistivities are  $6 \times 10^{14}$  ohms per cc. and  $5 \times 10^{18}$  ohms per sq. cm.

R343. ELECTRON TUBE RE- MU-RAD RECEIVER.  
CEIVING SETS.

*QST.* April, 1926, pp. 17-22.  
"The Making of a Single-Control Receiver,"  
A. S. Blatterman.

The electrical details to be taken into consideration in a single-control two stage r. f. amplifier are outlined in connection with the Mu-rad receiver. In designing a new type of r. f. transformer, the circuit characteristics inherent in the intermediate stages of the set had to be made equal to those in the first stage or antenna tuning coil. This necessitated considerable research and investigation concerning the effects of coil and tube capacities on each other. For specific reasons, the volume is controlled by varying the plate potential in the r. f. stages. Diagrams and photographs are presented to give the necessary details.

R356. TRANSFORMERS. TRANSFORMERS,  
*QST.* April, 1926, pp. 29-32. *Audio.*

"Peaked Audio Amplifiers," R. S. Kruse. In order to obtain maximum volume in c.w. telegraph receivers without introducing too much distortion and interference, the audio stage transformers should have a definite peak which should fall somewhere around 1000 cycles, says the author. The amount of peak, or sharpness, can either be made permanent through specific transformer construction or controlled through outside circuit arrangements. Since the tube impedance as well as the various circuit constants affect the location of this peak and its value, each circuit must be analyzed for best results.

R3763. LOUD SPEAKING REPRODUCERS. DIAPHRAGMS.  
*Radio News.* April, 1926, pp. 1410.

"A New Loud Speaker Diaphragm," G. S. Bennett. A new type of loud speaker diaphragm is described. It is made of a metal skeleton with a special parchment paper cemented to the metal. This method of construction is said to have remarkable reproducing qualities when used as a vibrating element in loud speaker units. Illustrations show method of making and using this new diaphragm.

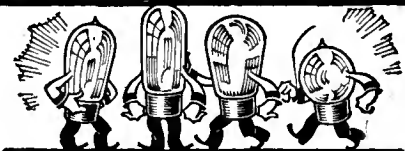

## Use any tubes

Any type or combination of Tubes can be used with AMPERITE. Insures filament regulation to meet each tube's individual needs. Specified in all popular construction sets. Price \$1.10.

**Radiall Company ★**  
Dept. R.B.-7 50 Franklin Street, New York City



IF you like this magazine with its coated paper and enlarged size—then why not subscribe and get it regularly—by the year, \$4.00, Six months, \$2.00.

Doubleday, Page & Co.  
Garden City New York

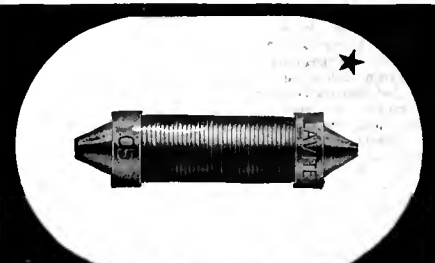

# AEROVOX

"Built Better"

**LAVITE RESISTANCES**  
Used by over 200 of America's leading set manufacturers, AEROVOX Fixed Mica Condensers have been approved by M. I. T., Yale, Radio News, Popular Radio and Popular Science.  
**AEROVOX WIRELESS CORP.**  
489-491-493 Broome St., New York  
Branch Offices:  
St. Louis, Mo., Syndicate Trust Building  
Cincinnati, O., 304 Palace Theatre Bldg.  
Chicago, Ill., 53 W. Jackson Boulevard  
Boston, Mass., 94 Portland Street  
Los Angeles, Cal., 324 N. San Pedro St.

R376.3. LOUD SPEAKING REPRODUCERS. LOUD SPEAKERS.

*Radio News*, April, 1926, pp. 1422ff.  
 "The Passing of 'Canned Music,'" Major J. S. Hatcher.  
 Major Hatcher reviews the developments made in sound reproduction, referring both to the radio and the phonograph reproducers in this article. The exponential horn is considered the proper type of horn to use for reproduction on high and low frequencies, the "cut-off" frequency at the lower range depending upon the rate of expansion. Thus a long horn is better than a short one, he says.

R382. INDUCTORS. TOROIDAL COILS

*Radio News*, April, 1926, pp. 1436 ff.  
 "All about Toroid Coils," S. Harris.  
 Toroid coils, with their confined field, are used mostly in r. f. amplifier stages, where magnetic coupling between stages is not desired. Their method of construction, and the relation existing between inductance, wire size, coil diameter, and number of turns, is compared in the several graphs and the accompanying discussion.

R148.1. DISTORTION. DISTORTION.

*Radio News*, April, 1926, pp. 1438-1439.  
 "What is Distortion," Dr. A. Anderson.  
 It is the writer's purpose to emphasize that distortion covers a multitude of sins, and to point out some of the most common types of distortion found in a radio receiver. Enumerated, these are primarily: Wave deformity, static, microphonic tubes, poor loud speakers, poor contacts, internal electrolytic action of B batteries, and poor broadcasting. All of these sources of trouble are taken up in turn, analyzed, and remedies suggested.

R134.4. REGENERATIVE ACTION. REGENERATION.

*Radio News*, April, 1926, pp. 1440ff.  
 "What is Regeneration," K. W. Jarvis.  
 The principles of regeneration, or "feed-back," in radio receivers, are analyzed. Regeneration results when a higher voltage is produced across the tuned plate coil than across the grid circuit of the same tube. The part the tickler plays in setting up oscillations is very important, and is considered at some length. A fundamental principle is emphasized, namely, that the voltage across the tuned circuit will always adjust itself to such a value that the power loss and the power input are equal. The author proceeds to prove that regeneration and oscillation are one and the same thing. (Continued in May issue).

R381. CONDENSERS. CONDENSERS.

RADIO BROADCAST, May, 1926, pp. 33-36.  
 "Will the New Type of Condenser Improve My Set," K. B. Morecross.  
 The three types of condensers, s. l. c., s. l. w., s. l. f., are compared, their advantages and disadvantages in circuits discussed, and curves presented showing the relation existing between capacity, frequency, and wavelength, against dial settings. Formulas are given showing by what method the s. l. f. and the s. l. w. condenser plates are designed. Many makes of condensers are shown in the photographs accompanying the discussion.

R090.1. HISTORY: UNITED STATES. HISTORY

RADIO BROADCAST, May, 1926, pp. 19-22.  
 "Breaking Into the Wireless Game," J. M. Baskerville.  
 Mr. J. M. Baskerville gives an account of his experiences in the field of wireless telegraphy during the early days of its history. Back in 1905, he installed some of the first wireless sets on shipboard, and operated installations on land and sea. The early history of wireless is graphically told by the author. He shows a daily "wireless" newspaper of the year 1906.

621.354.3. BATTERY CHARGING DEVICES. CHARGERS.

RADIO BROADCAST, May, 1926, pp. 47-51.  
 "Trickle Chargers for Your A Battery," J. Millen.  
 The author covers in detail the commercially available types of chargers and power units used in supplying A battery current to receiving sets. Constructional details are also presented for making a trickle charger of the lead-aluminum type.

R073. TRAINING OF OPERATORS. CODE FOR OPERATORS.

RADIO BROADCAST, May, 1926, pp. 56-59. OPERATORS.  
 "Easy Methods of Conquering the Radio Code," E. H. Felix.  
 The fascinating game of wireless telegraphy in the dot and dash language is related in this article. Mastery of the code is essential in order to listen-in on the amateur and commercial channels which the broadcast listener knows nothing about. How to proceed in learning the code, how to send and receive, and how to build a simple long-wave receiver to tune in on the long-wave time signals which are detailed in an accompanying schedule of transmissions, is told by the writer.

\$1000 For Radio Essay

WE ARE informed by the Faculty of Law of Northwestern University that the sum of one thousand dollars, together with a suitable medal, will be awarded to the author of the best essay, or monograph, submitted by March 1, 1927, on "The Law of Radio Communication," the scope to include the aspects of the subject as a problem of international law and as a problem of legislation in the United States. The prize is known as the Linthicum Foundation Prize, and is one of two, the second being on the subject of "Scientific Property." To be eligible for the award, the author must be, at the date of submission, a member of the bar or a student registered in a law school in the United States or Canada. The full conditions of the award may be obtained by writing to: The Linthicum Foundation, Northwestern University Law School, Chicago, Illinois.



Permanence!

The Metallized character of this grid-resistor renders it impervious to temperature changes under normal operating conditions. Guaranteed to maintain its resistance value permanently.



Metallized!

DURHAM Metallized RESISTORS



Durham Resistor Mounting

Made of moulded insulation of exceptionally high resistance. Has best quality, tension-spring, bronze contacts. The only upright mounting made. Occupies but little space in set.

Single mounting . . . . 50c.  
 For condenser . . . . 65c.

THE Durham Metallized Resistor is a laboratory perfected grid-resistor developed by two scientists of a leading university.

A glass wire of uniform diameter is accurately spun and passed through an ingenious, chemical and high temperature process, forming a thin conducting layer of high resistance. The glass wire with its conducting Metallized filament is then treated with a protective insulating material to render it impervious to atmospheric conditions, mounted in glass tubes, and soldered to terminal, brass caps forming either end of the completed resistance unit.

500 ohms to 10,000 ohms . . . . . \$1.00  
 Above 10,000 ohms to .24 meg. . . . . .75  
 .25 meg. to 10 meg. . . . . .50

DURHAM METALLIZED RESISTORS

International Resistance Co.  
 Dept. D, Perry Building Philadelphia, Pa.



This is a good time to subscribe for

RADIO BROADCAST

Through your dealer or direct, by the year only \$4.00

Doubleday, Page & Company

Garden City, New York



Radio Battery Chargers

Best by Test ★

\$850 minus bulb

east of Rockies

Your dealer can get it for you

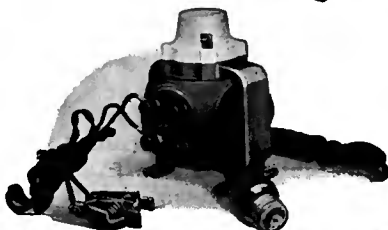

THE ACME ELECTRIC & MFG. CO.  
 1410 Hamilton Avenue Cleveland, O.



# ACME FLEXIBLE CELATSITE

Flexible, stranded wire for point-to-point and sub-panel wiring. Non-inflammable "spaghetti" covering. In black, yellow, green, red and brown; a color for each circuit. Put up in 25-foot coils.



### The Original Celatsite

—a tinned, copper bus bar wire with non-inflammable "spaghetti" covering, for hook-ups. 5 colors; 30-inch lengths.

### Celatsite Battery Cable

—a silk-covered cable of vari-covered Flexible Celatsite wires, for connecting batteries to set. Prevents

"blowing" of tubes; gives your set an orderly appearance.

We also offer the highest grade of "spaghetti" tubing for Nos. 10 to 18 wires. 5 colors; 30-inch lengths.

### Stranded Enamelled Antenna

Best outdoor antenna you can buy. 7 strands of enameled copper wire; maximum surface for reception. Prevents corrosion and consequent weak signals.

Send for folder

THE ACME WIRE CO., DEPT. B  
NEW HAVEN, CONN.

★ **ACME WIRE**  
MAKES BETTER RADIO

Make any Good Receiver **BETTER**

★ **CC TUBES**

C.E.MFG. CO.  
Providence R.I.

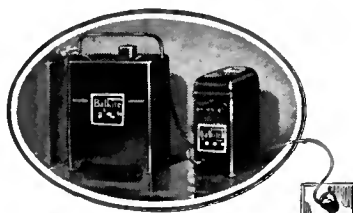

★ **Noiseless-  
full radio power  
from the  
light socket with  
Balkite "B" & Balkite  
Battery Charger**

FANSTEEL PRODUCTS CO., Inc.  
North Chicago, Illinois

(Continued from page 268)

instance Radio Paris, 171 kc. (1750 meters), and Koenigswusterhausen, Germany, 231 kc. (1300 meters), came in at very good strength. In the writer's opinion, the Roberts performed far better on the long waves than on the broadcast waveband. If interchangeable coils are used, a set could be adapted to either waveband at will; to keep the set neutralized with both sets of coils, the neutralizing condensers could be attached to the coils. The ends of the coils could be fitted with pins, similar to the General Radio formers, these pins would then engage in suitable bases.

### SOLENOID COILS

THE next step was to see what results could be expected with solenoid coils wound with very fine wire. Unfortunately, at the time of writing, these experiments have not been concluded, but the following

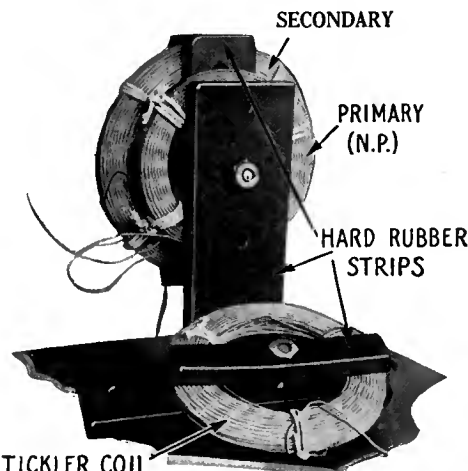

R.F. TRANSFORMER  
FIG. 2

may be of interest. A three-inch form wound with about two hundred turns of fine wire—about No. 28 gauge—brings in Daventry quite well on a straight crystal set; and Daventry is 180 miles away!

This coil is about 1 $\frac{3}{4}$ " long, so that quite compact long-wave coils seem to be possible. If only American manufacturers would go into the matter of long-wave Roberts and Browning-Drake coils, fans of all nations will benefit, and in the next International Tests, American DX hunters would stand a good chance of hearing Daventry and other European long-wave high-power stations.

Another plan would be to make the long-wave set to tune to a band having a maximum of about 120 kc. (2500 meters). In this case, the long-wave stations could be received with the "straight" set, while to receive the stations transmitting on the standard broadcast band, an O'Connor frequency changer could be used. This latter was described in the June and August, 1925, issues of RADIO BROADCAST. With suitable oscillator couplers, even the very short-wave stations could be received.

By referring to the circuit diagram of the four-tube Roberts on Laboratory Information sheet No. 10, and the data on sheet No. 9, the positions and size of the coils will be clearly understood.

### A NEW HOYT METER for RADIO



### The HOYT "Tip-In" Voltmeter

This is one of the new HOYT Meters for Radio. A moving-coil meter in a beautiful bronze finish case, for plugging into the jacks on the Radiola, Victor, and Brunswick Sets. A unique swivelling arrangement makes possible inclination of the meter at any angle, for easiest reading.

HOYT has added many new meters to the Radio line—a pocket A.C. voltmeter, for testing line voltage, a B-Eliminator Voltmeter, the HOYT Radio CELLCHECK—a universal low-priced cell-tester replacing the Hydrometer—the HOYT Direct Reading Static Tube Tester and Universal Test Set Model 200—which gives mutual conductance, amplification factor and plate-impedance of all kinds of vacuum tubes without calculation. HOYT has a new line of pocket meters in beautiful bronze-finish cases which should be the fastest selling pocket meter in the Radio field for 1926-27.

Send for catalogue "HOYT Meters for Radio."  
BURTON-ROGERS COMPANY ★  
26 Brighton Ave., Boston, Mass.

**Big FREE RADIO**  
*Catalog & Guide*  
**PARTS, HOOK-UPS, SETS and KITS**  
Send now for this valuable FREE book. Full of advanced hook-ups, parts and kits. A real guide. Shows factory built sets and the new ideas in radio. Send at once. No charge. No obligation. Please include name of radio fan.

**BARAWIK CO.**  
102-109 S. Canal St., Chicago

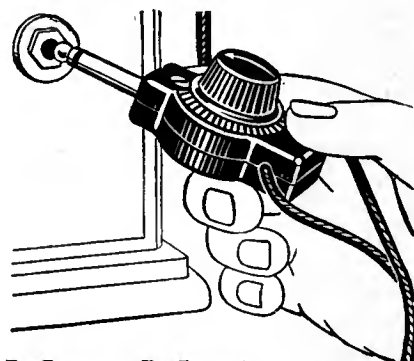

**More Music  
Less Noise**

Centralab Modu-Plug gives any degree of tone volume—to suit your mood—by the simple turn of a knob. Replaces your loud-speaker plug. Reduces apparent static; brings programs through soft and sweet. A great improver of summer radio!

\$2.50 at your dealer's, or order direct.

Central Radio Laboratories  
22 Keefe Ave. Milwaukee, Wis.

**Centralab**



# WHAT OUR READERS WRITE



## A Bouquet from Australia

ON PAGE 224 of the December RADIO BROADCAST, appeared a list of Australian broadcasting stations which was forwarded to us from Australia by Mr. A. W. Watt, editor of Australian *Wireless Weekly*. Here is an excerpt from a later letter from Mr. Watt which followed the publication of the list in question.

Editor, RADIO BROADCAST,  
Doubleday, Page & Company,  
Garden City, New York.

Sir:  
I am glad to see that you accepted my little correction of Australian broadcasting stations in the spirit in which it was offered. Perhaps I should tell you that I regard RADIO BROADCAST as the best radio publication put out in the United States. This is not merely idle flattery, but the opinion is based on direct comparisons which I have made for a long time between all your American radio journals.

Very truly yours,  
A. W. WATT,  
Editor.

## Criticizes Mr. Marriott's Statements

IN HIS article entitled "How Radio Grew Up," which appeared in the April, 1926, RADIO BROADCAST, Mr. Marriott referred to Guglielmo Marconi as a sales engineer, substantiating his belief by remarks to the effect that Marconi's patent taken out in England in 1896 was merely a combination of the Hertz-Branly-Lodge-Tesla-Popoff devices. Now, whether or not these statements are entirely justified, is a matter of opinion, so it was with considerable interest that we read the following letter from Mr. Packman, who is the vice-president of Dodge's Telegraph, Railway Accounting, and Radio (Wireless) Institute.

Editor, RADIO BROADCAST,  
Doubleday, Page & Company,  
Garden City, New York.

SIR:  
To anyone who is familiar with the developments in the art of radio communication, and who has studied the discoveries in the field of science which preceded it, it must be with deep resentment that he reads the statements in Mr. Marriott's article "How Radio Grew Up," which appeared in your April issue. In fairness to Marconi, and as a matter of common honesty, it seems that the least you can now do is to make an effort to correct the erroneous impressions which such an article must leave in the minds of the present generation of radio enthusiasts.

The history of wireless telegraphy dates back to the earliest days of the Morse telegraph, and many schemes, both practical and impractical, were proposed and tried out with varying degrees of success, over short distances. Prominent among the names of the early experimenters are those of Morse, Lindsay, Trowbridge, Hughes, Dolbear, Edison, and Preece. It must be recognized, however, in considering these names, that there is a difference between wireless telegraphy and radio telegraphy. Radio telegraphy, as we use the term to-day, is one form of wireless telegraphy, but the wireless telegraph systems used by the experimenters named above were

THE TUBE WITH THE SENSIBLE GUARANTEE



# A lucky break!



Vibrationless, Uniform and Good



"Granted—that all Radio Tubes test good before they are shipped from factory."

"But—due to ordinary interior construction, the mere handling of tubes in transit invariably disorders the tube."

"Therefore—if it works after you buy it—

*It's a Lucky Break!"*

The new and improved Supertrons are internally reinforced to withstand handling.

When you buy Supertrons you buy permanent quality as long as the tube lives—and it lives longer than others.

SUPERTRON MFG. CO., Inc., Hoboken, N. J.  
Export Dept. 220 Broadway, N. Y. C.



## SUPERTRON

A SERIAL NUMBER GUARANTEE

The Foremost Independent Tube In America

## LEARN THE CODE AT HOME with the OMNIGRAPH

"Just Listen—The Omnigraph will do the teaching!"

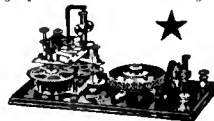

THE OMNIGRAPH Automatic Transmitter will teach you both the Wireless and Morse Codes—right in your own home—quickly, easily and inexpensively. Connected with Buzzer, Suzzer and Phone or to Sounder, it will send you unlimited messages at any speed, from 5 to 50 words a minute.

THE OMNIGRAPH is not an experiment. For more than 15 years, it has been sold all over the world with a money back guarantee. The OMNIGRAPH is used by several Depts. of the U. S. Govt.—in fact, the Dept. of Commerce uses the OMNIGRAPH to test all applicants applying for a radio license. The OMNIGRAPH has been successfully adopted by the leading Universities, Colleges and Radio Schools.

Send for FREE Catalogue describing three models. DO IT TO-DAY.

THE OMNIGRAPH MFG. CO., 13K Hudson St., New York City

If you own a Radio Phone set and don't know the code—you are missing most of the fun



"Sets that Jack and Dad Built"

This 50-page manual for building the most popular circuits sent for 25c to cover cost of postage and mailing.

# INSULINE

The Premier Panel Material

Drilled and decorated panels of Insuline in black, mahogany and "frieze" finish, also sub-panels mounted with sockets, are now furnished for over 20 popular circuits.

Insuline has greatest dielectric strength, by actual test, hence eliminates leakage losses, insuring better reception.

If your dealer can't supply the genuine Insuline, send to us direct. Write today for Free Booklet B.

INSULATING COMPANY OF AMERICA, INC.

Insuline Building

59 Warren Street, New York



*Immediate Shipment from Stock*  
**HAVE MERCHANDISE WHEN YOU NEED IT**  
*Catalog 466-B is free to dealers*

WHOLESALE

EXCLUSIVELY

# LUDWIG HOMMEL & CO

929 PENN AVENUE



PITTSBURGH, PA.



8D-18—Includes the NATIONAL Equicycle (straight line wave length) Condenser and the genuine BROWNING-DRAKE Inductance Coil with the new Type B Dial. Price \$18.25.

**The New NATIONAL Tuning Units**

Comprising the genuine BROWNING-DRAKE SPACE WOUND TRANSFORMER and the

NATIONAL Velvet Vernier Dials and Condensers

Are now in the hands of your dealer. Their beauty and efficiency will greatly surprise you. See them at your dealer's. Send for Bulletin 107 R. B.

NATIONAL COMPANY, Inc.

W. A. Ready, Pres., 110 Brookline St., Cambridge, Mass.

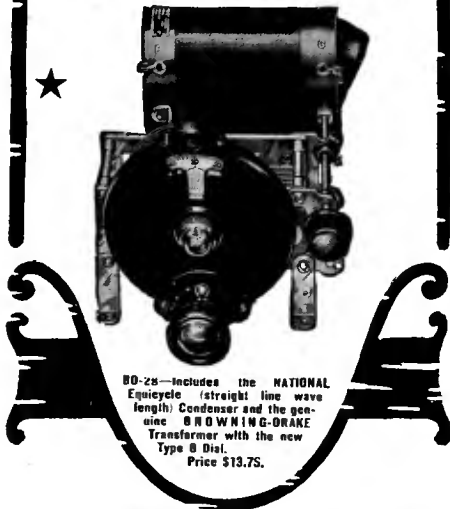

8D-25—Includes the NATIONAL Equicycle (straight line wave length) Condenser and the genuine BROWNING-DRAKE Transformer with the new Type B Dial. Price \$13.75.

**Could You Use More Money?**

No matter what your present income is, wouldn't you like some extra cash?

Well, here's your chance to get it!

DOUBLEDAY, PAGE & CO. wish to enlist earnest and reliable men and women throughout the country who will appreciate an opportunity to make money.

Our plan insures immediate cash returns, in amounts limited only by your own ability.

This is no ordinary subscription proposition. You can't afford to overlook it.

Write: Agents' Service Division

DOUBLEDAY, PAGE & CO. Garden City New York

not radio. Their systems were based on various electromagnetic and electrostatic-induction processes, or on conduction through the earth, or through water. There is no evidence that any of them had any notion, whatever, of free traveling electromagnetic waves. Dolbear and Loomis both show antennas or elevated wires as parts of their system, but they were attempting to utilize what we now term the "induction field" of the antenna, whereas in radio communication we make use of what is termed the "radiation field," that is, that portion of the antenna field which becomes detached from the antenna, when the frequency is sufficiently high.

Radio communication, like many other things which we enjoy to-day, had its beginning in the field of pure science. The names of Helmholtz, Maxwell, Fitzgerald, and other scientists, are so well known, and their work so fully recognized, that no one disputes their association with the beginning of the art of radio communication.

The history of radio communication, as we use this term to-day, is usually dated from 1865, in which year Maxwell enunciated his electromagnetic theory of wave motion. This theory was so abstract, so it is recorded, that even scientists of that day took but little notice of it, and it was not until the publication of Hertz's experiments in 1888 that the subject of electromagnetic wave phenomena became of general interest in the scientific world.

During the next few years, much knowledge was gained by scientists in various parts of the world through the reproduction of Hertz's experiments. Prominent among those taking up this work were Branly, Popoff, Lodge, Fleming, Crooks, and others. Branly invented the coherer, which was a more sensitive detector of electric waves than was the spark gap used by Hertz; Popoff applied the Branly coherer to the recording of electrical phenomena occurring in the atmosphere. In 1892, Crooks published a paper on "Some Possibilities of Electricity," and in speaking of electromagnetic waves made the following statement: "Here then, is revealed the bewildering possibility of telegraphy without wires." The fact remains, however, that it was not until 1895, some seven years after the publication of Hertz's paper, that a successful demonstration of wireless telegraphy, by means of electromagnetic waves, was made, and then by Marconi. It is interesting to note also, that at the time of the publication of Hertz's paper, Marconi was a very young man, in fact, a youth of some fourteen years, whereas Branly, Popoff, Lodge, and others who became interested in Hertz's work, were in their prime.

Mr. Marriott would have your readers believe that Marconi was a faker and a pseudo scientist without technical ability or education, but with a clever bent for sensationalism and commercialism. The facts are that Marconi, by the year 1894, had studied under such notable educators as Professor Rosa, and that he had specialized in physics and had familiarized himself with all that had been done in electromagnetic waves. Furthermore, Marconi's earliest patent application shows not only great creative ability and inventive ingenuity, but that he had a firm grasp of the fundamental principles of electricity. It is true that Marconi made the fullest use of the inventions of Hertz, Branly, and others, to whom he has given full credit in his own papers, but in the adaptation of these devices to a workable wireless telegraph system, he made many improvements. No better proof of this can be found than in the statement of Professor Slaby, who, though he himself had been working on the problem of Hertzian wave telegraphy, frankly admitted after witnessing Marconi's first public demonstration in England, that Marconi had succeeded where he had failed.

Very recently a claim has been put forward by the Russian Soviet to the effect that Prof. Alexander Popoff was the inventor of wireless telegraphy. In an interview relative to this, Marconi stated, "The Soviet's claim was never once put forward by Professor Popoff himself. When I was in Petrograd in 1902 Popoff sent me a telegram—'Greetings to the father of wireless.'"

Marconi brought wireless telegraphy to America in 1899, in which year he reported the races

**See That Screw**

A screw-driver adjusts on X-L in crowded places



**X-L VARIOC DENSER**

**RESULTS** in easier tuning, more distance volume and clarity—greater stability. Indorsed by leading authorities.

**Model "N"** A slight turn obtains correct tube oscillation on all tuned radio frequency circuits. Neutrodyne Roberts two tube, Browning-Drake, McMurdo Silver Knockout, etc., capacity range 1.8 to 20 micro-microfarads. Price \$1.00

**Model "G"** With grid clips obtains the proper grid capacity on Cockaday circuits, filter and intermediate frequency tuning in heterodyne and positive grid bias in all sets. Capacity range .00016 to .00055 and .0001 to .001 microfarads. Price \$1.50

**X-L Push Post.** Push it down with your thumb, insert wire, remove pressure and wire is firmly held. Releases instantly. Price 15c.

**Push Post Panel** permanently marked in white on black rubber. In box including soldering lugs, raising bushings and screws for mounting, etc. Price, \$1.50



**X-L RADIO LABORATORIES**  
2424 Lincoln Avenue Chicago, Ill.

**More thrills to the square inch in Short Stories than in any other all-fiction magazine**

A Doubleday, Page Magazine  
25 Cents At All Newsstands

**ACCUSTI-CONE SPEAKER**



FROM FACTORY TO YOU

Full floating 19 inch cone powerful unit, worth \$25 in a store; save by getting it direct from manufacturer for only **7.50**

Superior to any Speaker, at any price

MONEY BACK IF WE DO NOT PROVE IT ON YOUR SET

Reproduces all high and low tones, true and natural.

Beautiful cone, dust proof wall unit. Packed to go anywhere. Remember you have a free trial. We take all the risk. You don't. Fully guaranteed.

Accusti-Cone Laboratories

96 Church Street, New York, N. Y.

for the America's cup. Prior to this, little had been done with electromagnetic wave telegraphy in this country, and we have few claimants to the honor of inventing wireless telegraphy. In 1901, on the occasion of the next series of races for the America's cup, no less than five American wireless companies were engaged in attempting to report the races, and by one of these companies Mr. Marriott was eventually employed. Mr. Marriott was not one of the pioneers of the art in America, though he has been connected with its development for a long time, long enough to know more about the history of the development than his article would imply. Among those whose names stand out prominently in the commercial development of wireless telegraphy in this country, are those of Fessenden, Stone, Massie, Shoemaker, and DeForest. These were the American pioneers.

In submitting these remarks, it is in the belief that the high standard of RADIO BROADCAST can only be maintained by fair and square shooting, and it is with the hope that you will make an effort to ascertain and publish the facts relative to the question at issue. I personally resent the slur on the good name of Mr. Marconi, the founder of the art which has been my livelihood for more than sixteen years, and I am sure that many other workers in the field must feel the same.

Very truly yours,  
M. E. PACKMAN,  
Valparaiso, Indiana.

*Who Said Bad Reception?*

**WE HAD** firmly made up our minds that the season which is quickly fading into the dim past was about the worst on record, as far as radio reception conditions are concerned, when into our midst flutters the following letter.

Editor, RADIO BROADCAST,  
Doubleday, Page & Company,  
Garden City, New York.

SIR:  
No doubt you have received during the past winter many complaints from radio fans about poor reception, but in this connection I am glad to report my reception for the first year in which I have possessed a receiver, to be very good. I purchased in August, 1925, a five-tube receiver (factory built), and installed it in my home in Philadelphia. I use a 1/4" wide copper tape antenna, about fifty feet long (single wire), and my lead in is about twelve feet long. My receiver is located on the second floor, and it is grounded to a tin roof, which is about twelve feet square. The ground wire is about five feet long, and is soldered to the tin roof.

I have tuned-in about two hundred stations, representing 31 states in the United States, together with Cuba, Mexico, and Canada, and have received proof of reception from 180 Stations, including, KFI, KGO, KPO, CZE, WFAA, PWX, 6 KW, KOA, CNRA, CFCA, and many others. I have tuned-in several 100-watt stations from St. Louis, Florida, and New York. I have received KOA as early as 10 P. M. (E. S. T.), and KFI at 12:00 midnight, and PWX and 6 KW around 10 P. M. I had CZE one night in January about 10:30 P. M. (E. S. T.). The greatest number of stations I have tuned-in in any one night is 77 (from 7 P. M. to 2 A. M.). The following is a list of some of the stations from the various states: 26 from New York, 23 from Illinois, 10 from Missouri, 3 from California, 4 from Texas, 20 from Pennsylvania, 7 from Iowa, 10 from Ohio, 9 from Florida, 8 from Canada, 3 from Wisconsin, 10 from Michigan, 12 from New Jersey. I can prove reception of these stations, both by letter and by verification stamp. All stations were received on the loud speaker.

I think this is very good reception for what is known as a poor radio receiving year, and think I can do much better, if conditions are more favorable, next winter.

Yours very truly,  
C. M. REBOK,  
Philadelphia, Pennsylvania.

# A Point on Your Dial for Every Station! METRALIGN

(Straight Line Tuning)

The Condenser that Prevents Jamming

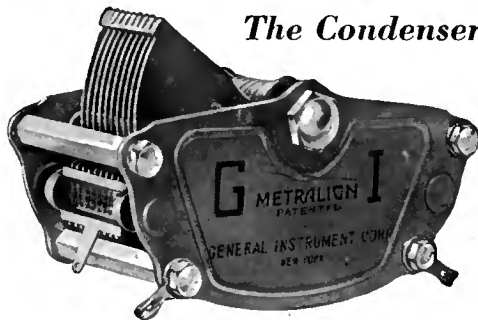

Straight Line Capacity Condensers crowd stations on the low wave lengths. Straight Line Frequency Condensers crowd stations on the high wave lengths.

## METRALIGN

Straight Line Tuning is the only condenser which is equally efficient on both high and low and intermediate wave lengths—and by spreading out the stations evenly over the entire band it naturally makes any

receiver much more **SELECTIVE**. The METRALIGN (SLT) Condenser makes it possible for the owner of any type set to bring in stations which he never heard before.

**FREE** We have prepared a very useful booklet, written in everyday language, covering everything you want to know about condensers. It's **FREE**—Write for it.

### GENERAL INSTRUMENT CORP.

Manufacturers of "Bureau of Standards" Variable Primary Condensers

477 BROADWAY

NEW YORK CITY

### Are You a Radio Dealer?

**WE** want Radio Dealers to get in touch with us as we have an interesting proposition for them in connection with *Radio Broadcast* Magazine.

*Radio Broadcast* is read by a class of readers who have money to spend on radio. The majority of them are radio constructors, they are buying parts and building sets all the time. They are always experimenting because radio is their hobby. Write us for our Dealer's proposition and information on how *Radio Broadcast* will create sales for your store.

RADIO BROADCAST  
Garden City New York

### RADIO PANELS OF GENUINE BAKELITE

Cut, drilled and engraved to order. Send rough sketch for estimate. Our New Catalog on Panels, Tubes and Rods—all of genuine Bakelite—mailed on request.

STARRETT MFG. CO. ★  
521 S. Green Street Chicago, Ill.

SENT ANYWHERE ON 10 DAYS' FREE TRIAL

**5 TUBE RADIO** GUARANTEED  
**BIG POWERFUL MIRACO Ultra S**  
Users everywhere report it gets programs coast to coast, Canada to Gulf, loud and clear on speaker; outperforms \$100 to \$250 sets. Many hear Europe. Mar. \$59.50  
velous value. Let us see your testimonial convinces you. Retail  
**FACTORY PRICES—SAVE** **MIRACO RADIO GETS 'EM COAST & COAST**  
1/3 TO 1/2. Smaller Sets \$13.75 up, retail.  
FREE Literature on latest 1to 8 tube models. (Agents SPECIAL OFFER! Write! new low prices and Dealers) **MIDWEST RADIO CORPORATION** Pioneer Builders of Sets 408-B-E 8th St., Cincinnati, Ohio

RADIO FANS, a one-year's subscription to *Radio Broadcast* will cost you four dollars, two years six dollars. Consider this expenditure as being a necessary investment on your part for the future development of your own knowledge of Radio.

The Allen D. Cardwell Mfg. Co., 81 Prospect St., Brooklyn

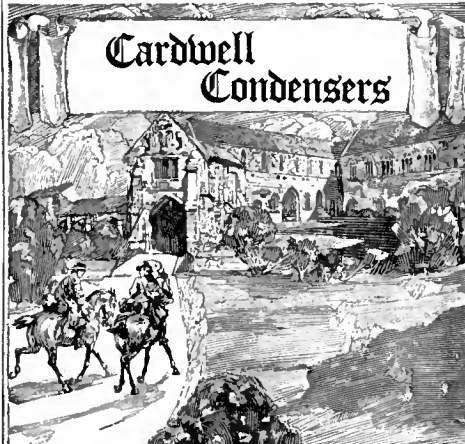

### In Olden Days

—the monastery was the cradle of science and learning. The most scientifically constructed condenser is the Cardwell.

|   |  |
|---|--|
| The Taper Plate Type "E"                      | Modified Straight Wave Length Type "C" for more long wave separation |
| Straight Frequency Concentric Compact Rugged! | ★  |
| PRICES  |  |
| 192E .0005 \$4.00 173C                        | 169E .00015 \$4.75 174C  |
| 168E .00015 \$4.25 170C                       | 167E .00015 \$4.00 168C  |

THE STANDARD OF COMPARISON

# INDEX TO ADVERTISERS IN THIS ISSUE

**A**

Accustj-Cone Lab. ....278  
 Acme Electric Mfg. Co., The ....275  
 Acme Wire Co. ....276  
 Aerovox Wireless Corp. ....274  
 All-American Radio Corp. ....191  
 Allen-Bradley Co. ....258  
 American Mech. Lab. ....255  
 American Transformer Co. ....265  
 Amplion Corp. ....269

**B**

Bakelite Corp. ....271  
 Barawik Co., The ....272-276  
 Belden Mfg. Co. ....189  
 Brach Mfg. Co., I. S. ....271  
 Bremer-Tully Mfg. Co. ....262  
 Burgess Battery Co. ....260  
 Burton-Rogers Co. ....276

**C**

C. E. Mfg. Co. ....276  
 Cable Supply Co. ....267  
 Cardwell, Allen D. ....279  
 Central Radio Lab. ....276  
 Chicago Solder Co. ....268  
 Copper & Brass Research Ass'n. ....266  
 Crosley Radio Corp. ....259  
 Cunningham, Inc., E. T. .... 2nd cover

**D**

Deutschmann Co., Tobe ....254  
 Dongon Electric Mfg. Co. ....256

**F**

Electrad, Inc. ....269-272-274  
 Fansteel Products Co. ....276  
 Frost Co., Herbert E. ....274

**G**

Gearhart-Schlueter ....268  
 General Instrument Co. ....279  
 General Radio Co. ....254-261  
 Goodrich Co., B. F. ....190  
 Grigsby-Grunow-Hinds Co. ....257

**H**

Hammarlund Mfg. Co. ....273  
 Holtzer-Cabot Elec. Co. ....272  
 Hommell Co., Ludwig ....277

**I**

Insulating Co. of America ....277  
 International Resistance Co. ....275

**J**

Jewell Elect. Inst. Co. ....266

**L**

Langbein-Kaufman Radio Co. ....273  
 Lynch, Inc., Arthur H. ....263

**M**

MacLaren ....190  
 Micamold Radio Corp. ....255  
 Midwest Radio Corp. ....279  
 Modern Electric Co. ....254

**N**

National Carbon Co. ....3rd cover  
 National Co. ....278  
 National Radio Inst. ....268  
 Norden-Hauck, Inc. ....269

**O**

Omnigraph Co., The ....277

**P**

Potter Mfg. Co. ....256

**R**

Radiall Co. ....274  
 Radio Corp. of America ....205  
 Raytheon Mfg. Co. ....253  
 Reichmann Co. ....274

**S**

Sangamo Electric Co. ....272  
 Seymour Co., The ....270  
 Sickles Co., The F. W. ....280  
 Silver-Marshall ....4th cover  
 Smith, B. H. ....269  
 Starrett Mfg. Co. ....279  
 Supertron Mfg. Co. ....277

**T**

Thordarson Elec. Mfg. Co. ....255

**W**

Webster Co. ....256  
 Wireless Specialty Apparatus Co. ....270  
 World Battery Co. ....280

**X**

X-L Laboratories ....278

## DIAMOND-WEAVE

(TRADE-MARK REGISTERED Aug. 4, 1925)

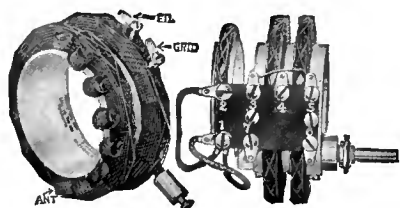

Sickles Coil Set No. 18A for Roberts Circuit, containing our new center-tapped N-P Coil. Price \$8.00.

*Sickles Coils for the "Aristocrat" Circuit, designed upon new scientific discoveries, set highest standards of efficiency.*

### COIL PRICES

|                             |             |
|-----------------------------|-------------|
| No. 18A Roberts Circuit     | \$ 8.00 set |
| No. 24 Browning-Drake       | 7.50 set    |
| No. 20 Craig Circuit        | 4.50 set    |
| No. 19 Acme Reflex          | 4.50 set    |
| No. 8 Knockout Reflex       | 4.00 set    |
| No. 21 Hoyt Circuit         | 10.00 set   |
| No. 25 "Aristocrat" Circuit | 8.00 set    |

## SICKLES COILS

*For the "Aristocrat,"  
Browning-Drake, Roberts,  
Craig, and Hoyt Circuits*

(Patented Aug. 21, 1923)

Our Coil Set No. 25 is specifically designed for the new "Aristocrat" Circuit, already very popular.

Compactness of form, rigidity of construction, and the supremely efficient Diamond-Weave method of winding are well-known characteristics of Sickles Coils.

These refinements of design and construction result in low distributed capacity, low dielectric losses and large range of frequency with small variable capacity.

There are Sickles Diamond Weave Coils for all leading circuits.

Send for descriptive catalog

**The F. W. Sickles Co.** ★

132 Union Street  
SPRINGFIELD, MASS.

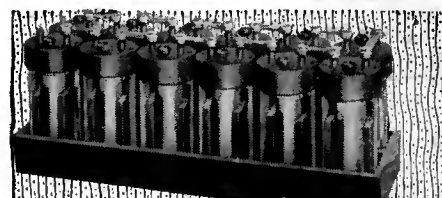

## FREE!

**12-Cell — 24-Volt  
Storage 'B' Battery**

Positively given free with each purchase of a WORLD "A" Storage Battery. You must send this ad with your order. WORLD Batteries are famous for their guaranteed quality and service. Backed by years of successful manufacture and thousands of satisfied users. Equipped with Solid Rubber Case, an insurance against acid and leakage. You save 50 per cent and get a

**2-Year Guarantee** ★

**Bond in Writing** "tell their friends." That's our best proof of performance. Send your order in today. **Solid Rubber Case Radio Batteries** 6-Volt, 100-Ampere. .... \$11.25 6-Volt, 120-Ampere. .... 13.25 6-Volt, 140-Ampere. .... 14.00 **Solid Rubber Case Auto Batteries** 6-Volt, 11-Plate. .... \$11.25 6-Volt, 18-Plate. .... 13.25 12-Volt, 7-1/2-Plate. .... 16.00

**Send No Money** we will ship day order is received, by Express C. O. D. subject to your examination on arrival. **FREE "B" Battery** Included. **Extra Offer!** 5 per cent discount for cash in full with order. **Buy now and get a guaranteed battery** at 50 per cent saving to you.

**WORLD BATTERY COMPANY**  
1219 So. Wabash Ave., Dept. 24 CHICAGO, ILL.

**World STORAGE BATTERIES** Set your Radio Dial at 210 meters for the new 1000 watt World Storage Battery Station, WSHC, Chicago. Watch for announcements.

ROKA - WFAF - WGN - WJS - KHJ - KGO - KFAF - WOJ - KOB



# Constant "B" Voltage with Power Amplification



For a dependable "B" eliminator-power amplifier unit which will enable your loudspeaker to deliver greater volume with a tone quality that is amazing, buy a General Radio Rectron "B" eliminator-Power Amplifier kit and carefully follow the few simple instructions for assembling the unit.

Price of Kit, including all parts and drilled baseboard

**\$47.50**

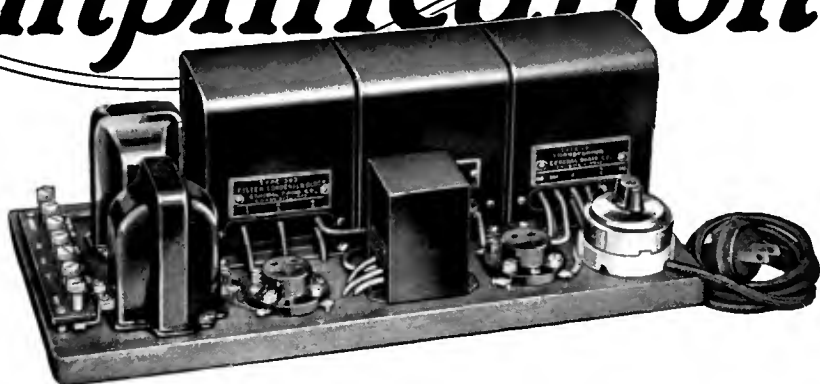

A properly built "B" eliminator operated from the lighting circuit noticeably improves the consistent quality of reception. It provides a constant, silent flow of current that makes it as dependable as the power station itself.

Worry whether the "B" batteries are run down and their continual replacement is forever abolished by the use of a reliable "B" voltage supply unit. Once installed and adjusted it is ready for years of constant service.

A Power Amplifier in conjunction with the "B" eliminator permits the use of a high power tube in the last audio stage. This overcomes the tendency toward tube overloading and removes the most common cause of distortion in loudspeaker operation.

*Get this Booklet*

Ask your dealer or write today for our pamphlet "How to Build a Rectron "B" eliminator and Power Amplifier".

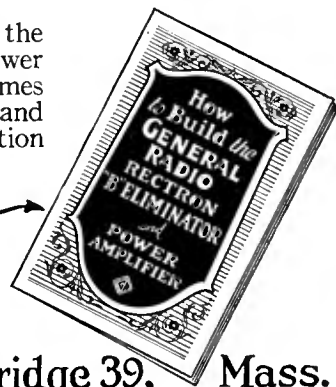

**GENERAL RADIO Co. Cambridge 39, Mass.**

# GENERAL RADIO

## ★ INSTRUMENTS

*Behind the Panels of Better Built Sets*