

Bound
Periodical

388450

**Kansas City
Public Library**



This Volume is for
REFERENCE USE ONLY

PUBLIC LIBRARY
KANSAS CITY
MO

From the collection of the

j r d
y z n m k
x o PreInger h
u v q g Library a
e
b t s w p c

San Francisco, California
2007

ROBERT L. HAY
GARDEN CITY

RADIO BROADCAST

VOLUME II

NOVEMBER, 1922, to APRIL, 1923

BETTER RADIO



GARDEN CITY NEW YORK
DOUBLEDAY, PAGE & COMPANY

1923

WASHTON
VIA
ON

Copyright, 1923, by
DOUBLEDAY, PAGE & COMPANY

Bound
Periodical

388456^{FP} 1 1923



TREASURES OF GOLD AND JADE
SAID LAO TZU, DESERVE A
PROPER DWELLING!
"GREBE RADIO IS NOW HOUSED IN A
MANNER BEFITTING ITS EXCELLENCE."

Doctor Wu.



© Underwood & Underwood

IN THE SHADOW OF THE STATUE OF LIBERTY

The U. S. Army Station at Fort Wood, N. Y., which broadcasts radio instruction and entertainment

RADIO BROADCAST

Vol. 2 No. 1



November, 1922

The March of Radio

TOO MANY COOKS ARE SPOILING OUR BROTH

EVERY month sees a remarkable growth in the number of stations licensed for radio broadcasting. This might be taken as a sign of the healthy growth of the new art, but a little reflection seems to point to the opposite conclusion. Apparently, a broadcasting license is to be had for the asking. The question now arises: Is this encouragement of broadcasting stations the policy which will make for the best development of radio and its appreciation by the listening public? It seems to us that a curb should be put upon the licensing of broadcasting stations or there will soon be country-wide troubles of the kind which recently occurred near New York—conflicts between the various stations for the most desirable hours and the resulting interference of signals between the several stations, which made listening-in no pleasure.

There are at present nearly 500 licensed broadcasting stations in the United States, and this list is being augmented each week; in one week recently there were 26 new licenses issued. Probably the majority of these stations are being operated by manufacturers and dealers, but many are controlled by the press. It looks as if we shall soon have 1000 licensed stations, which means that it is about time to inquire how many of them will be operated in such a fashion as to increase the interest of the public in radio and how many of them will merely send out advertising noise.

A radio enthusiast from the Middle South

recently related, in reply to our inquiry as to the progress of radio in his vicinity, with much disgust and vehemence the nuisances he and his fellow amateurs had been forced to put up with. They had all worked hard to perfect their sets so as to get some of the better transmitting stations. Frequently two or three of them worked together, combining their supply of tubes and accessories, and in this way they had been able to get radio concerts from some of the stations three hundred miles distant. But a few months previous to our inquiry a small local newspaper, sensing the possible advertising value of a broadcasting station, had obtained a license and had put into operation a set which the local radio fans declared to be "simply rotten." And this newspaper station runs when it wants to, on exactly the same wavelength as the good stations to which the amateurs had been accustomed to listen. "It has killed interest in the game around R—," said the Southerner.

Now, with the rapid increase in the number of stations, isn't this situation going to be duplicated elsewhere? And isn't the progress of radio and the interest of the public going to suffer seriously as a result? It seems almost certain, for it must be remembered that all broadcasting licenses are as yet being issued with permission to transmit only on 360 meters. Every one of these stations which is within a reasonable distance of the listener will tune in at about the same adjustment of the receiving set.

Lost in the mazes of Congressional procedure there is a radio bill, introduced in the House more than three months ago by Mr. White. This bill was intended by its framers to obviate the interference which, we firmly believe, is sure to occur soon. It gives Secretary Hoover more power over the control of radio than does the older radio law of 1912 and if the bill should be passed, the broadcasting situation might be remedied at once, by assigning to the various stations which are close enough to interfere, widely different wavelengths. If this had been done in the case of the Southern town already referred to, skilled amateurs with well-built sets could have listened to their distant "good" stations without any interference from the local newspaper. This station might then have poured out its advertising propaganda into an ether channel to which no sets within its range were tuned.

This reapportionment of wavelengths would evidently react to improve the quality of the broadcasting stations. Suppose that one station, with poor transmission, sends out a wretched programme on, say, 325 meters, and another in the same neighborhood sends out an excellent one on 375 meters.

With the usual broadcast procedure the announcers at both stations would, at the end of the programme, ask for comments and suggestions from the listeners. No one would have been listening on 325 meters, so no suggestions would be received and the owner of the station would soon find out that his signals were being sent to "deaf" radio sets, sets which had purposely shut out his message. He would then have to improve his station or stop transmitting.

In the re-apportionment, the longer wavelengths assigned to broadcasting should be given to the more powerful metropolitan stations, those which can afford better talent for their programmes. More power can be radiated on the longer wavelengths than on the shorter ones, so the shorter ones should be kept for the small radio jobbers and newspapers, whose programmes will generally be only of local interest.

A CASE IN POINT

IN OUR last issue we made comment on the advisability of installing emergency antennas on board vessels and also suggested that air-

planes could utilize emergency aerials, carried by a balloon or kite, to help them out of difficulties in case of forced landing in sparsely settled territory. Scarcely was the ink dry when there came the report of a plane being forced to land—because of engine trouble, in a remote region—and the aviator having to walk twenty miles to the nearest place where help could be obtained.

As the number of airplanes increases—and the increase will undoubtedly be rapid during the next few years—there will be a correspondingly growing demand for dependable means of communication in case of necessity.

A twenty-mile walk sufficed in this case, but the next time it may be farther and over more difficult terrain; or it may be impossible. Unless the radio apparatus was seriously damaged, it would surely have been able to summon help with a kite or balloon-flown antenna and so have minimized the danger which was present in this instance.



SECRET RADIO

RUMORS are continually indicating that secret radio, or super-radio, as someone has styled it, is soon to appear. Although our present knowledge of radio leads us to believe that this is practically impossible, we have seen sufficient recent development along spectacular lines to retain an open mind on such a question as this.

There are various lines along which such a development might take place, but it is very likely that our guess as to the direction from which it will come will prove wrong. Marconi's recent demonstration showed us that short-wave radio is quite possible and practical, and this is secret, to a certain extent, when compared to the present radio. The directional short-wave communication would eliminate all listeners except those quite close to the line joining the sending and listening stations; thus if the stations were 100 miles apart only those listeners in a band between the stations, perhaps 10 miles wide, could overhear the conversation. Of course this would not give a great deal of secrecy, but compared to the present scheme, which permits every one within 100 miles of the transmitting station to hear as well as does the intended listener, the 10 mile band would be quite exclusive communication.

Another likely development may use two waves for transmission instead of one, and the style of modulation be such that a receiving set must be properly tuned to both of these waves at the same time to get intelligible conversation. It would be extremely difficult for an undesired listener to eavesdrop by properly adjusting his set for the complex tuning

taking perhaps five minutes to make the complete record. The disc may then be used to excite the transmitting set, but it is run at, say, ten times normal speed, so that any one listening would get nothing but a few seconds of unintelligible blur. The listening station for which the message is intended, however, would, at the proper time, employ an automatic record-

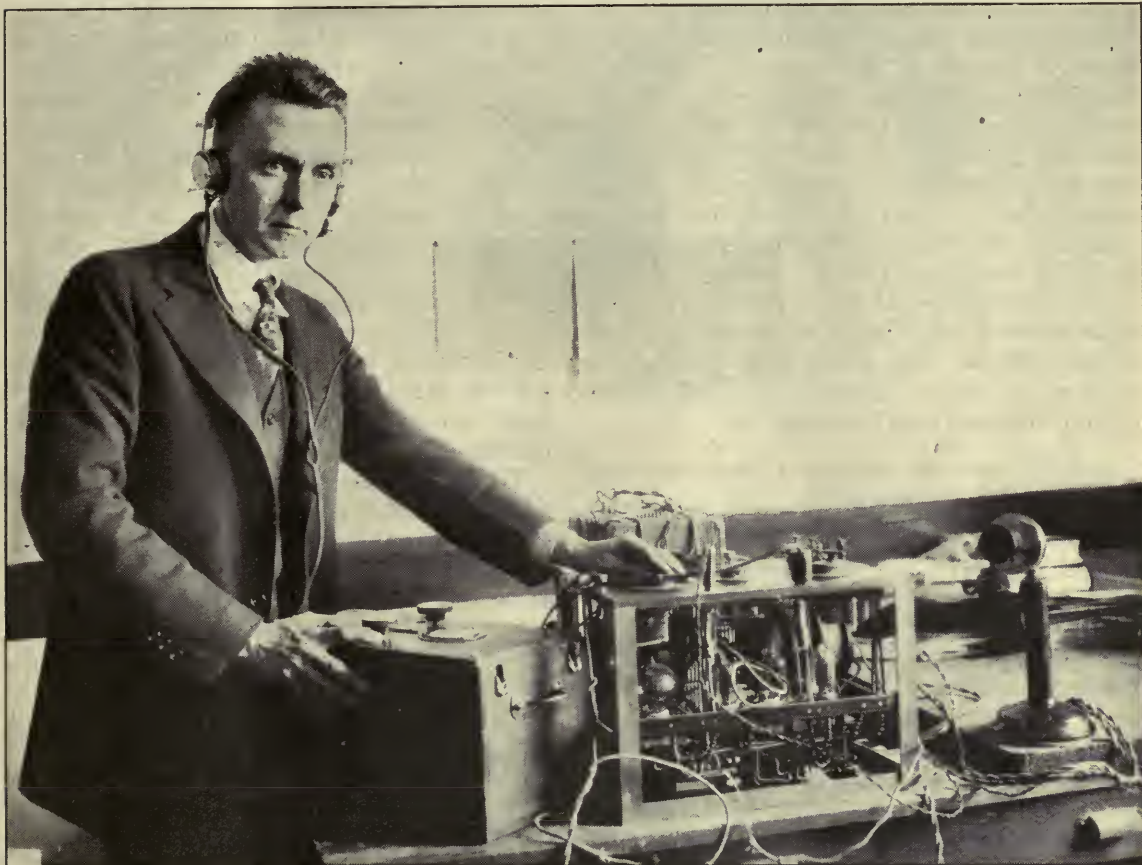

© Harris & Ewing

R. D. DUNCAN, JR.

Demonstrating the Superphone, credited as a system capable of secret radio communication

condition, and, if necessary, the transmitting station could use a series of these double wave-bands, after notifying the *bona fide* listener by code letter or otherwise of the new combination to which he was going to shift. This double-wave scheme may never be allowed, however, as it "uses up" two channels in the ether and so will cause twice as much interference as at present. Which heaven forbid!

Another possible scheme, used to some extent during the war, is to record the signal which it is desired to communicate at ordinary speed on a phonograph disc or similar device,

ing machine running at a rapid speed and let its receiving circuit make a record on the disc. The disc is then used to reproduce the message intelligibly by "playing" it through the phonograph at one tenth the speed it had while recording the received signal. This scheme is evidently of no use for secrecy in ordinary conversation as it takes too long.

BETTER RADIO EQUIPMENT FOR OUR SUBMARINES

SINCE the war, the radio experts employed by the Navy have been at work on the improvement of sets for submarines; and the

Navy Department has announced that when these new sets are installed, the reliable range of radio communication for our submarines should be more than 200 miles in the daytime. It is the belief of the naval authorities that these new radio outfits will put our submarine force at least on a par with that of any other nation in so far as radio is concerned.

The new sets are the outcome of experimental development by experts employed by the Navy, whereas the sets previously in use were designed and built by commercial concerns. But little new apparatus was required for the assembly of the new sets as most of the material which enters into the construction was already in Navy stores or in existing sets; it is estimated that if the new equipment had been purchased from a commercial concern it would have cost at least \$5500 a set, but as it is, the outlay will be only about \$500 a set, thus showing a "paper" saving of about \$300,000, as 59 of the new sets are being built.



"SCIENCE COMES TO YOU ONLY THROUGH YOUR FINGERS"

HOW well we remember, from our high school days, the "shopwork" which was given as a special course by the physics teacher to those students in his courses who showed special aptitude. Although the equipment was poor and insufficient, it seemed that an understanding of physics came to us more rapidly when talking and working with the instructor in the shop than by any amount of home study. In fact, we are inclined to believe a well-known physics teacher who said "Science comes to you only through your fingers." To be sure, shop and laboratory work can never compensate for lack of mental concentration such as is required for the solution of problems and analysis of theorems, but the interest of the student in a subject is absolutely necessary before useful concentration is possible, and this interest, this desire to know, constitutes the lasting benefits derived from shop and laboratory work.

Thirty years ago the instructor in shop courses was rather nonplussed to find jobs for his student workers. We well remember the glass-plate electric machines which took so many afternoons to build and which had practically no use after they were built. Of course we discovered that it was difficult to

glue glass plates to wood without having them crack and experience taught us how to drill holes properly in the glass plates, but how much more we learned when allowed to build a small dynamo! It worked—and we could light small lamps with it and charge the storage batteries which we also built in the shop. This generator gave us more appreciation of Faraday's laws than any amount of study and lecture.

Boys' high school shop and manual training courses are probably helping their choice of a career even more than a generation ago, not only because of the excellent equipment now general in our better schools, but because of the more fascinating work which it is now possible to carry out. The present interest in radio and the comparative ease with which apparatus can be built makes the work of the manual training instructor much pleasanter and more absorbing than in earlier days. The boys we know to-day are actually anxious for the shop periods to arrive.

To make a radio set which will work, and work well, is a great incentive for any boy to-day—especially as his parents are probably almost as eager as he is to have it completed, so he can set it up at home. Not only is it possible to teach him to saw straight and hit a nail square and use a lathe in making the radio set, but, during the construction of the apparatus, information as to how the thing works will be eagerly sought by the student from his instructor—information which would have to be forced on him if presented in the course of ordinary classroom exercises.

SENDING AND RECEIVING ON A TYPEWRITER

THE achievements of radio have already been so remarkable that scarcely any announcement of new uses can surprise us. By the most delicate and complicated relays, radio serves to guide a battleship in maneuvers, it utilizes the thousandth part of a watt of power to control accurately the output of a generator supplying hundreds of kilowatts to the antenna, and it utilizes the swing of a clock pendulum to send out time signals over all the earth's surface.

Being necessarily in the habit of admitting practically anything as possible, we are ready to accept the report issuing from Washington that recent Naval Air Service experiments

have shown it possible to utilize the "teletype" in radio communication. Two typewriters, of special construction and operation, are used in such a manner that the operator at the transmitting station, instead of manipulating the ordinary telegraph key to send out code signals, sends with the typewriter keyboard just as though he were actually typewriting. Pressing the *a* key of the machine, for example, makes the radio transmitter send letter *a* in code. At the receiving station this code *a* acts on a set of selective relays in such a way that the *a* of the receiving typewriter is depressed and written just as though the receiving operator himself had struck the key. Thus, as the transmitting operator works his typewriter keyboard, a typewritten copy of the message is automatically made at the receiving station. The teletype, as the automatic typewriter is called, has been used on land lines for several years so that its application to radio was expected and was sure to occur when sufficient research had eliminated the troubles first encountered. This new departure in radio will make for more reliability in transmitting orders, according to the Navy Department, as it does away, to a large degree, with the possibility of operator's errors. So far, the teletype has proved successful from plane to ground over a distance of several miles, and the reverse operation, from ground to plane, will probably soon follow.

BROADCASTING HEALTH

ONE possibility in radio broadcasting which has not been developed nearly as much as is warranted by its importance, is the dissemination of information regarding health; not, for example, the municipal arrangements for guarding against epidemics, but timely personal advice such as a good family physician gives. How many people suffer unnecessarily from severe colds at certain times of the year!

WORLD TIME CHART

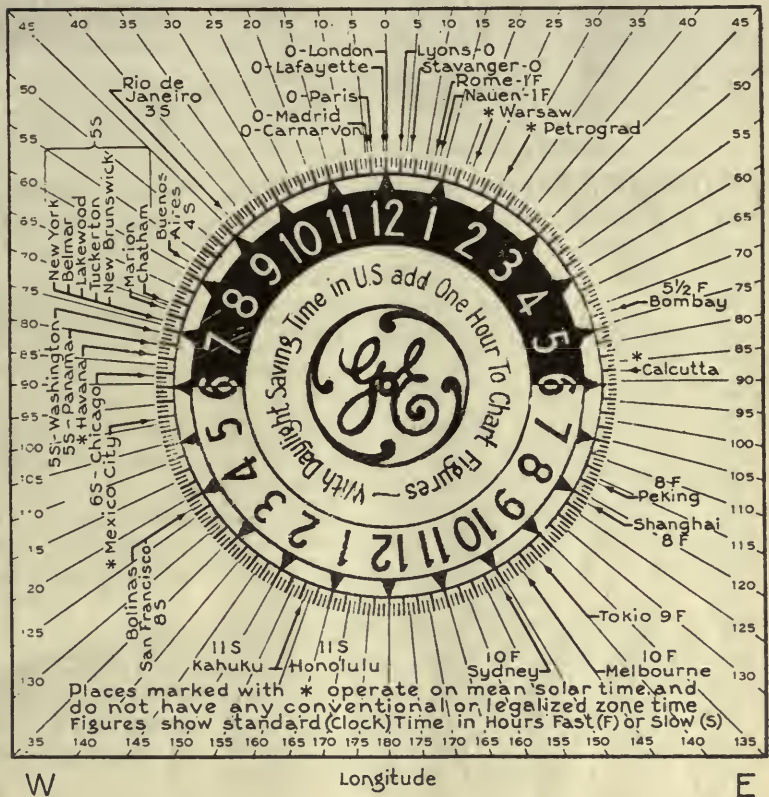

W

Longitude

E

Courtesy of General Electric Co.

If you mount this chart on a piece of cardboard and cut around the outside circle with a sharp knife and run a pin through the center to form an axle, you may tell the hour in any of the places indicated for a given hour in any other place

How many people go off on vacations and attempt such an extraordinary programme of exercising that they come back to their everyday occupation not refreshed, but thoroughly "played out"—what an eloquent phrase, that is!—after their vacation. And how many people get indigestion by eating too rapidly and exercising violently right after eating!

Everybody knows that these habits are to be avoided, but it needs more than knowledge to alter the ordinary man's method of living; he generally persists in a certain course until a visit to the doctor, or possibly the hospital, convinces him that he should have brought his habits of living into conformity with the dictates of common sense. If there were periodic radio talks on health and healthy living by reputable physicians, a real good might be accomplished. A physician can help us more by preventive measures when we are well than curative measures after we are "down and out"; yet we practically never

consult a physician until we are forced to do so by illness.

In recommending brief talks along this line we feel that those who arrange the programmes must be ever careful that only recognized authorities be allowed to address the radio audience.

RADIO'S RELIABILITY

CONSIDERING the pride with which we, as a nation, point out our radio achievements, it seems strange that in crucial tests, radio should occasionally so lamentably fail. When the N. C. planes were preparing for their remarkable trip across the Atlantic, we were informed that the radio equipment aboard was of the very best type, that the radio personnel was the most capable the Navy could command, and that the range of transmission and reception was several hundred miles. We stationed destroyers, fitted with powerful radio equipment, every few miles along the route—yet the planes were soon “lost” as far as radio was concerned, when they should never have been more than perhaps fifty miles from a destroyer! And now we read of the recent trip of the army airship C-2 making a carefully planned trip from Aberdeen, Md., to New York and back, and as far as radio was concerned, she was apparently

lost soon after leaving the ground—trouble with the apparatus prevented communication with land, although the ship was only a few hundred feet high.

Incidentally, this trip was made with a hydrogen filled balloon, the same kind as has on two recent occasions caused such a large loss of life. We are informed that the purpose of the trip was to show the practicability of night flying. In this respect the trip was successful. But how successful would it have been had it been necessary to make a forced landing, and had the bag come in contact with high voltage wires—or had it been fired by atmospheric discharges?

Of course, since no lives were lost and the army was not deprived of some of its most skilled personnel, the question may seem out of order, but we do wonder where was the explosion-proof helium about which we boasted so much a short time ago—the helium taken out of that other ill-fated dirigible and stored in tanks under strict guard, while our skilled and valuable officers and men, in carrying out tests which the good of the service seems to demand, go aloft through lightning storms and over electric wires under thousands of cubic feet of dangerous gas.

J. H. M.

THE REMAINS OF THE “ROMA”

America can ill afford to lose her most skilful birdmen and none but the most skilful are charged with the flying of our huge dirigibles. Non-explosive gas and efficient radio can greatly reduce the hazards of air navigation



© Wide World Photos

Phoning Home from Mid-Ocean

How the Problem of Simultaneous Radiophone Transmission and Reception Was Solved Aboard the S. S. *America*, and Reliable Communication Routed Direct from a Land Radio Station to Telephone Subscribers. An Indication of a Home-to-Stateroom Telephone Service that May Soon Be Generally Applied

By G. HAROLD PORTER

General Superintendent, Marine Dept., Radio Corporation of America

WHEN the steamship *America* sailed from New York on April 15th, 1922, destined for her usual brief visit to European ports, little did the public realize the significance attached to this particular trip. To a group of eminent engineers this was more important than the maiden trip of the big vessel, for her radio cabin held certain secrets that were close to their hearts.

The combined efforts of these men, representing the Radio Corporation of America, the General Electric Company, the American Telephone and Telegraph Company, and the Western Electric Company, have been focused for some time on the problem of establishing a shipboard radio telephone exchange. This, they intended, should provide the interchange of intelligence at sea, on a limited scale, with the same facility with which present land telephones handle the communications of our nation.

The realization of this plan in the form of a practical working radio service between ships on the high seas and land stations would provide a communication system differing radically from that which is now in universal use. manifold problems would find their solution in the successful conclusion of this venture which, since the very birth of radio, has been the subject of untiring study.

In the wake of progress, it is natural that we should find methods of the past superseded by the ever increasing products of advanced research. Radio is no exception. The principal undesirable feature of present-day radio systems, which the engineers working on the *America's* installation sought to supplant, was the switch employed for changing from the sending to the receiving conditions and *vice versa*.

It is almost universal practice in radio tele-

phone communication to-day to use a "send-receive" switch to connect the antenna to either the transmitting outfit or the receiving set, depending on which one is to be used. At the end of each transmitted message, the operator always makes a conventional signal indicating to the receiving operator that each must throw the send-receive switch to its opposite position. Of course, the interchange of thought would be far more rapid with a system permitting either participant of the conversation to interrupt the other instantaneously. This would avoid the loss of continuity in a conversation and the calls for "repeats" now frequently encountered.

Undoubtedly the greatest need for this duplex or two-way radio telephony is the installation of it in such a way that the public may avail themselves of it. Inexperienced persons could not be expected to operate a send-receive switch at the proper moment, and, accordingly, some substitute had to be found.

To the novice, the development of the wireless telephone so that it could be used as, and in connection with, the ordinary wire telephone, presents no particular difficulties; but to the trained engineer, the details and obstacles encountered are endless. Supported by the resources of some of the country's foremost research laboratories, months of painstaking efforts and measurements of the greatest precision were required before such a system was ready for trial.

SENDING AND RECEIVING AT THE SAME TIME ON THE SAME ANTENNA

THE engineers who worked on this system were concerned with carrying on two operations at the same time: the first, detecting the incoming antenna current and transforming it into speech, and the second, permitting the voice currents aboard the *America* to advance from the antenna into space, as waves, reaching



PHONING HOME FROM MID-OCEAN

Captain Rind of the *S. S. America* has been heard phoning home by nearly every amateur from Maine to Florida

a distant operator on shore or aboard another vessel. How to extricate the exceedingly feeble receiving current from the antenna system while the transmitter is driving enormous power into the antenna *at the same time* was the problem that had to be faced.

THE "TRAP" CIRCUIT

THE transmitted energy has a wavelength which differs from that of the received energy. The antenna forms the common path for both waves. Two branch electrical circuits connected at the end of the highway have different wavelengths. The received signal proceeds along the antenna until it reaches the junction point, where it branches off to the path which is tuned to accommodate it and then enters the amplifier. The transmitter supplies energy to the same antenna along the other path which, because of the difference in tuning, does not materially interfere with the incoming signals. While the two currents of different wavelengths exist in the antenna simultaneously, each has a special function; the feeble current energizes the receiving set and am-

plifier, and the transmitting energy flows through its proper path to the antenna and travels through space to be absorbed by the distant receiving station.

To make sure that the transmitter does not drive any current into the associated receiving set and thus establish interference to reception, "electrical constriction" is placed in the lead which branches from the main antenna to the receiving set. This so-called "trap" functions as a sentinel at the receiver connecting point, permitting only the feeble incoming currents from the antenna to flow along to the receiver, but which resists any attempt of the transmitter to feed its powerful energy back into the delicate receiver.

This trap circuit is not a new idea by any means, for one of its modifications is used in transcontinental telephony. It is, to explain briefly, a path composed of a group of inductances and condensers, designed and assembled so that their combination will permit only waves of approximately a given frequency to pass through. Since wavelength is a function of frequency, the filter may be designed for

almost any band of wavelengths and it is only necessary to have the transmitting wavelength of sufficient difference from the receiving wavelength to be resisted by this trap or filter.

Obviously, this arrangement provides a substitute for the send-receive switch, as the operator may speak into his transmitter and control the powerful antenna currents while he listens to the feeble signals arriving at his receiving set.

He may thus be interrupted while speaking by the man at the distant station who may wish him to repeat part of his message. Thus, interchange of thought is as instantaneous as with the ordinary land telephone.

This method was given a series of preliminary tests before the installation was finally made on the S. S. *America*. That it was the proper method of procedure was then well established. The tests aboard the ship were made as a means of determining the commercial worth of the system, and the accuracy with which this work was performed was well demonstrated by the remarkably successful trials at sea.

On her first and subsequent voyages and under normal atmospheric conditions, reliable telephone communication with the shore was established while the ship was more than 1,600 miles from New York. Both Captain Rind of the *America* and the shore operator reported the speech to be perfectly intelligible at all times during many conversations which they held while the ship was in mid-ocean. Incidentally, many amateurs located on the Atlantic seaboard listened-in and were thrilled by these remarkable experiments.

SHORE APPLICATION

THE duplex system was now an accomplished fact, but why should its application be limited to the service of the Captain of the *America* and the operator at the shore station? To render the maximum amount of service, the "ether line" between the *America* and the shore must be linked up with the regular wire telephone systems of the country, so that a business man, for instance, located any-

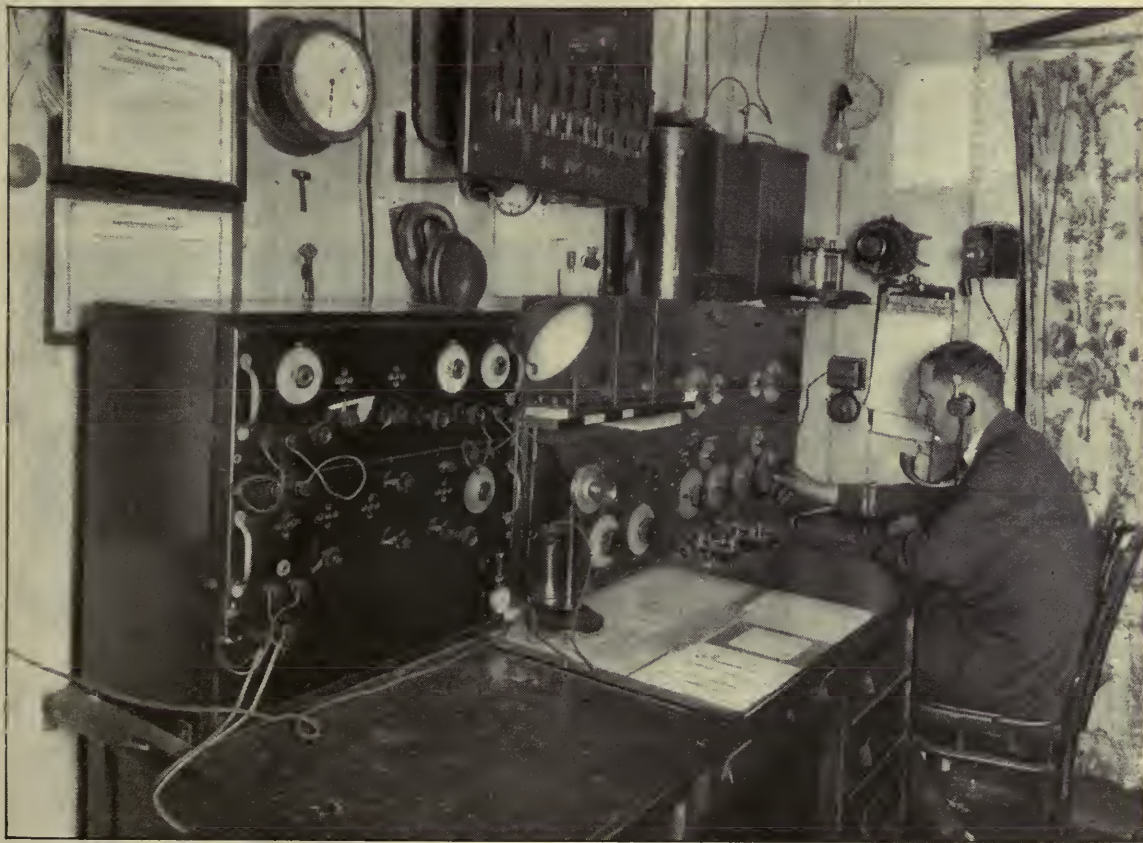

THE RADIO ROOM ON THE S. S. "AMERICA"

Through the complex circuits in this room incoming and outgoing voice currents pass simultaneously

where in the United States, might use his ordinary desk telephone to converse with one of his associates who might be on the *America* several hundred miles out at sea. This arrangement accordingly was made.

The shore station, where the radio and land lines were linked together, is located at Deal

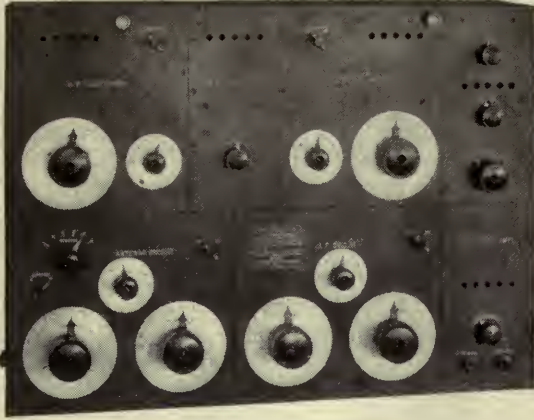

THE CONTROL PANEL OF
THE "AMERICA'S" RECEIVER

Beach, New Jersey. It is operated by the Western Electric Company, and is connected by a toll line to a telephone switchboard of the American Telephone and Telegraph Company in New York City. By means of this connection, communication could be carried on from a ship to any point reached by the regular wire telephone system. When it is desired to place a call for a party on shore, the customary practice used for a toll call in wire telephony is followed. A regular desk telephone was installed in Captain Rind's quarters on the *America*. When he desired to talk to someone on shore, he called the ship's radio operator by pressing a button on his desk. The operator answered and, after ascertaining the telephone number or name of the party desired on shore, established communication with Deal Beach. The operator at Deal Beach transferred the call to the New York toll line, completing the circuit between the *America* and the switchboard operator at New York, so that both operators could exchange information regarding the call. In placing a call for a party on shore, the standard practice used for a toll call in wire telephony is followed. When New York had the party at that end, the ship operator called Captain Rind and he conversed from his extension in the same manner as one would over any telephone system.

The equipment is, of course, not limited to a single telephone instrument on board the ship. An extension may be installed in every stateroom if desired.

When the *America* was 2,586 miles out of New York, a call was received from the S. S. *Westland*, asking medical advice for a sick member of the crew. The telephone was turned over to the ship's doctor who prescribed treatment for the patient. A great number of similar cases are on record indicating the tremendous possibilities of the radio telephone at sea.

On his recent visit to the United States, Marconi inspected the installation on the S. S. *America*. He stated that the now famous duplex system employed so effectively on every trip of the steamship was a tribute to splendid efforts of American radio engineers.

From the foregoing, it will be seen that combined radio and wire telephony, proved highly satisfactory in the case of the first experimental set installed on the *America*. It must not be inferred, however, that the immediate step is to equip all vessels which at present carry radio telegraph apparatus with this latest telephone system. This happy condition may not come about for some time, because there are still certain scientific engineering and traffic problems to be solved. Also the International Radio Convention and our own government must take note of the development

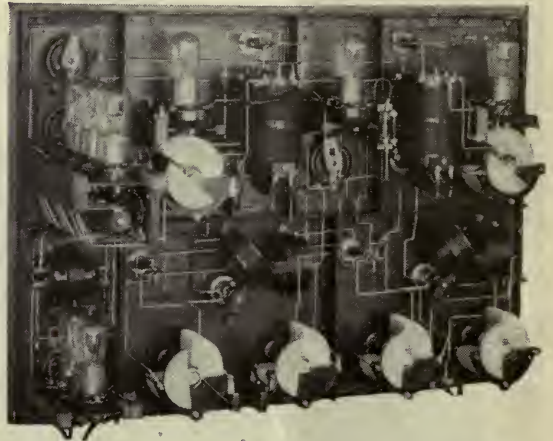

INTERIOR OF THE "AMERICA'S" RECEIVER

of wireless telephony and allocate suitable wavelengths. For purposes of a special nature, such as ship movements, medical and other urgent service, where the radio telegraph is not sufficiently direct, the radio telephone will be especially valuable.

Do Brains or Dollars Operate Your Set?

By W. H. WORRELL

HERE is more than one kind of person who likes to operate a radio set; there are, to be exact, two kinds. The first of these recognizes in radio a fad which he would feel ashamed not to appear interested in; he does what he does because it is "done." Radio to him is also an easy means of entertainment, and a source of free music—especially jazz. Where the music comes from doesn't concern him much, if it is only strong enough—regardless of weather conditions—and always on draught. He wants to be able to turn a spigot and just let 'er pour forth.

In short, such a man isn't a very good sport. He is the kind that generally doesn't like fishing unless he can get a boy to hang the worms on his hook and take off the fish. He would prefer catching bullheads to tempting trout, and might ask his dealer to guarantee the effectiveness of his tackle. He will not survive the first summer of static, nor the first week of experimenting with his receiving set. He will discover that radio is a game, in which a certain amount of patience and skill are demanded, and that a vacuum tube is more like a violin than a victrola.

The other type of person is fascinated by radio as by anything that seems to be above or beyond common experience, and that, while apparently contradicting common sense, invites investigation and stimulates imagination. He seizes upon the apparently supernatural, or at least the unusual, as affording a change from the regularity of nature and of average human experience; yet he does so with the intent of rendering it some day both natural and familiar. It interests him intensely to discover new wonders and then to try to solve their mysteries. His unconscious purpose is to render space and time, and all that limits and thwarts human existence, as completely amenable to the will of man as in a fairy tale.

This is the real radio devotee, whether he is a lawyer spending his evenings in the attic with his home-made set, or a boy tuning in at midnight for the signals of some distant comrade.

The fascination of radio lies in its atmosphere of magic, which is the accomplishment of something out of all proportion to the means employed, or in seeming contradiction to natural laws and common experience. It lies also in the uncanny way in which time and distance—the natural obstacles to quick interchange of thought between human beings—are reduced almost to insignificance.

Distance separates us from people and things. To reach them requires time. During the transition from one scene to another we ourselves are changed by the intervening time with its experiences. To some extent we may travel by telephone almost instantly to the presence of a friend at a given house in a distant city; but by radio we may, on a good night, pay flying visits to a dozen places between Schenectady, Detroit, and Atlanta.

When we learn a little more about radio it appears to be the transmission and reception of pure form, without substance. And isn't it amazing to think that this form, this exchange of thought, is constantly passing about us—*passing through us—from countless transmitting stations, at this very instant!* We possess no human faculty which can make us aware of this—but with sensitive enough instruments all this flow of ideas could be reduced to significant sound. At present, a tiny fraction of it—on a still winter night we may be inclined to think it is a big fraction!—can be made available for us by the intelligent use of such instruments as we may possess. All the fascination of a link between the physical and the spiritual is here, and it is far from easy to rid ourselves of the feeling that we are at the threshold of fundamental truths which have baffled humanity throughout the centuries.

Simple Bulb Transmitters

By ZEH BOUCK

IT IS probable that many people who have installed receiving sets during the past year are not content merely to listen-in, but are considering the possibility of simple, short-range transmitting sets. The use of the air for the amateur, however, is definitely limited. The government is becoming more discriminating in issuing licenses, and the citizen operator himself is apt to resent the intrusion of a novice unfamiliar with amateur tradition and ethics.

This article is intended to help those who, now laboring under the opprobrium of "concert fans," desire to follow up the possibilities of amateur radio on the transmitting side of the change-over switch.

Except for laboratory experiments, one of which is described in this article, *transmission cannot legally be effected without two government licenses: one licensing the station, and the second certifying the individual as an operator.*

The technical knowledge required in the examination for a first-grade amateur license is not very exacting. Radio inspectors are predisposed to license applicants whose diagrams indicate that their prospective stations are bulb or undamped transmitters.

APPLICANT FOR LICENSE MUST LEARN CODE,
BUT IT IS WELL WORTH WHILE

CODE is another matter, and is generally the bugbear of the would-be operator. Sometimes it takes two or three months to gain a safe margin over the ten-words-a-minute speed stipulated by the government. The only solution lies in attacking the problem systematically. If the determined experi-

menter will persistently copy the high-wave arc and alternator stations (many of which transmit very slowly), occasionally breaking the monotony with a weather forecast from NAA (Arlington. After 10 P. M. Eastern Standard Time), the average period for learning code will be more than halved. Once the code is acquired, the experimenter is no longer a dilettante—he is an operator, and he will find that a great new field of interest is open to him. The person who turns the knobs only to receive music, who can make nothing out of the code signals which fill the ether—well, he doesn't know what he is missing!

WHAT HAPPENS WHEN
WE SEND OR RECEIVE

IT IS generally understood that wireless messages—code and voice—are carried on "waves." Radio impulses, unlike water waves, to which they have been compared until we are sick of hearing the comparison, are not confined to two dimensions, but spread out from the

The numerous letters from our readers requesting further details of "A Compact, Portable Wireless Set," described in our May issue, indicate that many broadcast enthusiasts would like to transmit, if transmitting did not involve too much trouble and expense.

Accordingly, we shall publish articles from time to time describing simple sending outfits. Some of them may be made by altering a few connections in your present receiving set. Others may be operated from the current taken from a lamp socket—replacing the "A" and "B" batteries entirely.

The author of this article tells in a clear-cut way how a single tube transmitter may be made and operated.—THE EDITORS.

point of excitation in all directions. Indeed, a radio impulse is really composed of two waves, the electromagnetic and electrostatic, a condition difficult to visualize. A current pulsating in the antenna, like a current moving in any conductor, sets up about it an electromagnetic field similar to that surrounding a horseshoe magnet. There is also a capacity effect, for the aerial and ground act as the two plates of a condenser, and the intervening air as the dielectric. Whenever a difference of potential or voltage exists between these "plates," as during transmission, an electrostatic field or charge is distributed between them—a sort of electricity existing free in the air. These two

fields travel from the antenna 186,000 miles a second in all directions.

As these two fields cross the receiving antenna tuned to the same wave, the lines of force (the electromagnetic field) create therein, by simple induction, a current, similar, excepting in strength, to the transmitting one. This current is augmented by the electricity which the antenna also "picks up" from the electrostatic field. Hence any method of charging a transmitting aerial with a rapidly interrupted or alternating current (for the field moves only as the current fluctuates) will set up radio waves.

HOW WE OBTAIN HIGH-FREQUENCY CURRENTS

THERE are several systems of generating high-frequency currents: the spark, alternator, arc, and bulb. The spark, until the advent of the audion, was by far the most popular means of generating radio waves, and was demonstrated by Hertz many years ago. When a condenser is charged to a high potential by a transformer or static machine, and the

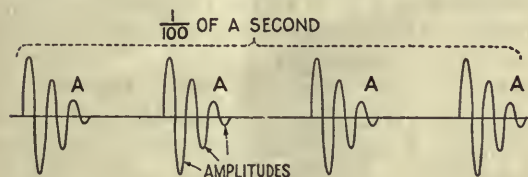

FIG. 1

terminals then approached to within sparking distance, the condenser will discharge across the gap in a spark. This spark, is not a single discharge as it appears to the eye, but a series of isolated discharges, *first in one direction and then in the other*, each one weaker than the last, until the condenser is discharged. The spark is, of course, accompanied by similar reversals in the current which, in electrical language, "alternates." But for radio-telegraphic purposes the condenser is immediately recharged, at which point the action is repeated, and the resulting radio current assumes the form of a group of oscillating discharges which can be indicated diagrammatically, as in Fig. 1.

The alternator is a modification of the alternating current generator or dynamo, designed to produce oscillations of a very high frequency, an effect that is also achieved by the arc and bulb. The radio impulses set up by these last named systems are of a continuous nature

and are shown in Fig. 2. In contrast with the preceding illustration, it will be noted that the successive oscillations in Fig. 2 are all of equal amplitude or power (that is there is no

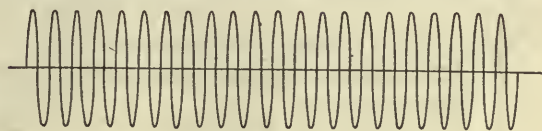

FIG. 2

"damping") and the wave train is not broken up into groups of audio frequency. In Fig. 3, the coil or inductance L_2 and condenser C comprise an oscillating circuit. L_1 is a similar winding connected through switch S to a battery. As the switch is closed a current flows through L_1 and sets up a magnetic field which, expanding, cuts L_2 . As L_2 is cut by these lines of force, a current is induced in it, flowing, we shall assume, in the direction indicated by the outer arrows. However, when the switch is opened, the flux collapses and L_2 is now cut by the lines of force in the opposite direction, and, by the same laws of induction, the induced current momentarily follows the direction indicated by the inside arrows. Hence, by rapidly opening and closing the switch S , an alternating current is induced in the second winding. *This switch action is exactly what is effected by the three-element tube, except that the interrupting of the circuit is accomplished far more rapidly than would be possible by hand.*

Fig. 4 shows a somewhat revised circuit with the audion bulb replacing the switch. For this purpose *almost any of your detector or amplifier tubes will do*. When the filament is lighted, the potential on the grid, as determined by the condenser and leak, having first been adjusted to a slight positive charge, the tube

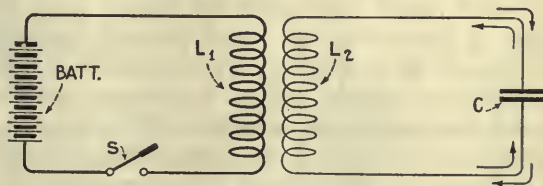

FIG. 3

will operate for a fraction of a second as indicated in A, Fig. 5. This small plus charge tends to draw the electrons (electrons are negative, and unlike charges attract one

another) from the filament, boosting the plate current which flows from the filament to plate, and, further on, through the tickler coil L_1 . As this current rises from zero to max-

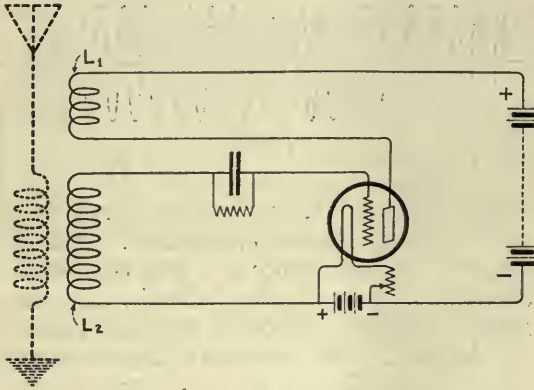

FIG. 4

imum, a secondary current is induced in L_2 which, if the tickler is connected in the right direction, will place a negative charge on the grid. The bulb will then react in accordance with Fig. 5, B, when the now negative grid will repel the like charges thrown off by the filament. This permits less electrons to complete their journey to the plate and decreases the plate current. As this space current drops, the magnetic field about the tickler contracts, cutting L_2 in the opposite direction, reversing the flow of induced current through this coil, and, necessarily, the charge on the grid which returns to positive (Fig. 5, A and C). With the return to normal, the phenomenon repeats itself, the cycle being completed many times a second with a frequency depending on the capacity and inductance in the circuit. As in the case of Fig. 3, with which comparison is suggested, the rise and fall of the flux surrounding L_1 induces an alternating electromotive force in the second inductance. If a third circuit, indicated by dotted lines in Fig. 4, comprising an aerial, ground, and inductance, be coupled to L_2 , a fraction of the alternating current will be transferred to the open antenna circuit where it will radiate energy from the aerial in the form of radio waves. However, this last circuit is not essential for producing oscillations, and for laboratory transmission L_2 alone will set up sufficiently powerful radio impulses.

The circuit just described is a fundamental one, and although to simplify it for practical purposes a single coil has been substituted for

the individual plate and grid inductances, it is easier to operate in the original separate circuit form. It is suggested that the beginner, in his early experiments, confine himself to the diagram as here given. The experience of constructing and operating such a transmitter will be of great value when he eventually signs his call on the air.

An experimental arrangement is illustrated semi-diagrammatically in Fig. 6. Honeycomb coils are indicated as they are probably the most convenient form of inductance easily available. But if the experimenter desires to make his own coils, they may be roughly wound on any suitable tubing approximating three inches in diameter. L_3 , L_2 , and L_1 , the latter a modulating coil, are wound with any insulated wire from No. 24 to No. 30, with 25, 35, and 50 turns respectively. Any arrangement for mounting the home-made coils permitting a variation of the coupling between them will be satisfactory. If honeycomb coils are preferred, the experimenter should obtain one each of the sizes L_{25} , L_{35} , and L_{50} , indicated in Fig. 6 as L_3 , L_2 , and L_1 , respectively. The standard three-coil mount affords the most convenient method of connecting them in their proper circuits. The rheostat may be placed directly under the coil mount with the B battery and bulb on the baseboard behind the supporting panel. Good results should be secured by using from eighty to a hundred volts on the plate of the average amplifying tube. As reference to Fig. 4 will show, the action of the set is critically dependent on the original grid charge, and variation of the grid leak is necessary in some sets. The addition of a variable grid leak

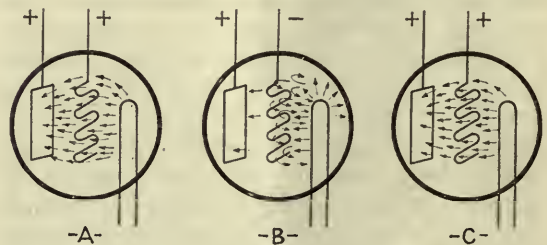

FIG. 5

will, in any case, add to the efficiency of the apparatus.

Modulation is secured by shunting the L_2 coil with an ordinary microphone using very loose coupling between L_3 and L_2 . The resistance of the modulating circuit is varied by

speaking into the transmitter, and with it the amount of energy absorbed by L_3 from the oscillating circuit. The residue energy in the middle coil, varying inversely, sets up modulated wireless waves. This is known as the absorption system of modulation, and it finds favor in many amateur stations. The quality of the modulation may be adjusted by changing the coupling between L_3 and the adjoining coil.

In first tuning the experimental set, it is advisable to include a pair of telephone receivers in the plate circuit, i. e., in series with the B battery. If the set is oscillating, words spoken into the microphone will be heard loudly and distinctly in the phones. *As the set is operative only with the tickler coil connected in the right direction, it may be necessary to reverse the connections leading to it.* If, after tentative adjustments on the filament and tickler, the circuit will not oscillate, it is possible that the modulating coil is absorbing too much energy from the main circuit, in which case ten or fifteen turns may be removed from L_3 .

This apparatus, without antenna and ground is, of course, capable of transmission only over very short distances, but it may be used for demonstration purposes across a small hall or between rooms.

If the experimenter is already in possession of his station and operator's licenses, he may transform this set into a short-range C. W. transmitter by removing the microphone and substituting an aerial with series condenser and ground. For tuning, it is advisable to include a radiation milli-ammeter in the ground lead. By breaking the plate circuit with a key, straight C. W. (continuous wave) may be used, which, under favorable conditions, should carry from

How to Get Your Transmitting Licenses

If you wish to transmit, you must have two licenses, one certifying you as an operator, the other for your station. You must be able to receive at least ten words a minute (five letters or characters to the word), and must comply with certain other requirements explained in the Government pamphlet: "Radio Communication Laws of the United States." It is advisable to obtain this pamphlet, as it gives a list of places where examinations are held and other information either necessary or helpful to the prospective operator. It may be had from the Supt. of Documents, Government Printing Office, Washington, D. C. Price, 15 cents a copy.

three to five miles, with the one tube.

This system is known as the *inductive feedback* circuit, and is so described in order to differentiate between it and other oscillating circuits which employ a condenser coupling, rather than the tickler, to effect the transfer of energy from the plate back to the grid circuit. This latter system is classified as *capacity feedback*.

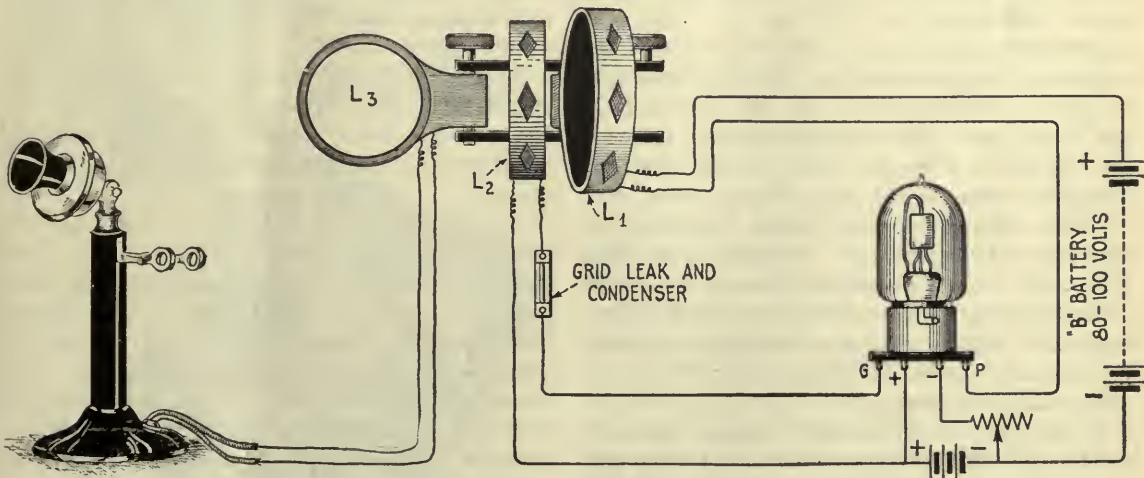

FIG. 6



Have You Written Your Radio Book?



By Following the Principles Here Laid Down, Any One, Regardless of Whether or Not he Understands the Subject, Can Write as Good a Book About Radio as Many Now on the Market

By RALPH MILNE FARLEY

Illustrated by TOM MONROE

SINCE the advent of the Radiophone, there has been an ever increasing number of books on the subject, until finally there has developed a regular technique for their production.

The present writer has reluctantly accepted the task of giving a simple explanation of the working theory of writing such books, so that any boy of sixteen or man of sixty can turn one out with equal facility and profit.

The first chapter should commence with an elementary explanation of the hitherto unsuspected fact that two and two make four and that stones thrown into ponds cause a wave-action. This naturally leads to the statement that sound, heat, light, color, and Hertzian waves are just alike, except as to frequency of oscillation. This isn't true, but it gets the book impressively under way. Also you can drag in the fact (which isn't true either) that seats in a theater are arranged in a semi-circle so as to take advantage of the travel of sound-waves in circles.

If your readers will swallow these two statements, they will believe almost anything: you will have laid a good foundation for comparing

Perhaps in no way are faults and foibles so clearly exposed as by satire. As Dryden puts it:

*"Satire has always shone among the rest,
And is the boldest way, if not the best,
To tell men freely of their foulest thoughts,
To laugh at their vain deeds and vainer thoughts."*

The author of this article is a mathematical physicist who has recently made an investigation of the books about radio which are now flooding the market. You will be interested in what he has to say. Probably you will agree with him; certainly you will be entertained.
—THE EDITORS.

the relation between frequency, inductance, and capacity with the dependence of the period of a pendulum upon its length and weight. Of course, it is a well known scientific fact that the period of a pendulum is absolutely independent of the weight, but why spoil a good analogy? Besides, your readers probably don't know any

more about elementary physics than you do.

But be sure not to explain what inductance and capacity are. You can have a great time with these two.

And while on the subject of oscillations, you might state that the waves caused by throwing a stone into a pond are called *damped* oscillations on account of the effect of the water.

At this point, permit me a word on the subject of illustrations for your book. The first few should show boys throwing stones into ponds, lightning striking houses in New Jersey, Ben Franklin flying a kite, etc. These can be picked up in almost any print-shop. The remainder of your illustrations, consisting of wiring diagrams and pictures of pieces of apparatus, can be lifted from the catalogues of one or two electrical supply houses. Thus you

will save having to split any of your loot with some artist.

Now, to go back to the text of your book. The electron theory should next be explained. In order that you may do this, I shall now explain it to you: each atom of matter is a little solar system, in which the sun is a positive charge of electricity, called the nucleus, and the planets are negative charges, called electrons. Conductibility consists in the presence of lots of stray electrons between the atoms. A dielectric (for Heaven's sake, don't say "non-conductor," or you might be understood) has but few stray electrons. The stray electrons in a conductor tend to flow toward any point of positive potential, i.e., a point where the stray electrons are fewer than normal. Generators and batteries act as pumps, sucking in electrons on one side and forcing them out on the other.

That is all there is to it. But, by the introduction of sufficient verbiage, hot-air, repetition, analogies, and plus and minus signs, it ought to be good for at least two chapters.

From this point on, explain nothing. You have been so elementary and explicit at the start, that your reputation is now safe, and the reader will blame himself alone, if he cannot follow you. And it will be just as well for you that he cannot. To be absolutely sure of this, after explaining that electricity consists in the flow of electrons, and that electrons always

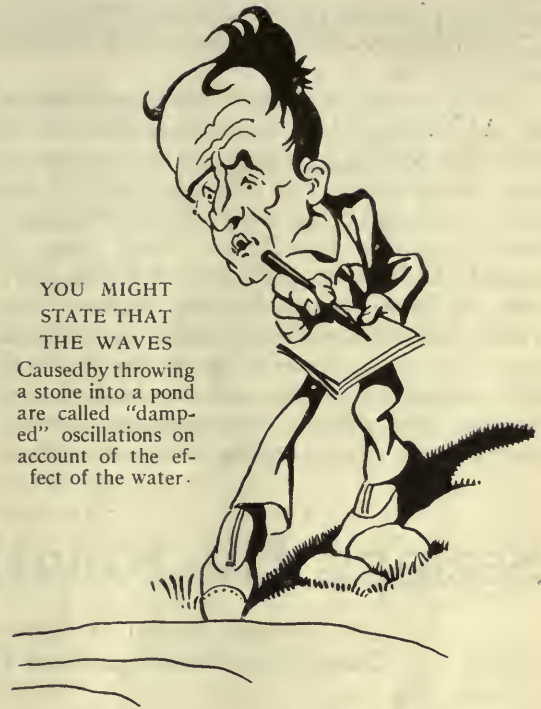

YOU MIGHT
STATE THAT
THE WAVES

Caused by throwing
a stone into a pond
are called "damp-
ed" oscillations on
account of the ef-
fect of the water.

flow from minus to plus, you should thereafter (without further explanation) always refer to electricity as flowing from plus to minus.

Next explain the Edison effect. You can enhance the effect, if you state that De Forest or Fleming, or some equally nice-sounding name, discovered that a Fleming tube could be used to rectify an alternating current. Don't destroy the effect by explaining what you mean by "rectify." Illustrate this chapter by a lot of wiggly lines, with appropriate titles. You can draw these illustrations yourself. Almost any sort of wiggly lines will do, if you do not explain the meaning of graphs and coordinates.

Next cover the antennas, sending and receiving. To do this, merely paraphrase and amplify the instructions which go with any amateur set put out by professionals. If you still have space left after this, get several radio amateurs to describe their installations, and then you translate, from English into radio-language, what they tell you.

Use the following words as often as possible: audion, audio frequency and radio frequency, capacity, counterpoise, filter, impedance, modulation, microfarad, potentiometer, super-regeneration, and variocoupler. This is a sure-fire way to give the impression that you are a full-fledged member of the Radio fraternity.

A whole chapter can next be made up out of

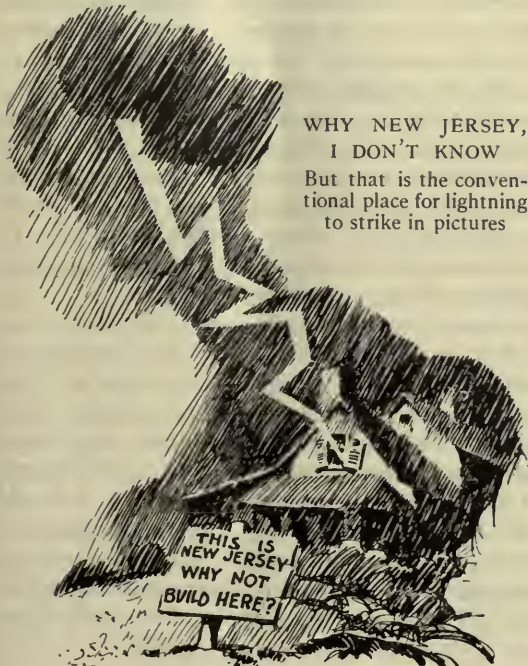

WHY NEW JERSEY,
I DON'T KNOW

But that is the conven-
tional place for lightning
to strike in pictures

THIS IS
NEW JERSEY
WHY NOT
BUILD HERE?

cautions which are to be found in the literature of manufacturers of storage-batteries, charging-apparatus, etc.

The last quarter of the book should consist of "helpful hints." It is remarkable how much space can be filled by ringing all the changes on any simple idea. For example, each of the following should be good for at least two pages: your apparatus is delicate, don't bang it around; don't blame your own set if you can't hear, lay it to the broadcasting station; don't try to receive during a thunderstorm (here insert the specifications of the National Board of Underwriters, which can be obtained free through any friendly fire-insurance agent); don't put the various tuning knobs, etc., where

you cannot reach them easily; and don't receive so loud that you can't make out the music.

In conclusion, let me tip you off to the most important idea of all, the only original thought in this entire article: get out a new edition annually, or even monthly. This can be done easily by printing a new copyright page periodically, the copyright costing you only two dollars and two copies of the book (which will be no great loss). Books on Radio are now so numerous and so alike, that a prospective purchaser will judge entirely by the date, and will invariably purchase the latest. Being the latest is infinitely more important than being of any use.

Seeking His Relatives by Radiophone

An Unusual Appeal to Thousands of Listeners-in by One Who Never Knew his Parents or Relatives or Their Acquaintances

MR. CLIFFORD HOLMES of Council Bluffs, Iowa, who has tried for years to find trace of his family, has recently been continuing the search with the help of various broadcasting stations located all over the United States. He writes: "Imagine yourself in my place and you will perhaps understand how much it means to me to get this story into the hands of all the people I can, in hopes that perhaps by some possible chance I may be rewarded."

As he suggests in his letter, the Radiophone can reach a far greater audience than was ever possible before, and may be the means of helping many people who have despaired of ever hearing from their relatives or friends, to get in touch with them.

This is the message Mr. Holmes is asking broadcasting stations everywhere to send out for him, and which he delivered himself on July 31st of this year, from the Omaha Grain Exchange station (WAAW):

"I speak over the Radiophone to-night in the hope that someone in this vast audience, hearing my message, may be able to give me information concerning myself or my relatives. Twenty-one years ago this September I was left in the Christian Home Orphanage in Council Bluffs, Iowa. That was on September 16th, 1901. The orphanage cared for me until

February 14th, 1902, when I was adopted into a family. They have reared me since. At the time of my adoption, my foster parents were given the information by the matron of the orphanage (who is now dead) that my name was Clifford Holmes, and that I was born September 13th, 1901.

The information at that time was also that my mother died three days after my birth, and that my father, a laboring man, disappeared shortly afterward. Since then I have been unable to find anything of his whereabouts or the place where my mother was buried, if the story concerning her death is true. The information I now seek is news concerning either my father or mother, relatives of theirs or any friends of either of their families. To aid in possible identification, I am giving you a brief description of myself as follows:

I am twenty-one years old; six feet three inches in height; weight 170 lbs; complexion medium dark; hair, medium brown; eyes brown. My address at present is 635 Bluff Street, Council Bluffs, Iowa, and any information any of you may be able to give me will be appreciated to the fullest extent. I would also be grateful to any other broadcasting station operator who might pick up my message and re-broadcast it. With the cooperation of other broadcasting stations, I sincerely hope that I may hear news of my people."

Rich Mines We Have Yet to Explore

How Bell, Trudging Over the Hills, Stumbled Upon His Gold Mine.
The Underlying Principle of Vibrations and Their Universal Importance.
Vibrations Known and Unknown. Can We Stretch Another "Octave"?

By ALFRED M. CADDELL

DO YOU remember hearing your Uncle Abner tell what he did when he was a boy, how he and the other lads of the village rigged up telegraph lines and sets and sent all manner of messages? How they made their own coils and keys and batteries, and otherwise tinkered with "lectricity"? A young fellow wasn't in it, those days, if he didn't know something about telegraphy and the Morse code.

To-day, the popular interest in radio forms an exact parallel to the situation in the early days of telegraphy. Thousands of young people got their first insight into electrical science by means of that time-honored art. It made them think about electricity as nothing else could have done; and thinking about it, their thoughts carried them far afield into other branches of science—sound, heat, light, and higher mathematics. A solid foundation was laid from which great minds were to develop, and out of the maze of experiments that went on between woodshed and garret, some big discoveries were bound to come. Discoveries have a penchant for happening just that way.

The great goal in radio to-day is selectivity—the elimination of interference in sending and receiving messages. The great goal in telegraphy half a century ago was the possibility of sending several messages over a single wire at the same time. Inventors experimented with different frequencies of alternating current, utilizing the law of sympathetic vibration—the basis of tuning for all radio receiving. One receiver would be tuned to the same frequency of alternation as was the transmitter—say 200 per second—and would select the message being sent over that frequency and that alone. Other receivers would be tuned to different frequencies—300, 400, and 500—to receive messages transmitted accordingly. It was a most fascinating dream, and it awoke many an exploring mind to the wonders that electricity was destined to bring forth in the future.

Numbered among the hosts of amateur experimenters was a young man in Boston, Alexander Graham Bell, who taught the art of visible speech to deaf mutes by day, and labored among coils, batteries, magnets, and vibrating reeds at night. His particular goal was a harmonic telegraph system, by which he confidently expected to send six or eight messages simultaneously over the same wire. The secret lay in tuning the vibrating reeds of the receivers, to correspond in pitch with those of the transmitters—so Bell thought, and so he labored.

However, like the miner trudging over the hills in search of gold and unwittingly kicking a nugget at his feet, the young experimenter stumbled upon a veritable gold mine. Throughout a ceaseless vigil and nursing to make his "brain child" perform in the manner he wanted it to, Bell's thoughts went wandering down a different path from that he had been treading for more than three years. Primarily, he was a student of vibrations. He lived and moved in the very thought of vibrations. As a professor of vocal physiology, he had studied the human voice, the human ear, and the medium through which the voice traveled—air. He knew that the voice was composed of complex vibrations set up by the vocal chords in the throat; that these vibrations, when modulated by the tongue and lips and expelled from the mouth, set up a mass vibration in the air in the form of sound waves, which waves, impinging on the drums of a listener's ears, caused them to vibrate and produce the sensation of sound. Bell knew that the air varied in density according to the vibrations of the voice. And by his experiments with vibrating reeds, he knew that when a receiving reed was tuned to the same pitch of a transmitting reed it would vibrate in unison—the current of electricity would carry the vibrations. So he reasoned: "if I could make a current of electricity vary in intensity, precisely as the air varies in density during the production of a sound, I should be able to

transmit speech telegraphically." Behold! the underlying principle of the telephone, both wire and radio—the varying in intensity of an electric current (or carrier wave) according to the complex vibrations of the voice.

The enunciation of this basic principle, however, antedated the actual discovery of it in action. Did it come right out in the open and show itself to the young experimenter's gaze? Indeed, it did not. All Bell had was an idea evolved by a study of the various rates and modes of vibration—a hopeful theory. But just as any one in search of a tool in his tool-box comes across a certain instrument that is especially suitable for another job he has in mind, just so Bell recognized something that filled the bill for this particular work. It was like the flicker of a camera shutter that let in a little light.

Hitherto, while experimenting with his harmonic telegraph, Bell's assistant had operated the transmitting key exactly as a telegraph operator does to-day—making and breaking the contact. The reed over the magnet of the transmitter vibrated, and if the reed over the magnet of the receiver was tuned to the same pitch, it would vibrate harmoniously with the transmitter. But now something different was destined to happen—the jinn of magic was about to spring from the lamp.

It was a hot day. Something had happened

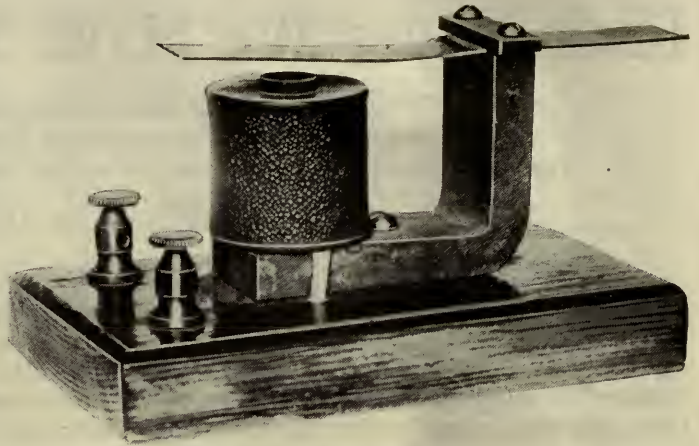

BELL'S VIBRATING REED

By adjusting the length of the reed over the magnet pole, the pitch could be raised or lowered

to the transmitting key. It stuck, forming a closed connection and a steadily flowing current. The assistant began fooling around with it and plucking the reed. Instantly there came a shout from Bell. Faint as it was, the twang of the reed could be heard at the receiving end—Bell had recognized the varying vibration, the complexity of pitch as the twang ranged from high to low. Then and there the telephone became an actuality, for Bell instantly knew that if a complex sound like that, with its ever-changing vibrations, could be transmitted electrically, the complex vibrations of the human voice could be transmitted equally well.

This is not intended to be a review of the history of the telephone. Rather, it is an attempt to point out the all-importance of vibrations in connection with its development, and to show that had not Bell thought in terms of vibrations and had a practical knowledge of the vibrations of speech or sound, the chances are that he would never have thought of impressing the vibrations of speech upon an electric current which could convey them swiftly to any desired place. If he had thought in terms of electricity and not in terms of the phenomena that constitute speech and sound—vibration—he would probably have lost himself in the scientific woods. For as Moses G. Farmer, one of the foremost electrical scientists of the day, said on a visit to Bell's laboratory, shortly after the



discovery was announced to the world: "That thing has flaunted itself in my very face a dozen times within the last ten years, and every time I was too blind to see it. But if Bell had known anything about electricity he would never have invented the telephone."

As far back as 1872, and perhaps prior to that, vibrations meant everything to Alexander Graham Bell. And nearly half a century later

"But, speaking seriously, I am struck by this fact—that nearly all developments in electricity have had to do with vibrations. Starting out with the vibrations of sound in the medium of air, we have reached the height of vibrations in the luminiferous ether of space—from the low vibrations of sound to the high vibrations of X-rays. Lying in between these extremes are the electrical vibrations of radio,



DR. ALEXANDER GRAHAM BELL

Engaging in the first telephone conversation between New York and Chicago

—May 18, 1915—in accepting the Edison Medal presented by the American Institute of Electrical Engineers, he said in part:

"Have you done yet? Are you going to make any new advances in electricity? You have electric light, electric heat, electric power, electric speech, or rather hearing by electricity. Are you going to see by electricity? I can imagine men with coils of wire around their heads communicating thought by induction. However, that is for you to do in the future.

tuned to instruments far above our ability to hear.

"All our knowledge of the external universe is gained through our sensations, our sensations taking cognizance only of vibrations. Now that we know so much about sound, heat and light, and other things, we can put to ourselves a hypothetical case.

"Suppose you had a rod, clamped at one end, and free to vibrate at the other. Now, pluck this rod and it vibrates. Endow it with

the property of vibrating continuously, faster and faster, and observe its vibrations in a dark, quiet room. We pluck this rod—you see nothing, you hear nothing, but put your hand upon it and you feel it move. It appeals to one sense, the sense of touch. Now let this rod vibrate faster and faster, and presently the vibrations appeal to two senses. You can feel it tremble, and when the vibrations number about thirty-two per second, you begin to hear low musical sounds. Let it go on vibrating. As the vibrations increase in frequency, they appeal more and more to the sense of hearing and less and less to the sense of touch. The pitch of the sound rises, and gradually you get a higher and higher pitch, like a siren shriek. And when the rod vibrates about 32,000 times per second, you have a very loud, shrill tone; the limit of perception will approximately have been reached. Feel it, and it is still—we no longer feel the tremble, and no human ear can hear much above 32,000 vibrations per second.”

From mechanical vibrations in the ponderable medium of air, we now pass on to molecular vibrations in the material bodies and their related waves, not in the air, but in the very imponderable medium of ether.

In effect, Dr. Bell continued as follows:

When we get up into the millions of vibrations per second, we begin to perceive an effect, not with the sense of touch, not with the sense of hearing, but with the sense of temperature—radiant heat begins to be evolved. As the molecules vibrate faster and faster red light appears. Now it appeals to two senses—the sense of temperature and the sense of sight. As the vibrations increase in intensity the light gradually changes, going through all the colors of the rainbow. The perception of

radiant heat diminishes, while the luminous perception increases. Finally, the rate of vibration becomes so great that violet light is produced—we have gone through all the colors that compose the spectrum (sunlight).

Go a little higher, and again we have no sense capable of recognizing the vibrations. Nothing can be felt, nothing heard, no tempera-

ture effect, nothing can be seen; and yet put a photographic plate near the rod and it will be affected by actinic and ultra-violet rays.

Beyond the ultra-violet lies the X-rays and radium rays. “But,” resumed Dr. Bell, “how much further up we might have vibrations I do not know. Now, the thought that comes to me is this—in that great gap between the highest pitch of sound and the lowest pitch of radiant heat—a gap much greater than the rest of our sensations put together—we experience no sensation whatever. All our knowledge of the external universe is derived from our sensations which recognize vibrations. Indeed, nearly all our knowledge comes through the sense of

sight (the 49th octave of the appended table). Just think of all the things you have ever seen—they are all derived through one octave of vibration. And then think of the vast gap that exists between the highest pitch of sound and the lowest pitch of radiant heat—we have no senses that can take cognizance of it, and yet these vibrations exist in nature.

THE GAP BETWEEN SOUND VIBRATIONS AND RADIANT HEAT VIBRATIONS

BUT now we know that there are electric waves in that gap. The phenomena of radio are made possible by the vibrations that lie in that gap. Why, then, are we not making instruments for our senses to use—creating



—LIKE THE MINER TRUDGING OVER THE HILLS

In search of gold and unwittingly kicking up a nugget at his feet

new senses? And is there not a field for you in investigating that electrical gap? If we have derived so much knowledge of the external universe through one octave of vibrations that affect the sense of sight, may we not hope for an enormous increase of knowledge concerning the vibrations that reach us from between these points?"

The vibrating rod has indeed formed the basis of many experiments in physics. The increase in the rate of vibrations is ruled by a definite law, the number of vibrations executed at a given time being inversely proportional to the square of the length of the rod. For instance, let us take a strip of brass two inches long. Make it one inch long and the resultant sound is the double octave of the former, though the rate of vibration is augmented four times.

Suppose we start with a strip 36 inches long which vibrates once in a second. According to the above law, when the strip is reduced to 12 inches, it would execute 9 vibrations a second; reduced to 6 inches, it would execute 36; to 3 inches, 144; while if reduced to 1 inch in length, it would execute 1296 vibrations per second.

In experimenting with a vibrating rod, to make its vibrations more evident, its shadow is thrown upon a screen. Sir Charles Wheatstone, the famed English physicist, devised a simple but ingenious optical method for the study of vibrating rods fixed at one end. Attaching silvered beads to the end of a metal rod and focusing a light upon the bead, he obtained a small spot intensely illuminated. When the rod vibrated, this spot described a light which showed the character of the vibration.

To a physicist, all phenomena in nature are simply various rates and modes of vibrations.

Everything is motion—sound, heat, light. Sound is a wave motion in the air and heat and light wave motions in the ether. The action of light and radiant heat is exactly the same as that of sound. They are controlled by the same law, diffusing themselves in space and diminishing in intensity the farther they travel.

Like sound, also, light and radiant heat, when passed through a tube with a reflecting interior surface, may be conveyed great distances with comparatively little loss. Every experiment on the reflection of light has its analogy in the reflection of sound. Engineers, when figuring problems in sound or mass vibration, may multiply the result by octaves and find correspondences of vibration in radiant heat and light; and vice versa—results found in ethereal vibrations may be "stepped down" the required number of octaves and exactly the same parallel or analogy found in mass vibrations.

But as to the region of experimental electric waves that lies between the highest pitch of sound and the lowest pitch of radiant heat—indeed, therein lies an immense field for investigation. Some day an experimenter, following in the footsteps of Bell, may stumble over another nugget while searching for a distant vein of gold. The great possibilities of television lie before us. Can the vibrations of light (the 49th octave) be reduced by some means and impinged on waves of a lower frequency and transmitted electrically as the vibrations of sound waves are impinged on an electric current or carrier wave? Will it be possible to "see" thoughts by researches in higher vibrations? Truly, the principle of vibrations underlies much that we know and a great deal more that we do not know.

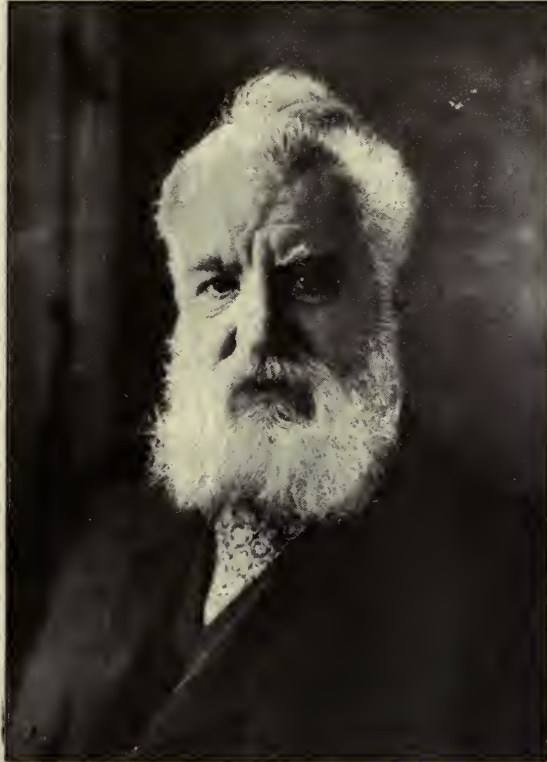

© Harris & Ewing

THE LATE DR. ALEXANDER GRAHAM BELL

Who recognized fifty years ago the tremendous importance of vibrations. "All our knowledge of the external universe," said Dr. Bell, "is gained through our sensations, our sensations taking cognizance only of vibrations"

TABLE OF VIBRATIONS

The 64th octave marks the approximate upper limit of vibrations that physicists have been able to register by physical means—the various rates are obtained in several ways, and are generally computed in terms of Angstrom units.

The physical meaning of the term "octave" (as in sound) is that it is a note produced by double the number of vibrations of its basic or fundamental note.

OCTAVES	VIBRATIONS PER SECOND	EFFECT OF VIBRATIONS
64th octave	18,446,746,473,709,559,616	Gamma rays, X-rays. Probably marks most rapid atomic or molecular vibration where atoms and molecules vibrate individually instead of in clusters, or masses
63rd "	9,223,373,236,854,779,808	
62nd "	4,611,686,618,427,389,904	Unknown
61st "	2,305,843,009,213,693,952	
60th "	1,152,921,504,606,846,976	Ultra-violet light waves
59th "	576,460,752,303,423,488	
58th "	288,230,376,151,711,744	Solar spectrum light waves (sunlight)
57th "	144,115,188,075,855,872	
56th "	72,057,594,037,927,936	Heat or thermal radiation. Infra-red rays
55th "	36,028,797,018,963,968	
54th "	18,014,398,509,481,984	Unknown
53rd "	9,007,199,254,740,992	
52nd "	4,503,599,627,370,496	Region of experimental electric waves—Unknown
51st "	2,251,799,813,685,248	
50th "	1,125,899,906,842,624	Radio waves
49th "	562,949,953,421,312	
48th "	281,474,979,710,656	The region of sound. The ear is capable of hearing 11 octaves, compared to one octave (49th) for sight. Practical range of musical sounds lies between 40 and 4,000 vibrations—approximately 7 octaves range of pitch for the human voice in singing is from 60 for a low bass to about 1300 for a very high soprano. The piano has a range of pitch from 27.2 to 4138.4; the pipe organ usually from 16 to 4138 vibrations per second.
47th "	140,737,468,355,328	
46th "	70,368,744,177,644	Unknown
45th "	35,184,372,088,832	
44th "	17,592,186,044,416	Unknown
43rd "	8,796,093,022,208	
42nd "	4,398,046,511,104	Radio waves
41st "	2,199,023,255,552	
40th "	1,099,511,627,776	Radio waves
39th "	549,765,813,888	
38th "	274,877,906,944	Radio waves
37th "	137,438,953,472	
36th "	68,710,476,736	Radio waves
35th "	34,359,738,368	
34th "	17,179,869,184	Radio waves
33rd "	8,589,934,592	
32nd "	4,294,967,296	Radio waves
31st "	2,147,483,648	
30th "	1,073,741,824	Radio waves
29th "	536,870,912	
28th "	268,435,456	Radio waves
27th "	134,217,728	
26th "	67,108,864	Radio waves
25th "	33,554,432	
24th "	16,777,216	Radio waves
23rd "	8,388,608	
22nd "	4,194,304	Radio waves
21st "	2,097,152	
20th "	1,048,576	Radio waves
19th "	524,288	
18th "	262,144	Radio waves
17th "	131,072	
16th "	65,536	Radio waves
15th "	32,768	
14th "	16,384	Radio waves
13th "	8,192	
12th "	4,096	Radio waves
11th "	2,048	
10th "	1,024	Radio waves
9th "	512	
8th "	256	Radio waves
7th "	128	
6th "	64	Radio waves
5th "	32	
4th "	16	Radio waves
3rd "	8	
2nd "	4	Radio waves
1st "	2	

Electric Waves in the Ether

Keeping an Eye on the Icebergs

How the Use of Radio Makes Possible the Work of the International Ice Patrol and Brings to Hundreds of Navigators a Relief from the Dread of Icebergs which, during Three Months of the Year, in the Vicinity of the Grand Banks of Newfoundland, Constitute a Serious Menace to Transatlantic Shipping

By ORTHERUS GORDON and CHARLES S. O'SHEA

THE iceberg menace was by no means unknown before that dark night in April, 1912, when the *Titanic*, on her maiden voyage, crashed into a monster berg, crumpled in like so much cardboard, and sank, with a frightful toll of human lives, in less than twenty minutes. Nothing much had been done about it, however, until the international clamor for some sort of protection against a repetition of this disaster resulted in the establishment of an International Ice Patrol.

Skippers had dodged icebergs in northern latitudes and waterspouts in southern, by unending vigilance. In the old days, the transatlantic lanes ran directly through what is now the most dangerous part of the spring ice field; then with the advent of faster, larger steamers, the lanes were shifted southward, so that they would clear the normal southern limit of danger. But we knew that the limit of danger was by no means fixed, and that an exceptionally early start from the north might still bring icebergs into the paths of commerce. In spite of this knowledge, we waited for the costly lesson—and got it. Our cry for protection was in accordance with our habit of locking the barn doors after one of our steeds has been spirited away by the hides-and-glue man.

Still, there were others left to be cared for.

Had it not been for radio, the problem then confronting the maritime nations would have been a difficult one to solve. Although radio was then, comparatively speaking, in its infancy, it was hailed as the only way in which detached and separated vessels might be warned of the presence of these prowlers of the sea; and the nations in conference at London in 1913, one year after the great disaster, agreed that the first step toward safety of life and property at sea was to install radio outfits on all vessels. The second step calculated to destroy the menace of the ice, was to place

vessels, with efficient radio equipment, on patrol in the dangerous region, whose sole duty it would be to locate the ice and disseminate the information to vessels concerned. That the ship-owners were more than willing to obey the law in the first case, if it meant the protection promised in the second, is easily believed. From that year to this, with the exception of the two years in which the United States was at war, two vessels of the Coast Guard Service have temporarily based at Halifax, Nova Scotia, and alternately sallied forth to patrol the Grand Banks of Newfoundland during the active months of the glaring white menace.

The United States, in the very year of the *Titanic's* fate, had taken upon itself the problem of ice protection, and sent out the scout cruisers *Chester* and *Birmingham* to the scene of that disaster. They formulated a procedure for the vessels which were to follow them in the work, and proved the adaptability of our seamen for this peculiar and strenuous service. All this, viewed by the nations at the International Conference, led to placing the responsibility for the Ice Patrol in the hands of our country. The work was to go on as before, but the expense was to be divided among the thirteen nations there present, in proportion to the size of their North Atlantic fleets.

Last year, the work was allotted to the Coast Guard cutters *Seneca* and *Yamacraw*, which were old hands at the game. Like all cruising cutters of the Service, they are equipped with the latest improvements in radio. The nature of their work for nine months of the year compels them to carry a reliable outfit, and also makes it imperative that the equipment be fool-proof. Always on the alert for distress calls, their sphere of usefulness is identical with their radio range. Hearing the distress call, they find their way to the vessel in trouble by means of their radio compass, despite boiling seas and swirling fogs.



U. S. S. "TAMPA"

Showing the exceptionally high mast which makes long-distance radio work possible

However much the patrol vessels perform by means of their radio on ordinary coast duty, their work is doubled when they set out in April for their ninety days' duty on the Grand Banks. What before was an occasional rush of work now becomes an untiring vigil. The radio cabin becomes the "fighting top" of the ship, and the clearing-house for all information.

From the time an iceberg is first reported until it breaks up under the demoralizing warmth of the Gulf Stream or goes back again to the north with the receding Labrador Current, it is the subject of countless anxious messages.

In the first place, a broadcasted notice of it is sent out immediately by the patrol ship, as well as individual warnings if the plotted position on the special chart in the navigator's room prove it to be in the path of oncoming steamers. The first night of its encounter, its drift—or the direction and speed with which it is traveling—is determined by the sure method of drifting with it. From then on, its hourly position is located on the chart. Its characteristics are noted, so that it may readily be recognized when a merchant ship comes across it and reports its presence by radio. Another feature of the patrol's radio work is that every four hours a request is broadcasted asking all ships within range to send in their position, course, and distance, together with the sea-water temperature. Most ships, desiring what protection the

patrol ship can afford them, respond to this call, with the result that the chart is not only a graphic picture of all the bergs in the vicinity but also of all the ships crossing the Grand Banks and likely to run into danger. The value of such a chart, continually brought up to date, is apparent, but the amount of key-pounding it means is astounding! Every four hours, there pours in on the overworked staff, a host of ship reports—TR's, as they are designated at sea—as well as hundreds of water temperature records, which come in at any and all hours.

Then there is the 4 A. M. report to the Branch Hydrographic Office in New York. Like the medical officer's morning report on the patient, this is a complete diagnosis of the condition of the ice field: its boundaries, its movement, and the individual bergs that constitute the most dangerous elements. This report is incorporated in a printed memo-

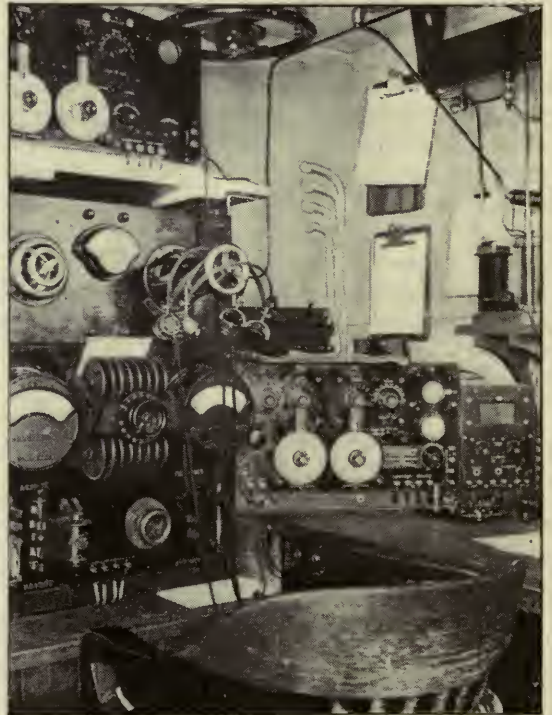

THE RADIO CABIN
Is the heart of an Ice Patrol Cutter



U. S. S. "SENECA"
Dwarfed beside this monster of the sea

randum sent out by the Branch Hydrographic Office, and distributed about New York City to the officials of interested steamship lines, to the Maritime Exchange, and to such others whose names are on the mailing list. From the New York Hydrographic Office, the 4 A. M. report goes on to Washington by land line, is recorded at the main Hydrographic Office, and broadcasted from the naval radio station at Arlington, Va. This report is undoubtedly the one that covers the most distance, and it would not be surprising if, emanating from the ship in the morning, it were to find its way back there before evening.

Again, there is the daily 6 P. M. broadcast, sent on the commercial wavelength of 600 meters, containing all the information gleaned that day from personal contact with the bergs or reported by other ships. It is repeated twice, with a two-minute interval between messages, and is designed to give navigators a chance to study the state of the stretch of ocean that lies before them that night. This done, the necessary reports for the day are completed, but not so the radio work. Assuming that the second dog watch from six to eight has been comparatively dull, things begin to hum after that.

For at eight comes the broadcasted request for all ships within the call to report themselves, so that they may be "spotted" on the

iceberg chart and given all possible protection. With this request, containing as it does a note of warning and caution, every navigator who is worthy of his tickets figures out his latitude and longitude, judges the speed of his vessel, corrects the compass for his true course, and hot-wires the information to the Coast Guard cutter, throwing in a water temperature by way of thanks, and to cover his trepidation. (This, you see, is really a voluntary contribution to the list of sea-surface temperatures always in demand by the cutters.) The navigator then has the assurance that his ship is placed on the all-knowing chart, with her course stretching out in a pencil line before her, while a government officer is bending over it, ready at a moment's notice to flash a warning should an iceberg be reported on, or drift across, that course. —

Most ships, however, are not content with the 6 P. M. broadcast, or with the service rendered by the chart, but must send in for special information. "Is there ice on my course?" demands one. "I am on the Louisburg (Cape Breton) track." And another asks, "What is the best route from the English Channel to New York, and what are the limits of the ice region?" "What are the limits of the danger?" "Is my course clear?" "Can I make Cape Breton without striking ice?" These three inquiries come from a group of

cautious commanders. There is also the ever-present case of the navigator who takes a chance on the weather and the shortest route across the berg-infested area, irrespective of warnings. This practice, while safe in clear weather, is very trying on the ship's personnel when fog or night overtakes them before clearing the region. They bombard the ether with requests for information that will enable them to proceed, but often it is only a quick shift of the helm that saves them from crashing into a berg.

For the navigator is particularly helpless in the ice region in a fog, despite the fact that most of them erroneously believe they can "sense" an iceberg, if not by some seventh faculty of their own, then by the sudden

change in air and water temperatures. It very suddenly gets cold. That is the belief, but nothing could be more misleading, nothing more dangerous to the mariner, should he depend entirely upon it. Fortunately, he does not. All sea-water temperatures taken thus far by the ice-patrol vessels fail to show that there is any marked change due to the nearness of ice, except when immediately alongside of a berg. A vindication of the tremendous amount of energy expended by the radio and chart-room personnel in carefully checking up on sea-water temperatures is demonstrated by the following incident:

It seems that near the end of the season, when the icebergs were working slowly to the north and while the *Seneca* was operating close to what she believed to be the southernmost one of the field, a radio came from a steamer reporting four of them thirty miles farther to the south. Naturally the commander of the *Seneca* was concerned and prepared to search them out. Could it be possible that these four bergs had escaped his vigilance? He thought not; but it was the sea temperature comparison that first impeached the accuracy of the steamship making the report. Her

temperature report did not agree with those taken by the *Seneca* and other vessels in the same locality, so a verification of the position was requested. Then the illuminating truth came out. The ship in question had not enjoyed the company of a noon-day sun for two days, and was totally in the dark as to her actual latitude! Later, it transpired that she was one whole degree to the north of her dead reckoning position! This placed the bergs

thirty miles to the north of the *Seneca* and not to the south as first reported. The sea water temperature work had saved the Ice Patrol a wild-goose chase.

But the work of this patrol! The constant, continual solicitation, with the willing coöperation of the merchant vessels

only adding to the sum total! During the three months of operating last year, no less than 945 vessels reported themselves and the temperature of the water they were in, 2,646 times.

Recently, when the *Tampa* and *Modoc*, two new electrically driven cutters, were carrying on the patrol duties, the *Tampa* led in the number of reports received, gathering 771 in a fifteen-day period. This was done under most adverse conditions, owing to the fact that the *Tampa's* $\frac{1}{2}$ -KW spark transmitter, on which the major portion of the work was done, heated up, causing a bad note. A few reports were handled on arc, but this type of transmission was found unsuitable, in general, for this sort of work, where speed and simplicity of operation are of prime importance.

The personal comforts of the crew of an Ice-Patrol cutter are few. On one cruise, an eight-day gale made life miserable, while on the *Tampa's* last trip a fourteen-day fog shrouded the ice area. Contrary to general opinion, the cutters do not see a large quantity of ice. In fact, on one trip, no bergs were sighted until the very last day; yet by data received by radio it was possible to keep the danger zones plotted at all times.



STUDYING THE CONDITIONS OF A BERG
From the deck of the *Tampa*

Loop Aerials for Broadcast Reception

By G. Y. ALLEN

Loop aerials are being rapidly and widely adopted, now that the principles of radio-frequency amplification and Armstrong's super-regeneration are being put into use. In general, the loop aerial is more directional, more selective, and more convenient than the types heretofore used. However, for the same signal intensity, the upkeep is greater.

In this article, Mr. Allen tells just what the loop aerial is and how it works, and explains its advantages and limitations.—THE EDITORS.

D ID you ever wish that your radio receiver would present deaf ears to all stations except the one you desire to hear? Does your landlord refuse to allow you to erect an antenna on the roof of your apartment? Would you like to have a receiver which you can move from place to place without moving your antenna or ground?

If any of these wishes have ever been yours, you will be interested in knowing the possibilities and limitations of the loop receiver. While the loop is by no means a perfect receiver, it has many desirable features which are already making it an important development in the field of broadcasting.

Early receivers and transmitters followed in the well-beaten path of Marconi by utilizing elevated wires to send out and receive their signals.

When the theory of radio became better understood, however, investigators looked into the possibilities of using a coil of wire, each end of which was connected to the radio receiver, thus replacing both the elevated antenna and the ground. The loops consisted of a rectangular frame varying from about two to ten feet on a side and carrying any number of turns of wire. A typical loop is illustrated in Fig. 1.

It is believed that a loop for receiving radio waves was first used by a German between 1908 and 1910. About the same time, the United States Navy and Bureau of Standards carried on experiments, paying particular attention to the property of the loop of being sensitive to the *direction* of travel of the radio waves. As will better be appreciated later in this article, the loop does not collect as much energy from the radio wave as does the con-

ventional antenna, and little progress was made in the early days, owing to the lack of sufficiently sensitive receiving instruments. With the advent of the radio-frequency amplifiers suitable for comparatively short wavelengths, however, the importance of the loop receiver has increased and its desirable qualities bid fair to make it a strong competitor, in certain fields, of the conventional elevated wire.

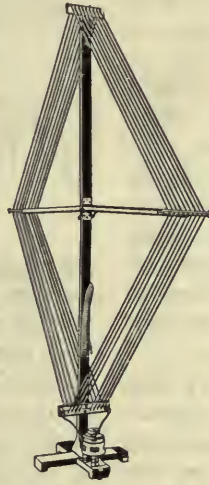

FIG. 1

HOW THE LOOP WORKS

TO UNDERSTAND how a loop antenna collects energy from a radio wave and how it develops certain of its characteristics, it will be well to review briefly the character of a radio wave itself.

A certain portion of the wave consists of magnetic flux similar to that produced by the common horseshoe magnet or supplied by the field poles of an electric generator. In the case of the generator, the magnet is stationary and coils of wire revolve in the magnetic flux field, generating current in the revolving coil as illustrated in Fig. 2. In the case of the radio loop, the coil remains stationary and the flux, traveling through space, is intercepted by the loop, generating a current in it, as shown in Fig. 3.

Now, the intensity of this flux varies as it moves through space, in step with the alternations produced at the transmitting antenna, and if the instantaneous intensity of the flux is plotted against position in space, the curve will appear as shown in Fig. 4.

At the instant shown by the black line, the flux is of maximum intensity in one direction at the left side of the loop and of maximum intensity in the other direction at the right side. The result is the setting up of an electrical potential in the entire loop which will

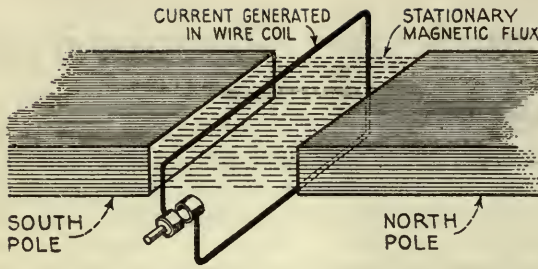
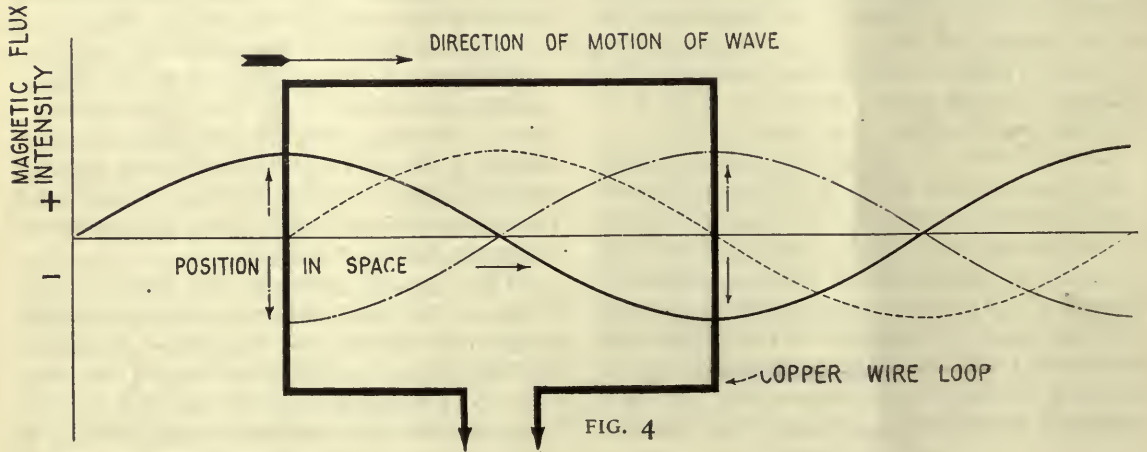

FIG. 2

cause current to tend to flow clockwise for the instant. An instant later, the wave will have passed half a wavelength to the right, and will be in the position shown by the dotted curve. Here the flux intensity is zero at each side of the loop and of course, there is no tendency to generate a current. The next instant the wave has assumed the position indicated by the dot-dash line, and the electrical potentials on either side of the loop are of the same magnitude as in the first case except that they are reversed. The wave continues to travel and the changes in electrical potential are repeated.

The resultant voltage (electrical potential) generated in the loop, if plotted against time, will appear as shown in Fig. 5. In other words, an alternating voltage will be generated across the loop, and the frequency in current reversals per second will be the same as that of the transmitter. This vibrating voltage can then be used to operate a radio receiver in the same way as the antenna and ground.

The loop shown in Fig. 4 is sufficiently long to extend over half a wavelength. Broadcasting stations operate at 360 meters and the length of the loop, therefore, would be 180 meters, or 590 feet, which would be far too long to permit the loop to be used conveniently.



Loops of much smaller dimensions are therefore used, and although they do not pick up as much energy as the larger types, with radio-frequency amplifiers they generally give very satisfactory results.

WHY THE LOOP IS DIRECTIONAL

THE loop as shown in Fig. 4, is turned so that each side is in a plane with a line indicating the direction in which the wave is traveling. If the loop is turned through 90 degrees, each part of the wave strikes both sides of the loop at the same time. The result is that although there will be a voltage induced in both sides of the loop, these voltages will

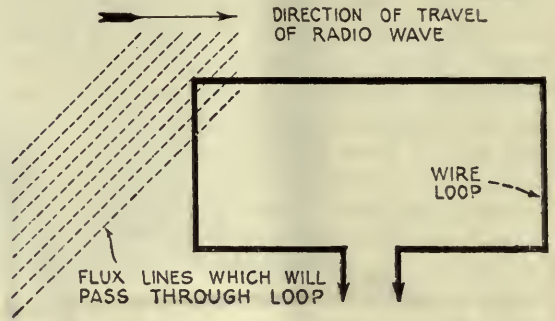

FIG. 3

be equal and opposite and there will be no current. In other words, the loop must be turned so that its edge is toward the transmitting station. When in this position, it reduces or eliminates entirely the signals coming from all other directions. In addition to the selectivity obtainable from tuning, therefore, there is a directional selectivity which is very helpful.

Fig. 6 illustrates how interfering stations

lying in a different direction from the one to which it is desired to listen have their signals intensity reduced by a loop aerial. Lines A and B are assumed to be in the direction of stations whose signals are not desired and whose signal intensity on an elevated antenna would be the same as that from the station we are tuning for. In both cases, the signal intensity on a loop would correspond to the lengths of arrows A and B as compared with the length of arrow C for the station desired. A station at right angles to the direction of the desirable station would not be heard.

In addition to reducing interference from stations, the loop antenna also reduces static interference. Loops are generally used indoors. As most of the static consists of discharges of accumulated electricity, most of these charges are drained to earth by the plumbing and electrical wiring within the house, and so loop receivers are practically immune from this annoyance. Then, too, the wave sent out by a static discharge acts upon the loop in the same manner as the radio wave. From the foregoing it is reasonable to assume that static disturbances will only be noticed when they come from points directly or almost directly in a plane with that of the loop.

A further feature of the loop will be appreciated especially by those living in congested districts. Many of us have anticipated a pleasant evening listening to a broadcasting station, only to have some well-meaning neighbor persist in adjusting his tickler to give the most powerful local oscillations, and tune his set so as to obtain a beat note of about 1000 cycles with the broadcasting station. The only effective measures in the case of those

As the loop is a very poor radiator, it does not send out much energy even if the receiver is made to oscillate, and the enforced use of such a type of receiver on those who persist in making their receiver oscillate would be an unquestionable remedy. However, as this is impracticable, the use of a loop by the person desiring immunity from this form of interference permits him to use its directional properties effectively, at least partially eliminating the

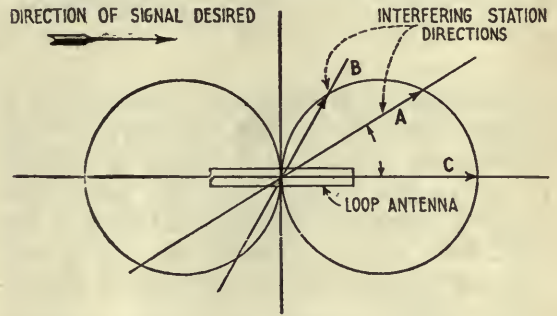

FIG. 6

interference even if the offender is using an elevated outdoor antenna.

Receivers for use with loops are generally of the simplest type. For short-wave receivers, the loop is made to take the place of the tuning coil and the wavelength adjustment is obtained by using a variable condenser across the terminals of the loop. Sometimes taps are taken from the loop if a greater wavelength range is desired. The radio-frequency amplifier, detector tube, and audio-frequency amplifier do not differ materially from similar apparatus used with elevated wire antennas.

Fig. 7 illustrates a schematic wiring diagram of a loop receiver using three radio-frequency and two audio-frequency amplifiers. Filament connections are omitted for the sake of simplicity.

TUNING THE LOOP RECEIVER

IN tuning, the variable condenser is adjusted so that the circuit is resonant to the wavelength desired, causing the signals to come in strongly. The loop itself is then turned until the desired station comes in loudest.

An inspection of the circuits will show that the oscillating voltage across the loop and condenser are applied directly to the grid and filament of the first tube. The signal is here amplified and transferred to the grid and filament of the second tube through the first

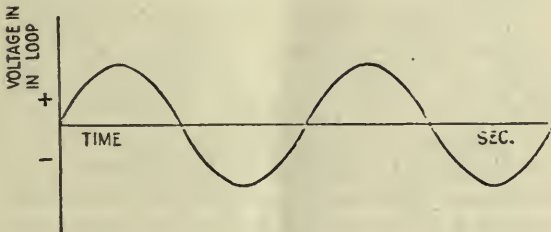

FIG. 5

possessors of oscillating receivers who seem to think that the "howl" gives a desirable quality to the music, would seem to be to give them each a loop receiver, which would give them all the noise they desire without inflicting the benefit of their pastime upon their neighbors.

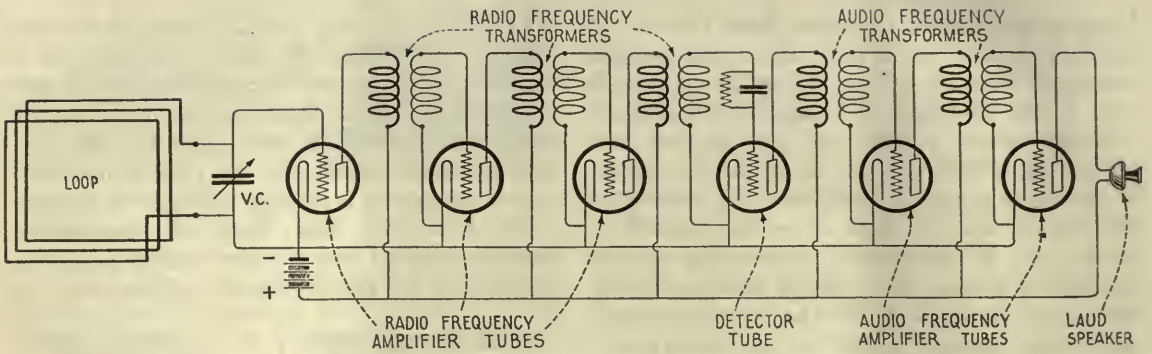

FIG. 7

radio-frequency transformer. This action is repeated through the first three tubes. By this time the strength of the signal is sufficient to be applied to the detecting tube. Detector or rectifying action is obtained in the usual way by the insertion of a grid leak and grid condenser in the grid lead of the detector circuit.

The amplifying tubes on the audio-frequency side of the detector tube amplify the voice-frequency part of the received signal and deliver it to the loud speaker with sufficient intensity to furnish the desired volume.

If it is desired to make the receiver regenerative, a number of methods may be used, one of which is shown in Fig. 8. Here a part of the inductance is connected within the receiver and is coupled to the tickler coil as in a receiver used with an antenna.

REGARDING AMPLIFIERS

AS HAS been stated before, the loop does not pick up as much energy as the outside antenna and, therefore, the success of a

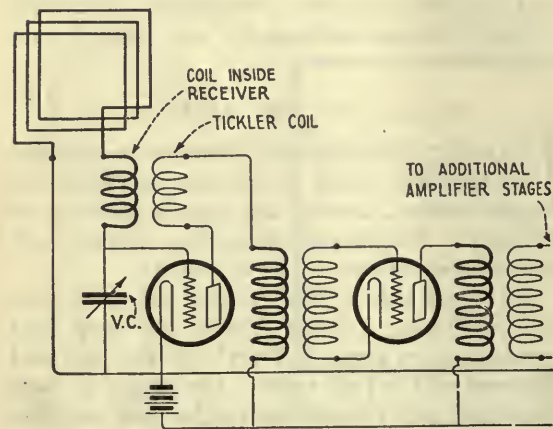

FIG. 8

loop receiver depends upon its sensitivity. The most satisfactory way of getting great sensitivity with stability of operation is to use radio-frequency amplification. Before the war, radio-frequency amplification was practically unknown, but the desirability of employing the loop receiver, particularly in plotting the positions of enemy vessels, led to the development of the radio-frequency amplifier to be used with it. The proficiency of the Allies became so great toward the close of the war that they could determine with great precision the position of enemy vessels. In fact, it is reported that the Battle of Jutland occurred as it did because the British radio compasses using radio-frequency amplifiers of some twenty stages traced the German fleet through the Kiel Canal and surmised from their movements that they were preparing for battle.

As in the case of audio-frequency, so in the case of radio-frequency amplification, amplifiers are divided into three classes: resistance-coupled, reactance-coupled and transformer-coupled.

A schematic wiring diagram of resistance-coupled radio-frequency amplifier is shown in Fig. 9. With this arrangement, the amplification per stage is not high because there is no step-up of the voltage and the amplifying constants of the tubes must be depended upon exclusively for amplification, but has the outstanding advantage of amplifying with equal efficiency over a very large range in wavelengths.

Fig. 10 shows a diagram of a reactance-coupled amplifier which acts very similarly to the resistance-coupled type except that the amplification per stage is somewhat greater. It will not cover such a great range in wavelengths and likewise has the disadvantage of

being confined to the inherent amplification of the tubes.

Because of the increase in the amplification per stage, the transformer type of amplifier is preferred. A schematic wiring diagram of such a transformer is similar to that shown in Fig. 7. Early designs of radio frequency transformers were of the air core type and they were generally wound in grooves cut in some insulating material. There were many objections to the air core radio-frequency transformer, among which was the tendency to start and sustain radio-frequency oscillations similar to those created by the use of a tickler coil in a simple radio receiving set. In a radio-frequency amplifier, such oscillations are very undesirable as they prevent the vacuum tube from functioning and reduce the amplification considerably.

Another undesirable feature of the air-core transformer is that each transformer in the amplifier must be operated round its own natural period for best results. The tuning effect of an air-core transformer is extremely critical, for such a transformer is nothing more than an inductance similar to that used for tuning a simple radio receiver. Early designers did not think of using iron cores for such very high radio frequencies on account of the fact that iron would make for a large amount of wasted energy in the circuits. Later developments, however, proved that the effect of thinly laminated iron was very beneficial in many respects. In the first place, iron being a better magnetic conductor than air, a greater voltage amplification is obtained in such a transformer.

The iron, as was anticipated, did cause a loss or a waste of energy, but in so doing also prevented the amplifier from setting up high-frequency oscillations. The over-all effect was an increase in the amplification, rather than a decrease. The effect of the iron in the

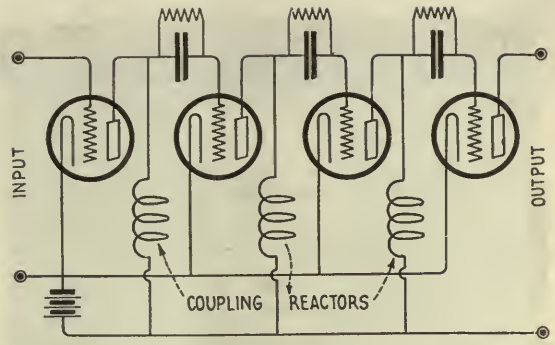

FIG. 10

transformer was similar to inserting resistance. It decreased the sharpness of tuning and permitted a transformer to be used on a greater range of wavelengths.

The wavelengths used during the war, and on which radio-frequency amplifiers were used, were generally above 600 meters. Now it is comparatively easy to design a radio-frequency amplifying transformer for wavelengths above 600 meters, but very difficult to design one that will operate efficiently below 600 meters, and particularly below 400 meters. Many attempts have been made to procure satisfactory results on these short wavelengths, but until recently they have been only partially successful.

A number of different makes of radio receivers using loops and radio-frequency amplifiers have been placed on the market during the past year. They are generally placed in cabinets similar to talking machine cabinets and the loop is found in a compartment at the bottom of the cabinet. When installing the receiver, the owner adjusts the loop until he gets the loudest signal, indicating that it is turned in the direction of the transmitting station.

In conclusion, it is doubtful whether the the loop receiver will ever entirely supersede the receiver using an elevated antenna. The radio-frequency amplifier, of course, is more expensive and has a higher maintenance cost than a simple receiver, and therefore, where price is an important factor, the simple receiver will probably always find a field. However, it is generally agreed that the radio-frequency amplifier type of receiver, utilizing a loop and installed in a cabinet, will find very wide use in the future in many of the homes of those who desire the best that is to be had.

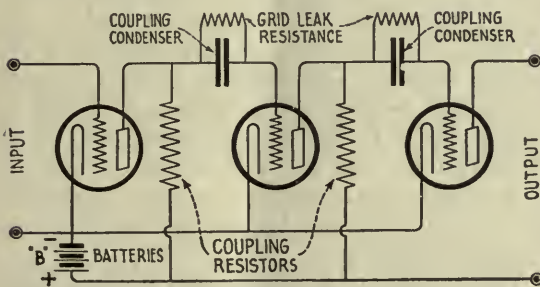

FIG. 9

The Englishman as a Radio Amateur

By M. B. SLEEPER

IT IS rather hard for the average American to realize the difference between the English radio enthusiasts and our dot-and-dash artists, hams, concert fans, and experimenters. In the first place, the Englishmen have no such classifications as these, nor any radio slang. For one thing, they take radio very seriously, making it either a real scientific study or a sport, which, if you know English sport enthusiasm, means a decidedly business-like pastime. This is particularly noticeable in the radio stores: in contrast to the rapid-fire discussions, claims, and arguments heard in our stores, the English shops have the atmosphere of scientific instrument salesrooms.

THE ENGLISHMAN'S ATTITUDE

WITH the Englishman considering the purchase of supplies, it is a case of "How can I get along without it?"

With us, it is "How can I manage to get it?" In consequence, he constructs more of his own equipment, improvises in every way possible, studies apparatus built for sale and reproduces it in his own way, and usually to his own satisfaction. And it may be said in passing that some of the workmanship is as fine as that on commercial products.

I have often heard it said that English automobile owners generally know much more about their cars than the average American. Perhaps, by the same token, English experimenters know more about the scientific aspect of radio than most of us, although I think that is hardly true, because they have not had the advantage of our many books and magazines on the subject. I did find that they are very

keen for competitions of all sorts, quicker than we are to express their views through the medium of the press and take full advantage of opportunities offered through the magazines to ask questions. They go at the radio game in a quieter way than we do, but probably enjoy it just as much, and certainly learn how to build and operate their apparatus more thoroughly than the majority of us.

It was interesting to note that their experi-

menters are much older than ours. The small boy takes practically no part in radio activities; it is the English fathers rather than sons who make up the ever-growing number of experimenters.

THE HAND OF THE LAW IS HEAVY

IT IS doubtful if radio broadcasting will find the wide popularity in England that its great appeal to the imagination has won for it here. Rather, it will be taken up by the many

mechanical and electrical hobbyists who are responsible for the great industry of making models.

One of the great difficulties which will be met in popularizing radio is of a governmental source. We know that there would be many less stations here if each person had to go through the formalities of applying for a receiving license. Our freedom in this respect has helped radio greatly, because it is such a simple matter to buy our equipment and set it in operation. Our ardor would be dampened if, in addition to obtaining a license, we had to pay a yearly license fee for the privilege of having a receiving set.

There seems to be the fear that stations operated by department stores or newspapers would

The author of the accompanying article is well known in American radio circles for his writings and other activities, not the least of which is his connection with the radio corporation bearing his name. Like many other manufacturers, Mr. Sleeper has been keenly interested in radio telephone developments in England, and has endeavoured to determine the field for American-made apparatus in that country. He has just returned from a visit to England during which he made every effort to understand the slow progress in broadcasting, allowing for the fact that British experimenters do not share the freedom of the ether enjoyed in the United States.

In our next issue, the broadcasting situation in England as seen from the British point of view will be discussed by Mr. Philip R. Coursey, editor of "The Wireless World and Radio Review" (London).

—THE EDITORS.

be used for advertising purposes. At least, that is the reason given for keeping broadcasting in the control of the radio companies. That it does not work out that way, we know, of course, but there has been very little disposition to investigate the exact status of broadcasting in America.

The most extraordinary regulation of all is that which differentiates between experimental and broadcast receiving sets. The former are permitted to receive on all wave-lengths, but the latter must be so designed that, with the 100-foot single wire allowed for the antenna and lead-in, the set will not be capable of receiving below 300 meters or above 500 meters. It must be far more difficult to decide whether a set designed for wavelengths of from 350 to 450 meters will or will not receive beyond the limits than it has been for our Bureau of Standards to say what process should be followed in judging the merits of a receiving set. It is obvious that a difference in the material over which an antenna is suspended would alter its capacity sufficiently to increase or decrease the wavelength more than 50 meters, assuming that the antenna inductance in the receiver remains the same. This regulation is so new that *no sets to meet these requirements have been designed for production thus far.*

NO SINGLE-CIRCUIT REGENERATIVE RECEIVERS

ANOTHER difficulty has been introduced by the condemnation of the single-circuit regenerative receiver. There is the most extraordinary fear in England that oscillating receivers will beat with each other, and in that way cause howling. Although I listened-in a great deal, both in London and in the country, I did not experience this dreaded difficulty at any time. However, the fact remains that the single-circuit regenerative receiver, once used almost universally in England, is no more. Our tickler coil circuits or the familiar loosely coupled regenerative sets with variometer tuning are almost unknown. It is practically impossible to buy a variometer in England. Very likely hundreds of dollars' worth of regenerative equipment in the hands of manufacturers will never see the dealers' shelves.

Perhaps the most extraordinary thing of all is the fact that English experimenters and manufacturers do not seem to mind the difficulties introduced by the new legislation. A number of radio men with whom I talked ad-



Photo by Bachrach

MILTON B. SLEEPER

mitted the apparent absurdity of conclusions which could hardly have been drawn by men familiar with the science of wireless, yet they are in no way disturbed by them or concerned with the delay in developments which must surely result.

NO FOREIGN APPARATUS FOR TWO YEARS

AMERICAN manufacturers who have been considering the exportation of radio equipment will be somewhat disappointed to learn that, during the next two years, one of the conditions under which licenses will be granted is that the apparatus used be of English manufacture. While this does not actually preclude the exportation of equipment, it does mean that imported apparatus will have no sale there. This may remove a possible field for expansion, and yet the manufacturers cannot be blamed for expecting the protection of the Government until such time as they can get well under way producing sets and supplies.

There are about fifty radio companies manufacturing apparatus, most of them in a very small way. The Marconi Scientific Company and Marconi's Wireless Telegraph Company are the largest builders of commercial equipment and have also gone in for amateur sets. Their factories may be taken as typical of the



CONTROL PANEL OF ENGLISH RECEIVER

This outfit is one of the best that is made, and sells for £25

larger concerns. At both places, complete shop equipment is provided for all kinds of work from turning out screw machine products, milled and drilled parts, coil windings, engraving, plating, polishing, and assembling.

WHEREIN ENGLISH EQUIPMENT DIFFERS FROM OURS

THE Marconi Company seems to be leading the way toward nickel finish, replacing the old and expensive method of lacquering brass parts. Instead of giving the pieces a high polish as we do, they use a dull nickel that looks like German silver. The effect is decidedly attractive. Only replacement parts are now lacquered. This change has not yet become universal, for such concerns as Burndept's still employ the other system in the belief that it gives the apparatus a more substantial and richer appearance.

It is hard to explain exactly the difference between English equipment and ours. It is probably a matter of the designers' point of view. That is, we have what might be called a definite school of design for radio equipment, while in England their apparatus is distinctly in the class of scientific instruments. The result has been something similar to that achieved by the Western Electric Company, whose first radio apparatus was planned by

men who had grown up in the school of telephone instrument design.

A striking characteristic of their equipment is that the panels are horizontal in nearly every case, with the tubes mounted outside. Possibly the fact that we have used vertical panels and cabinets with hinged covers permitting the inspection of the parts behind the panel accounts for our development in neatness of wiring and arrangement. That their sets are not open to inspection except by the removal of screws holding the panel down on the cabinet may account for the general appearance which we would call disorderly. That effect is heightened in apparatus made by some of the companies by the use of paraffin and a general daubing of shellac over wires, coils, and connections.

As for vacuum tubes, theirs are about the same price as ours, but in the matter of efficiency they are much superior. The most widely used design is similar to that originally known as the hard, French tube. The same type is used for both detector and amplifier, with 40 volts on the detector plate and up to 350 volts on the amplifiers.

NO MOULDED INSULATION TO BE HAD

AN OUTSTANDING feature of British manufacturing methods is the universal use of machine-finished insulating parts, for which hard rubber is used exclusively. I did not see a single molded part in England. Mr. Goodman, of the English Dubilier Company, told me they would like very much indeed to buy molded parts, but that it is impossible to secure acceptable electrical and mechanical characteristics in such material. Their good grades of hard rubber, on the other hand, are somewhat superior to those available in the United States. This rubber is low in price, too, but they consider it necessary to use such thick panels that our more expensive materials, which can be used half as thick, seem to me more desirable.

NO QUANTITY PRODUCTION

SO FAR there is no real quantity production of any radio supplies. In fact, it is difficult to see how quantity production can be effected when so much handwork in turning, milling, and drilling is required. This, no doubt, accounts for the embargo which, in effect, has been placed upon the importation of foreign-made equipment. But British manu-

facturers should have plenty of time to increase production, judging from the slow rate at which broadcasting arrangements are progressing.

Sales distribution is accomplished either by mail or by direct business with the dealers. There are no radio jobbers. Compared to our prices, even at the present rate of exchange, their equipment is, in general, expensive. The discounts to dealers are, in many cases, only 10%, running up to 15% or 20% in large quantities. On some parts in which I was interested the very best export quotation in large quantities was only 15%.

The wireless magazines published in England are four in number, "The Wireless World," with which we have long been familiar, "The Broadcaster," "Amateur Wireless" and "Popular Radio," providing plentiful sources of information of developments. As is the case here, great numbers of books have been put on the English market within the last few months written for those who are interested in taking up radio work.

Perhaps there is no better way of summarizing experimental radio in England than printing the following letter from Mr. E. Schulten, of Melchoir, Armstrong and Dessau, dated London, Aug. 29, 1922:

"The radio situation in England is, if anything, more befogged than when you were here. The latest Government regulation is that apparatus designed for purely amusement purposes, i.e., the reception of broadcasted concerts, is to be so constructed that it cannot receive a greater wavelength than five hundred meters. This has caused consternation in the Trade, as many firms had got into production apparatus of much greater capacity, and they have now all to be altered. It is further announced that when broadcasting comes into operation, a royalty of 10% on each complete machine will have to be paid to the Broadcasting Company toward the upkeep of

their stations, and the Government will also contribute 50% of the existing license fee for the same purpose. This regulation about wavelength is not to apply to experienced experimenters who can obtain licenses for the reception of unlimited wavelengths, and also use a regenerative circuit, which is forbidden to be used by the general public taking up broadcasting for amusement purposes only.

"While there are certainly firms pushing the sale of units for home assembly, I have not as yet come across one who explains in a clear, non-technical manner just what is to be done with the units, and how they are to be assembled when bought.

"It seems that the *Daily Mail* erected a broadcasting station on American lines above their offices and the Government refused them permission to use it. Then they took over the station in Holland, which is not a success and has not been heard with any degree of enjoyment by any of the experts I have talked to, and it is a hopeless failure for the ordinary amateur."

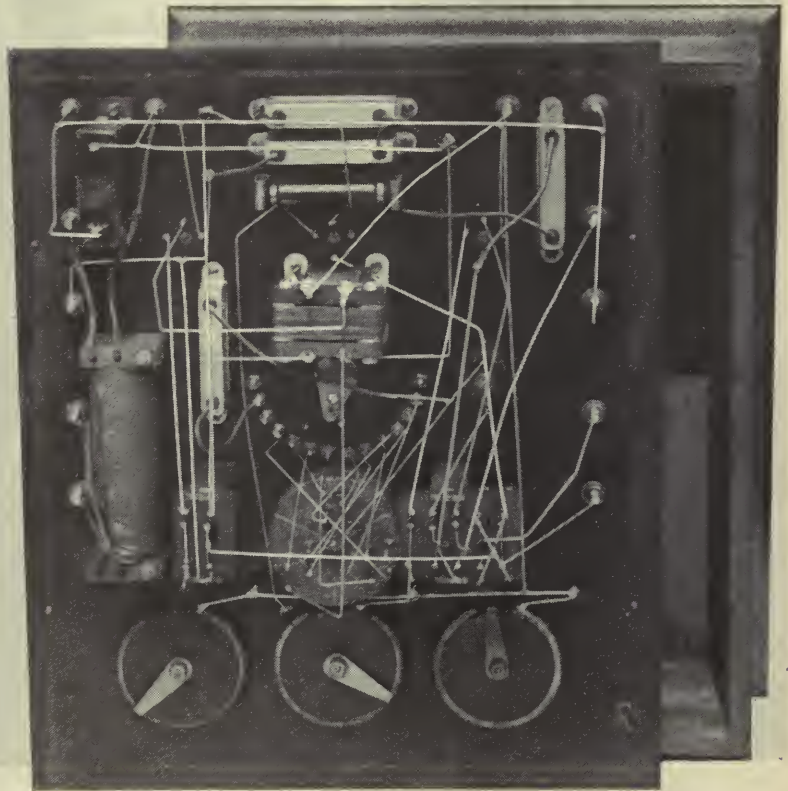

THE INTERIOR OF THE RECEIVER

Which is shown on the opposite page. Compare the wiring with that of the infinitely more complicated American receiver on page 12



© Harris & Ewing

DR. J. H. DELLINGER
Chief of the Radio Laboratory, U. S. Bureau of Standards

The Bureau of Standards Lends a Hand¹

By J. H. DELLINGER

Chief of Radio Laboratory

THE recent remarkable popularity of radio in the United States has caused the widespread impression that radio is something very new.

While it is true that its use for popular entertainment is new, the principles have been well known and certain uses of radio have been undergoing development for many years. The seed of the present extraordinary growth was, in fact, planted sixty years ago by the scientific research of the English physicist, Maxwell. This article will endeavor to give a glimpse of what Uncle Sam's radio laboratory is doing to increase the knowledge and extend the usefulness of this science.

THE CHANGING APPEAL OF RADIO

RADIO is now being exploited through its appeal to the play instinct of mankind, but it contains also the means of satisfying the service instinct; it is one of those extensions of man's powers which science is ever revealing. It seems certain that the present radio boom will last several years, and that its present popularity based on its entertainment features will be succeeded by an era of more substantial progress based on actual service. It is this which justifies whole-hearted effort and serious scientific radio work by Government and commercial interests alike. One of the interesting things about radio is that it furnishes perhaps the greatest stimulus to the popular study of science known. Radio puts life into the study of science—something which, possibly through his own fault, the average man has not always observed there.

THE BUREAU OF STANDARDS RADIO LABORATORY

THE Bureau of Standards of the Department of Commerce is the principal Government institution for scientific research and standardization work of all kinds. It specializes on fundamental principles, measurements,

and standards, and in this field assists the various other Government departments. On account of the extensive scientific facilities of this Bureau in electrical and related lines, it is the institution best equipped to carry on scientific radio work effectively. In recognition of this fact, there is located at the Bureau of Standards not only its own radio laboratory but also radio research laboratories of the Navy Department and of the Signal Corps.

The Navy Department's research laboratory has been situated at the Bureau since 1902, when the Bureau was founded. Then came the the Signal Corps laboratory. The Bureau's own radio work was begun in 1910 in response to requests for standardization of wave meters and other measuring instruments. In the same year General George O. Squier did his pioneer work on line radio at the Bureau of Standards laboratory of the Signal Corps. The work which has been done by Dr. L. W. Austin in the Navy Laboratory is well known among technical students of radio and is the foundation of a large part of the radio engineering of today. The bureau's own work during the war is described at some length in Miscellaneous Publication² of the Bureau of Standards No. 46, "War Work of the Bureau of Standards," pages 222 to 245. There were forty persons on the radio staff during the war. At present, there are fifteen.

The radio laboratory is housed in a two-story building adjoining the electrical building of the Bureau. The Bureau laboratory occupies the upper floor, the lower floor containing the research laboratories of the Navy Department and the Signal Corps. Two 150-foot towers support antennas. There are in addition two field stations consisting of small wooden buildings located at points within five miles of the Bureau. These stations, with auto trucks, facilitate experiments in radio transmission and reception.

¹Published by permission of the Director of the Bureau of Standards of the U. S. Department of Commerce.

²Obtainable from the Superintendent of Documents, Government Printing Office, Washington, D. C.

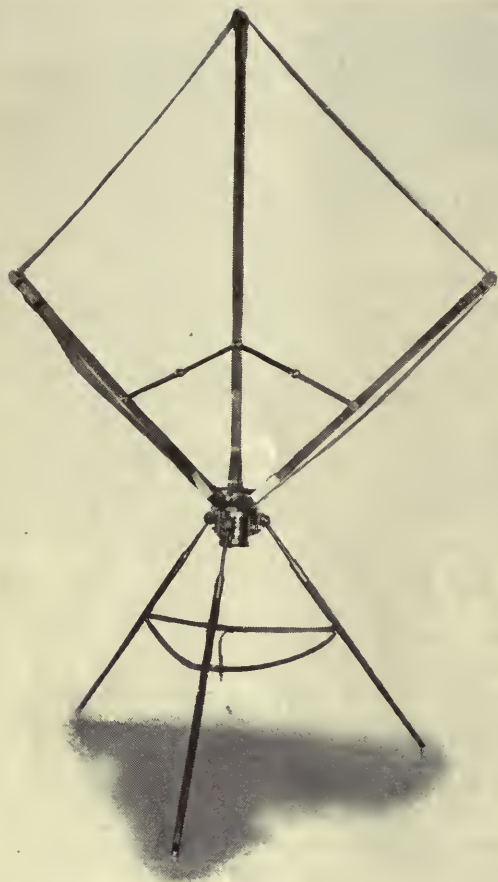

A COLLAPSIBLE, PORTABLE LOOP ANTENNA

Used by the Bureau of Standards for radio compass and similar experiments in the field

The Bureau's work in radio includes, broadly, research on principles and measurements, standardization of apparatus, and radio engineering, publication, and information.

RADIO WAVES AND SIGNAL "FADING"

WHILE the transmission of information by radio is carried on according to the process which is in accordance with simple scientific theory, yet any one who uses radio soon finds out that there are many vagaries in its action. Some of these are due to the behavior of the radio waves themselves. It is by no means easy to predict how loud received signals will be even when all the facts about the transmitting and receiving apparatus are known. One of the principal objects in radio research, therefore, is to determine the behavior of the radio waves with reference to time, weather, and the character of the surface over which

they travel. The gathering of information on this important problem involves an almost endless amount of scientific work. Careful measurements of radio wave intensity have to be made over long periods of time, by many observers in different places. This work is, in fact, being organized on an international scale, with the Bureau of Standards assisting. A study of the underlying principles of radio waves has been made, as a result of which it has been possible to develop simple ways of calculating approximately the amount of current received in various types of antennas. This helps one to determine how sensitive a receiving set is necessary to receive from a station at a given distance.

There are a number of interesting angles to this problem of predetermination of the signal intensity. One factor which complicates it is the erratic variation of signals at night. This variation, which has been noticed by many people who receive broadcasted entertainment and information, is called "fading." The Bureau, in coöperation with the organized amateurs of the country, carried on an investigation of fading a year ago which has led to a better understanding of its nature and cause. About a hundred of the best equipped amateurs took records each night of the variation in intensity of special signals transmitted from six amateur transmitting stations in the eastern half of the United States. The results showed that the radio waves are affected by conditions from far up in the atmosphere, as well as by conditions of the ground over which they travel.

"CONDENSER" AND DIRECTIONAL ANTENNAS

A GREAT deal of work has been done toward determining the best type of antenna for various purposes. This has led to improved understanding of the correct design of the two principal types, the ordinary elevated antenna and the coil antenna. It was found that a modification of the ordinary elevated antenna is valuable for many purposes, particularly at short waves; this is the "condenser antenna" consisting of an elevated pair of metal plates. The very great improvements that have been made in radio receiving apparatus make it possible to use much smaller antennas than heretofore, so that the condenser antenna and the small coil antenna are practicable. Among the contributions to the design of antennas has been the study of antenna resistance, as a result of which it was shown that the efficiency

of an antenna may be improved by keeping it away from trees and other objects.

One of the great future possibilities in radio is a means for confining the waves to one direction. Little progress has been made in this as far as the transmitting antenna is concerned, but a great deal has been done on the related problem of directional antennas for receiving. It has been found that the coil antenna is a very satisfactory direction finder, and a large amount of development work has been done to determine its accuracy, to improve its efficiency, and to adapt it to various uses. It not only determines the direction from which a radio wave comes but, by its use, it is possible to eliminate entirely any particular radio wave. The direction finder has been applied to marine and aerial navigation and found to be a valuable supplement to other navigational instruments. By enabling ships to be steered in fog, it has saved lives and property. The work at the Bureau showed that the coil antenna can be also used on a submerged submarine, or on lifeboats used in rescue work, and that it gives satisfactory communication where other types of antenna would be entirely useless.

The three-electrode thermionic tube is now a part of almost all radio receiving and transmitting sets. It is also extensively used in

wire telephony, electrical measurements and other applications. Its use is certain to extend still further, since it is so satisfactory in such diverse rôles as amplifier, rectifier, modulator, and generator of alternating current. These various uses of the electron tube have been among the objects of research. The Bureau has developed special methods of measurement, has prepared standard tubes, and developed new ways of using them. The use of electron tubes in amplifiers shows the dependence of practical utility upon scientific knowledge of the properties of the apparatus. A study of one of the properties of the electron tube, called the input impedance, has made it possible to design amplifiers much more accurately for any desired use. While the Bureau does not concern itself so much with practical development as with fundamental principles and underlying phenomena, its work occasionally includes specific applications. Thus it has recently developed an amplifier in which the current for the electron tubes is obtained from the ordinary alternating current supply, instead of from storage batteries.

One of the great advances that the electron tube has made possible is satisfactory radio telephony. In this field, the electron tube solved the two main problems: a constant

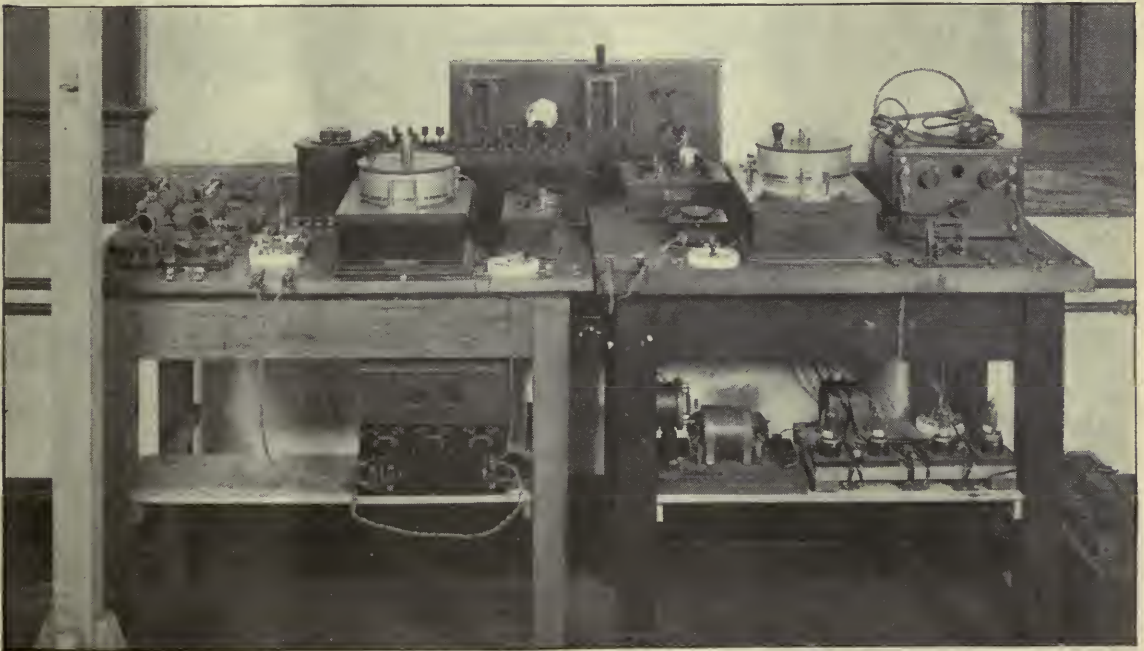

A VERY COMPLETE TESTING TABLE

Employed for making accurate measurements of the functioning of vacuum tubes

source of radio-frequency current, and a means for modulating it, that is, for making it reproduce faithfully the speech wave created by the voice. The Bureau has made studies of both uses of the electron tube, and the design of radio telephone apparatus for a given power or conditions has been correspondingly improved.

PRECISE MEASUREMENT—THE BASIS OF RESEARCH AND PROCESS

ALL scientific radio work is dependent upon special methods of measurement. It will be readily appreciated that radio measurements are more complicated and specialized than other kinds, because of the very rapidly alternating currents used. The simple methods devised by the Bureau for measuring the constants of electron tubes have formed a basis for methods now in general use. Methods of measuring signal intensity in telephone receivers have been developed and applied to measurements upon amplifiers and antennas. Measurement work has included resistance, power loss, decrement, wavelength, capacity, inductance, properties of conductors, and also the development of methods for producing and measuring high voltages and large currents. The laboratory has been equipped with cathode-ray oscillographs which make it possible to study the actual form of radio-frequency currents in radio apparatus. This is valuable in the study of electron tube phenomena and the mode of operation of spark-generating apparatus.

Radio instruments used as standards outside the Bureau are tested, and an effort is made to improve the apparatus and advance the principles of design. Such apparatus includes inductance coils, condensers, wave meters, decrementers, resistors, ammeters, crystal detectors, telephone receivers and accessory devices.

Measurements are also made of the properties of insulating materials and conductors. This work opens up a large field essential to progress in improving radio apparatus. A great deal has been done in the development of standard methods of testing apparatus all of which involve complicated and difficult procedure. Wave meters have been designed which have become standard in this country. As a result of study of the principles of decre-

ment measurement, simple means were developed for converting any wave meter into a decrementer. Work done on the study of the fundamental theory of some of the methods and apparatus has resulted in the production of formulas by which the capacity of antennas and of inductance coils can be calculated, such calculations forming an alternative to measurement. This study of measurements is fundamental to all radio research work and progress.

The research work sometimes leads into the design and development of apparatus, and of methods of utilizing radio communication. Such work is often requested of the Bureau by other Government agencies. The principal work of this kind is technical assistance to the Radio Inspection Service of the Bureau of Navigation. That Bureau issues licenses and regulates the radio communication of the United States. The Bureau of Standards coöperates with it by furnishing technical information, designing and testing measuring

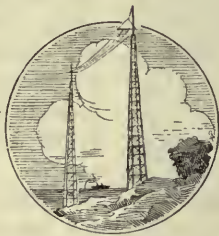

instruments for the use of the Radio Inspectors, and making studies of special problems. On several occasions the Bureau of Standards has made investigations of interference conditions in particular areas, to assist the Bureau of Navigation in its administration of the law.

The question of radio interference is an engineering problem which is of vital importance to the future of radio. It was recognized as such by the recent Radio Telephony Conference, which requested the Bureau of Standards to undertake an extensive investigation of interference in its various aspects. The same Conference requested the Bureau to undertake two other problems, the distance range of radio sets and the width of wave band required for radio telephony. On the range problem the Bureau's work already done includes the development of formulas for calculating the distance covered for given values of current in the transmitting and the receiving antennas.

In the general field of radio transmitting sets the Bureau, several years ago, designed a number of quenched gap sets for the use of various Government bureaus, and has more recently designed and constructed electron-tube generating sets for laboratory measurements and for radio telephony. Studies of receiving sets have included comprehensive tests

of the various types now on the market. Other work along this line included the development of very small, portable receiving outfits.

An investigation of the coil antenna as a direction finder has led to the development of a complete fog signaling system as an aid to marine navigation. Automatic transmitting apparatus was evolved for continuous transmission of radio waves from a lighthouse, together with a simple, practical direction finder for use on shipboard. This was begun before the war, in coöperation with the Bureau of Lighthouses. The development was suspended during the war, but the work done on the direction finder was found of considerable value for military use. Since the war, radio beacons have been installed at five lighthouses, and arrangements are being made by the Bureau of Lighthouses to install five more. With this

aid, a ship can steer toward a lighthouse or determine its position during the heaviest fog.

The Bureau serves as a radio laboratory of the Government in the sense that it is called on for technical assistance by various of the Government departments and bureaus. Advice upon the choice of equipment for particular kinds of service is given, for instance, to the Coast and Geodetic Survey, Bureau of Fisheries, Shipping Board, Coast Guard, Coast Artillery, Bureau of Markets, and Forest Service. The Bureau of Standards also coöperates in radio research with such Government organizations as the Signal Corps, Air Service, Navy Department, Patent Office, Patent Section of the Department of Justice, Post Office Department, Committees of Congress, and Bureau of Lighthouses.

In all of this, the Bureau supplements the work of other Departments. The development



TESTING INSULATORS IS A VERY IMPORTANT WORK

Where we deal with such infinitesimal voltages as those which find their way into our receiving sets, every little leak reduces the range and the strength of signals. Insulating materials play an essential rôle here. Where the high voltage surges of our transmitters are considered, the insulator is also very essential



RADIO BROADCASTING TRANSMITTERS

Present many difficult problems which cannot be solved at the broadcasting station, so the Bureau of Standards seeks the solution

of particular apparatus for military purposes, for instance, does not ordinarily come within the scope of the Bureau's activities; but research on the principles on which the design and development should be based constitutes a large part of this Bureau's work.

Lately, the Bureau has been closely identified with the remarkable rise of radio broadcasting. Near the end of 1920, the Department of Agriculture asked whether it would be technically feasible to transmit daily reports of crop prices and other agricultural news by radio for the benefit of the farmers. The Bureau undertook to try out the scheme and did transmit an agricultural news bulletin from its laboratory station daily for four months. The success of the plan having been demonstrated, a more permanent system of broadcasting was then instituted by the Post Office Department. The Bureau also showed in 1920, in an experimental way, that broadcasting of music by radio was feasible. This was done by a number of other experimenters about the same time and the great development of entertainment and other forms of radio broadcasting is now well known.

The rise of broadcasting has emphasized the need of careful radio regulation. Since all communications are carried on in the same

ether, the possibility of interference between simultaneous messages is very great and requires special understandings and rules. Radio is unique in that all concerned in it are enthusiastic for Government regulation. Recognizing this situation, in the early part of 1922 the Secretary of Commerce called a conference to consider the kind of regulations necessary in view of the constant growth of radio telephony and broadcasting. The Director of the Bureau of Standards was Chairman of this Conference. The problems and remedies were of a technical nature and centered about the assignment of different wave lengths for different uses. The principal result of the Conference was the assigning of a number of bands of wave lengths to radio telephony. This was a considerable extension of the work of international conferences which have been held in the past, and which naturally restrict the available wave lengths almost entirely to radio telegraphy. In these various conferences, the Department of Commerce has been represented by a member of the Bureau of Standards radio staff. The most recent of these international conferences was the one held in Paris in 1921.

Coöperation with manufacturers, universities, and others concerned with radio is in-

cluded in the Bureau's work. Service is rendered the universities through the furnishing of research suggestions, technical data and publications, bibliographies, information on radio laboratory equipment, etc. Coöperative transmission experiments are undertaken with university laboratories. Radio instruction in a number of universities has been facilitated by the use of the two textbooks prepared by the Bureau, "The Principles Underlying Radio Communication," and "Radio Instruments and Measurements." A file of research problems is maintained which facilitates the work of advising universities and other research workers.

The Bureau works with international research men, as well, participating in the work of the International Union for Scientific Radio Telegraphy. This Union has formulated a number of problems which require investigation by a large number of persons simultaneously. They include variations of radio wave intensity and direction, atmospheric

disturbances, electron tubes, and the improper radiation causing interference.

The Bureau is called on more and more for assistance in the commercial standardization of apparatus. There is great demand from dealers and users for standards of quality and performance by which to judge everything from tubes to loud speakers. In response to this demand, the Bureau has undertaken tests of the various commercial makes of receiving apparatus. One of the results of this work is the preparation of specifications for radio apparatus which are of use to the manufacturer and dealer as well as to the user. In this connection, a list of the manufacturers of radio receiving apparatus has been prepared. Little work has been done, as yet, on telephone transmitting apparatus, but the Bureau has received many requests for similar work in this field, and it is evident that a considerable need for standardization and information on transmitting apparatus exists.

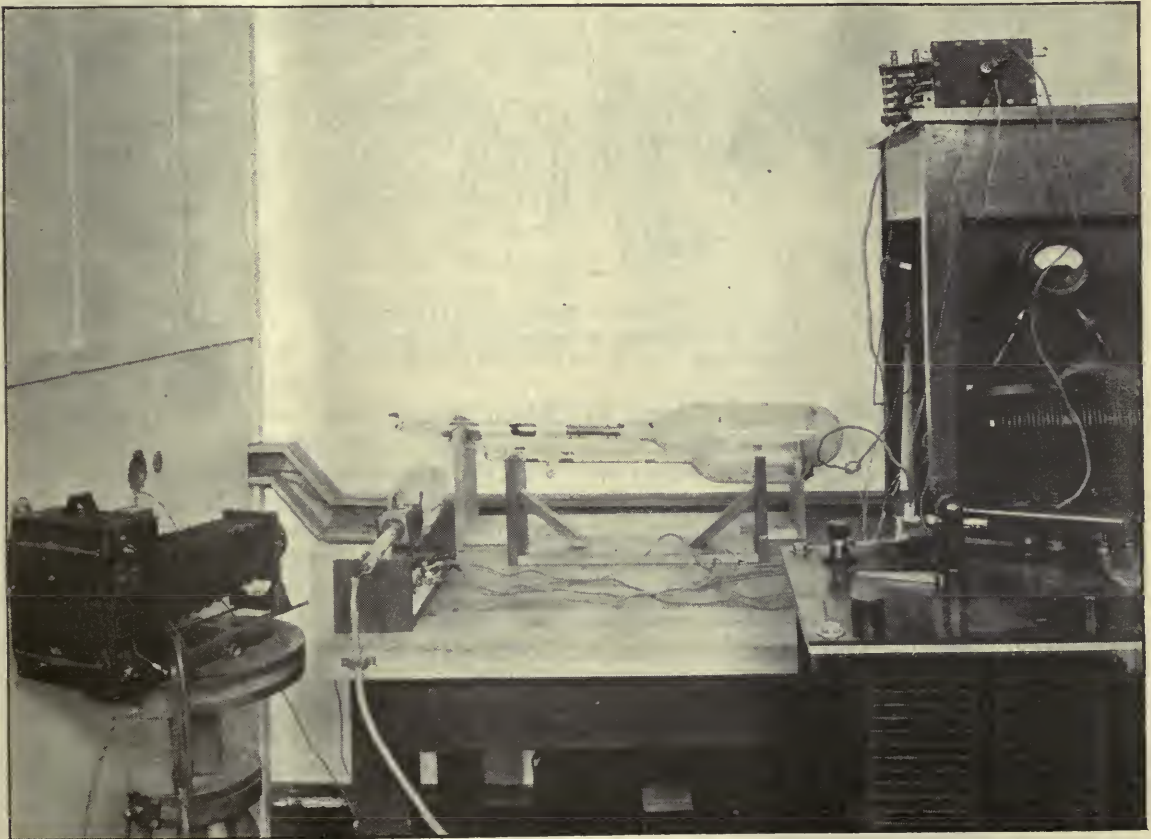

AN OSCILLOGRAPH

A device which makes it possible to reproduce on a photographic plate the action of alternating currents of high and low frequencies

By the collection and dissemination of radio information, the Bureau acts as a technical information clearing-house. Files are kept, containing results of information derived from printed articles, correspondence, reports from various organizations, and the research work of the Bureau itself. Part of the technical information is available in the form of printed publications, appearing either as Government bulletins or in radio and electrical periodicals. In addition, some of the information is edited in the form of mimeographed pamphlets, for example:

"Radio Publications of the Bureau of Standards," "Extension of the Dewey Decimal System Applied to Radio," "Methods of Radio Direction Finding as an Aid to Navigation," "Proposed Revision of Rule 86 of the 'National Electrical Code' on Radio Equipment" and "Electron Tube Amplifier Using 60-Cycle Alternating Current to Supply Power for the Filaments and Plate."

The Bureau does not in general supply its publications directly to the public. They are obtained by purchase from the Superintendent of Documents, Government Printing Office, Washington, D. C. The prices are usually from 5 to 15 cents. A list of the Bureau radio publications and other books, etc., on radio is given in Bureau of Standards Circular 122, "Sources of Elementary Radio Information," price 5 cents. Announcements of new publications of the Bureau are given in the "Radio Service Bulletin," which is a monthly publication of the Department of Commerce and can be secured by subscription, from the Superintendent of Documents, for 25 cents a year.

In recent months, the Bureau has been

called on for a wide range and large volume of information. One of the principal types of inquiry has been for information as to how a person should proceed to receive material broadcasted by radio. The Bureau prepared a number of brief pamphlets giving directions for the operation of simple home-made types of receiving equipment.

Radio has greatly stimulated the imagination of the American public. This is, in general, good. Under this stimulus, however, and lacking technical knowledge, many people are buying radio apparatus that is practically worthless. Work of the kind which the Bureau of Standards does will help this situation by supplying accurate knowledge, and eventually improving the apparatus on the market.

The greatest difficulty is that the technical work in this field

which requires the most highly specialized knowledge, has to be carried on with a constantly changing staff. The salaries which the Government pays scientific assistants are such as, in general, retain only inexperienced men just out of college. These men must be trained by the Bureau in this special field of work and they remain on the average but a short time. To maintain a staff of twenty scientific workers, there have been a total of seventy different persons on the radio staff in the past three years. This type of difficulty is especially serious at the present time when there is great demand for the services of any one who has a specialized knowledge of radio. Indeed, it may be stated that one of the Bureau's valuable functions in the radio field is the training of men for the industry.

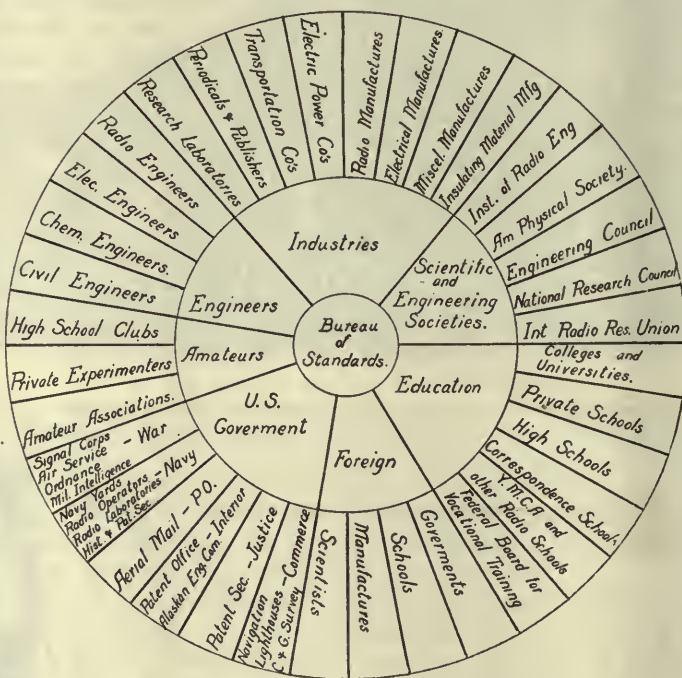

THE BUREAU'S MANY ACTIVITIES

And the numerous governmental and private institutions it serves are indicated by this chart

Singing to Tens of Thousands

Impressions of an Artist During His First Radio Concert

By LEON ALFRED DUTHERNOY

WHAT were my impressions when I sang, for the first time, over the Radiophone? What were they not! I ranged the gamut of human emotions, from helplessness to exultation.

Concert singers are all familiar with the complaint known to phonograph record makers as "horn fever," which means a bad case of nerves. That was it with me. It was a blue funk of the deepest indigo. If my knees had had cymbals attached to them, I should have been a whole brass band. Ask any movie actor who has faced the camera for the first time.

It has been my privilege to appear before 7,000 people at the New York Hippodrome, the Chautauqua Assembly Grounds, and the Chicago Auditorium, and I thought I was fairly intimate with mob psychology, but when I realized that there were 400,000 wireless outfits sold in this country, and that possibly ten per cent. of them were being tuned on me, the roof of my mouth puckered up, my tongue felt paralyzed, and my lips were blanched. Caesar may have had his thousands, but I was to have my tens of thousands! The thought went to my head, my feet, and my stomach at one and the same time.

There was I, alone in the wireless studio, except for an unassuring and impersonal accompanist and the radio representative, standing over there at the side, a model of decorum (not a bit interested in my repressed *mal de mer*), attending strictly to his knitting, said knitting being the care of some electric light bulbs. In front of me was a skinny arm, or skeletonized frame, and from that frame there hung the transmitter. It was a silly-looking little instrument about the size and shape of a ten-cent baked-bean can. When I realized that that wretched little tin can was all that stood between me and the world, his wife and his family, there was an acute palpitation around the heart, and a dry blottery feeling in the mouth.

I could think of nothing but that line of

Henley's from "Invictus" which all baritones love to burble, "Out of the Night that Covers Me," except that I was far from being "the captain of my fate" and "the master of my soul." In my mind I visualized a life-size map of the United States, and in every town, every hamlet, every cross-roads, there was *nothing but ears*. And all of these countless thousands of ears were cocked and pointed in my direction. I could see ears sticking out from behind library tables, book-cases and sideboards; the handles were ears, the glass knobs were ears, and *they were waiting for me*. Then came a comforting and cheering thought; one that brought a little gulp to my throat and a foolish bit of moistness around my eyes, and it was this: if there were ears on every sideboard and library table, then by the same token there must be people in hospitals, the bed-ridden folk at home, tubercular patients in sanitariums; old men and women in institutions, and little children in cripples'



NOTHING BUT EARS!

All cocked and pointed in my direction. If my knees had had cymbals attached to them, I should have been a whole brass band

wards. They, too, must be waiting and tuning in to catch stupid, simple me. It was with a sigh of relief that I thought of these people.

This all happened while that meticulously polite attendant fiddled around with his electric light bulbs. I tell you, it is a great mistake for a radio attendant to leave a professional singer alone to look around just before he is to sing. It is like wheeling a patient who is only half under the ether into the antechamber of an operating room, while the doctor



"ER-R-, IT IS 8:30. SHALL WE BEGIN?"

Said the model of decorum,
looking up from his knitting

is putting on his operating robe or thumbing the edge of his knives. One of these days the patient is going to get up and walk off, and one of these days when the radio gentleman looks up, he will find his singer has jumped out of the window. An amateur may be led to the slaughter unawares, but when you lead a professional to the dark water, you should keep an eye on your horse and bridle.

While waiting for 8:30 I looked the "studio" over. It was a room of about twenty feet square, and it was perfectly clear that no woman had had a hand in its design. It was furnished for utility, not beauty. Chairs were

pushed in a row against the wall which was hung with thousands of yards of yellow burlap. All the potato sacks in the city must have been draped from that ceiling. "Our accoustical engineer designed that," said the attendant, "to deaden all sound." I would have judged it the work of the office boy. To think that all this had been "conceived and deadicated" by a pedigreed gentleman with four years behind him in some technical institution! Education is certainly a wonderful thing. It looked exactly like a jute factory, although the smell was lacking.

Later I was to find that the burlap did precisely what was expected of it: namely, keep out extraneous sounds.

Over in the corner was what appeared to be a telephone switchboard—minus the gum-chewing central. At the side was a handsome grand piano. The room was certainly nothing to write home to one's mother about, although undoubtedly it was practical and efficient. Quiet reigned over all.

Presently the attendant stopped leaning over his insatiable bulbs and looked up and said, "Er-r-, it is 8:30. Shall we begin?" He then stepped over to the transmitter and announced in a voice so beautifully modulated that it was almost what actors call "Shakespearean," that "Mr. Duthernoy will begin the evening's concert with 'Vesti la giubba,' from 'I. Pagliacci.'" He then led me to within three feet of the transmitter, told me to withdraw my head for *crescendi*, and to step nearer for *diminuendi*—and abandoned me to the beyondness of the behindness of the nothingness.

I sang the aria to the tiny tin can. When I had finished, the room seemed dead. The piano had stopped reverberating and there was not the slightest sound.

So, that was that. Nothing more to it. I asked the courteous attendant if the people 'way off in Council Bluffs, Idaho, had heard that aria. He replied that to the best of his knowledge he "fancied they had."

The attendant then went over to the transmitter and announced that I would sing two songs, Bizet's "Angus Dei" and Verdi's "Celeste Aida" from the opera "Aida." This I then proceeded to do. At the end, there was the same dull, empty silence. I would have given anything for even a pathetic pattering of applause. It was my meat and drink, my board bill. But no—not a sound, not a flutter of a programme. I felt like a bell tinkling in

a vacuum—you know the example we used to have in high school in physics. I swore to myself that of all the stupid experiences, singing through a tin can was the most stupid. While I was catching my breath, the telephone jangled. The attendant picked up the receiver, and said "Yes, I will try." He then came over to me with the information that "A family up in Logan's Ferry, forty miles away, had just phoned in to ask if you wouldn't please repeat that last song again. They said it was the finest thing they had ever heard." So there was my applause—my encore! Oh, garçon, that was a moment of exaltation! Would I repeat that song? No power on earth, unless the electric juice gave out, could prevent me. That telephone call was better than a salvo of applause, all the clagues in the world couldn't make the noise that that one phone ring did in my head. When someone takes the trouble to phone in from forty miles away, it means that you scored a hit, that you shot a bull's-eye. No dead-heads in that audience. No "paper" in that house. These people knew what they wanted. Talk about flattery, satisfaction, appealing to one's vanity—it was all rolled up in one telephone call.

I stepped over to the dinky transmitter, and this time it looked as large as the Union Station. I repeated the "Aida" song. Later on in the evening, when I sang "Deep River" and "Swing Low, Sweet Chariot," the phone rang again and asked me to repeat both of them, and then someone called up to enquire if the singer wouldn't sing "Annie Laurie." I knew that all the "press agent stuff" and the three-sheetings were as nothing. These people didn't know whether I was blonde or brunette, whether I wore my hair parted in the middle, side, or in fact if I had any at all; or whether I won people through my "attractive personality" and all the other ridiculous prattle of the profession. Furthermore, they didn't give a tinker's profanation. What they liked was the singing and they wanted more of it. You may believe that they got it.

When unseen and unknown people clamor to hear you sing, it is far more to be desired than the roaring applause in the concert hall. I felt like the Boy Scout who had "done his good deed daily" and had shaken hands with the President.

I never thought much of Benjamin Franklin and his kite-and-key episode, but when I think what he did for mankind by discovering something for little boys and grown men to



—AND ABANDONED ME

To the beyondness of the behindness of the nothingness

capture and train, even if they don't know what it is, I genuflect; and when I think of what Westinghouse and Station KDKA have done and are doing for this country, I orientate. It's your old antenna to your Uncle Dudley, that wireless is *the* invention of the age.



Will Radio Replace the Phonograph?

Or Will the Radio Concert Merely be Added to the Existing Sources of Musical Entertainment without Supplanting Any of Them?

By WINSLOW A. DUERR

ANOTHER invention, rushed to a high state of perfection by the exigencies of the war, has entered our daily life and is this time disturbing the placid surface of our musical habits and traditions. According to some, it even threatens a revolution in musical entertainment. We have heard it predicted in speech and in writing, that with the radio telephone bringing music to every home, the faithful phonograph will soon be left to collect dust in the attic, symphony concerts will be attended only by impossible eccentrics who desire to have their names in the papers, and opera seats will go begging.

Of course, we cannot agree altogether with these predictions. Self-appointed prophets are as plentiful in most communities as seeds in a watermelon—like which, they are ordinarily to be avoided, not swallowed. We used to hear that the airplane would supplant the automobile by 1924, yet to-day, even in the most modern cities, the few specimens still to be observed look good for two or three years more. Once, the telephone was counted on to give the death-blow to wire telegraphy—hundreds of good-natured but erring folks had planned it so—yet the Western Union is still said to be eking out a precarious existence. And wasn't the movie to make the spoken drama a has-been? But—no further example is necessary.

As a matter of fact, what is there to be said on this radio-vs.-phonograph controversy? Both instruments are able to reproduce music played

by great artists and played at a distance from the "consumer"; both are more or less at the owner's beck and call, the phonograph, to be sure, to a somewhat greater degree than radio; and both furnish entertainment at a comparatively low cost after the original investment.

Fifteen years ago the talking machine was still a fad. People would listen to the most

horrible airs—appalling combinations of scratches and screeches—merely for the sake of hearing the human voice issue from a mechanical contrivance. But the rapid improvement in machines and records soon raised the phonograph above the plane of a curious toy. To-day, with an initial outlay of from forty to four hundred dollars, depending on the fineness of the machine and the class

There is evidence of a constantly growing feeling that the radio telephone is likely to supplant the phonograph as a means of entertainment. Many people will readily call to mind certain uses of radio which coincide with those heretofore served by the phonograph; and others can point out several important respects in which the functions of these two reproducing instruments are, and must always be, radically different. Perhaps, instead of a struggle for survival between the phonograph and radio, we shall find the newer instrument merely supplementing the older one. For example, the broadcasting of music may increase the sale of phonograph records throughout the country, as it has already done in the vicinity of some of the larger broadcasting stations.—THE EDITORS.

of records desired, one can furnish his own home with concerts, either classical or popular. The dance music is clear and loud enough to fill a good-sized room; the operatic stars are reproduced so faithfully that their voices can be readily recognized; piano and violin solos, string-quartet and even whole orchestra selections are rendered with almost the original fineness of tone and sometimes with greater clearness than is found in a concert hall. So fine is the reproduction, in fact, that great musicians and singers have often studied their records with a view to possible improvement in their own technique.

The greatest claim to popularity of the phonograph is, however, that you can have *what you want when you want it*. You can choose your favorite songs from your favorite

opera and hear them as often as you like; or you can dance at a moment's notice and need pay the orchestra no overtime. Practically every piece of great music that has been written is available on a record played or sung by one of the world's greatest artists; all the most modern popular music is to be had in its most modern form; and these are to be had at any moment of the day or night—unless the family next door lodges a complaint.

The radio concert seems to fall down in the face of such an array of advantages; but to be fair we must consider not only the radio of today but what we may expect in five or ten years. Broadcasting stations will be more powerful and long-distance reception consequently improved. Interference will be decreased by the ability to tune more finely. Receiving instruments will have been perfected to avoid "howling," and loud speakers will give a clearer tone. Static can probably never be entirely eliminated, but will be considerably reduced by the use of small, directional aerials and by other devices.

With these improvements, however, radio will still have some difficulty in crowding out the phonograph. The original cost of almost any serviceable bulb set is bound to be greater than the cheaper models of the phonograph, and no amount of large-scale production or improvement in manufacture can reduce, a great deal, the cost of the materials and skilled workmanship—even if manufacturers do content themselves with smaller profits. Breaking a bulb will doubtless always be more expensive than breaking a record; and in general, the radio apparatus, especially the batteries, will always require more attention than a phonograph. Finally, the fact that the choice of music lies with the broadcasting station, not with the audience, constitutes an inevitable and serious handicap. If we imagine a time when every receiving set is within range of ten or a dozen broadcasting stations, and if we suppose that the instrument is selective enough to tune out all but one station, with complete avoidance of interference, still the choice of enter-

tainment will be limited. It is possible to supply the music for an entire dance by radio, but a whole evening of dance music would be acceptable to only a small number of listeners in. Concerts, operas, and symphony orchestra performances are necessarily limited to productions actually being broadcasted—whether direct from the broadcasting station or from the theatre, and one might have to wait for weeks for a particular entertainment. Furthermore, the broadcasting of programmes given in theatres and concert halls, wonderful as it is, is far from perfect.

Besides the popular music and opera, many other kinds of entertainment are sent out at the same time. It might be well if two stations, for instance, occupied themselves with instrumental music (one for the soloists and quartets, another for symphonies), if a third broadcasted the semi-popular song, such as the announcer always insists on calling "That old but well-loved selection," and if still

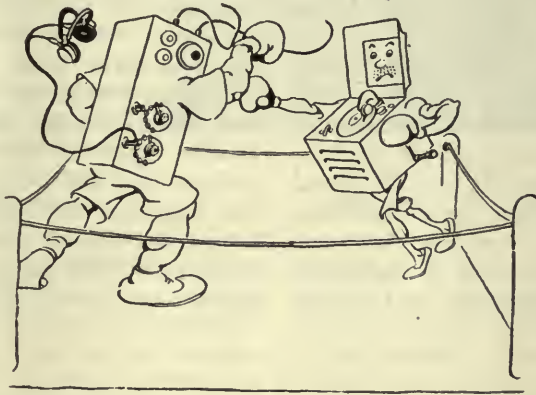

others would give news, market and business reports, political speeches, travel talks, children's stories, and all the various types of entertainment included in the present-day programmes of our big stations. This distribution could conceivably be managed. Different types of entertainment transmitted on slightly different wavelengths are undoubtedly to be an improvement of the near future. But even with this choice as to what sort of music one will hear, the radio must bow to the phonograph when it comes to supplying the individual with the particular selections he wants. Broadcasted programmes can please some of the people all of the time, and all of the people some of the time, but they can't please them all all of the time.

Generally speaking, then, radio is not likely for some time to capture the position held by the phonograph. Just as the phonograph has made no great inroads on the other sources of musical entertainment but has, instead, made more general the appreciation of good music and thus added to the desire of the public to hear the great artists, so radio is

taking good music into still more homes, and, since it cannot in many ways replace the phonograph, is supplementing it. We can readily imagine the time when the issue of the monthly record catalogues will be followed by broadcasting the records so that one may sit at home and listen to all of them before deciding what to buy.

But the greatest possibilities of radio are not as a competitor to the phonograph nor as an advertising agent for it. Its limitations are not greater than, but different from, those of the talking machine. The wireless transmission of church services has reached a remarkable degree of excellence, and for those who find the highest inspiration of divine service in the words of a great preacher or the singing of a famous choir, radio will supply that lack which may have prevented their attendance at a church which did not possess these advantages. The phonograph, furthermore, could make no attempt to publish in oral form the historical speeches, mass-meetings, and conferences which it is within the scope of radio to put at the disposal of the entire country. Many of us will listen to the next

president's inaugural address in his own voice at the actual time he delivers it. We shall be able to hear, from their own lips, the opinions of congressmen, labor-leaders, and visiting celebrities. In the realm of good music, too, radio offers this advantage: many who are too dubious of their appreciation of certain classical entertainments to purchase the expensive phonograph records will listen eagerly to symphony and vocal concerts when the cost is very small. Thus may grow up that universal appreciation of good music which cheap concerts and opera have given to Italy and Germany.

So, while we shall not expect the phonograph to suffer from the advent of radio, neither shall we expect to see radio falling into disuse because of any inherent inferiority; especially so long as there exists that almost universal fondness for tinkering with a machine ourselves and getting results *which are immediately dependent upon our own work*. This game of constructing one's own apparatus, trying out new hook-ups, and employing all one's skill in tuning the far-off stations *in* and the interference *out*, will always make the radio telephone a fascinating instrument.

Broadcasting the World's Best Literature

By EDGAR WHITE BURRILL

IT HAS been for some time apparent that radio audiences are becoming dissatisfied with many of the amateur or semi-amateur performances. The novelty of music and addresses by radio is already wearing off, and thousands of enthusiasts can no longer be held spellbound with recitals by ambitious young soloists or the mediocre efforts of would-be entertainers glad of all the free advertising they can get. Only the best will satisfy, and the leading artists are now agreeing that their services can no longer be regularly given gratis. Eventually, it is evident, just compensation must be given to those whose real talent is to be broadcasted to millions. The artist is worthy of his hire, especially if the manufacturers of receiving sets are to reap profits from his services.

But the problem of a satisfactory programme can be met in part if the quality of the literary features is of the highest. The purpose of the "Literary Vespers" given by the writer is to bring to busy people each week the choice passages of the world's best literature. The heart of each talk is a story that inspires, a story condensed to its essential human values, around which are grouped two or three famous poems, the whole being linked up with important current events.

It will be seen, therefore, that there is something deeper than merely entertaining the public in these presentations. There is a permanent stimulation in the direction of good literature, an impetus given toward the reading of books that will build character.

That the idea has been successful, there is

abundant testimony, but the secret of this success is in the idea itself. Unlike the academic atmosphere associated with college and university courses in literature, these talks emphasize only the basic human values of books. Unlike the usual addresses before clubs and Chautauquas, they are not book reviews, not talks *about* literature; they *are* the literature itself. There is no attempt to cover the mere facts of an author's life, nor to trace the influences at work on his style. The virile message of the man—what it is that makes his work of enduring value—is always the heart and soul of the presentation.

The task of selecting just the right portions of a piece of literature and of focusing upon them the light of sympathetic appreciation is a difficult one. To go a step further and select a group of poems of like theme with the short-story or drama under discussion, so that the whole shall illuminate a vexatious current problem, is perhaps the most difficult, as well as most distinctive feature of the talks.

Linking up in this way the week's news items with interpretative comment on the literature shows appealingly the vital relation between literature and life. No matter how high on the roll of honor a masterpiece may stand, it is of little avail in building character to-day unless its message can be interpreted in terms of the living present. The current events, therefore, serve not only as illustrations of a contemporary literary theme, but add a timely quality to the literature of remote ages. They point to a universality of experience which binds the centuries together.

SELECTIONS CHOSEN THROW LIGHT ON MODERN PROBLEMS

FREQUENTLY the literature selected bears intentionally upon a world problem prominent in the public eye, such as the war against war, the idea of racial solidarity, efforts for industrial peace, and the objective in education. When Mr. Wells had just arrived in this country, a story of his was introduced to illustrate the efforts for world peace then about to be made at the Washington Conference. The next week, the burial of the Unknown Soldier at Arlington led to a dis-

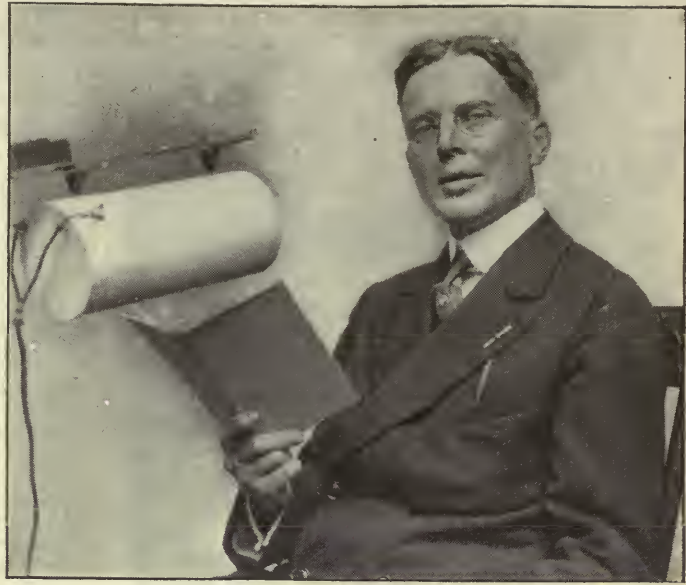

EDGAR WHITE BURRILL
Broadcasting one of his literary talks

cussion of the literature of the war. Sir Arthur Conan Doyle's visit to this country was the occasion for a talk on the great poems and stories dealing with immortality. The midnight before Memorial Day, a special address was given from the Wanamaker station (WWZ) entitled "In Memory of Those Who Died that America Might Live," the feature of which was Mrs. Frances Noyes Hart's prize war story, "Contact." Lincoln's birthday was observed by reading the major portion of Miss Ida M. Tarbell's "He Knew Lincoln," probably the best pen portrait ever made of our greatest President. Along with this were several of the best poems written to commemorate Lincoln's life and achievements.

A programme of special interest to those interested in radio is one called "The Radio of Spirit," with selections from Kipling's story, "Wireless." The let-down in idealism after the strain of war is met by the talk "The Will to Live," which includes Maupassant's "The Necklace," one of the finest short stories ever written, together with Kipling's "If," Henley's "Invictus," and Clough's "Say Not the Struggle Naught Availeth."

But whatever the theme, the core of every talk is a story, for the world is always hungry for stories. It may be a scene from a play, a passage from a novel, or part of a short story or fairy tale.

Stories have always been the surest avenues to truth, from the time of Æsop's fables and Christ's parables to Kipling's jungle tales. And the purpose of the talks, while not sectarian in any sense, and devoid of any intent to sermonize, is always in the broadest sense religious.

In the poems used, as in the news items, the aim is to throw the theme of the day into sharp relief. Just as a whole chapter of exposition and argument may be replaced by reference to a timely event, so the condensed beauty of a melodious line is often the key to a page of prose. A poem is sometimes a delightful short-cut across a field of thought. For instance, all the arguments that can be brought to bear against child-labor in the factories never have done so much good as four lines of verse:

"The golfer's club is on a hill,
And every sunny day
The toiling children in the mill
Can see the men at play."

Shelley said that "poets are the unacknowledged legislators of the world." Songs reach the hearts of men, and overturn thrones; melodies like "Tipperary" and "Over There" and "John Brown's Body" can win great battles.

THE UNIVERSALITY OF THE MATERIAL

UNDER the inspiration of famous poems and stories, the solution of our personal and social difficulties becomes more simple. A mental attitude is stimulated that is in itself helpful in the adjustment of daily problems. One does not need to preach, but to show what clear vision the poets have. "The world is so full of a number of things, I'm sure we should all be as happy as kings," sang Stevenson.

But the selection of material is not limited to masterpieces of proven worth. Often a bit of contemporary verse or fiction, or even a passage from a campaign speech, will shed light on a topic as well as a paragraph from some classic.

The keynote, however, is inspiration rather than mere information; not facts alone, but high ideals.

The world is our field, the living word of all times and ages our supply. And the choice of material for the talks has been widely endorsed not only for crystallizing the ripest race ex-

perience into the most helpful form, but for directing attention to the reading of books that are worth while.

From all sides have come expressions of appreciation that this type of service strikes home. People see how the inspired books really assist in the solution of the most perplexing difficulties. They testify to the balm and cheer to be found in the records of the best minds at their happiest moments, which alone constitutes great literature. They find a spiritual interpretation of current events, and, by analogy, a method of approach for their personal problems.

BEGINNING OF THE TALKS IN NEW YORK LAST NOVEMBER

THE home of the Literary Vespers is the Town Hall, New York City, where they were inaugurated on November 6th, 1921. Starting with no publicity campaign, the attendance grew steadily until the hall was filled. People liked the idea and went home and told their friends. It drew a constantly larger and more deeply interested class of men and women, some coming many miles especially for the service. People attended regularly from a dozen New Jersey towns, many from places well up the Hudson, or along the Sound.

The Town Hall itself is one of the most beautiful auditoriums in the city, dedicated to the service of truth and freedom. It was built to provide a suitable forum for the discussion of public questions, without partisan or sectarian bias, and is devoted to the perpetuation of American institutions and ideals. Here in the heart of the busiest city in the world, just around the corner from Times Square, where more people pass every twenty-four hours than in any other similar area, stands this temple erected to the mind and soul. It is a spiritual retreat indeed, a great radiating centre for many forms of community welfare, for all movements that will promote civic betterment.

But only a fraction of the people who listen to the talks by radio could ever be accommodated in this building. The wireless services reach far beyond the confines of one great city or one state. The ideal arrangement, of course, would be to reach both audiences simultaneously with the same service. Perhaps this will sometime be done.

Do You Know Them by Sight or by Sound?



DURING SPARE •MOMENTS

When not developing receiving outfits, W. F. Diehl, Chief Engineer of A. H. Grebe & Company, seeks enjoyment at Bayside, N. Y. His voice has been heard over the radiophone in nearly every state in the Union

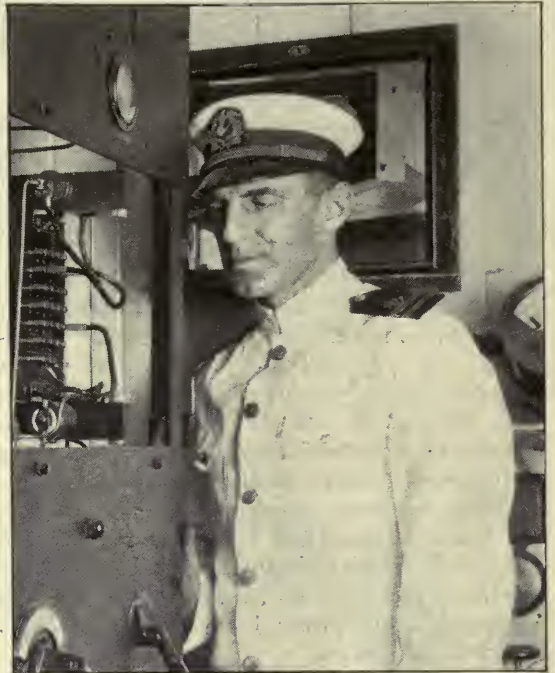

"HELLO 2XJ—KDW CALLING"

The voice of Chief Radio Officer F. G. Black of the S. S. *America* was heard in several thousand homes as the history-making radio telephone tests were carried on between that vessel and the Deal Beach, N. J., Station of the Western Electric Company

IF HER VOICE IS UNFAMILIAR

You may recognize her face, for Miss Norma Shearer shares the stellar honors with Reginald Benny in "The Leather Pushers"



THE MAN WHO SPEAKS TO YOU FROM WGÝ

Kolin D. Hager is studio manager of the General Electric Company's broadcasting station and thousands know his voice



Regenerative Radio Reception

What the Armstrong "Feed-back" Circuit Is,
How It is Used, and How to Tune It Properly

By PHIL M. RILEY

NEXT to the audion or vacuum tube, patented by Dr. Lee De Forest in 1907 and now generally used in its various forms as transmitter, detector and amplifier, perhaps the most important single instrumentality in radio is regenerative reception, or self-amplification. The invention of Edwin H. Armstrong, it is commonly known as the Armstrong "feed-back" or regenerative circuit. It makes possible the amplification of incoming waves, and without it neither long-distance radio telephone communication, nor broadcasting as practiced to-day, would be possible.

Under licensing agreements, several different forms of receiving sets now employ the Armstrong circuit. Many amateur enthusiasts are also applying it to apparatus, not so equipped, which they have bought or constructed themselves.

Receiving sets which do not provide for regeneration bring the waves of radio-frequency direct to the detector, which rectifies and passes them along to the telephone receivers at audio frequency.

Now, the Armstrong circuit includes a vacuum tube detector connected in such a manner that, prior to detection and rectification, the waves of radio frequency are partly reimpresed upon the grid of the audion. The

resulting reënförment of the grid charge causes a greater variation of the plate current and thereby produces louder signals. Hence the terms "feed-back," "regenerative," and "self-amplifying" circuits: the same tube is made to act as amplifier as well as detector.

TWO PRINCIPAL METHODS

TWO principal methods are commonly employed to reimpres the plate energy upon the detector grid in order to obtain the regenerative effect. Of these the simpler, and perhaps the more common, is known as the "tickler." It is a small extra coil located close to the winding of the secondary of the receiving tuner. A regenerative receiver may therefore consist of three adjustably-mounted air-core coils—the primary, secondary, and tickler coils.

Referring to the hook-up in Fig. 1, the first coil, P, is the primary of the loose coupler, C, connected with the antenna-ground circuit; the second coil, S, is the secondary of the coupler, connected with the detector grid of the vacuum tube; and the third coil, TIC, is the "tickler" coil connected with the plate circuit of the vacuum tube. The dotted line across this latter circuit shows the wiring which would be employed in a non-regenerative receiving set. Other symbols in the drawing are as follows: VC_1 is a variable condenser in the primary circuit for varying the antenna-ground wavelength, while VC_2 is a variable condenser for varying the secondary wavelength of the coupler. GL is the grid leak; GC, the fixed grid condenser, and VT the vacuum tube detector. "A" is the 6-volt filament battery for lighting the vacuum tube, and rheostat R controls the filament voltage; "B" is the high-voltage plate battery, which serves to pass current across the electronic bridge from the filament of the vacuum tube through the grid to the plate. FC is a fixed condenser, and T are the telephones.

In the second method of regenerative reception a variometer serves, instead of the "tickler" coil, to tune and feed back, into the grid of the

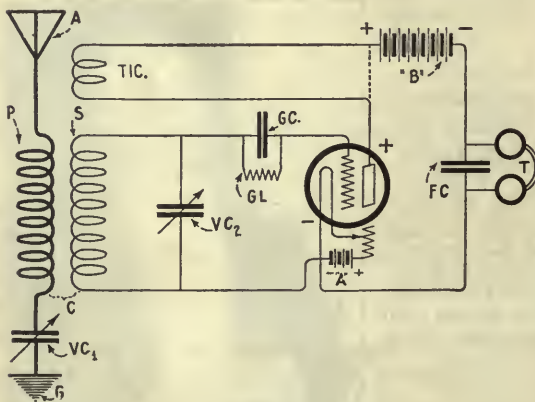

FIG. 1

A standard regenerative receiving circuit

vacuum tube, part of the increased voltage of the plate circuit. A variometer is an instrument which varies the inductance and therefore wavelength value of the circuit in which it is used. It comprises a set of fixed windings and a set of rotatable windings. When the current flow in both sets of windings is in the same direction, the variometer is at maximum inductance value and wavelength; when the rotatable winding is turned so that the current flow in the two windings is in opposite directions, the variometer is at minimum inductance value and wavelength.

Numerous wiring arrangements may be employed to secure regenerative reception by means of variometers. One of the simplest is shown in Fig. 2. C is a loose- or vario-

used across the "A" battery and in series with the plate battery to control its voltage. V_2 is the "feed-back" or regenerative variometer in the plate circuit of the vacuum tube.

A still different wiring arrangement for regenerative reception by means of variometers, also enabling very fine tuning, is shown in Fig. 4.

As in Fig. 1, VC_2 is a variable condenser for varying the secondary wavelength of the coupler, and VC_3 is a variable grid condenser like that in Fig. 3. R is the filament rheostat, and R_1 a plate battery rheostat. V is the "feed-back" or regenerative variometer in the plate circuit. The other symbols are as before.

Owing to their much greater sensitiveness, regenerative receiving sets are somewhat more

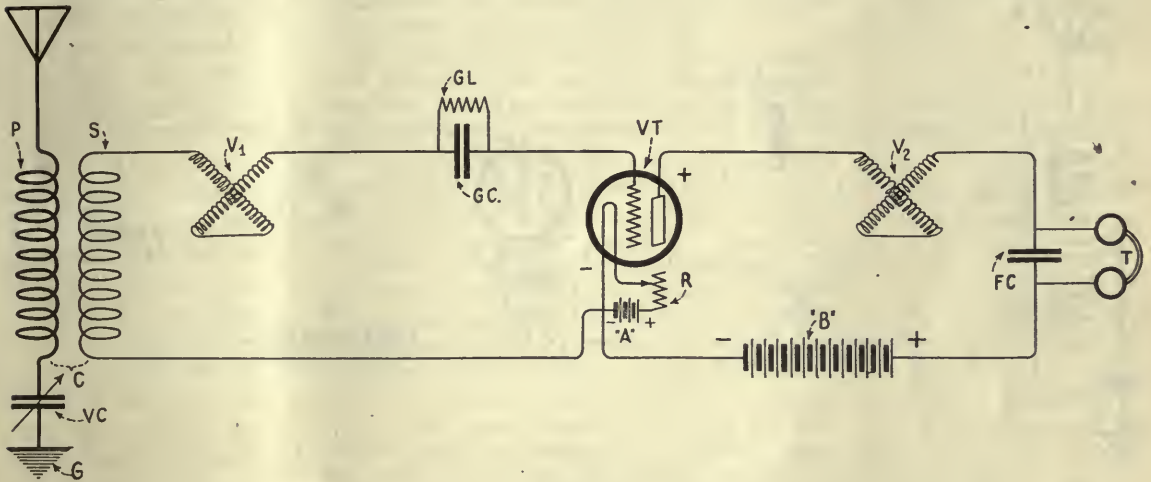

FIG. 2
A vario-coupler and twin variometer regenerative circuit

coupler (two names for the same instrument). VC_1 is a variable condenser in the primary circuit for varying the antenna-ground wavelength, V_1 is a variometer in the grid circuit for varying the secondary wavelength of the coupler; and V_2 is the "feed-back" or regenerative variometer in the plate circuit of the vacuum tube.

Another wiring arrangement for obtaining regenerative reception by means of variometers which permit of finer tuning is shown in Fig. 3. P is the primary of the vario-coupler C. VC_1 is the variable condenser in the primary circuit. V_1 is a variometer in the grid circuit. VC_2 is a variable grid condenser instead of a fixed grid condenser as in the previous hook-up. R is the filament rheostat, and R_1 a plate battery rheostat, commonly called a "potentiometer,"

difficult to operate than non-regenerative sets. But once the operator has grasped the purpose and use of the dials and become familiar with their concerted effects through a little practice, he will find that the self-amplifying feature of the "feed-back" circuit will greatly improve results. Distant signals, often even those inaudible with a non-regenerative set, will be heard much more loudly and clearly, and radio telegraph messages as well as radiophone broadcasts can be received. Except for Fig. 1, it will be noted that all regeneration in the circuits shown is controlled by variometers. The tickler coil arrangement of Fig. 1 is generally used for wavelengths above 1,000 meters. The other changes in the circuits are in the antenna and detector circuits, rather than in the regenerative or feed-back plate circuit.

Unless carefully tuned, regenerative sets cause many sorts of annoying noises in the telephone receivers, such as hissing, humming, and whistling. Indeed, so sensitive are these sets that it is advisable to place a metallic shield between the operator and the instruments comprising the set, in order to prevent the capacity of the human body from affecting delicate adjustments. High-grade regenerative sets have such metallic shields on the inner side of the front panel.

ADJUSTING SINGLE-CIRCUIT RECEIVERS

TO OPERATE a single-circuit regenerative tuner for radiophone reception, the detector tube is first adjusted to make it as nearly silent as possible, yet responsive to signals. Us-

tuning dial, often an arm or handle moving above a scale, must be adjusted to bring in the desired signals.

By turning up the dial of the "tickler" coil, thereby generally increasing the "feed-back" or regenerating action, the audibility of the signals can be increased. Careful adjustment of the "tickler" coil is essential. The "tickler" dial should be turned up only to a point just below but on the verge of oscillation of the detector, which is indicated by a slight hissing sound heard in the phones. Excessive regeneration, due to too much "tickler" action, causes a "mushy" distortion of the signals.

Final adjustment is made by means of a vernier, now provided on most single-circuit regenerative sets. A vernier is a small auxil-

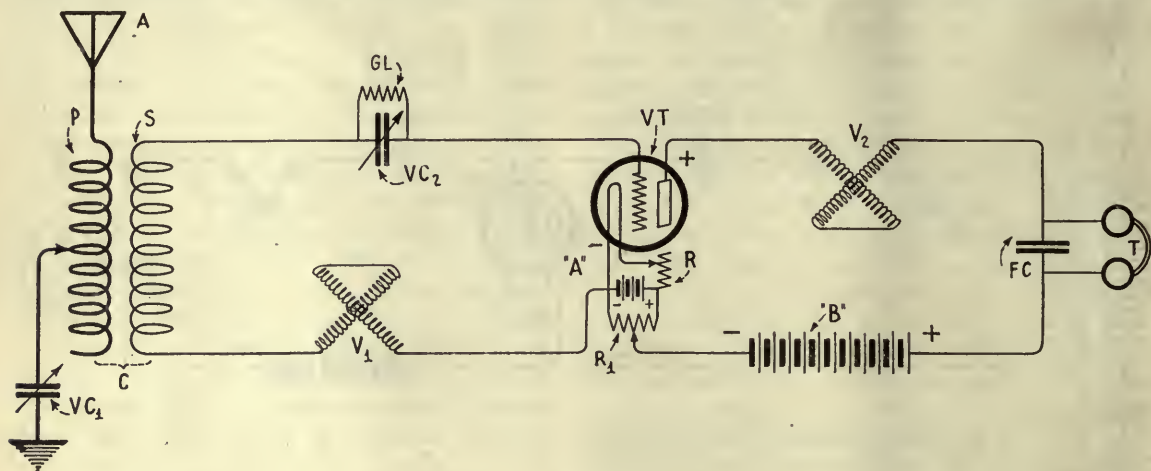

FIG. 3

In this circuit, a variable grid condenser and "A" Battery potentiometer are employed

ually the signals are loudest and clearest when the filament rheostat has been advanced to a point just before the tube causes a hissing sound in the telephone receivers. Occasionally, however, better results are obtained by advancing the filament rheostat beyond the point where noise is heard and into another zone of relative silence.

Some variation of the plate voltage from the "B" battery is often necessary in order to obtain the clearest and loudest signals. "B" batteries of the variable voltage type, with connections for voltages from $16\frac{1}{2}$ to $22\frac{1}{2}$ volts, make this possible, though still more accurate adjustment may be had by means of a potentiometer, with which some of the best receiving sets are now equipped.

After the filament and plate currents of the detector tube have been properly adjusted, the

ary tuner capable of producing much finer variations than the large tuning dial, a complete turn of the vernier being rarely equivalent to more than a movement of two points of the large tuning dial.

After a regenerative receiving set has been carefully tuned it will maintain its adjustment fairly well. Occasional changes of the vernier, and sometimes even of the tuning dial, may have to be made. Alteration of the filament rheostat now and then may also help.

THREE-CIRCUIT TUNERS

THREE-CIRCUIT regenerative receiving sets, employing variometers for separate control of the tickler and secondary circuit wavelengths, are operated substantially the same as the simpler "tickler" coil sets except

that more careful tuning is necessary. With such highly sensitive sets it is sometimes necessary to adjust the secondary and the "tickler" or plate variometer simultaneously, in order to preserve the right relation between them and keep the receiver in its most sensitive condition, on the verge of oscillation.

No one should find difficulty in operating a regenerative receiving set having several controls, once the function of each dial is understood.

Most regenerative receiving sets have controls for (1) filament brilliancy, (2) tuning the wavelengths of antenna and secondary circuits, (3) coupling the primary or antenna circuit by induction with the secondary circuit of the receiving set, and (4) for regeneration. If a two-stage amplifier is also part of the set, it is controlled by a filament rheostat for each vacuum tube, or sometimes one rheostat regulates both. In the case of single-circuit or single-control receivers, one control dial combines coupling with tuning the wavelength of both the primary and secondary circuits.

TUNING THE RECEIVING SET

THREE preliminary adjustments are necessary before it is possible to receive from any transmitting station.

(1) The antenna switch is thrown into the receiving position.

(2) The filaments of the vacuum tube are lighted by means of a filament switch or an

automatic jack which completes the filament circuit when a plug for the telephone receivers is inserted in the jack.

(3) The filament rheostat is gradually turned up until a slight hissing sound is heard in the telephone receivers. The rheostat is then turned back just enough to render the hissing inaudible.

The set is then ready for tuning, which is effected with the regeneration dial turned to zero. This dial is variously marked "tickler," "regeneration," "plate load," and, rarely, "grid load."

The tuning operations are as follows for single and two-circuit receiving sets:

(1) Adjusting the set to the wavelength of the transmitting station.

In a single-circuit or single-control set having only one tuning dial or arm, it is necessary only to turn up the dial away from the zero position until the signals of the desired station are heard.

(2) Adjusting the vernier of two-circuit receiving sets after

the best position of the large tuning dial has been found.

With three-circuit receiving sets the procedure is somewhat more intricate:

(1) Adjusting the wavelength of the primary circuit.

Several high-grade receiving sets have separate controls for the primary and secondary circuits, both of which must be adjusted to the wavelength of the incoming signals. This makes the set a little more complicated to

HOW FAR HAVE YOU HEARD?

There is all manner of loose talk about broadcasting concerts being heard at great distances with very simple equipment. For instance, a man in Florida and another in Cuba tell of hearing concerts from New York and other Northern cities with receiving outfits employing a single vacuum tube. Other folks wonder why, with a single tube outfit, they have difficulty in hearing *anything* and feel incredulous about the heralded wonders of radio.

Stations are heard over great distances at times and many elements must be considered in determining the difference between the *reliable* and *possible* range of a given receiver.

We are anxious to learn of experiences in broadcast reception, believing that their publication may help others to obtain the best results from their outfits.

Whenever you receive over distances in excess of 500 miles at night or 150 miles by day—*with a single vacuum tube*—let RADIO BROADCAST tell its readers how you have done it. For letters published, a very liberal rate will be paid.

Your reception should be authentic—that is, you must be sure of the station you report hearing. You must be positive of the name of the station as well as the call letters, for if you based your report solely upon the latter, it is quite likely that errors would occur. For instance, KDAN might be interpreted as KDAM, unless the name of the station was actually heard.

We are also anxious to tell our readers of the results obtained with loop aerials used with radio-frequency amplifiers or super-regenerative receivers.

In telling of your experience, a paragraph or two describing briefly the type of receiver employed would also be helpful, and good circuit diagrams are always in order.—THE EDITORS.

operate, but its greater selectivity enables much interference to be tuned out.

An approximate adjustment of the primary circuit is first made by means of the variable condenser and inductance switches or slider. If the average dial position for any given wavelength is not known, it may be set tentatively at one third to one half its maximum value. Meanwhile, if the coupling between the primary and secondary circuits is variable, the variocoupler dial is turned up to its maximum position where the two sets of windings are parallel or in their closest position.

(2) Adjusting the wavelength of the secondary circuit:

The dial of the secondary circuit variometer or variable condenser is then turned up until

After the receiving set has been tuned, regeneration is accomplished in the following manner:

(1) The dial of the "tickler" or "plate load" variometer is gradually turned up from the zero position for amplification of the signals.

At first the effect is imperceptible. Then comes a sudden and marked increase in signal strength, followed by increasing distortion of the tonal qualities of voice or music. High musical notes are first affected, complete distortion following if regeneration is increased too much.

(2) Filament brilliancy is reduced as regeneration is increased, until the maximum degree of regeneration is reached without signal distortion or reduced amplification.

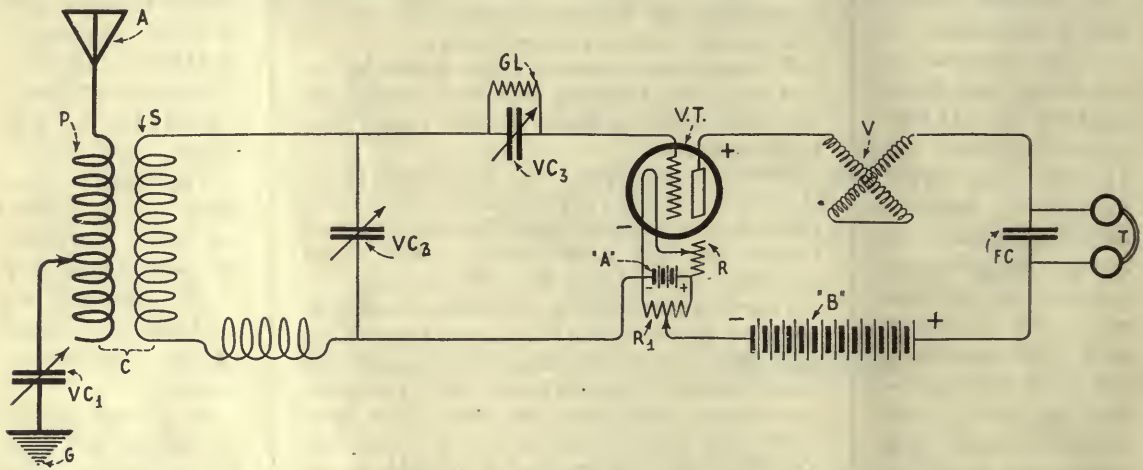

FIG. 4

Here the wavelength of the secondary circuit is controlled by a variable condenser

signals from the desired station are heard with the variocoupler still at maximum.

(3) Readjusting the primary circuit for maximum loudness of the signals.

(4) Final slight readjusting of the secondary circuit if necessary to increase the strength of the signals.

(5) Changing the coupling to eliminate interference.

With separate controls for primary and secondary wavelength tuning and variable coupling between the two circuits, great selectivity is possible. For example, should an interfering station begin transmitting, its signals can usually be eliminated by decreasing the coupling between the primary and secondary circuits and then re-tuning the primary and secondary circuits.

For storage battery economy and longer life of the vacuum tube, it is always best to employ the minimum filament brilliancy consistent with adequate audibility of the signals being received. Nothing is gained by burning the filament above the temperature necessary for maximum regeneration, and white heat is seldom necessary to accomplish this. By resorting to a two-stage amplifier in receiving from distant broadcasting stations, ample audibility can be obtained without excessive filament brilliancy.

As a matter of fact, signal strength may well be sacrificed to purity of tone in voice and music, for after all it is faithful reproduction of sound rather than maximum noise which makes radiophone reception enjoyable.

Radio for the Deaf

By P. J. RISDON

A YEAR or two ago an instrument was developed in England which is now arousing wide interest. The inventor is Mr. S. G. Brown, of London, and the invention is known as the ossiphone—derived from the Latin "os" or "ossis," a bone, and the Greek "phone," meaning sound. It is no less, as its name implies, than a device *which enables one to hear through one's bones.*

The writer has tested the ossiphone in a variety of ways, both in connection with the ordinary telephones, and with another instrument known as an aural box.

The ossiphone is quite small and can be carried in the waistcoat pocket. It comprises a little ebonite case containing an electromagnet of the horseshoe pattern, between the poles of which an iron bar is fitted that can be made to vibrate. The electromagnet is energized by current from the telephone batteries when used as a receiver in radio or wire telephony, or from dry cells in the aural box when employed for carrying on an ordinary conversation between persons in the same room.

The aural box and ossiphone together are used to take the place of the ear appliances commonly used by deaf persons. The former is a metal horn, in appearance like a loud speaker, with a microphone at the lower end. Connections between the ossiphone and aural box or telephone are made by means of small plugs and sockets to which ordinary flexible cord is attached. Dry cells in the aural box provide electric current for the microphone.

In order to carry on a conversation over the telephone, a small socket is wired in parallel with the ordinary receiver and, for the sake of convenience, is secured to the outside of the telephone box. There is a similar socket on the ossiphone, with a length of flexible cord having a twin plug at each end connecting the two. The vibrator bar, which projects outside the ossiphone case, has a small ebonite button screwed to the end of it. The case is held in one hand and the button is pressed gently but firmly against the finger knuckle. By this means, the vibrations of a person's voice at the other end of the line are conveyed through the

body to the aural nerves, and so to the brain, where the sensation of sound is produced independently of the outer ear. This may be proved by stopping the ears effectually, or by putting the ordinary telephone receiver temporarily out of commission. In this way it is possible actually to hear more clearly than with the ordinary receiver, although incidentally the ossiphone constitutes an excellent duplicate receiver.

It is not quite certain whether the vibrations follow the bony structure all the way, or whether the nerves compressed between the ossiphone knob and the bone take up and transmit them. In the former case it would certainly appear that, where the bones are separated by cartilage, the vibrations must be carried by nerves from bone to bone. In either case, however, it is only by means of the bones that the vibrations can be transmitted.

When it is desired to converse in the usual manner, one end of the flexible cord is secured to the ossiphone, and the other to the aural box, which is placed in any convenient position near one of the speakers, who merely has to face it and speak in an ordinary tone of voice within about eighteen inches of the opening. The



THE OSSIPHONE VIBRATOR

other person may be anywhere in the room, holding and applying the ossiphone as already described.

In order to appreciate the action of the ossiphone, it is necessary to bear in mind that sound is an effect on the brain produced by vibrations. When one person speaks to another, the vibrations of his voice cause the ear drum of the other person to vibrate, and so to communicate the vibrations through the mechanism of the ear to the brain. If the middle or outer ear be

damaged or stopped up or if the ear drum itself be injured, the vibrations cannot reach the aural nerves leading to the brain and the person is unable to experience the sensation which we call sound. Ordinary appliances for the deaf consist in magnifying sound waves. This, while of temporary service in certain cases, may in the long run simply aggravate the original

the brain, there is little hope of any instrument proving successful, since the aural nerves are an essential connection between the mechanism of the ear and the brain. It should therefore be clearly understood that it is not claimed for the ossiphone that it constitutes a certain remedy in every case of deafness.

From the foregoing description of this in-

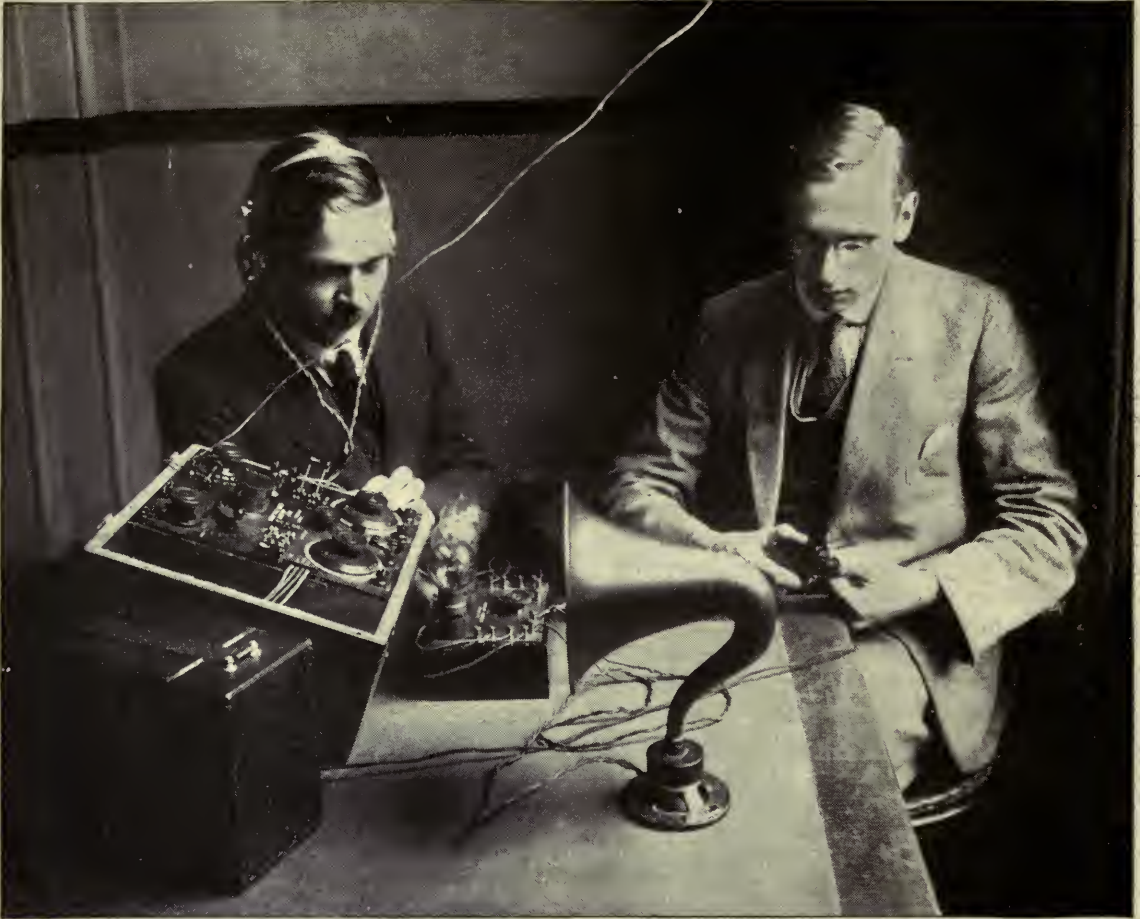

MR. PHILIP R. COURSEY

Editor of *Wireless World* (London), and his assistant demonstrating the use of the ossiphone

trouble and increase the degree of deafness. With the delicate vibrations of the ossiphone, such a result could not occur.

The value of this instrument to deaf persons depends to a great extent upon the nature and cause of their deafness. When deafness is due to what one may call mechanical causes, affecting the outer and middle ear, the ossiphone has often proved successful where all other appliances have failed. If, however, there be disease of the aural nerves leading to

teresting invention, it is evident that, in all cases where it assists the deaf to hear, it will enable them to enjoy equally well radio music and speech. For there is no difficulty in connecting the ossiphone to an ordinary receiving set, or in using it in conjunction with an aural box and loud speaker. Thus a way of hearing is opened to many deaf persons, to whom, otherwise, sound would be an almost meaningless expression, or a symbol of pleasures and interests not experienced for many years.



KING ELECTRON

On Vacuum Tubes

By R. H. RANGER

Engineer, Radio Corporation of America

Illustrated by TOM MONROE

SUCCESS has crowned the efforts of the experimenter who, with King Electron and his radio band, produced sound from radio waves by using a crystal; but with this success achieved, he seeks other fields to conquer.

"More power!" is his cry, to satisfy which, Fleming invented the vacuum-tube detector.

This consists of a wire filament in a vacuum, much the same as any ordinary light; but something most important is added—the plate around the filament inside the glass tube.

A storage battery forces a current, that is, a flow of electrons, through the filament. "How does this make the wire filament red hot?" King electron will explain.

"I have billions of electrons at my command. They live in many worlds. You people have speculated on life outside your world in Mars; many worlds inside yours are very common to us electrons. And we jump around from one to the other. In radio, we are guided by the operator.

"Well, we have many little worlds called atoms and larger ones called molecules. These molecules have all the attributes of your

ordinary substances except size. Many of them are clustered together to form a single substance, such as the wire filament. And then several different substances may go to make up such a weighty object as your storage battery.

"In this big storage-battery world, things are arranged so that there is so-called electric power in it. The reason for this power is that a large number of electrons are concentrated on the negative pole of the battery, clamoring to get away, and there are very few on the positive pole.

"The great concentration of electrons on the one side of the battery, is, of course, what gives that side a negative charge, as each of the electrons is negative. If a wire connects the negative pole of the battery to the positive, there will be a rush of the electrons to even things up.

"To get some practical use out of this great rush, the filament of the vacuum tube is included in the circuit.

"Onward pushes this happy throng, down this midway of the radio Mardi Gras.

"The filament is made up of molecules. The

molecule is a little center of attraction between the atoms which go to make it up. These little side-show atoms contain lots of electrons having a great time in their merry-go-rounds with a positive center keeping them together.

"Upon this scene rushes a crowd of electrons from the electrical world of the storage battery. They have heaps of energy and won't stay on the filament. They crowd back and forth, traveling very fast, first into this side-show, then into that.

"They take the places of some of the electrons already there, forcing them to go on to other centers. There is great vibration inside the molecules, which produces heat. As it increases, a point is finally reached at which the electron vibration is fast and furious enough to move the space in which the electrons live—the ether—back and forth so rapidly as to send out ether waves, known to common mortals as light.

"Now, the motion of each individual electron hither and yon is most rapid, in fact it may approach the speed of light—some 186,000 miles a second. And the movement starts all along the line very quickly. The word is passed from molecule to molecule that the electrons are coming. What might be termed this news-wave down the midway is fast, too; only something less than the individual speed of the electron or of light. But the general motion of all the electrons onward is much less than any of you might guess. If it were as much as half an inch a second, the tube would be dangerously near burning up.

"It all goes to show how a lot of running around may produce only an infinitesimal amount of general advance. But it is quite sufficient to do the job in this case. In the process of rushing about, many of the electrons get out of the beaten path, and go floating off from the filament. To be sure, some of them will come back, but if there is a great attraction for them elsewhere, they will certainly be normal and make the most of the opportunity. The plate of the vacuum tube is just such an oasis.

"Another battery, known as a 'B' battery, is connected to the plate of the vacuum tube. Its positive pole is connected to the plate of the tube, and its negative pole to the filament. This means that the plate is connected to the pole of the dry battery which is not occupied by the electrons. This is the sort of place

the floating electrons in the vacuum tube are looking for. So once they get away from the filament, they rush to the plate. From here, the dry battery carries them up to the top of the chute again by pulling them to the negative of the battery which is connected to the filament, and on goes the process."

The simple Fleming valve, as outlined by King Electron, is no longer used very much, because of another great invention brought about by De Forest. He was working with Fleming's valve and gaslights of different types, when he discovered that the addition of a "grid"

between the filament and plate of a vacuum tube would have a great effect on the action of these floating electrons. This grid is just what the name implies, a grating of parallel wires placed between the filament and the plate. Some of the electrons will of course go to this grid. If it were not connected to anything, it would soon get filled up, and this would have an important effect on the motion of the rest of the electrons floating towards the plate. Ordinarily, electrons leaving the filament would be attracted by the grid as it is so much nearer than the plate, but if they see that the grid is already crowded, they will not have any great desire to go that way. As a consequence, very few will go on to discover that attractive new world—the plate. But if something is done to remove the electrons from the grid even to such an extent as to have less of them there than normally, the floating electrons would come rushing over. Then many of them, in fact most of them, would miss the small wire grid and go on to the plate. So the number of electrons on the grid, or its "electric charge," has a tremendous effect on the flow of electrons to the plate.



THE TUBE AS DETECTOR

TO USE the tube as a detector of radio signals, a one-way action must be realized. A pair of telephone receivers is included in the circuit leading from the plate of the tube to the positive pole of the plate dry-battery. In this position the telephone will produce sounds as changes in the plate current take place, if the vibrations occur at the frequencies of sound. But these radio vibrations are much faster—some thousand times too fast in broadcast work. So as radio vibrations alone, they mean nothing to the telephone receiver. But

if all the changes which may be caused by radio waves are in one direction, the telephone receiver will notice the average effect of the rapid vibrations.

One means of getting this one-way effect is to keep the grid in a rather negative condition. This will shut off the plate current when no signals are coming in. Now, if the radio waves are such as to make the grid more negative, they will have no further effect in decreasing the plate current, as it is already practically at

radio wave is, the more the plate current will increase. As the intensity of the radio waves is determined by sound directed into the microphone at the transmitting station, the plate current will change in step with these sound-



"THE VACUUM TUBE," SAYS KING ELECTRON

"Is a miniature universe, composed of many individual worlds, inhabited by electrons. Here we find millions of these electrons crowded on the sunny side of the storage battery, 'A.' They force their way through the filament 'Mardi Gras' at 'B' and some of them seek other worlds to conquer. The grids at 'C' look inviting and they cannot resist the impulse, and while in the space between 'B' and 'C' they see an even more attractive and less thickly populated world, 'D,' which is called the plate"

zero. But on the other half-swing of the radio wave, when all the electrons have left the top of the tuning coil and the grid which is directly connected to it, the plate current will start to build up. Under these conditions, the plate current will increase with any radio waves, because the positive impulses alone produce an effect; and the more intense each

controlled variations in the intensity of the radio waves, and the telephone receiver will reproduce the sound.

THE "C" BATTERY AND THE GRID LEAK

THIS negative condition of the grid may be established by connecting a small flash-light battery of $1\frac{1}{2}$ to 6 volts in the grid circuit,

with the negative side of it leading to the grid. This is called the "C" battery. (The filament lighting battery is called the "A" battery. The plate battery is called the "B" battery.)

But there are already too many batteries around a radio set, so the use of the grid leak-condenser combination, which replaces the "C" battery as well as giving better signals, is a welcome development.

If a high resistance is inserted between the top of the tuner and the grid of the vacuum tube, the floating electrons in the tube which hit the grid will not be able to pass around to the tuner coil and back to the filament of the tube so readily. As a result they will pile up, to a certain extent, on the grid of the tube. This means that the grid will have a negative average condition due to the floating electrons themselves. But this resistance should not be large enough to permit its negative condition to shut off the plate current completely. In fact, the grid is kept well above this condition.

THE GRID-LEAK CONDENSER

ACCORDINGLY, another device is added. This is a small condenser in parallel with the grid leak; that is, it is connected between the same two points as the grid leak. This condenser consists of two metallic plates close together but separated by insulation. Electrons may rush on to one side of this condenser and in consequence shove off those on the other side. To this extent the condenser acts

to the grid will act quite well through this small condenser. This means that when there is a rush of electrons down the tuner coil, due to the radio wave, the electrons will pass from the grid to the small condenser. This leaves the grid "positive," which means that the plate current will increase, but more important still, it means that the grid will catch some more of the floating electrons. So there are now more electrons on the grid and the grid side of the small condenser than there were before. So, on the next negative half of the radio wave, when the electrons rush up through the tuner and small condenser to the grid, the grid will have more electrons in the way of the plate electron flow than before.

On each swing of the radio wave, this trapping of electrons will continue on the positive half of it, and the corresponding depression of the plate current will take place. This will more than offset the momentary increases in the plate current on the positive halves of each wave cycle of the radio vibrations. The grid leak will not let this concentration of electrons on the grid, and on the grid side of the small condenser, go too far, as the trapped electrons can pass off slowly through this grid leak resistance. So, when ether waves strike the receiving aerial and build up oscillations in the tuner, many of the floating electrons in the vacuum tube will be trapped by the grid and the plate current will be decreased. The plate current will hold this decreased value as long

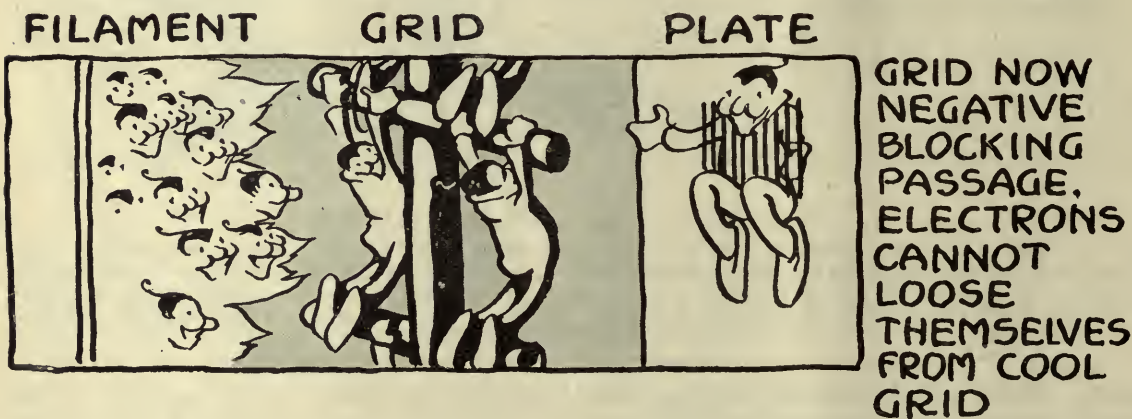

as if the sudden movements of electrons went right through. But this is only true for short, sudden movements such as the rapid radio vibrations. So, as the radio waves cause the electrons in the tuner to vibrate, the sympathetic movement of electrons back and forth

as the radio waves hold steady in their intensity. But if their intensity goes up, more floating electrons will be trapped on the grid, and in consequence the plate current will go down more. Therefore, an increase in the radio waves means a decrease in the plate cur-

rent through the telephone receiver. The fact that this action is thus reversed is of no consequence, as sound vibrations are back and forth. If they were "forth and back" they would sound just the same provided the vibration frequencies are the same, as is the case here.

signals. This latter condition is desirable from many points of view, as it will give the output of the telephone receiver a characteristic more truly representative of the actual radio wave variations. It is also advantageous from the point of view of static. For, if a detector is

FILAMENT GRID PLATE



GRID NOW POSITIVE. ELECTRONS RUSH BACK TO CONDENSER FROM GRID OTHER ELECTRONS CAN NOW PASS FROM FILAMENT TO PLATE SOME LAND ON GRID

The grid leak-condenser connection for the detection of radio wave changes is very reliable, although its efficiency compared to the crystal detector would make a poor showing if it were not for the radio-frequency amplification which may be accomplished in the same tube as King Electron told us in the September issue of RADIO BROADCAST.

THE HETERODYNE

WHEN Fessenden was at work in research tests in radio reception, he noted that stronger signals were received when a small generator was operating in the basement of the same building. He improved upon this arrangement and the result is the well-known "heterodyne" invention.

Almost any radio device has what might be termed a "threshold" value. This means that a certain minimum of electric energy must act on it before anything will happen. Incoming signals, for example, below this value will have no effect on such a device. Detectors in particular seem to possess a threshold value. A certain intensity of signals which may be referred to as having strength 1, will produce a certain effect in the telephone receiver. But a signal of strength 2 will produce four times the effect in the telephone receiver. This is sometimes referred to as the square law, inasmuch as the result increases as the square of the cause. But after the lower values of signal are passed, the resultant effects in the telephone receivers become more directly proportional to the strength of the incoming

working on the square law basis, a good crack of static would produce many times the effect of the desired signal in the receivers.

Fessenden overcame this difficulty with the heterodyne, and made a simple detector at the same time.

Reduced to its simplest form, his invention comprised a special form of telephone receiver. This telephone receiver had two different coils in it. One was fixed in the base in the same manner as in the normal receiver, the other was attached to the receiver diaphragm. The coil, fixed in the base was energized by a local generator of rapidly alternating radio current vibrations, located at the receiving station. The other coil on the vibrating diaphragm was energized by the incoming radio waves. These coils then became magnets of which the polarity reversed with the very rapid vibrations of the electric currents in them. Current passing through a coil of wire forms an electro magnetic field around the coil and the end faces of the coil are called its poles. And if the current goes in one direction through the coil, one face will become a south magnetic pole, and the other will become a north magnetic pole. (These names are used as they indicate the directions in which these poles would face if the electromagnet were free to swing.) When the direction of current flow reverses, the magnetic poles will also reverse.

Now Fessenden so arranged things that his local generator had a steady frequency slightly different from the signal he desired to receive. At the moment we start our consideration of

this, suppose that the currents are going through each coil in such directions as to make the poles of the small electromagnets opposite to each other; that is, one a north pole and the other a south pole. As opposites always attract, they will then attract each other and the diaphragm will tend to move in. As the currents rapidly reverse, the poles of the magnets will also reverse; but as they both reverse, they will still be opposite to each other and therefore still attract each other, and the tendency of the diaphragm to which the movable coil is attached will be to continue to move in. So, although the current vibrations are most rapid, still they tend to produce but one general movement of the diaphragm inwards. Now, as the two sets of electric currents, the locally generated and the received signals, are slightly out of step, this condition of being exactly opposite as we first considered, will not continue, and therefore the two magnets will not continue to be always opposite. Therefore, as the currents get out of step the diaphragm will gradually

recede, to return again when the currents are again opposite. This action will therefore make the telephone receiver diaphragm move in and out as long as the signals keep up, at a vibration period determined by the difference between the two current frequencies. As this can be made anything desired by changing the frequency of the local generator, the receiving operator has the means of getting a good readable note for his signals. Of course, it is evident that this was arranged primarily for radio telegraph work, where the operator reads the long and short tones as signals by the combination of the transmitted signals and the locally generated current. The action is very similar to that of the beats in sound made by two piano strings slightly out of tune with one another. The beating of the two with each other will be much slower than the vibration of either one alone, so rapid radio vibrations are brought down to slower audible vibrations by this device.

It was a natural step from this to combining the two electric currents in the same detector

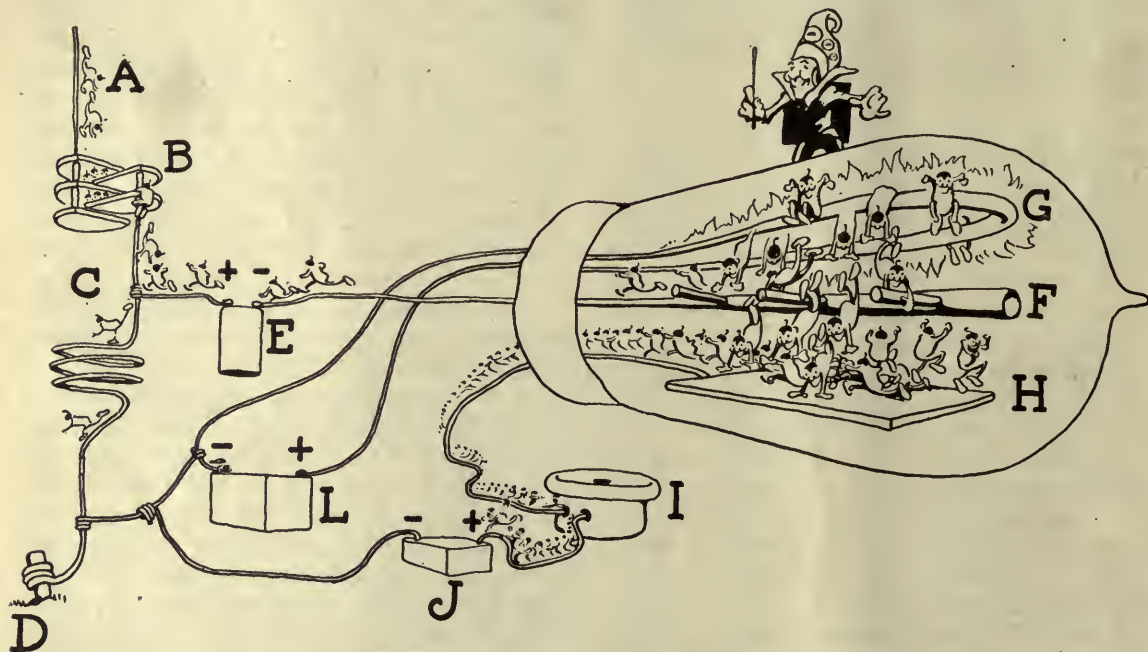

“ IN A TUNED RECEIVING CIRCUIT ”

King Electron tells us, “the grid ‘F’ of the vacuum tube is connected to the top of the tuner coil ‘C,’ through a small battery at ‘E.’ When radio waves rush down from the aerial, ‘A,’ the rush through ‘C’ pulls the excess of electrons supplied by the battery ‘E’ away from the grid, and the electrons from the filament ‘G’ then rush across to the plate ‘H’ and actuate the telephones ‘I’.” When the rush in the aerial to the ground circuit is over, the electrons rush back through the battery ‘E’ to the grid ‘F,’ and the rush of electrons to the plate ceases. With the back wave of the incoming radio signal, even more electrons pass from the coil ‘C’ to the grid ‘F,’ but they do not affect the electrons going to the plate and the latter have stopped their activity. In this case it is impossible to make the plate current less than nothing. So, we see, the action only takes place when the electrons rush down the aerial to ground circuit and the result is an increase in the rush of electrons to the plate, which in turn, pass through the telephone receiver”

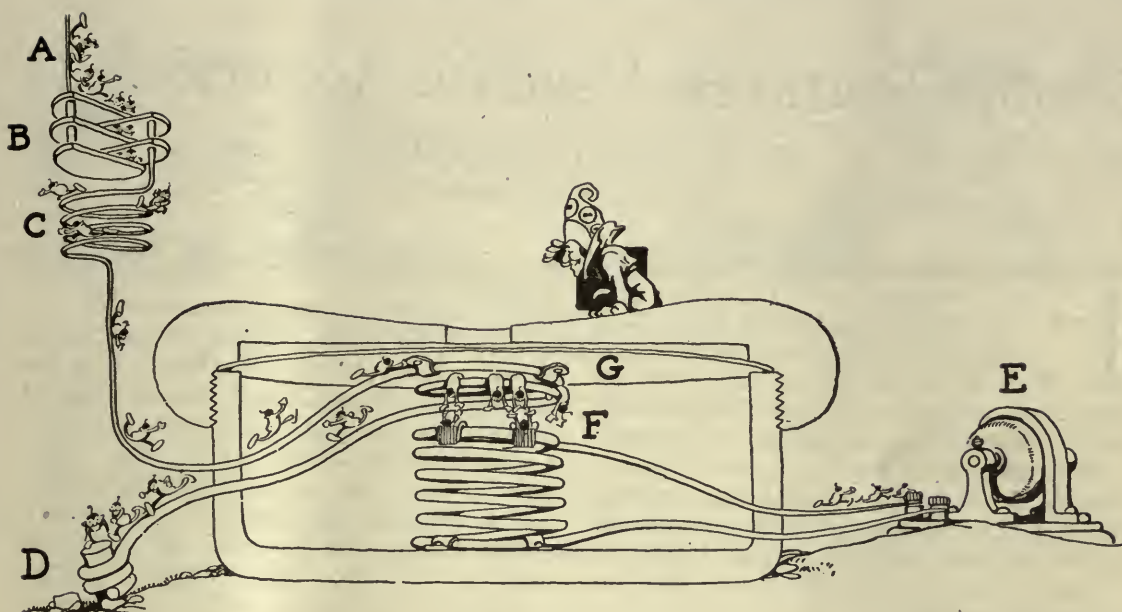

“THE HETERODYNE”

King Electron explains, “requires two groups of electrons to produce a sound in the telephone receivers. A local generator, ‘E’ supplies a group of electrons rushing to and fro at a very great rate, which pass through the coil ‘F’ attached to the base of the special telephone receiver. The incoming radio waves cause electrons to rush down the antenna ‘A’, condenser ‘B,’ and coil ‘C’ to the ground ‘D.’ A part of the coil ‘C’ is attached to the diaphragm ‘G.’ The two currents caused by the rush of electrons in the aerial to ground circuit, and those rushing through the circuit supplied by the generator, change their direction of movement at slightly different frequencies. At regular intervals the electrons move in the same direction at the same time, causing a sound to come from the telephone receiver. At other intervals the electrons in the two circuits repel each other, causing the telephone diaphragm to move in the opposite direction. The result is called a ‘beat’ frequency and the pitch of the sound made by the telephone receiver depends upon the rapidity with which the beats occur”

circuit. In fact, this is just what was happening when it was first noticed that the received signals were stronger when the small generator was working in the same building. So the local generator puts a rapidly oscillating current in the receiving circuit, and when the incoming signals are received, these alternately add to and subtract from the local current. And any of the detectors which have been described will give the beat tone for telegraph signals, when energized by incoming signals together with a local radio wave generator.

As the local generator can be made to give its power to any of the above arrangements continuously, the latter will be carried beyond their “threshold” values and the incoming signals will have an easier task for producing the changes which will give the sound.

For the local generator, the detector tube itself may be used in the Armstrong oscillating feed-back arrangement described in the September number. The oscillation of the tube in this condition will be constant and therefore

give the telephone receiver a steady pull, and will not produce sound—provided there are no other oscillations present in the set itself, causing the bothersome howling. When only the single oscillation is present, the incoming signal will add to or subtract from this steady radio vibration and a tone will result. This makes a very compact arrangement.

For telephony or broadcast reception, this steady tone is not desirable; but if the local generator is adjusted to be of practically the same frequency as the incoming signals, the beating of the two will be so slow as to be inaudible, and under these conditions the signals will be heard most loudly. It is hard to keep this adjustment, however, so it is not recommended for telephone reception except for picking up distant signals. After they are picked up in this manner, the set may be tuned sharply and the regeneration decreased just below the point of oscillation when the distant telephony should be heard more distinctly.

Should Radio Be Used for Advertising?

By JOSEPH H. JACKSON

Drawings by TOM MONROE

EVERY new discovery brings a host of problems with it. The well-known thorn and the rose, the familiar bitter and the sweet, the silver lining which theoretically forms the better half of every dark cloud—all these are not such inseparable companions as Discovery and his crony Difficulty.

Radio is a case in point. One after another, dating from the beginning of radio as a popular science, problems have had to be met and conquered. With clockwork regularity, Old Man Difficulty in one form or another has bobbed up to confront the pioneer, only to be just as regularly knocked down again. However, he's a hard one to keep put. Persistence is his middle name; trampled on and a hundred times subdued, he is up and at it again; and in his latest incarnation has assumed what threatens to be the most unpleasant guise in which he has appeared so far.

"*Advertising by Radio*" is his new name; and a very troublesome pest he is likely to become unless something is done, and that quickly.

No one who reads this article will have to consider very long what broadcasting advertising implies, before the presence of the difficulty becomes apparent enough. The very thought of such a thing growing to be common practice is sufficient to give any true radio enthusiast the cold shakes. And he doesn't need to be a dyed-in-the-shellac radio man to see the point, either; the veriest tyro with his brand-new crystal set can realize, if he has listened in only once, what it would mean to have the air filled with advertising matter in and out of season; to have his ears bombarded with advertisers' eulogies every time he dons a pair of headphones.

Once the situation is realized, its actuality

as a first-class Problem with all modern attachments cannot be doubted for a moment. Indeed, in the very plausibility of the idea lies the greatest danger. For, on the surface, to the uninitiated or to the man who is not particularly concerned about the pleasure and profit to be derived from radio, there seems to be nothing very improper or unethical in using radio as an advertising medium.

It is precisely this apparent harmlessness of the notion that makes it all the more likely to take hold, unless action is started

against it. Let us look at the question for a moment from the angle of the total outsider: the regrettable probabilities may be more clearly focused in that way.

Forget, then, that you are a radio enthusiast. Imagine yourself utterly and

abysmally ignorant of any inside facts about the subject. You know that radio has suddenly become very popular, you have heard about broadcasting, you see the radio columns in your daily paper and hear folks talk about it, but you never bought a radio publication of any sort in your life; your knowledge of the subject, other than the most elementary facts, is nil.

Now suppose, for instance, that you are the maker of some household article used universally. There are a dozen others putting out the same kind of article; it is a home necessity—every family should have one. Competition is keen: you're anxious to get the name of your product before as many people as you can, as often as you may, and, naturally, as inexpensively as you are able to do it. It is budget time and you are face to face with the job of okaying next years' advertising appropriation. It looks like a pretty big chunk of money. You don't mind spending it—no-o-o, not exactly—but you sometimes wonder whether everybody who passes a billboard,

Have you answered the question yourself? Perhaps advertising by radio has not yet affected you one way or another. But if what Mr. Jackson says in this article is true, the question is one which is going to demand interest, and thought, and a decision on the part of all who are in any way concerned with the transmission or reception of radio broadcasting.—THE EDITORS.



ALONG COMES A MAN WITH A PLAN

And says to you: "Suppose I guarantee to put over whatever advertising message you wish, to several hundred thousand people, who have *got* to listen to it"

picks up a newspaper, reads a magazine, or enters a store sees your dearly bought advertising and is influenced by it. You are wishing two things: that you could tell potential buyers what you have to tell them so you could be *sure* they heard you, and that you could tell them without spending quite so much in doing it.

Just as you are chewing over this thought and trying to resign yourself to the inevitable, along comes a man with a plan. He says to you:

"Suppose I guarantee to put over whatever advertising message you wish, to several hundred thousand people who have *got* to listen to it. All of them—since your product is a universal necessity—are potential customers. Suppose I promise to do this for you at a tiny fraction of the amount you pay for the usual advertising which may or may not be attracting attention. Suppose I tell you, in addition to this, that through my plan you can say ten times as much as you could through any other advertising medium with any hope of being listened to. Will you give me a hearing?"

Would you? And when you found that his plan was to utilize the practically national system of broadcasting radio messages; that he would syndicate your advertising so that it was distributed from coast to coast if you wished, or centralize it so that it was intensive in the localities where your distributing facilities were best equipped to handle massed sales; that he would guarantee you, in fact, what advertising salesmen call "one hundred per cent. coverage" among a certain class of people who, *ipso facto*, have money to spend—*would you be interested?*

And if you didn't care in the least about radio and its future but were only concerned with putting over your advertising with the least possible cost and to the greatest possible advantage, *would you agree to use his methods?*

Why! You'd probably run and lock the door to prevent that man from getting away!

Let's look at the question from another angle.

Suppose you are an advertising "free lance," more or less unscrupulous, out to get what pickings you can. Advertising by radio suggests itself to you. You tie up a dozen or so broadcasting stations on contracts which bind them to broadcast advertising matter at certain hours each day—the hours when most listeners are likely to be reached—and to take only such advertising as is placed through yourself. You get very reasonable rates from them, as they are beginning to feel the drain of operating and maintenance expenses and are glad to see a little something on the other side of the ledger. Then you are ready to go after the manufacturer. You have something good to sell him—a "circulation" of several hundred thousand *guaranteed listeners*. You can sell it at a low rate, comparatively speaking. You are on the crest of a wave which is sweeping the country: you have "talking points" galore for your plan: you don't care two pins for the radio enthusiast or what he feels in the matter. *Would you go out and sell your scheme?*

Of course you would—and you'd sell it as hard as the Lord would let you!

Now we'll examine the question from a third angle:

Suppose you are a manufacturer, jobber, or retailer of radio supplies. You have maintained a broadcasting station for some time. It has been good publicity for you; it has helped you sell instruments; it has been a source of pleasure to thousands who have listened in on your concerts. But the saturation point is slowly approaching. Sales of apparatus are dropping off a little. You begin to feel the drain on your pocketbook incident to keeping your station going. You can't dismantle very well, it would hurt your prestige; but you would certainly like to see some way to make that station pay for itself, at least.

Along comes a plausible, so-called advertising expert. He talks about *profits* from your broadcasting station. (You have just been thinking that you'd be glad to have it break even and call your publicity the profit.) He talks persuasively, expansively, in large figures: he produces a contract, an advance payment. You see all worry about how that station is to pay for itself sliding from your shoulders. *Do you sign that contract?* You not only do that, but you phone the wife that there will be company for dinner and put in a call for your favorite *edouegger!*

And, looking at the matter from the angle of the outsider, you couldn't be blamed very much

for acting as you did in any of these three cases.

So much, then, for examples which show how easily advertising by radio might almost overnight become an Old Man of the Sea—practically impossible to shake off once he got a good grip. It wouldn't take much time to get such a scheme going full blast: you have seen how plausibly it might be argued, how simply it could grow to be a fact.

Now, if you can bear one more impersonation, a more natural one, think of yourself as you really are—a radio enthusiast not above getting up on your hind legs now and then, as every liberty-loving citizen and taxpayer



THERE IS SOME EXCUSE

For mentioning the call letters and name of a particularly good station which conducts only the better sort of programmes, even though it is owned by some commercial company. This is KPO, Hale Bros. Department Store, San Francisco. A station may be made valuable to the operators without grating on the nerves of listeners-in



A GHASTLY BLUE-AND-ORANGE ATROCITY

Informing you that Blah & Blooey had in stock absolutely the best bathroom fixtures that could be bought anywhere for the money

should, and yelling loudly for what's coming to you. Try to realize, if you will, that there is nothing remote about this problem, and that the solution to it will directly affect all of us who like to spend an hour or so, of an evening, listening to good broadcasting. Now let's look into the matter from your own standpoint, that of the radio enthusiast.

By way of illustration and to point the moral a trifle more sharply, consider a little story.

Remember ever taking your girl, or your family maybe, to a regular, first-chop, home-and-mother, melodrama movie? You know the kind I mean—one that made you sneak out the old pocket-handkerchief and sort of wipe your nose on the sly. The picture was simply great! You were right *with* the heroine all the way; you felt her trials and her sorrows yourself, and when she and her shiny-haired leading man melted away in one last, lingering clinch against a pink sunset background, with the art-tile, "And So, Hand In Hand, They Took The Long, Long Trail Together," you had that creepy feeling up and down the old backbone, and you were glad that everything had come out right after all, and you settled back in your seat kind of running over the picture in your mind, enjoying it—all the sad parts—and waiting for the news weekly to begin.

And then what happened? A miserable purple, yellow, and green splash on the screen announced that Dr. Bunkum's Pale Pills for Punk People might be obtained at Goofey & Gink's Drug Store, "right in the same block with the theater"; a ghastly blue and orange atrocity informed you that Blah & Blooey, "just around the corner from the theater," had in stock absolutely the best bathroom fixtures that could be bought anywhere for the money—"Our Plumbing Pleases"; and a thumb-printed, ugly art-slide advised all and sundry that the Elite Bootery and Shoery would be only too glad to have your valued patronage

and that their place of business was "only three minutes from the theater where you are now sitting."

By that time you had entirely lost the thrill of the picture you had paid your good money to see. And as the awful, endless procession of advertising slides trailed before your eyes, each worse than the one before, you grew more and more disgusted.

Remember anything like that ever happening to you? Probably. In fact, some show-houses still cram advertising slides down their patrons' throats. But not most of them. Why? Because people didn't like that sort of thing and they let the exhibitor know it.

There's the illustration. Now for its application.

Supposing—just supposing—you are sitting down, head phones clamped to your ears, or loud-speaker distorting a trifle less than usual, enjoying a really excellent radio concert. A famous soprano has just sung your favorite song, and you're drawing a deep breath, sorry that it's over. Your thoughts, carried back to some pleasant memory by the magic of the radio, are still full of the melody. You are feeling sort of soothed and good-natured and at peace with the world. All of a sudden a gruff voice or a whining voice or a nasal voice or some other kind of a voice says "Good Morning! Have you used Hare's Soap?" Or maybe a sweet, girlish baritone implores you "Ask for Never-Hole Sox. There's a Reason. You just *know* she wears 'em."

Well, how about it? Do you like the idea? Can you picture to yourself the horror of sitting down to listen to a good song or two, or perhaps a newsy chat on the events of the day, and then being forced to listen to a broadcasting programme that is nine tenths advertising matter? Yes, "forced" is the word—there's the difficulty, life-size—for you can't refuse, like movie-goers, to patronize the show. If such

a thing as broadcasting advertising matter should become general—and it is no remote possibility—you'll *have* to listen to it or listen to nothing at all! And you didn't buy receiving apparatus to listen to nothing at all.

Now then, you have impersonated half a dozen or so characters in pursuing your way through this article. You have seen to what unmitigated horrors advertising by radio would lead, should it ever become a reality. You have seen how plausibly such a scheme might be presented and developed before measures to stop it could be taken.

Granted that it is possible enough: is it really likely? Does the problem of radio advertising seem at all imminent or is any warning regarding it merely to be classed with the alarmist's cry of "Wolf!"?

Any one who doubts the reality, the imminence of the problem has only to listen about him for plenty of evidence. Driblets of advertising, most of it indirect so far, to be sure, but still unmistakable, are floating through the ether every day. Concerts are seasoned here and there with a dash of advertising paprika. You can't miss it: every little classic number has a slogan all its own, if it's only the mere mention of the name—and the street address, and the phone number—of the music house which arranged the programme. More of this sort of thing may be expected. And once the avalanche gets a good start, nothing short of an Act of Congress or a repetition of Noah's excitement will suffice to stop it.

There is one factor which may appear at first blush to lighten the situation; that is the attitude held at present toward such means of advertising by recognized, reputable advertising agencies and by men who govern the advertising policies of the larger manufacturers. *Most of these are openly arrayed against the exploitation of radio for advertising purposes.* Sensing the situation broadly, they realize what a drag upon the science its use for purposes of this kind would prove. But the danger is not from reliable firms and individuals, so that the disapproval of these folk, pleasant though it may be for us to know their attitude, does not help matters much. It is the irresponsibles who are to be feared. Fly-by-nights, plenty of them, unburdened by any sense of what is fair and right, are always ready and waiting to put public enthusiasm to work for them. The woods are full of opportunists who



DRIBLETS OF ADVERTISING

Indirect, but unmistakable, are floating through the ether every day. You can't miss it: every little classic number has a slogan all its own, if it's only the mere mention of the name—and the street address, and the phone number—of the music house which arranged the programme

are restrained by no scruples when the scent of profit comes down the wind.

Those who care to look about may find signs of what we may expect on every hand. Particularly in the Far West has this tying-up of advertising with radio become a nuisance. The writer was recently asked to broadcast a ten-minute talk on the dangers of advertising use of broadcasting facilities. The talk was sent out from one of the larger Western stations and the response from those who heard it was tremendously significant. Letters from all parts of the West were received: suggestions of all sorts were offered to remedy the evil which all who heard the talk recognized as *already existing*.

There is our problem—what are we going to do about it? Unfortunately, nothing can be accomplished sectionally. There must be a country-wide movement, which will be powerful enough to overcome the inevitable legislative hesitation and which will result in definite, speedy action. The thing cannot be prevented by ordinary methods; legislation, carefully calculated and effectively administered is the only remedy. And the radio enthusiasts are the ones to whose interest it is that such measures become law as soon as possible. It is *they* who must bring it to pass.

Progress of Radio in Foreign Lands

PRESENT STATUS OF RADIO TELEPHONY FROM BRITISH STANDPOINT

RECENTLY a British Government committee, consisting of Admiral Sir H. B. Jackson (Chairman), Prof. C. L. Fortescue, Prof. G. W. O. Howe, and Major A. G. Lee, made a report regarding the possibilities of radio telephony. The conclusions of the committee are summarized as follows:

(a) The development of radio telephony for long ranges is in an extremely elementary stage, and no line of development which would be likely to lead to its establishment on a commercial basis within a measurable period is visible.

(b) For ranges of the order of 1,000 miles in certain remote localities, where the interference from atmospheric and other radio communications is not excessive, it would be possible to establish non-secret radio telephonic services using waves of the lengths usually employed by medium power radio telegraph stations communicating over the same range. The power necessary for radio telephony, however, would be much greater than that required for satisfactory communication by radio telegraph over the same distance.

(c) For ranges of the order of 200 miles, the position is more hopeful, and the lines of experiment which are being followed will lead to the development in a reasonable time of a system of radio telephony which will approach approximately, at least, to the requirements of a commercial system.

(d) The use of radio telephony as a substitute for any other means of telegraphic communication cannot be recommended except in those cases where the special requirements can be met in no other economic way—for example, the broadcasting of intelligence of general information where one costly transmitting station supplies a great number of simple, inexpensive receiving stations, seems a practical commercial problem, especially in localities ill-equipped with land lines.

THE RADIO TELEPHONE IN JAPAN

IT IS reported that telephone communication by radio has been inaugurated across the Chosen Strait. The stations at Fukuoka and

Fusan contain the necessary equipment for maintaining communication under virtually all conditions, and it is expected that shipping along the coasts of Kiushu and Chosen will take advantage of this service. This particular installation is a unit in the Japanese Government's plan for linking up the various islands of the Empire by radio telephone and telegraph, as a supplement to the cable service.

RADIO WEATHER REPORTS FOR FRANCE

THE Eiffel Tower radio station at Paris is preparing to send out radio telegraphic weather reports and forecasts three times daily. A suggestion has been made that radio receiving sets be installed at central points in the various country communes, and that the information thus received be signaled to the farmers by a code of sound signals from the church bells. For example, no signal would be given if no change in the weather is forecast; three strokes of the bell if rain is expected; six strokes for frost; and ten strokes for wind or hail storms.

DOUBLING THE TRAFFIC CAPACITY OF A RADIO STATION

IT HAS remained for Messrs. H. Abraham and R. Planiol, French radio engineers, to develop a new method of radio transmission which allows two messages to be transmitted simultaneously, each with the full power of the station, without one message interfering in any way with the other. In this way the full range is obtainable for both messages just as in the case of ordinary transmission. This result is obtained without difficulty by simple changes in the wavelengths of the emission.

According to the account of the new method given in the *Comptes Rendus*, the first message is sent mainly on a wavelength A, the second on a wavelength B; things are so arranged, however, that when the two signaling keys are simultaneously depressed the emission is made on a third wavelength C. Each of these three sets of signals is made with the full power of the station. The signals of the first message are in this way sent partly on wavelength A and partly on wavelength B. The receiving station for which the message is intended should there-

fore receive without discrimination signals of wavelengths A or C, but of no other wavelength. It suffices for this purpose to arrange at the receiving station two groups of resonant circuits, tuned to the frequencies utilized. These circuits actuate a receiving instrument which may be either a telephone or a recording apparatus.

This new method permits the amount of traffic handled by the station to be doubled, without any increased outlay. It is claimed that a transmitting station equipped in the way mentioned will give the same service as two separate stations of the same power. Incidentally, moreover, the constant changing of the wavelength of the emissions is a very effective aid to secrecy of the messages. Tests have been carried out with this new method, using the large naval arc station at Nantes, France. Two messages were sent simultaneously on full power. Satisfactory results were obtained.

BRAZIL'S STATION ON MOUNT CORCOVADO

WHETHER the new broadcasting station on Mount Corcovado, overlooking Rio de Janeiro is an earnest effort on the part of the Brazilians to inaugurate radio broadcasting service in their capital city, or only an addition to the attractions of the already spectacular Centennial Exposition, is not known. Whatever the case, the very fact that such a station has been established and is in operation is an indication that the Radiophone craze has at last struck the United States of Brazil. Buenos Aires has had radio concerts for over a year, and the practice has fostered a sizable coterie of radio enthusiasts; but this Corcovado station is Brazil's first attempt.

In some respects, perhaps, the Mount Corcovado outfit is the most unusual in the western hemisphere. Certainly it occupies a most commanding and spectacular position. Perched on an inaccessible peak, it is far above the height attainable by the average mountaineer. It can be reached only by the aid of the Swiss Electric Mountain Climber, which leaves the base of Corcovado every hour and laboriously pulls itself to the top on its cog railway. The entire metropolis below lies spread out before an observer on the summit.

The technical details of the installation have not yet reached this country. The apparatus is probably of American manufacture. A press report is responsible for the slight information

that the concerts and news reports have been heard in Sao Paulo, which is less than two hundred miles distant from Rio de Janeiro. If the station has any power at all, its radius should extend north of Cape St. Roque and south to Rio Grande do Sul; in short, from one end of the country to the other.

AMATEUR BROADCASTING LOCALLY CONTROLLED IN CANADA

ONE of a number of important new regulations governing amateur radio stations in the province of Ontario, Canada, is that local associations are given control of all amateur broadcasting in their territory, with power to issue licenses and withdraw them, to fix hours for broadcasting and to collect fees.

Discussing these new provisions at a recent radio convention in Toronto, Commander C. P. Edwards, director of the Canadian Government Radio Service said: "To meet the demand of the amateur for a broadcasting wavelength, a new license, called an amateur broadcasting license, has been established. This license is subject to certain restrictions, and with a view to protecting amateurs in each locality, it has been decided that the issue of the amateur broadcasting licenses will be limited to associations and they will be given the power to authorize the stations of one of their members to use the license. The wavelength for this class of work has been fixed at 250 metres.

"The underlying idea in this arrangement," he said, "is that if the majority of the members of any association desire local broadcasting, they can, under this license, obtain it."

Commander Edwards added that such amateur stations would be limited to a normal daylight range of twenty-five miles.

Experimental licenses are to be granted to advanced amateurs, who are undertaking original experimental or research work. The wavelengths are: spark, 175; continuous wave, 275.

Transmitting licenses of any class are to be granted only to British subjects, but receiving licenses may be obtained by any person, irrespective of nationality.

A NEW AFRICAN RADIO STATION

FROM the British annual Colonial report for Gambia, West Africa, we learn that radio telegraph and telephone stations have been completed in that colony at Bathurst and at McCarthy Island, distant 176 miles. These

stations are intended for internal communication, as the colony has no organized telegraphic wire system.

BRITISH RADIOPHONE RECEIVERS FOR BRITISHERS

WHILE Great Britain's radiophone broadcasting plans are still more or less in the air and will no doubt take quite a time before they crystallize into something like a definite programme, there is one outstanding fact that has been established since the very beginning: British radiophone enthusiasts are going to use British-made receiving sets. The companies which are to carry on broadcasting in Great Britain are going to see to it that no German or any other country's receiving sets flood their market to the detriment of home industry. Government aid has practically been pledged in this connection.

Meanwhile British receiving sets are now making their appearance. The Radiophone sets follow American practice quite closely; indeed, one line of sets practically parallels a well-known American line, using the designations "Junior" and "Senior" to indicate the difference between crystal detector sets and vacuum tube sets. A crystal receiving set, with telephones and single tuner control, sells for the equivalent of twenty dollars, complete with antenna wire, insulators, and ground connection. A vacuum-tube set makes use of two tubes—one as a detector and the other as an audio-frequency amplifier. The "B" or plate battery and the filament storage battery are contained in a separate acid-proof wooden case. The "B" battery is adjustable by means of a multi-point switch. The set complete with batteries, antenna materials, telephones, tubes and so on sells for the equivalent of one hundred dollars.

PLANS FOR ENGLAND'S MOST POWERFUL STATION

THE new transmitting station which the British Government proposes to erect at Bourne, near Spalding in Lincolnshire, in connection with the Imperial Wireless Chain, will be the largest yet constructed in the British

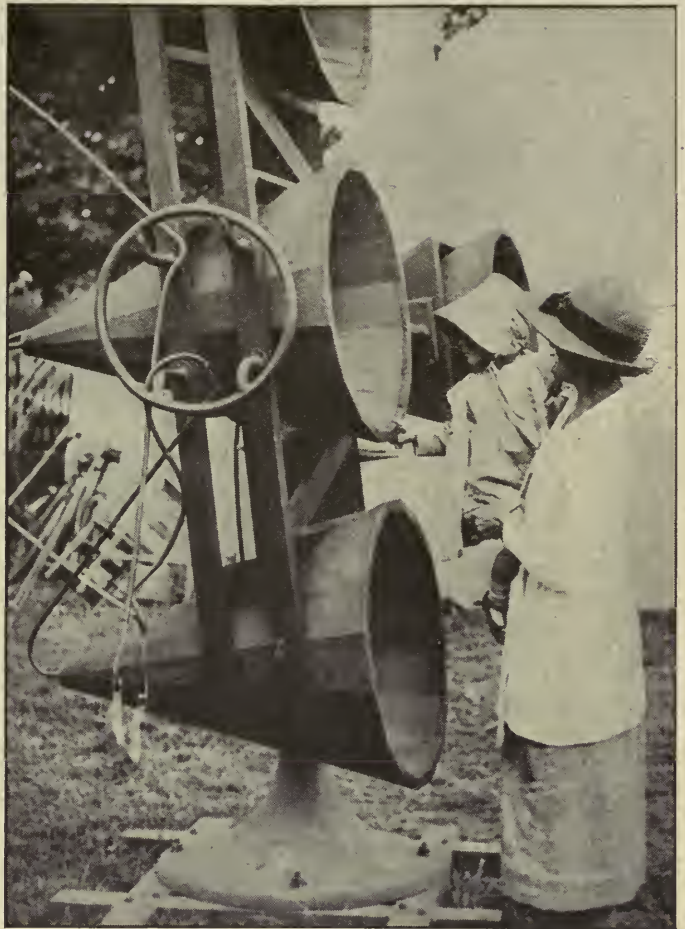

ONCE SEARCHLIGHTS, NOW LOUD SPEAKERS

These horns, used during the war to illuminate an English flying field, have been converted into amplifying horns for broadcast reception

Isles. There will be eight steel masts, each 800 feet high. Owing to the fact that steel is a conductor, and therefore liable to cause loss of electrical energy, the masts will be insulated in sections, and will stand on an insulating base. They will be guyed to concrete anchorages and will be designed to take a horizontal pull of ten tons at the top and a wind load of 60 pounds per square foot. The masts will be arranged in the form of a square, in the centre of which will be located the transmitting station. The apparatus will consist of vacuum-tube transmitters capable of transmitting continuously at 90 words per minute for reception in Poona, Johannesburg, or Perth. The new receiving station at Banbury, which will represent the other terminal of the Imperial Chain, will be built on similar lines to the station already in existence there in connection with

the Leaffield-Abu Zabal (Egypt) link of the chain.

C. BRANDES, INC. ESTABLISHES CANADIAN
FACTORY

ON JULY 3rd, Mr. Frederick Dietrich and Mr. M. C. Rypinski, President and Vice-President, respectively, of C. Brandes, Inc.,

left New York City for Canada to establish a Canadian factory for the manufacture of Brandes headsets. The following day C. Brandes, Ltd. was incorporated at Ottawa, and a day later a factory was leased in Toronto, Ontario. Immediately upon the return of the Brandes officials to New York, the entire output of the Canadian plant was sold for the next six months.

SUPPLEMENTAL LIST OF BROADCASTING STATIONS IN THE UNITED STATES FROM AUGUST 11 TO
SEPTEMBER 16 INCLUSIVE

CALL SIGNAL	OWNER OF STATION	LOCATION OF STATION	WAVE LENGTH
KFAY	Virgin Milling Co., W. J.	Central Point, Oreg.	360
KFBJ	Boise Radio Supply Co.	Boise, Idaho	360
KFBK	Kimball-Upson Co.	Sacramento, Calif.	360
KFBL	Leese Bros.	Everett, Wash.	360
KFBM	Cook & Foster,	Astoria, Ore.	360
KFBN	Borch Radio Corp.,	Oakland, Cal.	360
KFBQ	Savage Elect. Co.,	Prescott, Ariz.	360
KFCB	Nielsen Radio Supply Co.	Phoenix, Arizona	360
KFCC	Auto Supply Co.	Wallace, Idaho.	360
KFCD	Salem Elect. Co.	Salem, Oregon	360
KFDB	McKee, John D.	San Francisco, Cal.	360
WGAI	Southern Equipment Co.,	San Antonio, Tex.,	360
WGAX	Radio Elect. Co.	Washington, Ohio.	360
WJAH	Central Park Amusement Co.	Rockford, Ill.	360
WJAM	D. M. Perham,	Cedar Rapids, Iowa	360
WJAX	Union Trust Co.	Cleveland, Ohio	360
WJAZ	Chicago Radio Lab.	Chicago, Ill.	360
WKAG	Bruce, M. D., Edwin T.	Louisville, Ky.,	360
WKAH	Planet Radio Co.	West Palm Beach, Fla.	360
WKAJ	Fargo Plumbing & Heating Co.	Fargo, N. D.	360
WKAK	Okfuskee County News,	Okemah, Okla.	360
WKAL	Gray & Gray,	Orange, Tex.	360
WKAM	Hastings Daily Tribune	Hastings, Neb.	360
WKAN	Alabama Radio Mfg. Co.	Montgomery, Ala.	360
WKAP	Flint, Dutee Wilcox,	Cranston, R. I.	360
WKAQ	Radio Corp. of Porto Rico	San Juan, P. R.	360
WKAR	Michigan Agri. College,	East Lansing, Mich.	360
WKAS	Lines Music Co., L. E.	Springfield, Mo.	360
WKAT	Frankfort Morning Times,	Frankfort, Ind.	360
WKAV	Laconia Radio Club	Laconia, N. H.	360
WKAW	Turner Cycle Co.	Beloit, Wis.	360
WKAX	Macfarlane, William A.	Bridgeport, Conn.	360
WKAY	Brenau College,	Gainesville, Ga.	360
WKAZ	Landau's Music & Jewelry Co.	Wilkes-Barre, Pa.	360
WLAB	Grossman, George F.	Carrollton, Mo.	360
WLAC	North Carolina State College	Raleigh, N. C.	360, 485
WLAJ	Johnson Radio Co.	Lincoln, Neb.	360
WLAG	Cutting & Washington Radio Corp.	Minneapolis, Minn.	360
WLAH	Woodworth, Samuel,	Syracuse, N. Y.	360
WLAJ	Vermont Farm Machine Co.,	Bellows Falls, Vt.	360
WLAL	Tulsa Radio Co.	Tulsa, Okla.	360
WLAM	Morrow Radio Co.	Springfield, Ohio	360
WLAN	Putnam Hardware Co.	Houlton, Me.	360
WLAP	Jordon, W. V.	Louisville, Ky.,	360
WLAQ	Shilling, A. E.	Kalamazoo, Mich.	360
WLAR	Mickel Music Co.	Marshalltown, Iowa	360
WLAT	Bosch Co., Chas. G.	Burlington, Iowa	360
WMAB	Radio Supply Co.	Oklahoma City, Okla.	360
WMAC	Page, F. Edward	Cazenovia, N. Y.	360
WMAD	Atchinson County Mail	Rockport, Mo.	360
WMAF	Round Hills Radio Corp.	Dartmouth, Mass.	360
WMAH	General Supply Co.	Lincoln, Neb.	360, 485
WMAJ	Drovers Telegram Co.	Kansas City, Mo.	360
WMAM	Beaumont Radio Equipment Co.	Beaumont, Tex.	360
WNAC	Shepard Stores	Boston, Mass.	360
WNAL	Rockwell, R. J.	Omaha, Neb.	360

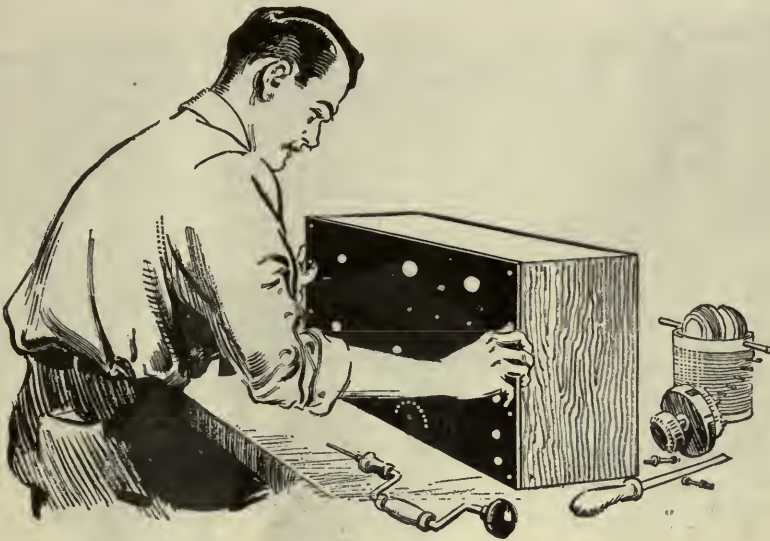

Improve Your Radio Set with a Panel of CONDENSITE **CELORON**

The better the insulation the finer your radio set will perform. Keep your connections tight and your insulation right. This is a radio axiom. Here is another; Get the best panel obtainable.

The essential qualities of a radio panel are non-conductivity, strength and appearance. Condensite Celoron is a strong, hard, waterproof material that will give you surface and volume resistivities, and a dielectric strength, greater than you will ever need. In addition to this, this material machines readily, engraves with clean-cut characters and takes a fine, natural, polish or, a beautiful, dull, mat surface. Mount your equipment upon a Condensite Celoron Panel **and** note the improvement.

Are you a radio enthusiast? Step into your nearest radio supply store and get a Celoron Panel cut to the size you want. If by any chance that dealer cannot supply you, write us direct.

Do you make radio equipment? If you are not now using Condensite Celoron let us give you the facts.

Are you a radio dealer? Send to-day for our special Dealers' Proposition covering Celoron Panels and Parts.

Diamond State Fibre Company

Bridgeport

(Near Philadelphia)

Pennsylvania

Branch Factory and Warehouse, Chicago

Offices in Principal Cities

In Canada: Diamond State Fibre Co., of Canada Ltd., Toronto

New Equipment

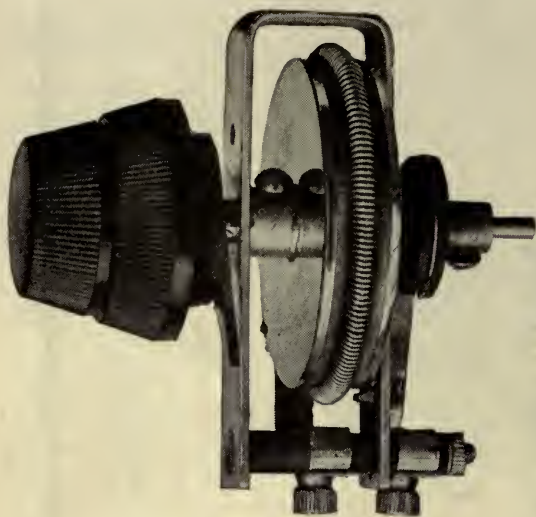

**CUTLER-HAMMER VERNIER
RHEOSTAT**

Type 1601-H1 is a fitting contribution to radio by an old manufacturer of electrical supplies. No mechanical details have been slighted in this rheostat and it enables the operator to obtain very precise filament adjustment. The list price is \$1.50 and the type 11601-H2 which is made without the vernier is listed at \$1.00. A paper template is provided with each rheostat to facilitate drilling the holes for panel mounting

WHITE ADJUSTABLE VERNIER CONDENSER

Type IVC, manufactured by the O. C. White Company, is one of the best devices which has come to our attention. In perfecting this unit, the makers have left no stone unturned, and it embodies many new and attractive features—one being the provision for altering the maximum capacity by changing the distance between the stationary and rotary plates.

The list price is \$2.50

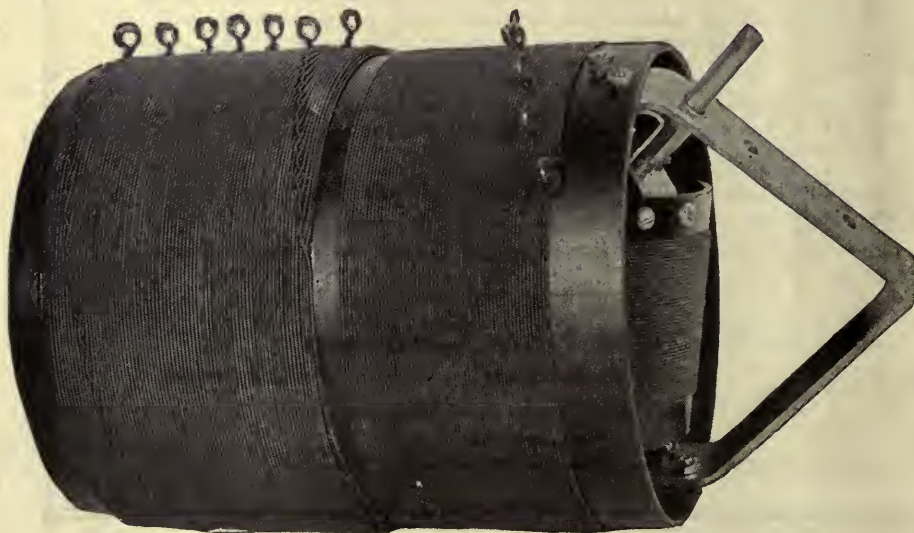
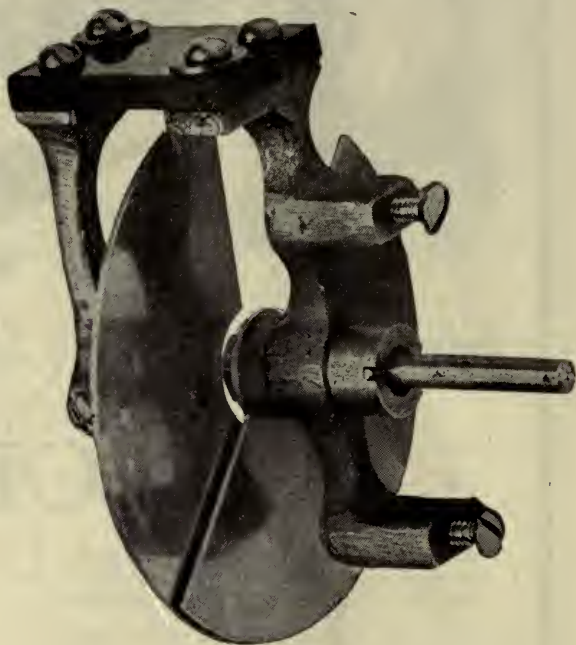

**RADIO GUILD
MULTI-RANGE
COUPLER**

This unit is well designed and well made. Its wavelength range, when employed with an average antenna, is approximately 180 to 3000 meters, the long-wave section is bank-wound and the windings are of silk-covered single conductor copper, on composition tubes. This unit is listed at \$11.00



After the
**THANKSGIVING
DINNER** *hear the voice
of the Outer World*

YOUR receiving set becomes in real fact a "family institution" when equipped with Magnavox Radio the Reproducer Supreme.

- R-2 Magnavox Radio with 18-inch horn:** this instrument is intended for those who wish the utmost in amplifying power: for large audiences, dance halls, etc. . . \$85.00
- R-3 Magnavox Radio with 14-inch horn:** the ideal instru-

- ment for use in homes, offices, amateur stations, etc. \$45.00
- Model C Magnavox Power Amplifier** insures getting the largest possible power input for your Magnavox Radio.
 - 2 stage AC-2-C . . \$80.00
 - 3 stage AC-3-C . . 110.00

Magnavox Products can be had from good dealers everywhere. Our interesting new booklet (illustrated in three colors) will be sent on request.

The Magnavox Co., Oakland, California
New York: 370 Seventh Avenue

MAGNAVOX RADIO

The Reproducer Supreme

The Grid

QUESTIONS AND ANSWERS

The Grid is a Question and Answer Department maintained especially for the radio amateurs. Full answers will be given wherever possible. In answering questions, those of a like nature will be grouped together and answered by one article. Every effort will be made to keep the answers simple and direct, yet fully self-explanatory. Questions should be addressed to Editor, "The Grid," Radio Broadcast, Garden City, N. Y. The letter containing the questions should have the full name and address of the writer and also his station call letter, if he has one. Names, however, will not be published.

DIAGRAMS AND GRAPHS

There are several things in the illustrations and diagrams accompanying radio articles that I do not understand.

Many diagrams indicating bulb apparatus show no connections to a filament battery, and the tubes themselves are often depicted as having only three terminals.

How are graphs to be interpreted?

E. S. H., BOSTON

DIAGRAMS are often abbreviated to avoid confusion resulting from a repeated criss-crossing of wires that are diagrammatically unnecessary. The fourth connection to the tube, invariably the remaining terminal of the filament battery in series with the rheostat, is understood. Also, a series of separate cells, such as a B battery, is often indicated merely by a line of dots between the terminal cells. Fig. 1 shows a circuit of this character. The A battery has been drawn in with dotted lines.

A graph is really a form of picture-writing, which conveys at a glance a series of happenings, and the relations of one thing to another, that might otherwise take pages to describe. For example, a graph may show the relation of varied grid charges to the plate current in a vacuum tube, i. e., the effect that such variations have upon the plate current. In the case of a variable condenser, a graph might show the correlation between the turning of the knob in degrees, and the capacity variation which results. In the two examples just given, the graph indicates immediately: (1) the plate current of the audion at any grid potential (other things being constant) and the general

If it is desired to establish a relationship between the plate current (the current passing through a bulb from filament to plate) of a certain type vacuum tube and the applied grid potential, observations of the tube's behavior in this respect must first be made.

The tube is connected with auxiliary apparatus according to the diagram in Fig. 1. B₂ is a grid battery of twenty volts, tapped at approximately half that potential, and shunted by the potentiometer, R. B₁ is the plate battery of a constant voltage, and B₃ lights the filament. V and A are micro-volt and milli-ampere-meters, respectively, from which the readings are made. As the contact on the potentiometer is varied, any plus or minus charge, within the limits of the battery, may be placed on the grid.

Starting from the negative side of the grid battery, the potentiometer slider is lowered until the first definite reading is shown in the milli-ampere-meter, at which point we shall assume the grid voltage to be between -5 and -4 volts. But bearing in mind that we are going to observe the *fluctuations in the plate current at certain definite grid voltages*, in other words, that we are going to plot E_g (grid voltage) as a function of I_p (plate current), we make our primary reading on the milli-ammeter, not at the first grid voltage (probably a fraction) at which an appreciable fluctuation is noticed, but at the round number (-4 volts) approximating it. At -4 volts, the plate current is found to be .3 of a milli-ampere, or .0003 of an ampere. Increasing the grid voltage in steps of one volt, we arrive at the following table showing the relations between grid voltages and plate current:

GRID POTENTIAL (volts)	PLATE CURRENT (milli-amperes)
-4.0	.30
-3.0	.90
-2.0	2.00
-1.0	3.50
0	5.00
+1.0	6.50
+2.0	8.00
+3.0	9.00
+4.0	9.55
+5.0	9.90
+6.0	10.00

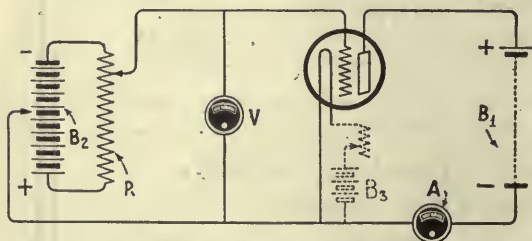

FIG. 1

characteristics of the tube; secondly, the capacity of the condenser in farads at any degree on the condenser scale.

Probably the clearest idea of how a graph is to be interpreted may be conveyed by showing how such a graph is built up. The graph itself is the curved or straight line plotted on a chart laid out in vertical and horizontal lines known respectively as ordinates and abscissae.

Having determined the above relationship, it now remains to express it in the form of a graph—to "plot" the data. The squared paper is first scaled, a definite number of squares or units from left to right (on the abscissae) corresponding to one volt, and another predetermined number (according to the arrangement that will best emphasize the curve) on the ordinates (up and down)



Choke off that "squawk"

AFTER all it is not always the bad vaudeville actors that "get the hook." Many owners have found an efficient hook to choke off the "squawk" of their radio sets and secure enjoyable music, by adding Acme *Audio Frequency Amplifying Transformers* to the ordinary detector unit. Acme Transformers cost but five dollars, yet the results are almost marvelous. Not only do they amplify sound, but they bring it naturally—realistically. They are necessary to the proper operation of the Acme Clear Speaker which enables a whole roomful of people to enjoy the broadcasting concerts.

In order to get more than one broadcasting station and thereby pick out the concert you like best, you should also add an Acme *Radio Frequency*

Transformer. This greatly increases the range of your set whether it be vacuum tube or crystal detector type. This wonderful little transformer sells for the same price as its twin brother the Acme *Audio Frequency Amplifying Transformer*. Your set is not complete without both these transformers and the Acme Clear Speaker.

The Acme Apparatus Company (pioneer transformer and radio engineers and manufacturers) also make detector units, the Acme phone, Acme C. W. and Spark Transmitters, etc. Write for interesting Transformer booklet if your own radio or electrical dealer cannot supply you. The Acme Apparatus Company, Cambridge, Mass., U. S. A. New York Sales Office 1270 Broadway.



Type A-2 Acme Amplifying Transformer
Price \$5 (East of Rocky Mts.)

ACME

for amplification

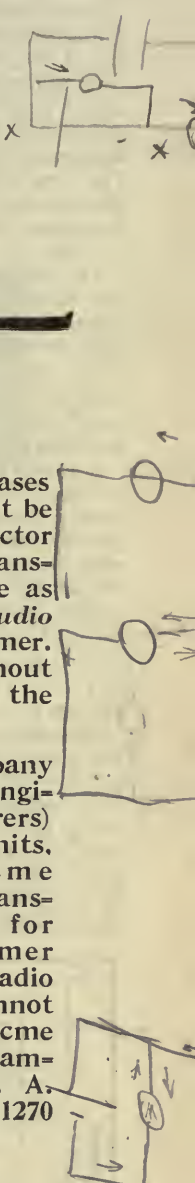

representing one or more amperes. As volts are being measured with relation to various current values, following an arbitrary rule, they will be indicated by distances on the abscissae, and the amperes, the result of the voltage variation, will be plotted as distances on the ordinates.

Referring to the relations arrived at by experiment, the line of the graph passes through points indicating those relationships. This is accomplished exactly as the position of a city or town is located on a map by two sets of numbered or lettered parallel lines running vertically and horizontally. The first point will fall at a position (A, Fig. 2) -4 volts horizontally and $.3$ of a milli-ampere (the plate current reading for that voltage) on the ordinates. The second point, B, will be located at the intersection of -3 volts and $.9$ of a milli-ampere, and so on.

The data being plotted, the next step is to draw "the best representative line," a smooth curve, following on an average (deviating, if necessary, first on one side, then on the other) the points on the chart.

The result is the characteristic curve of the vacuum tube, which, taken as a whole, instantly shows to the initiated mind, the complete action of the tube—its possibilities as a detector, radio and audio frequency amplifier.

A general analysis of the graph teaches that a decrease of a small minus grid potential (a positive increase) will cause a comparatively slight rise in the plate current for the first few volts; but as we approach zero the rate of plate current increase is much greater. For several volts on each side of zero the rate of increase is the same (the straight portion of the "curve"), but when a positive potential of approximately two volts is attained, the rate of increase drops back and continues to subside until, finally, at $+5.5$ or $+6$ volts, further increase in the grid potential does not augment the plate current.

Furnished with this information at a single comprehensive glance, the experimenter realizes that the bulb in question is an excellent amplifying tube. For, if operated at an original zero grid potential, variations of the grid charge by the signals, within the limits of two volts on each side of zero, will produce a uniform change in the plate current. (X-Y on the minus variation, and Y-X¹ on the positive side.) However, if the tube was not characterized by the straight line, or if it were operated

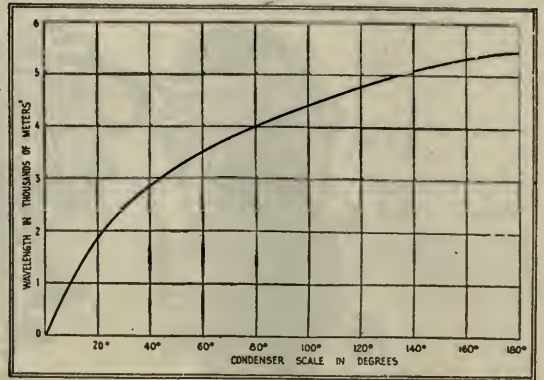

FIG. 3
Wavelength of a US500 duo-lateral coil shunted by a Standard 23-plate condenser

at $+2$ volts, point E on the curve (which, in effect, is the same as another tube deficient in the straight portion of the curve), a decrease in two volts would cause a much greater change in the plate current (X¹-Y) than would be effected by an equal increase (X¹-Y). Due to this lack of uniformity distortion—and hence unsatisfactory amplification—would result.

In the characteristic curve of an audion, there is little value in the individual volt-ampere relationship. That is to say, there is small opportunity to apply practically, for instance, the knowledge that at -2.5 volts on the grid, the space current, under a constant plate potential, will be 1.40 milli-amperes, or, at $+2$ the plate current will be 8.00 milli-amperes. The value of a tube's characteristic curve lies in its entirety, not in any one of the single readings from which it is drawn. Likewise, in resonance curves, and graphs depicting the effect of antenna resistance on sharpness, the reading at a single point is of less value than the graph as a whole.

However, in many cases—for example, the wavelength of a coil shunted by a variable condenser (Fig. 3), or the capacity of a condenser itself in relation to the dial indications—the significance lies in the individual readings.

Fig. 3 is a graph showing a variable capacity (a popular make of twenty-three plate condenser) shunted across a duo-lateral coil US500, in its relation to wavelength, i. e., the wavelength of the circuit at any degree on the condenser scale. If the experimenter is receiving a medium wave arc station, and desires to know to just what frequency he is tuned, a glance at the chart will tell him. If his condenser scale reads one 148° , the set is in resonance with 5200 meters; if 44° the wave is 3000 meters. Such a chart is of a very practical value on long-wave reception where, as the stations sign at long intervals, the only way of identifying a station is by the length of its wave.

While listening to radio telephone broadcast, I am often disturbed by a whistle, clear and flute-like, "swishing" across the music. As I am not touching the control knobs at the time, I should like to know if the fault is in my set.

R. W., TOPEKA, KANSAS

THE phenomenon is a beat wave or signal set up in the receiving circuit either by local oscillations (those caused in the receiving apparatus by its suddenly falling into an oscillating state) or, as is most

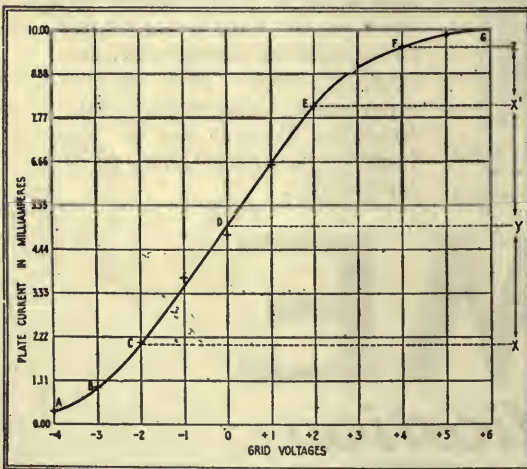
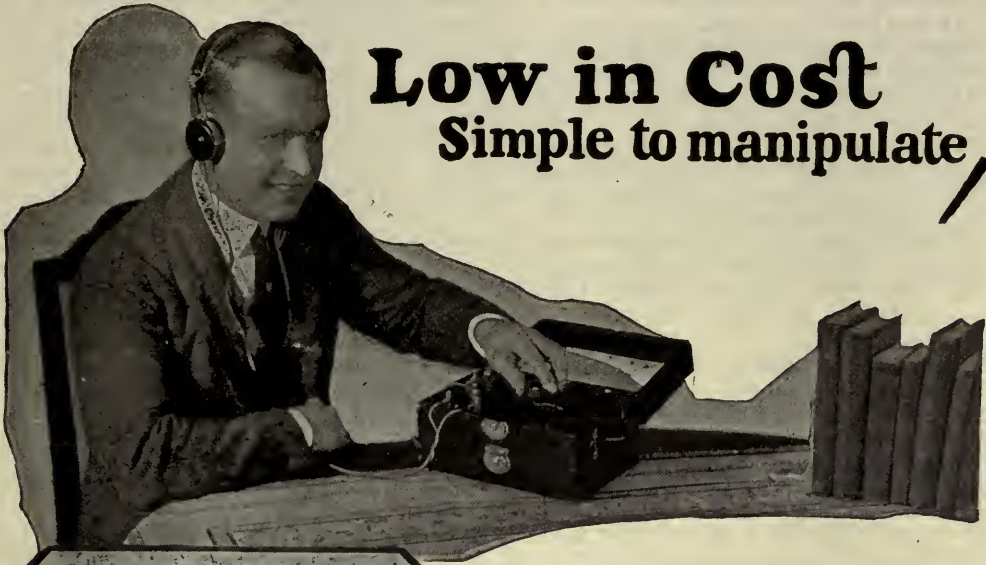

FIG. 2

Showing plate current variation with a constant plate voltage but a varying grid charge

Low in Cost Simple to manipulate



Opened like
a book



Carried like a
satchel

THE radio enthusiast who lives within ten to twenty miles of a broadcasting station has exactly what he wants in Radiola I (ER 753-A)—low cost, compactness, portability, and simplicity of manipulation.

Open the walnut cabinet, and on the front panel you find the tuning control, the crystal detector and the binding post. In the body of the cabinet are the head-telephones. Tuck away the telephones, close the front panel, and you can carry the whole set as you would a satchel.

Radiola I at your dealer, \$25.00



*This symbol of
quality is your
protection*

The Book that Brings Radio Into the Home

For 35 cents you can obtain from your dealer or from us a copy of the book "Radio Enters the Home." It explains the principles, the fascination of radio in plain English. It describes Radiolas and their accessories. It contains the most valuable wiring diagrams ever published.

Radio Corporation of America

Sales Department
233 Broadway
New York, N. Y.

District Office
10 South La Salle St.,
Chicago, Ill.

probable, those of a nearby receiving station *that is being tuned in a manner hardly considerate of neighboring stations.* There is also the third but unlikely alternative of another radiophone transmitter being tuned or tested on approximately the same wave as the broadcasting station.

A "beat" is the phenomenon resulting from superimposing one frequency or wave upon another. All waves are characterized by frequencies or periods of vibration, and when two of them are brought sufficiently close to interfere, a third wave is generated known as the "beat," the frequency of which is the difference between the frequencies of the two original waves. The phenomenon is analogous to the effect achieved by placing a yellow glass over a blue one. When the combined glasses are held to the light, the green filtering through is a very different shade from the two primary tints.

Previous to the coming of single-circuit broadcast receivers, beats in radio were most commonly heard when two radiophone stations were operating on waves so nearly alike that the voices were confused and jumbled. But loud above the speech would be the squeal or whistle, the beat note of the two stations. For a more specific illustration, it will be assumed that the first station is transmitting on 360 meters (a frequency of 833,300 cycles) and the second station on 359.8 meters (833,800 cycles). The beat note, as before explained, would be the difference between these frequencies, or 500 cycles, a high flute-like note. If there was a greater diversity between the two waves, if, for instance, the stations were operating on 360 and 350 meters respectively, a beat would still exist, but, as the difference between the two frequencies, 23,800 cycles, is far above the range of audibility, it would not be heard.

Thus any two-bulb transmitting stations within interfering distance of one another, and transmitting simultaneously, will generate a beat, which, if the difference between the individual waves is slight, will be heard as a howl or whistle.

A regenerative receiving set, similar to the Aeriola Senior, is capable of oscillating or producing radio waves, and in this respect acts as a short-range bulb transmitter.

Many operators tune their sets with the bulb oscillating (radiating wireless waves), searching around for the howl or beat note set up by the superimposition of local upon incoming oscillations when resonance has been practically effected. At this point the filament, or the tickler coupling, is reduced until oscillations are stopped, and the signals

brought in loud and clear. But the squeal heard in the operator's phones during the process of tuning is also audible in nearby receiving sets tuned to the broadcasting station, due, as before explained, to the fact that the "local" oscillations are not confined to the receiving apparatus, but are radiated as wireless waves. As the operator of the interfering receiver tunes his station, i. e., varies the frequency of his emitted wave, the beat note necessarily changes in pitch, running up and down the scale with the effect that our inquirer described as disturbing.

In tuning for broadcast reception there is no necessity for doing so in the manner just outlined. Indeed, the beginner will find the process greatly facilitated if he tunes scientifically with the bulb quiescent. An oscillating tube is characterized by hissing, a general amplification of static and tube noises, and the distortion of phone and spark signals.

TUNING YOUR BROADCAST REGENERATIVE SET

THE following is suggested as a considerate and efficient method of tuning the average broadcast regenerative set:

The filament should be first lowered appreciably below its normal brilliancy. At this point the set is adjusted in the usual manner for resonance and regeneration, by the antenna and tickler adjustments respectively. The filament is then turned up slowly to just below where oscillations commence, at which point the signals will have reached maximum amplification. It is likely, in achieving this final adjustment, that the critical point will be crossed and the tube oscillate until the filament is again lowered. However, if the preliminary tuning was skillfully and accurately accomplished, the local oscillations will "lock" with those radiated from the broadcasting station, and vibrate at exactly the same frequency. Thus no frequency difference, with the resulting howl, can exist—in other words, a "zero beat" has been effected.

It is also a very good practice to note the various positions on the dials and taps at which different consistent stations are received, and to tune to these adjustments before the filament is lighted. By this procedure all local and interfering oscillations are obviated.

It is interesting to note that in several foreign countries bulb receiving sets must be licensed, due to the possibility of interference.



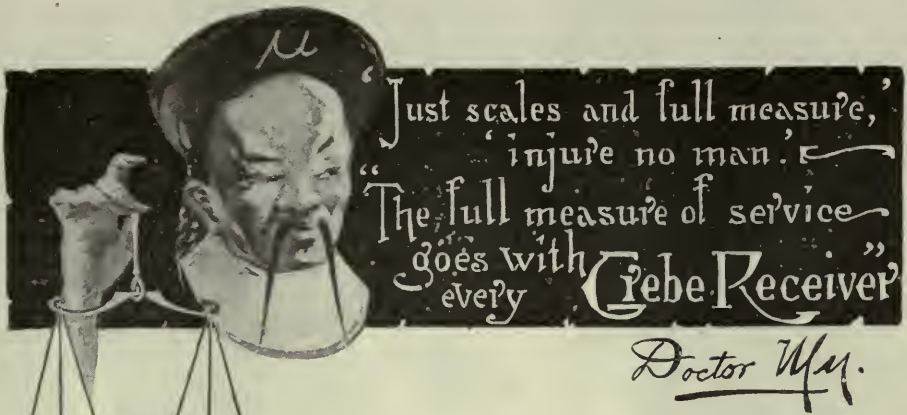

Just scales and full measure,
injure no man.
The full measure of service
goes with Grebe Receiver
every

Doctor May.

ANYONE who knows a radio will tell you how well the Grebe CR-5 performs on the daily concerts, lectures, etc., in the air.

Two simple tuning adjustments are used. Tiresome adjustments, unpleasant interruptions are unnecessary with the Grebe CR-5. Its

range, 150—3000 metres.

Ten years experience in satisfying a critical radio public has taught us how to build it for your year-round enjoyment.

If your Dealer does not sell Grebe Radio Apparatus, send us his name and receive interesting circular.

A. H. GREBE & CO., Inc.

Van Wyck Blvd., Richmond Hill, N. Y.

General Offices and Factory

Western Branch—451 East 3rd St., Los Angeles, Cal.

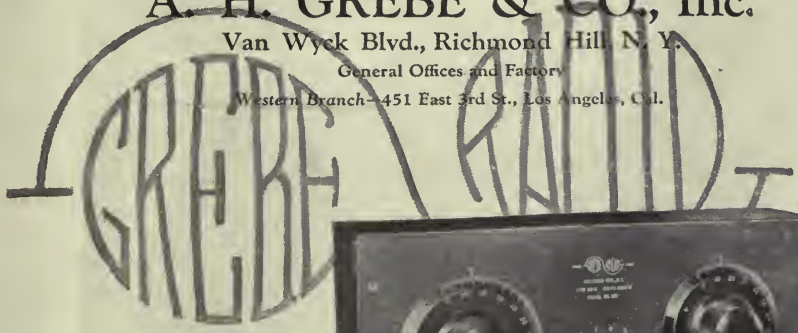

Licensed under
Armstrong U. S. Patent,
No. 1113149





J. H. MORECROFT

Professor of electrical engineering at Columbia University, New York, is the author of several of the most important technical books on radio

© Bachrach

RADIO BROADCAST

Vol. 2 No. 2



December, 1922

The March of Radio

THE AMERICAN BOY IN RADIO

THE tremendous popularity of radio in America to-day is due to the keen enthusiasm with which the American boy has taken it up and experimented with its possibilities. For the past ten or fifteen years he has been spending his extra hours and dollars in acquiring the apparatus and skill needed for operating a wireless transmitting or receiving station. Many a long hour has he spent at the Morse key, and later with the "bug," learning to send clean-cut, snappy code signals to his fellow enthusiasts — for those coming into the game during the past year or two must remember that until very recently all radio transmission was by dots and dashes, by a code that required considerable practice before a speed of even fifteen words a minute was reached, and much more before the thirty-five and forty word speed of the best operators could be attained.

Every evening, before the phenomenal expansion of the interest in radio occurred, the characteristic musical notes of certain stations could be heard, as attempts were made to beat previous records in speed or distance. The short-wave field was occupied entirely by the amateurs with spark stations; practically no transmission was carried on by other stations on wavelengths below 600 meters. In exceptional cases an amateur's 1-kw station could establish communication over two or three thousand miles, provided that a skilful operator was tuning at the other end. Many men, who as boys excelled in the field in those early days,

are now occupying important positions in commercial radio enterprises and they have carried their boyish enthusiasm right along with them. Practically all the radio engineers of to-day are the amateurs of yesterday. Radio is an art which the older engineers, trained in other branches of electrical engineering, have not always found it easy to break into.

Not only have the amateurs carried a very personal enthusiasm into the field of radio engineering, but they have continually pushed the commercial companies to develop and improve their radio apparatus. In this respect, radio differs from other phases of applied electricity: although few private experimenters could develop a lamp or electric motor to compare favorably with the product of the large research laboratories employing specialists in lamp or motor manufacture, many a boy has rightfully claimed that his home-made radio set was better than those put out by well known firms. The commercial engineers have had to be keenly alert merely to keep pace with the amateur, much more so to surpass him.

In no other country has the boy taken such a prominent part in the development of radio, partly because of the severe governmental restrictions in foreign lands, but largely owing to the different attitude here. A new application of science has an excellent chance for rapid development in a country which is itself new and rapidly developing: witness the automobile and the telephone. And as a simple radio outfit does not require a large outlay, it has been

possible for the boys to play the same part in the development of radio as their fathers did in the automobile and telephone industries. If the boy of to-day should suddenly lose interest in radio, it would probably mean the loss of many millions in business in the coming year alone. But he won't. His influence will probably continue to be felt more than ever, not only as a consumer of "parts," but in developing an occasional Godley or Armstrong to increase the value of radio for all of us.

Slightly Different Wavelengths Will Do

HOW far apart in wavelength must two broadcasting stations be so that the interference produced at receiving station may be inappreciable?

Any one versed in radio theory could make certain assumptions regarding proximity and power of stations, conditions in receiving sets, etc., and upon these assumptions he could give a more or less definite answer to the problem. It would be hard to apply the results to practical conditions, however, because of the variations of these conditions at different places. From a multitude of computations, an average could be obtained, but there would still be certain elements of the problem in doubt. How efficiently for instance, does the average listener tune his set? What is the resistance of the average receiving set as installed? How much interference can be allowed without causing appreciable bother to the listener?

A sensible attack on this problem has been started by Mr. Arthur Batcheller, Radio Inspector of the second district, by suggesting that the General Electric station at Schenectady, N. Y., WGY, try operating on 400 meters at the same time that the station at Rensselaer Polytechnic Institute at Troy, N. Y., WHAZ, is operating on 360 meters. Listeners in the vicinity of these two neighboring stations are requested to tune first for one station and then for the other, and report whether troublesome interference between the two is encountered. If sufficient answers are obtained, and if they are passed upon, the test will have been proved a valuable one.

With good receiving sets in the hands of skilled operators, little interference should be encountered if the wavelength difference is only twenty meters, instead of forty, as in the trials referred to above. But even if the forty-meter wavelength difference between stations has to be allowed, enough separate ether chan-

nels will be opened to improve broadcasting greatly, if the radio bill, referred to in our last issue, is finally passed by Congress.

Crystal Detector Patents

THE Wireless Specialty Apparatus Company has been trying to stop the sale of crystal sets of other manufacturers by advertisements intimating that any dealer handling crystal sets not made by or licensed by it would be held liable for damages. Among other ideas contained in the advertisements is the suggestion that all radio dealers should require the manufacturers of crystal sets to sign guarantees of protection against recovery of damages in case the court should declare certain of the crystal patents valid. Evidently the circulation of such an idea would harm the business of those not working under license from the Wireless Specialty Apparatus Company and suit was therefore brought against this company by one of the alleged infringers, the Freed-Eisemann Corporation, with the idea of testing the legality of the methods used by the owner of the patents.

The case was tried in the Supreme Court before Justice O'Malley, with Mr. W. H. Taylor, Jr., representing the plaintiff. The circulars and advertisements were declared to be unfair in giving the impression that the buyer of a crystal set must investigate for himself, or get expert opinion on all the twenty-one patents owned by the defendant, as the circulars stated that "one or more" of the defendant's patents were being infringed. As a result of the suit, the Wireless Specialty Apparatus Company was enjoined from a further advertising campaign along the lines it had been pursuing.

Modern Miracles

IN AN article dealing with the history of radio, which appeared in a recent number, comment was made on the complacency with which we accept the wonders which have come into existence only during the last generation. Illustrating this point we note the rather slight mention made of the remarkable progress of radio telephony in aviation, the development of which most of us have seen from its beginning.

In a brief paragraph in our foreign news, it is cited as a mere incident in the day's work that, in the regular service of the London-Paris Air Line, a storm over the Channel damaged one of the planes badly enough to necessitate landing,

upon reaching the French side; that the pilot, realizing this, phoned ahead to the nearest Air Line service station, three miles beyond Calais, stating his trouble; that a corps of expert mechanics awaited his landing soon afterwards, with the new parts required for repairs; that in fifteen minutes these were completed, the pilot with his dozen passengers ascended to his air

country-wide network of the Postal Telegraph-Cable Company will serve as a feeding system to the transoceanic radio channels. It is possible to file a message in practically any city, and it will be sent over an American-owned system to England, France, Norway, or Germany. With the opening of some of the new stations now being erected by the Radio Cor-



THE PIONEER BOYS' RADIO CLASS

Of the Philippines was recently greeted by Governor-General Leonard Wood. These boys are credited with being the first in the Islands to build their own sets. The Governor-General is an enthusiastic booster for the boys and has assured them of his assistance

lane, and arrived in Paris only twelve minutes behind schedule time!

Radio and Land Lines Coöperate

AN ARRANGEMENT by which the service of the Radio Corporation could be made available at all points in the United States was sure to come; it is a scheme by which the business of each system would receive added business with little additional investment. Until recently, most of the Radio Corporation's transatlantic business originated either in New York or Washington. Now, the

poration in other countries, direct service will soon be available also to Belgium, Holland, Italy, Poland, and Sweden.

Messages originating at any point in the United States will be forwarded to the Radio Corporation offices in New York, there put into the form of perforated tape and run through the transmitting apparatus in this office which, by remote control, operates the immense machines at the radio central station miles away. In announcing the new service, Mr. Nally, president of the Radio Corporation, pointed out that his company was the out-

growth of the Marconi Wireless Telegraph Company of America, the result of the appeal of government representatives for an American-owned, American-operated communication system extending over the whole world.

When the Barges Broke Loose in New York Harbor

A FLEET of coal-laden barges, forty or fifty in number, broke away from their moorings a short time ago and were carried in a jumbled mass straight down the channel of the East River, which at the time was crowded with ferry boats and other craft. Several of the large passenger steamers which ply between New York and eastern ports were starting up the river on their trips, ignorant of the uncontrolled fleet of water juggernauts bearing down upon them through the narrow channel, racing with the ebbing tide through Hell Gate.

All these steamers were notified by radio in time to get in shore, out of danger of collision. No casualties were reported following the incident, whereas if warnings of the danger had not been flashed out at once, accidents would undoubtedly have occurred.

Rum-Running by Radio

A LETTER published in the New York *Times* a few days ago unfolded a most remarkable tale of the sea. Although the incidents related took place only a few months ago, the story reads like the pirate narratives of our boyhood days—except for the part played by radio. A Jules Verne might have put even this into the story, had he been writing it, just as he used the submarine of his imagination.

The steamer *Korona*, under Peruvian registry, left New York with clearance papers for Greece, having a mixed cargo in which there were 400 drums of alcohol. Her machinery was in poor condition when she sailed, and the captain kept in radio communication with the owners, ostensibly, of course, to inform them as to how he was faring with the defective pumps and boilers. It developed later that the radio reports which apparently dealt with machinery were in reality code messages giving orders regarding the smuggling of the 400 drums of alcohol back into the United States. After getting well out to sea some armed gunmen appeared on deck for the first time, and forced the crew to carry out the orders for returning to within a few miles of our coast and loading

the alcohol on some barges which were waiting at the spot specified by radio. After having thus disposed of her cargo, valued at \$800,000, the *Korona* received orders to proceed to Bermuda, load up with whiskey and then steam back to Block Island, where barges had been ordered to meet her, and there dispose of her second cargo.

The vessel then sailed for Greece, whither her clearance papers indicated she was bound in the first place, got into trouble with the Spanish authorities at Cadiz and was there held. Without the use of radio, this smuggling would scarcely have been possible, as the meeting place where the unloading occurred could not be well determined until the position of the "Dry Fleet" had been ascertained. Through radio communication, with accomplices on shore, the smuggler's ship could avoid the government agents just as our transports avoided the German submarines. Radio is impartial and takes no account of the law in rendering prompt assistance.

Stolen Transmitter Reveals Its Whereabouts

AFTER a few incidents like that related herewith, thieves will probably leave radio transmitting apparatus alone for fear that it will call out "Stop thief!" while they are getting away with it. A small transmitter was stolen from an amateur operator. Of course, the only use for such apparatus is to transmit with it, and this the thief soon proceeded to do. The owner of the apparatus, and probably all his amateur friends, listened each evening to hear signals from a new transmitting station, and were soon rewarded. Moreover, the rightful owner recognized his own set by a certain peculiar quality of the signal tone. Knowing that his apparatus was being used somewhere within a few miles of his home, he made a radio compass by mounting a small listening set with a coil aerial in an automobile. Traveling about through the neighborhood, he succeeded in getting "cross bearings" on the location of the apparatus, and within a short time had located the station and recovered his set.

Making the Get-away a Give-away

FROM its earliest days radio has seemed to offer valuable assistance to those concerned with the capture of criminals. Every law-breaker needs a certain length of time to make his "get-away"—his crime may

be discovered soon after it is committed, but as the news of it and possibly his description cannot be spread immediately, sufficient time often elapses to permit disguise and flight before the police nets can be drawn about him.

That this interim is rapidly being lessened, we were reminded a few evenings ago, when the musical programme of one of the popular

quarters, information regarding a crime can be broadcasted over land and water. It is expected that this new service will be especially valuable in light of the almost universal use of automobiles by fleeing criminals—a method of flight which has frequently outdistanced the ordinary methods of spreading news.

Transmission will be on a wavelength other



THE CHIEF POLICE INSPECTOR'S OFFICE

In New York City has been equipped with this powerful broadcasting station which is being used to run down escaped convicts and other criminals. By coöperating with the police in other cities by radio, a huge network may be thrown over the entire country

broadcasting stations suddenly stopped, and the announcer sent through the ether the news that some criminals had just broken jail and fled in the direction of a neighboring village. Descriptions of the men and the clothes they wore were given over the radiophone, and at once hundreds of people within a few miles of the jail were on the watch for them. In this instance the criminals were apprehended a few hours after their escape.

The Police Department of New York City has now invoked the aid of radio and has installed at headquarters a modern radio telephone transmitter. All the district headquarters, station houses, and police boats are being equipped with receiving sets so that a few seconds after a report is received at head-

quarters, information regarding a crime can be broadcasted over land and water. It is expected that this new service will be especially valuable in light of the almost universal use of automobiles by fleeing criminals—a method of flight which has frequently outdistanced the ordinary methods of spreading news. By coöperation with similarly equipped police stations in neighboring cities and with innumerable amateur stations at present being operated, a country-wide net can be thrown out within a few minutes of the reception of news at police headquarters.

The Talking Movies

IT HAS been a foregone conclusion that when talking movies arrived they would be of great interest to the radio world because of the almost certain use of radio's most valuable instrument—the three-electrode vacuum tube. In the light of this fact, it does not seem strange that announcement should come from De

Forest, inventor of the audion, that he has perfected a process for producing talking films, in which the audion plays an important part both in taking the film and in reproducing it. Simultaneously with this announcement, word was sent from Germany that several inventors of that country had joined forces in this particular field and had succeeded in perfecting a talking film better than anything hitherto seen in Germany.

The talking movie film as it has been developed so far utilizes two phenomena which have heretofore been found almost entirely in the realm of pure physics, namely the luminosity of rarefied gas when carrying an electric current, and the variation of resistance of certain rare metals when they are illuminated to a greater or less degree. Within a short time after the experiments are shown

to be reasonably successful in their new field, millions of dollars will probably be invested in this new process.

Comparatively few people have heard of Richardson's study of the evaporation of electrons from hot metals, or of Thomson's book on the discharge of electricity through gases or even of the experiments on the property of light in changing the electrical resistance of selenium, yet these two actions will probably soon be represented in many moving picture machines.

When the film is being made, the sounds to be recorded make a diaphragm vibrate, by which an electric current is controlled. This variable electric current, properly amplified by an audio-frequency amplifier, flows through a small glass tube in which a rarefied gas is con-

tained. This gas glows as current flows through it and the light it gives off is proportional to the strength of the current. As the voice current goes through the tube, therefore, the gas varies its glow in step with the frequency of the voice, and the amount of variation in the glow depends directly upon the intensity of the voice sounds impinging upon the microphone.

Through a very fine slit in the light-proof covering of the tube, the luminous gas shines upon one edge of the film as this moves past the lens, causing a fine line of varying intensity to appear on the film at one side, between the picture and the row of registering holes. This line consists of a series of lines of varying strength, separated from each other by perhaps one-hundredth of an inch. Each of these fine lines represents one vibration of the voice and the



DE FOREST'S PHONO-FILM

Is of the same size as standard motion picture film. The speech is recorded on the outside of the strip and appears in the form of horizontal lines of different widths upon the "speech line," shown at the right. This is a picture of Dr. De Forest, and the speech recorded on the film is his own

closeness of the lines is determined by the pitch of the voice: a note of 1,000 vibrations per second would give 500 fine lines per foot of film if the film were being run two feet per second.

In the reproduction, a bright light shines through this series of fine lines upon a light-sensitive cell and as the lines move by, the intensity of light falling upon the cell will evidently vary 1,000 times per second; this variation in light intensity will make the resistance of the cell correspondingly vary. A battery connected to the cell will deliver a corresponding variable current through the cell, and this current, properly increased again, is sent through a loud speaker and reproduces the sounds occurring when the film was taken.

J. H. M.

Young America Building His Own

The American Schoolboy is not Content With the Purchase of a Complete Receiving Set—He Must Know What Goes on Inside and Tinker with it till He has Wrecked or Improved it

By HENRY L. ARTHUR

GONE are the days when the indulgent parent persuaded Santa to bring the Christmas mechanical and electrical toys to the house a week in advance. Santa has learned that many a dad has ruined an expensive railroad outfit or high-grade radio set before it ever reached the hands of the family young hopeful, who, no doubt, could have uttered the magic "Open Sesame" before the damage was wrought.

A failing, common to many fathers, is that which impels them at every opportunity to show their youngsters how to do things better—

especially the so-called "technical" things. It is safe to say that few there are among the dads who would permit their boys to connect an electric train circuit, fly a new kind of kite, shoot a new rifle, or cut with a new jack-knife, without first unloading a certain amount of superfluous parental instruction. Not that we revel, particularly, in the fact that there are certain lines of endeavor in which Young America can offer some real pointers to the older generation—but, as we have said, many an otherwise useful Christmas gift has been damaged beyond redemption by an over-zealous dad who felt that the only way to

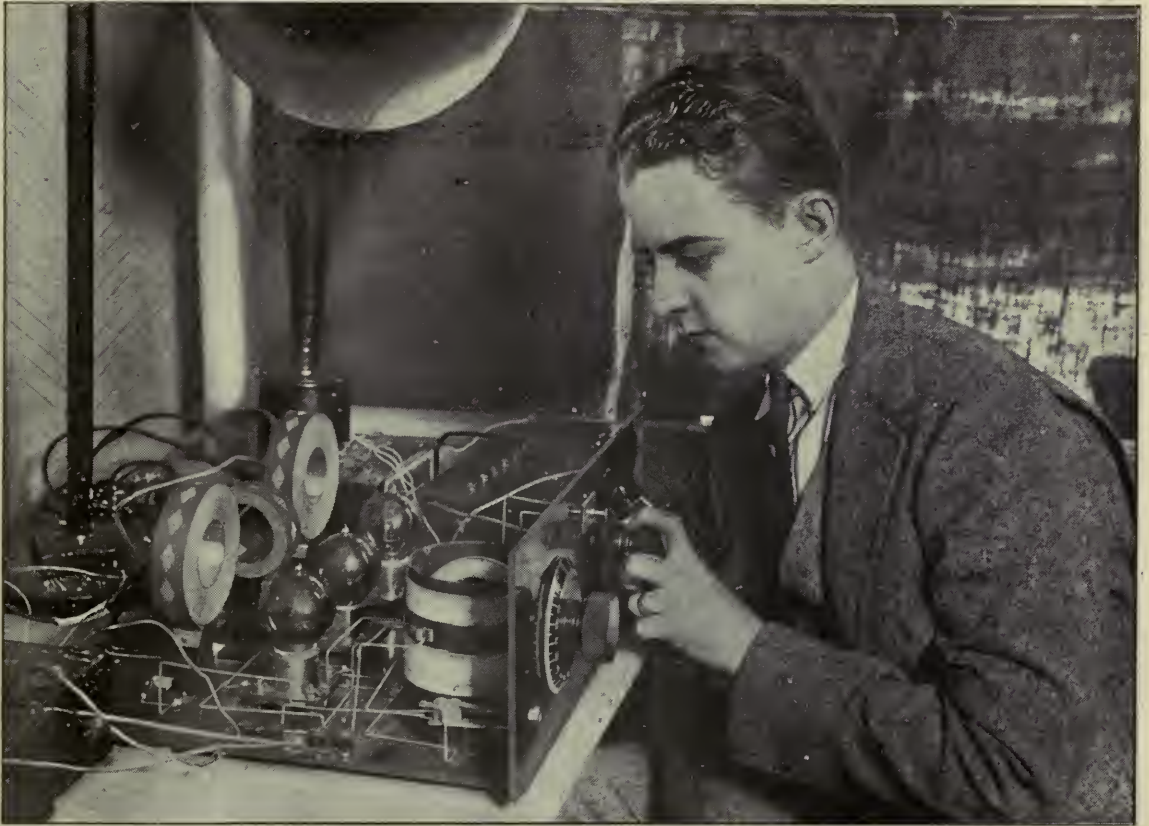

THE MOST CRITICAL OF CIRCUITS

Does not intimidate the American youth, and wrinkles he is responsible for sometimes find their way into the design of commercial equipment. This boy made the three-tube super-regenerative receiver he is operating

present the gift properly was to have it in operation on Christmas morning.

And further—does it not frequently happen that the ruler of the roost is somewhat keen about electrical toys himself and has a sneaking idea that he will get as much genuine fun from the gift as his son? How many nights does the receiving outfit, given a boy for Christmas, do extra duty for the “governor” after the boy has been tucked in bed or is doing his lessons! How many times has an anxious youngster had to stand patiently by, waiting for a chance to listen-in while the donor of the set listens to a concert under the guise of “adjusting it, so the boy won’t have any trouble with it!” Most of the boy’s trouble is getting near enough to the new wonder to become even casually acquainted with it. His joy of possession is sometimes reduced by having it too well “adjusted” for him.

So the day has come when the boys are no longer waiting for Saint Nick to bring them receiving sets to which their title is not entirely clear. They are making their own—and are doing a mighty fine job of it.

Among the articles made by boys in the

grammar and lower high-school grades and exhibited at many of the county fairs this year has been radio equipment of various sorts, and most of it compared favorably in design and workmanship with the devices offered for sale by the best manufacturers. The boys recognize a good design very quickly and lose no time in duplicating it, whereby they gain the large difference between the cost of their apparatus and the cost of commercial sets, to say nothing of considerable pleasure and knowledge.

A BOON TO MANUAL TRAINING CLASSES

IT IS doubtful whether a better practice could be established than having the manual training classes in our schools take up the building of radio sets, since this work offers opportunities for study and development otherwise impossible. The fact of the matter is, no work is hard that is interesting—nor does one learn much when the work is irksome. Many an idle period was spent in the school carpenter shop in days gone by when the class simply couldn’t work up a lot of enthusiasm over making a pair of book ends or a miniature table.



A BOY BUILT THIS OUTFIT FOR \$27.80

It is a three-circuit regenerative receiver with detector and two-stage amplifier and would cost between \$100 and \$130 if purchased ready-made

In a well-equipped school shop a boy may learn some very helpful facts about short cuts in several trades, if instruction in radio is adopted. For instance he learns about carpentry and cabinet-making and wood-staining and finishing by making the cabinet for his receiver. He learns something of wood turning by making the rotor balls for variometers or the wooden

learns much that will help him in later years—learns it thoroughly because he is interested, because he *wants* to learn.

Radio sets made by boys are usually anything but amateurish. As a rule, youngsters can discuss the reasons for and against a certain arrangement in the language indulged in only by engineers a few years ago, and the test of



AMERICAN BOYS IN THE PHILIPPINES

Are progressing very rapidly in acquiring real technique in home-made sets. They are handicapped somewhat by being so far from the source of supply and large broadcasting stations, but their work is already quite creditable

discs used for tuning-coil ends. He learns how to measure and lay out his work accurately when planning the receiver panel; he learns the proper way to use drills and taps and dies and how to work with brass, copper, nickel, slate, and bakelite. He learns how to use a soldering iron and a blow torch; how to make electrical machines from diagrams which would have been unintelligible to his father at the same age. He learns how to reason for himself by improving upon or altering a design to suit his particular purpose, or to reduce the cost of the material that he must have. By comparing the prices of parts and raw materials he secures a knowledge of comparative values never to be had from books. In short, he

their knowledge is seen in their work. The cabinet work is generally of a very good grade and boys show great patience in acquiring just the desired finish for their handiwork.

This interest is nation-wide and increases with the opening of every broadcasting station. Boys on the West Coast and in the South are busily engaged in making receivers to hear the broadcasting, and the programmes to be available this winter are the best in radio's rapidly moving career.

Some idea of the activity of boys in and around Chicago may be had from Mr. George P. Stone's article: "Radio Has Grippled Chicago" which appeared in the October issue of RADIO BROADCAST.



THE RIVAL OF ANY READY-MADE SET

Is found in this receiver, made by Donald Pierri, of New York. The cabinet is elegantly finished in dark mahogany. The bakelite panel is grained and engraved in a manner not excelled in the highest-priced receivers. The interior is shown below

The activity in New Jersey may be judged from the following paragraphs taken from *School and Society* for July 15, 1922:

"Several years ago radio sets were made in the manual arts departments in the schools of this state, but the boys' interest could not be sustained so long as only the dot-and-dash system of signals was available. Now the opportunity of hearing the actual voices, words, songs and music of the best kind has taken this project out of the more experimental stage and made practically every boy anxious to build and own a wireless set for his own use. Every effort has been made in schools throughout New Jersey to give boys a chance to design and build radio sets. The shop teachers have made a special study of radio construction; and boys have been given an opportunity to make various types of wireless sets. Schools have installed large radio sets. Montclair,

N. J., has erected over its high school an aerial that equals in size and construction those seen at broadcasting stations. A receiving set has been installed in the physics department, and at the last meeting of the Board of Education money was voted for the purchase of a sending set. Many of the high-school boys are licensed radio operators. In the manual arts department of the grammar schools of Montclair more than 600 wireless sets have been made.

"A report from Jersey City states that 655 radio sets have been built by upper-grade boys, while in the Hoboken high and junior high schools during this year 350 wireless sets have been made. The boys in the Bayonne public schools have made 249 sets, and it is reported that all of them are working.

"A great deal of attention has been given to the study of wireless in the public schools of

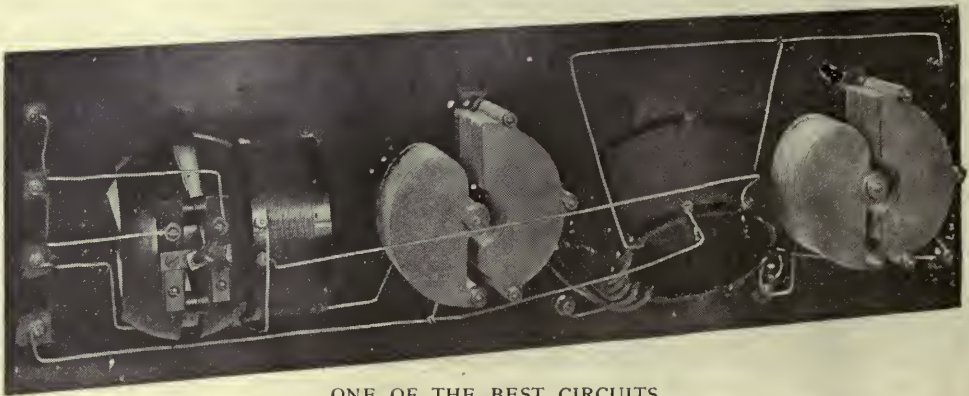

ONE OF THE BEST CIRCUITS

Has been incorporated in this receiver, which is home-made. This arrangement was completely described in RADIO BROADCAST for October, in an article entitled "Shielded Receivers"

East Orange. In the elementary schools 750 crystal sets have been constructed by boys taking shop work. The high-school boys have made 327 crystal receiving sets, 29 tube outfits with one and two stages of amplification, and one sending set is nearly completed.

"The city of Elizabeth was among the first places to encourage boys in building radio sets, and thus far, 251 sets have been made in the manual arts departments of the grammar schools. More than 100 sets have been made by the boys in the vocational schools.

"Interest in this project has been encouraged in places quite close to broadcasting stations, and in virtually all of the school-shops of the Newark public schools one may see boys working on wireless sets. More than 500 sets have been completed by the boys during their manual training period. Kearny and Nutley public schools have given their boys an opportunity to use the manual training departments for the construction of radio sets, and report that nearly 300 sets have been completed.

"Boys working on radio sets have not limited their time to school hours, but have

worked with their shop instructor after the close of the regular school day, and many of the instructors report that a great deal of work has been done after school hours. Boys are learning more through wireless about electrical circuits, batteries, the telephone and other phases of electricity, it is asserted, than text-books can ever hope to teach."

A more fitting tribute to Young America's interest in radio than this report could hardly be imagined. It means that the boys are learning a lot that is good for them and there is less time for



SANTA CLAUS TELLS A CHRISTMAS STORY

their minds to cultivate, or even pay attention to that which is bad—they are keeping pace with every improvement in the art and by reason of their knowledge are making it necessary for those manufacturers who can reasonably expect to stay in the business to supply nothing but the best equipment. The boys are providing entertainment for many a household. They deserve the encouragement of every dad in our land. It looks as if radio will solve, for thousands of parents this year, the problem of selecting Christmas gifts for their sons.

MANY AN OTHERWISE USEFUL CHRISTMAS GIFT
Has been damaged beyond redemption by an over-zealous dad



Simple Bulb Transmitters

By ZEH BOUCK

FOR low-power bulb sending sets, there are three simple and inexpensive methods of obtaining the required high voltage. They are, by using the "B" battery, the 110-volt electric lighting current—D.C., unrectified, or untransformed A.C. (alternating current)—and the spark coil system. Each of these systems is characterized by individual advantages and drawbacks, and the experimenter will do well to consider the possibilities of each, in order to determine which one of them is best adapted to his own requirements.

In the transmitting set described last month, "B" batteries were indicated as the source of high voltage, first, because their operation requires the least experience and experimentation, and secondly, because by their use the set may be operated as a radio telephone. This is not practicable with the lighting-circuit or spark-coil methods. "B" batteries are a source of constant current—there is no variation whatever—so that cumbersome chokes and condensers are not required to filter the current of ripples and similar fluctuations which invariably accompany generator and rectified systems. Furthermore, the advantages due to this smoothness of current are not confined to radio-telephone operation, but manifest themselves very noticeably in straight C.W. (continuous wave) transmission, where the clear flute-like note, identical to that of an arc station, is very easily copied. For low-power work, "B" batteries are fairly economical, and the average person can afford a 100 to 200 volt battery. However, when the potential runs over 200 volts, or when more than one tube is used, the drain on the cells is likely to exhaust them quickly. A plate current in excess of 15

milli-amperes (the average tube in receiving draws from 1 to 5) will rapidly deplete the battery, necessitating an expense of ten or fifteen dollars every few months. The most economical method of building up a high-voltage battery is to purchase standard flashlight batteries (the five and ten cent store variety is remarkably good!), connecting them with soldered connections in a rack. "B" batteries built up in this manner will often give double the service that would be obtained from a bank of block batteries, due to the fact that the exhausted units, with their resistance, can be removed. When the plate voltage shows a sudden drop of from 10 to 20 volts, the cells should be tested, and

This article continues the explanation of the action and construction of simple vacuum-tube transmitters which was begun in RADIO BROADCAST last month. There are several methods by which you can make an effective short-range outfit without a great deal of expense.

Various types of bulb transmitters operated from a lamp socket—replacing the "A" and "B" batteries by the ordinary house lighting current—will be described next month.—THE EDITORS.

the faulty ones eliminated.

If the amateur is fortunate enough to be supplied with 110 volts D.C., he may substitute this for the dry cells. This power supply, for purposes of bulb transmission, is practically without limit, and three or four tubes may be efficiently operated in parallel, and, although for transmitting tubes 110 volts are inadequate, five or ten miles can thus be covered. However, the use of lighting current (this also applies to untransformed A.C.) almost always limits the experimenter to an inductively-coupled transmitter (one wherein the oscillating power is transferred by induction from a closed circuit to a coil in series with the antenna and ground). There must be no metallic connection between the ground and the power supply, as one side of the electric light circuit is grounded. Such a chance connection would possibly result in a short, or complicate the circuit to such an extent as to render it inoperative. Also, the 110 D.C., when used for speech (radio telephone), requires a filter system, which, though not difficult to install, makes this source of power

less simple than the battery. Straight C.W., transmitted with D.C. on the plate, regardless of the source, can be received only on a set equipped for the reception of undamped waves. The signals cannot be copied on a conventional crystal set.

A.C., untransformed and unrectified, is the next consideration. This system supplies an adequate potential for low-power C.W. transmission, in which case it is almost as efficient as direct current. However, as it is interrupted from 40 to 120 times a second, it cannot be used in transmitting speech. It possesses an advantage over the previous systems, in that its wave is interrupted by the spark-coil vibrator, and it may be copied on non-oscillating and crystal detectors. The note is generally very low and consequently rather difficult and unpleasant to read. It may be improved, however, by including a chopper (a commutator wheel that interrupts the grid circuit many times a second) which breaks up the sixty-cycle throb into a higher and more agreeable note.

The output of a small spark-coil operated by a 6-volt storage battery, furnishes a fairly efficient source of semi-direct current for the plate of a single tube, and transmission in excess of fifty miles has been achieved with such sets. The great difficulty lies in reducing the secondary voltage below the point where the tube would be injured due to the breaking down of the insulation, and in drawing sufficient current from such a high potential, low power

source. The best results with this type of transmitter have been secured by rewinding the spark-coil secondary to the desired voltage.

YOUR RECEIVING SET AS A RADIO TELEPHONE

THE conventional regenerative receiver is capable, when oscillating, of setting up wireless waves. In this respect it is a "B" battery bulb set, and by a few simple alterations, it can be converted into an efficient combined transmitter and receiver. To accomplish this, the following accessories should be obtained:

One amplifying tube that functions well as a detector.

Two porcelain-base rheostats.

One double-pole, double-throw switch.

One microphone.

One key (if continuous wave telegraphy is to be employed) preferably of the land-line variety with a closing switch.

It would be clumsy to shift tubes or throw a switch for sending and receiving, and the experimenter is advised to procure a single audion to serve both purposes. Many amplifying tubes, particularly the A.P. and Western Electric J tubes, are satisfactory.

Fig. 1 indicates how the extra apparatus is connected with the receiving set. The change from sending to receiving is effected by the switch AB. When the switch is in the receiving position, side B, rheostat R₁ is varied in conjunction with the standard panel rheostat

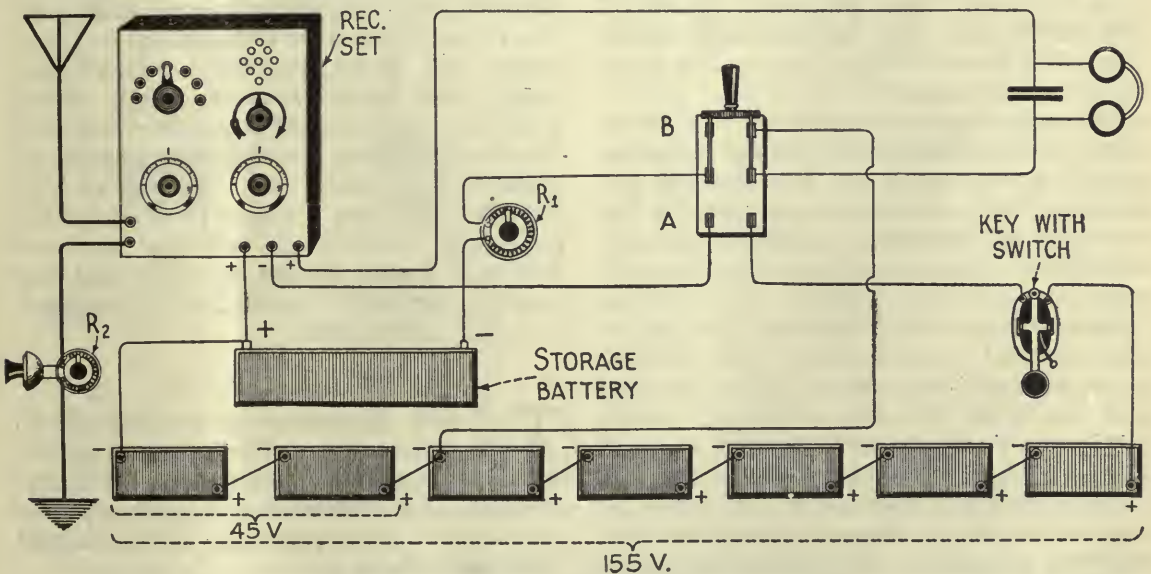

FIG. 1

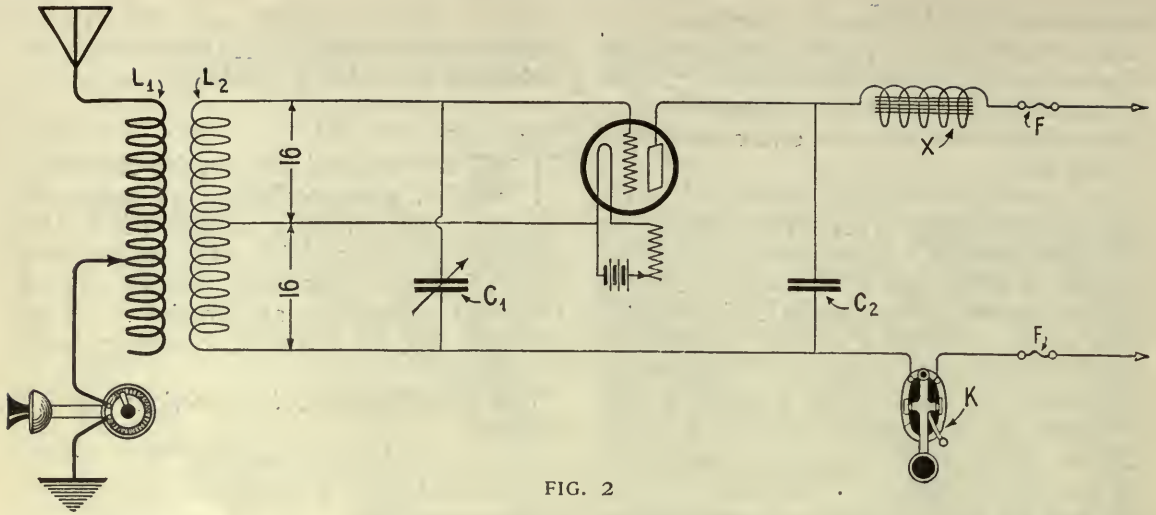

FIG. 2

until the amount of resistance in R_1 is just enough to stop oscillations, i.e., if the resistance were short-circuited, the set would oscillate. The switch in this position also throws the normal receiving plate voltage of 45 volts in series with the telephone receivers. (Amplifying tubes detect best at about this potential.) The microphone and rheostat R_2 in the ground lead will have no effect on incoming signals.

As the switch is thrown up to position A, the extra resistance in R_1 is shorted, which, brightening the filament, as before explained, causes the set to oscillate. This position also throws in the complement of "B" batteries—from 100 to 200 volts. The phones are always in the circuit, where they occasion but a negligible potential drop. They indicate the quality of modulation, and show that the set is oscillating, while in some circuits they act as a necessary choke or reactance.

For preliminary tuning, the switch is thrown up to the transmitting position, and the microphone short-circuited by the rheostat R_2 . Rheostat R_1 is likewise cut out, and the filament adjusted altogether by the panel rheostat. By tickler or variometer variation, the set is made to oscillate powerfully. Speaking into the microphone, the resistance of R_2 is gradually admitted into the ground lead until the voice, as heard in the phones, is loud, yet clear and free from distortion or breaks. Switch AB is then thrown down to the receiving position where it is probable that the set will continue to oscillate. Rheostat R_1 is now brought into action, and the filament reduced until the circuit is quiescent. The knack of tuning the combined adjustments for transmitting and

receiving on any wave will be acquired with a little practice.

A set of this type will necessarily send and receive on the same wave, and for this reason, during communication between two such stations, tuning is greatly facilitated. If one station shifts wave in an endeavor to avoid interference, the second station, in following the frequency variation, will shift his own wave, getting under or above the same interfering signal. In this manner, the station that is experiencing the interference selects the wave on which transmission is clear!

If a continuous wave is used, the key may be inserted in series with the "B" battery as indicated in Fig. 1. The key, of course, must be shorted when voice transmission is employed. The range of such a set is dependent on many factors, but, under favorable conditions, and using a well located antenna, a mile or two should be easily covered using the voice, and considerably greater distances may be expected when the key is employed. As with all bulb sets, the C.W. range is several times that of the radiophone, owing to the fact that the wave itself is of a more efficient character, and that a certain amount of amplification is secured in its autodyned reception.

A SIMPLE 110-VOLT SET

THE split filament circuit recommends itself to the beginner through its simplicity and reliable operation. Adjustments and parts are minimized, and the set will oscillate powerfully on low plate potentials without a grid condenser or leak.

This circuit is indicated in Fig. 2, showing a

radiophone transmitter operated from 110-volt direct lighting current. Both inductances may be wound with any convenient insulated wire from 18 to 24, superior results possibly being secured with the larger size. L_1 and L_2 are best wound separately on tubes of different size, so that L_2 will fit inside the larger coil in the manner of a loose-coupler. However, if desired the coils may be wound alongside each other on a common $3\frac{1}{2}$ -inch tube. L_1 has 12 turns of wire, and L_2 has 32 turns with a single tap taken at the centre. If L_1 is wound on a separate tube fitting over the other winding, its turns should be reduced to 10. Two tuning elements are indicated in Fig 2: the variable capacity C_1 , a 43-plate condenser, and a variable primary inductance, which may be tapped every other turn if it is desired to shift wave. C_2 is a large by-pass and filter condenser from two microfarads up. The conventional mica-foil condenser of this capacity is rather expensive, and it is suggested that the experimenter obtain one of the electrolytic type which, in cents per micro-farad, is much cheaper. Reactance X is a necessary part of the filter system, and may be wound of 2 lbs of No. 30 insulated wire on a core with a cross-section of one square inch built up of iron wire or strip. F and F are fuses of any convenient current capacity from 1 to 5 amperes, and should be invariably included on the power side of *all* instruments whenever the lighting current is employed for experimental purposes. Such fuse blocks are easily made by stretching the fuse wire, or $\frac{1}{8}$ inch strips of tinfoil, between terminals on a small wooden

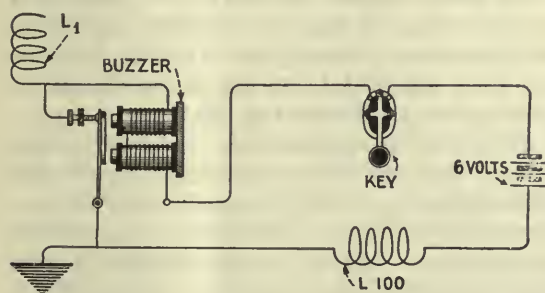

FIG. 3

slab. While it is not necessary, with so low an amperage, to cover the block with a sheet of mica, it is a practice compatible with caution, a habit, in all electrical work, well worth cultivating.

Modulation, in Fig. 2, is effected by the system employed in the combined transmitter-

receiver, and it is adjusted in the manner there described, listening-in on either a wavemeter or the receiving set.

If it is desired to use only continuous-wave telegraphy, the circuit in Fig. 2 can be further simplified by substituting a bell or telephone receiver bobbin for the choke coil X , and a thirty-five cent telephone condenser for C_2 . In any case it is essential that the positive side of the line lead to the plate. It is therefore necessary to determine polarity; and the simplest method is by "feeling" for positive. This is accomplished by grounding one hand on a steam or water pipe and touching, singly, the two electric light wires with the free hand. As the negative side is grounded, a shock will be felt when the positive is touched. This method of determining polarity is neither painful nor dangerous under three hundred volts, if the precaution is first taken to dry the fingers thoroughly. However, the more timorous may resort to the water test. If two electric light wires, carefully separated, are immersed in a tumbler of water in which a *few* grains of salt have been dissolved, the liquid will be decomposed, i.e., broken up into its component parts hydrogen and oxygen. These gases will escape, rising in bubbles to the surface about the wires, hydrogen from the negative wire, and oxygen from the positive. But water, H_2O , contains twice as much of hydrogen as of the other gas; thus there will be twice as many bubbles about the negative pole, easily identifying it from the positive.

A NON-TRANSFORMED A.C. CONTINUOUS-WAVE CIRCUIT

AGAIN referring to Fig. 2, with the simplifications suggested for use as a C.W. set, (choke X , a bell bobbin, and C_2 a small telephone condenser), 110 volts A.C. may be substituted for the direct current, and the set will function as a sixty-cycle, unrectified bulb transmitter. Voice transmission of course is impossible, due to the interrupted current, thus eliminating the microphone and shunting the rheostat. In the A.C. set (and in the direct current apparatus also, when continuous wave is used) the filament may be lighted by a small toy step-down transformer, with the secondary shunted by a spark-coil vibrator condenser.

In any one of the three foregoing sets, "buzzer modulation" may be effected. This consists of breaking up the continuous wave into rapidly consecutive wave-trains, giving a

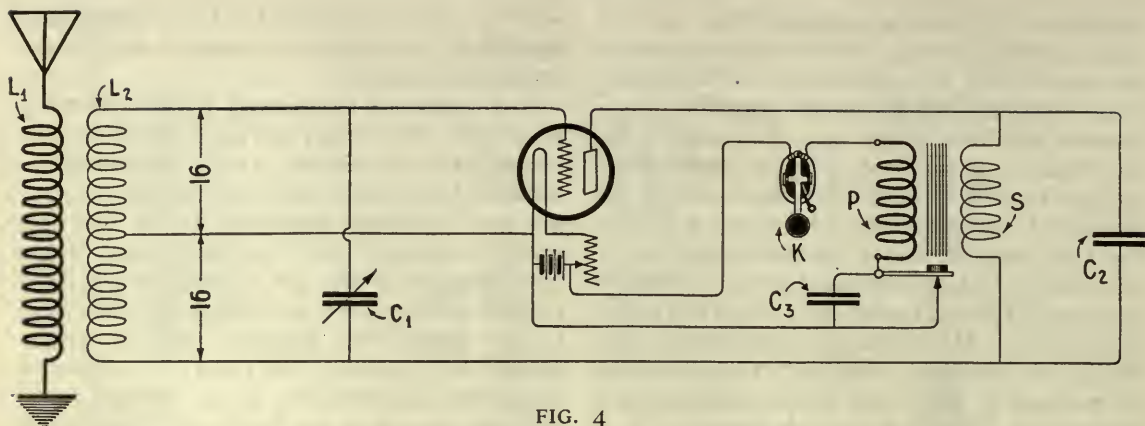

FIG. 4

pleasing high-pitched note that is audible on crystal and non-oscillating detectors. With the A.C. equipment, the buzzer, in effect, is the same as the chopper mentioned above. The connections of the buzzer vibrator in the ground lead are indicated in Fig. 3. L_{100} is a honeycomb coil of that size, which, in conjunction with the buzzer coils, acts as a high-frequency choke, preventing the passage of current through them to the ground when the vibrator breaks the direct circuit. The battery is conveniently three dry cells, but in any case, separate from the filament lighting source.

A SPARK-COIL BULB SET

THE output of a spark-coil is a semi-direct current. Strictly speaking, it alternates, but the alternations are many times more powerful in one direction than in the other, owing to the fact that the magnetic field collapses as the vibrator breaks the circuit, much more rapidly than it is built up.

Fig. 4 shows the circuit with which we are already familiar, employing this source of high potential. The induction coil is a $\frac{1}{2}$ -inch to $\frac{3}{4}$ -inch affair, such as is sold by radio dealers for spark transmission. A Ford coil cannot be used unless the common terminal to the primary and secondary is broken. A comparatively low note, which is more pleasing than a high pitch and carries very much farther, may be obtained by fastening a small piece of solder to the vibrator.

C_2 is a by-pass condenser of sufficient capacity, .01 micro-farad at least, to lower the potential to a voltage that will not injure the tube. The condenser must be of mica or glass plates in order to stand the high voltage. A satisfactory capacitance may be built up of

30 sheets of 4 x 6 inch tinfoil separated by 5 x 7 inch photographic plates.

The bulb for spark-coil C.W. should be a transmitting tube or an extraordinarily hard amplifier. With the exception of this, and the condenser C_2 , the values for this set are identical with those of Fig. 2.

If, after experimentation, the transmitter is inoperative, it is probably because sufficient current cannot be drawn from the spark-coil. To rectify this, the secondary must be rewound with No. 34 or No. 36 insulated wire, to approximately 100 times the number of turns in the primary. In the case of a half-inch coil, this will amount to about 17,500 turns. With the special secondary, C_2 may be of much less massive construction, 30 layers of 2 x 3 inch tinfoil, separated by mica, working very well.

As before stated, the output of the coil is semi-direct, so it may be necessary to reverse the secondary connections in order that the plate be supplied from the terminal that is positive the greater part of the time.

In tuning the various sets covered in this article, it is advisable to procure a radiation milli-ammeter, which, in series with the antenna, will indicate when the best adjustments are secured. In some cases, particularly with the spark-coil C.W., a small two-volt flashlight bulb may show resonance when substituted for the meter. In the absence of either indicating device, transmitting conditions can be fairly accurately determined by listening in on an adjacent wavemeter or receiving set. With the spark-coil transmitter, a smooth hum will be heard when it is radiating, in contrast to the rough, scratching note if the set is not oscillating.

O Woe! Radio

By ALICE R. BOURKE

Drawings by STUART HAY

ON THE 27th day of April in the current year, no bells spilled their joyous peals into the calm morning air. No cessation from business had been declared, no cannons succeeded in having themselves shot off, and there was no unusual prodigality in the city display of the national emblem.

Yet, despite the fact that none of these evidences of general rejoicing flaunted themselves to the eyes and ears of the populace, it was My Birthday, and it marked the end of that happy period when we had a Home, and when the only tobacco ashes I was obliged to sweep from the roof of the piano belonged to the Boss. (I put that last line in because he may see this article some time. Of course I am the boss, but it shows a nice disposition on my part, and incidentally it is handy in many ways to let him think he is the Great Voice around this radio-devastated remainder of What Was.)

As I said, it was my birthday, and on that roseate morn, if I had been asked, I could not have stated authoritatively whether trouble was spelled with one or two I's, so slight was my acquaintance with it. But be patient, there are more words to follow.

At breakfast, my Irishman told me my birthday gift was to be a radiophone, and during the forenoon the radio man and his assistants came. They had a heavy forty-foot mast with them, and immediately commenced adapting the landscape scheme of the far corner of my garden to their pedal extremities and the pole. They assured me that a good antenna was of the utmost importance.

Now do not throw the magazine away until

you get your money's worth. I certify upon my honor that this is *not* a technical article.

When school was out at noon, all the dear little boys and girls in the vicinity curtailed their gastronomic endeavors so they could hurry back to give their advice to the radio man and finish the decapitation of those tulips which the workmen had accidentally missed.

When my husband came home to dinner I was waiting in my pink organdie and new white pumps. With my very own hands I coaxed from the rubber-bunioned, carbolic-scented mahogany box the facts that Liberty bonds were going strong, and that it would be cooler tomorrow with variable winds.

We did not Fletcherize our dinner that evening. We impatiently awaited the

eight o'clock concert. It was not to be. The thoughtful little people who had paid our horticultural exhibit the noontime visit had a rather neat little broadcasting system of their own.

At five minutes to eight, the Jones and Smith families presented themselves in complete editions on our front porch. It was quite a coincidence that both Mrs. Smith and Mrs. Jones had believed I might like a little fresh lettuce!

Their remembrances made me very happy, but piqued my curiosity, inasmuch as we have such a large lettuce bed ourselves. Ah! How young I was then!

By eight-thirty a passerby would have thought the Bourkes were holding a mass-meeting.

The eldest Smith boy attends high school and knows all about radio. His father is very proud of him, and he kindly decided, in his

We have here a cry of despair, a burst of laughter, a tragic comedy and a sly, sound estimate of human character, all rolled into one. "O Woe! Radio" presents as accurate and entertaining a picture of the effects of radio in the home as we have seen. In thousands of homes is surely found an echo of the excitement and discouragement, the complications and absurdities which visit the Bourke household—that "radio-devastated remainder of What Was." Is the author describing your predicament, too, when she says: "The neighbors are still rooting for the K. of C. war slogan, 'Everybody Welcome. Everything Free.' We have been nominated and elected unanimately. Having heard, they want more. I can set my Ingersoll for five to eight by their nightly arrival"—THE EDITORS.



"THEY HAD A HEAVY FORTY-FOOT MAST WITH THEM

And immediately commenced adapting the landscape scheme of the far corner of my garden to their pedal extremities and the pole. They assured me that a good antenna was of the utmost importance"

positive way, that Gordy would run the set tonight, because he just knew I felt strange with it yet.

We had two head-sets, and a well-developed sense of hospitality, so my husband and I did not hear any of the concert; but we at least had the fun of turning off the current after they all went home at twelve-thirty. Gordy was not interested in the unimportant details of radio operation.

The night of the 28th John dropped into the Elks Club (to get some matches) and he spread the glad tidings that we had a great little radio set, and that the wife was a clever kid the way she could switch the kazazzies around and produce entertainment.

Those fatal words!

John has oodles of friends, and we know several nice obliging gentlemen of the medical profession, but honest, our private stock didn't last ten days.

I wouldn't mind if they would only come, hear, sample, depart, and allow sufficient time for pleasant memories to take root. But they do not. No repeater in the First Ward does his duty so nobly nor so often as do John's playful club fellows. They are all doing their durndest for Society, too. Married. Householders. And they *always* bring the Mrs. and the entire collection of descendants.

The wife invariably hails from some small town. After scrupulously coating her nose with my powder (\$2.75 per box, war tax extra), she will smile her killingest and say: "Oh, Mrs. Bourke, *do* get Oshkosh for me. Mama writes that the *Daily Prevaricator* puts on a program every night!" ...

The sweet little darlings want to know what makes the storage battery store, and what do them things do when you twist 'em around, and can't they play with it for a while now? Most of them cry because they cannot call their Uncle Tobias up over it.

We always have our fingers crossed that they will go home after the first concert, but do they? Nay, not so. They stay until everything is over, then make a feeble pretext of leaving.

Oh, no, we couldn't dream of troubling dear Mrs. B—— further, could we, Henry? But they are sure to make the weather and their appendicitis operations last while I hustle the coffee, dilute tomorrow's breakfast cream so there will be enough to go around, and develop writer's cramp slicing bread for sandwiches.

Each departing guest uses the same original conversational sally: "My, but it must be fun for you two, with nothing to do but listen to the radiophone every night!"

That calm, light-hearted statement sears my soul as I bathe and massage the dishes which have been bequeathed to me as part of my share of the evening festivities.

We are the most popular couple for miles around. Everybody loves us. My husband is a philanthropist. He gave me a birthday present with unguessed coöperative possibilities. It has become an item of common ownership, like a Carnegie Library, or gossip.

The neighbors are still rooting for the K. of C. war slogan, "Everybody Welcome. Everything Free." We have been nominated and elected unanimously. Having heard, they want more. I can set my Ingersoll for five to eight by their nightly arrival.

One man in particular is the joy of my young life. If the Nobel prize is ever awarded for persistency, I shall burn up the wires entering his cognomen. He never misses a night. He generally greets me with: "Say, last night you told me so and so, and tonight the *News* says"—and I know I am in for another Star Chamber session, my tongue and intellectual content not having properly coördinated the preceding evening. I've tried a million odd times to justify my manipulation of the set during atmospheric disturbances, and have spoken to him so learnedly about "static" that a college professor would hang his head in shame, but does this doubting Thomas believe? His eyes say what his lips yearn to: "You can't fool me. You gotta bum set, and don't know how to work it!"

Do not, I pray you, labor under the delusion that only my evenings are devoted to Public Service. Far from it.

In the morning, just about the time I am beginning to wonder how in the name of Heaven John *can* poke such big holes in his socks, the door-bell rings, and one of my fellow Household Slaves enters. The *Jacksonville Bazaar* has inaugurated a woman's hour from nine to ten. Would I please, etc.?

I accommodate, but the ether does not. She goes home possessed of two eggs, a cup of my butter, and the belief that I wouldn't let her hear Jacksonville because I did not want to be bothered with her.

One of the ladies nearby has intimated to me that she would like her son Wallie to have a key to my *ménage*. She thinks it would be nice if

Wallie could come in, very quietly, of course, after 2 A. M. on Saturdays and Sundays and listen in, as she understands that this is the best time for amateurs to learn the code.

Station KYW punctuates its musical programmes with news bulletins.

Last week John bet \$50.00 on the outcome of the Michigan City fight. Naturally, he was interested in his half century. During the news service, the head-set was occupied by a little bride of the neighborhood. When the announcements were over the bride said to her husband: "Oh, Lovey, there was a nasty prize-fight somewhere, and one man beat another. Isn't that terrible?"

Of course she could not remember the name of the brute who won, so John had to wait for the morning paper to learn that he would see his fifty dollars nevermore.

We are about desperate for a chance at the thing ourselves.

All last week, at all the nightly séances, we religiously spread the news that we were to bestow the favor of our presence upon a Saturday night presentation of dramatic art. In reality, we intended staying home in a darkened house and gorging ourselves on what made Westinghouse famous.

However, I was not to hear the golden voice proclaim that KYW is located on the Edison Building, Chicago. Thursday another popular neighbor borrowed our radio battery-charger in an attempt to recharge the battery of his family chariot. He then went away on a week-end motor trip, carefully locking our charger in his house so the naughty burglars could not get it.

JOHN HAD BET \$50 ON THE MICHIGAN CITY FIGHT

When the news announcements were over, the bride who had monopolized the phones, cried out, "Oh, there was a nasty prize fight somewhere, and one man beat another." Of course she could not remember the name of the brute who won and John had to wait for the morning paper to learn that he would see his half century nevermore



There was nary a kick left in our battery by Saturday and even front row seats, with lobster salad and cream puffs after the show, could not take the edge off my disappointment.

I see red when I read the newspaper inquiries of my fellow townsmen as to how they can tune KYW out and Detroit in. If I could only hear the music from KYW I would die with a sweet smile on my lips.

The only time our guests ask *me* to listen in is when the Sunday sermon is on or when the set gets out of focus and they want it readjusted for their shell-like ears.

We have thought some of purchasing a loud speaker but cannot do so for the present: John's employer will not hear of another increase in salary. Without the increase we cannot afford to have the foundation of our house strengthened, and until it is strengthened we are simply courting disaster by doing any-

thing to increase the nightly load our floors bear at present.

Now, please do not get the idea into your heads that John and I are disappointed in our radiophone or do not like it. We do. We are crazy about it. In fact, if we knew of any one who owned one, we would go over to his house every night to get a chance to hear the music.

They are like flivvers, nice when someone else owns them.

I'll tell you something else, too.

If you have some person in mind who has beaten you in a business deal or wagged a wicked tongue at your expense, waste no more time deciding between cyanide in his drinking water, or squealing about him to the prohibition agent.

Just buy him a radiophone for a present. Then tell his friends.

Where Radio is Helping the Phonograph Business

By W. T. WHITEHEAD

THERE is a general belief existing among those who do not know, that the advent of radio, with its broadcasted entertainments from many stations, is working to the detriment of the phonograph and record business in those parts of the country where the amateur receiving outfits are numerous. One section of the country which is not being hurt, but helped, is the Hudson River valley in New York State. This district is fairly well supplied with receiving outfits. It is mainly an agricultural district, and there are few farms which have not aerials of one kind or another on top of the barns, silos, or other buildings. The Newburgh *Daily News*, which maintains broadcasting station WCAB in the centre of this district, sends out concerts, farm talks, and lectures three times daily.

Now, phonograph selections are one of the features of the WCAB concerts. Wishing information as to the report that radio was reducing phonograph and record sales, the writer sought out the manager of a musical instrument store in Newburgh. He was told: "There isn't a thing to it. In fact, just the

reverse is true. Since a broadcasting station has been located in Newburgh, our record business has increased 45 per cent. while our phonograph business has jumped 50 per cent. We have customers come to our store every once in a while to ask for a number 'that was broadcasted from Newark, N. J., Pittsburgh, Pa., Schenectady, N. Y., or Newburgh, N. Y., the other night.' We keep files of the concert programmes of all the concert broadcasting stations. We go over these with the patrons, and invariably find what they are trying to ask for.

"Yes, this radio broadcasting has stimulated the record and phonograph business wonderfully. Any dealer will tell you that August is the dull month of the year in the phonograph business. But August, 1922, was by far the biggest summer month we have had in our seven years of existence. I believe this same condition is true all over the United States. We find that it pays us to keep tabs on every antenna that goes up. In this manner we know just where to send our outside salesmen. The phonograph business and the radio business seem to be going hand in hand."

Poor Fish!

Six Hundred Thousand of Them a Day Make a Tidy Haul, When Radio, Applied to the Menhaden Industry, Saves Time and Money and Helps to Make the Corn and Cattle Grow

By EVERETT EWING

WHAT are menhaden? This appears as the last of fifty stickers proposed by Thomas A. Edison in his recent questionnaire.

While the answer that is forthcoming may not be exactly what Mr. Edison expects, it is not inappropriate: Menhaden are the original "poor fish."

The term fits menhaden better to-day, with the application of radio to the menhaden fishing industry, than ever before.

This year, fishing vessels operating on the Atlantic coast from Maine to Florida are being equipped with radio. Radio might have come sooner to the menhaden industry but for the war, which halted the application of radio to private commercial enterprises. But now that radio has made a visit to this industry, it has been found "necessary" (so quickly do accompanying developments make anything that saves time or labor indispensable), and has been prevailed upon to stay. It is a time saver, a

money saver, and perhaps a saver of vessels and of men's lives.

The C. E. Davis Packing Company, manufacturers of fish fertilizers, fish meal, and fish oil, started the ball rolling by erecting a station at its plant at Fleeton, Va., and installing radio equipment on three of its fishing vessels. Part of last season this company directed its vessels from the company's $\frac{1}{2}$ -kw. station at Fairport, Va., the location of the rendering plant, near the company's offices. Enough was learned by the experiment to demonstrate the value of radio, and when the last season started, early in June, other fertilizer, meal, and oil industries were equipping their boats with radio.

"We have two Navy standard Emil Simon $\frac{1}{2}$ -kw. sets on the *East Hampton* and the *G. S. Allyn*," said Mr. Slaughter, general manager and chief engineer of the Davis Company. "On the *M. M. Davis* we have a $\frac{3}{16}$ -kw. Cutting & Washington transmitter, and receivers specially built to meet our requirements are on all three boats.



MENHADEN RUN IN SCHOOLS

Hordes of them—hundreds of thousands to a school!

"There has been no trouble working our steamers five times each day while they are between Cape May, N. J., and in False Cape, Va., and we have been successful working them between Sandy Hook and Boddie Island. Sometimes, when the big stations at Cape May and Norfolk are sending, it is hard to get our traffic through when our boats are beyond Cape May or False Cape.

"Our captains say," Mr. Slaughter continued, "that radio is worth what it costs to install and keep up, just to get the weather reports and storm warnings. Before we installed radio equipment, our steamers would run for hours to get to a harbor to spend the night. Now they get the weather report and stay at sea if the report is satisfactory. If it is bad, they get into a good harbor.

"Between 8 and 9 A. M. we give the steamers a report on the catch of the entire fleet, and state where catches were made on the day before. We usually get this to them by the time they reach the Virginia Capes. If the fish were caught on the 'south beach' or the 'north beach,' as our fishermen call the coast north or south of the Capes, they make a straight line for the place of the last catch. Then, as the steamers spread out looking for the schools, the first to sight the fish notifies the others. Usually it is only a few hours before our steamers are fishing.

"Between 5 and 6 P. M. steamers notify us of their catch and whether or not they will be in that night. They also state about the hour that they will arrive, so that we can be ready for them. If they are not coming in, we can save considerable fuel which would otherwise be wasted, because we can bank our fires. Formerly, we had to keep them going, as the plant had to be ready all the time. In the event of machinery trouble or a torn net we are advised as soon as the trouble occurs and we get busy and have new parts ready when the steamer gets in; that is another big saving."

The Fairport station works with its ships on 600 meters. Not only does it keep the plants of the Davis and other companies which operate in the Chesapeake Bay section in touch with their fleets at sea, but it assists communication between the air stations at Langley Field and the Hampton Roads naval base, and aircraft operating out of those stations on flights up the bay. Although the planes are equipped with radio, there are times when they are unable to get through

without being relayed. So, in a measure, the menhaden industry is repaying the naval flyers for favors done by them during the last two years.

For a "poor fish," the menhaden is a valuable animal. There are millions of dollars invested in the industry in which the menhaden is "raw material." Spread out along the Atlantic seaboard, back in the bays and up the rivers, are immense plants which cook, grind, and otherwise treat the fish, producing nitrogen, one of the most important fertilizer elements, yielding a fish oil that has many uses, and providing a fish meal that is steadily growing in favor in the United States as a cattle and livestock food.

There are nearly sixty fish oil and fertilizer plants scattered along the Atlantic and Gulf coasts. North Carolina has eighteen of them; Virginia, seventeen, centred in the lower Chesapeake, with seven at Reedville alone. In the North, Massachusetts has one active plant; Connecticut, two; Long Island, two; New Jersey, four, and Delaware, four. Farther south, South Carolina has one; Georgia, one; Florida, three, and Texas, three.

More than 5,500 men are employed, and about 150 vessels. During the war a large number of these vessels were used in European waters as mine-layers, and some of them, prior to their return to industrial pursuit, as mine-sweepers. The men who make up the crews of these steamers are, for the most part, skilled seamen, and during the war their hardiness and seamanship proved of great value.

The capital invested in thirty-four of the Atlantic Coast plants is approximately \$13,000,000. The annual value of the product of these thirty-four plants is about \$11,000,000. The menhaden industry is about seventy years old, but no considerable development in it has occurred until recently. With the application of radio, menhaden fishing is due for a rapid growth during the next few years.

The discovery that a rich stock food, the fish meal, was a valuable by-product, is comparatively new. The use of fish meal in feeding and fattening livestock permits thousands of acres that have been used for growing cattle provender, and for grazing purposes, to be turned over to the production of food for the human family!

The fish oil is an important commodity of varied uses, and new uses for it are constantly being found. Today it enters into the manu-

without necessitating the purchase of any additional receiving equipment. Such a receiver is now in operation in our office. The crowd around the automobile in the accompanying photographs are listening to the results of the World's Series baseball game. There is no antenna, no loop, nothing but a ground wire fastened to a fire hydrant. The speech could be heard a block away.

During the course of the baseball game someone happened to step on the wire connected to the fire hydrant and it came off, but the speech continued to come in and the crowd was none the wiser.

This led to the conclusion that no connections were necessary, and the next day a radio-equipped coupé was traveling around the city with a loud speaker, telling passers-by of the plays as they occurred.

We saw another receiving set mounted on a large truck used to tell the crowds of the progress of the games. But, though the latter outfit consisted of a loop aerial four feet in diameter, and a receiver employing seven vacuum tubes for radio-frequency amplification, detection, and audio amplification and a Western Electric power amplifier and loud speaker, the speech was not given to the crowd directly. An operator wore ear phones, heard the announcements, and then repeated them into a microphone attached to the loud speaker for the benefit of the crowd. Using no aerial at all and within twenty feet of this van, Mr. Wagner used a detector and two stages of audio-frequency amplification for producing speech from a Western Electric loud speaker which could be heard more than a block away and there was no need for repeating the announcements.

As a general rule, Mr. Wagner employs a detector and two-stage audio-frequency amplifier for operating a loud speaker, and a single



THERE ARE TWO RECEIVERS

The upper one is used with a detector and two stages of audio-frequency amplification for receiving, with nothing more than a ground connection. The lower set includes three stages of radio-frequency amplification in addition and is used for either ground or loop receiving

tube for telephone operation. Some of the stations he hears include:

STATIONS	MILES FROM N. Y.
WIT—Philadelphia, Pa.	100
KYW—Chicago, Ill.	750
WGU—Chicago, Ill.	750
KSD—St. Louis, Mo.	935
WOC—Davenport, Iowa	900
WHAS—Louisville, Ky.	675
WSB—Atlanta, Ga.	800
WBZ—Springfield, Mass.	235
KDKA—Pittsburgh, Pa.	325
WWJ—Detroit, Mich.	500
WFI—Philadelphia, Pa.	100
NOF—Anacostia, D. C.	210
WGY—Schenectady, N. Y.	150
WHAZ—Troy, N. Y.	125
Shepard Stores, Boston, Mass.	200

6,755

From the Log of a Radio Man

Many a ship operator's log book is born to blush unseen, yet often the hastily jotted notes could reveal graphic and thrilling pictures of life at sea. This excerpt from a radio log written two summers ago appears to you, except for the changing of names and places, just as it stood originally.—THE EDITORS.

SHE WAS a small cargo vessel, and left Halifax in July, 1920. The first part of the voyage was made without special comment in the log, but on July 24th we find the following entries:

8:50 p.m. The engines were stopped and I tho't some minor repairs were necessary. Listening to several ships working when the Captain came into the wireless office with a strained look on his face, saying "You're in for it now."

Taking a pad he wrote the following:—

"SOS—SS *Verance* with broken propeller shaft in Lat. 4250 N. Long. 3326 W. 225 miles N 25 W true from Delgada Head."

8:57 p.m. Cleared air—broadcasted distress call on 600 meters, full power, main set. Confusion reigned supreme, several ships answering at same time.

Finally, arrangements were made for the *Wilca*, another vessel of the same line, to tow the *Verance* to the Azores. The *Wilca* arrived about daylight and by 10:40 a.m. the disabled vessel was taken in tow.

For July 25th, we read:

10:00 p.m. No sleep for 44 hours. Have arranged with oprs on SS *Wilca* to answer calls for me, and if they or any one else wants me badly to communicate by blinker light to our bridge.

1:40 a.m. Bridge called me to ans *Wilca* on Radio. *Wilca* said they did not signal us.

2:00 a.m. Back to sleep.

On July 29th, the following entry is made:

7:50 a.m. I must say right here that the operator on the *Wilca* is so poor he can hardly send, and I never worked harder in my life copying than this past 50 minutes. One thing the communication service should impart to the new men is that when the Captain gives them something to send, they should use his wording and stick to it, and not try and send fast, as they sure will make a fizzle of it. My trouble this morning was that

the *Wilca's* Capt. would give his opr something to send to me and the kid would bat it out like fire, never stopping to make a perfect letter. Consequently I asked him to repeat, as I did not want to make any bulls. When he repeated he changed the entire wording of the message. This is not only out of order but very unbusinesslike.

12:15 p.m. Arrived Ponta Delgada.

Aug. 9th. Orders rec'd that we are to be towed to Gibraltar for repairs by the SS *McKender*.

Aug. 10th. Our Capt. tells me the SS *McKender* operator is very poor. Heard SS *McKender* working. Yes, the opr is even worse than the *Wilca* oprs were.

Aug. 11th. 6:00 p.m. *McKender* takes our anchor chain and commences towing us to Gibraltar.

7:50 p.m. *McKender* operator is very slow and both a poor sender and receiver, but think we shall get along O.K. He is using too much power. Will endeavor to coax him to use his head.

10:10 p.m. Circuit breaker went bad.

Aug. 12th. 10:40 a.m. Circuit breaker once more in commission. Have had more trouble with this breaker than any used before. It works magnificently until all the heavy work is over, and then lies down on the job.

Aug. 12th. 7:40 p.m. It's nice to be towing in back of another fellow and he wanting to work everybody on the Western Ocean. Nice for your Crystal Detector. Ha Ha.

Aug. 13th. 12:50 p.m. Our glass is down to 28.74. Blowing pretty bad with a heavy sea.

2:00 p.m. The sea is heavy. The *McKender* is pumping oil over, to knock down the sea. We have our storm tanks (oil) open, also bags of oil over the side.

4:30 p.m. Gale blowing.

4:45 p.m. Our tow line broke. We're in for it, no doubt.

4:57. We ask *McKender* if she can pick us up. Impossible.

- 7:00 p.m. Gale force 10 blowing. It's a question if we can stand it.
- 9:30 p.m. Wind and sea furious. We are worse off than a barge.
- 12 mid. Gale at its height. A couple of seas shook the old tub till she trembled as with grief.
- Aug. 14th. 2:00 a.m. *McKender* loses us. Goes over horizon. Our ship is riding it out pretty well. The crews are surely terrified.
- 4:00 a.m. I am all in. Sea continues. Ship lurches, but holds together.
- 5:00 a.m. Cap't says "She's a good ship and will ride it out."
- 5:30 a.m. Tried to catch a wink of sleep but impossible.
- 7:00 a.m. Still blowing about forty and sea is large. We take them green, over the top.
- 3:00 p.m. *McKender* is now abreast and endeavors to get close enough to shoot us a line but her Lyle gun refuses to work after two different complete turns around us.
- 4:00 p.m. We try our Lyle gun but it doesn't work. It's no fun lying in this sea with our only means of rescue, the Lyle guns, on both ships, failing.
- 5:00 p.m. We try to float a line to her and she tries same, but of no avail.
- 6:30 p.m. *McKender* captures one of our floating buoys but the strain is too heavy on the line and it parts. The crew is restless.
- 7:50 p.m. After several more attempts to float lines to one another, the *McKender* steams a mile away. Captain says he thinks it's best to wait until morning.
- 10:30 p.m. Have been up since 8 a.m. 13th—38 hours—and am all in, my second siege this trip.
- Aug. 15th. 6:30 a.m. They are coming for us again.
- 8:00 a.m. Sea going down slightly. After yesterday's failure to float lines and the non-working of the Lyle guns, we put a boat over to get a line to the *McKender*.
- 11:00 a.m. Our boat got a line to the *McKender*. Happy.
- 3:30 p.m. The *McKender* heaved on tow line before we had cut our anchor chain away. Almost tore our forward port bulwarks away.



- Some trip. We cut the chain to save the bulwarks.
- 3:45 p.m. The *McKender* started ahead slowly.
- 3:50 p.m. Tow line parted again. Talk about disheartened! I feel sorry for our crew. I feel resigned, myself. Surely a heavy strain on this ship's company. The crew of both ships working in rain and wind to get line back on board.
- 7:00 p.m. The *McKender* reports her end in.
- 8:10 p.m. Our end up. Captains decide to wait till daylight. Our nerves are about strung to the limit.
- 11:10 p.m. Going to sleep.
- Aug. 16th. 4:30 a.m. Sea very choppy but wind only about 4 force. Cannot launch a boat. We started a series of oil bbls. as floats. All morning it was lines parting here and there and lines getting caught. Getting rough again. We are pumping oil over the side to help smooth out the sea. A nerve-racking morning. The *McKender* opr. is oh so poor this morning. No doubt he's sick. I'm forced to send about 4 words a minute and we have msg after msg to get off. What a life. This cures me of wireless, if we ever get in safely. Never in my 11 years of radio have I had such a poor opr at the other end.
- 1:50 p.m. The *McKender* Captain dared to come close on leeward side. He came astern of us and when ten feet astern, a sea took us to leeward and him to windward. I heard yelling, went out on deck and saw her. It looked like the end. She was about to plough through our stern, when a sea took her one way and us the other. Our Capt. said "She'll hit us sure." Everybody stood transfixed, but she passed to windward a scant two feet from our rail. Our chance to get a line to her, yea. Never had a better chance, but all were so frightened, they could not move. When finally one of our men came to, he heaved a twenty pound lead line. Lead got over to her, but the line was too short and before another line could be tied to its end, we lost it and the *McKender* had again eluded us. After that experience we knew we had faced death. Everybody was solemn as we watched her steam away, seemingly to recover.

2:00 p.m. *McKender* floats more bbls. and comes on our lee side (not quite so close this time).

2:50 p.m. We finally get a line from her and bend on a two-inch wire cable.

3:05 p.m. She is heaving in our two-inch wire, slowly, very slowly.

3:50 p.m. They are bending our two-inch wire on to their towing cable.

4:10 p.m. We commence heaving the tow line aboard, slowly. Everybody is helping, watching, hoping.

5:10 p.m. We have the towing line aboard and shackling on the chain.

5:18 p.m. Paying out our 60 fathoms of anchor chain which will be the complete tow line.

5:21 p.m. *McKender* going ahead slowly to take up slack.

5:40 p.m. *McKender* stopped.

5:55 p.m. Captain comes in radio room. Can see a look of haggardness all over his face. Still, he's smiling, and gives me msg for the *McKender* to go ahead slow.

6:05 p.m. *McKender* gives us congratulations,

thanks God for everything, and starts pulling us, slowly. As we have used up every bit of line and gear aboard, and the *McKender* the same, our hope lies in the present cable. It consists of about 250 fathoms of $4\frac{1}{2}$ -inch steel cable, the same that parted in the storm. We have been adrift for 75 hours and the feeling is great to have some hope of reaching land again.

6:50 p.m. The crew are wondering whether or not she is going to hold. Three of them never were to sea before. It's telling on them.

Aug. 18th. 8:30 a.m. We are still going ahead slowly.

7:25 p.m. Engineers have been working on shaft, have repaired same, and the engine is turning over slow. No one knows what a relief it is.

Aug. 19th. 8:50 a.m. Engine still running and we are making around five miles per hour.

1:50 p.m. We are turning 34 revolutions. Our ship is quivering first time since July 24th when we broke down. Making good time.

Aug. 22nd. 3:25 p.m. Arrived Gibraltar.



“ARRIVED GIBRALTAR”

“Here in Great Britain—”

The Peculiar Broadcasting Situation on the Other Side of the Atlantic Contrasted With That in the United States. Profiting by America's Horrible Example

By PHILIP R. COURSEY, B. Sc., F. Inst. P., A. M. I. E. E.

Editor of *The Wireless World*, London

POPULAR interest in wireless has recently come to centre on the broadcasting of concerts and similar entertainments from a few special stations provided for the purpose. Broadcasting in the United States for many

months past has created tremendous enthusiasm for the reception of such transmissions in the home; but at the present time our position as regards this form of entertainment is not entirely clear. Although formal permission has already been given to the effect that licenses will be granted for such transmissions, it yet remains to be decided which wireless manufacturers will take part in such programmes, and what will be the terms of the licenses.

Here in Great Britain, one difficulty that has been raised concerns the financial return that the broadcasting companies are likely to obtain for their expenditure on the transmitting stations. In America, the large population, in conjunction with the nation-wide interest in anything new, has resulted in the rapid building up of a very extensive industry for manufacturing and selling apparatus for receiving the broadcast transmissions. A fear has been expressed that in the case of Great Britain, although many people will wish to purchase

receiving sets, there may not be a sufficient number to recompense the maintenance and running of the stations.

There is every indication at present that the British Government will retain a much closer and more stringent supervision of the

broadcasting arrangements in this country, and will retain more control over them than the American Government apparently has done in the United States. It has been stated that the broadcast transmissions are to be restricted to purely orchestral and concert transmissions with occasional news items, and that all forms of advertising matter will be prohibited. The only direct advertisement that the firms carrying out the broadcasting will obtain will arise from the announcement of the name of the company owning the transmitting equipment. The hiring out of

It is interesting to put ourselves in the place of the British amateur, for a moment, and to look at the broadcasting situation in both England and America from the British point of view. Our readers will see that Mr. Coursey is misinformed when he states that “almost every one of the tens of thousands of amateurs [in America] is licensed not only to receive but to transmit messages,” but he does reflect the apparently general opinion of those in English radio circles that our ether jam ought to be a lesson to them.

Captain Wedgewood Benn, M. P., expressed this idea in the columns of the *Westminster Gazette* not long ago. “If we [in England] are to enjoy the benefits of broadcasting,” he said, “control of sending is essential, otherwise the air will become a Tower of Babel. We know a little of the horrors which might ensue, from what we read of the situation in America. From nine o'clock in the morning, when crop reports and prices are sent, followed by programmes of music, news from the race-course, baseball scores, weather reports, and gospel sermons, right down to the ‘bedtime message for the chicks,’ there is no rest. Clearly there must be control.”

Yes, clearly there must. But is it possible that the British have been enjoying a little too much of it?—THE EDITORS.

broadcasting stations for the transmission of other classes of matter by various individuals or firms is not to be allowed, since the use of the stations is to be restricted solely to the broadcasting company.

In many cases this may be advantageous to the wireless industry itself; but at the same time it cannot but be felt that a freer policy might tend to a greater expan-

sion of the broadcasting facilities available to the general public.

The question is closely linked up with that of the wireless amateur or experimenter. There are in Great Britain at the present time several thousand wireless amateurs who are licensed by the Post Office to receive wireless signals, but only a few hundred who are licensed to transmit. These figures contrast strongly with America, where almost every one of the tens of thousands of amateurs is licensed not only to receive but to send messages. Since the War it has been felt in official circles that the great developments that have taken place in the way of ease of long-distance transmission and reception would be impeded if too great freedom were granted the wireless amateur.

To a certain extent this feeling is brought about by the proximity of England to other European countries, since any interference that may be caused by amateurs is not necessarily limited to our own territory. The number of transmitting licenses that have been granted has therefore been strictly limited in order that any possible interference may be kept down. For this reason also the granting of all amateur wireless licenses in Great Britain has been restricted to their use for purely experimental work only; they are not granted merely for communication purposes.

In the United States, amateurs may and do communicate with each other and transmit any kind of message to each other, often over very long distances, since the granting of their licenses is not provisional upon their carrying out definite scientific research or experiment. Were such freedom of communication to be granted here, it would be a violation of the Postmaster-General's monopoly of communication under which the Post Office alone is empowered to transmit intelligence from one point to another by any form of telegraphic or telephonic means.

The Wireless Society of London and its affiliated Wireless Societies throughout the country number among their members most of the best wireless amateurs, and they already have secured from the Post Office authorities considerable concessions as regards amateurs' work. They were, for instance, instrumental in obtaining permission for the first regular broadcast telephony transmission in this country. This transmission, it is true, is only allowed for a period of about *fifteen minutes on one day each week*, but it represented, particularly at the time

it was granted, a considerable concession on the part of the Post Office. Other arrangements with the Post Office have also been made by the Society for the benefit of amateurs, and it is to be hoped that in the near future still further privileges will be granted. The more extended use of transmitting apparatus by wireless amateurs for general communication purposes would considerably augment the volume of trade in such material.

TRANSATLANTIC TESTS BETWEEN ENGLISH AND AMERICAN AMATEURS

IN SPITE of the less extended use of wireless by British amateurs, the development of amateur apparatus has at least kept up with, if not surpassed, the standard attained elsewhere. In December last, a series of special tests was organized between American wireless amateurs, represented by the American Radio Relay League, and the amateurs of this country, with a view to establishing communication between America and England solely by amateurs, using the ordinary apparatus as licensed by their respective Governments. The maximum transmitting power licensed to the Americans is some hundred times that allowed here, and therefore the transmissions were all made in one direction—from America to Britain. The tests were successful, and the American signals were heard—not merely one or two, but many transmitting stations being identified and their calls and messages taken down. Some of these stations were using no more electrical energy than is required to light one or two small electric lamps, so that is a tribute to the development of the receiving apparatus that such feeble radiations could be detected and heard over a distance of more than 3000 miles.

The Americans themselves sent over to this country a representative equipped with their best apparatus. He, too, heard some of the signals, but although he used an aerial eight and a half times the size allowed to the British amateur, he did not hear many more stations than did the British listeners.

The radio amateur in Great Britain is, on the whole, not so hardly treated as he is in certain other places. In France, for instance, it is only during the past few months that the amateur has been recognized and has obtained any privileges at all; while in other countries he is still prohibited altogether from indulging in this hobby.

How the Vacuum Tube Works

By ARTHUR T. ENGLISH

EVERY radio amateur is of course familiar with the structure of the vacuum tube and its use in receiving circuits as a detector and an amplifier.

He can answer the question, "How does it detect?" readily enough by saying, "It rectifies the high-frequency waves and so makes them audible." But when pressed for a detailed explanation, he usually must take refuge behind some general statements such as "one-way conductivity," "characteristic curve," etc., until his questioner's attention can be diverted to the next selection from the broadcasting station.

Thoroughgoing explanations have of course been made, but they have usually been couched in such mathematical terms that they have received little publicity beyond the columns of technical journals. It is the writer's belief, however, that intelligent amateurs are interested in knowing both the "how" and the "why" of vacuum tubes in radio telephony. The subject is an interesting one, for it is vital to an understanding of some of the limitations of the art.

HOW THE RADIO VOICE IS CARRIED

TO BEGIN with the "why" of the vacuum tube, it is necessary to make one apparently dogmatic statement, viz.: that electrical energy in "commercial" amounts can be radiated from an antenna of workable dimensions and a portion of it received on a similar antenna, only when the wavelength lies between, say, 100 meters and 20,000 meters. Below the lower wavelength, the energy radiated is too small; above the other, the antenna is too long to be handled readily. These limiting wavelengths correspond to alternating currents of 3,000,000 and 15,000 cycles per second, respectively, in the antenna. In order that radio telephony may be possible, a means must be found by which audible sounds, having a frequency of anywhere from 50 cycles to, say, 3,000 cycles, can be transferred through the

ether by means of electric waves. To cite a typical instance, when a violin note "high c" is played at a broadcasting station whose wavelength is 360 meters, the musical note of about 1,000 cycles must be "carried" by an electric wave whose frequency is 833,000 cycles. This condition is fundamental to radio telephony.

In the transmitting station, the musical note is caught by a telephone transmitter and becomes an alternating electric current, colloquially called a "voice current" of 1000 cycles per second. (Fig. 1). We shall not explain how this current is combined with the 833,000 cycle current, save to say that vacuum tubes are used. As a result, electric waves are set up in the ether, and when your receiving set is suitably tuned, a corresponding current (Fig. 2) is set up in the primary coil of your receiving transformer. This current can be considered as made up of:

Component A, proportional in volume to the carrier, and of frequency 833,000 cycles. (Fig. 3)

Component B, at carrier frequency, (833,000 cycles), but whose volume at any instant is proportional both to the volume of the carrier and to the actual voice current at that instant. (Fig. 4)

Now, since both these components are at such high frequencies, they will be inaudible in a telephone receiver, partly because the diaphragm cannot vibrate fast enough, and partly because they will not pass through the high impedance of the receiver magnet coils.

Our problem, therefore, is so to transform the antenna current that we shall have a current at voice frequency, which will pass through the telephone receivers and produce an audible sound in them.

Now, if we impress an alternating voltage upon any device, such as a crystal detector, (Fig. 5) which conducts current more readily from terminal A to terminal B than in the reverse direction, we shall find that the resulting current, instead of being equal in both direc-



The filament, grid, and plate are seen here in their relative positions. The glass bulb has been broken away

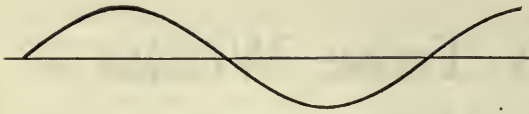

FIG. 1

A voice-current wave of 1000 cycles

tions, is greater in the direction A to B than in the other direction. As shown graphically in Fig. 6 the quantity of electricity flowing from A to B is indicated by the area of one loop above the zero line, and it exceeds the quantity flowing from B to A by the area shown in solid black. After a number of waves have passed, more electricity has flowed from A to B than from B to A which is the same as saying that an interrupted current from A to B is flowing in the circuit. If *no* current can flow from B to A, the alternating current is said to be completely rectified.

WHEN THE VOICE COMES IN

LET us suppose such a device introduced in a receiving circuit, as in Fig. 5. Then an incoming wave of constant volume, like Fig. 3, would be broken up into two components—the lightly shaded parts of Fig. 6 equal and opposite, and therefore an alternating current at radio frequency; and the heavily shaded parts,

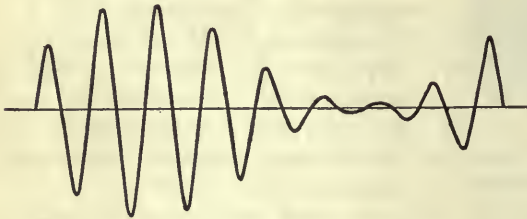

FIG. 2

A graph of antenna current—the sum of component A (carrier) and component B (modulated current)

pulses of direct current at radio frequency, and therefore exerting the same effect on the rather sluggish telephone receiver and human ear as a steady direct current. Suppose, however, that the incoming wave is carrying a 1000-cycle voice wave. Graphically it would look like Fig. 2. Since the rectifier will allow more current to flow above the zero line, the resultant current is as shown in Fig. 7. Here the lightly shaded areas are equal, and indicate a radio-frequency (inaudible) alternating current; the black areas indicate pulses of direct current whose magnitude is seen to increase

and decrease in step with the voice current wave. Since these pulses follow each other so rapidly, they will give the effect in the telephone receiver of a steady current which increases and decreases in step with the voice wave. This will set up a sound in the receiver which will be a reproduction of the sound at the transmitting end.

HOW THE TUBE DETECTS

HAVING explained the nature of detection, we now come to the interesting story of how the vacuum tube performs that work.

The simplest form of tube for detection alone

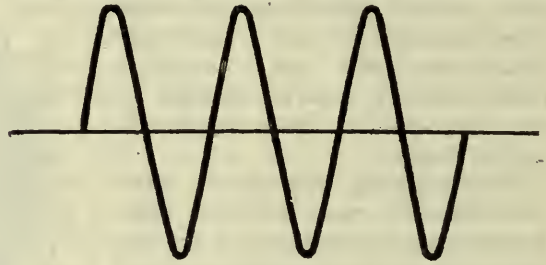

FIG. 3

Pure carrier wave for 360 meters (833,000 cycles), known as component A

is the two-electrode tube, or Fleming Valve. As shown in Fig. 8, this tube contains only a filament, heated by an "A" battery, and a plate. The hot filament gives off electrons which carry current from filament to plate. The amount of this "space current" (symbol, I_p) is proportional to the physical size of the tube, the temperature of the filament and the voltage between filament and plate (symbol, E_{fp}). For any given tube, with constant filament current, the relation between the space current and the voltage across the space is shown in Fig. 9. From this curve we may learn two important facts:

- (1) If the voltage E_{fp} between the filament and plate is such that the plate is negative with respect to the filament, no current will flow, because the negatively charged plate repels the negative electrons,

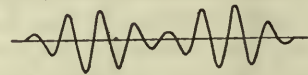

FIG. 4

Graph of a pure modulated wave formed by the carrier wave of Fig. 3 being modulated by the voice current of Fig. 1. This wave is known as component B

emitted by the heated filament, and the cold plate cannot give off electrons itself.

(2) If the plate is positive with respect to the filament, the plate will attract negative electrons given off by the hot filament, and current will flow, but the current I_p will increase more rapidly than the voltage E_{fp} .

This last statement means that if a battery is introduced into the plate-filament circuit,

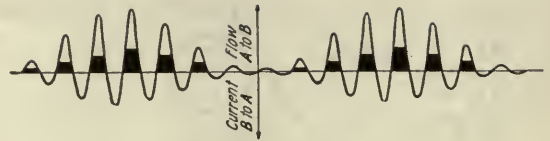

FIG. 7

The dark section in this graph illustrates the pulsations of current which result from the rectification of an incoming radio telephone wave. The pulsations occur so rapidly as to form a practically direct current which actuates the receiver diaphragm

condition necessary for partial rectification, as we have seen. The Fleming Valve, then, is a detector which will give an audible sound in a telephone receiver in series with it.

WHY WE USE "BLOCKING" CONDENSERS

LET us now insert into the secondary circuit a small condenser C, omitting for the moment the high resistance L. (Fig. 11) When the filament is first lighted, there will be no charge on the condenser, and its two sides will be at the same voltage with respect to the filament. Due to the voltage drop in the filament, that end of it to which the secondary, condenser, etc., is connected will be positive to the filament and so the plate will be positive to the filament.

But as negative electrons cross from filament to plate and flow along the wire, they are

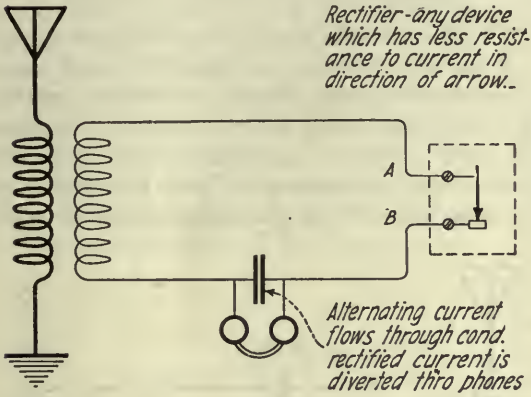

Rectifier—any device which has less resistance to current in direction of arrow.

Alternating current flows through cond. rectified current is diverted thro phones

FIG. 5

A simple receiving circuit

as at B, Fig. 10, the plate current I_p will have a steady value OM. In actual practice the small voltage ON is secured by omitting battery B and connecting the plate to the positive end of the filament. The voltage drop in the filament itself, due to the heating current, will keep this end more or less positive to the rest of the filament, so that the plate can be considered as positive to the filament by half the amount of the voltage drop across the filament.

Suppose, now, with E_{fp} held at a "normal" value of ON (Fig. 9), a radio wave impresses an alternating current upon the plate-filament circuit. At one extremity of the alternating current cycle, E_{fp} goes up by the amount NR; at the other extreme, it goes down by the equal amount NQ. But the current in the circuit increases first by the amount MU, then decreases by the smaller amount MT. In other words, the resulting current is greater in one direction than the other, which is precisely the

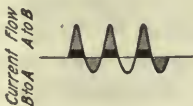

FIG. 6

The received current

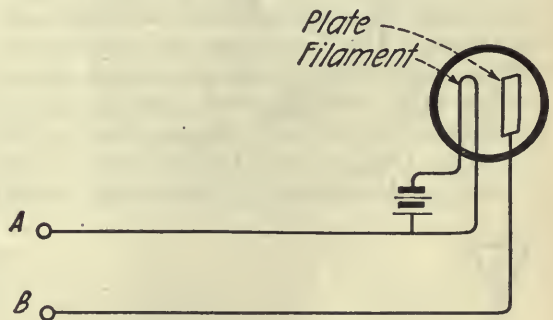

FIG. 8

The Fleming Valve Circuit

blocked by the condenser C. Soon a sufficient number of electrons accumulate to charge the right hand coating of the condenser, and also the plate, negatively. This negative charge repels the negative electrons, and so they no longer come to the plate, i. e., the plate current decreases, and may even become zero. This phenomenon is called "blocking."

The vacuum in the early Fleming Valves was none too good, and molecules of oxygen,

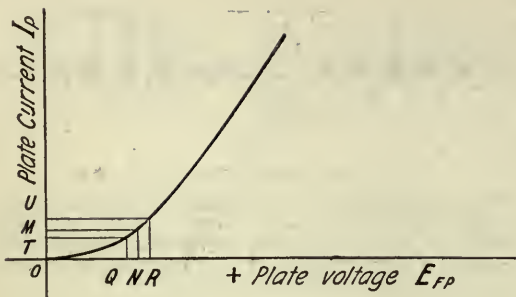

FIG. 9

The relation between the "space current" and the voltage across the space (between the plate and the heated filament) is illustrated by this curve

nitrogen, etc., were usually present. Some of these act as carriers of electricity, which will move from plate to filament. This will of course reduce the negative plate charge and allow the electrons to flow again to the plate. But a more reliable method is to use a high resistance, L , as a "leak" which will keep the voltage across the condenser from rising high enough to "block" the tube.

So long as the tube is lighted, but while no radio waves are coming in, the plate current (OM in Fig. 9) will flow through the high resistance L and raise the voltage across the terminals GH. When an unmodulated carrier wave comes in, it is partially rectified by the valve, and the resulting steady additional current through L will create an additional steady voltage across GH. When the carrier wave is modulated by voice-frequency current, then the rectified current will vary with the voice current and so the voltage across GH will vary. If we connect an extremely high-resistance receiver

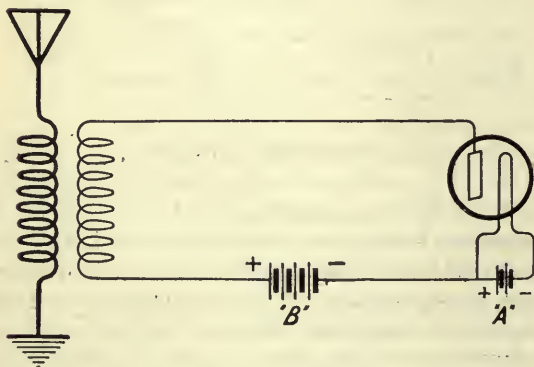

FIG. 10

A battery, commonly termed a "B" battery, is placed in the plate circuit in order to keep the plate current steady. In practice this battery is omitted and compensated for by connecting the plate to the positive end of the filament

here, we shall hear the transmitted sounds, and if we connect an amplifier, especially one that takes little or no current through its "input" circuit, we shall get a largely increased volume of sound. All amplifiers use a "three-electrode" tube, sometimes called "audion," or by other trade names; and this type of tube can also be used for detecting. We shall now review its characteristics.

WHY THE GRID IS USED—AND HOW

THE three-electrode tube contains a filament, preferably of platinum, and sometimes coated with oxides of certain metals; a grid of fine wires, and a plate of aluminum or other metal. In certain tubes, the filament forms an inverted V, with two grids, one on each side of it, and in planes parallel to the

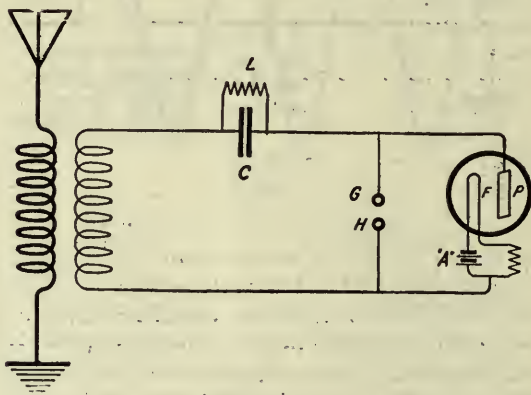

FIG. 11

By the combination of a condenser and a high resistance it is possible to control the voltage in the plate circuit

plane of the V. There are two plates, outside and parallel to the grids. In other tubes, the filament forms a short spiral, enclosed by the filament wound in a somewhat larger spiral, and the whole surrounded by a cup-shaped metal stamping which forms the plate. In all types, electrons emitted by the filament must pass through the grid to reach the plate.

The operation of a three-electrode tube is as follows: Assume first that the grid is absent. We have then a Fleming Valve, in which electrons emitted from the filament are drawn toward a positively-charged plate. Now let the grid be inserted in the stream of electrons, but kept insulated from both filament and plate. A few electrons strike it and cling, giving it a sufficient negative charge to repel any further electrons. Now let the grid be

given a varying voltage with respect to the filament, and we shall see that this voltage has a great effect on the flow of electrons. If the voltage is sufficiently negative, all the electrons will be repelled from the grid, and none will get through to strike the plate. This is the starting point "A" in Fig. 12. As the grid becomes less negative (ABC), it offers less and less resistance to the electrons, and more of them flow past it to the plate. When the grid becomes positive (CDF), the flow of electrons is increased still further until at last a point F is reached where the current can increase no more, because the filament is giving off the maximum number for that particular temperature and filament-plate voltage.

The first part of the characteristic is curved (A to B); the importance of this we shall see later. The second part BCDE is practically a

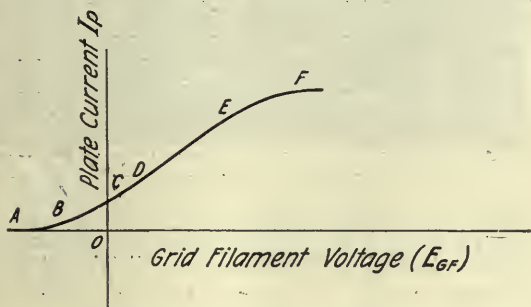

FIG. 12

The flow of electrons from the filament to plate is controlled by the relative charge on the grid as shown in this graph

straight line. This means (1) that each change in grid voltage causes a large change in plate current; and (2) that the current change is exactly proportional to the voltage change. The significance of (1) is that the voltage change of the grid requires very little current, and hence very little power; the current change in the plate circuit, on the other hand, may vary the power in its circuit through a wide range. Exact proportionality (2) means that if the input voltage is a voice wave, the output current will be a perfect copy, but on a much larger scale. In other words, the device will *amplify* without distorting.

MAKING ONE TUBE WORK AS TWO

IF NOW we connect the "input" terminals G'H' of a vacuum-tube amplifier set (Fig. 13), to the terminals GH of Fig. 11, we shall greatly increase the loudness of the signals

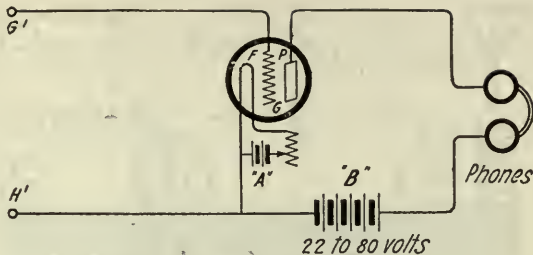

FIG. 13

Altering the circuit GH in Fig. 11 by adding this amplifier arrangement permits much better reception and results in a circuit represented by Fig. 14

which were heard when we connected the telephone receivers directly to GH. A diagram of part of this "hook-up" is shown in Fig. 14, in which it will be seen that the filaments of the two tubes are connected, and that the plate of Tube 1 is connected to the grid of Tube 2. It is evident that the filament and grid of a three-electrode tube can operate the same as the filament and plate of a Fleming valve, i. e., that the filament and grid will rectify incoming high-frequency currents just as do the filament and plate. So we can eliminate the Fleming valve and rectify and amplify in the same three-element tube. This circuit is shown in Fig. 15, and is familiar to most radio amateurs.

Let us now review briefly what happens in this circuit. The high-frequency voltage across the secondary S varies in proportion to the voice currents at the transmitter. This voltage, rectified by the filament-grid circuit, produces a small direct current through the tube, the high resistance L and the secondary S. This current will of course produce a proportional voltage drop across L, by Ohm's

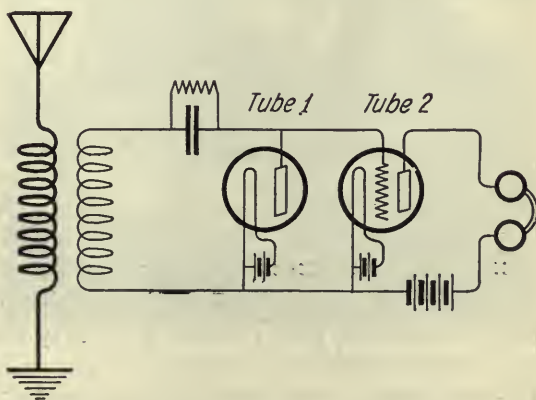

FIG. 14

A Fleming Valve detector with a three-element tube used as an amplifier

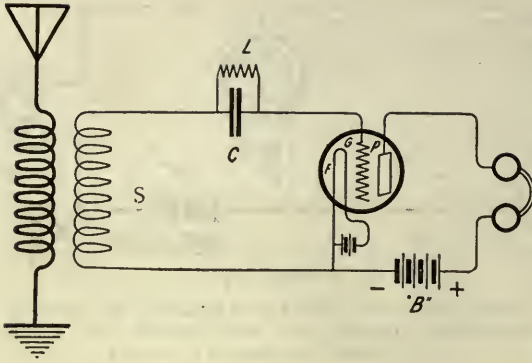

FIG. 15

By this further modification of Fig. 11 a single three-element tube is made to function as a rectifier and amplifier as well

law, which will vary the voltage of G with respect to F. But we have seen that this is the means by which the current through the plate circuit is varied. So this current, which flows through P, Phones, and B, will vary in step with the original voice current, and will reproduce the original sound in the telephone receivers. The condenser C serves as a bypass around the resistance L, enabling the high-frequency voltage induced in the secondary circuit from the antenna to reach the grid.

It is interesting in this connection to study the operation of a less common scheme, which is sometimes called the "C-battery hook-up." This employs a few dry-cells connected in place of the grid condenser and leak, and poled so as to make the grid slightly negative to the filament. Fig. 16 is an enlargement of the left hand part of Fig. 12. Suppose with no waves being received, the C-battery gives a voltage ON between grid and filament. The corres-

ponding plate current is OM, which is a steady current through the receivers, and inaudible. Now suppose an incoming wave gives a voltage swinging between Q and R as negative and positive maxima. As a result, the plate current will vary between OT and OU, with an average value at V, half-way between. This variation is of course at radio-frequency, and therefore inaudible. But due to the curvature of the characteristic at this point, UM is greater than TM, and hence the average value of the direct current is increased by an amount VM. The quantity VM is proportional to QR, which in turn is proportional to the amplitude of the high-frequency current in the antenna. This amplitude varies in step with the voice current at the transmitting station, so that we can sum up by saying that the direct current VM varies in step with the original voice current. Hence this varying direct current, passing through the telephone receiver, will reproduce the original sounds.

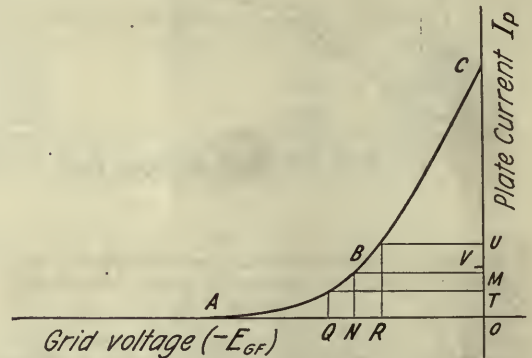

FIG. 16

Grid voltage and plate current are affected in this manner when a "C" battery is used instead of the grid condenser and leak resistance as in Fig. 15

EDITORS' NOTE

It is of the utmost importance to the radio public who are receiving broadcasting that this business develop to its maximum service and effectiveness. The Editors of RADIO BROADCAST would be glad to hear the opinion of its readers on such questions as:
 What voice should the receiving public have in selecting broadcasting programmes?
 Should the public get broadcasting free or should it pay for it, and if so, how?
 If the public should get it free who should pay for it and how are they to be reimbursed?

Do You Know Them by Sight or by Sound?



CHIEF STRONGWOLF

Whose Indian name is Guy You Ma Wanda, is an eloquent speaker. Perhaps you have listened to one of his very convincing pleas for citizenship for the American Indian



© Underwood & Underwood

GRANTLAND RICE

Who reported the World Series
Baseball games play by play



GEORGE T. JOHNSON

Is the Chief of Police at Pueblo, Colo. He has established a police service between Denver, Colorado Springs and Pueblo. Possibly you would be as well pleased if the Chief did not mention your name



© Underwood & Underwood

ELMER E. BUCHER

Finds time to send and receive now and again, despite his very busy life. He has written some of the most popular radio books, and directs the sale of amateur equipment for the Radio Corporation of America

Paris and Honolulu are Calling You

Stations Thousands of Miles Away are at Your Finger-Tips if You Convert Your Broadcast Receiver into a Long-Wave Set. Most of These Stations Can be Picked Up With a Single Vacuum Tube

By A. HENRY

AFTER several months of listening to the concert programmes, it is not unlikely that those of you who have recently taken up radio will seek additional fields to explore. You will find none more fascinating than that of long-wave, long-distance experimenting—bringing in and copying the high-power radio telegraph stations. It is by no means uncommon for amateurs in America to pick up the stations at Honolulu, Cavite, Bordeaux, Paris, Rome, San Francisco and Darien; sometimes, it is even possible to get Japan. Perhaps this sounds improbable; but you may be surprised—and encouraged—to learn that no radio- or audio-frequency amplification has been necessary in bridging these distances. They have been covered by using a *single vacuum tube*.

These statements should be qualified, of course, by mentioning that very distant stations cannot be picked up at all hours of the day or night, nor can you expect success without a certain amount of experimenting with your set in order to get it operating at the highest efficiency. But that is where individual skill and perseverance come in.

In order to convert a broadcast receiver into a long-wave set, you must have some idea of the circuits employed in each. Short-wave sets, especially those of the regenerative type, were described last month in *RADIO BROADCAST* in an article called "Regenerative Radio Reception" by Phil M. Riley, and the theory of tuning has been comprehensively covered by John V. L. Hogan in a series which appeared from May to October.

THE STANDARD REGENERATIVE RECEIVER

A STANDARD regenerative receiving set employing a tickler coil in the plate circuit to accomplish regeneration is shown in Fig. 1. If all the parts are removed other than those shown in Fig. 2, we may have the nucleus around which all vacuum-tube receiving sets are constructed. C_3 is the grid condenser, ordinarily of .00025 mfd., shunted from the grid leak resistance R_3 , ordinarily of 1 megohm. A is the six-volt storage battery used for lighting the filament. R_1 indicates the filament rheostat used to control the temperature of the filament. R_2 is a 200- or 300-ohm potentiometer shunted across the "A" battery with its

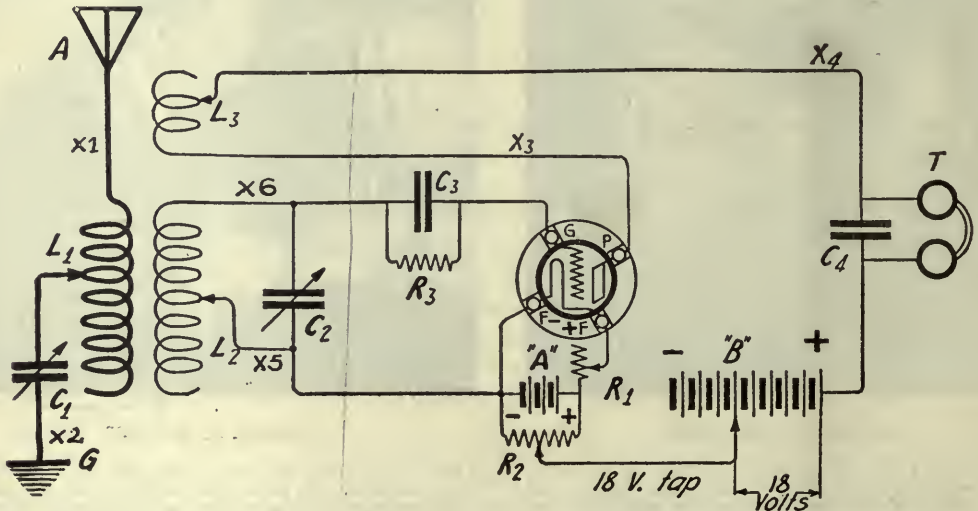

FIG. 1

third or movable contact connected to the 18-volt tap of the "B" battery. The potentiometer is used to control the voltage on the plate of the vacuum tube. C_4 is the telephone condenser but is not necessary in most circuits as the telephone cords themselves have enough capacity for this purpose. T , of course, indicates the telephone receiver. X_3 and X_4 are the points at which the plate circuit is altered for different purposes. For instance, in a simple vacuum tube receiver where the regenerative principle is not employed, X_3 and X_4 are connected together. Where a circuit such as is shown in Fig. 1 is used, the tickler coil in the plate circuit is connected between X_3 and X_4 . Where a variometer is used to tune the plate circuit for the production of regeneration, it is placed between X_3 and X_4 as shown in Fig. 3. Having the nucleus shown in Fig. 2, it is a simple matter for us to proceed with the development of a long-wave receiver.

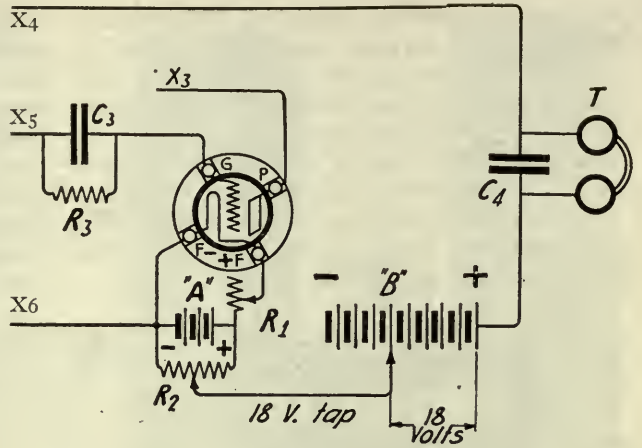

FIG. 2

the circuit between X_1 and X_2 ; the tickler coil between X_3 and X_4 and the secondary between X_5 and X_6 . Where the circuit employed in Fig. 3 is to be converted, both variometers are taken out and the points X_2 and X_3 are joined together and a variable condenser is connected between X_1 and X_2 for tuning the secondary circuit. The variometer V_4 connected between X_3 and X_4 is exchanged for a long-wave coil; otherwise the arrangement is as described with regard to Fig. 1.

A very convenient method of changing from short to long waves may be obtained by using a "Tunit" unit for the short waves and honeycomb, duo-lateral or Remler coils for the long waves. This arrangement is shown in an accompanying photo of a receiver made in the office of RADIO BROADCAST (page 136).

The results obtained with a receiver such as this depend largely upon the adjustment of the filament current and plate voltage. For this reason the use of a "Bradleystat," or at least a vernier rheostat for controlling the filament current for the detector tube is suggested,

CONVERTING A HONEYCOMB COIL SET

IT IS much simpler to convert a receiver of the character indicated in Fig. 1 than the one in Fig. 3, but in either case they must be stripped to the circuit shown in Fig. 2. For a combination long and short-wave receiver, it is quite necessary to procure a three-coil mounting. This mounting is provided with plugs for holding the primary, secondary and tickler coils. If a short-wave receiver of the kind shown in Fig. 1 is to be converted for long wave use, the only change necessary is the substitution of long-wave coils for short-wave coils. The variable condenser C_1 in series with the antenna circuit and C_2 shunted across the secondary circuit will function satisfactorily in both instances. The antenna coil is placed in

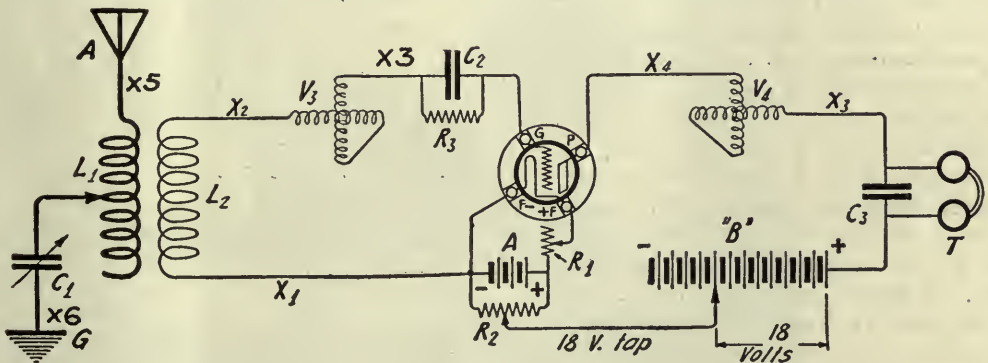
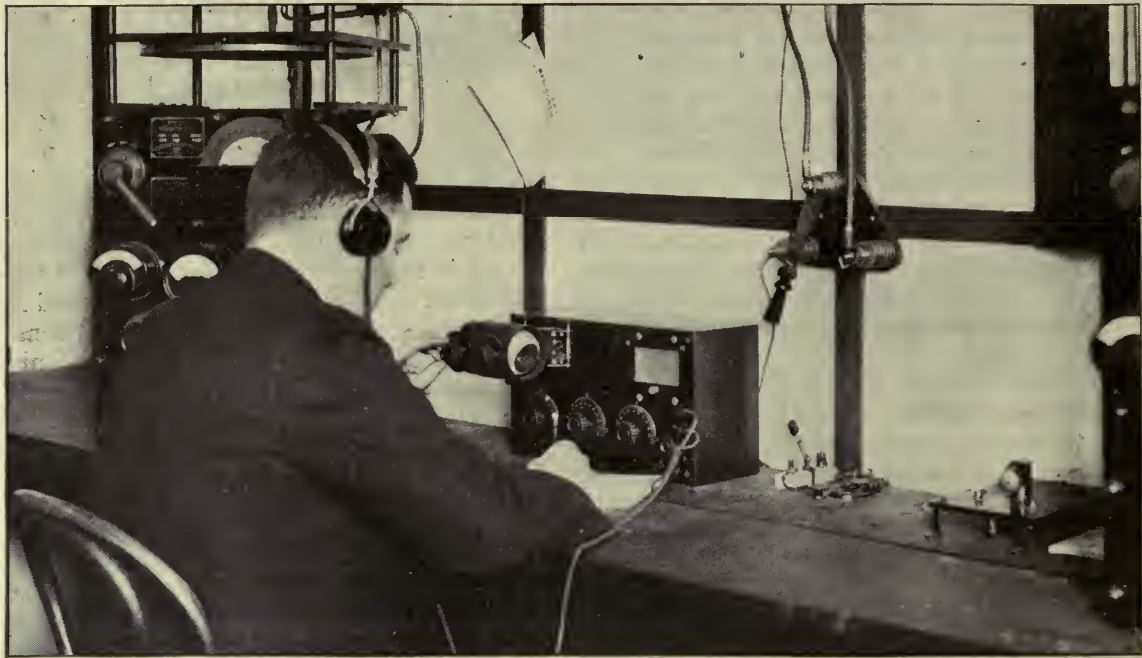

FIG. 3

and the plate battery should be of the storage type, or a dry battery variable in steps of $1\frac{1}{2}$ volts. Even though the potentiometer provides a means for controlling the plate voltage, it has been found that a variable "B" battery is essential. The use of vernier condensers is highly recommended and where they are not available, some adjustment permitting very fine variations should be attached to the condensers C1 and C2.

the holes with a graphite pencil. To the opposite side of the screw the circuit connections are made by a hexagon or battery nut. The resistance of the grid leak may be varied by rubbing the pencil line lightly with an eraser until the desired value is obtained.

The size of the coil necessary for any particular wavelength depends to a great extent upon the value of the variable condenser employed in the circuit. The following table is included for



W. J. ROCHE OPERATING THE "TUNIT UNIT," DEVELOPED BY HIMSELF AND HERBERT PEARSON

In tuning the primary and secondary circuits, it has been found that a fixed condenser shunted by a well-designed variable having a comparatively low maximum capacity works excellently. For this purpose, satisfactory results may be had with the "Faradon" UC-1820, which has a capacity range of .00004 to .0003 mfd. shunted by fixed condensers of .0025, .001, .0005 and .00025, mfd. or combinations of these values which allow close tuning.

With some types of vacuum tubes, notably the "Radiotron" UV-200, the variable grid condenser of about .0003 mfd. (maximum capacity), shunted by a variable grid leak, assists in tuning and helps to eliminate interference. A simple method of making a variable grid leak is to take a piece of bakelite or hard rubber and drill holes in each end with a number 19 drill, and mark the space between

your guidance, and in most instances, the values of all three coils may be identical:

Type	Milhenries inductant approx.	Approximate wavelength in meters in shunt with ordinary .001 M. F. D. Variable air condenser	Approximate price mounted on plug
L-25040	130-375	\$1.54
L-35040	180-515	1.54
L-5015	240-730	1.65
L-753	330-1030	1.65
L-1006	450-1460	1.71
L-150 . . .	1.3	660-2200	1.76
L-200 . . .	2.3	930-2850	1.82
L-250 . . .	4.5	1300-4000	1.87
L-300 . . .	6.5	1550-4800	1.93
L-400 . . .	11.	2050-6300	1.98
L-500 . . .	20.	3000-8500	2.20
L-600 . . .	40.	4000-12000	2.37
L-750 . . .	65.	5000-15000	2.59
L-1000 . . .	100.	6200-19000	2.86
L-1250 . . .	125.	7000-21000	3.30
L-1500 . . .	175.	8200-25000	3.85

A very simple manner of obtaining wavelengths of 1,000 to 15,000 meters is found in the Remler Q.S.A. 850 inductance units. In appearance they are quite like other multi-layer coils but an inductance switch has been added. There are four taps—at 25, 45, 75, and 100 per cent. of the coil winding. Shunted by a .001 condenser, these coils help to reduce the cost of the long wave receiver considerably.

The coils are designated by letters and numbers, honeycomb coils being marked L-, duo-laterals being marked DL, and Giblin-Remler coils, RG. These letters are followed by the number which indicates the number of turns in that particular coil, for example, DL-250 is a duo-lateral coil having 250 turns. By selecting several sets of coils whose wavelength ranges overlap, it is possible to run from 130 to 25,000 meters without going to very great expense. Thus, a set of 25-turn coils should cover a wavelength range of from 130 to 375 meters; a set of 75-turn coils should cover 330 to 1,030 meters; a set of 200-turn coils will function between 930 and 2,850 meters; 400-turn coils will cover a range between 2,050 and 6,300; 1,000-turn coils will cover a range between 6,200 and 19,000; and 1,500-turn coils between 8,200 and 25,000. In each of these groups, the upper value of the first set of coils overlaps the lower value of the next set, so that there is a continuous wavelength range of from 130 to 25,000 meters. Coils of this nature are not

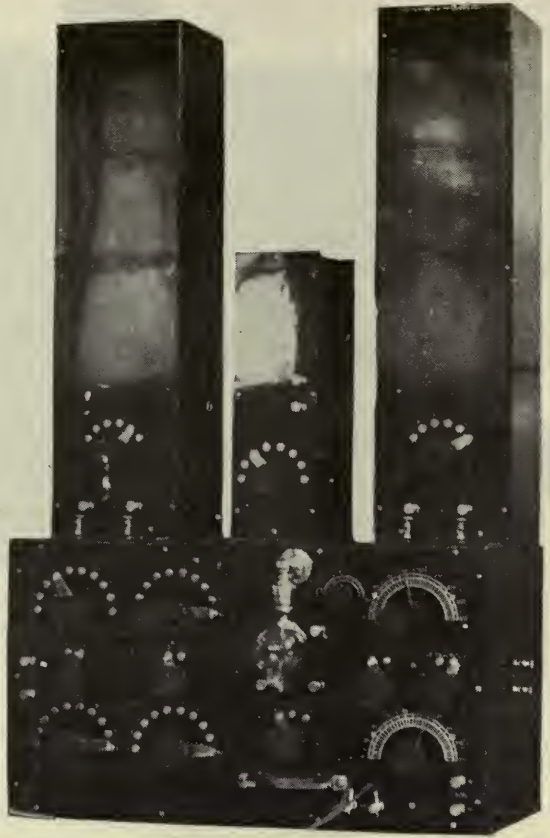

A PRE-WAR MULTI-RANGE RECEIVER
Designed for transatlantic work with a single tube



IN THE RADIO CLUB OF PORTO RICO

A receiver of the character we are considering is employed to receive broadcasting from the United States, and long-wave telegraphy from distant parts of the world. Remler tapped inductances are shown in the coil mountings



THIS IS THE NUCLEUS

Or equipment used in receiving either long or short waves merely by changing the values of the coils which fit in the mounting at the top of the panel

particularly efficient on wavelengths below 600 meters, but it is doubtful if they can be improved upon for ordinary long-wave use.

BUILDING THE RECEIVER

IF, INSTEAD of converting your present receiver, you consider making an entirely new one, why not make a good one rather than a poor one? First of all, it's easier! Before

drilling a single hole, make sure that everything needed for the completed set has been procured. If possible, mount every unit directly on the panel, leaving the base and walls of the cabinet clear. The various units may be mounted most satisfactorily if templates are used. Templates, or "life-size" patterns, may be made of paper for each unit mounted. For instance, a variable condenser is generally

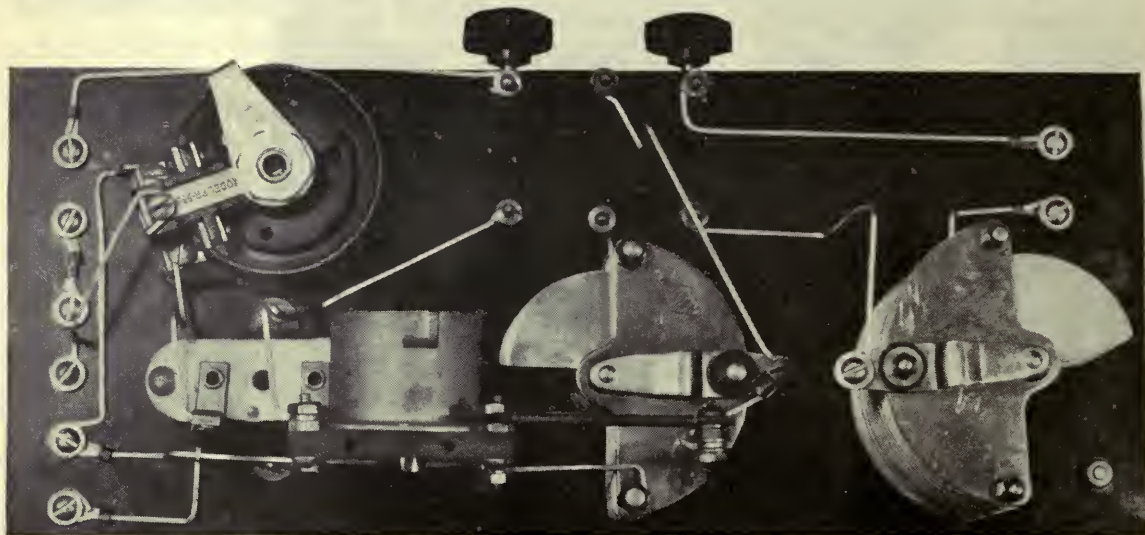

BEHIND THE SCENES

Showing a convenient arrangement of the units of the above receiver, with two variable condensers, a vacuum-tube control circuit and a potentiometer, all mounted on the panel. This receiver was assembled in the office of RADIO BROADCAST in a few hours

made with three holes in the upper plate, designed to accommodate the supporting screws. By passing the axle to which the rotary plates are attached through the paper, you can stick a pin through the paper just above the points where the three holes are located. This paper template is then used for drilling the panel.

In order to know which of the trans-ocean stations you are hearing, it is necessary to know the code, and perhaps the simplest method of learning it, after having memorized the code letters, is to listen to the automatic sending from one of the high-power trans-ocean stations in this country. These stations fre-

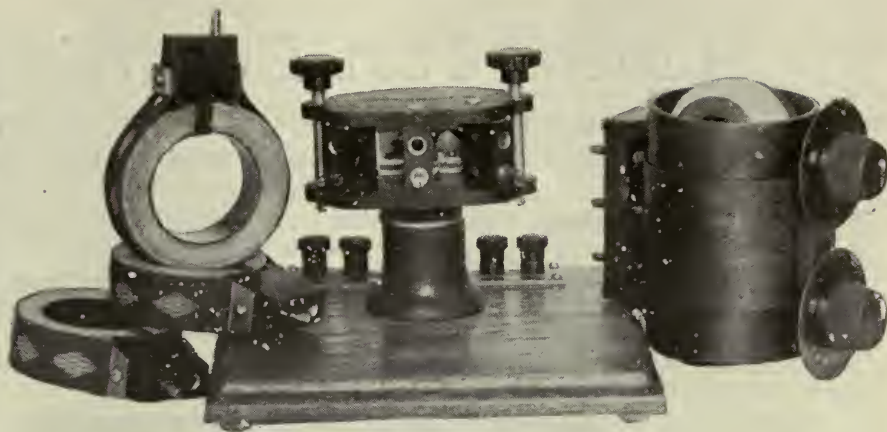

A DE FOREST COIL MOUNTING

To which the remainder of the receiving circuit is connected by six binding posts (two are behind the center support). Two of them are connected to the primary; two to the secondary and two to the tickler

quently operate at a very slow speed, and sometimes send each word twice. Their transmission is generally carried on by means of a tape machine and is therefore absolutely regular. "Learn the code" is the best advice we can give you, for your own pleasure.

SUPPLEMENTAL LIST OF BROADCASTING STATIONS IN THE UNITED STATES FROM SEPTEMBER 16 TO OCTOBER 5 INCLUSIVE

CALL SIGNAL	OWNER OF STATION	LOCATION OF STATION	WAVE LENGTH
KFBU	Thomas, Bishop N. S.	Laramie, Wyoming	360
KFDA	Adler's Music Store	Baker, Oregon	360
KFEC	Meir & Frank Co.	Portland, Oregon	360
WLAD	Arvanette Radio Supply Co.	Hastings, Neb.	360
WLAO	Anthracite Radio Shop	Scranton, Pa.	360
WLAS	Hutchinson Grain, Radio Co.	Hutchinson, Kansas	360
WLAV	Electric Shop Inc.	Pensacola Fla.	360
WLAW	New York Police Dept.	New York, N. Y.	360
WLAX	Greencastle Community Broadcasting Station	Greencastle, Indiana	360
WLAY	Northern Commercial Co. of Alaska	Fairbanks, Alaska	360
WLAZ	Hutton & Jones Elect. Co.	Warren, Ohio	360
WMAG	The Tucker Electric Co.	Liberal, Kansas	360
WMAK	Norton Laboratories	Lockport, N. Y.	360
WMAI	Trenton Hardware Co.	Trenton, N. J.	360
WMAP	Utility Battery Service	Easton, Pa.	360
WMAQ	The Fair Corp. & The Chicago Daily News	Chicago, Ill	360
WMAR	Waterloo Electrical Supply Co.	Waterloo, Iowa	360
WMAT	Paramount Radio Corp.	Duluth, Minn.	360
WMAU	Louisiana State Fair Ass'n.	Shreveport, La.	360
WMAV	Alabama Polytechnic Inst.	Auburn, Alabama	360
WNAB	Park City Daily News	Bowling Green, Ky.	360
WNAD	Oklahoma Radio Eng. Co.	Norman, Okla.	360
WNAF	Enid Radio Distributing Co.	Enid, Okla.	360
WNAG	Rathert Radio & Elect. Co.	Cresco, Iowa	360
WNAH	Wilkes-Barre Radio Repair Shop	Wilkes-Barre, Pa.	360
WOAA	Hardy, Dr. Walter	Ardmore, Okla.	360
WOAE	Medland College	Fremont, Nebraska	360
WPAN	Levy Bros. Dry Goods Co.	Houston, Texas	360
WQAQ	West Texas Radio Co.	Abilene, Texas	360
WRAU	Amarillo Daily News	Amarillo, Tex.	360

Stations That Entertain You

Are Any of These Old Friends of Yours? WOO, KSD, WJZ, WHAZ, WGM, and KDYL, Located in Six Different States, are Heard From Coast to Coast

PERHAPS you have wondered what some of the large broadcasting stations look like, as you have heard the announcer say: "This is XYZ, the Blankety Blank station at So-and-So." You may have listened to them night after night until they seem like old friends, and still you have not met them "face to face."

But it is interesting to become acquainted with the sources from which emanate the concerts you have heard. Take the case of WOO, for instance, the Wanamaker station in Philadelphia, which has aroused great interest by broadcasting the music of the store's beautiful organ. Organ music has for years almost completely baffled reproduction and it is therefore rarely found on phonograph records. In spite of this, Mr. Wanamaker was anxious that the music from the organ—the largest musical instrument in the world—be broadcasted. The Western Electric Company undertook the task, even against the advice of experts who said that no microphone could be constructed to transmit the organ's music successfully. A long series of experiments finally developed a microphone of the condenser type and an amplifying device constructed upon a new principle which has not yet been made known.

Although the Wanamaker station was designed to cover a region of from 100 to 150

miles from Philadelphia and to deliver 500 watts of radio-frequency power to the antenna system, it can be heard, under favorable conditions at much greater distances. Reports have been received from California and Porto Rico. Recently, WOO was re-licensed as a Class B station, with the privilege of transmitting on 400 meters



THE ORGAN AT WOO

KSD

ANOTHER station with the 400-meter privilege—the first, in fact, to receive it—is KSD, operated by the *St. Louis Post-Dispatch*. Opened on June 26, 1922, the new station KSD is already something of an "old-timer", so rapidly do broadcasting stations spring up and so widely is this particular one known. On September 12, KSD was heard in every one of the forty-eight states in the Union. On that occasion, a ship operator wrote

in: "We are off the Coast of California about 50 miles north of Point Arguello and about 30 miles out. Am getting you fine now, 9:50 P. M. You are QSA and modulation clear and distinct. Am using honeycomb set and one step of audio-frequency amplification, all home-made."

This is something of an achievement, but now that winter has come, it will be strange indeed if even greater distances are not covered by this station. Its central location in the United States should allow it to be heard beyond the boundaries of the country in all



(ABOVE) KSD'S AERIAL ON TOP OF THE "POST-DISPATCH" BUILDING IN ST. LOUIS
(BELOW) THE STUDIO AT WJZ, NEWARK, N. J., SHOWING MICROPHONE STAND IN BACKGROUND



directions. And why not? KSD radiates only a measly 1,000 watts!

WJZ

TO THOUSANDS of radio enthusiasts who do their tuning-in somewhere between the Mississippi River and the Atlantic Ocean, WJZ is as well known a combination of letters as the initials of their own names. Many operators in Texas, Kansas, and Iowa have reported good signals from this Radio Corporation-Westinghouse station, while Canada and Florida have compared notes with Maine and Newfoundland regarding the signals that originate in Newark, N. J.

WHAZ

WOO, KSD, and WJZ are controlled by three different kinds of interests: by a department store, a newspaper, and a sales and

manufacturing corporation, respectively. Now we come to a station owned and operated by an engineering institute—Rensselaer Polytechnic in Troy, N. Y. WHAZ was opened only in September, and is of particular interest in that it has no commercial side. It hopes that its service will have a far-reaching educational value.

This new station, located at the oldest American engineering college, is under the direction of the professors, instructors and practical radio men of the faculty. These men, who have conducted research in radio ever since the first practical wireless was given to the world, have long looked forward to establishing this station, the most powerful and most complete in any educational institution in the country. It was made possible through a gift in the names of three well-known graduates of Rensselaer Polytechnic: Washington A. Roebling, the late Charles G. Roebling and

John A. Roebling, the wire rope manufacturers, who built the Brooklyn Bridge.

The equipment is designed to give wide play to experimental development, not only in the field of the science of communication, but in the study of acoustics, the relation of color to the artistic temperaments of singers, musicians and dramatic readers, and the relation of light to the radio processes, besides the less aesthetic matters of wave transmission, power generation and antenna wiring. To make the broadcasting station of practical value, however, it must provide a radio service that will be of interest and benefit to the general listening-in public. Coupled with the experimenting of the Electrical Engineering department, the broadcasted matter will undoubtedly be of much service to the average schoolboy.



WHAZ, RENSSELAER POLYTECHNIC STATION AT TROY, N. Y.

ANOTHER station which opened up with a powerful transmitter in September, 1922, is WGM, belonging to the *Atlanta Constitution*, of Atlanta, Georgia. Previously, a small set of low power had been used to provide local entertainment, but the new 500-watt set is sending music and speech not only throughout the entire South but even into most of the states on the eastern seaboard and in the Middle West.

KDYL

IS THE broadcasting station owned by the Telegram Publishing Company, Salt Lake City, Utah. It is one of the few broadcasting stations in the country where most of the work has been done by a single man. Mr. Ira Kaar designed and superintended the installation of this station. It opened on the evening of August 28th and has been heard in a great many states as well as by ships at sea.



(ABOVE) ANOTHER NEWSPAPER BROADCASTING STATION: WGM IN ATLANTA, GEORGIA

(BELOW) A CORNER OF THE KDYL OPERATING ROOM, SALT LAKE CITY, UTAH



The Signal Corps in Alaska

By DONALD WILHELM

SINCE there are two sides to most questions, it behooves us to listen to the old-timers in the Signal Corps who assure us that "the Navy hasn't done it all in radio!"

They take you back and show you how, quite uncontroverted, it seems, the annual reports of the Signal Corps, for a half dozen years in succession hammered this paragraph home:

"As is well known, to Mr. Marconi's inventive genius and persistent application is due the demonstration of wireless . . . to the civilized world. Prior to his extensive work at the expense of the *New York Herald* and in connection with the international yacht race, the Signal Corps, on September 30, 1899, had operated its own system successfully between Fire Island and Fire Island Lightship, a distance of ten miles. In April, 1900, it opened two stations in New York Harbor, where messages were passed daily to and fro between Governor's Island and Fort Hamilton."

This work, the Annual Report of 1900 says, was originally undertaken by Lieutenant-Colonel James Allen and a certain Captain George O. Squier. Moreover, the Signal Corps then had in operation two additional stations in San Francisco Harbor and "was looking to the

establishment of stations in the Philippines, at suitable points."

The old-timers add, for good measure, that way back in 1862 the Navy got even its wig-wag system from the Signal Corps!

Then, coming forward again, they tell the simple yet startling story of an event that re-

sounded literally around the world, that, for the first time in history, linked this continent by radio with the Continent of Asia; or would have done so if there had only been someone or other with a receiving set on the Kamchatka Coast!

That was in 1904, a long time back in the history of radio. So the meager records of this event, which filled space in newspapers the world over long before the word "radio" was used, are all the more interesting.

In the years immediately following the initial work with wireless by the Signal Corps, there were disappointments, both in results and in funds.

That is why, when the Filipinos were still in rebellion, the Signal Corps gave over its contemplated plan of bridging the big gaps of the Island Archipelago with wireless, even though some of our outposts were "so remote from headquarters that two weeks' time was required to receive communications." And that is why you find a Congressman expressing his views of instruments now casually



A LONELY OUTPOST
Of America's vast communication system



A CLOUDY DAY ON THE YUKON

This is typical of the remote regions which the Signal Corps spanned by radio in 1904

referred to as transmitters, like this: "Sounded like a battery of guns, that thing! And sparks! I tell you this wireless business is impossible, practically!"

Nevertheless, there were officers who were devoted enough to wireless to continue their experiments out of office hours. And one also finds references to wireless tests made, in connection with Army and Navy maneuvers, of the De Forest, Fessenden, and Marconi systems, with the preference in one instance given to the De Forest system, because, as the old record says, "unfavorable conditions interfered with the work of the experts of the Fessenden and Marconi systems."

Then the time came, after two years of experimentation and very doubtful success in wireless generally, when the only conceivable way to bridge two gaps in Alaska, at the end of the Signal Corps' new Alaskan cable, was by the use of wireless.

Here was this enormous country, Alaska, which, if superimposed upon the United States, would extend from Wyoming to the Bahamas, off the Florida Coast; here was a submarine cable reaching it, a distance as great as that between Newfoundland and Ireland; here, in Alaska, were land wires as long as from Wash-

ington to Texas; here were these gaps that wires could not bridge. Also, here, was the coldest of cold weather!

So in 1901 the Signal Corps made contracts for wireless stations "to operate between Fort Davis (Nome City) and Fort St. Michael, and also covering the Tanana Marshes . . . between Fort Gibbon and the vicinity of Bates Rapids."

But, it was provided in the contract that no payments should be made until these lines had operated ten consecutive days!

Result: The stations were not built.

Hence, when 1903 came round, on the one hand you find the Chief Signal Officer thinking it advisable "to stop experimental work in wireless pending development of that science by experts in civil life", and, on the other hand, Captain Leonard D. Wildman, of the Signal Corps, working more or less on his own, between Forts Wadsworth and Hancock, in New York Harbor, a distance of twelve miles. By 1904 he and his men had linked up Safety Harbor (Nome City) with Fort St. Michael, a distance of 107 miles, by wireless!

Then, in the late summer of 1903, Captain Wildman directed the establishment of two bases in Alaska, at Safety Harbor and Fort St.

Michael, preparatory to reaching across 107 miles, a distance which could not easily be covered in any other way. At these bases were built portable houses in which were installed gasoline engines and wireless apparatus supplemented by two masts at each station 210 feet high, between which were supported fan-shaped antennas consisting in each case of 125 copper wires one foot apart. The power consisted in each case of "a 5-horsepower gasoline engine and a 3-kw motor dynamo, 60-cycle alternator". The report added that at one station there was "a transformer stepping up from 500 to 20,000 volts, and at the other, one stepping up from 500 to 25,000 volts."

At noon on August 4th, of the following year, 1904, the wireless material which Captain Wildman had been developing in the States was delivered at St. Michael. "At 9 o'clock on the 6th," he reported, "complete messages were exchanged and the telegram from me at Safety Harbor was released and sent forward. No serious trouble of any kind was experienced and every part of the machinery worked in a perfectly satisfactory manner. Since that time we have been pushing the machinery overloaded to 20 per cent. in order to see if it could be broken down. . . .The signals are fine,

and louder than I have ever heard them at either the stations at Schuyler or Wright. The operators have no difficulty in reading messages while the relay is working in the same room and with the engine running in the next room and men walking about and talking in an ordinary voice anywhere in the house."

The next day, the Nome station was thrown open for commercial traffic between Alaska and the outside world. Moreover, had some fan or other possessed a receiving set, somewhere along the Asiatic Coast opposite Nome, he could have been in communication by radio, for the first time, with our hemisphere.

And to top off this bit of a forgotten story, let us quote an official report:

"During the long winter, there was work to be done up there. Broken Leyden jars were successfully replaced by air condensers, the spark was muffled, and many other improvements applied. In fact, the efficiency of the service is largely attributed by Captain Wildman to the ingenuity and resourcefulness of his subordinates, Sergeants Harper, Monroe, Treffinger, Wilson, and McKinney, the latter being especially noted because he devised a key that increased the sending capacity from fifteen to thirty words per minute."

BACK IN '99

The Signal Corps used the heliograph for "wireless" communication. Like radio waves, the heliograph messages traveled at the rate of 186,000 miles a second



Locating Illegal Radio Stations*

By L. E. WHITTEMORE

Alternate Chief, Radio Laboratory, U. S. Bureau of Standards

ALL transmitting stations within range are really sources of interference if you are trying to listen to some other station. No receiver thus far developed can tune out absolutely all signals excepting those it is desired to hear. Receiving sets differ greatly in this particular, and it is possible to tune much more sharply now than a few years ago; but the problem of eliminating the signals from certain stations is particularly troublesome when you have to deal with near-by transmitters. In fact, it has been suggested that high-power transmitting stations be prohibited from operating in regions where there are a number of receiving stations handling a large amount of commercial traffic.

Since these difficulties are all too plentiful among stations which are handling commercial business and are entirely legal in their operation it is of particular importance that interference be avoided from stations which are operating illegally.

Sometimes stations cause interference quite unknowingly, and sometimes radio waves which cause a great deal of trouble are sent out from electrical apparatus or circuits whose useful performance lies entirely in some other field of activity. It has been observed that there may be serious interference from X-ray machines, violet-ray machines or apparatus employed in electrical precipitation processes. Leaky insulators on high-voltage power transmission lines may also be the cause of radio waves capable of reception by near-by sets. The recent radio telephony conference recommended that a study be made of the means required to avoid interference from such sources. It is sometimes difficult, especially on the part of operators who are not thoroughly acquainted with radio apparatus, to distinguish between the interference caused by these electrical machines and power lines and the interference caused by actual transmitting stations.

Those who have just become interested in constructing their own transmitting sets some-

times find it convenient to use a small automobile spark coil with a plain fixed gap, instead of a well-designed transformer and quenched gap with its associated circuits. Entirely by ignorance, these operators in experimenting with their sets send out waves which are extremely broad and cause serious interference in their immediate localities over a wide band of wavelengths. Certain operators of radio telephone broadcasting stations do not realize that when the programmes have ceased or during an intermission, the transmitting set, if allowed to continue to operate, emits unmodulated waves which cause a blanketing of other signals in the immediate neighborhood, or give a troublesome beat note in receiving sets which are tuned to closely adjacent wavelengths. These radio telephone sets should, therefore, be disconnected from the power supply at all times when the broadcasting service is discontinued. Much unnecessary testing is done with the transmitting set connected to the antenna instead of disconnecting the antenna circuit entirely while using a "dummy" or "phantom" antenna which causes very little radiation.

It speaks very highly for the radio amateurs of this country that in spite of the fact that there are over 15,000 licensed amateur transmitting stations at the present time, there has been so little willful and unnecessary interference that almost no attention has been required from the radio inspectors in tracing sources of such trouble. The amateurs have, through their local clubs, coöperated very heartily in almost every case in solving for themselves the problems arising from ignorant use of transmitting stations.

The rapid growth of broadcasting, however, has brought forth a number of complaints of interference which perhaps seem more aggravated on account of the fact that many of those who listen in are not familiar with the limitations of radio as a method of communication.

The radio laws call for the licensing of all transmitters whose signals can affect the reception of messages from beyond the bound-

*Published by permission of the Director of the Bureau of Standards of the U. S. Department of Commerce.



ARTHUR BATCHELLER, U. S. RADIO INSPECTOR
In charge of the Second District, keeps a close watch on the ether

aries of the state in which the transmitting station is located. On account of the very sensitive receiving apparatus now employed, this practically means that all transmitting stations must be licensed in order to operate legally. The call letters which are assigned to them at the time they are licensed, are for use in identifying the transmitting station whose signals may be heard. Sometimes the operators forget to sign their call letters at intervals during the handling of traffic and this raises a question as to whether or not the messages are being sent out from a station which is properly authorized.

In locating outlaw stations, the direction finder is indispensable. By its use it is possible to determine promptly the general direction of a transmitting station, and often to find its position exactly within a short time.

A direction finder in its simplest form consists of a few turns of wire wound upon a frame 3 or 4 feet square. The two terminals of this

coil are merely connected to the terminals of a variable air condenser. From these terminals connections are made to the grid and filament terminals of a detector-amplifier. The signals from the transmitting station are loudest when the coil is turned so that its plane is in line with the direction in which the received waves are traveling and the signals are weakest when the coil frame is turned at right angles to this direction.

The coil constituting a direction finder is really merely an antenna so constructed as to be easily portable. Such an antenna when used with a radio-audio-frequency amplifier constitutes a receiving set sensitive enough to receive loud signals from considerable distances when the coil is turned in the maximum direction, or to obtain a sharp indication of the direction of the minimum signal when used within a few miles of the transmitting station.

It happens, unfortunately, that in densely populated districts, where sources of radio

interference are most likely to be serious, the waves from a transmitting station are distorted and carried out of their normal path by electric power lines, trolley wires, the metal frames of large buildings and other metallic objects. The effect of such distorting influences was described in an article in the June issue of Radio Broadcast, entitled "Objects that Distort Radio Waves." A radio detective should be able to make good use of the knowledge of the distortion which radio waves undergo, but without this knowledge he might be seriously handicapped in his efforts to locate an illegal radio station or determine the location of some electrical machine which is causing interference.

The rapidly increasing congestion of radio traffic will require that amateurs and radio inspectors be equipped in the future to trace illegal radio stations and determine their locations. Whenever possible, direction-finder observations should be made in open fields or parks where the distortion is not serious. Two or three such observations of direction at points quite distant from one another will enable the inspector to locate on his map quite closely the position of the station which is being sought. Sometimes this brings him close enough to see the antenna and approach the station without difficulty.

Where these open spaces are not available, or after the general location is first determined, it may be necessary to use the direction-finder in city streets or among buildings where distorting wires are present. In such a case the inspector will set up a radio direction-finder and receive the signals or communications which are

being transmitted by an undesirable station. He will observe the apparent direction of the transmitting station, make note of the surrounding objects which may cause a bending of the waves and an apparent change in the direction of the station which is being sought. He will then move his direction-finder to some distant point possibly symmetrically placed with respect to the distorting structure and make another observation of the direction of the received wave. By moving his direction-finder to several points some distance from one another and taking his observations with proper consideration of the effect of the surroundings, he can rapidly go toward the point of intersection of the direction lines and finally move up to the transmitting station itself.

In the streets of a large city the objects which cause a bending of the radio waves are so numerous and so varied in size as to make this problem a difficult one. Sometimes the waves will appear to travel along the street while the transmitting station is actually in the line of a cross street, but by taking a series of observations at carefully chosen points and noting particularly the location of large steel buildings, bridges, elevated lines, or trolley wires, the errors may be foreseen to a great extent and the inspector may find the transmitting station much more quickly than if he were merely to move in the apparent direction of the wave as first determined. The cases which the inspector or the amateur radio detective finds which do not give the correct direction serve as interesting examples for further study leading to a fuller knowledge of the behavior of radio waves.

Radio Personalities

VI

DE FOREST—THE DREAMER OF A DREAM THAT CAME TRUE

By C. S. THOMPSON

A SLOW-MOVING river—a broad field of green—white tents—the sound of soldiers marching—bands playing—lowering of colors—and my first day in the "Yale" Battery of the Spanish-American War found me alone in the hour of camp hilarity.

My attention was soon attracted by a young soldier, alone too, deep in study, in the tent next to mine. He was a dark, rather tall angular-looking lad.

"Studying regulations?" I asked.

"No, just a little of the old college work," he said, without looking up.

But that same night, as we were walking along the Niantic River, this soldier-student said to me:

"This little book you've found me reading means a good deal to me, in fact, the subject it deals with will mean everything to me after we've defeated the Spaniards. I feel it may also prove some time of great importance to humanity—I've felt that way ever since I entered college. When my father died, a few years ago, and I was thrown upon my own resources, I decided to continue my studies by working my way through college. I mowed lawns, waited on the table and worked in summer hotels. I graduated from the Sheffield Scientific School in '96, and ever since I've been preparing for a doctor's degree. It is my thesis you saw me working on just a few hours ago—the subject is 'The Reflection of Hertzian waves along Parallel Wires.' Hertzian waves!—that means a whole world to me!—a new world of communication—without wires—wireless! There's no other enterprise like it to-day in fascination and in future possibilities."

Marconi was yet to pave the way for public interest in wireless by his early demonstrations, but even then my soldier friend, Lee De Forest, saw what was to come. The universal development of radio on a practical basis—his life-long dream!

Among the busy duties of camp life, I soon lost track of my enthusiastic companion and forgot the idealistic vision of the future which he had on that one evening revealed to me.

Shortly after the war was over, De Forest obtained his doctor's degree and went to work in Chicago. His first job was at the Clinton Street shop of the Western Electric Company, at \$8 a week. Teaching night classes in mathematics at the Lewis Institute and translating French at one time or another for the *Western Electrician* also helped. For a year and a half, the young inventor lived on next to nothing, so that he could conduct his research freely at the Armour Institute.

It was in the midst of these early-day struggles and privations that De Forest developed the self-restoring detector to take the place of the Marconi coherer, the telephone receiver to replace the relay and Morse inker and the alternator-generator and transformer to replace the induction coil and the interrupter.

In 1901, with his apparatus perfected to the

point where it could be used commercially, De Forest left for New York. Financial aid was necessary to float his company and develop his new American System, which, even then, had been proved superior to the older and well-established Marconi and Telefunken systems of Europe. Nevertheless, in the summer and fall of that year, De Forest walked his shoes out in Wall Street and Lower Broadway before he obtained the necessary backing.

His first commercial undertaking with the De Forest Wireless Telegraph Company, that same year, was the reporting of the International Yacht races. Then, during the historic tests by the British Post Office between Holyhead and Howth across the Irish Sea, De Forest demonstrated over all competitors the great advantages of his system. In 1904, he attained wider recognition for his system through the spectacular success of the London *Times* war correspondent, Col. Lionel James, in reporting the Naval maneuvers at Port Arthur



during the Russo-Japanese War. In the summer of that same year, also, came the first continental overland wireless service, established by De Forest between Chicago and the Exposition in St. Louis. In 1905, the honor of constructing the first high-powered wireless stations at Colon, Guantánamo, San Juan (Porto Rico), Key West and Pensacola, was accorded him by the United States Government.

Success had come, but only for the moment, for the fortune and recognition, won after so many years of struggle and sacrifice, were soon swept away, and the young inventor saw his company in the hands of others, with even his name removed from the corporation which he had made famous.

It was after this period of financial depression that I met him again. De Forest had made a crude laboratory in the old Parker Building in New York City. As he was explaining his laboratory to me, he picked up an audion bulb.

"This is my greatest discovery!" he said. "This little bulb is going to revolutionize the world of communication! It will make it possible for us to talk by radio telephone, not only over short distances, but across the lands and seas. I took out my first patents on this audion a little over a year ago, but it was in the hard days in Chicago that I first conceived the idea.

"I was at work in my room, one night, ex-

perimenting with an electrolytic detector for wireless signals. It was my good luck to be working by the light of a Welsbach burner. That light dimmed and brightened again as my little spark transmitter was operated. The

elation over this startling discovery outlasted my disappointment when I proved that the startling effect was merely acoustic and not electric. The illusion had served its purpose. I had become convinced that in gases enveloping an incandescent electrode resided latent forces which could be utilized in a detector of Hertzian oscillations far more delicate and sensitive than any known form of detecting device. And now at last I have managed to bottle this same gas effect!"

As he went on, he became even more enthusiastic:

"I've been asked to put radio telephones on the fleet going around the world. It won't be long then before all the ships will be equipped with it. It'll be on the yachts, tug-boats, steamers and sailing vessels too, and we'll soon be able to talk with our friends at sea. Passengers on moving trains will be able to radiophone to stations, and there be connected with the wire telephone. Church sermons, lectures, orchestral and grand opera music, too, will be sent out by radio throughout the country! The world needs this little audion; it is the one thing towards which I have been working all these years!"

In the spring and summer of 1907, through the transmission of music by radiophone,

through reporting yacht races on the Great Lakes, and later by broadcasting grand opera from the Metropolitan Opera House at New York, De Forest sought to create interest in the new art.



DR. DE FOREST

Experimented with bulb transmitters for airplane use, during the war, when patriotic service suspended his efforts in the field of broadcasting

Even thus early, foreseeing the field of public interest, he built radio apparatus for the amateur—for the citizen who was interested in picking up words and music out of the air. With his second De Forest Radio company, all his available funds and ingenuity were thrown into the cause of broadcasting.

It is clear that the public of that day was fully informed by De Forest of the possibilities of radio development. Newspapers were filled with his predictions. Reporters obtained from him long interviews. The Sunday pages were highly decorated with the stories of his achievements. Nevertheless, his appeals fell on empty ears. "The radio toy," some described it. Others read and forgot. Leaders in engineering, scientific, and educational circles were skeptical as to

the possibilities of broadcasting.

In the end, borne down by commercial rivalry, the Radio Telephone Company through which the inventor had hoped to interest the public, and to establish the radio telephone, was forced to suspend activity.

All that remained for him in the wreckage was the patent rights to the audion. Even these had been returned to him because they were considered of no value!

There was nothing left apparently, in 1911—the year when I next chanced to meet him—nothing except the spirit of other days.

“I’ve got to begin all over again,” he told me, “and that means—just a little more delay. That’s all. The day is coming, when things will be different. I don’t mean financially. I can stand the poverty and work—I mean the day will soon be here when people will see the thing as I see it—will recognize the part the audion will play in human progress!”

Nevertheless, that same year, De Forest was reading the Help Wanted ads in the very papers which, only a few years before, had been carrying pages relating his achievements. The position of Research Engineer of the Federal Telegraph Company was offered him in San Francisco, and he was glad to take it—finding joy in the thought of being able to experiment further on his audion. In the summer of 1912, in that little Palo Alto laboratory, he was led to still higher dreams of success. The audion had already proved to be a detector of remarkable sensitiveness as well as an amplifier of telephone currents; he then discovered it could also be made to oscillate, or to generate sustained currents of any frequency!

The engineers of the period were fully informed by De Forest on the possibilities of the audion. The newspapers and technical magazines were filled with it. Full descriptions of it were to be found in the patent office applications of 1906. De Forest took out his first patents applications on the audion as a wire telephone amplifier as early as 1907. But it was not until 1912 that the inventor was given his first opportunity to demonstrate the audion before the engineers of the American Telephone and Telegraph Company—the audion which, when further developed by them, made possible the transcontinental telephone service between New York and San Francisco, and later on the radio conversation from Arlington to Honolulu.

With the funds thus secured, the inventor established his De Forest Radio Telephone and Telegraph Company, and thereby sought to

realize his first dream of radio broadcasting. In 1916, many an amateur heard his nightly concerts, news bulletins, and election returns by radio from the Highbridge laboratories. The press told of this and of dancing to radio music, and from these reports emanated the idea of the educational as well as the entertainment value of radio. But though the inventor appealed to many, there was still no one to take the first step in this commercial or public enterprise.

Even government officials, who were in a position to help the broadcasting of news and music, vetoed this “pastime” on the score that it interfered with the Navy’s wireless telegraph.

The new era of radio which De Forest had predicted as far back as 1907, which he had so plainly demonstrated, appeared to be fading away!

Patriotic service during the World War interrupted his efforts towards broadcasting. Immediately afterward, De Forest made a desperate appeal to the publishers of the various newspapers of the country for recognition of the many possibilities of radio transmission. Only one responded, and the first newspaper radio service in the world was established in 1920 by the *Detroit News*.

With New York still blind to radio, De Forest went to San Francisco, where he started the broadcasting of orchestral music from the California Theatre. Shortly afterward, the directors of the Westinghouse Company opened their permanent stations at Pittsburgh and Newark. But the public interest was yet to be aroused!

De Forest sailed for Germany in November, 1921 to experiment on still another use of the audion—the production of talking motion-picture films. At about this time came the radio awakening in America, and some six months later, the inventor stepped ashore in New York from a European steamer. His hair was tinged with gray, but in his eyes shone a new light, as he turned to me and said: “*My dream of radio is finally coming true!*”

What Would You Like to Have in Radio Broadcast?

The editors would be pleased to hear from readers of the magazine on the following (or other) topics:

1. *The kind of article, or diagram, or explanation, or improvement you would like to see in RADIO BROADCAST.*

2. *What has interested you most, and what least, in the numbers you have read so far?*

Captain Kay Makes Port in a Fog

The Passing of "the Old Substantial Feel and Sound Method"

By ORTHERUS GORDON

ALTHOUGH the radio operator had successfully obtained bearings from the coastal Radio Compass Stations on the last vessel he was assigned to, and although the Third Officer had once before used this position-finding service, Captain Kay, of the oil tanker *W. L. Summers*, was frankly dubious.

"He's superstitious, too, like the rest of the old-timers", said Frazer to me. "He won't even give it a try."

This was two and a half years ago, in the days when nine out of every ten skippers entering New York Harbor in a fog were fighting shy of the new-fangled service which flashed a ship's position to it through the air. Most of those who did adopt the service had made the acquaintance of the rectangular aerial while serving in the Naval Auxiliary during the war. Captain Kay was one of these, but he had not seen a radio compass, and wasn't willing to trust his ship to something which was "worse than supernatural on the very face of it."

Not even in this present instance would he give way before modern science, although he was as hopelessly lost as he ever expected to be. He didn't admit it, of course, but he was. The soundings every thirty minutes didn't jibe, the log was running irregularly and the fog was getting thicker. According to his calculations, Ambrose Channel Lightship should be somewhere in the dark ahead. Either that or the shoals at Shrewsbury, or the long, wicked beach of Fire Island. To stop and wait for the fog to lift was out of the question—oil was wanted in New York and he had sixty thousand gallons of it on board. There was nothing to do but flounder around, trying to pick up a line of soundings which looked as if they led to the lightship, and sounding the whistle regularly every two minutes.

"At a loss of five hundred dollars an hour," said Frazer disgustedly. "It's disgraceful—and an insult to our intelligence."

Frazer was a practical radio man, who chafed at the thought of the captain's blindness to the help radio could give him.

"Not to mention the jackass he's making of himself in the bargain," he continued. "Oh, if people ashore only knew how their intrepid skippers shiver and quake out here in a fog—if the company only knew that they had a man who won't take advantage of a scientific achievement, who is this very moment on the bridge of their pretty ship, hanging on to the rail and praying to heaven that he sees something before he hits it. I'm going up to see him."

On the bridge, Captain Kay stood by the whistle cord. The second mate was on the starboard wing of the bridge, listening anxiously for the slightest indication of a fog signal. On the foc'sle head was a lookout, placed there to scan the water close down in an effort to see a ship, or land, or a

light-vessel fifteen or twenty seconds before it could be seen from the bridge.

"The *Western Bridge* just got her position by bearings—," Frazer began.

"And I suppose you want me to ask for the same help," broke in the old sea captain. "This is not the first time I've made New York in a fog, young man, and I am not crying for help at this stage of the game."

That is the trouble with most of the old-timers—they feel they are asking for help, and that it is a disgrace to send in to a radio station for a position.

"It's not crying for help—you can use it as a check on your soundings." This from Frazer.

"You know where you should be and what you should be doing, don't you?" said Captain Kay swelling up in rebellion like a pouter-pigeon; "then do it," he pursued, as if to an imagined reply.

Frazer left the bridge, went to the shack, which was in with the officer's quarters, and asked New York for radio bearings. He got a standby, then orders to go ahead with the



distinctive dashes used by all stations requesting bearings, and finally got his location. One from New York, the second from Cape May, and the third from Fire Island. He took them on the bridge and gave them to the captain.

"These are true bearings, Captain," he said, "and they don't have to be corrected for deviation or variation."

The captain swore. Then he looked at the sheet of paper. Then he swore again. Nevertheless, he took the bearings to the chartroom and plotted them on the chart. Much to his annoyance, Frazer hung over him.

"I'm not there—radio bearings or no radio bearings. They're no good. I'm at least thirty miles ahead of that position."

"Perhaps the log has been over-rating," suggested Frazer.

"I go by engine revolutions."

"Then we must have more current than usual—or a deeper drag. But that's where we are." Frazer was as confident as though he had just worked out a sun observation for longitude and latitude. "You are against a scientific exactitude—it can't be wrong."

This was strong; he watched the effect it would have on Captain Kay.

"Get another one," snapped the captain. "When we get in New York by the old substantial feel and sound method, we'll take the occasion to write these radio people and show them how much they're wrong."

So the captain went on the bridge again, and Frazer returned to the radio shack for another set of bearings. The first and third mates were amused spectators of this war between the skipper and the "radio" and were anxious to see how it turned out. Every fifteen minutes, when the second mate came down from the bridge to take a sounding, he dropped in to grin and to report progress.

"He's been looking for Ambrose for the last two hours," he said. "If it wasn't for the bearings, he would have stopped and floated around long ago. He's lost all confidence in his own reckoning, and for the first time, two soundings ago, the depth agreed with his idea of where we ought to be—and that idea was gained by the last radio bearings."

Something did seem to be changing in the Skipper's attitude. And the change, once begun, became rapidly more apparent.

Frazer was getting reports every thirty minutes now, and the instant he arrived on the bridge with a set of them in his hand, the captain rushed into the chart-room to lay the bearings down and check them with the last position. Finally, on the strength of three positions in line, he changed course, and increased his speed when the next two bearings indicated plainly that there was no mistake. He took soundings regularly, and was tickled to see them jibe with the radio positions.

The captain now capitulated—signed on the dotted line, as it were, and handed over his sword to the enemy.

"All a fellow wants," he said, "is one of these things. Why, it's like seeing a lighthouse! You can go right in on your own hook."

All this time, the *W. L. Summers* was approaching the end of her journey, and for the second time

that afternoon the captain was looking for Ambrose Channel Lightship. The number of ships whose whistles he could hear reassured him, and he steamed almost at full speed on the course line taken from the positions secured by the radio operator. Frazer was as happy as a child. He knew enough, of course, to keep away from the bridge and not to come out with "I told you so" to the skipper; but when finally the fog whistle of Ambrose was reported dead ahead, he was as pleased as the port superintendent of the line was next day, when that official heard that the *W. L. Summers* was at her dock in Bayonne and had already discharged twenty thousand gallons of her cargo.

"Made it in the fog, eh?" he asked the skipper.

"Last night," replied Captain Kay, "I had what might be called a twentieth century adventure, and in waters I have known since I was a kid. I came in by wireless, and you have the U. S. Government to thank for saving us about twenty hours' delay—a matter, I believe, of some ten thousand dollars. Well—it looks as if my business has gone ahead of me—but I'm not too old to chase after it."





KING ELECTRON M.D.

Several Pills for Radio Ills

By R. H. RANGER

Engineer, Radio Corporation of America

Illustrated by TOM MONROE

NOTHING works.
The set seems dead!
The case may be serious, or it may be easily remedied. In any event King Electron will start his diagnosis at once.

First, a rapid survey will be made to see if there are not some obvious breaks in wires, or even a part missing. If not, tests may then be rapidly made, starting with those parts which are ordinarily the first to give trouble. The best test for any part of a radio set is also the simplest—is that part functioning as it is supposed to? For example, a battery is designed to furnish power. Will it? If none of the bulbs light in your tube set, disconnect the filament battery leads from the set and touch them together for an instant. There should be a good spark from a storage battery and a fair one from dry cells. If not, the trouble is either in the battery or in its leads. If no break is evident in the leads and the connections seem good, try a direct test on the

battery by touching a single connecting wire for an instant directly to its output poles. If the battery is obviously dead, there is nothing to do but to get a new one in the case of a dry battery, or to recharge it if a storage battery. If recharging produces no results, there are fortunately many experts in the automobile battery repair shops. It is far better to take a storage battery to an expert in the early stages of evident trouble than to wait until it is practically ruined.

KEEPING THE BATTERY IN GOOD HEALTH

THE condition of the battery at all times should be known, even when it appears to be giving satisfactory results; and the hydrometer provides a simple means for determining it. This instrument consists of a glass tube with a rubber bulb at one end which will draw liquid from the storage cell up into the tube where a small float indicates the density of the solution. The following table indicates the density condition of an ordinary lead battery:

CONDITION	VOLTAGE PER CELL	DENSITY
Charged	2.2	1.260-1.280
In Service	2.0	1.225
Discharged	1.8	1.175

King Electron has found many of the hydrometers furnished with sets in the original box unopened! No wonder batteries develop all kinds of ills. The hydrometer is King Electron's thermometer.

It is most important that the direction of charging storage batteries be correct. The positive output terminal of the charging set should be connected to the positive or red terminal of the battery. King Electron has found one case at least where the charging was carried so far in the wrong direction, that the pole which had been negative (—) was made positive (+) and *vice versa*. However, it could not give good results in such a condition. A little care will easily prevent this sort of mistake.

If everything else seems as it should be about an amplifier set, yet a poor signal, or none at all, results, try reversing the filament battery connections to the set. The wires may have been connected wrongly after charging. Also, see that the plate battery connections check up with the hook-up as shown in your (correct) circuit diagram.

LOCATING TROUBLE WITH KING ELECTRON'S STETHOSCOPE

KING ELECTRON has one of the very best testing outfits for electrical instruments at hand with the usual radio set. This is the ordinary telephone head-set. The telephone receiver is a most sensitive indicator of electric currents, so with this as his stethoscope,

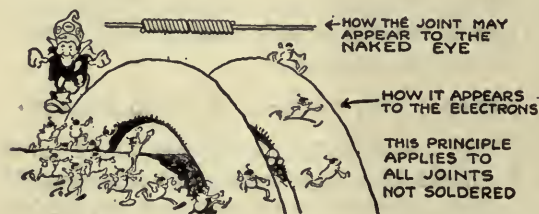

King Electron can quickly determine the condition of the various parts.

The telephone receivers are not apt to give trouble, and for the moment it will be assumed that they are in good condition. That they are may be readily determined by putting

them on, holding one of the cord terminals in one hand and touching the terminal swinging free to almost anything metallic. A distinct click will be heard. For example, touch it to the antenna wire. Or, if there are electric lighting wires in the house, touch the free terminal to the metal part of a fixture and the characteristic humming sound of the power current will be heard although there is no direct connection to the electric power.

NOISY BATTERIES AND TUBE TROUBLES

IF THE radio set is noisy, the trouble is likely to be with the batteries. King Electron takes the telephone receivers and puts them rather loosely on his head in order not to get too loud a crack in his ears. First he tries the storage battery. If, when he makes a connection between the two sides of the battery, he hears a good click and then nothing, the battery is acting normally. If there is noise, the battery is at fault. A sound similar to escaping steam indicates the need of charging a storage battery. The same test applied to a plate battery may indicate a crackling sound. There is nothing to do but to throw away such a dry battery.

Having assured himself of a good battery supply, King Electron now looks to the tubes as the next most common source of trouble. If none of them light, the battery connection is bad, or the tubes do not make good contact in their sockets, or are burned out. In connecting up a set, King Electron always leaves the plate, or "B" battery to the last and gets the tubes lighted correctly without it. There is then no chance of ruining a tube by getting the plate battery connected to the filament terminals. The battery is then connected.

It is usually possible to see whether a tube is burnt out by looking to see whether the filament is broken. A break near one of the filament supports is many times caused by shock occurring in shipping or handling the tube.

If no tube lights in a particular socket, the trouble may be in the springs of that socket, which should be bent slightly to make firmer contact with the base terminals of the tube when it is placed in the socket. If this does not remedy the situation, the rheostat is the next thing to examine. If the same rheostat controls other tube sockets which are working, the trouble must be in the connections between the rheostat and the socket. Rheostats will burn out themselves, but usually only

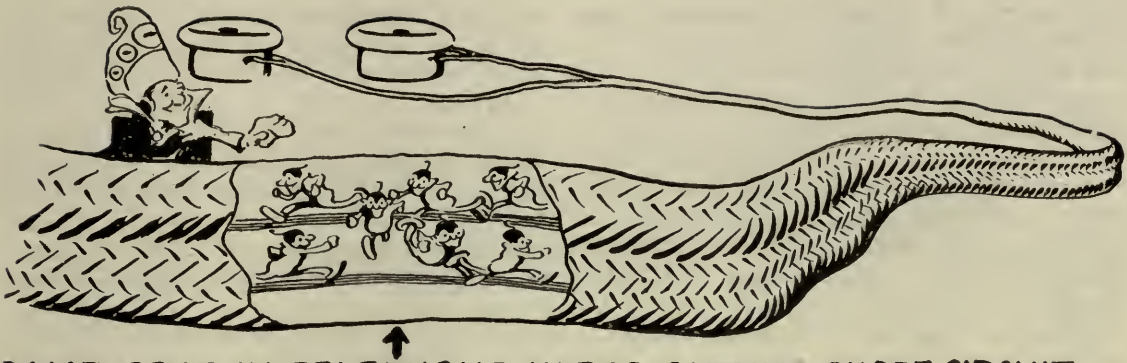

DAMP SPOT IN TELEPHONE WIRES CAUSING SHORT CIRCUIT

when tubes are used which take a larger current than those for which the set was designed.

With the tubes now properly lighted and still no signals, King Electron puts the telephone receivers back in their proper place and tests out the amplifier and detector. By tapping lightly on the tubes in succession, a ringing sound should be easily heard. If this is heard distinctly each time, the trouble is further ahead. If not, it is necessary to test the amplifier and detector connections. When the telephone receiver is disconnected and reconnected in its proper place, there should be a distinct click in the receivers. If not, there is an opening somewhere between the plate battery, the telephone receiver connections and the plate connection in the last tube. If the click is heard but no ringing sound when the last tube is tapped, either the tube is itself at fault or the transformer, which is connected to the socket of the last tube. It is always a good plan to have one or two extra tubes in order that they may be substituted to determine whether or not a particular one is at fault. In fact, much better results may often be obtained by substituting one tube for another. Although each of them may work to a certain extent, by getting just the right sequence of tubes, better quality will result.

If the trouble does not appear to be in the last tube, it is in the transformer ahead of the tube. In some amplifiers, resistances are used in place of transformers. About the only remedy here is again substitution of other transformers or resistances, and this is best done in a repair shop. Be sure the connections are right before condemning the transformer itself.

With the last tube now working correctly, the others may be tested in succession. For this, the receivers are removed from the regular connection. One of the terminals of the cord

is then connected to the plus "B" battery terminal in place of the plate battery connection, which is removed. Any of the amplifier and detector stages may now be tested in most sets by turning on the respective tubes alone. With any tube but the last on, a distinct click will be heard in the telephone receivers when the free telephone cord terminal is connected to the loose positive terminal of the plate battery. No click should be heard with the tubes all off. If a loud click is heard under this last condition, a short-circuit, either in the connection or in one of the tubes, is indicated.

If no click is heard with any particular tube lighted as the free telephone terminal is tapped on the plate battery "plus" wire, the connections to that tube or the plate of that tube are at fault. Again try the method of substitution to see if the trouble is the tube. If not, if no tube gives a click when lighted in that socket, the trouble is in the transformer. A transformer is made of very fine wire, and this wire may burn out, particularly if excessive currents are put through it to the plate of its connected tube. Again, this argues the use of as low currents as possible to give good signals. As in medicine, an ounce of prevention is worth a pound of cure. The use of transmitting tubes in receiver sockets may also cause transformers to burn out unless they are designed for just such use as will be indicated in the instructions that come with the sets.

A burnt-out transformer, as a burnt-out tube, is only remedied by a new one. The labor involved in repairs is much greater than the value of the actual materials that go to make them up. Only machinery makes these delicate instruments satisfactorily. And machinery does not know how to remedy trouble which has developed in its finished product.

The first (or in some sets the only) tube is the detector tube. It is usually at the left of the set, as seen from the front. If a tube set works for an instant and then plugs, the trouble is in the connection to the grid of the detector tube. This occasionally may happen in the input to one of the other tubes, where there is an opening in the grid side of a transformer, but this is rare. With the detector tube, this is usually caused by a faulty grid leak. The grid leak has too high a resistance, so that the "trapped electrons" which pile up on the grid when signals are received cannot get off the grid as they should. They will actually bring the set to rest for an instant until they have had the time to get off through the poor high-resistance grid leak. Most grid leaks are made of India ink on cardboard. A short immersion of such a grid leak in steam will usually add enough moisture to it to lower its resistance considerably. If the resistance is too low, the set will be continuously dead. The judicious heating of the grid leak will usually increase this resistance. Dirt lodged in the grid leak base may also make the resistance too low for signals. Dirt anywhere for that matter in the connections of the set will reduce the efficiency. It is well to look also for the green copper oxide which is to copper what rust is to iron. It will cause leaks and may even indicate a place where the wire is eaten away.

TESTING THE GRID CONDENSER

IF THE set still fails to function, the trouble may be in the grid condenser. One of the wire terminals may be loose or open, or the condenser may be shorted. To determine this, a small dry battery (the plate battery will do) is connected to the condenser and the telephone receivers in series; i. e., wires connect each one to the next in such a way that current from the battery has to pass through each in turn and then back to the battery. Now as the final connection is made and broken, a soft click should be heard if the condenser is all right. This click will be much fainter on the second making of the connection as the condenser has been charged the first time. If a steady click is heard each time, the condenser is most likely shorted.

With all the tubes lighted, the telephone receivers connected back in place, and a ringing

sound on tapping each of the tubes, and *still* no signals—the trouble resolves itself in the tuning elements of the set or in the antenna and ground.

If the set has a variable condenser, a scraping should be looked for which would indicate that the condenser was shorting from one set of plates to the other, which it should not do. The condenser may also be tested for its value as a capacity to hold current as just outlined for the grid condenser.

The inductance coil of the tuner should be tested for continuity by connecting it in series with a battery and the telephone receivers. A good click should be heard each time the final connection is made and broken if the inductance is working properly.

If there is a "feed-back" coil connected to the detector tube, this forms part of the plate connection of the first or only tube and will be tested along with the plate circuit of this tube as given before.

STILL NO SIGNALS?

THERE remain now only the antenna and the ground. To see if the antenna is alive, disconnect the lead-in wire from the set and let it hang free. Now take the telephone receivers as before, with one of the cord terminals held in the hand. The other terminal is touched to the lead-in. A distinct click should be heard. If not, there may be an opening from it to the outside wire, or the antenna may be grounded. Many people use great care in keeping King Electron and his band on the proper route in the antenna wire outside the building, and then grow careless of the insulation of the wire inside the building. This insulation should be well attended to, with insulated wire touching the woodwork at as few points as possible. Every point of contact with the antenna before it reaches the set means just that much more energy lost. Length is most important in antenna wires. For 360-meter waves, 150 feet of antenna is much better than 125. Very little is gained above 175 feet, however, except for the longer waves. If so long a single wire cannot be stretched, on account of space limitations, additional wires may be added in parallel to the single wire to make the best of the situation.

There seems to be a popular superstition against the use of insulated wire for antennas. The ether waves will act through insulation

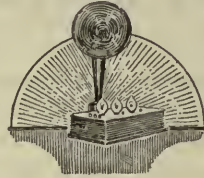

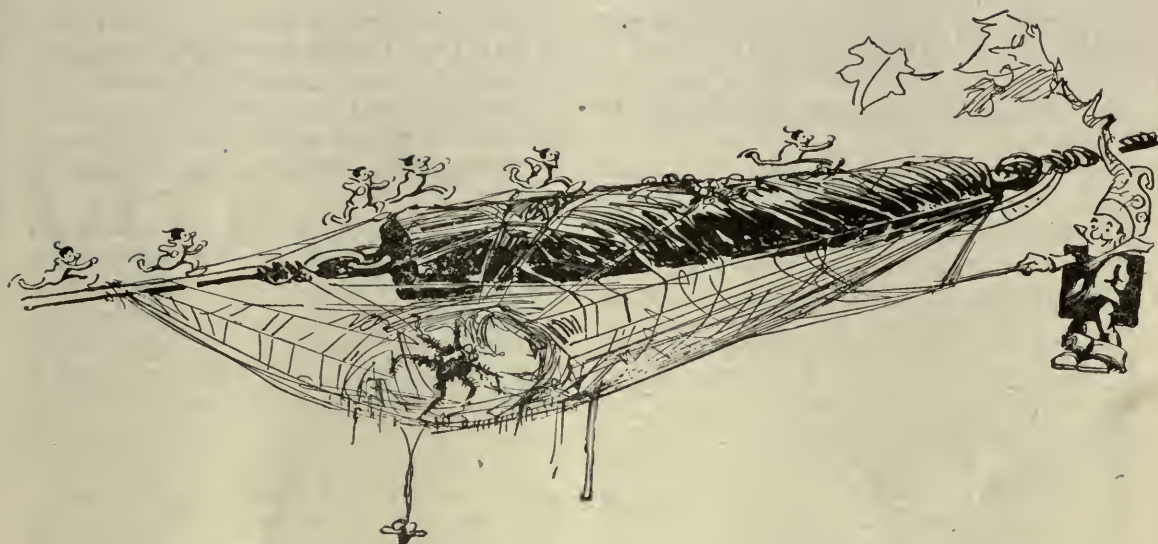

LEAKING ANTENNA INSULATORS CAUSE TROUBLE

This applies to other kinds of insulators as well, such as lightning arresters. Keep your insulators clean. Dirt absorbs moisture, and moisture is an electric conductor

on such wire perfectly well, and the added insulation which such wires give against possible contact with trees or buildings is well worth while, unless the wire is strung absolutely clear. The insulator at the far end of the antenna should also be of the very best. It should be of such design that dampness will not cause a conducting layer from the wire to the support except over a very long path, made long by the corrugations on the insulator, or by its actual length.

SEE THAT THE LIGHTNING ARRESTER IS O. K.

THE lightning arrester may be at fault. If there is a fuse in the arrester, make sure that it is not burnt out or open, by a series battery and telephone test, Dirt in the arrester gap will also short the antenna directly to ground. To determine this, disconnect the antenna wire completely from the arrester for a while, and connect it directly into the set, and see how active it becomes electrically. If the set goes dead again when the wire is connected back to the arrester—there you are! (Be sure the arrester is connected properly.)

AND NOW—THE GROUND

THERE remains but the ground, and it should be to a real ground. A water-pipe is excellent, a steam-pipe very poor, except when the steam is on, and then only mediocre. As for the gas-pipe, its use is forbid-

den by the National Board of Fire Underwriters. The chief trouble in a ground is apt to be in the actual connection between the wire and the pipe. The pipe should be well scraped, and preferably a clamp used to fasten the wire to it. The ground lead should not be over twenty feet long. This may make it necessary to use a ground rod under the window. Dry sandy soil makes a very poor ground. In such cases, what is called a "counterpoise" may be used to advantage. This consists of virtually a second antenna under the first, preferably longer (or covering more area, if several wires are used) than the antenna proper. The counterpoise should be as well insulated as possible from ground. The counterpoise may be made of weather-proof, insulated wire.

Many people are still discovering that radio signals can be received either without a ground or without an antenna. Of course they can, and they always have been. But most of these people have never discovered how much a real antenna and a good ground will help the signals. If a set works just as well with the ground on or off, the ground is surely not good. In some cases, the storage battery may be acting as a ground. It should be kept from direct contact with the ground, as many sets are so wired that a direct connection between the ground and the battery, together with the ground to the set, will short-circuit the battery and the radio energy as well.

A good test of the quality of an antenna and ground may be obtained with "tickler" or feed-back sets. If but little tickler has to be used, the aerial system of ground and antenna is good.

Now that all these tests have been made, surely good signals are being received. A word may then be said on the actual quality of the signals.

HINTS ON THE USE OF TELEPHONE RECEIVERS

IT HAS been supposed that the telephone receivers were working. Of course, breaks in the cord may be determined by pushing the cord together along its length. A break may show up this way, particularly near the ends. The weakness at the ends is overcome by the use of the tie-string placed on the cord at these points. If one of the receivers appears dead, tap the iron diaphragm gently through the centre hole in the cap, to see if the diaphragm is clearing the pole pieces. If not, a slight tightening of the cap may remedy the fault. A paper washer placed under the diaphragm may help also, particularly on strong signals to keep the diaphragm well away from the poles. The receivers may also be weakened by the loss of permanent magnetism in the poles of the receiver. To determine this, remove the cap and see if the diaphragm is well held by the magnetism of the poles. This magnetism is lost by the use of too large currents through the receiver coils. Alternating current, if it accidentally gets into the telephone receivers in good quantity, will destroy this magnetism almost instantly.

A PRESCRIPTION FOR DEMAGNETIZED RECEIVERS

TO REMAGNETIZE the receivers, which is of course best done in a shop, the receiver must be taken apart carefully, to prevent breaking the fine wire of the coils.

The semi-circular magnets in the bottom of the receiver are taken out and wound with some fifty turns of about number 18 insulated wire. The coil so formed is connected for a few moments to the storage battery, and the pieces of iron will have become good permanent magnets again.

Tone Quality. To get the best quality out of a telephone receiver, the cap should not be too tight. Loud speaker horns should be centered well on the hole in the receiver. The diaphragm itself should also be in the centre of the receiver case. This is especially true in the lever type of receiver such as the Baldwin.

The direction of connection of telephone receivers may make considerable difference in loudness as well as in quality. Try reversing the connections. The small vibrating metal armature should be well centred between the magnets of the Baldwin type of receiver.

All the electrons will do their best in the production of good quality music from radio waves, and it is largely a matter of common sense in giving them the best possible chance. The attempt to overwork them should be guarded against, as something is bound to give way sooner or later, besides the quality. In all cases, the instructions with sets or parts should be followed. Gas tubes should be used for detection only, amplifier tubes for amplifiers, and power tubes for power amplifiers, suitably arranged with so-called negative grid batteries.

Many tubes, especially the low-current consumption tubes, should be burned only at a very low heat point for best results. They are so designed as to give off plenty of electrons under these conditions. If they are heated to the brilliancy of electric lights, all the electrons will get away at once. Keep the batteries charged, and the set thoroughly cleaned, and the results will amply justify your efforts.

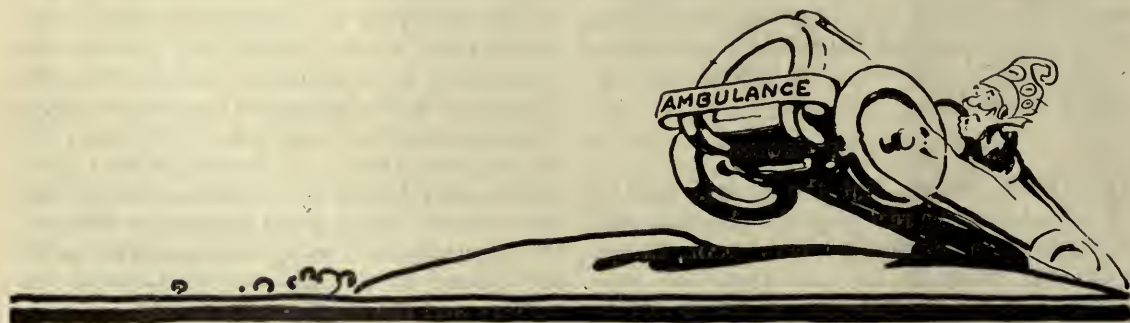

Making the Radio Department Pay

By ARTHUR H. LYNCH

WE CAN sometimes understand how a certain thing may be done properly, by first learning how it should not be done. "We all make mistakes, but only the wise profit thereby"; and it would seem that the lesson might just as well be taken from the errors of the other fellow. Since by learning the pitfalls it is easier to hold to the correct road, let us study some of the pitfalls in retail radio merchandising.

No matter how long a radio department or a radio retailing company has been in business, if it is to continue, it must keep alive to the newest developments. The departments of this character which are making record sales are run by men who live and breathe the atmosphere of amateur radio; they know the amateurs' pet expressions, their whims, and their enthusiasm; they can talk intelligently with the amateurs, because they are generally amateurs themselves when their daily work is over. Having their own outfits at home, they can think as the other amateurs think because they frequently encounter the very same difficulties their customers come in and tell them about.

DEALERS AND THE RADIO CLUBS

THERE are not enough dealers who belong to radio clubs. Those who do are generally observed to be successful. Naturally, some dealers have little time for the radio club, which they sometimes consider nothing more than a gathering of youngsters, anxious to exploit their knowledge. This knowledge is oftentimes profoundly greater than the dealer's own, and he could learn a thing or two if he would spare the time. Other dealers do not like to attend, because they know that their own knowledge is not so great along radio lines as that of some of the younger members of the club, and they feel that their prestige can best be upheld by aloofness. That is a sad condition, but it may be remedied.

There is a man in one of our Southern cities who has been retailing electrical apparatus and sundries for many years. His business has been very successful. When radio came along—that is when it began to gather a little

strength—he realized that it would be a good line to handle and he stocked up. He could afford to spend as much as he desired to furnish such a department, and he ordered just about everything there was listed in radio catalogues and began to get all the radio business for miles around. He not only got the radio business, but managed to pry loose some of his competitors' best customers. (The value of a radio department does not terminate with the department itself, but let us consider that more specifically anon.)

A second dealer soon realized that he was going to suffer more than a small loss, if he did not do something to stop the other's inroads upon his trade. Instead of taking up some radio magazine, making a list of the advertisers, and ordering apparatus from them, he joined a local radio club. For some reason or another he was not held in very high esteem by the young folks of the town but he was permitted to join the club. Then he attended a radio school during the evening and picked up information on both amateur and commercial radio. He read and he listened and he learned—then ordered, not a lot of miscellaneous parts, which were advertised as being for use in connection with radio, but units and sundries for which he knew there would be a demand.

His stock, upon the receipt of his initial order, was just about as great as you would find it if you went into his store to-day, and its value was just about one half that of his competitor's. There was little deadwood and it has only been necessary for him to make a few additions to his line occasionally and re-order what he has sold.

He did a little advertising and the amateurs began coming into his store; some of them out of mere curiosity. He made every effort to satisfy them, and he is now selling most of the apparatus in that particular city. His competitor still has a large stock and probably will have until he wakes up.

Now, the successful dealer did not sell his apparatus simply because he happened to study the "game" and gradually pick up a knowledge of the equipment which would be

in demand; it was because he could talk intelligently with his customers; he could give them advice concerning their purchases which would help them to get the greatest satisfaction from them; he knew their needs and could supply them. His competitor, however, could have sold the same units, for his stock covered about everything needed for radio, but the only knowledge he had of them was their trade names and the prices he paid for them and for which they should be sold; he knew nothing of how they were to be used. In the beginning, he secured the trade because he was the only dealer in the vicinity who could supply the demand; he lost it as soon as his competitor was in a position to supply the demand *intelligently*.

ONE OF THE BEST FORMS OF ADVERTISING

AT THE radio club, the second dealer, by nothing but consistent application and attention, managed to break down the original feeling against him. The fellows admitted that he knew what he was talking about. The club was not endowed with great funds for the purchase of equipment, so, when any particular lecture was to be given, the lecturer would only have to seek this man who would loan all the apparatus necessary for the actual demonstration of the lecture. Can you beat that for advertising?

The practice of one club member's telling all about some new wrinkle and showing how it could be done with apparatus which could be purchased at the local store, soon became a regular thing and the sales went up with leaps and bounds. This particular dealer now requires two counter men to take care of his radio trade, and he does a good mail order business as well.

The men who are behind his radio counter were selected from the best amateurs in the city and he pays them well. They, also, are members of the local radio club and have stations of their own. One of them teaches radio in a local evening school.

GOING OUT MILES TO GATHER IN SALES

THERE are so many good points about this business and the method of carrying it on, that we may well consider more of them. At his home, this dealer has erected a complete

radio station; he didn't go and hire someone else to do it, but put up the whole shebang himself, to learn just what sort of a job it was. He can work with other stations within more than a hundred miles of his home and, in this way, can keep in personal contact with many of his mail-order customers. They meet him, via the air, and they buy from him because they happen to "know" him.

Both his counter men continue to operate their amateur stations, and, by reason of the fact that they are well-known in amateur circles, have a following which they bring to the store merely by being connected with it. They have many a chat over the wire, and are able to let the fellows within miles know how things are progressing.

Do you wonder that this dealer's competitor frequently displays radio equipment in his window, with cut-rate price tags attached to it? He is certainly up against a stone wall, when trying to buck such an efficient radio department as this. The progressive dealer, by the way, has managed to increase his business not less than 20 per cent. *a month*, even during the comparatively dull summer period.

A BAD AND COMMON BLUNDER

IT MAKES little difference what you are selling; the fault we will now consider may be found just as often in the sale of automobile tires, frying pans, or cut-glass bowls, as in radio.

Bill Jones ambles up to the radio counter and asks to see a set, made by the So-and-So Company, and this is about the sort of thing that happens frequently:

After Bill has made known his desire to the man behind the counter, who happens to belong to the same radio club and with whom he is acquainted—let's call him Jack,—Jack's face lights up and he says: "Why, Bill, you are here just at the right moment to get all the dope on a So-and-So outfit." Then, nodding in the direction of a gentleman further down the room, he says, "I want you to meet Mr. Smith, who represents the So-and-So Company, and who is going to give us a little talk at the club this evening. Mr. Smith, meet Mr. Jones, one of our prominent amateurs and originator of the greatest little portable transmitter you could imagine; he is going to have it over at the club with him to-night."



There is nothing apparently wrong with such an introduction, but let us examine what follows right in its wake. The set which Bill Jones came into the store to buy is now the least of his troubles. He has heard about Smith and wants to know what sort of a fellow he really is. It is then up to Smith to "sell" Smith to Bill Jones. Bill begins to find out all about Smith by describing to him the portable transmitter he, Bill, has perfected and bases his opinion of Smith by the interest he displays in the recounting of the wonders of the outfit. Smith, of course, has to listen with great patience and register interest, though he may have heard similar stories in the last ten towns he visited; he has to agree what a wonderful little outfit it must be and all that sort of thing.

Then he has to tell Bill all about the So-and-So Radio Company—going over, for this one man, the whole story he is to tell the club that evening. Finally, he must sell Bill the outfit he came into the store to buy.

In the meantime, all the customers who happened to be at the radio counter at the time of the introduction, likewise forget that they came to make purchases and listen to the conversation of the two, who are reputed to be well versed in radio technique.

The radio department goes out for the air, so to speak, until Bill has made his purchase, said a lot of nice things to Smith, hoped he would surely see him at the club in the evening, and made his departure. Other customers who happen into the store and meet friends at the department, have, "There's Smith, of the So-and-So Radio Company", whispered to them. Bango! for everything they had in mind when they came in, and it is not at all unlikely that Smith will be called upon to perform again, before he has a chance to grab his hat and bag and escape.

This sort of thing happens so frequently and with such a great loss of time for the entire department, that it is decidedly to be avoided. The better practice to follow is for Jack, behind the counter, to sell Bill Jones everything he wants to buy; clear everything off that slate and then, without any fuss, make the introduction. Smith will not then have to sell first



"MR. JONES, MEET MR. SMITH

He is the man who knows all about the So-and-So Company." At these magic words the Radio Department ceases to function

himself, then his company and the set which Jones came into the store to buy. Those who desire to meet Smith will have the opportunity at the club meeting which, after all, is the proper place.

The man behind the counter should make every effort to hold the patron's attention until there is no further prospect of sales rather than divert his attention to other persons or events.

HERE'S ANOTHER

MANY dealers fail absolutely to take advantage of some of the manufacturer's efforts to make sales easy for them. A customer asked for a certain radio unit in a store where I happened to be making a few small purchases. The salesman did not have the unit he wanted—that is, not the desired make, though there were units designed for identically the same use, made by three other manufacturers, in his show case. The customer had a general knowledge of what the unit was to be used for, from a description he read in a catalogue, but he did not know what the thing looked like. When he was told there were none in stock he took it for granted that he would have to look elsewhere. Without his knowing it, I followed him to another store and hung in the offing while he was being waited on.

In the second store, the man behind the counter also had to tell his customer that the



THE SALE WAS MADE.

The instant the salesman placed the desired unit in the customer's hand

stock of the particular units he sought was depleted, but there was another unit designed for the same purpose and he had a number of them in stock, asking if his patron would like to see it. Of course he wanted to see it!

So, down came a little cardboard box, from among a number on one of the shelves, the tissue paper was quickly removed from the unit after the box had been opened, and the unit was then placed in the customer's hand. Do you suppose any sales talk was necessary?

stitutions which could be made without resulting in less service to the consumer.

It is this service to your customers which will determine the value your radio department will be to you. If you are not well versed in radio, you will do well to put men behind your counter who *are*, or the success which should follow the sale of radio equipment will not come up to your expectations. On the other hand, if your department is well directed, the profits will surprise you.

Not a bit of it! The fellow who wanted to buy that article was so tickled to have it actually in his hands that he could hardly wait to have it wrapped.

In the first instance, the man behind the counter could just as well have made the sale, in fact he could have sold a unit which was less costly than the desired one, and which would also have yielded him a greater profit, but he let it slip by because he did not know what the units were used for, and the one called for, instead of going under its technical name, carried a trade name. The man who did make the sale, as it happened, disposed of a higher-priced article than the one called for, because he knew his stock and the uses to which it could be put as well as the sub-

The Dictaphone High-Speed Recorder

By B. G. SEUTTER

AN INTERESTING and simply-operated high-speed recorder for radio signals is the Dictaphone shown in the accompanying photograph. This machine has been used by the *New York Times* for several years, for taking down European press. Its use, of course, is not limited to radio telegraphy: speech and music may be recorded equally well—to say nothing of static and all manner of interference! However, in transcribing, the records may be repeated as often as desired, and at any speed, so that the interference is a factor

of far less importance than when the operator takes down a message directly.

RECEIVING THE MESSAGE

IN operating the high-speed recorder, assurance must first be had that the intensity of the incoming signals is great enough to make a good impression on the wax recording cylinder. One telephone of the receiving set is attached to the mouthpiece of each recorder, and the motor started, with the blank cylinders on both mandrels. A single motor drives both recorders, and at a constant speed, determined

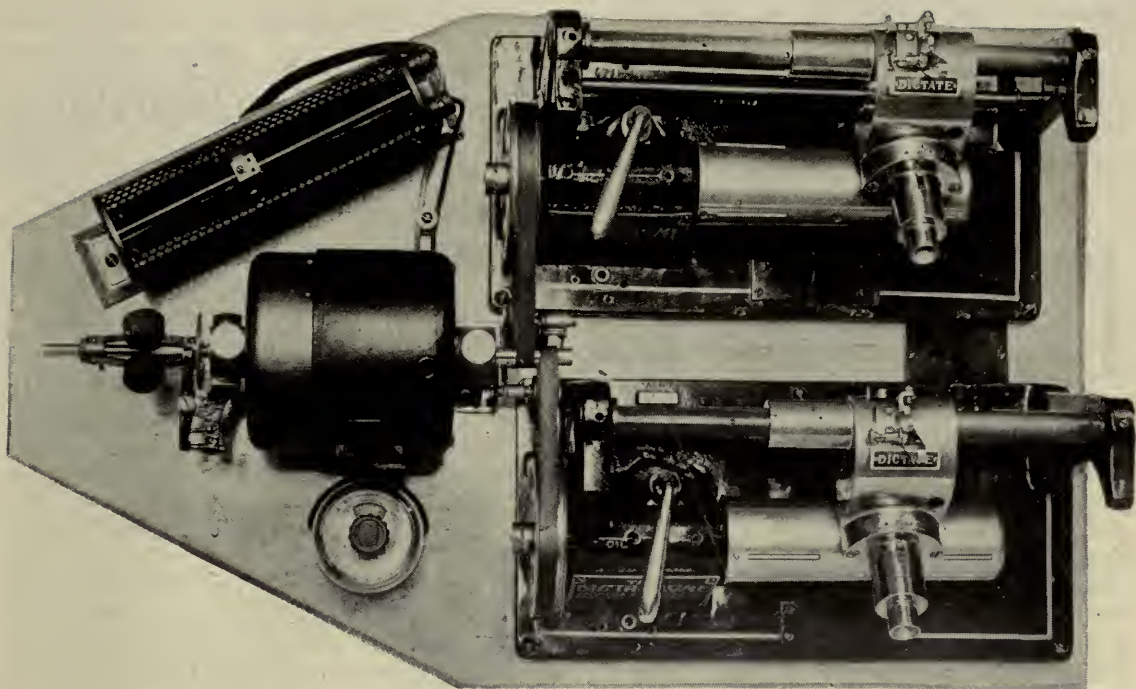

MACHINE USED FOR HIGH-SPEED TRANS-OCEAN RECEIVING

By the *New York Times*. A single motor operates two recording machines which are arranged so that one takes up the recording when the record on the other is nearly filled. Messages may be received at a very high speed which is reduced when the record is placed on the transcribing machine. Records containing important messages may be preserved indefinitely

by the conditions and speed of the transmitting station. The gears at the left of the mandrel on one machine being in mesh, this machine alone begins recording. When the carriage has nearly reached the end of the cylinder, it is automatically thrown out of gear and the other machine is started. This second machine begins recording a few revolutions before the first is stopped, so that no part of the message can be lost during the shift.

The operator in attendance then moves the carriage of No. 1 machine back to the starting point, and slips a fresh cylinder in place. When the carriage of No. 2 nears the end of the cylinder, No. 1 is automatically cut in, and the operation repeated as long as desired. When the Dictaphone is receiving high-speed messages, it is found by actual practice that the cylinders should make about one hundred and fifty revolutions per minute.

TRANSCRIBING THE MESSAGE

IN transcribing from the imprinted cylinder, a special Dictaphone is used with rubber hose attachment to fit the operator's head, somewhat like the ordinary head telephone

receivers. For best results, the cylinder should now be reduced to about ninety revolutions per minute, enabling the operator to transcribe with ease. He can also stop and start the record at any point desired, and if the signal is not sufficiently clear the first time, he can have it repeated over and over by pressing a key which shifts the carriage, in a way similar to the action of the back-spacer on a typewriter.

When the messages have been copied from the various cylinders, the cylinders are taken to an electrically driven cutting machine which leaves them with fresh surfaces, ready to be used again.

The Dictaphone has long been used for dictation in offices, taking the most complex words as easily as the simplest ones. In the radio field the adapted form of this machine has proved equally accurate. One advantage it has over the type of apparatus which records signals by an ink marker on a paper strip, is that the necessity of employing expert tape readers is obviated. Moreover, the ink-and-tape machine is good only for telegraphy; the Dictaphone or similar device is necessary when the complex sounds of the human voice, or of music, are to be recorded.

A Few More Books About Radio

Eight Works of Varying Merit Which Have Been Published, or Reprinted, During the Current Year

IF ENOUGH books; dealing in one way or another with radio, have not appeared to satisfy the needs and longings of every sort of reader, it is certainly not the fault of the writers on this subject. They have done their level best to keep the presses from remaining idle and the public from remaining ignorant. Whether or not the public emerges from a plunge into the bewildering mass of verbiage and diagrams enlightened or hopelessly entangled, cannot in every case be stated with certainty. At any rate, the current of books flows on, for better or for worse. It is agreeable to note that several of them are "for better," notably the

LEFAX RADIO HANDBOOK, by Dr. J. H. Dellinger and L. E. Whittemore; Lefax, Inc., Philadelphia, Pa. 1922, illustrated; price, \$3.50.

This is a loose-leaf book of pocket size, with cloth index tabs projecting beyond the page margin, bound in black, flexible leather. It is compact and practical, written in English, not Radio, by two men who are especially well qualified for the work. Dr. Dellinger is Chief of the Radio Laboratory of the U. S. Bureau of Standards at Washington, and Mr. Whittemore is his assistant. The matter is arranged under

the following heads: What Radio Does, How to Receive, Antennas, Fundamental Principles, Receiving and Transmitting, Lines of Advance, Apparatus,

and Appendix (in which you will find a variety of things, from a map showing the location of broadcasting stations in the United States to sheets of perforated, ruled, and squared paper on which you may add whatever of importance you find the authors have

omitted). An excellent and unusual feature of the book is that "new developments in radio, including new apparatus and hook-ups, will be described on additional sheets and mailed periodically to all holders of the handbook. This service will be supplied without charge until July 1, 1923." One of these supplements, already sent out to owners of the handbook, contains six pages of text and circuit diagrams relating to super-regenerative reception. Throughout the book, the explanations and diagrams are clear, adequate, and logically arranged: they breathe an air of practical common-sense. If you are just beginning to do a little experimenting with radio telegraphy or telephony, and can scrape together the necessary \$3.50, the "Lefax Radio Handbook" should prove of considerable value to you. It is a book for your coat-pocket or work-bench, rather than something to read through and put aside. If the authors continue to provide the means of keeping the handbook up-to-date—and there is every indication that they will do so—this book should live a long and useful life.

Another book, no less unusual than the Lefax product, but entirely different in presentation of material, is

THE RADIO PATHFINDER, by Richard H. Ranger; Doubleday, Page & Company, Garden City, N. Y. 155 pages, illustrated; price, \$1.50.

It is clearly written and amusing—yes, one of those rare birds among textbooks that actually refuses to be dull. The text itself is mostly "strictly business," progressing from the chapter on broadcasting history through the general theory of sending and receiving to practical instructions for installing and operating a modern radio set. But over fifty unusual line drawings by Thomas E. Monroe, as well as aptly chosen quotations for the chapter-heads, help to raise this book above the average level, and to make it a source of information and pleasure to the person newly interested in radio, who wants to read something in a language he can understand.

There is a certain amount of useful informa-



tion for the young boy who would build his own wireless set, in

THE BOOK OF WIRELESS TELEGRAPHY AND TELEPHONY, by *A. Frederick Collins*; *D. Appleton and Company, New York, 227 pages, illustrated; price, \$1.50.*

There is, we repeat; but it is rather hard to find much of it in the mass of pictures of every old-fashioned instrument from the Leyden jar to the tuning-helix. In bringing the book, which was originally published in 1915, up-to-date, the author or publishers have apparently forgotten to throw out a great quantity of material that no young boy, starting in to-day to make his radio set, would have any use for. One unconscious purpose served by this book is to show how much neater and more efficient our present-day home-built apparatus is than the stuff turned out six or seven years ago. Radio progresses too quickly to allow the text and diagrams of several years ago to be successfully reprinted and served up as a modern textbook for young boys. To read this book is something like picking up a best-seller of the vintage of '75 and doing your best to plow through a few pages of it. Invariably, you lay it down with a sigh, sadder if not wiser. Just think—it was once alive! You know how Hamlet must have felt when, picking up the skull of one whom he had long forgotten, he said: "Alas—poor Yorick! I knew him, Horatio!"

A book of interest to the experimenter is the RADIO EXPERIMENTER'S HANDBOOK, by *M. B. Sleeper*; *The Norman W. Henley Publishing Co., New York, 1922, 143 pages, illustrated; price, \$1.00.*

This is characteristically a Sleeper work. It is exceedingly well illustrated and is full of explanations of the various kinks and wrinkles which come only from the pen of an author who knows whereof he writes. This little book tells, in a very practical manner, a great deal about transmitting, receiving, the new fire laws, etc. It is particularly helpful to the enthusiast who listens on long waves.

A volume that has been written as a guide to those who have not followed radio from its beginning is the

STANDARD ENCYCLOPEDIA OF RADIO APPARATUS, by *A. Howland Wood*; *Perry & Elliott Company, Boston, Mass., 1922, 128 pages, illustrated; price, \$2.00.*

Special attention has been given in this book to making the reader familiar with the symbols

used in radio, and the devices they represent are depicted beside the symbols. A glossary of terms used in radio has been included and there are chapters on the proper method of installing and operating sets. The chapter on receiving-set costs, which also points out the approximate ranges over which various receiving combinations may be expected to function, should be helpful. A chapter describing the construction of a 5-watt radio telephone transmitter is also included.



Another book, and one which has been needed for some little while, is

HOW TO RETAIL RADIO, *McGraw-Hill Book Company, Inc., New York, 1922, 226 pages, illustrated; price, \$3.00.*

This is a discussion of the subject of radio merchandising. Part of the matter described and illustrated includes What Successful Radio Retailing Requires, Choosing a Radio Store Location, Good Business Records Make Good Profits, Financing the Radio Department, What Kind of Stock and How Much, Displaying Radio Goods in the Window and Store and How a Club Room for Amateurs Builds Sales. The subject matter has been taken from the writings of such merchandising authorities as Stanley A. Dennis, C. W. Muench, Frank Farrington, F. W. Christian, J. C. Milton, J. S. Older, Roi B. Woolley, Harry A. Mount, C. S. Funnell, and Arthur H. Lynch. It is indeed a good book for any radio merchant.

One of the most comprehensive descriptions of the Armstrong super-regenerative circuit is

THE ARMSTRONG SUPER-REGENERATIVE CIRCUIT, by *George J. Eltz, Jr., A. I. E. E., Radio Directory Publishing Co., New York, 1922, 52 pages, illustrated, price \$1.00.*

The work is as non-technical as a very technical subject will permit. The subject is covered from the point of view of the practical operator rather than the technician, for the man who is

not so much concerned with the technical as with the practical application of the circuit. A method for applying the super-regenerative circuit to a Grebe CR-5 receiver is illustrated and described. As most single-circuit receivers which operate over a range of from 150 to 3000 meters are patterned after the CR-5, this application is an important one.

From the view-point of the listener-in, it is doubtful that any more comprehensive group of books can be had than those which comprise

THE EASY COURSE IN HOME RADIO; *Morri-*

son, Kaempffert, Hogan, Morecroft, Ould, Yates, and Boucheron; 6 small, paper-covered vols., illustrated, price, \$3.00.

The course has been prepared by such authorities as Abby Morrison, Instructor in Radio, Y.W.C.A., Waldemar Kaempffert, John V. L. Hogan, Prof. J. H. Morecroft, R. S. Ould, R. F. Yates, and Pierre Boucheron, and Major-General George O. Squier is Editor-in-Chief.

The course covers all phases of radio from simple electricity to the super-regenerative circuit and is particularly well illustrated with diagrams, sketches, and photos.

Do You Want Broadcasting?

If so, it is highly important for you to sit right down and write a letter to your Senator and Congressmen, demanding that they exert every effort to have the White Radio Bill passed at the next session of Congress. If this is not done, the hands of the Department of Commerce will remain tied and no relief can be obtained from a rapidly increasing bedlam in the ether.

There are some objections to the bill—but the good overbalances the bad in it, and it is our only hope before 1924.

Exhort your representatives to have the bill passed—amended, if possible—but passed, whether amended or not.

The greatest crisis in radio history is at hand—you can help to make radio of value to every man.

A meeting of representatives of the radio press of the United States is being called to join in forming a definite policy to place before you. A comprehensive survey of the situation, written by Paul F. Godley, will appear in the January issue of RADIO BROADCAST.

But do not wait a minute—write a letter now demanding that the bill receive the attention it deserves and follow it next month with concrete suggestions drawn up by those who, with you, are most vitally interested in better radio, that is, the radio press.—THE EDITOR.

During National Radio Week

Which will extend from December 23rd to 30th inclusive, special broadcasting programmes are to be sent out from stations throughout the country. New York is holding a great radio show at Grand Central Palace, where practically all types of apparatus and parts made in this country will be on exhibition. The music of prominent violinists and singers at the exposition will be sent by land line to various broadcasting stations for transmission throughout the East and the Middle West.

You should make every effort to have your receiver working like a Swiss watch during Radio Week, for you and your friends will want to listen-in on the special programmes that will fill the air.

What kind of a show are you going to put on in your own home town?

The slogan for National Radio Week is the slogan that appears on our front cover:

“THIS IS A RADIO CHRISTMAS”

Doctor Stratton Leaves Bureau of Standards

His Election as President of Massachusetts Institute of Technology Deprives Bureau of Its Founder and Directing Genius

DR. SAMUEL WESLEY STRATTON is leaving the Bureau of Standards for good. Probably no other governmental change except a vacancy in the White House would create a greater stir in Washington than knowledge of this fact. The man who will take up his duties as President of M. I. T. in January in a sense *is* the Bureau of Standards. Called from a professorship in physics at the University of Chicago in 1901, he engineered through Congress a bill creating the Bureau, of which he promptly became the head. The expansion of services and facilities from that time up to the present, until the Bureau of Standards has become renowned the world over, has been directly due to Doctor Stratton's organizing and scientific genius.

To touch on the Bureau's war work alone would be to record a list of discoveries covering almost every physical function of the army, the navy, and the chemical plants. The thought of the losses in efficiency of equipment which our military forces would have undergone had not the Bureau of Standards been in existence is terrifying to any one who has read the Bureau's report of work conducted during the war.

Dr. Stratton has always been an enthusiastic supporter of amateur radio. Last February he acted as Chairman of the Technical Committee of the Radio Conference which made recommendations for a national radio policy. It is hoped that Dr. Stratton's successor will be a man whose interest in other branches of science will not overshadow his realization of the necessity of intelligent radio regulation.

Secretary Hoover, while congratulating Technology on obtaining Doctor Stratton as its head, is evidently exceedingly sorry to have him leave.

"The loss of Doctor Stratton as head of the Bureau of Standards," he says, "is a real national loss. He has built up that service from



© Harris & Fwing

DR. S. W. STRATTON

a bureau devoted to scientific determination of weights and measurements to a great physical laboratory cooperating with American industry and commerce in the solution of any problems of enormous value to industry which the commercial laboratories of the country, from lack of equipment and personnel, have been unable to undertake.

"While the Massachusetts Institute of Technology is to be congratulated on securing Doctor Stratton, one cannot overlook the fact that the desperately poor pay which our Government gives to great experts makes it impossible for us to retain men capable of performing the great responsibility which is placed upon them."

Progress of Radio in Foreign Lands

Latin-American Activities

SLOWLY but surely our Latin-American neighbors are getting more and more interested in radio communication and radio broadcasting. It is announced that the Radio Corporation of America has secured orders for the erection of five stations, each of which will have a sending radius of more than 2,000 miles. Three will be in Central America—in Honduras, Nicaragua, and Panama, respectively—and the other two in the United States. There is news, also, to the effect that certain South American republics are formulating new radio laws to take care of early broadcasting activities. Uruguay, for instance, has just made public its new laws. Private stations will be permitted anywhere except at points where State stations exist, provided that (1) they are not within 31 miles of the sea coast or of the Argentine and Brazilian frontiers, and (2) they are not installed in important cities or towns. Without being too inquisitive, it occurs to us that 31 miles in from the sea and from the two frontiers leaves very little room in which to operate, remembering that Uruguay is the smallest of the South American countries. Again, important cities and towns are barred to radio workers. We trust there is still a section of territory left for the followers of radio; they might go there and establish a colony!

Then there is good news from Cuba. Radio broadcasting has just been introduced in that Republic, and Cubans can now receive an all-Cuban programme instead of depending on the greatly attenuated programmes from the States. The demand for radio apparatus in Cuba is said to be enormous.

Radio Communication in Mines

EXPERIMENTS designed to demonstrate the possibility of radio communication between the shaft head and the lowest workings of a mine have been recently carried out in England by a party of Birmingham radio amateurs. The colliery used for the tests was chosen because its main shaft is one of the deepest in that country, nearly 700 yards. The receiving set employed in the experiments was of the three-tube type, and a temporary antenna was made by suspending a length of

insulated copper wire between the top of the steel hoisting gear above the shaft, and an adjacent railway bridge. The ground connection was made by clamping a wire to one of the rails of the permanent way. From this makeshift arrangement, messages were heard from the station at Bordeaux. The portable transmitting set was first installed in the steel cage of the shaft, the aerial being insulated wire suspended in a lattice pattern across the roof of the cage, the ground being a connection to the steel floor. It was expected there would be much "screening" on account of the steel framework of the cage, and by the structural steel work built inside the shaft for a depth of more than 100 feet. This did affect the first transmissions, which were begun from the cage at the top. As it slowly descended, however, signals became much stronger. When the cage was at a point 300 yards or so down, the maximum signal strength was attained, and this remained undiminished until the cage reached the bottom. When the bottom was reached—and here there was more steel work—the signals became inaudible. The transmitting set was therefore taken from the cage and a new aerial made by suspending the wire between pit props. The ground was improved by attaching the wire to a length of cable laid along the ground. The new arrangement resulted in faint signals being received above. A distance of nearly three-quarters of a mile was spanned by the radio set, working through solid earth. Radio telephony was tried and worked quite well.

Radio Outfits for Mexican Lighthouses

THE installation of small radio outfits in all lighthouses of the Mexican Department of Communications is reported in the Mexican press. Two sets of the apparatus are being installed on trial, after which, if they prove satisfactory, all lighthouses will be similarly equipped.

Nauen's Latest Improvements

GOOD progress is being made with the extension of the radiostation at Nauen, in Germany, according to *The Engineer*. It is expected that by the beginning of next year it will be possible to establish

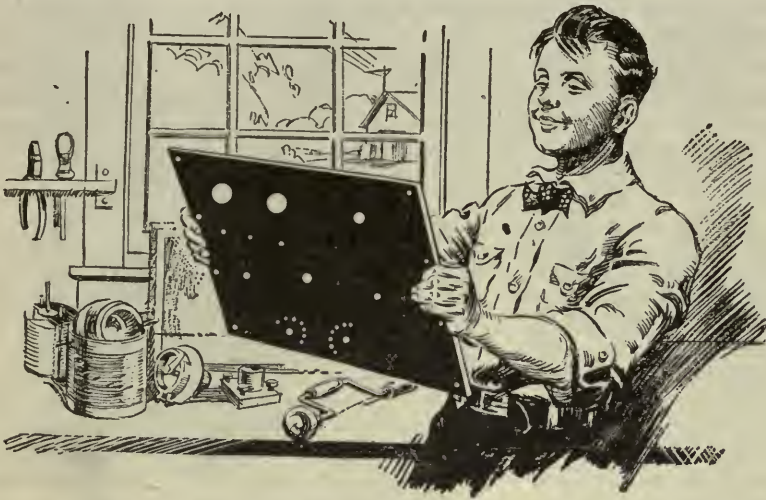

This Panel Will Improve Your Set

CONDENSITE CELORON

THE best panel made is none too good for your set. Dependable insulation is vital because it has a direct bearing upon the clearness and sensitivity of both transmission and reception.

Every thinking radio enthusiast certainly wants the highest type panel he can obtain and the surest way to get it is to insist upon Condensite Celoron.

This strong, handsome, jet-black material is not merely an insulating material—it is a radio insulation made to meet high voltages at radio frequencies. That is why it will give you greater resistivity and a higher dielectric strength than you will ever need.

Make your next panel of Condensite Celoron. It machines readily, engraves with clean cut characters and takes a beautiful polish or a rich dull mat surface.

An Opportunity for Radio Dealers

Condensite Celoron Radio Panels and Parts offer a clean cut opportunity to the dealer who is keen on building business on a quality basis. Write us to-day. Let us send you the facts. You'll be interested.

Diamond State Fibre Company

Bridgeport (near Philadelphia), Pa.

Branch Factory and Warehouse, Chicago.

Offices in principal cities

In Canada: Diamond State Fibre Co., Ltd., Toronto.

permanent communication with the new Argentine station at Monte Grande, near Buenos Aires. Four of the existing masts at Nauen, which are more than 390 feet in height, have been removed and replaced by a series of seven towers 688 feet in height, which provides four additional antenna circuits, each of which is served by a high-frequency alternator. The

new antennas will be used for American, Asiatic, African, and European services. For distant stations, such as those in South America, two or more antennas may be used together. The transmitting installation has been improved and enlarged, and the system of grounding connections has been extended.

The Grid

QUESTIONS AND ANSWERS

The Grid is a Question and Answer Department maintained especially for the radio amateurs. Full answers will be given wherever possible. In answering questions, those of a like nature will be grouped together and answered by one article. Every effort will be made to keep the answers simple and direct, yet fully self-explanatory. Questions should be addressed to Editor, "The Grid," Radio Broadcast, Garden City, N. Y. The letter containing the questions should have the full name and address of the writer and also his station call letter, if he has one. Names, however, will not be published.

What is wavelength?

THOUGH wavelength has often been discussed in this and other publications, a great deal of confusion still exists in the mind of the novice as to just what wavelength is. The accuracy of the average broadcast enthusiast's conception of the subject is well reflected in a recent newspaper write-up of an installation capable of receiving waves sixty meters long. The writer goes on to explain: "—which means that the set is particularly susceptible to atmospheric disturbances sixty meters above sea level."

The term "wavelength" is really self explanatory, for it is generally understood that the impulses from a transmitting station assume somewhat the form of a wave. Wavelength is, obviously, the size or length of the wave in meters (1 meter = 39.37 inches).

Electromagnetic impulses (radio waves), under practically all conditions, and *regardless of length*, travel 300,000,000 meters in one second, during which time a certain number of waves are sent out. If only one wave leaves the antenna each second, the first part of it will travel three hundred million meters before it is broken off and a new wave starts—in other words, the wave is "stretched" over a distance of three hundred million meters. If the frequency is two, the first wave will travel one hundred and fifty million meters, in only half a second, before it is terminated by the commencement of the following wave. If the frequency is three, the wavelength will be 100,000,000 meters, etc., thus establishing an evident relationship between frequency and wavelength; 300,000,000 divided by either quantity giving you the other. The frequency at a two-hundred meter wave (300,000,000 ÷ 200) is one million, while the wavelength at a frequency of one million cycles (300,000,000 ÷ 1,000,000) is three hundred meters. It will be observed that frequency varies inversely with the wavelength, and short waves are often referred to as "high frequencies."

The above relationship, stated in a mathematical formula, is $\lambda = \frac{V}{N}$ and, transposing, $N = \frac{V}{\lambda}$ where $\lambda =$

wavelength in meters, $N =$ frequency in cycles per second, and $V =$ velocity of radio waves in meters per second.

It is evident from the above that wavelength, in one sense, does not directly affect the number of turns of wire on a receiving coil. However, more than one tyro in his desire to receive 360-meter stations, has multiplied 360 by three (three feet to the meter), and, zealously wound 1080 feet of wire on a tuning coil!

But, in a less literal way, wavelength does determine the amount of wire on our receiving instruments. Alternating currents (radio currents are alternating currents of high frequency) in traversing a circuit, such as from antenna to ground, experience not merely the retarding effect of resistance, but also that of "reactance." Positive reactance is a result of inductance, a quality existing in almost every circuit, which causes the amperage and voltage to reach their maximum strengths at different moments. Work, such as turning a motor, or actuating a telephone receiver diaphragm, can be best accomplished only when volts and amperes work in unison (giving watts). Reactance thus results in a loss of power, which, in small radio currents, makes reception impossible. To overcome this negative reactance, condensers are introduced into the circuit, which, when properly balanced, exactly counteract the reactance caused by inductance, bringing the lagging amperes back into phase with the volts, thus permitting work to be accomplished. *But reactance varies with the frequency of the current, and, therefore, at different waves, various values of condenser and coil windings (inductance) must be used.* Tuning is nothing more than a balancing of the two kinds of reactance, positive and negative, so that at the wavelength to which the receiver is tuned, they nullify each other, and the weak radio currents will encounter only the comparatively negligible effect of resistance.

What is regeneration?

How can a non-regenerative set be made to regenerate?

REGENERATION, briefly, is a method of securing amplification with a single tube, by coupling the output of the bulb back to the grid in such a manner that it intensifies the slight potential applied to it



Make it
the **GREATER** Radio
Christmas ~

THE gift of all gifts is Magnavox Radio, the Reproducer Supreme; the gift that will mean most to every member of the family, young and old. Based upon the electrodynamic principle, Magnavox Radio has no comparison with "loud speakers" which merely combine a megaphone with the ordinary telephone receiver.

- R-2 Magnavox Radio with 18 inch horn . . . \$ 85.00
- R-3 Magnavox Radio with 14 inch horn . . . 45.00
- Model C Magnavox Power Amplifier, 2 stage . . . 80.00
- 3 stage . . . 110.00

Magnavox Products can be had from good dealers everywhere. Our interesting new booklet (illustrated in three colors) will be sent on request.

The Magnavox Co., Oakland, California
New York: 370 Seventh Avenue

MAGNAVOX RADIO
The Reproducer Supreme



by the incoming wave, the strength of which determines the audibility of the signal.

An incoming signal is impressed on the grid of the vacuum tube as a certain variation of a positive or negative charge, and by either repelling or attracting the electrons flowing from filament to plate, it varies the strength of the plate current. The plate or space current passes through the receivers, or the primary of an amplifying transformer, the high voltage battery, and finally across the elements of the tube. As the changes are thus caused by grid variations, it holds that the grid and plate fluctuations occur practically simultaneously, the change in the plate current being, in fact, nothing more than an intensified replica of the grid variations. Thus, if a part of this energy in the plate circuit is properly transferred back to the grid circuit, it will augment the like variations there, with a resulting greater change in the space current. This again reacts on the grid, and regeneration may be continued up to a certain point at which the circuit is said to oscillate. (The ultra amplification in the Armstrong super-regenerative set is secured by carrying out this feedback principle considerably further, and effecting regeneration far past the stage at which conventional receivers commence oscillating.)

Regeneration may be obtained in either of two ways—by inductive or by capacitive feed-back, each system functioning, as its name implies, by the respective means of inductance and capacity.

Inductive feed-back is the simpler system, and its action more easily understood. It consist of a coil or inductance in series with the plate battery and phones, coupled to another coil in the grid circuit, generally the secondary of a vario-coupler or its equivalent. Any receiver can thus be made regenerative by the installation of a "tickler" system, built up in the form of a small variometer with no electrical connection between the rotor and stator. Two cardboard tubes should be secured, one, the stator, approximately three and a half inches in diameter, and the second, of such a size, about three inches, that a one-inch

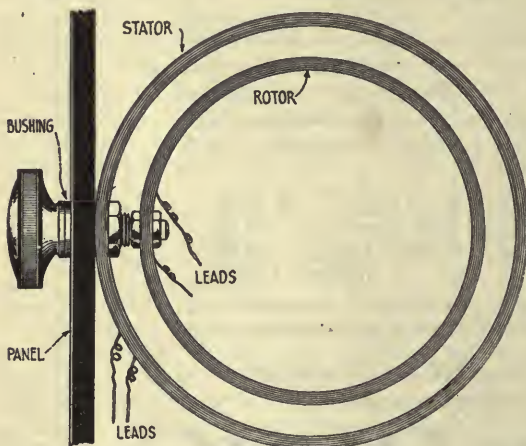

FIG. 1
Showing a simple method of mounting a tickler or variometer

length of it will turn within the stator. Ten turns of any convenient insulated wire is wound on the stator, and twelve turns on the smaller tube, the rotor. The experimenter may mount the tickler as his ingenuity sug-

gests, but a switch knob, minus the lever, and a bushing, probably afford the simplest method. Fig. 1 shows how the stator is clamped under the nut of the bushing, while the revolving tube is held between the lock nuts on the switch shaft.

The diagram for including the tickler unit in the conventional audion circuit is shown in Fig. 2. In any cir-

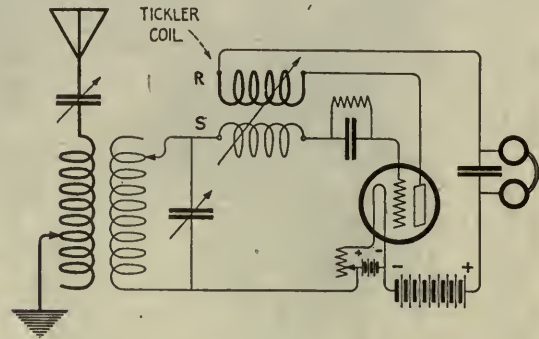

FIG. 2
A non-regenerative circuit made regenerative by the inclusion of a tickler coil. In the variometer set, the rotor and stator, R and S would be changed for individual variometers, well separated

cuit, one coil, generally the stator, is connected in series with the grid condenser on the A battery side, and the remaining coil, between the receivers and the plate.

Tuning is effected in the usual manner after having first set the coils at right angles to one another. When the station is tuned to maximum loudness, the tickler is brought into play by turning the rotor in the correct direction (to be determined by experiment). As this is done, the signal strength will increase until just before the circuit oscillates, beyond which point reception will be distorted and unsatisfactory. (Except for continuous-wave—C. W.—signals, which are most commonly received on an oscillating set.)

The tickler unit just described will give regeneration over a range of wavelengths up to six hundred meters, above which, larger coils must be made.

Regeneration by capacitive feed-back finds its most popular modification in variometer sets, where it is accomplished through the capacity between the grid and plate elements of a vacuum tube. However, as is easily understood, the capacity between these parts of a vacuum tube is very small, and to achieve an appreciable transfer of energy requires very careful adjustment of the two circuits—an adjustment that is effected by the variometers. Efficient transference of energy from one circuit to another is possible only when the two circuits are in resonance, or tuned to the same wave. Variometers, which are continuously variable tuning units, make it theoretically possible to arrive at this ideal condition.

This last type of regenerative set is the most efficient short-wave receiver, because, on higher frequencies (short waves), resonance plays a much more important part. Due to the variometers, complete resonance is sustained throughout the set, from the antenna through the plate circuit, thereby utilizing to the utmost the barely perceptible current of the incoming signal, as well as gaining an initial amplification by regeneration.

Two small variometers may be wound in the manner described for the construction of the tickler unit, except

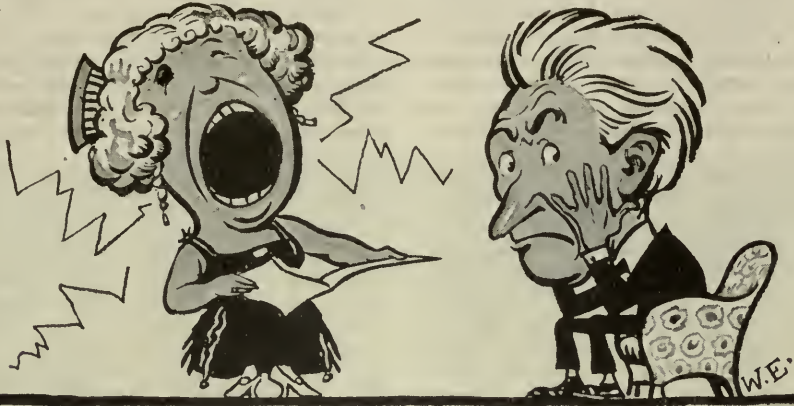

“Can those shrieks”

How often have you sat helpless while some amateur Farrar has tried to hit “High C.” But when your radio set starts in to show off its shrieking talent you need not go through another ordeal. Just drop in at your nearest radio store and order an Acme *Audio* Frequency Amplifying Transformer. Hook it up to your detector set and sit back easy. You’ll be surprised how clearly and distinctly incoming sounds may be heard. Then, too, the tones are natural. Something usually so lacking in the ordinary set.

You will also want the Acme *Radio* Frequency Amplifying Transformer because this will greatly increase the range of your set whether it be vacuum tube or crystal detector. Both Acme *Audio* and Acme *Radio* Frequency

Amplifying Transformers sell for only five dollars. Your set is not complete without them.

The Acme Apparatus Company (pioneer transformer and radio engineers and manufacturers) are also manufacturers of one and two stage amplifying units, detector units, detector and two stage amplifying units, the Acme Clear Speaker, the Acmehone. Acme C. W. and spark transmitting apparatus offer the amateur an opportunity to not only

receive but send his own messages. For sale at radio and electrical stores or write direct to the Acme Apparatus Company, Cambridge, Mass., U. S. A., or New York Sales Office 1270 Broadway. Ask also for instructive free booklet on the operation of amplifying transformers, both audio and radio frequency types. You need it.

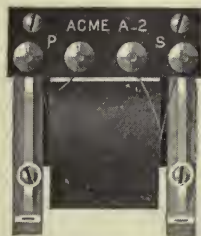

Type A-2 Acme Amplifying Transformer
Price \$5 (East of Rocky Mts.)

ACME

for amplification

that the rotor and stator are connected, leaving only two open wires from each variometer. These variometers may be added to almost any non-regenerative set, by connecting individual variometers in place of the rotor and stator coils indicated in the tickler hook-up (i. e., one variometer in the grid circuit, and one in series with the telephone receivers).

Tuning with a variometer set requires considerable practice, but once the operator becomes accustomed to the peculiarities of his apparatus, the remarkable reception will repay him for his efforts. The grid variometer will require certain definite settings for different wavelengths (which must be determined by trial), and should be first set on the wave adjustment for the signal it is desired to receive. The plate variometer is set at any non-oscillating position, and the station tuned by varying the antenna condenser or inductance. When the station is tuned in, generation is controlled by manipulating the plate variometer. The final adjustment is a very delicate tuning of the grid variometer.

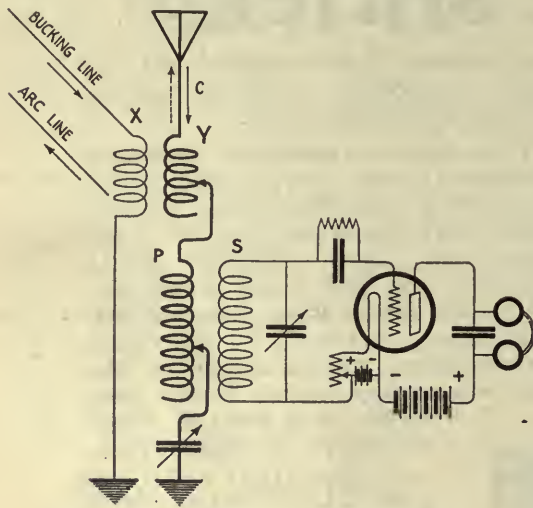

FIG. 3

A method for eliminating power-line noises in receiving sets

S. W. B., Davenport, Iowa is bothered by neighboring arc-light circuits, reception being practically impossible after sundown.

"Every evening, when the arc circuit is turned on, we get a continued roar in the receivers that sounds as though we were in the power house standing alongside one of the generators.

This trouble is not only at our place, but affects an area of about one hundred city blocks. . . . The current which is supplying these arcs is direct current, and each circuit has about 80 lights on it."

THIS problem has been a bugbear of radio experimenters since the early days of wireless, and many more or less successful solutions have been offered.

Arc circuit interference is reducible, for the purpose of dealing with, it systematically, to one of two causes: audio frequency variation of the supply current; or radio frequency. This last, however is often modulated at a sound frequency.

If the interference is in no degree tunable, it is probably interference of the first mentioned class. An audio-frequency disturbance may be due to many causes—generator hum, other line fluctuations, leakage in wet weather, arc sputtering, and sometimes, owing to certain values of capacity and inductance, the arc oscillating at audio frequency.

Radio-frequency variations are slightly tunable, but will probably force oscillations at any wavelength due to the proximity of the line.

If the annoyance comes under the first classification, (audio frequency) it will affect only single-circuit sets, and the solution is obvious. An inductively coupled receiver, such as a variometer short wave set, should be installed. Here, the inductance in the primary and secondary of the coupler (which is virtually a radio frequency transformer) is not sufficiently high to effect a transfer of pure audio frequency energy.

The simplest, but not always successful, solution to radio frequency interference is to vary the position of the aerial in relation to the arc line, making, if possible a right angle. In some cases, the erection of a fan antenna has reduced the annoyance to a negligible hum.

A logical, and in several instances successful system is the installation of a wave trap, a method, of course, only applicable when the interfering wave is considerably above or below the wave on which reception is desired. A wave trap is a circuit in resonance with the disturbing signal and in inductive relation to the antenna, which absorbs the undesired frequency, while not appreciably affecting signals on other waves.

The most successful systems employ the principle of "bucking" the disturbing oscillations by similar oscillations in the opposite direction. It is known that two sets of oscillations of the same frequency, but differing in phase by 180°, that is, one reaching its positive peak at the moment the other attains its negative peak, will nullify each other if they are approximately the same strength and vibrating in a common circuit.

This effect may be occasionally secured by erecting a counterpoise, one end of which is free to swing so that the relative position of the counterpoise to the arc line may be varied. This system, however, is not so effective as a separate bucking circuit shown in Fig. 3.

X and Y are respectively the secondary and primary of a variocoupler. The secondary is connected between the ground and a wire running as far as feasible (several hundred feet if convenient) parallel and near to the supply line. The primary is in the antenna circuit of the receiver. Arrow A indicates the momentary direction of the current in the arc line; B and C the current simultaneously induced in the parallel wire and the aerial. The dotted arrow shows the direction of the current induced from X to Y (provided X or Y is connected in the right direction). This last indicated current, by varying the coupling between X and Y, can be made to nullify the interfering current, designated by arrow C.

As was suggested, it may be necessary to reverse the connections to one of the coils, X and Y, for, if connected improperly, the disturbance will be magnified. The amount of winding on Y should be kept at as few turns as is compatible with the elimination of the interference, so as to increase the wave of the receiving set as little as possible.



"He is rich," said Confucius,
"who knows when he has enough!"
Would you find the richest man?
Look for the owner of a
Grebe Receiver.

Doctor Mu.

The whole world is at your fireside when you own a Grebe Receiver.

Ten years of radio manufacturing experience has taught us the importance of simplicity. Recommended by most good dealers because they know the shortcomings of ordinary apparatus.

Ask your dealer for a demonstration. Get your copy of "Musings of Dr. Mu"—the story of the development of the Perfect Receiver.

GREBE RADIO

A. H. GREBE & CO., Inc.
Richmond Hill, N. Y.



Licensed under Armstrong
U. S. Pat. No. 1113149



THE SET INSTALLED IN 1915 IN THE HOTEL ANSONIA, NEW YORK

By the Radio Club of America. This station was used by Admiral Fletcher to communicate with vessels of his fleet at anchor in the Hudson River. Over one thousand messages were sent and received in ten days. President Wilson sent a congratulatory message to the Club from the Mayflower, for the efficient service it had rendered

RADIO BROADCAST

Vol. 2 No. 3



January, 1923

The March of Radio

WHEN WINTER COMES

BY THE radio man the flight of the summer months is not viewed entirely with regret. A vacation in the woods or at the ocean has its attractions, but to the real fan an equal joy is found in getting ready for a winter's efforts to improve the performance and records of his receiving set.

The increased interest in radio with the coming of winter is due not to the lack of the summer's entertainment alone, but largely to the better reception made possible as the summer disappears, taking most of the static with it. On a hot summer's day the atmosphere is intensely active, electrically speaking; electric charges form and spread more rapidly in proportion as the rate of evaporation and condensation taking place in summer increases. Every motion of an electric charge means radiation of energy, and thus a certain amount of static for the listener.

But in the cold, quiet winter nights little electromagnetic radiation other than that sent off by stations is taking place. We have no proof, or reason to believe, that radio waves travel with more efficiency in winter than in summer. A signal of such strength that it cannot be heard even above the summer's hissing and crackling, may in the winter time be perfectly clear and several times as loud as required for good audibility. This is due to the fact that the ear automatically adjusts itself to the loudest sounds coming to it; with heavy static, the

ear becomes so insensitive that the radio signal, plenty loud enough to be distinctly heard by itself, is lost in the crackling noises in the phones.

One of our neighbors now reports that he hears, nightly, stations from 1,000 to 1,500 miles away, although in summer two or three hundred miles is his limit. His outfit is not extraordinary, consisting of a single wire, 30 feet high, and a three-tube receiver, one radio-frequency amplifier, a detector, and one step of audio-frequency amplification. Another experimenter reports that a single-tube set, with regenerative connection, located in New York City, consistently hears a station in Iowa over a thousand miles away. Such instances will multiply during the winter months as atmospheric conditions improve and by next spring there will be many people who, for the first time, will appreciate why the early workers in radio always established their records for long distance at night during the winter.

Of course these long-distance records with comparatively low-powered transmitting sets do not serve to indicate the power of apparatus required by a commercial company to maintain a regular transatlantic service; guaranteed service, through the day as well as the night, requires a transmitter at least one hundred times as powerful as those used in most present broadcasting stations.

That Big Problem—Interference

AT a recent meeting of the Institute of Radio Engineers, the society having in its membership the best radio talent in the country, the topic of interference due to the simultaneous operation of neighboring broadcasting stations on 360 meters and 400 meters was discussed. The "general public," it seemed, was well fed-up with the signal hash that is served every evening. One man having "several hundred dollars invested in his receiving equipment" was so bothered by the simultaneous operation of the two stations that the evening's entertainment which he had promised to some friends gathered around his set proved to be an unappetizing mixture of jazz from one station and opera from the other. He was ready to give up radio in disgust, according to the letter he sent to the local radio inspector.



The attempt to give the public better radio service by allotting different wavelengths to neighboring stations was mentioned in our last issue. The two wavelengths chosen, 360 and 400 meters, it seemed, were surely far enough apart to permit of tuning in one signal and completely tuning out the other, unless the listener was very close to one of the transmitting stations. But reports proved it otherwise; many of the listeners were unable to get rid of the undesired station by manipulation of their sets, and, according to the radio inspector, felt that an injustice had been done in permitting the two stations to operate at the same time. Some even went so far as to threaten the removal of the inspector by personal appeals to their congressmen.

Now it is really time for the public to be educated in the elements of radio communication. Undoubtedly many people have invested in radio with no knowledge at all of what the set they bought had in it or what it was supposed to do, and these people will be much disappointed until they learn the capabilities of the apparatus. Some who have purchased cheap sets, poorly designed and inadequately constructed, will remain disappointed, but those having sets built by reliable concerns will find it the easiest thing in the world to adjust their apparatus so that either the 360- or the 400-meter programme can be heard at will, with no interference from the other.

This margin of 40 meters between stations will probably be cut in two before long, so that sets will have to tune signals only 20 meters apart. This will not be difficult with efficient apparatus.

The relative merits of the single-circuit tuner and the two-circuit tuner was under discussion when one of the advocates of the latter type put forth the claim that a good set of this kind could sift out signals differing by only one meter! This seems like a rather extravagant claim because two signals differing by only one meter would have frequencies within 2,000 cycles per second of each other and for speech or music we should have more separation than this if one ether channel is not to encroach upon the other.

It seems likely, however, that the public should soon be able to separate two signals differing by not more than ten meters; such a margin will provide sufficient channels for all demands likely to be made on the broadcasting service in the near future. This means that people have to learn about tuning, coupling, etc., and at the same time they must get rid of some of the extremely poor sets that the fly-by-night companies have been foisting upon them as well as most of the "oatmeal box" sets made in accordance with the specifications of some Sunday supplement.

Furthermore, the public must learn to be content with smaller antennas where interference is troublesome. Small antennas, used with well designed and well built sets of two or three tubes and manipulated with reasonable skill, will soon prove that interference between stations separated by 40 meters is entirely unnecessary and that a lesser separation is feasible without causing any appreciable trouble.

Radio Central to Change Its Transmitting Apparatus

LESS than a year ago the opinion was offered that the installation at Radio Central, the Radio Corporation transmitting station on Long Island, would never be completed, as the machines would probably be superseded by tubes before the Alexanderson alternators could be put in. An announcement of the Radio Corporation just given out states that an experimental tube transmitter has been in successful operation for sixteen hours contin-

uously, sending out sufficient power to transmit perfectly as far as Germany. Instead of the 200-KW alternator ordinarily used, six pliotrons, rated at 20 KW each, were used to generate the high-frequency power required to excite the antenna. A 15,000-volt supply of continuous current power is required for the plate circuits of these tubes and here also the electron evaporation idea of Richardson is utilized. Two-electrode tubes, plate and filament

or even 1,000-KW whenever the demand for them will justify the expense involved.

Neckties, Soap, and Radio Sets for Sale

WITH the tremendous popular interest in radio, and possible profits in catering to the demands for apparatus, manufacturers and jobbers have placed radio apparatus in practically every place where

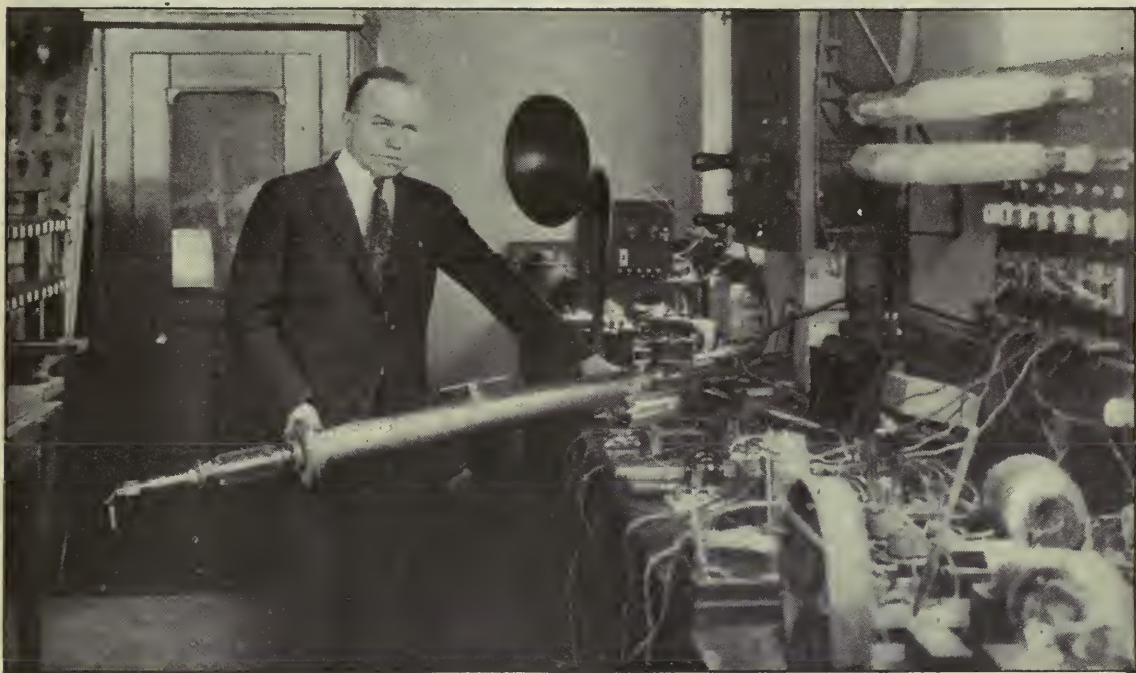

THE LARGEST VACUUM TUBE IN THE WORLD

This 1,000,000-watt tube, developed in the research laboratory of the General Electric Company by Mr. J. H. Payne, Jr., is designed for power purposes rather than for radio use. Its electrical output, expressed in terms of the incandescent lamp requirement, give some idea of its power. It will supply energy equivalent to that required to light 40,000 25-watt lamps, or the electrical energy required by 1,500 average homes. The tungsten filament in this tube is so large that if drawn into filament of the size used in the household incandescent lamp it would supply filaments for 175,000 such lamps

only, are used as rectifiers, to change the high voltage alternating-current supply available at the station into suitable continuous-current power.

The installation of these tube transmitters is so simple and the operation so reliable that it seems safe to predict that the life of all other high-frequency generators is already measured. The tubes used in this first large installation have about five thousand times the power of the small transmitter tubes used by amateur broadcasters, but the research men who are responsible for the development of these 20-KW tubes are ready to build tubes of 100-KW

people congregate. Drug stores, music stores, cigar stores, even men's furnishing stores have radio sets for sale. Can any good come from this method of merchandizing radio sets?

It seems to us that the practice will undoubtedly result in many disappointments for the purchasers, and consequent disgust with radio. If a store has apparatus for sale, the clerical force will naturally do its best to sell it, and if the customer seems doubtful about buying, unreasonable and foolish claims will be made regarding the reception to be expected from the sets. And because of ignorance of radio, both of purchaser and salesman, mis-

220
000



EDWIN H. ARMSTRONG

Goes down on this tire company's book of history as inventor of the feed-back circuit and native of Yonkers, N. Y.

understandings are sure to occur. How can it be expected that the haberdasher's clerk will know the relative merits of single-circuit and two-circuit tuners, regenerative and non-regenerative sets, soft tubes and hard tubes? And these are just the things the customer has a right to know before making his purchase.

Even some large department stores fail to have trained men in charge of their radio departments; only yesterday, we had explained to us in one of these stores the difference between a "single-current tuner" and a "double-current tuner"! The most extravagant claims are made for the reception distance of the apparatus, the clerks themselves not realizing the exaggeration in their statements.

What is to be done? It seems that here is an opportunity for the National Radio Chamber of Commerce to try a little missionary work in convincing the jobber and manufacturer that the only legitimate and worth-while outlets for their products are the regular electrical stores, having clerks trained in the elements of radio, who understand the relative merits of various types of sets. Every radio sale should be made in such a manner that the customer understands the merits of the article he has purchased and how properly to manipulate it. Hence he can get results which satisfy him, which lead to further purchases, and which help to keep alive and increase his interest in the radio game.

Public Health Service Talks

WE ARE glad to note that the Public Health Service recently resumed the broadcasting of talks from the Navy's Anacostia station, on a wavelength of 360 meters. Early in the year these brief talks were broadcasted from this station but, as there was some question as to the propriety of the Navy carrying on such work, it was suspended. One of the first acts of the Inter-departmental Committee, referred to in a recent issue, was to clear up this point, with the result that short lectures are being sent out three times a week. In the words of the officer in charge of this branch of governmental activity, "We try to make these talks as simple and direct as possible so that they will do the largest possible good and be understood by the largest possible number—not only those in the cities but those in rural districts as well."

Is a Radio Set a Musical Instrument?

THE State Convention of Music Dealers of Illinois, we hear, has under discussion the musical status of the radio set; if it can be classed as musical, they will consider it on an equal basis with other instruments and help in developing it. Of course, the instrument the music dealers are interested in is the loud-speaking horn; that there could be much

discussion on this question we are much surprised. For if there is any one thing of which the telephone engineer and manufacturer cannot afford to boast, it is this very instrument.

Musical? Yes, with a quality all its own—a quality fitting it more for an Indian war dance than for association with musical instruments. The raucous, throaty noises which emanate from the average horn should eliminate it from any discussion of instruments classed as musical.

It is not apparent just how much help the music dealers can render in improving the loud speaker but it certainly is time someone came to its aid; it is the one part of a radio set which, more often than any other, brings forth expressions of disgust from anyone with even the rudiments of musical appreciation.

Receiving in Steel Railway Cars

SIGNALING by wireless to moving trains has always seemed a remarkable feat; although, as we have pointed out before, it is really no more difficult for the signal to

reach a moving train than a stationary one. Compared to the speed of the radio message, the speed of our most rapid "flier" is negligible. Recent tests carried out on the Pennsylvania system have shown that it is possible to get a fair signal even inside a steel car. Now, it is a well-known fact that metal structures tend to keep out radio waves. In the laboratory when it is desired to shield a piece of apparatus from radio waves we build a metal cage or box around it and are thus able to protect it from high-frequency signals.

To be sure this shielding is only partially effective. It would take an immense amount of sheet copper to eliminate completely the radio waves from the inside of the shielded box. As an illustration it is found that a box made of copper (of about the thickness used for roofing) around a piece of apparatus cuts down the received waves to about 10 per cent. of their strength without shielding. The success of the reception in steel railway cars is due to this imperfection of the shielding action. A loop is used inside the car for an antenna, and this, in combination with an amplifier con-



THE KNIGHTS OF COLUMBUS FREE RADIO SCHOOL

In New York, where some hundred odd students, most of them ex-service men, are learning the theory and operation of radio apparatus

sisting of three radio-frequency tubes, a detector, and two audio-frequency tubes, was successful in picking up signals from points as far as 200 miles from the train. It seems certain that radio will have important use for

engine sparks, and the balloon was completely wrecked. Fortunately all the crew, including some aviation experts were able to get away by jumping, as the bag was still close to the ground when it exploded.

After the Roma disaster, Congress appropriated an extra \$400,000 to both the Army and Navy; the \$800,000 thus available was turned over to the Bureau of Mines for further development of the helium extraction process, and according to a report from Aviation Headquarters, future lighter-than-air machines of both Army and Navy will be filled with the non-explosive rival of hydrogen—inert helium.



MR. L. W. MEEKINS BROADCASTING FOREIGN INQUIRIES

From WGI, Medford, Mass. "A Swiss firm wants to buy 10,000 electric light sockets," is the report. Next morning the U. S. Bureau of Foreign and Domestic Commerce has scores of applications for the name and address of the Swiss importer

train operation and passenger service in the future.

The C-2 Meets Its Fate

IN OUR last number we had a picture of the ill-fated Roma, the huge American dirigible wrecked by a hydrogen explosion; the illustration was accompanied by the query as to why the Army dirigible C-2 had been sent up with defective wireless apparatus and filled with hydrogen, when there was, as we understand, sufficient helium stored somewhere for its inflation. The helium had been taken out of the Roma just before its disaster, for experiments of some kind or other.

The C-2 "got away" with its trip to New York and back, in spite of the failure of its radio, but there was ever present the likelihood of explosion of hydrogen, from engine sparks, lightning, or similar causes. After successfully crossing the continent, however, this same C-2 came to the fate predicted for it; it was ripped open, the escaping hydrogen caught fire from

one of the English radio companies has succeeded in transmitting pictures said to be "generally recognizable." Such conservatism from a promoting company leads us to believe that they really have something.

These first attempts will of course be crude as with any new development—witness Bell's telephone or Edison's talking machine, or the first flickering, jumpy, movie films. Progress in such a case is very rapid after the first steps have been taken, however, and it is not beyond our imagination to conceive the transmission even of colored photographs within the next few years. Why not? It is no more improbable than many developments of science which, ten years ago, were regarded as impossible!

The N. R. C. C. Acts

DURING the Chicago radio show a movement was started by the National Radio Chamber of Commerce to gather information on all phases of the broadcasting situation, with the idea of later making sug-

Transmitting Pictures by Radio

SEVERAL announcements have recently appeared, some of them undoubtedly premature, of the success of radio transmission of pictures. Even though these accounts may be greatly exaggerated when seen through the optimistic eyes of the inventor, the handwriting on the wall predicts early success. A conservative announcement from London puts forth the claim that

gestions to the proper government authorities as to how the situation may be improved. We are glad to note the spirit in which the Chamber is attacking the problem. In the words of its President, Mr. W. H. Davis, it appears that "the only scheme of broadcasting which can prevail in any real sense is one in which the end to be attained reconciles all the conflicting elements, even to the submerging of private interests." We hope that, in weighing these conflicting interests, however, the stress will be put where it belongs; the interest of the listening public must be the dominant factor upon which a decision is reached. What solution will give to the radio listener the best programmes, most excellently rendered—that is the test which will be applied in all cases coming before the Chamber.

Saved by Radio

UNDER this caption a recent editorial in the *Times* pays tribute to the service rendered by radio when the steamer *City of Honolulu* was burned at sea. In this instance there was plenty of time for the boats to be lowered, and as the sea was smooth, no immediate danger threatened the shipwrecked passengers and crew. But there was much to be done before they were saved; being adrift in the Pacific in small boats, with no other boat within perhaps a hundred miles, is far from being rescued. The Pacific often belies its name in the suddenness with which storms arise, and without the help of radio the small boats had but little chance of surviving until a steamer happened to pass by. As it was, the operators were able to notify other ships—one of which happened to be within fifty miles—as well as coast stations. The shipwrecked people were picked up by an outbound freighter, which, again by radio, arranged for their transfer to an inbound transport, permitting the freighter to proceed on her way to the Dutch East Indies whither the shipwrecked passengers would probably have gone

with her, had not radio been able to call the inbound vessel. The story is one to make us profoundly thankful to those who have invented and perfected radio.

Lightning and the Receiving Set

A SHORT time ago, the metropolitan press featured a fire which had started in a room equipped with a radio receiver, after lightning had apparently struck the antenna and burned up a part of the apparatus. The set was equipped with lightning protection in accordance with the requirements of the National Board of Fire Underwriters, having a ground to the water-pipes and an approved type of lightning arrester.

It is to be expected, of course, that as the number of antennas increases some of the houses having them will be struck by lightning and generally the trouble in such cases will centre about the radio apparatus. But in most of the cases the house would have been struck even had the antenna and set not been there—and probably greater damage done. As the number of radio stations increases, it is evident that the proportion of houses struck, which do have radio sets, must increase, and



THE "CITY OF HONOLULU" BURNING IN MID-PACIFIC
Another ship, summoned by radio, rescued all the passengers and crew

this increase will have nothing to do with the lightning risk of radio sets.

Illustrating this point of view, we note that a few days after the occurrence cited above, the newspaper headlines announced "many



THE DEPARTMENT OF AGRICULTURE EXPLAINS ITS RADIO SERVICE
Showing how people living on farms or in remote districts can profit from the crop and market reports

lightning hits in a severe electrical storm," and although many of the hits were described in detail, there was no mention of one in a building where an antenna was installed! With more logic than was used by those who tried to prove that the first storm showed radio sets to be a lightning menace, we might use the second announcement to show that radio sets

constitute a protection against this very thing! Before the radio sets can be considered as extra lightning risks, it will be necessary to have statistics showing that of the number of houses set on fire by lightning those having radio sets form a disproportionately large share. This, we very strongly suspect, will never prove to be the fact. —J. H. M.



Broadcasting by Remote Control

By R. W. KING

American Telephone & Telegraph Company

PRINCETON was playing at Chicago. It was Princeton's ball on her one-yard line, and the score was much against her. Then the unexpected happened. A forward pass advanced the ball forty yards, a kick to Chicago, a fumble. Princeton's ball again, and a forty-five yard run for a touchdown. So was defeat turned, in a fraction of a minute, into victory.

As the applause swelled to its height, the door of a little booth in the press stand opened and the face of a man, tense with responsibility, was thrust out. With an attempt at a smile he said, "Here's where I turn my job over to twenty thousand rooters."

But it was only for an instant. The teams were already lining up for the goal. The door closed, the speaker was again in his little sound-proof booth, and with a hurried sweep of his hand over the moisture-covered window in front of him and his eyes riveted on the play, he again began his task of describing it step by step to his huge, invisible audience.

Before him stood a microphone transmitter which joined him telephonically to radio station WEAF in New York City, 900 miles away, and as he spoke, his words were immediately broadcasted to the hundreds of thousands of radio listeners within the station's range. With so vast an audience hanging on every word he uttered, it is small wonder that he felt a heavy responsibility.

Now what significance is there in the fact that a great football contest is followed throughout its course by so many thousands of rooters of both sides who are scattered through half a dozen states?

Consider for a moment certain important stages through which broadcasting has passed. In the beginning, we find here and there an amateur, particularly enthusiastic and resourceful, rigging up a transmitter which we would now consider most diminutive, but which in its day was the marvel of his community, and for the amusement of a few neighbors occasionally placing a phonograph in front of his transmitter. By this arrangement, his little audience could hear snatches of ethereal music at very irregular intervals. Such was radio broadcasting not so long ago.

Another and very important stage began with the opening of the celebrated WJZ by the Westinghouse Company. In the two years which have elapsed since that time some five hundred other broadcasting stations have sprung up over the country and a small army of radio experts and musicians are busy every



THE ANNOUNCER'S BOOTH

Installed by the engineers of the American Telephone and Telegraph Company. On the flag pole just above the booth will be noticed one of the microphones used for picking up cheering. The amplification which the output of these cheering microphones undergoes can be varied at will. When the announcer is silent the volume of cheering can be run up, and then diminished before an announcement is made

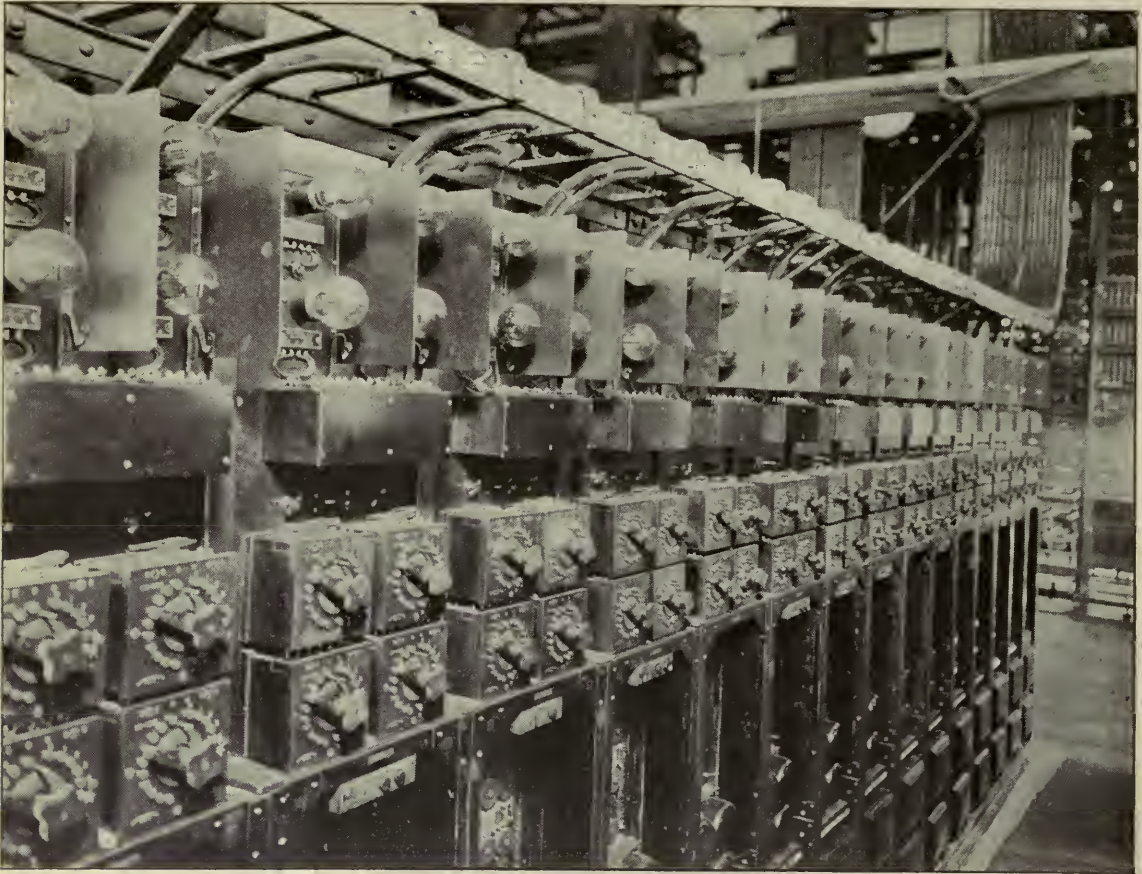

A TYPICAL TELEPHONE REPEATER INSTALLATION

As used on long distance telephone lines. Repeaters such as are here shown were also used for the remote control of W E A F when broadcasting the games between Brown and Yale, Princeton and Harvard, Yale and Princeton, and Harvard and Yale

day and evening putting on programmes. Moreover, the radio audience has grown from hundreds to hundreds of thousands and is today a body of people which, for enthusiasm, breadth of interest, and size, could not be gathered together by any other agency than the radio telephone.

This fact means that even greater stress must be placed upon the quality of the radio programmes. From where will they come? The only answer is that they will come from everywhere. Just as broadcasting replaced the amateur's phonograph programme, so it is reaching beyond the programme which originates in the radio "studio." The studio is not to be supplanted, but it is not enough. The time is rapidly approaching when the radio audience should have available a nation-wide, *even a world-wide, programme!* From boxing contests to grand opera, from church services to

great political mass meetings, from football and baseball games to international yacht races, from the inauguration of the nation's president to the dedication of great engineering achievements, there is a wealth of radio programme material which even the imagination can scarcely compass. But these events cannot be brought to the broadcasting station; *the station must, in effect, go to them.*

The purpose of this article is to discuss some of the technical developments by which this end is being accomplished.

Since broadcasting involves transmission of the voice or other sounds in only one direction, the problem of attaching a long-distance telephone circuit to the radio apparatus does not involve the use of such equipment as a hybrid coil and balancing network that are necessary whenever a two-way radio link is associated with a two-way telephone circuit. On the

other hand, the telephone circuit itself is of a special character designed to transmit without distortion the wide range of frequencies required for the accurate reproduction of speech and music. Two devices characterize the long-distance telephone line which is connected to broadcasting station: the electric wave filter and the telephone repeater.

Everyone appreciates the fact that music consists of sounds whose pitches range over a wide interval of frequencies. This interval extends from about 100 to about 5000 cycles per second for both instrumental and vocal music. It is not generally known that the normal speaking voice contains in it just as wide a range of frequencies as is used in music. The speaking voice consists of very complex sounds, in which the characteristic of pitch is not apparent. However, were one of these complex sounds to be carefully analyzed, we

would find it to consist of pure tones ranging in frequencies all the way from about 100 up to 5000 cycles per second. If it is desired to transmit the voice electrically either by radio or over a telephone circuit, and at the same time to preserve its individuality, we must therefore use an electrical system which will carry electric currents of frequencies from 100 up to 5000 with equal efficiency.

It is in this connection that a special form of the electric wave filter known as an equalizer performs a very important function. The filter is the invention of Dr. G. A. Campbell of the American Telephone and Telegraph Company, and, as its name implies, will separate currents of different frequencies somewhat as a screen will separate gravel of different sizes. In one sense, every long telephone circuit consisting of two parallel wires is a filter. It tends to transmit certain frequencies more readily



GETTING THE GAME PLAY BY PLAY

A crowd gathering around a loud speaker stand in Park Row, New York City. The input of the loud speaker was supplied from a radio receiving set located on the truck. On the upper left-hand corner of the truck may be seen a small loop antenna for receiving

than others, and this condition is particularly noticeable in cables, for there the two wires are twisted together with merely a thin paper insulation between them. Such a cable carries the lower frequencies with less alternation than the higher frequencies, and therefore distorts the speech currents sent through it. If it is necessary to use more than a few miles of cable in a long telephone line, and it was in the New York-Chicago line which was used to broadcast the game between Princeton and Chicago, this distorting effect must be counterbalanced. The use of equalizers accomplishes this. These special networks are introduced into the line at proper intervals and are so designed as to transmit most readily the frequencies which the line tends most to attenuate. The result is a conducting path for the speech currents which passes all the essential frequencies equally.

It is apparent that the use of equalizers will reduce the strength of the speech current which a line delivers, for, in effect, the transmission of the line for every frequency is reduced to the value it has for the least readily transmitted frequency. This difficulty, which at first sight might appear to be serious, is easily removed by the proper use of telephone repeaters. The repeater is a special form of vacuum-tube amplifier and can be installed at various points in a long telephone line to amplify the speech current and give it its original or an even greater value. In the New York-Chicago line, these amplifiers were installed at the football field in connection with the microphone transmitter, at Morrell Park, Illinois, at Beaver Dam, Ohio, at Pittsburgh and at Harrisburg, Pennsylvania.

As already indicated, the function of the telephone line is to deliver to the preliminary amplifier of the broadcasting station a speech current of about the same strength as it would receive were the transmitter at the station.

In accomplishing this, the spacing of the telephone repeaters at approximately equal in-

tervals along the line is a most important factor. The alternative to such an arrangement would be to introduce enough energy at the sending end so that, without amplification at any point along the line, there would still remain the amount required by the radio apparatus. This would necessitate an enormous power input and is not at all practicable. To take a concrete case, suppose that the speech current energy entering the preliminary amplifier at WEAf (New York) should be 0.01 watt. The attenuation of the New York-Chicago line is such that at Harrisburg, the nearest repeater station, the speech energy present in the line should be 0.14 watt. If there were no repeaters, then at Pittsburgh the line energy needed would be 2.9 watts, at Beaver Dam 41 watts, at Morrell Park 860 watts, and at the field 200,000 watts.

While it would not be impossible to-day to construct an amplifier with an output of 200 kilowatts, it cannot be regarded as a practical alternative to the five amplifiers which were used and none of which was required to give an output of more than a watt. Nor is this an extreme case. Were it a question of using a telephone line twice as long as that between New York and Chicago, the initial energy needed without intermediate repeaters would be the enormous figure of 20,000,000 kilowatts.

This comparison between the use of repeaters spaced along a line and providing all the necessary energy at the sending end gives rise to the question of how many intermediate repeaters it may be practicable to use successfully. While it is not possible to set a definite upper limit, it may be pointed out that an artificial telephone line, the equivalent length of which was 24,000 miles or the circumference of the earth, and containing thirty-six repeaters, has been successfully demonstrated. The area over which a broadcasting station may "reach out" for its programmes is therefore practically unlimited.



A Kingdom for More Wavelengths!

By PAUL F. GODLEY

JUST twenty-four hours before the time that I start this, the November elections were concluded. Directly, the elections have nothing to do with what is here set down. But there is little doubt that these same elections had considerable to do with the limbering-up exercises given to radio machinery by every broadcaster and radio listener in these United States. After last night most broadcast listeners have new impressions and I should like to know them. Information at hand shows that throughout that entire section of the country East of the Rockies reception conditions were very good. Note carefully! I mean by this that whether one wished to listen to the Fort Worths or the Bostons, to the Atlantas or the Chicagos, the New Yorks or the Denvers made little difference. They, and dozens more were all present with about equal pep, and *all together!*

An unruly Schenectady had been lulled into a state of coma. And, as swells of music from Detroit accompanied Atlanta's presentation of a great Senior, I remember—very distinctly I remember—offering up a fervent prayer for those simple-souled missionaries who might be demonstrating the wonders of a one-lunged "radio" to open-mouthed gatherings of their townfolk. If ever they needed expert radio aid, it was last night. If ever Santa booked an order for the receiver selective, it was last night. If

ever I wished that I might give to "fans" and manufacturers and editors and legislators and other sundry folks an earful, it was last night. I seemed to look out over a considerable tract of faces as the wish took form. A great wonder crept upward within me and turned to panic. No amazement was there. Open mouth after

open mouth was but registering expression—a collectively subconscious *though no less sincere* expression of a great desire to relieve the "gathering" in the ears.

What of it? Ah! but let me ask of *you* who have experienced this—let me ask *you* what of it! Can you not remember the universally heralded Conference of Radio Experts at Washington last spring who, called together by Herbert Hoover, finally made their recommendations? And, providing your interest survived, do you not remember the tenor of those recommendations? They assuredly promised that the much needed authority would be given the Department of Commerce in order that a *proper* founda-

Mr. Godley, well known as one of America's foremost radio experimenters, recently made an investigation in Washington of the sentiment on radio legislation. Addressing a conference of radio editors and business men in New York on November 6th, he summed up the results of his talks with Secretary Hoover, Chief Radio Inspector Terrill, Congressman White, Senator Kellogg and others, in these words:

"The entire personnel of the Department of Commerce, and some of the men in the Bureau of Standards with whom I talked, realized the great need for legislation. They all wanted it badly. They had been thinking about broadcasting, and what it is coming to, for a good many months, but they had the idea that the country as a whole—that radio folks as a whole—are not behind them in wanting legislation. . . . I was practically given to understand that the intention of the administration down there was to allow the radio people to stew in their own juice until they came to their senses sufficiently to decide definitely what they wanted and to get together and push that thing."

Meantime, the ether jam grows steadily worse. Mr. Godley's plea for a country-wide expression of the necessity for broadcasting legislation will surely stir to action those who have "suffered in silence" during recent months.—THE EDITOR.

tion might be laid for the soft-pedaling of chaos in radio. What of that? Here is the answer. These recommendations were drawn up in the form of legislative measures and presented to both legislative branches of our government and—*there they lie!* And there they will continue to lie as long as you and I who are interested in, and want the things which should be available to us now, permit it.

Even as this is written there is but slight chance that the proposed legislation will get action in time to permit of changed conditions *prior to the fall of 1925!* But, there is a *slight* chance, and that chance hinges entirely upon *your* interest and *your* effort *now!* If you don't know your Representatives at Washington you ought to. In any case do not disappoint them by failure to let them know what *you* think about radio and radio's mission in America.

The populace has tasted of radio and made a wry face. And yet, the great benefits to be derived from radio, unique as they are, completely overshadow in possibilities anything we have ever previously secured. Picture yourself as the chief executive of a mighty republic, able as you stand in your great office, to speak through radio directly to 100,000,000 souls. What contact! What inspiration to a nation! What uniformity of purpose during peril! Or, if

you will listen, no matter where you are, to Grand Opera, to famous orchestras, to stirring strains of military bands, to the thunder of the bleachers punctuated with play-by-play reports; to the roar of flood and fire and the cries of stricken cities, to news, news, news, and—if you live long enough—to the voices of other lands, voices with smiles and voices with tears! What contact! What annihilation of time, and space, and misunderstanding! Is that worth while? Every single bit of it is now possible. Some of it has already come to pass in limited areas. And, *if you want it*, a linking of super-landline and radio will secure nearly all of it within a few short months.

But legislation must come first. Radio laws of 1912, now sadly obsolete, placed certain bands of wavelengths solely at the disposal of the Army and the Navy. Between 600 and 2000 meters there are many wavelengths which must be made available to broadcasting

before a National Broadcasting System can be given birth. Both Army and Navy wish to keep them. For what purpose they do not seem to know. Suffice it to say that the Army now smears the ether with inter-departmental traffic of no apparent consequence which should long ago have been forced onto land wires. This traffic is all overland and land wires were built to carry such traffic. The rather lame excuse that its handling by radio serves to keep the personnel in training will not suffice. Any amateur operator will tell

you who did the very largest part of signal work during the late war, and he will also tell you that the Signal Corps personnel would get far more practice of the sort which is valuable during hostilities if that personnel were "boarding out" with the 30,000 amateur operators who, in spite of almost insurmountable interference, handle large quantities of "make believe" radiograms nightly. Amateurs would welcome signal



PAUL F. GODLEY

corps posts in their 200-meter band, and because of their greater resources as to equipment, would be inclined to class them, tentatively, as star relay stations.

One of the principal handicaps under which broadcasting is now struggling results from the great variation of any station's range in daylight and darkness. Other things being equal, the shorter the wavelength the more marked is this variation. At 200 meters, a station having a normal daylight range of but 40 miles may be depended upon to cover over 3500 miles during certain periods—a ratio of 90 to 1! Broadcasting stations now operating on 360 and 400 meters and having a normal daylight range of 75 to 100 miles may and do cover distances of 1500 miles at night—a ratio of 15 to 1. Stations having a wavelength of 1000 to 1500 meters whose daylight range reaches a limit of 150 miles may be expected to average a night range of approximately 2.5 times this figure. Thus, as wavelength is



"THE POPULACE HAS TASTED OF RADIO AND MADE A WRY FACE"

increased, complications which now exist, owing to the over-riding of one station by another, become markedly less. Because of the limited number of wavelengths available in the radio band, over-riding will have to be in some manner prevented. Too frequently, now, stations several hundreds of miles away may completely mar the programmes from a station two or three hours' train journey distant.

For fullest realization of its inherent benefits, broadcasting must be made dependable. Legislation must be secured as a start. Having secured it, its importance must immediately be forgotten. There is a vast amount of educating to be done. The very best that radio has to offer in the way of truly selective receiving equipment must be made popular. Even with the most highly specialized equipment in use to-day it is impossible to cut out interference of every kind. But the great majority of folks now struggle along with inferior equipment which represents in most cases initial expenditures equal to those necessary where the best available equipment is secured. This is due mainly to ignorance, and to what has been a misguided conception on the part of many manufacturers that the American public is incapable of handling a tuner which has more than one adjusting control.

Drawn up at the suggestion of Secretary of Commerce Hoover, the pending legislation is the result of recommendations made by a thoroughly representative body of the country's foremost radio engineers, amateurs, manufacturers, and editors. It provides for the establishment of an agency (the Department of Commerce) charged with the responsibility

of getting radio on the right track and keeping it there. By way of guiding this agency, a committee of twelve men is also provided for, each of these men to be chosen from one of the departments of the government, and six from among radio engineers of standing. Amateur station owners are taken care of through the allotment of all waves between 150 and 275 meters to their use under certain proper circumstances. The Secretary of Commerce is given power to stipulate what wavelengths are to be used for the various classes of radio services; to say how these services shall be conducted; to stipulate the nature of broadcasting programmes, time of operation of broadcasting stations, and power to be used; to penalize station owners who do not play the game; and to make changes in regulations as they become necessary. *He does not however have control over radio service operated by the government for the carrying on of official business.* Wavelengths for government stations are to be assigned by the president.

In this compromise with Army and Navy there lies potential friction which may produce a totally unsatisfactory state of affairs. Circumstances might very well arise, during peace times—should wavelength bands be assigned to a government branch without regard to the scheme of operations of the Department of Commerce which would find the public—you and me—in the rôle of bag-holder. It is hoped that in the hearings before the committee in whose hands these measures now lie, this one fly may be lifted from the ointment. You can be of assistance there too—if you will but speak.

When the "Carlos" Sank

The Unfortunate Predicament of a Radio Operator on a Sinking Vessel

By A. HENRY

IN DAYS gone by, the "call of the sea" was an annual event with me and my visit to the sanctum sanctorum of the Marconi Wireless Telegraph Company of America was as sure as the rising of the rent or the setting of the sun. Some folks have attributed my wanderlust to an abhorrence of hard work, others to a dislike for warm weather. I have never investigated thoroughly enough to decide which was correct.

Two or three trips were generally sufficient to satisfy me for the nonce and, because my duties as a radio operator permitted me to absent myself from the vessel, in port, I was frequently able to fill my erstwhile empty pockets or replenish a good, though elderly wardrobe from the commission I made selling phonographs or vacuum cleaners in Porto Rico or Nova Scotia—but that is another story and is merely brought in to show you that I had no business being on any steamer, especially one in distress. I was a vacationist with insufficient capital to vacation as I liked, and radio happened to be one of a few possible solutions.

The *Carlos* was a first-class American passenger steamer which plied between New York and several Porto Rican ports. She was in every way a fine vessel and was a particularly attractive berth for radio men. I was always a little fussy concerning the vessels upon which I sailed and had many disputes with the Superintendent over this matter, and must admit that he was very considerate as a rule. After a rather extended and heated discussion, which centred upon the fact that I had carried on regular communication with a certain amateur station on the last vessel he had assigned me to, and that I had no reason to expect assignment to so good a vessel, he finally gave in and let me down easily by reducing me to "junior" operator.

The man who was my senior—there were only two of us—happened to be an old friend with whom I had shared a very inferior berth on an assignment several months before. He seemed pleased to have me with him and I was

very well satisfied—for my heart was set on making another trip to Porto Rico.

One very fine day in June we sailed and I waved farewell to one who must have wondered: "Is it to be next June, or the next, or never?"

The trip was as most such trips are. There were travelers of all kinds—the shy little thing who runs away with the hearts of the bachelors, and the would-be shy little flower of forty-five or so, from whom the bachelors bend every effort to escape; the diplomat, plantation owner and the chauffeur traveling with a family of nouveaux riches. There were the usual poker games with rock and rye in the smoking room for the men, with bridge and Panama punches in the Social Hall for the ladies, while the younger set sought secluded sections of the upper deck to whisper sweet nothings and sip claret lemonade between observations of the tropical moon above a tranquil sea.

On the night of the fifth day out I was deep in slumber, after having partaken of a rarebit and a glass of beer in the smoking room at ten, when we came within sight of the light at the entrance to San Juan harbor. At one in the morning, which was the hour for me to arise and go on duty, my "partner"—juniors always like to use that term in speaking of their immediate superior—came in and shook me until I came to.

"We're riding at anchor now," he said, "and the light is just off the port quarter. Get up and see to it that nothing runs into us before morning."

My only answer was a pillow, hurled at him as he began washing his face in the basin we shared. As he prepared for sleep and I for duty, he told me of the happenings of the evening and we checked up the profit accruing from the sale of the radio paper we published twice a day.

Then he fell into his bunk and I went into the radio room through the door which joined our quarters. We enjoyed two rooms on the upper deck, away from all the passengers and the other officers.

There was nothing important for me to do

in the radio room so I strolled about the deck and, finding everything serene, ambled down to the pantry in quest of the night watchman, a cup of black Java, a couple of sandwiches, and some olives. The watchman and I lingered over

loaned me by a manufacturer, and copied several messages from Germany as they were going to the station at Sayville, L. I.

After a half hour of eavesdropping on the world and smoking many cigarettes I began to

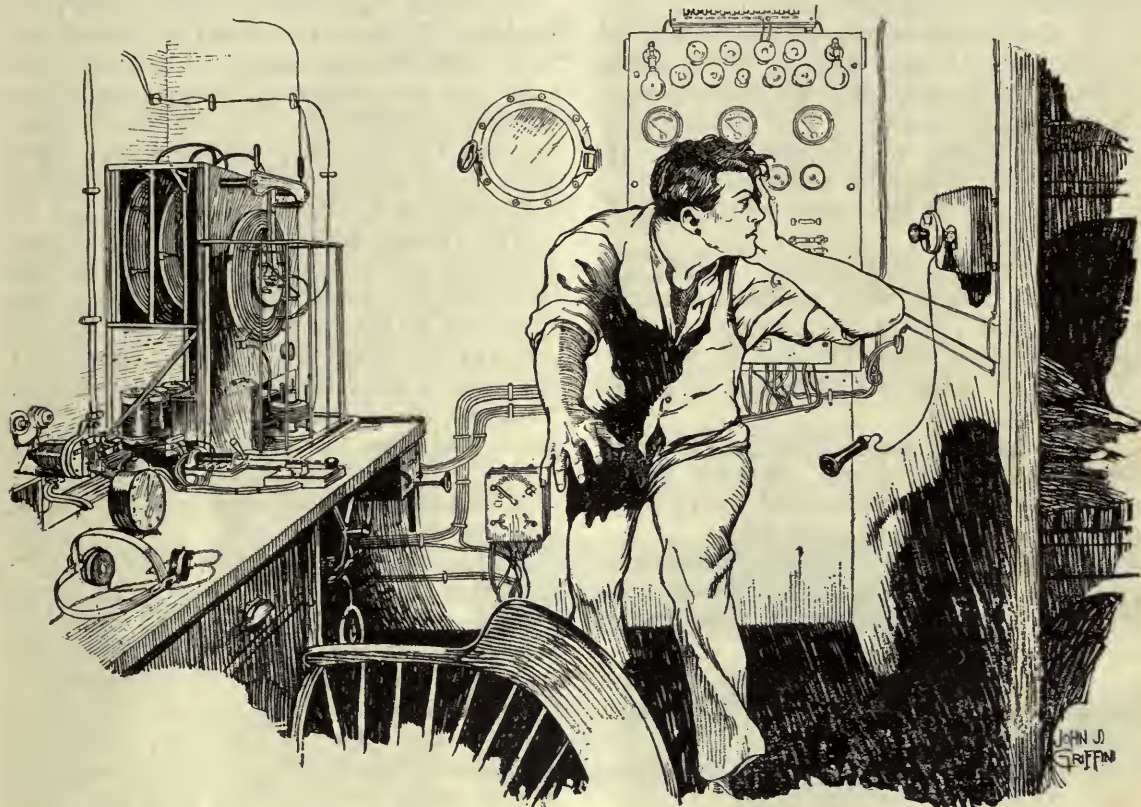

THE TELEPHONE STOPPED RINGING BEFORE I REACHED IT

A million thoughts flashed through my brain accompanied by a million different sounds from the deck below. Had we been rammed? Had a boiler blown up? Did our anchor drag and let us strike a rock? What to do to save the lives of those aboard?

our nocturnal meal, swapping jokes and tales of experiences on other packets—"wagons," as ships are called in deep-sea parlance.

At three o'clock I went back to the radio shack and listened-in. The Naval Station at San Juan was working an arc set and having difficulty clearing his traffic through Charleston, S. C. The station at Miami was carrying on his regular business with the vessels on the coast and in the Gulf of Mexico. The station at Morro Castle, Havana, was having some difficulty in getting a message from the Isle of Pines and the high-powered station of the United Fruit Company in New Orleans was sending a bunch of code messages to the Swan Island station for relay to the company's steamers.

For a short time I listened on a long-wave set,

grow weary. I fought off the increasing drowsiness for a time by trying new circuit arrangements. When, making a connection between a receiver and one of the "B" batteries, I fell over and struck my head on the corner of the bookshelf, I decided then and there that our vessel was entirely safe; that we were within a stone's throw of port and that I would go to bed.

The law requires that a passenger vessel carrying fifty or more persons maintain a continuous radio watch from port to port. I had absolutely no misgivings regarding our safety, for the deck officers were on duty and it was merely a matter of waiting for dawn before we would heave anchor and proceed to dock. However, I did feel as though I should be on

duty when we got under way and estimated the hour of daybreak.

I set the alarm clock at "repeat" for that hour, put it on the table in the radio shack, and turned in. I was so drowsy that sleep overtook me in a minute or two.

My sleep, however, was not very sound, for I subconsciously kept thinking of the alarm. It seemed as though I had just fallen asleep—though it was actually several hours later—when, like a thunderclap, came a crash—the vessel swayed to and fro and then settled. I woke with a start but merely waited, tensely apprehensive.

Then came a sudden, impatient ringing, and as I hastily climbed out of my bunk to answer the telephone, I heard the shuffling of many feet on the deck below, followed by the shrill shriek of the boatswain's whistle and several short verbal orders.

The telephone stopped ringing before I reached it and a million thoughts flashed through my brain accompanied by as many different sounds from the deck below.

Had we been rammed? Had a boiler blown up? Did our anchor drag and let us strike a rock? What to do to save the lives of those aboard?

"Hello, hello," I bellowed into the telephone transmitter. "Hello—this is the radio shack, what's the matter?"

But the telephone was both deaf and dumb. Not a sound came from the receiver.

I rushed out to see if the line from the bridge had been cut and fell on the dew-covered deck. As I got up the order "Over the side with 'er" followed by the deafening whistle and the

shuffling of many feet told me they must be launching the life-boats.

The telephone rang impatiently and I rushed back into the shack, repeating the vain attempt to get an answer from the bridge.

As I stood there yelling—words I can't remember—my entire life passed before my eyes in an overwhelming instant. I saw my boyhood and the succeeding years, some of my pleasant moments and all my faults. And here was the end—on a sinking vessel—a disgrace to my family and myself—a "ne'er-dowell" meeting well-deserved fate.

With the passing of that instant came consciousness and reason. I was about to run up to the pilot house when the telephone rang again, but by this time I had become cool and collected, so instead of shouting, I merely said in as near a natural tone as I could command, "Yes, Sir, this is Radio, junior operator speaking." But there was no response and I lost my nerve again. The activity on the lower deck became greater and more orders and more whistling droned in my ears.

I made a dash for the door when the telephone rang again and I stopped in my tracks about to yell for my partner when I heard him impatiently exclaim, "Say, you nut—turn off that alarm clock and quit that foolishness!"

The realization of it all dawned on me in a flash. I had forgotten all about the alarm clock; the boatswain was getting the booms and hatches ready for unloading when we should get to dock, and I had made a fool of myself.

From that day on, I never slept on watch and radio has meant something more than an opportunity to enjoy myself.

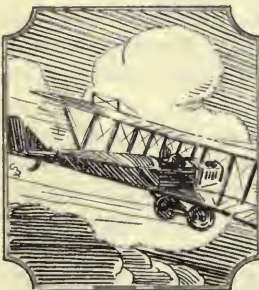

How Your Telephones Work

An Explanation of the Nature of Sound in Relation to Radio Telephone Reception

By G. B. CROUSE

Chief Engineer of The Connecticut Instrument Co.

GREATER acoustic excellence—more faithful reproduction—is becoming a necessity in radio just as it became a necessity in the development of the phonograph. Through the use of the electrostatic transmitter it is now possible to obtain practically perfect modulation in transmission, but it still remains to improve the receiving sets and especially the loud speakers and telephone head sets to the end that the waves received be perfectly reproduced.

One way of stimulating improvement is to show people what an interesting and important subject this is. In this article we shall describe briefly some of the most interesting phenomena involved in the reproduction of sounds by means of the telephone.

All sound waves consist of alternate expansions and compressions of the air. If we could cut through a cross section of air through which a sound is passing, and could see the arrangement of its particles at any particular instant, it would look somewhat like Figure 1.

When a train of such sound waves falls on the ear, the condensed portions push the ear drum in and the rarefied portions pull it out. This motion of the ear drum is transmitted to the nerves of the inner ear and a sound is heard.

When we hear a sound, we distinguish a number of different things about it. In the

first place we know that it is loud or soft; that is, we distinguish volume. We also know that the sound is deep or shrill; in other words, we distinguish pitch. Thirdly, we distinguish quality; that is, we can tell a violin from a tin whistle, even though they are both sounding notes of the same pitch and of the same loudness.

Let us examine the nature of these three characteristics of sound. In regard to the loudness of a sound, it is almost self-evident that it depends on the amount of motion of the ear drum, and thus on the amount of compression and expansion of the air which falls



FIG. 2

upon it. We therefore say that the loudness of a sound is dependent upon the amplitude of the air wave. The appearance of a loud sound is compared with the appearance of a soft sound in Figure 2.

The pitch of a sound wave depends upon the number of alternate compressions and expansions which strike the ear drum in a second. The greater the number per second, the higher the pitch of the sound. The pitch is determined by the distance from the centre of one condensation to the centre of the next. The wavelength is the distance A—B in Figure 3, where two sounds of different pitch are represented, the lower sound being one half the wave length and twice the pitch of

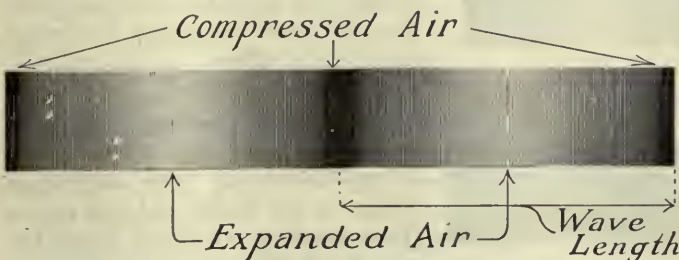

FIG. 1

the upper one. In musical terms this difference is called an octave.

WHAT IS QUALITY OF SOUND?

THE explanation of quality is more complicated. When we say that sound consists of alternate compressions and expansions of the air, or which is the same thing, of alternate to and fro motions of the air particles, we have said nothing about the manner in which they execute these motions.

In general, a particle may have a periodic or to-and-fro motion, and yet execute this motion in a variety of ways, and we are at once led to suspect that the quality of a musical tone is dependent in some way on the manner in which the air particles vibrate. Von Helmholtz discovered that the manner in which the particles of air vibrate is the result of combinations of a number of simple or elementary vibrations from which all sounds are made up.

In hearing words, we very seldom hear the simple sounds by themselves. A tuning fork used in music for giving the pitch to piano tuners, when lightly struck gives a pure tone, and some musical instruments, such as the pipe organ, give almost pure tones in some parts of their scales, but the pure tone is dull, uninteresting and very tiresome to the ear. All pleasing musical tones are made up of quite a number of simple tones, all combined to make one sound.

THE COMPOSITION OF A PIANO TONE

IN FIGURE 4 we have shown the keyboard of a piano. When we strike the key marked middle c, we hear a compound tone whose pitch is middle c, but this compound tone is

made up of a number of simple tones, the lowest one of which is a simple tone of middle c pitch. But in addition to this, we hear also what is known as the second harmonic, another simple tone whose pitch is twice middle c, or an octave above, as shown. And in addition to this, we hear the third harmonic, which is a simple tone



FIG. 4

of three times the pitch of middle c, or in musical terms is an octave and a fifth above the fundamental middle c. We also hear the fourth harmonic, or two octaves above middle c, and so on. We may hear simple tones of five, six or more times the fundamental which we struck.

Almost all tones which we are accustomed to think of as pure are in reality composed of quite a number of pure tones combined to form one compound tone.

Most of us are familiar with the method of representing music on paper, by means of notes placed on a "staff," the lines of the staff representing different pitches. For instance, in our experiment above, we struck the note middle c, and if we wished to write this in music, it would be represented as in Figure 5.

Now if we let our notes on the staff represent the various pure tones that were produced when the player struck this note, what the ear hears is indicated by Figure 6.

Now if this note, instead of being played on the piano, were played on a violin, we would at once recognize the difference, although the pitch would be the same. Upon analysis, it is found that while the tone we hear is made up of a number of simple tones, or harmonics, the relative loudness of these harmonics differs in the violin and the piano. If in our music, we let the size of the note mark represent its loudness as compared to the other harmonics, the

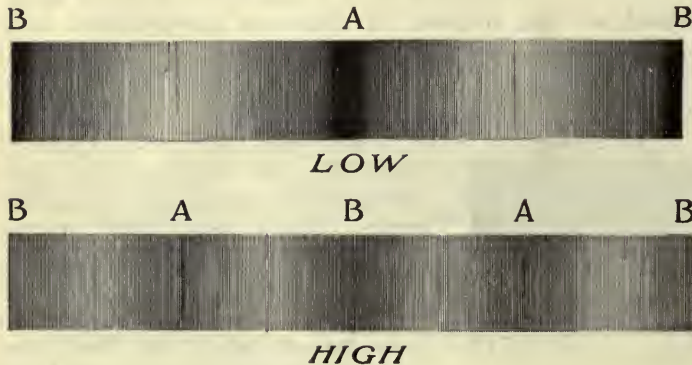

FIG. 3

analysis of a violin note would be correctly represented by Figure 7. A flute playing the same note would be represented by Figure 8.

Thus we see that the quality of a tone depends entirely upon the number and relative loudness of the harmonics which are present. The ear always determines the pitch of the compound tone from the pitch of the lowest simple tone present, but it determines the quality solely from the composition.

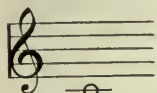

FIG. 5

In some cases, the lowest simple tone, or "prime tone," or "fundamental" as it is variously called, may only represent as little as 5 per cent. of the total volume of the compound tone, as for instance in the split tone on the French horn, whose sound is represented by Figure 9.

So far, we have discussed only musical sounds, i.e., in which the harmonics, or overtones, were two, three, four, etc. times the fundamental in pitch. However, the overtone may not be an even number of times the pitch of the fundamental, in which case the compound tone is generally jangling and unmusical. This is true, for instance, in the cymbal, and indeed in all metal plates. For instance, the sound heard upon striking a metal plate may be represented as in Figure 10 in which the proper position for the harmonics is shown by the shaded notes, while the actual overtones as produced by the plate are shown in white as in the other figures. We have there an overtone which is two and one fifth the pitch of the prime tone and another which is three and one seventh times the prime.

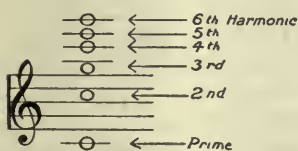

FIG. 6

This sound will be unmusical and discordant and all sounds containing these odd overtones we say are harsh and metallic in character. We are now in a position to see what an ordinary telephone receiver does to the quality of a sound. If you take a diaphragm of steel, or indeed of any thin hard material, say the diaphragm from an ordinary telephone, and holding it to the ear, tap it lightly with the blunt end of a lead pencil, you will find that the diaphragm emits a clear metallic note, having a very definite pitch. In other words we say that the diaphragm has a definite natural period of vibration. Therefore it will vibrate at this pitch much more easily than at any other pitch.

Thus when the telephone is called upon to respond to this note (which is generally from one to two octaves above middle c in most receivers), it will respond loudly,

whereas all other notes will be suppressed. Further than this, when the overtone of any note lies near this diaphragm period in pitch, it will be amplified at the expense of the other overtones, and from what has been said above, it is clear that this change in the relative loudness of one of the harmonics will change the quality and make it unnatural and less pleasant to the ear. In some cases it will make it difficult to recognize the instrument or voice which is sounding. This is one of the effects which is included in the term distortion. For instance a piano reproduction by radio often sounds more like a harp, due to distortion in some forms of receivers, and this is even more noticeable when certain kinds of loud speakers are employed.

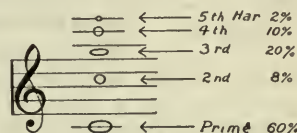

FIG. 7

Therefore, reviewing briefly, we will represent a note played upon a violin in Figure 11 and beside it the same note when heard in the ordinary telephone, Figure 12. In this case the second harmonic is made very much louder, because it is close to the natural period of the diaphragm. The characteristic tone of the violin is therefore partially lost.

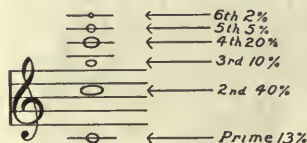

FIG. 8

UNMUSICAL OVERTONES AND TRANSIENTS

IF THIS were the worst effect in distortion, we should indeed be fortunate, for due to this cause alone, while the quality would not be the same as that of the instrument at the transmitting end, it would at least be musical.

There is, however a second effect of distortion which is distinctly unmusical and harsh. Since, as was shown above, the ordinary diaphragm note is always sounded along with whatever sound the telephone is reproducing, and this diaphragm sound is only very rarely an even

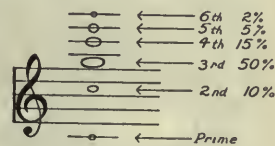

FIG. 9



FIG. 10

harmonic of the note which is being sounded, we have added to the musical sound, a number of overtones which are not an even number of times the pitch of the prime tone, with a resultant harsh metallic jangling quality.

We have seen, in Figure 11. c as played on the violin, and Figure 12 shows the distortion of the overtones due to the natural period of the diaphragm. Now, in Figure 13 we see the harsh, inharmonic diaphragm over-tones in black and the other tones in white.

The ringing of the diaphragm caused by the diaphragm overtones tends to persist after each syllable, thus not only distorting the individual sound but carrying over from one sound to the next with a blurring effect.

PROBLEM OF ELIMINATION OF DISTORTION

THE elimination of distortion in a telephone receiver resolves itself into the elimination of the natural period of the diaphragm, and while thus stated the problem sounds simple, it is in fact extremely difficult. It is only by the most careful acoustic, magnetic, and electric investigation that the problem can be solved. At present, an effort to find the solution is being made by a well-known instrument company. In this telephone, a diaphragm of special material is employed of such a nature that there is a great deal of friction between its molecules so that it cannot vibrate freely by itself and thus has no natural period which can be distinguished.



FIG. 11

NOISE FILTERING EFFECT OF NON-METALLIC DIAPHRAGM

THE freedom of this kind of diaphragm from free vibrations has another advantage for telephone receivers employed in radio work, in that it reduces the unpleasant effects of tube noises and static. In the ordinary re-

ceiver the noises produced by the tubes and static discharges set the diaphragm ringing strongly, and sometimes drown the useful sound. In the telephone mentioned these disturbances are partially filtered out, with the result that a dull sound is produced which does not produce as great a noise or tend to set up distortion of the desired sound.

In conclusion we will summarize the principal points that must be remembered when dealing with this subject of reproduction of sounds without distortion.



FIG. 12

1. Tone quality (the characteristic which distinguishes one musical instrument or voice from another) is the result of the combination of simple tones. For any given note on a given instrument this combination is always the same.
2. In order to be harmonious the resultant sound must be made up of simple tones which bear an even relation to each other, as 3 to 2, 1 to 3, 1 to 2, etc., and not an odd relation, as 7 to 11.
3. The introduction of any element which changes the values of the harmonics which make up a given sound will change the quality of that sound and may, for example, make a flute sound like a violin.
4. The introduction of any sound which does not bear an even relation to the fundamental tone will produce a jangling, unmusical effect.

Listening to the radio telephone is not like using the ordinary telephone where it is simply necessary to understand the words spoken. To enjoy radio broadcasting it is generally necessary to sit down and listen for a half an hour or more. It is then that the full effect of distortionless reproduction is appreciated.

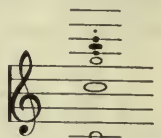
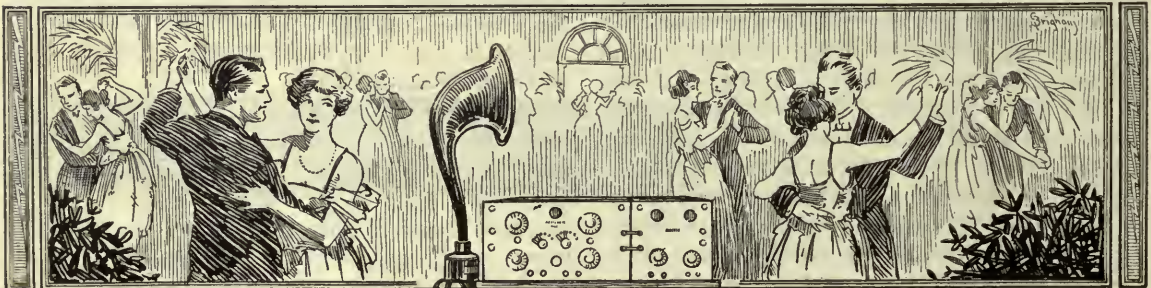

FIG. 13



Mining the Makings

By PHILIP S. RUSH

IT'S a far cry from the dark and dangerous passageways of a copper mine, half a mile below the surface of the earth, to the bright and happy sitting room where your radio set reproduces the concerts sent out from a distant broadcasting station. And there isn't the slightest similarity in appearance between the huge masses of copper ore-bearing rock and the tiny wires that make possible the wonderful achievements of radio. Yet, the first step in the development of the wireless outfit, whether it be the largest and most powerful or the smallest and crudest, is mining the ores from which the metallic parts of the apparatus, the filling for the dry cells or the plates of the storage battery, and the crystals for the detector, are obtained.

The metals used in the manufacture of the parts of a radio outfit are obtained almost entirely from mines of great depth, located west of the Mississippi River. Even though your headphone or variometer may be labeled "Made in Germany," the chances are ten to one that the ores from which the metal was extracted came from the Western part of the United States, were exported to Europe as bars, ingots, slabs, or pig metal, there manufactured into delicate parts, and finally reshipped to America for use. Thousands of miners are employed in digging the ores, other thousands operate the smelters and refineries; in fact, an unseen and unknown army works day and night to produce the bits of metal which are necessary to the successful operation of large and small radio stations all over the world.

First in importance, in point of volume of metal used in electrical work, is copper—the "red metal," as it is called by mining men. Arizona, Montana, Utah, and Michigan furnish most of the copper output of the United States, and, incidentally, they export to Germany nearly half their product. In these states are some of the largest mines, smelters, and refineries in the world, and here new feats in mining and metallurgy are continually being performed. In Michigan, copper was mined first by a race of people whose history is lost in the centuries that preceded the discovery of

America, yet to-day many of the most productive copper mines in the world are located around Calumet, Hancock, and Houghton, where copper was dug from open pits in prehistoric times. Some of the present mines are sunk 8,000 feet into the earth, where copper in almost pure metallic state is found.

Very different are the mines of Bingham, Utah, and certain properties in Arizona and Nevada. At Bingham is located the Utah Copper Company which owns one of the greatest copper mines in the world. It consists of a mountain of low grade copper ore, upon which tracks have been built in terraces. Twenty-five giant steam shovels load the ore and rock into long strings of waiting ore-cars; the mountain is gradually being carted away to the smelters, a trainload at a time. Some of the properties in Arizona and Nevada are worked in the same manner, but most of the copper mines in Arizona, and all those of Montana are operated through shafts sunk deep into the earth. From the shafts extend



THE MOST OPTIMISTIC MAN IN THE WORLD
The Western prospector, who is always hoping that the next blow of his pick will turn up mineral riches



ONE OF THE PRINCIPAL LEAD MINES

Located in the Joplin, Missouri, district. Perhaps the galena crystals in your detector came from this mine

tunnels, or cross-cuts as they are called in the West, in every direction, honeycombing the ore-bearing rock for the desired metallic content. While the ores of northern Michigan are almost pure metal—"native copper"—and those of the Utah Copper Company contain much rock and little mineral, the mines of Montana and many of the Arizona copper properties carry their ores in veins set in solid granite walls. The veins vary in width from a few inches to great pockets many feet wide and deep, and in some instances the ores assay 50 or 60 per cent. copper, with a certain amount of gold and silver thrown in for good measure.

The small mining area at Butte, Montana, contributes more than just copper to the wireless equipment of the world, for in addition to some of the richest copper mines yet discovered, there is the largest single zinc mine in the world. The most valuable manganese deposit in the United States lies about seventy miles west of Butte, at Phillipsburg, and it is from the Phillipsburg mines that most of the high grade manganese used in dry cell batteries is obtained.

New Jersey is the one Eastern state that competes strongly with the West in zinc production, but the greatest zinc-mining field in the world is in the neighborhood of Joplin, Missouri. The ores underlie a wide area, extending into Oklahoma and Kansas, and during the last four years Oklahoma mines, all relatively close to Joplin, have produced far more

zinc than the mines of any other state in the Union. Unlike Butte, the Oklahoma-Kansas-Missouri field is shallow, and the ore is found in pockets and blanket formations, somewhat like the coal beds of the central states.

Zinc is, of course, a vital element in batteries and alloyed with copper it becomes brass, which is used in a hundred ways in radio equipment:

The preëminence of the zinc fields about Joplin is a matter of only the last few years, but for a long time Joplin and lead mining have been almost synonymous terms. It is, in fact, not at all unlikely that the galena crystal in your newest detector is a product of the mines about Joplin. The Coeur d'Alene district of the Idaho panhandle, while a most different geological area, also abounds in galena or lead ore, and there are extensive mining properties centring about Wallace and Mullin, producing vast quantities of lead, silver, and zinc. Montana, Colorado, Utah, Nevada, Arizona and a few other states produce lead. A marked difference in the value of the galena crystals obtained from different mines has been noted in experimenting with radio detectors.

The tungsten filaments in your bulbs may come from the mines of California, Colorado, or Nevada, but by far the greater part of the tungsten used to-day is produced in China and neighboring countries and exported to Europe or America for treatment and manufacturing. The United States is also a small producer of



HAULING ORE IN THE WEST

Six-horse teams like this pull the heavily laden wagons along the deeply rutted roads of plain and mountain

platinum, but the Ural Mountain district of Asia, and Colombia, South America, export far more of this valuable metal than the total mined in Alaska, California, Oregon, and Arizona.

Nature distributed iron ore more generously than she did most of the other metals. The tall masts of the antenna of a great station, or the tiny core of an electromagnet, may have come from ores mined in almost any section of



GEOLOGISTS AND MINERS EXAMINING A VEIN

Just after a dynamite blast has brought down a lot of rock and ore. This flashlight was taken many hundreds of feet below the surface of the earth



MILES AND MILES OF WIRE

Are made from ore in this monster plant of the Anaconda Copper Co., at Great Falls, Montana

the United States. Deposits of iron ore exist in more than half the states of the Union, but in only a few is extensive commercial mining carried on; the fields of northern Minnesota alone produce more than fifty per cent. of the tonnage of the United States. Michigan is second, Alabama third, but a great deal of iron also is mined in Wisconsin, New York, New Jersey, and Pennsylvania. In the Lake Superior region, where most of the ore is mined, there is no coal or natural gas, consequently the ores are shipped to the coal fields, to Pennsylvania, Ohio, Illinois, Indiana, and Alabama, where are located the greatest blast furnaces and factories. Some iron mining is carried on in open cuts, with steam shovels, other ores are obtained by underground mining. Steel is, of course, derived from iron and finds its greatest appli-

cation to radio in masts rather than in the receiving or transmitting units themselves.

The West yields to the East in two minerals very important in the manufacture of wireless equipment: the aluminum for your condenser plates is mined chiefly in New York, North Carolina, and Tennessee, and the thin sheets of mica, used in insulation, are mined in North Carolina, New Hampshire, Georgia, and Virginia. The total American output of mica, however, is small in comparison with the product of the mines in British India where most of the world's supply is obtained. The one metal extensively used in radio equipment not commercially mined in the United States is nickel, used for plating the many bright knobs and screws. This we obtain chiefly from our Canadian neighbors.

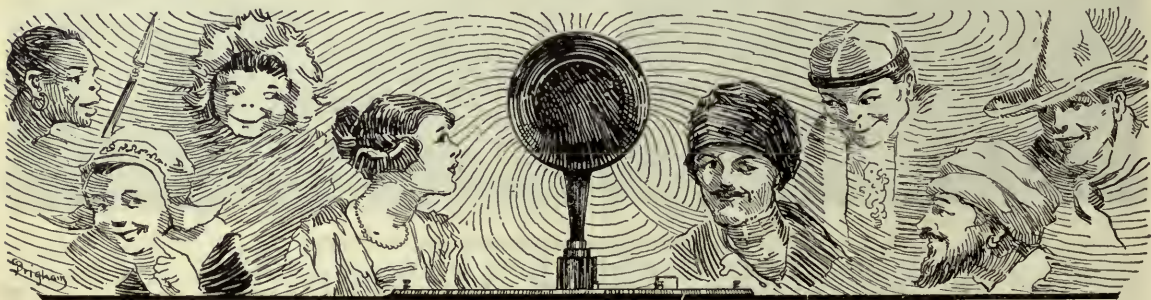

To Mr. Hoover From the Postmaster at Boone Stop, Mo.

By HOMER CROY

Boone Stop, Mo.

While waiting for
the 1:15 to come in.

THE HON. HERBERT HOOVER,
Department of Commerce,
Washington, D. C.

HONORED SIR:

I understand that you are head of the wireless telegraph of the country and that what you say is law, so I take my pen in hand to help you straighten things out, as no doubt you sometimes run up against knotty problems that are about all you can handle and make you wish for somebody to advise you who has had practical experience in wireless, such as the writer has.

As you can see from my letter head, I am also a part of the United States Government, being the postmaster in Boone Stop, Mo., which got its name because Daniel Boone stopped here. I have held the post under three consecutive administrations regardless of their politics, as I make it a principle to let each new postmaster-general do as he likes, as I find that is the best way to handle them. However, it seems to me if Will Hays has cleaned up the movies that he has kept it to himself, because when I put the duties and responsibilities of my office aside and go down to our theatre for a few minutes' recreation they are just about like they always were. But that is not the matter I wanted to take up with you, as no doubt you are more familiar with the intricacies of radio and haven't time for thought along other lines than what you are paid for. Nor do I blame you because I, too, know what the cares of public office are. It is only by closing the window that I can get any time to myself to take up these important matters with you. You may not know it, Mr. Hoover, but I was one of the first persons in Boone Stop to take up the wireless telegraph, or radio as it is often called. I have always been in the forefront of new ideas and as soon as I was convinced that the thing was sound, I threw my weight into it. I was also one of the first supporters of Bryan, and when prohibition came along I

again put my shoulder to the wheel so you can see that I am not a person afraid to use his brains. I have always done my own thinking, and have never been the pawn of clicks and parties. From what I have read of you, I judge you to be something of the same, so we should be able to work well together. It is said that Andrew Carnegie, the late millionaire, now deceased, attributed his success in life to his ability to pick brains in other men. But no doubt you already know this and are planning the same kind of career for yourself.

I have often thought that it was a pity that Mr. Carnegie did not make a trip out through the Missouri River Valley section of our country because it probably would have opened his eyes to the fact that there was some other place besides Pittsburgh where he got most of his talent, because he could have saved himself a good deal of money on the payroll by getting men who would have been willing to split the salaries he offered and yet work just as hard. But of course it is not too late, unless the same was carried into effect in official circles in Washington. If you chose me head of your radio work, or something that I am familiar with, you could rest assured that I would not slight my duties. I understand that there has been a good deal of complaint about our civil service system in Washington and that the employees work only when there is not a baseball game, or a new feature picture in town, but this would not be true of the writer. He would not walk down to the depot to see Babe Ruth and Judge Landis become personal, and as for features, the only difference that I can find is that there are more names of photographers and assistant photographers and assistant-assistant photographers on features than on the kind that don't cost so much.

I see that you are puzzled about giving out wavelengths to the different people who want them. Of course I do not want to butt in on your domain, but you must recognize that this is a very important matter, because if they get into the hands of unscrupulous people what will they do with them? If I were in your place

I would select a good man in each community that I could trust and then have him report as to who was the most worthy person to let have them. This person would be your confidential man. At any time you wanted to know anything about the radio situation in a certain district, all you would have to do would be to call Boone Stop 67-R.

I will explain my ideas to you because I know how busy you are, going to dinners and things that way that you can not very well get out of without hurting somebody's feelings. But there is one thing that I would not allow and that is the use of radio by politicians. It seems to me, Mr. Hoover, that this is too much of a good thing. What we need less of than anything else is too much politics. For my own part, if, as I said, you selected a good man for this district I would make it a first degree offense to mention politics over the wireless telephone. If a person wants to read it in the papers it is his own lookout, but think of having company that you like in to dinner and you want to give them a good time before they go home, and you take down your radio and there is somebody talking about what he would do if you elected him to office. Marconi is a good man, and I am not one to belittle him, but if that is going to be the sum total of his invention it would have been better if his parents had guided him along some other channel before it was too late. There are plenty of good inventions needed by the human race, let alone something that will make them worse off than before they were born.

A thing that comes to my mind is something to keep pens from rusting in a post office. This would be a help to everybody who has ever picked up a pen, dipped it into the ink, thought of something to write and then started and found it didn't have but one nib—and the only other pen is being used by a girl who is writing to a boy who isn't good enough for her. Besides, such an invention as this would not

only be of help to struggling mankind but would be of service to a busy postmaster who has ideas outside the routine of his work.

Another thing that we ought to deal with with a firm hand is the growing prevalence of people telling how far they have been able to receive. This may seem a small matter to you, because you have your nose to the grindstone and do not know what the country as a whole is thinking of, but more and more people are beginning to boast how far they have been able to establish communication. If the first person says that he has heard WMPO and that is 400 miles, then the second person says he has heard KNKM and that is 700 miles if it is a foot. And then the third person raises him a thousand. It is tending to make us a nation that does not have the proper regard for the truth. We should act together at once, Mr. Hoover, to discourage this before it permeates to other channels or our whole public life will be honeycombed with it. You will recall the case of the boy who stayed the waters by putting his thumb in the hole in the dike. Mr. Hoover, one of us must put our thumb in the opening. I know that you are busy and need every hand you have and probably more, so I will make the sacrifice.

These are only a small part of the things that have occurred to me. If you will send for me, so that we can talk it over face to face as I like to do on such occasions, then you can get a better idea of what is in my mind. Then I will collect my expenses, return and set about getting my affairs into shape. The only delay will be while Mr. Work is trying to get somebody to try to take my place.

Yours till radio conquers all,

AMOS MILLER, P. M.
(Postmaster)

P. S. If you telegraph, please send it prepaid, as the agent here says that it makes him less work.



Famous Radio Patents

By CHARLES H. KESLER

Member of Bar of District of Columbia, and of New York Patent Law Association

From the very beginning of radio, patents have formed the legal battleground upon which many theories have been proved and disproved. Conflicts over patents have been the stepping stones or stumbling blocks in many radio careers. They are important to every radio investigator and should interest every radio enthusiast. Humor, pathos, jealousy, revenge, and the cold facts of science are found aplenty in these legal battles and it is but natural to assume that the story may best be told by a warrior who has tasted both defeat and victory.—THE EDITOR.

RADIO as we know it to-day is the result of the work of thousands of men, some of them scientists interested in knowledge as an end in itself; others practical inventors whose goal is a product that will sell. The inventions which have contributed to make modern radio possible are many; but we shall discuss merely the most important inventions which are covered by patents which the courts have decided are valid.

The patent system of the United States is unique among the patent systems of various nations, and our industrial progress has been due in no small measure to it. The Constitution of the United States gives Congress power:

"To promote the progress of science and useful arts by securing for limited time to authors and inventors the exclusive right to their respective writings and discoveries." (Art. 1, Sec. 8.)

Such rights are granted by patents. A patent is a contract or agreement between the inventor and the United States in which the government agrees to give the inventor or patentee the exclusive right to make, use, and sell the invention for the term of seventeen years and the inventor agrees to make a full, clear, concise, and exact disclosure by description and drawing of the invention, such that after the expiration of the patent to which the description and drawing are attached, anyone of average skill in the art may be able to construct, make, or use it. The words, "exclusive right" means the right to exclude others from using the invention. The inventor has the right to use his invention himself, provided he does not infringe other patents.

Patents are granted for apparatus for doing a thing, or for methods or processes for doing a thing. A principle of nature cannot be

patented, as, for instance, the broad idea of using electromagnetic or radio waves for communication. Furthermore, the patent system is for the purpose of promoting "the progress of science and useful arts," granting the exclusive right to a patentee being merely a means to that end.

A patent when granted is presumed to be valid unless found invalid by a Federal Court.

In a patent suit, facts are mustered by both sides, for and against the patent. The defendant or alleged infringer attempts to show that he does not infringe or that the patent is invalid. From the contested facts the court decides what was granted by the patent and how far one can go without infringing it. In a well conducted patent suit, earlier patents and publications showing similar constructions are reviewed, the question being: Has anything been contributed by the inventor, which promotes science and the useful arts, not covered by previous inventions? Technical experts testify and the counsel for each side argues the case.

ADJUDICATED RADIO PATENTS

THE patents which have so far stood the test of litigation and are now in force cover three phases of radio: the vacuum tube, beat reception, and the Armstrong regenerative or feedback circuit. Certain crystal detector patents, alleged to cover selective contact, a crystal embedded in a fusible metal, the "cat-whisker" and other features owned by the Wireless Specialty Apparatus Company have been recently before the court, the Wireless Specialty Company having brought suit against several companies for infringement.

The patents covering the vacuum tube are by far the most important because in practical applications of beat reception and regeneration, tubes are used.

The basic and dominating tube patent was the Fleming patent No. 803,684 (expired November 7, 1922) owned by the Radio Corporation of America, the successor of the old Marconi Company.

The device described and illustrated in this patent is shown in Fig. 1, and comprises a glass

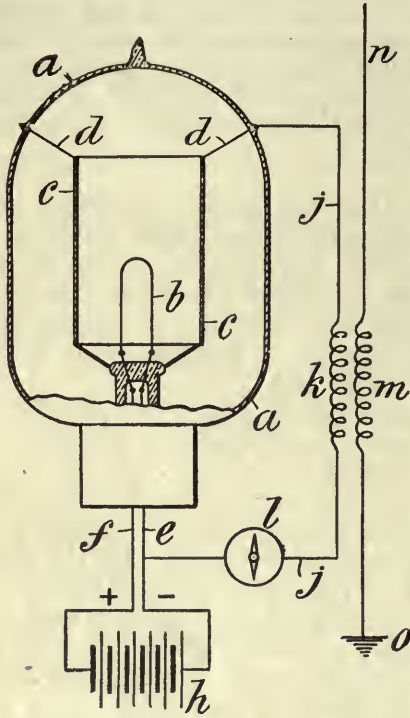

FIG. 1

The original Fleming valve arrangement

bulb *a*, a carbon filament *b* (the hot conductor), and an aluminum cylinder *c* (the cold conductor), which surrounds but does not touch the filament. The lead wires *f*, *e*, are sealed in the glass and are in circuit with a filament battery *b* for heating the filament to a high temperature and incandescence. The two electrodes are connected by an external circuit comprising the wires *d* and *j*. The circuit *j* includes an indicating device *l*, shown as a galvanometer, and is inductively coupled to the serial *no* through the coupling *mk*. The bulb *a* is highly exhausted to give a vacuum.

The invention relates to devices for converting alternating currents, and especially high-frequency alternating currents, or electric oscillations into continuous electric currents for the purpose of making them detectable by ordinary direct-current instruments. The device rectifies alternating current, that is, sup-

presses the electric current in one direction or changes the current so that the flow is in one direction only.

Fleming, in his patent, states:

"I have discovered that if two conductors are enclosed in a vessel in which a good vacuum is made, one being heated to a high temperature, the space between the hot and cold conductors possesses a unilateral electric conductivity, and negative electricity can pass from the hot conductor to the cold conductor, but not in the reverse direction."

That is, the oscillations set up in the aerial by the electromagnetic waves are transformed in the circuit *j* into direct pulsating currents of a form capable of actuating the galvanometer or other recording instrument.

This, in brief, is what Fleming shows in his patent and claims as his invention. Nothing is said in this patent about amplifying or oscillating tubes, two electrodes only being shown. We shall later see how the courts construed this patent.

Dr. Lee De Forest, the inventor of the "Audion" or three-electrode tube improved upon Fleming's work by making the vacuum tube practical. His inventions cover the three-electrode tube for all uses, as for detectors, amplifiers, and oscillators.

The first De Forest tube Patent No. 841,387 expires Jan. 15, 1924. The title of the invention is: "Device for Amplifying Feeble Electric Currents." In Fig. 2 is illustrated one form of the invention which shows how it is applied to a receiving circuit. The device is a glass bulb *A*, which has been exhausted or

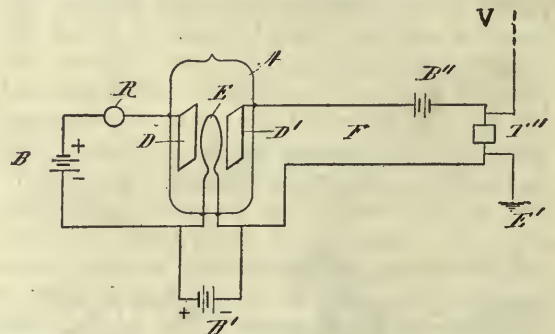

FIG. 2

One form of the De Forest patent No. 841,387

evacuated and in which are located the wire filament *E* with the spaced electrodes *D* *D'* upon opposite sides. The filament *E* is heated to incandescence by means of a battery *B'*,

and this use is described in the patent as follows:

"In Fig. 2 the current to be amplified may be impressed upon the medium intervening between the electrodes D and E, and thereby alter, by electrostatic attraction, the separation between the electrodes. In this case D' may be a strip of platinum-foil, and the slightest approach thereof toward the filament will act to slightly cool the gaseous medium, and thereby alter the current in the local circuit, or, if D' is rigid, the increase in electrostatic attraction between D' and E will cause E to recede from D, and thereby alter the current in the local circuit."

This patent covers, broadly, an evacuated vessel, that is, a vessel from which the air has been removed, three electrodes sealed within the vessel, means for heating one of the electrodes, a local receiving circuit, including two of the electrodes, and means for passing the current to be amplified between one of the electrodes of the receiving circuit and the third electrode.

In De Forest "grid" Patent 879,532, which expires Feb. 18, 1925, is found the culmination of the work on vacuum tubes, the form which is now standard and which is called the audion (the ion hearer).

The invention is illustrated in Fig. 3 and comprises a vacuum bulb D having sealed therein three electrodes, the heated filament F, the grid *a*, and plate *b*.

The filament F is heated by the battery A. The incoming oscillations are received by the aerial VE and are transferred across transformer M to the secondary inductance I_2 having a condenser C. The inductance I_2 is connected at opposite sides of condenser C with filament F at 2 and with grid *a* at 1, forming the input circuit. The now well-known grid condenser, C', is shown in this circuit. The output circuit,

including the telephone T and battery B, is connected at 3 to plate *b* and at 4 to filament F, the positive end of battery B being connected to plate *b* and the negative end to filament F. Fig. 3 is shown in the patent. Apparently the lettering used in the patent was adopted to describe the batteries shown, as these are now generally known as the A battery and the B battery.

The "hook-up" shown is for the use of the audion as a "detector" of electromagnetic waves, although the device also amplifies at the same time.

The invention covered in this patent is the grid located between filament and plate and broadly the use of a condenser C' coöperating with the grid in a manner now well-known.

The three patents above described were first considered in the Federal Court for the Southern District of New York in *Marconi Company vs. De Forest Co.* (236 Federal Reporter 942). Suit was brought upon the Fleming patent by the Marconi Co. on

the ground that the Audion (shown in Fig. 3 above) infringed it. A counter suit was brought by the De Forest Co. alleging infringement by the Marconi Co. of the two De Forest patents and others.

The Marconi Company, before trial, admitted that it infringed claims 4 and 6 of the above De Forest Patent 841,387 and the claims in issue of the above De Forest Patent No. 879,532, and also admitted that the claims infringed were valid. This is called "confessing judgment." The court then had to consider the Fleming patent only. Is the Fleming Patent valid and if valid, does the audion, the three-electrode type, infringe it?

Everything which had been accomplished before Fleming's invention was considered by the court, especially the detectors previously used in radio, such as the coherer, microphone, and

Time and Inventions

"The Edison lamp is an example of an invention," says Mr. Kesler, "which was made at the wrong time to reap material benefits therefrom. The patent was granted at the time Hertz was making his experiments which led to the discovery of the electromagnetic waves which bear his name. The Edison patent expired four years after the basic Marconi patent was granted but four years before Fleming secured his patent. Had Mr. Edison's invention been opportune, doubtless he would have dominated the audion vacuum tubes with his patent."

Scientific investigators frequently reason along similar lines and time becomes a very important factor in securing patents. Armstrong, De Forest, Hogan, Langmuir, Meissner, Waterman, Weagant and others independently observed that the vacuum tube would oscillate. Mr. Kesler will describe the resulting complex patent situation in an early number of RADIO BROADCAST.—THE EDITOR.

the magnetic, electrolytic, and crystal types. All these had some defect. Then came Fleming with his detector, and after him De Forest and the wonderful and rapid progress, not only in radio, but also in telephony and telegraphy.

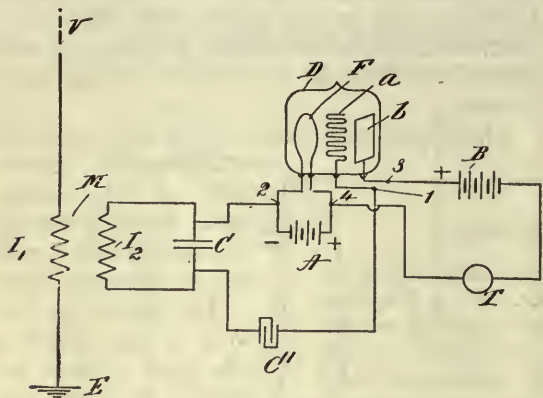

FIG. 3

The famous De Forest "grid" patent which expires in 1925

But the tube which Fleming proposed as a detector in radio was old. The wizard Edison, whose magic hand has touched almost every phase of modern development, had already noticed that a circuit including two spaced electrodes in a vacuum, when one is heated, has unilateral conductivity. This is called the "Edison effect." The Edison device was covered in patent 307,031 granted Oct 21, 1884 and is shown in Fig 4. For ten years or more the Edison device was known yet none thought of using it as a detector in radio. Fleming repatented it for use in radio. The Court said:

"What Fleming did was to take the well-known Edison hot and cold electrode electric lamp and use it for a detector of radio signals. Cohering filings, magnets, electrolytics, and sensitive crystals, at that time, failed to give any hint of the utility in this art of the Edison lamp."

The Edison lamp is an example of an invention which was made at the wrong time to reap material benefits. The patent was granted when Hertz was making his experiments which led to the discovery of the electromagnetic waves which bear his name. The Edison patent expired four years after the basic Marconi patent was granted, but four years before Fleming secured his patent. Had Edison's invention been opportune, doubtless he would have dominated the audion vacuum tubes with his patent.

In view of the Edison patent, which was used for low frequencies only, Claim 1 of the Fleming patent which was alleged to be infringed but was too broad as issued, was limited for use with high frequencies or oscillations of the order used in radio. This limitation was secured by filing a statement to that effect in the patent office, called a "disclaimer." The filing of the disclaimer enabled the court to hold Claim 1 of the Fleming patent valid and patentable over the Edison patent.

Fleming called the operation of his valve "rectification." His explanation of its operation, given in a 1905 lecture, is as follows:

"In the incandescent carbon there is a continual production of electrons or negative ions by atomic dissociation. Corresponding to every temperature there is a certain electronic tension or percentage of free electrons. If the carbon is made the negative electrode in a high vacuum, these negative ions are expelled from it but they cannot be expelled at a greater rate than they are produced."

The electron theory is the one now in vogue to explain the operation of the vacuum tube. To speak of "atomic dissociation" (the breaking up of atoms) to those of us who learned our chemistry in former days is enough to make agnostics of us all. As Chesterton says, "modern science has knocked the atom to atoms."

Then, after considering the prior art (what had been done before) the court said: "The contribution of Fleming was clearly invention and is entitled to liberal interpretation and consideration." The court decided that nothing which De Forest had done prior to

Fleming's time could be considered of sufficient importance and value to invalidate the Fleming Patent. The court was referring to what the plaintiff, Marconi Company, called the "Bunsen burner patents," which were either inoperative or differed in principle.

Now as to infringement. De Forest and his experts contended at the trial that the Audion operated according to a different principle from that of Fleming, that is, it was a "relay," its products being currents of audio frequency and of the local energy (the B

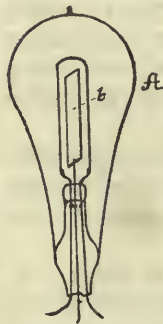

FIG. 4

The Edison patent which could have altered the entire radio industry had it been brought out at a later date

battery) and not of the input energy. Fleming's theory was that of rectification. It was the contention of the defendant De Forest that the radio impulses in the input circuit, causing potential variations on the grid, varied the resistance of the output circuit so as to cause a pulsating current in the latter due to the B battery. This is one way of looking at it.

It was shown by the plaintiff, however, that the use of a battery, such as B, had been used before Fleming and De Forest with detectors of different types to make them more sensitive. The court, relying on the testimony of Waterman and Armstrong and others, took the view that the grid and plate and the two circuits of the audion were the equivalent of the single plate and single circuit of Fleming and that the audion operated on the principle of rectification, the battery B assisting this action. The Court therefore decided that the three-electrode audion of De Forest, when used as a

detector, as an amplifier in radio, and as an oscillator infringed the Fleming Patent.

Although the two-electrode device of Fleming is seldom used in practice, yet the court felt that any real contribution which De Forest made was based on what Fleming did, crude as it was. Fleming made the first step and De Forest completed it.

The decision of the lower court just described insofar as it relates to a detector was affirmed later by the Circuit Court of Appeals, Second Circuit (243 Federal Reporter 560).

A pioneer invention does not deserve the name which does not blaze the way for future development, and as to De Forest's contribution to the art, the court said: "De Forest in his three-electrode audion has undoubtedly made a contribution of great value to the art, and by the confession of judgment in respect thereof, defendant company may enjoy the just results of this contribution."

The Urgent Need for Radio Legislation

By HERBERT C. HOOVER

U. S. Secretary of Commerce

THE present radio telephone situation in the United States is simply intolerable to those who have at heart the full value of radio broadcasting. Yet there is absolutely no adequate solution of the problem open to the Department of Commerce until pending legislation makes available to the public the use of the wave-band, 1600 to 600 meters, which is reserved for governmental purposes.

The reservation of this band was made by law in 1912, eight years before the radio telephone came into its amazing popularity. In February, the Radio Conference, which was made up of representatives of manufacturers and all other groups concerned, urged the necessity of making this band of waves available to the public, since it comprehends the logical range of any extension of available waves practicable, in the present stage of development of the art, for public use. Accordingly, bills were formulated and introduced into both the Senate and House looking to the amending of the law and the enlargement of the authority of the Secretary of Commerce to meet current

emergencies without the delays more or less inevitable in legislative action.

In the meantime the Radio Division of the Bureau of Navigation has utilized its ingenuity and resourcefulness to the full to make the most of the allocation of such wavelengths outside, but by no means including all outside, the governmental band. Thus, to make the most of the 400-meter wavelength, with an eye to the enjoyment of the greatest number, a new classification of broadcasting stations, Class B, was set up, with special requirements designed to make each broadcasting station using the 400-meter wavelength of the largest possible service to those having receiving sets.

The passing of the bills now before Congress will not of course constitute a panacea that will entirely do away with the necessity, for instance, of improving the selective power of receiving sets in general use. But until the existing law is amended certainly no considerable improvement in the situation can be looked for. Then a re-allocation of wavelengths can be made such as will, at least, make the most of existing potentialities.

Down on the Farm in 1923

By W. A. WHEELER

In Charge, Radio News Service, United States Department of Agriculture

THE lights in the living room went out. Conversation ceased. Only the ticking of the clock on the mantel could be heard. Presently the tiny wall bulbs came on and bathed the room in a rosy glow. There was something uncanny about it; it was like a seance.

Suddenly a voice spoke:

"Less fuel is required to cook the cheaper cuts of beef than is required to broil a thick steak properly."

The guests stirred uneasily. Someone laughed. Then the voice continued:

"Recipes for the proper preparation of stews, boiled beef, and braised beef have been prepared and are now ready for distribution on application."

Puzzled, Mrs. Baker switched on the centre lights. Something had gone wrong. Nothing wrong with the customary dramatic setting she had contrived for her radio concert, but she had not expected the beef stew. Again the message was coming:

"Less fuel is required to cook the cheaper cuts. . . ."

At the close, it was announced:

"This is the new 'Agriogram' service of the United States Department of Agriculture."

"Agriogram?" No need to look in the dictionary—you won't find it. "Agriogram" is a newly coined word, denoting the messages of a newly instituted radio broadcasting service. Secretary of Agriculture Henry C. Wallace is its author.

Jed Connors's crop of spring hogs had not yet been sold. This worried Jed, as he was hoping to start on a motor trip with his family. To delay the sale until his return might mean a heavy loss, because prices had been dropping steadily, and he had been holding out for an advance. He regretted now that he had not kept in closer touch with the market. Most of the information he had was several days old.

He heard a footstep on the walk, and looked up to see his friend Tuniper approaching.

"Well, I got it!" Tuniper announced jubilantly.

"Got what?"

"The radio. And say, guess what hogs did today. Jumped clear up to nine dollars."

"What!" shouted Jed. "Who told you that?"

"Came by radio. Come on over at 11 o'clock and we'll get the final report."

Half an hour later Tuniper and Connors were seated before a radio set, receivers over their ears. At 11 o'clock the market message came:

"Chicago live stock market: Hogs opened strong to 15 cents higher, light and medium weights closed firm at advance. Bulk of sales \$9.30 to \$11.60. Better grades beef steers . . ."

"Hurrah!" shouted Connors. Ten minutes later a sale was closed by telegraph—and the family was advised that the motor trip was "on."

These instances are not the product of imagination. They are actual occurrences reported to the United States Department of Agriculture. It is all part of the Department's Radio News Service. By radio, farmers nowadays get market news while it is hot. Distance from market means nothing. The hog raiser in the Corn Belt, or the fruit grower in California, can be as closely informed on markets hundreds of miles away as the operators in the individual markets. Through the Department's Agriogram service, city people are beginning to learn something about agriculture. Housewives are being taught home economics. The big facts about agriculture in their relation to national life are being brought into city homes.

More than six and a half million dollars' worth of business is transacted daily in the large livestock markets of the country. A thousand cars of wheat go into our ten largest markets each day. If farm products are to be distributed where and when they are needed, if overstocked markets that result in high prices to the consumer and low prices to the producer are to be prevented, producers must have up-to-the-minute news of market conditions. To get this news to farmers quickly, the Depart-

ment of Agriculture maintains a market reporting service unparalleled anywhere else in the world. Several hundred market reporters located at the various consuming centres and in large producing sections report daily crop and market conditions to branch offices, and by using a leased telegraph wire system, complete information of local and national agricultural marketing conditions is made available the day it is gathered.

Radio is the only agency that can get this market information to farmers everywhere immediately after the markets close. For farmers cannot daily pay tolls on telegraph messages, the press does not publish the market news until the next morning, and mail delivery of newspapers or mimeographed market reports is slow. By radio, the reports on fruits and vegetables, livestock, meats, grain, dairy products, hay, feed, seed, and cotton are flashed instantly, on regular schedule, to unlimited numbers of people. More than sixty Federal State and private broadcasting stations, covering practically the entire country, regularly send out the messages of the markets. Recently the Great Lakes and Arlington stations of the Navy Department were added to the list.

When the Department of Agriculture first suggested that radio be used to dispatch market reports about the country, the idea was received with good-natured tolerance. All right to send out the messages, it was agreed, but did the Department expect farmers to become wireless experts? At that time the radio telephone had not been perfected for popular use, and it was seen that to receive the reports direct, farmers would need to study the Continental code. But the Department replied that the country was filled with radio amateurs, and that farmers would simply need to get in touch with them to receive the messages. America's radio amateurs rose to the opportunity, toying with radio was discontinued, and they soon became an important agency in getting to farmers the market information so vitally needed in the intelligent conduct of the farm business.

The experiment started with the broadcasting of a daily market report from the Washington wireless station of the Bureau of Standards. The station covered a radius of 200 miles. Correspondence from amateurs in the territory soon began to pour in on the Department. One of the first of these was from a railroad telegrapher who stated that farmers in his com-

munity were "going wild" over the service, and kept him continually on the telephone calling off the news. The station was a junction point, and copies of the report posted on the bulletin board were eagerly read by local travelers. Similar letters were received from other operators.

The practicability of broadcasting market reports by radio having been demonstrated, agricultural interests throughout the country began to urge the Department to expand its radio service. Funds were lacking to do this, but the Post Office Department, through its Air Mail Service, jumped into the breach and offered to place some of its stations, at designated hours each day, at the disposal of the Department of Agriculture. Within three months of the beginning of the original experiments, market news was being dispatched from Post Office radio stations at Washington, Cincinnati, Omaha, North Platte, Neb., Rock Springs, Wyo., Elko and Reno, Nev.

When the science of radio telephony had reached a point of general utility, the possibil-



WAY DOWN YONDER IN THE CORNFIELD
Where radio has "entered the field of agriculture."
This station, built by the Connecticut Agricultural
College, Storrs, Connecticut will be used for broad-
casting information of an agricultural nature

ity of sending out market reports by radio telephone direct to farmers was investigated. It was seen that this was the ideal system to use, as reception of the messages involved no technical knowledge of radio, and with the use of simple receiving equipment farmers could get the reports themselves. Successful experiments along this line were conducted at Washington, and soon a chain of private radiophone broadcasting stations were granted permission to include market news in their programmes. Farmers and other agricultural interests began to install receiving sets. Agricultural colleges and market departments in a number of states installed broadcasting apparatus and through county agents and boys' and girls' clubs began to develop state-wide methods of receiving and disseminating the news. The number of farmers served with radio market news cannot be estimated, but reports from Federal and State agricultural representatives attest universal use of the service. The farm sky everywhere is dotted with antennas.

The "Agriogram" service is a more recent innovation. It consists of the preparation of brief agricultural news items for the general

public, broadcasted Monday and Thursday each week. The reports cover every field of agricultural activity, and although as this is written the service has been in existence only a few weeks, numerous letters of commendation have been received. Of particular interest to housewives are the matters pertaining to home economics, the selection, preparation, and cooking of foods. More than twenty-five broadcasting stations are now sending out the reports, and the list is growing daily.

The use of radio in broadcasting market news is one of the most progressive steps in the history of American agriculture. There are more than 32,000,000 people on farms comprising nearly one third the total population of the United States. Most of these people are located where they are practically cut off from immediate contact with the outside world. Radio is the only means of giving them quickly and at small cost the economic information necessary in the proper conduct of the farm business. In my opinion, there is therefore no single use of radio, except for marine and aerial purposes, that should take precedence over its utilization for the benefit of agriculture.

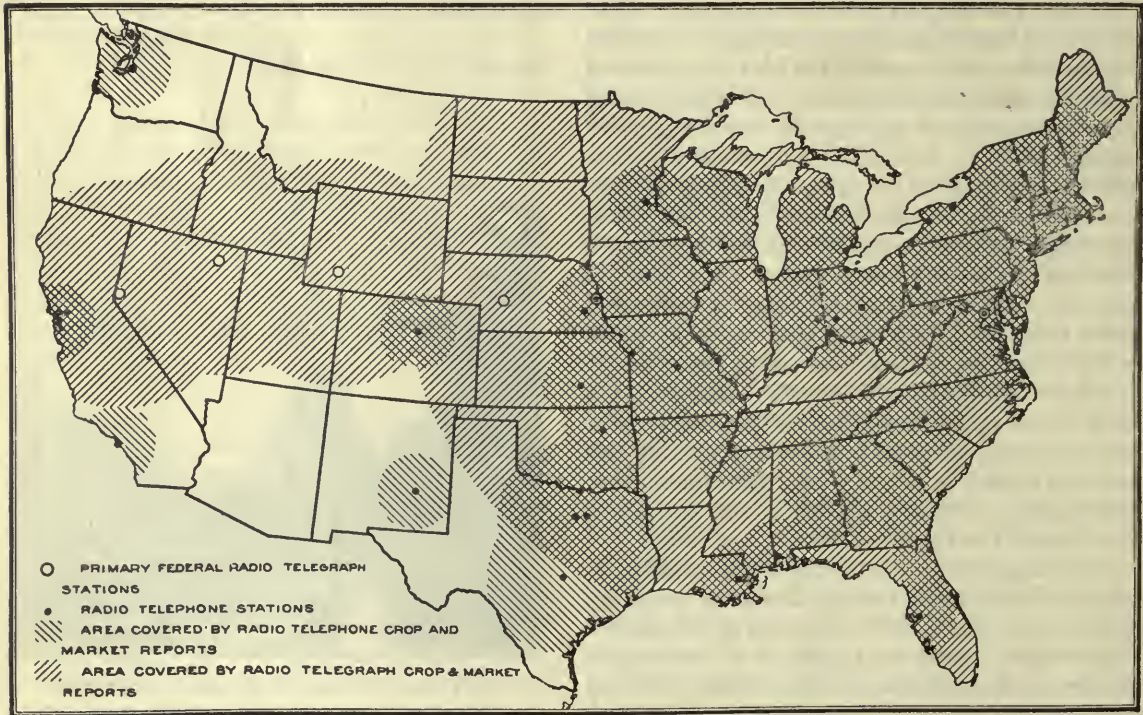

THE RADIO CROP AND MARKET NEWS SERVICE
Operated by the United States Department of Agriculture

Long Distance Amateur Work in Australia

By F. BASIL COOKE, F. R. A. S.

In Australia, as here, the tendency in amateur transmitting is toward reduction in the power accompanied by increase in the distance covered. In this account of an Australian amateur's station there are several features which may well be taken advantage of by Americans. Operating power tubes below their rated filament voltage, for instance, is a practice not usually found in this country. Transmitting 450 miles on 3.8 watts is quite an achievement, and we find that our confreres in Australia are using such highly developed receiving arrangements as the "reflex" circuit. We should like to hear more from Australia.—THE EDITOR.

MR. CHARLES MACLURCAN of Strathfield, near Sydney, has been devoting his energies with remarkable results to low-power transmission, throughout all his tests never exceeding 9 watts. He has designed every unit of his apparatus to contribute to a maximum efficiency to allow him to transmit farther than other experimenters have been able to do with the same power.

In order that his results may be fully appreciated, the writer wishes to give here a brief description of his station. A glance at the accompanying diagram shows that the circuit employed is a well-known one and reveals that the modulation is brought about by direct grid control. This method has been practically abandoned by many experimenters in favor of the valve system of modulation. It is therefore of interest to know that Mr.

Maclurcan has demonstrated that, for low power, this simple and inexpensive means of producing voice currents is at least as efficient as the elaborate and expensive valve system.

The transmitting valves are Radiotron 5-watt power tubes of which three are employed. The filament is supplied with only 6 volts instead of 7.5 in order that the tubes may have a longer life. The plate current exciting the tubes is drawn from a generator, developing 300 volts and passing 30 milli-amperes, giving a maximum input current of 9 watts.

The aerial and earthing systems deserve special mention. The aerial consists of four 18-gauge copper wires equally spaced round wooden hoops $2\frac{1}{2}$ feet in diameter. The hoops are placed 15 feet apart. The two spans are each 100 feet. The centre is fixed to an 80-foot mast while the two ends are supported by 25-foot masts. The feeder (lead-in) con-

MR. MACLURCAN'S TRANSMITTER

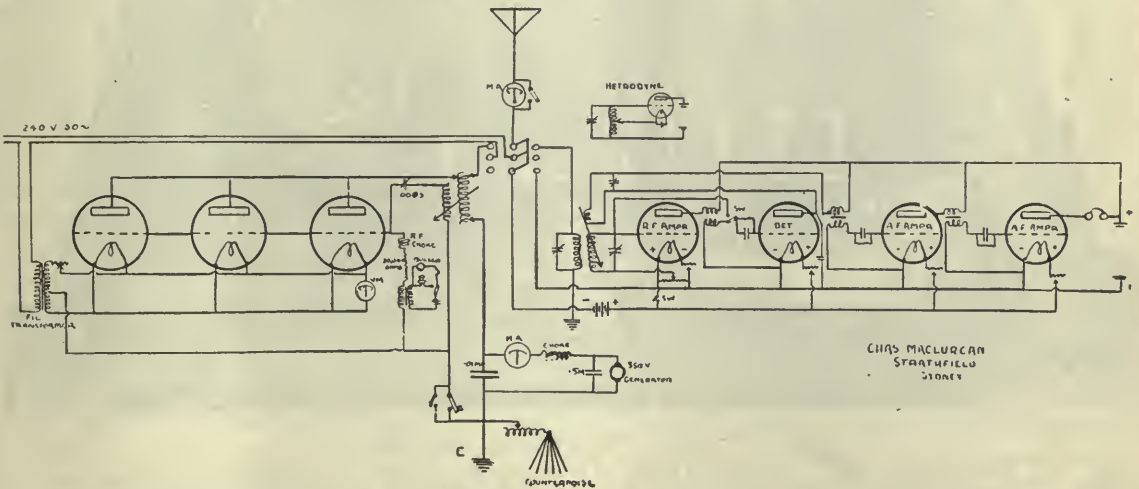

sists of four 18-gauge copper wires on 12-inch hoops. The natural wavelength of the aerial is 325 metres.

The earth system consists of a connection to a water pipe, together with a balanced counterpoise. The aerial-counterpoise is very carefully tuned to the same wavelength as the aerial-earth system. With the inclusion of the counterpoise, the radiation is increased by 33 per cent., giving a total radiation of from 1 to 1.2 amperes.

This description would not be complete without mention of the receiving apparatus of the station. As will be seen from the diagram, there are four valves grouped so that one valve acts as a radio-frequency amplifier passing the increased antenna current into the second valve, where it is rectified and detected. From here the received signals are coupled back with a tickler so as to use the regenerative effect and passed into the third valve which acts as an audio-frequency amplifier. The fourth

valve is a second stage of audio-frequency amplification. In practice, however, one valve only need be used to receive Nauen, Bordeaux, New York, etc.

Another feature of the receiver is the inclusion of an independent oscillator which acts as a heterodyne. In this manner much greater control can be attained with increase in signal strength and correspondingly greater selectivity.

On the night of May 21st last while conducting some tests in wireless telephony with the Sydney Observatory, using only 9 watts input, Mr. Maclurcan was heard in Melbourne 450 miles away. A telegram was received the following day stating that a Mr. J. Reed and several amateurs in Melbourne had heard the carrier wave on the previous evening.

Mr. Maclurcan then arranged to try to establish definite communication with Mr. Reed, with results entirely satisfactory.

Encouraged with the Melbourne success, Mr.



THE STATION AT STRATHFIELD, NEAR SYDNEY

From which Australians are getting their first broadcasting. Although the transmitter is never operated above 9 watts, it has been heard 2100 miles overland on a single-tube receiver

Maclurcan made arrangements with Mr. Dixon, the wireless operator on the S. S. *Montoro* while this boat was proceeding north from Sydney. Mr. Dixon wired back the following:

"10 P. M. June 3rd. 420 miles, telephone strength 6; continuous wave and tonic train strength 8."

"10 P. M. June 4th. 705 miles, continuous wave strength 6." Mr. Dixon was using one valve with standard ship's equipment.

Brief mention was made of these results in the daily press, and amateurs in the country and operators at sea immediately took the keenest interest, with the result that Mr. Maclurcan commenced broadcasting every Sunday evening. Amateurs all over Australia are now receiving these concerts, and reports are daily coming in from farther and farther afield. Music is being enjoyed from experimenters as far as 600 miles away and considering that Mr. Maclurcan is using only 8.25 watts, the results, to say the least, are very encouraging.

An extract from a letter received from Mr. Hull in Melbourne, 450 miles southwest of Sydney, is of interest in this connection.

"Was not able to listen for you until 8:40 P. M. and my accumulator was on its last legs.

"Upon switching on, however, reaction at zero, your music was excellent, readable at arm's length, to my intense surprise. At this stage of the proceedings the accumulator began to "peter," and I was obliged to switch off to give it time to pick up.

"At about 8:55 the record 'Mon Homme' was of similar strength to the above and I enjoyed almost the whole of it. Toward the end of the piece the accumulator gave up all hope."

In order to appreciate fully these results of Mr. Hull's it should be known that his receiving aerial consists of two wires 30 feet long supported at the eaves of the house 20 feet high and brought down to the edge of the workshop 10 feet above the ground. The whole aerial is below the level of the house and according to our ancient ideas he should be completely screened from anywhere. Instead of which Mr. Hull on this very inefficient aerial receives music and speech from a transmitter hundreds of miles away using less than 9 watts.

The writer is appending the circuit employed by Mr. Hull as it presents several novel features. By referring to this diagram it will be seen that only two valves are used and made to function



MR. CHARLES MACLURCAN

One of Australia's leading experimenters who has been doing remarkable work on low power transmission

as radio-frequency amplifier, detector, and audio-frequency amplifier thus doing the work of three. The writer has carefully tried out this circuit and finds it the best 2-valve circuit he has yet used, so some of you will doubtless be interested in trying it also.

Mr. Maclurcan has just completed some tests with the object of ascertaining how far his speech and C. W. could be heard. He made arrangements with Mr. Tuson, the operator of the S. S. *Ulimaroa* to listen-in while proceeding from Sydney to Auckland, New Zealand. Mr. Tuson's report discloses that he could read the C. W. at the wharf at Auckland (strength 4) and heard snatches of speech (strength 2). The distance of Auckland from Sydney is 1400 miles. One of the New Zealand land stations also confirmed Mr. Tuson's reports. This reception, by the way, was with a single valve.

Several weeks ago, Mr. Maclurcan received a telegram from Mr. Dixon on the S. S. *Montoro* from Thursday Island requesting him to transmit. Accordingly, signals were sent and a telegram was received stating that C. W.

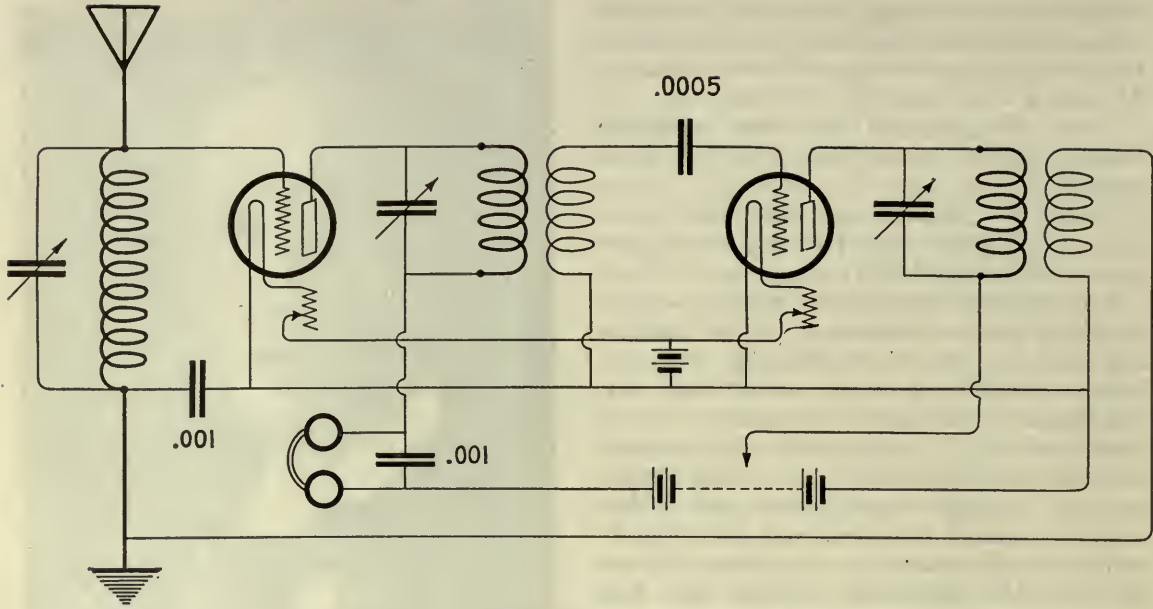

MR. HULL'S "REFLEX CIRCUIT" RECEIVER

In which two tubes are used to function as radio-frequency amplifier, detector, and audio-frequency amplifier, thus doing the work of three

signals were heard at Darwin, 2100 miles from Sydney. Mr. Dixon was receiving with one valve and standard ship's equipment.

It should be noted that Darwin is 2100 miles overland from Sydney which makes the test all the more remarkable. The power used in this test was very carefully measured and found to be 8.25 watts.

The results of Mr. Maclurcan's latest tests have just been received by telegraph, and state

that Mr. Hull at Melbourne (450 miles away) heard Mr. Maclurcan transmitting specially arranged code signals at noon yesterday, September 10th. Only one transmitting bulb was used and the input power 3.8 watts.

From the foregoing remarks, we might feel justified in thinking we can peep into the future and see ourselves talking to friends in distant lands with no more trouble than pushing a button.

If You are Thinking

Of submitting an article to RADIO BROADCAST, you may save yourself and the editors time and trouble by considering the following notes as to what we want:

WE WANT: True accounts of the uses of radio in remote regions.

Short, true stories of adventures in which radio played an important part: unusual and interesting occurrences to you or your acquaintances.

Clear explanations of new or especially effective circuits or uses for apparatus.

Concise and logical discussion of some important problem or phase of radio, whether in the field of broadcasting, constructing, operating, buying or selling; or of reading or writing that has to do with radio.

True accounts, of some particular interest, relating "What Radio Has Done For Me."

Humor, when the object is not merely to appear funny, but to present some phase of radio in an attractive, amusing way. The same applies to drawings.

Clear, unusual photographs are always in order, as are good circuit diagrams.

A liberal rate is paid for material used.

From Keyboard to Tape Through Space

By JOHN B. BRADY

THE Navy Department is enthusiastic over the results of experiments conducted during the past year with a system of printing by radio, whereby an operator can manipulate a keyboard resembling that of a typewriter and transmit radio signals automatically, which, received at a distant radio station, are set down simultaneously in print. The messages come through clearly and accurately, as can be seen by the reproduction of one of the first messages transmitted by this system.

The achievement of radio printing has been brought about by the coöperation of the Morkrum Company of Chicago with the Bureau of Engineering, Navy Department at Washington. The Morkrum Company manufactures the Teletype (Figs. 1 and 2), the invention of C. L. and H. L. Krum. It is a simple keyboard transmitting machine and printer unit, originally developed for operation in wire telegraphy. The levers of the keyboard are arranged to control the lateral movement of a set of five selector bars within the base of the machine. These selector bars are so notched that certain of them will slide endwise when a particular key is pressed and con-

Many of you who have read that printing by radio is a practical reality may be curious to know just how this "radio typing" is accomplished. Pressing letter *a* on the keyboard causes a letter *a* to be typed on a paper strip at a radio receiving station miles away: it sounds almost too easy. Modern efforts in the field of mechanics are making processes continually simpler: (whether life in general is made simpler or more complicated as a result is another matter), and although any real radio amateur would find more satisfaction in caressing a "bug" than in using the Hunt & Peck system on a typewriter transmitter, the Teletype gives an element of precision to radio communication which should be exceedingly important, as Mr. Brady shows, to such departments as our Army, Navy, and Air Mail Service.—THE EDITOR.

trol the position of locking latches and contact levers mounted upon the base of the unit. A motor, driven from a generator or a storage battery and mounted on the unit, has a driving shaft which rotates a set of cams against contact leaf springs pushed forward by the depression of a particular key. In operation, the contacts close in sequence according to the letters to be transmitted. Each contact gives a brief

interval of complete circuit connection, causing an impulse to be radiated from the antenna. The sequence of impulses distinguishes the letters of the alphabet. Mounted on the base of the keyboard, the printer unit, a small mechanical brain in itself, is controlled by the operation of an armature attracted in a sequence of intervals by Teletype magnet coils. The operation of the armature results in the positioning of a type wheel opposite a

paper tape for printing a character represented by the impulses received by the Teletype magnets.

Two sets of Teletype equipment were loaned by the Morkrum Company to the Navy Department for research on the printer system. Commander S. C. Hooper, Head of the Radio Division, Bureau of Engineering, Navy De-

NOW LET'S SEE HOW IT COMES THROUGH IT SEEMS TO
BE HITTING PRETTY FAIR NOW

A STRIP OF TAPE

Showing how clearly these words, sent during the first experiments, were automatically printed by the Teletype

partment, recognized the importance of adapting printing to radio and made available for this work the facilities of the Navy radio laboratories. Much skepticism was expressed

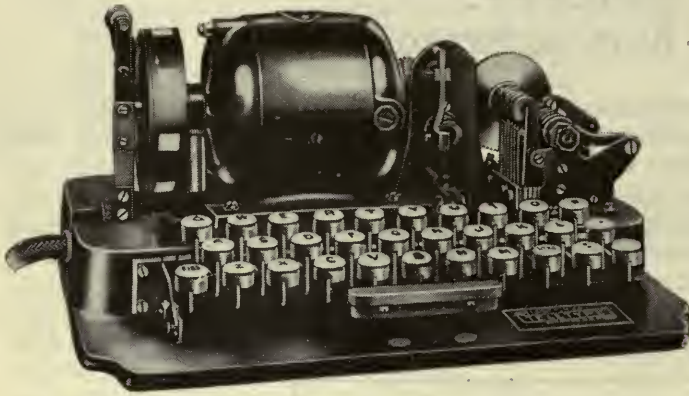

FIG. 1

The Morkrum light-weight keyboard control, designed for transmitting from an airplane

by experts in the government service as to the feasibility of operating printers by radio, but this was replaced by enthusiastic praise shortly after the beginning of experiments. A complete Teletype installation was made at the U. S. Naval Radio Research Laboratory, Bureau of Standards, and another complete outfit installed at the U. S. Naval Aircraft Radio Laboratory at Anacostia, D. C.

At the Anacostia Air Station, the transmitter was arranged so that the contacts on the Teletype keyboard controlled the radiation of impulses from the antenna system in groups of five impulses for each character, the sequence of the impulses distinguishing the characters. Throughout this work the usual code was entirely abandoned and the impulse code employed.

At the Bureau of Standards Radio Laboratory the Teletype was connected to a tuning arrangement in which a receiver with a local heterodyne detector and two stages of audio-frequency amplification were used. The relay employed was that developed by Mr. F. W. Dunmore, Physicist of the Bureau of Standards. The Dunmore relay in its different forms is illustrated on page 221 and is characterized by selectivity to tones of particular

frequencies. The selectivity is so marked that three different stations transmitting on the same wavelength, but with different tone frequencies, may be copied simultaneously. The relay is adjusted to pick out the signal desired and the other tones do not interfere. The relay at the receiver controls the circuit passing through the Teletype magnet coils. The armature of the magnets sets into operation selective mechanism resulting in the printing of the character represented by the sequence of the impulses transmitted.

When transmitting by Teletype and listening in with any ordinary type of broadcasting receiver, the signals sound like a confused jumble of noises and are absolutely unreadable. In this way, the system may be said to allow perfect secrecy. A quick change of the arrangement of the letters on the keyboard, with a corresponding change of the type-wheel at the receiver would make it practically impossible for an outsider to make anything out of the signals.

Having obtained the successful results described, with operation between shore stations, Commander Taylor suggested the application of the system for transmission from aircraft to ships or to shore stations. At the present time one of the big problems in the Navy is to transmit accurately directions from



FIG. 2

The Teletype equipped for both transmission and reception



THE DUNMORE RELAY

For use with batteries in receiving Teletype messages

an observer in an airplane to stations on the ground, to give the fleet officer gunnery ranges, for instance, on an enemy fleet.

The Morkrum Company designed a special light-weight keyboard shown in Fig. 1 to be carried aboard aircraft and operated by the observer, by which energy could be radiated from the aircraft antenna system to a ship or shore station operating a Teletype printer. The tests conducted have been highly gratifying, making the practicability of the method of transmission assured.

This achievement in radio printing has numerous applications besides its use in enabling a spotter in the Navy to fly an observation plane over a shelled area and typewrite back to the gunnery officer on shipboard information about the dropping of shells. The many human elements entering into conveying information by radio rapidly and accurately which have heretofore caused confusion were greatly reduced by this means of automatic transmission.

In the Post Office Department, the twelve radio stations used for communication with the mail-carrying planes can keep in direct touch, "in writing," with each other and with the Postmaster at Washington.

In commercial flying, the absence of a trained radio operator, in cases where the Teletype apparatus is used, means that one person less may be carried on each trip. The keys, however, are depressed more slowly than the usual typewriter keys, so that anyone without a knowledge of typewriting can employ the "hunt and peck" system

to operate the transmitter. A system like this is bound to prove valuable in such commercial aircraft routes as between Florida and Cuba or in communicating from Catalina Island to the coast of California.

THE DUNMORE RECEIVING RELAY

Developed by the Bureau of Standards for use with alternating current

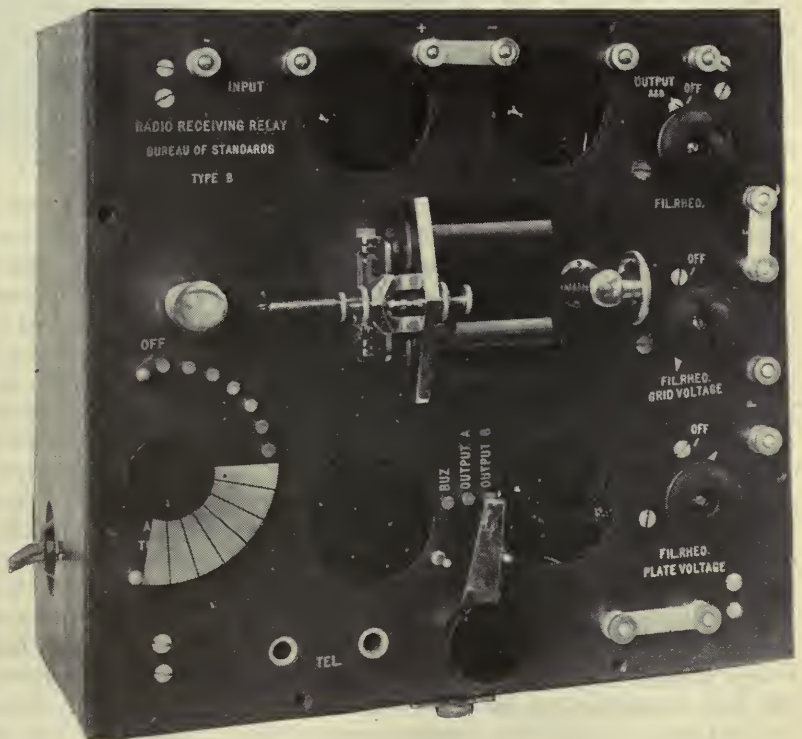

The First Amateur Radio Club in America

A Club That Dates from 1909 and Has Among Its Members
Men Who Have Helped to Make Radio Broadcasting Possible

PIONEERING in any field is in itself as valid a claim to fame as producing something of lasting good. Sticking to an ideal over a period of years, through the dark days when the very ideal itself seems to be threatened with extinction—that, too, deserves recognition.

With this in mind, we shall review the Radio Club of America's claim to lasting fame in the annals of radio. First of all, the Club dates back thirteen years—thirteen long years of the formative period of radio. This organization has stood for and has bitterly fought for amateur radio, even during those days when sinister wireless bills in the hands of unscrupulous and misinformed legislators were being discussed with the avowed intention of smothering amateur activities. This organization brought about an interchange and exposition of constructive ideas long before the founding of the present radio journals which serve that purpose so well. It has at every turn encouraged progressive steps and can, with pardonable pride, point to many names on its roster which have come to have real meaning in the first ranks of radio. That, in brief, is the background of the Radio Club of America.

It was in 1909, when amateur radio was just beginning to be taken up by a few pioneer experimenters that the Radio Club of America came into existence. Under the name of the Junior Wireless Club of America, it was founded through the efforts of W. E. D. Stokes, Jr., Frank King, George J. Eltz, Jr. and others as the first association of amateur experimenters in the land. At first, the headquarters of the

organization was in the Hotel Ansonia, in the residential heart of New York City, but soon the monthly meetings were held at Mr. King's house, 326 West 107th Street, at about the same time that the name was changed to the Radio Club of America. The reason for the change of name was that it was desired to have the organization national in its scope, with various branches in different parts of the country.

Perhaps the word "club," in this case, is unfortunate. A club is a place for good fellowship, true; and that describes the Radio Club of America, which has already stimulated good fellowship in radio and more specifically among its members. In that sense, the word stands.

But in the case of this group of young men, there has been something more than a club

atmosphere. With the serious intentions of its members, the thoroughness of the papers and discussions marking its meetings, and the scientific value of its experiments and tests, the word "club" is almost a misnomer. This organization might well call itself a scientific society, although it does retain that spirit of fellowship which goes with the usual meaning of club.

The papers prepared and read by members during those first few meetings of the young Radio Club of America were quite crude, and a family gasoline chariot was often called into service to carry long-wave receivers or "coffin" type transformers from the Long Island or Jersey residence of the speaker for the evening, in order to illustrate his "paper" by actual demonstration. Among the early papers were: "A Square Law Variable Condenser," by George J. Eltz, Jr., which by the

The story of the Radio Club of America and its members who were among the pioneers and are to-day leading the advances in radio, has never before been published. We greatly appreciate the valuable assistance given us by officers and members of the club in preparing this account of what we believe to be the first amateur radio club in America. It is doubtful that any other group of young men, banded together for the purpose of lending each other assistance in radio as well as the betterment of the art itself, can point to a record in any way comparable to the enviable record of the Radio Club of America.—THE EDITOR.

way, disclosed this type of condenser for the first time; and it is interesting to note that a long while afterward a condenser of this character was placed on the market by several companies and is used in several well-known wavemeters.

Another paper, "A Telephonic Relay Amplifier," was prepared and read by that ardent amateur, Dr. Walter G. Hudson, who has since died. Doctor Hudson also prepared a paper on the oxide filament for vacuum tubes, and this idea of his has since become an important factor in the construction of efficient vacuum tubes. It was tubes with oxide-coated filaments which our Army and Navy used to so great an extent during the war. They are widely known under the designations "J" and "E", the former being used for detecting and amplifying, and the latter in low-power radio telephone and continuous-wave telegraphy. At present, they are also employed in what are termed "power" amplifiers.

Still another of the early papers was "The Wavemeter, Its Operation and Uses," by Louis G. Pacent. This paper marked the first attempt to disclose to radio amateurs the mysteries of the wavemeter and the measuring of radio waves. Before then, the wavemeter was used only commercially.

Again, there were papers entitled: "Ground Antennae," by Walter S. Lemmon; "Radio Telephony," by Frank King; "A Radio Equipped Automobile," by Paul F. Godley; and "Audio Receiver System," by Edwin H. Armstrong.

The membership of the Club grew and grew and has kept on growing. Its serious character attracted the attention of early radio workers, so that aside from papers prepared by its own members, it was soon honored with ad-

resses by such well-known radio men as R. H. Marriott, Dr. A. N. Goldsmith, J. V. L. Hogan, F. Lowenstein, Dr. J. Zenneck, F. Conrad, W. C. White, and others. Subsequently, all of these men became members.

In order that one may have a better appreciation of what the pioneering work of the Radio Club of America meant, it is well to sketch a



© Bachrach

GEORGE BURGHARD
President of the Radio Club of America

true setting by way of contrast with the conditions of to-day. Turn back to 1909, and you find a very few young men, here and there, fascinated by the newspaper accounts of wireless attempting to receive and send radio messages. Wireless, it was then called, although the founders of the club had the vision to choose the word "radio" for their club name. Little or no real information on the subject was available. With a scant description of Marconi's experiments as a basis, the amateur of that day started to construct his set. There were no journals to guide him. He constructed his set through ingenuity of his own, and as often as not

the finished product would not work. Occasional articles on the commercial stations appeared in newspapers and magazines, and each new idea, gleaned from various sources, was added piecemeal to the experimenter's stock of knowledge.

It should be borne in mind that there were no radio manufacturers to turn to for complete sets and units. All the apparatus had to be constructed by the amateur. The success of each experiment was passed along by word of mouth to other amateurs and eagerly picked up. The coherer was then used as a detector; some of the more ambitious amateurs procured the Marconi magnetic detector. Later came the microphone, crystal and electrolytic types. All tuning was accom-

plished by means of sliders on coils of wire wound on the handiest block of wood obtainable, often a broomstick or a bread roller. The use of variometers and variable condensers was then unknown to amateurs.

For transmitting, we find a conglomeration of small spark coils, usually home-made. These coils were operated with a mechanical interrupter and battery current, but later the electrolytic interrupter and lighting current came into use. A distance of 100 miles with an amateur transmitter was considered a remarkable achievement. To-day, with a continuous-wave transmitter at one end, and a regenerative receiver at the other, an amateur spans one thousand miles with ease and thinks little or nothing of it!

One amateur, desiring to erect the best possible aerial, came across an article describing the Cape Cod aerial as used by the Marconi Company for transatlantic work. It was in the shape of a huge square funnel, the upper ends or rim of the funnel being insulated. A carefully built miniature copy of the aerial only four feet on one side and six feet high was built, with little realization of the change in the electrical constants between the Cape Cod aerial and the miniature copy. Needless to say, the miniature copy did not work very well, and it was only by chance that the amateur discovered that a stretch of telegraph wire worked far better.

The Radio Club of America, a gathering of progressive amateurs for the purpose of exchanging ideas and experiences and avoiding the repetition of mistakes, was a necessity. The meetings, at which important papers were read, served, as nothing else could, to stimulate improvement in amateur radio.

Experiments were made with different types of aeriels. It must be understood that the technical knowledge of the amateur in those days was very limited. He merely had the idea presented to him and would go ahead and experiment on any possible improvement that came to his mind. Some experiments were made with kites flown by a wire in place of the customary string. Those who tried this were sometimes surprised when, the kite having reached a height of several hundred feet, they received a good shock. This furnished considerable amusement. One member proudly announced that he would not get shocked from the wire because he had on O'Sullivan's, and walked about the tin roof

with his toes in the air. The manipulator of the kite-string rather doubted the insulating qualities of rubber heels against static charges, and at a favorable moment brought the kite wire very close to the boastful young man's ear. Said boastful young man received a distinct shock despite his O'Sullivan's, which then, as now, were intended for something more practical than insulating their wearer against static electricity. But the kite aerial gave excellent results.

Things were once far from cheerful for experimenters. In 1910, the legislators at Washington, urged by certain radio factions, turned their axes towards amateur radio. For a while everything seemed quite gloomy; amateurs in general felt that the death knell of their hobby had been sounded. There was to be no more listening-in or "talking" via radio. There were many protests and discussions, but no concerted action was brought to bear against the proposed measure until the Radio Club of America by promptly applied efforts, prevented the passage of the Depew Bill. If it had been passed, it would have terminated the art, as far as amateur radio is concerned.

Two years' respite followed, and then came the Alexander Wireless Bill, in 1912. This dangerous piece of proposed legislation was killed in committee by the quick work of the Club. Not long after the Armistice the bill was definitely buried by concerted action and immediate pressure brought to bear by the Radio Club of America through several members who had served with distinction in the Army and the Navy, and others who had helped in civilian capacities. T. Johnson, Jr., Lieut. Harry Sadenwater, U. S. N., Ensign Frank King, U. S. N., Ensign George Eltz, U. S. N., John Grinan, Ensign George Burghard, U. S. N., L. G. Pacent, Ensign T. J. Styles U. S. N., Capt. E. V. Amy, U. S. A. and others convinced the legislators that amateur radio was a constructive and necessary study.

But we are ahead of our story. In 1913, two of the members, Frank King and George J. Eltz, Jr., installed one of the first radio telephone *broadcasting* stations in the United States, at 326 West 107th Street, New York. The apparatus was all home made, and naturally crude. Successful transmission was obtained, however, and phonograph records were played for the benefit of several battleships swinging at anchor a short distance away in the Hudson River. An arc, burning in

hydrogen, with an improvised syphon cooling arrangement, was used. The hydrogen was supplied by vaporizing alcohol, and several amusing incidents occurred when the mixture in the arc chamber became explosive and the operators were forced to beat a hasty retreat.

It was during July, 1915, that the Club installed a model radio station in the Hotel Ansonia, the headquarters of Admiral Fletcher and his staff, enabling the visiting admiral and his men to keep in communication with the vessels of the fleet, anchored in the Hudson River. The station was operated by members of the Club for a period of ten days and handled over one thousand messages during that period. Because of this commendable work an interesting radiogram from President Wilson, who had reviewed the fleet on the last day from the deck of the *Mayflower*, was received

by the Club. Furthermore, a large banner was awarded the Club by the Navy League as a token of its patriotic activities.

When, in 1917, we found it necessary to become a warring people virtually overnight, the Radio Club of America was fortunately a going concern with a corps of highly trained members. The first business then being the winning of the war, the Club proceeded to devote its energies toward that end. Many of its members, through their training and experience, soon found important work to perform with the uniformed and civilian forces. Space does not permit of a full account of the Club's war record but we cannot refrain from mentioning the notable work done by Major Edwin H. Armstrong in the Signal Corps of the A. E. F. Also the flight of Lieut. Harry Sadenwater as radio officer in the NC1, during the attempted transatlantic flight at the close of the war. The



THE FIRST AMATEUR TRANSATLANTIC STATION

It was built in less than two weeks and operated by (left to right) E. V. Amy, John Grinan—the first amateur to send directly across the U. S.—George Burghard, E. H. Armstrong, inventor of regeneration and supper-regeneration, and Minton Cronkhite

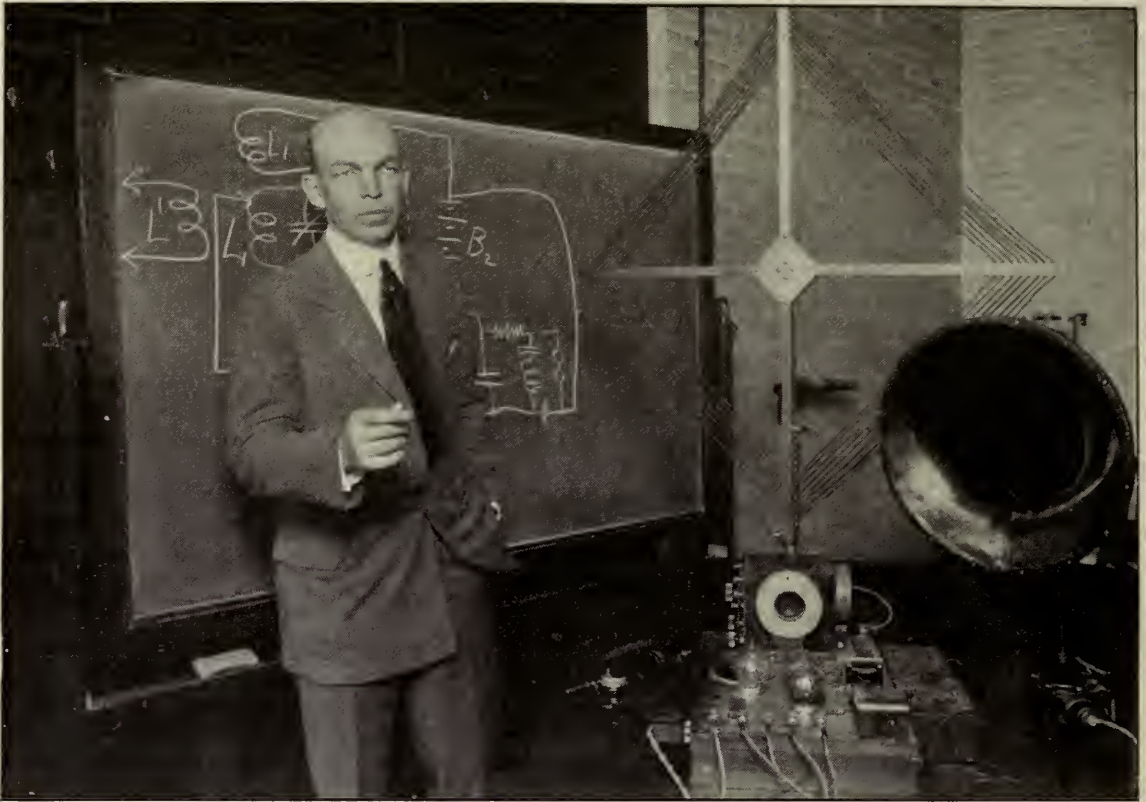

© and courtesy of Hearst's International Magazine

EDWIN H. ARMSTRONG

Explaining the principles of his latest invention, "super-regeneration" at a meeting of the Radio Club of America, held in Columbia University, New York City

NC1 was forced to abandon the attempt at the Azores owing to a forced landing caused by uncertain bearings, while the sister craft, NC4, made the entire flight.

In November, 1919, a banquet was given to Major Armstrong at the Hotel Ansonia, the scene of the Club's early efforts. All of the prominent local radio engineers were present to join with the members in paying homage to Armstrong. His work is so well known that nothing more need be said of it here. Sufficient to state that he made radio broadcasting of the vacuum-tube variety possible.

One eventful evening one of the Club members, Mr. John F. Grinan of New York, saw an opportunity to transmit a relay message to the Coast. He did so and received a reply from California. This was the first amateur transcontinental message and was not pre-arranged. About a week later, Mr. Grinan performed the remarkable feat of transmitting to California direct.

Another member of note is Jack Binns, the

operator who startled the world with the first C. Q. D. message from the sinking *Republic*.

Shortly after the war Mr. L. G. Pacent suggested the first transatlantic radio test with amateur transmitters and receivers. At that time the suggestion may have seemed fantastic—but it was carried out only two years later. When this first message was sent in the winter of 1921, from station 1BCG located at Greenwich, Conn., operating on 200 meters and 900 watts input, the messages were received by Paul F. Godley, a member of the Club, in Ardrossan, Scotland. The messages were also heard in Hamburg, Germany, and Catalina Islands, Cal. Thus 1BCG covered more than one fourth of the earth's circumference. It is interesting to note that the station was installed in two weeks' time, the Club having decided to enter the contest at the eleventh hour.

Although a period of thirteen years has elapsed since the formation of the Club, practically all its original members are still active, a fact which in itself is a tribute to the

fascination of radio. Thus we trace its history from a mere handful of interested experimenters, lacking in knowledge but filled with enthusiasm, to a well-organized body of three hundred members.

The present officers include: President, George E. Burghard; Vice-President, E. V. Amy; Recording Secretary, L. C. F. Horle; Treasurer, John Di Blasi; Corresponding Secretary, R. H. McMann, 380 Riverside Drive, N. Y. C.; Board of Directors, E. H. Armstrong, P. F. Godley, L. G. Pacent, J. F. Grinan, Minton Cronkhite, W. S. Lemmon, A. A. Herbert, Frank King, J. O. Smith and Nelson Dunham.

A branch has been started in Chicago, where many of the pioneers of that city and the vicinity are enrolled as members. The Affiliation Committee is working on plans to open other branches in Schenectady (N. Y.), Cambridge (Mass.) and Pittsburgh (Pa.) while plans are well under way to establish other branches throughout the country.

Since their high school and college days, most of the members have made radio their life work. The boys who used to climb to the topmost branches of trees or scale roofs, to the horror of their parents and landlords;

the boys who delighted in erecting antennas in forbidden places and who broke many a window with slings used to carry wires from apartment houses on opposite sides of the street; who built their transmitters and receivers in wood-sheds or barn lofts with tools taken from their dads' chests; who sat up into the wee hours of the morning much to the discomfort of solicitous parents, in order to add a few more miles to a distance record or pick up stations they had not "worked" before; whose deep-throated spark transmitters or musical rotary gaps kept whole neighborhoods awake; the boys who dimmed the lights of their community every time they pressed their keys; who fought the power companies tooth and nail; who succeeded in putting radio on the map and in thousands of homes—these boys, grown up, are now doing the same thing in business, in a less spectacular manner, no doubt, but as full of life and enthusiasm as before. They have left their original rôles to the beginner of to-day and have taken up the more important work in the radio field: they are pioneers, inventors, manufacturers, lawyers, lecturers, engineers, sales managers, editors and authors—and they are still boys.

BANQUET GIVEN IN HONOR OF MAJOR E. H. ARMSTRONG

Many of those present are famous in radio, and include W. F. Diehl, Harry Styles, John Styles, Thomas Styles, Jack Shaughnessy, H. Scutt, H. Houck, A. Herbert, Dr. C. C. Godfrey, C. E. Braden, C. R. Runyon, C. Calm, E. V. Amy, Paul F. Godley, A. Aceves, C. Cushman, A. H. Grebe, Walter Lemmon, Minton Cronkhite, A. Miesner, F. Humers, Prof. Hazeltine, W. Davis, E. J. Simon, L. R. Krumm, Prof. M. I. Pupin, E. H. Armstrong, T. Johnson, Jr., J. V. L. Hogan, Dr. A. N. Goldsmith, George Clark, J. A. White, L. G. Pacent, D. Sarnoff, W. Dubilier, C. Marshal, C. Hunt, C. Estey, C. Kaliant, E. Meyers, B. H. Noden, S. A. Barone, J. Di Blasi, H. Silversdorff, C. Burche, A. P. Morgan, C. Thomas, L. Spangenburg, E. Glavin, Joe Stanley, George Crouse, and others



How Far Have You Heard?

Theodore Bedell, Jr., Has Made an Enviably Record
with a Receiver which He Built for Ten Dollars

RADIO BROADCAST fans throughout the country are showing great interest in our "How Far Have You Heard" contest, which was announced in the November number. It is impossible for us to keep pace with the letters which every mail brings and many of them, unfortunately, cannot even be considered because the authors have not paid enough attention to the conditions of the contest. As has been explained in our December number, the aggregate mileage covered by a single tube receiver will count fifty per cent. in the final judgment, the other fifty per cent. will be divided among such factors as the cost of the receiver; whether or not the design or circuit is new; practicability for general use; simplicity of the circuit; ease of adjustment, etc. Clear photographs should accompany each description as well as a comprehensive diagram.

Up to a few short months ago Theodore Bedell, Jr., of Freeport, New York, tells us that he knew nothing more about radio than most of us do about antediluvian reptiles. He had heard several loud-speakers operating in radio stores, but never heard one of them that he could understand or would care about having in his home. Radio to him was just one of those things he was satisfied to let the other fellow tinker with and produce all the howls and unmerciful noises he had heard coming from the loud-speakers.

Toward the end of the summer a friend made him a present of a radio book which in addition to describing the uses to which radio was being

put by the Army, Navy, commercial companies, and amateurs, gave complete instructions for the building and operating of a receiver from parts which could be purchased at retail for \$10.

Like many others, he decided that ten dollars would not ruin him if he lost, and it would be a good investment if he was able to make the set half as useful as the book claimed it could be made.

It did not take him long to complete the receiver and the results he has obtained are really remarkable. It may be well to study some of the salient features of the circuit employed in this receiver. This is especially interesting in view of the rapidly increasing need for receivers which in addition to being sensitive must be selective if they are not to be subject to interference from several stations operating at the same time on

approximately the same wavelength and the interference caused by several receiving sets of the single circuit regenerative variety oscillating simultaneously in the same neighborhood. The circuit employed by Mr. Bedell is shown in Fig. 2.

WHY THE THREE-CIRCUIT RECEIVER

VERY few question the fact that a regenerative receiver is more responsive to weak signals than a non-regenerative receiver, whether the latter be of the vacuum tube or the crystal type. Nor is there much controversy over the fact that a regenerative receiver will tune more closely than most other receivers in general use, but opinions differ concerning the type of circuit one should employ in order

More About the Contest

Next month we expect to publish several more circuits which are proving valuable in long distance broadcast reception with a single tube. Letters are arriving so rapidly that only those of exceptional interest can be considered and preference will be given those accompanied by clear photos and well-prepared diagrams. Many readers who report excellent reception have failed to include diagrams, which reduces the possibility of full consideration of their letters. If a circuit similar to the one you use has already been published in RADIO BROADCAST do not bother to send in another; simply mention the page on which the diagram appeared. Let us have a list of the stations you hear, accompanied by the distance each one is from your receiver.—

THE EDITOR.

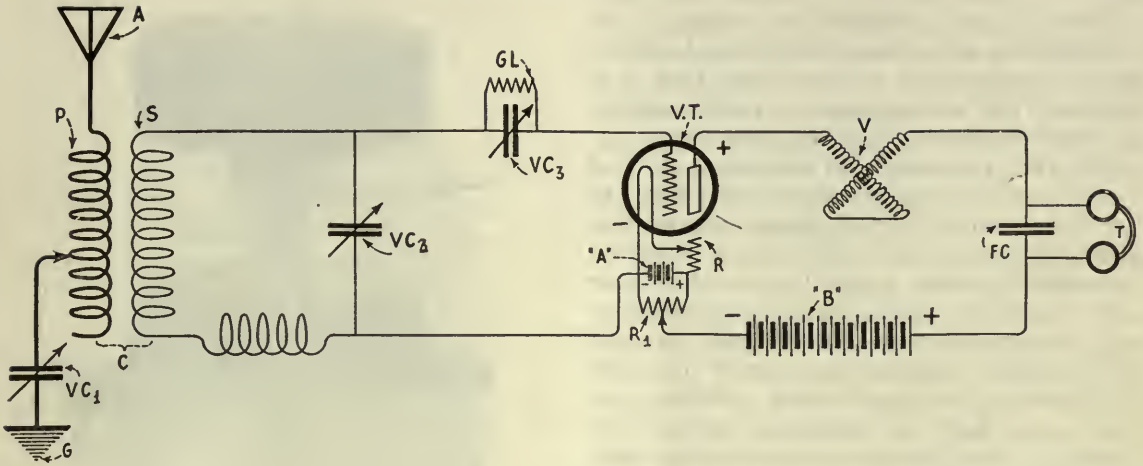

FIG. 1

In this circuit we have the secondary of the variocoupler, S, shunted by a variable condenser, V. C. 2

to get the most satisfactory results from regenerative receivers.

In its original form the regenerative receiver was merely a loose-coupled circuit, employing a vacuum tube for the detector, with what came to be called a "tickler" coil connected in series with the "B" battery and the plate of the vacuum tube and placed in inductive relation to the secondary of the receiving transformer or "loose coupler," as it was then commonly called.

Since that time various circuits have been developed for use as regenerators and various methods have been developed for tuning the primary, secondary, and tickler circuits. There is quite a difference of opinion concerning the most suitable way to take advantage of regener-

ation as well as the control of the secondary circuit wavelength. In the latter instance, some favor tuning the secondary by a condenser connected directly across the secondary of the receiving transformer as in Fig. 1 while others prefer the circuit shown in Fig. 2. The use of variable condensers is not necessary in the variometer type receiver and it is therefore easier and cheaper to make. The principal difference in opinion, however, is found in the supporters of the so-called "single circuit" receiver and the three circuit, whether the latter be of the character in Fig. 1 or Fig. 2.

It is claimed for the single circuit receiver, that simplicity of operation is brought about without reducing the selection power of the receiver—that is, it is claimed that it is just as

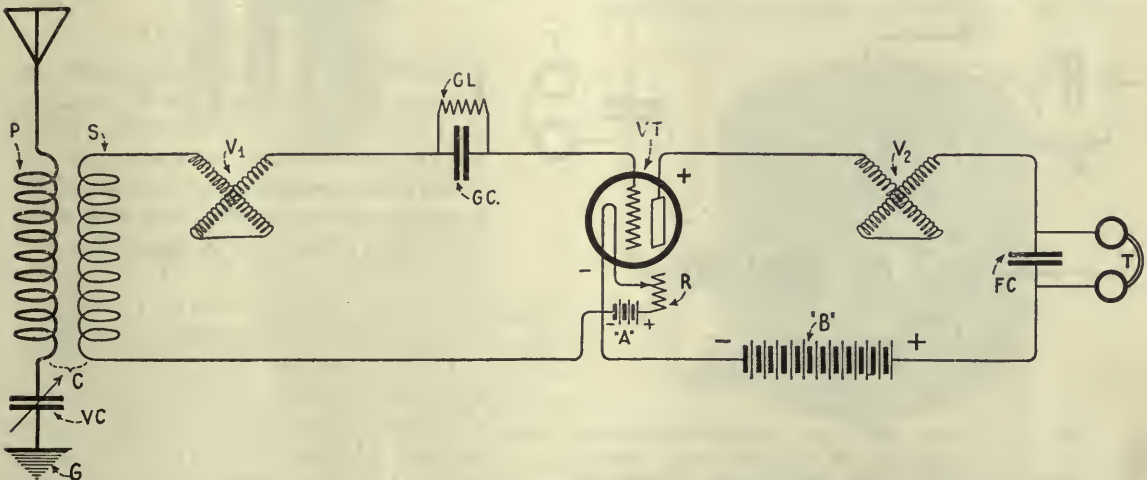

FIG. 2

Mr. Bedell uses this type of circuit but requires no variable condenser, VC, in the antenna circuit because his tuning is done by two switches—one for adjustment in steps of 10 turns and the other in steps of two turns

effective as an instrument for bringing in desired stations and cutting out undesired stations as the three-circuit receiver—and that it is certainly just as responsive to weak signals if not more responsive than the other types.

Whether it is possible for the person who had never operated a regenerative receiver before to get better results from the single circuit, than from the three-circuit receiver is not entirely a one-sided argument, especially now when there are so many broadcasting stations operating on approximately the same wavelength. It is not at all unlikely that the variation of the coupling between the primary and secondary circuits may spell the difference between an evening's entertainment and an evening spent in listening to howls. Nor is there any questioning the fact that the single-circuit regenerative receiver was subjected to some rather severe criticism at the conference held in Washington last February, for the interference it can cause other receivers when improperly operated. It is true that even a three-circuit receiver can produce a certain amount of interference, but not over any such distance as is possible with the other type, due to the fact that the coupling between the primary and secondary may be altered, greatly reducing the tendency to permit the current from the secondary circuit inducing a current in the antenna circuit, even though the latter may be tuned to the same wavelength.

The three-circuit arrangement may be a little

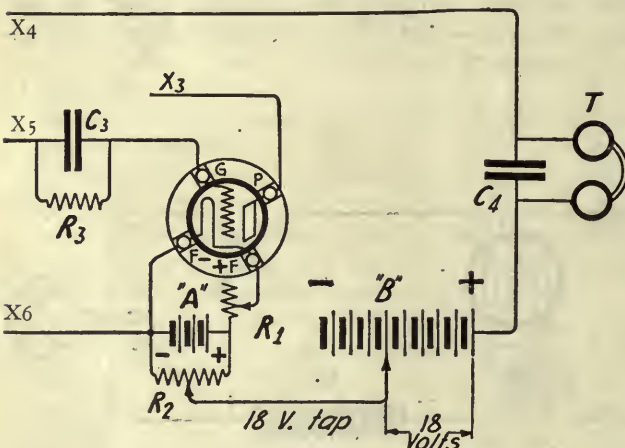

FIG. 3

This circuit shows some of the refinements which may be added to make any vacuum-tube receiver operate more satisfactorily. The potentiometer, R_2 and the variable "B" battery are very desirable. This arrangement was described in detail in "Paris and Honolulu are Calling You," in the December RADIO BROADCAST



A NEW POTENTIOMETER

Of the carbon compression type is now available in 200- and 400-ohm resistances. By moving the knob through 180 degrees the plate voltage may be materially altered

more difficult to operate, but the results obtained are generally worth the trouble. Mr. Bedell seems to have proved this rather conclusively.

PAINTING THE LILY

PERHAPS after receiving music and speech directly from the broadcasting station located at Havana, Cuba (PWX) and the other distant stations on his list, with a receiver which cost ten dollars, Mr. Bedell should be satisfied, but if he is like most radio fans of our acquaintance that will not hold true, and it is to enable him to get even better results that we suggest some possible improvements in his circuit.

There is no questioning the fact that proper adjustment of the plate voltage on a vacuum-tube detector causes a great increase in the sensitivity of a receiver and to a certain extent aids in prolonging the life of the filament of the vacuum tube because the filament need not be

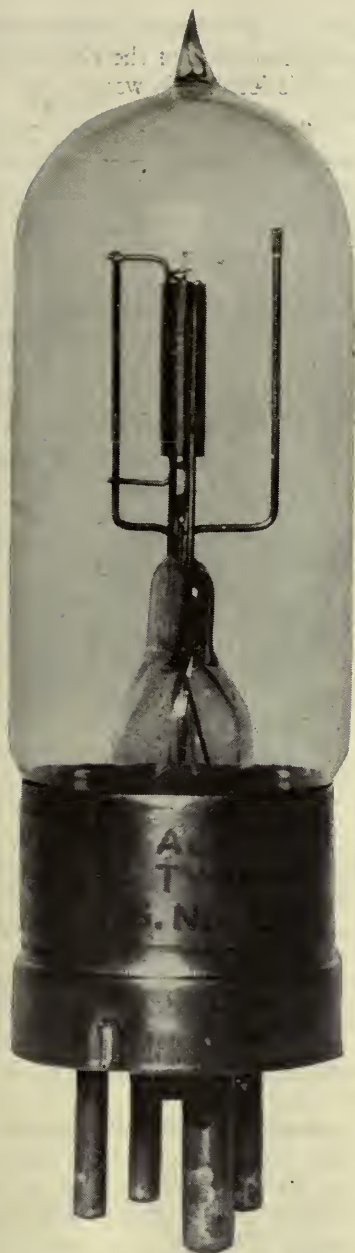

A ONE-AND-A-HALF VOLT TUBE

Capable of bringing in music and speech over long distances. The filament of this tube may be operated by a single dry cell

burned as brightly. With some particularly "gassy" tubes even the $1\frac{1}{2}$ -volt variation, made possible by a tapped "B" battery, is not sufficiently delicate and the ideal arrangement is found only when such a battery is used in conjunction with a potentiometer connected directly across the "A" battery. A satisfactory form of potentiometer is shown in an accom-

panying illustration and the necessary changes in the circuit arrangement are shown in Fig. 3.

Since a vacuum tube has been developed which may be operated by a single dry cell, of the type commonly used for doorbells and such purposes, it is quite likely that the use of the six-volt storage battery, which has been the standard for vacuum-tube reception, will become less general.

Many of those who have put off procuring receivers because of the expense entailed in procuring the storage battery, can now avail themselves of vacuum-tube reception at nominal cost. Those who already own receivers, fitted with standard vacuum-tube sockets may use the new type tube without in any way altering their layout, by employing one of the adapters, shown here, and replacing their storage battery by a single dry cell.

In using these new tubes great care should be taken to see that no voltage in excess of $1\frac{1}{2}$ is permitted to get into the filament circuit or disaster will result. (The price of the tube is \$8.00). Unlike the vacuum tubes in common use, these tubes function best when the filament is a dull red. The adjustment of the filament temperature (brilliance) is an important consideration and it is doubtful that a rheostat of the wire variety, will give the satisfaction to be had from the employment of one of the type employing carbon elements under a variable pressure, controlled by a knob.

THE USE OF VERNIERS

ALTHOUGH the receiver used by Mr. Bedell was designed specially for broadcast reception and arranged so as to permit more than the average movement of the tuning



AN ADAPTER

For using the $1\frac{1}{2}$ -volt tube with the ordinary vacuum-tube socket. Several have recently been put on the market

controls for adjusting the wavelength of the secondary and the regenerative action, the use of vernier controls is highly recommended for these circuits. A vernier attachment, which may be applied to any receiver fitted with dials, is shown in an accompanying illustration. There are other types on the market, but we have not seen any which are any more effective or can be applied more readily, or—and this is an important item to most fans—are as cheap.

INCREASING THE WAVELENGTH RANGE

IT IS quite likely that some of those who use this form of receiver would like to tune to six hundred or even longer wavelengths. In order to do this it is but necessary to connect a small fixed condenser directly across the secondary circuit, although a variable condenser would permit more delicate adjustment. If a short antenna is used it may also be necessary to connect a variable condenser directly across the antenna and ground terminals of the receiver, though this is not required with an antenna of normal size. If a fixed condenser

is employed it may be fitted with a switch so as to be thrown in or out of the circuit at will.

Mr. Bedell's letter follows:

Freeport, N. Y., Oct. 31, 1922.

MR. ARTHUR H. LYNCH,
Editor, "RADIO BROADCAST,"
Doubleday, Page & Co.,
Garden City, N. Y.

DEAR MR. LYNCH:

Undoubtedly it will interest you to know that I have had great reception with the one-tube receiver that I made from your book of "The How and Why Radio Broadcasting." Please find listed below stations other than those near by:

KDKA	Westinghouse Electric & Mfg. Co	350
	East Pittsburgh, Pa.	
WBAA	Purdue University	750
	West Lafayette, Ind.	
WBAG	Diamond State Fibre Co.	200
	Bridgeport, Pa.	
WEY	Casradia Co.	1350
	Wichita, Kans.	
WF1	Strawbridge & Clothier	150
	Philadelphia, Pa.	
WFO	Rike-Kumler Co.	600
	Dayton, Ohio.	
WGM	Atlanta Constitution	825
	Atlanta, Ga.	
WGY	General Electric Co.	150
	Schenectady, N. Y.	
WIP	Gimbel Bros.	150
	Philadelphia, Pa.	
WOH	Hatfield Electric Co.	675
	Indianapolis, Ind.	
WOO	John Wanamaker,	150
	Philadelphia, Pa.	
WSB	Atlanta Journal	825
	Atlanta, Ga.	
WGI	American Radio & Research Corp.	200
	Medford Hillside, Mass.	
WOC	Palmer School of Chiropractic Davenport, Ia.	925
WDAP	Midwest Radio Central	750
	Chicago, Ill.	
WHAM	School of Music	225
	Rochester University, Rochester, N. Y.	
WNAC	Shepard Stores	200
	Boston, Mass.	
WHAL	Phillips, Jeffrey & Derby	600
	Lansing, Mich.	
WHAS	Courier-Journal & Louisville Times	700
	Louisville, Ky.	
WHAZ	Rensselaer Polytechnic Institute, Troy, N. Y.	150

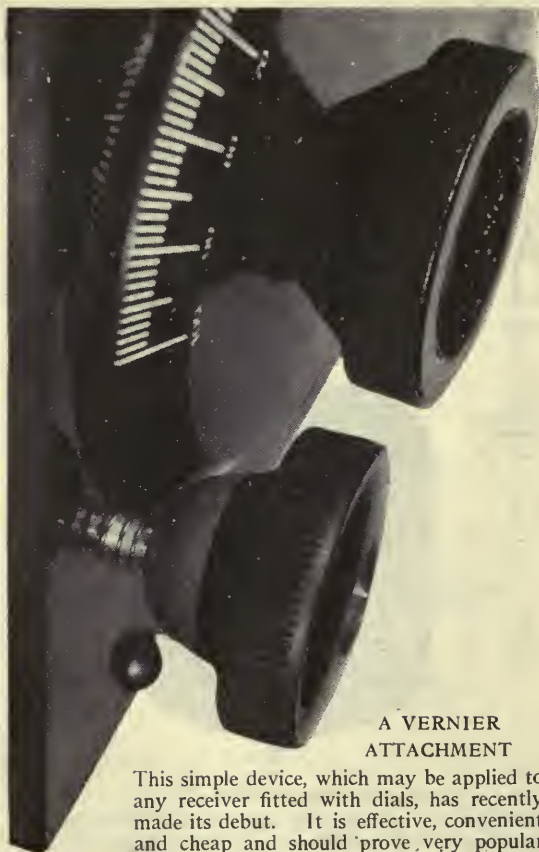

A VERNIER
ATTACHMENT

This simple device, which may be applied to any receiver fitted with dials, has recently made its debut. It is effective, convenient and cheap and should prove very popular

PWX Havana, Cuba 1350
 Aggregate mileage 11,275
 Yours very truly,
 (Signed) THEO. BEDELL, JR.

OTHERS WHO ARE BATTING WELL

NOR is Mr. Bedell alone in his good work, for Mr. Chas. Hodge of Baldwin, L. I., using a similar circuit with a set he made for ten dollars, informs us that he hears Davenport, Iowa, Havana, Cuba, and many other long distance stations, though he has not yet sent us in his statistics.

Mr. A. R. Lewis of Wichita, Kansas, who also uses this circuit, merely reports one station, Schenectady, N. Y., 1,350 miles distant. May we have your list, Mr. Lewis?

Mr. Harry C. Kisscaden, 4819 Ogle St., Manayunk, Pa., sends a partial list of the stations he hears with this circuit. There are 12 of them in all ranging from 150 to 1,050 miles with an aggregate of 4,450 miles.

Duane D. Karges of Wichita, Kansas, has had a set of this type for but three days and it is his first radio outfit, nevertheless he reports hearing 7 stations between 200 and 900 miles distant and has already piled up an aggregate of 4,300 miles. That is good work!

Mr. M. Davidson of Valley Cottage, N. Y., uses a condenser in the ground lead of his receiver and reports 10 stations of 325 to 925 miles distant with an aggregate of 6,400 miles.

Mr. Daniel W. Ingersoll of Chestertown, Md., reports hearing Davenport, Louisville, Schenectady, Atlanta, St. Louis, Shreveport, Peoria, Kansas City, Indianapolis, Birmingham, and Detroit, all more than 250 miles distant but none more than 975. Mr. Ingersoll's aggregate is 7,925 miles.

One of the most striking reports came from a letter unsigned but initialed W.B.M. and

headed 129 North Broad St., Cedartown, Ga. The circuit diagram accompanying the letter is identical to Fig. 2 except for the addition of a 43-plate variable condenser in the ground lead from the primary of the vario-coupler. Eight hundred miles is claimed for daylight reception and 3000 miles by night both of which are remarkable. The list of stations heard in the daytime is very commendable and the night

list bids fair to take first place in our contest if someone is not playing a joke on us.

We are endeavoring to have this contest carried on in a sportsmanlike manner with all the contestants "playing the game." If the letter from W. B. M. is a hoax, we are sorry to have a blight placed upon the efforts of those who are working so seriously. If, on the other hand, the letter is bona fide, we take off our hats to W. B. M.

SOME MORE GOOD WORK

WE ARE glad to learn so many of our readers are securing wonderful re-

sults from the circuit published in our December number which was brought to our attention by Mr. Edwin H. Parker. For instance, Mr. John Hoyt of Box 285, Rifle, Colorado, reports hearing 28 stations, the nearest being 225 miles distant, Denver, Colo., and the farthest being 975 miles, St. Louis, Mo. Mr. Hoyt has rolled up an aggregate mileage of 19,650. Mr. Hoyt holds first place, thus far.

Frank E. Williams, 1420 Euclid Ave., Cleveland, Ohio, reports hearing 62 broadcasting stations in two months and 27 stations from ten to twelve-thirty in a single evening. On the list of stations entered in the contest he has included but 19 stations and the shortest distance is 575 miles while the longest is 1290. He lists four stations each of which are more than 1000 miles distant. His aggregate mileage is 15,165 miles. Mr. Williams reports his

The Reflex Circuit

Frank M. Squier, Chief Engineer of the De Forest Radio Company and President of the Radiocraft Company has designed a receiver which uses three vacuum tubes and a crystal detector. The tubes function as 3 radio-frequency amplifiers and their output is rectified by the crystal detector and the rectified current is passed through two of the vacuum tubes a second time—in this instance they act as audio-frequency amplifiers. A two-foot loop which may be rotated easily projects through a hole in the top of the receiver cabinet. Mr. Squier demonstrated this new receiver for us at our plant and in several other places. Stations more than of 1000 miles away were picked up without difficulty. There are many novel features about this new receiver including its compactness, ruggedness, great sensitivity, and simplicity of operation. The first exclusive and complete description of this new development will appear in RADIO BROADCAST for February and will be written by Mr. Squier himself.—THE EDITOR.

tuning in the following manner: Set inductance switch so as to include nearly all the primary of variocoupler, leaving secondary parallel to primary. Turn condenser in to a point just beyond where the carrier wave is heard; then swing secondary of coupler around until almost at right angles with the primary. This makes for greater selectivity. Fine work!

Mr. L. B. Robinson of 537 Hillside Ave., Glen Ellyn, Ill., has recorded 18 stations, the farthest being 1720 (Los Angeles, Calif.) and the nearest 370 miles (Minneapolis, Minn.). His aggregate is 13,735 miles, which we judge to be conservative, for he has heard two other stations 700 and 800 miles distant which are not included in his report for the reason that he has only heard them for brief periods. Mr. Robinson says he has no difficulty in listening to any of the stations he has listed even though KYW, the Westinghouse Station in Chicago, is but 23 miles from his station. It is a pleasure to get a report like this.

Professor Frederick E. Croxton of the Department of Economics, Ohio State University, Columbus, Ohio, employs a modified single-circuit receiver and, because he can only listen at night, has listed only stations more than 500 miles distant. The eleven stations listed aggregate 7,545 miles. The longest single step is 975 miles. Professor Croxton makes the suggestion that some consideration be given the power employed at the transmitting station in judging the performance of a single tube. We should very much like to do this were it not for the fact that our contest is already assuming proportions which tax us to the utmost.

Mr. Edward Fox of 211 West 108th St., New York City, reports nine stations from 150 to 1,500 miles distant with an aggregate of 7,270 miles.

Mr. W. S. Wyman of Rome, N. Y., reports 7 stations 675 to 1650 miles distant and aggregates 6,850 miles.

Mr. Otis Maher of the Prendergast Company, Marion, Ohio, uses a single-tube, single-circuit regenerative set, the only unusual feature of which is a specially wound vario-coupler. He has heard 9 stations from 500 to 1,350 miles distant with an aggregate of 6,150 miles.

Mr. Edw. H. Schlader, 7754 So. Union Ave., Chicago, Ill., has listed 11 stations from 250 to 900 miles away with an aggregate of 5,275 miles. He has made a few slight changes in the circuit by using a load coil in the antenna circuit and two variable condensers.

Mr. C. K. Jones of Springfield, Mass., lists 12 stations between 175 and 975 miles with an aggregate mileage of 5,440.

Mr. Oscar Peterson of Youngstown, Ohio, reports 8 stations between 300 and 900 miles distant with an aggregate of 4,825 miles.

Mr. Walter E. Larsen, 4517 33rd Ave., So. Minneapolis, Minn., recorded six stations of 375 to 925 miles distant and aggregates 4,625 miles.

Mr. E. W. Benedict, R. D. 4, Waterbury, Conn., has heard five stations distant enough for entering our contest and all between 525 and 925 miles. His aggregate mileage is 3,750.

Mr. Harris C. Harvey of 1318 Kenmore Ave., Buffalo, N. Y., records 8 stations, the nearest being 225 and the most remote being 900 miles. His total mileage is 3,425.

Mr. Howard Sorey of 107 North Pecan St., Nowata, Okla., has heard six stations all between 225 and 825 miles distant with an aggregate of 3,225 miles.

Mr. C. F. Clarkson, 206 Victoria St., Amherst, Nova Scotia, Canada, reports three stations 600 to 675 miles distant with an aggregate of 1,950 miles, in spite of the fact that he is but a short distance from one of the Canadian



EDWARD FOX

With the receiver he made and used to pick up broadcasting from Omaha, Nebraska, 1,500 miles from his receiving station in New York

commercial stations which operates on C.W. using high power.

STANDARD REGENERATIVE RECEIVER

THE following results have been reported with a standard three-circuit regenerative receiver shown on page 58, Fig. 1, November RADIO BROADCAST:

Edward Howard, 76 High St., Waterbury, Conn., reports hearing nine stations 250 to 1,725 miles distant. His aggregate mileage is 8,650.

Mr. Hugh E. Woodward, 194 Kingsley St., Buffalo, New York, reports 16 stations from 200 to 900 miles distant with an aggregate of 7,650 miles. The total cost of Mr. Woodward's receiver was \$41 and he has had only five months' experience in radio.

Mr. M. J. Cleary, North Sidney, Nova Scotia, in spite of considerable interference from ships and the nearness to two high-power C.W. stations at Glace Bay fifteen miles away, has heard eight stations all of which are more than 550 miles distant but none more than 1,000 miles. His aggregate is 6,625.

Mr. A. D. Straussman, 601 Asbury Ave., Asbury Park, N. J., reports eight stations 375 to 900 miles distant with an aggregate of 4,100 miles.

Reports from contestants who are using Aeriola Senior receivers, operated by a single dry battery are very satisfactory. John Clum of Kensington, Md., who is only twelve years old, heads these contestants. He records 15 stations ranging from 150 to 1,050 miles distant and his aggregate mileage is 9,105.

Mr. Wm. J. Mincer, 53 Pine St., Mt. Holly, N. J., has received 10 stations from 225 to 1,500 miles distant. His aggregate is 7,025.

Mr. Edgar T. Anderson, East Mauch Chunk, Pa., reports hearing 5 stations from 750 to 1,050 miles distant and aggregates 4,475 miles.

Mr. John Int-Hout, Maurice, Iowa, has heard 5 stations 225 to 900 miles distant aggregating 3,150.

So much for this month. We are wondering what new hook-ups and new records you experimenters are going to spring on us during the next few weeks!

GETTING THE BEST FROM ONE TUBE

By P. B. CRONK

Few there are who question the assertion that music and speech received on a crystal set are clearer than when a vacuum tube is used. This receiver, which originated in the Bureau of Standards, combines the long range which the tube makes possible with the tone clarity of the crystal detector.—THE EDITOR.

THE diagram shows an electron-tube amplifier with a crystal detector. Any one already possessing an electron-tube receiver may construct this set with very little additional expense. It should be of particular interest to the many radio enthusiasts who now have single-tube sets and are not ready to go to the expense of adding a stage of amplification and still are not satisfied with the results obtained from a single tube.

The antenna circuit is variable and in the set described was tuned by a ten-point switch and a variable condenser in series-parallel. The oscillating circuit LC is tuned to the frequency of the incoming waves. The alternations of voltage between the terminals of the coil L are applied between the filament and the grid through the B battery, which is adjusted experimentally until the best value is obtained.

The amplified oscillations in the plate cir-

cuit are communicated to the oscillating circuit L₁ C₁, which is coupled to the plate circuit by the coil M. The circuit L₁ C₁ is also tuned to the frequency of the incoming waves.

The alternations of voltage between the terminals of the coil L₁ are rectified by the crystal detector and cause an audio-frequency current to pass through the phone receivers.

There are certain paramount advantages of this arrangement: first, the reception is pure and clear without the distortion accompanying the ordinary tube receiver. Second, static is greatly reduced and tube noises absolutely eliminated, although the set operates best with a very bright filament. Third, there is hardly any interference from "spark" stations, which is a point of considerable importance to most of those owning sets at this time. *This feature alone makes the set superior, for broadcast reception, to the Armstrong regenerative receiver.* And last, but most important—it is not finicky.

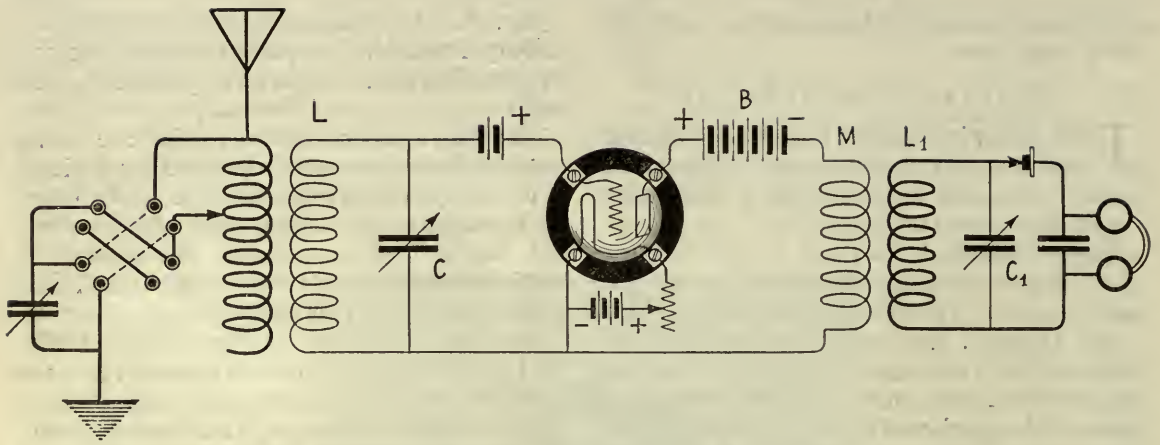

A VACUUM TUBE AND CRYSTAL COMBINATION

This circuit is being employed by Mr. Cronk with very satisfactory results

Except over long distances, you can use any tube, cross or parallel wires, take out the rheostat and C battery, disconnect the grid entirely, and the crystal alone will carry on the programme better than a crystal ever does independently. Tuning is the essence of simplicity.

One disadvantage which presents itself is the universal objection to the crystal detector, i. e., the difficulty of finding the proper contact. In receiving long distances the contact must be delicate and on a sensitive spot, using a first grade piece of mineral. However, the writer has found that this circuit gives better results than any other "hook-up" using only one tube, and in point of quality it is superior to any tube set now in common use, whether of one or more tubes.

The values are as follows: L is the secondary of a variocoupler or loose coupler of ordinary design; C and C₁ are .0005 mfd. air condensers; M and L₁ are wound on the same tube, M having 50 turns of No. 22 D. C. C. wire and L₁, 80 turns of No. 26 D. C. C. wire. M is wound first on about a 3½ inch tube and L₁ is banked over it. The coupler so made is placed in inductive relation to the antenna circuit.

The transformer ML₁ was arranged so that it could be placed in inductive relation similar to a "tickler," with good results. No marked effect was noticed from the closeness of the transformer coupling as long as the variable condensers were regulated carefully:

The detector may be of any design of galena detector, as long as a light contact can be maintained.

Individuals, no doubt, will devise many variations of the coupling arrangement and perhaps evolve something better, but it must be remembered that the principle here is not the same as that of a transformer coupling, where two circuits of different frequencies are closely coupled and the voltage ratio is about the ratio of the number of turns on the two coils. Here, there being no potential in the crystal circuit, the resistance of a transformer more than offsets any "step-up" effect which might take place. In the arrangement here described, both circuits are tuned to the same frequency.

No claim to originality is made by the writer for this "hook-up." It may be found in Bureau of Standards circular No. 40, which, however, is obtained with some difficulty. But the values have been carefully worked out by experiment, and the writer evolved the idea of putting the coupler in inductive relation to the primary of the antenna coupler.

The set described is giving perfect satisfaction to the writer, and in view of the fact that "a real amateur will try anything once," owners of single tube sets are urged to give this a try before paying good money for D. L. coils or transformers. The cost of the addition should be well under a dollar.

Up Before the Microphone



EDDIE CANTOR

Entertains about two thousand people a night when he appears before Broadway audiences. In a single evening before the microphone he entertained more people than he did in an entire season on the stage



MAY PETERSON

The noted soprano of the Metropolitan Opera Company has favored the invisible audience with her singing and we may say with no fear of contradiction that she has been heard by more than 100,000 people in a single evening, when she sang at WJZ



MRS. W. E. McADAMS AND MISS MYRTICE

Well known in Georgia before radio broadcasting became so popular as an indoor sport, now have made many friends among the listeners-in in almost every state in this large country of ours, through WSB



V. A. RANDALL

Is one of those men of mystery who tell you what the next number is to be and who is going to perform. Mr. Randall is Studio Manager of WEA and his voice has been heard in thousands of homes

The New Way to Make Americans

By J. M. McKIBBIN, JR.

WHERE will radio stop? When will its present rate of growth slacken? When will its ultimate maturity and standardization be reached?

Such questions are asked alike by fans and those responsible for the present development of radio.

The consensus of opinion is that we have merely scratched the surface, in spite of the astounding beginning that has been made. The record of KDKA at East Pittsburgh, Pa., in broadcasting its diversified programmes to places as far away as South America, some 4000 miles distant, is splendid, but it is mere pioneer work. Some day, and that not remote, we shall probably realize accomplishments which will eclipse in importance all present performances. Will not radio become international in its scope? What influence, educational, social, and economic will such daily communications have upon mankind at large? Who can at this time measure the effect of a radio appeal, universally made?

To-day this nation of ours is slowly but surely being conquered, not by a single enemy in open warfare, but by a dozen insidious (though often unconscious) enemies in peace. We are not facing the question of taxation without representation, state rights, or slavery, but we must deal with a situation that, if unnoticed, will gradually undermine our national unity. From that little nucleus of government in 1783, we have grown to a mighty nation, wielding a power and influence over the whole earth. In our beginning, unity was essential, the people were bound closely together for common protection. Without it, there was a possibility of extermination; therefore it existed. But a kindly Nature has showered so many gifts upon the United States that the growth has been very rapid. With this growth came the assurance of national strength. Millions of foreigners were received into the country, with little or no thought being given to their assimilation. What is the result? To-day we see it everywhere, in Little Italy, Chinatown, Slovakia, etc., each retaining, as far as possible, the customs, language, and traditions of its mother

country. Each is a parasite living upon the natural resources and under the protection offered by America, yet giving little or nothing in return. It is this process of nationality isolation within one country which is ruinous.

Our problem is evident. It is the problem of assimilation, not only of the foreign-speaking people (who compose but a small part of our population), but of millions of people who enjoy the privileges of American citizenship, yet who secretly cherish and adhere to the traditions and customs of their mother country. Perhaps, as a nation, we are at fault. We have showered the blessings of liberty upon all—gratis. Too often this priceless gift of freedom has been mistaken for license.

We have a long list of national heroes—men who seem to have been predestined to lead this nation through its periods of national crisis. Success was theirs and the American public showered honors upon them. National success and power gained by such leadership has made us, as a people, the most optimistic in the world. Until recently, we have given little thought to the assimilation of the foreign element within our shores. But now the crisis is upon us; and we must face it without a great leader. Perhaps no man could mould these one hundred and twenty millions of people into a harmonious whole, bound together by a strong national consciousness; but in place of a superhuman individual, the genius of the last decade has provided a force—and *that force is radio*.

If properly employed, radio will cause the indifferent or antagonistic American unconsciously to become familiar with our government, its people, and their ideals. Now, familiarity causes interest; developed interest creates desire; desire leads to action, and action will make a positive 100 per cent. American citizen. After two years of broadcasting, we find approximately one million receiving sets in North America, the result of the universal appeals of radio novelty and music. We can see, when we consider the vast reach of radio, what a tremendous influence it can be made.

Radio is too large a force to deal with the many petty social and political differences of

American Aviation Radio Is Rotten

village and town—it deals with matters of state and nation, with matters of international importance. The “listeners-in” are lifted from that common plane of trivial interests and unconsciously made to realize that they are (collectively speaking) responsible for the guidance of this nation; that its troubles are their troubles, and that its achievements are due, in part, at least, to the conscientious fulfillment of their duty. Only through the appreciation by each person of his responsibility to his country and his fellow men can come the realization of Tennyson’s prophecy:

The common sense of most shall hold a fretful realm
in awe,
And the kindly earth shall slumber, lapt in universal
law.

Let us teach the newcomer correct English. English correctly heard is English correctly spoken, and the foreigner landing on a strange shore is almost as imitative as a child. Let us offer the foreigner coming to our land more than mere opportunity: let us combine with this opportunity coöperation, which will enable him to become an intelligent citizen, working with us, instead of against us, making this people one and inseparable.

American Aviation Radio Is Rotten

By BRIGADIER-GENERAL WILLIAM MITCHELL

Reported by DONALD WILHELM

IN RELATION to aviation American radio is rotten, as compared with radio abroad. Even if we have the technical talent here, the airman doesn’t get the service that he gets over there. The fact is, the European nations—England, France, Germany, Italy, for instance—have us beat a mile in the

application of radio to aviation. That’s a fact that means a lot to airmen in days of peace. In time of war domination of air, land, and sea might turn on it.

On the other side they take these things seriously, even in peace-time, and make radio count in the development of aviation. They



BRIGADIER-GENERAL MITCHELL—AN INTREPID PILOT
General Mitchell knows the value of radio to airplanes from his own experience



SIGNAL STATIONS

Like this are valuable in communicating with planes in flight and for instructional purposes. There isn't anything "rotten" about stations of this sort other than that there are too few of them

can do that because each nation is organized. For instance, meteorological service via radio

is organized under the same head as aviation—at the fields and in the air the pilot can rely on weather information and storm warnings. A pilot needs that information a lot more even than the farmer—with passengers on board, for instance, when he's driving ahead at the speed of a hundred miles an hour, it's important to know whether he's driving into a storm or not. That's one reason why meteorological service ought to be extended by radio in every direction in which a plane is apt to fly. Here in America at the present time, neither aviation nor radio is organized—when the pilot is flying, he misses like anything an organized system of airways and fields, and if he's looking for weather information and radio guidance, he finds that everything is being handled by someone else. There's nothing new in all that; it's the old story of not enough money, mainly. We haven't enough fields. We haven't enough radio equipment. We haven't enough stations, and most of those we have aren't powerful enough, are undermanned or working only half the time. And we haven't enough trained personnel. All hands, no doubt, are doing their best in their respective little spheres with a lot to do and not much to do it with.

But the point I want to hammer home is this:

It isn't a far cry from these easy-going days of peace to the emergency of war. It's as plain as the nose on your face that in any crisis the planes will be the first over the top. And any one can see that a nation with its landing fields, and radio equipment, and planes schooled to using radio for the spread of meteorological information, can use that combined service just as well for other purposes, and, with all things equal, would have us beat a mile.

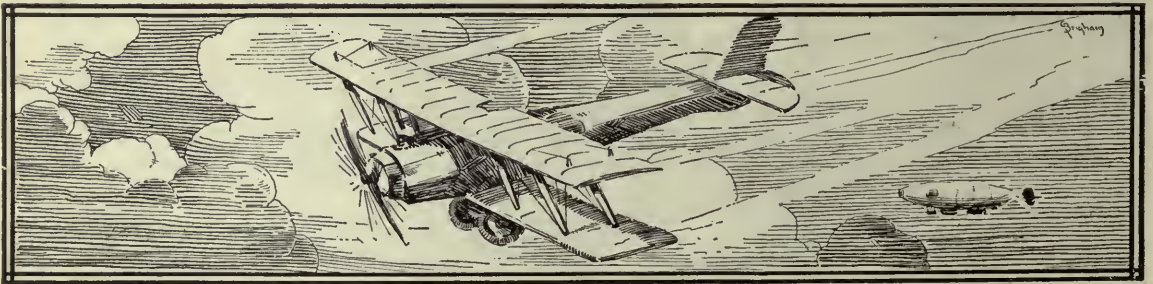

How Does This Receiver Work?

Dr. Francis Le Roy Satterlee, Who Invented It, Has His Own Theory, but Some Radio Engineers Dispute His Deductions. Do You?

By ARTHUR H. LYNCH

THERE is something more than amusement to be had from radio. Its manifold applications have been discoursed upon at length by many authors who did and many who did not know what they were writing about. Radio has recently come to be a subject of dinner table discussion and some very ambitious attributes have been credited to it by zealous though sometimes misinformed conversationalists. After listening to or reading an account of a young wizard who has success-

fully developed a marvelous "radiophone" or a loud speaker or a transmitter, it is a relief to learn of the efforts of a sober-minded scientist who has spent many of his years in fighting a brave fight against the most serious of human diseases. He tells but little of the story himself.

But before telling you of the receiver he has developed, may we tell you something of the man himself? His story is a most interesting one and he is a unique person, not only in radio, but in this work-a-day world of ours.



DR. SATTERLEE OPERATING HIS RECEIVER
Which is remarkably free from interference of any kind

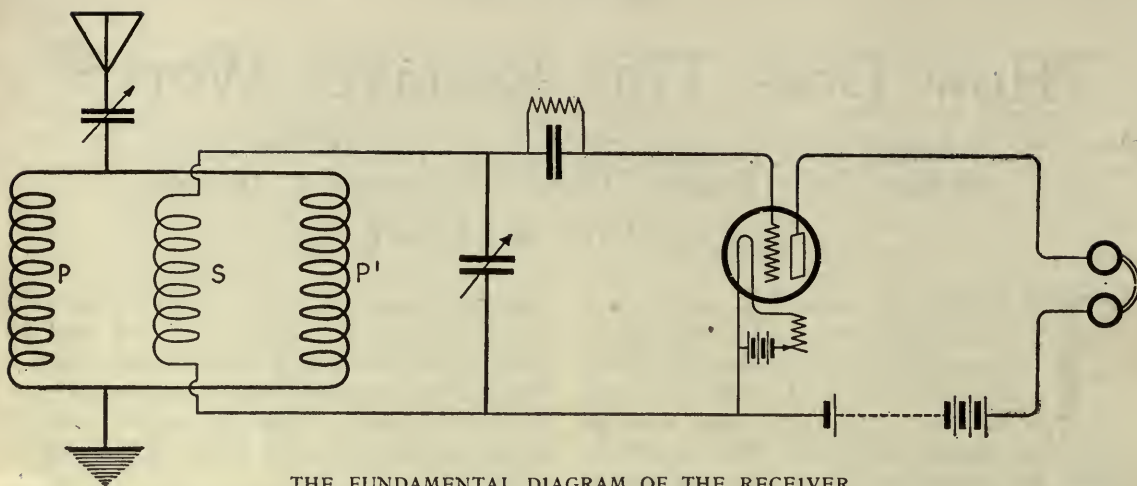

THE FUNDAMENTAL DIAGRAM OF THE RECEIVER

The double primary in this circuit is the principal point of difference between it and the ordinary loose-coupled circuit

He is one of those men who has fought death for others and is now fighting in order that he himself may live.

Dr. Francis Le Roy Satterlee has spent twenty-five years in X-ray work, which is a profession that undermines the health in a serious and painful manner. He is one of the half dozen survivors of the pioneers in Roentgen Ray work. He owned the second Crookes tube in America and had much to do with development work which led to the perfection of the lead glass screen used to safeguard X-ray operators to-day.

He is credited with making the first dental X-ray photograph and was laughed at by dental experts and physicians who claimed the X-ray could never be applied to practical use in dental work, though this same system is now used universally in modern dentistry.

Dr. Satterlee is truly a martyr to science and humanity. His forearms are covered with X-ray cancers which usually follow prolonged work with these helpful though sometimes fatal rays. Half his right hand has been amputated and specialists have recommended the amputation of his right arm. He has stubbornly refused to submit to this operation because it would handicap him in his research work.

The day before we visited his laboratory, Dr. Satterlee was ordered to go to bed for six weeks by his physician in order to offset the heart trouble he has developed as a result of his Roentgen Ray work. Finally, he compromised by agreeing to spend three days a week in bed over a considerable period.

As far back as 1909, Dr. Satterlee had some very positive theories on high-frequency alter-

nating current and one of his lectures appears in the *Medical Record* for 1902. His health has made it necessary for him to give up his X-ray work and he has been devoting his knowledge and time to radio for the past few months.

THE THEORY BEHIND THE RECEIVER

AMONG other things, the doctor maintains that radio waves and light waves are much alike, though the latter are of a much higher frequency and shorter wavelength, and claims that electromagnetic waves (radio) may be reflected and refracted by properly arranged units just as light waves may be controlled by mirrors, prisms, and lenses. In the last instance his argument is very well borne out by the work being done by C. S. Franklin, in England, which Marconi¹ himself dwelt so forcibly upon in his lecture before a joint meeting of the Institutes of Radio and Electrical Engineers on his last visit to America. Franklin's work, however, deals with a system for directing the waves sent from a transmitter while Dr. Satterlee has devised a method for directing the waves within a receiver in order that they may be properly focussed upon the unit used in the secondary circuit.

THE FIRST MODEL

IT WAS not until he had given the subject a great deal of thought and had proved his theory to himself time and again that he began building his first receiver. In April, 1922, Dr. Satterlee began to build his first crude model. When it was partially completed he told a

¹See "Radio Telegraphy," by Guglielmo Marconi, RADIO BROADCAST, August, 1922.

friend who was dubious about its success that he knew it must receive radio messages successfully because he had gone over the theory and circuit so many times in his mind and on paper that he was convinced he was on the right track.

A few days later the same friend was in the doctor's laboratory and saw the last connection made. To his utter surprise the receiver functioned almost immediately. The quality of reception was nearly as strong and clear as is obtained with the more carefully made sets he has built since then.

In spite of the fact that the original receiver performed satisfactorily, its inventor admits

that certain of the principles of its operation are still not fully known to him and several radio engineers who have seen the device have offered various theories.

Major General George O. Squier, Chief of the U. S. Signal Corps, motored to Dr. Satterlee's home in Flushing, N. Y., to see the receiver shortly after its completion. He said he could stay only fifteen minutes. The General, however, spent a long time in examining and adjusting the receiver and commented enthusiastically upon the strength of the received signals, the very fine tuning, and unusually clear tone of the music and voice which were heard.

During our own visit to Dr. Satterlee's

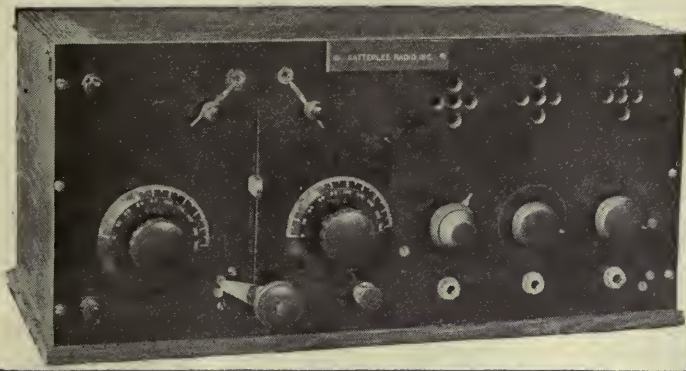

THE LATEST MODEL

Showing the control levers for the double primary and the secondary handle, which moves in the vertical slot. This unit comprises the tuning circuits, vacuum-tube detector, and two-stage audio-frequency amplifier



DR. SATTERLEE

Showing how the double primary is "focused" upon the movable secondary

laboratory, which, by the way, was on an evening when there was quite a little static, we heard a detector and two stages of audio-frequency amplification, operating Dr. Satterlee's own loud-speaker, produce music which it would be hard for any phonograph to duplicate. Not a scratch or a whistle or a howl or a single burst of static—not even a spark signal, though there were many amateurs in the neighborhood.

Dr. Satterlee has operated his receiver out at Montauk Point, L. I., which he says is carried on the Government radio maps as a "dead spot" for all radio from the West. In Maine, during mid-summer, he has received radio broadcasting from Denver, Colo., Louisville, Ky., New York, N. Y., Philadelphia, Pa., Newark, N. J., Boston, Mass., Chicago, Ill., Schenectady, N. Y., and many other points. The doctor says that he has heard San José, California, in his laboratory in Flushing, and he is now working on a system for receiving over long distances without an antenna.

A study of the fundamental diagram of Dr. Satterlee's receiver shows that the only way in which it differs from the conventional two-circuit receiver lies in the double primary. In the original arrangement three spiderweb inductances with their conventional mounting were employed but in the newer types the formation of the coils themselves has been changed and they are in the form of flat spirals, made with Litz wire after the manner of the French variometers used for aircraft work.

The centre coil, which acts as the secondary and is tuned to various wavelengths by a variable condenser shunted directly across its terminals, is mounted upon a shaft so that its position with relation to the two primary

coils—one being located on either side—may be altered. This is done by moving the shaft either up or down.

The primary coils are also moveable in the same way as the two external coils on a honey-comb mounting. The construction of the Satterlee coils and coil mounting, however, are considerably lighter than the usual spiderweb or multi-layer coil arrangements.

Within a short time this type of receiver is to be put on the market by one of the largest electrical manufacturers in this country. It is not to be sold, essentially, as a long distance receiver, though long distances have been heard with it. One of the greatest claims Dr. Satterlee makes for his receiver in addition to the clarity of tone is that, even with the best of material and workmanship, it will be possible for his outfit to sell at a price far below the price of others now available and there is surely room for a high grade product at a moderate price.

That is his story, or as much of it as he will permit us to make public just yet. Dr. Satterlee's work, however, has not been entirely confined to developing his receiver, for he is now working on inductances made without wire, which we may be able to tell you about later.

Here, indeed, is a new rôle for radio. Here we find it the playground for the highly trained scientific mind of one who has been compelled to relinquish an active interest in his life's work. And there is something fascinating about this genial man who is the picture of good health but is actually fighting death for himself, now, as he fought it for others for twenty-five years. Perhaps his grit may serve to stir us to greater achievement. Can you offer a concrete theory for the operation of Dr. Satterlee's receiver?

On the Job All Winter in the High Sierras

By CHARLES HESTON PEIRSON

IN THE dizzy altitudes of the Sierra Madre Mountains in Fresno County, California, radio will be used this winter to direct the activities of 500 men who will go into camp behind thirty miles of impassable snow-drifts to push forward during the winter one of the greatest pieces of tunnel construction now in progress in the Western Hemisphere. This

tunnel is a part of the gigantic hydro-electric project of the Southern California Edison Company, which is carrying on a program for the development of a million and a quarter horsepower of water-power electricity derived from the San Joaquin River and Big Creek and other mountain torrents.

The superiority of radio over the telephone

was so thoroughly demonstrated last winter, not only in directing the work of the men who were beyond wire communication, but in communicating with the general offices of the company in Los Angeles—270 miles from the outposts of operation—that, in preparation for this winter's work, new and expensive apparatus has been put into service. The work

territory, it was necessary to do considerable experimenting before satisfactory results were obtained. Portable radio telephone sets which had worked satisfactorily in the vicinity of Los Angeles were first taken into these mountains. Tests showed that to communicate a given distance, it was necessary to use about *twenty-five times more power* than was needed near Los Angeles!

The three transmitters rated at $\frac{1}{2}$ kilowatt were built on special order in about twelve days. One oscillion tube is used in each set. They were designed originally for continuous wave telegraphy, but have been successfully adapted for telephony or buzzer-modulated telegraphy, as well.

Involved in the work of developing the full electric potentiality of the streams of the



THE KAISER RANGE STATION

7300 feet above sea level
and "miles from anywhere"

of 4500 men, not including the 500 marooned on the upper end of the long tunnel over the crest of Kaiser Range, will be largely regulated by radio.

The headquarters station at Cascada is at an elevation of 5,000 feet, in a canyon approximately 2000 feet deep, with abrupt walls on three sides. The second station is located at a construction camp on the shore of Florence Lake, which is the south portal of the great Florence Lake tunnel, at an elevation of 7000 feet, and about seven and one-half miles in an air line northeast of Cascada. The third is located at a construction entrance camp, over the Kaiser Range, about eight miles in an air line north of the south portal on Huntington Lake. This is only about 300 feet higher than the portal station, but there is a mountain pass about 2000 feet high between them.

Owing to the fact that little was known regarding radio communication in mountainous



THE REMOTE STATION IN THE SIERRA MADRE MOUNTAINS

Which will keep the workers in touch, all winter,
with headquarters and the outside world

High Sierras and conserving their flow for irrigating lands in the San Joaquin Valley are many more daring engineering problems, which will necessitate the drilling of other tunnels, the erection of enormous storage dams in the mountain ranges far beyond lines of transportation and the constant employment of thousands of men for several years to come. It is not hard to appreciate the extent to which this work depends upon radio, nor to see that, by its use, vaster projects may be carried out than ever before in the history of engineering.

Transmitting with Your House Current

The Third Article in the Series on Simple Bulb Transmitters

By ZEH BOUCK

THE broadcasting enthusiast of yesterday, who has worked out his radio novitiate on simple low-power transmitters such as those described in the last two issues of RADIO BROADCAST, is now ready to QRO (increase power), and reach out with a 5-watt set.

The 5-watt installation is the lowest class of the power sets. But it is a power set, and in constructing and operating it, the experimenter will note many differences from the simple oscillators, using amplifying tubes, with which he is familiar. The 5-watt apparatus is built on a power basis, with more massive construction designed to stand up under greater strain. The panels are of heavier and less conductive material, well braced and capable of supporting comparatively heavy meters and shelves weighted with choke-coils, transformers, sockets and C batteries. Receiving parts, excepting sockets, can rarely be used. Rheostats are of special current-carrying capacity, the fixed condensers of a mica-foil construction, and the sockets well built and proof against insulation breakdown under the higher potential. The wiring cannot be carelessly insulated, with grid,

even the lowest power set from the quasi transmitters of our early experiments, the fundamentals and the theory remain the same; and the knowledge gained through our attempts will be of value in the intelligent operation of more complex apparatus.

The power source is the first and foremost consideration, and should be provided for, perhaps even prior to the actual building of the set. The B battery plate potential, and the 6-volt storage A battery, are no longer adequate. The filament of the UV 202, a typical 5-watt tube, draws 2.35 amperes at 7.5 volts, which may, of course, be supplied by an 8-volt battery. Nevertheless, such a battery is an expensive proposition, both in initial expense and in charging, while a step-down transformer with a specially wound secondary is much cheaper and prolongs the life of the tube.

The filament lighting transformer can be purchased, and it is generally provided for as a separate winding on power transformers for rectified A. C. transmission. However, the life of a radio enthusiast is one transformer after another, and so he is advised to gain the experience of building one as early as possible.

The core is first built up of 1"x6" soft iron strips, which may be purchased, cut to size, from a dealer in sheet metals. The core is constructed in the form of a 7-inch square; alternately overlapping the strips (Figure 1) until the core is one inch high. The sides are then taped, and the core knocked apart into four bundles, two opposite sides being selected for primary and secondary. These are prepared for winding by extra layers of tape, and by fitting the cores with heavy cardboard end pieces which serve to keep the wire within the winding area. The secondary is wound in two sections or "pies," and therefore three "end" pieces will be required, placed as indicated in Fig. 2, A. In addition to the original taping, a dozen 18" strips of tape are laid along the core with the adhesive surface outward, and are held in place by the end pieces and a few turns

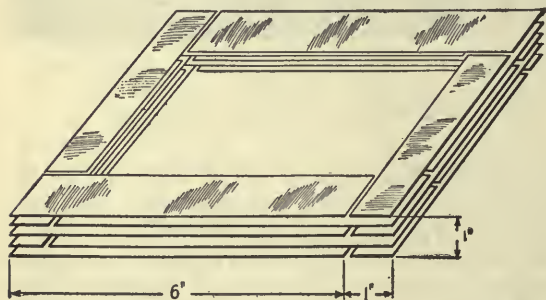

FIG. 1

Indicating dimensions and method of building up the soft iron core

plate and filament leads criss-crossing indiscriminately; for a short, or a blown tube is of far greater consequence with power apparatus. But in spite of these changes, which distinguish

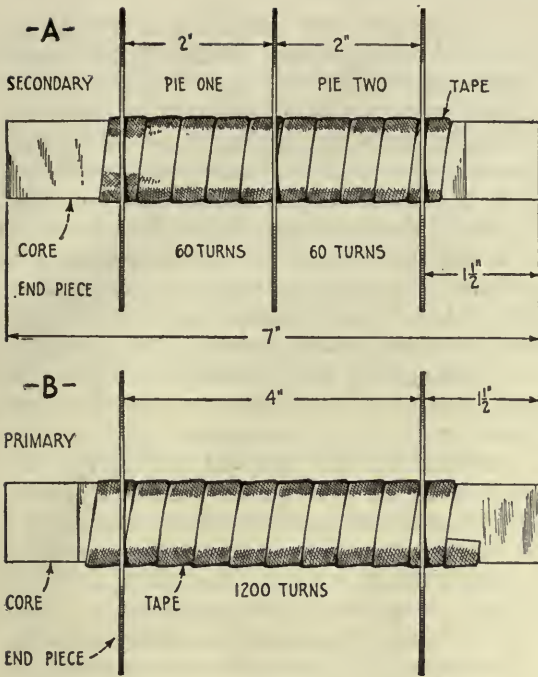

FIG. 2

Showing sides of core partially prepared for winding

of wound tape. The ends of these horizontal strips, extending six inches from each extremity of the core, are bunched together to facilitate winding. These strips are omitted, for the sake of clarity, from Figure 2.

The primary is wound with No. 22 single cotton covered wire, and every other layer wrapped with tape or empire cloth, giving an even surface for the next layer of wire. Wind the primary *very carefully*, five times across in each direction (ten layers), and allowing for a slight unevenness, this will approximate 1200 turns. After cutting the end pieces down to the size of the winding, the parallel strips of tape are unbunched, and brought up and over the winding, making the primary a neat and compact piece of work (Figure 3, A).

The secondary is wound with 120 turns of No. 12 single cotton covered, *soft drawn* wire. Pie No. 1 is first wound to 60 turns. The end is then brought out and over the middle "partition," given a few twists, and Pie No. 2 is wound as a continuation of the first. The secondary is finished up in the same manner as primary, i. e., the cardboard guides cut down to the level of the winding, and the tape brought over.

The transformer is then dovetailed together, a rather difficult task accomplished by first

starting the ends, and gently hammering the sides into place. The assembled transformer is shown in Figure 3, B. The transformer may be mounted as the experimenter's ability and industry direct, but it is, perhaps, most simply disposed of by boxing. In any event there will be five leads, two from the primary, and three (the terminals and the middle tap) from the secondary. The outside leads of the secondary are connected *only to the filament*, and will give from 5 to 7 amperes at 10 to 11 volts without overheating. The centre tap runs indirectly to the grid, and it is the only wired connection between the filament and the remainder of the set. As it is at all times neutral, being simultaneously positive and negative to the filament, it neither adds nor subtracts from the effective plate voltage, nor varies the charge on the grid, thus eliminating the alternating current hum. The transformer will draw a current from the house lines equivalent to one or two 50-watt lamps, depending on the load or the number of filaments it lights.

THE HIGH-VOLTAGE SUPPLY

RECTIFIED A. C. and the motor generator are the two systems in general use for supplying the high-voltage direct-current plate potential requisite in power radio telephones. The rectification method, as its name implies,

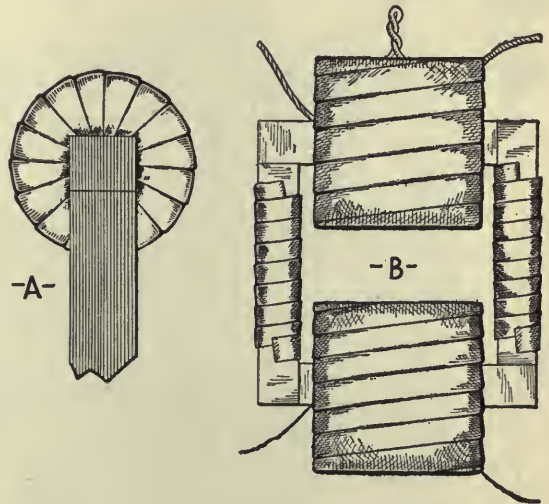

FIG. 3

Transformer construction

changes stepped-up alternating current into pulsating D. C. by virtue of the property of passing a current in one direction only possessed by some chemical solutions and the two-



FIG. 4

The commercial type motor-generator

element valve. While the initial expense of rectification is somewhat less than that of a new motor-generator, the latter is probably the more economical in the long run, and certainly more satisfactory. Due to an almost unavoidable hum, the 60-cycle A. C. systems require more complex and expensive filters, and the renewals of chemicals or bulbs are not a negligible expense. The purchase price of a direct-current generating system (Figure 4) is practically the only expense, and from the standpoint

of both economy and simplicity, it will be indicated throughout this article as the high-voltage source.

The dynamotor is somewhat similar to the motor-generator combining two fields and armatures in single stationary and revolving units, and is economical and efficient where D. C. is available for driving, Fig. 9. The dynamotor is of special advantage in isolated districts not wired for commercial lighting, where they may be had in models operating from a 6-volt storage battery, and delivering from 350 volts up. The price of a dynamotor averages three quarters the cost of an equally powerful motor-generator.

The Radiotron UV 202 and the Western Electric E tube, both five-watt oscillators, are designed to operate on a plate voltage of 350 to 400. 20- to 40-watt machines of this voltage can often be purchased second hand for as low as thirty dollars. However, the experimenter will find it desirable to increase power at times, and may later augment his equipment with more powerful tubes, such as the Singer, so, if the probable fifteen dollars difference in price is not prohibitive, he is advised to purchase a 500-volt machine. By the inclusion of a field rheostat or resistance across terminals provided for

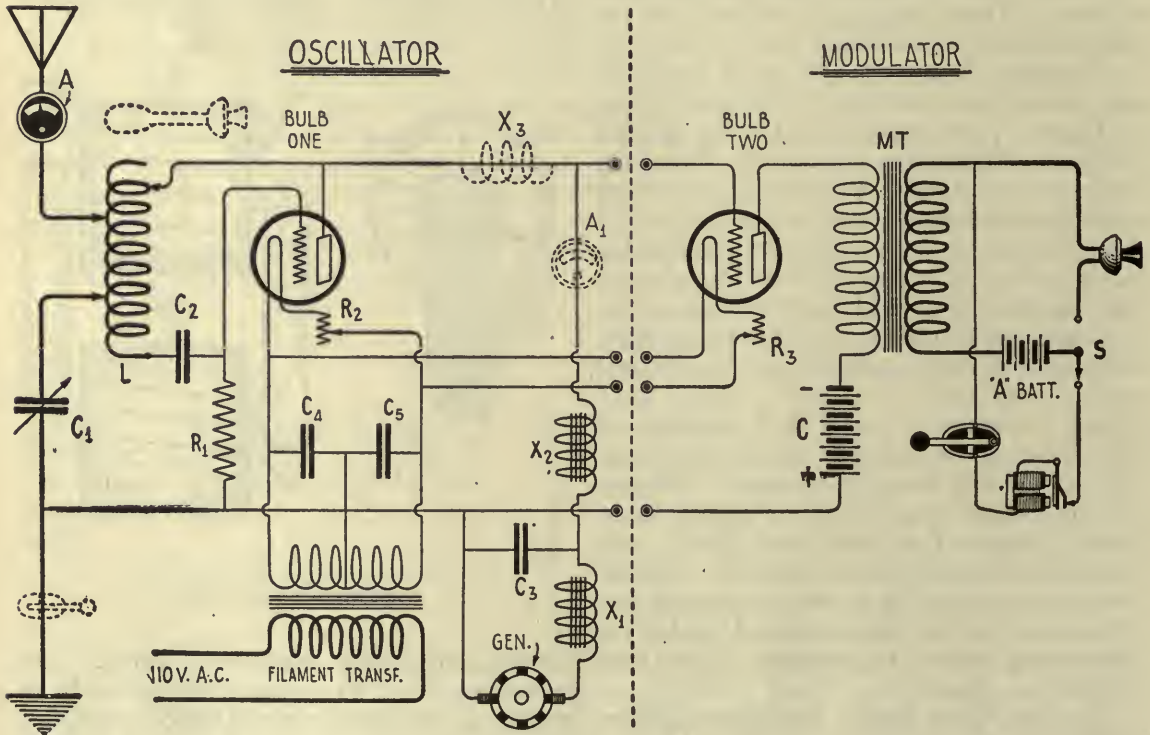

FIG. 5

this purpose, any desired voltage may be obtained.

If the amateur is in possession of a one-sixth to one-quarter horse-power motor, it will be but necessary to obtain the generator, several reliable makes of which are being marketed in the neighborhood of twenty-five dollars.

A very serviceable motor-generator can be built up by employing a 220-volt shunt-wound motor, driven as a generator at double its motor speed. A 220-volt motor of the type used to drive ceiling fans, when driven by a seventeen hundred R. P. M. induction motor, makes an excellent generator and delivers approximately 400 volts. In choosing a motor to be thus converted, the experimenter should select one having, if possible, not less than 24 commutator segments, and the bearings and insulation should be examined by one thoroughly familiar with motor construction. Two motors, one to be turned as a generator, are most easily procured second hand, and their combined cost should not exceed twenty-five dollars. It is occasionally necessary to include a 6-volt battery in series with the fields of such motors when they are first used as generators, in order to boost up the low residual magnetism.

The current from a motor generator, due to the commutator



FIG. 6

A convenient panel arrangement

action, is slightly pulsating, and the resulting ripple or hum should be filtered out. The filter generally consists of two choke-coils and one or more high-capacity condensers. It is advisable to purchase the condensers, but the chokes are easily wound. The core is of the same material used in constructing the filament lighting transformer, but preferably in larger strips about ten inches long, and built up until the core has a cross section of approximately one and a half square inches. Two cores should be made, and two and a half

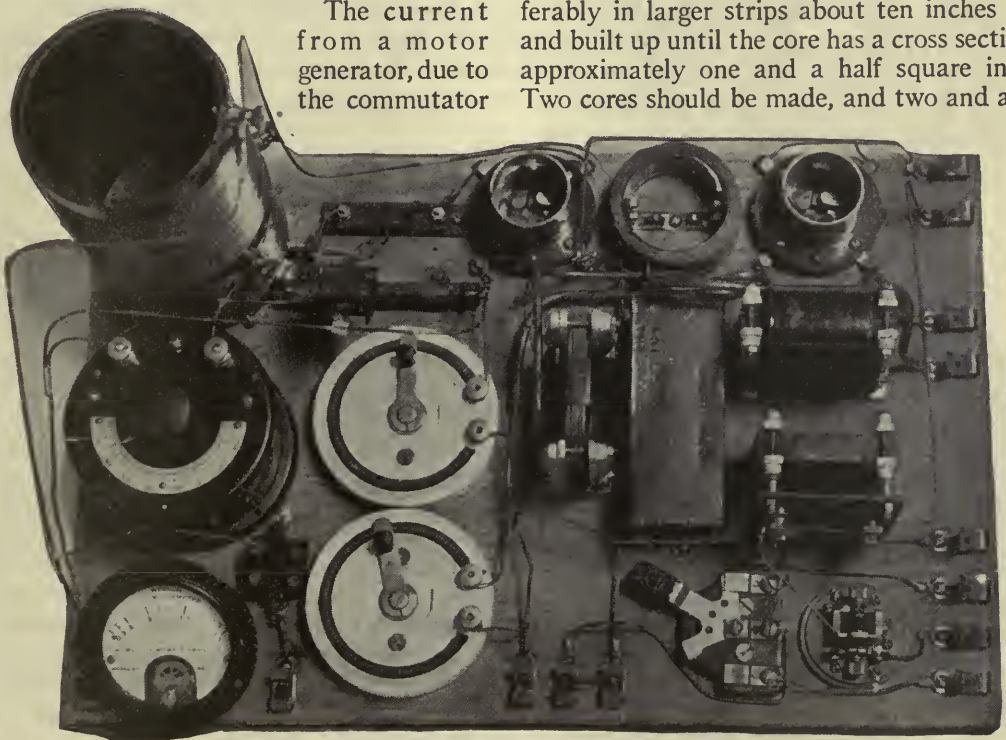

FIG. 7

It may be found convenient to experiment with your apparatus on a baseboard at first, and later to arrange it on a panel

pounds of No. 25 to No. 28 single cotton covered wire wound on each. The condensers, tested for breakdown at 600 volts, should aggregate at least .005 microfarads. The connections of the various units in the filter system are shown as part of the circuit in Figure 5.

The action of the filter is to counteract any fluctuations in the supply current caused by commutation. As the voltage rises above the average, the condenser is charged; and when, in the next instant, the generator voltage drops, the discharging condenser tends to keep the line E. M. F. normal. A similar effect is achieved in the choke-coils by the current of self induction, *which is always in such a direction as to oppose any change in the inducing current.*

THE CONSTRUCTION OF THE SET

THE radio-telephone circuit may be one of several oscillating systems, and if the experimenter is already transmitting on a well-built B battery set, he may merely modify it for power purposes. However, the Colpitts circuit is probably the best adapted to experiment with 5-watt bulbs, and if the results do not justify one's expectations, or the amateur wants to experiment further, it is quickly altered to the British airplane or other circuits.

The set may be built up in the form of a panel transmitter (Figure 6), or laid out systematically on a baseboard (Figure 7). As the

amateur is likely to make various alterations before constructing his more permanent equipment, this latter plan is, perhaps, the better.

The diagram (Figure 5), in its entirety, combines the Colpitts oscillating circuit (on the left hand side of the dotted line) with the Heising modulating system, this last being, without doubt, the most satisfactory method of superimposing the voice frequency on the outgoing wave. However, the oscillating circuit may be modulated by the absorption system (Cf. November, 1922, RADIO BROADCAST, pp. 16 and 17). The absorption loop is a single turn of wire about the inductance L, shunted by a microphone, and it is indicated by dotted lines in Figure 5. When the set is modulated in this manner, X₃, a radio-frequency choke, generally a honeycomb L₂₀₀ coil, may be omitted. If the oscillator is built up in the panel form, the Heising modulator may be constructed later with a similar outward appearance, and connected to the oscillator by four conveniently placed binding posts.

Inductance L may be either bought, or wound by the experimenter with No. 12 or No. 14 single cotton covered, soft drawn wire. For the Colpitts circuit the purchased inductance is more satisfactory (unless its design can be duplicated), as it admits of finer adjustments. A homemade inductance should be wound to 40 turns of wire on a 3-inch tube, or 30 turns on a 5-inch diameter, tapping every other turn in either case.

C₁, a variable feed-back condenser, should be of a reliable make, such as illustrated in Figure 8, tested for breakdown at 500 volts, and having a maximum capacity of at least .001 microfarads. The grid condenser, C₂, approximates .0015 mfd. and may be built up of six sheets of tinfoil, each having an active area of two square inches, and separated by a mica dielectric a hundredth of an inch thick. (By "active area" is meant the overlapping portion of each plate, exclusive of the remainder which merely acts as a lead.) C₃ is the filter condenser previously described, while C₄ and C₅ are paper-foil condensers of the type shunted across spark-coil vibrators. The purpose of these last is to reduce the positive reactance of the transformer secondary to radio-frequency variations of the plate current which must pass through half of it in going from the generator to filament.

R₁ is a non-inductive grid-leak of 5000 ohms resistance. Radiation ammeter A may be of

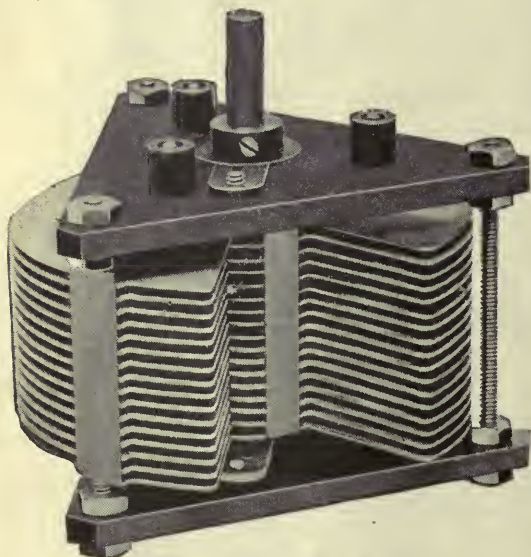

FIG. 8

A strongly built receiving condenser may sometimes be used for low-power transmitting

the hot-wire or thermo-couple type, preferably the latter, reading from zero to one ampere. X_1 and X_2 are the filter reactances (choke-coils). The rheostat R_2 (also R_3 in the modulating circuit) is especially designed for transmitting tubes and will carry 2.5 amperes. The resistance of these rheostats is just more than sufficient to lower the voltage of the transformer secondary to the filament operating potential, and will therefore be used with most of the resistance "in."

Tuning the set consists of adjusting the plate, antenna and condenser taps on L , and the capacity of C_1 . From 215 meters upward, the circuit oscillates best with the upper side of C_1 connected directly to the lower terminal of the inductance. However, it is possible to QSY (shift wave) unusually low, and still maintain good radiation, by tapping C_1 on the tenth turn of L as shown in Figure 5; then, by adjusting the antenna tap above the tenth turn, the wave may be brought down to well under 200 meters. On a similar set, radiation at three different wavelengths, 178, 192 and 200 meters was .3, .4, and .5 amperes respectively!

Radiation will drop when the modulating loop is in the circuit, and all adjustments should be made with it disconnected. Straight C.W. may be transmitted by including a key in the ground lead.

THE HEISING MODULATOR

THE "constant current" system of modulation may be added to any oscillating circuit with little, if any, modification. The bulb should be the same make or size as the oscillator, or, more accurately, the tube or tubes in the modulating circuit must be capable of dissipating an equal amount of energy as quickly as the bulbs in the oscillating circuit. If the oscillator is a single 5-watt Radiotron, the modulator should be of the same power. If two UV 202's are employed as oscillators, they may be modulated by a single 10-watt tube, and vice versa.

MT is a standard modulation transformer, which had best be purchased, though a Ford spark-coil often gives satisfactory results. The key and the single-pole double-throw switch for changing from microphone to buzzer are of conventional design. The 6-volt battery may be four dry cells or the receiving storage battery.

In adjusting the modulating circuit it is best to include in the common lead to the plates, a



FIG. 9
A dynamotor used for low-power transmission

milli-ammeter reading from 0 to 250. Guided by the plate meter readings, battery C (*negative to the grid*) is adjusted until the modulating tube draws the same current as the oscillator—in the neighborhood of 50 milli-amperes. The plate current varies inversely with the potential of the C battery, and as it need only approximate that of the first tube, a single 22.5 volt block-type battery will generally suffice.

In the Heising system, the chokes X_1 and X_2 act not merely as a filter, but also as a necessary part of the constant current system, by maintaining a current of unvarying strength through the ammeter A_1 . Thus the sum of the plate currents of the two bulbs is always the same, regardless of individual fluctuations; and it is due to this constancy that modulation is effected. As words are spoken into the microphone, the grid charge of bulb two is varied with each voice vibration, and, necessarily, the modulator space current. Assume that at a certain instant the constant plate current through meter A' of 110 milli-amperes, is equally divided between the two circuits, each tube drawing 55. At the next instant, with a different sound vibration, the space current of the modulator drops to 45 milli-amperes, and due to the choke maintaining the aggregate space current, 65 milli-amperes will be forced through the oscillator (45 plus 65 = 110) with a proportionately greater output. When the modulator plate current drops, the effect is reversed, the oscillating output always varying in perfect accordance with the sound.

The Heising system (which is used by practically all broadcasting stations), modulates perhaps twice the power controlled by the absorption method, and with the correct adjustments gives a permanently high quality of speech.

Avoiding the Jam in Southern California

By F. W. CHRISTIAN

WITH fifteen broadcasting stations in active service within twenty-five miles of Los Angeles, and only one wavelength to operate on, the question naturally arose, recently, as to who should have the best hours, conceded by all to be from 12 noon until 9 P. M. There are more people listening-in between 7 and 10 P. M. than at any other time, and the problem was to select stations having the best modulation and entertainment for these periods. Here, however, one difficulty presented itself: each broadcaster thought his programme was the best and that he had the best instrument.

Finally an association was formed composed of the managers of stations in and near Los Angeles and the president of the amateurs' association, who was elected president also of the broadcasters. Only one man from each station was to have a vote. They met, and have continued to meet once a month to allot hours to the various stations.

A percentage scheme was worked out whereby each station was voted on by the other members and rated, character of programme counting 50%, audibility 30%, and quality of modulation 20%. Then various stations were put up one by one and voted on conscientiously, each man stating what percentage of each of the three points the station was entitled to. After an average had been taken, the stations were classified according to the order of their total percentage of efficiency. The first half in rank were designated as class A and the other half as class B stations. The stations were next allowed to take their choice of hours, according to their rank in the percentage list, the A stations having double the time of the B stations. All A stations had an equal amount of time, as did all B stations. The schedule was to take effect the first of each month. Thus if a station in class A should fall down, either in the character of its entertainment or its modulation, it would be voted back into class B the next month. On the other hand, if a station in class B should surpass the A stations in the

three requirements, the people would be given a chance to hear more of its entertainment. This method resulted in assurance to the public that they would hear the best programme available at the times they would be most likely to listen-in.

As an example, during the month of June, a new station in Los Angeles, which had been heard only a few times, was put in the lower class. For the month of July, however, this station was voted second best of all the stations and put in class A, while one of the A rank of which the power had been increased but the modulation ruined, was voted back into class B. Had there been no changes made, the people would have been compelled to hear this station just when the best quality would be desired. As it was, however, they were allowed to hear a fine entertainment, sent out through a low-powered, well-modulated radio-phonograph. Thus the people had an absolute guarantee of good entertainment and there was little or no interference under this scheme. But, as might be supposed, some of the managers were dissatisfied and demanded a change of methods.

At the July meeting, a set of by-laws was proposed, and, after much discussion, was finally granted a period of trial. It called for actual tests to be made at remote points by a Bureau of Standards instrument, and the stations reclassified according to these tests.

This arrangement was tried out during the month of August. Tests were made at various points by a committee which proceeded to reclassify the broadcasters on a basis of audibility, modulation and character of programme. There was some disagreement and dissatisfaction after the re-assignment of schedules because the two stations that were rated best took all the best hours, leaving no time for the others during the evening. This was changed at the August meeting, when the larger stations agreed to give up some of their time, allowing the smaller ones a chance to show during the evening, what they could do.

Then new difficulties arose. The stations classified as the best in the July-August tests

seemed to have fallen off in their programmes, sending mostly phonograph music. None of their transmitters were standardized products, and they seemed to have great trouble in maintaining good modulation. Commutator hums, ripples, blasting microphones, etc., were very troublesome. It was found that the by-laws called for a 90-day lapse of time before the results of a new classification would be felt. A station must give 30-days notice of its demand for reclassification, thirty days would be allowed for the classification committee to report, then another thirty days for the new classification to go into effect. This seemed to spell

doom for the radio listeners-in, until the new "Class B" licenses were announced by the Department of Commerce.

One newspaper, an automobile house, and a religious institute have applied for this license, which calls for rigid examination of the instruments used, a minimum power of 500 watts, and careful selection of programmes. The newspaper has completed the installation of a Western Electric Company 500-watt set and had its grand opening November 2nd. The others will also be ready soon. These three stations will operate independently of the Association and must divide the time equally.

Concerning My Invention—The Audion

By LEE DE FOREST

October
Twenty-fifth
1922.

EDITOR, RADIO BROADCAST,
Garden City, Long Island.

DEAR SIR:

My attention has recently been called to an article published in the RADIO BROADCAST by Professor J. H. Morecroft under the title "What Every One Should Know About Wireless and Its Makers." In this article I find mention of my invention of the Audion and several references to the Audion which are by no means in accord with the facts. I am persuaded that Professor Morecroft in no way intended to do an injustice to me or your readers, and will himself in all fairness welcome a brief statement on the genesis of the Audion.

From time to time the statement has appeared, as in the case of the Morecroft article, in effect that in my invention I contributed the grid to a rectifier or two-element vacuum tube, and thereby created the Audion or the three-electrode vacuum tube, the present heart and soul of radio communication. What could be more simple in the way of an explanation? What at the same time further from the truth and still further from a knowledge of the simple facts of radio principles?

Professor Morecroft says: "It seems strange that Fleming did not at once jump to the idea

of the Audion, but the history of science is full of just such occurrences—a worker on the point of making an important discovery, yet missing it by the merest chance."

Had Fleming thought of the grid, had he inserted it in the Edison Valve, he would have had exactly what he did have, a rectifier—but with a grid-shaped anode—nothing more. Had I come to this stage by the route Fleming followed, I should have done exactly as Fleming did—missed it exactly as he missed the Audion.

To recognize that the anode battery circuit is as essential a feature of the Audion as is the third electrode, that by virtue of this local energy alone is the Audion a relay device and therefore an amplifier of transcendent value, instead of a mere rectifier of received alternating current—seems such a simple proposition, so self-apparent, that I have always been at a loss to understand why any one should fail to grasp it. Yet such is the very common position of many writers: "The Audion is the Fleming valve with a third electrode." "Its inventor improved the Fleming valve merely by the addition of the grid." I doubt if such misleading stupidities were elsewhere ever preached in the history of the electrical art.

Add a third, or any number of electrodes to the Fleming valve and it remains the Fleming valve—a mere rectifier, possessing the utility of the rectifier and nothing more.

The evolution of the Audion patent claims marks, in a general way, the evolution of the Audion—first it was a gas effect in the open air, then in an enclosed vessel, then in an exhausted vessel, exhausted like an incandescent lamp—then to higher and higher degrees of vacuua (as early as 1912 I employed an X-ray vacuum) But always it was a relay. Always the “B” battery was employed. The control electrode idea even preceded the enclosed vessel. And never was the Audion “the Fleming valve with merely a grid added.”

Professor Morecroft continues: “The thing which he (De Forest) actually did, namely, the insertion of the third electrode into a Fleming valve, was a most wonderful contribution to the radio art.” It was not. Remember that a mere valve with three electrodes is still only a valve—with one electrode too many.

Unfortunately, prior to the year 1917, very little, indeed scarcely anything at all, appeared in radio history concerning the Audion art, although nearly a decade had elapsed since my first patents were granted on the Audion. It

was in this period of bitter commercial rivalry that certain British radio interests first saw fit to attempt to discredit an American invention and put forth the suggestion, altogether at variance with the truth, that an American had simply put another electrode in the two-electrode tube. There is no excuse, however, why, at this late day, such an untruth should persist in American radio history, above all, when the whole world is making use of the Audion in radio communication as well as in long distance wire telephony and the successors of these same English commercial rivals are now operating under the original De Forest Audion patent licenses. In fact, their entire radio system, outside of the generators and aerials, is built around the three-electrode-anode-voltage vacuum tube.

Very truly yours,



Practical Pointers on Cabinet Wood-Finishing

By W. S. STANDIFORD

ELECTRICAL experimenters can make neat-looking cabinets, but often fall down in their finishing work. It is too bad to get so far along with the construction of a set and then omit those finishing touches that make it a pleasure to look at and to operate. As crudely finished apparatus is generally the result of a lack of knowledge of the processes and materials needed rather than to lack of interest or carelessness, a few practical pointers may prove helpful.

At the outset, it cannot be emphasized too strongly that a clean, smooth exterior is necessary in order to get a first-class finish, whether the wood is to be painted, enameled, oil-finished in natural-colored woods, or varnished. The first thing to do is to decide what kind of wood the box is to be made of, whether it is open- or close-grained, and also whether it contains any sap, as such conditions will make necessary different methods of working.

Open-grained woods include: Oak, ash, chestnut, walnut, mahogany, and butternut. These require fillers.

Close-grained woods include: Pine, cherry, maple, birch, cypress, whitewood, poplar, sycamore, beech, and redwood. These and others like them do not need fillers, but can be finished in natural colors or stained, as preferred. Five operations in wood finishing are needed: sandpapering, staining, filling, varnishing, and polishing.

First, plane the wood as smooth as possible. Then tack a piece of No. 00 sandpaper on a level block of wood and rub with the grain, using moderate pressure and taking care when working near the edges, not to round them. Wipe all dust from the surface with a cloth; if any remains, rough spots in the finished product will result. Staining comes next, if pine or poplar are used to imitate the appearance of more costly woods. By using pine or poplar, radio cabinets can be made which will

look as if an expensive natural-colored wood were used. In wood finishing, much trouble in working will be avoided by the purchase of the *best* stains and materials obtainable. There are two kinds of stains on the market: water and oil stains, each having their good points. Oil stains are those in which the coloring pigment is dissolved in linseed oil or turpentine; water is the solvent for the other. As pine wood in some cases has more or less sap, this wood, after being colored with an oil- or water-stain when dry, should have two coats of white shellac varnish applied, each coat to be lightly sandpapered after drying.

This shellac coating effectually keeps any sap from discoloring the finish; varnishing, rubbing down, and polishing can then follow. The best way

to use water- or oil-stains is to apply them with a brush and then rub them into the wood with a piece of cheese-cloth. This distributes the color evenly and absorbs surplus moisture (which in the case of water-stains is apt to raise the grain of wood, thus making more sandpapering necessary) and also makes a uniform color tone. If the first application does not give as deep a color as is desired, give it another one. If you want to use an open-grain wood, such as mahogany or walnut, and use a stain to make it deeper in color, the pores will have to be filled after staining. Otherwise staining can be omitted; but the filling is necessary. Supposing that such a wood has been stained; get a paste filler of a color to match the stain as nearly as possible; put some filler on a small piece of cotton cloth and rub it on the wood. As soon as this filler has dried a little (don't let it get hard) continue to rub the surface until all pores have been filled up, rubbing off the surplus, the idea being to have nothing but the pores contain filler.

After it is dry and smooth, give it a coat of white shellac varnish. This should be rather thin, and may be diluted with alcohol if desired. All surplus varnish must be wiped off the brush before applying it to the surface, for if too thick a coating is applied, it will not

be clear enough to allow the stain to show. The first coat of shellac will take about three hours to dry, after which you should apply another one. Rub the dried surface with fine sandpaper until the wood is smooth. Don't rub it too hard or you will cut through the shellac. Varnishing comes next. Good brushes should be used as cheap ones are generally coarse and shed their bristles. The varnish must not be too cold as this prevents it from flowing freely. Have only enough varnish on the brush to give

a level coating when it is brushed across the grain. Finish off by rubbing lightly, *with the grain*, letting it dry thirty hours, or until thoroughly hard.

Purchase some FF grade pumice stone at a paint store; likewise a rubbing felt. Dip the latter into linseed

oil, then into pumice stone which will now adhere to the felt. Rub the varnished surface lightly along the grain. Continue this process until all small depressions have disappeared. This may be ascertained by looking diagonally over the surface when it is held to the light. All hollow places will now show as dark spots: The surplus pumice stone should be carefully removed with a soft cloth.

Give it another coating of varnish and let it dry, then repeat the operation with the pumice stone. The cabinet will have a dead, non-glossy finish. Those who prefer a shining polish can easily obtain it by dipping a piece of felt into linseed oil and into powdered rotten stone (to be bought at a paint store) and going over the surface in the same manner as with the pumice stone. A higher polish can be obtained on the last coat by giving it the rotten stone treatment, and then rubbing the hard varnish with a soft cloth dipped into linseed oil, using plenty of "elbow-grease" until a high polish is obtained. The surplus should be wiped off with a chamois skin. The above gives a durable finish; one that will not scar easily. If all the work has been done carefully, you will have a neat-looking cabinet that will be envied by your friends who have not learned polishing work, which is quite easy when you know how to do it.

During National Radio Week, December 23rd to 30th, special concerts and addresses will be put on by broadcasting stations throughout the country, and everyone will have a chance to hear exceptionally fine programmes. Get your set in shape well in advance, so that you will be able to reach out and provide entertainment for yourself and your friends from many miles away during these Christmas holidays.—THE EDITOR.

Western Electric Broadcasting Stations in the U. S.

A glance at this list and map may give you some data on stations you have been hearing. Most of these are class B stations, transmitting on 400 meters.

STATION NAME	INPUT TO ANTENNA IN WATTS	CALL SIGNAL	CLASS OF STATION
Detroit (Mich.) <i>News</i>	500.	WWJ	B
Detroit (Mich.) <i>Free Press</i>	500.	WCX	B
Kansas City (Mo.) <i>Star</i>	500.	WDAF	B
Atlanta (Ga.) <i>Journal</i>	500.	WSB	B
St. Louis (Mo.) <i>Post Dispatch</i>	500.	KSB	B
Rochester (N. Y.) <i>Democrat & Chronicle</i>	100.	WHAM	A
Louisville (Ky.) <i>Courier Journal</i>	500.	WHAS	A
L. Bamberger & Co., Newark, N. J.	500.	WOR	B
Amer. Tel. & Tel. Co., N. Y. City	500.	WBAY-2XY	B
Shepard Stores, Boston, Mass.	100.	WNAC	A
John Wanamaker, Philadelphia, Pa.	500.	WOO	B
Union Trust Co., Cleveland, Ohio	500.	WJAX	A
Palmer School, Davenport, Iowa	500.	WOC	B
Western Electric Co., New York	500.	WEAF-2XB	B
Sweeney Automobile School, K. C., Mo.	500.	WHB	B
Mo. State Marketing Bu., Jefferson C., Mo.	500.	WOS	A
Rensselaer Polytechnic Inst. Troy, N. Y.	500.	WHAZ	B
Round Hills Radio Corp., South Dartmouth, Mass.	100.	WMAF-1XV	A
W. S. Harris, Minneapolis, Minn.	500.	WLAG	A
Fort Worth (Texas) <i>Star Telegram</i>	500.	WBAP	B
Chicago <i>Daily News</i> , Chicago, Ill.	500.	WMAQ	A
Dallas (Texas) <i>News</i>	500.	WFAA	B
Gimbel Bros., Philadelphia, Pa.	500.	WIP	A
<i>Times Mirror</i> , Los Angeles, Cal.	500.	KHJ	B
Oregonian Pub. Co., Portland, Ore.	500.	KGW	B

Class A—operating on 360 meters.
B — " " " 400 "

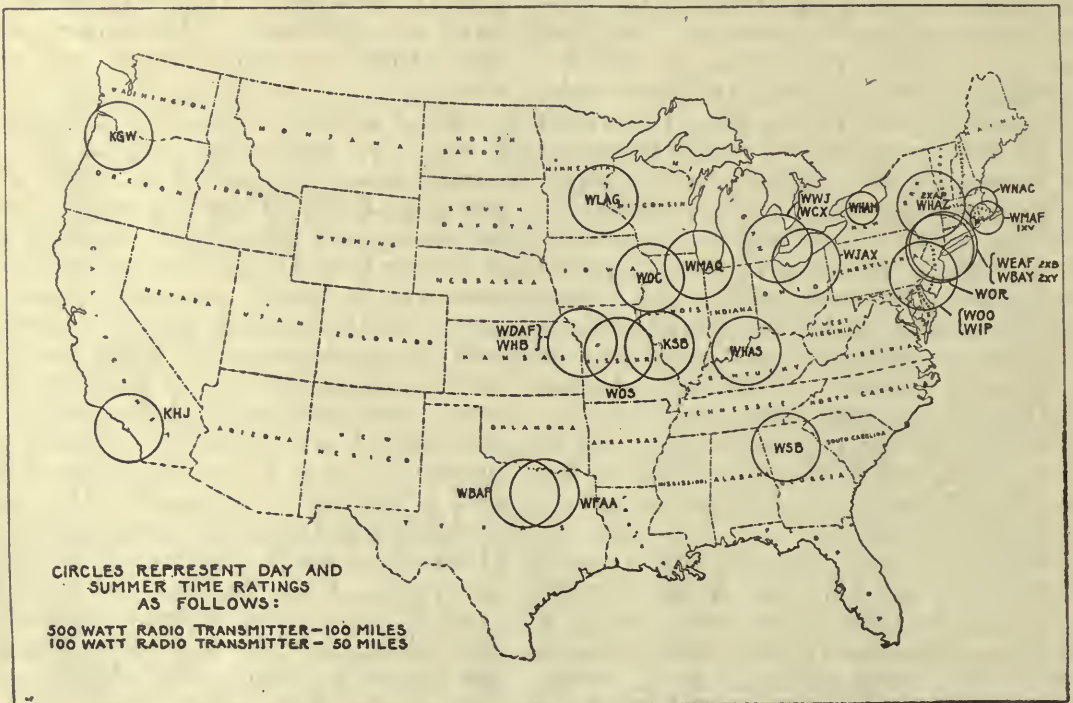

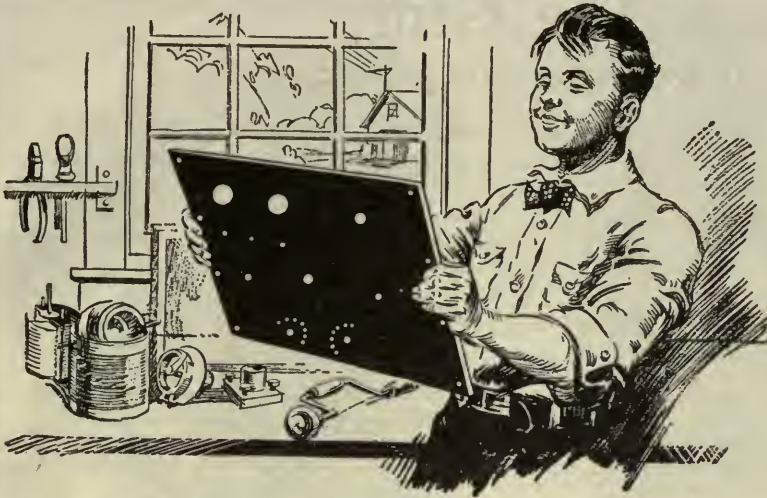

This Panel Will Improve Your Set

CONDENSITE CELORON

THE best panel made is none too good for your set. Dependable insulation is vital because it has a direct bearing upon the clearness and sensitivity of both transmission and reception.

Every thinking radio enthusiast certainly wants the highest type panel he can obtain and the surest way to get it is to insist upon Condensite Celoron.

This strong, handsome, jet-black material is not merely an insulating material—it is a radio insulation made to meet high voltages at radio frequencies. That is why it will give you greater resistivity and a higher dielectric strength than you will ever need.

Make your next panel of Condensite Celoron. It machines readily, engraves with clean cut characters and takes a beautiful polish or a rich dull mat surface.

An Opportunity for Radio Dealers

Condensite Celoron Radio Panels and Parts offer a clean cut opportunity to the dealer who is keen on building business on a quality basis. Write us to-day. Let us send you the facts. You'll be interested.

Diamond State Fibre Company

Bridgeport (near Philadelphia), Pa.

Branch Factory and Warehouse, Chicago.

Offices in principal cities

In Canada: Diamond State Fibre Co., Ltd., Toronto.

The Grid

QUESTIONS AND ANSWERS

The Grid is a Question and Answer Department maintained especially for the radio amateurs. Full answers will be given wherever possible. In answering questions, those of a like nature will be grouped together and answered by one article. Every effort will be made to keep the answers simple and direct, yet fully self-explanatory. Questions should be addressed to Editor, "The Grid," Radio Broadcast, Garden City, N. Y. The letter containing the questions should have the full name and address of the writer and also his station call letter, if he has one. Names, however, will not be published.

Technical Terms Used in This Month's Grid

Accumulator: A storage battery.

Zero-center meter: A direct-current meter having the zero at the middle of the dial, and reading to both right and left. In the case of a battery ammeter, one side will indicate the charging amperage and the other the rate of discharge.

Gassing: The "boiling" or excessive bubbling of a battery during the last period of charge.

Open circuit: Tested when the charging current is off, and no current other than that actuating the meter is being drawn from the battery.

Hydrometer: An instrument for measuring specific gravity.

Flux (in electricity): An energetic field of magnetic lines of force such as move the armature on a door-bell or the diaphragm of a telephone receiver.

Inductance: The property of a circuit which determines its ability to build up a flux. A coil of wire is also frequently referred to as an "inductance."

STORAGE BATTERY CHARGING

I have a 120-ampere-hour "A" battery. 110 volts D. C. is available.

How can I charge the battery?

L. A. H., LAINSBURG, MICHIGAN.

STORAGE batteries are very readily charged from 110 volts, direct current, by placing a resistance in series with the battery and line. This resistance should be of such a value that it will reduce the current flowing through the circuit to the amperage designated as the charging rate, which is generally specified on the nameplate of the battery by the manufacturers. The charging rate varies with the capacity of the cells, from three or four amperes for the 40-ampere-hour accumulator, to ten or fifteen amperes and higher with the larger batteries. For a 120-ampere-hour battery, an 8-ampere charging rate should be maintained from 15 to 20 hours, depending on the original degree of discharge.

The most convenient form of resistance is probably the electric light bulb, and 50-watt Mazdas, or 16-candle power carbon lamps should be used, except in the case of large batteries where doubling the power of the lamps will halve the number. One 50-watt bulb should be used for each half ampere—or a 100-watt lamp for each ampere. Thus, charging a 120-ampere-hour battery, at an 8-ampere rate, will require 16 50-watt bulbs.

The lamp sockets, and at least two switches, should be mounted on a hardwood panel, which is most conveniently installed close to the battery. The necessary switches are the line switch with fuses, and the battery, double pole double throw, charge-discharge switch. Two additional switches which add to the utility of the panel and facilitate operation are indicated in the diagram, Figure 1. An ammeter of the automobile zero-centre type, reading up to fifteen amperes in both directions is also desirable.

Switch B makes it possible to halve the charging rate,

as should be done during the last two hours of charge, without unscrewing eight uncomfortably hot lamps. With switch A open, the filament battery is placed on "trickle charge," to which the battery should be occasionally subjected, and which will compensate for surface leakage during comparatively long periods of disuse. It must also be born in mind that, while it is theoretically possible to dissipate all of the energy put into the battery, some of the energy is not available for useful purposes, a fact that necessitates a slight overcharge which is most safely effected by frequently placing the battery on an overnight trickle charge.

Also, with the charge-discharge switch open, or in the discharge position, the "B" battery, up to an 80-volt potential, may be charged from the binding posts X and Y at the half-ampere rate. Charging of the "A" and "B" batteries must be accomplished separately, but either may be charged while the set is in operation, *if the receiver is of the inductively coupled type*, i. e., with no wired connection between the antenna-ground circuit and the audion. In all other hookups, the batteries must be disconnected from the set during charge, a precaution most conveniently accomplished by charge-discharge switches.

In charging, the positive of the line must be connected to the positive pole of the battery, so it will be probably necessary to test for polarity. Four methods are in general use, and are indicated in order of their simplicity:

1. By feeling for shock.
2. By an electro-chemical polarity indicator.
3. By a direct current, magnetic type voltmeter
4. By the decomposition of salted water.

In almost every case the negative of the 110-feed is grounded. Therefore if the fingers of one hand are placed on the positive wire, and those of the other hand grounded on the steam or water pipe, a *gentle* shock will be felt. Contrary to general supposition, a 110-volt shock through *dry hands* is very mild, and a pleasant sensation rather than otherwise.

No Wireless Receiving set complete without it

PALS AGAIN
Never a dull evening in the home

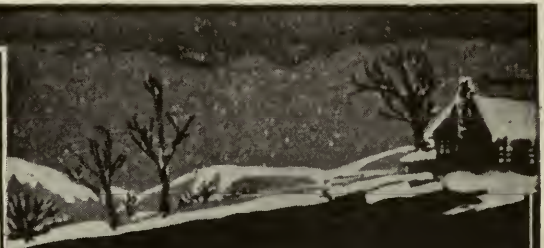

No matter what the weather, you can enjoy the world's best music and news in the comfort and privacy of your home by using

MAGNAVOX
Radio
The Reproducer Supreme



When you purchase a Magnavox product you possess an instrument of the highest quality and service.

R-2 Magnavox Radio with 18-inch horn: this instrument is intended for those who wish the utmost in amplifying power; for large audiences, dance halls, etc. \$85.00

R-3 Magnavox Radio with 14-inch horn: the ideal instrument for use in homes, offices, amateur stations, etc. \$45.00



Model C Magnavox Power Amplifier insures getting the largest possible power input for your Magnavox Radio.
2 stage AC-2-C . \$80.00
3-stage AC-3-C . 110.00

Magnavox products may be had of good dealers everywhere. Illustrated booklet on request.

IT was in 1913 that the Magnavox electro-dynamic receiver made its first public demonstration, when telephone communication was held by means of it between Denver and New York—a revolutionary advance.

The rise in radio broadcasting found Magnavox apparatus already fully developed to make possible the reproduction of wireless music and speech in ample volume and marvelous clearness.

The facilities and experience back of each piece of equipment bearing the Magnavox trade mark are unrivaled anywhere in the world.

THE MAGNAVOX COMPANY

Home Office and Factory: Oakland, California
New York Office: 370 Seventh Avenue

Chemical polarity indicators are made in the form of armored glass tubes with terminals at each end. They contain a solution of starch and iodide of potassium which, decomposed by the passage of current, turns blue at the plus terminal.

Direct current voltmeters, with a magnetic, motor movement, have the terminals marked + (positive) and - (negative). If they are improperly connected (the positive lead to the minus post) the needle will swing to the left of zero; and a reading will only be obtained when connected positive to plus and negative to minus.

Wires carrying direct current, carefully separated in slightly salty water, will decompose the solution into its composite gases, Hydrogen and Oxygen. As water, H_2O , contains twice the amount of hydrogen (H_2) as of oxygen (O), the greater number of the hydrogen bubbles, which rise about the negative wire, indicate its polarity.

A battery should be placed on charge when its voltage, under a normal load, drops to 1.7, and it may be considered fully charged when the current has been kept on for an hour and a half after it commences gassing freely, if, during that period, there is no further rise in either the voltage or the specific gravity. The voltage during the last hours of charge will vary, depending on the age of the battery from 2.3 to 2.5 (on open circuit 2.2 volts) and the specific gravity from 1.280 to 1.300.

The specific gravity is the density or weight of one cubic centimeter of the electrolyte as compared with a similar quantity of chemically pure water. Sulphuric acid, of which the electrolyte is a twenty to twenty-five per cent. solution, is heavier than water, and during discharge some of it is absorbed into the plates, leaving the solution so much lighter. Charging is fundamentally a process of

forcing the acid out of the plates back into the solution, boosting up the specific gravity until the electrolyte regains every bit of its original strength. Hence, the only loss in the electrolyte is occasioned by the evaporation of water, which should be replenished (preferably distilled water) from time to time, maintaining the level of the solution one half to three quarters of an inch above the top of the plates. All changes in the electrolyte should be made in accordance with hydrometer readings, and only when the battery is fully charged.

Directions for the maintenance and care of different batteries are furnished by their respective manufacturers, and the experimenter should be thoroughly familiar with those covering his own battery.

VACUUM TUBES

What are the structural differences that make some vacuum tubes more suitable for radio frequency amplification, and others suitable for audio-frequency amplification and for detection?

—G. K., NEW LONDON, CONN.

THE only structural differences between types of modern vacuum tubes are those differentiating power or transmitting tubes from low power receiving bulbs. The transmitting bulbs have larger elements in proportion to the amount of energy they control, with different spacing suited to the requirements of insulation, and a higher vacuum.

In low capacity receiving tubes (capacity in the condenser sense), which include practically all the present day bulbs used for detection and amplification, the structural details may be identical, whether used for radio or audio-frequency amplification. However, until a few years ago, when tube construction became a more exact science, all tubes possessed a comparatively high capacity, due principally to the design and placing of the elements and leads. As the tubes were imperfectly evacuated, it is also possible that the presence of air or gas, with the corresponding dielectric constant, may have increased this capacity.

Due to this condenser effect, pre-war tubes could not be used for radio frequency transformer amplification on short waves. The capacity of a tube is virtually shunted across the primary of the amplifying transformer, which, if the transformer is of the radio frequency type, will boost the wave, as will any condenser across an inductance. Thus, on short waves, where the addition of even small capacities has a comparatively large effect on wavelength, radio-frequency amplification was very inefficient, for little transference of energy could be effected on the few turns of wire to which the resonant transformer was limited.

As mentioned above, there is to-day no structural difference between radio-frequency and audio-frequency amplifying bulbs. However, detector tubes have a lower vacuum than those designed for amplification.

Several effects combine to make the low-vacuum audion more sensitive to weak grid impulses, and they are therefore more

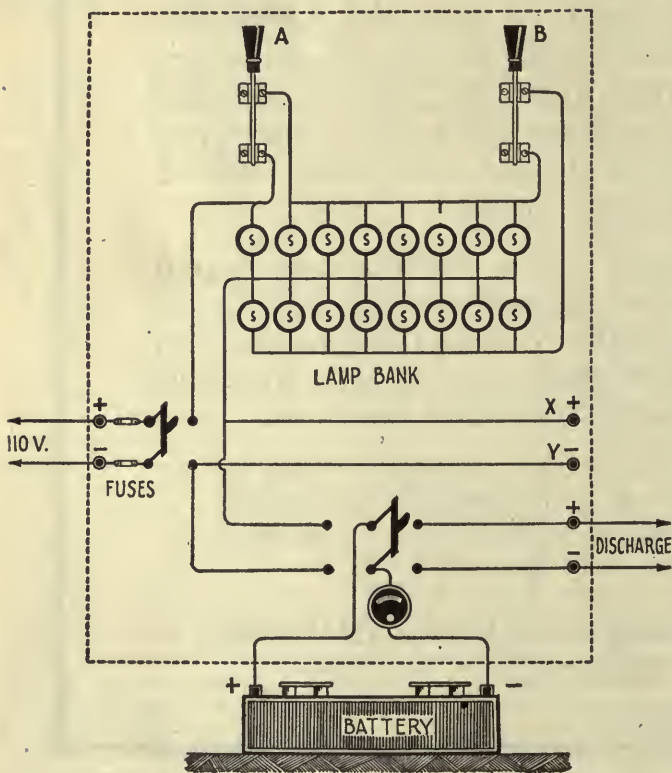
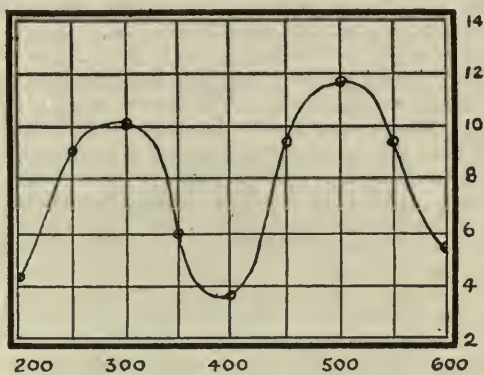
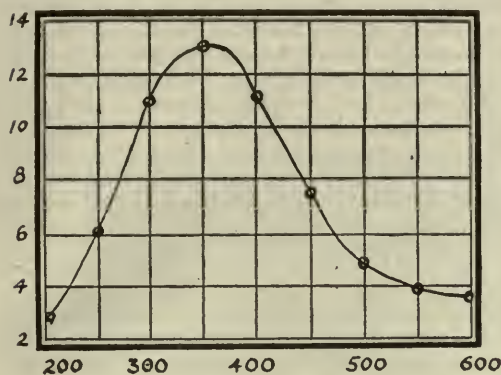

FIG. 1



Find this out

before you choose your radio frequency transformer

DOES it have marked depressions and peaks in its amplification range curve between 200 and 600 meters (indicating absence of amplification at the depressions)—or does it keep the amplification range curve uniform with its maximum efficiency around 360 meters—the place you need it most.

A test

THE two charts above tell a graphic story of tests made on radio frequency transformers in the laboratories of a well known concern. The chart at the left plots the amplification range curve of 12 Acme R-2's taken from stock. The chart at the right represents a composite plot of the curves of 6 ordinary types of different makes taken from stock. The superiority of the Acme R-2 is self-evident. Note its steadily increasing amplification curve with its maximum at 360 meters—just where it is most needed.

Getting greater distances

EQUALLY important is the greater distances over which you can get broadcasting when using the

Acme R-2. The R-2 used in a radio frequency amplifier builds up wave energy before passing it on to the detector. You hear signals that would ordinarily be inaudible. Even the simplest and most elementary type of set, either vacuum tube or crystal receiver type, will have its range tremendously increased when the Acme R-2 is employed in conjunction with a vacuum tube.



Acme R-2 Radio Frequency Amplifying Transformer. Price \$5. (East of Rocky Mountains.)

The best method

TO SECURE maximum results over long distance use both Acme Radio and Acme Audio Frequency Transformers. This insures maximum sensitivity and intensity, quietness in operation and freedom from distortion. A small indoor antenna or loop may

be used and sufficient intensity obtained to operate the Acme Kleerspeaker, providing perfect entertainment for a roomful of people.

You can get these and all other Acme Products at radio, electrical and many hardware stores. Write for booklet R-2 showing proper hook-ups and other information.

THE ACME APPARATUS COMPANY, Cambridge, Mass., U. S. A.
New York, 1270 Broadway

Pioneer transformer and radio engineers and manufacturers

ACME ~ for amplification

efficient in the original detection of signals. However, in succeeding steps of amplification, the impulses become stronger and stronger, and are capable of controlling a more powerful stream of electrons, or plate current, than was possible before, due to the inertia of the electron. (Inertia is a quality possessed by everything having mass, which resists any attempt to vary its relative state of motion.) The idea will be made more clear by analogy. It is an easy matter for a ball player to catch a baseball traveling fifty feet a second, but it would require a giant (no pun intended), comparable to a *larger grid impulse*, to control or stop a cannon ball moving at the same velocity! Thus a higher plate potential, which in part determines the strength of the electron flow, may be applied to the plates of successive steps of amplification, with a correspondingly greater response in the receivers or loud speaker.

Working back to the differentiation between detector and amplifying tubes, it is necessary to evacuate the bulb more completely when a heavier current is to be passed through it, owing to the fact that the partly gaseous content of a low-vacuum tube would be ionized by the electron stream. Ionization is the breaking up of the atoms of gas into their component positive and negative charges, a condition which is indicated by a blue or purple haze surrounding the elements of the tube, and which greatly affects the negative charges, electrons, given off by the filament, generally rendering the tube inoperative.

A very interesting example of ionization in a partial vacuum is the northern lights or Aurora Borealis. This phenomenon is caused by the passage of electrons thrown off by the sun, through the rarified upper strata of the polar atmosphere, where they are apparently concentrated by the earth's magnetism.

SUPPLEMENTAL LIST OF BROADCASTING STATIONS IN THE UNITED STATES FROM OCTOBER 6
TO NOVEMBER 22 INCLUSIVE

CALL SIGNAL	OPERATED AND CONTROLLED BY	LOCATION	WAVE LENGTH
KFCK	Colorado Springs Radio Co.	Colorado Springs, Colo.	360
KFDC	Radio Supply Co.	Spokane, Wash.	360
KFED	Billings Polytechnic Institute	Polytechnic, Mont.	360
KFFA	Dr. R. O. Shelton	San Diego, Calif.	360
KFGH	Leland Stanford University	Stanford University, Calif.	360
KYQ	Electric Shop	Honolulu, Hawaii	360
WNAQ	Charleston Radio Electric Co.	Charleston, S. C.	360
WNAV	People's Telep. & Teleg. Co.	Knoxville, Tenn.	360
WNAW	Peninsular Radio Club	Fort Monroe, Va.	360
WNAX	Dakota Radio Apparatus Co.	Yankton, S. Dak.	360
WNAY	Ship Owners Radio Service	Baltimore, Md.	360
WOAF	Tyler Commercial College	Tyler, Tex.	360
WOAH	Palmetto Radio Corp.	Charleston, S. C.	360
WOAJ	Erwins Electrical Co.	Parsons, Kans.	360
WOAK	Collins Hardware Co.	Frankfort, Ky.	360
WOAL	William E. Woods	Webster Groves, Mo.	360
WOAM	Arthur F. Breisch (temporary-1 day)	Bethlehem, Pa.	360
WOAN	Vaughn Conservatory of Music	Lawrenceburg, Tenn.	360
WOAO	Lyradion Mfg. Co.	Mishawaka, Ind.	360
WPAC	Donaldson Radio Co.	Okmulgee, Okla.	360
WPAD	W. A. Wieboldt & Co.	Chicago, Ill.	360
WPAL	Superior Radio & Telep. Equipment Co.	Columbus, Ohio	360
WPAM	Auerbach & Guettel	Topeka, Kans.	360
WRAA	Rice Institute	Houston, Tex.	360
WRAY	Radio Sales Corp.	Scranton, Pa.	360
WTAC	Penn. Traffic Co.	Johnstown, Pa.	360
WTAU	Ruegg Battery & Electric Co.	Tecumseh, Nebr.	360

What Would You Like to Have in Radio Broadcast?

The editors would be pleased to hear from readers of the magazine on the following (or other) topics:

1. The kind of article, or diagram, or explanation, or improvement you would like to see in RADIO BROADCAST.
2. What has interested you most, and what least, in the numbers you have read so far.

"The wise man looks into space,
and knows there is no limit to dimension."

said *Chuangtzu*.

The wise Radioist bridges the greatest
distances with a

Grebe Receiver.

Doctor Mu.



A LONG RECORD of unequalled performance has won for the Grebe Receiver the unqualified endorsement of all good dealers.

"Musings of Doctor Mu" — the story of the development of the Perfect Receiver, free upon request.

A. H. GREBE & CO.
INCORPORATED
RICHMOND HILL, N. Y.



Licensed under
Armstrong U. S.
Pat. No. 1113149





PUTTING THEIR HEADQUARTERS STATION ON THE MAP

Boy Scouts of Troop 1, Roslyn, Long Island, using a loop receiver to determine the position of their transmitting station at troop headquarters. Bearings taken from two or more locations are plotted on the map; and the point where these direction lines meet indicates the position of the transmitting station. Left to right: Scouts Denton, Fontaine, Miller and Malmros

RADIO BROADCAST

Vol. 2 No. 4



February, 1923

The March of Radio

"DRY-CELL TUBES" FOR RECEIVING

THE vacuum-tube is so far superior for distance work and selective tuning to the crystal detector that no comparison can be drawn as to their relative merits. The crystal set makes available in the telephone receivers a certain small part of the radio power picked up by the antenna, perhaps a fraction of one thousandth of a watt. The amount of power which the antenna can pick up decreases rapidly as the distance from the transmitting station increases, and this fact generally limits the use of the crystal detector to points fifty miles or less from the broadcasting station.

The vacuum-tube receiver works on an entirely different principle; in the B battery is stored energy millions of times greater than that picked up by the antenna and the tube acts as a trigger to this local energy supply, changing the rate of energy flow from the B battery in accordance with the potential of the grid which itself is excited by the minute energy picked up by the antenna. Thus a tube set may make audible a signal of perhaps one millionth the strength necessary for audibility with a crystal set. Why then is it that the crystal set has any chance at all in the competition?

To this question there are several possible answers, the principal one being that of cost, both the first cost and the maintenance. A fair crystal set can be purchased for \$25 and no auxiliary apparatus is required, whereas a

corresponding tube set would cost perhaps \$100 itself and in addition there must be purchased a storage battery and plate-circuit battery before it can function. The storage battery for the filament circuit is expensive, messy and inconvenient to care for, and is a continual source of expense because of the re-charging required. The B battery will last only about one year before it becomes noisy and it must then be renewed. Tubes burn out occasionally and many people find it very difficult to keep supplied with them.

One of the great advances in tube manufacture has recently been made available with the appearance on the market of the Westinghouse "dry-cell tube." In this tube the filament is coated in such a way that the emission of electrons occurs at the required rate at a low temperature: in fact, the filament has no visible glow in daylight, requires only one quarter of an ampere to heat, and has a low enough resistance to allow the voltage of one dry cell to force the required current through it. The power used in this filament is therefore about 0.3 watt, whereas the tungsten filament tubes ordinarily used require about 7 watts for the filament. The new tube therefore represents a decrease in the required filament power in the ratio of twenty to one. One six-inch dry cell is sufficient to excite the filament for from fifty to one hundred hours, depending upon how continuously the tube is used. The first cost and the recharging cost of a

storage battery are done away with and the single-tube receiving set, having a receiving range of a hundred miles or more, need be but little more expensive than the better crystal sets. From what tests we have been able to make, these new tubes should function about as well as the older type, both as detectors and amplifiers.

While in conversation with one of the research workers engaged in tube manufacture and development, we were told recently that a quarter of an ampere for the filament is much more than necessary—that one twentieth of an ampere is plenty for the filament of a satisfactory receiving tube! So events in the vacuum-tube field are crowding one another very rapidly. It is really very difficult for the manufacturing company to decide when and how to start a new tube in production, for no sooner are the dies, jigs, and processes perfected than the research man reports a new development which indicates that previous types should be discarded!

It is an expensive process for the manufacturer to cease production on one type and begin on another. Of course, the buying public must eventually pay the cost, and it is not to be expected therefore that the price of the new tubes will be materially lower than that of the present ones, until enough of them have been sold to pay for the development costs. Judging from the present rate of progress, the new tube will be discarded for a superior one before that point is reached.

Soon after the foregoing was written, Dr. A. W. Hull, of the research laboratory of the General Electric Company, justified the ideas there set forth by reading before the Institute of Radio Engineers a paper on a new tube he had developed during the past few months. Some years ago J. H. Morecroft pointed out several of the advantages to be gained by having a uni-potential cathode in a vacuum tube and actually constructed such a tube by putting the hot filament inside a tungsten thimble. The filament heated the thimble by radiation and this hot thimble served as the source of electrons. As no current was flowing along the thimble the resistance drop in the filament was zero and certain defects in the characteristics of the ordinary hot filament tube were eliminated. Dr. Hull has succeeded in developing a small receiving tube on this

principle, permitting the use of alternating current to heat the filament of the detecting tube. The technical value of this new departure in tube manufacture may not seem evident at once, but when it is seen that such a tube makes it possible to obtain all the power required, both for filament and plate circuits, from the ordinary house wiring with its alternating current power supply, some appreciation of the rôle it may play in receiving sets will be gained. A receiver, amplifier, and loud speaker, all operated from an ordinary lamp socket—that indeed sounds attractive. There is apparently nothing to prevent such a combination except the policy of the manufacturer in pushing the development of these new uni-potential cathode vacuum tubes.

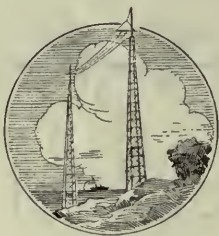

The Standing of the Amateur

RUMORS are emanating from Washington which indicate that the legal status of the amateur is being seriously threatened, and that his activities may be much curtailed. It would be a serious mistake, we believe, to hamper unnecessarily the activities of these enthusiasts who have done so much in short-wave telegraphy during the last twenty years. The present radio public must of course be properly served, but the amateur, who studied and worked at the game long before the public was interested, has contributed a great deal, directly as well as indirectly. By an amateur we don't mean the ten-year-old boy of your neighbor, who starts up a one-kilowatt spark set just when your family is enjoying an opera by radio, or when you are trying for a long distance record. We think that this kind of nuisance should be done away with at once, to keep the musical programmes free from spark splashes. A small boy with a big spark set is certainly a misfit in the present scheme of radio.

Many amateurs, however, are radio engineers, skilled in both the theory and practice of the art, and their activities do much to extend our knowledge of radio. They were the first to show the possibility of transatlantic communication by low powered, short-wave sets. In the tests recently inaugurated 33 American amateur stations were copied in England in the course of one day only, stations even as far away as California being heard there. This year a one-kilowatt

English station has been equipped to try the transmission in the opposite direction and undoubtedly many American amateurs will pick up its signals. In a recent all-American test, amateurs sent a message from Hartford, Conn., to Hawaii and return in four minutes! Radio workers who, by their enthusiasm, financial aid, and skill are performing these remarkable feats should be governed by legal measures only to the extent absolutely necessary for the development of short-wave transmission.

A New Type of Power Tube

AT THE time that Dr. Hull was announcing the new detecting tube described above, the press contained a report of another development which had taken place in the same laboratory—a power tube capable of delivering one million watts of high-frequency power. This is not an ordinary three-electrode tube; it has only a filament and plate, the filament being a piece of tungsten rod nearly half an inch in diameter!

The action of this tube can be well visualized only by those who have become accustomed to the idea of electrons and their actions in magnetic and electric fields; to such the functioning of this new tube presents a fascinating picture. The filament is heated by a high-frequency current, of a frequency half of that which it is desired to generate; the cylindrical plate surrounding the filament is maintained positive with respect to the filament at about ten thousand volts. The electrons evaporated from the hot filament tend to proceed at once along radial lines to the plate, and they do so unless the current in the filament exceeds a certain critical value. The filament current, being alternating, passes through all values between its maximum positive and negative values twice per cycle, and this new tube is so designed that at the maximum values of current the magnetic field set up around the filament by its own current is sufficient to deflect the electrons from their normal path to the plate and make them describe curved paths which land them back in the filament, a short distance farther along than the point at which they evaporated. Their motion is much like that of a school of flying fish following a ship: they swim swiftly toward the surface of the ocean, arrive at the surface with sufficient velocity to overcome the effect

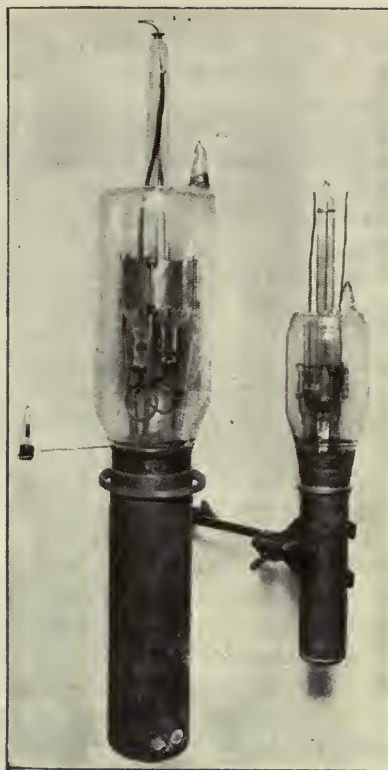

TWO GIANT POWER TUBES

A small receiving tube is shown in comparison

of gravity, break through the surface, and "evaporate" into the air; here they describe a curved path which lands them back in the ocean a few feet farther along than the point where they left it, only to "re-evaporate" perhaps a few hundred feet farther along their course.

In the case of the tube, during that part of the cycle when the filament current has low values, the electrons are not going back to the filament and so do get over to the plate. This action results in a series of pulses of current being delivered to the plate circuit, which pulses may be used to excite powerful oscillations in a properly tuned circuit. In this new tube the magnetism generated by the filament current itself performs the same function as does the grid in the ordinary three-electrode tube.

Where is the Radio Bill?

FOR many months we have been waiting for Congress to do something with the radio bill. It was introduced in the House early in June; in its substance it had the

endorsement of the membership of the Radio Conference called by Secretary Hoover to consider what should be done to further the progress of radio.

The bill as at first drafted by Mr. White was submitted to the Radio Conference. This body approved it generally, and made a few recommendations regarding minor changes, which were incorporated in the bill in so far as the advisory legal committee felt it possible to do so. The bill, then, represents the best thought of those executive and technical experts who have had most to do with radio development in America. The present legal status of radio is most deplorable, compared to what it might be if the provisions of this bill were put into effect, yet little or nothing is apparently being done to get the bill put through. With the bill passed, the wave-band allowed for broadcasting would be considerably widened over its present limits and practically all trouble from interference would disappear, even for the unskilled novice. The amateur investigator would have more latitude than he now has. So far as a layman's perusal of the measure discloses there is no political advantage to be gained by hindering the passage of the bill; it will not create new offices to be filled by deserving henchmen; its passage would apparently benefit Democrat and Republican alike.

Why, then, is there no action of the White bill?

The Rapid Increase in Radio Traffic

A FEW months ago the statement was made by President Carleton, of the Western Union Telegraph Company that transoceanic communication was practically monopolized by the cables, that radio carried only 12% to 14% of the total business. Now we have the statement of Mr. David Sarnoff, Vice-President of the Radio Corporation, that of the transatlantic business radio is handling from 25% to 30% and of the transpacific business, 50%. Even allowing for the natural inclination of each of the proponents to exaggerate somewhat the importance of his own field, it seems that radio is actually making rapid strides in the race for long distance traffic.

During the recent elections, storms se-

riously crippled the western land lines, but the International News Service was able to maintain 100% activity through the help of the Radio Corporation stations. It is stated that the transcontinental business, handled over radio channels on short notice, was carried out so successfully that the New York to San Francisco service was as good as is obtained with the land lines in normal condition.

To fill in its comparatively idle periods, the Radio Corporation is offering a new and remarkably low rate-schedule for delayed service, six cents a word to England or Germany. This new service, styled "radio letter" service, permits the filing of a message, in plain English, any time during the week and delivery in Europe is guaranteed before the following Monday morning. Undoubtedly this will prove valuable to business houses with European connections; it permits the closing of a deal without delay, at a cost but slightly exceeding that of the much slower mail service.



Copyright for Broadcast Material

AT THE request of the American Society of Composers, Authors, and Publishers, a meeting was held recently to consider the question of collecting royalties from the broadcasting stations which are sending out, by phonograph or otherwise, material which has been copyrighted by any of the members of the society. The society controls, through its membership, the copyrights on practically all the popular music of the day, including the so-called jazz music.

No agreement was reached as the representatives of the broadcasting companies required time to consider the proposition; many interesting views on the question, however, were brought out. The Society wanted to exact from a station a flat royalty rate, depending upon the number of listeners; such a measure evidently didn't look attractive to the broadcasters at this time because as this society controls but a small part of the material sent out, and as other composers and publishers have rights similar to those of the jazz writers, the total royalties which might be exacted under such a scheme might run into large figures.

Mr. Townley, for the Westinghouse Company, outlined the broadcasting situation very well and pointed out to the attorneys for the

jazz writers that the broadcasters were in a quandary as to where the money for the operation of the stations was coming from even with the present expense, let alone the extra expense which would be incurred by royalty collections. Although his company had sold many receiving sets, and this indirectly produced the money for running the transmitting stations, probably hundreds of thousands of sets were sold by others who had no connection at all with a broadcasting station and from whom copyright royalties evidently could not be collected.

We believe the society of jazz artists and publishers would do well not to press the matter; legally they cannot collect royalties from an activity which yields no profit and it is doubtful if the balance sheets of any of the broadcasting stations to-day show a profit. If the jazz is played at the transmitter station from a phonograph the artist has already collected one royalty and if the artists themselves appear at the station to perform, the advertising they get probably pays them for their trouble, otherwise they would not come.

Power Transmission by Electron Tubes

WITH the advent of the recently developed tubes which have outputs reckoned in hundreds of kilowatts, there has appeared several times in the press the statement that these tubes would soon make possible the transmission of power by radio; some articles seemed to quote eminent engineers to that effect. It seems extremely unlikely that such predictions were ever made; the economical transmission of power by radio is no nearer solution to-day than it was when that brilliant scientist-engineer, Nikola Tesla, performed his well known experiments in this field.

We say "economical transmission" of power by radio because, of course, power is actually being transmitted, by radio, every day; every

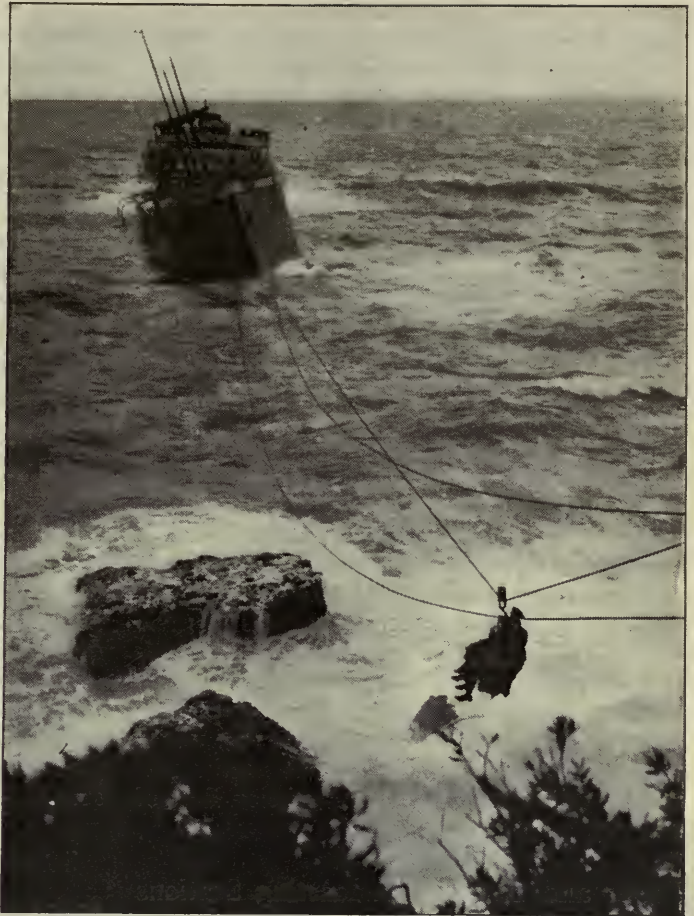

A STRIKING PHOTO OF THE WRECKED S. S. "WILTSHIRE"

Some may have read the account of this shipwreck which occurred during a dense fog and terrific gale last June off the east coast of New Zealand. Mr. Harmon Reeves, Consular Agent at Dunedin, N. Z., writes with reference to this event: "The wireless operators on the *Wiltshire* stood to their posts manfully, as most of these operators do on such occasions, and continued to despatch SOS calls as long as the plant remained in working order. Had the vessel been without wireless, it is more than likely not a man on board the ill-fated vessel would have been saved." Reaching the island and working under great difficulties, a rescue party finally saved the men in the manner shown. The picture shows the two junior operators being hauled ashore. (See Photo on

Page 273)

radio signal is an illustration of the action. But of the hundreds of watts sent out from a transmitting station only an infinitesimal part is picked up by a receiving antenna. Even when the combined action of all the receiving antennas is considered, the power sent out from the transmitter is nearly all wasted in empty space. The very fact that the power is radiated, or set free, to travel in an essentially spherical distribution, at once discourages the engineer who has ideas along this line. The

reason we use power transmission lines is to guide the electrical energy to the point where it is to be utilized; radiated energy is subject to no such constraint and it naturally tends to flow equally in all directions.

The reason the large electron tubes were at once associated with the idea of power transmission is that they are able to fill important rôles in the present transmission line projects; these new tubes may serve as rectifiers at the generating station, changing the alternating-current power of the generators to high-voltage continuous-current power for transmission over the long power lines and then reconvert it into alternating-current power at the place where it is to be used. This use of the electron tube seems to be a logical, in fact, almost certain development; continuous-current power can be economically carried over transmission lines much greater distances than is possible by alternating current, and because of this fact the new tubes may soon be serving in new long distance power developments; the power will not be transmitted as high frequency, radiated power, however, but as continuous-current power, guided by transmission lines of ordinary construction.



quality of the voice could be completely spoiled by poor wire transmission before it even reaches the radio station. Under these conditions the signal will be poor no matter how excellent the radio station itself may be. Thus if a transmitting station receives its signal over a hundred miles of wire, installed to handle ordinary land telegraphy only sufficiently well, instead of getting the signal over what is called a high quality telephone circuit, the broadcast signal will be of poor quality.

Some kind of an agreement should be reached between the various interests involved so that any qualified radio station may use the highest grade line available to bring the voice currents to the modulator. If this is not feasible, such a station should be allowed to broadcast only from microphones located at the station, so that the wires connecting the microphones with the modulator can have no bad effect on the quality of the signal. Broadcasting from a distant microphone should be attempted only by that station having the highest grade wire connections available. In this way alone will the quality of broadcasting improve as we should like to see it.

Fewer and Better Broadcasting Stations

WE HAVE several times expressed our views on this question, and as we see the art develop, our convictions along this line become more firmly fixed. It is now technically possible to send out broadcast messages of excellent quality, as the achievements of station WEAF (N. Y. City), for instance, have proved. The engineers responsible for this station evidently know the requirements for good voice transmission and have succeeded in getting it. Of course they, of all people, should be able to do just this thing; their research workers have spent years in studying this problem and their engineers know what voice frequencies are important and what are not and how to make the microphones and associated apparatus function properly.

Another important factor contributing to the success of WEAF's broadcasting is the knowledge of and control over high quality telephone lines. Many times the microphone which picks up the sound waves is miles away from the radio station and evidently the

The Passing of the Navigation Officer

THE navigator of the modern ocean vessel probably knows his position at all times to within a very few miles, no matter what the weather is. Time was, when it was a matter of guesswork as to what weather a ship was going to encounter and as to just when land would be sighted. Radio is largely responsible for the increased certainty of the ship's position and prospects. Are the chronometers correct? Twice a day they may be checked with the standard clocks, which, by radio dashes, throw out their reassurance over the thousands of square miles of ocean. Is there rough weather with storms ahead? A radio inquiry to a ship 500 miles ahead on the course at once eliminates the doubt. The "make everything fast" order may be given long before a threatening sky gives warning of the impending blow. How about the ship's position when nearing the harbor? A request for radio compass bearings will enable the navigator to locate his position on the chart to within a fraction of a mile. The radio compass may then pick up and follow the hum of a

submerged cable laid in the channel, sending off audio-frequency signals, and thus it may steam into the harbor without ever having sighted land.

All these things have already been accomplished, and are in use every day. They are not the possible, but the actual things science has accomplished during the last quarter century.

And now there comes to the further aid of the navigator another scheme of communication which will help to make his position doubly sure. As a result of certain researches carried on during the war, part of which have been disclosed, it is possible to get soundings of the ocean's depth by echoes. A sound-generating apparatus in the ship's hull sends straight downwards a pulse of sound which will reflect from the ocean's bottom and return to the ship to actuate a microphone which produces the echo for the listening operator. The time elapsing between the sending of the original signal and the return of the echo serves to give accurately the depth of the ocean. The ocean's floor can now be accurately and quickly mapped and accurate charts of its topography can be plotted; the navigating officer then

times the sound on its trip to the sea-bottom and back to the surface, and by comparison with the chart he at once checks his position which has been determined by other methods.

For shallow water where the echo would return too rapidly to permit an accurate determination of the time taken for the sound to travel to the bottom and back, another scheme is used, which does permit of very accurate measurements of the depth. A special listening device is located at the bottom of the vessel and it can be so turned that the listener hears the echo of the screw of his own vessel, this echo having been sent back by the ocean's bottom. Knowing the angle to which the device must be turned to get a maximum echo, and the length of the ship, the depth of the water can be determined to less than a fathom.

During certain tests in which the writer took part, it was found possible to recognize the ship's position in the harbor by the quality of the echo returned by a sound beam sent in towards the shore; in certain positions only one sharp echo would return, in others perhaps three or four, of different intensity and in some positions no echo at all came back. Here,



THE MORNING AFTER THE NIGHT BEFORE

Showing the S. S. *Wiltshire* divided into three sections; the stern has disappeared. The men, who had suffered frightfully from exposure, hunger, and thirst for 36 hours, were all saved

then, is another possible help to the navigator. It seems that the days of lead lines and dead reckoning are rapidly being relegated to the tales of the sea. The navigating officer practically never has to use his judgment in finding his position; with modern communication schemes he *knows*.

Radio Surgery and Doctoring

THE maritime law requires that any ship carrying passengers shall have a doctor on board, but there are thousands of vessels such as freighters, tankers, fruit boats, fishing schooners, tramps, etc., which carry no doctor; a case of pneumonia or a broken leg must be treated by the ship's cook, or someone equally unskilled in the practice of medicine. A patient's chances of adequate attention are evidently rather slim.

Many of these boats do carry a radio outfit, however, and more of them are continually installing equipment, for reports on docking

facilities, market conditions, etc., which may be received by radio make the investment pay. On such boats skilled surgical or medical advice may now generally be tuned in; cases are being reported daily of emergencies being successfully met by advice sent by radio. An example is that of a man whose broken leg was amputated by the cook; a description of the condition of the injured man having been sent by radio to the surgeon on a liner 200 miles away, detailed directions for the operation were wireless back and the cook (already equipped with suitable tools) successfully "did the trick." We may not relish the idea of being put through such an operation, but if it is necessary, the radio instructions without doubt make the cook a safer bet than if he were left to the dictates of his own inspiration.

With an adequate medical outfit on board and a good doctor within radio range, the wants of the crew of the doctorless boats will be much better taken care of than they have been in the past.

J. H. M.

THE HIGHEST RADIO STATION IN THE WORLD

The site is the peak of Mt. Corcovado, 2,100 feet above the city of Rio de Janeiro, Brazil. Workmen erecting the aerials experienced many thrills, when the slightest mis-step would have meant a plunge to the depths below



The Boy Scout's Place in the Radio Game

By ARMSTRONG PERRY

Sea Scout Radio Commodore, Boy Scouts of America

THIRTEEN out of every hundred of the radio listeners who cursed at the Government for putting a talk on cancer into the air the other night at the beginning of the radio concert hour, will die of cancer—unless they can secure the repeal of the law of averages. The only way to avoid it is to acquire individually the information broadcasted at that time and live up to it. Pneumonia, typhoid, tuberculosis, heart disease and kidney diseases will carry off a large percentage of the remainder, and will do it years earlier than they need to, unless they take the common-sense precautions suggested in the broadcasts of the United States Public Health Service.

One hundred per cent. of the commuters who missed their trains yesterday and blamed the erratic alarm clock could have reached the office on time if they had spent a minute or so listening to the clock at the Naval Observatory in Washington announcing the hour at ten the evening before. It can be heard in any American home, for its ticks are carried to the remotest corners of our country on radio waves rolling out from the Navy station at Arlington, Virginia and others along all our coasts. These same commuters could have carried their umbrellas and avoided their last wetting if they had spent as much time practicing the International Morse Code as many of them spent on bridge, and listened for the weather forecast that followed the time signal. In fact they need not have learned code, for there is a boy in every neighborhood who would get it more easily and who would delight in copying code broadcasts and passing the information to his neighbors if he had a little encouragement.

Out of the ninety per cent. of business men who make a failure of their enterprises, according to statistics, a fair proportion might win success by making intelligent use of information that is collected on an enormous scale by our Government and shot out in concise form by radio or held in reserve awaiting the day

when the public asks for it. One American citizen out of every 157 is an employee of the Federal Government and a large part of the 672,953 persons on the pay roll are engaged in collecting, tabulating, and disseminating useful information. By radio it can be transmitted, received, and used in less time than it takes a messenger to carry copy for a Government pamphlet from a Department building to the Government Printing Office.

And yet, with true American prodigality, a lot of us twist the knobs on our radio receivers, screw up our faces and superheat our tempers in trying to tune out the Government broadcasts, and as a nation we permit more than two hundred efficient Government radio stations to stand idle for forty per cent. of the time, when they might be adding to our enjoyment and prosperity. Worst of all, we waste almost one hundred per cent. of a natural resource more valuable even than our much discussed water power, namely, *our boy power*.

The present-day radio situation is made up of diverse elements. There are well-established governmental and commercial services which only a few far-sighted individuals are using fully. There are the commercial broadcasters who bear an enormous expense in filling the air with entertainment that sells their competitor's goods as well as their own. There are manufacturers and dealers who never know exactly whose alleged rights they may be infringing when they sell a piece of apparatus that has been made in cruder form by thousands of boys without let or hindrance. There are the amateurs and experimenters, the pioneers of radio, who, from the often unjust viewpoint of listeners who are interfered with by their dots and dashes, are as exasperating as the mosquitoes whose hum their code resembles. Outnumbering all the rest are the radio users whose aim when they sit down at their sets is to be amused.

A theatrical manager who built a stage and dressing rooms but no orchestra section, balcony or box office would be called a fool. A



SCOUTS RECEIVING INSTRUCTIONS IN VARIOUS SYSTEMS OF SIGNALING

Members of this St. Louis troop took up radio a long time ago. The picture was made in January, 1914

college that provided courses and faculty but enrolled no pupils, leaving the matter of attendance up to the loiterers who drifted by, would be held up to ridicule. A newspaper that gives away its daily edition on the street free of charge is seldom taken seriously by its readers and never by the reliable advertiser. Yet millions of dollars yearly are being spent in broadcasting entertainment and information by radio with no more definite or complete checkup as to results than the post-cards and letters sent in by those who listen.

So far as has been discovered, the first suggestion to the effect that there should be organization at the receiving end of the broadcasting came from the Boy Scouts of America. Or it might be more just to give the credit to the Navy Department. During the war the Navy and the Army found that the main source of supply for competent radio personnel was the "amateur." These amateurs, most of whom were self-taught, came forward in large numbers and filled the gap while the Government and private schools were getting under way with the task of developing operators and radio experts by thousands. After the war, the Navy planned to conserve the interest of the coming generation of amateurs by organizing a Radio Amateur Bureau in the Third Naval District and transmitting daily an Amateur Broadcast. These broadcasts were in a sense personal messages

to the amateurs who were registered with the Bureau. To give them the piquancy of secrecy they were often transmitted in a code which could be readily translated only by the use of a key furnished to the members of the Bureau. Sometimes a message was addressed personally to an individual.

One of these messages was picked up by a scout official. He copied the amateur broadcast night after night thereafter, became convinced that the system had great value, and scraped acquaintance with the Navy officers in charge. The Navy officers, limited as to appropriations, suggested that the Boy Scouts of America, the largest uniformed force, civilian or military, in the United States, might be of service by encouraging the registration of amateurs with the Bureau. Immediately the Scout organization accepted the assignment. A Seascout Radio Commodore was appointed to serve as a liaison officer. To give the arrangement greater force the Bureau began broadcasting for the Scout organization anything it wished to transmit to its local units. This all happened four years ago.

Since then the Army, the Post Office Department, and other governmental departments have established broadcasting schedules. The Boy Scout organization, with these programmes as additional talking points, has redoubled its efforts to encourage Scouts and others interested in radio to receive what

the Government transmits and give it local distribution.

Having more than half a million Scouts and Scout officials distributed throughout the United States in more than 20,000 communities, it is perhaps the only civilian organization that is in a position to develop local receiving stations for national broadcasting on a national scale. The Post Office Department is the only governmental agency that has as many representatives so well distributed for the purpose.

The "cute little Boy Scout," as doting grandmothers and enthusiastic aunts are apt to call him, is in fact almost a man. His average age is about the same as that of George Washington at the time when he surveyed a large part of the Shenandoah Valley for Lord Fairfax. It is above fifteen and one-half years. While scouting recently with M. C. Hopkins, President of the Cave Men's Club of America, the author found the name of the Father of his Country carved on the wall in the remotest chamber of a cave near the end of the 1748 survey, together with what appeared as though it might be the skull of a goat used in the Masonic ceremonies that old histories say Washington conducted in this chamber. He concluded that the boys of pre-Revolutionary days were much the same as the Scouts of today, except that their elders granted them more freely the privilege of undertaking man-sized jobs.

The Radio Amateur Bureau, for the further encouragement of operating ability on the part of radio scouts, reserved the numbers from 1 to 100 on its membership list for Scouts who would learn to send and receive code at the rate of twenty words per minute. One of the first scouts to meet the requirements was Lyman F. Barry of New York.

Scout Barry's record is an example of the way many Scouts are going after radio, heart and soul. He received his first radio training in his Scout troop and built a crystal set at his home in 1917, getting it into operation just about in time to dismantle it in obedience to the war order issued by the Government. He kept up his code practice and after the war often operated the headquarters transmitting station of the Manhattan Association of Radio Scouts, having received an amateur operator's license. Registering with the Radio Amateur Bureau some time before he could qualify for the reserved list, he improved his speed and was



LYMAN F. BARRY

Whose record as a Scout during the war and later shows a keen interest and exceptional ability in radio. He is now a Scoutmaster in charge of a New York troop

promoted from No. 345 to the second place on the list in 1920. Then, at the College of the City of New York, he served as secretary and vice-president of the radio club, and experimented with several transmitters of spark and continuous-wave types. For receiving, he has built a three-circuit honeycomb coil regenerative set with a two-stage amplifier.

By authority of Colonel Holden, the commanding officer, Scout Barry operated the U. S. Army station at Camp Devens, Mass., during the summer of 1920. Several times he has kept Scout camps in touch with the world when his radio gave them their only prompt communication. At the time of the *Roma* disaster he gave the first news of it to citizens of Geneseo, New York, where he had his set.

By 1922, he had passed an apprenticeship as Assistant Scoutmaster, reached his twenty-first birthday, and qualified as a Scoutmaster in charge of a troop. The troop, No. 503 of Manhattan, camped at Redding, Connecticut, last summer and for the first time in its history this little hamlet was in immediate touch with the world, through the Scouts' radio. "Reports and the weather luckily agreed very nicely," reported Barry, "and we became quite believed in during the two weeks we had camp there."



A "PUSH-CART" SET

One of these Kansas City Scouts is pulling on a guy-rope fastened to a mast made of scout poles lashed together

At present, nine of his Scouts have radio sets, four of which are good tube sets. Radio instruction and practice in town and on hikes are part of the routine. Stopping to rest under any convenient tree, they get a wire aloft and are immediately in contact with the world.

Radio Amateur No. 3, after serving in the Brooklyn Council's scout camp for a season, became a commercial operator while still very little above the average age of Scouts. He

made trips to the West Indies, Panama, South America, and Europe. Between jobs he gave his services to the largest Scout camp in America, bringing in news from all parts of the globe and transmitting headquarters traffic to the local units.

When the public stampeded for the radio-telephone broadcasts a year ago, he was invited to take a position which, had radio personnel been more plentiful, would have been filled by a man twice his years. A patent situation developed that led to a quick change in the management, and the Scout went to a radio store as a clerk behind the counter. One day he discovered that he, like others who had been connected with the manufacturing plant, was under the surveillance of detectives acting on behalf of a big radio corporation, whose rights were alleged to have been infringed. He was asked what he did when he discovered that he was being watched, "I got acquainted with the detective and sold him a receiving set," he answered.

Radio Amateur No. 4, Orin Livingston, and No. 5, Howard J. Wendler, serve the Scout troops in Roselle Park, New Jersey and go with them to their summer camp. Both hold amateur first grade licenses. No. 6 is Ralph Woodruff, also a first-grade amateur operator, who until recently worked his own and another Scout station at East St. Louis, Ill.

No. 8 is a Brooklyn amateur, David Talianoff. He is assistant scoutmaster and radio operator in Troop 97. His "fist" is well known to amateur operators, for he transmits not only



A RECEIVER THAT COST TWENTY-ONE CENTS
A Scout is explaining its construction to the author

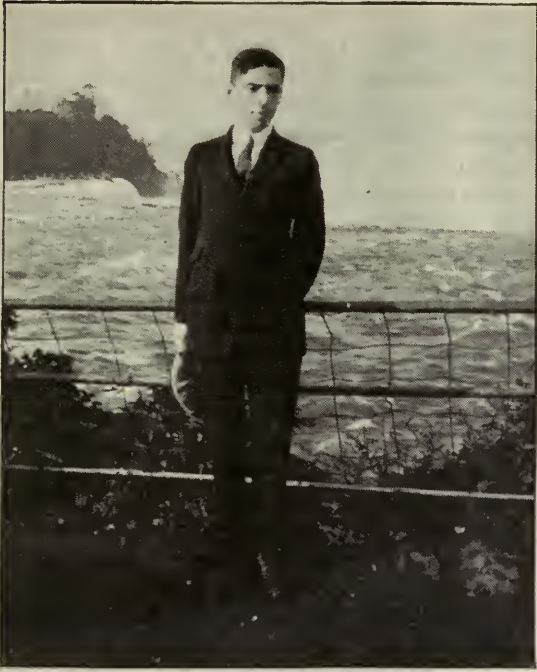

RADIO AMATEUR NO. 8

Assistant Scoutmaster David Talianoff at Niagara Falls

from his own station, 2PF, but also from 2FP at Brighton Beach, N. Y. This station is said to be one of the most efficient in the United

States. It is heard in every state in the Union and has been reported even from Hawaii, France, England, and Germany. He gives much time to handling the citizen messages relayed by the American Radio Relay League. Three of these taken at random from a crowded log book show delivery the same day they were filed, at such scattered points as Brooklyn, Cleveland, and Robling, Ontario.

The ambition of the radio Scout is as different from that of the technical radio amateur as the job of the automobile racer is from that of the rural postman and his flivver. The technical amateur is striving to get distance, the Scout to give service. When the technical amateur has sent a message farther than any amateur ever sent one before he is satisfied—for the moment. When the radio Scout has picked up and delivered in his community the information that it wants, he is satisfied—until he is needed again. He gets it from the nearest Government station that broadcasts it because that makes its reception most certain. The technical amateur incidentally handles a good many useful messages, and the radio Scout incidentally acquires a good deal of technical ability. When technical ability and the scout spirit are found in one individual it makes a very strong combination.



2FP, SOMETIMES USED BY TALIANOFF

Whose "fist" is well known to amateurs. This station has been heard in every State and far beyond the boundaries of the continent

In some places the radio training of Scouts has been highly developed. At Donora, Pennsylvania, there is a Boy Scout Radio Experimental Unit composed of boys of Italian, Finnish, Austrian, English, Slavish, German, and Scotch parentage. In 1921 an Eagle Scout, that is, one who has earned the highest award for scoutcraft, visited the town and talked to the Scouts about radio. Thirty-five of them formed a class that night and those who had to ask Dad before joining came in the next day.

From then on there was no rest for Deputy Scout Commissioner McCune, who took charge of the bunch. He took them to camp and they studied electricity and magnetism. After they returned home they did not give him a chance to get a bath and shave before they were asking when the first meeting would be held there. They overflowed from his experimental station and the Commissioner had to appeal to his Council for larger quarters. Within a week the School Board granted the

use of a room with electric light, running water, 'neverything. The Scout Council appropriated a hundred dollars for equipment. Work benches, a store room, and lockers were built. A local plant donated sixty-five pounds of magnet wire and a wood turning lathe. A motor was installed to turn the lathe. Models for variometers, variocouplers, transformers, and other apparatus were provided. There were three classes a week, with a half hour of theory and three times as much practice. Radio books and magazines were always available.

The membership grew until there were 110 in the class. When the public school closed last June, day and night work had worn the Commissioner to a frazzle. He did not admit it until he was laid up for two months. When he recovered he organized the Unit with ten members. "I make every effort to secure them odd jobs of work," he reports, "and they always perform as Scouts should." He enrolled in a well-known correspondence school which granted him the privilege of permitting all his Scouts to use the lessons and equipment that it sent him.

In fourteen months this group has entertained three thousand visitors with radio concerts, from stations hundreds of miles away in many instances.

Rear Admiral H. J. Ziegemeier, U. S. N., Director of Naval Communications, recently sent a message to the Boy Scouts of America "covering the reasons why Boy Scouts should be encouraged to receive regularly and distribute locally the broadcasts transmitted from Naval radio stations for the benefit of the public." "Your wonderful organization teaches you," he said, "that your greatest happiness in life comes from serving others. In receiving and distributing the information sent out by radio stations, you bring to others information that your experience and observation teaches you means but one thing—greater happiness in life."

The Admiral's argument hits the bullseye. But it is hard for an organization composed largely of boys, and with less than one per cent. of its official personnel on the salary list, to take the initiative and bear the whole burden of a service that will bring to a community daily the up-to-the-minute information that it needs and wants. The community should at least ask for the service and encourage the Scouts by thus letting them know that they are reckoned as an asset in the affairs of the public.



TWELVE YEARS AGO!

This picture, taken July 4, 1911, shows 1st Class Scout Pickering and 2nd Class Scout Ziefman of Troop 1, Roslyn, L. I., operating a spark-coil set. Compare this picture with the frontispiece, showing modern apparatus used by members of the same troop

There are other services for radio Scouts to perform besides picking up and distributing weather forecasts, market reports, and other Government code broadcasts. The radio horizon has been considerably broadened within the past few months by the work of a little-known inventor who is referred to above as the President of the Cave Men's Club of America. An expert in acoustics, he turned his attention a year ago to the problem of making radio a community feature as well as a hobby for an individual and a pastime for a household.

At his lodge in Waterford, Virginia, he erected a seven-foot cement horn with a loud-speaker mechanism of his own design. With any of the ordinary types of tube receivers he can bring in concerts, lectures and sermons so that they can be heard at a distance of two miles or more, yet with a mellowness that makes it agreeable to hear them within his own gates. No printed advertising is necessary. He merely tunes in the show and his audience assembles. There is little in Waterford to prevent their attendance at any time. That is what he is thinking of—the lack of things to keep the boys busy, useful, and self-respecting.

It is as plain as the stars and stripes on our flag that the present situation in radio, plus the status of the Boy Scouts of America, gives practically every American community an op-



A VERY LOUD SPEAKER

Built by Mr. M. C. Hopkins, President of the Cave Men's Club of America, on his place in Waterford, Va.

and whatever other broadcasting it may wish to receive, and at the same time develop the character of its boys by giving them useful things to do. All it needs is a man who will make radio service his hobby and an organization such as the local government, the Chamber of Commerce or the Rotary Club to boost it. Music and setting-up exercises in the public schools, business information, news from the ships at sea, diplomatic details from the capitals of the world—one is as easy as the other when Boy Scouts learn radio and use it for the public good.

February, 1923, brings the Thirteenth Anniversary of the Boy Scouts of America. Here's a wish for many happy returns of the occasion with an ever

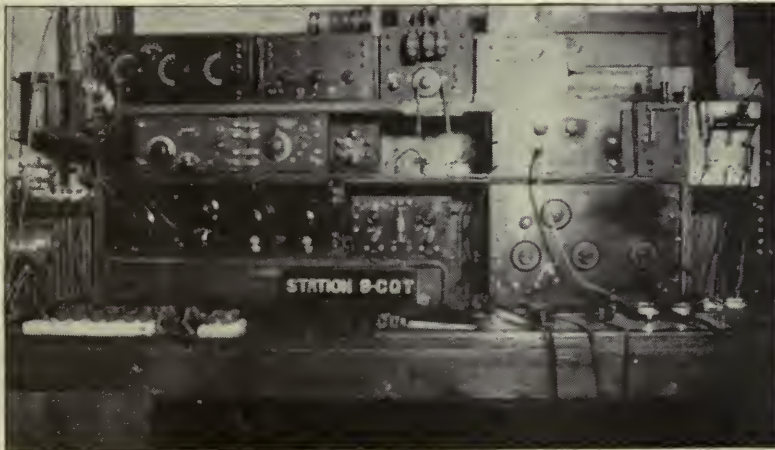

THE SCENE OF GREAT RADIO ACTIVITY

This is Station 8CQT, built and operated by the Boy Scout Experimental Unit at Donora, Pennsylvania

portunity to organize a radio service that will insure the receipt of all Government broadcasting, whether in code or by radio telephone,

increasing number of members ready to minister to their community and spread the example of unselfish service.

This Radio Bill We're Hearing About

By CHARLES H. KESLER

Member of the Bar of the District of Columbia and New York Patent Law Association

ALTHOUGH closely associated with the radio industry for several years, my practical experience was slight. But last fall, I became impressed with the intensely human side of it, as opposed to the radio of diagrams and technicalities. The boy next door had a set which was perfect (having made it himself). The boy was decidedly a radio bug. When he insisted that I try his set, I placed the phones to my ears, and instantly, through the ten-cent crystal (Woolworth), I was receiving the football scores and cheers. It was then that I "discovered"—as so many thousands had done before me—that radio is a great thing, that it is here to stay, and that, if there is any dissatisfaction with it, the causes of this dissatisfaction could be and should be removed.

A new law is being proposed for this very purpose. Work was started on the bill some time ago and is nearly finished. In what follows, I am offering a few tentative suggestions and pointing out certain features of the proposed legislation which may set people working on the bill and for the bill.

The problem presents certain difficulties; but none of them are insurmountable, and they will be solved, with the help and suggestions of all. Radio must be built upon a rock, for we cannot progress without firm foundations and without a goal which we are determined to reach. Our goal is the highest possible development of radio, and the foundation is law, reasonable and just.

The new radio legislation, which has the potentialities required, is designed to prevent interference and to make broadcasting practical and of service to all. But just what is there in this proposed bill or this legislation?

The proposed radio legislation is embodied in two identical bills: the House Bill H.R. 11964 introduced by Mr. White of Maine and the Senate Bill S3694 introduced by Mr. Kellogg. The House Bill was referred to the committee on the Merchant Marine and Fisheries and the Senate Bill to the Committee on Interstate Commerce.

The proposed Radio Bill amends the present

radio laws as embodied in the Act of August 13, 1912. Before the amendment can be understood, what is being amended must be known. Let us briefly consider the Acts now in force.

The earliest law now on the statute books is the Act of June 24, 1910, as amended, which requires ships licensed to carry fifty or more passengers, to have radio apparatus. This Act would remain in force under the new laws.

The spirit and purpose of the present laws is well summarized in regulations promulgated by the Secretary of Commerce as follows: "The principal purpose of the regulation of radio communication, international and national, is to secure the greatest efficiency of maritime communication through this agency, especially as a means of promoting safety to life." The new law proposed extends the purpose to broadcasting.

The Act of 1912, which enlarges the scope of the radio laws for the purpose of saving life, remains in force under the proposed legislation with the exception of Sections 1, 2 and 3 which are replaced by others in the bill now pending, and with the exception of Regulations three and four of Section 4 relating to the use of a "pure wave" and "sharp wave," which are repealed. Certain other slight changes are also made in the regulations.

The regulations of Section 4 made by Congress are for the purpose of preventing or minimizing interference and to facilitate radio communication, but these may be waived by the Secretary of Commerce at his discretion when no interference can ensue.

These regulations provide that every station shall be required to "designate" a wavelength as the normal sending and receiving wavelength of the station. Every ship station, with exceptions, and every coast station open to general public service must be prepared to use two sending wavelengths, one of 300 meters and one of 600 meters as required by the international convention in force, which convention is the law of the land. With exceptions, all stations may use other wavelengths.

At important seaports and where interference occurs between government stations and

other stations, a division of time may be made by the Secretary, the Government sending only during the first fifteen minutes of each hour, and other stations sending the remainder of each hour.

Private stations not engaged in commercial business or experimentation are limited, without special authority, under the regulations, as amended to wavelengths between 150 meters and 275 meters and to a transformer output not exceeding one kilowatt. This applies especially to amateurs.

No station not already in actual operation shall be licensed for the transaction of commercial business by radio if within fifteen nautical miles of the following government stations: Arlington, Key West, San Juan, Porto Rico, North Head and Taloosh Island, Wash., San Diego, Cal., or which may be established in Alaska or in the Canal Zone. The above are the main features of the regulations which will remain in force under the proposed legislation.

Section 6, which also remains in force under the proposed legislation, defines "radio communication" as follows:

"Sec. 6. That the expression 'radio communication' as used in this act means any system of electrical communication by telegraphy or telephony without the aid of any wire connecting the points from and at which the radiograms, signals, or other communications are sent or received." Will not this definition soon become obsolete? What about wired wireless? Have not high-frequency oscillations been transmitted over the network of wires and rails connecting the Pacific with the Atlantic, even without the knowledge of the Telephone Company and Railroads, and without disturbing the normal operation of their lines? Do we not plug in lighting circuits to receive these messages? Is it not possible that it is wired wireless?

The United States is a party to the London Convention, but its provisions and regulations apply only to stations on shipboard and to coastal stations open to general public service. This treaty, therefore, will not limit or prevent effective legislation for the adequate control of our domestic radio situation.

The difficulties involved in harmonizing the various interests desiring to utilize radio communication are enormous. Certain of these interests are now recognized by the

Department of Commerce and are classified as ship stations and land stations. Land stations are of two classes, coast stations and inland stations. Coast stations are stations which transmit messages to vessels at sea or on the Great Lakes or whose operation can interfere with the exchange of such messages. Inland stations are those which cannot transmit such messages and which do not interfere with such messages, depending on geographical position or range. Both coast stations and inland stations are divided for the purpose of the administration of the Act of 1912 as follows:

- (1) Public service stations
 - (a) general
 - (b) limited
- (2) Limited commercial stations
- (3) Experimental stations
- (4) Technical and training school stations
- (5) Special amateur stations
- (6) General amateur stations
- (7) Restricted amateur stations



All coast stations, except general and restricted amateur stations, must be able to transmit on the wavelengths of 300 and 600 meters for the purpose

of relaying distress signals. These are the international standard wavelengths agreed upon by treaty between the United States and other nations. All coast stations are required to listen in every 15 minutes on 600 meters to determine if any distress signals are being sent. General public service is defined as "paid business" conducted on commercial wavelengths between ship and shore, or between ship and ship.

Limited public service is "paid business" between certain designated land stations, ships or line of ships.

Limited commercial stations are not open to public service and are licensed for a specific commercial purpose. The nature of the remaining types of stations, it is believed, will be obvious.

The interests or classes interested in radio may be additionally or differently classified as follows:

- (1) The Federal Government (Army, Navy, Commerce, etc.),
- (2) The large class of persons interested in broadcast reception and using receivers,
- (3) Manufacturers and dealers (including the big fellow and the little fellow),
- (4) Broadcasting agencies, and
- (5) General public.

How are these various interests to be brought into cooperation on the principle of live and let live? The public is interested, because, if the radio industry is not in a healthy condition, it affects all, it lowers the general prosperity. A system of broadcasting which approximates the ideal means that people will want sets in increasing numbers. That means greater enjoyment, more business, a more satisfactory state of affairs for the people as a whole. The enactment of suitable legislation to approach this ideal condition, even though it remains an ideal, should receive the hearty cooperation of all the people and of their representatives in Congress.

Obviously any law that flexibly covers the situation and takes care of all classes must be more or less general in terms and yet of such character that injustice cannot be done by officers in executing the law. The law should operate automatically as far as possible, considering the volume of details which cannot be covered other than generally by law.

The only proper authority for controlling the radio situation is the Federal Government. But within the Government are various interests, the Army, Navy, Commerce and other departments. There will always be more or less friction between these several departments as long as one of them is placed in control. It is as if one of the parties to litigation acted as judge. Yet the best possible broadcasting system can be worked out only with the cooperation of these several departments.

The logical control would be a super-departmental control by the President or his representative. The new bill places the control in the hands of the Secretary of Commerce with one exception—the President is authorized to assign wavelengths to the Army and Navy. Of course, we might do well to have a Director of Radio just as we have had a Director of Railroads, etc., but the Secretary of Commerce has in the past controlled the situation and as the head of the Department of Commerce, the matter comes very properly under his supervision.

The proposed bill is, like most original bills, indefinite and inaccurate in places—but it is, in general, good. At least, all interests are taken care of while securing the best possible broadcasting conditions.

The Secretary under the new bill is the final

judge on the matter of granting licenses. No appeal to a court is possible. A writ of mandamus cannot be issued to compel the Secretary to grant or renew a license. Under the law now in force the applicant can have his day in court. Whether or not it is necessary to give the Secretary this autocratic power to control broadcasting properly I am not prepared to say. At least the matter should be thoroughly considered before passing the bill.

It must be admitted that such authority if rightly exercised, will be beneficial, yet to favor one's friends is not natural. The granting of a station license under the proposed act and its renewal is "in the discretion" of the Secretary. Certainly if a person has operated a station satisfactorily for ten years, he should have his renewal and it should not be dependent upon the whim or political motive of the Secretary. The granting of original licenses must depend on all the facts in the case, whether or not there will be interference. But even here there is the possibility of favoritism, and no recourse to a court is possible.

Section 2C provides that the Secretary may grant a license only to a station which is in the interest of the "General Public Service." A better expression could be used here in view of its acquired meaning, referring to a commercial station sending messages for pay as defined above. Construing this clause one way would rule out amateur stations.

Section 1C provides that government stations not used exclusively for communication of official business are subject to control by the Secretary of Commerce and licenses are required. Government stations used exclusively for official business shall use such wavelengths as are assigned by the President. Furthermore, they must observe "such regulations" as the Secretary of Commerce "may" (why not "shall"?) make to prevent undue interference. These regulations can be suspended by the President in time of war. This is all very good and shows that the officers of the Army and Navy who were on the committee which framed this bill are for doing everything they can to further the cause. Certainly if there is any point to be cleared up, it can be taken care of to the satisfaction of a great majority of the people.

The proposed law is also more stringent in regard to aliens. Under the present law citizens or domestic corporations can secure sta-

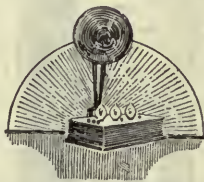

tion licenses. Under the proposed law even a domestic corporation cannot secure a license if one alien be a director or officer or if a fifth of the capital stock having voting power be owned or controlled by aliens. There is grave doubt as to the wisdom of or necessity for such restrictions. If there must be restriction as to a domestic corporation, it should be based on whether or not the corporation is in fact controlled by aliens. Certainly one alien director does not necessarily control a corporation nor does merely a fifth of the stock.

Section 2C is as follows:

"The Secretary of Commerce is hereby authorized to refuse a license to any person . . . which, in the judgment of the Secretary, is monopolizing or seeking to monopolize radio communication, directly or indirectly, through the control of the manufacture or sale of radio apparatus or by any other means. The granting of a license shall not estop the United States from prosecuting such person . . . for a violation of the law against monopolies or restraint of trade."

I don't know why this clause was made a part of the bill. At any rate the authority given here is unnecessary as the Secretary can refuse a license, "in his discretion," for any cause whatsoever. The whole thing is opposed to our fundamental scheme of government which separates the legislative, judicial and executive departments. Here the Secretary of Commerce is the judge. His judgment (or opinion) is final. If he thinks a company is a mono-

poly, it is. The printed record in the famous anti-trust cases would put the five-foot library of Doctor Eliot to shame, but with all the voluminous records before them, courts differ as to whether an organization is a monopoly or not. They even differ as to what a monopoly is. They may be lawful, such as a patent mono-

poly. Is the Secretary going to try the case before passing judgment? And as a climax to show how right the Secretary's judgment might be, the granting of a license is not to estop the government from bringing suit under the Acts provided for that purpose, putting the poor monopoly to further expense! Why not let the courts pass on monopolies and the Secretary on licenses. Unlawful monopolies are bad, but certainly this clause does not remedy matters.

Adequate provision is also made to enable the Secretary to revoke a station license whenever the owner of the station fails to obey the law or any regulation or "whenever the Secretary of Commerce shall deem such revocation to be in the public interest." The clause quoted is broad enough to allow the Secretary to revoke the license for almost any reason. The licensee or owner may have a hearing, how-

ever, on the matter of such revocation, but only before the Secretary.

Other clauses of the bill regulate the granting of operators' licenses and their control. No alien can be granted a license nor any representative of a foreign government. Manufacturers and importers of radio apparatus should

Keep Your Eyes Open!

Following a report that the radio legislation, prepared as a result of the Conference called by Mr. Hoover last February, had been "pigeon-holed," RADIO BROADCAST invited all the editors of radio publications in the Metropolitan District to attend a conference to decide upon a definite form of action to relieve the jam existing in the ether. This meeting took place November 6th, last, and was followed by a similar meeting in Pittsburgh, Pa.

The fact that legislation was essential and urgently needed was recognized by all, and a resolution was passed at both meetings to get the proposed bills out in the open and through the necessary legal channels.

Cognizance was taken of the weak points in the proposed bills but no time was lost in attempting to weed out the objections—that was left for *you* to do.

The National Radio Chamber of Commerce has prepared data of a technical nature, derived from questionnaires sent to all branches of the radio industry and other organizations have done likewise. It is quite likely that the technical aspects of the new legislation will be satisfactory to most of us, if due consideration is given the conclusions arrived at after a comprehensive study of such questionnaires.

However, it is essential in altering any legislation to be certain that the new is not even worse than the old—for it is possible for laws, in the hands of artful lawyers, to be distorted beyond recognition and made to defeat their own purpose. We must have some relief from existing conditions, but we must be sure that the relief is not temporary, to be followed by a relapse into some worse malady.—THE EDITOR.

visé the parts of the bill relating to restrictions on aliens. For instance, under Section 2B, a "representative" of an alien or of a foreign government cannot be granted a station license even though an American citizen or an American controlled corporation. What does "representative" mean? What does it cover? While these restrictions are apparently war measures they do tend to restrict importation of foreign apparatus. These restrictions of the proposed bill should be given full consideration at the hearings. Let the light of day shine upon them.

Under Section 4, a permit is required to start the construction of a station. This does not apply, however, to amateur stations and government stations used exclusively for official business. If the station is not constructed within the time specified in the application for permit, the latter is automatically forfeited. Why this is necessary I don't know. Nor does the granting of a permit oblige the Secretary to grant a license after the station is finished. Build the station first, and then take a chance on securing a license!

Section 5 provides for an advisory committee, acting as advisors for the Secretary. It is suggested that one of the matters on which this committee should report is broadcasting. The committee is to comprise twelve members, six from the government departments and six non-government members of "recognized attainment in radio communication," to be appointed by the Secretary.

Section 8 permits the Secretary of Commerce to impose a penalty for perjury! Even though this section be constitutional, it seems to me that the use of a transmitter without a license should be made a misdemeanor, the court having jurisdiction of such cases as well as of perjury. Of course, the Secretary should be able to revoke a permit or license when

obtained fraudulently and to impose penalties for violation of regulations in cases where licenses have been granted or to revoke the license.

I have merely touched on points of the bill which to me seem to need revision or amplification. It is believed that the bill will meet the recent phase of radio communication, that is, broadcasting, which must however remain subordinated to the use of radio for safeguarding or saving lives at sea.

The committee whose conferences resulted in this bill have done their work well. It may be advisable to incorporate in the act other of their recommendations made in their report, such, for instance, as prohibiting point to point radio communication, direct advertising, etc., instead of leaving it to regulation by the Secretary.

The Bureau of Standards should be empowered to make a complete study of the radio situation in all aspects. This can be done by suitable appropriation and enlargement of authority by Congress, if such power and money are now lacking.

This committee also recommended that the Secretary be empowered to prohibit the use of receivers which cause the radiation of energy. It is believed that, if any prohibitions are necessary, the law should positively so provide. While certain foreign countries now prohibit the use of such receivers, the enactment of such a law would render useless important and valuable patents as well as thousands of sets now in use, unless it should exempt sets now in use.

There, then, is the bill—a bill to put across even with its defects. This act is the foundation on which the future of radio broadcasting will depend. Every one of us should get back of it, offer suggestions, and push it hard. Let's get busy!

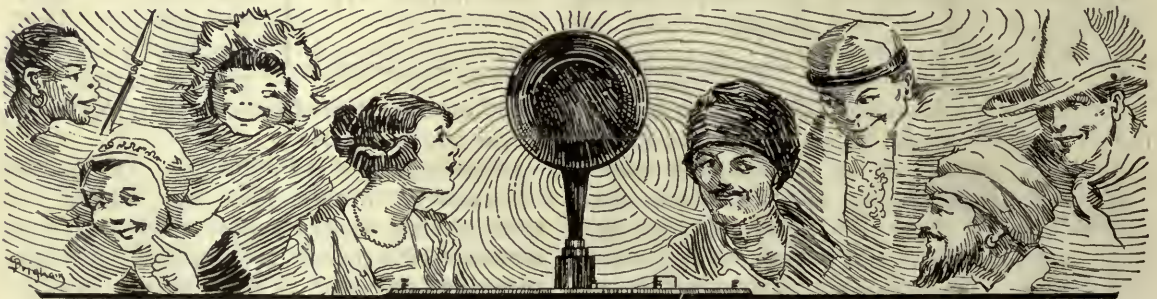

The Facts About the Loud Speaker

By G. Y. ALLEN

BEFORE the invention of the vacuum tube, the telephone head set was the universal device for recognizing radio signals. At that time it was necessary to use this highly sensitive device in its most efficient way, as the detectors in use were inefficient, to say the least.

With the coming of the vacuum tube, however, the situation became entirely different. Infinitesimal voltages received on the antenna may now be amplified to the point where they can be used to operate a relay if necessary, so that the extreme sensitivity of the telephone receiver is no longer essential. With the development of the vacuum tube came broadcasting, and the novice soon outgrew the limitations of the head set. The owner of the radio receiver is no longer typified only by the boy amateur intent on getting distance; for the business man—the home owner—as well, is now an enthusiast. The present-day novice wants concerts and educational programmes so that they are audible to the entire family without the necessity of wearing head sets. Thus has come the loud speaker and with it the emancipation of broadcast reception.

Early attempts at loud-speaker design were confined to attaching standard head telephone receivers to horns of various kinds. One of the earliest was the application of a telephone receiver to a phonograph. The reproducer was removed and by a special fitting, the receiver was attached to the tone arm, thus affording all the desirable characteristics of the phonograph tone chamber. The receiver with its

fitting is illustrated in Fig. 1. Another attempt along the same general lines was to provide a horn with one or two openings at its smaller end to which the head set was clamped.

While the art was in its infancy, the quality of transmission was poor, and such makeshifts were endured. As the quality of broadcast-

ing improved, however, two outstanding defects were noted. The quality was far from that heard on a head set and the amplitude was not enough for all purposes. Almost all developments in loud speakers in the past year have been along the lines of improving the quality and quantity of the received signals.

To have a loud speaker faithfully reproduce sounds is one of the most complex problems facing the manufacturers today. There are any number of loud speakers on the market, but it is generally admitted that none of

them has yet attained perfection.

Any loud speaker functions in two distinct ways. First, it must take the electrical impulses delivered to it by the vacuum tube and convert them into mechanical motion, then this mechanical motion must be transformed into air waves. Neither the electrical system nor the acoustic system can be designed separately, but both must be developed together.

One aim in the design of the electrical part of the loud speaker is to get the diaphragm to vibrate with the same amplitude at all musical frequencies that may be used for the same applied voltage to the terminals of the loud speaker. The ear is capable of hearing about eleven octaves, and the range of musical

In Search of a Loud Speaker

There is no such thing as a perfect loud speaker, any more than there is a perfect human being. Science, however, is ever trying to improve existing conditions and the loud speaker is receiving a great deal of attention.

There are some loud speakers, designed by acoustic and electrical experts, that produce even better music than the phonograph—but there are a great number of loud speakers capable of no speech whatever. Makeshift loud speakers, like makeshift shells, are usually “duds.” There is plenty of room for development in this interesting field.

In this article, Mr. Allen tells something of the difficulties to be overcome, the present methods in general use and the hope of an early solution to the problem. Following, as it does, “How Your Telephones Work,” which appeared in our January number, this article should be of especial value to those of our readers whose interest in sound reproduction has induced them to try to surmount the difficulties met in loud speaker design.—THE EDITOR.

sounds runs from about 40 vibrations per second up to about 4000. The range of the human voice extends from about 60 for low bass notes to about 1300. A good loud speaker, therefore, must cover these ranges without distortion.

The point of first importance is to insure that the forces acting on the diaphragm faithfully reproduce in air waves the variations in current that come to the loud speaker. To accomplish this end, designers of the electrical mechanism must be governed by certain physical laws.

A conventional loud speaker receiver mechanism is similar to that of a standard telephone receiver and is shown in Fig. 2. To the poles of a permanent magnet are attached two soft iron pole pieces on which the coils are wound. Supported very close to the pole pieces but not touching them is the iron diaphragm.

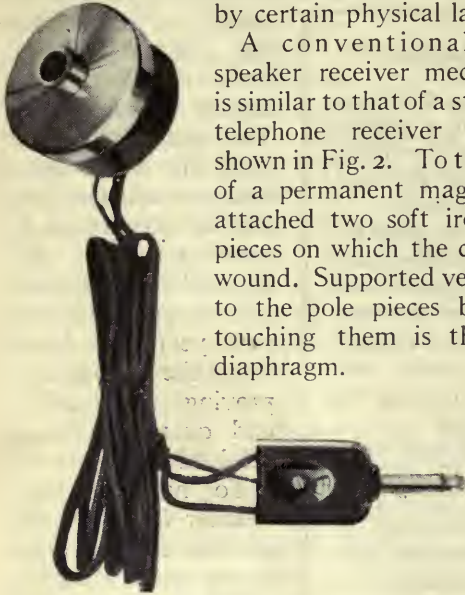

FIG. 1

Telephone receiver designed to fit over phonograph tone arm

When a variable current is sent through the winding, the pull or attraction of the pole pieces for the diaphragm varies, thus allowing the diaphragm to vibrate. It should vibrate with an amplitude proportional to the current strength. To insure this, the length of the air gap must be small which, therefore, limits the amplitude of vibration, and thus the volume of the loud speaker, by the diaphragm coming into contact with the soft iron pole pieces. A loud speaker constructed as shown in Fig. 2 is therefore limited as to the volume it can produce.

Now the variation in pull on the diaphragm depends on the variation in current in the winding and also on the number of turns of wire. As the currents used at the radio receiver are very minute, very many turns of wire are needed on each bobbin. To get a

large number of turns in the space available, the wire must be very small in diameter, which means that the electrical resistance of the winding is high. In a well designed loud

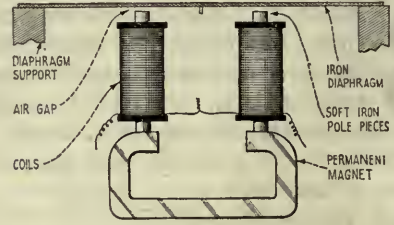

FIG. 2

speaker, therefore, the resistance of the winding is a measure of the "current sensitivity" of the instrument.

In radio, the loud speaker is generally connected in series with the plate of an amplifier tube as shown in Fig. 3. For loudest response, the alternating voltage or pressure caused by the incoming signal should be the same between the plate and filament of the loud speaker. This condition cannot be completely met as the voltage across the loud speaker varies with the voice frequency whereas the voltage across the tube remains nearly constant regardless of frequency. It is customary to make the voltages approximately equal at some voice frequency such as 500 or 800 cycles per second.

As the voltage depends upon the "resistance" or "impedance" of the tube and loud

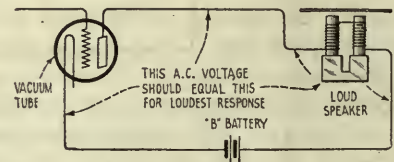

FIG. 3

speaker, the impedance of the loud speaker is generally made equivalent to that of the tube. Standard tubes have an impedance of about 20,000 ohms, and loud speakers should have an impedance of about this value at 500 to 800 cycles for maximum volume.

Sometimes it is more convenient to wind loud speakers to a lower impedance. In this case, a transformer must be interposed between the plate circuit of the tube as shown in Fig. 4. This transformer has the larger number

of turns connected in series with the plate and the lower number of turns connected to the loud speaker.

One very important feature to guard against in the design of the mechanical part of a loud

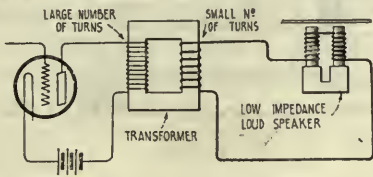

FIG. 4

speaker is mechanical resonance. All mechanical systems have a natural period of vibration, and if they are subjected to vibration forces of this period or frequency, they will respond with an amplitude far out of proportion to the applied force.

Fig. 5 shows graphically how a loud speaker diaphragm would respond to a range of frequencies including its own resonant frequency. In such a test, the voltage across the loud speaker or the current would be maintained constant. A loud speaker designed with a moving system whose natural period fell within the range of voice frequencies would distort horribly and would be practically worthless. All well designed loud speakers, therefore, aim to have the natural period of the diaphragm and moving system well above the range of the human voice or musical instruments.

Although the electrical and mechanical design of a loud speaker is involved, it is simple when compared to the design of the horn and sound chambers. In spite of the

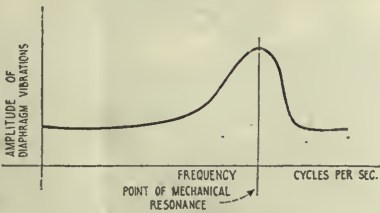

FIG. 5

large number of loud speakers now on the market, it is pretty generally acknowledged that a very large amount of research work must yet be done before a loud speaker that is absolutely distortionless is evolved.

Most of the development work on loud speaker horns and sound chambers have been

of the cut and try variety, and the human ear has in most instances been the means by which the quality of the different designs was measured. Now, it is extremely difficult to get two people, when listening to a loud speaker, to agree on fine differentiations in quality. It is an interesting fact that many people prefer a loud speaker which apparently distorts somewhat. Loud speakers that throttle the acid quality of a musical production and accentuate the string and wood wind instruments seem to be preferred, and yet such loud speakers will show obvious distortion on speech. In short, the successful design of a loud speaker is a most involved problem which has barely been touched as yet.

It was early discovered that the material from which the horn was made had an important bearing on the quality. It was found necessary to make metal horns from dead metals such as zinc, lead or cast aluminum. Horns made from wood and wood fibre, cellu-



FIG. 6
The loud-speaking unit of a device which uses an adjustable magnet system

loid, hard rubber and such non-metallic materials give a very pleasing quality to music, but it cannot be said that they do not distort. It has been found that the horn must be adapted to the particular loud speaker and a horn that would give good results with one mechanism may be totally unsuited for another.

Loud speaker development has progressed along two distinct lines. One type has been similar to the conventional telephone receiver in construction in that the diaphragm, made from iron, is subjected to the magnetic force and also sets the air in motion. In the other type, the diaphragm is mechanically attached to an iron vane on which the magnetic forces act. The diaphragm serves only to set the air waves in motion in this case.

One loud speaker of the first type is essentially an aluminum casting, into the base of which are screwed two telephone receivers of the same type that are used in the head set manufactured by the same company. Such a

loud speaker is limited as to volume but will give sufficient sound intensity for a small room, when used with a two-step amplifier. Another loud speaker of the first type uses no permanent magnet. The magnet system, however, is adjustable by means of a threaded nut, which in the complete loud speaker is operated

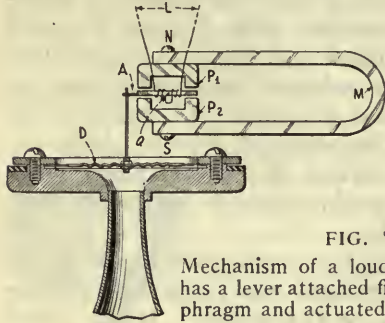

FIG. 7

Mechanism of a loud speaker which has a lever attached firmly to the diaphragm and actuated by the magnet

from the outside of the box. In this way considerable control of the volume and quality is obtained. Fig. 6 shows the loud speaking unit of this device.

To permit of greater amplitude in the motion of the diaphragm and still maintain a small air gap, various lever systems have been introduced into loud speaker designs from time to time with varying success. The danger arising from such a procedure of course is the introduction of distortion. There is the possibility of increasing the weight of the moving system to the point where it will be objectionable and also the air resistance may reach such a point as to interfere with rapid motion. Furthermore, great rigidity in the moving system is essential or the loud speaker will "rattle."

Fig. 7 illustrates the interior mechanism of one type of lever action loud speaker that has proved highly successful. M is a permanent magnet provided with two soft-iron pole pieces P¹ and P². Suspended between the poles of this magnet is a soft-iron armature, A. A is pivoted at its centre in the



FIG. 8

The horn is non-metallic

centre of the pole pieces in such a way that it can oscillate within limits. Surrounding the armature and supported by the pole pieces is

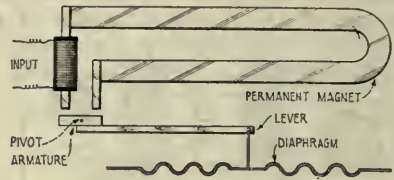

FIG. 9

the coil, consisting of a large number of turns of very fine wire. The armature has attached to it at one end a small rod mechanically connecting it to the corrugated diaphragm.

When a current is connected to the coil through lead wire L, one end of the coil is instantaneously north and the other end is south. An inspection of the sketch will show that this form of field will add to the flux on one side of the armature and subtract from it on the other side on both ends of the armature. This will cause the armature to tend to rotate about pivot Q, thus displacing the diaphragm. A reversal of the current will cause a displacement in the opposite direction.

As will be noted from the sketch, the distance from the diaphragm rod to the pivot is

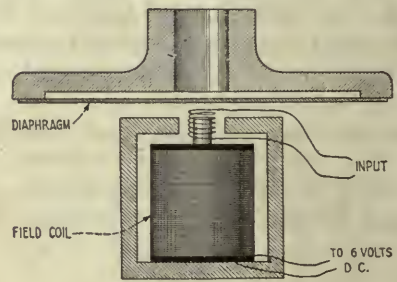

FIG. 10

about twice that from the middle of the pole piece to the same pivot. For any motion of the armature in the air gap, therefore, the motion of the diaphragm will be about twice as great. Great volume can thus be obtained from a loud speaker of this construction and distortion can be kept at a minimum.

Fig. 8 shows the loud speaker complete with a non-metallic horn. This horn is especially designed to produce the minimum of distortion and the metallic quality is, of course, entirely lacking.

The internal construction of another loud

speaker of the same principle is shown in Fig. 9. Here the armature is affected only on one side by the magnetic flux, and its movement must be kept down to a very small amount to maintain the length of the air gap small. A long lever is thus necessary to obtain sufficient displacement of the diaphragm.

This particular instrument is provided with a mica diaphragm which combines great flexibility with lightness. It is mounted on a stand in such a way that it can be rotated in any direction.

A loud speaker of a design differing from any of these mentioned is sketched diagrammatically in Fig. 10. In this case, no iron diaphragm or armature is used. Instead, there is attached to the diaphragm a coil that vibrates with the diaphragm. This coil is connected to the energizing source and vibrates in the field of an electromagnet, M. This magnet is energized from a 6-volt direct current source.

This construction gets away from a direct operating instrument being limited in its amplitude of vibration by the length of the air gap. In fact, it is claimed that practically any volume may be obtained from this instrument. A photograph of this loud speaker is shown in Fig. 12.

In general, good operation of a loud speaker at moderate volumes may be obtained by connecting it directly in the plate circuit of the last tube of a two-stage amplifier. This cir-



FIG. 11

An amplifier designed for loud speaker use

cuit will give good results in the home where it is desired to fill but a small room. There are cases, however, where more volume is desired. In fact, at times it is desired to make music and speech audible to crowds of people assembled in the open air. The power available from a two-stage amplifier becomes totally inadequate in such cases.

To get the necessary amplitude for large volumes, it is necessary to use additional stages of amplification with tubes that are capable of delivering very much more power than can be obtained from an ordinary receiving tube. The use of these tubes entails high plate voltages and heavy consumption of B battery energy. The resulting volume, however, is remarkable. Speech and music have been made easily audible over distances of more than a mile.

Fig. 11 illustrates an amplifier designed for use with the loud speaker shown in Fig. 8. It consists of two stages, using three tubes. The tubes are capable of delivering considerable power and the last two are connected in such a way that the loud speaker is supplied with the sum of their outputs.

The plate circuits of the last two tubes are connected to a transformer having a split primary and the sum of their effects is impressed by transformer action on the secondary which is connected to the loud speaker unit.

In conclusion, it might be said that the manufacturers of loud-speaking devices have accomplished wonderful results when the time they have been working on them is taken into consideration. The problem is extremely involved; but we cannot doubt that before long vast improvements will be made and that we shall see the day when broadcasted material can be made audible in practically any volume without distortion.



FIG. 12

N A A

By DONALD WILHELM

AT NIGHT, visible from all directions for miles around, there are now three lights glowing atop the Arlington Towers, one six hundred feet up, the others four hundred feet up from the hill that looms above the Potomac overlooking Washington. The towers of NAA, and these lights, now constitute a landmark for the aviator, signifying that he should bear off a bit southeast, or swing over the Washington Monument, the Capitol and the Navy Yard, and that Bolling Field is underneath. With the coming of planes and of radio, what a changed aspect this Arlington hill has taken on since George Washington and Major L'Enfant stood there, as tradition has it, and planned the city of Washington!

Not so long ago, when an amateur radio convention was about to assemble in Washington, more than three hundred of its delegates were asked what landmarks they desired most to see in and about the Capitol: should the Capitol come first, or the White House, or should it be NAA? Back came the post-card replies, almost unanimous for NAA. The giant on the hill has a distinct personality, and has long been immensely popular with thousands of acquaintances. It has had some great experiences, too. In February, 1920, for instance, there was that memorable snow and sleet storm that for whole days tied up nearly every railway wheel on nearly every railroad up and down the Atlantic Coast. It concentrated on Arlington. "Our antenna then consisted," said Charles Range, who is still in charge of the station's crew of six men, "of three wings, triangular in shape, each consisting of two spreaders eighty-eight feet long and each weighing 3,000 pounds. There were twenty-three wires in each wing, there was ice eight inches in circumference on each wire—eleven tons of ice on each wing, thirty-three tons altogether, if you figured it out, after that sixty-mile gale did its darnedest. Well, the evening of February 7, 1920, about 7:30, there were three reports that sounded like a battleship coming on the range—the first sounded like a three-inch gun, when the shackle in one of the insulators gave way, the next was a 14-inch gun,

when one end of the antenna parted from the big tower, and the last sounded like the explosion of the whole works, when that débris buried itself in the frozen ground."

But the point in all this is, not that the station kept working for two days before the last wing crashed, but that, during the ensuing six days, mariners, jewelers, farmers, amateurs and others, by radio, by telegram, by letter, and in sundry other ways, transmitted one long wail to the Navy: "What in the world has become of our old friend, NAA?"

And there were others who addressed themselves to the Secretary of the Navy, and to their Congressmen and Senators, about like this: "Save money if you have to, but for heaven's sake give us back NAA!"

NAA has a bigger circle of friends in fact than any gentleman we know. If service rendered is immortality, in radio history this station will always be what it is to-day—as much a landmark and institution as almost anything east or west of the Potomac.

NAA has given more service to more agencies and people and to the progress of radio itself than any other station. One can safely go further and say that its original 100-KW Fessenden spark set, which now seems as ponderous and noisy as a steam shovel, has given more service than any other set in existence. It is still hard at work, with its heavy rotor and forty-eight glistening tractors not much the worse for wear. It is still serving hundreds of people who are equipped only with crystal receivers. Yet, progress in radio is so rapid that this much-celebrated set with its 200-hp motor and belt drive is likely to be retired before many more years, and there is a movement on foot, which all loyal devotees of radio will join, to set this old fellow up in the National Museum for the benefit of posterity, with an inscription about like this: "Here lies the original set in the first high-power station. From February 13, 1913, until arc and tube sets supplanted it, it was a good neighbor and a friend in need to hundreds of thousands."

NAA, remember, was the first of the Navy's chain of high-power stations—that chain which, when combined with American Private

Enterprise, Inc., absorbed links from Germany's supreme chain, links from Britain's imperial chain, and in less than a decade gave America the world's radio supremacy and a more effective guardian of such international understanding and peace as is possible these days than any other agency on earth.

It was from NAA that the human voice first leaped the Atlantic. Very early in that morning of October 22, 1915, a little group of Naval officers and others were routed out of bed to be told that they might hasten to Arlington and from there talk to other Americans in the Eiffel Tower, with the bustle and roar of a thousand guns only a few miles away from Paris and the Tower itself used as a target now and then in the daytime. They talked, and were heard in France and at Pearl Harbor, in the Hawaiian Islands at the other side of the world. There's an epic in itself—how American Enterprise,

Inc., perfectly confident that we would have to enter the war, went secretly to the Navy in 1914, explained that it wanted to lend a hand to the Navy by developing the radiophone with the help of such facilities as the Navy alone could offer, and how, with the Navy, it put up a wooden shack beneath NAA's big towers, went to work, and came through, that October morning.

It was via Arlington, too, on September 29, 1915, that the human voice, Mr. Vail speaking, was first transmitted from New York to the Mare Island Navy Yard on the Pacific Coast, via land wire to NAA, then via ether westward.

It was NAA that first broadcasted a President's voice, and it has been NAA that has enjoyed all sorts of similar but less important distinctions. When the argument, spark vs. continuous wave, was raging, and the Navy wanted only the better system for the rest of its

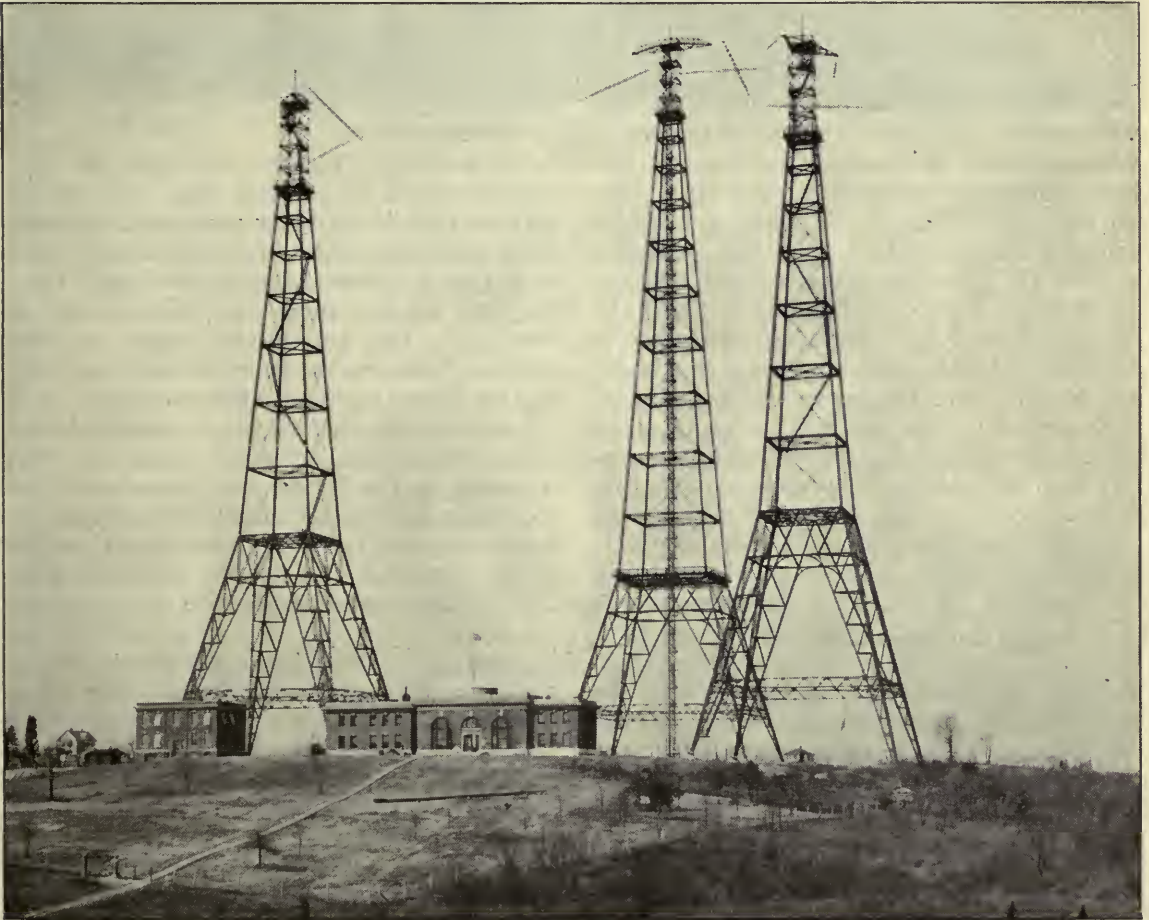

THE BEST KNOWN RADIO STATION IN THE WORLD

NAA, Arlington, Virginia, whose distinctive spark note is heard every noon and evening by thousands of people, both afloat and ashore, who tune in to keep posted on the time, news, and weather

chain, it was NAA that served at the land end while a cruiser, the *Salem*, moved eastward toward Gibraltar with experts on board, testing out both systems. And now, at the end of a period of not quite ten years, the same station is making experiments with tube sets, with the result, perhaps, that before long the Navy will be satisfied that even NAA's C.W. sets are destined for the National Museum.

Some years ago, the question arose as to whether a big and a little set could be worked at NAA simultaneously without the big one burning out the little one. There were those who declared it couldn't be done. It was Commander Hooper, as the story goes, who was one of those who said: "Let's try." So, it seems, suiting the action to the word, he pressed the keys of both sets at once,—and nothing disastrous happened.

Again, in 1915, authorities doubted whether the Navy Department, hardly more than half a mile from NAA, could receive with an antenna atop its own building while NAA was transmitting. Up the flag-pole of the State, War and Navy Building an antenna was run, with a wire down to the telegraph room. That worked. Now there is no receiving at NAA and no gob hammering a key either—receiving is done via a 5-wire antenna strung half the length of the new Navy Building just over the Potomac from NAA's big hill, and sending is done from a booth on the top floor of that building, by land wire and automatic key—by remote control, in other words. That's why, in the brick building hard by, but still entirely separate from the main radio building at NAA, you find two rooms, having doors half a foot thick with soundproofing and walls quite as thick, of which the doors are no longer closed. And that's why, in the smaller of these rooms, on a narrow shelf fastened to the wall, you see eight keys in a row and likely as not a couple of them working automatically, while perhaps the spark set next door is snapping or the C.W. or tube sets work in the adjoining building with nary a sound except the low hum of motors.

Now, after you've climbed NAA's big hill and looked about—at the neat brick buildings faced with limestone, at the towers rising high above you, at the fine lawn and flower gardens, at the wonderful view of Washington, and at other interesting things in and about the station (it cost originally only \$300,000, by the

way, and is maintained with a crew of six men at a cost of only \$18,000 a year), you wonder how they guarded this station during the war, and what happened. It dawns on you how fine a site it has—and that means a lot. You realize that there are no mountains, hills or big buildings anywhere near to divert or absorb electrical energy. You realize that NAA is far enough inland to be fairly safe from any attack except that of enemy aircraft, which might more likely make the Capitol itself the target. You see that the site adjoins Fort Myer; that there are ample sources of outside power; that the place, with screen protectors about the base of the towers and barb-wire entanglements all about its 16½ acres was, with a guard of marines on duty, safe enough from even pro-enemy fanatics. "But *did* anything happen?" you want to know.

"Nothing much."

"Well, what?"

"Well," your informant confesses at last, "not a doggone thing happened except one night."

"Then what?"

"O nothing! You see we had the wire entanglements all charged with just enough current to hold anybody that touched them. That particular night, a society flapper that took a fancy to one of the Marines, and I can't see that, tried to climb over, and he tried to help her. The searchlight picked up this romantic picture, the guard stopped the yells, and the flapper was sent home to mother!"

But there are other things you want to know, all in short space, about this giant and what it means to the Navy and the nation. The ground system is particularly interesting. It is a checkerboard of wires buried from 14 inches to two feet, extending over the entire 13½ acres of the original reservation. All of these wires are bonded at crossings. At one side of the reservation they terminate at a running brook and all are brought together at two sides of the transmitting building.

Above this checkerboard, resting on blocks of Vermont marble, with the ground switches evident enough, rise the three towers with their 1050 tons of steel.

These three main towers—there are now two new 200-foot ones receiving a final coat of paint—form an isosceles triangle with a base which runs magnetic north and south. The main antenna is lowered with electric winches





THE ARLINGTON HILLTOP IN WARTIME

Showing a part of the barbed wire barrier which was charged with electricity as a reminder to the mean or meddlesome

twice a year for inspection and overhauling. At the peak of the highest tower, by the way, there is now a wind-recording instrument tracing its records on a paper cylinder in what used to be one of the transmitting rooms. It is precisely 790 feet above sea level and it operates automatically, with no added labor for the Weather Bureau. East of the station about 100 yards rise the two new towers, each with an antenna strung back to the 400-foot towers. The Army built these in cooperation with the Navy, and they are on ground owned by the Army.

So there are now five sets of antenna, at NAA. These, with the new towers, indicate that, though the Navy Department is handling its own and other Federal long-distance work via NSS at Annapolis, NAA, at the advanced age of not quite ten years, is setting out on new ventures. It has long been sending out time, hooked up to the master clock at the Naval Observatory—but this is an old story. It has long been sending out, every day, weather reports and ship orders. Also Naval press news, so that mariners in and out of the Navy, shore stations up and down the Atlantic Coast and remote agencies and individuals innumer-

able have their daily newspaper, including the baseball scores, the football scores, almost everything except the morning murder.

You have only to consider what time, one of the constants in navigation, means to mariners, as well as to jewelers, to realize a phase of the service NAA renders when, at 11:55 A.M. and 9:55 P.M., the warning dashes flash out three or four thousand miles in all directions, followed by the longer dash that says "noon" or "10 P.M." exactly, 75 degrees meridian, Washington. Or go out with the Atlantic Fleet, see how the news is welcomed, and you understand even better what service that old spark set gives. Or consider what the weather forecasts mean to farmers and mariners. Yet these are only part of NAA's work. A big bulk of official orders, warnings about lightships out of position and of derelicts and icebergs,—to help prevent disasters like that of the *Titanic*—Shipping Board orders and re-routings, and thousands of other messages for the Navy or other Federal departments are all handled via NAA.

But this isn't all; for while NAA is giving over much of its former long-distance work to NSS, the more powerful near-by Annapolis station, it is going about the business of greatly

enlarging its usefulness in other directions. On that 7,416 square feet of floor space of the main building, which includes a well-equipped machine-shop and much other equipment in addition to motors from one-fourth horsepower up to 220, there are now six sending sets: (1) The spark set; (2) a 500-cycle A. C. tube set, for local work, such as traffic with New York, Boston, etc., and with ships out of range of shore stations along the Atlantic Coast and for Army work via one of the new antennas; (3) a 30-kw arc set for Navy long-distance work traffic to Guantánamo, Key West, Cuba, etc., for broadcasting general information from other Departments, for aeronautical reports, weather reports, etc. This set is going almost twenty-four hours a day and uses the big antenna mainly; (4) a 250-watt tube set for airplane work, using, generally, a secondary antenna swung between the two 450-foot towers; (5) another 250-watt tube set using the big antenna, for speeches, concerts, etc; (6) a long-wave 1200-watt telephone tube set, for band concerts, talks by the President and Cabinet, etc., with which the large antenna is also used.

Three of the sets use, it will be noted, the big antenna, but since all the four tube sets at NAA are used experimentally, and the antenna used with the arc set varies with the wavelength employed, all five antennas are used in various combinations. Here, again, now, you see NAA functioning, while doing a man-size routine job, as a great experimental station.

But from the popular point of view the transformations and experiments at Arlington are interesting mainly for the following reasons:

In the first place the Army and the Navy are for the first time consolidating their radio forces on a large scale. This means that the Signal Corps, confronted with the necessity of building a powerful station to serve, as none other could, as the control station of its net, was able, by pooling its interests with the Navy, to save \$50,000 or so by making use of Arlington instead of building a new station.

There's an economy for you and other taxpayers, but the mere matter of saving money is not the big story. This pooling of forces means a lot more. It means that the Army and Navy are pulling together better than ever before in radio; that the provisions by which the Army handles Navy inland business, such as traffic with recruiting stations, and the Navy

handles Army business to distant transports, stations, etc., are working out with real promise; that the Army and Navy have the promise, together, of developing an aircraft net, with NAA as the control station, that will, first by supplementing the Post Office airplane chain, later, conceivably, by coöperative work with it, get vastly better results than ever before. And since the radio work of the Shipping Board is also handled by the Navy, the Shipping Board is also in the picture.

But the important thing is that the strengthening of NAA for other than long-distance work alone means this: That the Government itself anticipates the time when, with the incredibly rapid development of all sorts of private and public utility intermediate broadcasting stations, *one* Federal station can do *all* Federal broadcasting to the public. And that station, if one reads the signs aright, will be NAA.

The Federal squabble in radio, in other words, is settling, and the passing of the pending radio legislation will simplify the station more. For months now, ever since the Radio Conference formulated that legislation, the inter-departmental radio board called into being by Secretary Hoover has been meeting pretty regularly, to discover ways in which to give all Federal Departments their due in radio and to make the most of the situation as it stands. Even as this is written, steps are being taken to allocate to each Federal Bureau such opportunities as it requires for broadcasting via the Navy's Anacostia laboratory station, NOF. And those who know the Navy's plans know that NOF is not long to retain this function—NAA is to have it.

In other words, NAA, so far as the radio public is concerned, is on the eve of becoming the biggest thing on the Federal horizon. Pending that time, the old giant on its hill is being rejuvenated and in large measure re-equipped.

As a pioneer and as a great experimental station, NAA has done its bit and is continuing to do still more; yet two years ago there was serious talk of dismantling it. We have seen how, as a public utility, it has become almost indispensable, with its weather reports and so on.

But that isn't all. The time is coming when even debates in Congress are to be sent out by tube! That's cheaper and better than paper, easier than reading the *Congressional Record*. Will NAA be the station to do it?

Making Tubes Do Double Duty

How the Pries "Reflex" Circuit Uses the Same Tubes for Radio and Audio Frequency Amplification

By FRANK M. SQUIRE

Chief Engineer, DeForest Radio Telephone & Telegraph Company

CONSIDER for a moment our utter dependence upon the benefits accruing from the invention of the wheel and axle and the appalling, befuddled state in which mankind would be to-day if this invention had not been made. In just such a state would the radio art now rest if it were deprived of the treasure with which it was enriched by Dr. Lee de Forest's invention of the audion.

Electricity is the art and science dealing with the production, the use, and the manifestations of infinitesimally small charged particles known as electrons. We believe that these particles are free to move through certain materials such as metals, which we call conductors, and are capable of a certain limited elastic displacement through other materials, which we call insulators. Although it was long known to scientists that electrons could be made to bound a short distance away from a hot metallic body and would then return to the heated body, that is to say that electrons or electricity could exist freely in space, it remained for De Forest to devise simple means and methods for establishing useful continuous paths for this free space and current and other novel means and methods for its control.

He demonstrated that he could control a powerful stream of electrons in space by a small electric or magnetic force and mould this heavy stream or electric current into exact conformance with his controlling force, the action being not unlike a trigger or valve action. The layman would picture an electric valve as an intricate maze of switches and noisily moving parts, in a brew of magnets and coils of wire. He is generally astounded to find that it is a static device that is physically little more complex than the familiar incandescent lamp. Dr. De Forest coined the name Audion from the Greek derivative meaning "I hear the ions."

The audion consists of an evacuated chamber, usually a glass bulb in which is mounted a filament similar to an incandescent lamp and

from which, when heated, the electrons are emitted into the space. These electrons would bound back upon the filament if it were not for a second metallic body called the plate, which is mounted in the tube and generally shaped to surround the filament. The electrons may be drawn off the filament across the space between the filament and the plate by properly applying a potential difference between them. The electrons fly across the space at a terrific velocity of the order of tens of thousands of miles a second, making our highest velocity bullet a mere sluggard by comparison. The problem of controlling the flight and even stopping these electrons would appear insuperable, and yet it is accomplished by a third element comprising a grill or mesh of fine wires known as the grid, which is supported in the space between the filament and plate and through which the electron stream must pass in going from the filament to the plate.

In this form of audion, Dr. De Forest controls the electron stream or electric current that is set up across the space in the tube merely by applying slight potential differences between the grid and the filament and accomplishes this remarkable action with an apparent absence of inertia. Complete openings and closures of the electric valve have been effected at the rate of hundreds of millions of times a second.

In 1912, John Stone Stone announced that Dr. Lee de Forest had discovered a method of amplifying voice currents, that is to say, had discovered a method of producing a relatively strong voice current exactly conforming with a corresponding weak voice current by means of an action of the audion known as its relay or amplifying action. The audion was immediately applied to telephone lines and clear and distinct telephony resulted from its use.

Radio engineers were stimulated by this announcement and many circuits and arrangements were devised to utilize the De Forest discovery. The most widely advertised of these is the "feed-back" or "ultra-audion" circuit which accomplished in one audion the

amplification that De Forest had previously obtained in a multi-audion or "cascade" amplifier. The ultra-audion had the additional advantage over the cascade amplifier in that it reinforced the radio-frequency currents prior to their rectification and thereby increased the sensitivity or range of the receiver when operating on weak signals. The circuit suffers from the great disadvantages not present in the cascade amplifier, namely, that it is operated at a point of great instability, and in general use sets up the radiation of interfering pulses which interact with the transmitted waves and cause the familiar squeals and whistles that are so annoying to the broadcasting radio audience. These interfering pulses also interact with the transmitted waves to cause a most disagreeable distortion or "mushing" of the received speech or music to the entire locality within the range of the radiating receiver.

Due to the low cost of production and the initial inexperience of the broadcasting public, enormous quantities of the whistling or interference producing types of receivers were placed on the market and absorbed by the public last winter. The worst offender is the single-circuit set of this type designed for use on an open antenna.

The future of broadcasting demands the retirement of all forms of radiating or interfering sets. A constructive programme might be worked out along the lines of the modification in the objectionable types of sets now in the hands of the public by the original manufacturer and a re-design of the present product of the manufacturers whose equipment radiates or interferes in the process of normal adjustment. The addition of a simple device to the existing receivers makes this possible at nominal cost.

The De Forest Company pioneered the broadcasting of music and entertainment as early as 1913 and appreciating that an inevitable Radio Tower of Babel would result from a dense operation of ultra-audion and other varieties of "whistling" receivers, produced for this use only such types of receivers as were strictly non-radiating. In the meantime their research organization was busily occupied in attempting to devise a receiver solution that would combine a great sensitivity and still be free from the production of radiating interference of either the "mush" or "whistle" types. After many disheartening

failures their efforts were realized in their acquisition of rights under the Priess amplifier inventions and the particular embodiment employed by them is in their design of the Priess "reflex" receiver.

This receiver is a three-audion design that possesses a very great sensitivity. It will provide good telephone reception without any form of antenna and merely the tuning coils in the receiver at distances of approximately fifty miles. It will give similar reception from a two-foot coil antenna with which the set is equipped over ranges in excess of 1000 miles. If an open antenna is used with the set, it need merely be a short wire run entirely inside the house from the receiving set to the moulding around the room and thereby completely dispense with lightning switches and the usual elaborate outside rig. An outside antenna may be used if desired without emitting interference. Added to these advantages of extreme sensitivity, the elimination of the outside antenna, the property of directional reception, and freedom from the production of interference, are a superior quality of distortionless reproduction that faithfully records the modulation of the transmitter, a small number of operating adjustments and a pronounced stability.

I am certain that the readers of RADIO BROADCAST will welcome a brief outline of the history of the conception and effort that culminated in the invention of the Priess amplifier system, since this romance has never been made public up to the present time. In April, 1917, with the prospect of war with Germany becoming increasingly apparent, William H. Priess, then a U. S. Radio Inspector attached to the Second District Office, entered the Navy, and thereafter joined the Radio Engineering Design and Research organization at the Washington Navy Yard, at first in the capacity of Radio Electrician and then as Radio Expert Aide. He remained there until he entered the U. S. Army in January, 1918, and sailed overseas. From the skeleton force of April, 1917, comprising Lieut. W. A. Eaton, U. S. N., Radio Expert Aide L. L. Jones, and Priess, the Washington Navy Yard radio organization was built up by hard work and the acquisition of additional talent to the most productive radio research, design, and development organization in this country. They were charged exclusively with the development and design of all radio receiving and amplifying apparatus to be used by the Navy and with the

prosecution of vacuum-tube development and production. In April, 1917, the Navy Department did not possess a receiver or amplifier of its own design, excluding minor modifications of standard apparatus of other manufacturers. The existing receivers in use by the Navy were very poor in selectivity. None of the oscillating forms of receivers would actually oscillate below 800 meters. Amplifiers were not in general use, owing to a lack of the necessary audions and the general unreliability at sea of the types then available. There was a severe shortage of vacuum tubes. No approved aircraft transmitting or receiving equipment was available. Ten months later, due to the untiring efforts of Eaton, Jones, and Priess and the support of others in the Navy Department (notably Commanders Hooper and Le Claire), the entire aspect of the situation had been altered. The Navy was in possession of its own designs of selective receivers for ship, air, and shore application that ranged from 35 meters to 25,000 meters and regenerated all over this range, audions in such quantities that store stocks could be maintained, amplifiers, and many special devices which are confidential naval data. In addition, the ice had been broken on tube transmitter design, and numerous improvements devised for arc transmitter signaling, and certain circuits developed that permitted the simultaneous transmission and reception from a single station.

During the war, all technical minds in Navy service and employ turned for recreation to devising methods for locating and exterminating the undersea peril of the German submarine. Jones evolved a system of submarine detection based upon magnetizing the steel hull of a vessel with an audio-frequency alternating magnetic field, and arranging coils on either side of the field near one of the poles in such manner that when cross-connected with a receiver they balanced out the electromotive forces induced in them. If media of greater permeability than water were introduced on one side of the ship—for example, the iron hull of a submarine—the flux from the ship through the space on that side would be increased and the balance disturbed. Either an orientation of the coils or the ship would give a direction line and a base run establish the location of the hidden menace. The solution was a very ingenious one but not considered by Jones of sufficient range to have warranted its installation.

Priess worked on his pet theory that the



FRANK M. SQUIRE

The author of this article, completed models of the "reflex" receiver last summer and has had excellent results from them in rigorous tests

submarine would, when running under water, emit a complex but regular high-frequency radiation, modulated by some complex but regular low-frequency envelop due to the high-frequency oscillations set up by the sparking of the brushes on the commutator of the electric driving motor and the modulation affected by the regularity of this sparking and the influence of other pulses due to parasitic effects of pole tips, short resonant circuits, and so on. This radiation should be capable of directional reception. Its regularity and characteristics should serve to identify the type and speed of the submarine. He reasoned that the predominating radio frequency would be at the natural period of the submarine hull, and that the predominating audio-frequency modulation would depend on the sparking rate, that is, the speed and number of commutator bars. He concluded that the receiving device would have to be several orders of magnitude more sensitive than existing receivers since the pulse would necessarily be weak and that the investigation should include all frequencies since no German submarines were available to

measure the predominating radiated or modulating frequencies. Benefiting greatly from the tube tuition and experience of Jones, and the open grid circuit audio-frequency amplifier designs of De Forest, he plunged into this problem early in May and by the middle of January, the following year, had evolved many discoveries of new fundamental principles, methods, processes, and apparatus for stable highly efficient amplification of any frequency from the high radio to the low audio frequencies, non-distorted audio-frequency amplification, the control of the breadth of band of an amplifier, certain simple circuits for heating filaments of a receiver or amplifier audion from a line, many designs and principles relating to coupling means between audions to effectuate amplification, and many important amplifier circuits.

Results were netted mainly from methods of attack based upon conceptions of physical actions and reactions in the coupled tubes as not much different from the familiar resonant-coupled circuit solutions evolved in quenched spark-transmitter practice with account taken for the amplifying constant of the tube, its grid and plate circuit characteristics and the capacity couplings between the tube elements. Pries designed and released for production before leaving the Navy several amplifiers, the most widely known being the Type S. E. 1000. The United States Government has prepared and filed a patent application on the Pries amplifier inventions, receiving a license for government use and ceding all title and commercial rights to the inventor.

The "reflex" set of the De Forest Company is known as their Type D7. The author designed it, as a combined three-tube amplifier and receiver. The receiver includes a two-foot coil antenna and tuning condenser system. It has a wavelength range of 250-500 meters with an adequate overlap. The original model of the Type D7 included a primary and secondary coil system to provide reception from an open antenna via the usual two-tuned circuits. In the later models the coupler has been replaced by a vernier condenser although posts are retained for antenna and ground connection to permit the user the same flexible antenna systems and at the same time reduce the number of adjustments in the set. In this form, if an open antenna is used, it is always used in combination with the coil antenna. The received powers of both open and coil antenna are then

additive and both antennas are simultaneously tuned by the same adjustment knob. The coil antenna is a pancake coil of a size usually found in transmitter loading inductances. It operates to receive via the electric and magnetic components of the wave jointly as shown in the coil or directive antenna patents of Lee de Forest and John Stone Stone owned by the De Forest Company and not, as popularly believed, as a receiver solely of the magnetic component of the wave. The latter is a phenomenon of induction and not of radiation.

The received power stored in the tuning condenser is impressed upon the grid circuit of the first tube and is then amplified through each of the three tubes at radio frequency, building up the received signal from an infinitesimal value to a very great amplitude. The signal is then rectified by a galena crystal detector and "reflexed" back and its potential raised through an audio-frequency transformer to the grid circuit of the second tube. It is then further amplified at audio frequency in the third tube and the complete output drawn off the plate circuit of this tube. A control is placed in the grid circuit of the first tube to enable a continuous variation of the grid circuit damping over a range resulting from the grid current losses that follow the change of grid potential from a value of zero to a positive value equal to the potential drop across the filament. This is not a grid "bias" for the purpose of securing rectification or operation on the non-symmetrical portion of the tube characteristic nor an application of grid potential for the purpose of securing operation on the symmetric portion of the tube characteristic as clearly evident from the range of these values and the fact that neither of these effects if present are in any manner useful in the Type D7 circuit. All the remaining grid circuits of the amplifier are tied in permanently at zero potential and are therefore in a condition essential for them to be highly efficient amplifiers.

The type of radio-frequency amplification in the Type D7 is of such form that it provides an enormous sensitivity accompanied by a correspondingly great stability. It is effective over a very wide band. The transformers have an insulation between primary and secondary sufficiently great to safely withstand potential differences of the order of 1500 volts.

Since all detectors have a threshold value,

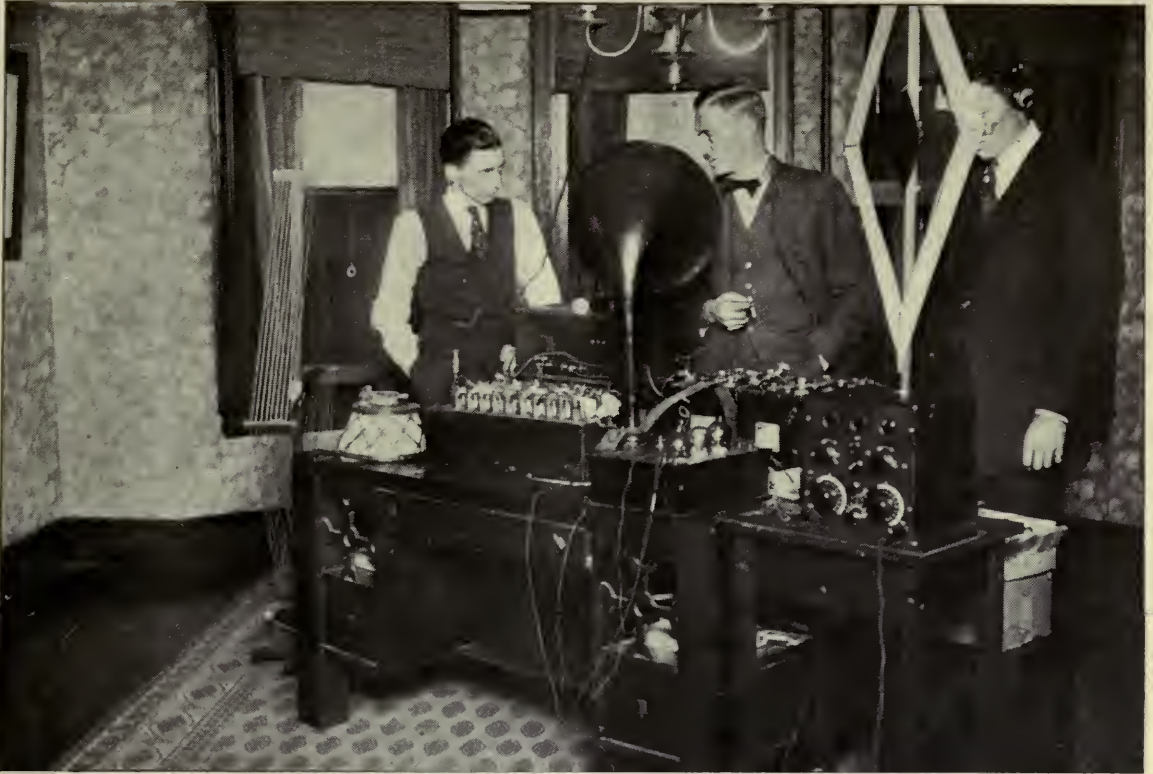

TRYING OUT THE REFLEX RECEIVER

Left to Right: Arthur H. Lynch, Richard Wagner (whose remarkable no-aerial receiver was described under "How Far Have You Heard?" in the December issue), and Frank M. Squire

that is to say they require a certain appreciable minimum value of radio-frequency amplitude before they are operative, the problem of distant or sensitive reception necessarily requires a system of radio-frequency amplification prior to the detector to attain at least this threshold value. It is an error to evaluate a detector followed by a powerful audio-frequency amplifier as the equivalent of a correspondingly powerful radio-frequency amplifier feeding a detector, for the reception of weak signals. The radio frequency solution is satisfactory; the audio solution is not, for if the threshold value of the detector is not attained, the following audio steps have nothing to amplify; the radio frequency steps start at an infinitesimally lower limit and are effective up to the point of saturation of the detector. In radio-frequency amplification there is no tube or transformer noise and if the correct principles and method are employed in the design there is no distortion. Very high audio-frequency amplification is accompanied by tube noise and, in certain designs, by transformer noise and generally plays

an independent tune of crackles. It is also very susceptible to distortion.

The receiver employs a crystal rather than a tube as a detector. This use of a crystal sensitized by a radio-frequency amplifier between it and the antenna has never been previously applied to commercial sets due to the presence of many difficult problems involving instability and reaction. Radio engineers have for a long time appreciated the inherent value of the solid rectifier in this general use, but it remained for Priest to solve the problems in a balanced adjustment, free design, and attain the inherent benefits accruing from its use. Some of these are: a total absence of parasitic noise at the rectifier which ordinarily occurs in a detector tube and is amplified at audio frequency to a disagreeable amplitude, the relatively greater freedom from distortion of a crystal as compared with a detector tube, the elimination of a number of detector-tube adjustments and the necessity of changing them very materially as the tube ages, and the saving of a tube and the filament and plate

powers required to operate it. In this use of a crystal, all points on the crystal give reception and the adjustment of the contact point merely gives a variation in the received signal. Furthermore, the adjustment will remain fixed for months since it is not effected by static or the factors which are present in the usual crystal circuit. The crystal is both electrically and mechanically cushioned against both types of shock.

In the Pries "reflex" circuit, used in the Type D7, the vacuum tubes are made to perform simultaneously a double duty, first as amplifiers of radio-frequency currents and then as audio-frequency amplifiers without instability or squeals and with each amplification separately efficient. Added to this phenomena there is a certain amount of radio-frequency "reflex" which is accomplished by adding to the combined amplification some of the double-frequency radio frequency generated in the detector circuit and led back via the mutual capacity of the transformer windings and the capacity of the wiring and circuits in the set. "Reflex" is not feed-back or regeneration. In feed-back, changes in plate-circuit potential caused by corresponding grid-circuit potential variations are reimpressed in identical wave form, phase, and frequency upon the grid circuit and they result in additional changes in plate potential, or an amplification. In the phenomena of "reflex" an output circuit which may be a grid circuit or a plate circuit or a circuit coupled to either or both of them is passed through some device which changes any one, two, or all three of the characteristics of the phase, wave form or frequency of the output wave, the resultant—which is usually of a complex form and may even be discontinuous periodically—is then impressed upon a grid or a plate circuit of the tube device which is primarily causing the "unreflexed"

output. Reflex may be at higher frequency than the output frequency and usually a harmonic, or at a lower frequency, or both step up and step down may be simultaneously present.

Several reflexes are possible simultaneously in a tube. In feed-back, factors are present to hold the system in phase. In reflex no such factor is useful in most of the simple forms.

The writer completed models of the Type D7 in August and has since had them under rigorous tests. In one of the tests the set was installed with its coil antenna inside the metal body of a Hupmobile sedan with the intention of determining both the action of the set in dead localities and its daylight range on the Newark, N. J., station. Tests were made every five miles without removing the set from the car. At sixty-five miles from Newark, no appreciable reduction was found in the received signal and this test was abandoned. Good reception was had at all the notoriously "dead" spots on Long Island. The jouncing of the machine did not affect the crystal detector adjustment during these tests. Tests were made with the set installed inside of steel frame buildings in the heart of New York City. Both local and distant reception was very good under these conditions. At his home in Bay Ridge, N. Y., the writer has received practically all of the stations east of the Rockies and north to Buffalo and south to Havana using the coil antenna provided with the set. Good success has also been had by backing up the output of the set with power amplifiers for the entertainment of a group of listeners.

Owing to arrangement with the inventor certain of the methods, principles, processes and apparatus involved in his invention are being maintained as secret, and it is regretted at this time that these details cannot be made public.

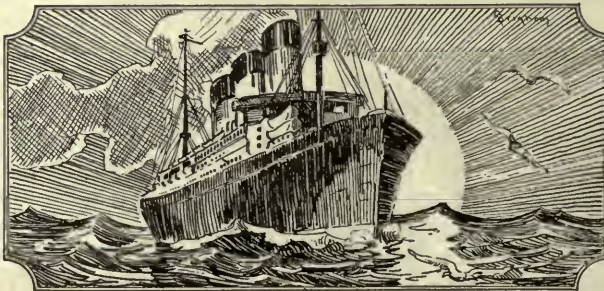
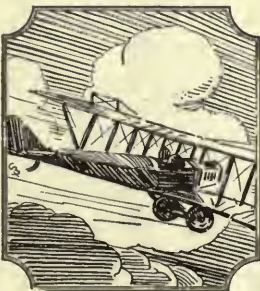

The "Ham" What Am

By ROBERT F. GOWEN

I AM just beginning to find out why I did not remain in China. I left there sooner than I had planned as I felt I was getting out of touch with radio development at home. Letters from my friends told obscurely of the remarkable inventions that had taken place in the short nine months of my absence; of how broadcasting had revolutionized both transmission and reception and that I would have to begin all over again and learn the new game of 1922. But the temptations to stay were many. I had learned to like the Chinese people with whom I was doing business and they in turn almost refused to let me go. They insisted that I should stay with them for another year at least, working out their radio problems which, though difficult, were intensely fascinating. I felt I could not afford to get behind the times. And now I am just awakening to the fact that it was not being out of touch with the new development that was worrying me but that I was hankering to get back to my old amateur set and into the game again as a "Ham," which, after all, gives us more pleasure than the professional phase of radio.

And what did I find on my return? Listening in on 200 meters brought back the old thrill that one gets when he is able to copy a little code after a long struggle as an amateur to learn it and to send it out with a home-made transmitting set made up of miscellaneous junk parts at a minimum of expense. There were a few of the oldtime buzz-saw rotaries asking each other "QRK" and "QRU" with the usual "MSG," etc., tacked on. I noticed an increase in the number of CW and ICW sets though the traffic was pretty light, it being the off season when the static was bad. I tuned to 360 meters and heard a babel of phonographs sending out the inevitable jazz just as I and many others had done some two years previously.

I began to look for the new developments, and beyond the Armstrong super-regenerative circuit, the value of which seems to be somewhat questionable in its present state of development, I am still looking for them. In other words the stunts which we, as amateurs, had tried out and discarded as worthless have now been commercialized to be inflicted upon the

unsuspecting public. I had heard that some wonderful thing had been brought out by which you might use the electric wiring in your home as an antenna and thus do away with expensive outside aerials forever. I found it to be nothing but a condenser such as we used in attempts to employ electric light wiring and telephone lines as aerials in the old days, the only difference being that the condenser was now moulded into a plug form that would screw into the ordinary electric light socket. The results obtained with it were identical with those we used to obtain, i.e., practically negative. So now I am not quite so worried about being behind the times except in one respect and that is that I find that practically all my old amateur pals have also been commercialized and are now operating broadcasting stations or acting as chief engineers for the thousands of radio manufacturing companies that have sprung up during the past year.

Broadcasting progressed as the public got tired of "canned" music. The Government was forced to allot a 400-meter wave to super-broadcasting stations which were not allowed to transmit music of the "canned" variety and were therefore compelled to send out something worth while. This was excellent and a great step in advance. And then what happened? The public who were beginning to enjoy broadcasting were beginning to hear strange things with the many cheap, single-circuit tuners that the thousands of illegitimate, so-called "radio-manufacturers" forced upon them. These strange numbers which were not on the programme consisted of dots and dashes which interfered with the listeners' enjoyment of the music, and Mr. Public, having read in the papers that the country was infested with amateurs immediately said to himself, "Why, that is an amateur next door bothering us and he has no right to play with his apparatus when we want to hear this music that is so worth while!"

And so to-day, the "Radio Fan" as he is popularly known, is attempting to bring legislation to squash the amateur and put him out of business on the ground that he is a nuisance and is merely playing with a toy that bothers other people. But Mr. Public does not stop to real-



“THE HUB OF THE RADIO UNIVERSE”

Mr. R. H. G. Matthews, known to hams as “Matty,” is here shown operating the “hub,” which is so-called because, located in Chicago, it is a clearing house for amateur messages in all directions

ize that if this is true perhaps he too is playing with a toy for his own amusement. He does not understand or appreciate what “wavelength” means. He does not even know what kind of a circuit he is using for reception and that if he used a different type of circuit, perhaps a little more expensive or perhaps even cheaper (if bought with more intelligence), he would not hear the dots and dashes when he wanted to hear music. He does not know that if he had the proper type of receiver and knew how to tune it he could hear either dots and dashes or music at will, one without interfering in the least with the other. And the problem is, how are we going to educate him to these facts so that he may play at the same time that the amateur is playing?

But does the amateur play, and what is a “ham” anyway? Perhaps not ten per cent. of the readers of this article know the proper definition of the word “ham.” And yet it is very simple. A “ham” is not a small boy

using a spark-coil, jamming up the ether with noises sounding like a boiler factory in action, but a young man of the average age of twenty years, who has enthusiastically studied radio both theoretically and practically and whose idea is to better the art in any way he can by unselfish application. He has solved many problems that have confronted him, not for financial gain, but for the love of the thing. The very apparatus that you are using to-day, as well as the equipment that is sending its music to you, is the result of his effort and conscientious endeavor. The man who announces at a broadcasting station is a “ham.” The man who operates the broadcasting transmitter is a “ham,” and the man who designs your receiving set is a “ham.” Why? Because no one but a “ham” can do these things. When I was chief engineer for the De Forest Company, designing among other things radio telephone transmitters, purchasers would ask me to get them men to operate the equipment that they

bought. Do you suppose I could get a commercial operator to operate a radio telephone set? No. I found they knew absolutely nothing about it and in every case I had to get a "ham", simply because the former was a man who knew only how to press the key and read code while the latter was a technician who had trained himself in the fundamentals of radio and knew how to analyze the circuit and keep it functioning properly in addition to his knowledge of key pressing. Likewise, every man I had in my laboratory was an amateur, not because I was one but purely because they were the only men obtainable who could tackle the problems placed before them. The question naturally arises, "Why does the amateur have such enthusiasm and why does he not lose interest after a while?" The answer is "sportsmanship." This sportsmanship is the finest type we know of, as it is dependent for its existence on personal unselfishness in not interfering with the other fellow; a sportsmanship that breeds good fellowship. Then there is the mystery and thrill of it and the tremendous

incentive to beat the other fellow's record. And some of these records are hard to beat. Fellows on the Pacific coast and some as far east as Minnesota "work" an amateur in Hawaii nightly. Figure the distance for yourself and remember that these stations are restricted to an output of 1 kw. of power and usually employ less than this amount. And this with home-made apparatus!

Everyone knows of Frank Conrad, assistant chief engineer of the Westinghouse Electric and Manufacturing Company, and Paul Godley who went to Scotland to listen for the transatlantic tests of the amateurs. These men are "hams" through and through, always were and always will be, and there are hundreds of professionals just like them though they are not so well known. Did you ever hear of Mr. H. P. Maxim, President of the American Radio Relay League and his fine station that does remarkable things at Hartford, Conn.? Then there are Irving Vermilya at Marion, Mass., "Johnny" Clayton at Little Rock, Ark., J. A. Gjelhaug at Baudette, Minn.; A. L. Groves at

(BELOW) 9QK, A PRE-WAR STATION

Built and operated by John
A. Gjelhaug, Baudette, Minn.



(ABOVE) MR. GJELHAUG'S NEW STATION

Located in Baudette, Minn. This picture was taken November 27, 1922

Brooke, Va., C. R. Runyon at Yonkers, New York, Mr. and Mrs. Charles Candler at St. Mary's, Ohio, and a host of others too numerous to mention, all known from coast to coast for their untiring enthusiasm in American amateur radio. There is the ever popular "Matty"—R. H. G. Matthews of Chicago, one of the best known "hams" in the game. And yet he never did anything very startling. He is not of the fireworks type. But he runs a station, 9ZN, that has been called "The Hub of the Amateur Universe" because it can be absolutely depended upon to relay messages north, east, south and west, a thousand miles or more any night without fail. It has been built and rebuilt by Matthews and his assistant operators to a remarkable state of efficiency which every true sport is bound to admire. Then too "Matty" is the manager of the Central Division of the A.R.R.L.

A.R.R.L., the American Radio Relay League, is an organization of thousands of these amateurs, conducted by and for amateurs. It came into existence in the old days after the ama-

teurs in the East awoke to the fact that there were a lot of them located all over the country. The thing that awakened them was the Federal Radio Law of August 13, 1912. Among other things which this law provided was a call book and this book contained the names and addresses as well as the call letters of all the amateurs who had passed the necessary tests to secure transmitting licenses. The book disclosed the astounding fact that there were several hundred of them scattered over the various States of the Union. It demonstrated immediately that it was a good thing to observe the law and take out a transmitting license because it established one's standing and gave one a dignified position among the better amateurs of the country. With it came the birth of the radio club. It came from the natural tendency to gather together and exchange experiences, information and knowledge. In this way the radio club became the meeting ground of the amateurs and presently there came into being a wonderful spirit of fraternity. One felt a queer little thrill at these early radio club meet-



THE AERIAL IS OUT OF THE WAY UNDER THE TOP

With this portable set, Mr. Gjelhaug has heard long-wave arc stations hundreds of miles away with a single tube. While the car was making twenty-five miles an hour, he has copied signals from a spark-coil transmitter using 12 watts input, up to five miles

ings when he came face to face with the fellow he knew well in the air but whom he had never seen. To one who has never sat in his little back room late at night and conversed with another fellow seated in *his* little back room away over in some remote town, and then finally come to grasp the hand of this fellow, can never come this peculiar thrill.

The radio club was the natural birthplace of the relay. It probably developed in the minds of several of the clubs at about the same time, but it was in the Radio Club of Hartford, Conn., that the relay idea which finally became the American Radio Relay League first took practical form. It was born of the fact that one amateur in Hartford found he could communicate with another amateur in Windsor Locks, 25 miles away. If Hartford could reach Windsor Locks which was half way to Springfield, why could not Windsor Locks reach Springfield? And if this could be done why would it not be

possible to branch out and to eventually link up with amateurs in distant parts of the country? The idea was an incentive for the amateur to study and work harder and to improve his apparatus to cover great distances, to simplify it and to make it more practical.

Just look at the result! To-day the whole United States is divided into operating districts, each supervised by a competent and enthusiastic amateur who is responsible for the traffic in and through his district. He appoints amateurs to take care of traffic along certain lines so that now there are trunk lines from one end of the United States to the other, North, East, South, and West by means of which messages may be sent to any point in the United States. The organization is so perfect that substitute stations and even alternate



MR. GOWEN'S STATION IN OSSINING, N. Y.

The tube transmitter, mounted on the upright panel at the right, is used for broadcasting and has been heard all over the country

lines are established to handle a message should an amateur on a regular trunk line be out of commission for any reason. Monthly reports of the traffic are made by the Division Manager to the Traffic Manager at the headquarters in Hartford, Conn., and these are published in the official organ of the League, a truly remarkable magazine known as "QST." The nominal dues of the association go to pay the expenses of publishing this magazine which is no small matter and requires to-day a rather large office force.

What have the amateurs accomplished by such organization? To begin with they have maintained their very existence by it for attempts have been made from time to time to legislate against them. By appointment of the present vice-president, Charles H. Stewart,

as chairman of the Legislation Committee of the Association, it has been strongly represented at all hearings of radio bills in Washington with the result that bills detrimental to the interest of amateur radio have been tabled. Such representation has been of vital importance and the amateurs are now called in for consultation on important matters of radio policy so that Mr. Stewart and others were present at the Radio Telephone Conference called by Secretary Hoover last Spring.

The record of war needs no telling. These young amateurs to the number of nearly five thousand gave to Uncle Sam in his Army and Navy the best radio operators the world has seen. It is no reflection upon the Navy or Army operator to say that the amateur beat him at his own job. The amateur had developed his extreme expertness because of his love for his hobby, and he represented furthermore the pick of the young men of the country. No matter where one went in the Army or in the Navy during the war one encountered the amateur on every hand, from the high officer to the enlisted man. The chief operators in all of the important stations were ex-amateurs. When President Wilson journeyed to France

and back, the chief radio operators on the *George Washington* were ex-amateurs.

And now all of these young men are amateurs again, and in these days of peace, they have rebuilt their organization. Their recent accomplishments are a good indication of what they are and what we may expect of them in the future. Over a year ago they decided to demonstrate what their organization could do in the way of a rapid interchange of messages from the Atlantic to the Pacific and back, and from the Canadian border to the Gulf of Mexico and back. A series of messages was started from Portland, Maine, Boston, Mass., Hartford, Conn., New York, and Chicago, and destined for points on the Pacific Coast and on the Gulf of Mexico. Each of these messages had to be relayed through several stations, the message delivered, the answer secured, and this answer transmitted back to the starting point. A Portland, Maine, organization sent a message to a Portland, Oregon, station, and received its answer back within an hour. Similar messages went from the various points mentioned. One message originated in Hartford, Conn., and was addressed to one of the amateurs in Los Angeles, Calif. From the time that this mes-

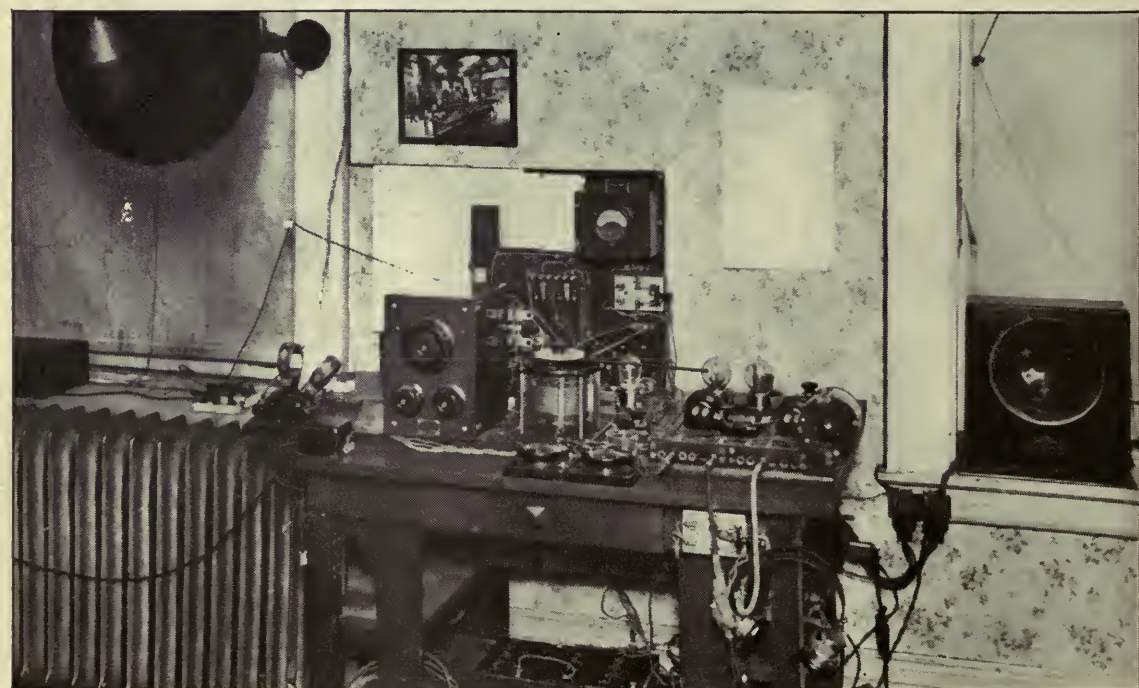

SOME BROADCAST ENTHUSIASTS PROCURE ELABORATE APPARATUS

For the purpose of getting the distant stations. In a receiver of this type there are entirely too many adjustments for the "ham" to bother with, especially where rapid DX (long distance relay) work is carried on



THE STATION OF HAROLD ROBINSON AT KEYPORT, N. J.

When built, the transmitting apparatus of 2QR was of better design than that employed on most commercial vessels. However, spark transmitters are rapidly going into the discard in favor of the continuous wave system. The tube transmitter which supplanted the one shown at the left in this picture was heard in Aberdeen, Scotland

sage started its first dot at the key in Hartford to the time the answer was received back from Los Angeles and all written out on a telegraph blank was just *six and one half minutes*. This message was relayed at Chicago and Roswell, New Mexico, and the *esprit de corps* was such that the entire country full of amateurs remained quiet during the interval of the tests so that every assistance might be given to a quick transit.

Within the past year it was decided the technical advance in Amateur Radio and the advance in organization had been such that the greatest of all feats might be attempted. This was to span the Atlantic Ocean by amateur wireless and establish communication between the amateurs of America and those of Great Britain. These young men selected one of their number, Mr. Paul Godley, to go to Europe and look after the reception and encourage the English amateurs to take an interest in the matter. All the expenses were borne by the amateur organization. The result of the transatlantic tests are a classic in radio history, for more than thirty American amateur stations were recorded in the British Isles. On November 22nd last, all records were smashed to atoms when 1 AW at Hartford, Conn., sent a message to 6 ZAC in Hawaii via 9 AWM at

Sleepy Eye, Minn., and the answer returned in just *four minutes and eighteen seconds*. 9 AWM was the only intermediate station! There is no telling where these young men will carry American amateur radio and it is very safe to assume that it will not be long before they will be exchanging messages regularly with their brothers across the seas.

In addition to their own interests in intercourse among themselves they have been of material benefit to radio in general because "Necessity is the mother of invention" and, having but little to work with, they have been forced to find a cheaper and better way out of their difficulties. In 1920, as an organization, the amateurs of this country collected data for the Bureau of Standards which was not obtainable from any other source in the world. Night after night the "hams" sat up and made fading tests on signals sent out from several selected stations in the hope that the data collected would give some insight into the cause of fading as a basis on which to combat it. An analysis of the results obtained, however, showed little of value at the time, but it is believed that later when we know more about the peculiarities of the ether this data will be of inestimable value in overcoming this or similar problems.

The amateurs have checked and rechecked test after test at the request of the broadcast operators and it is safe to say that without the amateurs, broadcasting would never have developed to its present state of efficiency in so short a time. In fact, broadcasting could not have existed without the amateur for he is responsible for the education of the public in the use of receiving apparatus, by inviting his friends to hear the music at his own set. Broadcasting is impossible without an audience and without the amateurs there would have been no audience.

Is it possible, then, that men who know as much about radio as outlined above; men who have designed, constructed and operated the broadcasting stations; men who are conscientiously fair to their brothers in handling traffic and in interference questions; men whose activities have been used many times by an ignorant press as an excuse to cover up some shortcoming of the radio service which has been due to other causes; men who know fully and appreciate the limitations of radio communication and who have therefore unselfishly and without restraint of law agreed to stop transmitting between the hours of 7 and 10.30 P. M. to make certain the enjoyment of broadcast listeners—is it possible that these men maliciously interfere with the work of broadcasting stations on a wavelength removed from that allotted to

them by law? Why should they deliberately wish to go out of their sphere of communication and trespass upon the rights of others, especially since the advent of the Armstrong, Super-regenerative Circuit tends to make for transmission on wavelengths less than 200 meters.

The amateurs have no axe to grind even though in all fairness it must be said that the broadcasting stations, because of their high power output and improper tuning in some instances, do bother them. All they want is to be let alone that they may go forward and develop in years to come with the same remarkable advance as formerly. They agree, as we all agree, that there is a place for broadcasting—a most important place—with its Philharmonic and Symphony Concerts, its Grand Opera and its sporting events as amusement, together with its stock market and weather reports of inestimable value to the public in general. It is fast becoming a public utility that cannot be dispensed with. But American amateur radio must also exist, for of it broadcasting cannot continue to develop to the unforeseen heights to which we are sure it will climb. There are places for both amateur radio and radio broadcasting, and the solution of the clash between them is a mutual understanding of each other's rights.

Proper Radio Legislation is Urgently Needed

By S. W. STRATTON

Chairman of the Committee Appointed by Secretary Hoover to Study Radio Regulation as Discussed at the Washington Conference, and Chairman of the Inter-Department Radio Board

THE fullest utilization of radio implies, of course, better understanding of the laws and principles concerned and the improvement of apparatus for sending and receiving. But such existing problems as that of static interference, and the need of increasing the selective power of receiving sets in general use, only serve to emphasize rather than to diminish the need for such relief legislation as that formulated by the Radio Conference. In the present situation there is no substitute for that legislation.

It is clearly necessary to readjust the allocation of the wavelengths that are practicable for broadcasting. Within the limitations estab-

lished by the law of 1912, the inter-departmental board called together by Secretary Hoover has sought, in coöperation with the Bureau of Navigation, to facilitate the largest possible use of available wavebands. What is clearly needed, however, is the removal of many of the present legal restrictions so far as that is practicable. The bills now before Congress do not fix the details but give the Secretary of Commerce authority by which to make and to enforce such adjustments as conditions warrant and progress requires. Such authority, based on general terms, is particularly needed in a situation which changes rapidly and has so large a promise of usefulness as radio affords.

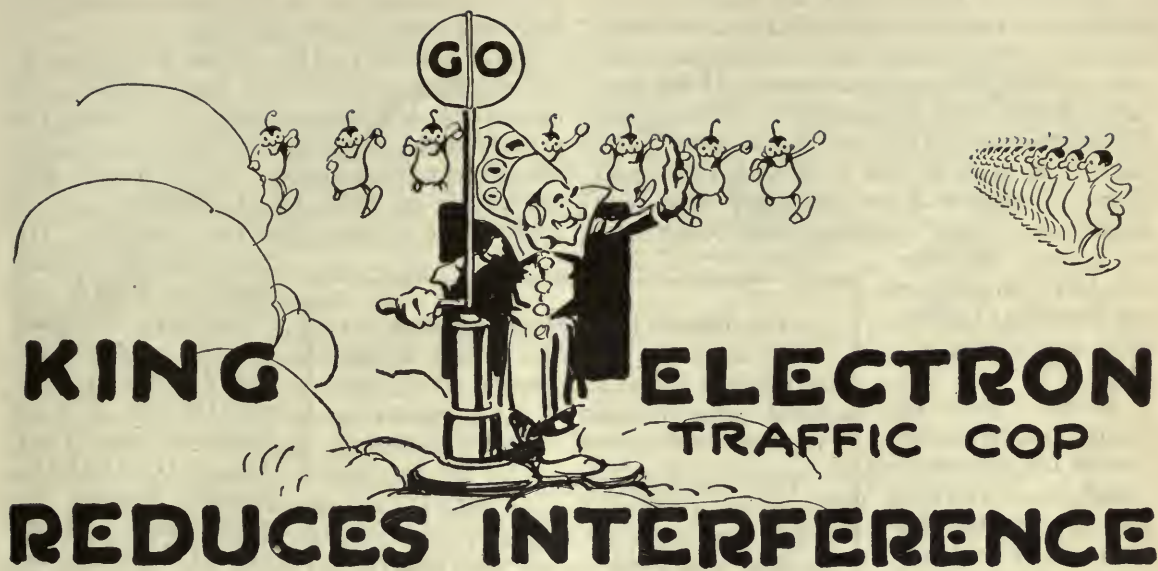

Preventing Confusion Along the Ether Highways. What to Do with the Road Hogs and How Not to Be One

By R. H. RANGER

Engineer, Radio Corporation of America

Illustrated by TOM MONROE

The traffic down Main Street of a Saturday afternoon is nothing compared to the electron congestion down the aerials of the million receiving sets all over the continent. Federal, commercial, and amateur interests are doing effective work in establishing traffic rules and schedules; and each set owner can assist in making this ether highway of the greatest possible service to the country; first, by seeing to it that he is not interfering with other listeners by radiating energy from a too "tightly" coupled "feedback," and second, by making his own equipment as free from interference as possible.

INTERFERENCE of all kinds—electric power lines, motors, X-ray machines, and worst of all, interference between radio transmitters themselves—is now the bugbear of the listener-in. It is no longer a question of not hearing enough, but rather of hearing too much!

First, the non-radio sources of interference. If the disturbance comes in as a soft humming sound, the trouble is most apt to be in the insulation from the ground or building to the set, the batteries, or the aerial wire. This interference is not of a wave variety at all, but comes in by direct conduction of the electricity from a lighting or power source.

If it is on the aerial, disconnecting the receiving set from the aerial with the set still on will produce silence. With the trouble lo-

calized in the antenna, the antenna should be looked over carefully to see where it comes nearest to any such power source. This is apt to be inside the building. To determine if it is, reconnect the aerial to the set and disconnect the outside portion of the aerial where it enters the building. If the noise still continues, the leak is evidently between the outside connection and the set.

All radio wires should be kept as far as possible away from lighting wires. If it is necessary to cross lighting wires, as great an air gap should be maintained as possible between the two, and insulators should support the radio wires as well as the lighting wires. "Loom" or porcelain tube insulation should cover the radio wires where they cross power wires. This "loom" is flexible insulating tubing.

The storage battery and dry batteries connected to a radio set are distinctly in the radio circuits so they should be well insulated from any possible extraneous currents. If the battery is kept dry on the bottom, no difficulty will be experienced. This will be the case if the battery is kept off the floor with two small pieces of hardwood, or preferably with four insulators. These insulators may be screwed to a piece of board slightly larger than the bottom of the battery, which acts as a stand.

Motors. These are the next most common source of outside interference. Naturally, one of the simplest answers to any of these disturbances is to keep as far away from them as possible. However, such interference can be greatly reduced and even completely eliminated, with care. The first thing to do is to determine what motor is at fault. This will be done of course by observing when the trouble is caused, and determining what motor goes on at that time. The same effect which makes a motor cause interference is most apt to be detrimental to the motor itself, so little difficulty should be experienced in getting the owner of such a motor to assist in remedying the trouble. The faulty motor will be found to be sparking badly. This indicates bad "commutator" adjustment on the motor or even worse, perhaps a burned out section. If allowed to continue, this will greatly injure the motor.

There are other methods of reducing interference from such causes such as placing electric condensers across the wire connections to the motor. This involves expense and careful testing, however, and if disturbances continue from such causes, it is better to move your

station, if possible. A removal of some fifty feet may make a great difference.

Noisy Grounds. The ground wire may be picking up a great deal of interference. The method of determining this is of course the same trial of connecting and disconnecting the ground wire from the set. If the ground wire does bring in noise, try a different type of ground. If a water pipe has been used, try

the radiator which should be good in the winter with the steam in it, or try a ground rod driven directly into the soil. A small fixed condenser of say .001 microfarad, placed between the ground wire and the ground binding post of the set is quite effective in keeping out power-line or street-car noises while it still lets through the radio signals readily.

Those who have ground space available will find a "counterpoise" of great value, both from the point of view of absolutely eliminating ground disturbances and also in increasing the selectivity or ability of the set to tune sharply to desired signals. Such a counterpoise consists

The following paragraphs came to us a few days ago from Mr. Robert Brock, of Wallace, Idaho, and express vividly the great value of radio as a companion to those in lonely places.—THE EDITOR.

This is written from a lonesome eagle's nest in the heart of the Coeur d'Alene National Forest. The spot is the Sunset Fire Lookout Station. I have been up here since June 15th, seeing practically no one in all that time—yet I am not alone. My radio outfit is the best company I could have.

Every night I hear concerts from Los Altos, San Francisco, and Sunnyside, California, Portland, Oregon, and Seattle, Washington. Beside the concerts, I hear the telephone conversations between Los Angeles and Santa Catalina Island, and every noon the time signals from San Diego. Using my large honeycomb coils, the world's news is at my finger tips.

It is hard to realize the great value of radio to a man isolated as I am. It is indeed wonderful to hear so clearly music played five hundred or a thousand miles away. It was a lucky thought that I had when I brought my set along with me. It is the most valuable part of my equipment.

virtually of a second aerial of three or four wires spaced some six feet apart and running parallel to and under the antenna. Preferably they should be kept off the ground by insulators, the same as the aerial; but weather-proof wires laid on the ground will give quite satisfactory results.

The set, with no ground or aerial connected, should be perfectly quiet. To obtain this condition in a commercial marine receiving station where very long distance work is accomplished, extreme quietness has been obtained by shielding the sets completely in copper-lined iron boxes—batteries and all. This is more feasible of course when dry-

battery tube sets are used. The radio connoisseur will find his time well repaid in building such a wooden box lined with roofing tin or with copper, with lined front doors to the box as well, so that the set may be closed in completely for the last word in refinement. Even the loud-speaker may be kept within the box to advantage, with a screened opening to let out the sound.

X-Ray Machines. There is no known remedy for removing the interference from an X-Ray machine except getting far enough away from it, or shielding the machine itself.

Smoke Precipitators. A bad cause of interference is a high-voltage smoke stack equipment. The difficulty is greatly reduced if the owners can be persuaded to shield the high-voltage lead to the smoke stack with a grounded metal screen. This also acts as a safety screen in the factory, so it will serve two purposes.

Interference Check. Before deciding that interference comes from any outside source, it is well to check up with someone else in the vicinity to see if he is experiencing similar difficulties. It is well to remember too, that few of the broadcast transmitters can yet give 100% continuous service and quality.

Radio Interference. Wavelength interference is by far the most common source of trouble on cool winter nights when long ranges are possible. The first steps will be the same as those already given, a perfectly quiet set with no ground and no aerial.

Short Aerials. The first and perhaps simplest method of reducing interference between stations of various wavelengths is to shorten the aerial wire. During the winter months, an antenna fifty to seventy-five feet long will give plenty of received energy to the set. With such a short aerial, the tuning in the set will be greatly improved. With a long aerial, the tuner cannot change the wavelength of the complete circuit of aerial, tuner, and ground very much. The tail cannot wag the dog, in other words. With the short aerial, the tuning is largely in the tuner and much greater selection is possible. Some radio fans will like to have two antennas, a short one to get selectivity, and a long one to get the weaker signals when local stations do not interfere.

Loose Coupling. Most of the tuners are of the single-circuit variety. Double-circuit tu-

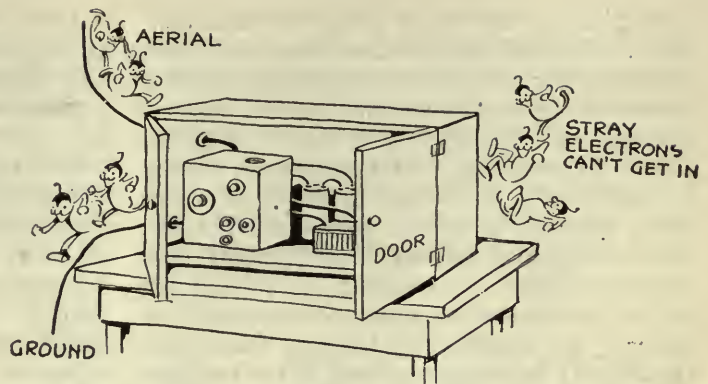

A METAL-LINED BOX

In which the entire set is housed, is of considerable help in keeping out stray electrons

ners are somewhat more difficult to adjust, but permit very much better tuning. As a matter of fact, loose coupling may be accomplished with single-circuit tuners. The shortened aerial is a step in this direction.

To carry the idea further, disconnect the single-circuit tuner from the aerial and ground completely. The aerial and ground are then connected to the two ends of a simple twenty-five to fifty-turn coil. This coil may be of any standard design for radio purposes such as the basket-wound coils or the cobweb type. This coil is then placed near the tuning coil of the single-circuit tuner, say on the cover of the box. The aerial or antenna and "ground" binding posts of the tuner are connected together by a short piece of wire. Or, if another small coil is connected between these same two binding posts, and the first extra aerial coil brought near this second one, the second will pick up the energy from the first, and with the receiver actually loose coupled it will be found by trial that the tuning will be much sharper. As skill is obtained in the adjustments, it will be found possible to have the extra aerial coil quite a distance from the tuner coil.

To make this arrangement a complete double-circuit tuner, it is now only necessary to add a variable condenser between the first extra aerial coil and the ground. The variable condenser should have a maximum value of about .0005 microfarads. This will make it possible to tune the aerial-coil-condenser-ground circuit to the desired signals, and substitutes the "primary" circuit; and the single-circuit tuner which now picks up the energy is the "secondary" circuit of the combination. By varying the position of the extra coils the "coupling" is adjusted.

In place of the extra aerial coil and condenser, another single-circuit tuner may well be used. By this arrangement, one tuner is connected to the antenna and ground, and its detector and any other attachments are completely disconnected. This extra tuner is then brought close to the second tuner which has no direct antenna or ground connection but has its antenna and ground binding posts connected together as explained before and will act on its regular detector and telephone receivers. By adjusting the two sets, the desired signals may be picked up, and as the two sets are moved farther and farther apart, the sharpening of the tuning will be greatly increased although there will also be a diminishing of the strength of the signals. Any two tuners may be used for this double arrangement. Most fans have a simple set with which they started operations which may well be used for the first, and their amplifier set will do very nicely for the second. The simple tuner consists of nothing but a coil and a condenser in series with the antenna and the ground.

Such double-tuning arrangements are best applied to tube sets in which the amplifier tubes make up for the loss in signal energy.

Sharp tuning is by all odds the best means for reducing interference of all kinds. Good ground connections, good insulation of the aerial, and good wire conductors at all points help the sharpness of this tuning. Regeneration also sharpens the tuning, particularly in high-resistance circuits.

Loop Receivers. As a further means of reducing interference, there is the loop aerial. The signals which are coming in a direction in a plane with that of the loop—that is, “end on,” not “broadside”—will be the loudest. This is because the oncoming waves will create electromagnetic charges of slightly different potential in each side of the loop, and the amplifier is used to make the most of these differences. Almost any form of loop will give results. Six turns of wire around a yard-square frame will be about right for broadcast reception. The tuning of such a loop is accomplished by means of a single condenser placed across the two wire terminals of the six turns. This condenser should have a maximum value of about .0005 microfarads. The same two terminals which connect to the condenser are also connected directly to the tube set.

Naturally, the loop cannot be expected to collect much energy. As a result, a loop receiver will not be of much value except on an amplifier set. And radio-frequency amplification is in order.

Radio-frequency amplification. The experimenter who has conquered ordinary audio amplification, may well try radio-frequency amplification. The circuits are exactly the same except that a special radio-frequency transformer must be used.

For radio-frequency amplification, the electrons have to shoot back and forth at very high rates of change in the tubes. And the capacity of the tube to hold the electrons on its surfaces, regardless of the ordinary action of the electrons out from the filament, has a very important effect on the amplification. If the electrons can rush in and out of the tube easily,

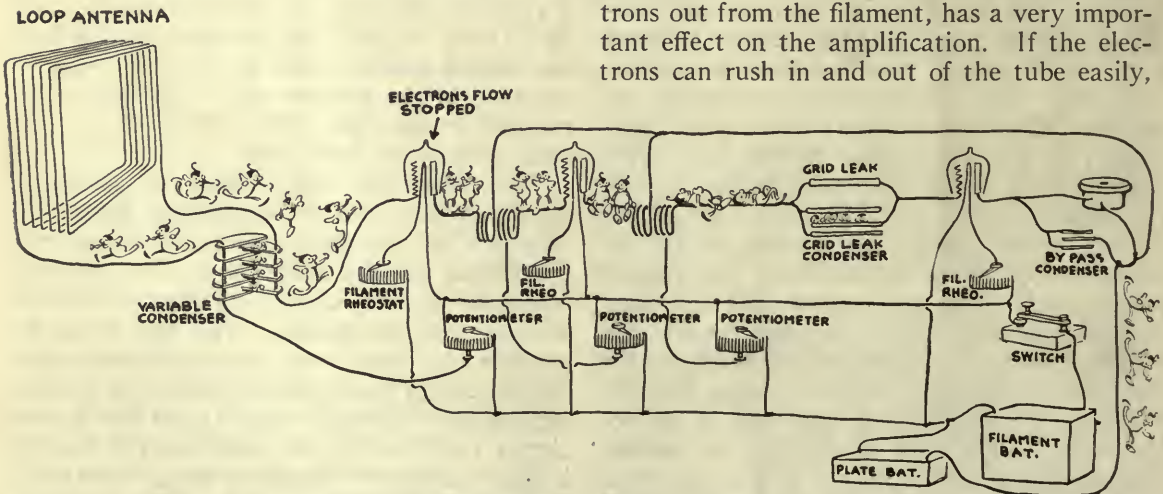

A LOOP ANTENNA MAKES FOR REDUCED INTERFERENCE

It does not collect so much energy as an outdoor antenna, however, and needs an amplifier to help it out.

they will do little real work in the way of giving amplification. As the "impedance" or reaction to their intrusions is increased, the force they will develop as electric pressure or voltage will be increased to a point where it will do useful work. Fortunately, this is readily accomplished by making the grid of the tube more negative than usual. By this is meant the average electric condition of the grid, before any action due to radio signals starts. Under these average conditions, the grid is made to have a concentration of electrons on it. This is determined in turn by the number of electrons on the part of the circuit to which it is connected. The first grid is connected directly to the loop aerial or antenna. The other end of this loop is connected to the filament. If it is connected to the side of the filament which is directly connected to the negative side of the filament battery, the whole arrangement will react back like the House that Jack Built to make the grid negative; the whole loop and the grid as well will have the same negative condition as the negative side of the filament which means a large number of electrons already on them. Under these conditions it may be said that the capacity of the grid is already pretty well used up. And practically no more electrons are going to it from the filament inside the tube. Likewise the plate current inside the tube is greatly decreased. Therefore with very few active electrons passing in the tube, the resistance between the filament and grid is likewise greatly increased. So the "impedance" of the grid to a further rush of electrons produced by radio signals will be high.

The whole action of the radio-frequency amplification starts in the development of rushing electrons in the loop in step with the oncoming signals. If this rush happens at a certain instant to be in such a direction that the side connected to the grid receives a rush of electrons, even though only a relatively few get on the grid, these intruders will produce a comparatively large change in the grid voltage. This will in turn decrease the plate current in the output of that tube to a greater degree as has been described by King Electron in previous accounts. This plate current decreases through the primary coil of a coupling trans-

former to which it leads directly. This transformer consists of two windings, the first or primary connected between the plate battery and the plate of the first tube; and a secondary winding very close to the primary, and connected between the grid of the next tube and back to the negative side of the filament of this second tube. For exactly the same reasons as given before, for the back connection

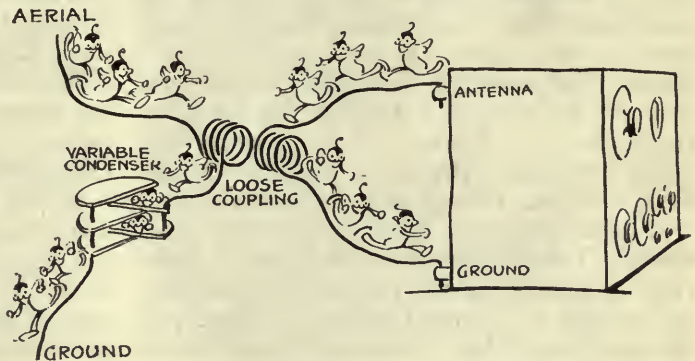

MAKING A DOUBLE-CIRCUIT TUNER FROM YOUR SINGLE-CIRCUIT ONE

The two coils have 25 to 50 turns. The variable is of about .0005 mfd. capacity

of the loop to the negative side of the first filament, this back connection of the transformer to the negative filament makes the grid of the second tube negative.

Now there are electrons in both primary and secondary of the transformer as connected, and as any motion of electrons in one side will be resented by those in the other side to such an extent as to make them rush in the opposite direction, a change to slow down the electrons in the plate current will react to make a change to speed up the secondary electrons of this transformer. This secondary connects directly to the grid of the next tube, so the electron change will act directly on the grid of the second tube. As the grid has a great effect on the plate current, the effect is amplified successively through the radio amplification stages. The reaction goes on through one, two, or three stages. It is then made to act on a grid-leak condenser to give detection as previously described and the consequent desired signals are produced in the connected telephones.

As a matter of fact, it is frequently necessary to make the grids of radio-frequency amplifier tubes more negative than even the negative side of the filament. For this purpose, it is

necessary to add small extra dry batteries between the secondary of the transformers and the negative filament of the tube. These are called "C" batteries. The positive side of these batteries will be connected to the negative side of the filament, and the negative side of these batteries will be connected to the back end of the transformer secondary. This extra negative action will push even more electrons through the transformers into the grids of the connected tubes. These extra batteries need only be very small—the kind used in flashlights. The two-cell or three-volt type will generally be sufficient, but it is well to have some three-cell (4.5 volt) ones for trial. The current which they take is practically nothing, so their life will be that of their ordinary deterioration. A more adjustable arrangement which will make a radio-frequency outfit cover a wide range of frequencies or wavelengths is provided by the use of "potentiometers." These potentiometers are high resistances placed across the filament-battery. A sliding contact on such a resistance is connected to the back connection of the transformer which carries the electrons back to the grid. As this slider is moved over the resistance, it will take up the electric potentials which correspond to electron densities along the resistance, and this is the reason for the name "potentiometer." This density will be greatest at the end of the resistance connected to the negative terminal of the filament battery; and least at the positive end. By varying this, it is therefore possible

to get a smooth variation over the range. It is well to put the tube rheostats in the negative leads from the battery instead of the positive as is done with audio amplification. The potentiometers are directly across the filament battery. This makes it possible for the connected grids to be more negative than the negative side of the filament by the amount of resistance in the filament rheostats, and does away with the need of any extra "C" batteries. If the tubes are turned out by using the rheostats, the potentiometers will still be in circuit, so it is well to have a main switch to disconnect the filament battery from the whole set. This switch also makes it possible to leave the separate rheostats at their best adjustment.

By the use of radio-frequency amplification, much better results may be accomplished in the way of selectivity, as the input power may be reduced to a minimum. Such radio-frequency amplification is of course applicable to double-tuner sets where loose coupling is arranged. There is little if any advantage in using radio-frequency amplification on single-circuit tuners connected directly to an antenna.

As a matter of fact, the radio inspectors have been doing very careful and helpful work over the whole country in arranging slight changes in the wavelength for the broadcasting stations to eliminate as far as possible any beat-note interference between transmitting sets; and with equal care in the design and use of the receiving lay-out good results may now be obtained by the listener-in.



Listen to These

Some "Inside Dope" on Four More "Stations that Entertain You": WOC in Davenport, Iowa; WHN in Ridgewood, Long Island; PWX in Havana, Cuba; and KHJ in Los Angeles, California. You Must Be Within Range of At Least One of Them

I HEARD Davenport, Iowa, last night," says Smith to Jones.

"That's nothing," replies Jones to Smith, "I get Havana 'most every night. On one tube, too."

"You don't say!"

Smith is crushed, impressed, and interested.

"Sure—but of course you've got to know how to tune your set. You can't just sit in front of it and twirl the dials around, in the hope that some far-away stations will speak up. Now, for instance, when I start in to tune—"

And they're off in a cloud of dust. Facts that

sound fishy, and fish stories that sound more or less like facts are reeled off with equal glibness and solemnity.

Judging from the lists that have been sent to RADIO BROADCAST in the "How Far Have You Heard on One Tube?" contest, however, the midnight radio anglers are making the most of their opportunities during this "open season."

The four stations shown this month have widely different geographical locations, representing the Atlantic Coast, the Pacific Coast, the east central part of the United States, and the territory beyond our southern boundaries.



"WHERE THE WEST BEGINS AND THE TALL CORN GROWS"

The stuffed birds hovering near the ceiling, the bits of wisdom stenciled on the walls, and the "rustic" furnishings give this-music studio of the Palmer School of Chiropractic in Davenport, Iowa, an unusual appearance, to say the least



THE ATTRACTIVE STUDIO AT WHN, A LOW-POWERED STATION AT RIDGEWOOD, L. I.

THE IMMACULATE OPERATING ROOM AT PWX, HAVANA, CUBA





OPERATING ROOM AT THE LOS ANGELES "TIMES" STATION

Litzendraht vs. Solid Wire

By RALPH R. BATCHER

Engineering Staff, Western Electric Company

LITZENDRAHT, a special cable composed of a number of strands of fine insulated wire, has long held the reputation of giving lower losses with radio-frequency currents than any other type of wire. The statement is not without foundation, for in most cases coils of high grade Litzendraht may show a five to fifty per cent. decrease in resistance, compared to solid wire, *if all the strands are perfect.*

On test, it has been found that a coil employing litzendraht may act perfectly for six months or a year, and then develop troubles which indicate a broken strand or so in the cable with which the coils are wound. This often occurs, no matter how carefully the coils are manufactured, mounted and tested, although it does not make the set inoperative and would pass unnoticed by many users. Manufacturers who are intent on satisfying the most discriminating amateur have investigated all factors which cause excessive resistance in litzendraht coils.

Recent experiments have shown that solid copper (No. 25 B. & S.) with one layer of cotton and one of silk, is equivalent to the litzendraht used (20 strands of No. 38). Complete measurements were made on equivalent coils so that a direct comparison might be made. To make sure that there were no broken strands to begin with in the litzendraht, each strand was tested for continuity separately, stripped of enamel and separately tinned. Upon soldering, the complete direct-current resistance of the cable was measured and checked with the theoretical resistance. When tests were completed on this coil, one strand was intentionally broken at one end and the tests repeated, after which another wire was broken at the opposite end.

The first was a practical test in a receiver. It was found that the solid wire coils will oscillate (for c w reception) with the filament current just as low as when the perfect stranded wire coil was used. This test was thought to represent actual receiving conditions.

The high-frequency resistance was next measured. With ordinary methods of measuring high-frequency resistance, it is impossible to separate the resistance from the impedance, and as the measurements were made at frequencies very near the natural period of the coil, the resistance was apparently greatly increased at the higher frequencies. The reason for this will be taken up later.

A graphical presentation of the results is shown on the accompanying graph. Curve "A" represents the apparent resistance of the coil wound with litzendraht in which each strand was tested and found perfect, and perfect connection made with each strand at each end. Curve "B" shows the apparent resistance for the similar coil wound with solid wire. Curve "C" shows the same coil as used in "A" with one strand purposely broken near one end.

It will be seen that Coil "A" has the lowest resistance. Strictly speaking, however, Curve "B" should be moved 25 meters to the left in order that direct comparisons may be made, as it happened that in this case the solid wire coil had a natural wavelength 25 meters higher

than the litzendraht coil. This difference is relatively small and may be due to any of a number of reasons.

Curve "C" has several outstanding features: the distributed capacity has increased apparently to about four times its original value, since the natural period is about doubled. There is also another frequency lower than the fundamental, at which the resistance increases.

Another strand was broken, this time at the end opposite the first break. The result was that the coil seemed to respond slightly to several wavelengths other than its natural one, giving a curious effect in tuning and being very poorly adapted for precise work in a regenerative receiver.

The apparently high resistance shown on the curves at the lower wavelengths may surprise some radio experimenters. That these results are logical may be shown by the fact that theoretically a coil has infinite impedance at a frequency corresponding to its natural wavelengths. In fact, any inductance shunted by a condenser (in this case it is shunted by the distributed capacity) will act as a very high impedance to frequencies at and near the natural or resonant frequency of the combination.

We can, however, console ourselves by the fact that a large part of this apparent resistance at such frequencies is due to the reactance, and so will not absorb energy and produce heat as a real resistance would. The method used for measuring the above resistance was to couple the coil very loosely to a vacuum-tube oscillator. A thermo-couple, condenser (variable, having negligible losses) and a high-frequency resistance box made up the rest of the circuit with the coil. The change in the deflection of the galvanometer across the thermo-couple was noted when resistance was added to the circuit and the coil resistance computed from such data.

The problem then resolves itself into choosing the lesser of two evils. Laboratory measurements show litzendraht superior as long as it is in good condition. Actual tests in a receiver show apparently no difference as far as sharpness of tuning is concerned or for its qualities in an oscillating circuit. It is believed that the desire to safeguard the user from the freakish effects of broken strands is enough to throw the balance over in favor of solid wire.

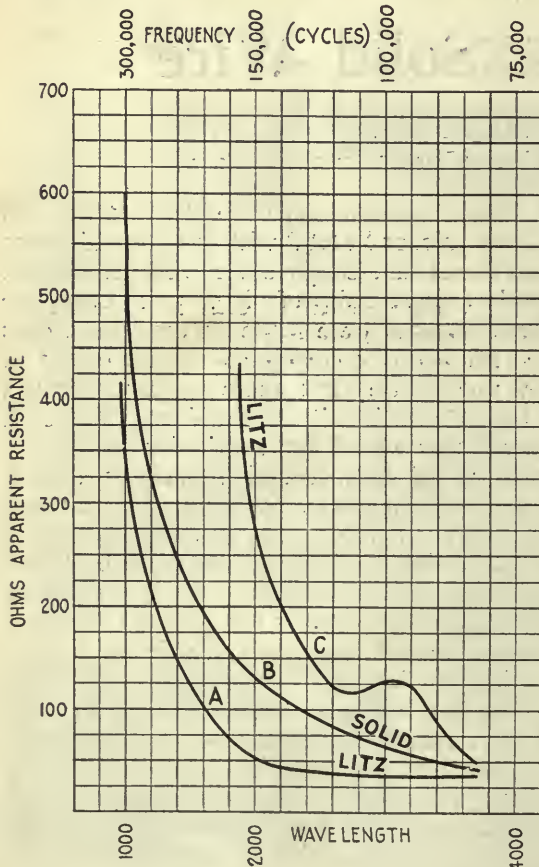

Simple Bulb Transmitters

By ZEH BOUCK

PART IV

Alternating Current Systems

AC. TUBE transmitters are classified, according to the characteristics of the plate supply, as rectified or self-rectified sets. In rectification systems, the 110-volt alternating current is transformed to an adequate plate potential, and passed through rectifying apparatus where it is changed to direct current. It is then filtered in the manner described last month for the output of a motor-generator, and finally applied to the plates of vacuum tubes, the oscillating output of which may be modulated at voice frequencies for the transmission of speech. Radio telephony is thus simplified to the extent that all power may be obtained from a single electric light socket. At the same time the noise and moving parts of the motor-generator are eliminated. A. C. radio telephones generally represent a less formidable initial expenditure, and when properly and intelligently operated, give results comparable to those secured with a motor-generator.

Self or unrectified sets employ the "raw," stepped-up A. C. as the plate potential, without modifying it by filters or similar apparatus. This system has become especially popular with amateur stations working distance, where it solves the problem of an economical, high-power C. W. transmitter.

As any one terminal of an alternating current supply is positive for half an alternation, it is capable, during that time, of supplying a vacuum-tube plate with the current essential to oscillations. Such circuits are "self-rectifying" in the sense that the tubes automatically use the positive fluctuation of the current, and cease to take current or oscillate when the terminal feeding the plate is negatively charged. Bearing in mind that a flow of electrons constitutes a plate current (which is necessary for oscillations), and that electrons, being negative, are repelled by a like charge, Fig. 1 will clarify the phenomenon of self and

plain rectification. The three progressions indicate, respectively, the alternating current fluctuations in the power transformer, the resulting variation of the plate charge, and the accompanying effect on the oscillating output.

If two oscillating tubes are used in a self-rectifying circuit, the plates being supplied from the opposite terminals of the transformer (one of which is always positive), each tube will operate on the opposing half of the cycle, giving a more smooth and powerful wave. The radiated output of the second tube, which is really the complement of the first, is indicated by the dotted oscillations in Fig. 1. The frequency of the combined oscillations is, of course, double that of the single bulb, and a far more pleasing tone. Utilizing both halves of the cycle in this manner is often referred to as full wave self-rectification.

Attempts have been made to adapt full wave self-rectification to the transmission of speech and music, but to the knowledge of the author, experiments in this direction have been only partially successful. For radio telephony,

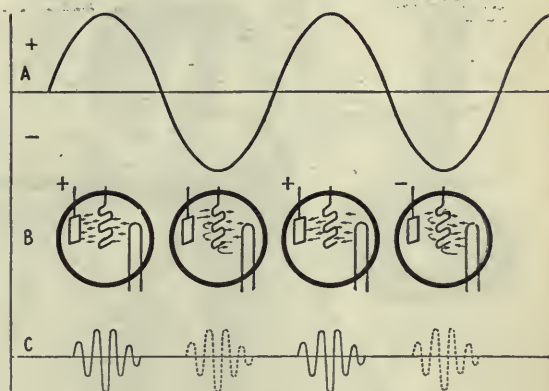

FIG. 1

operated from an A. C. source, separate rectification must be employed.

This is commonly accomplished by either of two methods, bulb or chemical rectification.

The latter is the more economical system, but often requires considerable experimentation before success is achieved. As explained above, an audion will pass a current in only one direction, from plate to filament, the phenomenon on which bulb rectification is dependent. The grid does not function in this operation, and rectifying tubes are generally built with only two elements, the plate and filament.

A typical bulb rectification circuit is indicated as that part of Fig. 3 enclosed in dotted lines. P is the primary of a transformer designed to operate on 110 volts, 60-cycle current. R. F. is a secondary winding giving eight volts across the outside terminals, and supplying current to the rectifying tube filaments. P. F. is likewise an eight-volt filament winding, and lights the 5-watt power tubes. Though this last winding is indicated as a part of the power transformer, it is often desirable to wind it as a single secondary on a separate transformer, such as described in the January RADIO BROADCAST. S is the high-voltage secondary, giving 1100 volts between terminals X and X'. All secondaries are tapped in the middle.

The centre tap Y is always negative in re-

spect to the positive terminal of the high-voltage secondary, a charge that alternates between X and X'; and is therefore the negative high-voltage lead. When X is positive, a current passes through rectifying tube number one, the filament of which (or terminal Z) is charged positively in respect to Y. In the next fraction of a second, conditions are reversed, and X' is now the positive terminal of secondary S. Tube one, with the plate negative, ceases to function (Cf. Fig. 1) while bulb two passes a current; positive electricity again being drawn from Z. Thus Z, which is plus regardless of current alternations, supplies the positive potential to the plates of the power tubes. As only half the transformer secondary (550 volts, between the terminals and the centre tap) is applied to the radiophone circuit, and allowing for a voltage drop through rectification, the plate potential will approximate 400 volts, the general working voltage for 5-watt tubes. The plate voltage may be further decreased, in order to reduce power, by lowering the rectifier filaments. However, the voltage should not be dropped more than 50 to 75 volts in this manner, as the A. C. hum is likely to be emphasized when the rectifying



FIG. 2

Material for a 5-watt rectified, radio telephone transmitter, using two rectifying tubes and two power bulbs

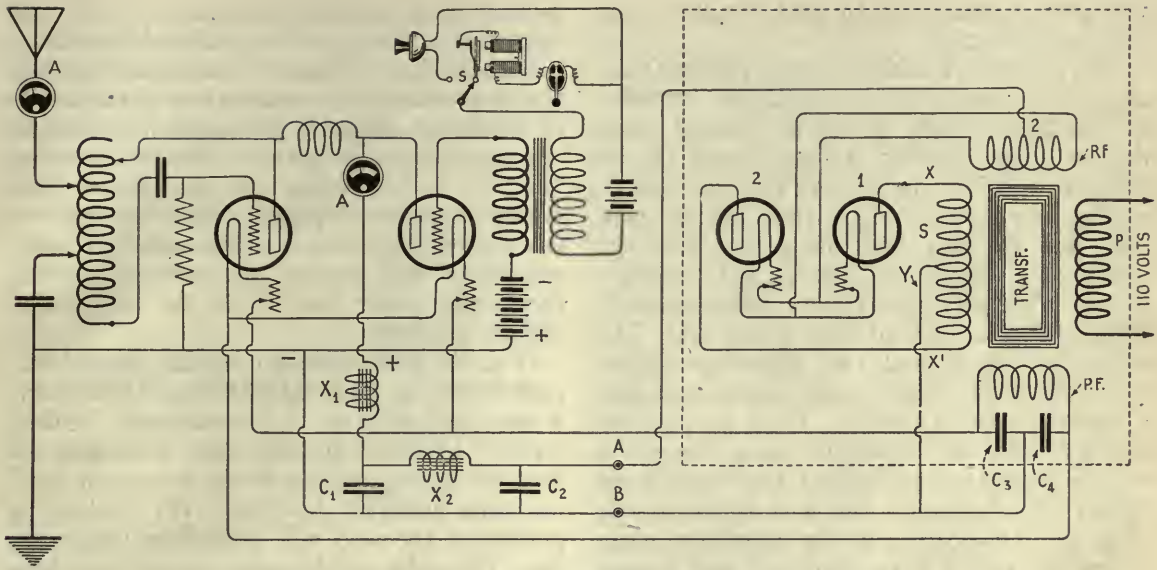

FIG. 3

The circuit used with the equipment shown in Fig. 2. This system is fundamentally the Colpitts oscillator with Heising modulation

tubes are burned below their normal brilliancy.

The special transformer for rectification is best purchased, but the intrepid experimenter may build his own, following the general procedure outlined in the preceding issue of RADIO BROADCAST for the construction of a filament lighting transformer. The core should be built up two inches high in the same manner, using 10" x 2" soft iron strips. The exact dimension of the core may be varied as occasion necessitates, *but the cross-section must in all cases approximate four square inches*. The secondaries are best wound on three legs of the transformer. Care must be taken to insulate the four windings for 1100 volts, and empire cloth or tape should be used generously.

The primary is wound with 300 turns of No. 15 single cotton covered wire. The two filament lighting secondaries are each wound to 24 turns with No. 9 single cotton covered wire; and the high-voltage secondary with 3000 turns of No. 27 double cotton covered wire. The secondaries are wound in two sections or pies (*both windings in the same direction*); the finish of the first pie connecting to the first turn on the second, and the joint brought out for the centre tap. Every other layer of the high-voltage secondary should be insulated with a single covering of empire cloth or tape.

The various units used in the construction of a bulb rectifying set are shown in Fig. 2. The

circuit is indicated in Fig. 3, and is fundamentally the Colpitts oscillator with Heising modulation, the operation and values of which were described in detail in the January number. Tuning and the adjustments of the modulating circuit are effected in the same manner as was suggested for the D. C. apparatus. The substitution of rectified A. C. for the motor-generator, necessitates no change in the constructional details, excepting the chokes X1 and X2, and the condenser C1 and C2. These chokes and condensers constitute the filter system, and as the ripple accompanying rectification is more difficult to eliminate than the comparatively gentle hum of a D. C. generator, they must be of larger sizes. The reactance coils (chokes) are each wound with three pounds of No. 27 single cotton covered wire, on 10-inch cores with cross sections of approximately three square inches. C1 and C2 should have a combined capacity of at least ten microfarads. C3 and C4 are capacities similar to those shunting the filament lighting transformer in the motor-generator installation, and may be paper-foil condensers such as are used across spark-coil vibrators.

ELECTROLYTIC RECTIFIERS

RECTIFICATION is accomplished in a chemical rectifier by the electrolytic action of different solutions on aluminum which, when that metal is used as an electrode,

will permit electricity to pass through it in only one direction.

The chemical rectifier is much cheaper than the bulb system, and its installation, exclusive of the transformer, should not exceed three dollars. The rectifier is constructed in the form of small jars, the number and size depending on the current which they are to pass. The jars are best built in a rack after the fashion of a storage "B" battery, and a twenty-jar set of the jelly glass variety will adequately handle the plate current for a 5-watt set. The electrodes are of lead and aluminum strips, one inch wide, three inches long, and one sixteenth of an inch thick. Each jar contains one lead and one aluminum plate, separated by thin blocks of hard rubber, the whole being bound into a compact unit with rubber bands (Fig. 4). One corner of the aluminum plate is drilled, and a brass nut and bolt passed through the hole and tightened over a short length of copper wire lead. The twenty jars are broken up into groups of ten in series, the wire on each aluminum electrode being soldered to an adjacent lead plate. The active elements (aluminum) at the end of the two series are joined, a connection that forms the positive lead, while the lead plates are connected individually to the terminals of the high-voltage secondary, the centre tap of which is again

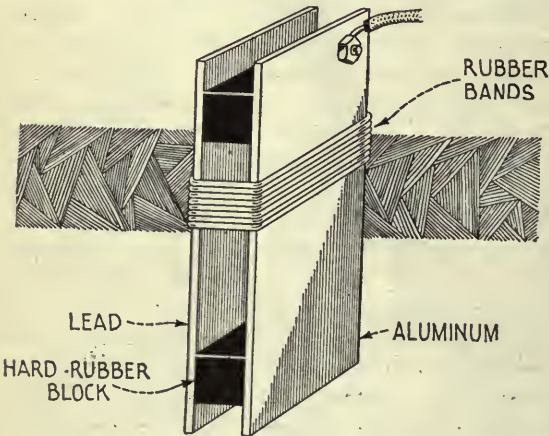

FIG. 4

negative (Fig. 5). The transformer may be identical with that used in bulb rectification except that the rectifier filament winding is eliminated.

Care must be taken in securing the aluminum, as the success of the rectifier is directly dependent on the purity of the metal. Aluminum sheet, especially "formed" for this

purpose, may be obtained from Eimer and Amand, 240 West 42nd Street, New York City.

Several electrolytes are in common use, but the most satisfactory solution is probably made by mixing six ounces of *pure* phosphoric acid to one quart of *distilled* water. The best grade of ammonia is then added until the mixture tests neutral with litmus paper. After the mixture has cooled, ammonia is again added in small quantities, until there is just sufficient to turn the litmus paper blue, i. e., the solution is slightly alkaline.

If it is impossible to obtain phosphoric acid, it may be replaced by boric acid, of which a saturated solution is formed with distilled water. In accomplishing this, it is best to heat the water, and stir in the boric acid until no more will be dissolved. On cooling, a portion of the acid will crystallize, indicating that the solution is truly saturated. Ammonia is added as before, until the electrolyte tests alkaline.

The solution for all jars must be made at one time, in a single receptacle, and poured into the cells until an inch and a half of the plates is covered. The rectifier is then ready for use, and is made part of the Colpitts circuit by connecting the wires A and B (Fig. 5) to the correspondingly lettered leads in Fig. 3.

Many experimenters employ an electrolyte consisting of a saturated solution of borax. This is made by dissolving as far as possible a portion of a ten-cent package of 20-Mule-Team Borax in one quart of distilled water. While this is cheaper than the phosphoric acid solution, and obviates the litmus testing, it is necessary to "form" the plates before the rectifier will operate. This is accomplished by subjecting the rectifier to the high potential, first for a minute at a time, then gradually increasing the period until the transformer secondary ceases to heat under the load. During the preliminaries, until the plates are formed, the jars are virtually a short-circuit.

When the rectifier is working properly, there is generally a gentle glow about the aluminum plates, and the temperature rise in the solution, or transformer secondary, if any, should be barely perceptible. There should be no pyrotechnics, and the presence of such is indicative of overloading, which may be remedied by adding more solution or increasing the number of jars.

Electrolytic rectification is an interesting and instructive experiment, and so cheap a one,

that the experience of building even an unsuccessful rectifier is well worth the cost. If the experimenter is at present transmitting on a small B battery radiophone, such as has been previously described, he is advised to adapt it to electrolytic rectification, following out the

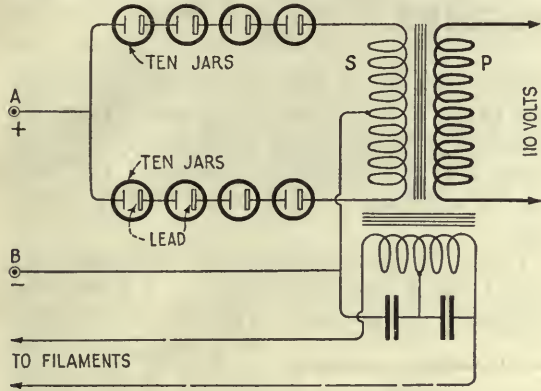

FIG. 5

principles demonstrated in applying this system to the originally direct-current Colpitts circuit. Indeed, it would be well to construct especially, a 5-watt set of simplified design, in order to become familiar with the characteristics of rectified operation, before attempting to build more complex apparatus.

AN EXPERIMENTAL 5-WATT SET

SUCH an installation is indicated diagrammatically in Fig. 6, and the cost of the various parts should not total more than twenty-five dollars! The apparatus has been

boiled down to essentials, and the set is operated altogether from power supplied by a single A. C. lamp socket.

Excepting for the rheostat, microphone, bulb, socket, the 5000-ohm grid-leak, C₃, C₄ and C₅, the set is home-made. If the amateur has facilities for the construction of any of these items, the cost of the set will be still further reduced. Inductance L₁ is wound with 40 turns of any convenient insulated wire under No. 22 and tapped every fourth turn. L₂ is a single turn of wire wound over L₁. C₁ is a fixed capacity of three to eight plates (to be determined by experiment) of one by 3-inch tin-foil (two square inches active area) separated by mica. C₂ is similar to C₁, using however, only two or three plates. X has already been described, and C₃ may vary from two to ten microfarads, the higher capacities being desirable. C₄ and C₅ will probably cost the experimenter nothing, but in advent of his inability to obtain the spark-coil vibrator condensers, telephone shunt capacities of .0025 mfd., used for receiving purposes, may be substituted. The only variation in the rectification transformer from that designed for the Heising modulation set exists in the secondary S, which is wound to 2500 turns, a reduction that permits the cutting down of the rectifier to sixteen jars. A radiation ammeter should be borrowed for tuning the set.

Tuning and operating is done as suggested for the D. C. installation in the January RADIO BROADCAST.

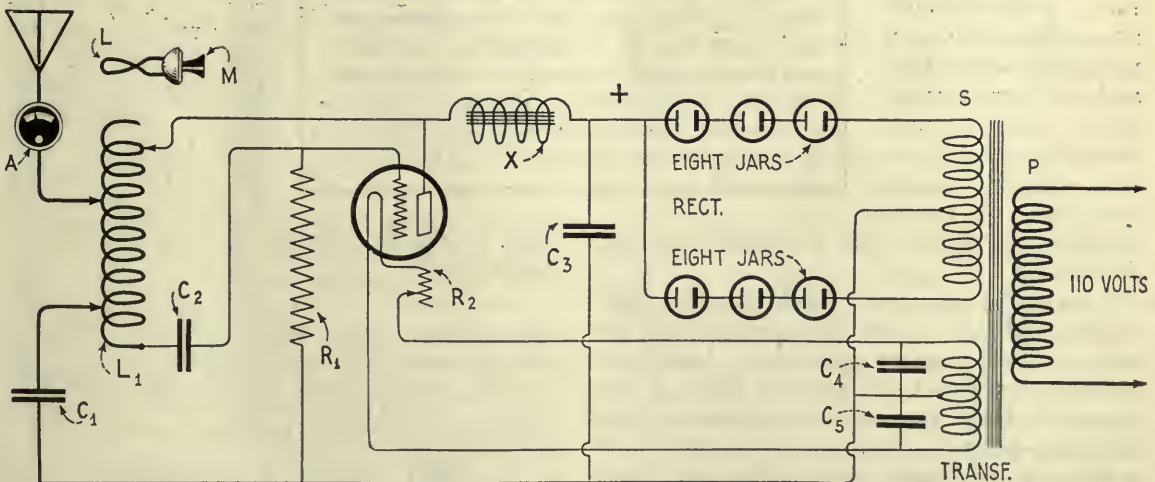

FIG. 6

Diagram of a 5-watt set, operated by power from a single A. C. lamp socket

Cave-Man Stuff, But It Works

A Rough but Ready Outfit that Gives Excellent Results on One Tube.
Some Pointers on the Delicate Art of Bringing in Long-Distance Stations

By I. R. TANNEHILL

IN THE average discussion of the single-circuit, single-tube, regenerative receiver, the writer starts off with the single circuit but is unable to confine his remarks to the subject and introduces a vast hash of selectivity, inductively coupled circuits, variometers, electrons, loop aerials, and radio-frequency amplification. It may be that the single circuit is less selective, but the average beginner finds any type of radio receiver so selective that he has trouble hearing anything at all. Hence why trouble him with methods of tuning out interference?

Confidentially, I believe that every one of these writers is guilty of the variometer habit and that his cellar or attic conceals a number of parts that do not fit into a single circuit. Have any of them conscientiously and consistently employed the single tube and the single circuit? If so, why do they claim that it requires two stages of radio and two of audio amplification to pick up a station 200 miles distant?

I have for one year employed the single vacuum tube in a single circuit more than any other type of receiving apparatus. Located in southeastern Texas, the home of static, I have frequently heard stations 1,000 miles away and for long-distance reception I would have nothing in preference to a single-tube, single-circuit receiver. My aerial is fifty feet long, one end tied to the chimney and the other to a two-by-four nailed to an outhouse. My

phones cost \$4.37 and my vernier condenser, the pride of my outfit, was made from the plates of a knock-down condenser that I was never able to assemble as directed. The knob on the condenser is one of my wife's clothes pins.

From the above remarks you can readily see that I am a first-class "ham". I have never soldered a connection. The only time I tried

it I succeeded in making nothing but a lot of smoke. Every time the wind blows I am afraid my aerial will fall down. Yet fourteen of the stations I have heard with this outfit give an aggregate mileage of 11,950.

In every instance I found by making inquiries that others in town had heard the same stations on similar sets. Therefore the freak, as it has been termed, was not due to the set but perhaps to atmospheric conditions. As far as the freak is concerned, I feel sure that it was about 50 per

cent. atmosphere and 50 per cent. careful and patient tuning.

A₁ (cost \$2); C₁, .001 mfd. (\$4); C₂, 3-plate (\$3); GL, grid leak, combined with C₃; C₃, .00025 mfd.; S, tuning coil (25c. to make); R, tickler coil (25c.); G, ground to water pipe; C₄, approx. .001 mfd. (35c.); T, (\$5); B, 22.5 volts (\$1.50 to \$3); R, rheostat (about 75c.); VT, tube (\$5 to \$8).

The tuner may be a variocoupler. Parts can be purchased for about \$1.50 to \$2.00. A cheaper and really more satisfactory procedure is to cut two narrow rings from a

"The listener who does not occasionally hear stations farther away than 500 miles," says the author of this article, "is either in a dead zone or is not acquainted with his apparatus. If he tunes his set systematically instead of turning the knobs in a haphazard manner with the hope of accidentally hitting an adjustment, he will get results. The directions herewith may not conform with the practices of the manufacturers of apparatus, but manufacturers do not guarantee any great ranges and furthermore do not furnish directions with the apparatus that would enable anyone to get great ranges. You get thirteen pages of directions with a liver pill and practically nothing with a radio receiver!"

Some of Mr. Tannehill's home-made equipment may lack finish and compactness, and we should hesitate to endorse his practice of never soldering a connection; but he does get results. The method of tuning described in this article should help many set-owners to improve their receiving records.—THE EDITOR.

cardboard tube. Wind fifty turns of No. 26 or No. 28. wire around one, tie the ends around the rings, and leave about a foot or more of wire at each end for connections. Around the other wind about sixty turns and secure in the same way leaving leads for connections. Screw two curtain pole brackets into the end of the table, lay a piece of broom pole across them and hang the two coils on the pole (see photo, p. 329). Set four binding posts into the edge of the table and fasten these four coil leads between the bolt head and washer of the binding post, leaving the binding post for other connections unless you wish to tie more than one wire into the clamp of the post. This tuner is very satisfactory and will cost about 50 cents to 75 cents. Use the 50-turn coil for a tickler and the 60-turn coil for a tuner. After testing the set you may find that there is too much wire on the tuner, in which case remove a few turns at a time while testing.

Connect the other apparatus as shown in the diagram. Increase the brilliancy of your filament until a slight hiss is heard. Decrease it till you are just below the hissing point. Do this with your two coils at extreme ends of the pole or with rotor of variocoupler vertical. Bring the coils together. Rotate your condenser plates and you may hear the tube oscillating. The oscillation of the tube usually takes place more easily at the low capacity end of the condenser, or in other words with the condenser nearly open.

This is the primary consideration for the beginner if he must tune in long distance stations. The tube must oscillate with the coils close together. When the tube is oscillating there is a mushy sound in the receivers, something like a faint rushing of air. The static noises become louder as the point of oscillation is approached either by turning the condenser or moving one of the coils back and forth. Spark signals, if heard, will usually be clear and more or less musical with the tube quiescent, but become hissing noises when the tube is oscillating.

If the tube does not oscillate under this test, then turn one of the coils around and try it again. Instead of turning a coil around you may exchange the two connections to one of the coils. If you are using a variocoupler, make the test with the rotary coil horizontal and if you do not hear the tube oscillating, turn the rotor completely over and try again.

Occasionally you get a tube that does not

oscillate with the usual hook-up. In that case increase the grid condenser to .001 by substituting a fixed condenser of that capacity. You may use the one shunted across the telephones for the grid and replace the phone condenser with one of about .0005 mfd. capacity, also fixed. Oscillation will usually be obtained with a relatively low filament current with these latter capacities.

However, do not fail to try it with the rotor

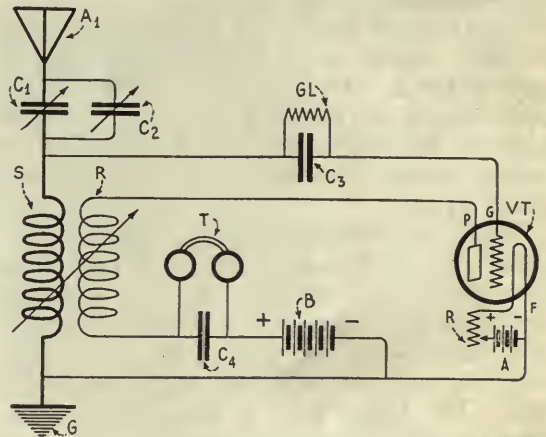

MR. TANNEHILL'S SINGLE-CIRCUIT HOOK-UP

With which he has heard stations
over 1,000 miles away, with one tube

inverted (or with the coils reversed). Once you have learned how to produce the oscillations it is but a short time until you have learned to control them by changing the filament brilliancy or turning the rotor, or if coils are used, by moving one of them back and forth on the pole.

Occasionally there is almost a total absence of static, spark signals, or other sound, so that it is nearly impossible to determine whether or not the tube is oscillating. This is rare, however, at the present time when there are so many broadcasting stations and amateurs.

The second step is to tune in a telephone station. With the tube oscillating, turn the condenser around *very slowly* and listen for a whistling note. This is the carrier wave of the broadcasting station. As you change the condenser capacity you come upon a high-pitched whistle. As you turn further the pitch of the whistle becomes lower and lower. As you turn on, the whistle repeats itself becoming higher and higher in pitch until it disappears. At the centre of this double wave you will perhaps hear music or voice. If you do not hear the carrier wave, separate your coils

slightly or reduce the filament or incline the rotor slightly and try again. If this test does not produce a carrier wave, then remove a few turns from the tuner coil or try another tap on the stationary coil of your variocoupler (if the latter is used), and try again. With the ordinary antenna and a .001 condenser in series as shown in the diagram, the broadcasting stations should be heard with about 40 to 60 turns of wire on the tuner. In some cases you may require only 35 turns.

Turn the condenser slowly, as the broadcasting stations require very sharp tuning when at any distance. After you have obtained an approximate setting with the .001 condenser you will find that the vernier in shunt with it on the vernier attachment will give a much closer setting.

While you are experimenting with this set, your tube will be occasionally in a state of oscillation. Much has been said about the interference that one creates in tuning a regenerative set. Don't let that worry you. *The output of a detector tube will not split anybody's ears.* The fellow who is using four or five hard tubes in an amplifying circuit is the fellow who hears your little wave and usually he is the fellow who is creating all the interference with the tuning of his set. Let the blame rest where it belongs—on the fellow who is using five-watt power tubes in his receiving circuit.

If you try to tune in a distant station without oscillating you will never get anywhere. You can pick up that carrier wave a dozen times easier than you can his music or voice.

Now we shall suppose that you have succeeded in picking up a carrier wave after altering your coils until tuned within the proper range for broadcasts. At the centre of the wave you will hear something that bears a distant resemblance to music or a man's voice that sounds more like the barking of a dog than anything else. Your next problem is to clear it up and amplify it.

You will now have learned that your hand has a capacity effect. While you have your hand on the condenser dial or knob you hear the carrier wave, but when you take your hand away it is gone. Your hand affects the tuning by increasing the capacity. You will therefore find that by increasing the capacity of the condenser till you cannot hear the wave, it comes in when you take your hand away. By experience you will learn just about how much

capacity effect your hand has and make an allowance for it.

Then you learn another thing. You have the carrier wave tuned in at last and now you seek to clear up the music by inclining the rotor of your coupler, or by separating the two coils (if tuning with them), and you find that this also affects your tuning.

When the coils are close together or, when the rotor of the coupler is horizontal or nearly so, a slight change in the coupling causes a decided change in the wavelength of your receiver. As your tuning coil and tickler coil are placed farther apart (or as the rotor is inclined toward the vertical) the detuning effect of the movement becomes less pronounced. It is therefore easier to tune and adjust the tickler control simultaneously when the coupling is rather loose, provided that the set is so constructed that oscillation can be obtained with a fairly loose coupling without crowding the filament.

As stated before, the oscillations occur more readily at low capacity in the aerial than at high, as a usual thing. Therefore, on rotating the condenser to decrease the wavelength, the set breaks over into self-oscillation. It may do this very gradually, beginning with a slight hiss, or it may do so with a sudden popping sound in the receivers. The latter state is difficult to control and causes a great deal of trouble in tuning. It is usually due to operation at too high a filament temperature. Reduce the filament temperature until the oscillations are set up gradually with change of capacity.

Having established these conditions, you are ready to tune in the broadcasting station. A distant station may be tuned in systematically by the following method. Increase your condenser capacity until the removal of your hand leaves the upper or high wave portion of the carrier whistle in the receiver. Then incline your rotor until you pass through the centre of the wave and beyond to the low-wave half of the whistle. Again increase your capacity until you are set on the upper half of the wave. Incline the rotor (or separate the coils as the case may be) until you are again on the lower half of the wave. As you alternate from one side of the wave to the other in this fashion the wave becomes more and more pronounced and the music or speech at the centre becomes louder and clearer. You are approaching the point of regeneration.

When this procedure has brought you to such a point that the next increase in condenser capacity shows you that the upper portion of the carrier wave has disappeared, you are very close to a perfect adjustment. The last few settings of the condenser are best made with a vernier condenser of about three plates. A condenser with capacity of .001 with a vernier plate can be used instead.

If the station is about 50 to 100 miles away, tuning should be easy. At 500 miles a little care is required to tune in the stronger stations and considerable patience in tuning in the faint stations.

At 1,000 miles with a single tube you must make accurate allowance for the capacity effect of your body; you must avoid any jar of your equipment; you must

not change your position in front of the receiver; and you must have patience.

In other words, at distances in excess of 1,000 miles you must "sit in the middle of the boat, keep your hair parted in the middle, keep your stogie on the same side of your face, etc. (though I never could say that there was any decided effect from the hands of my watch moving around!)" In this way I have listened with great enjoyment to a concert at a distance of 1,100 miles for more than an hour without any but slight cramps. I remember about a year ago watching a man tune in a Detroit station at a distance of more than 1,000 miles while a friend (not myself!) sat carelessly with his feet on the work bench beside the receiver. Just as he succeeded in tuning in with complete satisfaction and told us to listen, his friend took his feet off the table. We could hear nothing.

Of course, with stations at that distance, the receiver does not remain in perfect adjustment. Because of slight changes in capacity of the aerial, due to swinging or other causes and perhaps to changes in filament current, a slight

adjustment of the rheostat or vernier condenser is occasionally required. It is my experience that anywhere from 10 to 30 minutes is required to make a satisfactory adjustment of the controls to tune to a station at a distance of 1,000 miles.

I confidently believe that any listener with a single-tube set, unless in unfavorable territory, can hear stations at that distance, though of course manufacturers will not guarantee any such

ranges. This is largely because old man Static has a habit of running a file across your lead-in wire, pouring shot down your aerial, dumping gravel into your condenser and emptying wagon loads of hard coal into your battery.

But don't be afraid. Buy your parts, tie them together, part

your hair in the middle and go after Havana and San Francisco and Schenectady. You can hear as far but not as loud with a single tube as you can with two stages of audio-frequency amplification. I have consistently obtained greater ranges with one tube than with three.

The main idea is to get something that will bring in the signals. Afterwards you can worry about selectivity, radio-frequency amplification and shielding.

P. S. The same day the above was written I went home, spent about an hour weeding out the various stations, using one tube, and finally picked up WGY at Schenectady perfectly at a distance of about 1,450 miles. On turning on two stages of audio-frequency amplification this station was as strong as one could listen to comfortably with a headset on. Tuning-coils used were as described above—two homemade coils on a piece of broom pole. And please note that the above results are only ordinary. There are many men here who claim to have heard Kansas City stations on a crystal.



THE PRIMITIVE BUT EFFECTIVE VARIOCOUPLER

Shown at the left, consists of two coils wound on cardboard rings, and slides on a section of broomstick. Sixteen-months-old Doris Marie Tannehill is listening intently to whatever this extraordinary set of her father's is bringing in

A Super-Sensitive Long-Range Receiver

Another Invention of Edwin H. Armstrong Which He Calls the "Rolls-Royce" Receiver

By PAUL F. GODLEY

ARMSTRONG, of radio receiver fame, called it a "Rolls-Royce." He named one after the "flivver," too. It was his single-tube super-regenerative receiver. But, notwithstanding the marvels which are to be unearthed from beneath the intricacies of the super-regenerative scheme, the real "bug" on radio reception methods—super-sensitive radio reception methods—has a very keen and long unsatisfied hankering to know all about that *most sensitive* receiver, the super-heterodyne.

That long-to-be-remembered sporting proposition so spectacular and successful in its outcome, the bridging of the Atlantic last winter by American amateurs, brought the super-heterodyne receiver into the limelight. Armstrong's phrase, "the Rolls-Royce receiver"—a phrase which he coined at the time of his disclosure of the super-regenerative receiver, added considerable prestige to that intriguing and mystifying word, "super-heterodyne."

And, when, in starting to learn about the super-heterodyne, the reader finds the statement that it is a method of radio-frequency amplification, he is not for one moment to jump to the conclusion that radio-frequency amplification by the super-heterodyne method is by any means an ordinary method. It is perhaps the simplest of receivers in operation. At the same time it is, no doubt, the most complicated of receivers to construct because of the care which needs to be taken with it.

Let it be said for the benefit of those few who

may not yet have learned it, that the three-element vacuum tube as a detector of radio oscillations has an adjunct which is known as its "threshold value." To be specific, the three-element vacuum tube will not function as a detector until the incoming oscillatory currents are of a certain disappointingly large value. As a result of this defect (we are

sorely tempted to call it that), many, many surging signal currents come to dwell in our antenna and receiver circuits, unannounced and unknown. Long ago their presence there had been suspected and, even in early times, methods which we would now consider quite crude were employed in an attempt to make their acquaintance. Primarily, most of these attempts had to do with amplifying the

The Super-Heterodyne

Here, again, we find the practical genius of Edwin H. Armstrong, inventor of regeneration and super-regeneration, applied to a receiver designed to help America terminate the World War. Again we find a war development of great peace-time value. For many years Armstrong and the author of this article have been close friends. It is not surprising, therefore, that Godley knew of the super-heterodyne receiver and used it in his tests at Ardrossan, Scotland, in December, 1921, when he proved its value by copying signals from about thirty amateur stations located in various sections of this country.—THE EDITOR.

audible signal currents in the belief that after the weaker signals had operated the vacuum-tube detector, they were so nearly exhausted as to be below audibility. Further study disclosed the fallacy of this, and then it was that the great value of employing the three-element vacuum tube in their amplification prior to their detection was discovered.

Radio-frequency amplification has been used for several years, quite successfully, at long wavelengths where the frequency of oscillations is comparatively low. It was not until the World War that any great attention was given to finding out the reasons for the difficulties encountered when radio-frequency amplification was attempted on very short waves. Here the oscillatory currents are of comparatively high frequency. Up to this

time, no readily practical method of securing radio-frequency amplification on wavelengths below about 400 meters had ever been devised. During the war, both the French and the British Army and Navy gave considerable attention to this phase of the art, for the reason that communication between airplanes, destroyers, and division headquarters had to be carried on through the medium of short-wave radio telegraphy and telephony. It took but a little while to discover that where the higher frequencies were to be handled in the amplifier, the distributed capacities inherent to all amplifier coils, circuit wiring, vacuum-tube receptacles, and the elements of the vacuum tubes themselves, offered a rather serious barrier to further progress. The reason for this is evident when it is understood that even extremely small capacities offer a rather low-resistance path to high-frequency oscillations. The higher the frequency of the oscillations, the lower the resistance of the path offered by any given capacity (condenser). The capacity between adjacent wires, metal fixtures, the elements of the tubes, terminals, and the layers of the windings upon the radio-frequency transformers, were sufficiently large to induce the currents to pass through them rather than through the paths laid out for them. Under these circumstances only a very small percentage of the currents actually passed through the transformers or the vacuum tubes to perform their functions there. Result, no amplification, although the amplifier tubes and their connected circuits either singly or in groups frequently set up oscillations among themselves, causing a further blocking of the

amplifier or a great to-do of hissing and howling.

The British were the first to take the most obvious path, that of reducing to an irreducible minimum the capacities existing in the transformers, the connecting wires, and the vacuum tubes, as a result of which there was developed a class of vacuum tubes—very good ones, too—now quite generally used by British radio folks.

Armstrong, above mentioned, and even then well known, had none of these British tubes available. Yet, as a loyal American, and an important link in the communications system of our expeditionary forces, it behooved him to provide, with such American made equipment as was at hand, a means of performing this so urgently needed service. Perhaps his mental processes at that time were something like this.

“Radio-frequency amplification on long wavelengths is a practicable proposition. Radio-frequency amplification on very short wavelengths is not a practicable proposition with vacuum tubes and other material available. Why not, then, by virtue of a frequency changer, *change the wavelength from short to long prior to amplification; amplify it as a long-wave oscillation and detect it afterwards?*” Apparently that seemed reasonable enough and I doubt that it took him more than a few moments, not only to conceive the idea, but to lay his hands upon the medium which would enable him to make of the conception a practicality. At any rate, as nearly as available records show, it was but a very short time after his introduction to the problem before he actually had what he was pleased to call his

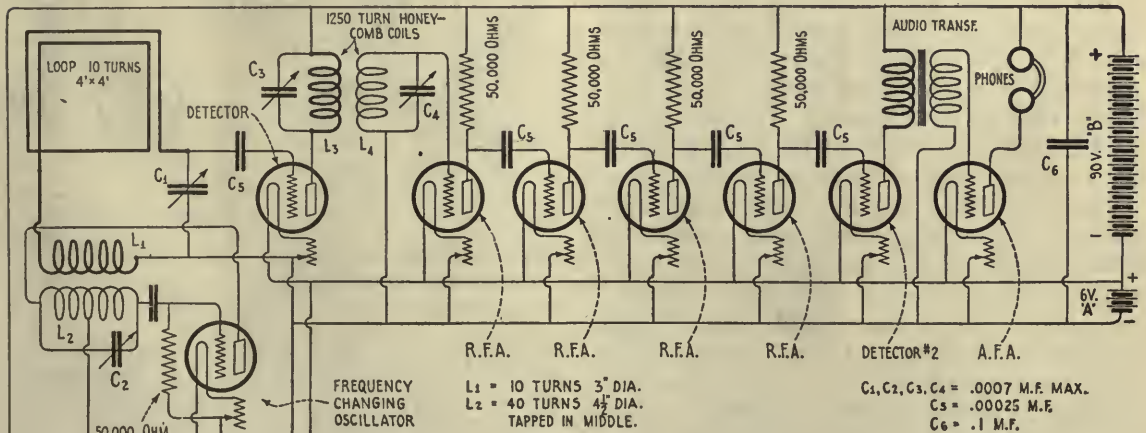

FIG. 1

The super-heterodyne circuit

super-heterodyne receiver, in action. It may be considered in one way unfortunate that before receivers of this type could be manufactured and put into service on the field, the armistice had been signed. But, as though the super-heterodyne were destined to assist in the making of history, it quickly found its way into the hands of a few fortunate, delighted, appreciative amateurs—created a worshipful enthusiasm—and was packed away to the dreary shores of Scotland. Here, during a short ten days' vigil, it showed its history-making calibre when it initiated international amateur radio communication.

As this is being written, considerable tinkering is being done with super-heterodyne receivers. The occasion for this tinkering is the transatlantic amateur tests of December, 1922. Before this reaches the reader's hands, there is little doubt but that the super-heterodyne will have shown again its great dependability, as a receiver for sorting out, classifying, and recording extremely weak signals from great distances.

HOW IT WORKS

A THOROUGH understanding of the operation of the super-heterodyne is no difficult task. There are three actions which take place in the receiver in the following order: (1) a changing of the frequency of the incoming oscillation; (2) amplification of the oscillation at its new frequency; and (3) rectification (commonly considered as detection).

To the novice, the most mystifying function of the receiver combination is the frequency-changing action. This is simplicity itself. A detector tube has fed into it the incoming signal oscillations. This same detector has fed into it simultaneously oscillations which are generated at the receiving station by an oscillating vacuum-tube circuit. The circuits of the local vacuum-tube oscillator are so adjusted as to be either slightly lower or slightly higher in frequency than the incoming signal oscillations. The mixing of the two currents of different frequency in the detector tube gives rise to a new current of entirely different frequency in the output (plate) circuit of the detector tube which is known as the "beat-frequency current." By way of example in explaining the above, let us suppose that the detector circuit was tuned to receive signals on a wavelength of 200 meters. The oscillatory currents at this wavelength would be recurring

at a frequency of 1,500,000 times per second. Let us now adjust the local oscillator circuits so as to produce a frequency of 1,400,000 cycles per second. Under these circumstances the two currents differing in frequency by 100,000 cycles per second would re-act one upon the other in the circuits of the detector, so as to produce the "beat frequency" above mentioned, which would be equal to the difference of the two initial frequencies. This frequency-changing method was devised by Professor R. A. Fessenden, an American, and is known as the heterodyne method. Now, a frequency of 100,000 cycles per second corresponds to a wavelength of 3,000 meters. As mentioned above, there is no great difficulty encountered when alternating currents having frequencies as low as 100,000 cycles per second are to be amplified. Three, five, seven or even nine stages of radio-frequency amplification may be used with complete success if a few necessary precautions are taken. Subsequent to this amplification, a rectifier tube (detector) receives the amplified energy, rectifies it, and, if desired, passes it on to a second amplifier in order that the volume of the now audible signals may be increased.

A review of the foregoing explanation and reference to Figure 1 will quickly show that in its usual form, the super-heterodyne receiver is exceedingly easy to tune. There are only two prime adjustments. One controls the

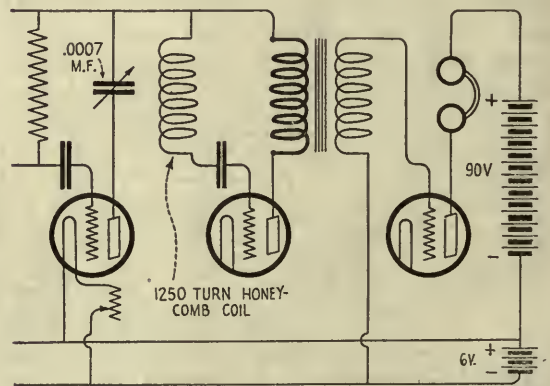
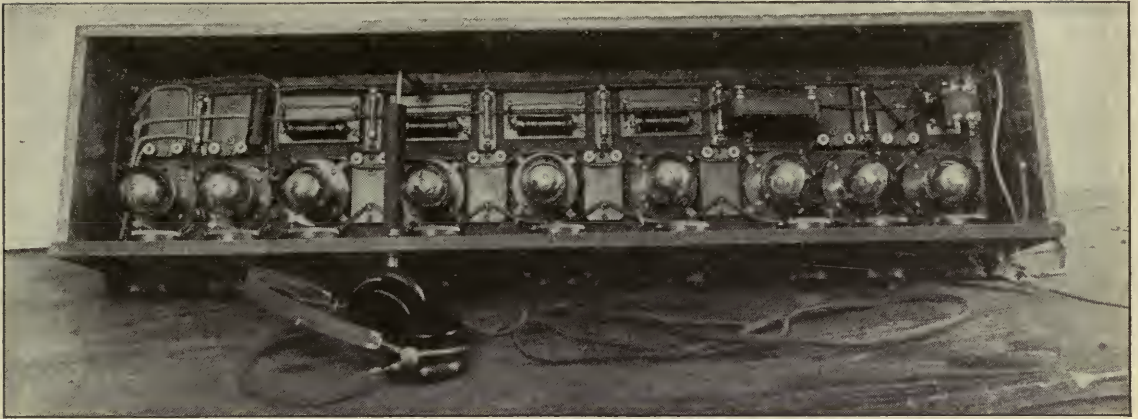

FIG. 2

wavelength of the "collector" or antenna circuit, while the other controls the wavelength (or frequency of oscillation) of the vacuum-tube oscillator circuit. Having set the one at the desired wavelength, it is only necessary to adjust the other until the dif-



THE SUPER-HETERODYNE RECEIVER

The walls of the cabinet are lined with copper sheeting, and the joints between sheets are carefully soldered

ference of their frequencies is equivalent to that frequency for which the amplifier itself is suited. The tuning of the circuits in the *output* side of the first detector tube and the input side of the amplifier are set once and for all and no change need ever be made in them.

REFINEMENTS WHICH COUNT

IN FIGURE 2 it will be noticed that the output circuit of the amplifier is also tuned to the frequency of amplification. This serves in great measure to stabilize the action of a multi-stage amplifier of this type, as indicated by the fact that when resort is had to this expedient it becomes immediately possible to add two more stages of radio-frequency amplification before reactions in the amplifier circuits have reached the point where any great pains need to be taken to shield the various stages of the amplifier to prevent self-oscillation. Having guarded against self-oscillation of the amplifier, no matter by what method, advantage may be taken of the possibilities which lie in the regenerative action so closely allied with its tendency toward oscillations. Prior to the actual setting up of oscillations in any vacuum-tube circuit, considerable amplification of the signal which may be present results from the regenerative action inherent in the tendency toward oscillations. Control may be had over this tendency by utilizing a minute capacitive coupling between the output circuit of the last amplifier tube and the input circuit of the first amplifier tube. This usually takes the form of an exceedingly small, carefully shielded, variable condenser, as indicated in the figure above mentioned. Having taken these steps, the amplifier itself

will be working at or very close to maximum efficiency.

The third and final step in bringing the super-heterodyne receiver up within striking distance of the theoretical ideal is to produce in the circuits of the first detector tube a regenerative action upon the initial currents (the incoming signal currents). Not until this has been attempted do the complications of the circuits as a whole become apparent to the operator. But, to those who are skilled in the handling of regenerative circuits and multi-stage amplifiers this does not act as a deterrent. To the novice even, I should suggest that this method be tried, because a considerable and greatly-to-be-desired building up of the initial feeble currents results.

CONTINUOUS-WAVE RECEPTION

AS TREATED thus far, the super-heterodyne receiver will not act as a receiver of continuous-wave (undamped) signals except under certain conditions of advancement where regeneration of initial

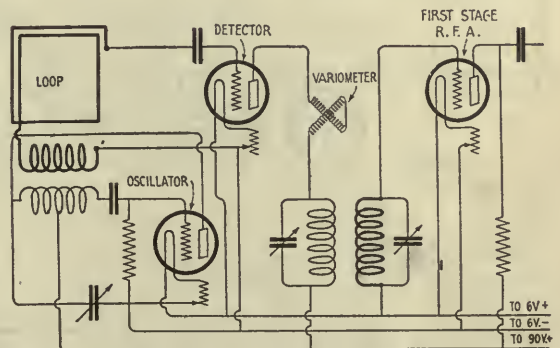

FIG. 3

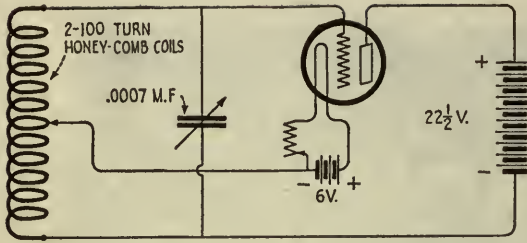

FIG. 4

An oscillator for continuous-wave reception

frequencies is being effected, and usually then in an unsatisfactory manner.

A simple and by far the most effective method of procuring audible reception of continuous-wave signals is to set up still another vacuum-tube oscillator (Fig. 4) *in the vicinity* of the amplifier circuits, this oscillator being so adjusted as to frequency that a second "beat frequency"—this time an audible one—is produced. In the case which we considered above, where the amplification frequency was 100,000 cycles, the practice would be to set the second oscillator so as to generate a frequency of 100,500 cycles. The "beat frequency" then produced would be an audible one, i.e., 500 cycles, which would give a note having a pitch just slightly lower than that heard when the middle C is struck on the piano. Having set this oscillator to produce the 500-cycle tone, it need not be changed, regardless of changes which may be made in the wavelength setting of the receiver. For, it will be remembered, the amplifier has passed to it only currents which have a frequency of 100,000 cycles.

In actual practice, it is found impractical to set the beat note oscillator at 100,500 cycles, because, unless great pains are taken to shield

the beat-note oscillator carefully, the oscillations produced by it—even though they be very feeble ones—tend to paralyze the action of the amplifier. This problem may be easily solved by setting the oscillator at double the wavelength (half the frequency). There always exists, in the circuits of the oscillator, harmonics of the true oscillation. If the fundamental oscillation (100,500 cycles) is so strong as to paralyze the action of the amplifier, either the third or fifth harmonic will usually be found of proper strength to give the desired signal without paralysis of the amplifier tubes. The third harmonic is obtained by setting the oscillator at double the wavelength of amplification (6,000 meters or 500,000 cycles, approximately). The fifth harmonic is obtained by setting the oscillator at four times the frequency of amplification (12,000 meters or 250,000 cycles). Figure 3 shows this last arrangement. Attention is called to the fact that the beat note oscillator need be no nearer to the amplifier than about four to six feet.

Care in selecting and placing the tubes available for use in the super-heterodyne is of great importance. That great thing which is to be desired is *silence* in the amplifier. Noises due to tube faults are a great deterrent. Tubes which show inclination toward noisiness should be used in the latter stages of the amplifier if at all.

I have found many users of multi-stage amplifiers complaining about tube noises which were not tube noises at all. The noises which I have in mind were due to poor connections in the battery circuits. In fact, a poor connection at any point will cause noise, but it seems that the most common cause is the existence of carelessly made connections

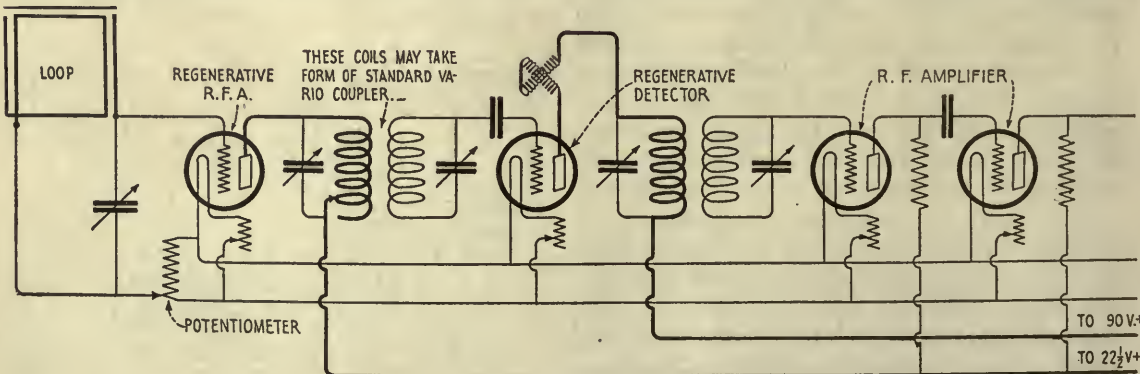
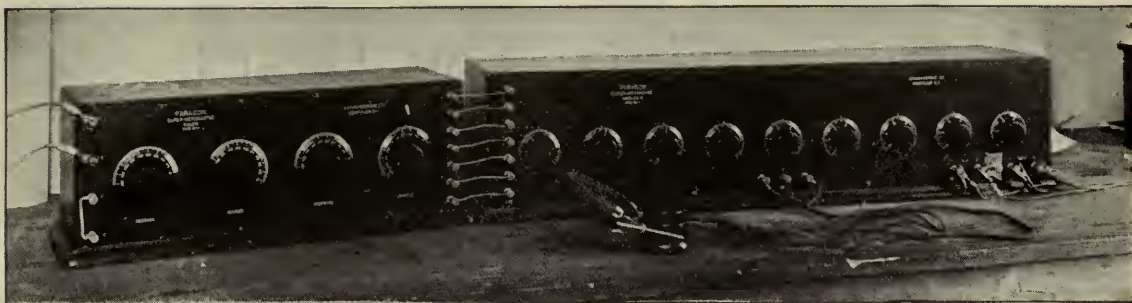

FIG. 5

The super-heterodyne circuit with tuned radio-frequency amplification



PANEL VIEW OF THE SUPER-HETERODYNE RECEIVING SET

There is a separate rheostat provided for controlling the filament voltage of each tube

in the filament-lighting circuit or to the filament-lighting battery itself.

Further, it is frequently necessary to set an amplifier of this character on rubber cushions so that mechanical shocks due to movements within the room will not cause a "ringing" of the tube elements. Preferably, each tube should have its own individual shock absorber. This enables work upon the amplifier while in operation without great noise in the headphones due to handling units in the circuit.

The final touch to be given to the super-heterodyne consists in adding to it a stage of tuned radio-frequency amplification. Of course this still further complicates tuning. The gain in signal strength is fairly well worth while, however, and the expedient will be adopted by all true experimenters. This arrangement is shown in Figure 5.

Having added this improvement, the user can be certain that he is in possession of the most sensitive radio receiver ever devised.

If You are Thinking

Of submitting an article to RADIO BROADCAST, you may save yourself and the editors time and trouble by considering the following notes as to what we want and what we cannot use:

WE WANT:

True accounts of the uses of radio in remote regions.

Short, true stories of adventures in which radio played an important part: unusual and interesting occurrences to you or your acquaintances.

Clear explanations of new or especially effective circuits or uses for apparatus.

Concise and logical discussion of some important problem or phase of radio, whether in the field of broadcasting, constructing, operating, buying or selling; or of reading or writing that has to do with radio.

True accounts, of some particular interest, relating "What Radio Has Done For Me."

Humor, when the object is not merely to appear funny, but to present some phase of radio in an attractive, amusing way. The same applies to drawings.

Clear, unusual photographs are always in order, as are good circuit diagrams.

A liberal rate is paid for material used.

WE CANNOT USE:

Fiction, unless it deals in a striking way with some subject of interest to those interested in radio.

Articles or illustrations to which RADIO BROADCAST would not have the exclusive rights.

The best way to do is to read through several numbers of the magazine to get an idea of the various kinds of articles we publish.

How Far Have You Heard on One Tube?

64,660 is the Best Aggregate Mileage Record So Far. Notes on Tuning. What Others Have Done. The End of the Contest February 1st

FEELING THE NATION'S PULSE

By RUSSELL SHEEHY

Mr. Sheehy, who has piled up an aggregate mileage of 63,860 of stations 150 to 2050 miles distant, literally has his fingers on the nation's pulse at his home in Newfields, New Hampshire. He listens-in on Dallas, Texas; New Orleans, La.; Tampa, Fla.; Denver, Colo.; Wichita, Kansas; Havana, Cuba; Ensenada, P. R.; Toronto and Montreal, Canada; Lincoln, Nebraska; Chicago, Ill.; Kansas City, Mo., Louisville, Ky., and other stations too numerous to mention.

He has reduced the operation of his set to a logical set of rules which should be of value to others in securing similar results.—THE EDITOR.

USING the circuit shown in Figure 1, I have been able to hear, from my home in New Hampshire, most of the Eastern, Southern, Western and Southwestern stations on a single tube. Most of them come in very clear and loud when conditions are not extremely bad, and it is generally possible for me to hear the entire programme from any one of the stations on the list appended. Many sets are capable of picking up one or two selections from these stations, but somehow or other they cannot be held. With the circuit I am employing, after once a station has been found, it may generally be held until you desire to tune in another.

My entire outfit is home-made, including the variocoupler which is wound with 35 turns on the stator and 35 on the rotor. No switch points or taps are used. After experimenting with different values, I found these values suited my aerial, the series condenser being .001 mfd. in the aerial circuit.

The only trouble I had with this circuit was in the paper condensers and I strongly advise the use of mica condensers and tubular leaks in the grid circuit. The .001 mfd. variable condenser across the phones and batteries may be substituted by a .002 mfd. fixed condenser or sometimes on near-by stations by a .005 mfd. fixed condenser. In the last instance, the signal strength is very materially increased.

The entire circuit is quite simple of operation and most of the tuning is done with the condenser in the aerial circuit and the tickler con-

trol. A filament volt-meter or ammeter is a good addition, and after once finding the plate and filament voltages, this part of the tuning is almost eliminated from the routine. I operate my filament on 4.4 volts and very rarely have to change it. With most of the detector tubes I have tried, the best B battery voltage is 18. Of course, this has to be found by experimenting with your particular tube. I have found that two potentiometers are quite an asset when long distance signals are desired. In this connection, the variable condenser across the phones and batteries is also very helpful. The potentiometer with the slider grounded at the correct position of the tickler may cause the tube to oscillate, by moving it toward the negative side, and it is just before this point of oscillation that signals are clearest and loudest. The set is operating at its best when you find that moving the condenser either way produces no oscillation, but there is a sort of "purr" on each side of your signal.

The simplest method for beginning the operation of this set is to set your tickler at about 10 and move the condenser until a signal is heard (this is taking it for granted that you are on the correct switch point for the broadcasting wavelengths if you are using a variocoupler with a tapped primary.) If you find a squeal on either side of your signal, loosen the tickler, that is, bring it back toward zero, moving it very slowly, however, and the distance you will have to move it depends on the strength of the signal. If it is quite loud, move

it three or four degrees, whereas if it is weak, a fraction of one degree may sometimes suffice. Every time you move the tickler it is necessary to readjust the condenser in the antenna circuit, going back and forth until the signal is produced without any interfering noises. If no signal is heard when the condenser is moved, it is generally necessary to tighten the tickler coupling, moving it up to 15 or 20 and reducing it according to the previous routine after a signal has been picked up.

This outline of operation may seem rather long-winded, but it takes much longer to tell about it than it does actually to carry it out, and once you become accustomed to your set you know just about where to set the tickler at the start so that it is generally necessary only to move the condenser in order to receive the desired signals. If you find that you get a station just on the point of oscillation and there is a click and then no signal left when you move the condenser, you will have to try different values of filament current and B battery voltage. It took me two days to find the proper places for these two variables with my last tube, but this particular point is well worth the time spent in securing it, for it stays there very well afterward.

With mica condensers and tubular grid leaks, there is nothing to pull the set apart for when the signals are not coming in particularly well on some night. After testing the A and B batteries and finding them all right you had better leave the set alone and call it a "bum" night and wait until the next night when you will be surprised at the way it works. Give it a fair chance. When your automobile goes bad you don't immediately take the engine apart, take the gas tank off, or see what the carburetor is made of. Of course not. Give the radio receiver a chance. Look at some simple things like loose connections or low batteries first before you take condensers apart.

With the two potentiometers across the A battery, it is a good plan to put a switch on one side of the line from set to battery and then there is no drain such as would otherwise exist.

Don't turn your filament right off. Turn it off a little at a time.

Don't put up a length of telephone wire when you can get some aerial wire for a dollar or less.

Keep your aerial well insulated on both ends and don't spend one month on a set and one hour on an aerial and ground system. They

have tasks to perform which are as important as those of the set itself.

If these instructions are carefully followed, you may rest assured that if you are getting poor signals some night there is no need of going over to your neighbor's, as he will be in the same boat.

My ground system is rather unique, and I have found it better than those ordinarily employed. It is a single wire directly under the single-wire aerial (125 ft. long), buried about a foot in the earth, at the end of which are extended six wires about 50 feet in

a fan shape also buried about a foot and extending beyond the aerial. My aerial runs east and west with the lead-in on the western end. I couldn't find much advantage in direction, but think that the direction from which you are to receive should be reasonably free of objects that are near, like trees and houses. Try to have a clear view in the direction of the transmitting stations considering yourself as standing on the top of the aerial.

Don't run No. 24 wire to your A battery, use No. 14 at least.

This set is really selective and sharp, especially since I have built an 8-inch cage lead-in. It is sometimes possible to leave the antenna condenser set and tune in three or four different stations by properly manipulating the tickler.

The following is the list of stations heard that are 150 or more miles distant:

THE CONTEST ENDS FEBRUARY 1st

Unless your aggregate mileage exceeds 50,000, do not include a description of your receiver, merely send in a circuit diagram accompanied by a list of the stations you have heard with the mileage opposite each. If a diagram of the receiver you are using has already appeared in RADIO BROADCAST, it is not necessary to do more than refer to the page of the issue in which it appeared.

First consideration will be given to descriptions accompanied by photographs, and the cost of building the receiver will also figure in judging a report.

The final reports in the "How Far Have You Heard?" contest will appear in RADIO BROADCAST for April. *Material received later than February 1st cannot be considered.*—THE EDITOR.

STATION	MILES DISTANT
WFAA —Dallas, Texas	1650
WRR —Dallas, Texas	1650
WCAR —San Antonio, Texas	1800
WEAY —Houston, Texas	1700
WBAY —Fort Worth, Texas	1650
WAAB —New Orleans, La.	1450
WGAQ —Shreveport, La.	1500
WEAT —Tampa, Fla.	1300
WHAD —Milwaukee, Wisconsin	885
WHA —Madison, Wisconsin	960
KDZU —Denver, Colorado	1835
WAAP —Wichita, Kansas	1470
WDAJ —College Park, Ga.	1000
WGM —Atlanta, Ga.	1000
WSB —Atlanta, Ga.	1000
PWX —Havana, Cuba	1600
WGAD —Ensenada, P. R.	1700
BFGA —Toronto, Canada	450
CFC A —Toronto, Canada	450
CKAC —Montreal, Canada	225
CFCF —Montreal, Canada	225
WGAT —Lincoln, Nebraska	1400
WGAS —Chicago, Illinois	900
WDAP —Chicago, Illinois	900
KYW —Chicago, Illinois	900
WMAQ —Chicago, Illinois	900
WWJ —Detroit, Mich.	650
WCX —Detroit, Mich.	650
WHB —Kansas City, Mo.	1300
KSD —St. Louis, Mo.	1100
WLK —Indianapolis, Ind.	840
WOH —Indianapolis, Ind.	840
WJAX —Cleveland, Ohio	600
WHK —Cleveland, Ohio	600
WFO —Dayton, Ohio	750
WLW —Cincinnati, Ohio	800
WAAD —Cleveland, Ohio	600
WGAM —Orangeburg, S. C.	900
WBT —Charlotte, N. C.	800
WLB —Minneapolis, Minn.	1150
WAAL —Minneapolis, Minn.	1150

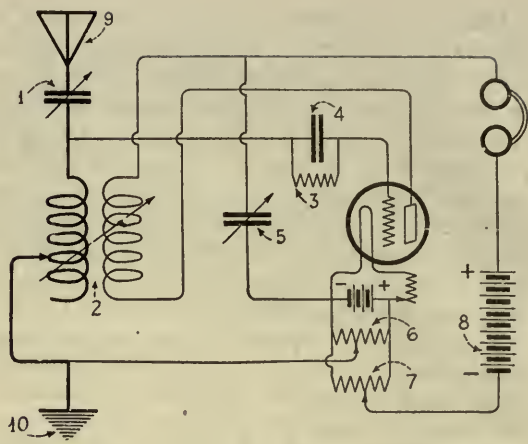
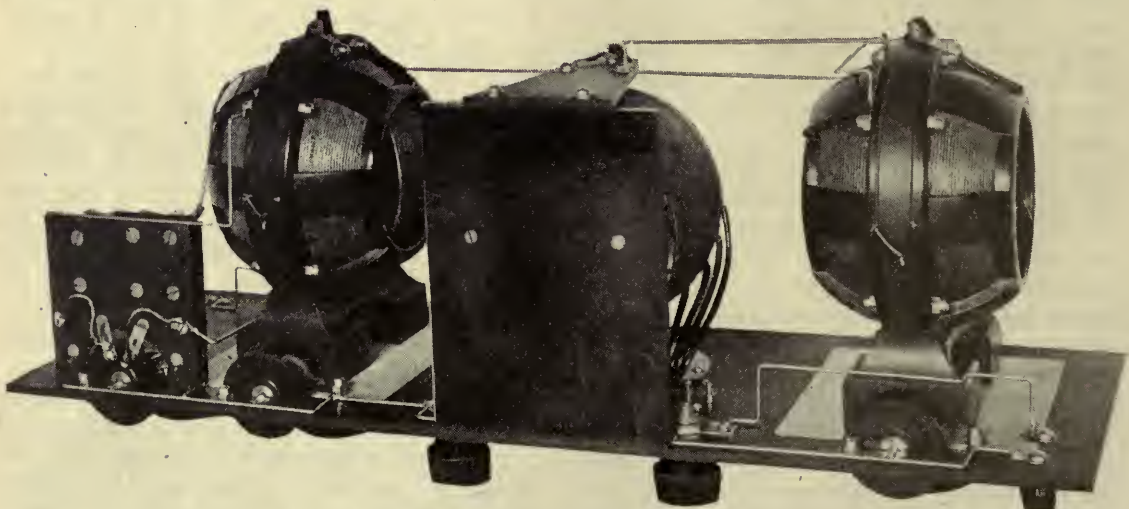

FIG. 1

- 1 Variable condenser of .001 mfd. capacity.
- 2 Any variocoupler of standard make, range 150 to 600 meters.
- 3 1-megohm grid leak.
- 4 Grid condenser of .0005 mfd. capacity.
- 5 Variable condenser of .001 mfd. capacity.
- 6 200-ohm potentiometer.
- 7 200-ohm potentiometer.
- 8 B battery, 16½ to 22 volts, for UV200 tube.
- 9 Antenna 125 feet long, 40 feet high, 7/22 stranded.
- 10 Counterpoise ground. Single wire 125 feet long, buried one foot deep, under the antenna

WBAU —Hamilton, Ohio	850
WOC —Davenport, Iowa	1050
WOI —Ames, Iowa	1200
WGF —Des Moines, Iowa	1200
WHAS —Louisville, Ky.	870
WBAZ —Richmond, Va.	550
WSN —Norfolk, Va.	550
NOF —Washington, D. C.	450
WMU —Washington, D. C.	450
KPM —Washington, D. C.	450



A WELL-DESIGNED 3-CIRCUIT TUNER

Of the type that has been in service for several years. Those who build their own will do well to attempt the same class of workmanship

WHAV—Wilmington, Del.	350
WGL —Philadelphia, Pa.	315
WIP —Philadelphia, Pa.	315
WOO —Philadelphia, Pa.	315
2CDT —Philadelphia, Pa.	315
WCAU —Philadelphia, Pa.	315
3XW —Parkersburg, Pa.	280
WBAK —Harrisburg, Pa.	375
WBAX —Wilkes Barre, Pa.	250
WIAN —Allentown, Pa.	275
WGAL —Lancaster, Pa.	350
WJT —Erie, Pa.	480
KQV —Pittsburgh, Pa.	500
KDKA —Pittsburgh, Pa.	500
WJAS —Pittsburgh, Pa.	500
WJZ —Newark, N. J.	240
WOR —Newark, N. J.	240
2XA ₁ —Newark, N. J.	240
WAAM —Newark, N. J.	240
WRP —Camden, N. J.	315
2XJ —Deal Beach, N. J.	250
WEAM —N. Plainfield, N. J.	225
WIAD —Ocean City, N. J.	225
WBAN —Paterson, N. J.	225
WAAT —Jersey City, N. J.	225
WCAN —Jacksonville, Fla.	1110
WIAO —Milwaukee, Wisconsin	885
WGY —Schenectady, N. Y.	150
WGR —Buffalo, N. Y.	400
WRL —Schenectady, N. Y.	150
WHAM—Rochester, N. Y.	350
WFG —Waterford, N. Y.	180
WRW —Tarrytown, N. Y.	180
WMAK—Lockport, N. Y.	385
WCAB —Newburg, N. Y.	200
KDOW—S. S. America, at sea	750
WCAX —Burlington, Vt.	150
WHAZ —Troy, N. Y.	150

Aggregate mileage: 63,860

THE "CARPET OF BAGDAD"

ANOTHER simple application of the single-circuit regenerative receiver is found in Fig. 2 on page 340. It was brought to our attention by Mr. W. McMiller of the Southern Methodist University, Dallas, Texas. In describing the operation of this circuit, which Mr. W. M. K. Young of Kansas City, Mo. calls the modern "Carpet of Bagdad," Mr. McMiller says: "During the summer months when so many fans were complaining of the so-called static, I was receiving Kansas City, St. Louis, Jefferson City, Denver, Cincinnati, Atlanta, Houston, San Antonio and other stations a long distance off quite regularly. Static has been the very least of my troubles. Since the cooler weather has set in, I have been able to receive up to 1400 miles. I have been able to hear 128 different stations in 27 states as well as Cuba and Mexico. It is also possible for me to hear

foreign countries by employing various sized coils according to the wavelength desired.

"One of the most remarkable features about this set is that it is quite simple to tune out stations that are not wanted, and another very attractive feature is that the materials necessary may be had for a few dollars.

Mr. McMiller says that he has discarded two variometers and a variocoupler and a two-stage audio-frequency amplifier in favor of the very small outfit he has described.

In using the same circuit, Mr. Young says: "My 'Carpet of Bagdad' and I started on a journey one evening, and I will give a description so that you may judge the value of the design. My stops were all over 500 miles from my starting point, the farthest being 1,140 miles by air line. I had not been long on my way when the "Voice of the South" from The Atlanta Journal stopped me with the well-known melodies of the Southland. Continuing, I soon heard a voice saying, 'This is WFAA, the Dallas News, and then I heard 'In the Garden of My Heart' being sung by Mr. Losier. Only a short distance from there I heard WBAP, the Fort Worth Star Telegram. These old songs from the Southland were beautiful and I hated to leave them, but adventure was in the air and I had to continue.



A SUITABLE VARIOCOUPLER
For broadcasting or amateur reception, with its metal shield which reduces body capacity effects

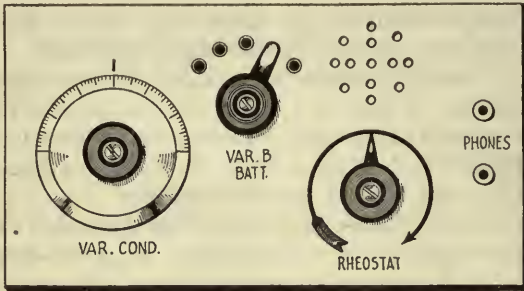

MR. McMILLER'S PANEL ARRANGEMENT
Controlling the B battery from the panel is a great convenience

So back to the North I went to get a serenade from WLAG, Minneapolis, as I passed over on the way to KDKA at Pittsburgh and then on to WRL, Union College at Schenectady, N.Y. This completed the Eastern part of my trip, and I started back, stopping at Indianapolis with the Hatfield Electric Company and hearing WWJ, the *Detroit News*, while I waited. My next and last stop was back in the Central West, where the mountains hold a station designated as DN4 operated by the Colorado National Guard at Denver, a beauty spot 640 miles from my home.

"My first evening's journey is completed and only a memory now, but while I have lengthened my trips and have spent more time at each of my stops, my first evening will always be the best that I ever took because of the thrill and enjoyment it gave me."

THE STANDINGS OF CONTESTANTS PREVIOUSLY UNMENTIONED

THE single-circuit regenerative receiver seems to be leading in the contest, and the great number of letters we have received and the great distances being covered have made it necessary for us to increase the minimum number of aggregate miles to 15,000.

Mr. Leonard B. Robinson, 537 Hillside Ave., Glen Ellyn, Illinois has an aggregate mileage of 30,430.

Mr. R. A. Riggs of Vevay, Indiana has an aggregate of 22,045 miles.

Mr. George J. Schottler of Dexter, Minnesota aggregates 16,790 miles.

We rather expected to find that the users of the Rheinhartz circuit would stand well to the front in this contest, but the best single distance made by any contestant using that circuit is 1,325 miles, and there is no aggregate mileage as high as 15,000.

With a standard loose-coupler, Mr. Edwin H. Sands, State Housing Commissioner at Des Moines, Iowa, has been able to pile up an aggregate mileage of 25,835, this with a non-regenerative receiver.

The Aeriola Seniors are standing up very well. Mr. W. J. Buckley of Fairfax, Oklahoma has an aggregate mileage of 19,030. His best single jump is 1,425 miles.

Mr. A. B. Johnson, Garfield Ave., DuBois, Pa. has an aggregate mileage of 17,375 with the best single jump of just 1000 miles.

The best report from Aeriola Senior operators we have received so far comes from Mr. A. R. Ackerman, who has received directly from Los Angeles at his home in Nashville, Tennessee. This is 1800 miles.

Mr. L. W. Carlisle, of Lisbon, North Dakota has come so close to the aggregate mileage necessary that we just can't overlook him. His aggregate is 14,795.

STANDARD REGENERATORS

REPORTS from users of standard regenerative receivers are fairly good. John R. Corrish of Bridge St., Monson, Mass. aggregates 18,465 miles with 1,500 miles as his best single jump.

Mr. C. L. Hobart of Grant's Pass, Oregon reports an aggregate of 45,580, his best single jump being 1,275 miles.

VARIOMETER REGENERATORS

THE best report from the users of a variometer regenerator receiver is from Maury Simmons, 2700 Darien St., Shreveport, La., whose aggregate is 36,250 with 1300 miles as his best single jump.

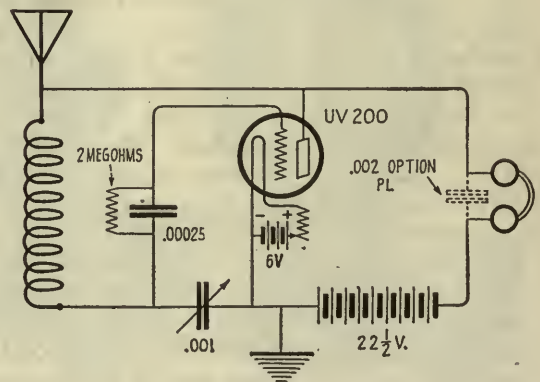

FIG. 2

The "Carpet of Bagdad" circuit. When the set is adjusted, all tuning is done with the variable condenser

55,000 Miles on a Dry-Cell Tube

ANOTHER BEGINNER'S STORY

By HARDING GOW

WE SPENT last summer on Orcas Island of the San Juan group up in the northwest corner of the United States. Of course we took a crystal set along, but as that limited us to one station it naturally followed that we had to have a tube set. At that time I did not know the difference between a variometer and a grid leak, so I came down to the Seattle Radio Show in search of information and material.

I selected a tube which had just been put on the market and which required only one dry cell for the A battery, inasmuch as there was no way of charging storage batteries at East Sound, and decided on spider-web coils because I had obtained good results with them on a crystal set, and also because there seemed to be practically no data obtainable on them and I was curious to try out their possibilities. I may add that I have never regretted the choice.

In first assembling my apparatus, I followed the conventional custom of compactness and got the condensers too close together. I tried shields between them and also a panel shield for body capacity but this seemed to me to reduce materially the signal strength, and in working distant stations on one tube, the tiny bit of energy absorbed by the shields may decide whether the voice of that fellow 1,800 miles away comes in clearly or as a confused murmur. So I pulled the set to pieces (a frequent occupation at first) and spaced the condensers well apart in a larger cabinet, mounting the coils on the ends of four-inch brass rods to get them away from the condensers. Then I began to get results.

The final assembly is shown in the photograph, which I am free to admit could not be called handsome, but the way it reached out and gathered in the distant stations was a constant surprise and delight.

The hook-up is the ordinary three-circuit regenerative type except that I used a variable condenser across the B battery and phones, and another across the tickler coil, and find them of great value in tuning the plate circuit without changing the tickler coupling, and they also bring out the tone of both voice and music.

The secondary condenser is sensitive to body capacity, but with the type of vernier handle shown it is possible to avoid annoyance from this cause.

For the values given, the primary and secondary condensers work best on about the same reading. I usually set them at 35° to 40° and pick up the stations by varying the primary coupling, maximum signals being obtained by adjustment of the plate condensers and the primary vernier.

The set is extremely selective. I think the most surprising feature to my wife was that she could shift from Fort Worth, Texas, to Calgary, Alberta, by moving the primary coil perhaps an inch!

From six to ten stations could be tuned in and out in this way without resetting the condensers, and I frequently was able to pick up both ends of test conversations between stations. One night I heard Calgary, CFCN, calling Wallace, Idaho, KFCC. I listened to them for some time when KFAY at Medford, Ore., came in, KDZZ at Everett, KMO at Tacoma, and 7X1 at Portland, all by shifting the primary coil, and I seemed to hear them better

On Standardizing Radio Equipment

Commander Stanford C. Hooper, U.S.N., is the man who suggested the formation of an American organization to maintain our position in radio communication. The Radio Corporation of America is the result. Commander Hooper has entire charge of the Navy's intricate radio communication system and is head of the Radio Division of the Bureau of Steam Engineering. He has some very constructive views on standardizing equipment and is preparing for RADIO BROADCAST an article on this important subject, which will appear in the March number.—THE EDITOR.

than they heard each other as several of them asked the others to repeat.

I think one of the best records was our hearing KFAU at Boise, Idaho, 475 miles one night when they happened to be using *only 5 watts*.

There is a little mountain, "Constitution," due east of us about three miles, or rather I should say that we were due west of it, and I believe it blocks the eastern stations to some extent, as we did better to the southeast, and the world turns the wrong way for us to pick up the eastern stations after things quiet down at night as they can do with us.

I have not found my WD -11 tube critical as to filament voltage, and I get best results by using 39 volts on the plate.

Here are some values for my equipment:

Coils wound on $\frac{1}{8}$ " fibre frames 6" in diameter with 2" centres, 15 sections, frames being moisture proofed with fixture lacquer before winding. Coils mounted on cartridge fuses, swung in fuse clips.

- L-1 60 turns No. 23 DCC wire
- L-2 70 turns No. 23 DCC wire
- L-3 50 turns No. 23 CDC wire
- C-1 43-plate plus 3-plate vernier
- C-2 9-plate plus 3-plate vernier
- C-3 23-plate
- C-4 5-plate

Grid condenser, .00025 mf. (no grid leak)

Antenna, single wire 35 ft. high, top 110 ft., lead-in 40 ft.

STATION	LOCATION	DISTANCE FROM EAST SOUND, WASH.
CHBC	Calgary, Alberta, Canada	445
CHCQ	Calgary, Alberta, Canada	445
CFCN	Calgary, Alberta, Canada	445

KFCB	Phoenix, Ariz.	1220
CJCB	Nelson, B. C.	265
Catalina	San Pedro Radio Link	1070
KUY	El Monte, Cal.	1060
KLP	Los Altos, Cal.	815
KHJ	Los Angeles, Cal.	1070
KYJ	Los Angeles, Cal.	1070
KOG	Los Angeles, Cal.	1070
KWH	Los Angeles, Cal.	1070
KFI	Los Angeles, Cal.	1070
KZM	Oakland	770
KLX	Oakland	770
KDYN	Redwood City, Cal.	800
KFBK	Sacramento, Cal.	725
KVQ	Sacramento, Cal.	725
KFBC	San Diego, Cal.	1185
KDPT	San Diego, Cal.	1185
KDYM	San Diego, Cal.	1185
KRE	San Francisco, Cal.	770
KFDB	San Francisco, Cal.	770
KUO	San Francisco, Cal.	770
KSL	San Francisco, Cal.	770
KDN	San Francisco, Cal.	770
KPO	San Francisco, Cal.	770
KLS	San Francisco, Cal.	770
KDZX	San Francisco, Cal.	770
KQW	San Jose, Cal.	805
KJJ	Sunnyvale, Cal.	800
BF4	Denver, Col.	1100
DD5	Denver, Col.	1100
KLZ	Denver, Col.	1100
KFAF	Denver, Col.	1100
WSB	Atlanta, Ga.	2300
KFBJ	Boise, Idaho	475
KFAU	Boise, Idaho (10-Watt)	475
KFAN	Moscow, Idaho	310
KFCG	Wallace, Idaho (10-Watt)	340
KYW	Chicago, Ill.	1840
WOC	Davenport, Ia.	1700
WHB	Kansas City, Mo.	1600

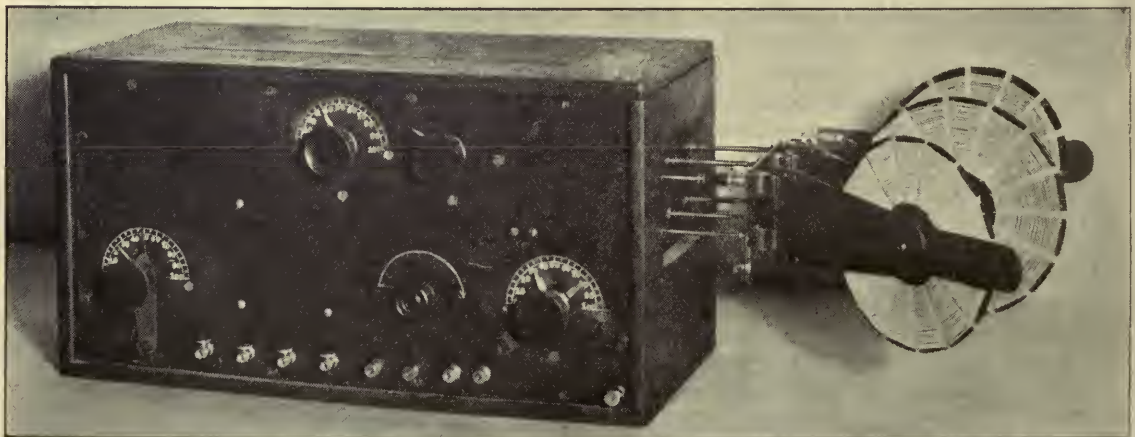

MR. GOW'S INTERESTING HOME-MADE RECEIVER

Showing the three spider-web coils mounted outside the cabinet in order to get them away from the condensers

KFAP	Butte, Mont.	525
KDYS	Grest Falls, Mont.	560
KFBB	Havre, Mont.	625
7XD	Polytechnic, Mont.	325
KDZK	Reno, Nev.	660
KFAS	Reno, Nev.	660
CJCG	Winnipeg, Man.	1175
KFBM	Astoria, Ore.	190
7YJ	Corvallis, Ore.	290
KDZJ	Eugene, Ore.	325
KFAY	Medford, (Listed Central Point)	450
KYG	Portland, Ore.	225
KGW	Portland, Ore.	225
KGG	Portland, Ore.	225
KFAB	Portland, Ore.	225
7X1	Portland, Ore.	225
KQY	Portland, Ore.	225
7XS	Portland, Ore.	225
WEAY	Houston, Tex.	2000
WFAA	Dallas, Tex.	1800
WBAP	Fort Worth, Tex.	1780
KZN	Salt Lake, Utah	780
KDYL	Salt Lake, Utah	780
BQ3	Vancouver Barracks, Wash.	225
KZV	Wenatchee, Wash.	150
KDZI	Wenatchee, Wash.	150
KFBF	Walla Walla, Wash. (new Sta.)	285
KFV	Yakima, Wash.	175
		55,150

The stations listed have all been positively identified both by call letters and name, and all

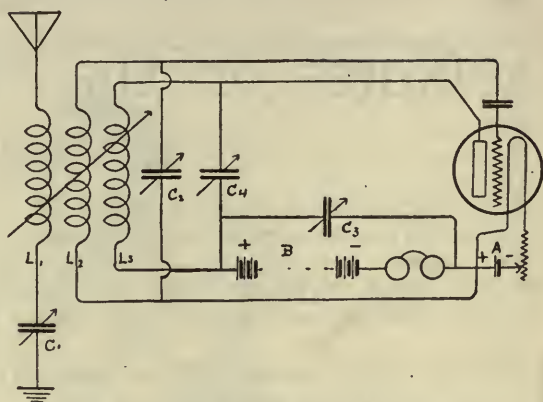

THIS IS THE CIRCUIT USED BY MR. GOW
On one tube, he has heard stations 2000 miles from his home

of the "W" stations and almost all of the remainder have been heard by my wife, as we use two headsets, the only distant station on which I have not her check being KYW.

It was hard to leave out WEAR, Baltimore, 2,450 miles, of which I had the call clearly, but Bellingham started up on so nearly the same wavelength that I was unable to verify the name.

The summer static was bad until well into September, so most of the stations were listed from Sept. 10th to November 13th when we left East Sound.

Concerning Mrs. Hale's Lecture on Cancer

IN OUR October issue we called attention to the broadcasting of a lecture by Mrs. Annie Riley Hale on the subject of cancer treatment.

Mrs. Hale feels that some of the statements in that article are a personal reflection upon her. Our purpose was not to attack the character, the motives, or the education of Mrs. Hale in any way, and we wish to retract anything that could be so construed, and to express our sincere regret for it. The object of the article was to remind the broadcaster of the duty he owes to the radio public to scrutinize with care anything he sends out which is calculated to affect people's decision and judgment, and especially so in matters affecting health and perhaps life itself. We are not to be understood as modifying views which we expressed, but we are very sorry to have said anything that could be considered as a personal criticism of Mrs. Hale.—THE EDITOR.

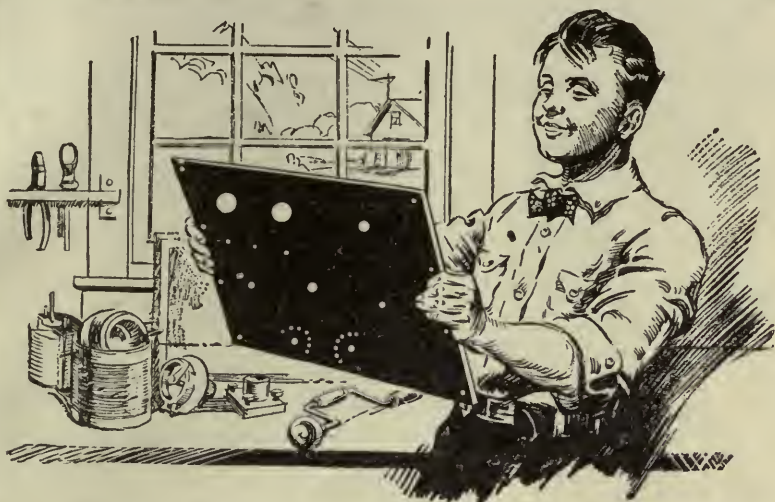

This Panel Will Improve Your Set

CONDENSITE CELORON

THE best panel made is none too good for your set. Dependable insulation is vital because it has a direct bearing upon the clearness and sensitivity of both transmission and reception.

Every thinking radio enthusiast certainly wants the highest type panel he can obtain and the surest way to get it is to insist upon Condensite Celoron.

This strong, handsome, jet-black material is not merely an insulating material—it is a radio insulation made to meet high voltages at radio frequencies. That is why it will give you greater resistivity and a higher dielectric strength than you will ever need.

Make your next panel of Condensite Celoron. It machines readily, engraves with clean cut characters and takes a beautiful polish or a rich dull mat surface.

An Opportunity for Radio Dealers

Condensite Celoron Radio Panels and Parts offer a clean cut opportunity to the dealer who is keen on building business on a quality basis. Write us to-day. Let us send you the facts. You'll be interested.

Diamond State Fibre Company

Bridgeport (near Philadelphia), Pa.

Branch Factory and Warehouse, Chicago.

Offices in principal cities

In Canada: Diamond State Fibre Co., Ltd., Toronto.

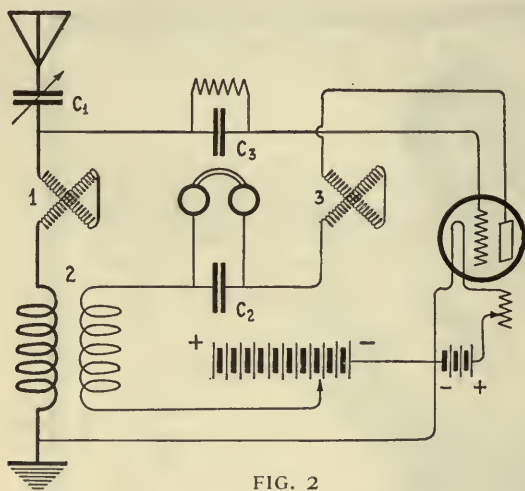

FIG. 2

Several other minor changes have been made. The variable condenser has been shifted to the antenna side of the coupler primary, by which maneuver, control of the set is apparently facilitated, owing to a possible stabilizing effect of the ground on the directly coupled grid. A grid leak, quite an important item, has been added, and a condenser placed across the phones or primary of the first transformer, as the case may be. For convenience, the receivers have been shifted nearer to the plate. If, when constructing the set, the experimenter does not fancy the immediate expense of amplifiers, the auxiliary apparatus is merely eliminated on the diagram, along with the extra B batteries, and the phones connected in place of the first jack.

A slight variation in the fundamental circuit, which has proved remarkably popular where introduced, is shown in Fig. 2. The tuning elements, exclusive of the variable condenser, are three home-made variometers, which may be constructed for less than fifty cents apiece. The variometers are wound on cardboard stators and rotors (the stationary and revolving parts) three and a half inches in diameter respectively. The stators are wound with 18 turns of No. 22 or No. 24 single cotton-covered wire, and the rotors with 22 turns of the same. The variometers may be panel mounted by bushings as described in the *Grid* in Radio Broadcast for December. The connection between the stator and rotor of variometer number two is broken in order to permit the hooking-in of the detector "B" battery. C2 is a .0015 mfd. telephone shunt condenser.

The set is slightly more difficult to tune than Mr. Parker's circuit, but the semi-regenerative function of the third variometer is soon comprehended with surprising results. Variometer number one, in conjunction with the variable condenser (which should be provided with a shorting device for waves in the neighborhood of six hundred meters) varies the wavelength. The middle variometer controls feedback or regeneration.

The set has no taps, all tuning elements being *continuously variable* by the variometers and condenser. As a result, it is remarkably selective, with tuning possibilities that, used appreciatively, rival the best inductively coupled outfits.

SUPPLEMENTAL LIST OF BROADCASTING STATIONS IN THE UNITED STATES FROM NOVEMBER 23
TO DECEMBER 24 INCLUSIVE

CALL SIGNAL	OPERATED AND CONTROLLED BY	LOCATION
KFCL	Los Angeles Union Stock Yards	Los Angeles, Calif.
KFCQ	Motor Service Station	Casper, Wyoming
KFDB	Mercantile Trust Company of California	San Francisco, Calif.
KFDC	Radio Supply Co.	Spokane, Wash.
KFDF	Wyoming Radio Corp.	Casper, Wyoming
KFDH	University of Arizona	Tucson, Arizona
KFDJ	Oregon Agricultural College	Corvallis, Oregon
KFDL	Knight-Campbell Music Co.	Denver, Colorado
KFEJ	Guy Greason	Tacoma, Washington
KFEP	Radio Equipment Co.	Denver, Colorado
KFGG	Astoria <i>Budget</i>	Astoria, Oregon
KFGH	Leland Stanford Jr. Univ.	Stanford University, Calif.
KFHJ	Fallon Company	Santa Barbara, Calif.
KGW	Portland <i>Oregonian</i>	Portland, Oregon
WLAG	Cutting & Washington Radio Corporation	Minneapolis, Minn.



No Wireless
Receiving
set is
complete
without

MAGNAVOX
Radio
The Reproducer Supreme



R-2 Magnavox Radio with 18-inch horn: this instrument is intended for those who wish the utmost in amplifying power; for large audiences, dance halls, etc. \$85.00

R-3 Magnavox Radio with 14-inch horn: the ideal instrument for use in homes, offices, amateur stations, etc. \$45.00

Model C Magnavox Power Amplifier insures getting the largest possible power input for your Magnavox Radio. 2 Stage . \$80.00
3 Stage . 110.00

When you purchase a Magnavox product you possess an instrument of the highest quality and service.

Magnavox products can be had of good dealers everywhere. Write us for copy of new illustrated booklet.

EVERY improvement in the science of radio broadcasting and reception only emphasizes the truly extraordinary qualities of Magnavox.

To enjoy all that radio offers in the way of daily concert, lecture and news, ask your dealer for a receiving set equipped with the Magnavox Radio Reproducer and 2-stage Power Amplifier.

Magnavox can be used with any good receiving set—the better the set, the more Magnavox can do for you.

The Magnavox Co., Oakland, California
New York: 370 Seventh Avenue

WOAH	Palmetto Radio Corp.	Charleston, S. C.
WOAK	Collins Hardware Co.	Frankfort, Ky.
WOAL	William E. Woods	Webster Grove, Mo.
WOAN	James D. Vaughan	Lawrenceburg, Tenn.
WOAP	Kalamazoo College	Kalamazoo, Michigan
WOAQ	Portsmouth Radio Ass'n.	Portsmouth, Va.
WOAR	Henry P. Lundskow	Kenosha, Wisconsin
WOAS	Bailey's Radio Shop	Middletown, Conn.
WOAT	Boyd Martell Hamp	Wilmington, Delaware
WOAU	Sowder Bolling Piano Company	Evansville, Indiana
WOAW	Woodmen of the World	Omaha, Nebraska
WOAX	Franklyn J. Wolff	Trenton, New Jersey
WOAY	John M. Wilder	Birmingham, Ala.
WOAZ	Penick Hughes Co.	Stanford, Texas
WPAC	Donaldson Radio Co.	Okmulgee, Okla.
WPAG	Central Radio Co., Inc.	Independence, Mo.
WPAH	Wisconsin Dept. of Markets	Waupaca, Wisconsin
WPAJ	Doolittle Radio Corporation	New Haven, Conn.
WPAK	North Dakota Agricultural College	North Dakota
WPAP	Theodore S. Phillips	Winchester, Ky.
WPAQ	General Sales & Engr. Co.	Frostburg, Md.
WPAR	R. A. Ward	Beloit, Kansas
WPAT	Saint Patrick's Cathedral	El Paso, Texas
WPAU	Concordia College	Moorhead, Minn.
WQAB	Southwest Missouri State Teachers' College	Springfield, Mo.
WQAK	Appel-Higley Electric Co.	Dubuque, Iowa
WQAL	Cole County Tel. & Tel. Co.	Mattoon, Ill.
WRAA	Rice Institute	Houston, Texas
WRAN	Black Hawk Electric Company	Waterloo, Iowa
WSAJ	Grove City College	Grove City, Pa.
WTAC	Penn Traffic Co.	Johnstown, Pa.
WTAU	Ruegy Battery & Elect. Co.	Tecumseh, Neb.
WWAD	Wright & Wright, Inc.	Philadelphia, Pa.

The Grid

QUESTIONS AND ANSWERS

The Grid is a Question and Answer Department maintained especially for the radio amateurs. Full answers will be given wherever possible. In answering questions, those of a like nature will be grouped together and answered by one article. Every effort will be made to keep the answers simple and direct, yet fully self-explanatory. Questions should be addressed to Editor, "The Grid," Radio Broadcast, Garden City, N. Y. The letter containing the questions should have the full name and address of the writer and also his station call letter, if he has one. Names, however, will not be published.

LOOSE COUPLERS

How does a loose coupler work without any connection between the primary and secondary?

I have a set consisting of a loose coupler, variable condenser, crystal detector, fixed condenser and Turney 3000-obm phones. I get no results at all. Could you help locate my trouble? My antenna is of the T type; one end is about fifty feet high and the other end sixty feet high.

I enclose my bookup.

—J. B., NEW YORK CITY.

IN a general way, electricity is transferred from the primary of a loose coupler to the secondary by means of a phenomenon called induction. Whenever electricity traverses a circuit, such as from the antenna, through the coupler primary to the ground, magnetic

lines of force, similar to those surrounding the poles of a horseshoe magnet, spread out from the conductor, and reproduce magnetically every fluctuation of the current. When these lines of force cut an adjacent conductor, such as the secondary of the coupler, they "generate" another current which exactly follows the variations of the magnetic field, and therefore duplicates, excepting in strength (there is a small loss) the antenna current. Large generators in power houses operate on this principle, and are nothing more than machines which pass a dense flux, at a high speed, through windings from which the current is drawn.

However, in a loose coupler, induction alone does not explain the transference of energy from primary to secondary, for it is doubtful that with the low inductance (due to the few turns of wire and the absence of an iron core), and the comparatively great distance that often separates the

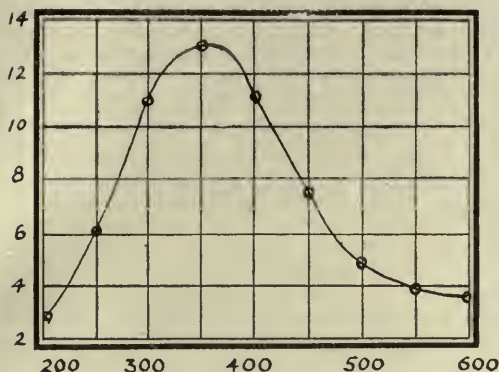

CHART I

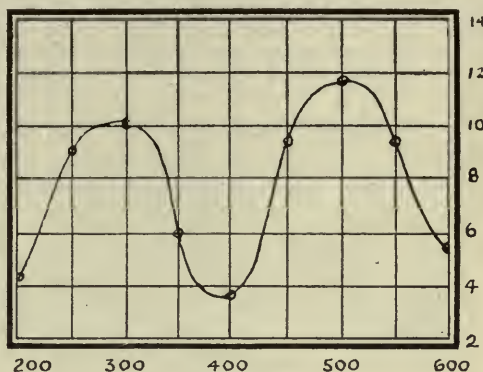

CHART II

The Importance of Uniformity

How to avoid amplification losses when using radio frequency

BEFORE you purchase a radio frequency transformer be sure to find this out. Does it show marked depressions and peaks in the amplification range between 250 and 500 meters? No amplification is possible in such depressions. Getting distant stations becomes a gamble as to whether or not there is any amplification at a given point.

How to get uniformity

THERE is a radio frequency amplifying transformer which has been so perfected that the peaks and depressions are eliminated. This is the Acme R-2. This unique transformer, after long months of experimentation, has been perfected with a special type of iron core and windings which eliminate the peaks and depressions and provide a steadily increasing volume of amplification up to the point of maximum importance—360 meters.

Gets greater distance

EQUALLY important is the far greater distances you get broadcasting. The Acme R-2 used in a radio frequency amplifier builds up wave energy before passing it on to the detector. You hear signals or-

dinarly inaudible. The simplest and most elementary type of set, either vacuum tube or crystal receiver type, will have its range tremendously increased.

The best method

TO SECURE maximum results use three stages of Acme Radio Frequency Amplification (R-2, R-3 and R-4), a crystal detector and three stages of Acme Audio Frequency Amplification. This insures maximum sensitivity and intensity, quietness in operation and freedom from distortion. A small indoor antenna or loop may be used and sufficient intensity obtained to operate the Acme Kleerspeaker, providing perfect entertainment for a roomful of people.

You can get these and other Acme Products at radio, electrical and many hardware stores.

Write for booklet R-2 showing proper hook-ups and other information.

The Acme Apparatus Company

(Pioneer transformer and radio engineers and manufacturers.)

CAMBRIDGE, MASS., U. S. A.

New York, 1270 Broadway
Chicago, 184 W. Washington Street



Acme R-2 Radio Frequency Amplifying Transformer. Price \$5. (East of Rocky Mountains.)

ACME ~ for amplification

windings, that more than a small fraction of the received signal is transferred to the detecting circuit in this manner. It is probable that the primary, acting as a transmitting antenna energized by the received signal, wirelessly the

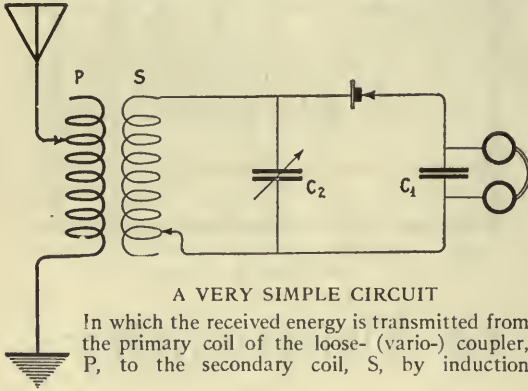

A VERY SIMPLE CIRCUIT

In which the received energy is transmitted from the primary coil of the loose- (vario-) coupler, P, to the secondary coil, S, by induction

energy to the secondary which is virtually a receiving aerial, and which must be tuned to pick it up!

The advantages of the loose coupler over the single circuit tuner are several. Aside from permitting delicate and sharp tuning by slight changes in the coupling, which simultaneously varies the wavelengths of the primary and secondary, the coupler is very efficient in eliminating undesired signals, a quality known as selectivity. If the primary is tuned to a certain station, the antenna will pick up its wave with a partial exclusion of all others. But at the same time, signals from a powerful or near-by transmitter, tuned to a different wave, will force oscillations in the non-resonant circuit. The secondary, which must be tuned to the same wave as the primary, will readily receive energy induced by the tuned station, but will discriminate against, and still further tend to eliminate, the forced signal. The primary and secondary are analogous to two water filters. While some impurities may flow past the first, few if any pass the second.

HUNTING TROUBLE ON A CRYSTAL RECEIVER

THOUGH your antenna is not all that could be desired (we suggest a single wire inverted L, from a hundred to a hundred and fifty feet long), you should certainly receive signals on your set, which is probably the most efficient combination of instruments for crystal reception. One or more of several things may be at fault.

The condensers C_1 and C_2 should first be removed from the circuit, one at a time in the order named, and the set tuned after each removal. If signals are received, it is evident that one or both of the condensers is shorted. When the variable capacity is at fault, the experimenter can probably repair it by adjusting the relative position of

the stationary and revolving plates. If it is the fixed condenser that is shorted, it is best replaced by a new one. The receivers should be next tested by touching the ends of the phone cord to the terminals of a dry cell. If the headset is in good condition, a loud definite click will be heard. Having once determined that the receivers are not at fault, the phones themselves may be used for further testing the set.

It is possible that the antenna is grounded and this should be next ascertained by disconnecting the aerial from the coupler and transferring it to one of the receiver cords. The remaining phone cord is grounded through a dry battery. On making and breaking the connection, a fairly loud click will indicate the difficulty.

The primary and secondary are next in order, and are individually tested by connecting the phones to one end of the winding, and the other to the switch lever through the dry cell. As the circuit is interrupted by running the lever on and off each tap, a loud click should be heard in the phones.

The connections between the various instruments, particularly soldered joints, should be carefully examined. Inexperienced enthusiasts often use rosin as a poor substitute for soldering pastes. Aside from being an unsatisfactory flux, if the iron is slightly cool it will remain between the metals, merely sticking the solder on with a highly insulative glue, with the result that an ostensibly perfectly soldered joint is no connection at all! After having determined that the condensers are not broken down or shorted, a battery substituted for the crystal detector will indicate, by a definite click, that the essential secondary connections are well wired.

The last possibility is that the detector crystal may not be a sensitive one, a condition that should be ascertained by

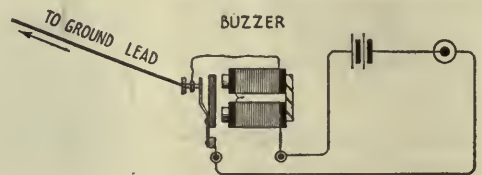

HOW TO CONNECT A BUZZER

For use in testing your crystal set

buzzer test, an arrangement that is at any time a desirable addition to a crystal set. A small, high-toned radio buzzer should be connected as here shown, where the only deviation from the conventional announcing buzzer hook-up is the single wire running from the stationary contact to the ground lead on the receiver. If the push-button is replaced by a telegraph key, the buzzer may be used for code practice. The detector is adjusted while the buzzer is vibrating, and the note will be plainly audible in the receivers when the cat-whisker is on a sensitive spot.

What Would You Like to Have in Radio Broadcast?

The editors would be pleased to hear from readers of the magazine on the following (or other) topics:

1. *The kind of article, or diagram, or explanation, or improvement you would like to see in RADIO BROADCAST.*

2. *What has interested you most, and what least, in the numbers you have read so far.*

"When happiness or calamity is about to come,"
said Confucius, "it can be known
beforehand." Insure complete
radio happiness with
a **Grebe Receiver.**

Doctor Mu.

IF YOU buy inferior radio apparatus
you must not expect the best
results.

Its long record of satisfactory service has won for the Grebe Receiver the unqualified endorsement of all experienced radioists and dealers.

Your copy of "Musings of Doctor Mu" sent free upon request.

A. H. GREBE & CO., INC.
RICHMOND HILL, N.Y.



Licensed under
Armstrong U. S.
Pat. No. 1113149

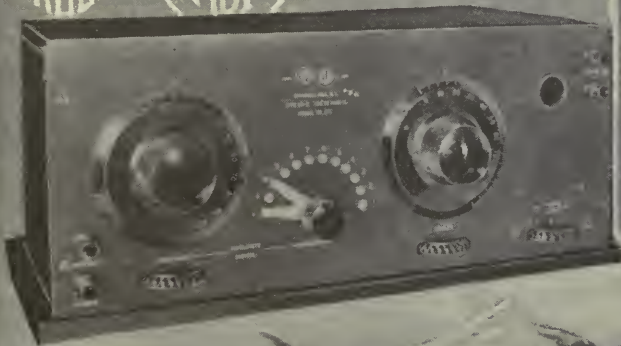



ICE FROM HEAD TO FOOT

It is at such stations as this that a lighthouse-keeper learns the value of a home-made receiving set for brightening the lonely hours. This is the Racine Reef Light Station on Lake Michigan

RADIO BROADCAST

Vol. 2 No. 5



March, 1923

The March of Radio

MONOPOLIZING PRODUCTION OF APPARATUS

WITH the almost innumerable patents which have been issued for radio circuits and appliances during the last decade it was a foregone conclusion that turmoil and strife were soon due for those undertaking the manufacture and sale of radio apparatus. It would be difficult to point to one piece of radio apparatus, or even a detail of that piece, which is not covered by a patent of some sort. The wise manufacturer is obliged to call to his aid the services of a shrewd patent attorney if he is to make anything to do with radio and "get away with it."

Of course there are a few basic patents which seem to hold water and serve as an effectual deterrent to those not owning, or operating under, the patent licenses. Thus the manufacture of ordinary vacuum tubes at present is apparently a risky undertaking for any one not operating under license from the Radio Corporation; the manufacture of regenerative sets is feasible only for those operating under license from the Radio Corporation or those who acquired an Armstrong license before the patent was sold to the Radio Corporation. Even the Radio Corporation occasionally has to contend with some patent trouble. We understand that the present tubes with their elliptical plates and grids have been given that peculiar shape in order to "get by" a patent covering a cylindrical construction

of vacuum tubes. The use of a grid leak is patented. The use of a grid biasing-battery is patented. In fact, the complete radio set involves literally scores of patents.

It is now nearly prohibitive for any but a few "inside" firms to manufacture a good radio receiving set; a new company trying to break into the game and make a good set finds that to acquire licenses and pay the royalties demanded requires so much money that they could not manufacture and market a set at a profit. We understand that a short time ago a firm desiring to manufacture regenerative sets was asked \$35,000 cash and \$15 a set royalty for the privilege. Other patents would require their royalties also, so that naturally a set put together under such restrictions must cost the customer a lot if the manufacturer is to get any profit at all.

There are about a score of firms which have been making regenerative sets under Armstrong licenses. They have apparently been more or less immune from patent troubles. These firms acquired their licenses for practically nothing before the Radio Corporation got control of it. It seems now, however, that the situation is to be made somewhat more difficult for them. The A. H. Grebe Co., one of the better known radio manufacturers, is now being sued for infringement of five different patents owned by the Radio Corporation—patents issued to De Forest, Langmuir, Lowenstein, and Mathes over a period reaching from

1907 to 1922, these patents covering tubes and circuits for using tubes.

Should the injunction which is sought by the Radio Corporation be granted, it seems that every manufacturer of radio apparatus in the country would be put out of business—excepting, of course, the Radio Corporation itself. It seems that a monopoly of the most grinding sort is the object of this firm. The resulting situation might not be reckoned as a monopoly by that corporation because it seems that head telephone sets might possibly still be manufactured, although even that might prove to be covered.

To give some idea of the scope and nature of the injunction sought by the Radio Corporation, we quote a part of one sentence of the plaintiff's bill, as affecting the De Forest patents. In one paragraph of the complaint on which the Radio Corporation bases its prayer to the Court, it appears that the defendant, said A. H. Grebe Co. ". . . did unlawfully and wrongfully make . . . wireless receiving sets adapted, designed, and intended for use in combination with, and useful only in combination with, vacuum detector and amplifier tubes."

If the defendant should be enjoined from radio set manufacture on a complaint of this kind, the radio monopoly would be even more stringent than is that covering the manufacture of tungsten lamps to-day. We recall the testimony of one of the General Electric officials, recently given in some case involving lamp manufacture, that the General Electric Company did not have a monopoly of the lamp industry, because they controlled only 99 and a fraction per cent. of the product. This will be about the situation in the radio field should the plaintiff's prayer be granted.

A radio set must necessarily be used in combination with a detector, crystal or tube, and evidently all radio apparatus, be it coil, condenser, or what-not, is "intended for use in combination with" either tube or crystal. Hence the owner of the crystal and tube patents could control everything in the radio field. They might even start suit against the wire manufacturers who manufacture radio cable (litzendraht) as it is evidently intended for use in radio sets which are used in combination with tubes! And every high-resistance head telephone set is evidently intended for use with either a crystal or tube, so why not sue the telephone manufacturer into the bargain?

And the Bakelite Corporation might also receive the attention of the Radio Corporation because it evidently markets much of its product "to be used in combination with vacuum-tube detectors and amplifiers."

All of which means endless conflict and general dissatisfaction. However, there is a way out of these conditions, and RADIO BROADCAST will suggest, next month, lines along which this conflict and this dissatisfaction may be avoided.

The New Method of Reproducing Speech

IT IS often impossible for speakers of importance to make and keep engagements to appear in person at the broadcasting stations, with the result that the ability of the speakers engaged for the radio audiences is not always as high as it might be. We cannot expect that the Chief Executive or his cabinet officers will appear at broadcasting stations frequently, yet we should be much interested to hear them express their views on the topics of the day. We have elected them to office and are entitled to hear them express, first hand, not through reporters, their views on those questions in the settlement of which their influence will be decisive.

One of the great defects in our representative scheme of government is the very slight relations between our elected officers and those who elected them. After seeing the prospective office holders and hearing them, face to face, make promises of what they are going to do if elected, the average voter never again hears the voice of the man he helped to office, and generally has but little knowledge of what he is doing to carry out the promises he made. What a remarkable situation would arise if we could call upon those we have elected to give an occasional accounting of their activities—say once monthly. When an important question arose the elected officer would be called upon to express, publicly and personally, over the radio, his stand and reasons therefor. Many of us would soon know more about the way our government functions, and take more interest in it, than we do now.

The heads of departments of any commercial organization are required to have personal interviews with the chief who appointed them to their positions; why shouldn't our appointees, our representatives and senators, regularly report to us on their activities so that we may

continually be informed as to whether or not they are doing what they promised to do when they asked for our votes? The prospect is a very interesting one, and it seems that the electorate would be much more conscientiously served if advantage could be taken of its possibilities. We are reminded of the progress of communication by radiophone in the Navy. By its use, the admiral is able to hold the officers to a much more exact observance of orders, with no excuse due to fault in communications—the admiral is able to talk directly to the commanders of the various vessels and so can know that his orders are perfectly understood by the whole fleet. That is just the kind of control the electorate would like to exercise over their chosen servants, and it may be that the radiophone will help in this as it has done in the Navy.

Any step in this direction, making closer the contact between important business men or office holders, and those to whom their views are of especial interest, is to be welcomed. There has been developed in the laboratories of the General Electric Co. a device which promises to be an important factor in improving this branch of radio broadcasting, styled the pallophotophone. With this euphonious title the sponsors have decided to christen a new photographic method of recording and reproducing speech or music, which has apparently been developed along somewhat different lines from any other method of which we have heard.

There is apparently no new scientific principle involved in the scheme; it is an ingenious combination of pieces of apparatus which had not been tried before. There can be but few really new discoveries or fundamental inventions with the present rate of progress of science;

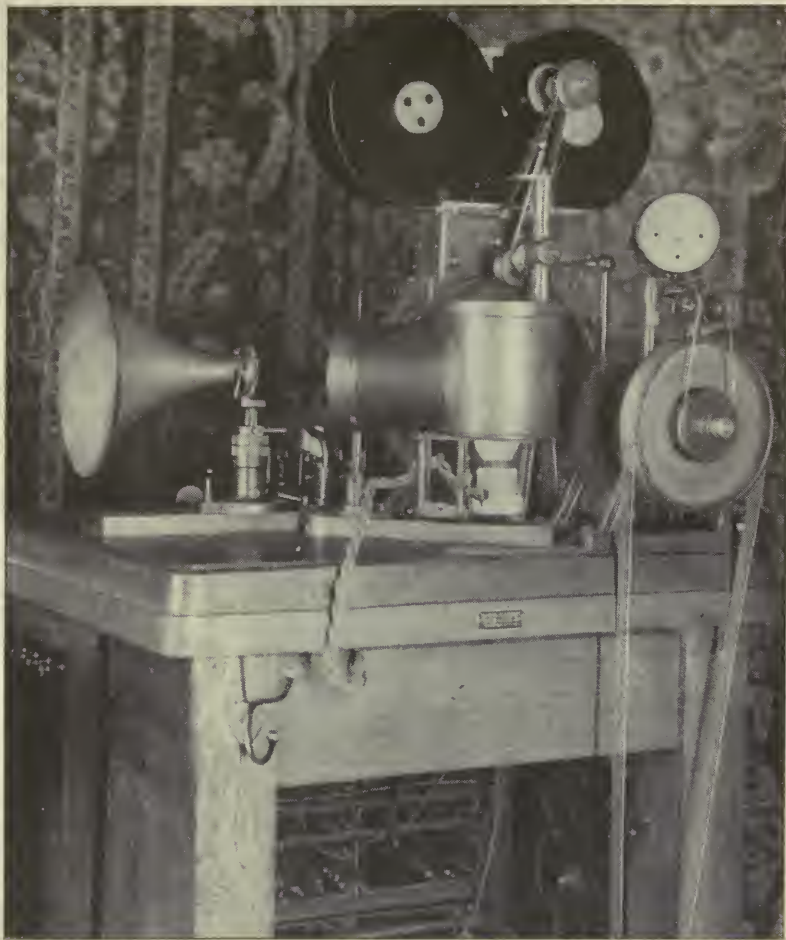

AS CLEAR AS THE HUMAN VOICE

This is the claim for the speech reproduced by Charles A. Hoxie's pallophotophone, the remarkable combination of inventions by which sounds are photographed on a moving film and changed to corresponding electric currents which may be used, at any time, to control the output of a broadcasting station

most inventions must be merely an improvement on devices already known or new combinations of these devices. Such is the pallophotophone, for which Mr. Charles A. Hoxie, of the General Electric Co., a well known inventor, seems to be responsible.

This scheme of Hoxie's involves, first, photographing sounds on a moving film by means of a vibrating diaphragm, suitable magnifying levers, and a mirror, and secondly, changing this record on the film by a photo-electric cell to corresponding electric currents which, sent through amplifiers, are able to control the output of the broadcasting station. Both of the actions involved in the pallophotophone have really been developed in university laboratories by so-called "pure" scientists;



MAJOR-GENERAL JAMES G. HARBORD

Who succeeded Edward J. Nally as President of the Radio Corporation of America, on January 1st. He is a former Rough Rider, a veteran of the war in Cuba and the Philippines, was Chief of Staff under General Pershing in France, and later commanded the Marine Brigade of the Second Division at Belleau Wood, Boursesches, and Château-Thierry. In 1918, he commanded the Service of Supply which was responsible for all supplies of the A. E. F.

so far as we know it was not necessary for Hoxie to do much investigation of the action of either the recorder principle or the reproducer principle, but it undoubtedly did require a deal of ingenuity and skill to make them operate properly in a piece of commercial apparatus.

To Professor Miller of the Case School of Applied Science is due the credit for the pioneer work in recording sound waves by the use of suitably mounted small mirrors. His book giving the results of this pioneer work makes fascinating reading and is illustrated with many remarkable photographs of the sound waves from various instruments.

The photo-electric cell has been a subject of inquiry, during the last few years, for many able investigators; an explanation of its action, it seemed, might throw much light on the nature of electromagnetic waves as well as on the structure of the molecule. Even as we

are writing this, there has just arrived a valuable contribution to the theory and action of photo-electric cells by two of the research workers of the Western Electric laboratories. A photo-electric cell is essentially a two-electrode vacuum tube, one of the electrodes being such a metal as potassium or sodium. If the other electrode is made positive with respect to the potassium, an electron current will flow to it from the potassium whenever the latter is illuminated. The light wave impinging on the surface of the potassium is apparently able to pull out some electrons, which, once through the surface of the potassium, go over to the positive electrode. The number of electrons set free by this so-called photo-electric action, is proportional to the intensity of the light, so that if a light of variable intensity is thrown on the surface of the potassium, the electron current to the anode will correspondingly vary.

In the pallophotophone Hoxie has been able to coordinate the work of Miller and that on photo-electricity to create a wonderful sound-recording and reproducing mechanism. By making the mirrors, levers, and diaphragm of extremely small mass, the oscillating light beam sent off from the mirror actually follows even the high-frequency consonant sounds of the voice. The record looks like a black line about one quarter of an inch wide, one side of which has a serrated appearance, due to the peaks of the sound wave reaching out past the edge of the black line. With loud sounds, the pointed projections from the edge of the black line are comparatively long, looking like a lot of fine needle points about one eighth of an inch long, the needle points being at right angles to the edge of the black line. With high pitched sounds the needle points are close together, and with bass notes they are much farther apart.

In the reproducing scheme, light shines through this strip of film on to a photo-electric cell; according to the number and size of the serrations on the edge of the black line, a varying amount of light falls on the sensitive cell and so a varying current flows through it. This current goes to the amplifiers and on to the control circuit of the broadcast transmitter.

According to those who have heard the reproduction, it is excellent. On several occasions WGY has operated with the pallophotophone film as the voice control and the listeners have been under the impression that the speaker was in the studio of the station. Evi-

dently a device as good as this one seems to be, may prove of great importance in the development of the talking movie.

Interference from Arc Stations

THE highest-powered transmitting stations in the world to-day use the Poulsen arc as the source of high-frequency power for the antenna. A high-voltage, continuous-current generator supplies power to a very intense arc, burning in a closed, water-cooled chamber filled with illuminating gas or alcohol vapor. When suitable connections are made between this arc and the antenna, part of the continuous-current power supply, perhaps 40%, is changed into high-frequency power and fed to the antenna. The scheme is good only for long-wave stations. This method for generating high-frequency power is used at practically all the government's high-power stations as well as some smaller commercial stations on the west coast.

Unfortunately, these arcs generate other frequencies than those desired for operating the station, some of them high enough to be heard by stations listening on wavelengths perhaps one tenth that used by the arc station. This extra power, at the higher frequencies, is undesirable both from the standpoint of efficiency and interference, and attempts have frequently been made to eliminate it. That the schemes are not quite as successful as the arc advocates would have us believe is shown by the following extract from a letter sent by one of our correspondents.

"—Permit me to relate that any one living in this city or within a radius of more than fifteen miles, possibly farther, has very discouraging difficulties to overcome in the line of interference from two very powerful government stations located at the Mare Island Navy yard—interference from the 100, 30, and 12-kilowatt arc stations at that place commonly referred to as "mush." One or more of these powerful arc stations is in almost constant operation during broadcast hours."

The Amateurs and Professionals

FOR a considerable period this winter the amateurs of America and Europe carried out tests to see how consistently communication on the 200-meter wavelength, with low-powered transmitting sets, could be estab-



©Underwood & Underwood

EDWARD J. NALLY

Who was President of the Radio Corporation from the time it was founded until January of this year. He has now taken up the duties of his new post as Managing Director of International Relations for the Radio Corporation, with offices in Paris. Mr. Nally, who has been in communication business all his life, has been a prominent figure in the development of radio in this country, and because of his familiarity with conditions abroad is especially qualified to represent the growing interests in the foreign field

lished. It seems remarkable how many of the American amateurs have been heard in Europe, stations from as far west even as the Pacific coast having been copied on the other side of the Atlantic. Altogether, between one hundred and two hundred stations were successful in spanning the ocean. From the latest reports available, European transmitters have not been so successful in crossing the ocean from east to west—just why is not yet apparent.

We have always considered short waves as entirely unsuited for long distance communication. In fact it seems, from some of the accepted formulas of radio, as though a two-hundred-meter wave would be so attenuated in its two thousand miles of travel that even an excellent receiving set would be unable to detect it. The accepted equations for wave propagation have been based on experimental data and of course the data may have been unreliable in the short-wave range. Marconi,

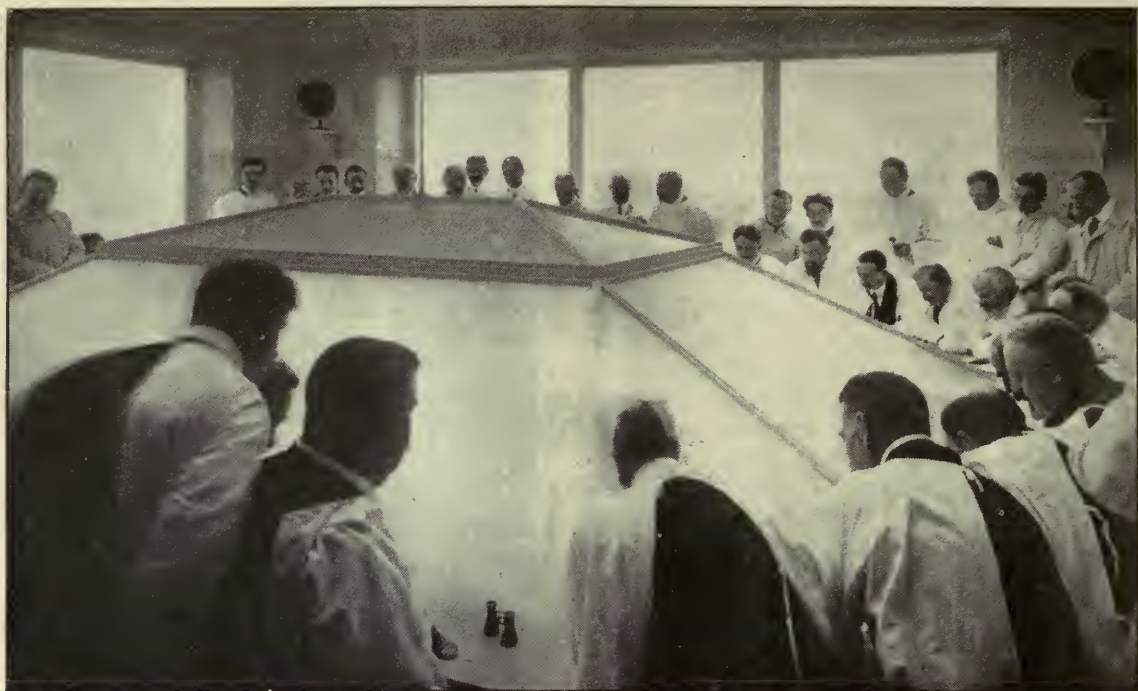

A MODERN SURGICAL CLINIC IN PARIS

Doctors and students at St. Michel view the operations through this glass dome, and hear the slightest sounds in the room below, including the comments of the operating surgeons, by means of a microphone installation. Two loud-speaking horns may be seen at the far side of the room

during his most recent visit, gave the results of short-wave transmission in England, showing that it was possible to telephone over a hundred miles with waves much shorter than those used by the average amateur.

A difficulty encountered with short-wave transmission is that of sufficient radiation. With the small antennas necessarily used for tuning to the short wavelength it is at present impossible to radiate much power. It is not apparent to-day that it will ever be possible to send out several hundred kilowatts on 200 meters, but if continued experimentation shows that the attenuation is much less than has been supposed, some scheme will probably be found for operating a whole series of antennas synchronously so that the radiation from each is in the right phase to assist that of all the others. When such developments come, directional radio will be much nearer of accomplishment than it now is; a whole set of small antennas, properly operating at 200 meters, would send practically all their power in one direction, a beam of radiation perhaps ten degrees wide.

It seems strange that the powerful radio-

phone stations of the commercial companies are scarcely ever heard on the other side of the Atlantic. Only occasionally do we get reports of WJZ or WEAJ being heard in Europe. Certainly in this country these professional stations reach greater distances than do most amateurs, and we should naturally suppose they would span the ocean much more effectively than the short-wave amateur stations. It is not at all evident, however, that this is the case. We may yet find that the short wave is much more suitable for long-distance transmission than we have heretofore supposed.

Again the National Radio Chamber of Commerce

THE formation of this body was commented upon some time ago. Its functions, as expressed in the circulars sent out by the organizers, were to be many and varied, among them being the regulation of the activities of broadcasting stations. The Chamber announces that, after conferences with the Navy Department, Department of Commerce, Bureau of Standards, and other

interested agencies it expects to assume the leadership in directing the location and activities of the broadcasting stations in the United States. In order to take care properly of the interests of the various districts into which it has seemed advisable to divide the radio field, local radio chambers are to be formed which will function under the parent body having headquarters in New York. Chicago was selected as the place to start the first local chamber.

There is a great deal of useful work which can be done in the field of properly caring for the activities of the various broadcasting stations as was evidenced on two recent occasions of importance. There was the Friars' dinner on the programme of WJZ and many listeners, thousands of them far from New York, justifiably anticipated an evening's real enjoyment; the speakers were some of the best in America. The affair was late in getting started, as such affairs are likely to be. Much time was spent in broadcasting the menu and table manners of the worthy friars, but finally the anticipated humor and skill of the spokesmen was on the ether. Scarcely had the fun begun, however, when the announcer had to bid us good-night, as his allotted time was up; WJZ must shut down as the next hour had been assigned for broadcasting purposes to a small station in the vicinity of New York, and of course WJZ had to abide by the agreement. A very large radio audience was sadly disappointed as was evidenced by comments on all the commuters' trains next morning, and by notices in the local press. Shortly after this occurrence, the convention of the American Society of Mechanical Engineers, participated in by economists of America, was interrupted in the same fashion. On both these occasions the interests of the radio public were badly served—WJZ should have been able to continue its programme as the importance of the material being broadcast justified encroachment on the period assigned to the small stations which were sending

out comparatively weak programmes—weak artistically as well as electrically.

It seems to us that on such an occasion the local authorities should be able at once to make arrangements to permit the continuance of the more important broadcasting programme. In fact, the need of such a flexible arrangement is evident to any person interested in the increased utility of the broadcasting service. At the beginning of the period assigned to the smaller station the local radio authority should be able to, and should, announce that the smaller station had been temporarily assigned to broadcast on—meters instead of the customary—meters, so that Station—could continue its programme. The wave difference between the two stations should be chosen large



AN OPERATION IS IN PROGRESS

While doctors and students observe the work carefully, from above. All sounds are carried to them through the microphone, which stands on a table below the middle window. In this way forty or fifty people can study the operations without disturbing the surgeons

enough so that those desiring to listen to the poorer programme could do so without interference from the more powerful station. This new plan would result in some dissatisfaction at the smaller station, but it would be much less than under the present plan.

Was there ever such an absurd situation? Plenty of wavelengths available—a governmental radio service intelligent and capable enough to put any plan of this kind into effect—and yet nothing done. Let us see what the National Radio Chamber of Commerce can do in the matter. They surely have our well wishes in anything they undertake along the line of starting the governmental machinery into motion.

Simpler Instructions, and Service, for Ready-Made Sets

THE following letter, making a plea for simpler instructions and a service of some kind for bought apparatus, came to the Editor's desk a few days ago:

EDITOR "RADIO BROADCAST,"
Garden City, N. Y.

DEAR SIR:

Can't you use your influence to induce the makers of radio instruments to give service which will make their instruments more useful and valuable?

I have now purchased at one time or another four different instruments, and with none of them was I able to get competent instructions, or even printed matter which was intelligible to a person unfamiliar with radio technicalities.

It may be all right to assume that because a man buys a radio instrument he is one of these super boy amateurs, or a college professor; but, as a matter of fact, a very large number of people who *would* buy instruments need to have careful instructions, and there should be people who can teach them how to run the machines to get the most out of them. I should think one of the most dangerous points that the industry has to face is the selling of instruments which do not give satisfaction for one reason or another.

All of which is respectfully submitted.

Very truly yours,

A RADIO FAN.

It cannot be doubted that the opinion of thousands of set-owners, who do not know where to turn for help in operating the receiving sets which they have purchased, is voiced by the writer of this letter. As one of our readers expressed it recently: "We get thirteen pages of directions with a liver pill and practically

nothing with most radio receivers." Nothing, that is, that the newcomer in radio can understand and use in operating his set to the best advantage. What is very evidently needed is simple instructions in "plain American." The radio set owners of to-day include more newcomers in the broadcasting game than old-timers, and they cannot be expected to rush in, successfully, where all but old-timers fear to tread.

Rather complicated receiving sets are frequently accompanied by nothing but wrapping paper and excelsior. In some cases, where manufacturers do supply instructions, they miss the mark entirely, because the old-timer will "arrive" by experiment, anyway—in fact, he derives his greatest pleasure from trying various methods of bringing in better and stronger signals—and the novice will put aside the circular after five minutes, when he finds that it is (from his point of view—*which is the only point of view that counts!*) quite incomprehensible.

What happens when a novice buys a set, gets it home, and starts to put it in operation? First of all, most of the electrical names so commonly tossed about by the fraternity—or even by the fourteen-year-old boy experimenter—mean nothing to him. And why should they? He is not necessarily "good at electrical things"; he is probably interested in learning, in time, some of the theory of radio transmission and reception, but to begin with, he wants results—signals—music. And he doesn't want to have to appeal (as frequently seems necessary to him) to an electrical engineer or a college professor to get them.

There is a crying need also for adequate instructions for getting the *best* results—not merely results. As it is, many a fine receiving set lies idle, or limps along on two cylinders.

Granted all this, how are instruction sheets or pamphlets to be prepared that are of real value to the "consumer"? One way is for the manufacturer to put himself in the place of the non-technical buyer, and supply in black and white the information that he would be likely to need. Another way is for the manufacturer to get hold of some acquaintance—an out-and-out neophyte, whose knowledge of radio is nil—make him thoroughly familiar with the care and operation of a given set, and then have *him* write the directions for others.

The first method of attacking the problem is likely to be difficult for the man who exists in an atmosphere of technical terms. To him,



© Underwood & Underwood

LISTENING TO CUBA — FROM CUBA

A Sunday crowd gathered about the grocery and liquor store at San Jose de las Lajas, a "four corners" 25 miles from Havana, to see their first radio set and hear their first concert broadcasted by station PWX of the Cuban Telephone Company

everything about the operation of the set he manufactures may seem childishly simple. But the second method—having one of those people for whom the greater number of sets is destined, do the explaining—ought to work out satisfactorily, if the results are carefully checked up by the technical man. In fact, the best way of all might be for representatives of both maker and buyer to write instructions separately, and then get together and boil down and clarify the results in non-technical language, including all that is necessary for any buyer to know. A few symptoms of, and remedies for receiver ills, might also well be included.

Facilities for supplying service to owners of receiving apparatus should be a logical development of the business of producing and selling broadcasting receiving sets. Until this service is developed, however, manufacturers should provide, and buyers should demand, simple and adequate instructions for the care and operation of their apparatus.

Ocean Letters by Radio

ACCORDING to a recent announcement from the Shipping Board, a radio letter service has been inaugurated on its vessels for the convenience of its travelers. Messages from a ship bound in one direction are to be transmitted by radio to a ship bound in another direction for mailing when the receiving ship arrives at her destination. Thus a passenger on a ship from New York for Liverpool might, when two days out, want to send a letter back to New York; his letter is sent by radio to the nearest Shipping Board vessel steaming to New York, and it will be put in the mails when this vessel reaches port.

Including registration fee, the rate for this service will be \$1.20 for a letter of twenty words; each additional word will be charged at the rate of four cents a word. Letters are limited in length, 100 words being the maximum allowed for one letter.

J. H. M.

“Out-of-the Studio” Broadcasting

By WILLIAM H. EASTON, Ph. D.

Westinghouse Electric & Manufacturing Co.

THE outstanding feature of broadcasting during the present season is the large number of “out-of-the-studio” events that are being broadcasted by some of the larger stations through wire connections direct from the scene of action. Prominent among the events that have thus been given to the radio audience are the World Series baseball games and championship football contests; boxing matches; organ recitals, symphony concerts and grand opera, plays, banquets and civic exercises; addresses by famous men, church services; and even a message of the President to Congress. To say that the radio audience appreciates programmes of this sort is to put it mildly—even the dyed-in-the-wool “DX amateur” admits that now there *is* something in broadcasting.

Broadcasting is, in fact, entering into the third stage of its development. In the first stage, the phonograph is the main reliance.

Practically all broadcasting stations started at this point, and many have never gotten beyond it. Phonographic programmes are simple and inexpensive. No special equipment is required except the actual transmitter, and no staff except the operators. A friendly music dealer, who hands out a dozen or so records every day in return for the mention of his name and address in the ether, provides the bulk of the entertainment.

In the second stage of development, artists in person form the chief attraction. This is a greater step in advance than most listeners realize. First of all, there must be a place for the artists to perform in. The ordinary transmitting room is utterly unsuitable for such purposes, so that a studio must be provided. This studio should be well furnished; it must contain a piano and other musical instruments; and it ought to be made sound-proof and free from echoes. There must also be a competent



CLEAR TRANSMISSION OF GROUP SINGING IS DIFFICULT
But thanks to acoustical and electrical experts, thousands have enjoyed the singing of this choir, of St. Thomas's Church, New York



THE ANNOUNCER AT A CHURCH SERVICE HAS AN INCONSPICUOUS POSITION

The cabinet beside him controls the system of microphones, which are located at various points in the church, and also the degree of amplification used for each selection. He is in communication with the broadcasting station by telephone, and he listens-in to the service as it is broadcasted by means of a local receiving set

staff to engage and receive the several thousand artists utilized every year by a station in daily operation; and finally, there should be a musical director to select voices and arrange well balanced programmes. All this involves a good-sized organization and considerable expense.

It was the studio that transformed broadcasting from a curiosity into a national institution of culture. By providing the proper accommodations, it made possible the transmission of solos and speeches of every description, concerts by full bands, orchestras, and choruses, and even oratorios and condensed operas. But its resources are not inexhaustible. After a programme manager has staged three or four different events every night for a year or so, he finds that he is milling around in a circle. His programmes have become monotonous even in their extreme variety, and real novelties are almost unobtainable.

Then, those stations in a position to do so, take the third step and go out of the studio for their chief features. An immense field is thus opened up, especially for stations located in large cities, since experiments show that practically anything that is audible can be broadcasted in this manner.

The use of wires to reach outside events originated with KDKA, the Westinghouse station at East Pittsburgh. As early as January, 1921, this station broadcasted services direct from Calvary Church, Pittsburgh, and in the same month, it sent out a speech by Secretary Hoover from the Duquesne Club of that city. A few weeks later, it transmitted a boxing contest direct from Duquesne Gardens, and the radio audience heard for the first time the shouts and applause of the spectators at an athletic event. In the following year, KYW, Chicago, made notable use of wire connections by broadcasting almost every performance of the Chicago Opera Company.

This year, about a dozen other stations are undertaking this highest grade of service. The list will probably never be a long one because highly special apparatus and expert operators are needed for this work. In addition, the cost of installing and renting the necessary wires is high.

It is no easy matter to broadcast "out-of-the-studio" events successfully. In the studio, everything is under the control of the manager and all speakers and artists can be arranged with reference to the microphone. Outside,



EXPLORING THE ACOUSTIC PROPERTIES OF A THEATRE
Prior to installing the equipment which is to carry the sound to the broadcasting station

however, the broadcaster has no control, and he must arrange his transmitting apparatus to suit the messages to be transmitted. This means a very careful study of each "location." What are the acoustic properties of the scene of action? Will there be speakers? If so, how many? Where will they be? What sort of voices will they have? Is there much extraneous noise? If so, is it to be broadcasted (as with applause) or eliminated? Are there any special noises that are particularly wanted (as with the gong at a prize fight)? What sort of music will there be? Is it to be orchestral, organ, piano, or choral? Will there be solos? Is there to be great variation in the volume of music?

All of these questions, and many more, must be correctly answered, and arrangements to cover every possible contingency must be made in advance, for there is little opportunity to make changes during the broadcasting, and every detail of the event must be transmitted perfectly or else the radio audience will protest most vigorously.

The most complicated event to broadcast is

an Episcopal Church service, owing to the number of places from which the minister speaks, and the great variations in the volume and character of the music. A brief description of the method used by the Westinghouse-Radio Corporation Station WJZ to broadcast the services of St. Thomas's Church, 5th Avenue and 53rd Street, New York, will serve to illustrate how problems of this sort are solved.

Nine microphones are used in this installation, located as follows: in the anteroom where the opening and closing prayers are said; on the pulpit for the sermon; on the lectern for the service prayers; on the reading desk for the lessons; on the altar rail for the creed and other parts of the service; on the altar for the communion prayers; near the organ for the organ voluntaries; in the chandelier for the choir; and in a place that is out of the way but still commands a view of the service for the radio announcer and operator. All of these microphones are connected to a little switchboard controlled by the radio operator. He also has a small cabinet providing three stages of amplification, connected with the wire line

to the station and supplied with energy from a storage battery. A receiving set, which tells him what is going on in the ether, and a telephone line to the station, complete his equipment.

During the service, the operator is a busy man. He must not only switch on the proper microphone to transmit whatever is happening at the moment, but he must constantly change the degree of amplification to correspond with changes in the volume of the sound. To do this without producing abrupt crashes of sound in the listeners' receiver, or the even more disturbing breaks in the continuity of the service, requires a great deal of skill and quick judgment.

Other installations provide other problems. When arrangements were being made to broadcast Clemenceau's speech at the Hotel Pennsylvania, for example, it was found that the "Tiger" always walked around when he spoke, so that no single microphone could catch all he said. Investigation showed, however, that the speaker would be confined to a narrow aisle formed between the long table at which he was to sit, and the wall. A string of a dozen micro-

phones, concealed in the decorations, was placed on this table; and as Clemenceau paced up and down, the operator followed his movements by switching on one microphone after another.

At football games, there is generally a microphone for the announcer, placed high up in the stands where a good view can be obtained, and two in the field, each opposite a students' section, for the cheers and songs. Some difficulty was experienced in making the announcer heard over the uproar, especially during critical plays, and the latest practice is to place him in a sound-proof booth.

Theatrical plays are especially difficult to broadcast because the actors move over so large an area and have voices of such different qualities. Furthermore, the microphones can be located only in the footlights, wings, and prosceniums, and not directly on the stage where they should be. These difficulties are even greater in the case of grand opera, where the stage is apt to be much larger and the variation in tone much wider.

The chief value of "out-of-the-studio" broad-



THE SPEAKERS' TABLE AT THE FRIARS' CLUB BANQUET

Held recently at the Hotel Astor, New York. People as far west as Minnesota and Kansas attended the banquet by radio. Four microphones may be seen in the picture, placed at intervals on the long table. Among the speakers were George Cohan, DeWolf Hopper, Judge Kenesaw Landis, and Will Rogers



BROADCASTING DANCE MUSIC FROM A PLACE WHERE THERE IS DANCING

Vincent Lopez' well-known orchestra, in the Hotel Pennsylvania grill room, is heard twice a week by WJZ's audience

casting lies in the possibility of securing events that cannot be staged in the studio. But there is also another factor that is important; namely, the atmosphere of life that is transmitted. The artist or speaker in the studio is addressing a silent audience. When he indulges in humor, there is no laughter; when he scores a point, there is no sign of approval; and when he finishes, there is no applause. But when the affair is broadcasted in the presence of a real audience, both the speaker or artist and the radio audience feel the difference.

The great difficulty with outside broadcasting is the poor acoustic conditions that are often encountered. Proper location of the microphone will sometimes remedy the worst defects, but there is usually a great deal of echoing and extraneous noises. The best artistic results will therefore always be obtained in the well-designed studio, until (which is more than likely to happen) theatres, churches, auditoriums, and other public places are specifically designed with reference to broadcasting.

Another difficulty is that, owing to the time schedules on which most stations operate, it is often necessary to close down in the middle of an interesting outside event. This always vastly irritates the radio audience, but it is never the fault of the stations doing the broad-

casting. They always endeavor to obtain extension of time from the stations scheduled to follow them, but if this is refused, they have no option but to cut off. The remedy is obviously to give a free hand to those stations who are earnestly engaged in improving the quality of broadcasting.

This development of broadcasting still further emphasizes the difference between the better and the poorer stations. The Chicago Grand Opera, as broadcasted from KYW twice a week, could be heard over nine-tenths of the United States on a single stage of amplification, provided there was no local interference. As it is, probably only a small proportion of the radio audience can hear much of this really great undertaking, except a few snatches now and then between the lulls of local jazz and other trivialities. Stations that are doing creative, worth-while work earn their places in the ether; but too many stations are unable to do more than weakly imitate the poorest efforts of the leaders and do actual injury to broadcasting by interference and by occupying time that could be applied to better advantage. The radio audience, in fact, does not know what it is losing—how many first class events are not scheduled by the larger stations, simply because their time schedules do not permit them to do all they would like to do.

How Our Lighthouses Use Radio

By GEORGE R. PUTNAM

U. S. Commissioner of Lighthouses

IT IS only 26 years since wireless telegraphy was proven a practicable possibility, but in this brief period its use has developed to be of the greatest value in safeguarding navigation, in increasing the efficiency of the operation of ships, and in adding to the comfort and convenience of those travelling upon the sea. The U. S. Lighthouse Service has the definite function of providing marks or signals for the guidance of vessels, and in carrying out this important responsibility, wide use has been made of radio in furnishing additional safeguards for shipping, in facilitating the operation of the Service itself, and in providing instruction and relaxation for its personnel.

The most important use of radio in Lighthouse Service work is its use to protect ships in fog, through the establishment of fog signals, which, in conjunction with the radio compass on shipboard, give the navigator for the first time a means of taking accurate bearings on invisible objects. Electric waves readily penetrate fog, and can be received at much greater distances than light and sound waves, on which the mariner has heretofore had to depend.

Fog and other conditions rendering objects invisible constitute the greatest menace to safety of shipping, and demand every help that science can give to vessels thus imperiled. The development of fog signals has lagged much behind the improvement of lighted aids. The first fog signals in this country were guns, fired occasionally, and it was a hundred years after the building of the first lighthouse at Boston before a fog bell was installed on our coast, and not until about 60 years ago were the first air and steam signals used. The fog conditions differ greatly in different regions. The North Atlantic coast of

the United States and portions of the Pacific and Alaska coasts are extremely foggy, while on the South Atlantic and Gulf coasts and in Porto Rico and Hawaii there is little fog. The highest record of fog for a year is 2,734 hours, or 31% of the total time, at Seguin Light Station, Maine. There is a record of $7\frac{1}{2}$ days of continuous fog at a station, requiring the operation of a fog signal 181 hours without cessation.

The Lighthouse Service on May 1, 1921, placed in commission the first radio fog signals in this country, at 3 stations in the vicinity of New York Harbor: on Ambrose Channel and Fire Island Light Vessels, and at Sea Girt Lighthouse. Since that time additional radio fog signals have been established on the light vessels at the entrance to San Francisco and on Diamond Shoals Lighthouse off Cape Hatteras. Provision is being made for seven additional stations, on Boston, Nantucket Shoals and Cape Charles Light Vessels, and at Cape Henry Lighthouse on the Atlantic coast, and on the light vessels anchored off the entrance to the Straits of Fuca (Swiftsure Bank), off the Columbia River, and off Cape

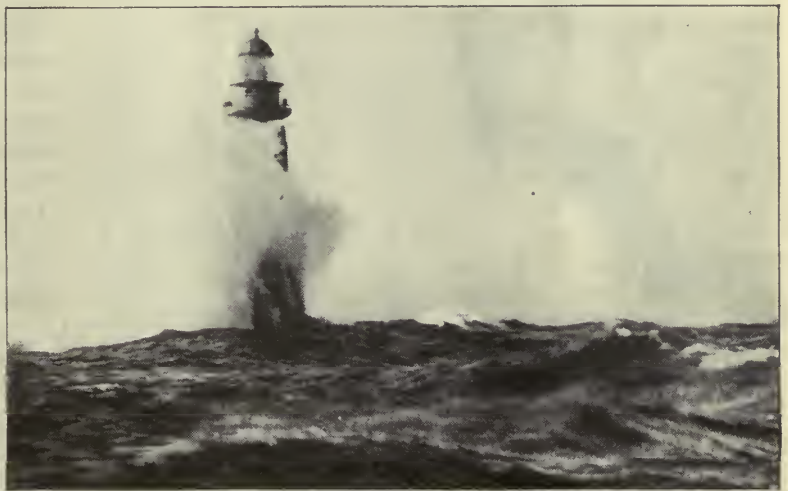

NONE BUT THE HARDIEST

Of the brine-beaten sons of Neptune could sleep through a buffeting like this. A week of this life would wreck the nerves of the average land-lubber. This lighthouse, located on Minot's Ledge off the coast of Massachusetts, now has a telephone connection through a cable, but a radio receiving set would greatly lessen the isolation of the keepers

Mendocino (Blunts Reef). The relief light vessels, which replace the station ships, are also being supplied with apparatus.

This system is based on the installing in selected important lighthouses and light vessels along the coast of apparatus for sending automatically, during the continuation of fog or thick weather, radio signals of simple characteristics by means of which the navigator of any vessel provided with a radio compass may take definite bearings to guide or to locate his ship, although no object is visible.

The locations of radio fog signal stations in this country have been selected so as to furnish convenient leading marks for vessels approaching the principal harbor entrances which are subject to much fog. The group of stations near New York provides a means of location also by cross bearings. Each station has a distinctive signal. Thus, Ambrose Channel

sends one dash, Fire Island a group of two dashes, and Sea Girt a group of three dashes, with brief intervals between the groups. The particular station on which a radio bearing is being taken in a fog is by this means just as definitely known as is the light on which a sight bearing is taken by the navigator of a ship, identified by its order of flashes or color. The signals are operated continuously during thick or foggy weather, and also at the present time they are sent each day from 9 to 9:30 a. m., and from 3 to 3:30 p. m., so as to permit any vessel equipped with radio compass to try out the method and apparatus in clear weather. To avoid continuous interference between the signals themselves for stations in one vicinity, they are sent on different time schedules as follows: Ambrose sends for 20 seconds, silent 20 seconds; Fire Island sends for 25 seconds, silent 25 seconds; Sea Girt sends for 60 seconds,

silent 6 minutes. The signals are repeated rapidly, Sea Girt, for example, sending over 40 groups of dashes a minute.

The transmitting apparatus now in use is a commercial panel type transmitting set of simple and rugged construction of about 1-kilowatt power. In addition to this set, a special automatic motor-driven timing switch for producing the desired signal at regular intervals is provided. The antennas at the transmitting stations are the same as used for ordinary radio communication. The wavelength used is 1,000 meters, the present international standard for such signals, and the range of usefulness varies from 30 to 100 miles, depending upon the sensitiveness of the receiving apparatus.

The radio fog signal stations are operated by the regular personnel of the light stations and vessels, and the radio compasses on shipboard may be used directly by the navigating officers of the vessels or by the wireless operators, so that at neither end are additional persons or specially trained technical men required. Of course radio experts are necessary for installing the equipment, calibrating the compasses, and making the periodic inspections.



U. S. LIGHTHOUSE TENDER "MARIGOLD"
Completely hemmed in. In places like this it is good to be able to keep in touch with the rest of the world

The important possibilities of utilizing the directive element of radio signals for the location of vessels in fog were recognized ten or more years ago, but the successful application of the idea in this country was greatly advanced by the development by the Bureau of Standards of a simple and effective radio compass suitable for use on shipboard. Extensive tests have been carried out by the Lighthouse Service and the Bureau of Standards commencing in January, 1917, of radio signal sending apparatus and radio compasses mounted on lighthouse tenders.

The value of radio fog signals has been recognized internationally by the action in 1920 of the Preliminary Conference of the Universal Electrical Communications Union in setting aside the wavelength of 1000 meters for radio beacons.

During the World War considerable use was made abroad of radio compass stations located on shore for obtaining bearings of ships and furnishing this information for use in navigation, especially of naval vessels. After the war the Navy Department established such stations on the coast of the United States, to be operated in conjunction with the naval communication stations already existing. A number of these shore compass stations are now in active operation on both the Atlantic and Pacific coasts, and are furnishing many bearings to ships asking for them. These stations are usually arranged in groups. The system is the reverse of that employed by the Lighthouse Service, in which the navigator determines the position of the ship himself.

While the use of the radio compass on shipboard is only in an early stage of development, the results already obtained give strong indication that it will prove an addition of the highest value to the navigational equipment of a ship. Bearings on automatic radio fog signals may be taken directly by the navigator, without knowledge of radiotelegraphy, but for taking bearings on other sending stations and on vessels it is necessary to be able



MORE DECORATIVE THAN HELPFUL

That is the light-tender's opinion of these cold-weather caprices that Nature has engaged in at the expense of the Ludington North Breakwater Light

to recognize the calls. The radio compass gives the navigator an instrument by which he may obtain bearings on invisible signals at will, and these may be repeated and checked as often as needed. The radio compass on shipboard will probably prove to be an instrument of very wide possibilities in navigation, for in addition to taking bearings on especially established radio fog signal stations, it may be used throughout the world for bearings on radio sending stations whose location is known; for bearings of vessels approaching or meeting, so as to avoid collision in fog; for bearings of vessels in distress; and for mutual bearings between a vessel and its boats in a fog, as for example, fishing boats and the mother ship. It should be possible to equip life boats so that their position may be detected by means of radio, and this may be the means of saving many lives.

Radio communication has greatly added to the safety of life at sea by enabling a vessel equipped with radio to call for help when needed. A recent striking case of this was the burning of the steamer *City of Honolulu* in the Pacific Ocean 700 miles from land, on October 12, 1922, when the entire ship's company of 260 persons had to put to sea in small boats. The nearest vessel at the time was many miles away, but the SOS call brought assistance promptly and there was no loss of life. Without radio communication, such a dis-

Mendocino (Blunts Reef). The relief light vessels, which replace the station ships, are also being supplied with apparatus.

This system is based on the installing in selected important lighthouses and light vessels along the coast of apparatus for sending automatically, during the continuation of fog or thick weather, radio signals of simple characteristics by means of which the navigator of any vessel provided with a radio compass may take definite bearings to guide or to locate his ship, although no object is visible.

The locations of radio fog signal stations in this country have been selected so as to furnish convenient leading marks for vessels approaching the principal harbor entrances which are subject to much fog. The group of stations near New York provides a means of location also by cross bearings. Each station has a distinctive signal. Thus, Ambrose Channel

sends one dash, Fire Island a group of two dashes, and Sea Girt a group of three dashes, with brief intervals between the groups. The particular station on which a radio bearing is being taken in a fog is by this means just as definitely known as is the light on which a sight bearing is taken by the navigator of a ship, identified by its order of flashes or color. The signals are operated continuously during thick or foggy weather, and also at the present time they are sent each day from 9 to 9:30 a.m., and from 3 to 3:30 p. m., so as to permit any vessel equipped with radio compass to try out the method and apparatus in clear weather. To avoid continuous interference between the signals themselves for stations in one vicinity, they are sent on different time schedules as follows: Ambrose sends for 20 seconds, silent 20 seconds; Fire Island sends for 25 seconds, silent 25 seconds; Sea Girt sends for 60 seconds, silent 6 minutes. The signals are repeated rapidly, Sea Girt, for example, sending over 40 groups of dashes a minute.

The transmitting apparatus now in use is a commercial panel type transmitting set of simple and rugged construction of about 1-kilowatt power. In addition to this set, a special automatic motor-driven timing switch for producing the desired signal at regular intervals is provided. The antennas at the transmitting stations are the same as used for ordinary radio communication. The wavelength used is 1,000 meters, the present international standard for such signals, and the range of usefulness varies from 30 to 100 miles, depending upon the sensitiveness of the receiving apparatus.

The radio fog signal stations are operated by the regular personnel of the light stations and vessels, and the radio compasses on shipboard may be used directly by the navigating officers of the vessels or by the wireless operators, so that at neither end are additional persons or specially trained technical men required. Of course radio experts are necessary for installing the equipment, calibrating the compasses, and making the periodic inspections.



U. S. LIGHTHOUSE TENDER "MARIGOLD"
Completely hemmed in. In places like this it is good to be able to keep in touch with the rest of the world

The important possibilities of utilizing the directive element of radio signals for the location of vessels in fog were recognized ten or more years ago, but the successful application of the idea in this country was greatly advanced by the development by the Bureau of Standards of a simple and effective radio compass suitable for use on shipboard. Extensive tests have been carried out by the Lighthouse Service and the Bureau of Standards commencing in January, 1917, of radio signal sending apparatus and radio compasses mounted on lighthouse tenders.

The value of radio fog signals has been recognized internationally by the action in 1920 of the Preliminary Conference of the Universal Electrical Communications Union in setting aside the wavelength of 1000 meters for radio beacons.

During the World War considerable use was made abroad of radio compass stations located on shore for obtaining bearings of ships and furnishing this information for use in navigation, especially of naval vessels. After the war the Navy Department established such stations on the coast of the United States, to be operated in conjunction with the naval communication stations already existing. A number of these shore compass stations are now in active operation on both the Atlantic and Pacific coasts, and are furnishing many bearings to ships asking for them. These stations are usually arranged in groups. The system is the reverse of that employed by the Lighthouse Service, in which the navigator determines the position of the ship himself.

While the use of the radio compass on shipboard is only in an early stage of development, the results already obtained give strong indication that it will prove an addition of the highest value to the navigational equipment of a ship. Bearings on automatic radio fog signals may be taken directly by the navigator, without knowledge of radiotelegraphy, but for taking bearings on other sending stations and on vessels it is necessary to be able



MORE DECORATIVE THAN HELPFUL

That is the light-tender's opinion of these cold-weather caprices that Nature has engaged in at the expense of the Ludington North Breakwater Light

to recognize the calls. The radio compass gives the navigator an instrument by which he may obtain bearings on invisible signals at will, and these may be repeated and checked as often as needed. The radio compass on shipboard will probably prove to be an instrument of very wide possibilities in navigation, for in addition to taking bearings on especially established radio fog signal stations, it may be used throughout the world for bearings on radio sending stations whose location is known; for bearings of vessels approaching or meeting, so as to avoid collision in fog; for bearings of vessels in distress; and for mutual bearings between a vessel and its boats in a fog, as for example, fishing boats and the mother ship. It should be possible to equip life boats so that their position may be detected by means of radio, and this may be the means of saving many lives.

Radio communication has greatly added to the safety of life at sea by enabling a vessel equipped with radio to call for help when needed. A recent striking case of this was the burning of the steamer *City of Honolulu* in the Pacific Ocean 700 miles from land, on October 12, 1922, when the entire ship's company of 260 persons had to put to sea in small boats. The nearest vessel at the time was many miles away, but the SOS call brought assistance promptly and there was no loss of life. Without radio communication, such a dis-

aster might have had an appalling result. Only a few days ago, in Alaska, by reason of radio communication, it was possible to get the light-house tender *Cedar* to the aid of the passenger steamer *Jefferson* within four hours of the time the latter vessel lost her propeller; the *Jefferson* was drifting helplessly in the dangerous waters of Dixon Entrance and the *Cedar* with some difficulty took the vessel in tow and brought her into port. But there are cases where the call for help alone is not sufficient to bring sure relief; the vessel in distress may be enveloped in fog or may be much out in its reckoning, making it difficult to find, and the resulting delay may mean the difference between saving and losing lives. The radio compass has already proven of the greatest value in the location of vessels in distress.

The following are illustrations of the importance of radiobearings in rescue work, which have recently been reported:

During somewhat heavy storms in the North Atlantic, the Norwegian steamer *Mod* was so badly damaged that she became practically a wreck, and for thirty-six hours the crew were huddled on deck without food. The captain sent out an SOS message, giving what he believed to be his position, but which proved erroneous. At least six vessels diverted their courses in an endeavor to render help, but no trace of the *Mod* could be found. For some time the British vessel *Melmore Head* was too far away to be of any assistance, but the captain kept in touch with what was happening, and when he found the *Mod's* signals getting stronger he directed the wireless operator to ascertain her position by means of his direction finding apparatus. According to the reading thus obtained the *Mod* was seventy-eight miles away from the position she herself had sent out and in an entirely different direction. The Captain of the *Melmore Head* placed his reliance on the direction finder and found it to be correct, arriving at the foundering vessel just in time

to save twenty-three members of the crew before the *Mod* sank.

The rescue of the crew of the Norwegian steamer *Ontaneda* constitutes a triumph for one of the latest developments of wireless science. A heavy gale had left the *Ontaneda* drifting helplessly with broken down engines and listing at an angle of 50 degrees in a heavy sea. Her captain sent out the SOS signal, but in the thick weather he could get no observations of sun or stars, and had to estimate his

position by dead reckoning. His calculations proved to be ninety miles out. Several vessels went to his assistance and steamed about near the position given without finding a trace of the *Ontaneda*, but the steamer *Fanad Head*, by means of her direction finding apparatus, discovered the true position of the vessel. She was nearer to the *Fanad Head* than to the ships which had originally steamed to her assistance, and the captain of the *Fanad*

Head proceeded to the spot where he calculated the *Ontaneda* to be. The wireless direction proved to be correct, and the distressed sailors were rescued.

On the night of March 15, 1922, the British steamer *Lord Strathcona* lost her propeller in a rough sea and sent out signals of distress. The American steamer *W. M. Burton* was assigned to her assistance, but upon arriving at her given position no signs of the vessel could be seen. The captain on the disabled ship was uncertain of his position. The visibility was very poor at the time and nothing could be seen further than one mile. The British ship *Cassandro*, which had a radio compass in its radio equipment, gave the bearings of the two ships from her position and very shortly afterward the steamer *Lord Strathcona* was sighted.

In August, 1921, the steamer *Wabkeena* was within 14 miles of the steamer *Alaska*, off Cape Mendocino, Calif., when she picked up the radio distress signals of the *Alaska*, but it

Making Life Safe at Sea

Radio is being used in many ways undreamed of a year or two ago, but its one greatest purpose remains, and will remain, the safeguarding of our marine carriers and their human cargoes.

But the number of those who lose their lives at sea is still appallingly great. The pity of it is that some of this loss could be avoided by better equipment in our merchant marine. It is significant that most of the vessels referred to by the author of this article as not knowing their own location, were found by radio compass on *foreign vessels* answering the S O S.

America leads in several branches of radio, but not in its marine applications.—THE EDITOR.

was 10 hours before the *Wabkeena* reached the scene of the wreck, having no means of determining the direction of the signals; of the 42 lives lost in the disaster, many might have been saved had there been a radio compass on the *Alaska*, and on the *Wabkeena*. The radio operator of the *Alaska* wrote: "Strongest in my mind remains the picture of the *Wabkeena* 12 or 15 miles from us at 9:15 p. m., and after that, trying unsuccessfully all night to locate us, while many unfortunate human lives were clinging to floating wreckage and succumbing slowly to exposure."

RADIO COMMUNICATION WITH LIGHT VESSELS

THE Lighthouse Service maintains light vessels on 49 stations. Of these, 22 are on exposed positions in the open sea; these are the outermost signal stations of the country; they are of the greatest value to navigation, and they are also the most difficult aids to maintain. They are placed off the principal harbor approaches, and offlying dangers along the Atlantic, Gulf and Pacific coasts, and these small vessels and their crews are exposed not only to the danger of storms, anchored in the open ocean, but to the risk of collision, as most of the vessels lay their courses for these lightships and endeavor to pass close to them regardless of fog or weather. Nantucket light vessel, a mark for most of the transatlantic vessels, is 41 miles from the nearest land, and there are always many vessels headed for this spot.

There are evident advantages in maintaining radio communication stations on the more isolated of these vessels, as this permits the vessel to report promptly an accident occurring to it, or a defect in the signal lights or fog signal apparatus, or need of supplies or medical assistance, or a disaster to other craft in the



BRINGING THE SUPPLIES AND NEWS

Landing in bad weather is not so easy as this, and it is sometimes necessary to employ a crate, swung out over the boat on a long boom. This is Bishop and Clerks Light Station, Massachusetts

vicinity and the need of relief, and to forward reports of passing vessels, transmit messages from vessels not equipped with radio or whose radio is out of order, and to forward special information. The radio furnishes ready communication between the district office and the light vessel, and enables orders to be sent to the vessel, and reports and requisitions from the vessel.

One of the earliest service installations of the Marconi system of wireless telegraphy was in 1898 between the East Goodwin lightship and the South Foreland lighthouse in England; this communication was maintained for over a year, and was the means of saving both life and property. Radio was installed experimentally on Nantucket Shoals light vessel in 1901, its first use in lighthouse work in this

country. At the present time radio communication is maintained by the Lighthouse Service on 20 light vessels. Most of the apparatus was originally installed by the Navy Department, and the radio service on these vessels was until recently maintained by that Department. During the World War there were 44 lightships, including reliefs, equipped with radio, and they afforded useful coöperation. In August, 1918, the Diamond Shoal light vessel sent out radio warnings of a German submarine which was sinking merchant ships off Cape Hatteras. As a result many vessels took refuge and were saved, but the submarine opened fire on the light vessel and sank it.

On October 8, 1916, the crews of a number of vessels of the Allies, sunk in the vicinity by a German submarine, sought refuge on board the Nantucket light vessel, and at one time on that day there were 115 shipwrecked men and 19 boats on the small lightship. The radio was used in summoning assistance and all the men were transferred; had it not been for the light ship most of the men would probably have been lost, as there were gales on the two following days. Within a few years of the first installation of radio on Nantucket light vessel, it was the means of saving all of the crew of that ship. On December 10, 1906, the Lighthouse Inspector at Boston received a radio message from the lightship that she had sprung a leak, the fires were out and assistance was urgently needed. Although a strong gale was blowing, the tender *Azalea* at once proceeded to the light vessel, reaching her early the next morning. After towing the vessel with great difficulty for some distance, it was finally necessary to abandon the ship, which sank 10 minutes after the crew had all been taken off.

Light vessels have on several occasions sent word of fishing boats in distress in their vicinity by means of radio. Several of these light vessels are now equipped with radio fog signals, to assist vessels in steering for them in fog, and others will soon be so provided. A number of light vessels have apparatus so that the crews may receive radio broadcasting programmes. It is intended to extend this system to as many light vessels as practicable, as this will be valuable for instruction, and will do much to relieve the monotony and isolation of those

stationed on light vessels, and will tend to keep the men keen and alert.

LIFE AT THE LIGHTHOUSES

CONGRESS long ago recognized the isolated life of the light keepers by authorizing the supplying of small libraries of books to the stations. This has been done at little expense, as many of the books have been donated. Although the Government endeavors to give every reasonable consideration to the men on the remote stations and vessels, the conditions are sometimes necessarily difficult, as these instances show. The keepers of the Alaska lighthouses at the entrance to Bering Sea remain three years on the stations, getting leave only each fourth year. They have been without mail for 10 months at a time. The experiment is now being tried of installing radio telephones at these stations. At Tillamook Rock Light, south of the Columbia River mouth, there have been intervals of seven weeks when the tender was unable to reach the rock on account of stormy weather. Landing is made on this rock by means of a crate swung out over the boat from a long boom.

For many of the more isolated lighthouses radio would be a great boon to the keepers, as it is to the men on the vessels. The following letter shows how the keeper of a lighthouse on an isolated island in Lake Erie is keeping in touch with the world by means of a home-made radio set:

I thought you might be interested to know that I have a small home-made radio set from which I receive, through WWJ, wireless broadcasting station of the *Detroit News*, the latest world news, the time, reports of sporting events, etc., musical concerts, and a talk every morning by the household editor, giving recipes for each day's dinner, also on the care of flowers and the home. From WCX, of the *Detroit Free Press* station, we hear concerts, speeches, and the news. On Sunday mornings and evenings we hear the services of the St. Paul's Cathedral of Detroit, Mich., through the broadcasting station of WWJ. As we do not get ashore very often we enjoy all this very much. I think a radio receiving set is a wonderful thing for isolated stations.

A number of the lightkeepers are now making and installing their own receiving sets, and the Service will encourage this good work.

Not a Bit Technical

Some Plain Facts About Receivers, Receiving, and Pocketbooks. How to Install Your Antenna and Ground, and What Type of Set to Buy

By ROGER A. WEAVER

TIME and again we hear the radio novice complain about this or that article in a magazine being too technical—"too deep for me," he says. For this reason, it will be interesting to the new listener-in to have the story told him in "plain American" rather than in technical language.

It is doubtful that any one part of a receiving set gets as much *needless* attention as the aerial, or antenna. I say "needless" because the aerial really requires very little attention, despite long arguments to the contrary. Provided with an aerial which is usually credited with being poor, a person who knows how to operate a receiving outfit properly can secure very satisfactory results. Long distances have been covered with good receivers attached to nothing more than a wire fence or even a bed spring or the strings of a piano.

This does not mean that ordinary care should be thrown to the winds when the aerial is put up, nor does it mean that all receivers will operate if merely connected to a wire fence or a bed spring. There are a few simple rules which make possible the stringing of a good antenna in about the same time as a poor one may be set up. Briefly, this is all you need do:

Use copper wire not smaller than No. 18, if you can get it, otherwise use any kind of wire you can procure. If the only wire available is covered, such as bell wire or telephone wire, do not bother removing the covering (insula-

tion) for it will work just as well or better if you leave it on.

Insulators are used to keep the antenna wire away from other objects which would allow the small current, caught by the antenna, to leak off into the ground instead of letting it

pass through the receiving instruments. This means weaker signals and a much shorter receiving range. It is seldom necessary to use more than two antenna insulators and they may be nothing more than glazed porcelain "cleats" and are not very expensive. The pair may be had at any electrical store and should cost less than a dime.

A "lead-in" insulator is a hollow tube, made of some form of insulating material, used to permit the lead-in wire to be brought from outside the building into the

room where the receiver is to be set up, without letting it come in contact with the building itself. A lead-in insulator may be nothing more pretentious than a porcelain tube, six to ten inches long. Such tubes are often used in regular electric light wiring and may be had for about a nickel at most electrical stores.

Lightning arrestors are used to protect the buildings, in which radio sets are installed, from fire due to lightning. You should procure one which has been approved by the National Board of Fire Underwriters. They range in price from one dollar up—the dollar kind are just as effective as those that sell for considerably more.

Choosing a Receiver

If you are among the throng who stand undecided, on the threshold of radio; if you are one of the millions who have listened to the spirits singing and laughing and playing about them by the use of a simple radio receiver; or even if you are an enthusiast with a long line of distance records to your credit, you will find interest in this article. We quote from it the following paragraph:

"Your choice of a receiving set should be made according to the distance over which you desire to receive as well as with relation to your pocket-book. It may be well to point out, in a general way, what you may expect from any of the seven types of receivers in common use. An intelligent selection may save you a considerable amount of annoyance and money, and much satisfaction may justly be had in being able to do for little what a neighbor has only been able to do for much."—THE EDITOR.

You will need a "ground" wire to connect between your ground and the lower terminal of the lightning arrestor and the "ground" terminal of the receiver. The most suitable wire for this purpose is copper wire, not smaller than No. 18. It should be insulated.

In putting up the antenna, you should bear in mind that height lends distance to your "view"—height above surrounding objects, not height above sea level. Seventy-five or one hundred feet of wire in a straight line, thirty or more feet above the earth or other objects, makes a good antenna for broadcast reception. The insulators should be used as shown in the

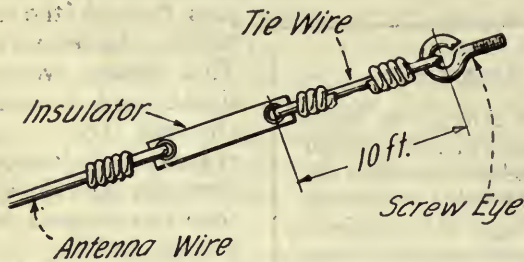

CONNECTIONS AT THE FAR END OF THE ANTENNA

accompanying illustration, and the antenna wire should always be ten feet or more from any other object.

The lead-in should be taken from a point on the antenna-wire some distance from the building in which the receiver is, so that it will not come near the house except where it enters the lead-in tube. With these few things in mind, put your antenna up where it is most convenient.

THE GROUND

IT IS not uncommon for people who spend a long time getting their antenna up to show no appreciation for the value of a good ground connection. Connect to a water pipe if one is available. Use a "ground clamp," scraping the pipe first with a rough file to be sure of a good connection.

If a water pipe is not available, good results may usually be obtained by connecting to the piping of a steam or hot-water heating plant. Where these are not to be had, a pipe driven five or six feet in the ground just outside the house will do, but the results will not be as good. *Do not connect to gas pipes.*

The wire from your ground connection to the receiving set should be as short as possible and it is usually a good idea to have the receiving set as near the point where the lead-in wire

enters the building as is convenient. Wires leading from the lightning arrestor—which may be mounted on the wall inside the house if no transmitter is used—to the antenna and ground terminals of the receiver, should be short.

VARIOUS KINDS OF RECEIVING SETS

YOUR choice of a receiving outfit should be made according to the distance over which you desire to receive as well as with relation to your pocket-book. It may be well to point out, in a general way, what you may expect from any of the seven types of receivers in common use. An intelligent selection may save you a considerable amount of annoyance and money, and much satisfaction may justly be had in being able to do for little what a neighbor has only been able to do for much.

CRYSTAL RECEIVERS

IF YOU live within 25 miles of a good broadcasting station and there is no reason why you cannot put up a good antenna—a single wire 75 to 100 feet long and 30 or more feet high—you may be satisfied with the results which a crystal receiver will give. However, many owners of crystal receivers, living within ten miles of a broadcasting station, find it difficult to receive satisfactorily, especially in the summertime.

In addition to the meagre range of the crystal receiver, it is subject to a great deal of interference from undesired stations. This is particularly true in seaports where the spark transmitters on shipboard cause much tearing of hair among those who would listen-in.

There is little difference to be found in the performance of the various crystal receivers, though there is a very great variation in the prices asked for them. The most essential element in this form of receiver is the crystal itself and the ability of the operator to locate its sensitive points. Most of the difference in various sets of this character is found in the workmanship and the materials used in manufacture. It is not an uncommon occurrence for the youngster who makes his own crystal receiver from an oatmeal box, some bell wire and a good piece of galena, to receive over longer distances than the users of far more expensive outfits.

Second in importance to the crystal are the telephone receivers. It should be borne in

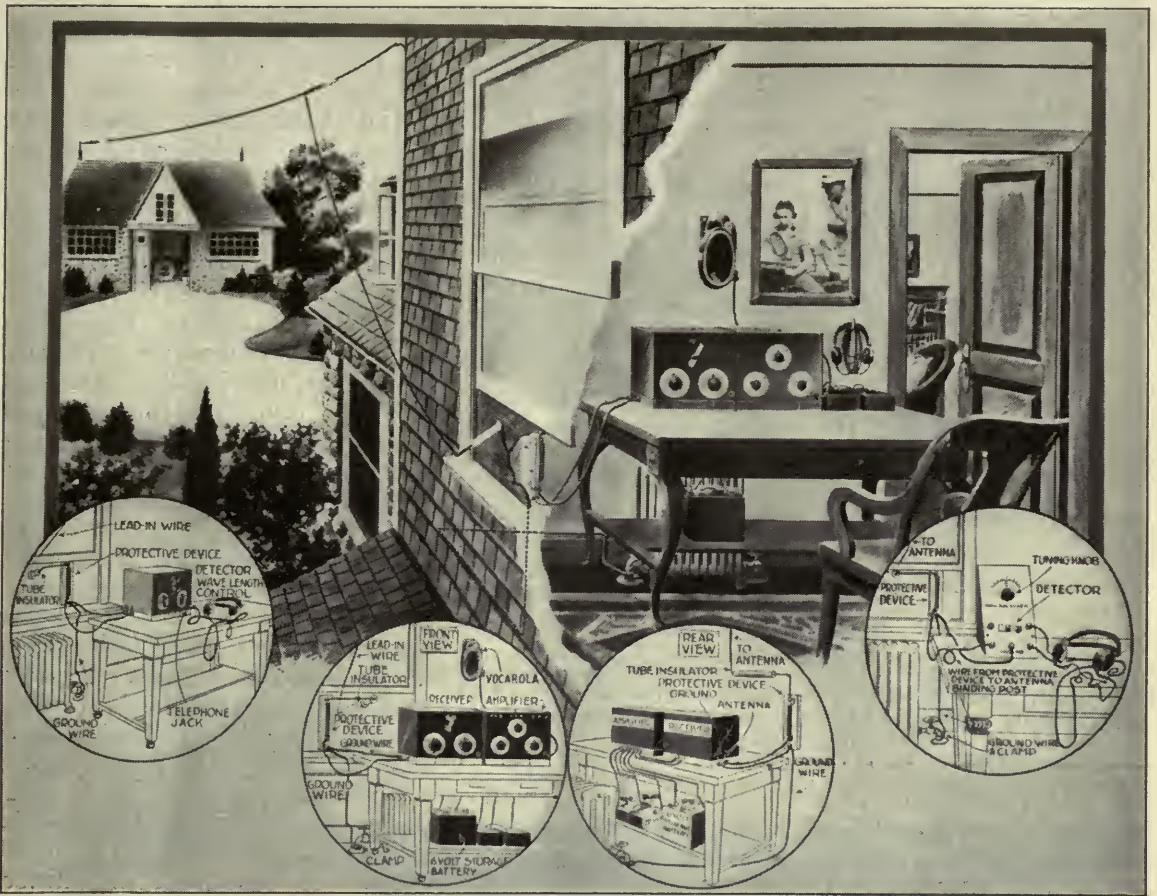

Courtesy of Radio Corporation of America

SHOWING HOW THE ANTENNA AND GROUND ARE INSTALLED

The porcelain lead-in tube is set into the window-board at an angle, so that rain will not enter. Note that the lead-in does not come close to the house except where it enters the tube

mind that the head-phones are a considerable item, when you purchase a complete crystal receiver. A difference in the choice of phones may make the difference between satisfaction and disgust.

There are many circuit arrangements used in crystal receivers, and much is claimed for each of them, but in the final analysis, there is mighty little difference in the average performance.

VACUUM-TUBE RECEIVERS

THE selection of a vacuum-tube receiver is a rather serious proposition and it is likely to be expensive unless you know just what you want before going into the market. So many combinations are possible with vacuum-tube receivers that it may be well to classify them briefly and then discuss each class in its turn:

TYPE	AVERAGE RELIABLE RANGE	COMPLETE PRICE
Single-tube, non-regenerative set	25 miles	\$ 45-\$ 60
Single-tube, single-circuit, regenerative set	50 miles	\$ 50-\$125
Single-tube, three-circuit, regenerative set	50 miles	\$115-\$150
Two-stage audio amplifiers for above, increase price		\$ 60-\$ 90
Loud speaker increases price		\$ 15-\$162
Radio-frequency amplifiers increase range materially, and the price		\$ 50-\$100

SINGLE-TUBE NON-REGENERATORS

MOST of the receivers made for use with a single tube in a non-regenerative circuit have been designed for the use of standard vacuum detector tubes, like the Radiotron UV-



ON APARTMENT HOUSES

The erection of an antenna may be a difficult job. Even though every precaution is taken, the "cliff dweller" has a hard time competing with his country cousin. This picture shows how a lead-in may be held away from the walls of the building, in cases where it has to be brought down a shaft or into a court

200 or the Cunningham C-300. Some employ a so-called single circuit, while most of them have a movable secondary, providing better tuning and selection by altering the position of the secondary with relation to the primary.

The single-circuit, non-regenerative receiver is but little better than a good crystal outfit, though it is much more expensive and troublesome. Single-tube non-regenerative receivers of either of the above types are nearly as costly and not as satisfactory as the next class, which is very popular among those who desire a long range, comparatively strong signals and comparatively good selection power—that is, the power of being able to hear the desired and weed out the undesired stations.

SINGLE-TUBE, SINGLE-CIRCUIT REGENERATORS

FOR simplicity of operation it is doubtful whether any form of regenerative receiver may be had that compares with the single-circuit regenerative receiver. Most of these receivers are made with but three major controls, one for controlling the brilliancy of the vacuum tube, one for regulating the wavelength, and one for controlling the degree of regeneration, which makes the received signals louder or weaker.

In addition to the major adjustments, the better quality receivers are provided with "verniers" used for making delicate changes in the major adjustments. Where long distance and good selection are desired, verniers are necessary.

Receivers of this class may be procured with or without the vacuum-tube control apparatus, but those with the tube control are to be preferred and are usually no more expensive than the two units purchased individually. Some of the best results obtained from a single vacuum tube used for broadcast reception have been obtained with single-circuit regenerative receivers.

However, this class of receiver has a weakness not shared by types which are a little harder to learn to operate but more satisfactory in the long run. This is especially true when a number of broadcasting stations of nearly the same intensity and on nearly the same wave-

length are operating together. Here, the single-circuit regenerative set, although it is the best type we have considered so far and is in very common use, becomes a transmitter when in the hands of a person not familiar with its proper manipulation, and causes shrieking and whistling in other receiving sets in its vicinity. Several receivers of this type can create quite a hub-bub if operated near each other. There are those who would abolish this form of receiver, because of its ability to transmit, but no such action has been taken as yet.

SINGLE-TUBE, THREE-CIRCUIT REGENERATIVE SETS

FOR the person who is willing to spend a short time in learning to operate it, there is no receiver employing a single vacuum tube which can hold a candle to the three-circuit regenerator. It is a little more expensive than the receivers we have been considering, but the results which can be obtained from it are surely worth while.

There are three classes of three-circuit regenerators on the market and they are all good. We have those made with lattice-wound or spider-web coils; those employing a condenser

for tuning the secondary circuit; and those utilizing a variocoupler and two variometers. Each type has its group of supporters. Most of them swear by their choice, and at the other two. They all have their individual advantages, but you are safe with any of them. My own preference is the variocoupler and twin variometer arrangement.

Three-circuit tuners provide the best method of receiving what you want to hear and eliminating what you don't want to hear (with a single tube), that has so far been developed. The slight difficulty experienced in learning to operate them is well repaid by music and speech being received with a minimum of interference.

In purchasing a three-circuit receiver you should be sure that it is provided with verniers, which aid greatly in making delicate adjustments. Other factors for you to consider are material, workmanship and ease of control. It is better to buy a good receiver than a makeshift.

AUDIO-FREQUENCY AMPLIFIERS

IT IS sometimes desirable to increase the volume of the signals that a single vacuum tube gives you, in order that a loud speaker may be used instead of the telephone receivers. *A loud speaker cannot be used without amplification.* Two stages of audio-frequency amplification are generally necessary. Using the amplifiers increases the volume of the received signals, but does not increase very much the *distance* over which you can receive.

There are a few important facts to remember concerning this form of reception. Knowing the limitations may save you some acute disappointment as well as the useless spending of considerable cash.

An audio-frequency amplifier is used to increase the volume—not the distance. An audio-frequency amplifier may be used with any of the receivers we have considered and any signal loud enough to be heard easily

without an amplifier may usually be heard over an average-size room when a two-stage amplifier and loud speaker are provided. A good two-stage amplifier may be had for about \$45, but that is not all you need.

A two-stage amplifier means that you must use two more vacuum tubes, additional B batteries and it is usually better to use a larger storage battery for lighting the filaments. The additional tubes should be amplifier tubes, not detector tubes, and they may be had for about \$6.50 each. At least two additional 22½-volt B batteries should be procured.

The storage battery used with a three-tube receiver should have a capacity of not less than 100 ampere hours unless the new uv 201-a tubes are used. This is especially true if the loud speaker is one that requires a connection to a six-volt battery.

If you purchase a single-tube receiver, and expect to add the amplifier and loud speaker at a later date, you will save yourself trouble and expense by purchasing a 100-ampere-hour storage battery in the beginning. You may meet a clerk who will argue that a 40- or 60-ampere hour battery will do, especially if you have your own charging apparatus, but don't

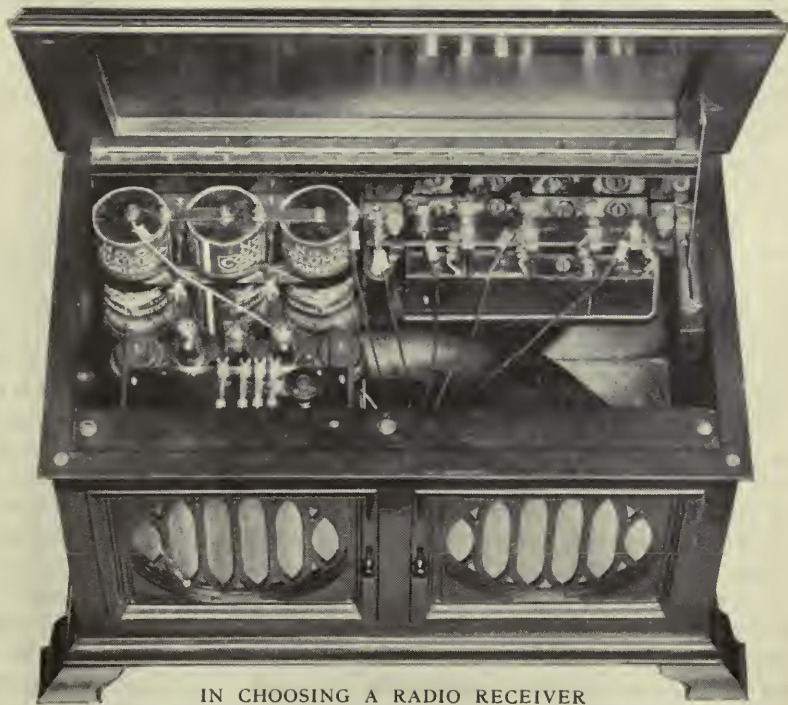

IN CHOOSING A RADIO RECEIVER

It is well to investigate the possibilities of outfits like this. Here we find everything—tuner, tubes, amplifier, loud speaker, and the necessary batteries, all within the cabinet, which is not too large and presents an attractive appearance

let him best you, for you are sure to be disappointed. A well charged storage battery is necessary for good operation, and the larger size will hold its charge under heavy duty for a longer period than the smaller one.

RADIO-FREQUENCY AMPLIFIERS

ALL sorts of claims are being made for receivers employing one or more stages of radio-frequency amplification and many of these claims are absolutely trustworthy. However, unless you have had some experience in manipulating ordinary receivers, radio-frequency amplification is likely to cause you a lot of worry and give little satisfaction. It always means several extra adjustments, as well as more delicate manipulation of the other units in your receiver. More than two stages, except in the hands of an expert, are quite likely to do more harm than good.

By the proper use of radio-frequency amplification, it is possible to receive over about the same distance with a loop antenna as is ordinarily possible with the detector tube alone, when an outside antenna is used to feed a regenerative receiver. Radio-frequency amplification is used to increase the distance over which a receiver will operate—not to increase the volume of sound produced by the receiver.

If you are just beginning your voyage on the good ship *Radio*, you will do well to leave radio-frequency amplification, loop aerials and super-regeneration alone until you have learned some of the peculiarities of vacuum-tube reception with a regular antenna. On the other hand, if you have finished your first cruise and desire new oceans to explore, the brevity with which the subject must be treated in an article like this would make it almost useless to you.

DRY-CELL TUBES

YOU may use dry-cell tubes (which make the six-volt storage battery unnecessary and are usually as satisfactory as the standard tubes) in any of the receivers described above, and their use cuts down the cost of a receiving outfit in a way that warms the cockles of the hearts of the thrifty.

As its name signifies, the dry-cell tube is operated from a single dry cell, and such a cell will last about a month, under ordinary operating conditions, when a single tube is used. Where more than one tube is used, an addi-

tional dry cell should be added for each additional tube. For instance, a receiver employing a detector and two stages of audio-frequency amplification should be supplied with three dry cells, connected in *multiple* (in parallel). Multiple connection merely means that all the positive, or centre terminals, are connected together and all the negative, or outside terminals, are connected together, and then one negative and one positive terminal are connected in the filament circuit just as if only one cell were used.

Dry-cell tubes perform nicely as detectors but are not uniform in operation when used as amplifiers. Some require a great deal more plate voltage than others, but three variable B batteries are generally capable of supplying the voltage desired.

DOLLARS AND CENTS

LET us see the difference in cost between a set employing standard tubes and one employing dry-cell tubes:

UNITS	STANDARD	DRY CELL
Antenna Equipment	\$ 5.00	\$5.00
Tuner (three-circuit)	70.00	60.00
Amplifier (two-stage)	40.00	40.00
Loud Speaker	20.00	20.00
Detector Tube	5.00	8.00
Amplifier tubes (2)	13.00	16.00
A Battery	35.00	1.20
B Battery (3)	6.00	6.00
	\$194.00	\$156.20

Here we find a saving of \$37.80 in favor of the dry-cell outfit, but that is not the only saving. The three dry cells used for the A battery, at a cost of \$1.20, will last considerably longer than a single charge of a 100-ampere-hour storage battery. To have the battery recharged will cost \$1.00, to say nothing of the inconvenience of getting it to and from a charging station. If you figure on charging it at home, add \$15 to the cost of your standard outfit for a battery charger.

Of course these figures can be altered by a little "shopping" and the more you do the more you will find in favor of the dry-cell outfit. Doing so will help you to make an intelligent selection of equipment and may help you to avoid a "severe financial crisis."

Teaching the Chinese Radio

By ROBERT F. GOWEN

Consulting Engineer

THE great republic of China is dependent upon two factors for its coordination, and the lack of these is responsible for the so-called civil war which exists at the present time between the North and the South. One of these is transportation and the other is communication. Both are vital factors in unifying the people of such a vast country. At present, transportation facilities are confined to the rivers and to narrow stone walks over which coolies carry merchandise on poles from one village to another. Communication consists of a string of inefficient telegraph lines, with extremely bad facilities for telephoning over a limited area in the large coastal cities. The result is that inland towns and villages are cut off entirely from the active export centres.

It was with the communication problem in South China that I was fortunate enough to be connected during the past year. In October, 1921, I was given three days' notice to pack up and leave New York for Hong Kong, to remain in the Orient for at least a year. This rather brief notice required considerable action and was further complicated by my marriage, which took place an hour before our departure. After weathering a hurricane on the Pacific we arrived at Yokohama, spent three days in Japan, a day in Shanghai, another in Manila, and reached Hong Kong on November 4th. There I received orders to proceed to Canton, where I found that a man connected with the American engineering organization

which had engaged my services was about to leave after nine months of trying to give the Chinese radio communication, without result. The problem was one of eighteen one-kilowatt telephone and CW telegraph installations, with gas engines and storage batteries for the power supply. I found the equipment in terrible condition, gas engines broken, batteries sulphated and motor generators full of moisture and burned out. The radio equipment which I had designed and built some two years previously for the De Forest Radio Telephone and Telegraph Company was almost unrecognizable. There was a quarter of an inch of green mould on all wires and the parts were so corroded that



AN INTERESTING-LOOKING STREET IN OLD CANTON

they were almost black, while the coils were full of moisture so that in some cases their finewindings were loose and their insulation completely gone. The one-half kilowatt oscillion tubes were even worse. Of the eighty that were shipped I found but forty, and on inspection and test I discovered that most of these were smashed, leaky or soft. In fact, there was but one tube in the forty that was commercially workable for telephony, although two other soft tubes could be used on low power for test purposes.

It was evident that my first step was to re-condition the material. I found an interpreter in the person of a young lad who had learned some English in a Chinese school in Hong Kong and with him rounded up two or three so-called Chinese mechanics. The problem was rather staggering as there were no tools to work with and it was impossible, of course, to obtain standard parts or such things as American machine screws, nuts, etc., which the sets required. The saving grace was a former Navy operator named Leslie Grogan, who had arrived at Canton three weeks before me. He, with a young English boy who knew nothing about radio, had been trying to make some headway, but did not get far as unfortunately Grogan had had little experience with continuous-wave transmitters. He knew gas engines and storage batteries, however, and was invaluable to me in conditioning those on hand. My first official act was to discharge the English lad, who proved to be worthless, and to make a trip to Hong Kong where I bought all the tools that were available. Grogan was then assigned to the engine and battery work while I, through my interpreter, by manual illustration, attempted to teach the brightest of the Chinese "mechanics", Mr. Wu, how to put the radio

equipment into workable shape. This was a long drawn out process. It meant tearing the sets completely to pieces, boiling out coils in beeswax and resin and rebuilding them from the bottom up.

In a few weeks we had equipment ready for an installation and started to place it in the master station known as "Canton Central" in the city. I immediately found that the aerial must be taken down as the joints were not even soldered, a new ground must be installed and even the wiring to the motor generator set had to be renewed as it was improperly installed and not of sufficient capacity to carry the required operating current. The result was that the station had to be rebuilt throughout, but as we had new equipment ready for the job, it was but a question of a week or ten days before it was completed and in working order. At this point the day was again saved by the arrival of a Chinaman from San Francisco with

Who the Author Is

If you are an "old-timer," Robert Gowen needs no introduction. Possibly you have listened to some of the broadcasting he did in 1920 from 2XX, at Ossining, N. Y.

In 1902, Mr. Gowen built a receiver and transmitter himself. From that time to the present, he has always been an ardent "ham" and has filled many important posts. He was attached to the Engineering Department of the American Telephone and Telegraph Company from 1909 to 1912. In 1918 he was made Designing Engineer of the De Forest Company after about a year with the company as a laboratory assistant. In 1921 he became Chief Engineer and Plant Manager. During the same year, Mr. Gowen took over the duties of Consulting Radio Engineer for Davis Co., Ltd., of Hong Kong, China.

Mr. Gowen is responsible for a number of improvements in radio, such as the honeycomb coil and coil mounting, the vernier condenser, etc. At present, he divides his time between work in his laboratory and the consulting practice he has established since his return to this country.—THE EDITOR.

two more De Forest equipments for which he had brought eight standard oscillion tubes. After some negotiations four of these tubes were purchased from him in order that we might go ahead with the other stations.

As soon as the defective equipment was removed from the Canton station we immediately went to work and conditioned it for the station at Shui Chow, 140 miles north. This took several weeks, at the end of which time we hired a freight car, loaded about a ton of apparatus aboard, took along a Chinese cook, my interpreter and mechanics, camping outfits and food, and after bumping over the rails for a full day on the only inland railroad in South China, reached our destination. It was then necessary to transport this heavy equipment from the freight car to the radio



MR. GOWEN AND HIS SCHOOL

These thirty young men of Canton, exasperatingly slow to learn at first, finally became so proficient that they constructed, by themselves, a complete radio telephone station, which they showed their teacher with great pride on "Commencement Day"

station located in an old temple on a hill about a mile away. This was done by forty coolie women who were happy to receive ten cents each for lugging such things as motor generators a mile up the hill.

Like the Canton station, this one was also found to be in very bad condition, improperly arranged and connected so that rebuilding throughout was necessary. The gang worked early and late, however, and in a week I returned to Canton to open communication with Grogan at Shui Chow. The day before Christmas, telegraph communication was established, and telephony was tested out with excellent results, but was immediately discontinued because of lack of proper oscillation tubes. These stations, together with two smaller ones which we had rebuilt and established in the meantime, were then turned over to the Government, which manned them with the operators whom they had retained to work some old Telefunken spark equipment which the Germans had installed for them some ten years previously. Conditioning of the equipment from Shui Chow then began, but it was impossible to go

further with installation because of lack of tubes.

While these negotiations were in progress some difficulties arose with regard to payments by the Government to the American concern which had retained me, with the result that the Government decided to take over the equipment and do the installing in the future themselves with their own mechanics and so-called engineering force. I was much surprised to learn that their new plans included taking me over with the material.

Like everything else in China, business negotiations move at a snail's pace and it was therefore not until the first of January that I found myself officially appointed Chief Consulting Engineer and Technical Advisor to His Excellency Chung Kwing Ming, Governor of Kwangtung Province. The appointment was the result of many conferences with Chung Yuk Hang, the Director of Communications, the Chief of Staff and others, and it was most surprising that I got it at all, for the Governor's original idea was that I should continue to build stations, using the Government's employees just as I had been doing previously with the



MR. CHUNG YUK HANG

Director of Radio Communications. He didn't know a vacuum tube from an inner tube but he held down the job with assurance and distinction

American concern. I argued that this was out of the question as the Government did not have the personnel, materials, transportation facilities, or the testing equipment for the work; that it was impossible for me to build the four stations already finished in a month and a half without the aid of Grogan and a force of intelligent mechanics whom I had trained with much difficulty and at great expense. The Government refused to take over this staff with me on the ground that the expense was unwarranted in view of the fact that they had mechanics and I therefore proposed that instead of building stations for them I teach their operators and mechanics how to build future stations and maintain and operate those already in existence. I also insisted that they allow me to retain Mr. Lowe as interpreter and Mr. Wu, my chief mechanic, in order that I might supervise putting the remaining equipment into shape. This they finally agreed to do.

Accordingly I set to work writing a textbook

for them which Mr. Lowe translated into Chinese. Both versions were mimeographed and made up into books so that each scholar might have his own. This work took several weeks and proved to be exceedingly difficult, as I found that the Chinese had no characters with which to represent technical phrases. Therefore it was necessary for Mr. Lowe to translate my English version into Chinese and read it back to me, after which I would alter and simplify it into such English words as he could readily grasp and retranslate into Chinese.

In the textbook, though it dealt of course with strictly technical things, I was obliged to use the simplest kind of primer phrases, as I was dealing with men who knew as much of electricity as an American child of about ten years of age. For instance, when I talked about the armature of a generator, Lowe would translate it back to me from his Chinese version as a "ball of wire" and state that this was the nearest translation he could get for the term. This was all very well, but I found that he was translating the terms "Honeycomb coil, grid choke coils, transformers," etc., also as "balls of wire." Accordingly, it was necessary to supplement the Chinese translation with the proper technical term in English in order to differentiate between these types of windings, which, of course, function differently in each case.

I opened school with thirty pupils including Chung Yuk Hang, the Director of Radio Communications, and Mr. Fung, the Assistant Director. The first day of it nearly killed me. I lectured through an interpreter for two hours in the morning to this group of earnest but none too intelligent students, using a blackboard for illustration, and when I finished I hadn't the remotest idea whether or not they had the slightest conception of what I had said. Their blank, immovable expressions gave no hint of what, if anything, was going on within their brains and the effect on me was as if I were talking to a stone wall. It was exasperating, to say the least, and the effort in racking my brain over and over again for a different means of expression that they might understand through the interpreter was very fatiguing. I divided the class into groups and gave them laboratory work in the afternoon and instruction on the actual mechanical arrangement of the apparatus, insisting that they connect it and disconnect it until they had become ac-

customed to the handling of the different controls.

The second day I gave them notebooks and asked that they keep them and write notes of what I said as best they could. This scheme worked and I soon found by having Lowe translate their Chinese notes back to me that they were actually getting something. They reproduced the drawings that I made on the blackboard accurately and eight of the class who could write a few words of English were noting in English the technical terms that I was giving them in addition to the Chinese interpretation.

Then I tried examinations and struck another snag as they positively refused to take exams on the ground that they were not being paid enough to do so much extra work. I argued that I could not tell whether they were learning anything or not without these examinations. They then put up the defense that it was dishonorable, according to their code, for one man in the class to be compared to another by the result of examinations when they were all being paid the same wage. For several days I argued and insisted, but finally brought them to my way of thinking by convincing them that coöperation with me would benefit them to

such an extent that their wages would in due time be increased.

The first examination papers as Lowe translated them to me were certainly hopeless, but I could see that I was on the right track and took occasion to humor them by marking them high and complimenting them on their good work. The result was that I had no further difficulty with the examinations until the final one at which they balked *en masse*. I was very much discouraged at this, as the weekly examinations had been growing markedly better each time and their notebooks had improved wonderfully. Their argument this time was that the final examination would determine who should and who should not graduate, and they would not agree to such a distinction, as all must graduate in order to be retained in the Government employ. It was not difficult to see their point, yet I felt a final examination was essential in order that the Director might have a comparative standard by which to pick men to whom he could entrust the direction of future work. I therefore insisted that they take the examination and set aside a certain day for it. I opened school as usual and not a soul appeared. All I found was a note from one of the star pupils, as follows:



THE DIRECTOR OF RADIO COMMUNICATIONS AND THE STAR PUPILS

In this group, left to right, we find: Messrs. Wu, Chief Mechanic; Si Tot, a star pupil; Fung, Foreign Correspondent, Radio Dep't. (so elected because he could write a little English); Lowe, interpreter to Mr. Gowen; another star pupil; Chung, Director of Radio Communications; two more star pupils; and Chung (another Chung: this seems to be the "Smith" or "Jones" of China), Assistant Chief Engineer, who helped also as interpreter



THE VASE PRESENTED TO MR. GOWEN

By his class of Chinese radio students. It is made of silver and carries elaborate designs and inscriptions. Three Oriental gentlemen on the front represent Long Life, Good Luck, and Happiness. On the opposite side of the vase is a stork bearing a diploma

“Mr. R. F. Gowen,
Sir:

As I am returning to my ship for some pressing business, I regret very much that I can't attend this examination and your favorable excuse will be much obliged by,

Yours obediently,
Ng Lau-Cheong”

I therefore posted a notice on the blackboard that the examination would be held the following day instead. The result was that the class appeared next morning full of apologies and stated that their non-appearance was due to the fact that they had to spend the previous day in forming a union by which they might appeal to the Government for better wages.

Needless to say, everyone passed the final examination but not all with the same degree of success. The results, however, were beyond my expectations and were very gratifying indeed. In order to ascertain what they knew

about the practical work, I had given them orders actually to construct in every detail a complete station in the laboratory without my assistance. It was a great event when they ushered me in on commencement day and showed me with triumphant pride what they had accomplished.

The events of that commencement day are a story in themselves and the banquet and “send off” they gave me will always retain a place in my memory. A volley of presents was exchanged on both sides, according to the Chinese custom. On the beautifully engraved silver vase which was given me by the class, was an inscription which was translated for me by Fung Shin Suan, as follows:

Unusual works, if never done before, will not appeared comparatel better; and, if not be continued by the others, will not be known for its success. As the Radio-service in Canton had its progress so limited, Director Chung has the desire to have its enlargement, and therefore many outlying stations have been established somewhere, and many newest Radio-telephones of De. Forest system, have installed. Mr. Gowen, the radio expert of U. S. A., has been appointed to be the Chief Engineer and also the of the Radio-telephone educating cause and have done his utmost to our satisfaction. Now, the valuable cause is compered and he will go apart somewhat different from being accompanied in the same place, and this present is asked to be accepted for our ever remembrance.

31st., 3rd., 11th. C. R.

By The staffs of the Radio Comm. Dept.
Canton, China.

Here is the letter he wrote in English to accompany the vase:

The Republic of China
Radio Communications Department
South Bund, Canton, 1st 4th 1922

To Mr. Gowen,
Sir,

I, with the most honorest, send you a vase and a photo, of which I beg your kind acception.

On the surface of the vase, the Chinese composition, I have translated into English by my simple knowledge, and the appearance of all of us in the photo, will both cost your ever remembrance in my foolish anticipation.

With best compliment to Mrs. Gowen,

I am

Your obedient student
Fung Shin Suan.

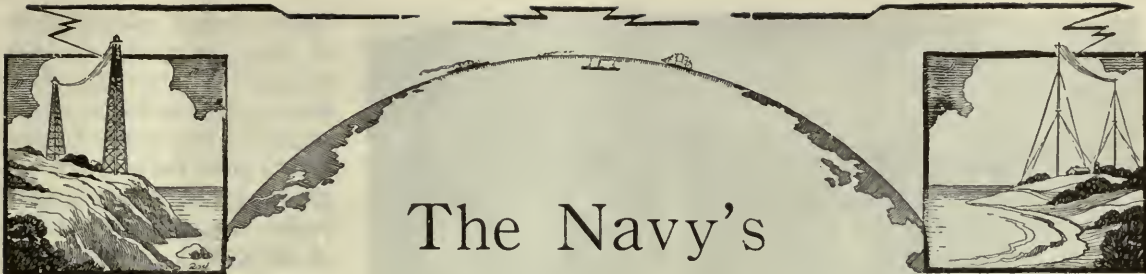

The Navy's Example in Standardization

By COMMANDER STANFORD C. HOOPER, U. S. N.

Head of Radio Division, Bureau of Steam Engineering, Navy Department

ONE of the fundamental essentials in the supply and use of any mechanical device is an early and thorough consideration of standardization.

In nearly every new trade, however, consideration of nationwide standardization is made secondary to less important yet seemingly more urgent factors, and the trade in the particular device grows along the lines best suited to satisfy immediate demands, without particular regard, on the part of the company putting the article on the market, for future replacement of worn-out parts and present reduction in manufacturing costs. Also, competitors in furnishing machines designed for similar use have an inherent antipathy to making any parts interchangeable with those of their competitors.

All this is very natural, but there are many cases in which, if a little forethought and additional effort had been

made, the public would be saved financial loss and much discomfort, had the manufacturers taken pains to foresee the time when their machines would begin to wear out and the difficulty the consumer would have in obtaining spare parts.

Take the automobile industry as a glaring example. Of course, in recent years considerable standardization has taken place between competing makers of nearly all classes of motor cars. But we can all remember how, until quite recently, hardly anything which one particular make of car needed could be obtained at the average automobile supply shop, unless the car was one of the few in most general use. And yet there was no real advantage to the automobile manufacturer in not using standard tires, wheels, battery sizes, fan belts, etc. In fact, the earlier the manufacturer realized

Standardization

At the time we entered the war our radio equipment was anything but standardized and it was necessary for our Signal Corps and the Radio Section of our Air Service to carry on much of their work with apparatus obtained from the Allies.

The truth of the matter is that very little American radio material was in operation in the Advance Zone of the A. E. F. prior to the signing of the Armistice, and much of the equipment in the training schools in the Service of Supply was of French or British manufacture. We can ill afford a second experience of this nature.

Commander Hooper is in charge of that section of the U. S. Navy that draws the specifications for our Naval equipment and the equipment used on the vessels of our emergency fleet. His view-point should be of interest to all those who follow radio, especially at this time, following the conference called by the Bureau of Standards to standardize radio manufacture at the joint request of The Institute of Radio Engineers, National Radio Chamber of Commerce, Radio Apparatus Section of Associated Manufacturers of Electrical Supplies, National Retail Dry Goods Association, American Radio Relay League, and Radio Corporation of America.

—THE EDITOR.

the advantage in using the same standards as the majority, the earlier the public became

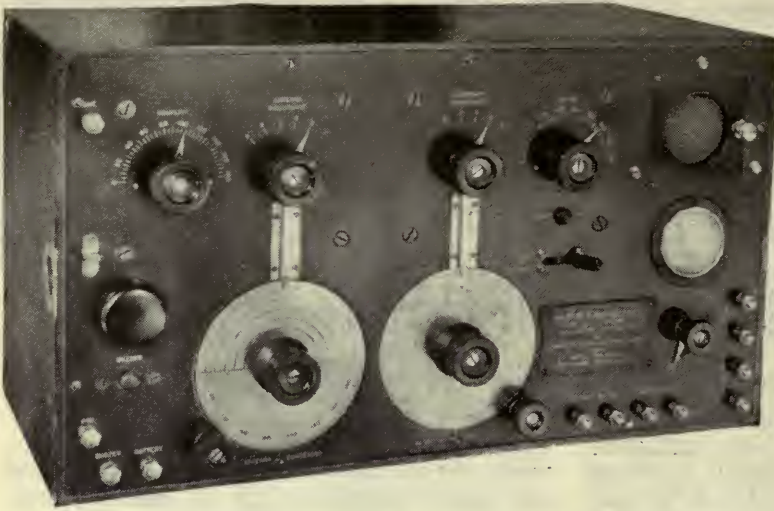

RECEIVER MANUFACTURED FOR THE NAVY IN 1920

Most of the mountings on this set have been standard for the last eight years

cognizant of the fact that his particular automobile was preferable to another make for which spare parts could not be obtained at almost any automobile accessory shop along the road.

The points which the careful buyer inquires particularly about, in purchasing an automobile to-day, are initial cost, upkeep, appearance, comfort, durability and "Can I get spare parts anywhere along the road?" In many cases where competition is keen, the latter point is the deciding factor.

Not only from a point of view of salesmanship, but from a point of view of duty to the public, manufacturers should keep in mind the importance of standardization. Is it fair to sell a poor boy a radio set which he has saved his money for months to buy, and then have him find, after a month or two of use, that it would cost nearly as much as the initial price of the set to replace one particular part?

Probably one of the best standardized

trades to-day, and yet one of the youngest, is the airplane industry. The desire to standardize came after the outbreak of war, rather than before. In regard to airplane motors and parts, the standardization of these was finally given such importance that the heavier-than-air production programme was greatly delayed in order to secure standardization, and our military forces were seriously hampered in their final work of winning the war. This was a prominent example in which standardization was so delayed that the nation's interests suffered. You and I are paying

taxes to make up for the nation's lack of foresight in matters of this nature.

There are numerous examples in other phases of our military work in the great war where the

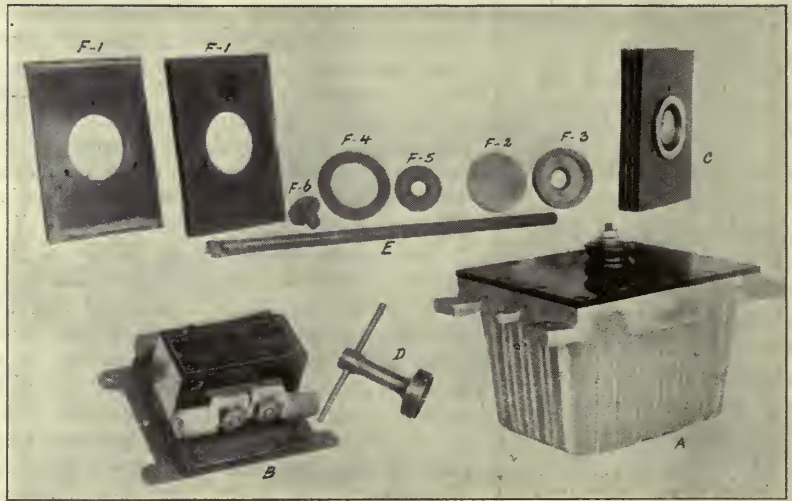

INTERCHANGEABLE UNITS FOR NAVY APPARATUS

These parts, designed for the 1-KW set, may be used equally well with the 2, 5, or 10-KW transmitters. A—Mica condenser, B—Protective device, C—Quenched gap (assembled), D—Quenched gap wrench, E—Quenched gap test rod, F—Quenched gap unit (apart), 1—Cooling flange, 2 and 3—Hub and electrode, 4—Gap gasket, 5—Bolt gasket, 6—Bolt

failure of standardization in advance caused great delays, delays which might have resulted in our paying taxes to the Kaiser had they been a little more serious. The Germans, in their

preparedness, had well considered the value of standardization as a military necessity, and were not handicapped in this respect as much as the United States and its Allies.

There are three important reasons why standardization in industry is essential:

(1) Those who standardize have a natural advantage when it comes to selling their goods.

(2) The duty to the public.

(3) The duty to the nation, in being better prepared for war.

The first reason will appeal at once to the average business man, and he will give this point serious consideration. It is a matter that he will handle on his own initiative.

The second point he may think worth while, and he will probably cooperate in it if some patriotic organization perhaps will prepare the machinery and red tape for making standardization easy. This matter could be taken care of by some such organization as the Radio Chamber of Commerce, a radio manufacturers' association, or possibly by the encouragement of the Government through the Department of Commerce.

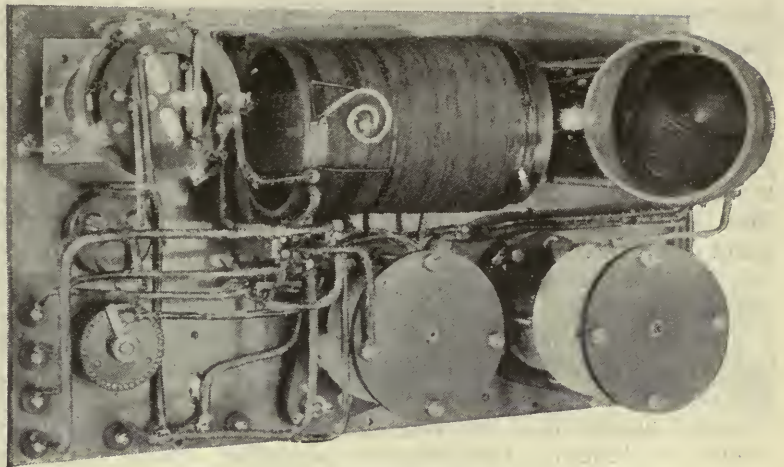

BACK OF RECEIVER SHOWN ON OPPOSITE PAGE

The vacuum-tube socket and the two condensers are standard pieces of equipment

The third reason is one from which results will be obtained only through the efforts of a few of the more patriotic manufacturers or through the constant efforts of the Army and Navy. The function of a military service is to keep prepared for the defense of a nation. This preparation includes not only the number of men, ships, and munitions in the actual service of the Army and Navy but the skill of the organization—the men behind the guns.

The World War was a lesson from which all thinking men naturally draw their own conclusions about such matters as the value of organizing private manufacturers as an aid to the military along definite prearranged lines. The reason is now perfectly clear.

As inventors, designers, and distributors of radio sets, any representative assembly of the radio profession might well give serious thought to the necessity for peacetime standardization if for no other purpose than to assist in preparedness, even though other reasons for such action do not appear sufficiently important. In a republic, with all its superior blessings, we are prone to pay vast sums in taxes after a war in defense, rather than in advance at a time when a much smaller sum would have been necessary as an insurance of adequate protection.

It is very difficult at this time to



A 2-KW 500-CYCLE MOTOR-GENERATOR

The terminal boards and fittings of this model are interchangeable with the corresponding parts of the 5 and 10-KW generators

state exactly what the Army and Navy would require in the way of radio material, owing to the rapidity with which the art is advancing. Suffice it to say that it is the duty of the military experts always to have their plans ready for complete standardization of equipment, and not only ready, but in such shape and detail that in event of hostilities the manufacturers could commence work on the morrow turning out standard equipment, in quantity and without delay.

The personnel engaged in this work in the Government is exceedingly limited and now that radio has grown into such a tremendous business it would appear that the most natural procedure for obtaining standardization would be by the radio commercial interests themselves, in consultation with the Government's experts.

The Army and Navy have been in the radio business for twenty-three years, and the advent of the public into this business, with limited exceptions, has been only in the last two years. A small number of civilian and military engineers have developed their art and have handed it over to the public on a silver platter, for the profit of the radio business man and for the

happiness of the public. Not only that, but the transfer of paramount control of transoceanic radio communication from foreign to private American control was directly due to our own Navy Department.

For these and other reasons there is a duty for the radio business man, particularly, to show some measure of gratitude to his military representatives in the way of assistance in keeping a step or two in advance of any possible adversaries.

In the history of the design and development of radio equipment it will be remembered that many of the principal advances have been due to the ever-increasing demands by the Naval Service for increased range, economy, selectivity, durability and flexibility of apparatus. For years there was very little attempt at improving the standard of commercial installations on shipboard, except where naval installations paved the way. Naval specifications have each year been made more and more rigid and the requirements more difficult to comply with. The result is that the inventors and designers produced something better from something not so good, and solved the problems which appeared impossible of solution.

Follow briefly a few developments, and note the advance and standardization of certain parts of Navy equipment:

The open or straight gap, to the rotary gap, with standardization of moving parts, interchangeable for 1, 2, and 5-KW sets.

The rotary to the quenched gap, with standardization of gaps, plates and washers.

The standardization on 375 meters for naval work, later 600 meters, and later still the transfer of military work into a band of wavelengths clear of the 600-meter wavelength, in order that maritime commercial communication could enjoy it exclusively.

The standard Navy 500-cycle 2-KW, 5-KW and 10-KW spark sets of

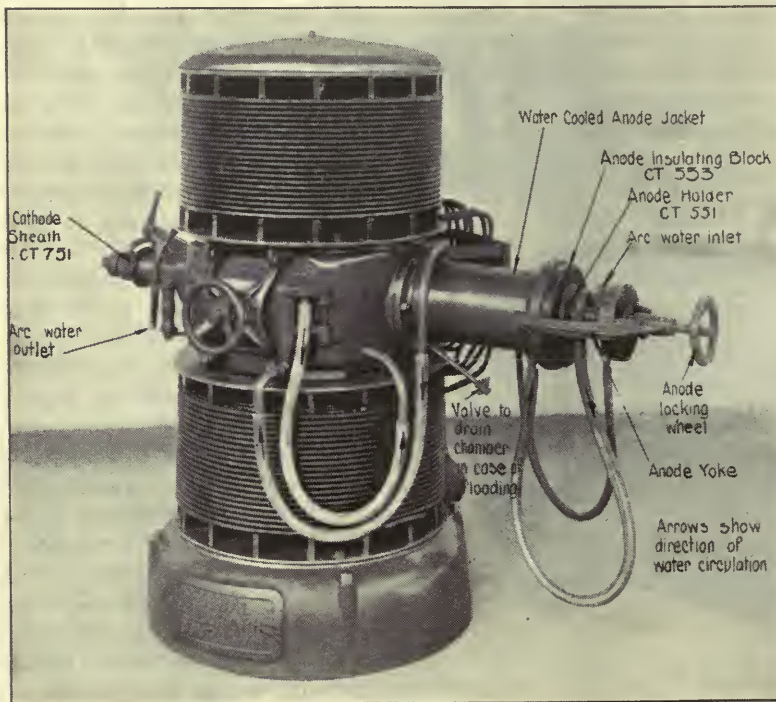

A 30-KW ARC CONVERTER

Its fittings are intended to be used equally well on the 20, 60, and 100-KW Converters

1914-17, which included standardized gaps, motor-generators, standard sizes of switchboard instruments, key contacts, fan motors, condensers, jar racks, and loading coils. The same sizes of condensers and gap units, for example, were applicable to all sizes of standard sets. Standard plans were prepared by the Navy and distributed to all manufacturers for use in bidding on these sets.

Standard $\frac{1}{2}$ -KW spark sets, adopted in 1917.

Standardized requirements as regards rating of 2, 20, 30, 100 and 350-KW arc sets, including certain interchangeable motor-generator parts, arc electrodes, electrode holders for arc sets, in 1915-16.

Standard form of operating procedure in 1915.

Standard sockets and standard electrical constants for receiving tubes in 1916.

Requirement for 2,000-hour life receiving tubes in 1916, raising the standard from 100 hours due to Naval insistence.

Standard mica condenser units and racks interchangeable in all sizes of sets were adopted in 1916.

Standardization on continuous waves for high-power communication, in 1915, although bitterly opposed by the Marconi Company.

Standardization on transmitting tube sizes, sockets and electrical constants in 1918-19, when these tubes were still in practically a research stage. The Navy invited the other interested departments of the Government, and the four tube manufacturing companies, to attend meetings in Washington for determination of standards in advance of development. This resulted in the adoption of standard sizes of 5, 50, 250, 750, and 3000-watt transmitting tubes and private companies immediately proceeded with developments of tubes to meet the requirements of these specifications. The filament voltage was standardized in each case.

Standard battery racks, and battery sizes were required, where practicable.

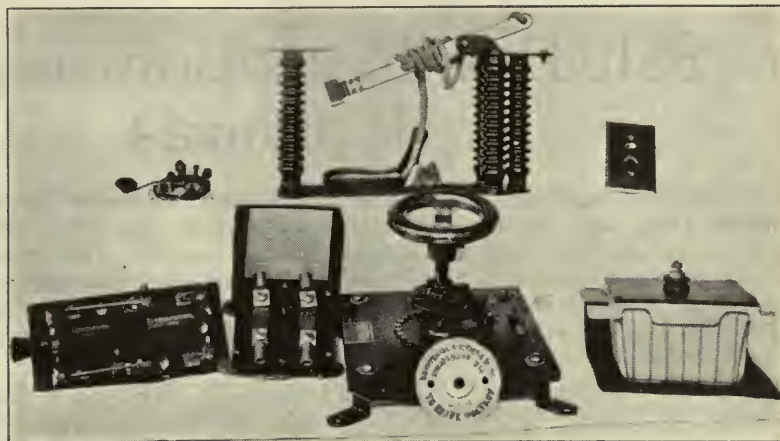

FOR USE WITH 1, 2, 5, AND 10-KW SETS

This group of interchangeable parts comprises a standard hand key, antenna switch, starter switch, control rheostat, condenser and transformer switch

Standard requirements of purchase and testing of installations and insulating material have been issued yearly for ten years, each year more rigid.

Standardization of aircraft radio specifications covering ratings of sets, aircraft antenna wire, fittings, fans for power supply, and other features requiring interchangeability, since 1918.

These are but a few examples of standardization that have been required as the art progressed and as foresight demanded.

The time has arrived to take stock again and to ascertain what standards are good, what standards are unsatisfactory, and what additional ones will be required to bring the art up to date. Where patent reasons stand in the way of standardization it is well to consider the desirability of making such concessions on the part of the patent owners, as may be necessary to the mutual advantage of the public, the manufacturer, and the military.

It is not necessary that the various manufacturers approve a standard in efficiency and appearance of equipment, or in improvements to aid in salesmanship, but it is highly desirable, that standardization be required as regards interchangeability of accessories and moving parts to a certain degree, and above all that a standard of quality be adopted so that the service will not be a laughing stock to the detriment of the trade and the interest of the nation.

Salt-Box Reception in Yoakum, Texas

This interesting letter, describing the experiences of one family with a home-made receiving set of the simplest type, needs only the plain statement of facts to show clearly how important a place radio holds among those who live in remote localities all over the country. The Orrs wound their coil on a salt-box and backed the family chariot up near the set when they needed a storage battery for their vacuum tube—and they tuned in Detroit, 1,230 miles to the northeast! There is no telling how far Billie and his mother and father will hear when the “chief electrician” gets one stage of amplification.—THE EDITOR.

Yoakum, Texas
Dec. 3, 1922.

RADIO BROADCAST,
Garden City, N. Y.
DEAR SIRs:

This is a composite letter written by a 13-year old boy, acting as chief electrician; his dad, some fifty years of age, as supervisor and reader of technical papers; and the silent partner, the mother (age not mentioned), enthusiastic listener and giver of hard-saved nickels when needed. I mention these details to show how radio can and does grip people of all ages.

We live in a small town, and last spring we caught the fever, so after much reading and talking, we built a set, consisting of a variometer and condenser. Alack and alas, nothing doing but a little of the now familiar rat-ta-ta. What was wrong? After much study and thought, it was decided the lack of sufficient inductance was responsible. We made a tapped coil on the old standby—a cardboard salt box—hooked it up, and presto, we had it! How good that music sounded, and when we heard the announcer say, “Our next selection—Mr. Watkins on the pipe organ,” we felt like throwing our hats in the air. Now, after months of experimenting and learning, we often think of our first thrill on getting this music out of the air.

How far do we hear? Bless your heart, we hear all over. We have heard Detroit, 1230 miles, Louisville, 930 miles, Atlanta, 840 miles, Davenport, 960 miles, Denver, 870 miles (our limits so far), and numberless stations between. St. Louis, Kansas City, Fort Worth, and Dallas are as familiar to us as the girl in our local phone exchange. We have also heard other stations, which we do not count, as in fairness to ourselves and friends, no stations are listed unless we hear the call letters, the name of the city, and at least two numbers on the programme.

What do we hear on? A tuning coil consisting of a cardboard salt box wound with some discarded No. 22 wire, tapped every ten turns for ten taps and every two turns for ten taps, a variometer in the plate circuit, a .001 condenser variable in the aerial, one tube and accessories. This set has been copied by several friends and it works. The aerial consists of a single wire, about ninety feet long (counting lead-in), strung up between two 2 x 4 x 20's on the roof, height above ground about forty feet. The aerial and guys consist of discarded telegraph wire, the total cost of the aerial, guy wire and masts being sixty-four cents. The filament current is supplied by our old automobile, which we drive close to the set, which we maintain in the shop where dad makes his living. Part of our success, we believe to be due to the fact that all joints are tightly soldered, all connections made of bare, hard-drawn copper wire No. 14, and all leads to the coil covered with spaghetti. From experience, we can say that loose connections are responsible for half the troubles in a set.

Now, Mr. Editor, if this letter is worth printing in your magazine, do so, and as the chief electrician wants to add one stage of amplification to his set, and is running errands, etc., to buy the parts, and you feel disposed to give him a helping hand, he will be grateful to you. We mention this in view of the statement made on page 61 (insert) November RADIO BROADCAST.*

Cordially in radio
BILLIE ORR,
Dad and Ma

*This refers to the announcement of the “How Far Have You Heard?” Contest, in which it was stated: “We are anxious to learn of experiences in broadcast reception, believing that their publication may help others to obtain the best results from their outfits. . . . For letters published, a very liberal rate will be paid.” This will still hold good, even after the contest itself has ended.

Radio-Frequency Amplification From the Ground Up

With Some Simple Details for Applying It to Your Present Receiver With Little Difficulty, and a Series of Six Graduated Circuits

By ARTHUR H. LYNCH

MUCH of the trouble experienced by listeners-in is directly due to an exaggerated ambition for long distance. Many of them read descriptions of new forms of receivers for which great claims are made and they decide to have one—and have it immediately. As a rule, their knowledge of the set is confined to a few technical terms which they repeat in parrot-fashion to some harassed dealer who is just as much in the dark as they are. Not more than a few days ago, a youngster asked me to draw a diagram and tell him how to make a radio compass. In the course of the conversation that followed, he described his single-tube receiver, which had been assembled from units bought one at a time, after comparatively long periods of saving. He spoke of the purchase of his storage battery as a great event and prided himself on a pair of phones that cost eight dollars—and he wanted a radio compass, for he had read of the great work being done by the U. S. Navy at its compass stations. He had a notion that a

radio compass could be made in a few minutes by adding a loop or something to his outfit. He thought it would be a fine thing to carry around and locate stations that interfered with his receiving. He also had some very vague ideas about radio-frequency and super-regeneration and many other technical subjects of which he knew little more than the name, but he was anxious to try them all—at once.

And this lad is just like a great many others and they are not all youngsters. It is a mighty good thing for the person just being initiated into the vagaries of radio to be satisfied with a good single-tube, three-circuit, regenerative receiver until he has mastered it. It takes a lot of skill to get the best from a receiver of this type and vacuum-tube detectors themselves offer plenty of opportunity for experiment before the best working point is found. Two steps of audio-frequency amplification do not cause much additional difficulty and are helpful when you desire to use a loud-speaker. They add but little to the distance over which you can receive, however. Of course there are some

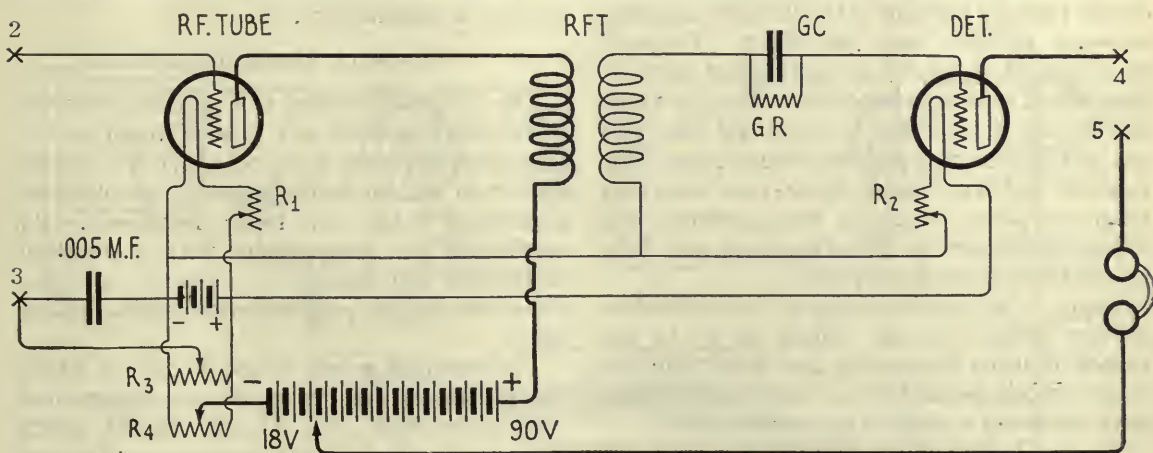

FIG. 1

A single-stage, transformer-coupled, radio-frequency amplifier and vacuum-tube detector applied to a standard coil mounting. Various adaptations of this arrangement are possible

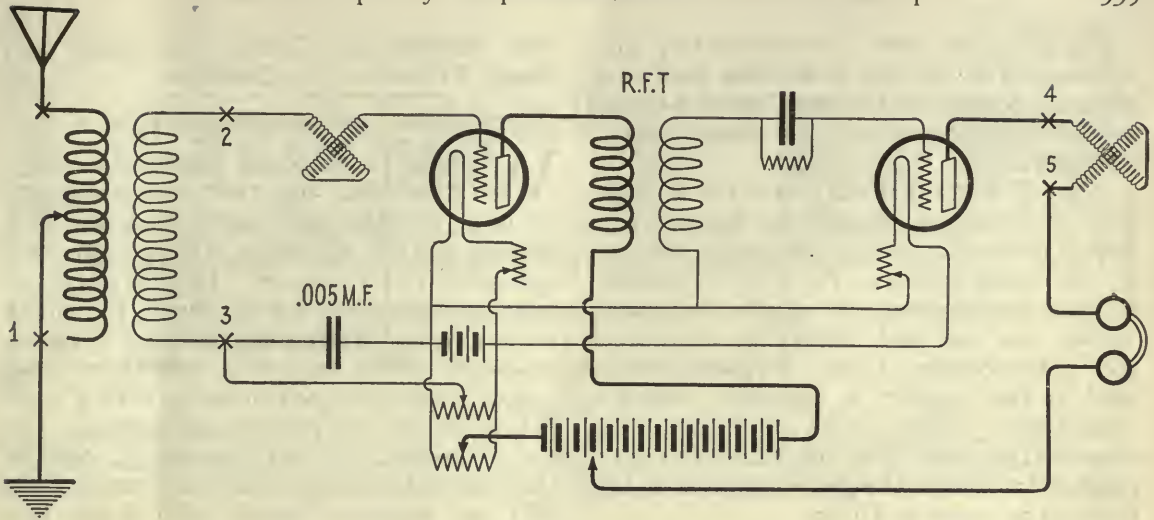

FIG. 3

A vario-coupler and twin variometer regenerator and one stage radio-frequency amplifier may be made from Fig. 1 as shown here

the secondary terminals and the wiring to their right and to the left of X⁴ and X⁵ should be made in a permanent manner with "bus" wire if it is available.

Where a standard regenerative circuit is employed, the connections are made as in Fig. 2. In order to employ a variometer and twin variometer regenerator, the circuit in Fig. 3 is used.

Where a Tunit unit is used to convert a standard long-wave receiver into a short-wave outfit, the Tunit is merely plugged in, in place of the three multi-layer coils.

For those who would employ a loop antenna there are two methods available—the non-

regenerative and the regenerative. The difference is found in that portion of the circuit between X⁴ and X⁵. Where regeneration is not desired, it is but necessary to connect a short piece of wire between these two points.

But regeneration is usually desirable, and is obtained by connecting a variometer between X⁴ and X⁵.

The loop itself should be provided with two flexible leads, twisted together and attached to a plug which may be used in place of the secondary coil of the three-coil regenerator. When a loop antenna is employed, the regular antenna should be removed from the set and the primary coil should also be taken out.

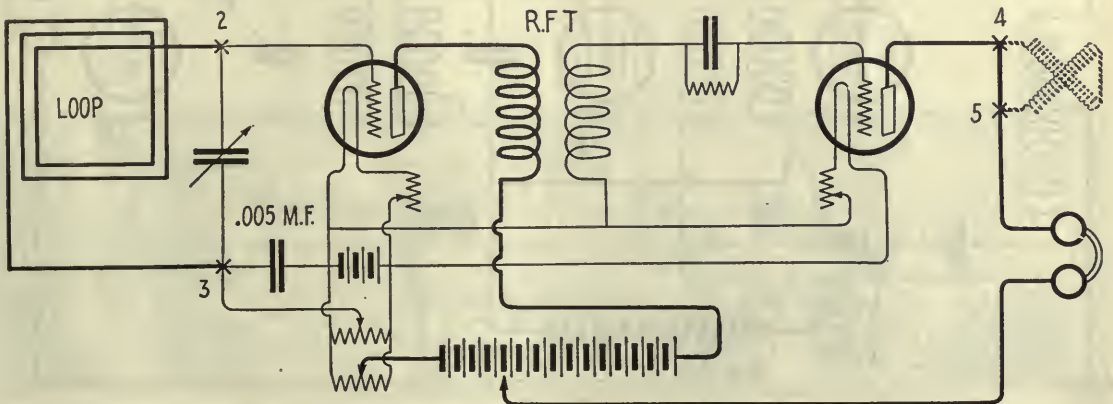

FIG. 4

For loop reception no primary is used. The loop is plugged in across the terminals X² and X³. If direct connection is made between X⁴ and X⁵, as shown by the dotted line, the receiver will be non-regenerative. The usual variometer method of producing regeneration is indicated at the right by dotted lines

The condenser used to tune the loop may be mounted on the base of the loop itself or in the usual position on the panel, where it is used to tune the secondary when the outside antenna is employed.

You will notice that the grid of the amplifier tube is connected through the secondary or loop as the case may be, to the centre terminal of the potentiometer, R_3 . It is possible, by this arrangement, to impose a suitable voltage on the grid under the control of the potentiometer knob. A potentiometer used in this manner is frequently called a "stabilizer." Where more than one stage of radio frequency is employed, it is a good practice to have all the grids connected to this terminal as shown in Fig. 5.

The plate of the amplifier tube is supplied with 90 volts and none but a hard tube should be employed. The plate voltage of the detector tube is twice variable because a "B" battery with taps is used and a potentiometer, R_4 , is also in circuit.

Tuning of the various arrangements is apparent to those who understand the tuning of other circuits, so there is no need of discussing it here. For those who are not familiar with this form of tuning, it would be well to read "Regenerative Radio Reception" page 58, RADIO BROADCAST for November, and "Paris

and Honolulu Are Calling You," page 132, RADIO BROADCAST for December.

TUNED AND TRANSFORMER-COUPLED R. F.

WHERE a standard regenerator or a variocoupler and twin variometer outfit is to be fitted with radio frequency, it is possible to take advantage of two stages with a single R. F. transformer. In these instances, which are illustrated in Figs. 5 and 6, the tuning of the antenna circuit is accomplished by means of a coil, which may be a multi-layer or a tapped single-layer coil in series with a variable condenser, the antenna and ground. For loop reception, it is but necessary to connect the loop and its shunt condenser between the grid and negative battery lead of the first amplifier tube.

By the arrangement shown in these two figures, the primary of the tuner is shunted by a variable condenser (23- or 43-plate) and may be tuned to any wavelength within the limit of its inductance and capacity. The secondary circuit in Fig. 5 may be tuned by the condenser and in Fig. 6 by the variometer. Here we have two tuned circuits forming the primary and secondary of the second radio-frequency transformer—in other words, we have one step of transformer-coupled and one step of tuned radio-frequency amplification.

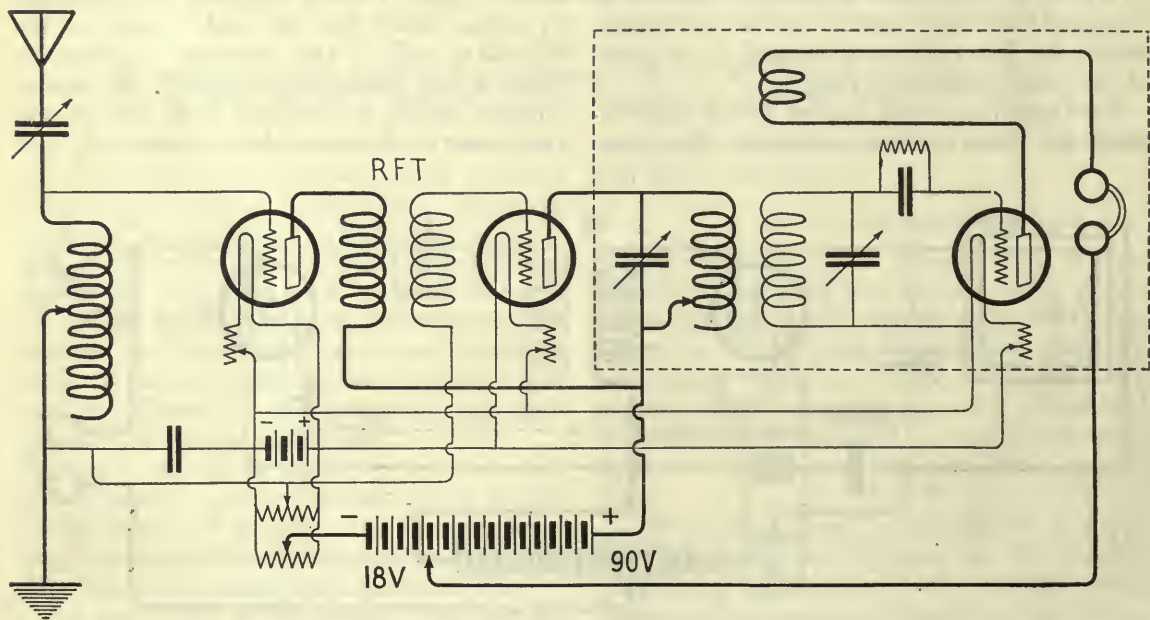

FIG. 5

A single radio-frequency transformer and two amplifier tubes may be applied to a three-circuit regenerative receiver (shown within the dotted lines) to provide one stage of transformer-coupled and one stage of tuned radio-frequency amplification

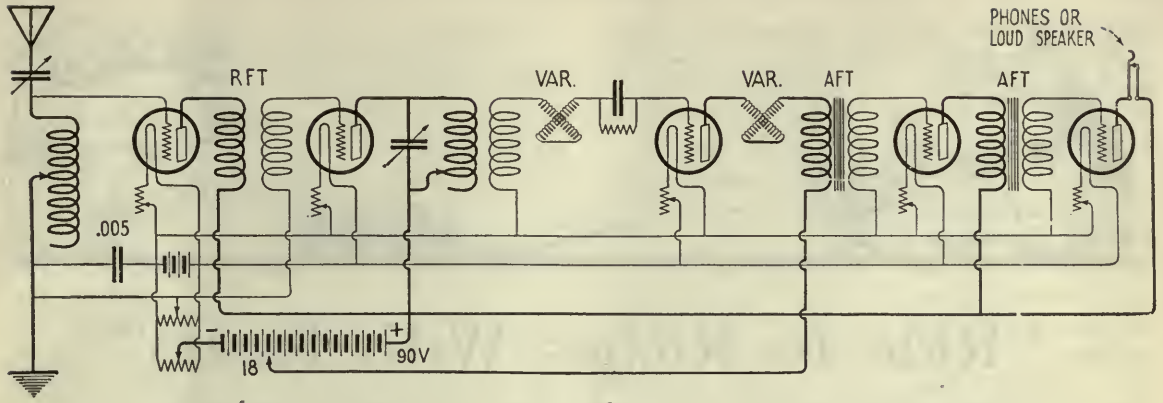

FIG. 6

In this five-tube circuit there are two stages of radio, a detector and two stages of audio-frequency amplification. A variocoupler and twin variometer, regenerative tuner is employed and the antenna circuit is tuned by a tapped coil and variable condenser. Long distance and loud signals are the reward for mastering the complex manipulation this outfit requires

These circuits are more difficult to operate than the single-stage, transformer-coupled variety we have considered, but there are many experimenters who will derive a great deal of pleasure from the two-stage arrangement. Some fellows revel in complexities—and more power to them!

Before signing off, we must point to the two stages of audio-frequency, illustrated in Fig. 6. They follow immediately after the detector assembly and no trouble should be experienced with applying them to any of the foregoing circuits. If you want to do yourself a favor, don't attempt too much at once, or, like the fellow who bites off too much, you won't be able to chew.

The following symbols are used in the figures and the capacities and values of in-

ductances are those used in operating below 600 meters. Very few of them perform very well at 200 meters. Most radio-frequency transformers are designed to function at greatest efficiency on the broadcasting waves of 360 and 400. Some very ambitious claims that do not hold 'water are made by certain of the manufacturers and it is well for you to procure your radio-frequency transformers from dealers who know and can be relied upon telling the truth concerning their wavelength range.

X, X¹, X², X³, X⁴, X⁵ indicate the standard multi-layer or spider-web coil mountings.

R₁ and R₂ are receiving filament rheostats.

R₃ and R₄ are 200-ohm potentiometers.

RFT indicates the R. F. transformer.

GC and R are the grid condenser and leak resistance; .005 is a .005 mfd. condenser.

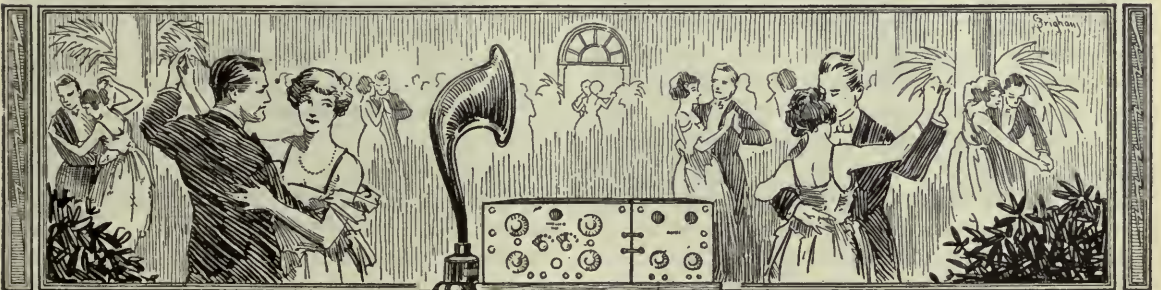

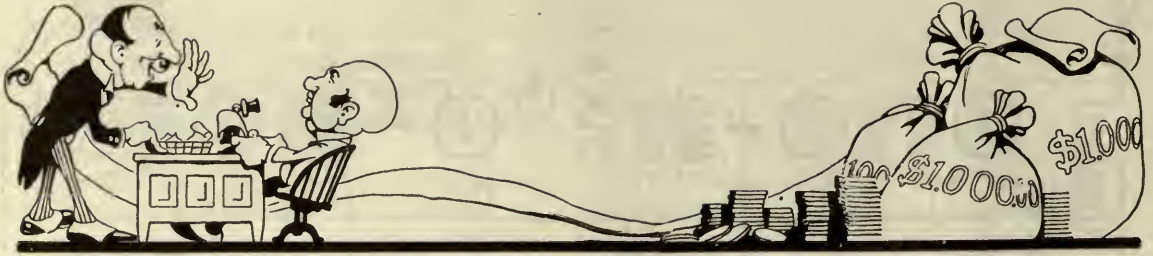

“Ride to Riches With Radio”

Some Get-Rich-Quick Schemes that are All Bull and a Yard Wide

By H. J. KENNER

Managing Secretary of The Better Business Bureau of New York

LAST summer the public was greeted by the lusty and hungry cries of new-born radio promotions in the latest infant industry of the United States. These companies had sprung up all over the country as a direct result of the sudden popularity of radio and the almost unlimited publicity gained by this fascinating product of many inventions.

The best known and most experienced radio engineers, who were plugging away at their scientific tasks, refused to get over-excited by the public furor, and were most reticent about the commercial possibilities in the manufacture of apparatus, but the professional promoters and stock manipulators, who cared nothing for the scientific development of radio and who were merely determined to make this new art and industry pay them a tribute, were not slow to tell the public what would happen. This gentry moved by the scores and hundreds into the radio field, organized companies and began campaigns for funds to launch their own corporations. In New York, they had started many companies, had done most of the work in preparation for their stock sales campaigns, and were already descending upon the public with small, select armies of hair-trigger salesmen and with advertising of the “do-it-now” ballyhoo type.

The Better Business Bureau of New York City undertook a survey of the radio field. It found the industry already infested with unsound financial organizations. If none of these companies had gathered in big sums of money from the public, it was because it had not had the time. In line with the policy of the Bureau

and the Truth-in-Advertising movement, it was determined to tell the public about the fake radio companies before they gained much headway.

Among the stock-selling radio companies the International Radio Corporation appeared to be the worst offender. It was capitalized for \$4,000,000 and the stock was being sold by various small brokers in and around New York. The company had a large suite of offices. It professed to be a going concern and boasted a plant in Newark. The company's officials and sales agents talked very optimistically of its immediate future, saying, among other things, that the “I.R.C.” had acquired several valuable patents, and that its officials were nationally known in finance and prominent in radio science. Immediately after the bulletin exposing the International Radio Corporation had been published, Charles Beadon, promoter of the “I.R.C.,” brought complaint against the managing secretary of the Better Business Bureau for criminal libel, and two civil libel suits asking damages of \$600,000 were filed against the managing secretary and the members of the board of directors of the Bureau.

The result of all this bluster was that the criminal libel case was thrown out of court and the other two suits were dropped. When the criminal libel suit came up for a hearing, Jerome Simmons, counsel for the Bureau, merely pleaded truth in defense of his client. Relying entirely on the testimony of former officials and employees of the “I.R.C.,” Mr. Simmons proved that every statement made in the Better Business Bureau's bulletin was true.

Thus, according to the “literature” of the

"I.R.C.," it had acquired the assets of the P.W. P. Manufacturing Company of Newark, N. J., "which already had a nation-wide reputation for the wireless and radio apparatus it has manufactured for four years." Bureau pointed out in its bulletin that the P. W. P. Manufacturing Company had been in existence in Newark only about a year, not four years, had very limited distribution and that it was not nationally known. In its sales circular, the "I. R. C." stated that it had taken over the output of four factories in addition to its own. The Bureau's bulletin stated that it had actually contracted with two small factories for their products, at prices which the consulting engineer of the "I. R. C." admitted to be high. In order to impress prospective stockholders, salesmen of the "I. R. C." claimed that the De Forest Company and Butler Brothers, the mail-order house, had placed with it big orders for radio parts, and that from forty to fifty persons were busy at work in the company's Newark factory. The bulletin, dated August 18th, showed that all these claims were false, that the company was making no profit whatever, that the De Forest Company and Butler

Brothers had never placed any orders for radio sets and not more than twelve people, mechanical and clerical, were employed in the so-called Newark plant.

Another falsehood in the "I. R. C." sales circulars gave an account of valuable patents owned and controlled by the corporation, especially the "Rich-Tone Loud Speaker Horn" invented by Mr. Francis Judd, who for a short time was employed by the International Radio Corporation. Salesmen claimed this instrument would revolutionize the loud speaker industry, both in price and quality. The Better Business Bureau bulletin said that these patents had not been granted, and the inventor himself, Mr. Judd, testified that only an application had been made for patents and that none had been granted. It was hardly necessary to refute a claim made by salesmen of International Radio Corporation stock that Mr. Judd's horn *eliminated static!*

One of the chief stock-selling devices of the "I. R. C." was a motor car equipped with a radio set which toured the streets of New York. The sales literature of the "I. R. C." referred to the operator of this car and its radio set as



"SECTION OF MACHINERY AND TURNING ROOM. NEWARK PLANT, N. J."

"An elaborate sales circular, which had been sent through the mails, contained several full-page pictures of the exteriors and interiors of factories located in various New Jersey towns. The sales circulars did not actually state that these pictures were taken of buildings owned or operated by the new radio company, but that was the inference that anyone would draw from hastily looking over the booklet. A brief investigation disclosed that the company owned nothing and that the pictures were of factories with which the company had entered into tentative agreement to supply it with various radio parts"

follows: "He makes the impossible possible, receives while in motion with the aid of its International Radio set and loud speaker."

At the hearing on the criminal libel complaint, a young electrician, who had originally equipped the motor car, testified that he had used a standard radio set and apparatus made by the Westinghouse and General Electric companies and that none of the apparatus which he put on the car had been manufactured by the "I. R. C."

The company had advertised that its financial adviser was:

"Internationally known to business men and has been the associate of such well-known magnates as J. P. Morgan, Cornelius N. Bliss, Gov. Benj. Strong, Jr., J. D. Rockefeller, Jr., and the late Henry P. Davison, Herbert Hoover, and a score of others." In various other ways, stock salesmen referred to this same man as "former financial adviser to J. P. Morgan & Company," or as "former member of the Advisory Committee of J. P. Morgan & Company." The subject of these laudatory remarks testified that he had never acted as the financial adviser of J. P. Morgan & Company. He resigned his position with the "I. R. C." as soon as he discovered that these misrepresentations were being made about him.

The truth of the assertion made by the bulletin that the "I. R. C.," had, without authority, used the name of a junior officer connected with one of the best known trust companies of New York City, as a director of the "I. R. C.," was likewise proven in court.

Another radio company, whose affairs were scrutinized by the Better Business Bureau, promised to mend its ways at once. This company had gone even further in misrepresentation than the "I. R. C.," but its activities had been very limited. The company had been organized by a few men who knew practically nothing about the radio field, except that radio sets had leaped to instant popularity and that prospects of the money-making possibilities in the industry appeared to be good. The company was prepared to market a \$5,000,000 stock issue, ostensibly for the purpose of manufacturing radio sets and parts. An elaborate sales circular, which had been sent through the mails, contained several full-page pictures of the exteriors and interiors of factories located

in various New Jersey towns. The sales circulars did not actually state that these pictures were taken of buildings owned or operated by the new radio company, but that was the inference that any one would draw from hastily looking over the booklet. A brief investigation disclosed that the company owned nothing and that the pictures were of factories with which the company had entered into tentative agreement to supply it with various radio parts. Within two or three months the company had three times changed its president and had twice changed its entire Board of Directors. The "moral pressure" effort of the Better Business Bureau led to the abandonment of stock-selling by this company.

Another company had stolen, almost word for word, the corporate name of a radio manufacturing company which was recently taken over by one of the largest corporations engaged in the manufacture of radio sets. All of these companies sketched, in their sales literature, the enormous profits made by various remarkably successful industrial enterprises, such as the telephone and telegraph industries, and indulged in various blue-sky speculations which led prospective stockholders to believe that radio might rival the telegraph and telephone in profits to investors in companies that manufactured apparatus. They failed to tell the public they had no "service" to sell, which is the source of profits of the long-established telephone and telegraph corporations.

There seems to be a widely prevalent belief that the salesmanship of wild-cat stocks are endowed with marvelous salesmanship ability. As a matter of fact, such stock salesmen, as a general rule, are men of very mediocre calibre. They do not depend on cleverness, but on effrontery and tricks that are almost childish. They know certain practices that are prevalent among men of their type. And one reason they succeed in selling their securities is that they are early in a new field, offering stock in companies in fields which have greatly aroused the public's curiosity and interest. Promoters of fake companies work on the theory that "where there is public interest, there also may be found public confidence," and salesmen of fake stock play their strongest card when they trade on the public's hopeful confidence in the success of enterprises in fascinating new fields of science and industry.



GOVERNOR CHANNING H. COX
 Of Massachusetts, broadcasting from WGI,
 the American Radio and Research Corpora-
 tion's station at Medford Hillside, Mass.

DR. ERNEST M. STIRES
 Whose sermons have been transmitted by wire
 from St. Thomas's Church, New York, to WJZ, and
 from there sent out to a huge radio congregation



© Underwood & Underwood

TITTA RUFFO SINGING AT THE FIRST OF THE CONCERTS FROM THE BROOKLYN NAVY YARD (NAH)
 Left to Right: Lt. Comdr. J. W. Reeves, Jr., U. S. N., Rear Admiral C. P.
 Plunkett, U. S. N., Titta Ruffo, Captain R. D. White, U. S. N., and Enid Grange

What About Operating as a Career?

Not Much Money But Opportunity Aplenty. A Chapter from the Diary of a Commercial Radio Man

By A. HENRY

FROM time immemorial there have always been those youths, who upon reaching eighteen years of age and a knowledge greater than that of all their forebears combined, find the section of the world they occupy small and stuffy. They feel the call of the wild, so to speak, and occasionally prevail upon parents, whom they consider a trifle behind the times, to permit them to leave school and get a "job".

I was one of them, and although I knew absolutely nothing about the sort of life I was heading for, an overwhelming desire to travel—to see the world—filled me.

At school, my record had not been bad, in fact my parents used to take some pride in it, but from the time the wanderlust siezed me I was a slave to it. In justice to myself, I must tell you that I did try to carry on for a while, but it was a forlorn hope. As I spent more and more of my spare time devouring books of travel, my marks ran lower and lower.

I knew it was an effort for my parents to keep me in school and that was a trump I held up my sleeve awaiting an opportunity to play it when it would be most effective. But it wasn't necessary. One Friday afternoon, school was let out early for the week-end in celebration of a victory for the debating team. I caught a train and entered the house without making any noise. My mother was in tears. I had never seen her cry before and it would be hard to describe my feelings. It seemed that

the trouble was a poor investment—some houses built, well but not too wisely

That was the last straw, and I cannot help remembering with mingled wonder and amusement at the eloquence with which I told the ruler of the roost that the morrow would find

me employed—making money, not spending it. It is a rather strange truth that at six, a boy thinks there's no one in the world so great as his father; that at eighteen, he believes his father a "back-number," a "has-been"; and that at thirty, he begins to realize that the "Governor" was not such a dull star, at that.

The next day found me in the job all right. It was not too far from the holidays for the department stores to require additional help and

I had no trouble in locating as an "inspector" in one of the largest and best stores in our city. When I learned I was to attend the store's school for a few days before entering upon my inspecting duties, I felt that I had the world by the forelock and actually wondered how I had managed to talk the grandiose gentleman, who allowed me a few minutes of his time, into making an inspector of me at the very outset. Nor was my joy entirely toppled over when I learned that my salary was to be five dollars a week. I had asked for ten, but a fellow shouldn't be too grasping, especially when he has never been employed before.

To cover this period briefly I may tell you that I was an inspector in the book department. The duties of an inspector were to inspect the

Perhaps You, Too, Would Like to Travel

It may be that you are a father of a restless son, or an ambitious son of a "father of the old school." Be that as it may, you may want to choose a career for yourself or help some young man to choose one. Radio operating offers a great reward for the youth who can use his wits. The pay is not great, but there are many ways of increasing one's earnings.

This is the second of a series of true stories about the life of a radio man written by men who have been through the mill. The first was "Choosing a Radio School," by Howard S. Pyle, published in the October number. In this article, and those which are to follow, Mr. Henry pictures life at sea as it really is—without the dolling-up usually found in the radio school advertisements.—THE EDITOR.

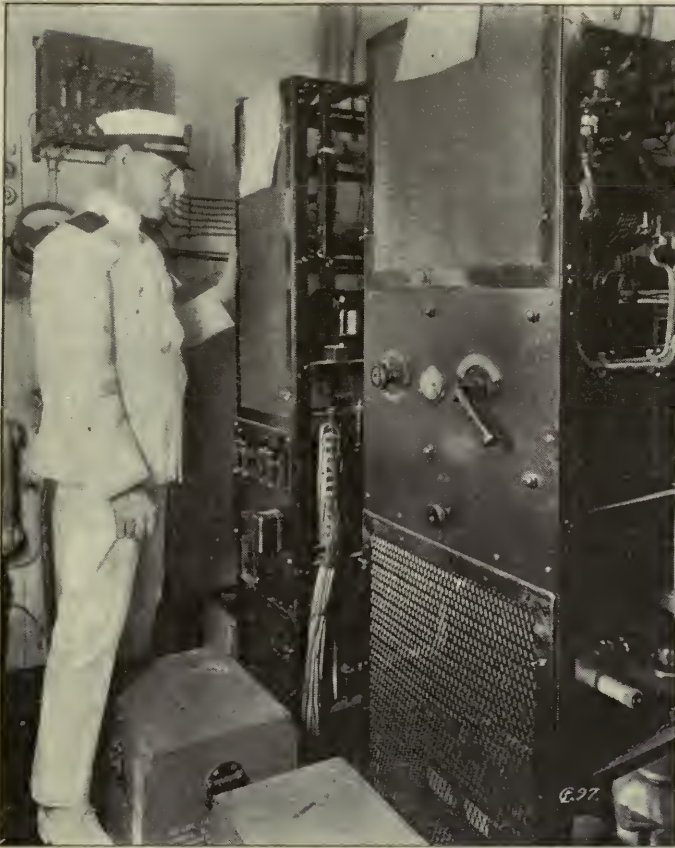

COMPLICATED MACHINERY AND A MAN IN WHITE UNIFORM
Are the average layman's idea of the radio man's job. It may be so, if you have been in the game long enough or are particularly fortunate. As a rule, however—

sales slips and the articles that accompanied them, to see that they corresponded, and then *wrap them up*. "Inspector" proved a polite term for "wrapper." At the end of two weeks I found that, after carfare and lunch had been paid for, I saved one dollar and forty cents per week. And the approach of the Christmas season made it necessary for me to work until nine o'clock at night, without extra compensation. I rebelled and was "fired."

My second job was "stock boy" in the jewelry department of another large department store, at a salary of seven dollars a week, with an additional fifty cents for "supper money" for evenings we had to work. By this time I had cajoled myself into the firm belief that I was truly a "comer," and my belief in my ability to brow-beat the world was aided and abetted by the stories of young men who had accomplished great things, appearing from time to time in the magazines.

I had affected long trousers but was not permitted to wear socks and suffered some embarrassment at the hands of the boys who delighted in pulling my trouser legs above my knees to display and laugh at the long stockings thus brought into view.

And I never lost the ambition to travel, though it was squelched occasionally by the pressure of events.

After the holiday rush, I expected summary dismissal with the arrival of each pay day, but my forebodings were unjustified and I was beginning to feel more and more like a business man. By catching a train before the "Governor's," I could sit in the smoker and enjoy my morning pipe and paper, just like the other men of affairs. And with the abating of the duties I was called upon to perform, came the wanderlust again with renewed vigor. From the Geographic Magazine and the pamphlets of steamship companies and railroads, I began to learn of Bombay and Callao, Honolulu and the Fiji Islands. Each had its own distinctive appeal.



—THE RADIO MAN IS HIS OWN LAUNDRY
And he finds that salt water and salt water soap, even when mixed with plenty of elbow grease, do not make things very white

I had no money and knew my parents would not hear of financing a trip to the many places I wanted to see, even if they could afford it. For some time past I had been a radio enthusiast and had, by diligent practice upon an old automobile horn, connected to a half dozen dry cells and a key, acquired a slight knowledge of the Morse code. Continental, the code used for radio now, was not in vogue then, and the neighbors were treated to my practice until late at night—every night, even Sunday, for the "Governor" sang in church and the Sabbath was duly desecrated during his absence.

A friend informed me of a radio school run by the Marconi Company for instructing young men, with a view to placing them on its vessels when they became proficient. I persuaded the family to let me go to the school. I do not dilate upon this for the reason that it was a very difficult task and I nearly lost out. The folks wouldn't hear of my going away—they hadn't been informed of my ambition to travel and the ice had to be broken carefully. The man in charge of the radio school looked me over rather critically and said, "Too young! Come back in about a year!"

But I haunted the school and refused to take his decision as final and he softened to the

to remain at the school it was necessary for me to carry home stories of jobs at the "land stations." I spoke of them as though land stations were the only places where they employed operators. In two days I was talking motor-generators and spark-gaps and tuning-coils and carborundum detectors as glibly as though radio had been my special study for many years.

After ten days' schooling, I was called into the holy of holies presided over by the superintendent, who told me he was going to assign me to a sea-going tug owned by the Standard Oil Company. The assignment was accepted in all seriousness, just as though I expected to be allowed to fill it.

The valuable slip of paper was not displayed at home until the evening meal had been long completed and the three girls were in bed and asleep—I knew loud talking would wake them. So we held a council of war and I was chairman of the council. In the course of my week at school I had learned that the land stations to which I had called attention so frequently could only be secured after a rather indefinite period at sea—sort of a sea-going novitiate.

"Where's the steamer going and how long is it to be away?" was my father's question.

I had not informed him that the steamer was a tug, so my remarks had to be framed with great care, for I firmly believed that there would be no trip for me if the whole truth of the case were known. Most of my remarks dealt with the fact that I was to be the *Chief Operator* and I discreetly refrained from mentioning that in addition to being chief, I was to be the *only* one. The superintendent had told me that my room was a spacious one right beside the Captain's. That was very fine ammunition to feed the folks.

By the time sailing day arrived, nearly everything was ready and my bags were duly packed. I pass

over the "good-bye" scene, for it was just like any other, where the young hopeful leaves everything near and dear to him to go out and conquer the world. There was a single exception. My father accompanied me to the "vessel." I will never cease being grateful to him for having done so.

I found that the *Astral*—that's the name of the good ship—was coaling at Communipaw,



MY OUTFIT AT HOME

Gave me a great deal of practice and made it possible for me to get through the school in a short time

extent of allowing me to take an examination. He must have been satisfied with the result, for I was admitted to the school. I went home in a burst of glory that evening to spread the glad tidings. I waited until we were well launched in the evening meal before breaking the news.

No one enjoyed that supper very much, for there was a mixture of tears and speeches I cannot and would not care to recall. In order

New Jersey, and was going to pull out about midnight. So we took the train from our home on Long Island at about six, and ferried to Jersey. I don't remember just what happened then.

You see, it was February and it was cold and it was dark and we had to trudge along railroad tracks without end. Neither of us had ever seen the *Astral* before, and all vessels looked more or less alike in the haze caused by escaping steam intermingled with flickering and sputtering arc-lights. Dad was straining his eyes for a liner and I kept a sharp look-out for a tug.

After walking a very long distance we came upon two men and I saw a battle raging in my mind's eye, as they approached. As soon as they were within a reasonable distance, the "Governor" hailed them and the blood nearly froze in my veins.

"Do you happen to know where the steamer *Astral* is coaling?" he asked.

After a moment of consultation one of the pair said, "If you mean that Standard Oil tug, she's right ahead of you—about a quarter of a mile. Think that's her name. Watch your step, there's a break in the rails about half-way up."

During the remainder of the walk, neither of us had anything to say, and after having visited three other boats, we found the *Astral*.

Coal buckets were flying hither and yon and it was a hard job for us land-lubbers to get up the single, narrow plank used as a gangway. Surely this was no time to give the vessel a looking over, so we repaired to the Radio Room under the guidance of a raw-boned, genial-looking brute, who told us in battered English that he was a fireman.

My room was all the "Super" had said it was—and a lot more. It was located on the main deck just about 'midships and extended all the way from the port to the starboard side. I did not know which was which but did know one was right and the other left, so there was little chance of a *faux pas* in the presence of the begrimed sea-going fireman. There was a wooden door and a port-hole on each side and there were half-inch steel storm doors used to protect the wooden ones in bad weather.

On the after side of the room, recessed in the bulkhead (that means wall) were spaces for four bunks, but only one was made up, and a nice, clean looking bunk it was. Directly opposite the bunk was the radio outfit. It would have delighted the heart of any radio



THE GOOD TUG "ASTRAL"

I had not informed my dad that the steamer was a tug. Most of my remarks had dealt with the fact that I was to be *Chief Operator*. I had discreetly refrained from mentioning that I was to be the *only* operator

man. It was an outfit of the sort that was standard in those days and I could not suppress the desire to operate it.

At that time, the New York *Herald* operated a station in New York City and sent press items to ships at sea at regular intervals. The operator was on that night. I copied the press and for the first time the "Governor" seemed to think that there was really something to "this radio thing" after all, and I felt like a conquering hero—that is, I guess conquering heroes must feel as I did that night.

Then Dad went home and left me to my own devices.

I unpacked my three bags. It's a good thing none of the real sea-goers happened in on the performance, for it might have amused them greatly and been embarrassing for me. It might have been difficult for them to appreciate the need for the two bottles of spring water I had with me to prevent getting typhoid from the water kept in dirty tanks for weeks on shipboard. Cans of potted beef, cocoa, evaporated milk and many other delicacies were to be found aplenty, for no one would ever expect to find such things at sea—unless, of course, he had been to sea.

Be that as it may, here I was in a position

of respect, which would carry me to parts unknown and ports unseen. Here, indeed, was opportunity to see the world and to be paid for the trouble. My salary at that time was thirty dollars a month, or as one

of the "mates" put it, when we had moved four miles after bucking a head wind for nearly two days, "What do we care, Sparks? The more days, the more dollars—a million days, a million dollars!"

Mr. Henry has promised us some very interesting incidents for the articles to appear in the series he is preparing for RADIO BROADCAST.

He will tell how, on his first trip, he spent four hours calling S O S—when shipwrecked only a few miles from a lighthouse and a radio station—before his call was answered. His experiences as a salesman of vacuum cleaners and phonographs in foreign lands are humorous and instructive.

The story of his visit to England, in 1914, just after Germany declared war, and his three-day respite in a Liverpool jail for taking movies of the famous "Black Watch" as it paraded up Lord Street, Liverpool, will be enjoyed especially by those who visited England with the A. E. F.—THE EDITOR.

Becoming Familiar with Great Music

By MABEL TRAVIS WOOD

THE average American is none too familiar with the great in music. He may know that Donizetti is not an Italian breakfast dish, but could he whistle the second movement of "Danse Macabre" at a moment's notice, or give the title and the composer of "that operatic thing that's played so much"? How many radio fans, hearing a well-known musical classic wafted into their living room without an introductory announcement, could quickly recall just what it is?

Radio can help train your music memory, as well as your musical appreciation. Seattle's music memory is batting high on account of a recent Music Memory Contest in which radio played an important part. The contest was arranged by Seattle Community Service and a local newspaper, following the plan which has been promoted in many cities by the National

Bureau for the Advancement of Music and by Community Service.

For three weeks the city was familiarized with twenty-four selections of the world's greatest music through newspapers, schools, churches, music stores—and radio. At the end of that time neighborhoods gathered at the various schools, listened to phonograph snatches of the selections and wrote down the names of the compositions and of their composers. Young and old competed, and two hundred and fifty dollars in prizes was awarded to the neighborhoods having the highest scores.

Every night during the contest one of the selections was broadcasted, together with a short description of the music and biographical sketch of the composer. Radio enthusiasts in all parts of western Washington could listen to such treats as the sextet from "Lucia" and Cadman's "Land of the Sky-Blue Water."

To Acknowledge an Error

Through an error, we stated in our November number, page 36, and in our December number, page 123, that Mr. Philip R. Coursey was editor of *The Wireless World & Radio Review*, London. We have been advised that such is not the case, but that he is a member of the editorial staff of this organ. Mr. Hugh S. Pocock is the editor, and we take this opportunity to express our regret at the mistake

Famous Radio Patents

By CHARLES H. KESLER

Member of Bar of District of Columbia, and of New York Patent Law Association

WHILE several courts have decided that the Fleming patent covers the audion when used as a detector, such courts are divided on the question of infringement when the audion is used as an amplifier and as a generator of oscillations.

Beginning in 1912, Armstrong, De Forest, Hogan, Langmuir, Meissner, Vreeland, Waterman, Weagant, and others, while using the audion as a detector, independently observed that it could oscillate or generate oscillations. These observations and investigations have resulted in numerous inventions involving the oscillating tube circuit and amplification, the most noteworthy of which is the Armstrong circuit. With the impetus given to the use of

tubes by these investigations, it is but natural that the question should arise as to whether such improved circuits infringed the Fleming patent.

A tube when oscillating is acting in a reverse manner. Instead of putting an oscillating current into the tube to get a rectified or direct pulsating current, a rectified current is imposed on the tube and an oscillating current is obtained. The action is analogous to that of an electric motor which, while producing motion, when current is passed through it, will produce a current when its armature is mechanically rotated. Neither Fleming nor De Forest contemplated this use of their tubes at the dates of their inventions.

The district federal court in New York has decided that the Fleming patent covers the

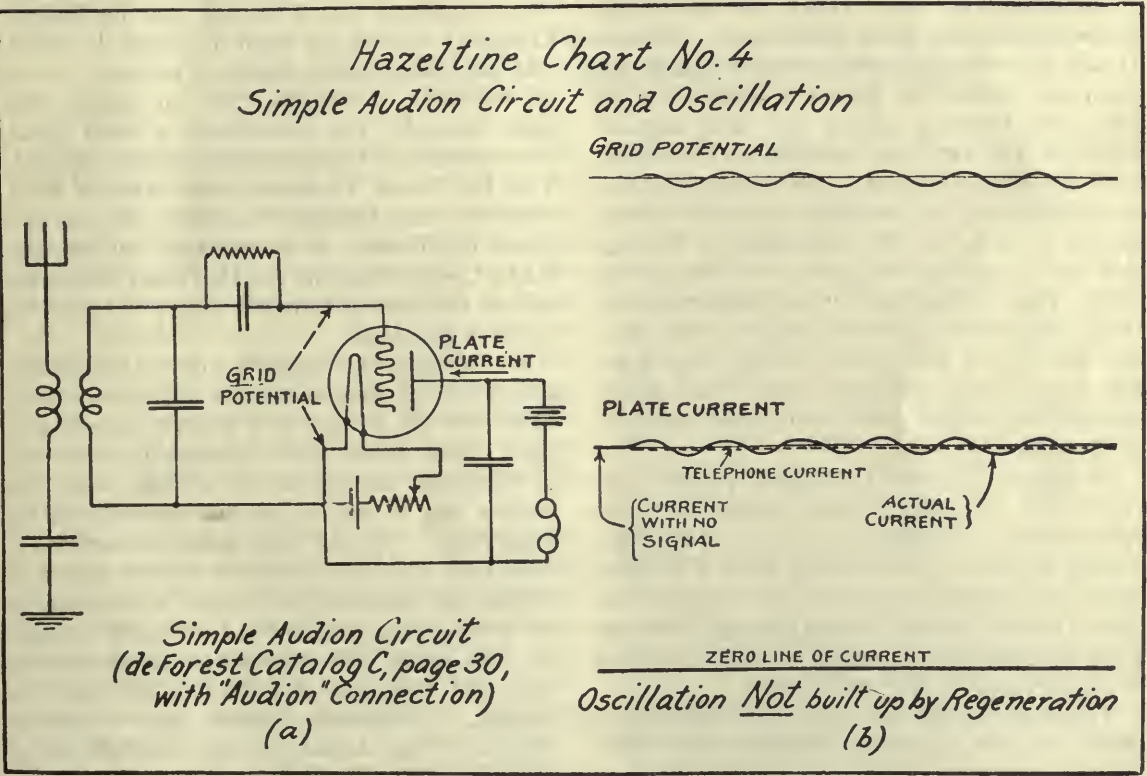

FIG. 1

Circuit of De Forest grid patent, in use before Armstrong's invention

oscillating circuits (such as Armstrong's) and also the amplifying radio circuits. Although it was admitted that Fleming, at the date of his invention, had no knowledge of the use of his radio tube as an oscillator, yet the court was convinced that the two-electrode Fleming tube would oscillate when used with a battery and condenser and decided that the audion when used as an oscillator infringed the patent, Fleming being entitled to cover all uses of his invention whether appreciated or not, especially when it is a reversible use.

In the Federal courts of Delaware and California, however, on motions for preliminary injunctions, the courts, while granting injunctions on the Fleming patent against the manufacture and sale of tubes as detectors, refused to grant such injunctions in so far as the tubes are made and sold as oscillators or amplifiers. In other words, the courts refused to decide the question definitely before all the facts were before them at final hearing or trial, a preliminary injunction being issued only in clear cases.

Appeals have been taken by the Radio Corporation from these interlocutory decrees. It will be some time before these courts will definitely decide the points in issue, if at all, since the Fleming patent has now expired. After all the facts are presented, the courts may decide that Fleming covered the audion as an oscillator or an amplifier or both, or may decide in favor of the defendants. In each case an appeal can be taken. All we can say at this time is that the Fleming patent covered the audion when used as a detector but, as no appellate court has passed on the other questions, we do not definitely know if the patent covered the audion when used as an oscillator or amplifier in radio.

Of course the two De Forest patents also cover the improved tube circuits such as Armstrong's. No one can use the Armstrong circuit without a license and, even if licensed under the Armstrong patent, the regenerative circuit cannot be used unless licensed tubes are used (a license being implied from the purchase of a tube from an authorized seller.)

The rights in the two De Forest patents are owned by the American Telephone and Telegraph Company, which may license others to make, use and sell the tubes and by the De Forest Company, which has limited and re-

stricted rights to make, use, and sell them. The Radio Corporation of America, prior to the expiration of the Fleming patent, was the sole licensed distributor of radio tubes under the Fleming and De Forest patents, such tubes being manufactured by the General Electric Company and the Westinghouse Company. The De Forest Company can now manufacture tubes under its patents, being no longer under injunction by reason of the basic or dominating Fleming Patent.

The American Telephone and Telegraph Company recently sued the Radio Audion Company and the De Forest Company for infringement of the De Forest patents in the District of Delaware, in which suit the validity of the De Forest patents was conceded. The defense was a certain "immunity contract" given the Radio Audion Company by the De Forest Company, the latter agreeing not to sue the former for infringement. On a motion for preliminary injunction, the court decided that



the De Forest Company could not grant such immunity to the Radio Audion Company, which in effect was a license (the De Forest Company having no right to grant licenses) and held the Radio Audion Company to be an infringer. It seems that an appeal has been taken by the defendants, a bond being given in place of the injunction, pending appeal. The De Forest Company was held to be a "contributory infringer" merely. If this decision is affirmed, as it probably will be, the Radio Corporation and the De Forest Company will be the only authorized sellers of tubes for amateur purposes.

We will now continue the story of the audion and tell what Armstrong did. Between 1908, when the De Forest grid patent issued, and 1912, very little was accomplished, so far as the court records show, in improving the audion and in understanding or studying its properties. It was little used commercially. About 1912, a young student by the name of Armstrong was making himself a nuisance to the professors at Columbia University because he was using the laboratory to determine data and constants of inductive and reactive devices. Professor Arendt told Professor Mason to "get Armstrong and his stuff out of the laboratory." In fact, because of his interest in radio, Armstrong came near "flunking"—as it is called among the flunkable.

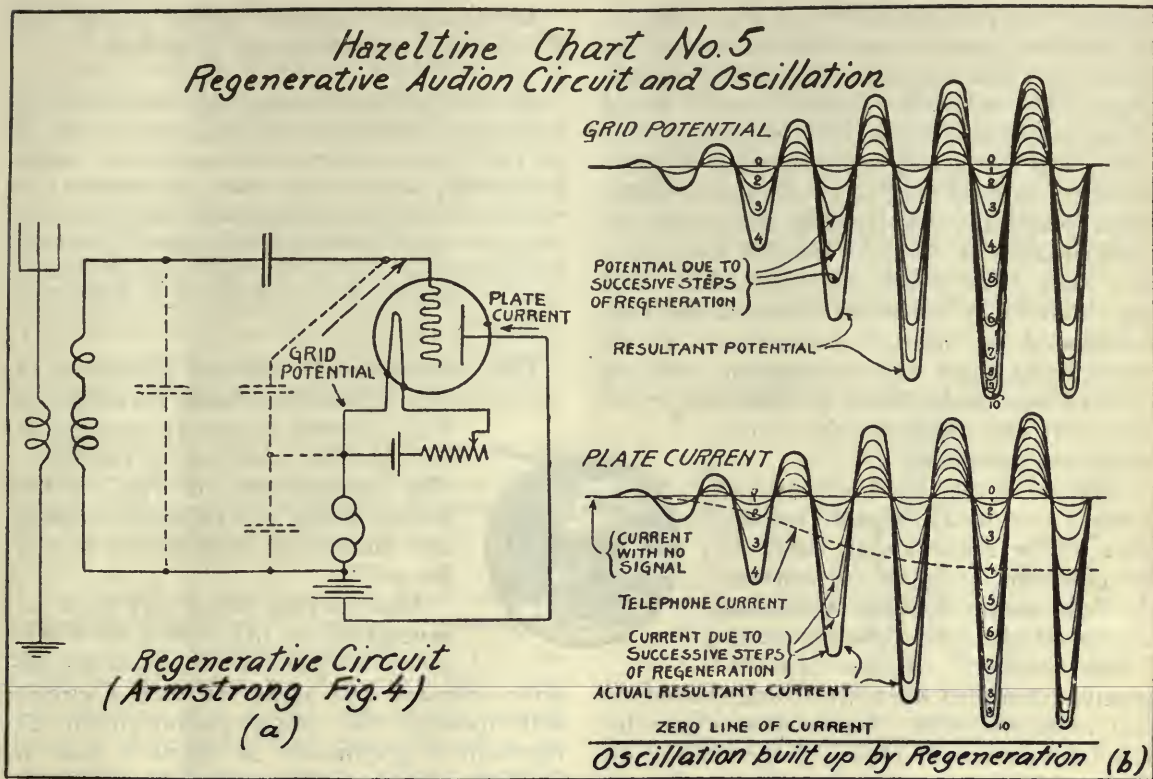

FIG. 2

Here, with the relocation of the telephones in the common portion of the input and output circuits, we have the "feed-back" circuit and regeneration. Compare with Fig. 1

This work of Armstrong at Columbia and at his home culminated in the invention of the now well-known regenerative or feed-back circuit, an instrumentality on which he was granted patent No. 1,113,149, which has been held to be valid and infringed, and to cover the regenerative circuit whether used as an amplifier or as a generator of oscillations and amplifier, either in receiving or transmitting. I have been informed that Armstrong has received for this patent and his recent patent covering super-regeneration, sums amounting to a million dollars.

The Armstrong Patent came before the court in the Southern District of New York in the case of Armstrong and Westinghouse Company vs. The De Forest Company. What the Armstrong invention is and what it is not was ably presented to the court by Prof. L. A. Hazeltine of Stevens Institute by means of two charts (Figs. 1 and 2). In chart 4 (Fig. 1) is shown a wiring diagram which was old or was in use before Armstrong's invention. In fact it is the circuit of the De Forest grid patent

which I described in RADIO BROADCAST for January. In chart 5 (Fig. 2) is shown an Armstrong circuit (Fig. 4 of his patent). It will be noticed, comparing the two circuits, that each comprises an input circuit including the grid and filament and an output circuit including the plate and filament. What is the essential difference in the two circuits? The difference is so slight that it may not be foolish to point it out: the relocation of the telephones in the common portion of the input and output circuits. But it was this slight change in the arrangement that made all the difference in the world. For, as the court found, we have here the feed-back circuit and regeneration.

Armstrong made a deep study of the audion and read everything which had been written on the subject. The invention was one, however, requiring experimentation—trying this and that—until the right arrangement was obtained and understood. In his investigations Armstrong made two important scientific observations, first, that the audion had an inherent capacity, acting like a condenser, and

secondly, that the radio-frequency oscillations, to an extent, were carried over into the output circuit and superimposed on the direct current produced by the battery in that circuit. As far as the record of the case definitely shows, Armstrong was the first so to crystallize or appreciate these ideas or facts as to attempt to utilize them practically by tangible means, an instrumentality, a circuit. Whether Armstrong first made these observations and then made the invention, or made the invention and then formulated the theory is immaterial. As the court found, there was an invention, while the observations made served to make the invention clear and understandable from a scientific standpoint.

Professor Pupin, the Columbia University electrical wizard, testified that all he knew about tubes he learned from his "pupil" Armstrong. At that time he thought the tube had no capacity, because of the conductive "space charges" therein. He was greatly astonished when Armstrong showed the fact to be otherwise. An inventor or patentee is not bound by any theory of operation of his device. It is enough if the device will work and can be intelligently adjusted to work. Armstrong's theory of operation of the audion and of regeneration is now generally accepted, however, as being correct (that is, of being consistent with all the facts as now known).

How Armstrong utilized the inherent capacity of the audion as a coupling to feed back the high-frequency oscillations in the output circuit to the input current, to reinforce the oscillations therein, is shown in Fig. 3 (which happens to be Fig. 3 of his patent). Comparing this figure with Fig. 1 (chart 4), the essential difference resides in the tuning inductance coil L' . The output or plate circuit is tuned to the frequency of the incoming oscillations. The circuit is otherwise the same except for the condenser C_4 shunting the battery to provide a free path for the electrical oscillations. The telephones in Fig. 3 are not located in the common path but may be, if so desired, to increase the coupling between the output and input circuits. The capacity coupling between the output and input circuit is very critical, as it was shown at the trial by an actual demonstration how, by merely moving the hand, the circuit could be put into and out of the "hissing" state, the oscillating state.

The invention covered by the patent was described by Prof. Hazeltine as follows:

The provision of an arrangement for transferring oscillating current energy from the plate circuit to the grid circuit whereby oscillations present in the grid circuit are assisted. Any arrangement by which oscillating current energy is transferred from the output or plate circuit of the audion to the input or grid circuit to sustain the oscillations in the grid circuit is included in the principle of the Armstrong invention.

The "arrangement" referred to, shown in chart 5, is the telephones, including the telephone leads, forming a capacity coupling, as indicated in broken lines in the figure. The "arrangement" of Fig. 3 is the audion acting as a capacity coupling and functioning as such by reason of the coil L' .

After having found out what regeneration is (if it be sufficiently clear) we can now compare the results obtained and action of such a circuit with those of the simple audion circuit, as represented graphically in charts 5 and 4. In chart 4, at the right (marked b), the upper curve represents the variations in grid potential and the lower curve the corresponding variations in plate current. These variations are caused by the incoming signal and are weak, and the dip in the average plate current is likewise weak.

In chart 5 (above b) we find curves marked 1 identical with the curves on chart 4, representing the grid potential and plate current for the first half cycle. During the next half cycle energy is transferred to the grid circuit by the feed back due to the variation of the plate current. This low plate current causes a building up of potential in the plate circuit, which is transferred to the grid circuit, reinforcing the low oscillation to give a greater oscillation 2, 3, 4, etc., that is, a higher variation in the grid potential, which in turn causes a higher variation of the plate current 2-3-4, the effect being cumulative, the variation being built up by increments applied successively, but even then substantially instantaneously.

The curves shown in chart 4 and 5 do not represent the magnitude of the energy in the circuits, but only grid potential and plate current, the energy varying as the square of the plate potential or of the plate current. For example, if the plate current in chart 5 has



a variation twenty times as great as the current variation of chart 4, then the energy in the oscillation which determines the intensity of the signal will be 400 times as great in the chart 5, which could not be illustrated for lack of space.

Another characteristic of the Armstrong circuit is that the potential of the plate varies inversely as the potential on the grid. That is, when the potential of the grid decreases the potential on the plate increases and vice versa. This is not true of the circuit of chart 4. Hence in the Armstrong circuit, as the plate potential increases, energy will be forced into the grid circuit.

While it was clearly proved what the regenerative circuit is and how it operated, yet at the trial the question arose as to whether or not Armstrong was the first inventor of the circuit.

And another question arose as to whether or not the patent in suit covered a regenerative circuit in an oscillating condition. The defendants attempted to show that De Forest was the inventor of the regenerative circuit prior to Armstrong, and especially of a regenerative oscillating circuit. Many sketches were introduced into evidence and much testimony was taken to prove this point, but to no avail, especially since it was shown that De Forest filed some twenty applications between 1912 and 1915, none of which showed or disclosed regeneration, and it was not until 1915 that De Forest filed such an application, which was after Armstrong's filing date, Oct. 29, 1913, and after Armstrong's publication in the *Electrical World*, December 12, 1914. This publication is now accepted as the last word on the subject and should be read by those sufficiently interested.

On March 16, 1914, a German by the name of Meissner filed in the United States patent office an application disclosing the regenerative circuit. The oath recited a German application filed April 9, 1913, which, under treaty arrangements, was the effective date of filing of the United States application. In other words, Meissner had a filing date over six months prior to Armstrong.

Under the patent laws of the United States, a patentee may show that he made the invention prior to his filing date. This Armstrong did, by introducing in evidence sketches, apparatus and testimony showing what the device was and when used or invented. Armstrong

testified that he had constructed and used apparatus embodying the invention in the fall of 1912, which apparatus was before the court at the trial. During the winter of 1912-13, he demonstrated the invention to several, but did not disclose the construction and arrangements of circuits. But these witnesses observed that the apparatus when adjusted gradually produced increased signal until a point was reached when the apparatus started to "hiss," a characteristic of the regenerative circuit.

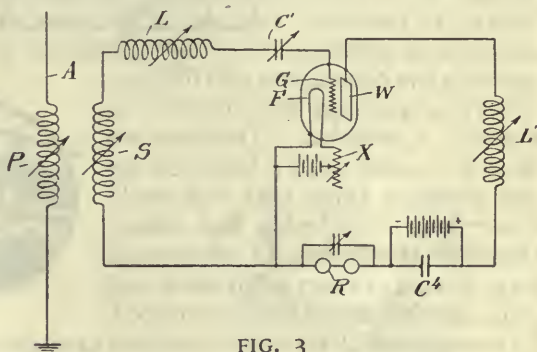

FIG. 3

The essential difference between this and Fig. 2 is in the tuning inductance coil, L'

It was not, however, until January 31, 1913, that Armstrong made a disclosure of the circuit arrangement to anyone. On that date he took a sketch of the apparatus and had it witnessed before a notary. His squadmate, Burgi, went with him and saw the sketch, but in testifying was not decided as to whether he understood the circuit or not. This sketch is identical with Fig. 2 of the patent (Fig. 4). However, it was not plain sailing for Armstrong at the trial, for not only had the notary died meanwhile but it was shown that the notary's recorded signature did not agree with the signature on the sketch. Testimony had to be taken to show that the signature was genuine and that the notary sometimes signed his name differently. In view of all the facts, the court decided that January 31, 1913, was the date of Armstrong's invention, thus beating Meissner by two and a half months.

It was a close call for Armstrong, not because he disclosed his invention to others, but because he didn't do it as fully and timely as he should have done. Although he was successful, he was successful only after going to a lot of trouble and expense to prove his point of early invention.

It is a misconception that a large number of inventors have, that they should keep their in-

ventions secret, at least until the application has been filed. How do they expect to prove priority of invention, either in a patent office interference or in a suit without witnesses, without something tangible such as a sketch or apparatus which can be authenticated by others? When an invention is conceived, make a sketch of it and have it signed and dated by several witnesses. Be sure that they understand the invention. But a mere sketch is not an invention. The sketch must be reduced to practice, as it is called; the invention must be reduced to practice. One way of reducing an invention to practice is to make the device or assemble the circuit, and also to make it work or perform the function for which it is intended. This does not mean a "model" but a full-sized actual practical thing that will work. Then have Bill Smith and Henry Jones see the thing and understand what it is. Let them see it work and point out to them the results obtained.

To strengthen still further the chain of evidence, sit down and write out everything that was done at the demonstration and make a sketch of what was seen and have everyone sign and date it. Now an invention has been made which can be proved, and if the invention as made checks up with the original sketch, the "date" of the invention is the date of the original sketch; provided diligence is exercised in the reduction to practice, the application can then be filed at leisure, but preferably as soon as possible.

In some cases, owing to a lack of capital, the inventor is unable to reduce his invention to practice. In such cases the application should be filed as soon as possible, the filing of the application being considered a "constructive reduction to practice." But a constructive reduction to practice is rather sketchy under a recent decision, in which it was held that the filing of an application cannot be considered a constructive reduction to practice where the invention shown and described in the application cannot, in fact, be constructed to make a practical operative device. So it is better to actually try the thing out before filing an application, so that the details of the invention can be covered and one can feel assured that what is shown and described in the application is operative.

In an interference proceeding in the patent office, the question of who was the first inventor among several applicants, or between an ap-

plicant and patentee, is decided. Testimony is taken just as in a law suit. The application of the Armstrong patent in suit, for instance, was in interference in the patent office with an application of Langmuir of the General Electric Company, in which interference Armstrong won out.

There is pending in the patent office at the present time an interference between pending applications of Armstrong, De Forest, Meissner and Langmuir involving the question as to who is the first inventor of the regenerative oscillating circuit, Armstrong having filed an application which he considers an improvement over the invention of the patent in suit, which covers regeneration or the feed-back circuit for all purposes. In this interference, priority of invention was awarded to Meissner by the examiner of interferences, on the ground that Armstrong had not proved a date of invention earlier than the filing date of Meissner in Ger-

many; the examiner taking the diametrically opposite view to the courts on substantially the same state of facts. The examiner believed that Armstrong lacked corroboration and that the sketch, as a sufficient disclosure of the date of invention, was not proven. It is understood that the examiners-in-chief have reversed the lower tribunal and awarded priority to Armstrong. It may be several years before a final decision is reached, as a defeated party can now appeal to the commissioner and from the commissioner to the Court of Appeals of the District of Columbia. In case the defeated party does not like the decision of the Court of Appeals, an action can be filed in any district court of the United States in which the commissioner is willing to appear to compel an issuance of a patent covering the invention in issue. Even though Armstrong may win out in the long run, it will be seen how important it is to fully disclose the invention as early as possible and to have available witnesses, drawings and apparatus to prove the invention and earliest date, especially in case of an interference and also in litigation. At least, large expense can be saved.

In summary, the Armstrong patent has been held valid in the second circuit and covers not only the feed-back circuit, when used as a receiver for amplifying, but also when used either as a receiver to produce beats by causing local oscillations, or as a transmitter to produce electrical oscillations.



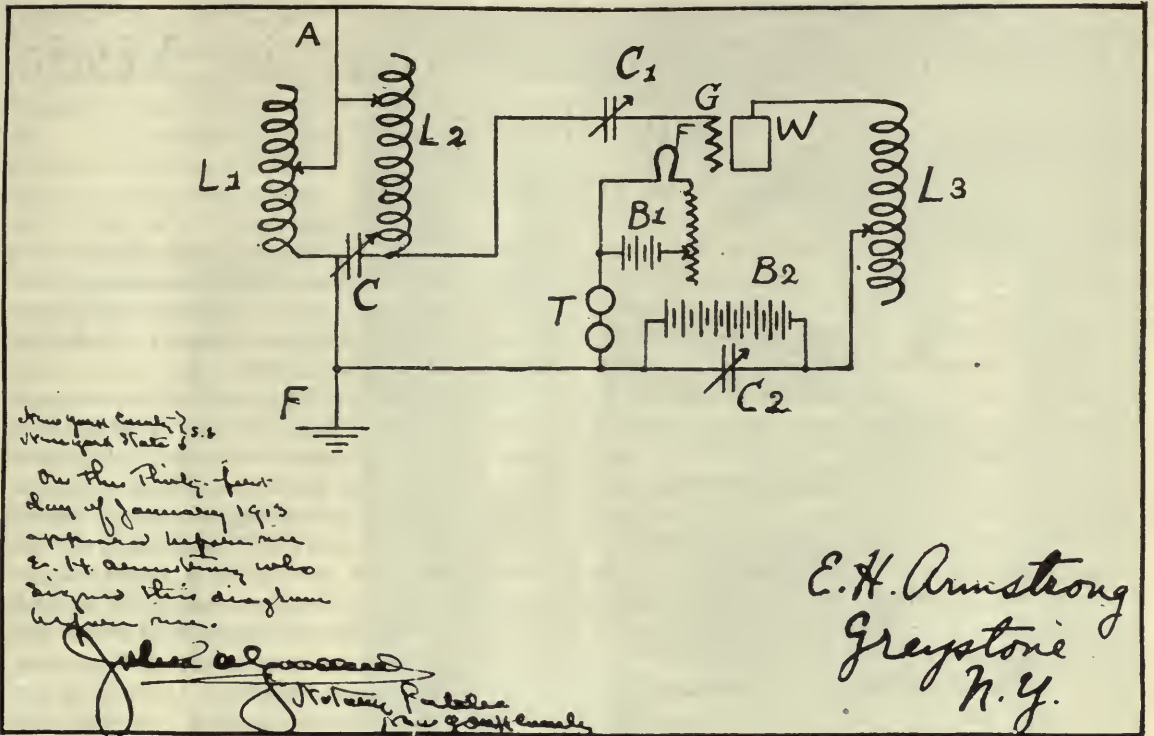

FIG. 4

The original drawing of the feed-back circuit which largely determined the court in Armstrong's favor

Whether Armstrong will secure a patent covering more specifically the feed-back as an oscillator depends on the outcome of the present interference. With the court decision to back him up he is in a very good position, I should say. While the court has been very liberal with Armstrong, and given the patent a very broad interpretation, yet it had no occasion to pass on all types of apparatus in which the feed-back may be or can be present, either deliberately or intentionally or accidentally or incidentally. In radio-frequency amplification, for instance, it has been found difficult by those who have no desire to infringe the Armstrong patent to prevent regeneration by reason of the inherent capacity of the tube, such regeneration being more detrimental to clear reception than advantageous.

Although Armstrong lays no claim to cover audio amplification by the cascade arrangement,

I understand he claims to cover certain arrangements of radio amplification, where it is necessary to have circuits tuned to the high frequencies, and especially when there are adjustments capable of varying the amount of regeneration.

It must be admitted that the endeavors of engineers to avoid patents have always resulted in important contributions to the development of the art, yet it is also an advantage to know where we stand and it is hoped (without wishing anyone any hard luck) that the courts can soon pass upon the scope of the Armstrong patent as applied to radio-frequency amplification.

While the Westinghouse Company is the owner of the Armstrong patent, fifteen or more other manufacturers are licensed under it and these as a rule advertise this fact and place a notice of the license on their sets. The patent expires in 1931.



How Synthetic Insulation is Made and Used

By D. J. O'CONNOR, E. E.

DURING the past six or seven years a new type of insulating material has been rapidly taking the place formerly occupied by hard rubber or vulcanized fibre in all types of devices. This is a material whose important element is a resin, produced by condensing phenol in the presence of formaldehyde and other chemicals. This synthetic resin has been produced by several different processes and has been marketed under a number of different names, but in spite of some slight variation in its characteristics it may be said to be approximately identical in its effect when used for radio purposes.

The names under which these resins produced from phenol have been marketed are Redmanol, Bakelite and Condensite. For insulating purposes, in radio or general electric work, each of them is used in two forms—moulded and as a laminated product with a fibre base. The laminated form is most im-

portant in radio work, being used generally for panels, winding tubes, socket insulation and so on. It is known to the radio manufacturer, dealer and amateur as Formica, Bakelite-Dilecto, Condensite Celoron, etc.

The remarkable progress which this material has made in competition with hard rubber and other forms of insulation is due to the fact that the synthetic resins give it the highest dielectric strength and permit it to be cut, drilled, milled and tapped very easily with tools that are ordinarily used with metal. It is preferable, as an insulator, to hard rubber and can be worked much more rapidly. It lacks brittleness and will rarely chip or crack. It will survive a heavy fall without breaking.

Fibre is a satisfactory insulator as long as it is kept perfectly dry. Phenol insulation differs from fibre in that it has a considerably higher puncture voltage, and more important still, it will not absorb water and thereby become a conductor instead of an insulator. It possesses

higher tensile strength and the ready working qualities of fibre. In other words, Formica and the other phenol insulating materials combine the high dielectric strength and waterproof qualities of hard rubber with the high tensile strength and good working qualities of fibre.

The phenol resin binder has other qualities that make it valuable. It is practically inert chemically. It is not affected by alkalis, is practically unaffected by acids, except sulphuric and one or two others, and is resistant to steam and to heat under 350 degrees or so.

While the synthetic phenol resins of which the various materials of this type are made, are substantially



HALF OF THIS HAS BEEN IN A PRESS

And is finished Formica. The other half shows the many layers of fibre which make this material very tough, although it is easily cut and drilled. The synthetic resins give it a high dielectric strength

identical, there is still noticeable a considerable variation in the behavior of the finished products from this base. The phenol varnish is composed of two chemical elements which react upon each other; and at various stages in this reaction the characteristics of the resin vary considerably. The behavior of the materials made from the resin is therefore determined by the exact stage in the reaction which has been reached when the material is used in making the laminated or moulded material. This is a question of accuracy in manufacture and is handled by the better makers in such a way that the resulting product is remarkably uniform both in its electrical and mechanical properties.

Then there is the greatest opportunity for divergence in the nature of the fibre base that is used for the panels or tubes. Each of the manufacturers usually makes several different grades of materials. Some products have very high percentages of resin to provide the greatest possible dielectric strength. Others, intended for mechanical uses, or for uses where electrical insulation is under considerable mechanical strain and wear, are made up of especially strong fibrous material with a smaller percentage of resin.

The commonest forms of fibre base are paper and cloth. Some of the makers have given a great deal of attention to developing exactly the right type of paper for their use. In radio panels and tubes this is commonly a high grade of cotton rag paper, although good wood pulp papers are used for some purposes. In other grades, the best quality of cotton duck may be used, or cotton fabric of finer thread than duck.

The fibrous material is carried in rolls on a treating machine. The sheet passes through a compartment filled with the resin which it absorbs, and it then passes through a drier.

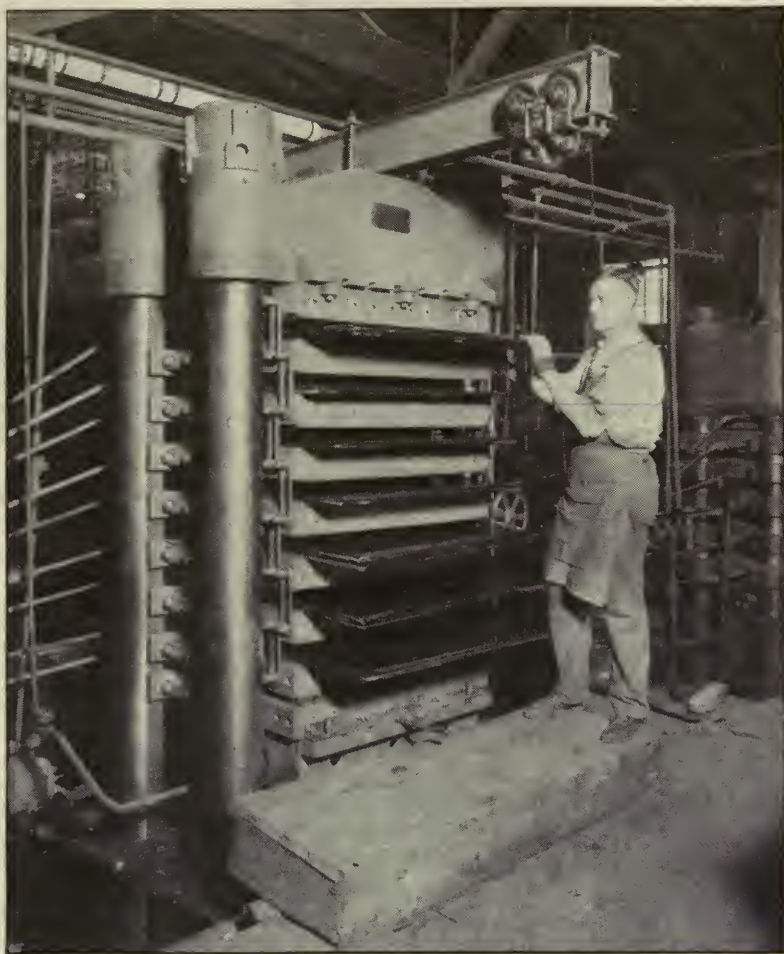

PRESSES IN WHICH LAMINATED INSULATION IS MADE

These sheets with the resin dried in them are then cut to the standard size and vulcanized under great heat and pressure into a solid sheet.

If tubes or rods are to be made, the impregnated fibre stock is wrapped on a mandrel, or simply rolled up tightly by special machinery. These round forms are then subjected to heat and pressure in the same way as the sheets. Some rods are also made by turning them out of sheet materials. The material takes a highly glossy finish, and it can be dyed different colors.

The moulded insulating parts made of Bakelite, Redmanol, or Condensite are similar in their electrical properties to the laminated material, but of course lack its high tensile strength, being more like hard rubber in a tendency to chip and crack, or break under a sharp blow, and do not machine as easily as the laminated material.

Simple Bulb Transmitters

PART V

By ZEH BOUCK

THE Colpitts system has been the fundamental circuit indicated in the radio-telephone and continuous-wave transmitters we have described as "power installations." The Colpitts circuit is probably the most efficient system when used with the average antenna, and seldom requires excessive experimentation to achieve success. However, in some cases, which are determined by certain inductive and capacitive antenna values, it is very critical and unstable in operation. If the experimenter, after following the instructions given for tuning and testing the set, is unable to secure at least three tenths of an ampere radiation on a single five-watt bulb, he is advised to alter the circuit to the British

aircraft system. This may be done by winding one additional coil, transferring the positive of the high potential to the upper side of the feedback condenser, and shifting the grid connection of the oscillating tube.

Figure 1 shows the fundamental British circuit, to which may be added any of the modulating systems previously described. For the sake of clarity in the drawing, an absorption loop has been indicated. The C and L values, excepting for the additional L₂, have been given in the December and January issues of RADIO BROADCAST. The auxiliary grid coil, L₂, is wound over the main antenna inductance, L₁, if the structure of the latter inductance permits it. In thus winding L₂, the inductances should be thoroughly insulated from each other by several layers of tape or empire cloth. If, however, L₁ is of the open winding or helix

type, the grid coil is best wound separately on a smaller tube, and placed inside of L₁, or otherwise in inductive relation to it. In either case, thirty turns of wire, tapped every other turn beginning at number ten, will suffice. As this is fundamentally a tickler circuit, it may be necessary to reverse the connections to L₂.

The final consideration in the category of low-power bulb transmitters, is apparatus which operates with alternating current on the plates. The power sets which have been heretofore described have been operated from a high-potential, direct-current source, supplied by some form of a motor-generator, or by rectifying stepped-up A. C. This last was accomplished by virtue of the unilateral (one way) conductivity of rectifying tubes and the chemi-

How to Get Your Transmitting Licenses

If you wish to transmit, you must have two licenses, one certifying you as an operator, the other for your station. You must be able to receive at least ten words a minute (five letters or characters to the word), and must comply with certain other requirements explained in the Government pamphlet: "Radio Communication Laws of the United States." It is advisable to obtain this pamphlet, as it gives a list of places where examinations are held and other information either necessary or helpful to the prospective operator. It may be had from the Superintendent of Documents, Government Printing Office, Washington, D. C. Price, 15 cents a copy.

cal rectifier, both processes being described in the February issue of RADIO BROADCAST.

Almost any circuit, such as the Colpitts or British aircraft, conventionally operated from a direct current plate supply, may be changed to a self-rectifying system, by merely substituting alternating current for the D. C. This of course alters the character of the emitted wave. The circuit now oscillates only one half the time (when the current is on that half on the alternation which charges the plate positively) with the result that the output is interrupted sixty times a second (assuming a sixty-cycle supply). Needless to say, it is impossible to smooth out this hundred per cent. modulating hum, and half-wave self-rectification can therefore not be used to transmit telephony.

The advantage of self-rectified C. W. sets is their economy, particularly with very high

power sets, for the only primary power consideration, the transformer, is comparatively cheap. Thus a $\frac{1}{4}$ -K W. I.C.W. (interrupted continuous wave) transmitter is an economical possibility where a similarly powerful radio telephone, with rectifier or motor-generator equipment, would be from three to ten times as expensive.

A simple but efficient half-wave self-rectified set is shown diagrammatically in Figure 2. This set can be constructed for less than eighteen dollars, and was actually built by the author for \$16.70! The apparatus has a reliable range of twenty-five miles, and under very favorable conditions it can cover many times that distance. The transmitter uses a five-watt tube (or larger) with filament potentials supplied from a single transformer built according to the general directions outlined in the two preceding articles. The transformer core is built up of 10" x 2" soft iron strips until it is two inches high. The primary is wound with 300 turns of No. 15 single cotton covered wire; the high-voltage secondary with 1700 turns of No. 27 double cotton covered; and the filament winding with 24 turns of No. 12 single cotton covered. It will be observed that none of the windings is "split," or tapped in the middle. The transformer is insulated throughout for 600 volts.

The antenna coil, L, is wound with 40 turns of any convenient insulated wire between No. 14 and No. 22, and is tapped every fourth turn. A 3- to 5-inch winding-form or tube may be used. C₁ is a fixed condenser of 3 to 8 plates of 1" x 3" tin-foil (two square inches active area) separated by mica. C₂, excepting that it uses only two or three plates, is similar to C₁. C₃ may be almost any capacity above .002 mfd., and is preferably the type of condenser shunted across sparkcoil vibrators.

R₁ is a 5000-ohm grid leak.

The following price list indicates the probable cost of the apparatus:

L	\$ 0.50
R ₁	1.10
R ₂	2.25
C ₁25
C ₂10
Transf.	3.50
Socket	1.00
Bulb	8.00
TOTAL	\$16.70

In the preliminary tuning, a radiation am-

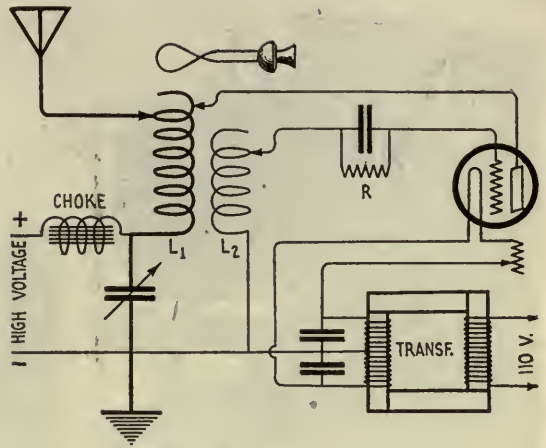

FIG. 1
The fundamental British circuit

meter should be included in the antenna circuit, and the lead from the condenser tapped to the eighth turn from the lower end of the inductance. The plate lead should be tapped to the upper end of the coil, and the antenna tap varied between the two.

A more desirable type of self-rectified set is that described theoretically last month as employing full-wave self-rectification—i.e., using two tubes, each operating on opposite halves of the cycle. Figure 3 shows a set of this type partially completed (mounted but unwired) which was designed and constructed by the operator of station 2ABP, New York City. The circuit is given in Figure 4.

The operation of the set is simple, and its self-rectifying action is evident at a glance. As the secondary current alternates, the positive and negative charges of terminals *a* and *b* undergo rapid reversals. When *a* is positive, the plate of tube *A* is supplied with the plus

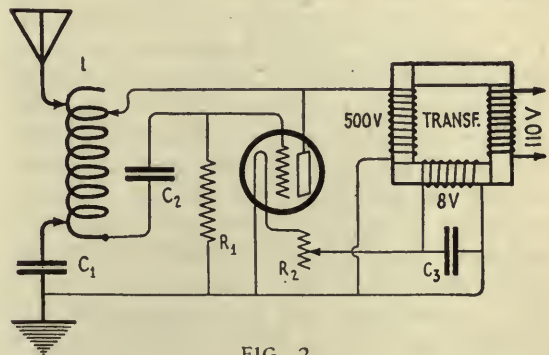

FIG. 2
Circuit of the half-wave self-rectified set which has been made for less than seventeen dollars and which has a reliable range of twenty-five miles

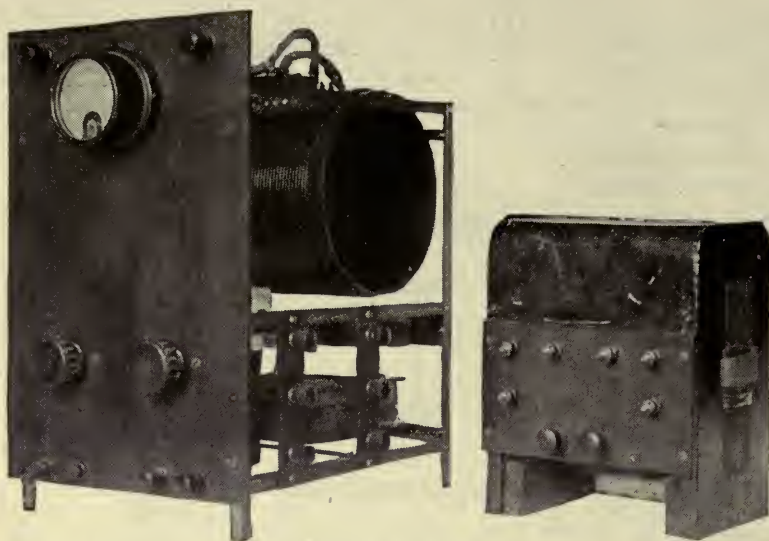

FIG. 3
Set employing full-wave self-rectification. The circuit is given in Fig. 4

potential essential to oscillations, while *B* draws no current and is quiescent. With the next half alternation the conditions are reversed, and the Plate of *B* is now positive. The centre tap is at all times negative in respect to the positive side of the high-voltage secondary.

Coil *L* is preferably of the copper ribbon design wherein the inductance is continuously variable. If the experimenter is unable to obtain a coil of this type, and the inductance is, instead, wound on a tube, it should be tapped at least every other turn. 40 to 60 turns of a 6-inch diameter are about right. *L*₂ and *L*₃ are radio-frequency choke-coils, which, though desirable, are not always essential, and may be *L*₂₀₀ honeycomb coils or their equivalent.

*C*₁, in a well balanced set, may be eliminated, and really lowers the over-all efficiency. However, it assists in tuning and compensates for the inadequate capacity of some antennas, having, on the whole, a stabilizing effect on the oscillations. If *C*₁ is used, it may be a receiving variable condenser immersed in oil. *C*₂ and *C*₃ are stopping condensers of approximately .002 mfd. each; but they are most conveniently built up in the form of a single condenser of .004 mfd. capacity with a centre tap. These condensers are conventionally of mica-foil construction, but the experimenter will probably find it more simple and economical to build it up with a glass plate non-conductor. Such a condenser may be made of six 8" by 10" photographic plates with 6" by 8" (active

area) sheets of tin or copper foil between them (Figure 5). *C*₄ and *C*₅ are by-pass condensers of the type already referred to as being shunted across spark-coil vibrators.

The transformer is identical with that described in the February RADIO BROADCAST for use with the experimental five-watt set.

Extensive experiments with this circuit have indicated that grid bias, either by condenser leak or "C" battery, is seldom necessary. However, when operation appears to require it, a grid condenser, shunted by a variable leak (5,000 to 20,000 ohms), may be

inserted in series with the grid lead.

As one of the two bulbs is always oscillating, excepting perhaps for the fraction of a second when the alternation is at zero, the output of this two-tube set is much more continuous than that of half-wave self-rectified circuits. By the inclusion of a large choke-coil (such as described as a filter reactance in the previous article) at *X*, the oscillations of the two bulbs may be made to overlap, thus further smoothing out the wave. Using an extremely large choke, or a multiplicity of smaller ones, this circuit has been successfully employed for telephony.

CONSTRUCTION

THE set is built up on an 8-inch by 15-inch panel, with a skeleton superstructure of angle brass forming the sides and back of a "box" twelve inches deep. These details are clearly shown in the photograph. Brass braces, conveniently placed, support the condenser, radio-frequency chokes, sockets and inductance. If the variable condenser is eliminated, the front of the panel is pleasingly simple, displaying only the rheostat control knobs and the radiation milli-ammeter.

Mr. Plumb (2ABP) has mounted the transformer in a very neat and original manner. Deviating slightly from transformer construction, as previously detailed by the writer, the two pies of the filament secondary have been wound on opposite legs of the transformer, the connection between the two being brought out

(current squared times resistance). Hence, if the amperage or current is always kept constant (by gradually turning up the rheostats to overcome the increased resistance), the filament will be constantly burned at a temperature increasingly higher than normal, with a resulting rapid disintegration. On the other hand, if the voltage is kept constant, this will obviously not be the case.

For quiet and convenience, and to avoid possible induction, the motor-generator, filter and transformers should be located apart from the operating table—preferably in a closet, the generator slung from springs or resting on rubber cushions. The leads from the filament transformer must be of a very low resistance, necessitating No. 10 or even larger wire, to prevent an excessive fall in the voltage—a drop equal to IR , the current times resistance.

To transmit legally, it is necessary to secure

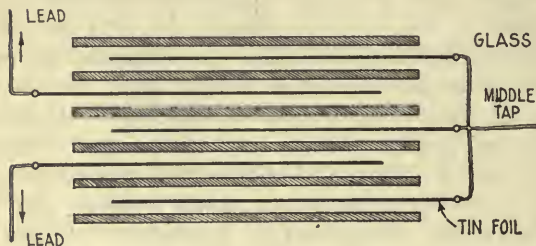

FIG. 5

Showing the construction of the stopping condensers (C_2 and C_3 in Fig. 4.) The glass plates are 8" x 10" and the sheets of tin or copper foil are 6" x 8"

two government licenses, a station license with the call letter assignment, and an operator's license qualifying the individual as a person capable of handling a station. Both licenses are generally issued simultaneously, following a successful examination for the operator's ticket. The applicant must receive and transmit ten words a minute, which, discounting nervousness and the sometimes erratic character of the copy, requires a general ability in excess of twelve words a minute. In preparation for the written examination, the student is advised to familiarize himself thoroughly with the following considerations:

How to tune his prospective station to two hundred meters; this question covering the theory and use of a wavemeter.

The more important stipulations of the

International Radio Telegraphic Convention of 1912, such as regulations concerning SOS signals, superfluous signals, interference, wavelengths, decrement, etc.

The International abbreviations ("Q" signals). The prospective operator should memorize and use whenever possible, QRT, QRX, QSA, QTA, QRS, QSZ, QRA and QSC. (See RADIO BROADCAST for May, 1922).

The theory of his contemplated transmitting and receiving set.

All inquiries regarding licenses should be addressed to the Radio Inspector in care of the nearest customs house.

However, the problem of transmitting is by no means solved by the Government's permission to send. The amateur fraternity, the backbone of citizen radio, has its own requirements and stipulations, which are far more exacting than those set forth by the Government. With the increase of transmitting stations, the air is rapidly acquiring more definite limits, and the amateurs are becoming less tolerant of those inexperienced ones who do not live up to their traditions.

The beginner should under no condition transmit until he is master of sending and receiving twenty words a minute! A clumsy, faltering, twelve-words-a-minute fist, or the long drawn out, inconsiderate telephonic speech of an operator whose few months in the game are perfectly mirrored in his poor code ability, will surely gain for the operator the permanent antagonism of the air.

The experimenter who can copy twenty words a minute generally has a solid year of experience behind him—experience that has taught him the desirability of two hundred meters, the methods of securing a sharp wave that will interfere with neither broadcast nor amateur listeners, the value of snappy concise operating, and the courtesy of the air.

The experimenter should join a progressive radio club, and become a member of some national amateur organization such as The American Radio Relay League. He should associate with amateurs, learn their language, their thoughts, their own abbreviations (which run into the hundreds)—in other words, becoming a psychological amateur before he is one in ability!

Best of luck, O M, and 73!

W J Y. Shenectoday

General store

sir

New York

states

i am gide for hunter man wat
come at dis place lac-des ilse for
hunting deer dese hunter man bring
it wit him machine for heer you
spik from far place i lissen wit
him sunday nite also tuesday nite
i heer song bout my ole modder
dats long tam i dont see my modder
an i ting dats dame fine song
also i heer oder song i dont no
de nam tuesday nite store for
de small boy an l girl bout mak
de star shine for dem if dey is good
boy and girl hunter man luff lak
hell an tole me ax you how we
make some moon shine
i heer you spik jus de same lak
your at me place i ting you have
good machine i lissen more
nex wick

tank you and much ablig

Gide Canille Poirier
Chemin P.O. Quebec Canada

A VOICE FROM THE WILDERNESS

This letter, purporting to be the original expression of a Canadian guide, was received by WGY, the General Electric Company's broadcasting station in Schenectady, N. Y.

Putting Through the White Bill

There Should be Little Delay in Reporting It Out of
Committee for Passage by the House of Representatives

BY JOHN V. L. HOGAN

Consulting Engineer, New York; Fellow and Past President, Institute of Radio Engineers;
Member, Institute of Electrical Engineers

THE new year of 1923 dawned auspiciously for radio. On January 2nd, the day before Congress reconvened after the holidays, the House of Representatives committee on the Merchant Marine and Fisheries opened hearings on the White bill. Notice that the public meeting was to be held had gone out only a few days before, but there were on hand representatives from the Telephone Company, the Radio Corporation, the American Railway Association, the American Radio Relay League, the Wireless Association of Pennsylvania, the National Radio Chamber of Commerce, and the government departments of War, Navy, Commerce, Agriculture, and the Post Office, in addition to a few others.

As you will doubtless recall, the White bill is directed toward amending the existing radio laws, and particularly the Act of August 13, 1912, to improve the governmental regulation of radio communication. As the law now stands, the Department of Commerce has little authority of a character that will permit control of such complicated interference situations as have arisen in ship-and-shore radio telegraphy and broadcast radio telephony. Secretary Hoover called a conference in Washington, last February, to study this matter of interference and to recommend steps for improving the conditions then existing. A report of this conference recommending amendment of the radio laws "to give to the Secretary of Commerce adequate legal authority for the effective control of the establishment of all radio transmitting stations except amateur, experimental and Government stations, and of the operation of non-governmental radio transmitting stations," was issued in March, 1922. Representative Wallace H. White, Jr., of Maine, prepared, and on June 8th, introduced into the House of Representatives, a bill resulting from the work of the Legal Committee of this Department of Commerce Conference on Interference. The bill was referred to the Merchant

Marine and Fisheries Committee, and has been lying in its hands pending disposal of the legislation on shipping.

Meantime, the broadcasting interference became worse and worse; new stations added to the babel, and with the coming of "long-distance weather" last fall, the need for fewer and better broadcasters grew evident to everyone. Even those radio users who had heard nothing of the proposed legislation said "the Department ought to do something about it"; the radio magazines began to ask what had happened to the White bill; and people commenced to write to their congressmen. As a result of all this, the projected law reached the public-hearing stage early in January and will probably have been passed by the House of Representatives (if not by the Senate also) by the time this report is published.

Secretary Hoover addressed the Congressional Committee on the afternoon of January 2nd, and in an interesting talk pointed out that the radio art was largely stifled by congestion of traffic on the comparatively few wavelengths available. As of December 27th, 1922, there were 21,065 licensed transmitting stations in the United States, of which the 16,898 amateur stations constituted by far the largest group. The next largest classification was that of ship stations, numbering 2,762; following that came the 569 broadcasting plants, only 25 of which were of the high grade type authorized to transmit on the 400-meter wavelength. There are, Mr. Hoover said, from one and one-half to two and one-half million radio receiving stations in use, and, necessarily, public interest in radio is profound. Nevertheless, the matter of interference (particularly in radio telephone broadcasting) threatens to undermine the useful purpose of the whole art.

The Secretary then explained that this bill had been drawn up by Mr. White to allow regulation of the causes of interference in so far as they could be reached by legislation, and that it was based upon the conclusions of the con-

ferences held last winter. One useful result of its passage would be the opening for commercial use of the formerly reserved military wavelength band of 600 to 1600 meters, and consequent relief of the crowding between 300 and 600 meters which causes so much of to-day's interference. Further, the Department of Commerce feels keenly its lack of authority in endeavoring, by means of the present laws, to reduce interference; thousands of interference complaints are received each month, and further regulation is desired by those working in the art. Mr. Hoover believed that the White bill had general approval.

The hearings lasted until late Wednesday morning, January 3rd. Every witness who appeared before the Committee endorsed the general provisions and the scope of the bill, though a number of amendments were offered to modify its applications in some details.

Rather than to abstract the suggestions of each of the interests represented, it will probably be more convenient to take up the topics that came under discussion.

The very first section of the bill states that the use or operation of "any apparatus for radio communication by telegraphy or telephony" or for the "transmission of radiograms or signals by telegraphy or telephony" shall require a Department of Commerce license. The American Telephone and Telegraph Company proposed that these clauses be made to indicate clearly that they referred to radio telegraphy and radio telephony, and this seemed to meet the views of the committee. Nevertheless, the possibility of radio interference arising from radio control or picture-transmitting systems, and from "wired wireless" or carrier current signaling over wires, was discussed at some length and it is probable that in redrafting the bill for reporting to the House of Representatives, the definitions will be broadened to give the Secretary of Commerce some control over certain of these other interference producers.

In the second paragraph of Section 1, the Secretary of Commerce is called upon to "make . . . regulations applicable to all licensed stations . . . concerning . . . the kinds of instruments or apparatus in any station with respect to the external effects produced thereby." This provision brought up the question of regulating interference produced

by oscillating regenerative receivers, a matter that had much attention from the earlier conference. Mr. White stated that the present bill was not intended to give the Department of Commerce power to regulate interference-producing receivers, although it was perhaps possible to define them as transmitters. Such definition would, it appeared, require them to be licensed and would subject them to complete regulation. Mr. White said further that the conference of February had thought the problem of controlling these receivers to be so great

that it had better not be taken up; enforcement of a law against their use might be even more difficult than enforcement of the Volstead act. Nevertheless, those present at the hearings seemed to feel that some authority should be given to the Secretary of Commerce that would permit him to minimize this "sending receiver" type of interference

if the art's progress did not automatically take care of the situation within a reasonable time. It was brought out that by using the new Donle "intensifier" tube or the regenerator with a non-oscillating radio-frequency repeater in the aerial circuit, the possibility of such interference was eliminated and yet nothing in sensitiveness was sacrificed.

THE NAVY'S "COMMERCIAL" STATUS

THE next point that came up for criticism was the proposal to have the Department of Commerce regulate (as to wavelength, decrement, etc.) such governmental stations as might handle commercial radio traffic. The Navy Department, represented by Admiral Ziegemeier, indicated that much trouble might come of this double supervision, particularly as practically all Naval stations had to send occasional messages that might be considered "commercial" and therefore would require licenses from the Department of Commerce as well as licensed operators. Secretary Hoover, in replying, said he considered the question more hypothetical than real. He divided the Navy stations' commercial work into the two classes of incidental and, so to speak, cultivated communication; the occasional transmissions could easily be covered by a blanket authority, but he felt that regular transmission of commercial messages must be subject to the same regulation that governs the civilian organizations if an orderly system is to be created.



Before the hearings closed Mr. Hoover and the Secretary of the Navy had conferred on the matter, and Admiral Ziegemeier reported that there seemed nothing to prevent an agreement between the Departments in regard to regulation.

LICENSES AND MONOPOLIES

SECTION 2C of the Bill authorizes the Secretary of Commerce to grant a license "only to a station which is in the interest of the general public service." With the thought that the last three words might be taken with too narrow a meaning, the Telephone company suggested omission of the word "service." This alteration was generally agreed to by those present. The "monopoly clause" in this same section, 2C, which authorizes the Secretary to refuse licenses to any party "monopolizing or seeking to monopolize radio communication, directly or indirectly, through the control of the manufacture or sale of radio apparatus, or by any other means" came in for very little criticism. It was suggested that the wording be limited to "unlawful" monopolies, though Mr. Hoover said he thought no Secretary of Commerce would attempt to set up his own standards as to what constituted a monopoly. Mr. White felt the entire clause might well be omitted, and no one at the hearing seemed disposed to disagree with him.

In section 2F the Secretary of Commerce is given authority to revoke any station license for violation of regulations, etc., and no appeal is provided for. The Telephone company proposed that any order of revocation should state the cause, and that an appeal from such order might be made to the District Court. This amendment was not criticized.

THE ADVISORY COMMITTEE

SECTION 5 of the bill establishes an advisory committee of twelve, comprising a representative from each of the six government departments of War, Navy, State, Agriculture, Commerce, and the Post Office, together with "six members of recognized attainment in radio communication not otherwise employed in the government service." Proponents of the bill expect this committee, which is to consider administration of and changes in the laws and regulations on radio and to correlate the regulations with scientific problems and progress in their solution, to be of great service

to the art in general. Much interest was shown in an amendment proposed by Mr. Maxim, on behalf of the American Radio Relay League, to the effect that none of the six non-governmental members should be "affiliated directly or indirectly in the manufacture, sale, transmission or operation of radio telegraphy or radio telephony for financial profit." Such an amendment would exclude all but amateurs from the non-governmental half of the committee. On this point, Mr. Hoover said that if the wording were made too broad it would make ineligible the technical professions and engineers, and pointed out that present laws prohibit persons "at interest" from accepting government employ. He said he would not like to see the bill embody restrictions that would preclude recognized men of public spirit from appointment on the advisory committee, and this seemed also to be the view of the Congressmen and other witnesses at the hearing.

A number of other amendments were offered on various details, but most of them restated matters already included, either in the bill or in authorizations to the Secretary of Commerce. The proposals of the Radio Corporation of America were contained in a letter which was not read, and consequently are not commented upon in this report. There was no direct opposition to the bill as a whole, however, and there should be little delay in reporting it out of committee for passage by the House of Representatives. It is understood that Mr. White has undertaken to prepare a re-draft embodying such of the proposed amendments as seem to the Committee important enough for inclusion.

Those who attended the hearings were strongly impressed by the interest shown by the Congressmen present. Chairman Greene, Mr. Chindblom, Mr. Davis, Mr. Bankhead, Mr. Bland, and Mr. Hardy all were active in the examination of the witnesses who appeared; it was evident that the Committee intended to give the bill a thorough inspection and revision in the light of the suggestions made at the two-day session. There is no doubt in the minds of those who addressed the Merchant Marine and Fisheries Committee that the bill is in good hands and that, upon its passage, the new powers delegated to Secretary Hoover will result in his clearing the radio art of many of its current difficulties.

Telephoning to England

By R. W. KING

American Telephone & Telegraph Company

THIS is Mr. Thayer of the American Telephone and Telegraph Company speaking from 195 Broadway, New York City through the Rocky Point Station of the Radio Corporation of America."

Ushered in by these words, radio telephone messages were sent from this side of the Atlantic for nearly two hours on Sunday evening, January 14th, and were successfully received at New Southgate, London. Those who listened at New Southgate not only understood every thing that was said by the speakers, but could even recognize the voices of their friends. For the first time in the world's history the two greatest English-speaking countries were joined by the intimate bonds of speech across 3400 miles of water.

This is not the first time that the human voice has been heard across the ocean. In 1915, the telephone engineers sent out messages from Arlington, Virginia. Single words and sometimes sentences were received by other engineers who were listening, some in Paris and some in Honolulu. The present demonstration, however, marks a great advance over that of 1915. Since that time great improvements have been made in the two arts of radio and of telephony. The radio apparatus and system used in this latest test have been made possible by cooperation between the American Telephone and Telegraph Company and the Radio Corporation of America.

The story of preparations for the present transatlantic test is replete with dramatic incidents. On December 1, 1922, J. J. Carty, Vice-President of the American Telephone and Telegraph Company, sent a message to Frank Gill, European Chief Engineer of the Western Electric Company, as fol-

lows: "Planning to send to England engineer with radio receiving set associated with electrical measuring apparatus for determining field strength of received telephone currents transmitted from America." There is little in this matter-of-fact message to stir the imagination or to suggest the brilliant success that was attained just 45 days later. About midnight of the 45th day, after the close of the tests, Carty sent another message to Gill, reading as follows: "Nothing that we could say here could express our complete satisfaction at the results. It does indeed mark an epoch in the history of the telephone and in the history of your country and mine. Tonight, for the first time, they have been joined by the bonds of our common language. Good-night."

Of the many developments since 1915 which have contributed to the demonstration of January 14th, the two most important are a new high-power water-cooled vacuum tube and a new type of radio transmitting system of which the electric wave-filter is an essential part. These water-cooled tubes are used as amplifiers to deliver the 100 K. W. of modulated high-frequency energy to the antenna and also

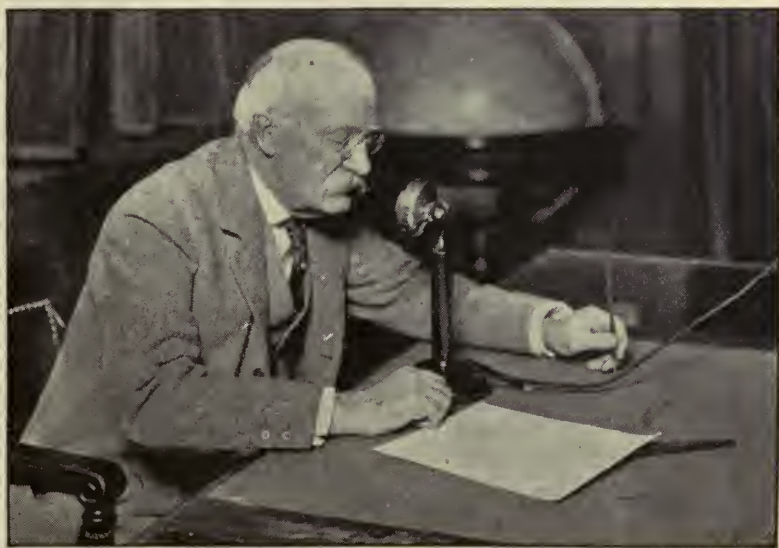

MR. H. B. THAYER TALKING TO LONDON FROM NEW YORK

as rectifiers to produce the high-voltage direct current required to operate the amplifiers.

The series of experiments, of which the tests of January 14th are but a part, will be continued until all the information necessary to the designing of a practical transoceanic telephone system is available. This information pertains largely to the transmission characteristics of the ether which apparently undergoes wide variation from hour to hour, from day to day, and from season to season. It is for this reason that we can not yet speak of telephone service, as we ordinarily understand that term, across the Atlantic. However, the

present experiments are of great significance. In the words of General Carty:

"The experiments which we are now making represent some of the advances which have been made in the first half century of the telephone art, which is now drawing to a close. They belong to the golden age of communication which has achieved the extension of the spoken word throughout both space and time.

"But this golden age has not yet ended, and when we contemplate the possibilities of the future, we discover that it has only just begun. It is to the future that we must now turn our minds and direct our endeavors."

SUPPLEMENTAL LIST OF BROADCASTING STATIONS IN THE UNITED STATES FROM DECEMBER 25
TO JANUARY 13 INCLUSIVE

CALL SIGNAL	OWNER OF STATION	LOCATION
KFAZ	Weatherell, C. H.	Readley, Calif.
KFCM	Richmond Radio Shop	Richmond, Calif.
KFEL	Winner Radio Corp.	Denver, Colo.
KFFJ	Jenkins Furniture Co.	Boise, Idaho
KFFQ	Marksheffel Motor Co.	Colorado Springs, Colo.
WCAE	Kaufmann & Baer Co.	Pittsburg, Pa.
WPAV	Tinetti & Sons, Paul.	Laurium, Mich.
WPAW	Radio Installation Co., Inc.	Wilmington, Del.
WPAX	S-W Radio Co., J. R. Shumate, Jr.	Thomasville, Ga.
WQAC	Gish, E. B.	Amarillo, Texas
WQAE	Moore Radio News Station.	Springfield, Vt.
WQAF	Sandusky Register	Sandusky, Ohio
WQAN	Scranton Times	Scranton, Pa.
WQAY	Gaston Music & Furniture Co.	Hastings, Nebraska
WRAO	Radio Service Co.	St. Louis, Mo.
WSAT	The Plainview Electric Co.	Plainview, Texas

LIST OF BROADCASTING STATIONS DELETED DURING THE MONTH OF DECEMBER

KDYR	Pasadena Star—News Pub. Co.	Pasadena, Cal.
KFBA	Ramey & Bryant Radio Co.	Lewiston, Idaho
KFBJ	Boise Radio Supply Co.	Boise, Idaho
KGF	Pomona Fixture & Wiring Co.	Pomona, Calif.
KYF	Thearle Music Co.	San Diego, Calif.
WAAG	Elliot Elect. Co.	Shreveport, La.
WAAO	Radio Service Co.	Charlestown, W. Va.
WAAR	Groves—Thornton Hardware Co.	Huntington, W. Va.
WAAV	Athens Radio Co.	Athens, Ohio
WCAZ	Compton, Robert E.	Carthage, Ill.
WCJ	Gilbert, The A. C. Co.	New Haven, Conn.
WDAN	Glenwood Radio Corporation,	Shreveport, La.
WJAR	Hall & Stubbs	Sanford, Maine
WIAA	Waupaca Civic & Commerce Ass'n.	Waupaca, Wis.
WJAC	Redell Co., The	Joplin, Mo.
WKAM	Breede, Adam, Hastings Daily Tribune	Hastings, Nebraska
WLAD	Arvanette Radio Supply Co.	Hastings, Neb.
WJAH	Central Park Amusement Co.	Rockford, Ill.
WMC	Columbia Radio Co.	Youngstown, Ohio
WPAN	Levy Bros. Dry Goods Store	Houston, Texas

Another Receiving Contest!

Any Number of Tubes—Any Kind of Receiver

The "How Far Have You Heard On One Tube?" Contest, which closed February 1st, has been a great success. The hundreds of reports, diagrams, questions, and suggestions which we have received indicate the keenest interest in long-distance receiving throughout the country. The final reports of this contest will appear in RADIO BROADCAST for April.

AND—we take pleasure in announcing, owing to the enthusiastic response to this contest, A SECOND LONG-DISTANCE RECEIVING CONTEST, to determine who has done the best with ANY NUMBER OF TUBES AND ANY TYPE OF RECEIVER.

The Four Prizes

First Prize: DE FOREST D-7 REFLEX LOOP RECEIVER

This receiver, described in RADIO BROADCAST for February (page 297), is the latest product of the De Forest Company: it makes three amplifying tubes and a crystal detector do the work of six tubes. The loop antenna aids in selectivity because of its directional properties. An ordinary antenna and ground may be used, however, if desired. Recently, a man in Brooklyn, N. Y. heard a broadcasting station in Seattle, Wash., with one of these sets.

Second Prize: GREBE TUNED RADIO-FREQUENCY AMPLIFIER, TYPE RORN

Illustrated on page 352, RADIO BROADCAST for February. This amplifier, which has a wavelength range of from 150 to 3000 meters, may be used with any form of home-made or bought receiver. It is the most recent development of a company widely known for the excellence in design and workmanship of its products.

Third Prize: Choice of

THREE OF THE NEW RADIOTRON UV-201-A AMPLIFIER TUBES (6 volts, $\frac{1}{4}$ of an ampere), or

THREE AERIOTRON WD-11 DRY-CELL TUBES ($1\frac{1}{2}$ volts, $\frac{1}{4}$ of an ampere).

Fourth Prize: TIMMONS LOUD-SPEAKER UNIT

This unit, which may be connected directly to the output of your amplifier, has a diaphragm adjustable for sounds of different intensities, and when used with two stages of amplification reproduces broadcasted programmes loud enough to fill an average-size room.

Rules of The Contest

1. You should list all broadcasting stations 150 or more miles away from the receiving point, which you have heard distinctly (announcement of location as well as of call letters.)
2. Measure distances accurately, and give aggregate mileage. (This is the sum of all the distances, each station counted once, but two or more stations in the same city being counted separately.) An aggregate mileage of less than 15,000 miles will not be considered.
3. Manuscripts should include the following: description of set, directions or advice for constructing and operating it; any "wrinkles" or makeshifts which you have used to advantage; photograph of your apparatus; circuit diagram; in general, anything you have to tell that will make your story more interesting and helpful. Manuscripts should not be longer than 2000 words. Typewritten reports preferred.
4. Data should be arranged in three columns, under the headings: call letters, location, distance.
5. For material used, a liberal rate will be paid.
6. In judging contributions, the quality and interest of photographs, text, and drawings, and the originality and general effectiveness of the apparatus described, will have greater weight than the list of stations heard, although a long list of distant stations will distinctly help.
7. The Contest begins now and closes May 31st, 1923.
8. Address: Receiving Contest, RADIO BROADCAST, Doubleday, Page & Co., Garden City, N. Y.

How Far Have You Heard on One Tube?

A pretty fair idea of receiving conditions throughout the country may be had from a few minutes' study of the scores in this contest. (Page 436.) Many of the letters from our readers could not be accepted for publication because their aggregate mileage was below 15,000, or because a circuit diagram or at least a mention of the character of circuit employed was omitted.

One of the best descriptions of home-made receivers submitted up to the time of going to press is described below by the designer of it.—THE EDITOR.

A PRACTICAL LONG-RANGE SINGLE-TUBE RECEIVER

How to Build It, and How to Operate It to Best Advantage

By E. V. SEAGER

SOME people enjoy starting at the bottom of radio construction, and, through experiments and improvements, gradually work up to perfection. Others are more interested in the excellent programmes that are continually filling all space, and, while they are interested also in constructing their own set, do not care to take a roundabout way by experimenting, but are desirous of making the best set possible, at the least expense and in the shortest time.

To these last I respectfully submit the following description of a set that will meet their requirements and give them all that can be expected from a single tube. With a like set,

the writer, located in Indianapolis, hears, every evening, stations from Massachusetts to California and from Canada to Cuba.

I shall first give a list of parts needed, and follow with the instructions for constructing and assembling the set:

- $\frac{1}{4}$ pound No. 24 cotton-covered enameled wire
- $\frac{1}{4}$ pound No. 30 cotton-covered enameled wire
- 8 nickel-plated binding posts
- 1 double binding post
- 15 feet No. 18 bare copper wire
- 12 feet spaghetti tubing
- 22 switch points
- 2 switch levers with $1\frac{1}{2}$ -inch arms
- 1 43-plate, vernier condenser with dial
- 2 dials
- 1 Rheostat, vernier preferred
- 1 Tube socket
- 1 UV201 amplifying tube, or one that corresponds to it
- 1 Bezel
- 1 foot flexible wire
- 1 grid condenser, .0005 mfd.
- 1 phone condenser
- $1\frac{1}{2}$ feet brass rod, to fit dials
- 1 large, 22 $\frac{1}{2}$ -volt, variable B Battery
- 1 small, 22 $\frac{1}{2}$ -volt B Battery
- 1 piece wallboard 12 x 24 inches
- 1 6-volt storage battery
- Enough $\frac{1}{4}$ -inch lumber to make cabinet 6 $\frac{1}{2}$ inches high, 8 inches wide, by 24 inches long
- 2 fancy brass hinges
- Enough small, brass wood screws for cabinet
- Small can of varnish stain for cabinet
- Small can black enamel for panel
- A few sheets of tinfoil or leadfoil
- A pair of good phones

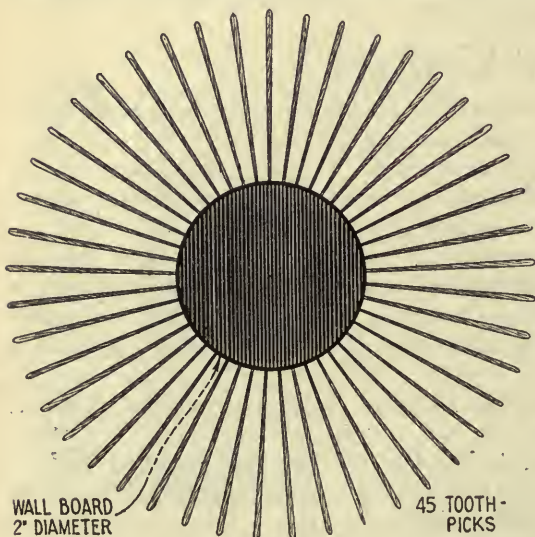

FIG. 1

Form on which coil is wound

First cut two discs 2 inches in diameter from

a piece of wallboard, and mark the rim off into 45 spaces. This can best be accomplished by making a large circle about 6 inches on a piece of paper, placing 45 dots, evenly spaced around the circumference, and drawing lines from the centre to each dot. To space the disc, lay it on the circle in the exact centre and place a mark on the edge where it intersects the lines on the drawing.

Next, stick 45 toothpicks around the edge of each disc, using the marks as guides. Do not push the toothpicks far enough into the disc to split it. These will be a little insecure at first, but when a few turns of wire are wound on, they will be solid. The form will now resemble Figure 1, and is ready for winding.

Before winding wire on the form, it may be easier for some to place the taps on first, as follows:

Unwind the No. 24 wire from the spool, and 16 feet from the end make a tap by taking an 8-inch loop in wire (Fig. 2). Continue measuring off the wire, placing another tap 15 feet from the first one, then one every 10 feet thereafter until there are 4 taps. Cut the wire about 11 feet past the fourth tap.



FIG. 2

In making taps, scrape the insulation from the wire next to the base for about $\frac{1}{4}$ inch, and twist the wires together (Fig. 3), after which a little solder should be run on to insure a good contact (at point indicated, Fig. 3). The ends of the loops should also be scraped, where the wire will be soldered to the switch points.



FIG. 3

Now, starting in at the first end, begin weaving the wire back and forth between the toothpicks on the disc, skipping two toothpicks at a time (see Figure 4). Wind to the right and keep all ends and taps to the back of the coil. Continue until the 60 feet of wire are wound on the coil, leaving one foot on the end for a terminal. It is best to secure the coil by taking loop stitches between each toothpick with needle and thread, after which the toothpicks may be cut off flush with the coil. This makes a very neat inductance coil.

The foregoing is a description of the primary



FIG. 4

Winding the coils—over two and under two

coil. The secondary is constructed in the same manner, with the following exceptions:

Use No. 30 wire, and make taps as follows: 15, 30, 40, 50, 60, 70, 80, and 90 feet, leaving one foot on each end. Wind coil to the right and keep ends and loops on *front side*. (Side next to you.)

The next instrument to be constructed is the variometer, which is simply one cardboard cylinder which rotates inside of another larger one, with a continuous winding on both. Obtain a round oatmeal box, having an outside diameter of $4\frac{1}{8}$ inches and cut out a section $2\frac{1}{4}$ inches in width. Punch three or four small holes near the edge of the cylinder and lace No. 24 wire through them, leaving about one foot free. This will secure the wire from slipping while winding. Wind on 50 turns, leaving enough space in the centre of the tube to accommodate the brass rod used for the axle of the rotor.

For the rotor, or inside coil, a salt box having an outside diameter of $3\frac{3}{8}$ inches is about right. Cut out a 2-inch section, as this is all that will turn inside of stator (the large tube). This should be wound the same as the large tube, being careful to wind in the same direction, and leaving space in the centre for the shaft. Wind on all the wire possible in a single layer.

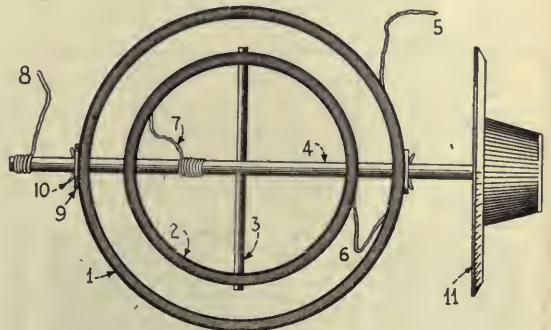

FIG. 5

1—Stator, 2—rotor, 3—rod to secure rotor, 4—shaft, 5—stator terminal to B battery +, 6—continued winding between coils, 7—terminal of rotor soldered to shaft, 8—flexible wire from plate soldered to shaft, 9—Washer, 10—stop pin, 11—dial

Holes should be made in both tubes for the shaft to go through. The best method of doing this is to heat one end of the shaft red-hot and burn them through, which makes the holes the exact size required. Place the rotor inside of large tube and run the rod through both. The rotor should be secured to the shaft so it can be rotated inside the stator. A simple method of doing this is by previously having a small hole drilled in the centre of the rod, and placing a short rod through both tube and shaft (see Figure 5).

The last end of the stator winding should be run through a hole in the stator near the shaft and connected to the beginning of the rotor winding, soldering the connection and winding with adhesive tape. The last end of the rotor winding may be soldered to the shaft, which will then answer for one terminal.

The rod should also be fastened in some manner to prevent slipping back and forth in the stator. This may be accomplished by drilling small holes in the shaft just outside the stator, through which a short piece of rod or wire is inserted as a "stop." It is best to have brass or copper washers between these stops and the tube to bear the wear.

The construction of the cabinet is not difficult, and outside of the general dimensions, it will be left to the builder. For the base use a $\frac{1}{2}$ - or 1-inch board, 8 inches wide by 24 long. The rest of the cabinet should preferably be $\frac{1}{4}$ -inch lumber. This can be procured at small expense by getting a box at the grocery store, which has smooth boards of the required size. By rubbing the boards down and applying a few coats of varnish stain, a very handsome cabinet can be made.

The panel may be made from wallboard, if desired, and if given two coats of black enamel, will very closely resemble hard rubber. It is certainly easier to work, for the amateur who is shy on tools. Of course, if the very best is desired, bakelite or formica is the material to use, but the writer is using a wallboard panel, with absolutely no bad results so far as can be discerned.

All holes in the wallboard panel should be burned through. A tenpenny nail, heated red-hot, is just right for switch-points. Rods can be used for the different sizes on the other holes. There is nothing critical about the measurements for holes, etc. These should be made to accommodate the instrument you are using. The photos will readily give the idea of how things are arranged. Arrange the instruments and design the panel accordingly.

Brass screws should be used in the construction of the cabinet. Never use iron or steel nails. To prevent splitting the thin boards, it is safest to drill or burn a hole first about half the diameter of the screw, and stick the screw itself into a cake of common soap, before inserting it.

As can be seen from a glance at Fig. 9 there should be a partition around the B batteries, vacuum tube, and tuning condenser. These partitions, along with the back of the panel, should be shielded by pasting tinfoil on them. Care must be taken that the shielding does not touch any of the switchpoints, instruments, shafts, etc. It should, however, be connected to the ground.

Binding posts for the aerial, ground, and A battery connections are on back of the cabinet; the aerial is opposite the condenser, the ground

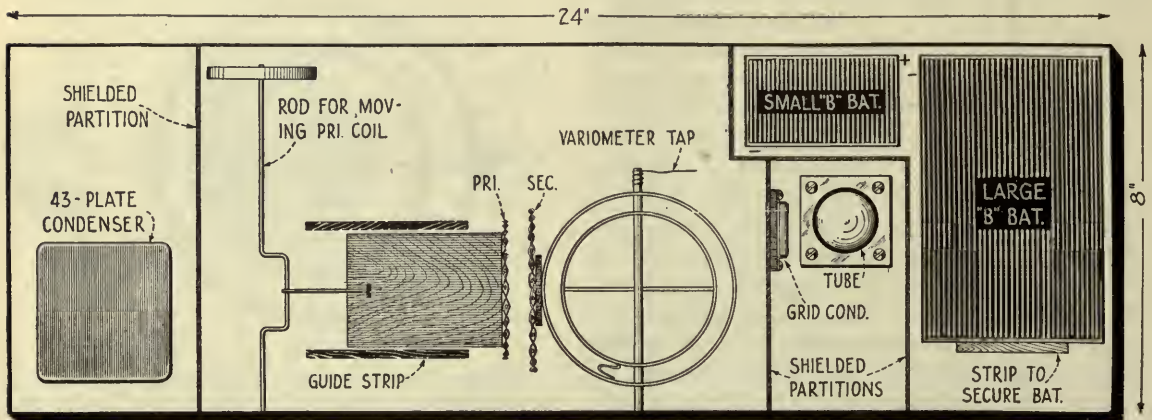

FIG. 6

Arrangement of apparatus within the cabinet

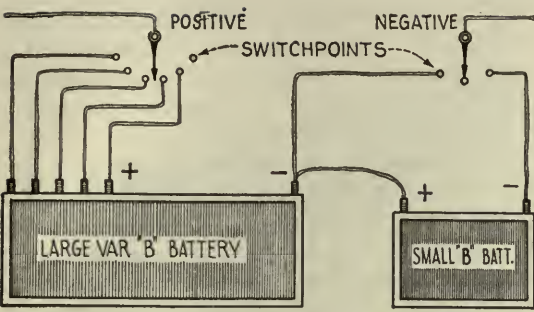

FIG. 7
Method of connecting B batteries

of this set. The hole, through the panel, that accommodates the variometer shaft, should not be burned until after the secondary coil is fastened in place, unless careful calculations are made beforehand.

The stator of the variometer should be placed horizontally (see Fig. 10), with top of cylinder about $\frac{3}{8}$ inch below the centre of the secondary coil, and the winding about $\frac{3}{8}$ to $\frac{1}{2}$ inch from the winding of the secondary. Here is a very important point: current which flows through the stator from the plate of the vacuum tube, must travel in the same direction as the induced current in the secondary, which, if the inductance coils are wound right, would be around the stator to the right, as viewed from above. However, this is best determined after the set has been completed and a trial made to receive signals. All that is necessary to reverse the current is to turn the stator over.

For B battery connections see Figure 7. The two $1\frac{1}{2}$ -inch switch arms, which control the battery currents, are fastened to the panel with small brass machine screws. Put a screw through the switch arm, then run a nut on to the arm and adjust for tension, after which the screw may be put through the panel and another nut screwed on to hold it secure.

Place three switch points on the negative side, having one point in the centre that has no connection. This insures against shorting the

a little past the partition, and the A battery opposite the tube.

The position of the instruments, which may be seen in the diagram (Fig. 6), is as follows: 43-plate, tuning condenser on left, device for moving primary coil to change coupling, primary coil, secondary coil, variometer, tube, and finally, B batteries.

A simple, efficient method of moving the primary coil can be seen in the illustration, and consists of a brass rod, bent in a U shape. Cut a piece of wallboard 1×4 inches and tack one end to the centre of the primary coil and the other to a block of wood, which should be heavy enough to keep the coil upright. Tack guide strips beside block to insure the primary being held parallel to the secondary.

Keeping coils parallel to each other insures uniform induction at all coupling spaces. A strip of wood or metal connects the rod to the coil, so when the rod is turned by the dial, the primary coil may be moved back and forth.

The secondary coil may be secured permanently to the base. Mount the coils so there are no taps between them; in other words, so that the current in the primary and the induced current in the secondary run parallel and in same direction.

We now are ready to set the variometer. This should be very carefully done, as upon its proper installation depends the high efficiency

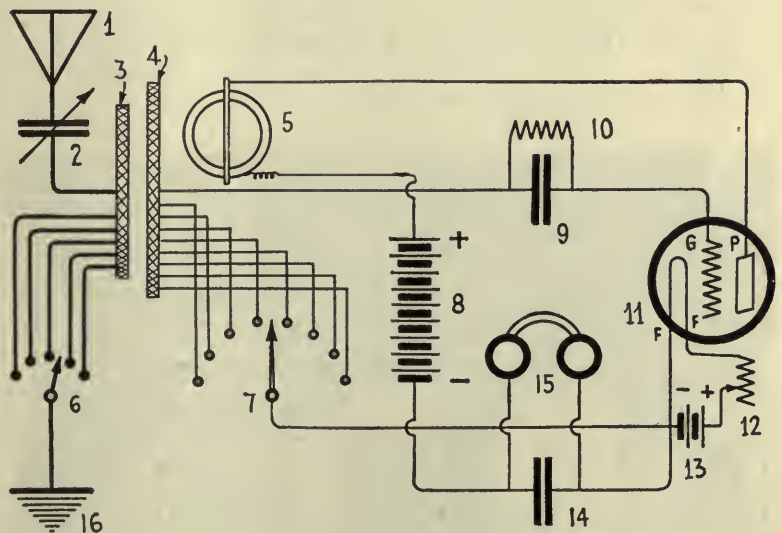

FIG. 8

- 1—Antenna, 2—43-plate condenser with vernier, 3—primary spider-web coil, 4—secondary spider-web coil, 5—variometer, 6—primary switch lever and taps, 7—secondary switch lever and taps, 8—45-volt variable B battery, 9—.0005 grid condenser, 10—grid leak, 11—UV 201 amplifier tube, 12—rheostat, 13—6-volt storage battery, 14—phone condenser, 15—phones, 16—ground

terminals of the battery as well as providing an "off" point, when wishing to disconnect the battery. The switch points on the positive side should be placed far enough apart so that the switch arm cannot touch two at once, which prevents shorting on that side. To do the job in good shape, an "off" point may also be placed at one end.

The phone condenser must be placed between the two phone binding posts (shown at lower right, Fig. 10). The double post, which shows slightly above the two in use in the illustration, is provided for connecting two sets of phones in series, and may be left off if desired.

Near the top of the partition between vacuum tube and variometer, place two binding posts, far enough apart so that the grid condenser can be connected between them.

A suitable grid leak can easily be made by soaking a thread in India ink and, after drying, winding it across the grid condenser binding posts. It is a question for the builder to decide, whether this leak is necessary or not. The set functions perfectly without it. But in case squealing develops, it will help to stabilize the circuit.

All connections should be soldered. Solder the coil and battery taps to switch points before the panel is screwed on, as it will be easier to get at them. However, do not solder the secondary and variometer terminals until after signals are coming in well, as they may have to be reversed. Use No. 18 bare copper wire for internal wiring and cover it with spaghetti tubing.

There is no interference between phone

stations unless they are on exactly the same wavelength. Although the carrier wave can be heard for four or five meters on either side, it is not so strong that it is impossible to hear a station within two meters difference.

Spark stations are more broad, but as a general rule, only those that are close cause much difficulty in reception. Most of them can be almost, if not completely, tuned out by adjusting the coupling and variometer and throwing on a higher plate voltage. All this will change the tuning adjustment, but a little experimenting will teach one how to make up these differences with the tuning condenser.

With a good ground connection, stations can be heard 500 miles without an antenna. In this case the ground should be attached to the aerial binding post. About the same results can be obtained, using the aerial without a ground connection. In this experiment the aerial may be attached either to the aerial binding post or the ground. Local stations can be heard very plainly without either aerial or ground connections. This requires very close tuning and is very directional, so that the set itself will have to be turned until best signals are heard. It also requires all the wire that is in the coils. In this case the coils themselves are the collectors of the radio energy. There are big possibilities in experimenting along these lines.

Purchase the best set of phones obtainable. You will not regret it. There is as much difference in phones as there is in automobiles.

Referring to the photo (Fig. 9), it would seem that there is no attempt made at neatness in wiring. However there is some method in the madness. It is based on the theory that the shortest cut is the best, and, at the same time, it avoids running wires parallel. The beauty of it is that it "percolates" to perfection, so what more could one want?

Just a word about tuning: In first tuning the set, having no idea where the stations should come in, the beginner is liable to tune in on a harmonic wave and not get the best results, although it may be hard to notice any difference in volume.

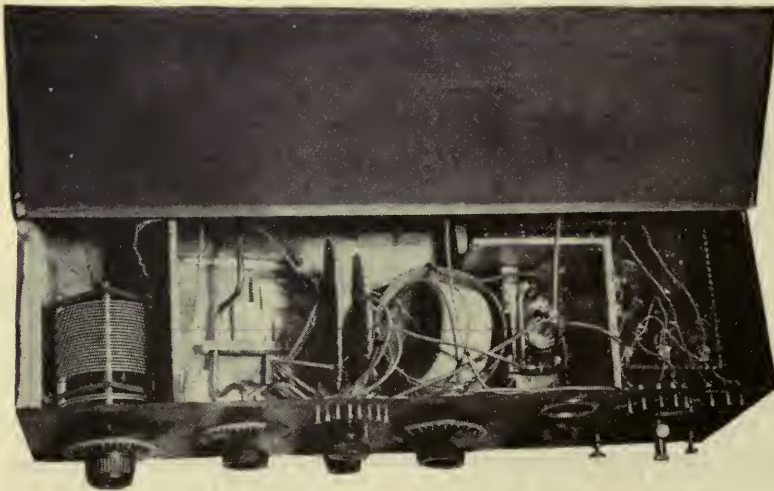
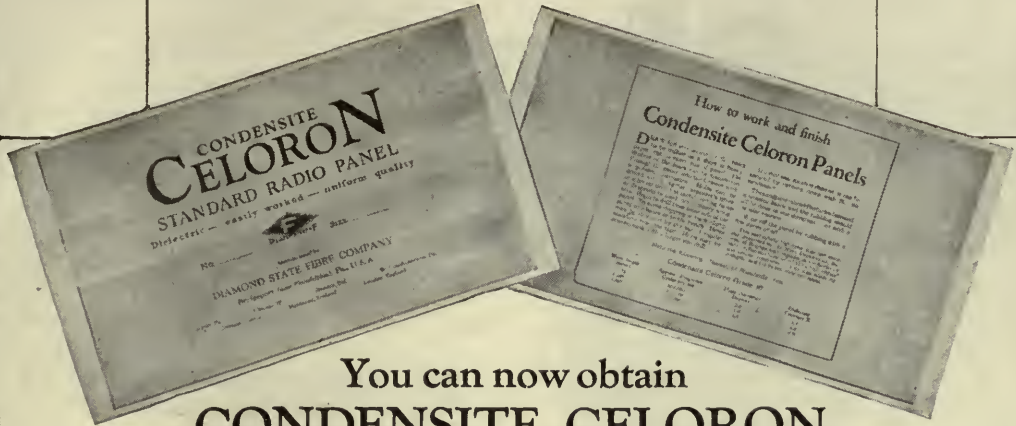

FIG. 9



You can now obtain
CONDENSITE CELORON
RADIO PANELS
 cut in standard sizes

YOU can now get radio panels already cut to a size to fit your needs. For your convenience we are making Condensite Celoron Radio Panels in seven standard sizes. No longer will you have to wait and pay extra cost for having your panel cut to order.

These sizes have been so designed as to meet practically every need of the set-builder. Each panel comes trimmed and wrapped separately in glassine paper to protect the surface. They are all ready for immediate use. On every one are full instructions for working and finishing.

What Condensite Celoron Is

Condensite Celoron is a laminated phenolic condensation product used

by many of the leading manufacturers of radio equipment. It has high insulation resistance, high dielectric strength, low dielectric losses and is easily worked. Because Celoron has these qualities it has received the approval of the U. S. Navy Department Bureau of Engineering and the U. S. Signal Corps.

You can obtain any of these seven standard sizes:

- | | |
|-----------------------------|-------------------------------|
| 1. — 6 x 7 x $\frac{1}{8}$ | 4. — 7 x 18 x $\frac{3}{16}$ |
| 2. — 7 x 9 x $\frac{1}{4}$ | 5. — 9 x 14 x $\frac{3}{16}$ |
| 3. — 7 x 12 x $\frac{1}{8}$ | 6. — 7 x 21 x $\frac{3}{16}$ |
| | 7. — 12 x 14 x $\frac{3}{16}$ |

Select the size you need for your set. If your radio dealer has not yet stocked them, ask him to order for you. Or write direct to us, designating by number the size you want. We can make prompt shipment.

To radio dealers: Write for special dealer price list showing standard assortments

Diamond State Fibre Company

BRIDGEPORT (near Philadelphia) PENNSYLVANIA

BRANCH FACTORIES AND WAREHOUSES
 BOSTON CHICAGO SAN FRANCISCO

Offices in Principal Cities

In Canada: Diamond State Fibre Company of Canada, Limited, 245 Carlaw Avenue, Toronto

CONDENSITE
CELORON
 STANDARD RADIO PANEL



FIG. 10

The panel, made of wall-board, is given two coats of black enamel

It must be borne in mind that different aerials have different natural wavelengths, which affect the setting of the dials, but the following procedure should put you in the right neighborhood of the desired signals:

Set the variometer so that rotor lies in same direction as the stator, with the current flowing in the same direction in both coils. A mark should be made at the top of dial and dial set on rod so that either "0" or "100" is on the mark. Now turn stator about 35 spaces and leave it in this position.

Set the coils about 10 spaces, or $\frac{3}{4}$ of an inch apart. Set the secondary switch arm on the sixth point, or 75 feet. Set the primary switch arm on the second point, or 30 feet. Set the tuning condenser with the moving plates turned out from the stationary plates about 80 spaces. Set the B battery switch at $16\frac{1}{2}$ volts. The set now will be in resonance with a radio wave under 360 meters, when the tube is lighted.

THE GREAT MOMENT

WE HAVE now reached the point of greatest moment in a radio bug's career: the lighting of the tube. The next few moments will disclose whether you are an embryo genius, or merely human. If the former, one of the greatest marvels of the times is about to be revealed with the mere turning on of the rheostat. But if you are merely human—well, we all make mistakes, and it may be that you will have to do a little adjusting before having the pleasure of listening-in.

Turn the rheostat until there is a frying noise in the phones, which will be about $\frac{2}{3}$ of the way around (on the resistance wire wound type of rheostat). If turned too far, the tube will set up a howling in the phones. It should be turned down just below this. You are now ready to locate a station.

Set the B battery switch on 21 volts, after which the tube may have to be turned down some. Turn tuning condenser slowly toward the point where moving plates are enmeshed in the stationary ones. This is raising the wavelength of the set. Soon a high whistle will be heard in the phones, which gets lower as the condenser is turned slowly. After reaching a low point, it will start

rising again, until it passes out of the range of the ear. The correct place to hear the station is between the two low points, which can be brought into adjustment with the vernier on the condenser, or by rotating the variometer slightly.

As the condenser is turned, the variometer can also be turned occasionally until, with the condenser plates entirely enmeshed, the variometer coils should be parallel, with dial reading "0" or "100," whichever the case may be. The set is then in the neighborhood of 400 meters.

If, when the tube is lighted, the set refuses to bring in a sound, assuming that the storage battery leads, aerial and ground are connected to the proper binding posts, the chances are that one of two things are wrong: the terminals of the secondary coil may have to be reversed, or the stator of the variometer probably needs to be turned over to reverse current in relation to secondary. It is possible that both would need adjusting. When proper positions are found, all unsoldered connections should be soldered.

I hope that with the above description and diagrams, the very beginner in radio work will have no difficulty in constructing a set that he will be proud of. There is nothing so enjoyable as to be able to tune in about any station desired, which can be done if records are kept of dial settings, etc. The air is constantly full of good entertainment. I have stayed up until three o'clock in the morning waiting for the last dog to die, and finally had to give up.

With this set, I have heard (from Indianapolis, Ind.) the following stations:

CFCA, CJCG, DN₄, KDKA, KHJ, KLZ, KNJ, KSD, KYW, ₁XAC, ₂XI, NOF, WAAB, WAAC, WAAO, WAAP, WAAZ, WAAV, WBAH, WBAY, WBAP, WBAV, WBL, WBT, WBZ, WCAE, WCM, WCX, WCAS, WDAF, WDAJ, WDAP, WDAV, WEAB, WEAJ, WEAV, WEAY, WFAA, WFAT, WGF, WGR, WGM, WGY, -WFAV;

This
combination
completes any
**RADIO
RECEIVING SET**



MAGNAVOX
Radio

*The Power Amplifier
and Reproducer Supreme*



R-2 Magnavox Radio with 18-inch horn: this instrument is intended for those who wish the utmost in amplifying power; for large audiences, dance halls, etc.

R-3 Magnavox Radio with 14-inch horn: the ideal instrument for use in homes, offices, amateur stations, etc.

Model C Magnavox Power Amplifier insures getting the largest possible power input for your Magnavox Radio. 2 and 3 stage.

When you purchase a Magnavox product you possess an instrument of the highest quality and service.

Magnavox products can be had of good dealers everywhere. Write us for copy of new illustrated booklet.

THE Magnavox, in amplifying with extreme sensitiveness every signal supplied to it from the receiver, must necessarily amplify any extraneous sounds which may originate in the receiver or power amplifier itself.

Therefore, the combination of Magnavox Reproducer with Magnavox Power Amplifier (as illustrated) is very desirable. By this equipment, in connection with a good receiver, you get the music or speech with true clearness—and in practically any volume required.

To own a good receiving set without Magnavox equipment, is like having your house properly wired and then using only small, feeble candle-power lamps in the sockets!

The Magnavox Co., Oakland, California
New York: 370 Seventh Avenue

WHAE, WHAS, WHAZ, WHB, WHK, WIAO, WIAR, WIP, WJAE, WJAF, WJAP, WJAX, WJD, WJZ, WJAN, WKN, WKG, WLAG, WLAL, WLK, WMAB, WMAC, WMAK, WMAH, WMAQ, WMAV, WMAF, WMAT, WMH, WNAC, WNAD, WNAF, WOAI, WOH, WOC, WOR,

WOS, WOI, WOO, WPA, WPAD, WSB, WSY, WWJ, KOP, PWX.

In the "How Far Have You Heard Contest," this represents a distance of about 52,000 miles.

SUMMARY OF RESULTS OBTAINED BY OTHER ENTRANTS WHOSE RECORDS HAVE NOT BEEN PUBLISHED PREVIOUSLY

SINGLE-CIRCUIT REGENERATORS

NAME AND ADDRESS	NO. OF STATIONS	NEAREST STATION	FARTHEST STATION	AGGREGATE MILEAGE
W. E. Davison, Berwick, N. S.	52	460	3045	55,565
Leland Whitelock, Petersburg, Indiana	99	162	1771	52,334
Frank Williams, East Cleveland, O.	79	150	2200	50,635
Neal G. Barnard, Detroit, Minnesota	80	150	1380	47,194
Allan S. Harvey, Snohomish, Wash.	45	415	2000	46,305
H. R. Anderson, Twin Falls, Idaho.	57	185	2080	44,670
J. Edwin Wilson, Frankfort, Ky.	81	175	1150	44,435
M. C. Ridenour, Kingwood, West Va.	78	155	2260	43,280
Harry L. Van Brunt, Council Bluffs, Iowa	52	425	1350	41,725
Calvin C. Cooper, Dufur, Oregon	60	150	2500	40,850
Raymond Smith, Ladoga, Indiana	59	160	2200	35,515
Louis Delhotel, Riverbank, Calif.	18	1500	2500	34,300
H. Holm, Preston, Ontario	61	150	1450	34,073
Frederick E. Croxton, Columbus, O.	66	150	1285	33,995
W. F. Fennell, Saltsburg, Pa.	57	175	2030	31,768
Francis S. Beeler, Hamilton, O.	48	210	1800	31,525
D. W. Longfellow, Elk River, Minn.	42	200	1500	30,630
Richard B. Barker, Newport News, Va.	35	225	1275	30,470
Gerard Curtiss, Wauwatosa, Wis.	44	150	2400	29,550
Phillip W. Patterson, Two Harbors, Minn.	35	150	1200	29,500
Teddy Conrad, Montrose, Mo.	59	150	1100	29,110
D. M. Osborne, Kansas City, Mo.	49	150	1450	28,720
Glen Gately, Rifle, Colo.	42	160	1700	27,815
G. W. Burkhardt, Montebello, Calif.	31	150	1800	27,225
Harold A. Kirk, Tama, Iowa	56	175	1400	27,090
Glenn E. Smith, Germantown, O.	41	250	2300	26,640
Milton D. Satterlee, Quilcene, Wash.	32	165	1650	26,305
Merle Schulling, Beaumont, Calif.	29	300	2512	26,237
R. W. Edmonds, Lancaster, Ohio	48	150	2100	25,865
Philip N. Enigh, Indian Creek, Pa.	39	200	1575	25,688
Lewis M. Ripley, Glastonbury, Conn.	41	180	1530	25,440
Goodwin Compton, Harrisburg, Pa.	44	205	1275	23,325
A. E. Herman, Mexia, Texas	33	150	1350	23,150
A. D. Turnbull, Sydney, N. S.	18	600	2325	22,500
Harry Leeper, Monongah, W. Va.	48	150	1690	22,275
Norman C. Theobald, Attleboro, Mass.	25	375	2000	21,525
Sam Zimerman, Port Lavaca, Texas	21	600	1500	21,515
E. T. Sealey, Donna, Texas	26	270	1750	20,525
Merrill Firestone, Middletown, Pa.	26	350	1295	20,045
F. W. Brenchley, Carbondale, Pa.	37	150	1200	19,920
Walter Kramer, Chicago, Illinois	35	183	2075	19,730
Arthur L. Carlson, Prairie City, Oregon	30	170	1950	19,518
Charles Adams, Algona, Iowa	26	285	1090	19,148
Albert P. Cook, Pittsburgh, Pa.	38	150	1500	18,905
H. P. House, Rensselaer, Indiana	35	190	1840	18,720
I. Potter Lynch, Glens Falls, N. Y.	30	200	1500	18,455
Ray C. Poulson, Detroit, Mich.	35	150	1200	17,865
H. R. Grasskopf, San Antonio, Texas	16	600	1800	17,250
Raymond A. Riedner, Republic, Wash.	28	170	1490	17,225
Walter L. Slater, La Center, Wash.	22	150	3000	17,200
W. F. Neukirch, Chicago, Illinois	26	150	2000	16,905
George Eberhardt, Newark, N. J.	32	150	1375	16,540
Ainsworth Moore, Spiro, Okla.	35	220	1230	16,450
Herbert Snow, Jenks, Okla.	24	225	1300	16,380
Clark C. Radinor, Florence, Mass.	27	175	1500	16,110
Robert D. Shaver, Bay City, Mich.	27	225	875	16,075
H. B. Hunter, Detroit, Mich.	30	200	1025	15,605

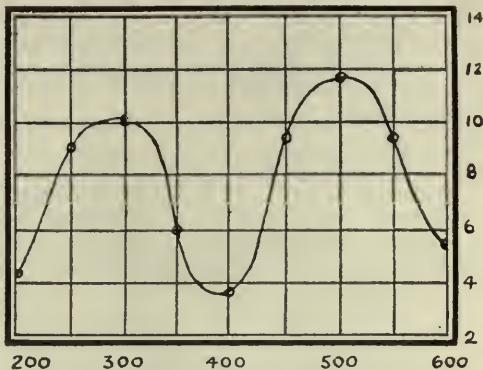
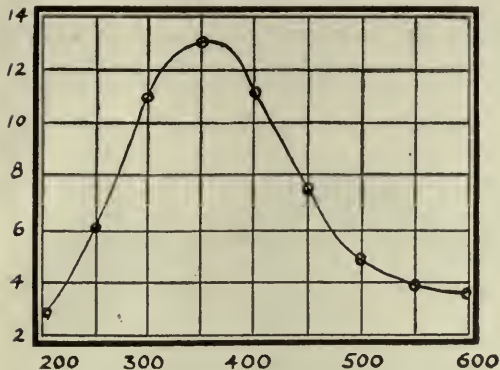

How to get distant stations clearly

Why the Acme Radio Frequency Transformers eliminate distance and distortion

BEFORE you purchase a radio frequency amplifying transformer find out if it has marked depressions and peaks in its amplification range between 250 and 500 meters (indicating absence of amplification in the depressions)—or whether the amplification range curve is uniform.

A Test

THE two charts above tell a graphic story of tests made on radio frequency transformers in the laboratories of a well known concern. The chart at the left plots the amplification range curve of 12 Acme R-2's taken from stock. (Note: The Acme R-2's are made with a special iron core and windings.) The chart at the right represents a composite plot of the curves of 6 ordinary types of different makes taken from stock. The superiority of the Acme R-2 is self evident. Note its steadily increasing amplification curve with its maximum at 360 meters—just where it is most needed.

Better results—greater distance

TO HEAR the distant station is not enough. To understand them—to be entertained by them—that is the real thrill. The Acme R-2 used in a radio frequency amplifier builds up wave energy without distortion before passing it on to the detector. Even the simplest and most elementary types of set, either

vacuum tube or crystal receiver type will have its useful range tremendously increased when the Acme R-2 and a vacuum tube are employed.

The best method

TO GET the distant stations clearly, use Acme Radio and Audio Frequency Amplification. This insures maximum sensitivity and intensity, quietness in operation and freedom from distortion. A small indoor antenna or loop may be used and sufficient intensity obtained to operate the Acme Kleerspeaker providing perfect entertainment for a roomful of people.



Acme R-2 Radio Frequency Amplifying Transformer. Price \$5. (East of Rocky Mountains.)

You can get these and other Acme Products at radio, electrical and many hardware stores. Write for booklet R-2 showing proper hook-ups and other information.

The Acme Apparatus Company

(Pioneer transformer and radio engineers and manufacturers.)

CAMBRIDGE, MASS., U. S. A.

New York, 1270 Broadway
Chicago, 184 W. Washington Street

ACME ~ for amplification

VARIOMETER REGENERATORS

NAME AND ADDRESS	NO. OF STATIONS	NEAREST STATION	FARTHEST STATION	AGGREGATE MILEAGE
Duane D. Karges, Wichita Falls, Texas	99	170	2100	64,160
D. C. McBride, Winchester, Tenn.	74	150	1875	44,355
Mrs. John H. Patterson, Harrisonville, Mo.	60	175	1525	34,286
H. N. Walker, Detroit, Mich.	72	200	2000	33,180
R. V. Hammer, Creston, Iowa.	57	150	1450	32,920
Ralph B. Ritter, Milwaukee, Wis.	47	200	1800	29,800
Raymond G. Miller, Evansville, Ind.	49	160	1700	29,125
Edmund Howard, Waterbury, Conn.	43	150	1575	27,925
Raymond Cartwright, Sharpsville, Pa.	58	150	1160	27,385
Otto C. Steinberger, Vicksburg, Mich.	52	152	1475	27,114
H. H. Nicholson, Rural Valley, Pa.	37	185	1502	25,418
R. M. Blain, Galt, Ontario	37	300	2200	24,880
Earl M. Polk, Dayton, Ohio	46	150	1200	24,785
George A. Istok, Pittsburgh, Pa.	34	225	2330	23,135
Alvin T. Harrison, Spring Valley, Minn.	38	160	1010	22,590
Laurence Dean, Petaluma, Calif.	22	400	2000	22,190
P. C. Mayfield, Oberbrook Boro., Pa.	47	195	1235	21,980
Edwin Hines, Hayward, Wis.	29	450	1050	21,605
A. C. Van der Bent, Philadelphia, Pa.	35	150	1700	21,560
William B. Gibson, Connellsville, Pa.	47	160	1350	21,135
Henry H. Wilson, Paterson, N. J.	32	150	1470	20,960
Harold Pike, Fairgrove, Mich.	39	165	1175	20,565
Charles N. Alexander, Sioux Falls, S. D.	31	345	1380	20,419
M. L. Halcum, Imboden, Arkansas	27	300	1400	18,050
Cecil Newton, Webster, N. Y.	37	190	1425	17,140
Clifford Lauer, W. Philadelphia, Pa.	35	150	1350	15,375

STANDARD REGENERATORS

Garlon Tice, Marshfield, Wis.	56	150	1650	35,265
Harold Ingledue, Guthrie Center, Iowa	55	150	1250	34,510
Ralph Ray, Newburgh, N. Y.	55	150	1890	32,339
Hodge Eaton, Carbondale, Illinois	60	150	1200	31,665
G. O. Wilkinson, Philadelphia, Pa.	59	150	1240	29,770
M. A. Poulk, Oil Hill, Kansas	45	150	1425	28,580
G. E. Pike, Toronto, Ontario	51	150	1350	25,900
M. J. Cleary, North Sydney, Nova Scotia	28	550	2100	25,375
Bernard Johnson, Moorhead, Minn.	35	230	1350	25,310
Robert Paxton, Troy, N. Y.	27	200	1450	17,227
Seton Scott, Owen Sound, Ontario	33	175	1260	17,141
Hugh Quick, Manitou, Colo.	25	400	1500	15,600

WESTINGHOUSE "RC" RECEIVERS

Frank H. Jones, Tuinucu, Cuba	47	200	1600	59,025
Dixon M. Meuller, New York City	20	150	1700	16,990

NON-REGENERATIVE RECEIVERS

S. U. Tymeson, So. Lancaster, Mass.	41	150	1550	25,300
-------------------------------------	----	-----	------	--------

SINGLE-TUBE LOOP CIRCUIT

H. Lardner, Halifax, N. S.	18	550	1800	15,225
----------------------------	----	-----	------	--------

CLAPP-EASTHAM "HR" REGENERATIVE RECEIVER

George S. De Lisle, Kansas City, Mo.	38	150	1350	20,330
--------------------------------------	----	-----	------	--------

SINGLE TUBE SUPER-REGENERATOR

Charles H. Byrnham, Newtonville, Mass.	31	150	2620	20,082
---	----	-----	------	--------

REINARTZ CIRCUIT

A. O. Rowe, Detroit, Michigan	45	275	1535	26,680
-------------------------------	----	-----	------	--------



A. H. GREBE & CO., Inc.
 Richmond Hill, N. Y.
 Western Branch
 451 East 3rd St., Los Angeles, Cal.

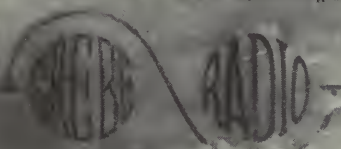

Write for
 "Musings of
 Dr. Mu."

What is whispered — in
 the ear is heard miles away.
 said Mencius.
 The wise radioist hears voices
 a thousand miles
 away with. **A Grebe Receiver.**

Doctor Mu.

U.S. Pat. No. 1113149



AEOLIAN HALL, NEW YORK

Where many of the world's greatest singers and instrumentalists appear. It is likely to become the music centre of America, for the music of the masters may be enjoyed by a greatly enlarged audience

RADIO BROADCAST

Vol. 2 No. 6



April, 1923

The March of Radio

A START ON STANDARDIZATION

WE HAVE heard much recently regarding the standardization of radio apparatus—not so much about what has been standardized as about what ought to be. It would seem that the movement for standardization probably originates with the dealers rather than with those responsible for the design and building of apparatus. The Army and Navy officials want standardization, for one reason, so that in case of another war it would be easier to assemble sets from apparatus already existing (this having been standardized) than to design and make completely new sets.

We can well imagine that the buyer of apparatus for a large department store would appreciate standardization of the most thorough kind—he would undoubtedly like to purchase sets on the basis of, say \$25 per hundred miles of guaranteed reception. If then the purchaser couldn't hear distinctly a station one thousand miles away with a set which he had purchased for \$250, woe betide the manufacturer of the set! But let it be said once for all—such standardization as this in the radio game is impossible. The degree of skill of the operator and the atmospheric conditions count so much that guarantees of distance are practically meaningless. For example, with certain apparatus Espenschied in 1915 picked up a telephone conversation from Arlington 5,000

miles away. If the same apparatus had been in the hands of some one having the same ability as the average purchaser of radio equipment to-day, it probably would not have proved successful for 1,000 mile reception, much less 5,000 miles. The variability in behaviour of a set, of course, increases generally with the number of tubes and adjustments used so that it would be inadvisable for a manufacturer to guarantee any but possibly crystal sets, or tube sets having no regeneration, on a mileage basis. Such receiving apparatus may be standardized for distance within reasonable limits. A regenerative set, on the other hand, or one having radio frequency amplification of the ordinary variety, requires a certain amount of skill and knowledge of the functioning of the different parts of the circuit to get the best results, and the difference in reception distance may easily be five to one for the same apparatus, used on different antennas by different operators.

There are certain features of the radio game, however, that can well be put on a more reliable basis than they are to-day. We refer to the actual electrical characteristics of the parts of a set. Coils, condensers, resistances, telephone receivers and tubes—that's about all there is of importance in a radio receiving set. Can these be standardized with benefit to the radio public? The answer is certainly Yes, if we mean by standardization the certification of the

electrical constants of the apparatus. As regards the mechanical features of the device—ruggedness, accessibility, durability, etc.—the purchaser can use his own judgment, as he does when he buys a lawn mower or dish-washing machine, but the electrical constants of a coil or condenser cannot be estimated even by an expert, so they should be certified just as they are in any other branch of the electrical industry. If we want an incandescent lamp to use 50 watts on a 110-volt circuit, we can buy a lamp which will have these characteristics within several per cent. If we want a one-half horse-power motor to run 1,800 revolutions a minute on a 220-volt line, we can buy just such a motor, guaranteed by the manufacturer to perform as we specify.

Can we buy radio apparatus which has its electrical constants thus guaranteed? In most instances, most assuredly not. Could it be done, to a reasonable degree of accuracy, without increasing the selling price appreciably? It could. Hence here is a field where standardization and guarantees may reasonably be expected and they should be called for by any body that takes upon itself the task of starting standardization in the radio field.

The most flagrant case of non-standardization to-day is in the matter of condensers. A condenser is supposed to have a certain electrical capacity, just as a gallon jar is supposed to hold a certain amount of liquid. A condenser should be sold with a guaranteed capacity, yet it is generally sold to-day by the number of plates—a 23-plate condenser or a 43-plate condenser. A more absurd specification was never heard of. It makes us think of a certain radio editor who, in his descriptions, continually gives the number of turns in a coil to be used in a radio set and never mentions the diameter of the turns! He evidently doesn't know that the diameter of a coil makes a difference in its electrical behavior. Two novices, building radio sets from the same description, use, we will say, 23-plate condensers, as the specification calls for. One uses A's 23-plate condenser and the other uses B's 23-plate condenser and their sets may differ in wavelength range by one hundred meters, because of the difference in the two condensers. One buys the .0008-mfd. kind and the other buys the .001-mfd. kind, and they are both 23-plate condensers. *Condensers must be sold with a guaranteed capacity—that's the first step any standardizing body should take.*

A coil used in a radio set enables the tuning of certain stations because it has a certain amount of inductance, yet coils are practically never sold with a guaranteed inductance. One variometer on the market may have an inductance of 800 micro-henries and another 1,500 micro-henries, yet both are sold by the clerk, and bought by the customer, as being electrically equivalent. Coils should be sold with a guaranteed inductance, and this should be marked on the device, just as the capacity should be marked.

The excellence of either coil or condenser, in so far as its electrical behavior is concerned, depends upon how low the electrical losses are, when used for receiving a signal; the lower these losses the sharper is the tuning and the louder is the signal. The electrical expert knows that a device should have a low effective resistance if it is to function well, and the easiest way of covering this point in specifications is to call for the power factor of the device. This should be as low as possible. The guarantee of power factor, at various wavelengths, will require a higher grade of technical skill than is generally available in the small companies but it should be called for nevertheless. Practically no electrical company to-day is selling motors, transformers, and other devices without guaranteeing their efficiency, and the power factor of a coil or condenser is a measure of its efficiency as a component part of a radio set.

At a meeting of the representatives of nearly all branches of the radio art held recently, it was voted to have the Institute of Radio Engineers and the American Institute of Electrical Engineers act as sponsors for getting together a committee on standardization, and its decisions will undoubtedly clear up some of the points mentioned above. As the decisions of such a committee must have great weight in guiding future radio development, it is well that the scheme for organizing the committee was so propitiously chosen and that the functioning of the committee has been so specified that its actions will be thoroughly reviewed and passed upon by the sponsor societies before being accepted as recommendations for practice. The technically trained members of these two engineering societies well know the deterrent effects of too much standardization in an art growing as rapidly as is radio and will see to it that only conservative, well conceived, steps along the line of standardization are taken.



© Pacific and Atlantic Photos

QUENCHING THE GREAT AMERICAN THIRST

Liquor is smuggled from the Bahamas to our own shores via schooner, dory, and airplane, and radio is used to arrange meetings between the ships and those whose task it is to get the contraband ashore. This picture was taken just outside the three-mile limit off the Long Island coast by one of the men who has adopted bootlegging as a "calling." The seaplane, which has its berth in one of the inlets along the coast, flies out, takes on its cargo and returns under cover of darkness. The dory here shown, laden to capacity with bottles of high alcoholic content, and handled by Bahaman natives, is about to leave the side of the rum-runner for the seaplane, the wings of which can be seen in the background

information on, and skill in, the adjustment of apparatus can be acquired by the public. Elementary books on radio, and the radio articles in the daily press should keep the listener sufficiently well informed so that he may know theoretically how to avoid interference when it is possible to do so; and the actual manipulation of his set, intelligently carried out, should soon show him when the theoretical results can be attained, and when they cannot. Now, before delivering reprimands to the public, the radio engineer would do well to consider the reliability of these two sources of knowledge.

We recently heard one of the newspaper radio editors deliver a broadcast talk in which he made the statement that a vacuum tube had been constructed which could deliver one million kilowatts of energy. What he really meant was power, not energy, and in his enthusiasm for making striking statements he forgot the difference between a watt and a kilowatt—if he ever knew it. In one of his recent articles on new circuits, a diagram was given of a circuit highly recommended to his readers, in which the only way the electrons could get from the

The Necessity for Accurate Wavelength Standards

ON SEVERAL occasions recently, the public, or at least the radio portion of it, has been severely scored by the trained radio engineers because of the complaints regarding interference between broadcasting stations—interference which might be avoided if the public knew more about radio technique. There are two methods by which

plate back to the filament was by jumping across a condenser. As long as such material as this is served up for the education of the public it cannot be expected that an understanding of interference will be soon reached.

Another matter which is the cause of much confusion to those whose knowledge of radio is not sufficient to permit an intelligent discrimination in what they accept and reject, is the subject of wavelengths of the various broadcasting stations. These are given in govern-



ESTABLISHING THE FARTHEST NORTH BROADCASTING STATION

Mr. Akbard Ekerold (third from left) headed the party which built a station for broadcasting weather forecasts on Jan Mayen Island, a small cone of an extinct volcano in the Arctic Ocean, north of Iceland. All science seems to be agreed that the world's weather, good or bad, originates within the Arctic Circle and that if storm warnings could be sent out from there, many lives might be saved and many shipwrecks avoided

The picture at the left shows the station which has been established in the desolate Arctic territory. Mr. Ekerold now proposes to put up three other stations in the far North, with which he believes the weather forecasting of the world can be broadcasted daily

ment bulletins as either 360 or 400 meters; in the press an occasional station is advertised as 370 meters, or 403 meters, etc. The fact is that very few of these stations actually transmit on their advertised wavelength—if they did it would be impossible to hear both of them at once as we actually can do to-day. Of two well-known stations, A is advertised as being on 400 meters and B on 403 meters yet B tunes in with less capacity in the receiving circuit than is required for A! How can it be expected that the layman will gain a knowledge of radio by study of the action of his set when such anomalies exist.

It is time wavelengths were somewhat more significant than they are to-day. The question is a simple technical one and could easily be remedied. The standardization of wavelengths throughout the country should be attacked at once by some such representative and capable organization as the Bureau of Standards; it is realized that the Bureau has but a small staff and they are overloaded with work, but it seems that this question is of enough importance to warrant putting aside other work if necessary. If the broadcasting stations actually transmitted on their specified wavelengths, receivers could easily be calibrated for

wavelength when they are installed. Such calibration is generally impossible until the set is in place and connected to its antenna. Let us hope that it will soon be impossible for a listener to tune a 403-meter station with less capacity than he uses for a 400-meter station. Then the public may have a fair chance to learn the elements of radio by observing the action of their sets.

This standardization of wavelengths is a familiar idea to those who worked with the Signal Corps in France. The military service was so crowded with signals that it was necessary to use channels separated by only ten meters. With the present accuracy of our broadcasting stations this would be impossible—a station would not only be out of its own proper channel but in that of some other station. During the war, standard signals were sent out from Eiffel Tower periodically, on specified wavelengths and the various radio experts of the army used these signals for calibrating their wave-meters. By this scheme they were able to maintain their communica-

tion system with a minimum of interference in spite of the very narrow band of waves allowed for each channel.

England Tells About Hearing WJZ

THE following letter and a newspaper clipping, describing an American broadcasting programme heard in England, and throwing some interesting sidelights on the English reaction to our after-dinner speakers, have been received by the Editor. The programme mentioned has been verified as that of the Radio Corporation—Westinghouse station at Newark, N. J., on January 19th.

Derby Wireless Club, Eng.,
22nd January, 1923.

DEAR SIR:

I gather that you welcome communications from wireless amateurs, so I think you may be amused at enclosed cutting from the Derby *Daily Express* of 20th January.

Possibly the station may have been WJZ and not WJD, as I think you pronounce Z as "zee" and not as "zed" as we do over here.

Anyway if you could identify the station we should be pleased to know which it was, and we should much like a list of call signs of your broadcasting stations so that we could endeavor to track them down.

The banquet referred to in the article was probably in a marble hall devoid of carpets and curtains—judging by the resonant quality of the voices—and we noted an entire absence of the popping of corks! I am,

Yours truly,
S. GRIMWOOD TAYLOR.

Here is the clipping, in full:

LISTENING-IN TO AMERICA

Some interesting experiments were carried out locally last evening, or rather during the early hours of this morning, using different types of circuits. An American broadcasting station was soon picked up, calling itself WJD (or possibly WJP or WJB), sending out Tannhauser on the organ, followed by selections from Mendelssohn, with some preliminary explanation by the wireless director. After half an hour of this—and it must be allowed the organ was magnificent—a gentleman who had just returned from the Ruhr, a Mr. Abbott, proceeded to tell America all about it. He referred specially to the withdrawal of the American troops and dwelt volubly on the moral superiority of the American nation, and said what good Samaritans they were. He spoke for about half an hour, and was most useful for testing purposes, and then we were switched on

to after-dinner speeches at a banquet of leading educational authorities. The principal of the University of Iowa appeared to be presiding, and reference was made to the head of Michigan University, who received some applause.* The first speaker had obviously the gift of fluency, and indulged himself in some rather florid oratory. The next was a more typical American after-dinner style of speech. The speaker laughed at his own jokes, and everybody laughed with him, until he unexpectedly dropped into a serious vein and declared that money isn't everything. A dismal silence followed on a ridiculous sentiment of this kind. Perhaps they were all thinking of Mr. Baldwin, or else their darling dollars.

By this time, it was 2.30 A. M., and the experiments were discontinued. It is, however, a novel experience, listening-in to after-dinner speeches in New York.

The aerial used was a single wire one, running north and south—about as unsuitable as possible for the test. The circuits comprised the well-known local capacity-resistance 3-valve amplifier, a tuned-anode high frequency two-valve set, a high frequency transformer, and a double note magnifier, with arrangements for switching in whichever circuit was desired. One of the orators was loud enough to be faintly heard on a "loud speaker." He wound up with a beautiful peroration exhorting his hearers to carry their responsibilities in all sobermindedness, and to do their utmost to re-establish a unified American ideal. The applause following this was quite as loud as what Mme. Melba received at Covent Garden the other night.

Locating Mineral Deposits and Communicating Through Earth

THE technical press has frequently mentioned the possibility of locating ore by radio waves, either by sending radio waves through the ore body and measuring the absorption, or by reflection from the ore body. Some capable and enthusiastic experimenters are putting all their efforts into the investigation of the feasibility of this scheme and it seems likely that radio will soon be performing valuable service for the mining geologist.

The Bureau of Mines is interested in another phase of underground radio, as an adjunct to their other schemes for life saving, when accidents occur which shut the miners off from ordinary outside communication. In connection

*The announcement of this programme was published in New York papers on January 19th as follows:

7:30 P. M.—Estey organ recital from the Estey Auditorium, New York. 8:30 P. M.—Literary programme. 9:00 P. M.—After-dinner speeches at the Western College Conference, Hotel Astor.

with some of the engineers of the Westinghouse Electric and Manufacturing Company, experts of the Bureau of Mines have found that the radio waves do penetrate through perhaps one hundred feet of cover and it is quite possible that they will find it feasible to communicate through several times this distance when the best wavelength has been found and suitable receiving amplifiers are used. We know that signals penetrate sea water about one hundred feet before being attenuated beyond recovery and it seems that penetration in ordinary earth should be greater than in sea water which is a fairly good conductor. Because of the comparative absence of atmospheric disturbances it should be possible to use greater amplification than is advisable with the ordinary antenna reception.

Eliminating the Carrier Wave

IN THE ordinary radio telephone transmission, the antenna is excited by a wave of a certain frequency, e. g., 1,000,000 cycles a second for a 300-meter wave. When the microphone is idle, this frequency is radiated from the antenna with no variation of amplitude. This is the frequency which gives the whistling note when received by an oscillating tube detector.

When the microphone is actuated by the sound waves of the voice the amplitude of this 1,000,000-cycle wave is varied in accordance with the voice wave and this variation of amplitude occurs periodically, say 500 times a second for an upper C note. This variation of amplitude of the 1,000,000-cycle current is equivalent to sending out from the antenna a 1,000,000 radiation plus two other frequencies, 1,000,500 and 999,500 cycles. If the musical note varies in pitch, these two latter frequencies spread out into a band, e. g., the upper might be from 1,001,000 to 1,000,100 and the lower from 999,900 to 999,000 cycles per second. These are called the side-band frequencies and the 1,000,000-cycle wave is called the carrier. Ordinary radio telephone transmission sends out all three, the two side bands and the carrier, and these recombine in the detector circuit to give the original musical note.

In the recent tests by the American Telegraph and Telephone Company in which speech was successfully carried across the Atlantic, not as a stunt but as a commercially justifiable proposition, the casual listener-in received nothing but a jumble of sounds. A set, built

to receive the usual broadcasts perfectly, would yield nothing intelligible in these tests. The engineers responsible for the development had decided to transmit only one side band, suppressing altogether the other one and the carrier. Now, one side band by itself is unintelligible. It is not necessary to have both side bands for successful speech, it is only necessary to have the carrier in addition to one side band, in order to get sounds which can be understood. The trick in this transmission is to put the carrier frequency back into the signal at the receiving station so that although it has not come the two thousand or more miles traversed by the signal, in so far as the detector tube is concerned, its action is just the same as though it had. This scheme of not sending the carrier wave along with the signal saves about 50 per cent. in the capacity of the transmitting tubes required.

In listening to this one side band radio transmission it is therefore necessary to have at the receiving station besides the ordinary tube receiving set, a small oscillating tube set; this oscillating set is made to generate a frequency just equal to that of the carrier frequency at the transmitting station and to feed into the receiving antenna just sufficient of this carrier frequency so that the signal which gets to the detector is just the same as though the carrier frequency had been sent across the ocean with the side band. Nothing if not ingenious!

A Suggestion for Announcers

MANY of our correspondents join in a suggestion which we think well worth bringing to the attention of station managers; it has to do with the announcing of the call letters of the station just before and after broadcasting. One correspondent mentions the fact that many, if not most, radio enthusiasts are more interested in picking up a distant station, even if faint, than in listening to even a good programme from a near-by station. Although some believe this phase of radio will gradually be subordinated to reliable entertainment from the nearest high-grade station, while there are so many listeners straining their ears to catch the station 2,000 miles away their interests must be cared for. Our correspondent writes:

We have all had the experience of listening patiently through some long-winded speech or unin-



REAR ADMIRAL C. P. PLUNKETT, U. S. N.

Through whose courtesy a series of monthly concerts is being broadcasted from station NAH at the Brooklyn Navy Yard. The station operates on a wavelength of 507 meters. Admiral Plunkett is here shown at WJZ, Newark, N. J.

teresting musical number, waiting for the announcement of the station call which we hope will be forthcoming, but we are often disappointed in this respect and find that before the announcement is made the station has faded or local interference has arisen. It would help very much if all stations would give their call letters and location immediately after each selection, as some stations do now.

We think the idea a good one and hope the managers will pay heed to it.

Directional Effects

BY COMPARING notes, radio enthusiasts find that, contrary to what ordinary theory teaches, the waves do not travel outward in all directions from a transmitting station with equal intensity. Until many observations, by different experimenters, had been obtained, it seemed possible that the skill of the various operators might account for apparent discrepancies in the distance a given station could reach. Thus station ABC might be heard consistently by a listener 1,000 miles west of a certain position and practically never by a listener 200 miles east or south. Such an effect was at first attributed to the greater skill of the first listener, or superior apparatus, but by comparing many observations, by many

observers, we now know that stations do not penetrate equally well in all directions and an apparently simple explanation is at hand.

It has been known for some time that a mountain range of conducting material, such as iron ore, acts as a rather effective screen for radio waves, and, of course, theory would predict just such an occurrence. Thus it is often impossible for two ships on opposite sides of a mountainous island to communicate with each other when both are close to the island, but if they each steam away in opposite directions, say 100 miles, communication becomes easy. The mountain range casts a radio shadow, the conducting ore

bodies of the mountain range absorbing the radiation which tries to penetrate them. In a similar manner any ordinary body casts a light shadow, either because it absorbs the light which tries to penetrate it, or reflects it.

It seems also that in a city of tall iron-frame buildings such as New York, a large part of the power radiated from the antenna of a station is absorbed within a few miles of the station. The conducting framework of the buildings have currents set up in them by the traveling waves and these currents represent just so much energy abstracted from the radio waves. The effect is much like that which would occur in trying to set up waves in water filled with floating sea weed; the ripples are able to advance only a short distance through the weed-filled water before their energy is completely used up and they disappear, whereas if set up in clear water with no floating obstructions they might travel several hundred feet.

A modern steel-building city seems to act toward the radio waves just as a patch of seaweed does to the water waves. Because of this effect, it may well be that a station located, let us say, in the western part of such a city, is heard at points a thousand miles west and only a hundred miles or so in the easterly direction. The eastward traveling waves have to travel

over the city and have much of their energy abstracted before they have gone very far. We have heard of a geologist being consulted as to the best place to sink a well for oil; he looks the ground over thoroughly, makes borings, etc., and then gives an intelligent guess as to where the best chances lie. In locating a broadcasting station in or near a large city (as all good stations must be located for accessibility to the performers), it seems that similar expert advice will be required in order to place the station so that minimum absorption will occur in the important directions.

How the British Do It

IN VIEW of the remarkable activities of our amateurs during the last ten or fifteen years and of the country-wide interest and participation in the recent broadcasting developments, it would be natural for us to jump to the conclusion that the other countries can offer us no suggestions in this field which merit our attention. But such is not the case.

It seems to us that the wholesale licensing of broadcasting stations, only a few of which will be able to send out programmes of reasonable technical and artistic quality, is storing up trouble for us in the near future, when it is attempted to get rid of the mess of interference which exists to-day. Our British cousins are apparently cognizant of such a possible trouble and are therefore going to license but few broadcasting stations, each of which will be carefully regulated as to wavelength. But in the matter of receiving stations they have taken a step which, while putting a few difficulties in the way of the manufacturer, will eliminate the source of much of our present trouble—receiving sets which generate oscillations in the antenna.

All receiving sets put on the market in Great Britain must be approved by the Post Office authorities, and before their approval is bestowed, certain regulations must be complied with. The sets must be able to receive any wavelength in the broadcast band, 350 to 425 meters, with an antenna of any length between thirty and one hundred feet; sets must also be so built that it is difficult to change the connections without unsoldering joints (that wouldn't stop the average American boy very long!) and some other similar requirements. But most important among the requirements are those having to do with sets having regenerative

features. No set will have the approval of the Post Office if it can be made to set up oscillations in the antenna; it will be tested under all reasonable conditions with extra plate voltage, extra filament current, etc.—and if oscillations are set up in the antenna, the apparatus is to be condemned.

Shouldn't we have erected, or at least tried to erect, this barrier against the interference of oscillating receivers? It might mean more expense for the enthusiast who wants to receive continuous-wave telegraph signals, but the slight inconvenience to a few would be more than offset by the resulting freedom from interference of this kind. This restriction does not mean that the remarkable improvement in reception which regeneration makes possible could not be utilized in our receiving sets, but the regenerative feature would have to be applied in a circuit not directly coupled to the antenna.

High Tension Wires Transmit the Voice

THE idea of sending the voice over wires by using modulated high-frequency currents is apparently to be the subject of legal action between General Squier and the Western Electric Company, but even though the priority of the idea is in question its application keeps right on growing. The method is actually used by the telephone company in some of its trunk lines, where it goes by the name of "carrier telephony." General Squier calls it "wired wireless."

Within the last few years electric power companies have been attempting to use wired wireless as an extra link in the communication system connecting their various stations and substations. Especially in case of storms is it necessary that the various parts of the power system be closely coordinated and on just such an occasion is it likely that the overhead telephone wires may be down. So, partly to reduce telephone expense, but principally with the idea of assuring the continuity of communication, the effort has been made to send the weak high-frequency carrier currents over the same wires as those carrying the powerful high-voltage currents for operating railways and lighting systems.

Reasonable success has attended the experiments. Recently the General Electric Company announced the satisfactory operation of such an installation through forty miles of

70,000-volt transmission line. The modulated high-frequency current, generated by a 50-watt triode transmitter is supplied to a wire about a thousand feet long which is strung underneath the transmission line wires, at a safe distance. Sufficient power is thus sent into the high-voltage wires, by induction, to send the current along the wires, and a similar arrangement—a “pick-up” wire—at the receiving station enables the operator to receive the signal without danger of shock from the high-voltage lines. No trouble from fading or atmospheric disturbances is encountered and no government rules restrict the application of this idea. Thus the scheme seems likely to win an important place in the field of communication. The only feature which had to be worked out for this application of carrier telephony was the connection of the transmitting and receiving apparatus to the power wires of very high voltage without danger of shock to the operators.

Radio in South American Politics

OUR politicians would do well to turn their eyes southward when laying plans for their next campaign. Of course there must be uppermost in their minds the question as to how radio may best serve their candidate. During the last elections a start was made in the use of radio for campaigning, and we were able to sit comfortably at home and listen to the various candidates extol their own virtues. But the managers who sent their candidates to the broadcasting stations for a few evenings, and were content with that, should read of the exploit of the Colorado party of Uruguay.

A broadcasting station of considerable power has been installed at Montevideo, we learn through a communication from our consul there. This station was rented by the management of the Colorado party—rented for the whole period up to election day. It naturally follows that their opponents didn't profit much by the



BROADCASTING IN A DRAMATIC SETTING

On top of the peak which rises precipitously above the city of Rio de Janeiro is station SPC, erected by the Westinghouse Company and used for broadcasting the Rio operas and other entertainment during the exposition

messages which were sent out and as this is the only radio station in Uruguay it seems that there the ether played a rather more biased rôle than we have ordinarily assigned to it. It would be interesting to know how much of a part radio plays in our elections, but we shall never find out unless each of the parties will voluntarily desist from using radio propaganda every other election, for instance. If each party could have the sole control of the broadcasting on alternate elections we might be able to evaluate radio as a political asset—but the politicians probably will not agree to try the experiment.

Receiving with Horizontal Loops

ONE of the anomalies encountered by the student who tries to bring into agreement the theory and practice of radio transmission occurs in connection with the loop antenna; according to the generally accepted views of radio waves a loop must be placed vertically if it is to pick the energy out of the advancing waves. Yet dwellers in apartment houses who have recourse to loops (to avoid a conflict with the landlord which is likely to occur when the subject of antennas on the roof is mentioned) find that a horizontal loop receives about as well as does a vertical one.

The reason is undoubtedly to be found in the action of the steel framework of the building; this itself acts as a receiving antenna, picking up appreciable energy from the signal waves as suggested above in discussing the directional effects of stations. These currents in the steel framework flow in haphazard directions and are as likely to affect a horizontal loop as a vertical one.

That such effects do occur in steel frame buildings is seen when the attempt is made to get directional data on stations by using a loop in a steel building. The direction of a station is seldom obtained correctly, and often no directional effect at all can be found. In no position will the coil yield zero signal and there is no appreciable maximum, regardless of the direction in which the coil is turned.

What Broadcasting Regulation is in Store for Us

UPON the passing of the White Bill we are likely to find a marked tendency toward suggestions for altering the scheme of broadcasting wavelengths and schedules. Many of these suggestions will come from those who make and sell some particular kind of receiver or who have some other axe to grind.

Properly arranged, we feel that the wave bands suggested by Secretary Hoover's committee would work out satisfactorily if good receivers are used. Reviewing the recommendations of this committee, we find broadcasting wavelengths treated in the following manner:

Government and public broadcasting . . .	1050-1500 meters
Government and public broadcasting, 700 miles inland . . .	700-750 meters
Private and toll broadcasting	310-435 meters
City and State public safety broadcasting .	275-285 meters

Further along, we find the terms described in this manner:

"Broadcasting" signifies transmission to an unlimited number of receiving stations without charge at the receiving end. It includes:

1. *Government Broadcasting*, signifying broadcasting by departments of the Federal Government;

2. *Public Broadcasting*, signifying broadcasting from public institutions, including state governments, political subdivisions thereof, and universities and such others as may be licensed for the purpose of disseminating informational and educational service;

3. *Private Broadcasting* signifying broadcasting by the owner of a station, as a communication company, a store, a newspaper, or such other private or public organization or person as may be licensed for the purpose of disseminating news, entertainment and other service, and

4. *Toll Broadcasting* signifying broadcasting by a public service radio telephone company as a paid service.

Some few months ago the National Radio Chamber of Commerce sent out a questionnaire to representative radio people throughout the country. The recipients were asked for their views on radio legislation and were told that a symposium would be arranged from their replies.

The Chamber reports a very hearty and wholesome response to the questionnaire and is working upon a report to be submitted to its members and forwarded to those who regulate such matters at our National Capital, as the Chamber's view of how the wavelength and similar matters should be handled. The findings in brief, are these:

The following requirements are urgently needed:

1. Reduction of interference between broadcasting stations.

2. A method for permitting three stations in a given district to operate simultaneously.

3. Broadcasting stations to arrange their schedules to include:

A. Technical or advanced music

B. Popular music

C. Educational features

Each of these classes to be on an individual wavelength in a given district.

4. Establishment of a silent period to permit long-distance reception.

By dividing the country up into districts, the size of the district depending upon the population; dividing the operating hours between the three stations in a district; arranging wavelengths, time periods, power and classes of broadcasting, it is thought that great relief from existing conditions may be brought about soon. Rotating of the time periods allotted each district should result in a fair division of time for the broadcasters and much more satisfaction for the listener-in.



“OUT-OF-THE-STUDIO” BROADCASTING IN THE JAPANESE CAPITAL
The Viscount Shibusawa addressing a vast crowd in Hibiya Park, Tokio

The report points out that sharp tuning in a radio set is possible, but that a vast majority of the receiving equipment available now would not function satisfactorily, especially in the hands of an unskilled operator, unless the wavelengths of various stations were fairly well separated.

The amateur has not been disregarded in the matter of wavelengths, and it is quite likely that the immediate future will find him better off than he is at present.

If the proposed arrangements of the Chamber were followed, the value of the average receiving set would be increased some 300 per cent., while an even greater increase in value is promised for the set of more than average sensitivity.

From a study of both these plans, made by the Department of Commerce Conference on Radio Telephony and the National Radio Chamber of Commerce, it would seem as though the interference problem is anything but

an insurmountable one and relief from the present chaos should soon be at hand.

Radio Again Serves in Its Most Important Rôle

FIRST and last the rôle for which radio is preëminently fitted is that of saving life at sea. The freighter *Montello* met with such terrific storms on her trip out from Philadelphia on her way to Marseilles that in mid-ocean it became necessary to abandon her. An SOS call, giving the location of the sinking vessel was picked up by the Italian liner *Giuseppe Verdi* and in half a day she had located the sinking ship and started the rescue work. Ultimately, she was able to save the entire crew. The life boats of the *Montello* had been smashed by the mountainous seas and it seems certain that all on board would have been lost, had it not been for radio.

J. H. M.

There Are No Noisy B Batteries

By E. E. HORINE

National Carbon Company

THE appearance of the usual block type B battery is more suggestive of a paving brick than a fine musical instrument, yet in radio-telephony the B battery becomes one of the most versatile musical instruments known. On occasion, it reproduces perfectly the music of a violin, a French horn, or an entire symphony orchestra, for everything heard from a radio set, whether it be speech, or music, or code signals, proceeds directly from the B battery to the ear of the listener.

True, the immediate source of sound is the telephone receiver, or loud speaker. But these devices do not generate the sound; they merely serve to transform electrical energy into sound, much as the electric lamp transforms electrical energy into light. In the case of the lamp, the real source of light is the generator in the power station; with the telephone receiver, the actual source of sound is the B battery, for it supplies the current which operates the receiver.

The work done by the B battery in reproducing sound is rather complicated, and to get some idea of its nature, it will be necessary to touch lightly upon the subject of sound.

Sound is a wave motion, consisting of alternate layers of compressed and rarified air. Sound waves may be generated by any vibrating body. In radio receiving sets, they proceed from the vibrating diaphragm of the telephone receiver.

Each sound in nature has a wave-form which differs in shape from the wave-form of every other sound. These wave-forms are usually quite complex, and the difference between them is sometimes minute, but it is the tiny variations in the shape of the waves which enable the ear to distinguish between musical instruments, or to identify individuals by the sound of their voice.

When a sound wave strikes a diaphragm, the compressed layer of air pushes it in one direction, and the rarified layer pulls it back in the opposite direction. If the diaphragm is properly constructed, and is sensitive enough, its motions will follow accurately the wave-form of the sound.

The illustrations (Figs. 1 to 5) were made by recording the motions of such a diaphragm. The motion of the diaphragm is transferred by suitable mechanical devices to a small mirror, on which is concentrated a beam of light. As the mirror swings back and forth due to the motions of the diaphragm, the spot of light reflected from the tiny mirror also swings back and forth on a sensitive photographic film, which moves past the mirror at a uniform speed. The moving spot of light is thus made to trace on the film a permanent record of the sound wave. These records were made by Professor Dayton C. Miller in his laboratory at Case School of Applied Science, and will serve to illustrate the manner in which sound waves from various sources differ from each other.

Fig. 1 is a reproduction of the sound wave produced by a tuning fork vibrating 256 times a second (Middle C). This is an example of a pure tone, consisting as it does of the fundamental only. It is a pure sine curve, and is, perhaps, the simplest sound wave in nature.

The curve in Fig. 2 is somewhat similar to that of Fig. 1, but it will be observed that there is a series of overtones superimposed on the fundamental, appearing as minor ripples on the main curve. It is the number, amplitude and position of these overtones that give "quality" to the sound, and enable the ear to identify the instrument producing it. This particular record was made by a violin.

Fig. 3, was produced by a French horn. Here the overtones almost overshadow the fundamental, which accounts for the peculiar booming quality of the sound produced by this instrument.

Figs. 4 and 5 are records of the human voice. Both were made by the same individual, Fig. 4 being produced by the sound "ōō", and Fig. 5 by pronouncing the vowel "ēē".

These curves are comparatively simple, representing as they do a single sound proceeding from only one instrument or voice. The complexity of the curve which results from blending the individual wave-forms of seventy or more instruments all playing at once is simply beyond comprehension! And yet, if a

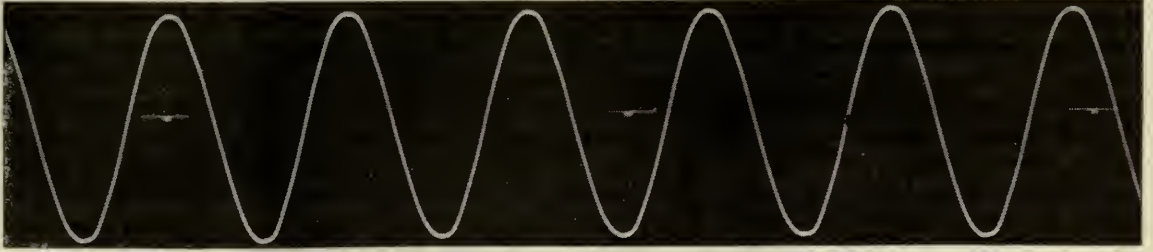

Fig. 1—Tuning fork

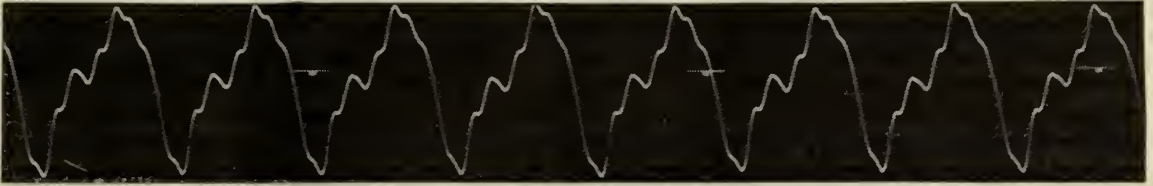

Fig. 2—Violin

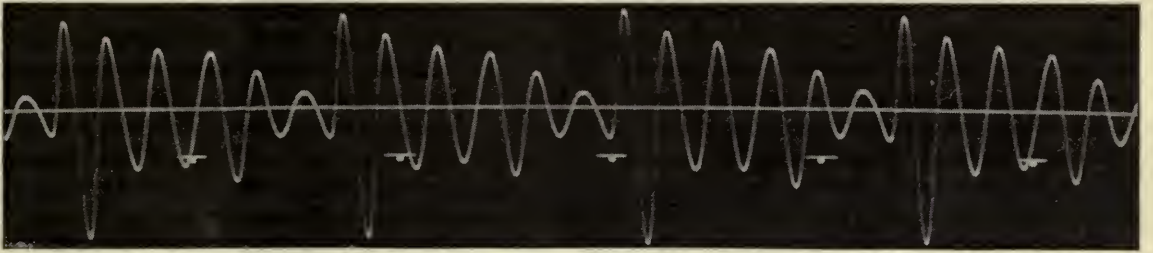

Fig. 3—French horn

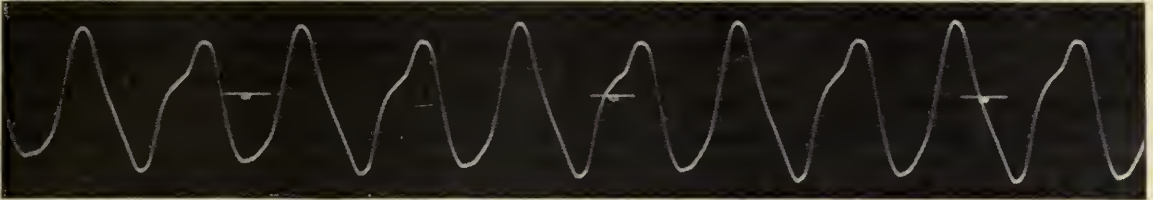

Fig. 4—Human voice, sound "oo"



Fig. 5—Human voice, sound "ee"

PHOTOGRAPHIC RECORDS OF SOUND WAVES

telephone receiver is to reproduce a symphony orchestra, its diaphragm must vibrate strictly in accordance with that unbelievably complex curve. It seems impossible that any man-made thing could do this, but the telephone receiver undoubtedly does, for the air is full of orchestra music every night, and any one possessed of a radio set can hear it.

To make a receiver diaphragm vibrate, it is necessary to furnish it a current which fluctu-

ates accurately in accordance with the waveform of the sound to be reproduced. While the curves shown in Fig. 1 to 5 are really photographs of sound waves, they might as well have been labeled "B Battery Current," for the two are identical.

It is characteristic of batteries in general that the current delivered by them is steady and free from all traces of fluctuations. There is no property in a battery itself which enables it to

establish fluctuations in its own current, hence some external device must be employed to change the steady battery current into a fluctuating one.

Fig. 6 illustrates an elementary method of accomplishing this result. As long as the handle of the rheostat is stationary, the current flowing in the circuit will be steady, and the receiver remains silent. By moving the handle back and forth from A to B the current is caused to vary in strength. When the current is strongest, the pull of the permanent magnet is increased, and the diaphragm is deflected to position b; when it is weakest, the attractive force of the magnet is diminished, and the diaphragm recedes to a. As the controller handle is moved back and forth, the diaphragm also moves back and forth, keeping step with the motions of the handle. If the motions are sufficiently rapid, the receiver will emit a note. It is conceivable that some one endowed with an extra amount of agility might be able to manipulate the handle in such a manner as to cause the current flowing in the circuit to assume the form shown in Fig. 2, in which case the sound emitted by the receiver would be a perfect reproduction of a violin. The act of setting up desired fluctuations in an otherwise steady current is called "modulation."

It is, of course, beyond the bounds of human ability to modulate the B battery current manually, as just outlined. In radio receiving sets, this function is performed by the vacuum tube.

Fig. 7 is exactly like Fig. 6, except that the

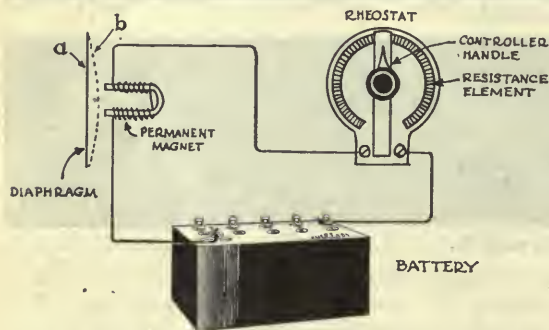

FIG. 6

Illustrating how the B battery causes the receiving diaphragm to vibrate and thus produce sound

rheostat is replaced by a vacuum tube. The space in the tube between the plate and the filament corresponds to the resistance element of the rheostat, and the grid becomes the controller handle. Under the action of the radio waves, the grid causes the resistance of

the tube to fluctuate, which results in corresponding fluctuations in the current drawn from the B battery, and since this same current also flows in the coils of the telephone receiver, the diaphragm is thrown into vibration, and thus the B battery energy is transformed into sound.

The ultimate purpose of the vacuum tube is to set up these desired fluctuations in B battery current. Unfortunately, however, there are occasionally other agencies at work which set up undesired fluctuations, and when this happens, the result is noise.

Noise in radio receiving sets is always the result of irregular, non-periodic fluctuations in B battery current, just as speech or music is the result of regular, accurately-controlled fluctuations. Noise is simply current fluctuations out of control, and anything which acts to introduce these outlaw fluctuations in the B battery current becomes a source of noise. *And just as it is necessary to resort to some device external to the battery to produce the desired fluctuations, it is also necessary to look for something outside the battery when seeking the cause of undesired fluctuations, or noise.*

A great deal has been said and written from time to time about noisy B batteries, and the impression is rather general that certain noises occasionally heard in radio sets are "battery noises." The arguments presented by the proponents of the noisy B battery, sound logical and convincing, especially to those possessing rudimentary knowledge of the chemistry of the battery; but to one who has thoroughly studied the subject, they are ridiculous.

The truth of the matter is, batteries are never noisy. It does not matter whether it is a dry B battery or a storage B battery (unless the storage battery is "gassing"); there is nothing in either type which could possibly make it noisy. Of course, if there is a loose or faulty connection anywhere in the battery, the connection may cause noise. A poor contact will do that anywhere in a radio set. But in a well designed, carefully constructed B battery the chances of poor connections are extremely remote.

It is probable that loose connections in the radio set account for most of the so-called battery noises. To produce noise in a radio set a contact does not have to be very poor; a joint which would be called perfect on a lighting circuit might easily be unfit in a radio set. It does not follow that because a joint

is soldered it is a good joint; it not only must be soldered, it must be well soldered. Some mysterious noises have been traced to the use of dissimilar metals in different parts of the radio circuit. Whether the noise was due to galvanic action between the metals, or to thermo-electric effects, cannot be said. But it was due to one of these causes.

Under certain circumstances the grid leak

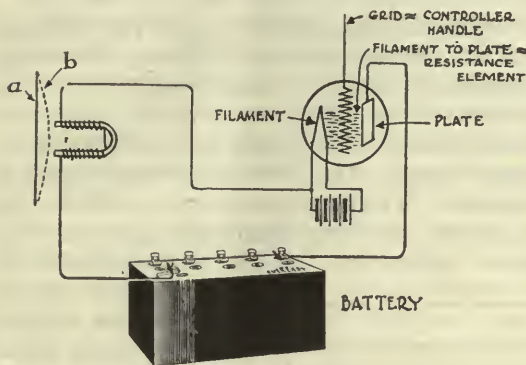

FIG. 7

Here the rheostat of Fig. 6 is replaced by a vacuum tube. When the resistance of the tube is made to fluctuate by incoming radio waves, the B battery current fluctuates correspondingly, producing sounds in the telephone receiver similar to those producing the incoming waves

may become a source of noise. Most leaks are constructed by drawing a line between terminals with India ink. Under the microscope, such a line reveals itself as myriads of tiny particles of carbon, loosely touching each other. Here are literally millions of loose contacts, and the worst part of it is, they are in the grid circuit, where even the tiniest fluctuation results in greatly magnified variations in B battery current.

Accumulations of dust on the plates of variable condensers can produce noise. There are four possible loose contacts in the average tube socket. Many a case of alleged B battery noise has been cured by pushing a tube down more firmly in its socket. The usual wire-wound filament rheostat presents another chance for loose connections. Varico-couplers and the variometers with brush connections to the moving element may become noise producers. The list is almost endless.

These things are listed as possible noise producers. It is not claimed that they invariably cause noise. If well designed and carefully made, they give satisfactory service. But the average radio enthusiast seems to think it possible to buy a thirty-cent article and get

two-dollar performance from it. And when he doesn't, nine times out of ten he blames the poor results on his B battery!

In addition to noises which can be traced directly to a loose contact in some form or other, there are at times other noises which are not so easily accounted for. The causes of these mysterious noises are not definitely known, but it has been observed that the tendency to produce noise is increased by sub-normal B battery voltages. This is why B batteries are believed to become noisy when nearly exhausted. Substituting a new battery for the old one will stop the noise, not because the old battery was noisy, but because this procedure restores the voltage to normal.

At present, it appears that certain of the so-called battery noises are due to some unknown peculiarity of receiving sets. The exact reason for these noises will probably be discovered in the course of future radio developments which may upset many of our present ideas. However, one thing is sure: future developments may revolutionize certain parts used in radio sets, but in doing so, they will surely bear out the statement, "There is no such thing as a noisy B battery".

The same thing was true of the telephone. In the early days when this remarkable instrument was first coming into general use, a great deal of trouble was encountered with what was then believed to be noisy batteries. Those old noises were exactly like the present-day "battery noises" encountered in radio sets, and everything pointed to the battery as the offender. Yet, as the telephone underwent its natural process of development and refinement, the battery noises ceased. And to-day, a noisy telephone battery is unheard of, although there are millions of dry cells in telephone service. To be sure, the telephone dry battery underwent a similar process of refinement, so that, to-day it possesses greatly increased capacity, and gives much more dependable service over longer periods, but nevertheless, chemically, it is the same dry battery of thirty years ago.

No one would have the temerity to say that present-day receiving sets are the final product. It is impossible to say what the ultimate set will be. But it is safe to predict that radio receiving apparatus will undergo the same process of development and refinement as did the telephone; and it is also safe to say that the result will be the same: it will eliminate the belief that the battery is a noise producer.

What Good is a Patent?

What a Patent is, and is Not. How to Play the Game According to Hoyle

By ROGER SHERMAN HOAR, A. B., M. A., L. L. B.

Former Assistant Attorney General of Massachusetts

Decorations by RALPH MILNE FARLEY

IN ORDER that there may be no misunderstanding, let me state at the outset that it is not the object of this article to attempt to explain the present patent situation with respect to radio. That situation is pretty nearly in a hopeless chaos, a veritable de Forrest of technicalities. The radio inventors are the boys who put the TNT in patent; so the best advice which I can give in this connection is never to blow down the muzzle of a radio patent, unless you are sure it isn't loaded.

But, seriously speaking, this situation is bound to rectify. In the meantime, the amateur experimenter ought to know just what his rights and duties are under the general patent law, and just what steps he should take for the future protection of any bright ideas which he may originate in the course of his experiments.

To what extent may an experimenter legally duplicate a patented device? Is it lawful to repair a patented machine oneself? What steps should an inventor take to protect an idea, so that he can eventually patent it, or at least so that some later inventor may not exclude him from the use of his own invention? How should one go about getting a patent, what will it cost, and how much good will it be when issued? These are but samples of the many legal questions which undoubtedly occur daily to many radio fans.

Do you remember how, when you first took up radio, you were mystified by the glib way

in which full-fledged fans juggled the following words: audion, audio frequency and radio frequency, capacity, counterpoise, dielectric, electron, filter, impedance, modulation, microfarad, potentiometer, super-regeneration, variocoupler, etc? Yet how simple they seem to you now! You are now equally mystified when a patent attorney learnedly mentions the terms: prior art, constructive reduction to

practice, and interference—which to you vaguely suggest painting, architecture, and radio, respectively, but otherwise mean absolutely nothing in your young life.

Yet patent law is A B C compared with radio. The object of the series of four articles of which this is the first is to explain the general principles and technical terms of this law, so that they can be digested by any intelligent person at one reading.

The great trouble with most inventors, engineers, and scientific experimenters—

the present reader, of course, excepted—is not that they fail to realize the need of some smattering of knowledge on this subject, but rather that they have absorbed much of the heterogeneous mass of popular superstition and misinformation which passes current for patent law.

As Josh Billings used to say: "What we don't know don't hurt us as much as knowing a lot of stuff that ain't so."

The most firmly entrenched erroneous idea concerns the very nature of patents themselves. Therefore it will be my first task to lay the

The author, a well-known writer on law and mechanics, is at present Head of the Patent Department of the Bucyrus Company, Milwaukee, Wisconsin. This article is the first of a series of four by Mr. Hoar, in which various angles of patent law will be simply explained.

In experimenting with radio you are likely to stumble on some peculiar and new arrangement of great value. By protecting your discovery properly, it may mean a great deal to you. Lacking this protection, a fortune may slip through your fingers.

Most experimenters know little of patent law, sometimes because they hesitate to plow through a mass of dull technicalities. But this series of articles, lightened by the author's humor, will make interesting reading for anyone.

Next month, Mr. Hoar will answer the question, "What Can Be Patented?"—THE EDITOR.

foundation for the rest of the series by explaining just what a patent is.

The Constitution of the United States empowers the Congress to "promote the Progress of Science and useful Arts, by securing for limited Times to Authors and Inventors the exclusive Right to their respective Writings and Discoveries." Pursuant to this power, the Congress on April 10, 1790 enacted our first patent statute, the terms of which have remained practically unchanged since 1870.

Under this law the Commissioner of Patents, after an investigation has satisfied him that the applicant is the original and first inventor of some new and useful improvement, will grant to the applicant a "patent," which will be good for seventeen years from the date of issuance.

The most important thing to realize about patents in general is that a patent is *not* a license to manufacture; in fact, most owners of patents cannot manufacture their own patented device without thereby infringing someone else's earlier patent.

To make this point more clear I shall employ a fictitious illustration, to which I shall often revert during succeeding articles of this series. Let us suppose that a Mr. Adam conceives of, and makes, the first desk ever known, and secures a patent on his broad basic idea. A few years later, along comes John Smith, with the bright conception of a desk with a round hole in the middle, and applies for a patent on *his* invention. If he can show that the hole serves some useful purpose, he has clearly made an improvement on the first invention; and, if his claims all mention the hole, his patent will issue without the examiner ever once mentioning the Adam device.

Let us now suppose that Smith, with his patent, goes to a furniture manufacturer to induce him to make such desks on a royalty basis.

"Are you sure that we are safe in going ahead?" asks the manufacturer.

"Here is my patent, guaranteeing us the right," replies Smith, "My case was so clear that the Patent Office did not cite a single patent against me."

So the royalty agreement is drawn up and executed, and the desks-with-the-hole are put on the market. But one day, to the surprise of the manufacturer, along comes Adam's lawyer, armed with an injunction prohibiting the making of any more desks.

"But, look here!" exclaims the manufac-



"I'LL INVENT SOMETHING YET! THE FIRST HUNDRED YEARS ARE THE HARDEST"

turer, "I own Smith's patent, which states in so many words that it grants him the exclusive right to make, use, and vend his invention throughout the United States."

"Ah!" replies the lawyer, "but Adam's patent grants *him* this same right with respect to *his* invention; and, as Adam's grant is earlier than Smith's, and broader than Smith's, Smith's patent is subject to Adam's prior rights."

There you have it in a nutshell, just why a patent does not guarantee to the owner the right to use his own invention, but merely guarantees to him the right to prevent others from using it. Adam, who invented the first desk, can keep any one else from making desks of any sort. Smith, who invented the desk-with-the-hole, can keep any one else from making *that sort* of a desk. He can keep even Adam from making desks-with-holes; but that fact does not entitle Smith himself to make them. Smith's only hope would be to offer to license Adam to make the improved desk, in return for a cross-license, entitling Smith to make his own invention himself!

Oh, how many heartbreaks would be spared, if the Patent Office would kindly add to the grant-words of a patent, the phrase "Subject however to any prior rights of others," for that

is the real intent and effect of every valid patent.

Please note that we have assumed that Smith's patent was valid. If so, its *validity* was in no way affected by the production of Adam's patent, though its value was greatly reduced. The grounds on which a duly issued patent may later be declared to be *invalid*, will be treated elsewhere in this series.

Having now seen what a patent is, namely merely a license to prevent others from using your invention, let us now consider just what



"YOU CAN'T MAKE
DESKS WITH HOLES"

constitutes the infringement of a patent. There is a deal of misinformation current on this subject as well.

Infringement consists in the unauthorized making, using, or selling of the invention of another, during the life of his patent. And yet almost any one will give you the gratuitous misinformation that it is perfectly all right

for you to manufacture, and even to use a patented invention, provided that you don't sell it or otherwise make any money out of it. That this is incorrect is seen by reverting to the wording which occurs on the face of every patent stating that the government grants to the patentee "the exclusive right to make, use and, vend the said invention throughout the United States and the Territories thereof."

But these words are not to be taken too literally, for the making of the patented invention for amusement or for scientific investigation, although technically an infringement, nevertheless cannot be prevented or made the basis of a suit. The reason for permitting scientific experimenting with an invention is that the object of the whole patent system is, as we have seen, "to promote the progress of science and useful arts." The reason for permitting a man to amuse himself with another's invention is probably based upon the legal maxim that "Courts refuse to bother about trifles."

There is, however, an exception to this right to make and use the device of another for pur-

poses of amusement: namely, that you cannot so use a patented game, toy, radio outfit, etc., for otherwise the whole object of patenting such an invention would be destroyed.

At all events, manufacture or use, for any other purpose than experiment or play, can be stopped by injunction, or made the basis of a suit for damages, or both. Making money out of the device, of course, takes the use effectively out of the experiment-or-play class, and *sale* for *any* purpose is an infringement.

Infringement is not avoided by the substitution of an equivalent for one of the elements of the invention. In determining the question of infringement, each claim of the patent is treated as though it were a separate patent; thus one claim may be held to be valid and infringed, another claim may be held invalid, and another claim may be held valid but not infringed, all in the same patent. To sell an element, knowing that it is to be used in assembling an infringement, is in itself a contributory infringement. So also is the selling of a machine, useful only in the production of infringements.

Right here comes in a very important point, which is generally overlooked, namely that the innocent purchaser of an infringing article can be enjoined from its use and can be sued for damages by the patentee. In fact, this is the means usually employed by manufacturers of patented articles in order to bring suit in a convenient jurisdiction against an infringing competitor. Furthermore, it is much more annoying to such a competitor to have its customers jumped on one by one, than it would be to have a single suit brought against itself.

So it would pay the radio fan to be very careful lest he get himself into trouble by buying some infringing piece of apparatus from some outlaw concern. And yet this question of infringement by an innocent purchaser is more of a practical, than a legal, one. In the first place, it is extremely unlikely that the owner of a patent is going to bother himself about such small-fry as individual users. In the second place, it would be bad business for the owner of a patent to antagonize a lot of potential customers. And in the third place, the infringing manufacturer, if he is at all reputable, is going to back up those to whom he has sold.

The following rather technical question sometimes arises, which can best be illustrated by reverting to the desk-with-the-hole. Suppose that either Adam (holding the basic desk pa-

tent) or Smith (holding the desk-with-the-hole patent) should sell you a desk-with-a-hole, and then should acquire the other patent. He could not, under the second patent, prevent you from using the desk which he had sold you under the first. A great many similar applications can be made of this principle of fairness, which applies equally well to licenses under one or more of a group of several patents.

And now suppose that you own a patented machine, legally bought by you from the patentee. To what extent can you repair it yourself without infringing the patent? Obviously you have the right to use it until worn out, and therefore you can repair it and substitute new parts for old, so long as you do not destroy the identity of the machine. You cannot legally, however, reconstruct or rebuild a worn-out patented machine. No general rule can be laid down by which to determine the exact line of demarcation between legitimate repairs which the purchaser of a patented machine can rightfully make, and a reconstruction or reproduction which will constitute infringement. Each case must be decided on its own facts, taking into consideration the scope of the invention and the actual intentions of the purchaser. Also it should be noted that, if the repairs consist in replacing some part, which is itself specifically patented or which constitutes the patented feature of the whole machine, then this would amount to the *making*, rather than the *repairing*, of a patented article, and hence would not be permissible.

There can be no infringement of a patent before it is issued, which fact is often important in determining whether or not to rush proceedings in the patent office. But note that, although a machine can be legally made and legally sold without the permission of the owner of a *pending* patent; yet, as soon as the patent issues, the patentee can stop the purchaser from *thereafter* using the machine. The fear of this is what makes even a merely pending patent of some value.

The inventor's remedy for infringement consists in an injunction, damages, and an accounting for profits, all obtainable by suit in the Federal Court of the District in which the infringer lives, or in which the infringement takes place. The plaintiff has the burden of proving both the validity of his patent and the fact of infringement by the defendant.

A preliminary injunction (i.e., an injunction issued before the final termination of the suit) will not be granted except when irreparable injury to the plaintiff is clearly imminent. It will usually not be granted if the defendant is financially responsible. If the defendant is *not* financially responsible, he will usually merely be required to give bond to pay whatever damages may be awarded. If the validity of the patent is disputed and has never been previously established by a court decision or been generally acquiesced in by the public, then an injunction will be refused.

But an injunction can always be obtained at the end of a successful suit.

Damages are to be measured by the actual loss to the plaintiff, and will be confined to the particular part of the machine covered by the patent, although the entire damage will be assessed if the entire value of the machine is due to the patented feature. License fees charged to others are

a good guide. The judge, in his discretion, can allow double or treble the amount of the damages.

No damages can be collected unless the infringer actually knew of the patent, or at least had "constructive notice" because of the proper marking (i.e., "patented" and the date) on all machines lawfully made under the patent. And in no event can damages be collected further back than six years prior to the commencement of the suit.

Where there is no other means of estimating the damages, the profits made by the infringer may be considered; but the real test is what the plaintiff lost, rather than what the defendant gained.

However, the plaintiff can collect, in addition to damages, an amount representing the gains and profits of the defendant. These consist in the saving or advantage in the use of the patented improvement, as compared with former substitutes. When an infringer profits on some sales and loses on others, he is liable for the profits without deduction for the losses.



**"YOU CAN'T MAKE
ANY KIND OF DESK"**

To emphasize some of the foregoing points, let us revert again to Smith and his desk-with-a-hole. When Adam, as owner of a more basic patent, stops him from manufacturing, he goes to a patent attorney to see if there isn't some other way to make a living out of his patent. Smith lives in Boston. The Golden Gate Co. of San Francisco is making desks-with-holes.

"Sue them," suggests the attorney.

But the expense of a suit in California frightens Smith. However, it appears that the Golden Gate Co. has sold quite a lot of its desks right in Massachusetts. Smith gets a list of these customers and goes over it with his attorney.

Customer 1 is using his desk as a bean-bag game to amuse his children, and so can't be touched.

"Too bad we didn't mention that use in our specifications; then we could get him," laments the attorney.

Customer 2 is a furniture maker. He has taken his desk to pieces to see how it works and is trying to improve on it. He can't be touched, either.

But five or six other customers are employing the desk as a desk, or for some other useful purpose. Smith has nothing to lose by their antagonism, for Adam has forced him out of business, so he sues them all in the District Court of Eastern Massachusetts, collects damages enough to pay for his trouble, and compels the Golden Gate Co. to make a royalty agreement with him.

Then, on the side, he sues two of his own customers for repairing the desks which he had sold them. He wins against one who has put a new top on his desk, but loses against the other who has merely put on a new leg.

We have seen that the value of a patent lies chiefly in the protection which it gives the inventor in manufacturing his own device (subject, of course, to prior more basic patents), and in the power which it gives him to enjoin competition and to collect royalties, damages, and profits.

In conclusion, let me point out that even an *invalid* patent may be valuable. I know of one actual case where a patent, very vital to an entire industry is held by the A Company. All of its competitors, except the B Company, pay a royalty of \$50.00 for this device on every machine that they build, these royalties aggregating some \$100,000.00 per year. The reason that B Company pays no tribute, is that it has found and bought a machine, embodying the patented feature, and made more than two years before the filing of the patent application. A exacts no royalty from B, and in return B keeps the existence of this machine a secret, for its production in any Court would at once result in A's patent being declared absolutely void.

But note that A's patent is *not* void—yet! And until it is declared void by some Court of competent jurisdiction, there is nothing illegal, or even immoral, in A continuing to collect royalties.

Keeping Your Storage Battery Working at Its Best

By W. S. STANDIFORD

THE storage battery is one of the most important pieces of apparatus used in receiving sets. If it is not functioning well, your set will give you poor entertainment, or none at all. But since many newcomers are joining the ranks of radio enthusiasts, and since it is easy to keep a battery working efficiently, some practical information on this most abused and least understood appliance may be of interest.

There are two types of storage batteries on

the market, the first consisting of specially prepared lead plates standing in a sulphuric acid solution. The other is known as the Edison battery; its plates are made of nickel steel, containing nickel peroxide and spongy iron immersed in a solution of caustic potash. Both kinds have their advantages and disadvantages, there being no perfect storage cells made. Storage battery capacities are rated by their manufacturers in ampere-hours. Thus theoretically, a 60-ampere-hour cell will supply

6 amperes of current for about 10 hours; 3 amperes for about 20 hours and 1 ampere for about 60 hours. In practice, however, as the discharge rate is increased the capacity of a single charge is reduced, and a 60-ampere-hour battery would deliver 10 amperes for five hours instead of six. It would ruin such a battery to take 60 amperes out of it in one hour's time, however; the plates would buckle under such a rapid discharge. From this it will readily be seen that holding a thick wire across the terminals to see it get red-hot, is an expensive experiment. Batteries in radio service as contrasted with those used for automobile lighting and starting, operate at extremely low discharge rates, one, two or three amperes being about an average current, although it depends upon the number of tubes used. In purchasing and using storage batteries, the radio enthusiast should realize that while a 40-ampere-hour battery costs less than one of 120-ampere-hours, capacity the former will become exhausted sooner than the larger one, thus making it necessary to bother with frequent recharging, which costs money and takes time.

For the benefit of those who have a charging outfit and are unable to tell when a storage cell is fully charged, the following pointers will be of help. The completion of charging is told by several signs. The density of the acid is brought back to its highest value, 1,300. The pressure is more than 2 volts per cell and in some cases may be 2.5 at the end of recharging. Copious streams of gas bubbles are given off from both plates—oxygen at one and hydrogen at the other. These bubbles appear at first in small quantities, but increase as the plates become more completely charged. The acid and water mixture at this stage looks quite milky. When nearing completion of the charge, a fine spray is given off from the surface of the electrolyte. This is hydrogen and as it is very inflammable the battery ought to be kept away from all flames.

This spray is also corrosive and it should be kept away from carpets, clothes, etc. The most used device for determining whether a storage battery is fully charged is called a "hydrometer" and can be bought at any automobile or electrical supply store. The explanation of the working of this instrument is simple. Sulphuric acid used in battery solutions and known as "electrolyte" is heavier than pure water. The hydrometer merely indicates the relative weight of the solution as compared

with that of pure water. As a charged storage battery discharges, the sulphuric acid leaves the water and goes into the plates, forming lead sulphate. When a battery is discharged, a large amount of the fluid has combined with the lead compounds in the plates. Naturally, as the solution is weak in acid, it is lighter, and the indicator in the hydrometer tube sinks deep. But when a battery is fully charged and the acid is in the mixture, the mixture has become heavier thus forcing the hydrometer indicator to ride high.

At this stage a fully charged battery should read 1,300. A specific gravity of 1,260 indicates a quarter discharged battery, 1,225 shows that it has been one half discharged, 1,185 three fourths discharged, and 1,150 entirely discharged. Under no circumstances is it advisable to let your battery get more than three-quarters discharged, because the formation of an insoluble lead sulphate on the plates increases so rapidly that it is difficult to dissolve it by charging. Another important point to remember is that a fully charged battery, even if it is not used, will gradually discharge itself through electrical leakage, in from 90 to 110 days. Ordinary water from faucets ought not to be used to make electrolyte on account of the iron and other impurities in it. Use nothing but distilled water and also chemically pure sulphuric acid. They can be obtained at any garage.

Always keep a close watch on the water in the battery, adding enough to come $\frac{1}{2}$ of an inch above the tops of the plates, twice a month. The acid does not evaporate and needs replacing only if it has been spilled, or due to accumulated plate impurities. In making up acid electrolyte, always *pour the acid slowly into the water*, stirring slowly with a glass rod; do not pour water into acid or it will fly up into your face. In fact the best way is to add no acid—let a battery expert do it if it becomes necessary.

Winter weather is hard on storage batteries. They should not be kept in any place where they will freeze, because, once thoroughly frozen, a storage battery is totally ruined.

To sum up, then, keep your battery well charged, keep plenty of distilled water in it, and don't let it stay in a freezing temperature if you can help it. If these points are observed, you should be able to hook in your filament battery and forget about it. Otherwise, it may remind you of its presence at a time when you least expect or want it.

What Goes On at a Transatlantic Station

By CARL DREHER

Drawings by TOM MONROE

THE popular idea of commercial high-power radio is highly romantic. People imagine a transatlantic station somewhat as follows: A lonely shack on the beach at 2 A. M. The operator sits with the telephones pressed to his ears and a strained expression on his features. Suddenly his face lights up. "Ha! A call!" The operator scribbles feverishly. After a few minutes he relaxes, and proudly contemplates his copy. A message from Europe! In some way, after that, the radiogram proceeds from the beach shack to its destination, inland, while the operator waits patiently to "catch" another communication on its westward flight. By a reversed but equally simple process, messages jump off from the States to Europe. Thus we have high-power radio.

This picture is in no wise exaggerated. In fact, far more fantastic notions are prevalent. Under ordinary conditions, all the west-bound commercial radio traffic over the Atlantic between Europe and the United States passes through the Radio Corporation's station at Riverhead, Long Island, and thence by wire to the Broad Street central telegraph office in New York City. Non-technical visitors to the station, being told this, almost always imagine that the Riverhead staff of four or five engineers, of whom usually only one is on duty actually copies at Riverhead the thousands of daily messages from England, France, Germany, and Norway, and relays them over the wires. In reality, of course, the traffic flows automatically through Riverhead, as through a telephone repeating station, and all the copying and recording takes place in New York. And some visitors have felt much injured when the man on watch was unable to let them hear music. They came to the station expecting to hear radio concerts, and were disappointed at being offered nothing except indecipherable buzzing noises, somewhat like those emitted by a water faucet when it needs a new washer.

When one considers the situation for a moment, it is obvious that trans-ocean radio communication must be systematized like any other business—like cable communication, for example—and that a highly specialized organization is necessary to perform its functions. But radio's long association with romance—rescues at sea, the exploits of war, and so on—has made it hard to realize that it is based, like any other engineering enterprise, on more or less humdrum machinery and a trained designing and operating personnel.

The equipment and upkeep of a trans-ocean radio circuit are so expensive that it cannot be maintained except on a basis of practically continuous service. If it were to be used only as often as the average ship station, for example, its owners could never hope for a return on their investment. The 2 A. M. beach shack of popular fancy might serve as a fair representation of shore-to-ship radio fifteen years ago. At that time messages were few, and if the operator heard nothing for an hour it may have been due to his silicon crystal jarring out of adjustment, but, just as likely, there were simply no ships within range. But a modern trans-ocean station is a different matter. The operating personnel consists, not of three recluses on a sand bar, but of a community approaching the size of an incorporated village, with its hotel, cottages, water supply, and heating system, perhaps a few hundred acres of land, and means of transportation to and from the near-by towns and railroad stations.

The plant itself, if it is a transmitting station, reminds one of nothing so much as one of the sub-stations of the electric light company in a large city, and its upkeep is commensurate with that of a good-sized electric power plant. The entire radio system consists of perhaps a dozen such stations, all of necessity connected by wire lines leased or owned outright, and in either case highly expensive in upkeep and initial outlay. Then there are urban telegraph offices for collection and distribution

of messages; the central offices of the concern with executive officers, accountants, and the usual business organization; and an associated manufacturing body. All this is very far removed from the free-lance-tour-the-world notion of the radio art.

The writer has no intention of discussing here, however, all these parts and ramifications of an international communication system. The object of this article is to give non-technical readers an idea of how messages are sent and received over long distances, how the stations—particularly the receiving stations—are operated, and to enable broadcast listeners to form some conception of what the life of an engineer or operator in high-power radio is like.

In a modern long-range system the functions of transmitting and receiving are entirely separated. In a ship station the transmitter and receiver are of necessity in the same cabin. But, as the two are entirely different in their functions and nature, it is expedient, when the thing is done on a grand scale, to separate them. The transmitter is a power apparatus, like the motor of an electric train. Its object is to generate power and to dissipate it in a certain way—specifically, in the case of radio, to make a noise at a distance. The receiver is a detection apparatus, somewhat on the order of a seismograph for detecting earthquakes, and its characteristic is sensitivity. When the transmitter and receiver are close together the operator cannot send and receive at the same time. But this factor of simultaneous transmission and reception, or duplex working, as it is termed, is essential in the high-power field, and so in general we find the receiving station located from twenty to several hundred miles from the transmitting station. The seismograph, that is, is not mounted in the same building with a rock-crusher.

Transmitting stations are characterized by their high aerials. To transmit effectively, no substitute has been found for a high,

large antenna structure. Hence transmitting stations have towers from 400 to 800 feet high, built, usually, by contractors specializing in structural steel erection. Up to a few years ago radio engineers thought it necessary to use high antennas also for receiving; the plans for the 1913 Marconi receiving stations, for ex-



A MESSAGE FROM EUROPE!

Scene: a lonely shack on the beach at 2 a. m. The operator (according to the romantic popular idea) sits with the telephones pressed to his ears and a strained expression on his features. When a call comes, he scribbles feverishly

ample, included a line of 400 foot towers. But with the development of sensitive vacuum-tube receivers the costly high receiving antenna could be discarded. It was discovered, furthermore, that small or low antennas offered possibilities in the way of reducing static interference. Thus the French have used small frames, some four feet on a side, for receiving American signals; and in the United States the "wave antenna," developed for high-power reception, is run on ordinary telephone poles only thirty feet high. In either case the appearance of the receiving station is totally different from that of the sending station; and at the present time high towers may be safely taken as the index of a transmitting station.

Taking up the operation of a receiving station, we may describe an actual large American station as it was only a year or two ago. The Belmar, N. J. plant of the Radio Corporation of America will serve as an example. The system has changed considerably since that time, and these alterations will be discussed later. The description as given will hold approximately, however, for a number of European stations in their present form.

Unlike the ship station, in which one operator both tunes the receiver and copies the message, in the high-power station the apparatus is adjusted by a receiving engineer, and the

operator has nothing to do with the handling of the equipment. At Belmar the tuners and

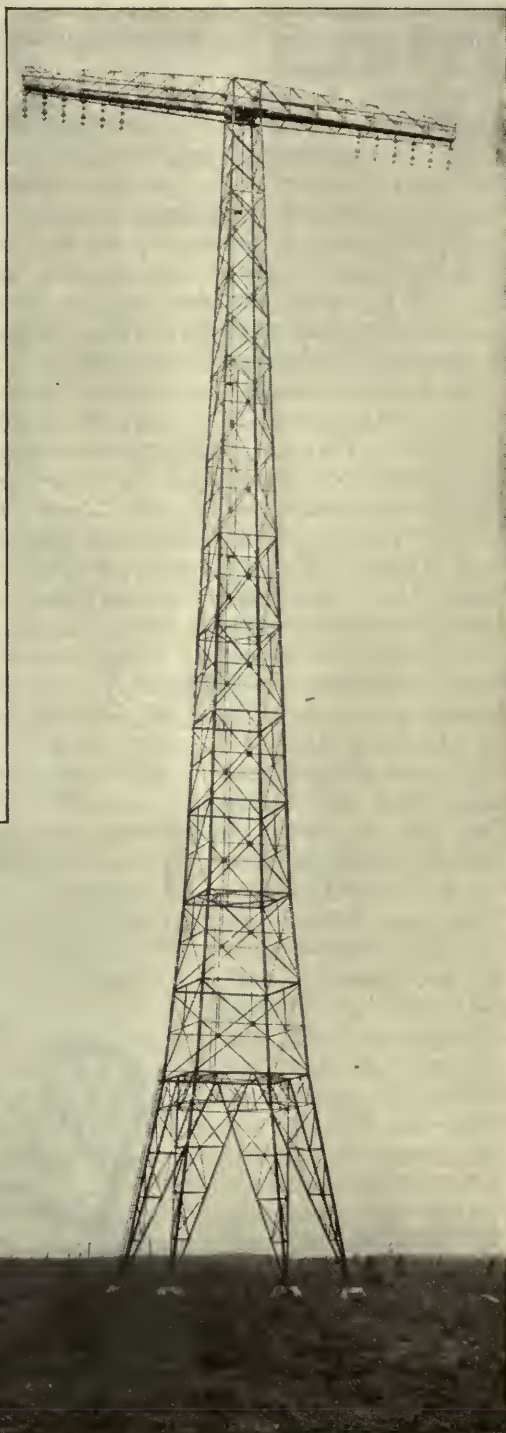

THE TWELVE TOWERS AT ROCKY POINT, LONG ISLAND

These towers carry the antennas used in transmitting to European stations. The power which radiates from the antennas is controlled by delicate mechanism in New York City, 55 miles away

amplifiers, in fact, were in a separate room. The engineer had his own pair of telephones plugged in on the signal and thereby he could tell when anything went wrong in the set, adjust the static balance for optimum reception, and generally supervise the working of the circuit.

In the telegraph room messages were copied on the typewriter, one operator being assigned to each overseas circuit. Belmar, for example, at one time handled the circuits from Carnarvon, Wales; and Lyons, France. Accordingly there was an MUU (Carnarvon) operator, and a YN (Lyons) operator. Each man would copy as fast as conditions permitted, usually below thirty words a minute at that time, and throw the message blanks into a wire basket. At intervals a check clerk would come, count the number of words in each message, compare it with the check given in the preamble of the radiogram, and enter the figure in an abstract. If there was no discrepancy, the message was taken across to the wire operator, who sent it on an ordinary telegraph line, using a sounder with its click signal as distinguished from the buzzing or whistling signal of the radio circuit, to New York City. At the central telegraph office in New York the message was copied and re-dispatched via wire to the point of destination. The radio station, therefore, was in effect the junction of the radio circuit with the radio company's wire circuit, and the central telegraph office was the junction between the radio company's wire circuit and the land telegraph company's wires, and two receptions and two transmissions, with the attendant possible errors and certain delays, were necessary on this side of the water alone.

In the event that an error was discovered in the check of the message, or when the radio operator missed a certain word or was not sure of its correctness, an "RQ", or message of inquiry, was sent to the transmitting station. The answer to the "RQ" was termed a "BQ". These designations are still used and continue to puzzle a great many amateurs who listen in on the long-wave circuits and wonder what it is all about. Two operators, termed the RQ clerk and the BQ clerk, respectively, took care of the numbering, sending, and tabulating of these verification messages.

The transmitting station, which in the case of Belmar was located at New Brunswick, N. J., fifty miles away, was controlled from Belmar by means of a wire line. The Belmar operator,



TRANSATLANTIC WORK AT LAKEWOOD, N. J.

This picture was taken three years ago, before all the Radio Corporation's messages to and from Europe were handled at one central station in New York. In this picture, the man at the left is copying a message from Carnarvon, Wales, on the typewriter. The operator on the other side of the supervisor is sending to England on a key which controls the New Brunswick, N. J. transmitter

that is, controlled the dots and dashes sent into the air from New Brunswick directly with his key. Messages came by wire line to Belmar and were thence dispatched to Europe. Belmar could also "break" the European sending operator, when a word was missed in reception on this side, by making the symbol "BK", whereupon the distant operator would re-send the last word correctly received and proceed. At an early date, direct control of the transmitters from New York was instituted, but the outlying receiving stations continued to possess an auxiliary control for "breaks" only. "Breaks" save RQ's, which take longer and are more costly to the service. A "break" is like saying, "I beg your pardon," to a man with whom one is talking; an RQ is like writing him a letter afterward to verify what he said. In charge of the operators was a supervisor, who saw to it that all the circuits were worked to capacity, that no disputes occurred on the wires—nothing is easier than to fight with a man at the other end of a cable if one does not fancy his style of sending—and that the busi-



ONE OF THE "LONELY SHACKS"

Which used to house the long-distance receiving apparatus, but which now exist only in the popular imagination, at least as far as transatlantic work is concerned

ness of the station was transacted efficiently during his tour of duty. Under the supervisor there were as many as twenty operators during busy stretches.

There were three daily watches: Midnight to 8 A. M., 8 A. M. to 4 P. M., and 4 P. M. to midnight. Each watch had its staff of operators and supervisor, and the watches were changed every week, so that a man did not have to stand the graveyard watch, as it is called in steel mills, more than seven days in succession. This placated the operators' wives by widowing them not over a week at a stretch.

The station was in charge of a superintendent, who in turn reported to the New York office, discharging the usual functions and assuming the ordinary responsibilities of an official in charge of an outlying factory or branch office of a corporation. As there might be as many as fifty skilled operators at a receiving station, with power house and radio engineers, linemen, cooks, servants, gardeners, and other help, this was quite a sizeable job.

The unmarried men lived at a large brick hotel maintained by the company on its property. There were cottages in which the superintendent and other officers lived. The social life of the place was much livelier than that of the average small community, for inasmuch as almost all professional radio men have served an apprenticeship on shipboard, the men at the stations were generally well-traveled and often highly interesting in conversation. There was always a fair percentage of Britishers, as is usual in any communication enterprise, for England has a far-flung empire, whose natives learn communication as a matter

of course, and go wherever cables are laid or wires are strung. The atmosphere of the recreation rooms was highly cosmopolitan. At one of the stations, for example, there was a supervisor who had sailed with William McFee, and had heard Titta Ruffo sing "Hamlet" at the Milan opera, which is more than many literary and operatic critics can boast of. All this is a far cry from the lonely beach shack. And as for isolation, it was nothing for the staff to have twenty girls, vigilantly chaperoned and matroned, down from New York for a week-end party, and not a few of them were quite at home in the smart supper clubs of the town to which all the wires run and where all good circuits, line and radio, find their end.

But efficiency required that the signals be received in New York City directly, and to-day Belmar is only an experimental station. All the operators are now at the Broad Street Central Telegraph Office. At the same time it would not be expedient to pick up the signals in New York, for an urban receiving location is generally inferior to a rural one, and the present system of static elimination requires a large amount of space—specifically an eight-mile line on poles, which of course could not be readily obtained in the city. The problem was solved by the development of line-transfer apparatus. That is, the signals as they come out of the audio-frequency amplifiers at the receiving stations, are put through repeating coils on to metallic wire circuits, and at Broad Street re-amplified and given to the operators. In short, there is a system of audio-frequency tones sent along wires, following the radio-frequency oscillations sent through space. Under normal conditions the operator in New York hears exactly the same signal that the engineer in Riverhead, say, listens to. This system, of course, is subject to the usual troubles of a wire telegraph under bad weather conditions, but by the use of good lines, spare pairs, and other standard expedients, serious delays are obviated, and the advantages of a single central telegraph office and an outlying receiving station effectively combined.

The Radio Corporation's main receiving station is at Riverhead, L. I., at the head of Peconic Bay, about eighty miles east of New York City. The antenna runs southwest to Eastport, a distance of about nine miles. This collecting system, the invention and development of Mr. H. H. Beverage of the Radio Corporation and Messrs. Chester Rice and

E. W. Kellogg of the General Electric Company, has been described at considerable length in non-technical publications, and a technical account has appeared in the A. I. E. E. Proceedings, so that only a brief description is warranted here. The salient feature of the wave antenna, as it is known, is that it will pick up signals from the northeast, say, if properly oriented, and be sensibly "deaf" to the southwest. By suitable adjustments, therefore, in the United States, it may be made receptive for the European stations to the northeast, while blocking out station interference and static from the southwest. In this way the wave antenna makes the radio circuits proof against practically all forms of disturbance except local lightning, which is seldom of serious duration. At the same time, by virtue of its length, the antenna collects a great amount of signal energy, and as it is not in itself tuned to any wavelength, any number

of tuned receiving sets, within reason, may be connected to it. It is thus possible to terminate six or a dozen radio circuits in one small building and to transfer the signals to wire lines at this point.

The visitor to Riverhead sees, in a room twenty-five feet square, three long open cabinets slightly higher than a man, each holding three shelves. A receiving set is placed on each tier. The component parts of these sets—tuning apparatus and amplifiers—were built by the General Electric Company. They are designed for hard, continuous service in a fixed installation. The various units are enclosed in large iron cases, and the appearance is that of power apparatus rather than the usual laboratory impression given by radio instruments.

By means of plug and jack boards, somewhat like those in a telephone exchange, any signal may be put on any pair of wires to New York, a



A VIEW OF THE CONTROL STATION AT BROAD STREET, NEW YORK CITY

In the foreground is a modified typewriter keyboard used in conjunction with a perforating machine which punches out dots and dashes on the tape. The tape is later fed into an automatic transmitter which controls the key circuit of the transatlantic transmitter according to the dots and dashes on the tape

signal may be duplicated on two or more tone channels, wires may be tested, sets changed, and all the other possibilities of a highly flexible arrangement realized.

The stations at present handled via Riverhead are MUU, Carnarvon, Wales; LCM, Stavanger, Norway; OUI, Hanover, Germany; POZ, Nauen, Germany; and UFT, Saint Assize, France. Thus five receiving sets are continuously in service, with a sufficient number of spares in case of breakdown. When, occasionally, the European station has no traffic—is “running idle” or is “out”—the set is left on until the station resumes traffic. The tubes are not turned off and a set may be in use continuously for months.

These stations all operate on long wavelengths—between 12,000 and 15,000 meters. People often inquire whether the multitude of local broadcasting stations do not interfere with transatlantic reception. Inasmuch as the broadcasters do not go above 400 meters, it is obvious that they are not likely to “jam” stations whose waves are thirty or forty times as long.

Power is supplied to the station from a 2200-volt transmission line. The filament and plate supply to the tubes is from storage batteries “floating” on A. C.-to-D. C. motor generators. When the A. C. power is interrupted, the amplifiers will run on the storage battery reserve for a period of about a day, which is sufficient to tide the station over any conceivable breakdown in the power supply.

Communication between the engineers at Riverhead and the traffic personnel at Broad Street is maintained over a wire telegraph line. The engineer at Riverhead must therefore also be a competent wire operator, so that instructions and information may be rapidly sent over the line and good contact maintained between the two parties. The Broad Street end of the wire is manned by the Office Electrician on watch. Personal calls are used in order to secure the maximum degree of coöperation between the two departments. The system has proved very effective and is practically equivalent to the antedating arrangement wherein the engineer and sets were in the next room.

A corrupted form of Phillips’s Code is used in conversation on the Riverhead-Broad Street wire. Phillips’ Code is the system of symbols and abbreviated spelling used on commercial press wires and fast bonus circuits. Of course when one has to spell out every word, as one does in telegraphing, one is apt to be in favor of highly simplified spelling. “That” becomes “tt”, “ing” is cut to “g”, “what” is “wt” and so on. The Phillips’ on the Riverhead wire, however, is somewhat unique and may be compared to Ward Line Spanish, familiar to every good radio man. Also, while most of the communication is of necessity terse, during light periods, flashes of fancy have been known to slip through, as the following at four o’clock one morning:

“Hey, brush off the Swede,” which, translated, means, “Clear up the LCM (Norway) signal.”

Over the water, most of the service messages and traffic directions are in English, but occasionally the English is a little unsteady, and may be abandoned altogether, as once when the French operator delivered himself of the following:

“Pse Mr OM we have much msgs o h can you take a grande vitesse?” which means, “Please Mister Old Man we have much messages on hand—can you take high speed?”

Many such gems could be picked up by anyone listening for them, but in the press of traffic they go unnoticed and are lost.

Curious incidents sometimes occur to break up the routine of operation. Wire trouble, for example, sometimes originates in unusual ways. In one case three tone channels were thrown out of service for twenty hours by a piece of haywire slung over the line by some boys at an isolated spot. On another occasion an ice-house some five stories high, and large in proportion, caught fire and fell over upon the main telephone trunk line in the middle of Long Island, carrying the Radio Corporation’s wires down with the rest. All circuits went out with an unprecedented bang. One or two telephone pairs were left intact, and soon Broad Street and Riverhead were in communication by telephone. But not for

G r e e k c i t i z e n s l e a v e

A PRESS BROADCAST FROM POZ, NAUEN, GERMANY

This strip is part of a message received at the Riverhead, L. I. station on an ink recorder. The letters have been written in above the lines representing dots and dashes of the Continental telegraph code



“DIT DIT DAH DAH DIT DIT”

It is related that when the Broad Street official began to warble and chant into the telephone, the office broke into a commotion and he narrowly escaped being rushed to a psychopathic ward

long. The surviving pairs began to be affected by the heat, terrific crackling noises and roars broke up the conversation, and, while voices could still be heard, the speech was unintelligible. The single engineer left at Riverhead—the rest of the staff having rushed to the scene of the fire in cars—then conceived the idea of howling code mouth signals into the telephone transmitter, thus:

“Dah dah dit dah—dit dah dit—dah dah—dit dit dah dah dit dit” (QRM—Interference—Repeat, repeat).

The Broad Street Office Electrician replied in kind, and communication was maintained through the wire noises until the regular wires were patched temporarily with twisted pair lying on the ground. The Riverhead man, being by himself, had nothing to lose, but it is related that when the Broad Street official began to warble and chant into the telephone, the office broke into a commotion and he narrowly escaped being rushed to the psychopathic ward. So a man may be misunderstood when he is behaving most rationally.

The receiving engineers' time is normally taken up keeping the sets accurately in tune (a transmitting station's frequency may shift

slightly, necessitating compensating changes at the receiving end); balancing static; keeping a log of observations on the conditions of the circuits and the rate at which traffic is moving, and taking care of contingencies which arise, such as trouble on the tone lines, or interference between transmitters whose wavelengths are not far separated. In this respect a radio man's business differs greatly from selling shoes or running a movie house, occupations subject only to local disturbances, for when one is receiving from Europe some arc transmitter in Hawaii or the Philippines may, under certain conditions, cause one as much trouble as a fire next door. Again, while many other occupations are subject to only minor variations from day to day, in a radio station one may have little to do one minute, and the next instant trouble may start, and one is listening to Europe with one phone on and the other ear turned to the sounder, twirling knobs with both hands, and trying to open a switch with one's feet. But the man whose temperament is not adjusted to rapid changes belongs in some other business than radio. . . . No doubt a few specialists in the broadcasting end of the industry can be found to second this.

1300 Miles On a One-Foot Loop

Three Tubes are used in a Clever Arrangement to Give R. F. and A. F. Amplification in the New Grimes Circuit

By CHARLES H. DURKEE

UNTIL very recently, in this country, radio-frequency amplification was a closed book to all but a select few. This is rather hard to explain in view of the fact that the European radio enthusiasts have long been using practically nothing else. From time to time information has arrived from across the ocean both in the form of patents and articles, but still little resulted. Even the war, which brought hundreds of our radio men in direct touch with radio-frequency did not seem to stir up a great deal of enthusiasm for its use in the United States.

It may surprise many to know that radio-frequency amplification was introduced in this country at about the same time as the now famous Armstrong circuit. So, speaking in relative terms, instead of being a recent development, it is really rather old.

There are several decided advantages in radio-frequency amplification, but there have been also several serious drawbacks, as seen when it is compared with the regenerative arrangements. It has been the drawbacks which have outweighed the advantages in the past as far as this country was concerned. When radio frequency is operated properly there results a purity of tone in broadcast entertainments which is hard to equal with the regenerative set even though extreme care is taken in adjustment (although the latter is more selective). This difference in quality becomes more and more noticeable as high enough amplification is obtained for loud speaker use, unless great precautions to eliminate it are employed.

Another advantage in using radio frequency is that the reception of distant stations even on a loop becomes a simple matter, both with respect to volume and to ease of operation, as compared to the regenerative circuit in the hands of the uninitiated.

And last, but not least, is the overwhelming advantage of radio frequency in that it does not regenerate back into the air—an action which sometimes causes annoyance to everyone

possessing any kind of radio receiver within several hundred feet. These disturbances are the familiar and ever increasing number of rising and falling whistles which are heard when you have comfortably adjusted your set for an evening's entertainment.

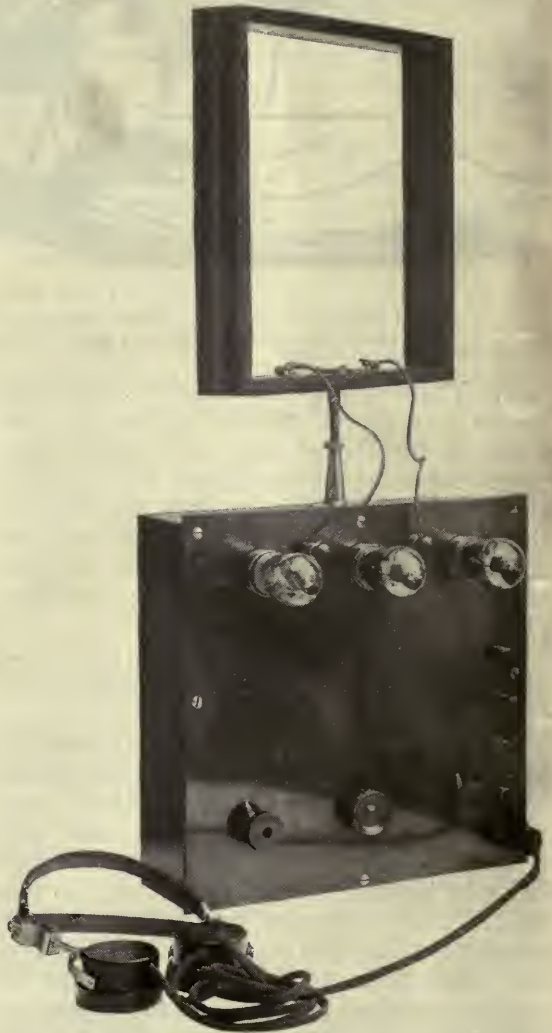

THE COMPLETE "INVERSE DUPLEX" RECEIVER

One of these sets has been tried out by the Editor of RADIO BROADCAST. The first night, he heard, from his home on Long Island, PWX (Havana, 1300 miles) and WDAF (Kansas City, 1080 miles)

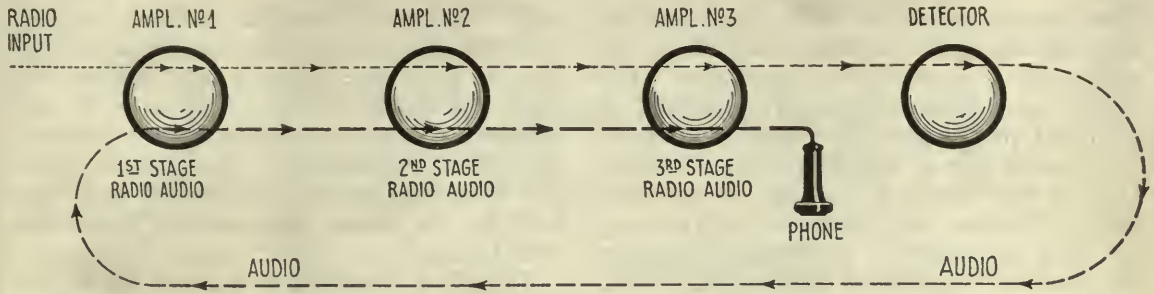

FIG. 1

Schematic diagram of French circuit employing 3 steps of radio, detector, and 3 steps of audio-frequency amplification

The disadvantages of radio-frequency amplification have been, mainly, that it has required several more vacuum tubes than other types of receivers—an expense in more ways than one when power and depreciation are considered—and that it has not been satisfactory for local reception, the radio-frequency tubes being practically useless on near-by high-power stations.

Naturally, in Europe, where the circuit has been most popular, several more or less successful attempts have been made to overcome these drawbacks. One noteworthy and commendable attempt has been called the La Tour circuit—a French development. This circuit has recently appeared on the American market in commercial form. Only one of these American types, however, shows a radical departure from the French principle.

The French principle consists in employing some of the amplifying tubes in a dual capacity to amplify both the radio and audio currents. It was hoped by this arrangement to reduce the number of tubes and thus compete with the regenerative circuit from the standpoint of expense, thereby overcoming the main objection to radio-frequency amplification. Difficulties and objections arose, however, in actual practice, and it is the various solutions of these difficulties which form the basis of the commercial sets made in this country.

It is the object of this article to disclose the details of a circuit developed by Mr. David Grimes of Grasmere, Staten Island, New York. His circuit offers the logical solution to the difficulties outlined and he alone has radically departed from the general scheme of performing the dual process of amplification employed in all other sets of this type.

Mr. Grimes is a graduate of the Electrical Engineering College at the University of Minnesota. He studied radio while at college and

during the war, and although he enlisted as a private, he was soon placed in full charge of radio instruction at Kelly Field, Texas, one of the largest flying fields in America. He was later ordered overseas to carry on investigating work in connection with radio navigation of bombing planes. It was while engaged in this work that he ran many tests which led up to the present circuit. For some time after the war he was employed in the Development and Research Department of the American Telephone and Telegraph Co. and it was here that he gained experience in judging voice qualities, and, realizing this weakness with respect to quality that existed in most commercial sets, he resigned to devote all of his time to this work.

Mr. Grimes calls his circuit the Inverse Duplex—the name being derived from the unique way in which the audio energy is amplified through the tubes with respect to the radio. The sketch shown in Fig. 1 is a schematic form of the La Tour circuit using four tubes. The radio enters amplifier tube No. 1, and passes on through amplifier tubes No. 2 and No. 3 to the detector. Here it is changed to an audio-frequency current and is then led back through the first three tubes in the same manner and sequence as the radio. This arrangement has several inherent disadvantages.

In the first place it is readily seen that amplifier tube No. 3 is greatly overloaded by trying to carry both strong radio energy and strong audio energy. The whole system is thus limited to the carrying capacity of the third tube. This prohibits its use generally for local reception. Another serious difficulty with this arrangement (Fig. 1), is that if any leakage currents of radio frequency pass from the output of the detector tube through the audio circuit to the input of the first audio tube, it will there be amplified as radio three times

again before reaching the input of the detector. This causes radio-frequency oscillation and renders the circuit almost inoperative. Obviously this arrangement is very unstable. A third and very important trouble encountered in suburban homes with the circuit shown in Fig. 1 is that the least 60-cycle and harmonic energy picked up from the electric light wires by the loop is amplified at audio frequencies through three stages before reaching the phones, and three stages of audio-frequency amplification can usually make a very loud noise from one that is almost inaudible originally. The humming noise is extremely annoying, often completely predominating over the radio signals of a distant station.

An improvement is shown in the schematic sketch Fig. 2. Here the audio-frequency current is brought back through but two of the three amplifying tubes although still in the same sequence as the radio amplification. The overloading of tube No. 3 is somewhat relieved by the dropping of one stage of audio amplification. It is still noticeable, however, especially on local reception. The stability is partially improved by the fact that only two steps of radio-frequency amplification now exist between the output and input of the detector circuits. Even two stages of radio, however, cause no end of exasperating oscillations. Of course the trouble from 60-cycle interference is overcome here in separating the loop from the audio amplifying circuits by one stage of pure radio amplification which passes no audio energy.

Fig. 3 shows an adaptation of the above where the detector tube is replaced by a crystal. This crystal, inasmuch as it merely rectifies whereas the tube both rectifies and amplifies, so reduces the energy passing through the circuit that no appreciable overloading of amplifier No. 3 occurs. For the same reason the

radio leakage currents in the audio output circuit of the crystal are practically nil; so that the two successive stages of radio between the input and output of the crystal are of no consequence so far as disturbance from inherent oscillation is concerned. This circuit is also free from the 60-cycle noise picked up by the loop for the reason mentioned in connection with Fig. 2.

Fig. 4 is a schematic diagram of the Grimes Inverse Duplex Circuit using four tubes, and Fig. 5 gives the details of a three-tube arrangement which is thought to be sufficient for most purposes. Considering Fig. 4, the radio passes through amplifiers No. 1, No. 2, and No. 3 into the detector in the same manner as before. The audio currents from the output of the detector tube are then led back through amplifier tube No. 3 as the first stage of audio. From here they pass around through amplifier tube No. 2 for the second stage of audio and then through amplifier No. 1 for the third and last stage of audio.

In this manner the first tube carries weak radio and strong audio currents. The second tube carries medium energies of both and the third amplifier tube passes strong radio and weak audio currents. The load on the tubes is thus equalized and greater volume of signals results. All these amplifying tubes are used to their maximum capacity, instead of being limited by the overloading of the third tube, while the other tubes are delivering less than their full capacity as in the standard La Tour circuits. This enables the circuit to be used for loud-speaker operation on near-by stations, overcoming one of the difficulties of radio-frequency amplification.

Another decided advantage of this design is that no matter how many tubes are added to the set, there never exists more than one stage of radio amplification between the output and

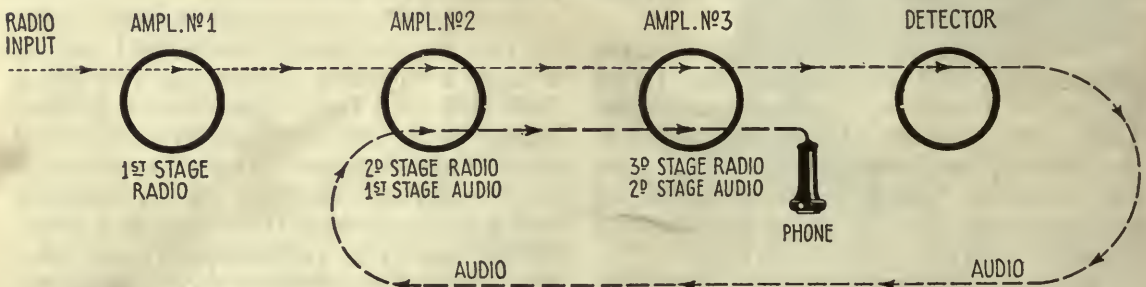

FIG. 2

Here 3 stages of R. F., a tube detector, and 2 of A. F. amplification are used

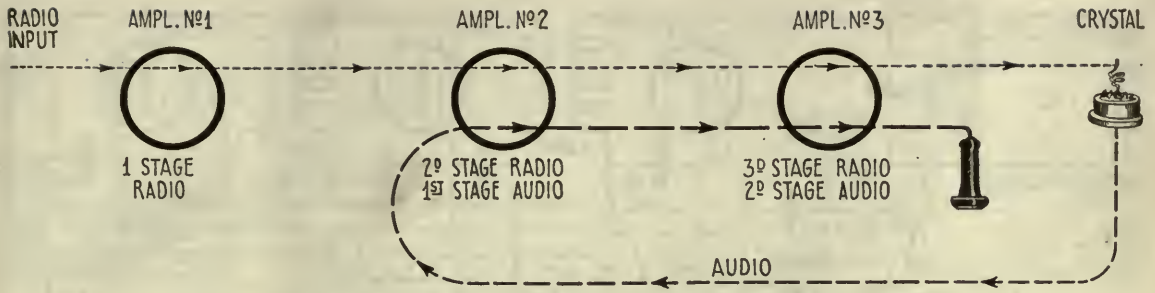

FIG. 3

This shows the French circuit employing a crystal detector and having 3 steps of R. F. and 2 of A. F. amplification

input circuits of the detector. Any radio leakage currents passing out of the detector through the audio path are given the benefit of only one stage of amplification and inasmuch as these leakage currents are very small one stage is not sufficient to cause howling. With the ordinary connections two or more stages of consecutive radio-frequency amplification cause this leakage current to become appreciable and howling results.

The third important advantage of this circuit is seen in always placing the phones in the plate circuit of the first amplifying tube. No matter how many tubes are used, the phones should be in this position. In this way the audio induction current picked up by the loop from such a source as a 60-cycle power line is never amplified by more than one stage before going through the phones. As a rule this one stage of amplification is not sufficient to make the induction audible.

Stability, uniform loading, and freedom from induction noise are the salient points in this circuit, and this means ease of operation, volume with quality, and long distance without an outdoor antenna, but economically. Other minor improvements in the circuit are found in the radio-frequency paths. Here the radio energy is led back to the tube directly after passing through the radio transformers.

It is not by-passed around the audio transformers and through the B battery, as the resistance here is very liable to cause "cross-fire" between the radio currents of the several tubes, resulting in a tendency toward oscillation, which is recognized by the novice as "howling."

Another improvement is the tuning and radio control circuit. Many radio-frequency circuits to-day are very broadly tuned and therefore susceptible to interference. This is because an attempt is made to control the quantity of radio energy passing through the tubes by placing a slightly positive biasing potential on the grid of the first tube. This reduces the radio amplification, but it also makes the grid-filament circuit a resistance path instead of acting as a small condenser, as is the case when the grid is negative. This resistance path is directly across the tuning circuit and causes an appreciable loss in that circuit. Any loss in a tuning circuit immediately broadens the tuning. In the Grimes circuit the grids of the tubes are all connected to the negative ends of the filaments and the radio input to the first tube is regulated by means of a variable 400-ohm resistance rheostat. This rheostat is so placed that it is in series with the small capacity of the tube and in view of the fact that the impedance of this shunt path is already high,

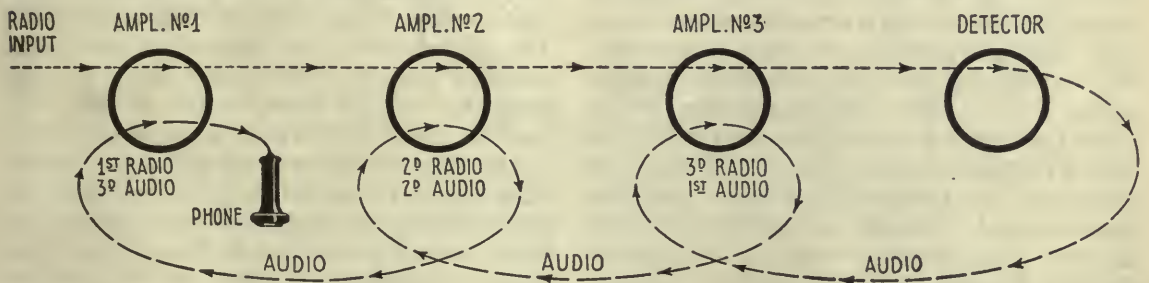

FIG. 4

Schematic diagram of the Inverse Duplex circuit

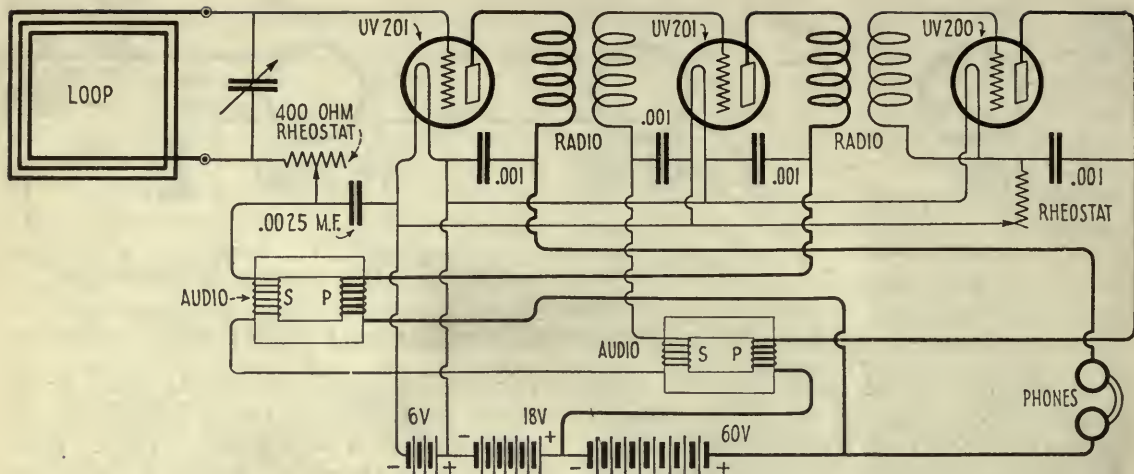

FIG. 5

The Grimes Inverse Duplex circuit as used in the set shown on page 472

the addition of this comparatively low resistance has practically no effect in broadening the tuning, as it causes little or no loss in the tuning circuit. It is this feature combined with the loop that enables the operator of this circuit to pick up distant stations even while the local stations are broadcasting.

In closing, a word or two may be in order about the results and suggestions as to methods of operating this circuit. Under ordinary conditions with the set shown in Fig. 5, Chicago, Davenport, Atlanta, Havana, and other distant stations have been brought in quite easily and consistently with a one-foot loop on Staten Island, New York City. Pittsburgh, and Schenectady are brought in regularly with all of the local New York and Newark stations broadcasting and with no interference.

It has probably been noticed by the reader that only three controls are necessary to obtain these results. A tuning condenser, preferably arranged for vernier control—a rheostat for adjusting the detector tube—and a rheostat for regulating the quantity of radio-frequency energy. It is this latter control which is new and therefore perhaps the least understood. On near-by stations, radio-frequency amplification has not been very effective simply because the detector tube refuses to rectify more than a certain maximum quantity of radio. It overloads, and the additional radio amplification is wasted. It is this fact which has reacted against radio-frequency, because the person desiring distance was compelled to add additional tubes which were almost useless for local reception. In the Inverse Duplex ar-

angement the radio may be cut down by the 400-ohm resistance to a point where the detector is not overloaded, permitting full audio amplification, as the grids are always on the negative side of the filament. It operates, then, just as effectively on near-by stations as on distant ones and in each case every tube is being fully utilized.

For best results it is wise to run the set with as little radio-frequency energy as is necessary to operate the detector. Obviously, if the tubes are overcrowded with radio energy which is wasted by the detector, there is little room left for satisfactory audio amplification. The first thing that happens upon boosting the radio too high for a given station is poor quality, generally known as distortion. If boosting of the radio amplification is still continued, the excessively strong radio currents will set up powerful magnetic fields about the radio-frequency transformers. These fields when strong enough react upon each other, causing howling. Howling is a sure sign of too much radio amplification, and poor quality means that the limit of the tubes is being approached. The remedy in either case is adjusting the 400-ohm rheostat. On distant reception, this resistance will be nearly if not all out. On local stations it will be practically all employed.

The mica condensers used for by-passing the radio are so connected in the circuit that the plate voltage is constantly across them. If these happen to be slightly leaky a crackling sound is continuously produced. These condensers are mentioned because this is a special problem that arises in duplex circuits.

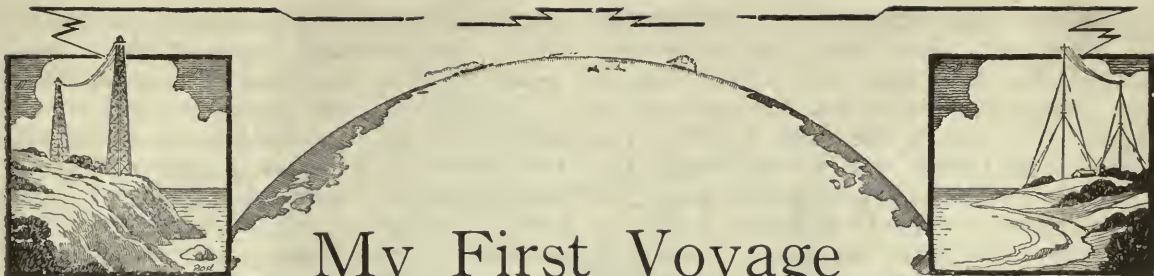

My First Voyage As a Sea-goin' Telegrapher

Sea-sickness, Home-sickness, Practical Jokes, Bed-bugs and Shipwreck,
If Taken in a Single Dose, are Likely to Make One Sick of the Sea

By A. HENRY

GOOD MORNING, Sparks!" bel-
lowed the Captain as he grabbed
a fried egg in each hand from a
platter in the centre of the table
and flopped them one on top of
the other on his plate. "What kind of a night

did you have and how
do you feel?"—this
last with a twinkle in
his eye—"Here's your
seat, right beside me,
so's I can see that you
behave yourself."

"Good-morning,
sir," was my reply, "I
never felt better in my
life and it is a pleasure
and honor to occupy
the seat next to the
Captain."

Whatever possessed
me to add the touch
of blarney I have no
idea, but it must have
been a master stroke,
for it struck the old
fellow just right. Any-

one, even as inexperienced as I, could have
seen that the Captain was pleased, for his chest
went out and he sat straight up on his stool and
made room for me to pass behind him.

Possibly you dislike descriptive narrative as
much as I do, but in order to let you appreciate
the utter ridiculousness of my position, it is
necessary for me to ask your indulgence.

Shortly after my father had seen me safely
aboard the Standard Oil tug *Astral* (for I had

never before been away from home alone), he
departed and left me to my own devices.
After unpacking my bags and tinkering with
the radio equipment for awhile I fell gladly
into my bunk and into the arms of Morpheus.
Meanwhile, our tug pulled out from the coal
dock, picked up the
barge we were to tow,
at dawn, off Staten
Island, and made for
the open sea and ports
to the south. So, by
the time the mess
boy poked his hand
through my door, ring-
ing a huge bell and
bawling "Breakfast,
Breakfast!" we were
well beyond Ambrose
Channel Lightship and
down the Jersey Coast.

I had jumped up,
dressed in a hurry and
made every effort to
look as presentable as
possible, putting on a
good suit, a collar and
tie and shining shoes which were hardly in need
of the attention. The Captain's remarks, as I
entered the mess-room, were at once discon-
certing and reassuring, for I had expected to
find the Captain more sedate—the fact that
good nature beamed from every wrinkle of his
weather-beaten countenance and that he
seemed anything but unapproachable smashed
some of the theories about captains that one
learns in a radio school.

Have You Taken Your First Ship to Sea?

In this article, the author, who has spent
many years in radio as an amateur, a sea-going
operator, an investigator of long-wave phen-
omena at high-powered trans-ocean stations,
and an instructor in radio at an army officers'
training school in the A. E. F., tells of his
first trip to sea. There is much about it that
one would not relish—but it is life in the rough.
One article of this series by A. Henry appeared
in RADIO BROADCAST for March under the
title, "What About Operating as a Career?"
In a third article of this series of true stories
about radio as a career, Mr. Henry will tell,
next month, of his first passenger assignment.

—THE EDITOR.

The mess room (that word "mess" always grated upon my nerves and I could never bring myself to think of "food" and "mess" being at all synonymous and it was very difficult to refrain from calling the room in which the process of eating was accomplished, the "dining-room") was an institution of an entirely new character to me and is, no doubt, to many of the young fellows who leave good homes for a life on the ocean wave. The room itself was located in the forward part of the main deck housing just beneath the pilot house. There were several port holes in the forward bulkhead and two on either side. Entrance could be made through doors from the deck on either side, or through the companionway from the galley—which in everyday language means kitchen. This last was used only in heavy weather. A huge table filled most of the room and chairs were out of the question; we sat on stools. If the sea was the least bit frolicsome, the stools might be found individually or collectively cavorting about beneath the table. After reclaiming one, the reminder that there were others by a crack on the shins invariably resulted in a volume of anything but edifying ejaculations—and a laugh all around. In seas of this sort, racks were put on the table and the cloth put over the racks. The racks occasionally prevented one's plate of soup from unceremoniously becoming tired of being respectable and racing across the table into someone else's lap.

Upon recovering from the temporary embarrassment brought about by the unceremonious

reception of the Captain, and seated solidly upon my stool, I was introduced in a general sort of a way to the others at the table.

"Sparks," said the Captain, his fork poised deftly in his left hand and his knife pointing in the direction of a begrimed gentleman whose sole preparation for breakfast could only have been a wash of the "lick-and-a-promise" variety, "that old-looking duffer over there is the Chief Engineer. Engineers ain't good fer nothin' but makin' trouble and this particular one is worse'n most. You'll find out, when you need juice for that wireless business o' yours. If it wasn't for his assistant who's on watch now and that oiler over there—pointing to another gentleman whose upturned coat collar was intended to disguise the fact that he was at the table in his undershirt—this old tub wouldn't ever leave the dock. It's always boiler tubes or spark plugs or somethin' goin' wrong and he don't know what it's all about. Look out for him, boy, he's a bad actor." And with these remarks, stuffing a jellied pancake in his mouth, using his hand for a pusher, he made his departure before the Chief Engineer had time to reply.

Then the Mate came in and occupied the Captain's chair, smiling in my direction and wishing me good-morning. He was entirely different from the other men and reminded me of ads I had seen for young men's clothes. If Douglas Fairbanks had been romping on the screen in those days, no doubt he would have reminded me of him. A young, powerful giant and possibly the only American among

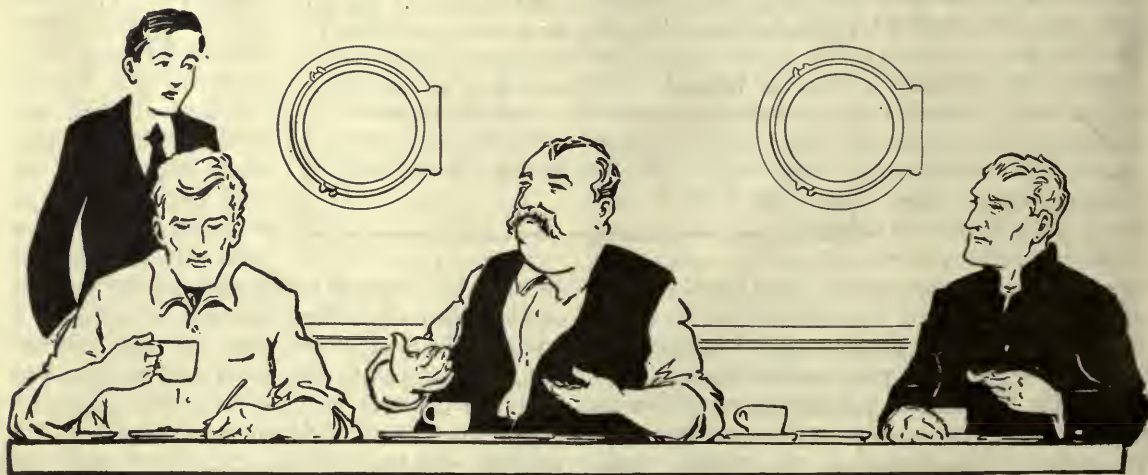

"GOOD MORNING, SPARKS!" BELLOWED THE CAPTAIN
As he grabbed a fried egg in each hand from a platter in the centre of the table and flopped them, one on top of the other, on his plate

the Norwegians and Danes and Englishmen and Sky-hoovians who made up our crew. And his speech was as perfect as one would wish. In others words a gentleman. Here, thought I, was one who could teach me much of the world and in language I could fathom. Here was a young man, second in command, who held the respect of his subordinates, some of them twice his age, because he knew his job and even the old salts could not bluff him.

Everything seemed to be going along very nicely. My new acquaintances were surely rough diamonds—but diamonds, none the less.

I went back to my room and listened-in for awhile, finally starting my transmitter and calling the barge we had in tow, which was also equipped with radio. The operator happened to be on and we agreed upon a regular schedule for communicating with each other. Following this we "chewed the rag" a little and signed off.

Most of my morning was spent in roaming about the vessel, "getting the lay of the land" and becoming acquainted with those men who had been on watch at breakfast time. About eleven o'clock, however, I decided to polish some of the bright work on the radio outfit and write a letter or two. On entering my room I found one of the mess boys lying in my bunk, his hands clasped over his stomach and a look of anguish on his pale face.

"Don't put me out, Sparks," he begged, "I'm nearly dead. When do we get to Wilmington?" Then in a terrible fright he pleaded, "Quick! Quick! Air, Sparks, I'm dying."

I dragged him out of the bunk, pushed him toward the door, grabbed him by the shoulders while I straddled his back and braced my feet against the top of the rail to prevent him from falling overboard.

"Gosh!" he sputtered, when it was over; "never so sick in my life. Better now—thanks—guess I'll drift in and get the table ready for lunch." And he walked up the deck after the fashion of one who has lain long in bed. His knees were very wobbly.

I noticed that we were rolling around a little but felt anything but sick. I had a ravenous



EVEN A TUG MAY BE A HAPPY ENOUGH HOME

If a fellow does not mind rearranging his digestion to function with the new variety of food he gets. This picture shows the S. G. T. (sea-going tug) *Astral*

appetite and waited with some impatience for the dinner bell to sound.

During the course of the morning stroll, I had picked up quite a little sea-going lingo and etiquette. For instance, one of the oilers said that it was customary to wait for the "Old Man" before taking one's place at the table, so under the guise of examining one of the lifeboats, I watched for him to leave his room for the mess room and then followed immediately.

We had soup. Mine was about half finished when I felt a sort of "all gone" feeling in the pit of my stomach. Cold perspiration began to appear on my brow and cold shivers raced up and down my spine. My appetite disappeared like a flash and I could feel the blood leaving my face. A weak feeling came into my knees and I gripped the under side of the table and didn't move. For a moment I felt better and then a thousand per cent. worse. I knew what was coming and excused myself, leaving the table amid a burst of uproarious laughter and mock sympathy, and a hundred suggestions for obtaining relief. I shall draw a veil over the events of the next two minutes. But afterwards, I felt much relieved, and returned to finish my lunch.

They were rather surprised and a little taken aback at my reappearance, but presently suggested many and contradictory remedies to ward off a recurrence of my malady.

"Stuff yourself, Sparks," volunteered the Captain, and the Chief Engineer said, "Don't pay any attention to that old fool, Sparks, he can't even steer a straight course, much less practice medicine. You eat light and an hour after you're through, get a rope and tie it to a

bucket. Then drop the bucket over the side and get some sea water and drink two glasses every hour. That's a real cure."

Many other suggestions were made, but for the most part the men in the deck department agreed with the Captain, and the Chief Engineer's men agreed with him. As for me, I paid little attention to any of them and ate according to the dictates of my appetite, which might be characterized as indifferent.

Just before the after-lunch pow-wow was about to break up, the cook, who was a good-natured looking old devil, came in and said, "There's no use in ever gettin' sick again, Sparks, come on out on deck and I'll show you what to do."

Everyone left his seat and made for the deck as though it were a foregone conclusion that I was going to submit to the cook's treatment. The First Assistant Engineer confided, in a whisper, as we passed through the door together, something to the effect that the cook was the best doctor he had ever seen.

So they gathered around in a semi-circle having its opening in the direction of the rail, and the cook took his place beside me, saying, "Here y'are, just swallow this and you'll be all hunky-dory." He offered me a cube of salt-pork almost an inch on a side and to my objection that there was a string tied to it, he said that was to prevent choking if it stuck in my throat. After two unsuccessful trials I got it down and the cook then assumed the attitude

of a dentist about to pull a tooth. Holding on to the string he gradually retrieved the piece of pork.

Some one cried, "He's sick, get a bucket." So they got a bucket, dropped it over the side, and a fellow with his arm around my neck offered me a glass brimful of salt water. I drank it, but it, also, stayed on my stomach but a few seconds. If you've ever been sea-sick, you know how I felt, but the treatment, severe as it was, must have been effective, for the wildest of seas never nauseated me again and that evening I enjoyed a good supper.

My radio duties were very light, so I retired early and was soon lulled to sleep by the drone of the engine and unsteady but now pleasant rolling motion. I had seen no sign of a bath tub and because I was too sleepy to have used it any way, inquiry concerning it was, for the time being, postponed.

During the night my sleep was made restless by an itchy feeling on my legs and neck. For a time I scratched myself in my sleep but a severe irritation on the back of my neck woke me and my return to consciousness was accompanied by a peculiar bewilderment and I was rolled around like a weighted toy clown as I sat in my bunk and switched on the light. When I woke, the itchiness disappeared so I sat in my chair and listened-in for awhile, gradually becoming sleepy and returning to bed. Before sleep overtook me, the itchy feeling returned and I sat up for another little while. This sort

of hide and seek went on for some time until, in scratching one particularly itchy spot, I felt something under my nail. I switched on the light and found that I was holding some sort of a red insect. Quick as a flash I tore the clothes from the bed and there they were—possibly a dozen of them—racing to get away from the light. I became acquainted with some uninvited guests of a species previously unknown to me. They were bed bugs! This part of my experience may best be told by merely stating that the bed was given over to the exclusive use of the nocturnal callers, while



LIFE ON A TUG IS HARDLY LIVELY

And a fellow welcomes an opportunity to paint the deck or shine brass or do any of the things the union might object to

the bed clothes, after a thorough shaking, served very comfortably when spread on the floor. (They call the "floor" the "deck" at sea, but it is just as comfortable for sleeping purposes, under either name.)

The next day I inquired for the bath tub and was led to a remote corner of the engine room, where a round wooden wash tub, of the variety used in old-fashioned country places, graced a stick which protruded from one of the steel ribs that held the ship's sides in place. Near by there was a steam pipe which could be swung in any direction. By inserting this pipe in a pail of water and turning on a valve, cold water could be transformed into hot at a moment's notice. It was necessary to carry the water to this "bathroom" from the deck above and the engine room grating and iron stair and lower deck was very slippery. To lose one's balance could result in a too intimate relation with the crank shaft and other heavy parts of the engine. I felt that the degree of privacy was about the same as one would expect in the bleachers at a world's series base-ball game. One soon learns to worry little about such delicacies, on a tug, however, and becomes quite adept at bathing beneath a noisy crank shaft or in a boiler room, emerging equally dirty in either case.

Nothing much happened for the next few days and I began to feel more of a sailor than ever. Plenty of food—of a strange sort to which I was becoming acquainted, for it was of an entirely new variety to me—plenty of sleep and I was feeling a growing affection for the scribbler who penned the tale of "Life On the Ocean Wave."

At lunch there was some talk about approaching Diamond Shoals Lightship, which is located off Cape Hatteras, reputed among those who know nothing about it as the roughest point on the Atlantic Coast.

"Sparks," said the Chief Engineer, "how would you like to go up in a bos'n's chair and watch for the lightship from the mast-



ON A LINER, HOWEVER

There is so much "going on" socially that it is difficult to know which functions to pass up in order to get enough sleep to be able to stand the hours of watch!

head? The skipper will let you, won't you Cap'n?

To which there was an affirmative grunt and a few minutes later I was strapped in the chair and being hoisted up the mainmast by two husky deck hands. The masts on our tug were nearly ninety feet high and the expanse of water with not another vessel in view was a sight to fill one with awe. They permitted me to enjoy the scenery for a while and then began lowering me. The wind was in my direction and heavy black smoke from the stacks blew right at me. When I got to the midst of it they stopped the lowering process and let me enjoy the smoke. No black-faced comedian was ever as black as I, when they eventually did lower me to the deck. Of course they weren't looking for the lightship at all and the Captain and Chief Engineer had framed the joke up before lunch and the firemen produced all the smoke they could.

By the time we did approach Diamond Shoals Light, the head wind had changed to a gale and it took us two days to go four miles. Diamond Shoals remained off our starboard beam for two days and nights. On the third day, the wind abated and once again we were on our merry way, with the storm nothing but a memory. Of course I copied the press from the N. Y. Herald Station at night and HA (Cape Hatteras) in the morning. This, along with a daily



THERE IS LITTLE NEED FOR A UNIFORM

On a ship where the Captain calls the fireman "Joe" and the fireman calls the Captain "Bill"

message to the Standard Oil Co., the owners of the tug, completed my duties and there was plenty of time for sleep.

Awaking one sunny morning, I found that we were at dock in Wilmington, North Carolina, and there were several letters at my place at the table when I appeared for breakfast. They were all read and re-read before the meal was touched and the next thing to do was to make a combined sight-seeing and shopping tour of the city.

By the time the shopping, which included the purchase of lythia tablets and Peterman's Discovery to purify the ship's water and fight off my nocturnal visitors, it was lunch time and I enjoyed the customary mariner's choice of food after a voyage, namely, ham and eggs. A strange sort of feeling came over me as I sat alone, many miles from home—an experience I had never had before—and it was not wholly unpleasant.

After lunch, a trolley ride, and then back to the ship for supper to find someone to go to the movies with me. Several of us went and there was one of those "home and mother" thrillers being shown to the tune of an automatic orchestra that seemed to delight in playing ragtime regardless of the scene depicted on the screen. Then I became homesick. Just what the sickness is I can't tell you but it is worse than any other malady I've become acquainted with and I've had the "flu" and the malaria fever in Mexico where you get it correctly,

and the usual run of unpleasant though popular forms of sickness. I felt like crying and my head felt as though it would split. None of the others seemed to be in any such plight and you may be sure I was glad to get back aboard and asleep.

None of the sailors or firemen had gone ashore because the Captain would give them no money. He did give them some the next day, however, despite the fact that we were to sail for Baton Rouge at noon.

My morning was spent writing letters and post cards and taking a few pictures.

One by one, the men began returning in various stages of insobriety. This all occurred some time prior to the passage of the Volstead Act. During lunch, the firemen's and sailors' mess waxed quite noisy but there was no real excitement until the firemen told the mess boy to tell the cook the potatoes were not cooked and they wanted cooked ones. In no uncertain language the cook told the mess boy to give the firemen his compliments and tell them to go to the devil. He, too, had imbibed a bit too freely of the flowing bowl. The mess boy did as he was bidden and a delegation of firemen immediately made their way to the galley to talk it over with the cook. That gentleman lost little time talking and by way of demonstrating his feelings in the matter punctured one fireman's chest with the point of a carving knife. The injured one gave an unearthly yell and several of us ran into the galley in time to see the firemen in the act of setting the cook on top of his stove. Before the Captain could bring order about, the air had become well permeated with the odor of burning flesh.

Here indeed was adventure of the most blood-curdling variety. I was less than two weeks on my trip to experience, and here, before my very eyes, was a man saved from being roasted alive while another had just been stabbed but a few feet from where I was enjoying a mid-day repast. Verily this was Diamond Dick and Nick Carter and Jesse James stuff all rolled into one. It was better than the movies because it was real.

Due to the performance in the galley, our departure was somewhat delayed, but night found us once again in the open sea and bound south.

During the beautiful days that followed I tore down the four bunks in my room and applied so much Peterman's Discovery that I'm afraid he will have to discover a substitute, but all to little avail. One of the sailors sold me a hammock which he told me was made at Sailor's Snug Harbor. That was one of the best investments I ever made, and the only trouble was that the Captain frequently woke me in the morning by upsetting it and dumping me on the floor which he thought a huge joke.

And thus the days rolled by until we approached the coast of Florida when I was made the butt of many a joke, such as bottling water from the Gulf Stream and sealing the bottle. This water was supposed to turn to Florida Water in a month and to have a delightful odor. There was some truth in its being Florida water, I suppose, and after a month it surely had an odor.

In sailing south it is quite customary to pass between the Gulf Stream and the Florida Coast and it is not an uncommon thing for

vessels to travel near enough to the shore for those on board to see the famous winter resorts at Palm Beach and Miami as well as people in the surf. We looked forward to this sight and I retired to my hammock somewhat earlier than usual so as to be on hand when the beauty spots were to be seen in the morning.

A rather rough hand began swinging my hammock in an uncomfortable up and down motion. I woke and remember saying, "Cut it out! Cut it out!" without so much as opening my eyes.

In a moment or two my hammock was again shaking violently and when I awoke one of the Norwegian sailors with whom I had become quite chummy was tugging at it and calling to me in broken English.

"Spark! Spark!" he shouted, "get up, hurry up, *Astral* run on beach, Captain come in minute wireless for help."

At first I thought it was another hoax but his face surely wore a troubled expression and I was brought to realize the seriousness of the situation by an occasional thud which meant that we were aground and getting a bumping. Grabbing a bath-robe I rushed for the deck where I could hear the roar of the surf breaking on the beach and it seemed but a stone's throw



THE U. S. NAVAL RADIO STATION AT JUPITER INLET, FLORIDA
This was but a few short miles from the point where the *Astral* struck the beach, yet the SOS rent the ether for four hours before an answer was received

from our vessel to where there was a lighthouse. Men rushed up and down the deck while the mate bawled orders on the after deck and the Captain bawled his from the pilot-house window. The barge we had been towing was closing in on us and looked for a time as though she would ram us, but we saw her, too, pile up on the beach.

Men on the after deck were grappling with hawsers and chains and slice bars in an effort to get the rudder, which had broken, under control, but they were making little headway and every swell drove us against the bottom with a sickening thud. I went back to my room and called the barge by radio but could get no answer. The captain sent a message to me by a sailor and wanted it sent to the barge. There was only one way of getting it across and knowing that it was received and that was by sending the code symbols with a light. All the hand flashlights were engaged so there was nothing to do but connect a switch in the line to the main mast light. By standing on the engine room settee with my head poked through a port hole and manipulating the switch, the message was sent and a flashlight on the barge signalled back the answer. A second message from the barge told me that the operator could receive by wireless and would answer by flashlight. That helped a lot and we shot messages from one captain to the other with little loss of time. We were within plain view of the Jupiter Inlet Lighthouse and I made an effort to raise the Jupiter Inlet Naval Radio Station but to no avail.

The Captain came fuming into my room and wanted to send a message to the Naval Station and went into a tantrum when I told him it couldn't be done. Eventually he reappeared and told me to call for help.

I threw on all the power there was and boomed out SOS several times, followed by a message the Captain gave me, telling our position and condition. Then I listened but heard nothing. After repeating this discourag-

ing performance four or five times it occurred to me that my receiving set might possibly be inoperative, though an occasional burst of static did get through. So I called the barge and asked the operator to reply by the flashlight method if he heard me and if he had heard any response to my distress call. The flashlight told me that our signals were very strong but that no replies had been heard. We could not understand the silence of the Navy radio station and my SOS kept droning a periodic tattoo upon the ether for nearly four hours. Then the operator at the Jupiter Inlet Radio Station informed me that they had heard our first call and had followed our operation ever since. They could not reply because of trouble with the gasoline engine that drove their generator.

In the meantime, however, they had been able to get another station by land wire and through it had reached a revenue cutter, which was speeding to our relief and had been for nearly three hours.

This news delighted the Captain, who had begun to call radio all sorts of names, not the worst of which was "a useless damn nuisance."

The night was a strenuous one for all hands and it was a great relief to get in communication with the Revenue Cutter *Yamacraw* and later have the beam of her powerful searchlight thrown upon us. Little could be accomplished in the darkness, however, and no great harm could result from waiting until morning.

The cutter had little difficulty in towing the *Astral* and the barge off the beach and then towing both to Jacksonville, Florida, where we spent a few days in the dry dock. They found our tug in worse shape than we expected and, to make a long story short, I was sent back to New York. The only regret I had at my homecoming was that I was out of a job, but that was fairly well repaid by the reception accorded me by my family, to say nothing of the local press which capitalized on a lot of bunk hero business.



Jacks and How to Use Them

By G. Y. ALLEN

Westinghouse Electric and Manufacturing Company

THE use of plugs and jacks for quickly making and breaking electrical connections dates back to the early days of the telegraph. When the wire telegraphic art had developed to the point where more than one line came into an office, it was found desirable to provide for connecting quickly any line to any instrument, and for this purpose it became the practice to have each line end in two brass blocks with tapered holes, and to provide the ends of the wires leading to the instruments with tapered brass plugs, as shown in Fig. 1. With this

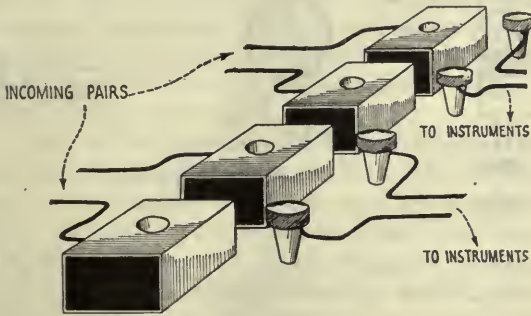

FIG. 1

How connections were made in the early days of the telegraph

system, any instrument could be connected to any incoming line.

Flexible leads were found to be troublesome, and so the practice of connecting the plugs to the line was somewhat later superseded by connecting the incoming lines to vertical brass strips such as are shown at A, Fig. 2, and to connect the instruments to brass blocks arranged in a horizontal line, as shown at B. By inserting tapered plugs in the holes, which are drilled half in the vertical blocks and half in the horizontal blocks, any instrument could be connected to any line.

Another early telegraph jack is shown in Fig. 3, and was known as the spring jack. It differed from the earlier types in that the pressure was supplied by a heavy spring and thus was more constant and reliable than the tapered pin type. When the plug was inserted, the contact surfaces were automatically cleaned

of any dust that might have accumulated, and thus one fundamental feature of good plug and jack design was discovered and incorporated in one of the earliest of the jacks developed.

It will be noted that the two types of jacks mentioned are single-circuit jacks. That is, two operations were necessary to change the two wires of a circuit. This is unquestionably the most flexible arrangement, but at the same time is the most cumbersome where the most frequent operation involves a change of two wires. It is a simple transition from the simple circuit jacks above mentioned to the type shown in Fig. 4. Here the two plugs are merely mechanically attached together by means of a piece of insulating material. Such a device, while being simple to make, has disadvantages, among which is the comparatively large amount of space that it occupies and furthermore the difficulty involved in getting the prongs of the plug and the holes in the jack in perfect alignment.

The development of the telephone art is responsible for the remarkably compact and efficient plugs and jacks that we have to-day. The big problem in the telephone practice is, of course, to provide for making connections between any two of the myriads of lines quickly and perfectly. For the sake of economy in operators, and to reduce the time required to complete connections to the minimum, compactness in the design of jacks and plugs is essential and very early in the telephone de-

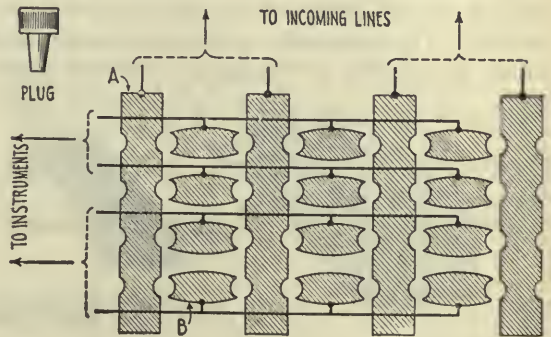

FIG. 2

Flexible leads were avoided with this system

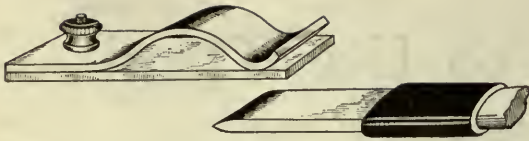

FIG. 3

The spring jack. One plug made one contact

velopment the cylindrical type of plug, comprising two and three circuits, was evolved.

The two-circuit plug consists of a metal shell called the "sleeve" carrying within itself and insulated from it, a metal pin mechanically and electrically connected to a ball-shaped piece called the "tip." The flexible cord is connected with one terminal to the pin and one to the sleeve.

When inserted into the jack, a flat spring is arranged to make contact with the tip and one with the sleeve. In some of the designs, the part of the jack through which the plug passes is made of metal and serves the dual purpose of guiding the plug and making electrical contact.

Very early in the history of the telephone, it was found necessary to develop a signaling system so that the act of inserting a plug into a jack would not only make the desired electrical connections between lines, but would also indicate, either through a mechanical or electrical indicator, that the plug had been inserted. In some systems, it was found necessary to complete additional electrical circuits on inserting the plug. These requirements soon were met by many ingenious attachments to the jack and plug, some of which operated mechanical signals right at the switchboard and some of which operated additional electrical circuits.

The mechanical devices, some of which are in use to-day, were generally actuated by the spread of the springs when the plug was inserted. The electrical circuits were controlled either by making or breaking contact through

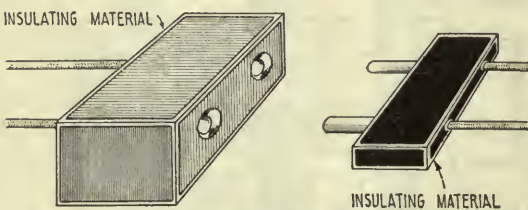

FIG. 4

This improvement was also cumbersome, and the prongs did not always fit. Later, each block, had one hole and one plug, to prevent the reversal of polarity

the spread of the springs on inserting the plug, or by means of relays which were controlled by local circuits operated as above. One development that is only of passing interest to the radio user was the three-circuit plug and jack which is in use in all of the large telephone exchanges to-day. The plug was provided with three contact making portions known as the "sleeve," the "ring," and the "tip." The ring and the tip comprised the talking circuit and the sleeve in conjunction with one of the other parts completed the control circuit. This plug is not generally used in radio, as other types seem to do the work more satisfactorily.

When radio communication was in its infancy, the telephone art was a full grown child.

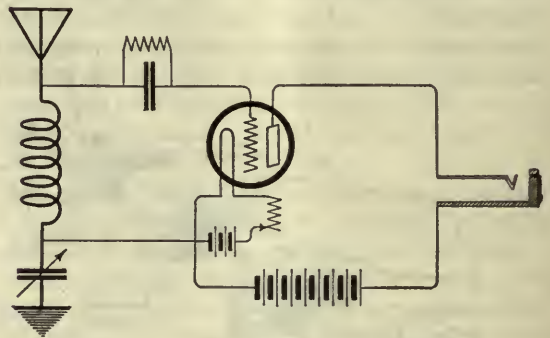

FIG. 5

The simplest method of using a jack in a circuit. This is an open-circuit jack, and it merely connects the telephones

It was but natural, therefore, for the younger art to absorb from its predecessor those developments which applied. Practically no change in the fundamental design was necessary, as the audio-frequency currents in a radio receiving circuit are of telephone magnitude and frequency.

The widest use of the plug and jack has been in the head telephone circuit. Since the advent of the vacuum tube and its use in amplifiers, it has been found very desirable to be able to change the head set quickly from the plate circuit of the detector tube to the plate circuits of any of the amplifying tubes. To accomplish this conveniently, the practice has become common to provide radio sets with as many jacks as there are tubes and to provide telephone head sets with plugs. A standard size plug has become common, this plug being one of the standard sizes adopted in telephone practice.

The first plugs employed were identical with those used in the telephone field. The diameter

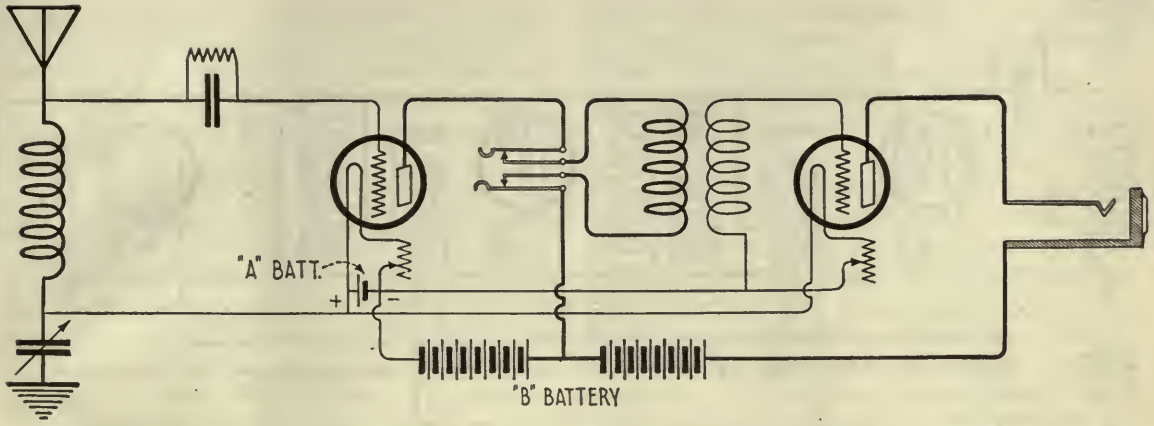

FIG. 6

When the plug is placed in the first jack, the A. F. transformer is cut out. When the plug is withdrawn, the transformer is connected, and the telephones are then placed in the second jack

of the handle was very small, which was a desirable feature in telephone practice on account of the necessity of having to place jacks as closely together as possible. The available space for making connections to the flexible cord, however, were very meagre and required a special type of cord terminals.

Now, in the radio field, the requirements are somewhat different. In the first place, the space requirements are not so rigid and furthermore there had grown up a practice among the manufacturers of head telephone receivers of attaching pin terminals to their cords. The conventional telephone plug would not take these terminals, of course, and the temporary result was that special cords were required whenever it was desired to use a plug.

This condition soon stimulated manufacturers to design a special plug for radio purposes that provided means for attaching the plug to the standard pin terminal cord. In fact, some of

the plugs on the market to-day will take practically any kind of cord tip, either pin, spade, or plain wire.

CIRCUITS EMPLOYING PLUGS AND JACKS

THE simplest circuit in which a plug and jack may be used is one involving the connection of a head set to a simple crystal or vacuum detector with no amplification. The elements of this circuit are shown in Fig. 5. The only reason for using a plug and jack here would be in the event that it was desired to use the same head set on other sets or that it was desired to remove the head set frequently for some other purpose.

The simple jack may also be used for connecting the head set to any of the stages of a multi-stage amplifier, but with an efficiency below that which may be obtained using a pair of auxiliary springs.

The simple jack may also be used in any of

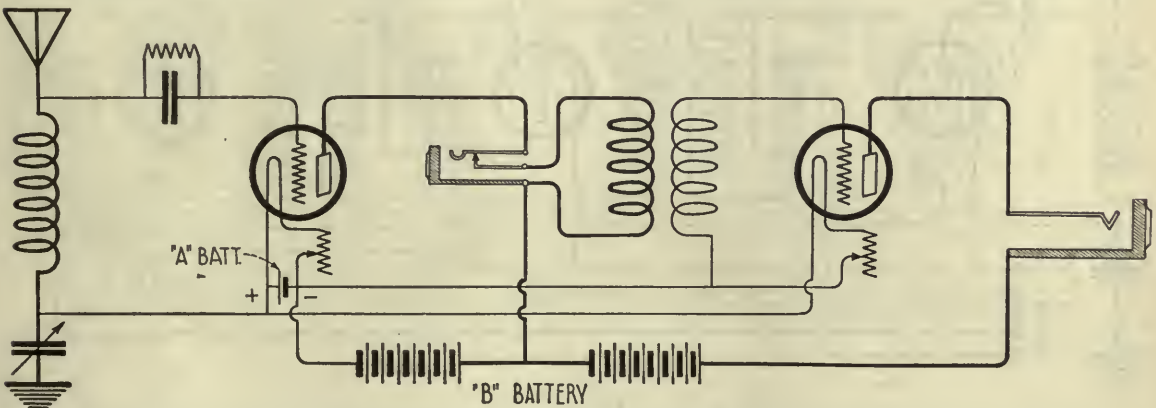

FIG. 7

This arrangement is similar to that of Fig. 6, except for the difference in the type of jack used

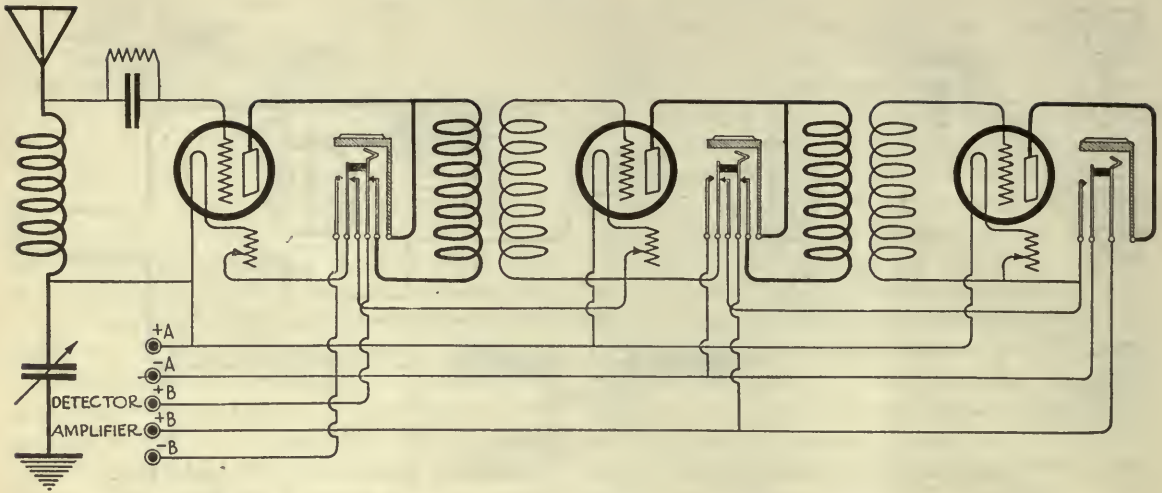

FIG. 8

An automatic filament control is provided by the multi-contact jacks shown here

numerous other places where circuits are to be disconnected rapidly. For instance, the antenna wire and ground wire also, may be provided with plugs which may be plugged into jacks mounted in the set. In non-regenerative sets, it is not advisable to use the same plug or jack for both antenna and ground, although there would be the requisite number of circuits. The reason for this is that the insulation in both the plug and jack operates to raise the effective resistance of the antenna circuit which will reduce the strength of the received signal. In regenerative sets, the increase in antenna resistance caused by the insulation of the plug and jack can be compensated for to a certain extent by the regenerative feature. The effect of the capacity in both plug and jack,

however, which will increase the effective antenna capacity and thus reduce the amount of inductance with corresponding reduction in signal strength and selectivity, cannot be compensated for, and in general it is best to use two separate plugs and two separate jacks for antenna and ground.

A very convenient method of mounting a small loop antenna consists in providing the end of the mounting stick with a plug and arranging a jack in a vertical position to receive the plug. The ends of the loop are connected to the plug and the circuit completed through the jack. The loop may be instantly removed if desired, and may also be turned in any direction.

Undoubtedly the most popular use of jacks

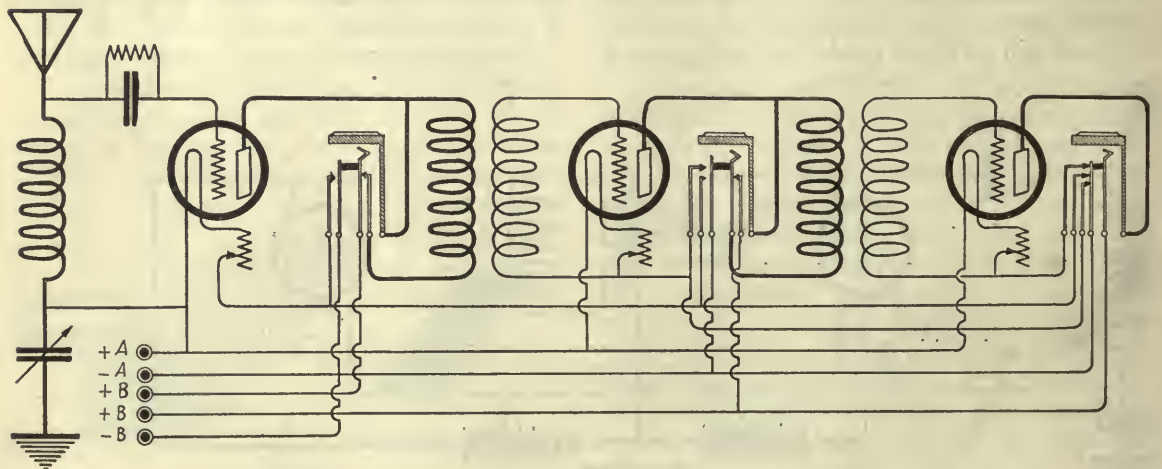

FIG. 9

Three types of jacks are used in this arrangement, the chief difference being in the number of filaments controlled by each jack: the first controls one, the second two, and the third all three filaments

in radio sets to-day is to change the head set or loud speaker from one stage of amplification to another. To accomplish this efficiently, one or two additional springs are needed on the jack. Figs. 6 and 7 illustrate the schematic connections.

An improvement on the more simple arrangement shown herewith is a connection in which all filaments are extinguished except those that are in actual use. That is, when it is desired to use less than the entire number of stages of amplification only the filaments of the tubes used are connected to the circuit, thus saving both tubes and batteries. To do this complicates the wiring somewhat, especially when there are more than two stages of amplification, but if less than the maximum number of stages are used frequently, the extra complication is well worth while on account of the economy involved. Furthermore, with the more uniform tubes that are now being produced, the tendency is toward the use of fewer filament rheostats, and as the filament rheostat on most sets is the only means of control, the filament control jack is becoming more and more desirable from the standpoint of economy.

Two methods of automatically controlling the filaments are shown in Figs. 8 and 9. By following these two circuits out it will be seen that only the filaments of the tubes in use are operated. The circuit shown in Fig. 8 requires jacks with three extra springs for the detector

and for all stages except the last, where two additional springs are needed. The circuit shown in Fig. 9 requires a different type of jack for each position.

At times, it is desired to use the amplifying part of a complete two-stage amplifier, detector, and tuning set with another set in which no amplifier is provided. This is particularly true in the case of very complete amateur stations where a number of different sets are used to get different wavelength ranges. It is desirable in such cases to provide the amplifying set with means to facilitate these connections.

A suitable wiring diagram that provides for great flexibility in this direction is shown in Fig. 10. The terminals marked "External A battery" are for connecting to the A battery terminals of the detector tube set. It is intended that the terminals of the non-amplifying set that are normally connected to the telephone headset shall be connected to a plug and that the plug shall be inserted into the jack marked "External Detector." With the connections shown, the filament control feature is retained and only the tubes in actual use will have their filaments connected to the battery.

It may be well here to say a word to the uninitiated on the use of sets using filament control jacks. The filament of a vacuum tube draws an appreciable amount of current and therefore the voltage drop in all of the filament

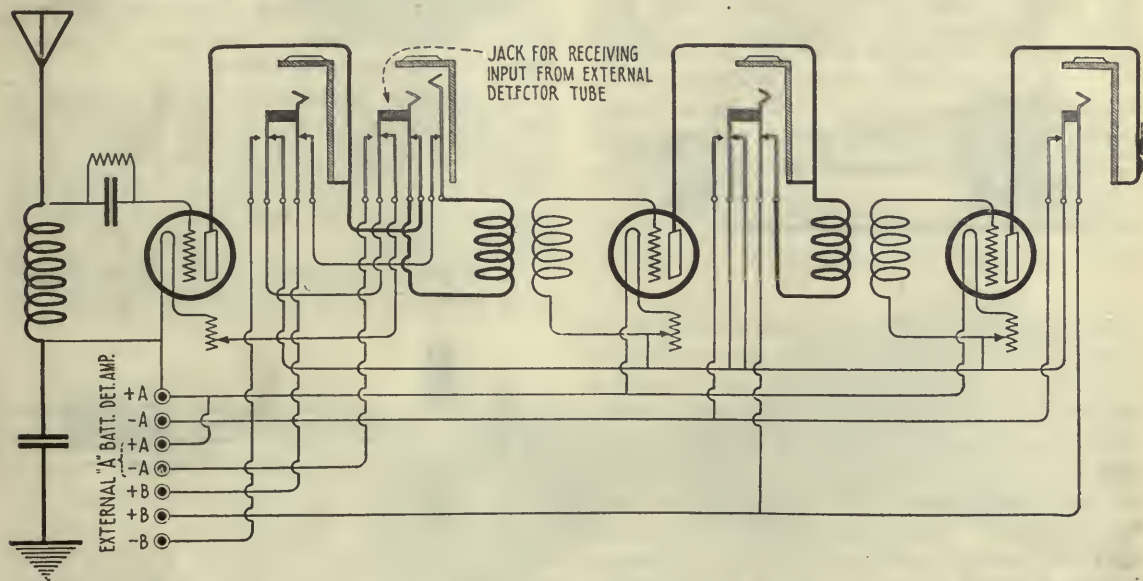

FIG. 10

By this arrangement, the signals from any receiver may be amplified by using the amplifying part of this complete receiver. In this case, the tuning elements are automatically cut out and those in the external set are used

wiring is an appreciable percentage of the voltage drop across the filament. Now, assume that the telephone plug is inserted in the detector jack and all adjustments have been carefully made. On attempting to use the amplifier, by shifting the plug to the amplifier jacks, it may be found that the added voltage drop due to automatically cutting in the additional amplifier tubes may be sufficient to decrease the detector tube filament current below its most sensitive spot. It is well, therefore, to readjust all filament rheostats after changing the number of stages of amplification used in any filament control jack set.

Various other uses of jacks will suggest themselves. In small tube transmitters, the favorite key or telephone microphone may be plugged into any one of more sets by suitable jack connections. Experimental sets can well afford to use jacks and plugs to facilitate the trial of any connections that may be desired. Two-circuit jacks should seldom be used in radio-frequency circuits on account of the losses in the insulation at these high frequencies and also on account of the capacity added. When it is desired to use jacks in high-frequency circuits, a separate jack should be used for each wire.

TYPES OF PLUGS AND JACKS

ALTHOUGH both plugs and jacks are comparatively simple devices, yet there are several points in their design that very largely determine their efficiency. One of the

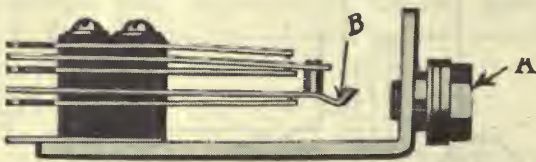

FIG. 11

prime requisites of any electrical connection, of course, is that it shall give good electrical conductivity at all times. This requirement is particularly important in circuits employing telephone receivers because the slightest variation in contact resistance, even though the average conductivity of the circuit may be good, can be heard. And with vacuum-tube amplifiers, any slight variations in circuit resistance in the detector or first stages of amplification are heard in the head set as loud responses. It is thus important that the design of jacks for

radio work be such as to remove the slightest possibility of poor contact.

The points constituting good design of both plugs and jacks can perhaps be best illustrated by showing photographs of actual apparatus.

Fig. 11 illustrates a jack of a type commonly

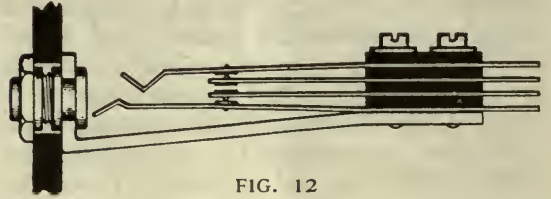

FIG. 12

used. The frame is made of sufficiently heavy metal to give rigidity and to permit the engagement of enough threads of the screws to prevent stripping of the threads. Micarta, bakelite, and hard rubber are satisfactory for insulation between springs. Fibre should never be used, as it absorbs moisture, which reduces the insulating qualities and furthermore its physical dimensions change with variations in atmospheric conditions, which may either strip the threads or lessen the springs. Springs should be either of German silver or of phosphor bronze, and should be heavy enough to exert from one to two pounds pressure against the plug. The springs should in all cases be long enough so that when the plug is inserted they will not be bent in any one position sufficiently to exceed the elastic limit of the material from which they are made. Otherwise, the spring pressure will gradually diminish.

All auxiliary contacts should be designed so that in addition to moving in a direction perpendicular to their surfaces, they will have a wiping effect. This is necessary to keep the surfaces clean of dust and to insure good contact at all times.

As all plugs are standard and as the dimensions of the tip must be small, the tolerances in

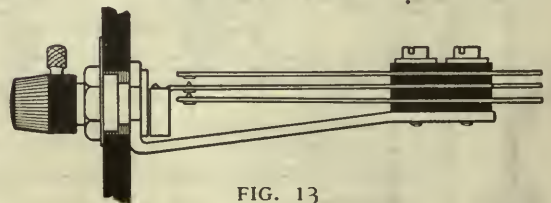

FIG. 13

the distance from the surface A to the centre of the tip spring B in Fig. 11 must be small. In this particular design, washers are provided

to maintain this distance constant when the jack is used on panels of different thickness.

A jack of somewhat different construction is shown in Fig. 12. It will be noted that the frame of this jack is so bent that the large pile-up of insulating material is avoided. Also, the part of the jack that guides the plug is rigidly attached to the frame, thus maintaining a constant distance between surface A and the middle of the tip spring without the use of washers for different

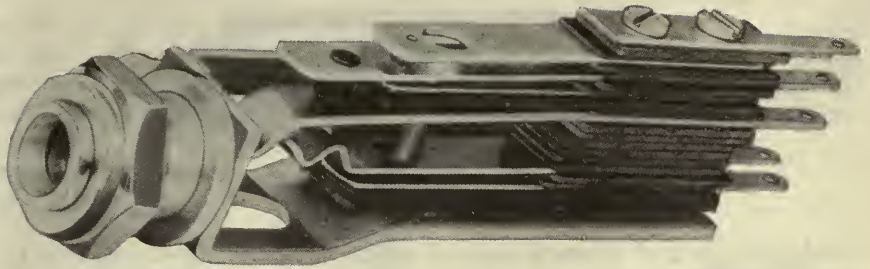

FIG. 14

This heavily built jack has two spring contacts and does not rely on the sleeve for connection to the plug jacket

tion. In this type, the frame is of the angle type which makes for extreme rigidity. The contact between the sleeve of the plug and the guide surface of the jack is not relied on for electrical contact, but a spring is used for the sleeve as well as for the tip. It might be stated here, that a point of good jack design requires that all jacks relying on the plug guide for contact should always have all springs pressing on one side of the plug only. If springs are applied to both sides of such a jack, there is a possibility of the spring pressures on the opposite sides of the plug just balancing, which may cause the plug sleeve to make poor contact with the plug guide.

A jack differing somewhat in its basic design from those already described is shown in Fig. 15. As will be seen, all springs are mounted on a circular piece of insulating material which in turn is attached to the back of the panel. This type of jack is much shorter than the conventional type and, where it is not necessary to mount them closely together, it gives excellent results. One convenient feature of this type is that screw connections make it unnecessary to solder the connections.

The jack shown in Fig. 16 is designed for a totally different field than those heretofore described. It is intended for mounting wholly



Left: This jack extends but an inch in back of the panel. Soldered contacts are unnecessary

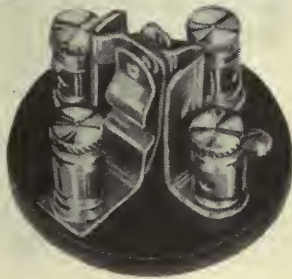

Right: Same as above, but of the double-circuit type

FIG. 15

thicknesses of panel. A good appearance on panels of all thicknesses within the limits of application is preserved through an ingenious design of hexagon nut.

On this particular jack, auxiliary contacts of pure silver are used. This metal seems to give excellent results when very small currents are to be broken.

An interesting and useful adaptation of this type of this jack is shown in Fig. 13. A cam has been inserted in the guide sleeve, and by turning the knurled head, many types of circuits can be controlled.

Fig. 14 illustrates a radically different construc-

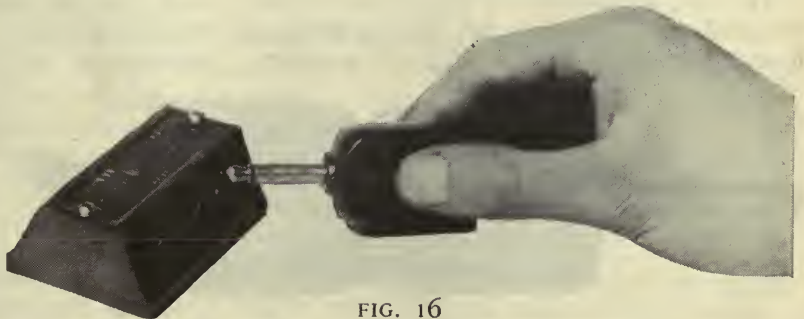

FIG. 16

One, two, or three pairs of telephones may be plugged into this jack at the same time

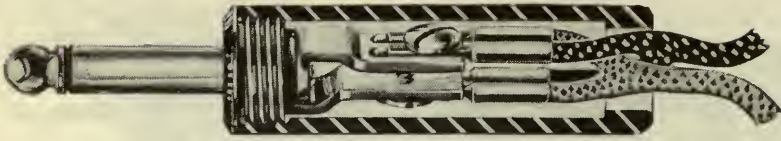

FIG. 17

This plug will take two sets of telephones

outside the set and is more adapted to completed sets that do not have jacks as a part of their regular equipment. It is made in the one type only, and has provision for taking three plugs. The springs are so arranged that all plugs are connected in series with the circuit and on withdrawing a plug, the springs of that particular jack are short circuited so that, regardless of the number of plugs used, the circuit is continuous. The instrument is made from moulded composition and presents a neat appearance.

As stated at the beginning of this article, the modern plug designed for radio can be used with cords with pin terminals. Various methods have been devised for securely holding the cord terminals; and much thought has been applied to reduce to a minimum the number of tools required to make connections. Many of the plugs on the market can be attached to the cord with no tools at all while others require but the assistance of a small screw driver or thin coin.

A cylindrical type of plug that requires but a thin coin for making connections is shown in Fig. 17. One of the advantages of this design is that two head sets may be connected to the same plug if desired. The holding screws are arranged to take any type of terminal. The composition cylindrical cap may be unscrewed from the plug without tools.

A plug with a split moulded handle is illustrated in Fig. 18. A screw driver is needed in this case to make the connections.

The plug illustrated in Fig. 19 is also of the moulded split type, but has the outstanding feature that no tools whatsoever are necessary

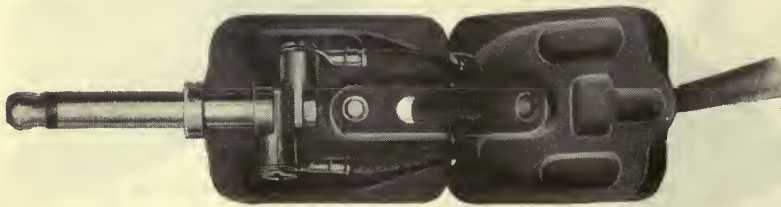

FIG. 18

You need a screw driver to fasten the telephone terminals in this plug

for making connections to the cord tips. Thin steel springs tightly grip the tips, making very good connection. This type of plug, however, is not adapted to taking spare terminals.

For the sake of those not fully acquainted with the uses of jacks in various circuits different types are given in Fig. 20.

In conclusion, let it be said that with the numerous well designed plugs and jacks on the market to-day, there is no excuse for the radio manufacturer, be he professional or novice, for incorporating poor jacks into his radio set. Although comparatively small in size, they

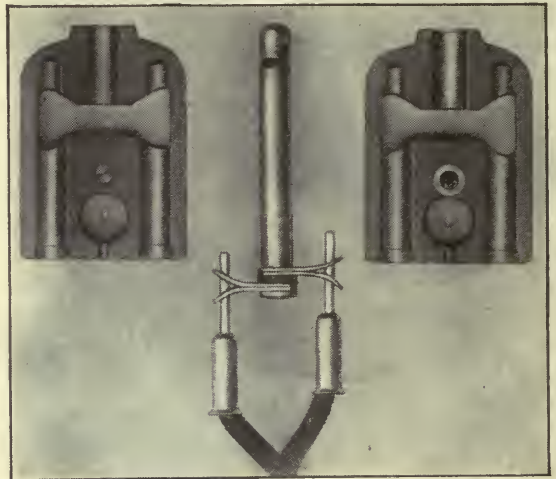

FIG. 19

Spring clips hold the telephone tips in this case. No tools are necessary

are largely instrumental in determining the over-all efficiency of the set. Only the best designs should be tolerated. Many of the manufacturers of plugs and jacks for the radio trade have had years of experience in the telephone field, and they are able now to place this experience at the disposal of the radio manufacturer. If the points governing good jack and plug design are kept in mind when purchases are made, serviceable plugs and jacks will be assured and by following the diagrams given herewith, the efficiency of the entire radio set will be greatly augmented.

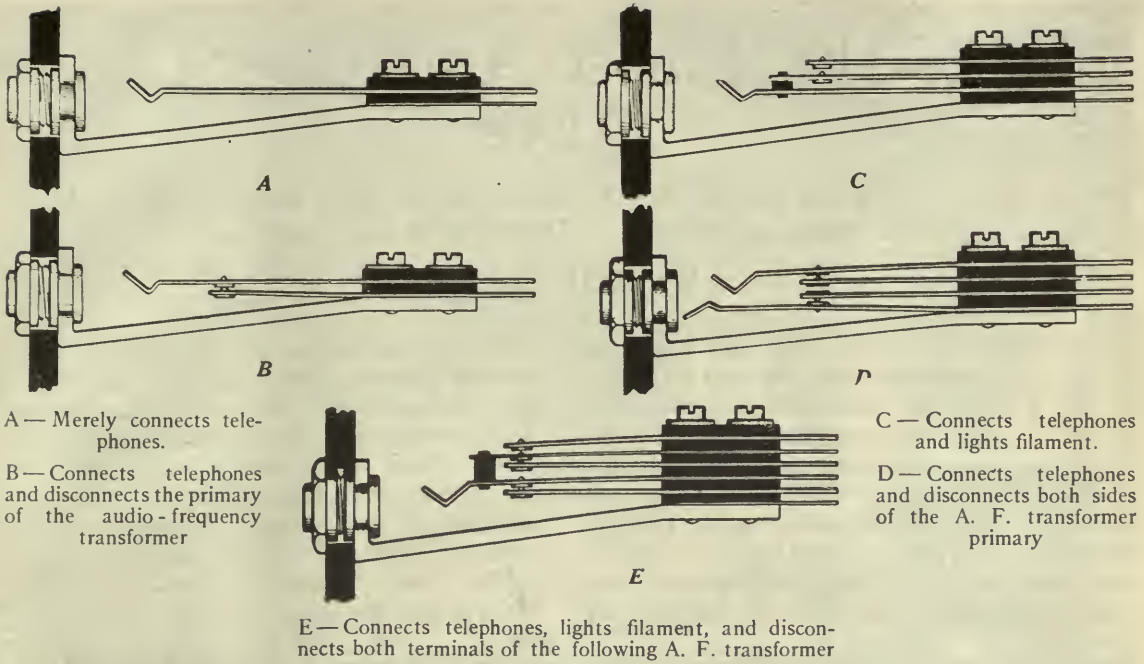

FIG. 20

If You are Thinking

Of submitting an article to RADIO BROADCAST, you may save yourself and the editors time and trouble by considering the following notes as to what we want and what we cannot use:

WE WANT:

True accounts of the uses of radio in remote regions.

Short, true stories of adventures in which radio played an important part: unusual and interesting occurrences to you or your acquaintances.

Clear explanations of new or especially effective circuits or uses for apparatus.

Concise and logical discussion of some important problem or phase of radio, whether in the field of broadcasting, constructing, operating, buying or selling; or of reading or writing that has to do with radio.

True accounts, of some particular interest, relating "What Radio Has Done For Me."

Humor, when the object is not merely to appear funny, but to present some phase of radio in an attractive, amusing way. The same applies to drawings.

Clear, unusual photographs are always in order, as are good circuit diagrams.

A liberal rate is paid for material used.

WE CANNOT USE:

Fiction, unless it deals in a striking way with some subject of interest to those interested in radio. Articles or illustrations to which RADIO BROADCAST would not have the exclusive rights.

The best way to do is to read through several numbers of the magazine to get an idea of the various kinds of articles we publish.

One of the Finest Amateur Stations Alive

2 FZ is Very Much Alive, and It is the "Bee's Knees" in Amateur Stations, as They Say in Our Language

By ZEH BOUCK

THE term "amateur" has long since freed itself from the restrictions of Webster, who defined it merely as differentiating between one who follows a field as a means of livelihood, and one who devotes himself to it purely from motives of non-professional interest. The connotation of inferiority, as in the expression "a rank amateur," exists only in the minds of those who have forgotten or have never known of the

ability of our leading football and collegiate baseball players, some of our most artistic and able photographers, and the many possessors of private but none the less exquisite art collections. There is no illusion more false than the prevalent picture of the amateur radio operator as a malignant youngster in short trousers, horns and a forked tail!

Many amateur stations are far superior to the average run of commercial installations,



2FZ, ONE OF THE MOST ELABORATE AMATEUR STATIONS IN EXISTENCE

The entire station, with its myriad switches, motor-generators, dynamotors, tubes, and batteries, is at the finger tips of the operator, who may effect a hundred and one different combinations of apparatus without rising from his chair



THE MAP WHICH FLASHES THE POSITION OF VARIOUS STATIONS

The illuminated map of the United States is, to the layman, perhaps the most interesting feature of station 2FZ. With a flip of a telephone switch on the control box, the coast lines become dotted with dark green lights indicating the ship-shore commercial stations. Another switch is thrown, and red lights flash the position of the naval stations, and the constellation is completed by a sparkle of white dots—the broadcasting stations

which exceed them only in power, the general amateur being restricted to a single kilowatt input on a wavelength of two hundred meters.

Such a station is 2FZ of the Bronx, New York, owned by Mr. Frank Frimmerman, and operated by a corps of experienced men. This station, though merely typical of amateur installations in its efficiency and embodiment of progress, is of especial interest because of the elaborate equipment, combined with simplicity of operation due to an ingenious development of remote control. The entire station, with its myriad switches, motor-generators, dynamotors, tubes and batteries, is at the finger tips of the operator, who may effect a hundred and one different combinations of apparatus without rising from his chair. What may be described as "the central nervous system" of the station, is located in the small control box in the centre of the operating table (shown in picture on page 494) and the flip of a telephone switch, or the plugging into a jack, commands the miracles of Aladdin! The thousand-volt generator slips into its gentle whine; the trans-

mitting tubes light simultaneously with the whirl of the cooling fan before them; indicators jump on the switch-boards; and tiny red and green pilot lamps flash above the controls, indicating the functioning of every circuit!

To the left in the first illustration (also to the right in the one just above); is shown the transmitting equipment, exclusive of the power supply. The tubes and auxiliary apparatus are mounted in an open board arrangement, permitting adequate cooling and instant inspection for trouble. The meters at the top of the mounting panel indicate the values of the various voltages and currents supplied to the bulbs, as well as the antenna output, which, on a single tube, is three amperes at two hundred meters. The input meters register the plate and filament voltages and the space current. The inductance, of edgewise wound copper strip, is mounted to the right of the meters. The transmitting bulbs are 50-watt Radiotrons, three being used individually for radio telephony as oscillator, modulator, and speech amplifier. In low-power sets, this last

tube may be dispensed with, but with higher outputs, the unaided voice is not sufficiently strong to control, or modulate, the radiated output. The speech amplifier strengthens the comparatively weak voice impulses, and applies them as powerful electrical vibrations to the grid of the second or modulating tube. Instant change from voice to buzzer modulation (telegraph) is effected at the control box by plugging in buzzer and key. Switches are provided for throwing the transmitting tubes in parallel for continuous-wave transmission, which, if it is desired, may be broken into I. C. W. (interrupted continuous wave) by the motor-driven chopper in the foreground.

Between the control box and the receiving equipment, is a land-line telegraph instrument, at present not in operation.

The receiving apparatus is in perfect keeping with the elaborateness of the transmitter. A Reinhartz tuner is used for amateur reception, particularly of continuous waves; while broadcast and the higher wavelengths are brought in on the honeycomb set. Change of tuners is effected by a single-pole double-throw antenna change-over switch. Separate bulbs are used in each receiver, a detector and one step of audio-frequency amplification with the Reinhartz, and detector and two stages on the honeycombs, thereby avoiding a multiplicity of switches or plugs where capacitative and inductive effects are especially undesirable. The output of either receiver may be plugged into a single-stage power amplifier with loudspeaker, operative from B batteries or dynamotor.

The first picture also shows the main switchboard containing power and storage battery controls. The Tungar rectifying tube at the top of the board charges the six- and twelve-volt batteries through the horizontally mounted double-pole double-throw switches. The batteries are shelved beneath the board, and consist of twelve- and six-volt units, respectively, lighting the receiving filaments and providing current for the indicating lights, relays, etc.

The condition of the fuse bank below the rectifying tube is flashed by the omnipresent red and green lights—green being the normal operating color, and red indicating a blown fuse.

The meters indicate the conditions of the two batteries in respect to charge, and individual discharge and voltage. The lower half of

the panel contains the power switches and two relays which are part of the remote control system.

To the rear of the station (see photo, page 497) are located the connection rack, the receiving high-potential control panel and the motor-generators.

The connection rack (A) is unique, and is found in few stations. Its main advantage lies in the facility with which it permits the tracing of circuits and shooting trouble, for, with few exceptions, all power and control leads pass through this framework en route to the various pieces of apparatus. The rack also makes possible the bridging of one circuit upon another, with an almost infinite variety of connections for experimental purposes.

The comparatively diminutive switchboard in the background regulates the receiving high-voltage supply, both directly and by means of controlling the dynamotors suspended beneath the panel and the smaller of the motor-generators. The B batteries, mounted on the lower shelf, generally suffice for receiving with ordinary amplification, while the dynamotors supply the high plate potential for power amplification, individual machines feeding the two-step amplifier and power bulbs. The dynamotors run from the fifty-five-volt motor-generator previously mentioned, and their output is regulated from one to three hundred and fifty volts, by varying their speed with series rheostats, the control wheels of which project from the front of the switchboard. The four meters above the controls indicate both the current consumption of the receiving set in milli-amperes and the voltage at which it is supplied.

The motor-generator in the rear is a thousand-volt, quarter-kilowatt machine, generating the transmitting potential, and is under relay control from the operating table. Both machines are mounted on massive concrete blocks, eliminating vibration and assuring silence.

The photo on page 495 shows the opposite side of the operating room, and the transmitting apparatus already described. The illuminated map of the United States is, to the layman, perhaps the most interesting feature of station 2FZ; and even an operator, were the air dead, might while away an evening playing with its lights. The map is divided by the heavy lines into the nine radio districts of the United States, each section being indicated by a num-

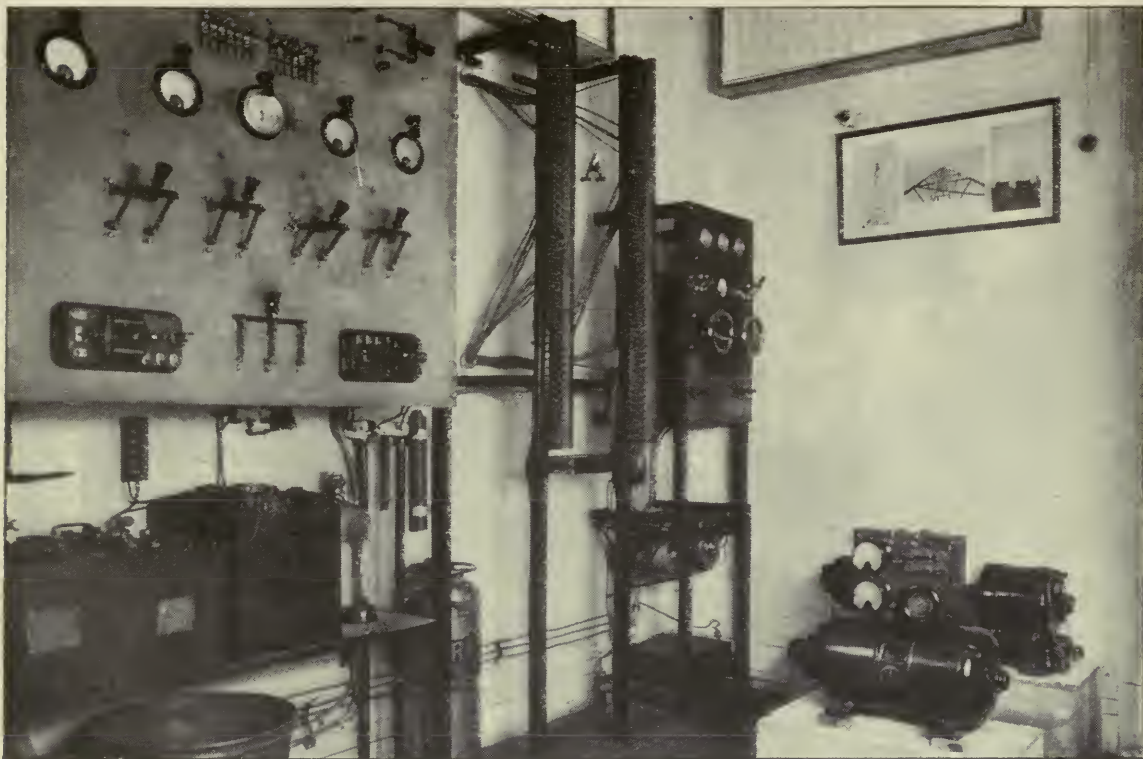

A VIEW OF THE SWITCHBOARDS, MOTOR-GENERATORS AND CONNECTION RACK

The connection rack (A) is unique, and is found in few stations. Its main advantage lies in the facility with which it permits the tracing of circuits and shooting trouble, for, with few exceptions, all power and control leads pass through this framework en route to the various units of apparatus

bered electric light. With the flip of a telephone switch on the control box, the coast lines become dotted with numbers of dark green lights indicating the ship-shore commercial stations. Another switch is thrown, and red lights flash the position of the naval stations. A moment later the Atlantic coast is dappled with light green flares, marking the locations of the long-wave, trans-ocean stations; and the constellation is completed by a sparkle of white dots—the broadcasting stations.

The map is also speckled with tiny pins locating the distant stations that have heard and worked 2FZ; and they dot the map from west of the Mississippi to the frame out in the Atlantic ocean! Until recently, the map of the United States sufficed, but with the verified report of the reception of 2FZ's signals in England and Honolulu, the old map has been supplemented by that of The World! Pins are ready, and this new mural addition is now being wired for similar electrification—and the rainbow searched for new combinations!

The antenna system of 2FZ is consistent with the operating department. The transmitting aerial is a three-and-a-half-foot cage, seventy-five feet long, "T" type, with a cage lead-in, and seventy-five feet above ground. The receiving antenna is a single wire, six hundred feet long, and swung at right angles to the transmitting aerial to minimize the absorption of energy. It is permanently connected to the receiver, obviating the necessity of a change-over switch, and permitting the station with which communication is being carried on to "break in" for correction when 2FZ is transmitting.

Station 2FZ, in recognition of its place in the DX (distance) field, is the office of the Bronx City Manager of the American Radio Relay League. Communication with both western and New England stations is consistent, and traffic to the extent of hundreds of messages a month, routed via New York City, is relayed through it to points perhaps a thousand miles nearer its destination.

Stations That Entertain You



WGI, THE AMERICAN RADIO & RESEARCH CORPORATION'S STATION AT MEDFORD HILLSIDE, MASS. The 100-watt transmitter, shown at the right, has been heard in Kansas, Texas, and Cuba

THE STUDIO AT KDZE, RHODES DEPARTMENT STORE, SEATTLE, WASHINGTON
A wall of plate glass allows shoppers to see the broadcasting in progress



Radio-Frequency Amplification From the Ground Up

Applying Radio-Frequency to Single-Circuit, Three-Circuit, Super-Heterodyne and Reflex Methods of Reception and Some Suggestions for Combining the Last Two Methods

By ARTHUR H. LYNCH

PROVIDED with a circuit of the type shown in Fig. 1, it is possible for us to obtain many interesting and satisfactory results from almost any of the more common forms of receivers.

Last month the application of a circuit of this variety to three-circuit tuners and loop antennas was explained, and now some comment upon applying radio-frequency to a single-circuit receiver may be of interest.

To begin with, the single-circuit receiver used in conjunction with Fig. 1, may be regenerative or non-regenerative, depending upon what is used to connect X^4 and X^5 . For simplicity of operation, the non-regenerative method may be used, but where long distance and greater selectivity are sought, regeneration is helpful. If a short piece of wire connects X^4 and X^5 , the regenerative action of the detector tube is not brought into play, but a variometer or the tickler coil of the common single-circuit regenerator inserted between these two points will, on the other hand, take advantage of re-

generation, which may be controlled in the usual manner.

The character of the antenna circuit of the single-circuit outfit makes but little difference. It may be a variable condenser and tapped coil between the antenna and ground; a fixed condenser and a variometer in a similar position, or merely a variometer. Connection to the points X^2 and X^3 are made to the upper and lower ends of the *active* turns of the inductance. Condensers, either fixed or variable may best be placed between X^2 and the antenna. By *active* turns, in speaking of inductance, is meant those turns actually in use. For instance, one common form of single-circuit regenerator employs a variable condenser and a vario-coupler as its turning units. The primary of the latter is tapped. The upper end of the primary winding is connected to X^2 while the various taps are connected to switch contacts and the switch lever is connected to X^3 . This arrangement is shown in Fig. 2.

Audio-frequency amplification may be added

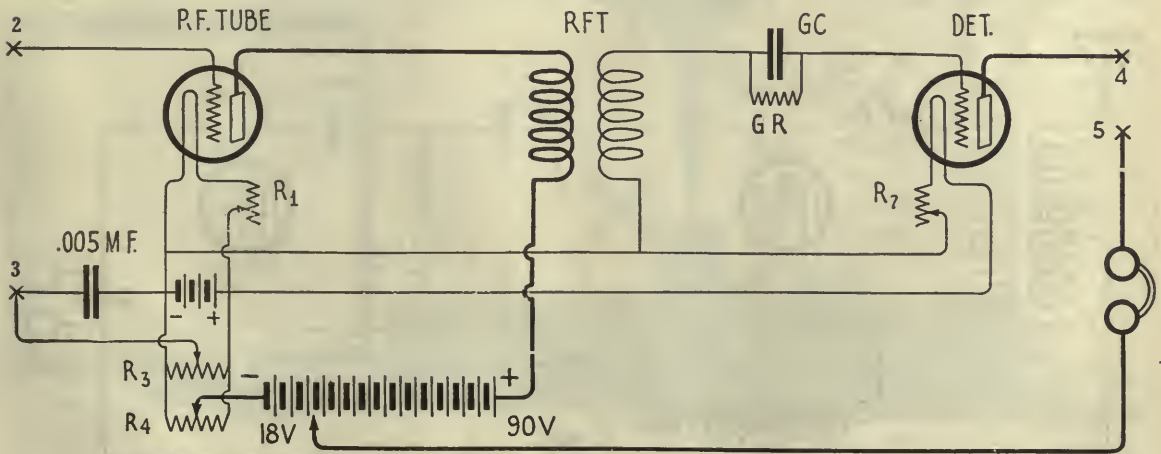

FIG. 1

A single-stage, transformer-coupled, radio-frequency amplifier and vacuum-tube detector applied to a standard coil mounting. Various adaptations of this arrangement are possible

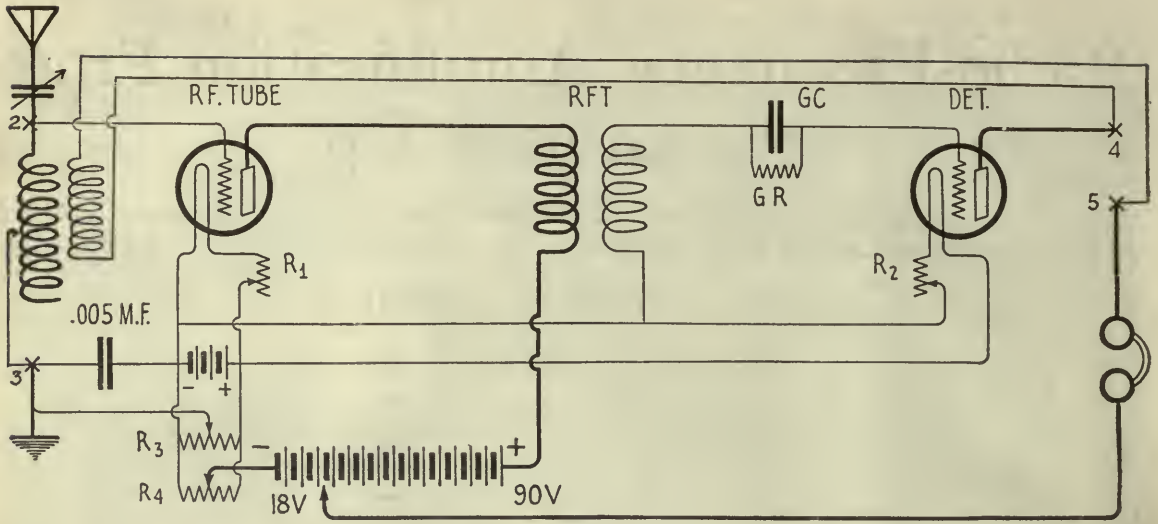

FIG. 2

By making the connections indicated here, the range of a single-circuit regenerative receiver may be greatly increased. If regeneration is not desired, a direct connection between X₄ and X₅, and the elimination of the tickler coil, are the only changes necessary

to a circuit of this variety in the usual manner, though it is not necessary unless a loud speaker is to be used. For this purpose a single stage will usually suffice for local stations and two stages for the more remote stations.

REGENERATIVE R. F. AMPLIFICATION

FOR those who use the vario-coupler and twin variometer circuit, the addition of a single stage of radio-frequency is a comparatively simple matter. It is but necessary to take the grid condenser and leak out of the circuit in which they are usually found and make

a direct connection to the grid in their place. If you wish to leave the wiring as it is, the grid condenser and leak may be short-circuited by a small piece of wire. An amplifier tube is then put in the socket which formerly held the detector and the plate voltage is raised from the customary $16\frac{1}{2}$ - $22\frac{1}{2}$ to 45-90. It is then but necessary to couple the output of the regenerative amplifier tube to the input of a detector tube circuit. This arrangement is shown to the right of the plate variometer in Fig. 3.

The units required for this circuit arrange-

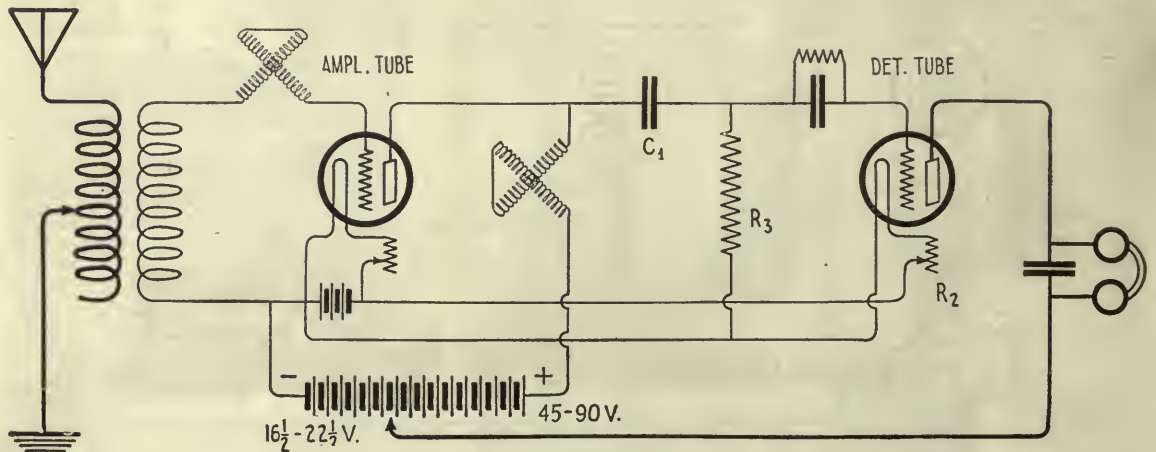

FIG. 3

A standard vario-coupler and twin-variometer regenerative receiver will have a stage of tuned radio frequency added to it if the arrangement shown here is followed

ment, in addition to those in use with the regenerative receiver, include:

R² Filament rheostat (with vernier or compression type preferred)

C¹ Fixed Condenser, .001 M. F.

R³ Resistance may be a grid leak resistance, its resistance is not a critical factor.

A vacuum-tube socket, an amplifier tube and from one to three additional B batteries complete the list.

The necessary elements for this circuit may be included in the receiver cabinet, or an additional cabinet for the coupling elements and detector control may be added. In fact there is plenty of room in most of the detector control units now on the market to mount the condenser and resistance in them. Such units, however, are not frequently provided with rheostats capable of very delicate filament control and this is very desirable where a "gassy" detector is used.

REFLEX AMPLIFICATION

ONE of the most economical methods of long-range radio reception is found in the system of employing vacuum tubes to serve the dual purpose of radio- and audio-frequency amplification. Some of the history of this arrangement, which is not new, was told by Frank M. Squire, Chief Engineer of the De Forest Radio Telegraph & Telephone Company, in RADIO BROADCAST for February. Another article, describing the Grimes method of reflexing, by Charles Durkee, appears on page 472 of this issue.

Since the introduction of the WD-11 dry-cell tubes and the new coated-filament tubes, designed for storage-battery operation, much of the objection to the use of several tubes has been removed, and we can now operate three of the new 5-volt tubes with less drain on the storage battery than a single tube of the old type required.

The cost of tubes has ever been a factor among those of us who build our own sets, but the cost of several tubes has been more or less overshadowed by the cost and inconvenience of keeping a storage battery well charged. Now, however, these difficulties have been greatly reduced, and it is not surprising to find a rapidly increasing interest in circuits which because of first cost and upkeep, found little favor in the past. With the reduction of operating cost and an economical method of making tubes do double duty, there is a growing tendency toward receivers which are easy to install and easy to operate. Loop antennas, which usually require at least two additional tubes and their accessories to produce a signal equal in strength to that picked up by an average outdoor antenna may be used at comparatively small additional expense.

Of all the receivers the radio art has developed, it is doubtful that any has more possibilities and has received less attention than Armstrong's super-heterodyne. This is especially true in view of the great improvement made in the art since this receiver was developed. The one striking disadvantage of this form of receiver has been found in the great number of tubes required: eight to ten or more, in most of the receivers that really performed well.

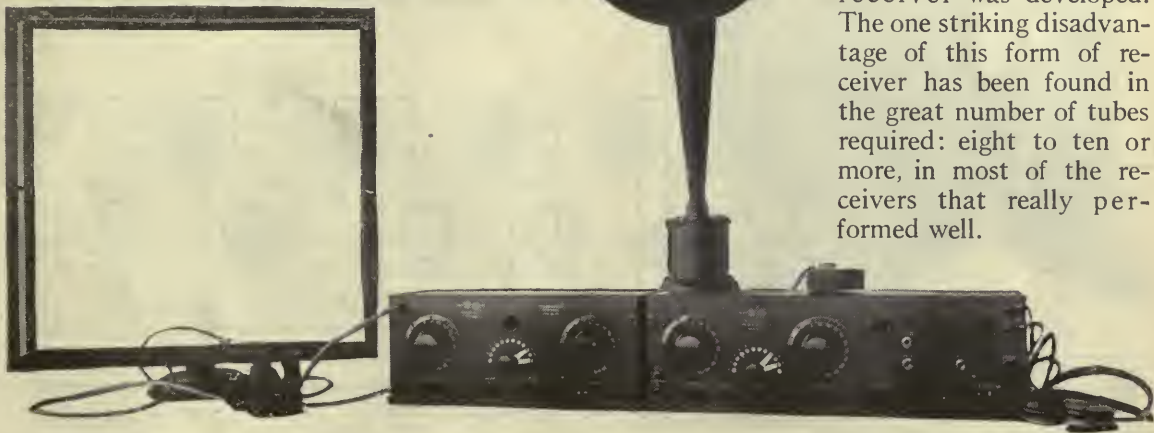

WITH THIS OUTFIT, A LISTENER IN CHICAGO HEARD STATIONS ON THE EAST AND WEST COASTS. It consists of a two-foot loop, a Grebe tuned R. F. amplifier, tuner with detector and two-stage A. F. amplifier, and Western Electric loud speaker. The R. F. amplifier may be used with any receiver and has a wavelength range of from 150 to 3,000 meters

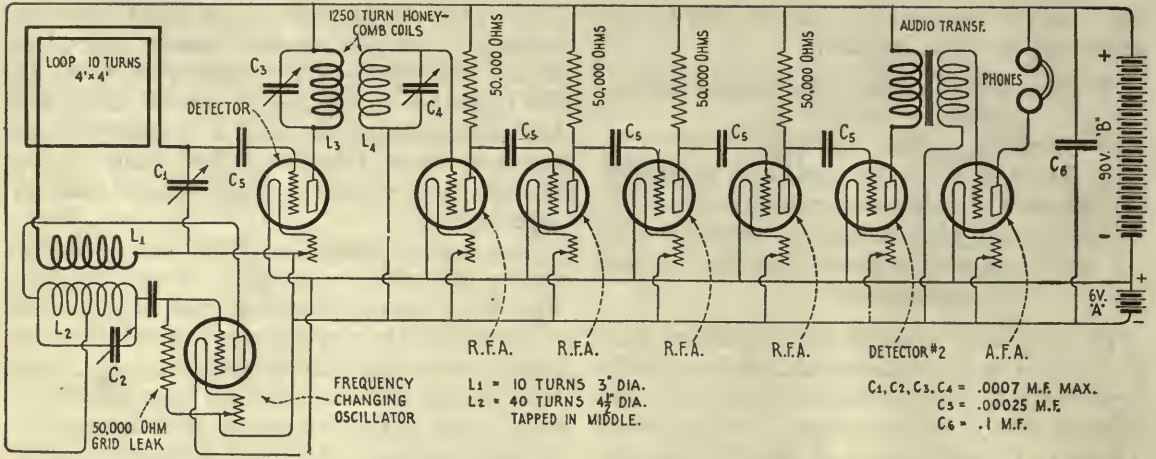

FIG. 4

R. F. amplification of the resistance-coupled variety is employed in this super-heterodyne circuit. (Described by Paul Godley in RADIO BROADCAST for February, 1923)

Paul F. Godley was one of the first to bring the value of this receiver to the attention of the amateur world by using it to receive American amateur signals across the Atlantic. His experience with the super-heterodyne covers a long period, and an article by him describing its construction and operation appeared in RADIO BROADCAST for February. One of the simplest forms of the super-heterodyne is shown in Fig. 4.

In describing this invention before a meeting of the Institute of Radio Engineers, Mr. Armstrong said that two stages of resistance-coupled radio-frequency amplification were necessary to bring the signal up to its original intensity after it passed through the first detector tube. Additional stages were then necessary, if any

increase over the original value was desired. That meant the use of a great many tubes.

In a recent lecture before the Radio Club of America, Mr. George Eltz, Jr. told of some very important improvements in the super-heterodyne method and demonstrated an outfit in which but seven WD-11 tubes were used in conjunction with a three-foot, nine-turn, loop antenna and a loud speaker.

His circuit arrangement is shown in Fig. 5. It will be noted that iron-core radio-frequency transformers are employed, and Mr. Eltz explained that they are well warranted because they improve the amplification, per stage, some five to six hundred per cent. over the resistance-coupled variety, thus reducing the number of tubes necessary. The transformers in his cir-

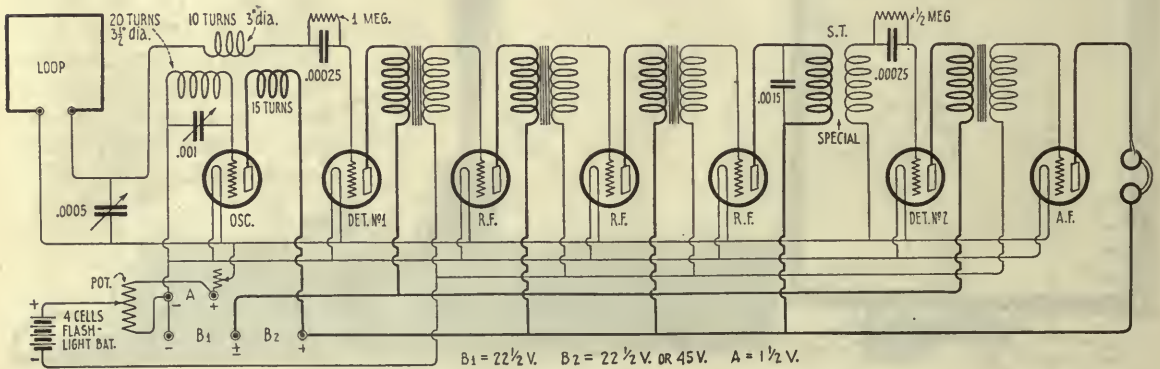

FIG. 5

This super-heterodyne arrangement was described and demonstrated by George Eltz, Jr., before the Radio Club of America. Seven WD-11 dry-cell tubes are employed and the Radio Corporation UV-1716 R. F. transformers are used in the radio-frequency amplifying circuits

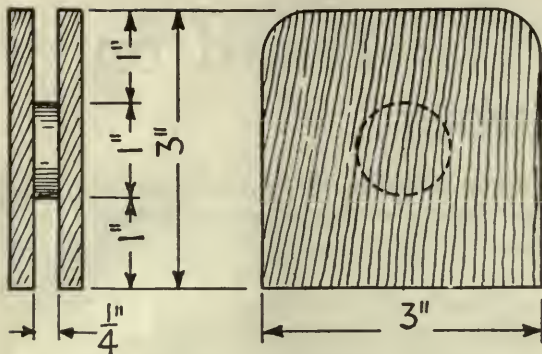

FIG. 6

This special transformer is used to couple the last R. F. tube to Detector Tube No. 2 in Fig. 5, and provides a sharp resonant point for the radio-frequency circuit. The walls of this transformer may be made of bakelite or hard rubber. The primary is wound with 200 turns of No. 29 D. S. C. and is separated from the secondary, which has 1500 turns of No. 36 D. S. C., by several layers of empire cloth

cuit are the Radio Corporation's type UV-1716, (Fig. 7) which may be used to cover a very broad band of frequencies. Each stage of R. F. is shielded by rather heavy metal shielding.

Another advantage of the arrangement shown in Fig. 5, lies in the fact that the tuned R. F. coupling transformer (S. T.) which determines the frequency at which the intermediate frequency circuit must function is placed directly before the second detector tube rather than directly following the first detector tube, is as the case in Fig. 4. The construction of this transformer is indicated in Fig. 6. Its advantage lies in the fact that whatever losses are brought about in this circuit may be sacrificed with less ultimate loss after the amplification has taken place.

A SUGGESTION

FOR those who would use the super-heterodyne and would care to cut down the expense of its operation, we would suggest a method for reducing still further the number of tubes required. We have not had time to give this method the trial which usually precedes the publication of information in RADIO BROADCAST and therefore refrain from publishing the circuit we have in mind, but there is no apparent reason for any difficulty being experienced with it.

Where such high amplification is used, there seems to be no reason for overlooking a good crystal detector to follow the R. F. amplifiers. That would eliminate one tube.

There seems to be much logic in the Grimes method of reflexing and if Armstrong's contention is true, the current flowing in the first two R. F. tubes is very small indeed. Why not go back to them, then, for the audio-frequency, thus doing away with two more tubes without a great loss in over all performance.

In suggesting this arrangement, we have not lost sight of the fact that a tube used in a reflex arrangement may not be serving at its best as a radio or audio-frequency amplifier, but this loss does not seem to be a very serious matter. For the experimenter who is anxious to produce great volume, the use of three stages of audio-frequency is to be considered. In this last arrangement, however, a great variety of difficulties are likely to arise.

The production of uniform tubes for use in amplifying circuits operating on very low filament consumption and amplifying transformers that will cover a great band of frequencies make it possible for us to look for some very marked improvements in reception. To the best of our knowledge these suggestions have not been made before, and RADIO BROADCAST would like to hear from those who attempt to put them into practice.



FIG. 7

The UV-1716 R. F. transformer has a wavelength range of from 5,000 to 25,000 meters. It may be used at the frequencies found in the intermediate frequency circuit of the super-heterodyne and produces a much greater amplification, per stage, than is possible with the resistance-coupling

How Far Have You Heard on One Tube?

Results of the First Contest. Three Final Articles on One-tube Reception: "An Evening's Trip Around the Whole United States," "The Automatic Regenerative Circuit," and "Cheap at Twice the Price." Some Further Points on Constructing and Tuning. Summary

The contest which closed February first, and of which the final reports are printed in this issue, has brought to light a wealth of interesting and useful information about hook-ups, constructing, tuning, and in general getting the best out of one-tube sets. Some painstaking and excellent work has been done by experimenters in gathering complete details regarding their receivers and working them up, with the help of photos and diagrams, into clear descriptions from which any one can profit.

Now that the net has been hauled in and the deep-sea catch examined, what do we find in it that seems to be of particular significance?

Three Facts Stand Out Strikingly

1. The great distance that is possible with a single tube. *A score of contestants have heard stations more than 1,500 miles away*, while 1,000-mile reception is common. A dozen or so report an aggregate mileage of more than 50,000 (the record is 111,240 miles, made by Russell Sheehy. His circuit is given in Fig. 1), and many have identified more than sixty different broadcasting stations!

2. The excellent showing that single-circuit regenerative sets and variometer regenerative sets have made in reaching out after the distant stations. A glance at the summary of results on page 436, last month, and page 513, this month, will show this clearly.

3. The remarkable work done by those operating homemade, makeshift (this does not mean carelessly made!) apparatus. What accounts for it? Is it because the man who "winds his own" learns more about the fine points of operation through being thoroughly familiar with every unit that goes into his finished receiver? Or is it because this type of experimenter is just naturally forever changing the elements in his circuits, experimenting, improvising, and improving until everything is adjusted for maximum efficiency *under his particular conditions*? In any case, those who have done the splendid work described in this and previous issues have well earned their success, and we congratulate them.

Two Prizes Awarded

Contestants whose reports we have published have been sent checks for their articles. Two of these articles have been considered by RADIO BROADCAST so interesting and instructive with regard to text, so well illustrated with photos and diagrams, and so exceptional in the number and distance of stations heard, that they have been unanimously awarded First Place and Second Place in the contest, and two prizes, voted by the Editors, have been sent them.

We announce, then, as winner of the "How Far Have You Heard on One Tube?" Contest, MR. RUSSELL SHEEHY, whose article, "Feeling the Nation's Pulse" appeared in the February issue. He will receive a Grebe CR-8 Regenerative Receiver and Two-Stage Amplifier.

And as second in the contest, we announce MR. E. V. SEAGER, author of "A Practical, Long-Range, Single-Tube Receiver" (See page 428, RADIO BROADCAST for March.) He will receive a Paragon Two-Stage Audio-Frequency Amplifier.

It will be noticed that the manuscripts chosen for publication in this contest—appearing in the December, January, February, March, and April numbers—have not necessarily been those with the highest mileage reports. As previously announced, a high aggregate mileage was considered one of the principal factors in judging contributions, but the interest, clearness, and general worth of the articles also carried great weight.

We hope that the hundreds of contestants who sent in their contributions to this contest will read the announcement of the *new contest* on page 514, and will send us some interesting material on what they have done with *any number of tubes*.

The three articles which follow wind up the one-tube contest with a variety of material which will be of wide interest to all long-distance broadcasting experimenters and in which everyone should find some hook-up, receiving wrinkle, or bit of information to suit his own particular demands.—THE EDITOR.

AN EVENING'S TRIP AROUND THE WHOLE UNITED STATES

By MILO SHUTT

I HAVE read the articles on "How Far Have you Heard?" with great interest and am sure the records which I have made will be of interest to the readers of RADIO BROADCAST.

My set has been in operation for about three months and I have not tried particularly to break any long distance records, but have tried to tune in, from my home in Alliance, Ohio, the different stations in consecutive order, beginning at either Schenectady or Boston and going down the Atlantic coast and the Gulf and following the stations westward until I stop at the Pacific Coast, which also includes the Canadian stations.

My idea has been to take a trip to the Pacific Coast, which requires me to stay at it until 1:30 or 2:30 A.M.

I like to listen-in on the proceedings of the "Put a Tack" Club of Dallas and the "Radio Bug" and "Night Hawk" clubs of Kansas City.

My outfit consists of a modified three-circuit

regenerative set using spider-web coils, which may be seen in the accompanying photographs. The price of the outfit by parts is as follows:

1 set Goodman coils and mountings . . .	\$6.50
1 43-plate vernier condenser	3.80
1 23-plate vernier condenser	2.90
1 tube socket60
1 ammeter	3.00
1 Bradleystat	1.85
1 series-parallel switch85
1 Dubilier grid leak and condenser . . .	1.50
1 7 x 18 x 3-16 inch Radion panel . . .	1.60
Total cost of parts, less tube and phones	\$22.60

The tuner consists of a Goodman spider-web mounting which I have arranged with a device for tuning from the front of the panel and is capable of vernier adjustment, thus allowing very fine tuning.

I find that the vernier condensers are a great help, especially in preventing interference from several stations broadcasting at the same time. I can set my outfit for WEA, New York, and rotate the vernier on the 23-plate condenser $\frac{1}{4}$ of a turn to bring in WOC, Davenport, Iowa. I have had very little interference from spark stations.

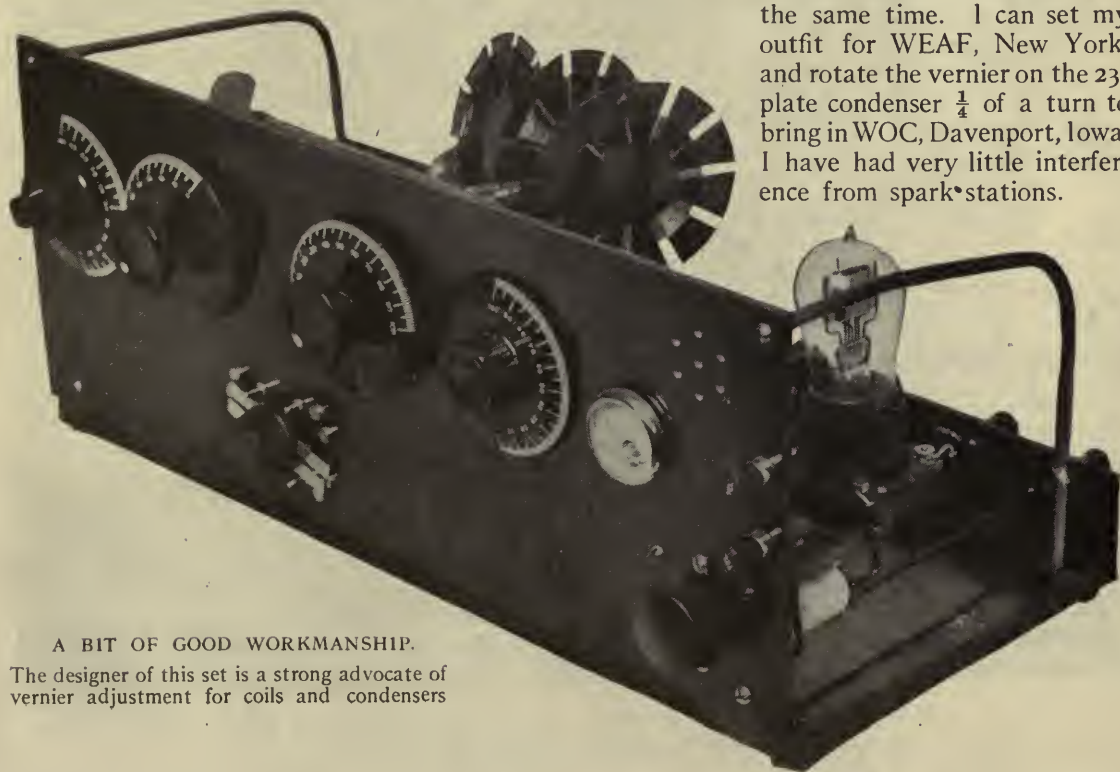

A BIT OF GOOD WORKMANSHIP.

The designer of this set is a strong advocate of vernier adjustment for coils and condensers

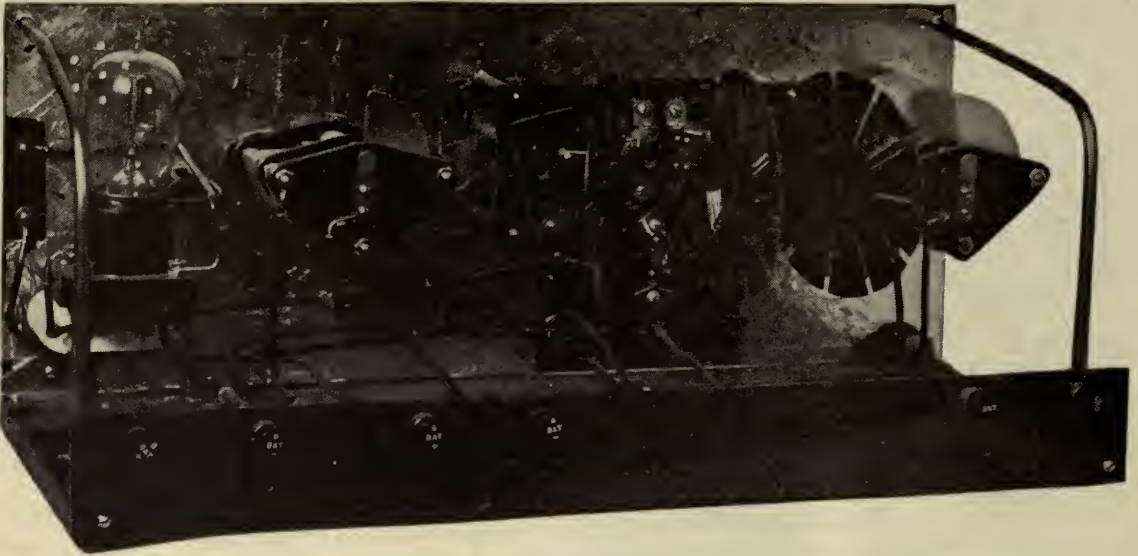

SHOWING THE NEAT ARRANGEMENT OF THE UNITS, AND THE CAREFUL SHIELDING

My aerial is a single wire about 110 feet long and averages 25 feet in height. It is not in an ideal location as there are several small trees

under the wire. However, I have it stretched as taut as a fiddle string which I find brings in the signals better. I can get any of the large



ALLIANCE, OHIO, IS THE STARTING POINT FOR MANY A TRIP

In a single evening, Mr. Shutt can jump from Spokane to "San Antone," from the Ca'linas to California, and from Cuba to Calgary

CHEAP AT TWICE THE PRICE

By FRANK J. MYERS

EDITORIAL NOTE:

Any rags, any bones, any bottles to-day?
 If you have any junk, don't throw it away—
 Mr. Meyers will put it inside of a box,
 And hear all the programmes, from wos's to woc's!

HERE is a photo of a receiving set which I put together recently. It employs a single-circuit regenerative circuit, with 50 turns on a 3½ inch tube for the primary and 15 turns on a 3-inch tube for the secondary. The first evening that I tried it out, I tuned in seventeen broadcasting stations with little or no interference. They came in loud and clear and the results were very gratifying, as this set compared favorably with my standard receiver which sells for \$130.00. The net cost of this receiver was \$1.98, which included one socket, one rheostat, one condenser and grid-leak unit, wire, and binding posts. I already had a 43-plate variable condenser that is panel mounted, and counting that, the set would come to not more than four dollars. I made the dial out of heavy paste-board. The panel and entire cabinet are of odd pieces of boards. I used a piece of number eight fence wire for the shaft and an electric light switch knob on the dial; and I wound number twenty-two cotton covered wire on two pieces of paste-board boxes that I picked up in my studio. The time consumed in making the cabinet and assembling the entire outfit was eight hours. The loudness and clearness of both music and voice are almost unbelievable until you have tried this circuit out; even PWX, Havana, Cuba, WOAI, San Antonio, Texas, and Denver, Colorado come in loud enough to be heard while holding the phones away from your ears several inches. I might also add that I can hear Ft. Worth and Dallas, Texas, every night they are on, and they are nine hundred and thirty-five miles from my home in Kendallville, Indiana. As stated above, I heard programmes from seventeen stations the first night I tried it out, and then on the following night I heard eighteen new stations with it and since then I have been getting one or two new stations each evening.

The following list of forty-one stations, ranging from 150 miles to 1300 miles from Kendallville, Indiana, was heard in three evenings.



THIS BROUGHT IN 17 STATIONS THE FIRST EVENING

It cost the owner \$1.98, plus an old 43-plate condenser, plus 8 hours' work

	MILES
PWX	Havana, Cuba 1300
WPA	Ft. Worth, Texas 935
WLAJ	Waco, Texas 980
WBAP	Ft. Worth, Texas 935
KFAF	Denver, Colo. 1100
WLW	Cincinnati, O. 175
WDAF	Kansas City, Mo. 525
WHAZ	Troy, N. Y. 625
WOAI	San Antonio, Texas 1165
WIAO	Milwaukee, Wis. 270
WDAP	Chicago, Ill. 150
KSD	St. Louis, Mo. 340
WBAJ	College Park, Ga. 585
WFAA	Dallas, Texas 925
WMAQ	Chicago, Ill. 150
WMAT	Duluth, Minn. 535
WSB	Atlanta, Ga. 575
WHB	Kansas City, Mo. 525
WEAF	New York City 600
WGM	Atlanta, Ga. 575
WGY	Schenectady, N. Y. 625
KYW	Chicago, Ill. 150
KDKA	Pittsburgh, Pa. 300
WSY	Birmingham, Ala. 575
WHAM	Rochester, N. Y. 400
WOS	Jefferson City, Mo. 440
WBT	Charlotte, N. C. 510
WNAD	Norman, Okla. 815
WLAG	Minneapolis, Minn. 490
WAAP	Wichita, Kansas 700
WJAS	Pittsburgh, Pa. 300
WJAX	Cleveland, O. 185
WHAS	Louisville, Ky. 265
WBZ	Springfield, Mass. 675
WJZ	Newark, N. J. 515
WOC	Davenport, Iowa. 275
WAAQ	Greenwich, Conn. 625

TOTAL 20,815

windings are tight and will stay so. Paste-board tubes should be treated with parafine, shellac, or other such substance in order to exclude moisture, so that they will retain their original shape and size. Bakelite or formica tubes are much to be preferred as coil forms. Loose windings experience sudden erratic changes in capacity and inductance, are liable to spring off their forms, cause mechanical annoyances, and are generally inefficient."

Another contestant, Carol Nason, of Livermore, California, echoes the "solder everything" advice of Mr. Johnson and cites an interesting example.

"Before wiring with copper strip and soldering every joint," he says, "number 18 bell wire was used. This worked fine for two or three days, but after that the set began to hiss. All the connections were shined up—and the hissing stopped! Another thing that is apt to produce undesirable noises is poor A battery connections, both at the battery and on the rheostat. Keep your eye on them all the time. In conclusion, I might say that it takes some patience to get distant broadcasts, but you feel repaid and then some when you hear an announcement 2000 miles or so away. There is no trick in it. It requires a good set and a decent aerial and a little close tuning.



THE HOLMSES, OF PRESTON, ONTARIO, WITH THEIR HOLM-MADE SET

One other thing: When you use a detector alone you get to know your set much better than if you use two steps to start with. Then, when you do put in one or two steps you have a real set." Mr. Nason's aggregate mileage is 56,477, made with a standard regenerator.

One of the highest mileage reports received is that of Milton L. Johnson, who seems to be bringing in about everything worth hearing from his conveniently central home in Atchison, Kansas. He has heard 175 stations in all and has piled up an aggregate of 110,755 miles. His set is a standard 3-circuit regenerator.

Several reports were received in which the stations heard on a single night were recorded.

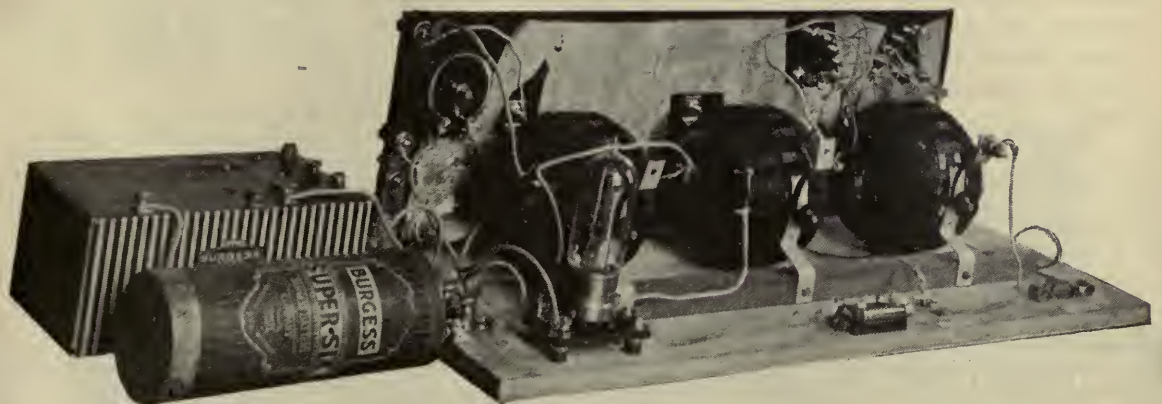

RALPH S. RAMSAY, IN MADISON, WISCONSIN, HEARS LOS ANGELES WITH THIS
It employs the twin-variometer, variocoupler arrangement, and the tube is a WD-11



A PRODUCT OF THE BUCKEYE STATE

Willis Danback, of Tiffin, Ohio, is the designer of this receiver. It has 2 stages of A. F. amplification, but he has done some good work with one tube

Vernon Trigger, of Carsonville, Michigan, relates making a score of 25,500 miles in six and a half hours. "This little long-distance hop," he tells us, "was accomplished with the aid of a home-constructed standard regenerative receiver. By the way, it appears that the old 'stand-by' seems to be losing out to the new and numerous single-circuit outfits. The trouble with three circuits, using two variometers and a vario-coupler, is the difficulty of tuning them. Hauling in 2000-mile stations with another about 150 miles away ripping along with a beautiful carrier-wave is the result of a fifty-fifty mixture of perseverance and perspiration."

J. E. Bradley, of Justin, Texas, reports practically the same mileage, 25,010, in one evening. That particular evening, he and Mrs. Bradley started listening-in at 5:45 P. M. and finally called it a day, or rather a night at 3:18 A. M. Has a sort of familiar sound, hasn't it? We wonder if there is one among our readers who hasn't sat down at his set with a firm resolve to spend fifteen or twenty minutes at it, and then put off the quitting time again and again until the bell in the clock-tower from somewhere outside boomed in the news that it was 1 G. M.!

Charles H. Hewitt, of Southern Pines, North Carolina relates hearing stations all over the country on a single-circuit regenerator, to the tune of 109,025 miles. Much of his DX results he obtained after 2 A. M. He uses a vernier condenser in parallel with the usual variable in the ground circuit. This is a good point, and ought to improve the tuning of any set.

Ralph S. Ramsay, of 625 North Frances St., Madison, Wisconsin, has been using a dry-cell tube with a home-made set, and gets Los Angeles (1500 miles), Calgary (1200 miles), and San Antonio (1000 miles) consistently. He lists only 21 of the stations he has heard. These aggregate 15,975 miles.

D. C. McCoy, of Charleston, West Virginia, who has been a radio bug for some thirteen years says that he recalls with a smile the old days when he "used to sit up half the night to get a few signals from some station 50 to 100 miles away." He made his present set out of various improvised, bought, and salvaged parts, making all connections as short as possible between the various units and soldering everything—even the connections on the prongs of the tube, instead of using a tube socket. The set is of the single-circuit regenerative variety. Mr. McCoy's longest jump is 2150 miles, and his aggregate is 28,205.

The final summary of results follows:

SUMMARY OF RESULTS OBTAINED BY OTHER ENTRANTS WHOSE COMPLETE RECORDS HAVE NOT BEEN PUBLISHED PREVIOUSLY

SINGLE-CIRCUIT REGENERATORS					Name and Address	No. of Stations	Nearest Station	Farthest Station	Aggregate Mileage
Name and Address	No. of Stations	Nearest Station	Farthest Station	Aggregate Mileage	Maury Simmons, 2700 Darian St., Shreveport, La.	91	175	2020	72,820
F. W. Crary, Carsonville, Mich.	116	150	2175	85,100	Perkins Benneyan, 637 Poplar Ave., Fresno, Calif.	79	160	2500	69,690
Leland Whitelock, 408-9th St., Petersburg, Ind.	153	160	1775	81,081	J. W. Bowser, 206 Greenwood Ave., Punxsutawney, Pa.	82	150	2375	60,725
Harrie R. Eachus, Sutter, Calif.	80	150	2540	74,765					

How Far Have You Heard on One Tube?

Name and Address	No. of Stations	Nearest Station	Farthest Station	Aggregate Mileage	Name and Address	No. of Stations	Nearest Station	Farthest Station	Aggregate Mileage
C. D. Mason, Kirby Bldg., Cleveland, O.	102	150	2100	59,050	Leo A. Mondt, Pont. College Josephinum, Columbus, O.	29	500	1460	22,515
Roy R. Hess, Jr., Edna, Texas	60	150	2040	46,190	Albert J. Bezek, Ely, Minn.	32	220	1720	22,350
James S. Norton & Frank D. Baker 902 N. Mariposa Ave., Los Angeles, Calif.	46	210	2250	43,450	S. A. Robinson, Lucketts, Va.	43	150	1175	22,335
Ray Dannenbaum, 313 Georgia St., Vallejo, Calif.	38	350	2504	43,168	Eric Burrell, Nova Scotia Sanatorium, Kentville, N. S.	26	375	2000	20,675
Wendell Thomas, Trenton, Mo.	68	150	2000	41,800	E. H. Swift, Rossville, Ill.	36	150	1875	19,615
W. K. Kreuits, Clifton Forge, Va.	76	175	1065	38,035	Edward F. Armstrong, White Plains, N. Y.	24	190	1500	18,090
Laurance Angel, Jr., Huntington, N. Y.	54	150	1475	36,401	STANDARD REGENERATORS				
George Jesse Schottler, Dexter, Minn.	50	150	1650	35,164	Joe McCormack, 1018 Peachtree St., Gadsden, Alabama	103	160	2800	85,560
Norman Olding, New Glasgow, N. S.	43	475	3025	33,576	C. W. Cooper, 810 N. Jackson St., Waukegan, Ill.	96	185	1750	53,770
C. T. Nelson, 2824 Clermont Ave., Pittsburgh, Pa.	68	175	2125	33,570	Alfred Magnuson, Lincoln, Ill.	59	150	1700	30,900
A. J. Muldowney, Highland, Wis.	55	150	1700	33,295	Caesar Cone, Greensboro, N. C.	54	260	1025	27,780
José Hernandez Banza, Calle 27, No. 307, Vedado, Cuba.	26	700	2350	31,800	Horace W. Wardle, Qu'Appelle, Sask.	25	300	2325	24,240
Ray L. Atkinson, Lakeworth, Fla.	34	185	1860	31,730	VARIOMETER REGENERATORS				
Paul Glaister, Napanoch, N. Y.	52	150	1950	31,130	Robert Shafer, Croton, O.	107	150	2000	58,835
Gilbert Edwards, 428 Marsh Ave., Reno, Nevada.	46	150	1950	30,000	Edwin E. Pike, Fairgrove, Mich.	83	165	1400	46,520
Vine Stoddard, Aurora, Iowa	47	175	1550	27,350	A. C. Van der Bent, 3436 Walnut St., Philadelphia, Pa.	37	150	1700	32,520
Arthur Hulteen, 636 White Bear Rd., St. Paul, Minn.	39	150	2023	26,955	Theodore Bedell, Jr., 39 Bedell St., Freeport, N. Y.	57	150	1500	32,185
Richard Haynes, Northeast Harbor, Me.	38	200	1840	26,505	9756 Prospect Ave., Chicago, Ill.	46	175	1800	23,630
Werner R. Nygren, 174 Whaley St., Freeport, N. Y.	42	150	1500	25,095	A. C. Callen, West Virginia University, Morgantown, W. Va.	49	160	1225	21,680
H. A. Sanders, Jr., Greenville, Me.	33	350	2200	24,600	Earl Hassler, 425 S. Lahoma St., Norman, Okla.	26	175	1350	20,010
R. H. Shell, Gregory, Texas	29	150	1775	24,280					
Charles Salter, 1516-8th Ave., Lewiston, Idaho.	26	175	2200	23,250					

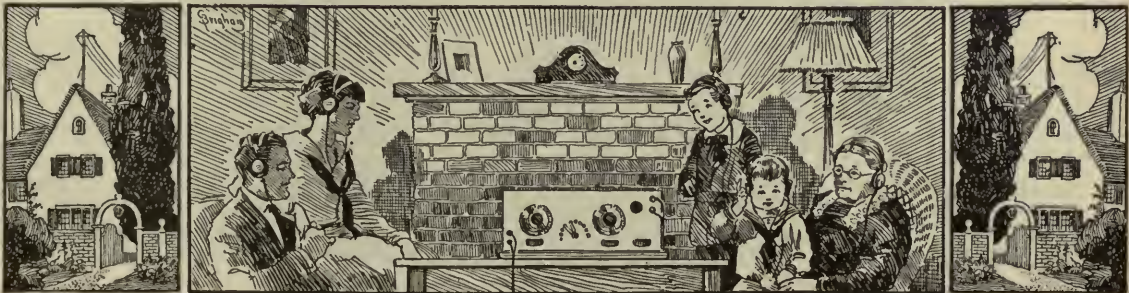

Another Receiving Contest!

Any Number of Tubes—Any Kind of Receiver

The "How Far Have You Heard On One Tube?" Contest, which closed February 1st, has been a great success. The hundreds of reports, diagrams, questions, and suggestions which we have received indicate the keenest interest in long-distance receiving throughout the country. The final reports of this contest appear in *RADIO BROADCAST* this month.

AND—we take pleasure in announcing, owing to the enthusiastic response to this contest, A SECOND LONG-DISTANCE RECEIVING CONTEST, to determine who has done the best with ANY NUMBER OF TUBES AND ANY TYPE OF RECEIVER.

The Four Prizes

First Prize: DE FOREST D-7 REFLEX LOOP RECEIVER

This receiver, described in *RADIO BROADCAST* for February (page 297), is the latest product of the De Forest Company: it makes three amplifying tubes and a crystal detector do the work of six tubes. The loop antenna aids in selectivity because of its directional properties. An ordinary antenna and ground may be used, however, if desired. Recently, a man in Brooklyn, N. Y. heard a broadcasting station in Seattle, Wash., with one of the sets.

Second Prize: GREBE TUNED RADIO-FREQUENCY AMPLIFIER, TYPE "RORN"

Illustrated on page 352, *RADIO BROADCAST* for February. This amplifier, which has a wavelength range of from 150 to 3000 meters, may be used with any form of home-made or bought receiver. It is the most recent development of a company widely known for the excellence in design and workmanship of its products.

Third Prize: Choice of

THREE OF THE NEW RADIOTRON UV-201-A AMPLIFIER TUBES (6 volts, $\frac{1}{4}$ of an ampere). or
THREE AERIOTRON WD-11 DRY CELL TUBES ($1\frac{1}{2}$ volts, $\frac{1}{4}$ of an ampere).

Fourth Prize: TIMMONS LOUD-SPEAKER UNIT

This unit, which may be connected directly to the output of your amplifier, has a diaphragm adjustable for sounds of different intensities, and when used with two stages of amplification reproduces broadcasted programmes about as loud as the music from the average phonograph.

Rules of the Contest

1. You should list all broadcasting stations 150 or more miles away from the receiving point, which you have heard distinctly (announcement of location as well as of call letters.)
2. Measure distances accurately, and give aggregate mileage. (This is the sum of all the distances, each station counted once, but two or more stations in the same city being counted separately.) An aggregate mileage of less than 15,000 miles will not be considered.
3. Manuscripts should include the following: description of set, directions or advice for constructing and operating it; any "wrinkles" or makeshifts which you have used to advantage; photograph of your apparatus; circuit diagram; in general, anything you have to tell that will make your story more interesting and helpful. Manuscripts should not be longer than 2000 words. Typewritten reports preferred.
4. Data should be arranged in three columns, under the headings: call letters, location, distance.
5. For material used, a liberal rate will be paid.
6. In judging contributions, the quality and interest of photographs, text, and drawings, and the originality and general effectiveness of the apparatus described, will have greater weight than the list of stations heard, although a long list of distant stations will distinctly help.
7. The Contest begins now and closes May 31st, 1923.
8. Address: Receiving Contest, *RADIO BROADCAST*, Doubleday, Page & Co., Garden City, N. Y.

Up Before the Microphone



MISS HARRIET WILLIAMS AT PWX

When she was playing, recently, from the Havana station, her mother, listening in at Toledo, Ohio, heard the programme clearly. And more remarkable still, when Miss Williams also sang, at PWX, the same evening, she was heard in Douglas, Alaska, 3,500 miles away



THE "WAVE FROM LAKE ERIE"

He rolls in from WJAX, the Union Trust Company's station in Cleveland. In private life, the "wave" is E. G. Johnson. He has a deep bass voice which, it is reported, knocks 'em dead all the way from the Atlantic Coast to the Mississippi and from Nova Scotia to Cuba



STATION PERSONNEL AT WJZ, NEWARK, N. J.

Standing, left to right: J. L. Watt ("AWN announcing"), G. E. Oliver (OON), P. W. Harrison (OWN), and M. J. Cross (AJN). Seated, left to right: H. E. Hiller (OHN), G. E. Bliziotis (OBN, Chief Operator), and R. F. Guy (OGN)

“Coöperative Competition”*

The Agreement of Automobile Manufacturers of Vision to Exchange Patents, and the Resulting Growth to the Industry. Cannot a Similar Agreement Well Form the Basis for the Settlement of Present and Future Radio Disputes?

By JOHN K. BARNES

Financial Editor of *The World's Work*

AFTER the automobile had passed the “horseless carriage” age of the late nineties, and the pleasure of skimming over the roads without a slow-going horse ahead of one overcame the public ridicule that greeted the first cars, it became evident that this infant industry had been born with a silver, if not a gold, spoon in its mouth. The making and selling of four thousand curved-dash Oldsmobiles in 1903 showed many people the possibilities in the business. The early dreams of Charles E. Duryea; Elwood Haynes, R. E. Olds, and other pioneers were coming true. Then began the great growth of the industry. The bicycle manufacturers followed Alexander Winton and E. R. Thomas into this new field. The wagon makers, led by the Studebakers and Mitchell, became interested. The Cadillac Company and the Ford Motor Company sprang up and became successful. Henry B. Joy, Buick, Marmon, and others, in addition to those who had been trained at the Olds Motor Works in Detroit, started with companies of their own. In the next few years many others entered the industry. And there was enough business for all, for the public demand for automobiles grew beyond all expectations. Companies which had good management, sufficient capital, and produced cars that the public liked made large profits.

But the industry was not without its failures—many of them. Young men of mechanical bent but little manufacturing ability got into it. Some were financed by rich fathers and then that backing was withdrawn before they had established a place for their cars. In fact one of the great drawbacks in the whole industry was the lack of capital. Bankers were almost unanimous in the belief that the “craze” for automobiles would die out. Then later they complained that there were already too many companies in the field; they would

not risk their money in new ventures. If the industry had not been established on a cash basis at the start, and if the parts-makers had not extended liberal credit to the companies, this timidity of capital might have proven fatal to the young industry. It certainly would have retarded its marvelous growth. Fortunately there were a few rich men who had the vision of the future of the automobile and were willing to risk their money in it. But when the 1907 money panic came a good many automobile companies went under. And in 1910 the death rate was as high as one a week.

Among the men with money who became interested in the business was Henry B. Joy, of Detroit, known by his friends as Harry Joy. He not only invested his money, but went into the industry himself and became an important element in its successful development. He had tried to buy one of Henry Ford's early experimental cars, but Mr. Ford had told him to wait for the next one, that it would be a better car. Meanwhile Mr. Joy heard of the phaeton Col. J. W. Packard was making in Warren, Ohio, and he went down there and got one. At that time, Mr. Joy and Mr. Emory W. Clark, now president of the First and Old Detroit National Bank, were making plans to start in the banking business. After Joy got his Packard phaeton, however, Clark saw little of him for a month or more. Joy was out on the roads around Detroit at all hours, in and under his new car, testing it and tinkering with it. His enthusiasm for the automobile grew rapidly and it was contagious enough to influence other Detroit men of means to put money into the building of a large factory in Detroit for the manufacture of the Packard car in quantities. Col. Packard was to come on from Warren to run it. At the last minute, however, he could not come, and it devolved upon Joy to take charge of this four hundred thousand dollar plant. The first year the company lost two hundred thousand dollars. The factory became known around Detroit

* From an article in *THE WORLD'S WORK*, May, 1921.

as the “millionaires’ folly.” But Joy increased the production schedule for the next year, and by his own untiring efforts, together with the financial backing of his directors, made the Packard Company a success.

MR. SELDEN AND HIS PATENT

FOR several years the Selden patent was a dominating influence in the industry. Mr. George B. Selden, a patent lawyer of Rochester, N. Y., with inclinations toward mechanics, invented the gasolene automobile in 1879. He immediately made application for a patent, but there followed repeated delays—apparently encouraged by Selden himself, who was trying to interest capital in his new invention—and it was not until 1895 that the patent was issued. Mr. Selden did not manufacture under it and in 1899 sold control of his patent to the Columbia & Electric Vehicle Company which soon afterward became the Electric Vehicle Company. Eastern capitalists were interested in this company. They began a campaign of vigorous enforcement of the

patent the next year. Suit was brought against the Winton Motor Carriage Company for infringement. This suit ran along until 1903 when the Association of Licensed Automobile Manufacturers was formed and ten companies signed an agreement recognizing the validity of the Selden patent and agreed to pay a royalty of $1\frac{1}{4}$ per cent. of the retail price of all cars sold by them. The Electric Vehicle Company had an arrangement with Mr. Selden as to

amount of the royalty he was to get. Mr. James Rood Doolittle, who wrote “The Romance of the Automobile Industry,” estimates that Mr. Selden realized about two hundred thousand dollars from his invention.

As the industry grew, this $1\frac{1}{4}$ per cent. royalty soon began to run into large sums and the payments became burdensome on the industry. It was then that Henry B. Joy, president of the Packard Company, led a vigorous fight within the ranks of the Association of Licensed Automobile Manufacturers to have the royalty reduced, and was successful in first having it cut to 1 per cent. and then to $\frac{2}{3}$ of 1 per cent.

It was in the fall of 1903 that the famous test suit against the Ford Motor Company was instituted by the Electric Vehicle Company at the request of the Association of Licensed Automobile Manufacturers. This case was in the courts eight years and the testimony taken fills thirty-six large volumes. In 1909, Judge Hough, in the United States District Court, rendered an opinion sustaining the Selden

Why Not “Coöperative Competition” in Radio?

Last month, in our editorial, “Monopolizing Production of Apparatus,” attention was called to the possible harmful results of the patent litigation of the Radio Corporation, involving various smaller manufacturers of radio apparatus. It seems to us that there is a marked similarity between the patent situation in the radio business and that which existed in the automobile industry until an agreement resulting in “coöperative competition” was reached. This agreement is described in the accompanying article.

There is one essential point of difference between the radio and the automobile patent situations: The Radio Corporation, with its associated companies, in all likelihood holds patents of greater value than those of all the other companies together, and the working out of an equitable arrangement may be an even more difficult problem than that which the automobile industry had to face. It does seem, however, that a study of the agreements made by the automobile companies might result in a working plan that will save millions of dollars, not only for those now vitally interested—the manufacturers—but also for those who ultimately pay the piper—the users of radio apparatus.

Many people view with alarm what seems to be an attempt by the Radio Corporation to form a monopoly in the production of radio apparatus. Perhaps the litigation is designed merely to test the validity of certain basic patents and thereby to determine their commercial worth. If this is the case, should not the public be informed by the Corporation how it expects to use the power acquired if the courts decide in its favor?—THE EDITOR.

patent in every particular and granting an injunction and an accounting. Ford appealed the case to the United States Circuit Court of Appeals and gave bond to cover damages to the complainants while the case was pending. The other so-called “independents,” who were interested with Ford in the fight, but were not as strong financially as the Ford Company, decided, after Judge Hough’s sweeping decision, that they could no longer afford

to run the risk of heavy penalties, and practically all of them went into the Association of Licensed Manufacturers. Ford continued the fight alone. In January, 1911, Judge Noyes delivered the opinion of the Circuit Court of Appeals that the patent was valid, but that Ford did not infringe it because Selden described an engine of the Brayton type while the defendants and almost all modern automobile makers used the Otto type. Mr. Ford said that the advertising his company got from this case was worth more than all it cost.

It was in this Association of Licensed Automobile Manufacturers; in the American Motor Car Manufacturers Association, formed to combat it, and in the National Association of Automobile Manufacturers, organized in 1900—before the other two—including both “licensed” and “independent” companies, that the leading figures in the automobile industry learned many lessons in coöperation. They also learned something regarding the costs of patent suits and the uncertain value of patents. But the full fruits of this knowledge would probably never have been realized if there had not been drawn into the industry at an early date a man who had seen at first hand the disastrous results of patent litigation in another field, and who had the perseverance to follow an ideal for many years, until he finally got practically all the automobile manufacturers of the country to accept it.

This man is Mr. Charles C. Hanch, who started in the automobile business with the Nordyke & Marmon Company of Indianapolis. That company was, and still is, a large manufacturer of flour milling machinery.

When the Nordyke & Marmon Company entered the automobile field, Mr. Hanch saw that there was likely to be the same rapid development as in the flour milling machinery business, and he foresaw that unless something was done to prevent it there would be even a worse tangle of patent litigation. He went to see Mr. Chester Bradford, of Indianapolis, who had been an attorney in much of the flour milling machinery litigation. Mr. Bradford suggested that a Maine corporation be formed to take over the patents of the various automobile companies, to issue stock to the different companies in proportion to the value of their patents, and to fix reasonable royalties to be charged for the use of the patents. Mr.

Hanch talked to some of the automobile manufacturers about this. They all said, “Go to Detroit and see Harry Joy. If you can get him interested in the scheme, there is a chance of getting it adopted by the industry.” So Hanch went to Detroit, but Mr. Joy could see no possibility of getting the automobile manufacturers to agree to such a plan. Mr. Hanch’s hopes were checked, but he did not abandon his idea.

That was in 1909. In 1915, practically all the companies in the National Automobile Chamber of Commerce, the successor of all the earlier organizations of manufacturers, which includes all the leading automobile producers except the Ford Motor Company, agreed to a plan of cross-licensing their patents which permits of their use by every other member *free of charge*. It is not surprising to find that C.

C. Hanch was chairman of the patents committee that put this plan through. The chief credit belongs to Hanch. In the six years between the birth of the idea in his mind and 1915 he had not been idle. Upon every suitable occasion he had advocated a scheme that would eliminate patent litigation. He had the background of experience in the flour milling machinery industry to draw upon for horrible examples. But even he never dreamed at first that a plan could be effected that would permit of the free interchange of patents. It was when the committee started work on a definite plan and the difficulties of appraising the value of patents and fixing royalties for their use became apparent that it was suggested that no charge at all be made. As no manufacturer had patents worth as much as the aggregate value of the patents of all the others, there was a sound basis of fairness in this proposal. It was this argument that finally convinced the automobile manufacturers in the N. A. C. C. and induced them to adopt the plan. Each one had much more to gain from it than he was asked to contribute.

THE EXCHANGE OF PATENTS

THIS cross-licensing agreement does not cover radical patents, for it was felt that any company making inventions of a striking character, involving a radical departure from what is known, should be entitled to special compensation if such inventions proved valuable. At present there are no patents owned



by the members of the National Automobile Chamber of Commerce that have been determined to be of this class. Nor are design patents which apply to the outward appearance of a car—its shape and lines—included in this agreement. But all other patents, such as improvements on the engine or on other parts of the car, come under the cross-licensing agreement and can be used by all the parties of this agreement free of charge. There are about eight hundred such patents owned by the members of the N. A. C. C.

The practicability of this agreement is clearly evident when one stops to realize that a patent of this kind does not give the holder the right to manufacture a car. If it is an improvement on an engine, for instance, the holder of the patent must get licenses from the holders of all other patents on that engine before he can manufacture it. And none of these holders of other patents could make use of his improvement, which might be highly valuable, until they had gotten the right to do so from him. It is obvious that the development of an industry can be seriously retarded by patent conflict and litigation.

The nearest thing to this cross-licensing agreement that had existed up to that time was an agreement between the General Electric and the Westinghouse Electric companies covering an interchange of certain of their patents. But there a compensation was paid. The scheme has since been adopted by the aircraft industry, but never before had it been contemplated for an entire industry.

WHAT “COÖPERATIVE COMPETITION” IS

THUS did the automobile makers solve in a new and sensible way one of the most difficult problems that faces young manufacturing industries. There has never been keener competition than in the automobile field, and yet there is wholesome coöperation. A phrase has been coined to describe this situation: “coöperative competition.” By eliminating the rock on which manufacturers in other industries had been wrecked, or had been forced to combine for their own salvation, the automobile makers reaped some of the advantages of combination without losing any of the benefits of competition. The life of this agreement was fixed for its trial at ten years, but it has operated so successfully that there is

little doubt that when it expires in 1925 it will be extended.

The National Automobile Chamber of Commerce performs other valuable service for its members in connection with patents. It maintains a patent department under the management of Mr. Robert A. Brannigan, which studies every patent that relates to the automobile industry. As one of every four patents issued by the Patent Office in Washington does relate to the automobile, this keeps several men busy. When any patent is brought to the attention of a member of this Chamber, it is referred to this patents department. If it seems to be a valid patent and the invention is one that has merit, the patents department then undertakes the negotiation of a uniform license for the benefit of the members of the Automobile Chamber of Commerce and the industry as a whole.

An example shows how this works. A man named Wright invented a hinge for the engine hood that was protected from the rain by a fold in the upper part of the hood. He licensed one company to use his patent at twenty-five cents a car; then he licensed another at fifteen cents, and another at ten. This got him into trouble with the companies that were paying the higher royalties. When he died, leaving his patent to his wife, she was realizing practically nothing from it. Other companies had seen the hinge and started using it. Several members of the National Automobile Chamber were charged with infringement of the patent. Mr. Hanch, as chairman of the patents committee, saw Mrs. Wright. He explained to her that a small uniform royalty would not only be fairer to the industry, but also more profitable to her. Mrs. Wright fixed a five cent royalty. To-day she is receiving a handsome income from her husband's invention as it is being used on about eight hundred thousand cars a year.

A case of the opposite character, where it seems clear that the inventor is not getting anywhere near what he might, because he asked too much, is that of the Knight sliding sleeve valve motor. Mr. C. Y. Knight invented this type of engine in 1904 and patented it in 1910. At that time the poppet valve motor in general use was not entirely satisfactory. The Knight motor was apparently an improvement over it. But Ameri-



can manufacturers would not consider using the new invention at the high royalty Mr. Knight asked for it. He went to Europe and was successful in getting some foreign makers of high-priced cars to adopt it. They agreed to a royalty based on horse-power that averaged about sixty dollars a car. They stipulated that if manufacturers in any other country were licensed at a lower rate, they were to get the benefit of the lower rate. Then Mr. Knight came back to this country and found American manufacturers more interested in his motor. But when he told them his rate of royalty again they said it was too much. And to-day only four companies in this country use the Knight motor, and under an agreement which, without changing the rate of royalty, limits the amount of payment each year to a fixed maximum. This, in effect, greatly reduces the royalty per car for a large producing company. (If the foreign companies' production ever brings their royalties up to this maximum they will enjoy the same limit.) It is believed that if Mr. Knight had not demanded a royalty that was regarded as prohibitive, the automobile industry would have adopted the Knight motor and abandoned the other. Instead of that it went ahead in its efforts to improve the poppet valve motor and the result has been that now the poppet valve motor compares favorably with the Knight motor.

The National Automobile Chamber of Commerce defends its individual members against patent suits when it is considered in the interest of all the members to do so. This protects the industry from patent hold-ups which might gain headway by starting with small companies that could not afford to defend suits. Through its legislative department its members are heard as a unit in regard to legislative matters. There are also good roads, commercial vehicle, foreign trade, and service departments, through which coöperative work is carried on in those various fields.

In the constitution of the National Automobile Chamber of Commerce is this clause: "Each manufacturing member shall render

to the corporation [the N. A. C. C.] within the first fifteen days of January, April, July, and October of each year, written reports under oath setting forth the number and kinds of self-propelled vehicles made and sold, or otherwise disposed of, by such member, during the preceding three calendar months, and the aggregate net amount charged therefor. . . ."

This clause is an inheritance from the old Licensed Association, as is much of the coöperative spirit in the industry. This information was necessary then in figuring the royalties under the Selden patent. To-day it is used as a basis for collection of dues in the Automobile Chamber of Commerce, but it is of much more value than that. These reports go out to each member. Each one, therefore, knows just what his competitors are producing. That places them all in much better position to make plans for the future. The cards in the automobile industry are on the table; the game is a friendly one.

Differences and misunderstandings arise among the members of the N. A. C. C. just as they do in every other industry, but four times a year representatives of the member companies are brought together in a general meeting—the Chamber pays the traveling and hotel expenses of these men—and their differences are brought out into the light of day and subjected to the views of all the members. The inevitable result is the correction of misunderstandings and usually the composition of differences. Friendly coöperation is thus maintained. Back of this is another man—Mr. Charles Clifton, chairman of the board of directors of the Pierce-Arrow Motor Car Company, who has been president of the National Automobile Chamber of Commerce since its organization. His great vision in regard to the industry, his remarkable personal charm and firm hold on the affections of its leaders, have been largely responsible for the safe course that has been steered past the rocks of discord and dissension which have upset other industries.

Much could be learned by the radio industry from the "coöperative competition" in the automobile field.

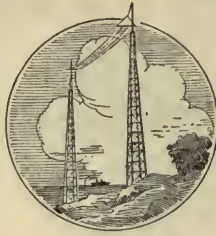



When every hour counts

BILL wanted to make his radio set as quickly as possible. But at the very beginning there was a delay in getting his panels. It wasn't a long delay, but he was impatient and wanted to make every hour count.

You, Bill, and every radio set-builder can avoid such a delay by getting Celoron Standard Radio Panels. You don't have to wait for your panel to be cut. There's no extra expense for cutting to your order. You go to your dealer and give him the size. He has a Celoron panel which you can carry home with you at once.

Each panel comes trimmed and

wrapped separately in glassine paper to protect the surface. On each one are full instructions for working and finishing.

Celoron makes an ideal panel. It is easily worked, machine drilled and tapped, and will engrave evenly without feathering. It has high surface and volume resistivity, high dielectric strength, and low dielectric losses.

Select from these sizes the one you need:

- | | |
|-----------------------------|-------------------------------|
| 1. — 6 x 7 x $\frac{1}{8}$ | 4. — 7 x 18 x $\frac{3}{16}$ |
| 2. — 7 x 9 x $\frac{1}{8}$ | 5. — 9 x 14 x $\frac{3}{16}$ |
| 3. — 7 x 12 x $\frac{1}{8}$ | 6. — 7 x 21 x $\frac{3}{16}$ |
| | 7. — 12 x 14 x $\frac{3}{16}$ |

Make every hour count in making your radio set. If your radio dealer has not yet stocked these panels, ask him to order for you. Or write direct to us. Be sure to designate by number the size you want.

Diamond State Fibre Company

BRIDGEPORT

(near Philadelphia)

PENNSYLVANIA

BRANCH FACTORIES AND WAREHOUSES
 BOSTON CHICAGO SAN FRANCISCO
 Offices in Principal Cities

In Canada: Diamond State Fibre Company of Canada, Limited, 245 Carlaw Avenue, Toronto

★ CONDENSITE
CELORON
 STANDARD RADIO PANEL

Who Will Ultimately Do the Broadcasting?

There Were 570 Active and 67 Discontinued Broadcasting Stations in the United States as of December 1, 1922. Radio and Electrical Manufacturers and Dealers, and Educational Institutions, Seem to Be the Most Permanent in the Broadcasting Field. Statistics* by Months and by Businesses

TABLE No. 1 shows the monthly growth in the number of broadcasting stations during the past year for the entire United States, including Alaska, Hawaii, and Porto Rico. The deletions were deducted each month so that the figures given represent the total active stations at the beginning of the month.

It seems that the point of saturation in broadcasting stations as determined by present conditions has about been reached. As of December 1st, there were 570 active and 67

cause for discontinuance of stations is the fact that large stations of superior quality have now been installed in many territories, these making unnecessary and inadvisable the continuance of small, poorly equipped stations—unnecessary from the standpoint of stimulating receiving set sales and inadvisable from the standpoint of relations between the owner and the radio public.

Table No. 1 shows also the number of stations that were deleted in this country, beginning April 1, 1922, before which time there

TABLE NO. 1
REPORT ON RADIO BROADCASTING STATIONS FOR YEAR 1922

	TOTAL NUMBER OF STATIONS AS OF											
	Jan. 1st	Feb. 1st	Mar. 1st	Apr. 1st	May 1st	Jun. 1st	July 1st	Aug. 1st	Sept. 1st	Oct. 1st	Nov. 1st	Dec. 1st
ACTIVE STATIONS	28	36	65	133	217	314	378	441	496	539	554	570
DELETED STATIONS				4	4	8	12	14	16	22	44	67

discontinued stations, *but during the month of December alone, 20 stations were deleted.* The last four months of 1922 show a distinct decline in the net monthly gain in stations as follows:

	Oct. 1st	Nov. 1st	Dec. 1st.	Jan. 1st.
New Stations	48	38	38	33
Discontinued	6	22	23	20
	42	16	15	13

Many broadcasting stations were continued in operation up to September 1st, last year, with the expectation of another "boom" similar to that of the previous year. When the sale of receiving sets was seen to follow a more healthy and less spectacular growth, these stations began to drop out of the broadcasting field in increasing numbers. Another

were no deletions. It will be seen that 570 stations were still active as of December 1, 1922, a total of 67 stations having been discontinued up to that date.

Table No. 2 is particularly interesting and significant. It shows the businesses engaged in by the various broadcasters in each state, with the totals for states and businesses. Those broadcasters classed as unknown include individuals and companies whose businesses were not evident from their names or from other available sources. The radio and electric manufacturers and dealers make up 40% of the owners of stations, with publications and educational institutions coming second and third, although with totals far below that of the manufacturers and dealers.

In Table No. 3 is indicated the stability of various lines of business doing broadcasting, with the percentage of the total in a given

*From statistics compiled from Government Bulletins by the American Telephone and Telegraph Company.

Why do you do it ?



Do you lug your battery to have it charged?

Do you put off lugging it until it fails to give good results?

How many concerts do you miss or only half hear?

With Tungar—the go-between—from the house lighting circuit to storage battery—you are prepared for best results always.

Just turn it on and leave it. It charges your battery while you sleep. Its cost of operation is low. It makes convenient the necessary charging that prolongs battery life.

Tungar has no moving parts to cause trouble. It is *certain, clean, quiet.*

Good for the auto battery too—the same Tungar.

See it at any good electrical shop, or write for literature. Address Section RB-4.

Merchandise Department

General Electric Company

Bridgeport, Connecticut

Tungar Battery Charger operates on Alternating Current.

2 ampere outfit—\$18.00.

5 ampere outfit—\$28.00

(east of the Rockies)

Special attachment for charging 12 or 24 cell

"B" Storage Battery—\$3.00

—fits either size Tungar.



Charge 'em at Home, with

Tungar ★

BATTERY CHARGER

A GENERAL ELECTRIC PRODUCT

TABLE NO. 2
BUSINESSES ENGAGED IN BY OWNERS OF BROADCASTING STATIONS

	Radio and Electric Manufacturers and Dealers	Newspapers and Publications	Educational Institutions	Department Stores	Auto and Battery Cos. and Cycle Dealers	Music and Musical Inst. and Jewelry	Churches and Y.M.C.A.'s	Hardware Stores	Police, Fire and City	Banks and Brokers	Stock Yards, Foultry Farms and Grain Dealers	Clubs and Societies	Mine Supplies, Marble, Oil Cos.	Railroads and Power Companies	Tel. & Tel. Cos.	Parks and Amusements	State Bureaus	Theatres	Laundries	Unknown	TOTAL
Alabama	2		1											1							4
Arizona	2	1		1																1	5
Arkansas	1	1				1														2	5
California	28	9	2	4	1	1	2		2	2	1			1		1		1	1	12	68
Colorado	6	1	1				1													1	11
Connecticut	2	1			1															1	5
Delaware	1																				1
D. of Columbia	4			2	1		1														8
Florida	4	3																		2	9
Georgia	3	2	2											1							8
Idaho	3		1		1		1														6
Illinois	6	5	2	1	1	1		1								1		1			21
Indiana	7	5	1																	1	14
Iowa	10	2	3		1	1			2											4	23
Kansas	10	1	1		2									1						1	16
Kentucky		2						1												3	6
Louisiana	4	2	2																	1	9
Maine	3							1													4
Maryland	2	1				1															4
Massachusetts	4		2	1			2														9
Michigan	3	3	2		1				1											3	13
Minnesota	7	1	3																	2	13
Mississippi																					0
Missouri	3	4	3	2	1	2	1										1			7	24
Montana	1	2	1																		5
Nebraska	8	4	3								1	2					1			4	23
Nevada	1				1																2
New Hampshire	1																				1
New Jersey	6		1	1	1		1	1				1								1	13
New Mexico			1											1							2
New York	12	2	5	1					1						3					4	28
North Carolina	2		1																		3
North Dakota	3																				3
Ohio	10	2	7	1		1	1		1	1										2	35
Oklahoma	6	2																		1	10
Oregon	6	2	1			2	1				1									2	15
Pennsylvania	12		4	10	1	1											1			4	33
Rhode Island	1			2	1											1					5
South Carolina	4																				4
South Dakota	1	1	3																		5
Tennessee						1									1					2	4
Texas	13	5	4	2					1				1							8	34
Utah	1	2																		1	4
Vermont			1																	1	2
Virginia	3		1																		5
Washington	9	2	2	1	1		2													7	24
West Virginia	1		1					2													4
Wisconsin	3	1	2	1	1							1								2	11
Wyoming	1				1		1														3
Alaska																				1	1
Hawaii	1	1																		1	3
Porto Rico	1		1																		2
TOTAL	231	70	65	30	17	12	10	8	7	5	4	4	4	4	4	3	3	2	1	86	570

line of business who have discontinued the use of their station. From this table, it will be seen that radio and electrical manufacturers and

dealers, and educational institutions are apparently the most permanent in the field of broadcasting.

3 Letters! and they will be interesting to every ~ radio user.

HUDSON MOTOR CAR COMPANY OF N.Y.

HUDSON AND ESSEX MOTOR CARS
1408 HUDFORD AVE. BROOKLYN

November 23rd, 1922

Acme Apparatus Company
Cambridge, Mass.

Gentlemen:—

It will possibly be of interest to you to know that with the aid of your radio Frequency Transformers R2, R3 and R4, I have built an ideal set. This set brings in PWX, Havana, as clear as a bell any time that I care to hear him. I have also reached other stations that I never knew existed. Last night I hooked up 3 Transformers in place of yours, and with the stations that I received there was enough howls and yells to make one think that all Hell was let loose at once, so put the old Acme's back and the loud speaker started to give out some real music. This set has given such satisfaction that I simply couldn't refrain from writing you to let you know that you have satisfied at least one Radio Bug. However, I might add that I am using a loop antenna and my tuner consists of only 2 Variable condensers, one 43 plate and one 3 plate hooked right across the loop outlet.

Please do not think that this is the first set I have ever seen and that my enthusiasm is running away with me. I have owned a a step and a and have also built numerous other sets, but this Acme Radio Frequency Transformer sure has the world licked.

Very truly yours,

Hudson Motor Car Company of N. Y., Inc.

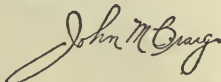

Service Manager

ACME APPARATUS COMPANY

TRANSFORMER & RADIO ENGINEERS & MANUFACTURERS
106 MASSACHUSETTS AVENUE
CAMBRIDGE 38, MASS., U.S.A.

December 7th, 1922

Mr. John M. Craig
510 St. Marks Avenue
Brooklyn, N. Y.

Dear Sir:—

We wish to thank you for your letter of November 23rd and would like to know if you would be willing to allow us to use this as a testimonial either with or without your name.

We worked for practically nine months before putting a radio frequency amplifying transformer on the market and it is exceedingly gratifying to receive such letters as yours as a reward for this endeavor.

Yours very truly,
ACME APPARATUS COMPANY



Per Chief Engineer

HUDSON MOTOR CAR COMPANY OF N.Y.

HUDSON AND ESSEX MOTOR CARS
1408 HUDFORD AVE. BROOKLYN

December 8th, 1922

Mr. G. E. M. Bertram
186 Massachusetts Ave.,
Cambridge, Mass.

Dear Sir:—

Your letter of the 7th instant came to hand this morning, and in reply would say that you are at liberty to use my letter of November 23rd, in any way you desire, with or without my name. I might add that I know of four sets copied from mine that are giving results equal to mine.

On Wednesday evening I had a transmission engineer from the New York Telephone Company out to my home and believe me he was the most surprised man I have seen in some time. Without having ever seen my set, in twenty minutes he tuned in PWX, WOC, WBAP, WSB and several near stations. What pleased him especially was that he could tune in the 200 meter stations as well as the 400 meter boys.

Very truly yours,
Hudson Motor Car Company of N. Y., Inc.

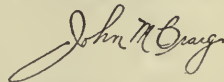

JMC:N
510 St. Marks Avenue
Brooklyn, N. Y.

Service Manager

YOU can purchase all Acme Transformers at radio stores. If your dealer does not carry them, we will see that you are taken care of. Leaflets describing hook-ups for various Acme Transformers will be sent on request.

THE ACME APPARATUS COMPANY

(Pioneer transformer and radio engineers and manufacturers.)

CAMBRIDGE, MASS., U. S. A.

New York
Chicago

1270 Broadway
184 W. Washington Street

ACME for amplification

TABLE NO. 3

STABILITY OF VARIOUS LINES OF BUSINESS IN BROADCASTING FIELD

Business	Active Stations	Deleted	Total	Per Cent Deleted
Educational Inst.	65	5	70	7.1
Churches and Y. M. C. A.'s	10	1	11	9.1
Radio and Elec. Mfg. and Dealers	231	26	257	10.1
Plumbing and Hardware	8	1	9	11.1
Newspapers and Publications	70	12	82	14.6
Unknown	86	17	103	16.5
Clubs and Societies	4	1	5	20.0
Parks and Amusements	3	1	4	25.0
Railroads and Power Companies	4	3	7	43.0

The Grid

QUESTIONS AND ANSWERS

The Grid is a Question and Answer Department maintained especially for the radio amateurs. Full answers will be given wherever possible. In answering questions, those of a like nature will be grouped together and answered by one article. Every effort will be made to keep the answers simple and direct, yet fully self-explanatory. Questions should be addressed to Editor, "The Grid," Radio Broadcast, Garden City, N. Y. The letter containing the questions should have the full name and address of the writer and also his station call letter, if he has one. Names, however, will not be published.

MOTOR-GENERATORS FOR RECEIVING PLATE VOLTAGE

Can a motor-generator be used to furnish 110 volts for the operation of a W. E. loud-speaker and amplifier set?

How should one test an Edison nickel-iron storage battery?

What are the operating characteristics of the old-style Audiotron tube, such as its A and B batteries? How do they compare in sensitivity with the bulbs now on the market?

E. H. B., HARRISBURG, PA.

SUPPLYING the plates of a power amplifier from the average motor-generator is not practicable due to the impossibility of eliminating the hum caused by commutation.

However, generators and dynamotors have been developed especially for this purpose which quite adequately replace the B battery. Such a generator is preferably a high-speed machine, running over 3000 revolutions per minute, and should have no less than 36 commutator segments. The resulting 900- or 1000-cycle ripple is more easily smoothed out than a lower frequency.

The filter for the elimination of generator hum consists of choke-coils and condensers, the later aggregating no less than 10 mfd. The reactances or chokes may be wound on any convenient soft iron core with two and a half pounds of double-cotton covered wire. Two such chokes should be constructed, and the filter wired according to the diagram in Figure 3. The commutator must be kept scrupulously clean by an occasional light scouring with the finest grade of sand-paper. (Emery cloth must not be used.)

Generators and dynamotors designed for this purpose,

generally supply up to 350 volts, and many of the latter machines are operative from a six-volt source.

As the specific gravity of the Edison Cell is constant regardless of its state of charge or discharge, it is impossible to determine the condition of the battery with a hydrometer. In large banks of nickle-iron batteries, an ampere-hour-meter is used for this purpose. An ampere-hour-meter is an instrument which registers the amount of current drawn from or fed to the battery.

Voltmeter readings, however, are fairly sure indications as to the condition of the battery. When fully charged, the Edison cell should read 1.9 volts on open circuit. This drops rapidly at first, and then gradually falls to .7 at which voltage it should be placed on charge. The Edison battery may be completely discharged and severely overcharged without damaging the plates. For further details concerning battery charging, the reader is referred to the January GRID.

The old style tubular Audiotron operates from a six-volt battery in series with the standard rheostat. The tubes were seldom uniform, and the plate voltage varied from eighteen to forty.

There is little electrical difference between the Audiotron and the modern soft bulbs, except that the latter are more consistently good.

A VARIOMETER TICKLER CIRCUIT

I enclose a circuit which I stumbled on while experimenting with my honeycomb set. It is giving me remarkable results with an unusual wave range on a single set of coils. Is there anything new about the circuit?

T. O. B., NEW YORK CITY.

INDEX

(*Illustrated Articles. Editorials in Italics.)

	PAGE		PAGE
A BOUT the "Machine for Hear You Spik".	421	erature (Edgar White Burrill)	54
Additional Broadcasting Stations in the United States.	80, 137, 262, 346, 426, 510	<i>Fewer and Better Broadcasting Stations</i>	272
*Advertising, Should Radio be Used for (Joseph H. Jackson)	72	*Kingdom for More Wavelengths, A (Paul F. Godley)	191
Africa:		*Singing to Tens of Thousands (Leon Alfred Duthernoy)	49
A New African Radio Station	79	*Stations That Entertain You	138
<i>Again the National Radio Chamber of Commerce</i>	360	Supplemental List of Broadcasting Stations in the United States from Aug. 11 to Sept. 16, Inclusive	80
Alaska:		Supplemental List of Broadcasting Stations in the United States from Sept. 16 to Oct. 5, Inclusive	137
*Signal Corps in Alaska, The (Donald Wilhelm)	142	Supplemental List of Broadcasting Stations in the United States from Oct. 6 to Nov. 22, Inclusive	262
Amateurs:		Supplemental List of Broadcasting Stations in the United States from Nov. 23 to Dec. 24, Inclusive	346
<i>Amateurs & Professionals, The</i>	359	Supplemental List of Broadcasting Stations in the United States from Dec. 25 to Jan. 13, Inclusive	426
Amateur Broadcasting Locally Controlled in Canada	78	Supplemental List of Broadcasting Stations in the United States from Jan. 14 to Feb. 9, Inclusive	528
*Englishman as a Radio Amateur, The (M. B. Sleeper)	36	*Western Electric Broadcasting Stations in the United States	256
*First Amateur Radio Club in America, The	222	*Bureau of Standards Lends a Hand, The (J. H. Dellinger)	40
*Long Distance Amateur Work in Australia (F. Basil Cooke)	215	C -2 Meets Its Fate, The	184
*One of the Finest Amateur Stations Alive (Zeh Bouck)	494	Cabinet Wood Finishing, Practical Pointers on (W. S. Standiford)	254
<i>Standing of the Amateur, The</i>	268	Canada:	
*Young American Building His Own (Henry L. Arthur)	97	Amateur Broadcasting Locally Controlled in Canada	78
*American Aviation Radio is Rotten (Wm. Mitchell)	239	C. Brandes, Inc. Establishes Canadian Factory	80
* <i>American Boy in Radio, The</i>	91	*Captain Kay Makes Port in a Fog (Ortherus Gordon)	151
*An Evening's Trip Around the Whole United States (Milo Shutt)	505	"Carpet of Bagdad," The (W. McMiller)	339
Another Receiving Contest!	427, 514	<i>Case in Point, A</i>	4
Australia:		*Cave Man Stuff But It Works (I. R. Tannehill)	326
*Long Distance Amateur Work in Australia (F. Basil Cooke)	215	*Cheap At Twice the Price (Frank J. Myers)	509
*Automatic Regenerative Circuit, The (H. L. Peterson)	507	Concerning Mrs. Hale's Lecture on Cancer	343
Avoiding the Jam in Southern California (F. W. Christian)	252	Concerning My Invention, The Audion (Lee De Forest)	253
B ECOMING Familiar with Great Music (Mabel Travis Wood)	406	Contest, Another Receiving	427
<i>Better Radio Equipment for Our Submarines</i>	5	Coöperative Competition (John K. Barnes)	516
Books:		<i>Copyright for Broadcast Material</i>	270
*Few More Books About Radio, A	164	<i>Crystal Detector Patents</i>	92
*Have You Written Your Radio Book? (Ralph Milne Farley)	18	* D E FOREST, The Dreamer of a Dream That Came True (C. S. Thompson)	147
Boy Scout's Place in the Radio Game, The (Armstrong Perry)	275	*Dictaphone High-Speed Recorder, The (B. G. Seutter)	162
Brazil:		<i>Directional Effects</i>	449
Brazil's Station on Mt. Corcovado	78	Do Brains or Dollars Operate Your Set? (W. H. Worrell)	9
British Radiophone Receivers for Britishers	79	*Do You Know Them By Sight or By Sound? (Photos with captions only)	57, 131
Broadcasting:			
Amateur Broadcasting Locally Controlled in Canada	78		
*Broadcasting by Remote Control (R. W. King)	187		
<i>Broadcasting Health</i>	7		
*Broadcasting Out of the Studio (Wm. H. Easton)	364		
*Broadcasting the World's Best Lit-			

INDEX—Continued

	PAGE	PAGE
Doubling the Traffic Capacity of a Radio Station.....	77	(D. J. O'Connor)..... 414
*Down on the Farm in 1923 (W. A. Wheeler), 212		<i>How the British Do It</i> 450
"Dry-Cell Tubes" for Receiving..... 267		*How the Vacuum Tube Works (Arthur T. English)..... 125
During National Radio Week..... 166		*How Your Telephones Work (G. B. Crouse) 197
E <i>ELIMINATING the Carrier Wave</i> 448		I <i>ICEBERGS, Keeping an Eye on the</i> (Ortherus Gordon and C. J. O'Shea)..... 27
England:		<i>Interference from Arc Stations</i> 359
British Radiophone Receivers for Britishers..... 79		<i>Interference, That Big Problem</i> 180
<i>England Tells About Hearing WJZ</i> ... 447		<i>Is a Radio Set a Musical Instrument?</i> 182
*Englishman As a Radio Amateur, The (M. B. Sleeper)..... 36		J <i>JACKS and How to Use Them</i> (G. Y. Allen)..... 485
"Here in Great Britain" (Philip R. Coursey)..... 123		Japan:
<i>How the British Do It</i> 450		The Radio Telephone in Japan..... 77
Plans for England's Most Powerful Station..... 79		K <i>KEEPING an Eye on the Icebergs</i> (Ortherus Gordon and C. J. O'Shea)..... 27
Present Status of Radio Telephony from British Standpoint..... 77		Keeping Your Storage Battery Working At Its Best (W. S. Standiford)..... 462
Radio Communication in Mines..... 168		*King Electron, M. D. (R. H. Ranger)..... 153
<i>Equipment, Better Radio for Our Submarines</i> 5		*King Electron on Vacuum Tubes (R. H. Ranger)..... 65
*Equipment, New..... 82, 176, 264, 352		*King Electron Reduces Interference (R. H. Ranger)..... 311
F <i>FACTS About the Loud Speaker, The</i> (G. Y. Allen)..... 287		*Kingdom for More Wavelengths, A (Paul F. Godley)..... 191
*Famous Radio Patents (Charles H. Kesler) 207, 407		L <i>LATIN-AMERICAN Activities</i> 168
*Feeling the Nation's Pulse (Russell Sheehy) 336		Lighthouses:
<i>Fewer and Better Broadcasting Stations</i> 272		*How Our Lighthouses Use Radio (George R. Putnam)..... 369
*55,000 Miles on a Dry-Cell Tube (Harding Gow)..... 341		<i>Lightning and the Receiving Set</i> 185
*First Amateur Radio Club in America, The.. 222		*Listen To These..... 317
France:		*Listening to Half the Country on the Ground 117
Radio Weather Reports from France 78		*Literature, Broadcasting the World's Best (Edgar White Burrill)..... 54
*From Keyboard to Tape Through Space (John B. Brady)..... 219		*Litzendraht vs. Solid Wire (Ralph R. Batcher)..... 319
*From the Log of a Radio Man..... 120		*Locating Illegal Radio Stations (L. E. Whittemore)..... 145
G <i>GERMANY:</i>		<i>Locating Mineral Deposits and Communicating Through Earth</i> 447
Nauen's Latest Improvements..... 168		*Long Distance Amateur Work in Australia (F. Basil Cooke)..... 215
*Getting the Best from One Tube (P. B. Cronk)..... 235		*Loop Aerials for Broadcast Reception (G. Y. Allen)..... 31
*Grid, The—Questions & Answers		* M <i>AKING the Get-away a Give-away</i> 94
Arc Circuit Interference..... 171		*Making the Radio Department Pay (Arthur H. Lynch)..... 159
Beat Wave..... 86		*Making Tubes Do Double Duty (Frank M. Squire)..... 297
Diagrams & Graphs..... 84		*March of Radio, The (J. H. M.) 3, 91, 179, 267, 355, 443
Hunting Trouble on a Crystal Receiver..... 350		Mexico:
Loose Couplers..... 348		Radio Outfits for Mexican Lighthouses 168
Motor-Generators for Receiving Plate Voltage..... 526		*Mining the Makings (Philip S. Rush)..... 201
Regeneration..... 170		<i>Modern Miracles</i> 92
Remedy for Poor Amplification..... 440		<i>Monopolizing Production of Apparatus</i> 355
Storage Battery Charging..... 258		*My First Voyage As a Sea-Goin' Telegrapher (A. Henry)..... 477
Tuning Your Broadcast Regenerative Set..... 88		* N <i>A A</i> (Donald Wilhelm)..... 292
Vacuum Tubes..... 260		<i>N.R.C.C. Acts, The</i> 184
Variometer Tickler Circuit, A..... 526		<i>National Radio Chamber of Commerce, Again the</i> 360
Wavelength..... 170		Nauen's Latest Improvements..... 168
*"H A M" What Am, The (Robert F. Gowen)..... 303		*Navy's Example in Standardization, The (Stanford C. Hooper)..... 387
*Have You Written Your Radio Book? (Ralph Milne Farley)..... 18		<i>Necessity for Accurate Wavelength Standards, The</i> 445
"Here in Great Britain" (Philip R. Coursey)..... 123		<i>Neckties, Soap and Radio Sets for Sale</i> 181
<i>High Tension Wires Transmit the Voice</i> 450		
*How Does This Receiver Work? (Arthur H. Lynch)..... 241		
*How Far Have You Heard on One Tube? 114, 228, 336, 428, 504, 510		
*How Our Lighthouses Use Radio (George R. Putnam)..... 369		
*How Synthetic Insulation Is Made and Used		

INDEX—Continued

	PAGE		PAGE
New African Radio Station, A.....	78	*Radio-Frequency Amplification from the Ground Up (Arthur H. Lynch).....	393, 499
*New Equipment:		*Radio in Foreign Lands, Progress of.....	77
American Art Mache Co. Loud speaker.....	264	<i>Radio in South American Politics</i>	451
Atwater-Kent Mfg. Co. Detector & Amplifier Unit.....	264	Radio Outfits for Mexican Lighthouses.....	168
Bank-Wound Vario Coupler.....	176	Radio Personalities:	
Bethlehem Spark Plug Co. Phone Plug.....	352	*VI De Forest—The Dreamer of a Dream That Came True (C. S. Thompson).....	147
Cutler-Hammer Battery Potentiometer.....	352	* <i>Radio's Reliability</i>	8
Cutler-Hammer Vernier Rheostat.....	82	<i>Radio Surgery and Doctoring</i>	274
De Luxe Model Homcharger.....	176	Radio Telephone in Japan, The.....	77
Grebe Amplifier and Receiver.....	352	Radio Weather Reports for France.....	77
Kay-Dee Radio Supply Co. Receiving Set Parts for \$10.....	264	<i>Rapid Increase in Radio Traffic, The</i>	270
Merchant Radio Desk.....	176	<i>Receiving in Steel Railway Cars</i>	183
Radio Guild Multi-Range Coupler... ..	82	<i>Receiving with Horizontal Loops</i>	451
Radio Improvement Co. Telephone Jack.....	264	*Regenerative Radio Reception (Phil M. Riley).....	58
White Adjustable Vernier Condenser	82	*Remote Control, Broadcasting by (R. W. King).....	187
<i>New Method of Sending the Voice by Radio, A</i>	356	*Rich Mines We Have Yet to Explore (Alfred M. Caddell).....	21
<i>New Type of Power Tube, A</i>	269	*Ride to Riches with Radio (H. J. Kenner)... ..	398
New Way to Make Americans, The (J. M. McKibbin, Jr.).....	238	<i>Rum-Running by Radio</i>	94
*Not a Bit Technical (Roger A. Weaver).....	375	S ALT-BOX Reception in Yoakum, Texas (The Orr Family).....	392
*O WOE! Radio (Alice R. Bourke).....	107	<i>Saved by Radio</i>	158
<i>Ocean Letter by Radio</i>	363	"Science Comes to You Only Through Your Fingers".....	6
*On the Job All Winter in the High Sierras (Charles H. Peirson).....	244	* <i>Secret Radio</i>	4
*One of the Finest Amateur Stations Alive (Zeh Bouck).....	494	Seeking His Relatives by Radio.....	20
*Operating As a Career?, What About (A. Henry).....	402	<i>Sending and Receiving on a Typewriter</i>	7
*Out-of-the-Studio Broadcasting (Wm. H. Easton).....	364	<i>Sending the Voice by Radio, A New Method of</i>	356
*PARIS and Honolulu Are Calling You (A. Henry).....	132	*Should Radio Be Used for Advertising? (Joseph H. Jackson).....	72
**"Parker Circuit," Notes on the (Zeh Bouck)	344	*Signal Corps in Alaska, The (Donald Wilhelm).....	142
<i>Passing of the Navigation Officer, The</i>	272	*Simple Bulb Transmitters (Zeh Bouck) 14, 102, 246, 321, 416	416
*Phoning Home from Mid-Ocean (G. Harold Porter).....	9	<i>Simpler Instructions and Service for Ready- made Sets</i>	362
Plans for England's Most Powerful Station	79	*Singing to Tens of Thousands (Leon Alfred Duthernoy).....	49
*Poor Fish (Everett Ewing).....	111	<i>Slightly Different Wavelengths Will Do</i>	92
<i>Power Transmission by Electron Tubes</i>	271	South America: Radio in South American Politics....	451
*Practical, Long-Range, Single-Tube Re- ceiver, A (E. V. Seager).....	428	<i>Standing of the Amateur, The</i>	268
Practical Pointers on Cabinet Wood Finishing (W. S. Standiford).....	254	<i>Start on Standardization, A</i>	443
Present Status of Radio Telephony from The British Standpoint, The.....	77	*Stations That Entertain You.....	138, 421, 498
*Progress of Radio in Foreign Lands.....	77	<i>Stolen Transmitter Reveals Its Whereabouts</i>	94
Proper Radio Legislation Is Urgently Needed (S. W. Stratton).....	310	*Storage Battery Charging (The Grid).....	258
<i>Public Health Service Talks</i>	182	*Stratton, Dr., Leaves Bureau of Standards... ..	94
Putting Through the White Bill (John V. L. Hogan).....	422	<i>Submarines, Better Radio Equipment for</i>	5
R ADIO Again Serves in Its Most Important Capacity.....	453	<i>Suggestion for Announcers, A</i>	448
<i>Radio and Land Lines Cooperate</i>	93	*Super-Sensitive Long-Range Receiver, A (Paul F. Godley).....	330
Radio Bill:		* T ALKING Movies, The.....	95
Putting Through the White Bill (John V. L. Hogan).....	422	*Teaching the Chinese Radio (Robert F. Gowen).....	381
This Radio Bill We're Hearing About	282	*Telephoning to England (R. W. King).....	425
<i>Where Is the Radio Bill?</i>	269	<i>That Big Problem—Interference</i>	180
*Radio Book? Have You Written Your (Ralph Milne Farley).....	18	*There Are No Noisy B Batteries (E. E. Horine).....	454
<i>Radio Central to Change Its Transmitting Apparatus</i>	180	*1300 Miles On a One-Foot Loop (Charles H. Durkee).....	472
Radio Communication in Mines.....	186	This Radio Bill We're Hearing About (Charles H. Kesler).....	282
*Radio for the Deaf (P. J. Risdon).....	63	To Acknowledge an Error.....	406
		*To Mr. Hoover from the Postmaster at Boone Stop, Mo. (Homer Croy).....	205
		<i>Too Many Cooks Are Spoiling Our Broth</i>	3
		*Transmitters, Simple Bulb (Zeh Bouck)....	14, 102, 246, 321, 416

INDEX—Continued

	PAGE		PAGE
<i>Transmitting Pictures by Radio</i>	184	Matthews, R. H. G.....	304
* <i>Transmitting With Your House Current</i> (Zeh Bouck).....	246	*Meekins, L. W.....	184
* U P BEFORE the Microphone, 237, 401, 515		Mitchell, Brig.-Gen. William.....	239
Urgent Need for Radio Legislation, The (Herbert Hoover).....	211	Morecroft, J. H.....	90
		Myrtice, Miss.....	237
V ACUUM Tubes:		*Nally, Edward J.....	359
*How the Vacuum Tube Works (Arthur T. English).....	125	Parker, Mrs. Edwin H.....	115
*King Electron on Vacuum Tubes (R. H. Ranger).....	65	Peterson, May.....	237
Vacuum Tubes (The Grid*).....	260	*Plunkett, Rear-Admiral C. P.....	449
* W ESTERN Electric Broadcasting Stations in the United States.....	256	Randall, V. A.....	237
*What About Operating As a Career? (A. Henry).....	402	Rice, Grantland.....	131
<i>What Broadcasting Regulation Is in Store for Us?</i>	452	Roche, W. J.....	134
*What Goes On at a Transatlantic Station? (Carl Dreher).....	464	Ruffo, Titta.....	401
*What Good Is a Patent? (Roger Sherman Hoar).....	458	Satterlee, Dr. Francis L.....	241, 243
<i>When the Barges Broke Loose in New York Har- bor</i>	94	Shearer, Norma.....	57
*When the "Carlos" Sank (A. Henry).....	194	Sleeper, Milton B.....	37
<i>When Winter Comes</i>	179	Squire, Frank M.....	299
Where Radio Is Helping the Phonograph Busi- ness (W. T. Whitehead).....	110	Stires, Dr. Ernest M.....	401
Who will Ultimately Do the Broadcasting? . . .	522	Stratton, Dr. S. W.....	167
*Will Radio Replace the Phonograph? (Win- slow A. Duerr).....	52	Strongwolf, Chief.....	131
Y OUNG America Building His Own (Henry L. Arthur).....	97	Talianoff, David.....	279
		Tannehill, Doris Marie.....	329
		Thayer, H. B.....	425
		Williams, Harriet.....	515
		*Wood, Gov.-Gen. Leonard.....	93
		AUTHORS	
PORTRAITS		Allen, G. Y.....	31, 287, 485
(*Portraits in "The March of Radio")		Arthur, Henry L.....	97
Armstrong, Edwin H.....	226	Barnes, John K.....	516
Barry, Lyman F.....	277	Batcher, Ralph.....	319
Batcheller, Arthur.....	146	Bouck, Zeh.....	14, 103, 246, 321, 344, 416, 494
Bell, Dr. Alexander Graham.....	23, 25	Bourke, Alice R.....	107
Black, F. G.....	57	Brady, John B.....	219
Bucher, Elmer E.....	131	Burrill, Edgar White.....	54
Burghard, George.....	223	Caddell, Alfred M.....	21
Burrill, Edgar White.....	55	Christian, F. W.....	252
Cantor, Eddie.....	237	Cooke, F. Basil.....	215
Coursey, Philip R.....	64	Coursey, Philip R.....	123
Cox, Gov. Channing H.,.....	401	Cronk, P. B.....	235
De Forest, Lee.....	149	Crouse, G. B.....	197
Dellinger, Dr. J. H.....	40	Croy, Homer.....	205
Diehl, W. F.....	57	De Forest, Lee.....	253
*Duncan, R. D. Jr.....	5	Dellinger, Dr. J. H.....	40
Duthernoy, Leon Alfred.....	51	Dreher, Carl.....	464
Fox, Edward.....	243	Duerr, Winslow A.....	52
Godley, Paul F.....	192	Durkee, Charles H.....	472
Hager, Kolin D.....	57	DuJherney, Leon Alfred.....	49
*Harbord, Maj.-Gen. James G.....	358	Easton, William H.....	364
Johnson, E. G.....	515	English, Arthur T.....	125
Johnson, George T.....	131	Ewing, Everett.....	111
McAdams, Mrs. W. E.....	237	Farley, Ralph Milne.....	18
Maclurcan, Charles.....	217	Godley, Paul F.....	191, 330
		Gordon, Ortherus.....	27, 151
		Gow, Harding.....	341
		Gowen, Robert F.....	303, 381
		Henry, A.....	132, 194, 402, 477
		Hoar, Roger Sherman.....	458
		Hogan, John V. L.....	422
		Hooper, Stanford C.....	387

INDEX—Continued

	PAGE		PAGE
Hoover, Herbert C.....	211	Ranger, R. H.....	65, 153, 311
Horine, E. E.....	454	Riley, Phil M.....	58
Jackson, Joseph H.....	72	Risdon, P. J.....	63
Kenner, H. J.....	398	Rush, Philip S.....	201
Kesler, Charles H.....	207, 282, 407	Seager, E. V.....	428
King, R. W.....	187, 425	Seutter, B. G.....	162
Lynch, Arthur H.....	159, 241, 393, 499	Sheehy, Russell.....	336
McKibbin, J. M., Jr.....	238	Shutt, Milo.....	505
M., J. H.....	3, 91, 179, 267, 355, 443	Sleeper, M. B.....	36
Mitchell, Brig.-Gen. William.....	239	Squire, Frank M.....	297
Myers, Frank J.....	509	Standiford, W. S.....	254, 462
O'Connor, D. J.....	414	Stratton, S. W.....	310
O'Shea, Charles J.....	27	Tannehill, I. R.....	326
Peirson, Charles Heston.....	244	Thompson, C. S.....	147
Perry, Armstrong.....	275	Weaver, Roger A.....	375
Peterson, H. L.....	507	Wheeler, W. A.....	212
Porter, G. Harold.....	9	Whitehead, W. T.....	110
Putnam, George R.....	369	Whittemore, L. E.....	145
		Wilhelm, Donald.....	142, 292
		Wood, Mabel Travis.....	406
		Worrell, W. H.....	13



It's Here!



50¢



A Quality Plug at A Popular Price

This plug will do everything that can be expected of any plug at any price.

PACENT
—of course

*Don't improvise
"PACENTIZE"*

The PACENT aim, for over fifteen years, has been to facilitate radio work with plug and jack devices. The PACENT New Universal Plug No. 40 removes the barrier heretofore existing between the user's desire for a quality plug and cost. As with its senior, No. 50 PACENT Universal Plug, this new plug insures a permanent biting contact by its patented method of connection with cord tips. Its remarkably low price enables you to enjoy the convenience of plug connections on every piece of radio equipment—and to keep extra plugs always on hand for emergency use.

Write for Descriptive Bulletins RN4

PACENT ELECTRIC COMPANY
INCORPORATED

Executive Offices: 22 Park Place, New York, N. Y.

BRANCH OFFICES

Philadelphia
Chicago
St. Louis

Washington, D. C.
San Francisco
Minneapolis



*Canadian and British Licensees:
Colonial Radio, Ltd., Hamilton, Can.
Members, Radio Section, Associated
M'rs. of Electrical Supplies*

★ Tested and approved by RADIO BROADCAST ★

REMLER

Cumingham

APPARATUS THAT RADIATES QUALITY

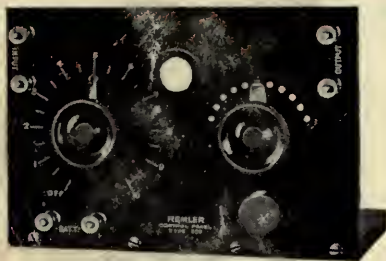

Remler Type 330 Detector Panel. Price \$8.50

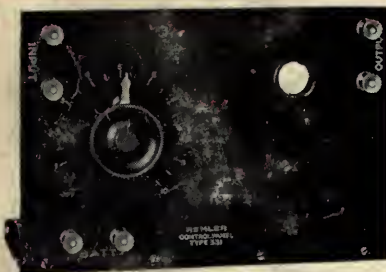

Remler Type 331 Amplifier Panel less transformer Price \$6.00



Remler Type 333 Amplifier Panel less transformer Price \$9.00

THE MOST POPULAR

Panels ★

ON THE MARKET

IN designing these Remler Control Panels, Remler Engineers combined every point necessary for efficient detector and amplifier tube control with special features of construction for the convenience of the user. No process of manufacture that would make these panels efficient in operation and beautiful in appearance has been neglected.

Each panel is a complete unit, mounted on a hardwood base for table use, but so designed that it may be easily mounted in a cabinet. The input and output binding posts are located on opposite sides of the panel at a standard height to facilitate the neat and easy connection of other Remler units.

The 330 Detector Panel contains the Remler Grid Condenser and Variable Grid Leak unit. Also the patented Remler "A" Battery Potentiometer for plate voltage control—an item very necessary for obtaining maximum efficiency from the sensitive gas filled detector tubes.

The 333 Amplifier Panel contains the Remler Rotary Cam Switch which does the work of two jacks and plug in cutting in or out steps of amplification.

All panels are of highly polished black Bakelite and only Remler standard Quality parts are used in the assembling of the unit. All lettering is recessed and filled with a special white enamel that will not discolor or chip out.

NEW REMLER CATALOGUE

Send 10c for new 40 page Remler catalogue just off the press containing circuit diagrams for Remler Apparatus and other useful information, including a table of inductance, capacity and wave length

REMLER RADIO MFG. CO.

FACTORY AND HOME OFFICE
248 FIRST ST. SAN FRANCISCO, CAL.

EASTERN REPRESENTATIVE
154 W. LAKE ST. CHICAGO, ILL.

★ Tested and approved by RADIO BROADCAST ★

THE COUNTRY LIFE PRESS, GARDEN CITY, NEW YORK

